

**UNII Straddle Ch. IEEE 802.11n HT40 mode Output Power and PSD**

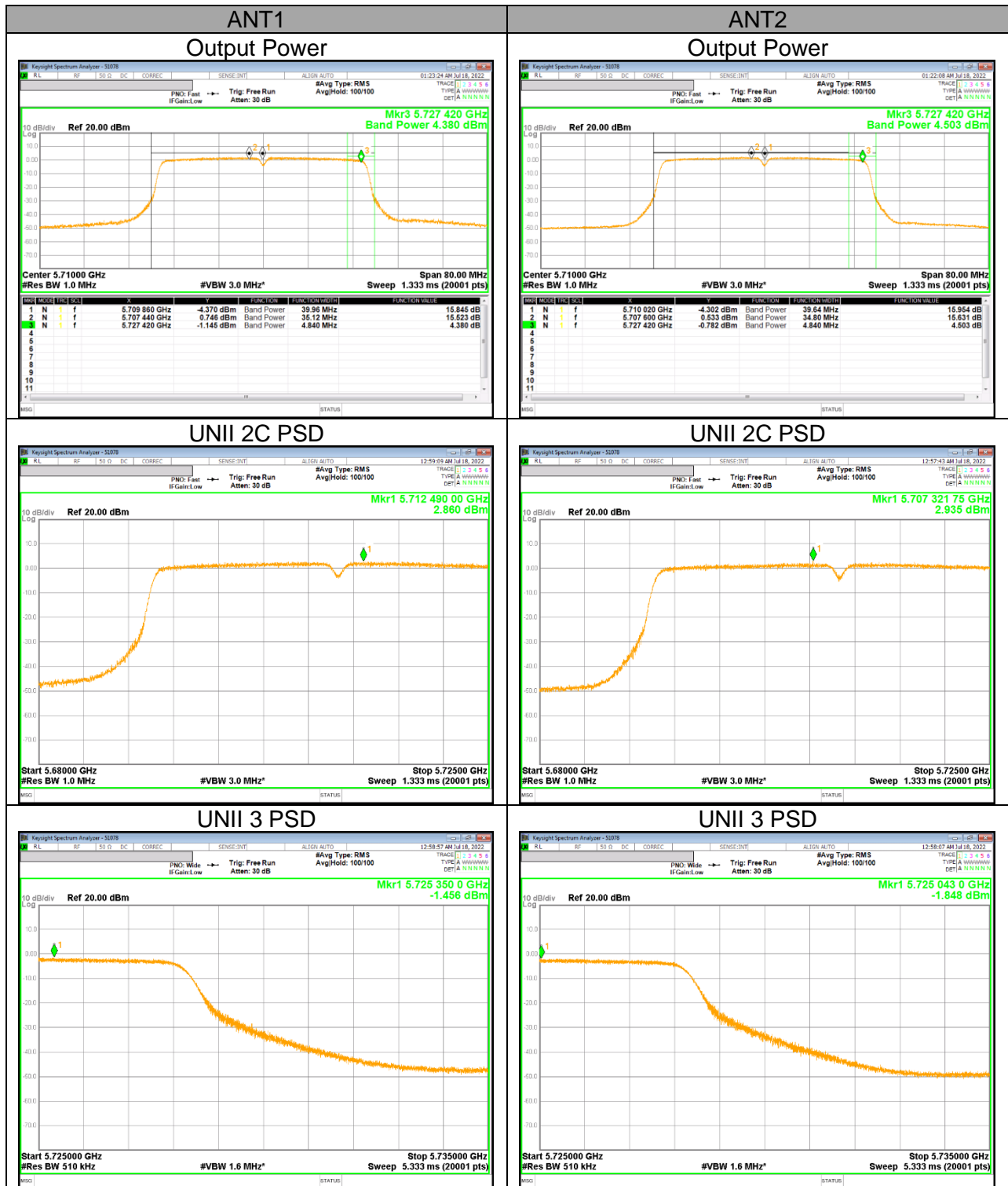

**UNII Straddle Ch. IEEE 802.11ac VHT80 mode Output Power and PSD**

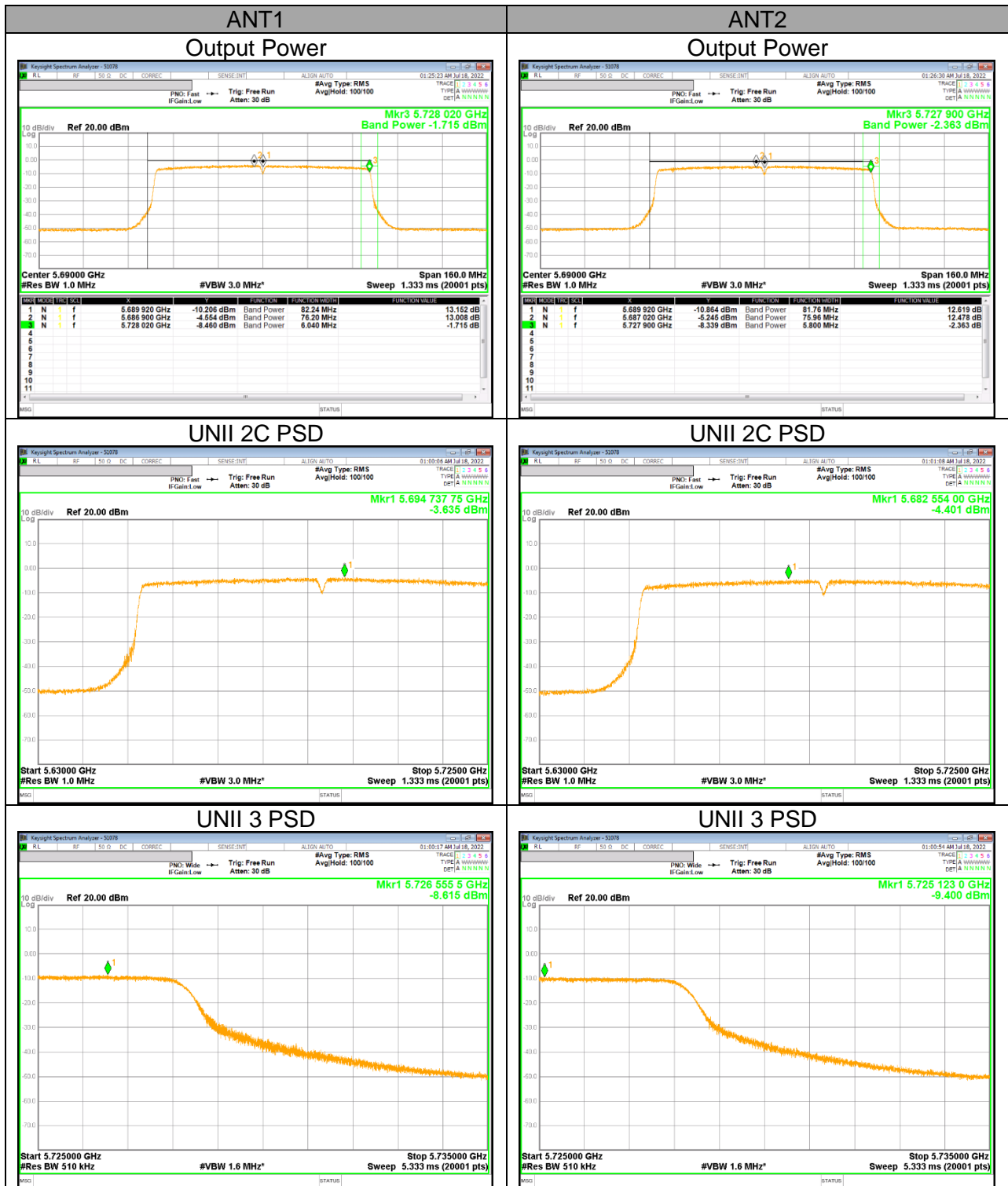

**UNII Straddle Ch. IEEE 802.11ax HE20(SU) mode PSD**

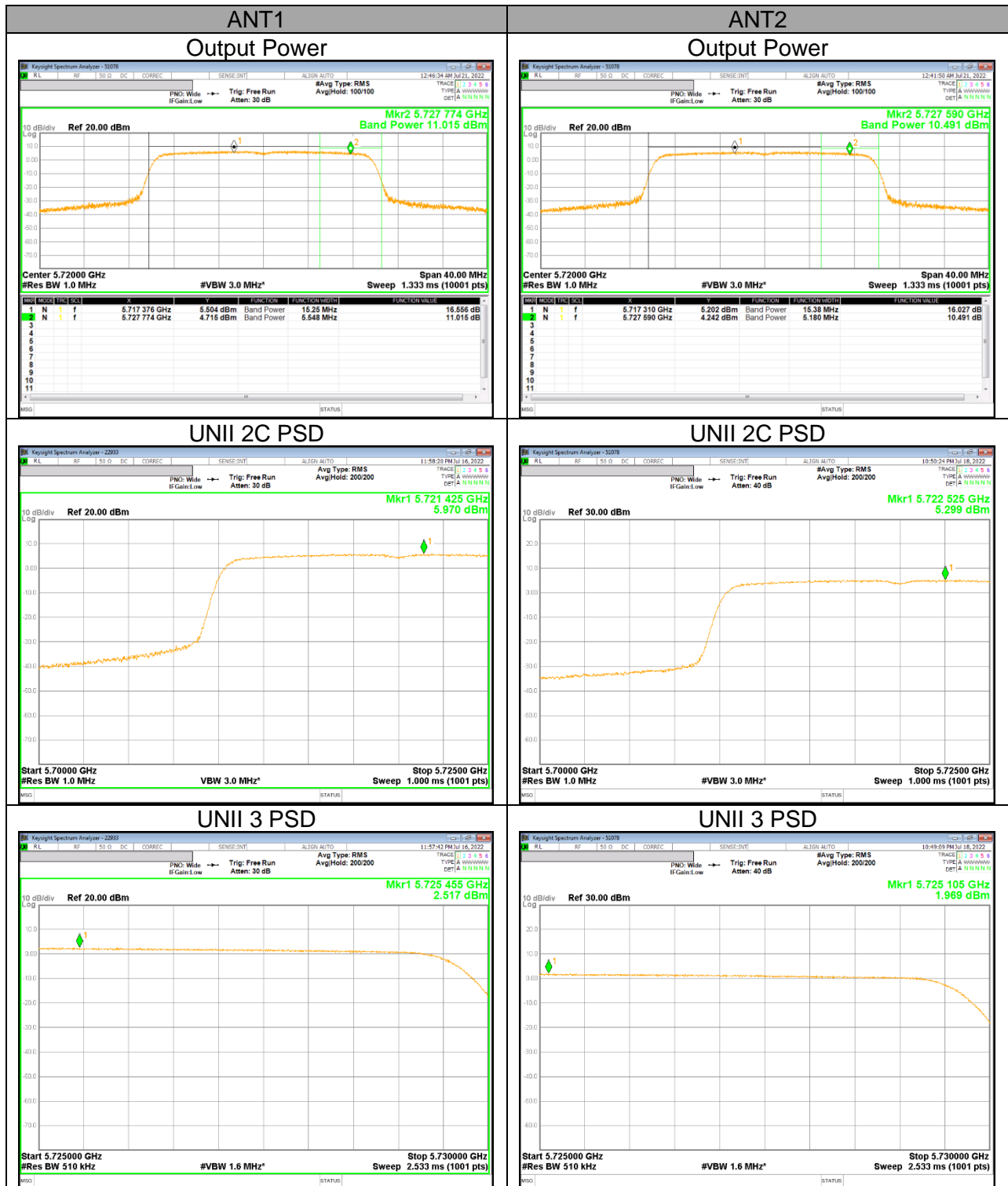

**UNII Straddle Ch. IEEE 802.11ax HE40(SU) mode PSD**

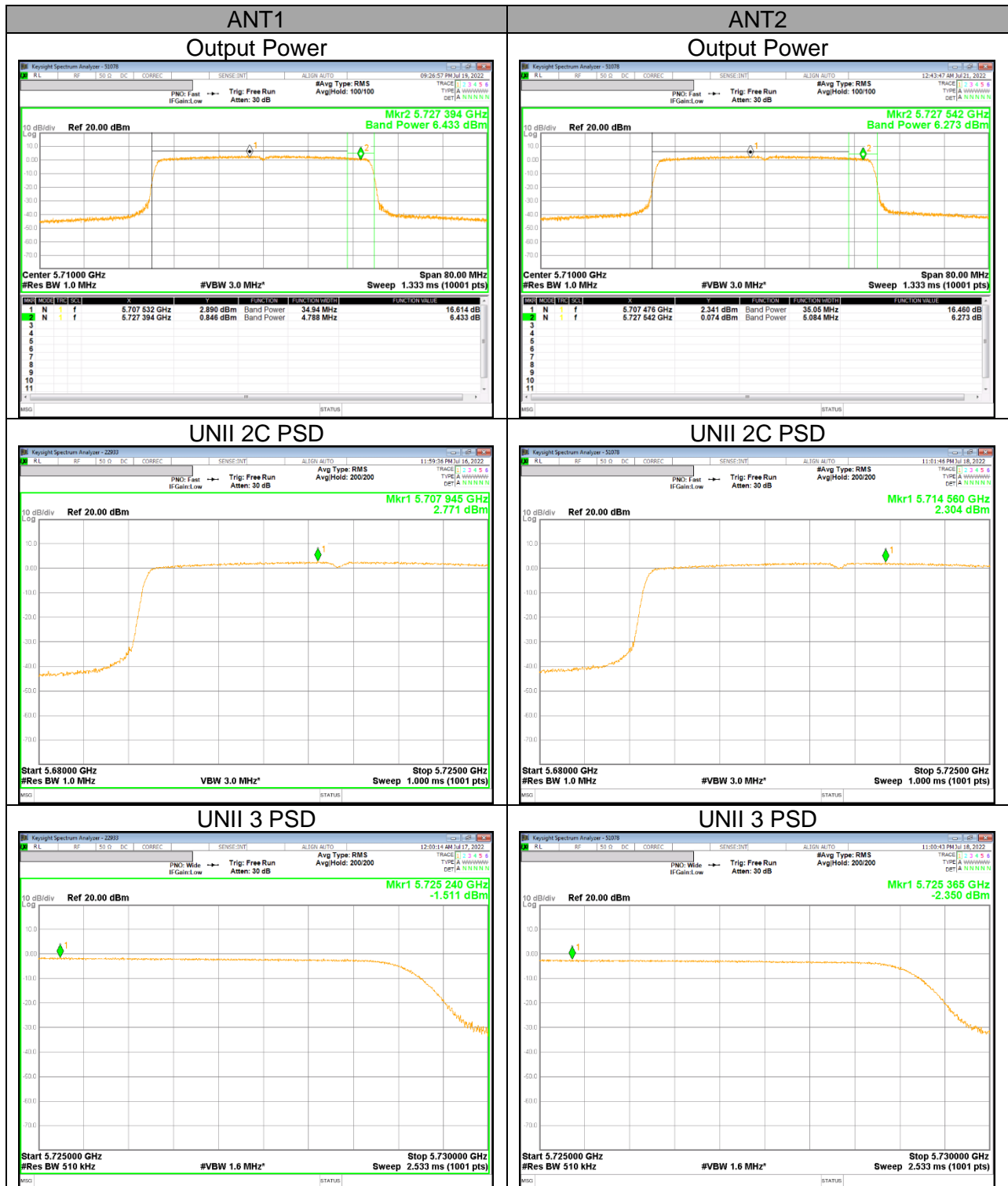

**UNII Straddle Ch. IEEE 802.11ax HE80(SU) mode PSD**

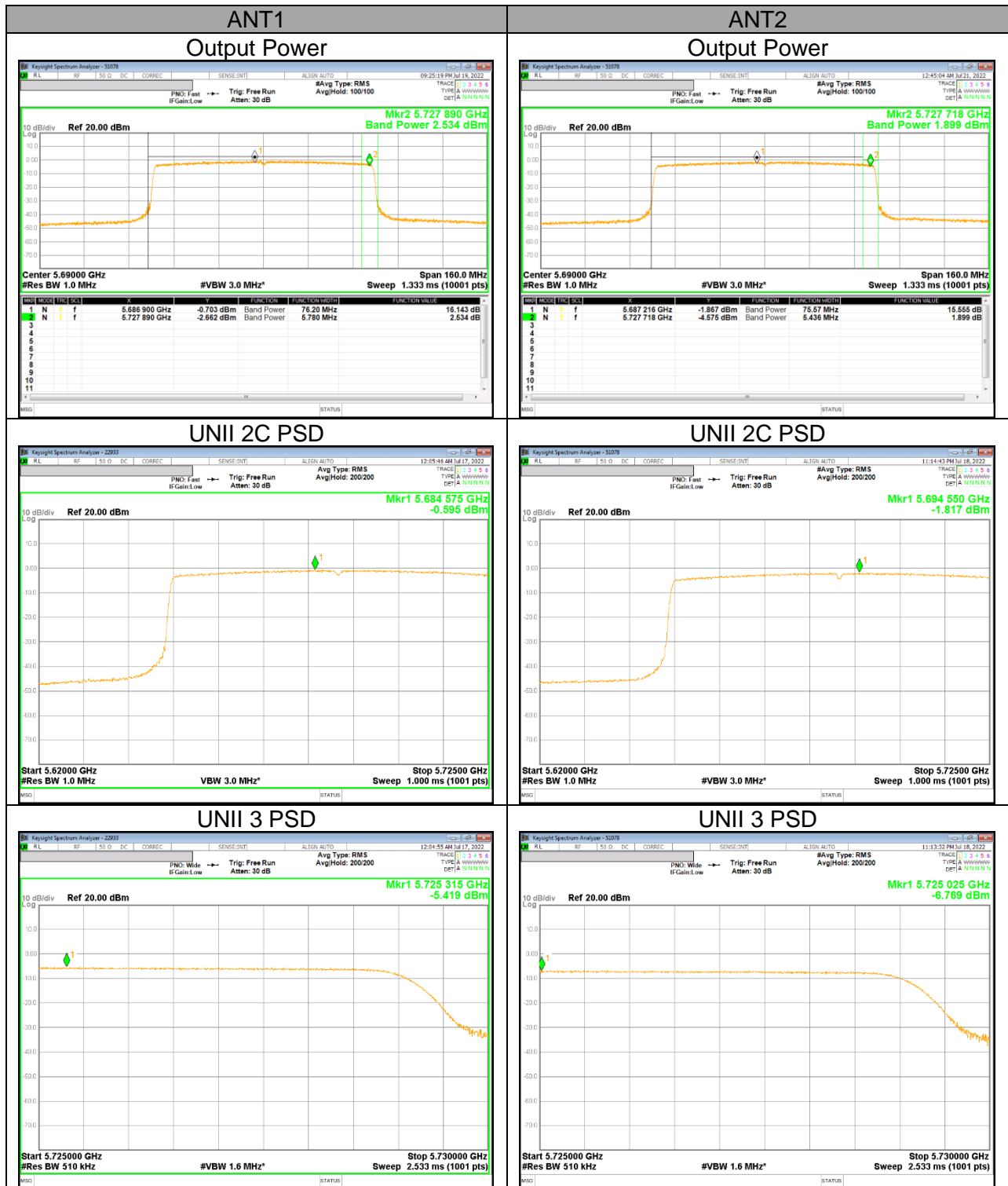

**UNII Straddle Ch. IEEE 802.11ax HE20(6RU) mode PSD**

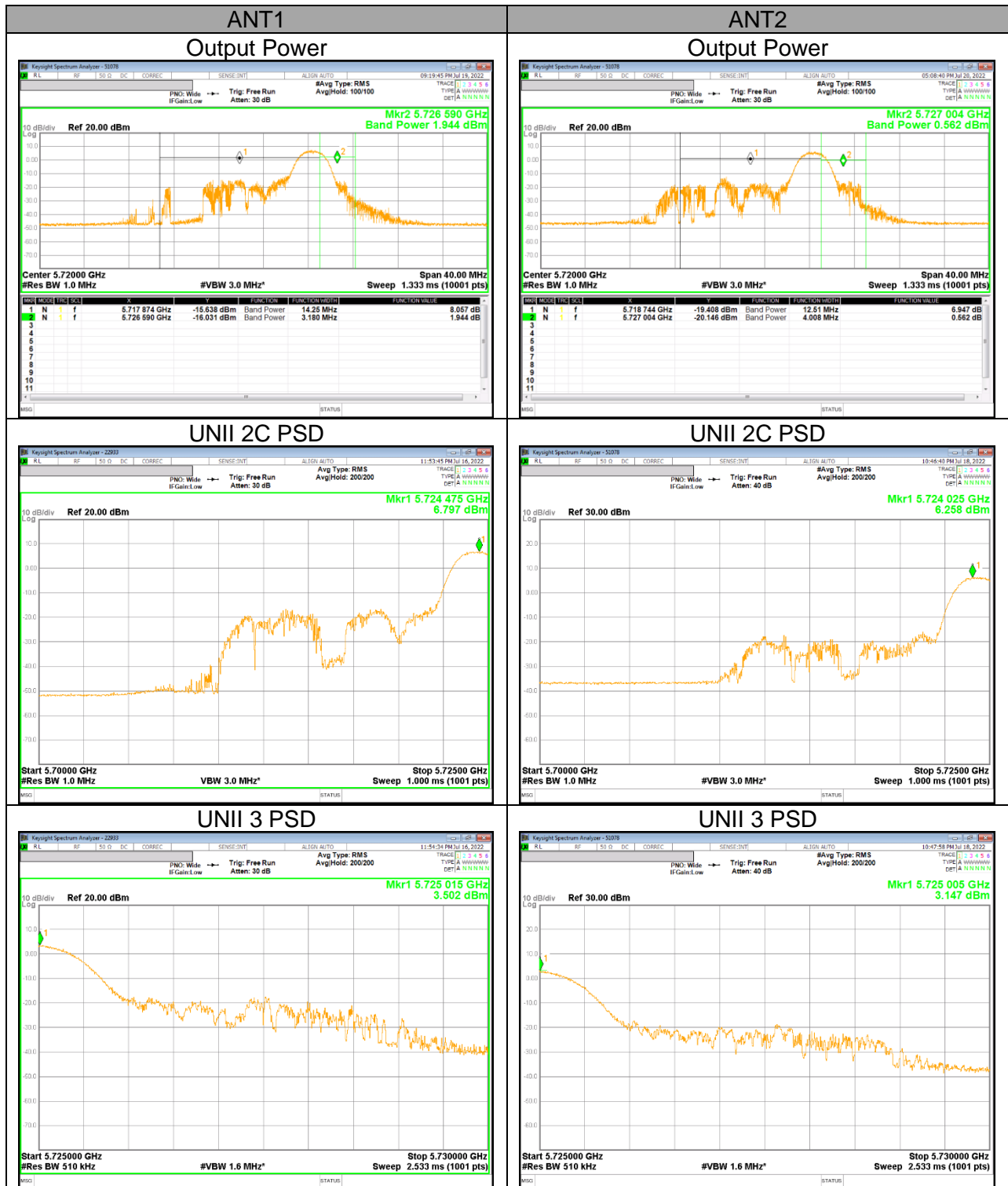

**UNII Straddle Ch. IEEE 802.11ax HE40(15RU) mode PSD**



**UNII Straddle Ch. IEEE 802.11ax HE80(34RU) mode PSD**

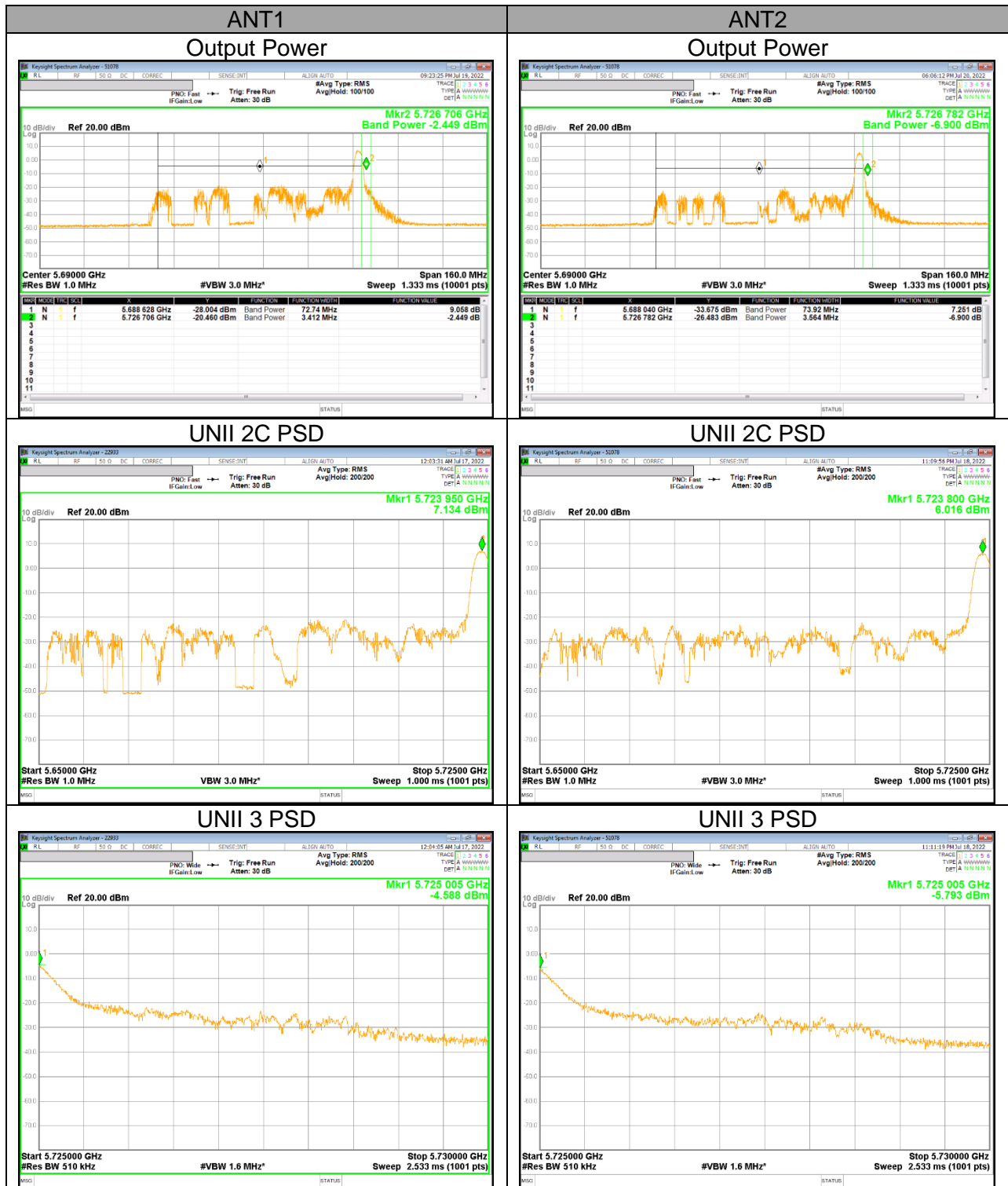



## 11. TRANSMITTER ABOVE 1 GHz

### LIMITS

FCC §15.205 and §15.209

Limits for radiated disturbance of an intentional radiator		
Frequency range (MHz)	Limits (µV/m)	Measurement Distance (m)
0.009 – 0.490	2400 / F (kHz)	300
0.490 – 1.705	24000 / F (kHz)	30
1.705 – 30.0	30	30
30 – 88	100**	3
88 - 216	150**	3
216 – 960	200**	3
Above 960	500	3

\*\* Except as provided in paragraph (g), fundamental emissions from intentional radiators operating under this section shall not be located in the frequency bands 54-72 MHz, 76-88 MHz, 174-216 MHz or 470-806 MHz. However, operation within these frequency bands is permitted under other sections of this part, e.g. §§ 15.231 and 15.241.

FCC Part 15.205 (a) : Only spurious emissions are permitted in any of the frequency bands listed below :

MHz	MHz	MHz	MHz	GHz	GHz
0.009 ~ 0.110	8.41425 ~ 8.41475	108 ~ 121.94	1300 ~ 1427	4.5 ~ 5.15	14.47 ~ 14.5
0.495 ~ 0.505	12.29 ~ 12.293	123 ~ 138	1435 ~ 1626.5	5.35 ~ 5.46	15.35 ~ 16.2
2.1735 ~ 2.1905	12.51975 ~ 12.52025	149.9 ~ 150.05	1645.5 ~ 1646.5	7.25 ~ 7.75	17.7 ~ 21.4
4.125 ~ 4.128	12.57675 ~ 12.57725	156.52475 ~ 156.52525	1660 ~ 1710	8.025 ~ 8.5	22.01 ~ 23.12
4.17725 ~ 4.17775	13.36 ~ 13.41	156.7 ~ 156.9	1718.8 ~ 1722.2	9.0 ~ 9.2	23.6 ~ 24.0
4.20725 ~ 4.20775	16.42 ~ 16.423	162.0125 ~ 167.17	2200 ~ 2300	9.3 ~ 9.5	31.2 ~ 31.8
6.215 ~ 6.218	16.69475 ~ 16.69525	167.72 ~ 173.2	2310 ~ 2390	10.6 ~ 12.7	36.43 ~ 36.5
6.26775 ~ 6.26825	16.80425 ~ 16.80475	240 ~ 285	2483.5 ~ 2500	13.25 ~ 13.4	Above 38.6
6.31175 ~ 6.31225	25.5 ~ 25.67	322 ~ 335.4	2655 ~ 2900		
8.291 ~ 8.294	37.5 ~ 38.25	399.90 ~ 410	3260 ~ 3267		
8.362 ~ 8.366	73 ~ 74.6	608 ~ 614	3332 ~ 3339		
8.37625 ~ 8.38675	74.8 ~ 75.2	960 ~ 1240	3345.8 ~ 3358 3600 ~ 4400		

▪ FCC Part 15.205(b) : The field strength of emissions appearing within these frequency bands shall not exceed the limits shown in §15.209. At frequencies equal to or less than 1000 MHz, compliance with the limits in §15.209 shall be demonstrated using measurement instrumentation employing a CISPR quasi-peak detector. Above 1000 MHz, compliance with the emission limits in §15.209 shall be demonstrated based on the average value of the measured emissions. The provisions in §15.35 apply to these measurements.

**FCC §15.407 (b)**

(b) Undesirable emission limits. Except as shown in paragraph (b)(7) of this section, the maximum emissions outside of the frequency bands of operation shall be attenuated in accordance with the following limits:

- (1) For transmitters operating in the 5.15-5.25 GHz band: All emissions outside of the 5.15-5.35 GHz band shall not exceed an e.i.r.p. of -27 dBm/MHz.
- (2) For transmitters operating in the 5.25-5.35 GHz band: All emissions outside of the 5.15-5.35 GHz band shall not exceed an e.i.r.p. of -27 dBm/MHz.
- (3) For transmitters operating in the 5.47-5.725 GHz band: All emissions outside of the 5.47-5.725 GHz band shall not exceed an e.i.r.p. of -27 dBm/MHz.
- (4) For transmitters operating solely in the 5.850-5.895 GHz band or operating on a channel that spans across 5.725-5.895 GHz:

(iii) For a client device or indoor access point or subordinate device, all emissions below 5.725 GHz shall not exceed an e.i.r.p. of -27 dBm/MHz at 5.65 GHz increasing linearly to 10 dBm/MHz at 5.7 GHz, and from 5.7 GHz increasing linearly to a level of 15.6 dBm/MHz at 5.72 GHz, and from 5.72 GHz increasing linearly to a level of 27 dBm/MHz at 5.725 GHz

- (5) The emission measurements shall be performed using a minimum resolution bandwidth of 1 MHz. A lower resolution bandwidth may be employed near the band edge, when necessary,  
provided the measured energy is integrated to show the total power over 1 MHz.
- (6) Unwanted emissions below 1 GHz must comply with the general field strength limits set forth in §15.209. Further, any U-NII devices using an AC power line are required to comply also with the conducted limits set forth in §15.207.
- (7) The provisions of §15.205 apply to intentional radiators operating under this section.
- (8) When measuring the emission limits, the nominal carrier frequency shall be adjusted as close to the upper and lower frequency band edges as the design of the equipment permits.

**Note**

- Limit translation to field strength level (FCC §15.407)

$$E[\text{dBuV/m}] = \text{EIRP}[\text{dBm}] + 95.2 = -27\text{dBm} + 95.2 = 68.2\text{dBuV/m}$$

$$E[\text{dBuV/m}] = \text{EIRP}[\text{dBm}] + 95.2 = -17\text{dBm} + 95.2 = 78.2\text{dBuV/m}$$

## **TEST PROCEDURE**

The EUT is placed on a non-conducting table 80 cm above the ground plane for below 1GHz and 100 cm for above 1GHz. The antenna to EUT distance is 3 meters. The EUT is configured in accordance with ANSI C63.10. The EUT is set to transmit in a continuous mode.

For measurements below 1 GHz the resolution bandwidth is set to 100 kHz for peak detection measurements or 120 kHz for quasi-peak detection measurements. Peak detection is used unless otherwise noted as quasi-peak.

Reference to KDB 789033 D02 v02r01 UNII part G) 6) c) Method AD:

For measurements above 1 GHz the resolution bandwidth is set to 1 MHz; the video bandwidth is set to 3 MHz for peak measurements and add duty cycle factor to the reading offset for average measurements.

Pre-scans to detect harmonic and spurious emissions, the resolution bandwidth is set to 1 MHz; the video bandwidth is set to 30 kHz for peak measurements.

The spectrum from 1GHz to 40 GHz is investigated with the transmitter set to the lowest, middle, and highest channels in each applicable band.  
(From 30MHz to 1GHz, test was performed with the EUT set to transmit at the channel with highest output power)

The frequency range of interest is monitored at a fixed antenna height and EUT azimuth. The EUT is rotated through 360 degrees to maximize emissions received. The antenna is scanned from 1 to 4 meters above the ground plane to further maximize the emission. Measurements are made with the antenna polarized in both the vertical and the horizontal positions.

Note : Emission was pre-scanned from 9kHz to 30MHz; No emissions were detected which was at least 20dB below the specification limit (consider distance correction factor).  
Per FCC part 15.31(o), test results were not reported.

Although these tests were performed other than open field test site, adequate comparison measurements were confirmed against 30 m open are test site.  
Therefore sufficient tests were made to demonstrate that the alternative site produces results that correlate with the one of tests made in an open field based on KDB 414788.

# 11.1. TX ABOVE 1GHz 2Tx MODE IN THE 5.2GHz BAND

## BANDEDGE (WORST CASE: 802.11ax HE80 / 5210 MHz)

### HORIZONTAL PEAK AND AVERAGE DATA

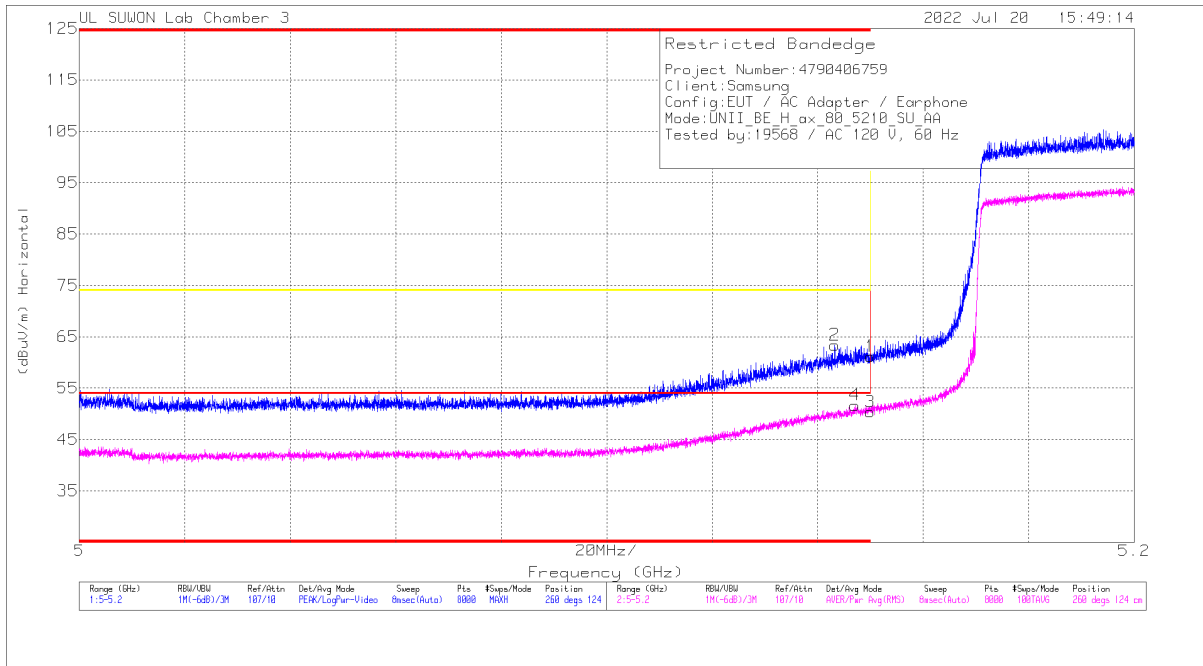

### Trace Markers

Marker	Frequency (GHz)	Meter Reading (dBuV)	Det	3117_00218957	10dB_ATT[dB]	DC Corr (dB)	Corrected Reading (dBuV/m)	Average Limit (dBuV/m)	Margin (dB)	Peak Limit (dBuV/m)	PK Margin (dB)	Acimuth (Degs)	Height (cm)	Polarity
1	* 5.14999	46.97	Pk	34.8	-20.6	0	61.17	-	-	74	-12.83	260	124	H
2	* 5.14322	49.2	Pk	34.8	-20.6	0	63.4	-	-	74	-10.6	260	124	H
3	* 5.14999	36.21	RMS	34.8	-20.6	0	50.41	54	-3.59	-	-	260	124	H
4	* 5.14704	37.46	RMS	34.8	-20.6	0	51.68	54	-2.32	-	-	260	124	H

\* - indicates frequency in CFR47 Pt 15 / IC RSS-Restricted Band

Pk - Peak detector

RMS - RMS detection

**BANDEDGE TEST DATA**

Mode	Freq. [MHz]	Antenna	Frequency [GHz]	Reading [dBuV]	Detector Mode	ANT Factor	Loss [dB]	DC Corr [dB]	Result [dBuV/m]	AV Limit [dBuV/m]	AV Margin [dB]	PK Limit [dBuV/m]	PK Margin [dB]	Azimuth [Degs]	Height [cm]	Polarity	
802.11a	5180	MIMO	* 5.14999	40.52	Pk	34.80	-20.60	0.00	54.72	-	-	74.00	-19.28	259	101	H	
			* 5.14922	42.05	Pk	34.80	-20.60	0.00	56.25	-	-	74.00	-17.75	259	101	H	
			* 5.14999	30.01	RMS	34.80	-20.60	0.15	44.36	54.00	-9.64	-	-	259	101	H	
			* 5.14949	30.22	RMS	34.80	-20.60	0.15	44.57	54.00	-9.43	-	-	259	101	H	
			* 5.14999	39.03	Pk	34.80	-20.60	0.00	53.23	-	-	-	74.00	-20.77	150	357	V
			* 5.14992	40.52	Pk	34.80	-20.60	0.00	54.72	-	-	-	74.00	-19.28	150	357	V
			* 5.14999	28.34	RMS	34.80	-20.60	0.15	42.69	54.00	-11.31	-	-	150	357	V	
802.11n (HT20)	5180	MIMO	* 5.00393	29.49	RMS	34.70	-20.60	0.15	43.74	54.00	-10.26	-	-	150	357	V	
			* 5.14999	38.51	Pk	34.80	-20.60	0.00	52.71	-	-	74.00	-21.29	260	115	H	
			* 5.00038	40.65	Pk	34.70	-20.60	0.00	54.75	-	-	74.00	-19.25	260	115	H	
			* 5.14999	28.41	RMS	34.80	-20.60	0.00	42.61	54.00	-11.39	-	-	260	115	H	
			* 5.00057	29.62	RMS	34.70	-20.70	0.00	43.62	54.00	-10.38	-	-	260	115	H	
			* 5.14999	36.85	Pk	34.80	-20.60	0.00	51.05	-	-	74.00	-22.95	19	100	V	
			* 5.00228	40.58	Pk	34.70	-20.60	0.00	54.68	-	-	74.00	-19.32	19	100	V	
802.11n (HT40)	5190	MIMO	* 5.14999	27.43	RMS	34.80	-20.60	0.00	41.63	54.00	-12.37	-	-	19	100	V	
			* 5.00603	29.48	RMS	34.70	-20.70	0.00	43.48	54.00	-10.52	-	-	19	100	V	
			* 5.14999	47.29	Pk	34.80	-20.60	0.00	61.49	-	-	74.00	-12.51	259	124	H	
			* 5.14929	49.66	Pk	34.80	-20.60	0.00	63.86	-	-	74.00	-10.14	259	124	H	
			* 5.14999	36.22	RMS	34.80	-20.60	0.00	50.42	54.00	-3.58	-	-	259	124	H	
			* 5.14942	36.40	RMS	34.80	-20.60	0.00	50.60	54.00	-3.40	-	-	259	124	H	
			* 5.14999	38.25	Pk	34.80	-20.60	0.00	52.45	-	-	74.00	-21.55	260	116	V	
802.11ac (VHT80)	5210	MIMO	* 5.14894	40.16	Pk	34.80	-20.60	0.00	54.36	-	-	74.00	-19.64	260	116	V	
			* 5.14999	28.58	RMS	34.80	-20.60	0.00	42.78	54.00	-11.22	-	-	260	116	V	
			* 5.14869	29.50	RMS	34.80	-20.60	0.00	43.70	54.00	-10.30	-	-	260	116	V	
			* 5.14999	41.42	Pk	34.80	-20.60	0.00	55.62	-	-	74.00	-18.38	244	105	H	
			* 5.14477	43.16	Pk	34.80	-20.60	0.00	57.36	-	-	74.00	-16.64	244	105	H	
			* 5.14999	31.16	RMS	34.80	-20.60	0.24	45.60	54.00	-8.40	-	-	244	105	H	
			* 5.14767	32.05	RMS	34.80	-20.60	0.24	46.49	54.00	-7.51	-	-	244	105	H	
802.11ax (HE20)	5180	MIMO	* 5.14999	38.03	Pk	34.80	-20.60	0.00	52.23	-	-	74.00	-21.77	150	376	V	
			* 5.14709	40.40	Pk	34.80	-20.60	0.00	54.60	-	-	74.00	-19.40	150	376	V	
			* 5.14999	28.85	RMS	34.80	-20.60	0.24	43.29	54.00	-10.71	-	-	150	376	V	
			* 5.13934	29.08	RMS	34.80	-20.60	0.24	43.52	54.00	-10.48	-	-	150	376	V	
			* 5.14999	39.41	Pk	34.80	-20.60	0.00	53.61	-	-	74.00	-20.39	266	129	H	
			* 5.14899	42.01	Pk	34.80	-20.60	0.00	56.21	-	-	74.00	-17.79	266	129	H	
			* 5.14999	28.08	RMS	34.80	-20.60	0.00	42.28	54.00	-11.72	-	-	266	129	H	
802.11ax (HE40)	5190	MIMO	* 5.00036	29.94	RMS	34.70	-20.60	0.00	44.04	54.00	-9.96	-	-	266	129	H	
			* 5.14999	38.50	Pk	34.80	-20.60	0.00	52.70	-	-	74.00	-21.30	174	283	V	
			* 5.01758	40.97	Pk	34.70	-20.60	0.00	55.07	-	-	74.00	-18.93	174	283	V	
			* 5.14999	28.61	RMS	34.80	-20.60	0.00	42.81	54.00	-11.19	-	-	174	283	V	
			* 5.00018	29.72	RMS	34.70	-20.60	0.00	43.82	54.00	-10.18	-	-	174	283	V	
			* 5.14999	47.74	Pk	34.80	-20.60	0.00	61.94	-	-	74.00	-12.06	256	101	H	
			* 5.14902	50.97	Pk	34.80	-20.60	0.00	65.17	-	-	74.00	-8.83	256	101	H	
802.11ax (HE80)	5210	MIMO	* 5.14999	36.97	RMS	34.80	-20.60	0.00	51.17	54.00	-2.83	-	-	256	100	H	
			* 5.14969	37.37	RMS	34.80	-20.60	0.00	51.57	54.00	-2.43	-	-	256	100	H	
			* 5.14999	41.44	Pk	34.80	-20.60	0.00	55.64	-	-	74.00	-18.36	153	377	V	
			* 5.14869	43.79	Pk	34.80	-20.60	0.00	57.99	-	-	74.00	-16.01	153	377	V	
			* 5.14999	30.81	RMS	34.80	-20.60	0.00	45.01	54.00	-8.99	-	-	153	377	V	
			* 5.14982	32.09	RMS	34.80	-20.60	0.00	46.29	54.00	-7.71	-	-	153	377	V	
			* 5.14999	46.97	Pk	34.80	-20.60	0.00	61.17	-	-	74.00	-12.83	260	124	H	
802.11ax (HE80)	5210	MIMO	* 5.14322	49.20	Pk	34.80	-20.60	0.00	63.40	-	-	74.00	-10.60	260	124	H	
			* 5.14999	36.21	RMS	34.80	-20.60	0.00	50.41	54.00	-3.59	-	-	260	124	H	
			* 5.14704	37.48	RMS	34.80	-20.60	0.00	51.68	54.00	-2.32	-	-	260	124	H	
			* 5.14999	40.78	Pk	34.80	-20.60	0.00	54.98	-	-	74.00	-19.02	150	377	V	
			* 5.14769	42.16	Pk	34.80	-20.60	0.00	56.36	-	-	74.00	-17.64	150	377	V	
			* 5.14999	31.24	RMS	34.80	-20.60	0.00	45.44	54.00	-8.56	-	-	150	377	V	
			* 5.14949	31.28	RMS	34.80	-20.60	0.00	45.48	54.00	-8.52	-	-	150	377	V	

Note1. Pk - Peak detector, RMS - RMS detector  
 Note2. \* - indicates frequency in CFR47 Pt 15 / IC RSS-Restricted Band

**HARMONICS AND SPURIOUS EMISSIONS(WORST CASE: 802.11a / 5180 MHz)**  
**5180 MHz HORIZONTAL**

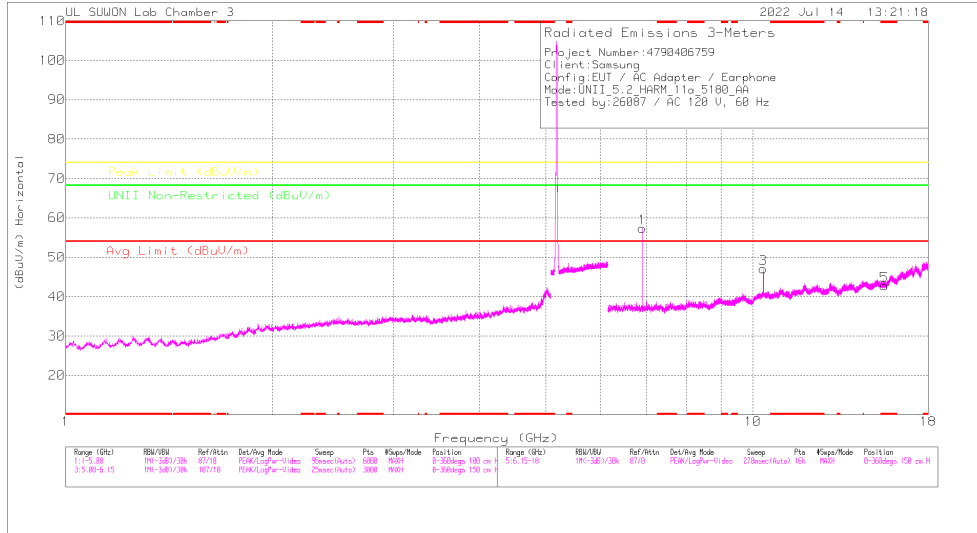

**5180 MHz VERTICAL**

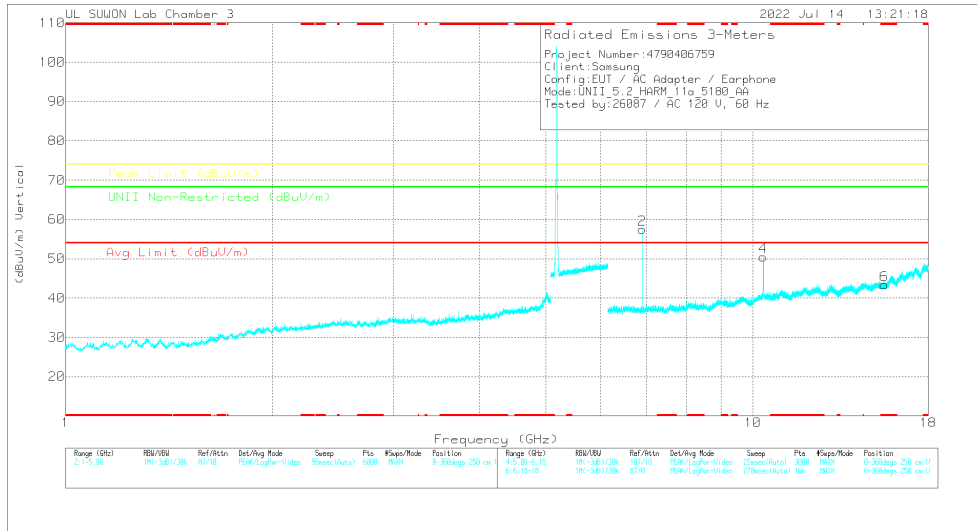

Note: Emission was scanned up to 40GHz; No emissions were detected above the noise floor which was at least 20dB below the specification limit.

**5180 MHz DATA**

**Radiated Emissions**

Frequency (GHz)	Meas Reading (dBuV)	Det	317_0021867	60Hz HF[dB]	DC Corr (dB)	Concord Reading (dBuV/m)	Avg Limit (dBuV/m)	Margin (dB)	Peak Limit (dBuV/m)	Margin (dB)	UNII Non-Restricted (dBuV/m)	Margin (dB)	Asmth (Degs)	Height (cm)	Polarity
6.90661	49.71	PK-U	36.2	-26.5	0	59.41	-	-	-	-	68.2	-8.79	359	112	H
6.90661	48.65	PK-U	36.2	-26.5	0	58.35	-	-	-	-	68.2	-9.85	42	100	V
10.36151	40.95	PK-U	38.1	-21	0	59.05	-	-	-	-	68.2	-10.15	237	103	H
10.36155	43.27	PK-U	38.1	-21	0	60.37	-	-	-	-	68.2	-7.83	79	103	V
* 15.53587	33.86	PK-U	40.2	-21.4	0	52.66	-	-	74	-21.34	-	-	360	100	H
* 15.53339	34.04	PK-U	40.2	-21.4	0	52.84	-	-	74	-21.16	-	-	0	100	V

\* - indicates frequency in CFR47 Pt 15 / IC RSS-Restricted Band  
 PK-U - U-NII: Maximum Peak

**HARMONICS AND SPURIOUS EMISSIONS TEST DATA**

Mode	Freq. [MHz]	Antenna	Frequency [GHz]	Reading [dBuV]	Detector Mode	ANT Factor	Loss [dB]	DC Corr [dB]	Result [dBuV/m]	AV Limit [dBuV/m]	AV Margin [dB]	PK Limit [dBuV/m]	PK Margin [dB]	Non-Restricted [dBuV/m]	Margin [dB]	Azimuth [Degs]	Height [cm]	Polarity
802.11a	5180	MIMO	6.907	49.71	PK-U	36.20	-26.50	0.00	59.41	-	-	-	-	68.20	-9.79	359	112	H
			6.907	48.65	PK-U	36.20	-26.50	0.00	58.35	-	-	-	-	68.20	-9.85	42	100	V
			10.362	40.95	PK-U	38.10	-21.00	0.00	58.05	-	-	-	-	68.20	-10.15	237	103	H
			10.362	43.27	PK-U	38.10	-21.00	0.00	60.37	-	-	-	-	68.20	-7.83	79	103	V
			* 15.53587	33.86	PK-U	40.20	-21.40	0.00	52.66	-	-	74.00	-21.34	-	-	-	360	100
	* 15.5339	34.04	PK-U	40.20	-21.40	0.00	52.84	-	-	74.00	-21.16	-	-	-	0	100	V	
	5200	MIMO	6.933	49.25	PK-U	36.20	-26.40	0.00	59.05	-	-	-	-	68.20	-9.15	360	102	H
			6.933	49.08	PK-U	36.20	-26.40	0.00	58.88	-	-	-	-	68.20	-9.32	86	105	V
			10.401	40.97	PK-U	38.10	-21.10	0.00	57.97	-	-	-	-	68.20	-10.23	236	101	H
			10.401	42.42	PK-U	38.10	-21.10	0.00	59.42	-	-	-	-	68.20	-8.78	83	105	V
			* 15.59863	33.90	PK-U	40.30	-21.20	0.00	53.00	-	-	74.00	-21.00	-	-	-	360	100
	* 15.59551	33.67	PK-U	40.30	-21.20	0.00	52.77	-	-	74.00	-21.23	-	-	-	0	100	V	
	5240	MIMO	6.987	48.20	PK-U	36.20	-26.00	0.00	58.40	-	-	-	-	68.20	-9.80	341	130	H
			6.987	47.91	PK-U	36.20	-26.00	0.00	58.11	-	-	-	-	68.20	-10.09	85	103	V
			10.482	39.62	PK-U	38.20	-21.20	0.00	56.62	-	-	-	-	68.20	-11.58	235	100	H
10.485			42.42	PK-U	38.20	-21.20	0.00	59.42	-	-	-	-	68.20	-8.78	326	103	V	
* 15.72673			33.86	PK-U	40.50	-20.90	0.00	53.46	-	-	74.00	-20.54	-	-	-	360	100	H
* 15.72591	33.89	PK-U	40.50	-20.90	0.00	53.49	-	-	74.00	-20.51	-	-	-	360	100	V		
802.11ax (HE20) 4RU Spot-Check	5180	MIMO	6.907	49.31	PK-U	36.20	-26.50	0.00	59.01	-	-	-	-	68.20	-9.19	357	141	H
			6.906	48.71	PK-U	36.20	-26.50	0.00	58.41	-	-	-	-	68.20	-9.79	79	105	V
			10.358	39.27	PK-U	38.10	-21.00	0.00	56.37	-	-	-	-	68.20	-11.83	79	100	H
			10.360	41.27	PK-U	38.10	-21.00	0.00	58.37	-	-	-	-	68.20	-9.83	284	116	V
			* 15.54023	26.53	PK-U	40.20	-21.40	0.00	45.33	-	-	74.00	-28.67	-	-	-	360	100
* 15.54182	34.77	PK-U	40.20	-21.40	0.00	53.57	-	-	74.00	-20.43	-	-	-	0	100	V		
802.11ax (HE40) 9RU Spot-Check	5190	MIMO	6.920	49.07	PK-U	36.20	-26.50	0.00	58.77	-	-	-	-	68.20	-9.43	356	128	H
			6.920	48.68	PK-U	36.20	-26.50	0.00	58.38	-	-	-	-	68.20	-9.82	81	101	V
			10.383	39.85	PK-U	38.10	-20.90	0.00	57.05	-	-	-	-	68.20	-11.15	80	100	H
			10.382	41.44	PK-U	38.10	-20.90	0.00	58.64	-	-	-	-	68.20	-9.56	304	101	V
			* 15.5765	33.79	PK-U	40.30	-21.40	0.00	52.69	-	-	74.00	-21.31	-	-	-	0	100
* 15.5794	34.76	PK-U	40.30	-21.40	0.00	53.66	-	-	74.00	-20.34	-	-	-	0	100	V		
802.11ax (HE80) 0RU Spot-Check	5210	MIMO	6.947	48.91	PK-U	36.20	-26.30	0.00	58.81	-	-	-	-	68.20	-9.39	356	119	H
			6.947	48.55	PK-U	36.20	-26.30	0.00	58.45	-	-	-	-	68.20	-9.75	39	107	V
			10.344	39.34	PK-U	38.00	-21.10	0.00	56.24	-	-	-	-	68.20	-11.96	80	100	H
			10.344	41.08	PK-U	38.00	-21.10	0.00	57.98	-	-	-	-	68.20	-10.22	287	101	V
			* 15.63059	25.06	PK-U	40.40	-21.10	0.00	44.36	-	-	74.00	-29.64	-	-	-	360	100
* 15.63799	33.36	PK-U	40.40	-21.20	0.00	52.56	-	-	74.00	-21.44	-	-	-	0	100	V		

Note1. PK-U - U-NII: Maximum Peak  
 Note2. \* - indicates frequency in CFR47 Pt 15 / IC RSS-Restricted Band

## 11.2. TX ABOVE 1GHz 2Tx MODE IN THE 5.3GHz BAND

### BANDEDGE (WORST CASE: 802.11ax HE40 / 5310 MHz)

#### HORIZONTAL PEAK AND AVERAGE DATA

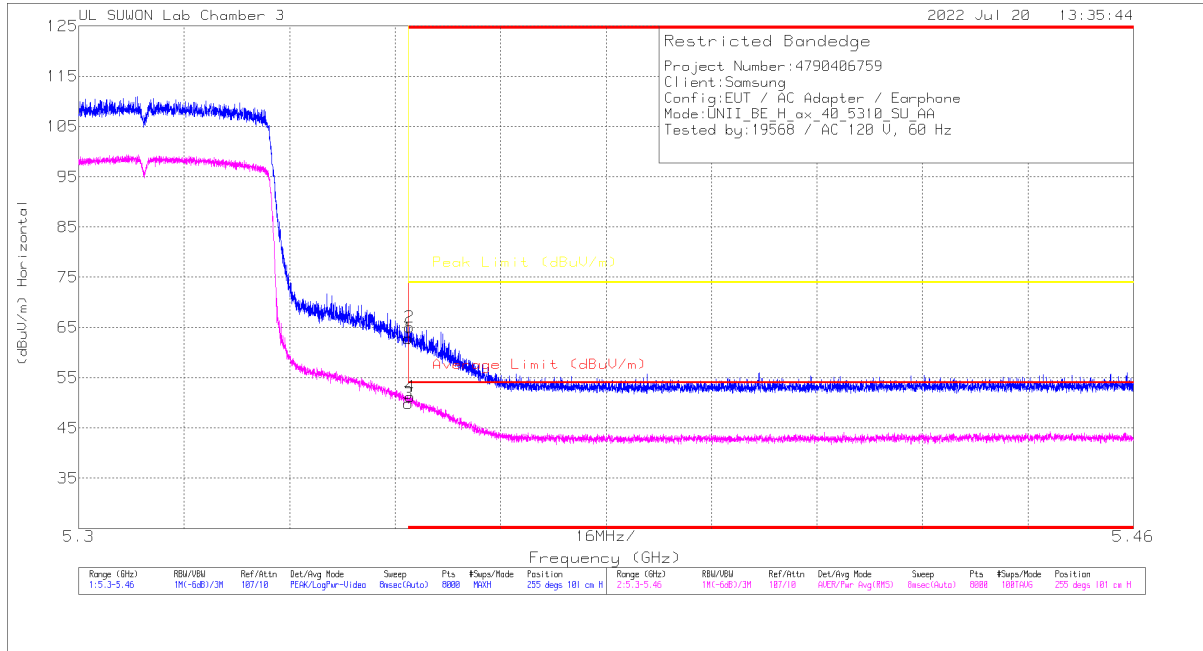

#### Trace Markers

Marker	Frequency (GHz)	Meter Reading (dBuU)	Det	3117_00218957	10dB_ATT[dB]	DC Cor (dB)	Corrected Reading (dBuU/m)	Average Limit (dBuU/m)	Margin (dB)	Peak Limit (dBuU/m)	PK Margin (dB)	Azimuth (Degs)	Height (cm)	Polarity
1	* 5.35001	47.95	Pk	35.1	-20.2	0	62.95	-	-	74	-11.15	255	101	H
2	* 5.35021	50.16	Pk	35.1	-20.2	0	65.06	-	-	74	-8.94	255	101	H
3	* 5.35001	35.04	RMS	35.1	-20.2	0	49.94	54	-4.06	-	-	255	101	H
4	* 5.35025	36.4	RMS	35.1	-20.2	0	51.3	54	-2.7	-	-	255	101	H

\* - indicates frequency in CFR47 Pt 15 / IC RSS-Restricted Band

Pk - Peak detector

RMS - RMS detection



**BANDEDGE TEST DATA**

Mode	Freq. [MHz]	Antenna	Frequency [GHz]	Reading [dBuV]	Detector Mode	ANT Factor	Loss [dB]	DC Corr [dB]	Result [dBuV/m]	AV Limit [dBuV/m]	AV Margin [dB]	PK Limit [dBuV/m]	PK Margin [dB]	Azimuth [Degs]	Height [cm]	Polarity
802.11a	5320	MIMO	* 5.35001	40.62	Pk	35.10	-20.20	0.00	55.52	-	-	74.00	-18.48	258	111	H
			* 5.35009	41.90	Pk	35.10	-20.20	0.00	56.80	-	-	74.00	-17.20	258	111	H
			* 5.35001	28.49	RMS	35.10	-20.20	0.15	43.54	54.00	-10.46	-	-	258	111	H
			* 5.35343	29.78	RMS	35.10	-20.20	0.15	44.83	54.00	-9.17	-	-	258	111	H
			* 5.35001	38.19	Pk	35.10	-20.20	0.00	53.09	-	-	74.00	-20.91	296	100	V
			* 5.43552	40.28	Pk	35.30	-20.10	0.00	55.48	-	-	74.00	-18.52	296	100	V
			* 5.35001	27.53	RMS	35.10	-20.20	0.15	42.58	54.00	-11.42	-	-	296	100	V
			* 5.43844	28.37	RMS	35.30	-20.10	0.15	43.72	54.00	-10.28	-	-	296	100	V
802.11n (HT20)	5320	MIMO	* 5.35001	38.27	Pk	35.10	-20.20	0.00	53.17	-	-	74.00	-20.83	256	110	H
			* 5.4542	40.73	Pk	35.30	-20.10	0.00	55.93	-	-	74.00	-18.07	256	110	H
			* 5.35001	27.78	RMS	35.10	-20.20	0.00	42.68	54.00	-11.32	-	-	256	110	H
			* 5.42558	28.93	RMS	35.30	-20.10	0.00	44.13	54.00	-9.87	-	-	256	110	H
			* 5.35001	37.31	Pk	35.10	-20.20	0.00	52.21	-	-	74.00	-21.79	296	100	V
			* 5.44104	40.05	Pk	35.30	-20.10	0.00	55.25	-	-	74.00	-18.75	296	100	V
			* 5.35001	27.72	RMS	35.10	-20.20	0.00	42.62	54.00	-11.38	-	-	296	100	V
			* 5.43622	28.64	RMS	35.30	-20.10	0.00	43.84	54.00	-10.16	-	-	296	100	V
802.11n (HT40)	5310	MIMO	* 5.35001	45.63	Pk	35.10	-20.20	0.00	60.53	-	-	74.00	-13.47	258	110	H
			* 5.35089	48.25	Pk	35.10	-20.20	0.00	63.15	-	-	74.00	-10.85	258	110	H
			* 5.35001	34.82	RMS	35.10	-20.20	0.00	49.72	54.00	-4.28	-	-	258	110	H
			* 5.35033	35.39	RMS	35.10	-20.20	0.00	50.29	54.00	-3.71	-	-	258	110	H
			* 5.35001	40.43	Pk	35.10	-20.20	0.00	55.33	-	-	74.00	-18.67	55	104	V
			* 5.35003	41.91	Pk	35.10	-20.20	0.00	56.81	-	-	74.00	-17.19	55	104	V
			* 5.35001	29.97	RMS	35.10	-20.20	0.00	44.87	54.00	-9.13	-	-	55	104	V
			* 5.35017	30.49	RMS	35.10	-20.20	0.00	45.39	54.00	-8.61	-	-	55	104	V
802.11ac (VHT80)	5290	MIMO	* 5.35001	43.27	Pk	35.10	-20.20	0.00	58.17	-	-	74.00	-15.83	258	110	H
			* 5.35643	44.49	Pk	35.10	-20.30	0.00	59.29	-	-	74.00	-14.71	258	110	H
			* 5.35001	31.74	RMS	35.10	-20.20	0.24	46.88	54.00	-7.12	-	-	258	110	H
			* 5.35267	32.24	RMS	35.10	-20.20	0.24	47.38	54.00	-6.62	-	-	258	110	H
			* 5.35001	38.08	Pk	35.10	-20.20	0.00	52.98	-	-	74.00	-21.02	152	353	V
			* 5.35163	42.63	Pk	35.10	-20.20	0.00	57.53	-	-	74.00	-16.47	152	353	V
			* 5.35001	29.18	RMS	35.10	-20.20	0.24	44.32	54.00	-9.68	-	-	152	353	V
			* 5.35037	29.84	RMS	35.10	-20.20	0.24	44.98	54.00	-9.02	-	-	152	353	V
802.11ax (HE20)	5320	MIMO	* 5.35001	41.08	Pk	35.10	-20.20	0.00	55.98	-	-	74.00	-18.02	255	100	H
			* 5.35149	43.26	Pk	35.10	-20.20	0.00	58.16	-	-	74.00	-15.84	255	100	H
			* 5.35001	28.93	RMS	35.10	-20.20	0.00	43.83	54.00	-10.17	-	-	255	100	H
			* 5.35091	29.90	RMS	35.10	-20.20	0.00	44.80	54.00	-9.20	-	-	255	100	H
			* 5.35001	37.58	Pk	35.10	-20.20	0.00	52.48	-	-	74.00	-21.52	302	100	V
			* 5.4191	39.86	Pk	35.20	-20.10	0.00	54.96	-	-	74.00	-19.04	302	100	V
			* 5.35001	27.41	RMS	35.10	-20.20	0.00	42.31	54.00	-11.69	-	-	302	100	V
			* 5.41212	28.85	RMS	35.20	-20.10	0.00	43.95	54.00	-10.05	-	-	302	100	V
802.11ax (HE40)	5310	MIMO	* 5.35001	47.95	Pk	35.10	-20.20	0.00	62.85	-	-	74.00	-11.15	255	101	H
			* 5.35021	50.16	Pk	35.10	-20.20	0.00	65.06	-	-	74.00	-8.94	255	101	H
			* 5.35001	35.04	RMS	35.10	-20.20	0.00	49.94	54.00	-4.06	-	-	255	101	H
			* 5.35025	36.40	RMS	35.10	-20.20	0.00	51.30	54.00	-2.70	-	-	255	101	H
			* 5.35001	40.53	Pk	35.10	-20.20	0.00	55.43	-	-	74.00	-18.57	302	100	V
			* 5.35271	41.91	Pk	35.10	-20.20	0.00	56.81	-	-	74.00	-17.19	302	100	V
			* 5.35001	29.19	RMS	35.10	-20.20	0.00	44.09	54.00	-9.91	-	-	302	100	V
			* 5.35211	29.90	RMS	35.10	-20.20	0.00	44.80	54.00	-9.20	-	-	302	100	V
802.11ax (HE80)	5290	MIMO	* 5.35001	47.45	Pk	35.10	-20.20	0.00	62.35	-	-	74.00	-11.65	256	110	H
			* 5.35495	48.71	Pk	35.10	-20.30	0.00	63.51	-	-	74.00	-10.49	256	110	H
			* 5.35001	35.61	RMS	35.10	-20.20	0.00	50.51	54.00	-3.49	-	-	256	110	H
			* 5.35057	36.27	RMS	35.10	-20.20	0.00	51.17	54.00	-2.83	-	-	256	110	H
			* 5.35001	39.07	Pk	35.10	-20.20	0.00	53.97	-	-	74.00	-20.03	302	100	V
			* 5.35655	41.08	Pk	35.10	-20.30	0.00	55.88	-	-	74.00	-18.12	302	100	V
			* 5.35001	28.11	RMS	35.10	-20.20	0.00	43.01	54.00	-10.99	-	-	302	100	V
			* 5.35379	29.59	RMS	35.10	-20.20	0.00	44.49	54.00	-9.51	-	-	302	100	V

Note1. Pk - Peak detector, RMS - RMS detector  
 Note2. \* - indicates frequency in CFR47 Pt 15 / IC RSS-Restricted Band

**HARMONICS AND SPURIOUS EMISSIONS(WORST CASE: 802.11a / 5320 MHz)**

**5320 MHz HORIZONTAL**

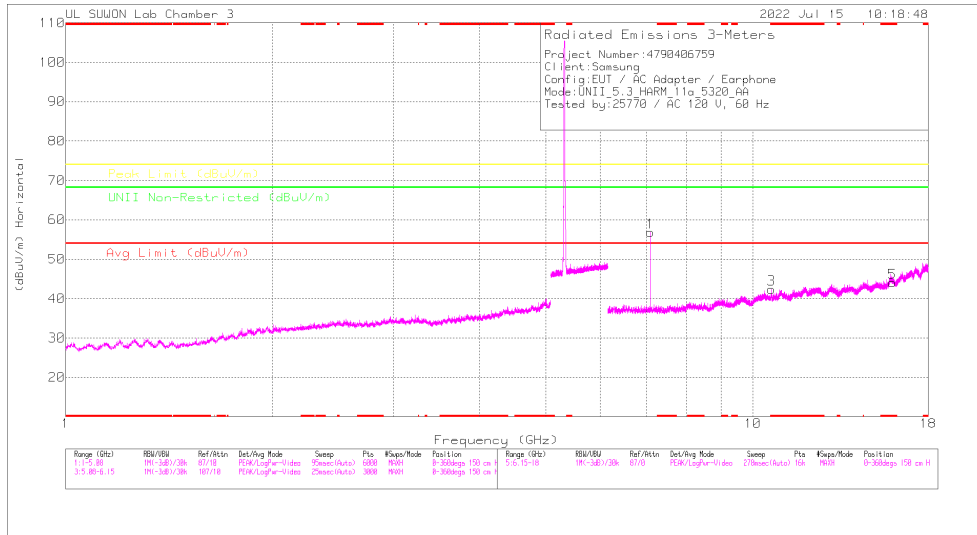

**5320 MHz VERTICAL**

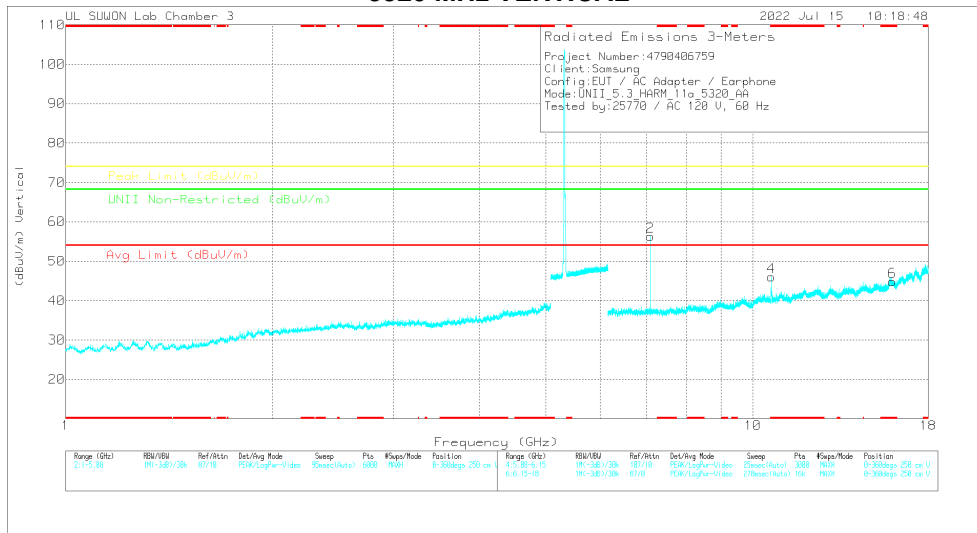

Note: Emission was scanned up to 40GHz; No emissions were detected above the noise floor which was at least 20dB below the specification limit.

**5320 MHz DATA**

**Radiated Emissions**

Frequency (GHz)	Meas. Reading (dBuV)	Det.	317_0021867	6GHz_HPS(B)	DC Corr (dB)	Corrected Reading (dBuV/m)	Avg Limit (dBuV/m)	Margin (dB)	Peak Limit (dBuV/m)	Margin (dB)	UNII Non-Restricted (dBuV/m)	Margin (dB)	Altitude (m)	Height (cm)	Polarity
7.09333	48.79	PK-U	36.2	-26	0	58.99	-	-	-	-	68.2	-9.21	344	135	H
7.09325	48.02	PK-U	36.2	-26	0	58.22	-	-	-	-	68.2	-9.98	65	102	V
* 10.64018	35.69	PK-U	38.3	-21.1	0	52.89	-	-	74	-21.11	-	-	309	379	H
* 10.64	24.45	ADR	38.3	-21.1	-15	41.8	54	-12.2	-	-	-	-	308	379	H
* 10.64046	40.4	PK-U	38.3	-21.1	0	57.6	-	-	74	-16.4	-	-	326	100	V
* 10.64031	29.77	ADR	38.3	-21.1	-15	47.12	54	-6.88	-	-	-	-	326	100	V
* 15.96625	33.74	PK-U	40.9	-20.4	0	54.24	-	-	74	-19.76	-	-	360	100	H
* 15.96932	33.65	PK-U	40.9	-20.4	0	54.15	-	-	74	-19.85	-	-	360	100	V

\* - indicates frequency in CFR47 Pt 15 / IC RSS-Restricted Band  
 PK-U - U-NII: Maximum Peak  
 ADR - U-NII AD primary method, RMS average

**HARMONICS AND SPURIOUS EMISSIONS TEST DATA**

Mode	Freq. [MHz]	Antenna	Frequency [GHz]	Reading [dBuV]	Detector Mode	ANT Factor	Loss [dB]	DC Corr [dB]	Result [dBuV/m]	AV Limit [dBuV/m]	AV Margin [dB]	PK Limit [dBuV/m]	PK Margin [dB]	Non-Restricted [dBuV/m]	Margin [dB]	Azimuth [Degs]	Height [cm]	Polarity		
802.11a	5260	MIMO	7.013	48.58	PK-U	36.20	-25.90	0.00	58.88	-	-	-	-	68.20	-9.32	339	130	H		
			* 7.013	48.05	PK-U	36.20	-25.90	0.00	58.35	-	-	-	-	-	68.20	-9.85	44	100	V	
			10.522	39.30	PK-U	38.20	-21.10	0.00	56.40	-	-	-	-	-	68.20	-11.80	233	103	H	
			* 10.521	42.15	PK-U	38.20	-21.10	0.00	59.25	-	-	-	-	-	68.20	-8.95	324	103	V	
			* 15.79041	34.18	PK-U	40.60	-20.80	0.00	53.98	-	-	-	74.00	-20.02	-	-	-	360	100	H
			* 15.78004	34.10	PK-U	40.60	-20.80	0.00	53.90	-	-	-	74.00	-20.10	-	-	-	360	100	V
	5300	MIMO	7.066	48.90	PK-U	36.20	-25.90	0.00	59.20	-	-	-	-	-	68.20	-9.00	343	106	H	
			* 7.067	48.08	PK-U	36.20	-25.90	0.00	58.38	-	-	-	-	-	68.20	-9.82	46	100	V	
			* 11.62602	34.28	PK-U	38.80	-21.50	0.00	51.58	-	-	-	74.00	-22.42	-	-	-	236	101	H
			* 11.58556	22.64	ADR	38.80	-21.60	0.15	39.99	54.00	-14.01	-	-	-	-	-	-	236	101	H
			* 11.75977	33.69	PK-U	39.00	-21.50	0.00	51.19	-	-	-	74.00	-22.81	-	-	-	325	100	V
			* 11.57395	22.52	ADR	38.80	-21.60	0.15	39.87	54.00	-14.13	-	-	-	-	-	-	325	100	V
			* 15.90317	33.86	PK-U	40.80	-20.30	0.00	54.36	-	-	-	74.00	-19.64	-	-	-	0	100	H
			* 15.90904	33.96	PK-U	40.80	-20.30	0.00	54.46	-	-	-	74.00	-19.54	-	-	-	360	100	V
			7.093	48.79	PK-U	36.20	-26.00	0.00	58.99	-	-	-	-	-	-	68.20	-9.21	344	135	H
			* 7.093	48.02	PK-U	36.20	-26.00	0.00	58.22	-	-	-	-	-	-	68.20	-9.98	65	102	V
			* 10.64018	35.69	PK-U	38.30	-21.10	0.00	52.89	-	-	-	74.00	-21.11	-	-	-	309	379	H
			* 10.64	24.45	ADR	38.30	-21.10	0.15	41.80	54.00	-12.20	-	-	-	-	-	-	309	379	H
	* 10.64046	40.40	PK-U	38.30	-21.10	0.00	57.60	-	-	-	74.00	-16.40	-	-	-	326	100	V		
	* 10.64031	29.77	ADR	38.30	-21.10	0.15	47.12	54.00	-6.88	-	-	-	-	-	-	326	100	V		
	* 15.95625	33.74	PK-U	40.90	-20.40	0.00	54.24	-	-	-	74.00	-19.76	-	-	-	360	100	H		
	* 15.96932	33.65	PK-U	40.90	-20.40	0.00	54.15	-	-	-	74.00	-19.85	-	-	-	360	100	V		
	802.11ax (HE20) 4RU Spot-Check	5300	MIMO	7.066	45.06	PK-U	36.20	-25.90	0.00	55.36	-	-	-	-	68.20	-12.84	341	130	H	
				* 7.066	47.61	PK-U	36.20	-25.90	0.00	57.91	-	-	-	-	-	68.20	-10.29	40	107	V
* 11.77809				34.06	PK-U	39.00	-21.60	0.00	51.46	-	-	-	74.00	-22.54	-	-	-	360	100	H
* 11.5724				33.86	PK-U	38.80	-21.60	0.00	51.06	-	-	-	74.00	-22.94	-	-	-	360	100	V
* 15.89259				34.08	PK-U	40.80	-20.30	0.00	54.58	-	-	-	74.00	-19.42	-	-	-	360	100	H
* 15.90249				33.50	PK-U	40.80	-20.30	0.00	54.00	-	-	-	74.00	-20.00	-	-	-	360	100	V

Note1. PK-U - U-NII: Maximum Peak / ADR - U-NII AD primary method, RMS average  
 Note2. \* - indicates frequency in CFR47 Pt 15 / IC RSS-Restricted Band

### 11.3. TX ABOVE 1GHz 2Tx MODE IN THE 5.5 GHz BAND

**BANDEDGE (WORST CASE: 802.11a / 5700 MHz)**

**HORIZONTAL PEAK AND AVERAGE DATA**

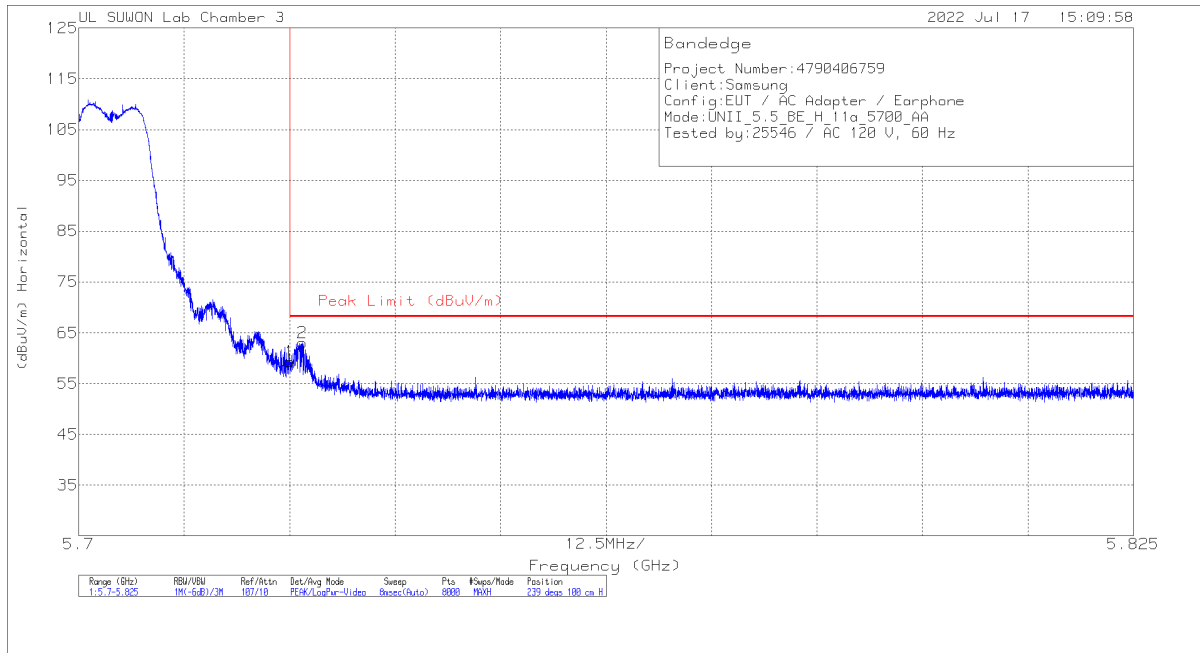

**Trace Markers**

Marker	Frequency (GHz)	Meter Reading (dBuV)	Det	3117_00218957	10dB_ATT[dB]	DC Corr (dB)	Corrected Reading (dBuV/m)	Peak Limit (dBuV/m)	PK Margin (dB)	Azimuth (Degs)	Height (cm)	Polarity
1	5.725	43.09	Pk	35.7	-19.5	0	59.29	68.2	-8.91	239	100	H
2	5.72649	46.78	Pk	35.7	-19.5	0	62.98	68.2	-5.22	239	100	H

Pk - Peak detector

**BANDEDGE TEST DATA**

Mode	Freq. [MHz]	Antenna	Frequency [GHz]	Reading [dBuV]	Detector Mode	ANT Factor	Loss [dB]	DC Corr [dB]	Result [dBuV/m]	AV Limit [dBuV/m]	AV Margin [dB]	PK Limit [dBuV/m]	PK Margin [dB]	Azimuth [Degs]	Height [cm]	Polarity		
802.11a	5500	MIMO	* 5.45998	37.82	Pk	35.30	-20.10	0.00	53.02	-	-	74.00	-20.98	243	105	H		
			* 5.41207	40.95	Pk	35.20	-20.10	0.00	56.05	-	-	74.00	-17.95	243	105	H		
			5.46998	40.95	Pk	35.30	-20.10	0.00	56.15	-	-	68.20	-12.05	243	105	H		
			5.46998	43.76	Pk	35.30	-20.10	0.00	58.96	-	-	68.20	-9.24	243	105	H		
			* 5.45998	27.59	RMS	35.30	-20.10	0.15	42.94	54.00	-11.06	-	-	-	-	243	105	H
			* 5.3752	29.30	RMS	35.20	-20.20	0.15	44.45	54.00	-9.55	-	-	-	-	243	105	H
			5.46998	29.77	RMS	35.30	-20.10	0.15	45.12	-	-	-	-	-	-	243	105	H
			5.46998	30.88	RMS	35.30	-20.10	0.15	46.23	-	-	-	-	-	-	243	105	H
			* 5.45998	36.58	Pk	35.30	-20.10	0.00	51.78	-	-	74.00	-22.22	295	100	V		
			* 5.41752	40.16	Pk	35.20	-20.10	0.00	55.26	-	-	74.00	-18.74	295	100	V		
	5.46998	39.43	Pk	35.30	-20.10	0.00	54.63	-	-	68.20	-13.57	295	100	V				
	5.46972	40.87	Pk	35.30	-20.10	0.00	56.07	-	-	68.20	-12.13	295	100	V				
	* 5.45998	27.53	RMS	35.30	-20.10	0.15	42.88	54.00	-11.12	-	-	-	-	295	100	V		
	* 5.37453	28.65	RMS	35.10	-20.20	0.15	43.70	54.00	-10.30	-	-	-	-	295	100	V		
	5.46998	28.14	RMS	35.30	-20.10	0.15	43.49	-	-	-	-	-	-	295	100	V		
	5.46959	28.95	RMS	35.30	-20.10	0.15	44.30	-	-	-	-	-	-	295	100	V		
	5.72500	43.09	Pk	35.70	-19.50	0.00	59.29	-	-	68.20	-8.91	239	100	H				
	5.72649	46.78	Pk	35.70	-19.50	0.00	62.98	-	-	68.20	-5.22	239	100	H				
	5.72500	42.29	Pk	35.70	-19.50	0.00	58.49	-	-	68.20	-9.71	66	102	V				
	5.72544	44.01	Pk	35.70	-19.50	0.00	60.21	-	-	68.20	-7.99	66	102	V				
802.11n (HT20)	5500	MIMO	* 5.45998	37.86	Pk	35.30	-20.10	0.00	53.06	-	-	74.00	-20.94	242	100	H		
			* 5.37597	40.38	Pk	35.20	-20.20	0.00	55.38	-	-	74.00	-18.62	242	100	H		
			5.46998	37.80	Pk	35.30	-20.10	0.00	53.00	-	-	68.20	-15.20	242	100	H		
			5.46193	39.67	Pk	35.30	-20.10	0.00	54.87	-	-	68.20	-13.33	242	100	H		
			* 5.45998	27.49	RMS	35.30	-20.10	0.00	42.69	54.00	-11.31	-	-	-	242	100	H	
			* 5.39354	29.25	RMS	35.20	-20.20	0.00	44.25	54.00	-9.75	-	-	-	242	100	H	
			5.46998	27.17	RMS	35.30	-20.10	0.00	42.37	-	-	-	-	-	-	242	100	H
			5.46403	28.77	RMS	35.30	-20.10	0.00	43.97	-	-	-	-	-	-	242	100	H
			* 5.45998	35.76	Pk	35.30	-20.10	0.00	50.96	-	-	74.00	-23.04	295	100	V		
			* 5.43018	40.07	Pk	35.30	-20.20	0.00	55.17	-	-	74.00	-18.83	295	100	V		
	5.46998	38.34	Pk	35.30	-20.10	0.00	53.54	-	-	68.20	-14.66	295	100	V				
	5.46994	39.46	Pk	35.30	-20.10	0.00	54.66	-	-	68.20	-13.54	295	100	V				
	* 5.45998	27.66	RMS	35.30	-20.10	0.00	42.86	54.00	-11.14	-	-	-	-	295	100	V		
	* 5.43406	28.39	RMS	35.30	-20.10	0.00	43.59	54.00	-10.41	-	-	-	-	295	100	V		
	5.46998	27.63	RMS	35.30	-20.10	0.00	42.83	-	-	-	-	-	-	295	100	V		
	5.46514	28.29	RMS	35.30	-20.10	0.00	43.49	-	-	-	-	-	-	295	100	V		
	5.72500	37.66	Pk	35.70	-19.50	0.00	53.86	-	-	68.20	-14.34	305	105	H				
	5.79607	40.00	Pk	35.80	-19.40	0.00	56.40	-	-	68.20	-11.80	305	105	H				
	5.72500	36.64	Pk	35.70	-19.50	0.00	52.84	-	-	68.20	-15.36	63	101	V				
	5.78865	40.50	Pk	35.80	-19.40	0.00	56.90	-	-	68.20	-11.30	63	101	V				
802.11n (HT40)	5510	MIMO	* 5.45998	38.46	Pk	35.30	-20.10	0.00	53.66	-	-	74.00	-20.34	114	114	H		
			* 5.35466	40.73	Pk	35.10	-20.30	0.00	55.53	-	-	74.00	-18.47	114	114	H		
			5.46998	42.91	Pk	35.30	-20.10	0.00	58.11	-	-	68.20	-10.09	114	114	H		
			5.46906	45.68	Pk	35.30	-20.10	0.00	60.88	-	-	68.20	-7.32	114	114	H		
			* 5.45998	28.81	RMS	35.30	-20.10	0.00	44.01	54.00	-9.99	-	-	-	243	114	H	
			* 5.45858	28.94	RMS	35.30	-20.10	0.00	44.14	54.00	-9.86	-	-	-	243	114	H	
			5.46998	31.91	RMS	35.30	-20.10	0.00	47.11	-	-	-	-	-	-	243	114	H
			5.46924	32.44	RMS	35.30	-20.10	0.00	47.64	-	-	-	-	-	-	243	114	H
			* 5.45998	37.31	Pk	35.30	-20.10	0.00	52.51	-	-	74.00	-21.49	61	101	V		
			* 5.4474	40.06	Pk	35.30	-20.10	0.00	55.26	-	-	74.00	-18.74	61	101	V		
	5.46998	38.54	Pk	35.30	-20.10	0.00	53.74	-	-	68.20	-14.46	61	101	V				
	5.46969	40.48	Pk	35.30	-20.10	0.00	55.68	-	-	68.20	-12.52	61	101	V				
	* 5.45998	26.75	RMS	35.30	-20.10	0.00	41.95	54.00	-12.05	-	-	-	-	61	101	V		
	* 5.45989	28.55	RMS	35.30	-20.10	0.00	43.75	54.00	-10.25	-	-	-	-	61	101	V		
	5.46998	29.03	RMS	35.30	-20.10	0.00	44.23	-	-	-	-	-	-	61	101	V		
	5.46825	28.93	RMS	35.30	-20.10	0.00	44.13	-	-	-	-	-	-	61	101	V		
	5.72500	36.88	Pk	35.70	-19.50	0.00	53.08	-	-	68.20	-15.12	289	332	H				
	5.78490	40.24	Pk	35.80	-19.40	0.00	56.64	-	-	68.20	-11.56	289	332	H				
	5.72500	36.10	Pk	35.70	-19.50	0.00	52.30	-	-	68.20	-15.90	334	100	V				
	5.76831	40.23	Pk	35.70	-19.40	0.00	56.53	-	-	68.20	-11.67	334	100	V				
802.11ac (VHT80)	5530	MIMO	* 5.45998	38.06	Pk	35.30	-20.10	0.00	53.26	-	-	74.00	-20.74	242	105	H		
			* 5.46821	41.00	Pk	35.30	-20.10	0.00	56.20	-	-	74.00	-17.80	242	105	H		
			5.46998	40.48	Pk	35.30	-20.10	0.00	55.68	-	-	68.20	-12.52	242	105	H		
			5.46348	41.54	Pk	35.30	-20.10	0.00	56.74	-	-	68.20	-11.46	242	105	H		
			* 5.45998	28.86	RMS	35.30	-20.10	0.24	44.30	54.00	-9.70	-	-	-	242	105	H	
			* 5.45781	29.81	RMS	35.30	-20.10	0.24	45.25	54.00	-8.75	-	-	-	242	105	H	
			5.46998	28.96	RMS	35.30	-20.10	0.24	44.40	-	-	-	-	-	-	242	105	H
			5.46558	29.90	RMS	35.30	-20.10	0.24	45.34	-	-	-	-	-	-	242	105	H
			* 5.45998	37.48	Pk	35.30	-20.10	0.00	52.68	-	-	74.00	-21.32	64	100	V		
			* 5.45569	39.86	Pk	35.30	-20.10	0.00	55.06	-	-	74.00	-18.94	64	100	V		
	5.46998	36.31	Pk	35.30	-20.10	0.00	51.51	-	-	68.20	-16.69	64	100	V				
	5.46538	39.08	Pk	35.30	-20.10	0.00	54.28	-	-	68.20	-13.92	64	100	V				
	* 5.45998	26.94	RMS	35.30	-20.10	0.24	42.38	54.00	-11.62	-	-	-	-	64	100	V		
	* 5.42406	28.78	RMS	35.20	-20.10	0.24	44.12	54.00	-9.88	-	-	-	-	64	100	V		
	5.46998	27.38	RMS	35.30	-20.10	0.24	42.82	-	-	-	-	-	-	64	100	V		
	5.46226	28.44	RMS	35.30	-20.10	0.24	43.88	-	-	-	-	-	-	64	100	V		
	5.72500	36.71	Pk	35.70	-19.50	0.00	52.91	-	-	68.20	-15.29	241	100	H				
	5.73094	39.75	Pk	35.70	-19.50	0.00	55.95	-	-	68.20	-12.25	241	100	H				
	5.72500	37.09	Pk	35.70	-19.50	0.00	53.29	-	-	68.20	-14.91	63	100	V				
	5.76059	39.34	Pk	35.70	-19.40	0.00	55.64	-	-	68.20	-12.56	63	100	V				

Mode	Freq. [MHz]	Antenna	Frequency [GHz]	Reading [dBuV]	Detector Mode	ANT Factor	Loss [dB]	DC Corr [dB]	Result dBuV/m	AV Limit dBuV/m	AV Margin [dB]	PK Limit dBuV/m	PK Margin [dB]	Azimuth [Degs]	Height [cm]	Polarity	
802.11ax (HE20)	5500	MIMO	* 5.45998	37.37	Pk	35.30	-20.10	0.00	52.57	-	-	74.00	-21.43	246	107	H	
			* 5.41463	41.01	Pk	35.20	-20.20	0.00	56.01	-	-	74.00	-17.99	246	107	H	
			5.46998	38.61	Pk	35.30	-20.10	0.00	53.81	-	-	68.20	-14.39	246	107	H	
			5.46856	40.03	Pk	35.30	-20.10	0.00	55.23	-	-	68.20	-12.97	246	107	H	
			* 5.45998	27.71	RMS	35.30	-20.10	0.00	42.91	54.00	-11.09	-	-	246	107	H	
			* 5.41163	29.78	RMS	35.20	-20.10	0.00	44.88	54.00	-9.12	-	-	246	107	H	
			5.46998	27.10	RMS	35.30	-20.10	0.00	42.30	-	-	-	-	246	107	H	
			5.46976	28.87	RMS	35.30	-20.10	0.00	44.07	-	-	-	-	246	107	H	
			* 5.45998	36.27	Pk	35.30	-20.10	0.00	51.47	-	-	74.00	-22.53	298	100	V	
			* 5.45939	39.84	Pk	35.30	-20.10	0.00	55.04	-	-	74.00	-18.96	298	100	V	
			5.46998	36.90	Pk	35.30	-20.10	0.00	52.10	-	-	68.20	-16.10	298	100	V	
			5.46932	38.82	Pk	35.30	-20.10	0.00	54.02	-	-	68.20	-14.18	298	100	V	
	* 5.45998	26.59	RMS	35.30	-20.10	0.00	41.79	54.00	-12.21	-	-	298	100	V			
	* 5.44604	28.42	RMS	35.30	-20.10	0.00	43.62	54.00	-10.38	-	-	298	100	V			
	5.46998	27.39	RMS	35.30	-20.10	0.00	42.59	-	-	-	-	298	100	V			
	5.46552	28.18	RMS	35.30	-20.10	0.00	43.38	-	-	-	-	298	100	V			
	5700	MIMO	5.72500	40.81	Pk	35.70	-19.50	0.00	57.01	-	-	68.20	-11.19	286	100	H	
			5.72513	43.13	Pk	35.70	-19.50	0.00	59.33	-	-	68.20	-8.87	286	100	H	
			5.72500	39.87	Pk	35.70	-19.50	0.00	56.07	-	-	68.20	-12.13	60	101	V	
			5.72555	41.16	Pk	35.70	-19.50	0.00	57.36	-	-	68.20	-10.84	60	101	V	
	802.11ax (HE40)	5510	MIMO	* 5.45998	38.48	Pk	35.30	-20.10	0.00	53.68	-	-	74.00	-20.32	226	144	H
				* 5.45624	40.99	Pk	35.30	-20.10	0.00	56.19	-	-	74.00	-17.81	226	144	H
				5.46998	42.25	Pk	35.30	-20.10	0.00	57.45	-	-	68.20	-10.75	226	144	H
				5.46969	43.94	Pk	35.30	-20.10	0.00	59.14	-	-	68.20	-9.06	226	144	H
* 5.45998				27.63	RMS	35.30	-20.10	0.00	42.83	54.00	-11.17	-	-	226	144	H	
* 5.4593				28.85	RMS	35.30	-20.10	0.00	44.05	54.00	-9.95	-	-	226	144	H	
5.46998				30.12	RMS	35.30	-20.10	0.00	45.32	-	-	-	-	226	144	H	
5.46939				31.12	RMS	35.30	-20.10	0.00	46.32	-	-	-	-	226	144	H	
* 5.45998				37.71	Pk	35.30	-20.10	0.00	52.91	-	-	74.00	-21.09	59	100	V	
* 5.45926				40.17	Pk	35.30	-20.10	0.00	55.37	-	-	74.00	-18.63	59	100	V	
5.46998				39.98	Pk	35.30	-20.10	0.00	55.18	-	-	68.20	-13.02	59	100	V	
5.46867				41.40	Pk	35.30	-20.10	0.00	56.60	-	-	68.20	-11.60	59	100	V	
* 5.45998		27.57	RMS	35.30	-20.10	0.00	42.77	54.00	-11.23	-	-	59	100	V			
* 5.45482		28.44	RMS	35.30	-20.10	0.00	43.64	54.00	-10.36	-	-	59	100	V			
5.46998		28.65	RMS	35.30	-20.10	0.00	43.85	-	-	-	-	59	100	V			
5.46980		29.79	RMS	35.30	-20.10	0.00	44.99	-	-	-	-	59	100	V			
5670		MIMO	5.72500	38.08	Pk	35.70	-19.50	0.00	54.28	-	-	68.20	-13.92	239	100	H	
			5.72636	41.23	Pk	35.70	-19.50	0.00	57.43	-	-	68.20	-10.77	239	100	H	
			5.72500	37.53	Pk	35.70	-19.50	0.00	53.73	-	-	68.20	-14.47	61	101	V	
			5.72622	40.67	Pk	35.70	-19.50	0.00	56.87	-	-	68.20	-11.33	61	101	V	
802.11ax (HE80)		5530	MIMO	* 5.45998	42.12	Pk	35.30	-20.10	0.00	57.32	-	-	74.00	-16.68	242	100	H
				* 5.45768	45.68	Pk	35.30	-20.10	0.00	60.88	-	-	74.00	-13.12	242	100	H
				5.46998	44.75	Pk	35.30	-20.10	0.00	59.95	-	-	68.20	-8.25	242	100	H
				5.46740	47.07	Pk	35.30	-20.10	0.00	62.27	-	-	68.20	-5.93	242	100	H
	* 5.45998			31.62	RMS	35.30	-20.10	0.00	46.82	54.00	-7.18	-	-	242	100	H	
	* 5.45954			32.51	RMS	35.30	-20.10	0.00	47.71	54.00	-6.29	-	-	242	100	H	
	5.46998			33.05	RMS	35.30	-20.10	0.00	48.25	-	-	-	-	242	100	H	
	5.46987			34.25	RMS	35.30	-20.10	0.00	49.45	-	-	-	-	242	100	H	
	* 5.45998			38.32	Pk	35.30	-20.10	0.00	53.52	-	-	74.00	-20.48	61	101	V	
	* 5.44569			40.87	Pk	35.30	-20.10	0.00	56.07	-	-	74.00	-17.93	61	101	V	
	5.46998			38.69	Pk	35.30	-20.10	0.00	53.89	-	-	68.20	-14.31	61	101	V	
	5.46954			41.41	Pk	35.30	-20.10	0.00	56.61	-	-	68.20	-11.59	61	101	V	
	* 5.45998	27.44	RMS	35.30	-20.10	0.00	42.64	54.00	-11.36	-	-	61	100	V			
	* 5.45289	28.68	RMS	35.30	-20.10	0.00	43.88	54.00	-10.12	-	-	61	100	V			
	5.46998	28.48	RMS	35.30	-20.10	0.00	43.68	-	-	-	-	61	100	V			
	5.46554	28.94	RMS	35.30	-20.10	0.00	44.14	-	-	-	-	61	100	V			
	5610	MIMO	5.72500	37.71	Pk	35.70	-19.50	0.00	53.91	-	-	68.20	-14.29	238	101	H	
			5.77713	40.59	Pk	35.80	-19.40	0.00	56.99	-	-	68.20	-11.21	238	101	H	
			5.72500	37.53	Pk	35.70	-19.50	0.00	53.73	-	-	68.20	-14.47	45	100	V	
			5.75287	39.73	Pk	35.70	-19.40	0.00	56.03	-	-	68.20	-12.17	45	100	V	

Note1. Pk - Peak detector, RMS - RMS detector  
 Note2. \* - indicates frequency in CFR47 Pt 15 / IC RSS-Restricted Band

**HARMONICS AND SPURIOUS EMISSIONS(WORST CASE: 802.11a / 5500 MHz)**  
**5500 MHz HORIZONTAL**

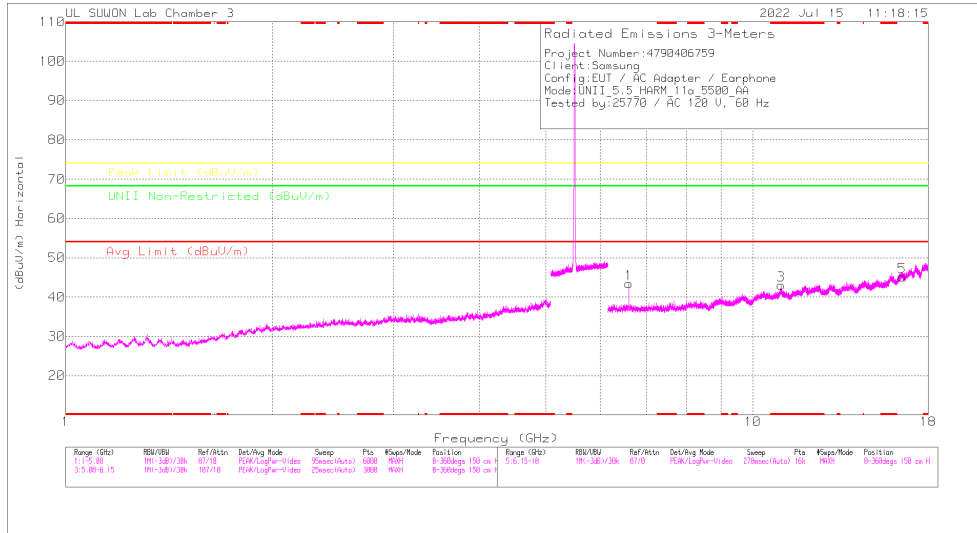

**5500 MHz VERTICAL**

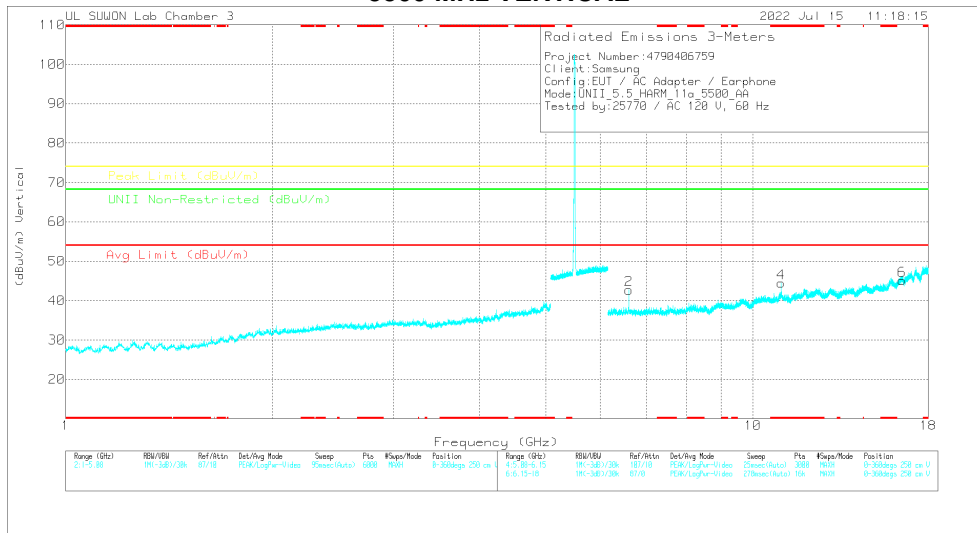

Note. Emission was scanned up to 40GHz; No emissions were detected above the noise floor which was at least 20dB below the specification limit.

**5500 MHz DATA**

**Radiated Emissions**

Frequency (GHz)	Meas Reading (dBuV)	Det	317_0021867	6GHz_HPS18	DC Corr (dB)	Compos Reading (dBuV/m)	Avg Limit (dBuV/m)	Margin (dB)	Peak Limit (dBuV/m)	Margin (dB)	UNII Non-Restrictd (dBuV/m)	Margin (dB)	Admth (Chap)	Height (cm)	Polarity
6.60003	40.28	PK-U	36.5	-26.3	0	50.48	-	-	-	-	68.2	-17.72	293	106	H
6.59945	40.48	PK-U	36.5	-26.3	0	50.68	-	-	-	-	68.2	-17.52	81	103	V
* 11.0007	36.64	PK-U	38.5	-21.2	0	53.84	-	-	74	-20.06	-	-	99	101	H
* 11.00034	24.56	ADR	38.5	-21.2	15	42.01	54	-11.99	-	-	-	-	99	101	H
* 11.00056	35.93	PK-U	38.5	-21.2	0	53.23	-	-	74	-20.77	-	-	341	100	V
* 10.99981	24.74	ADR	38.5	-21.2	-15	42.19	54	-11.81	-	-	-	-	341	100	V
16.49208	33.29	PK-U	42	-19.3	0	55.99	-	-	-	-	68.2	-12.21	360	100	H
16.49906	33.06	PK-U	42	-19.3	0	55.76	-	-	-	-	68.2	-12.44	360	100	V

\* - indicates frequency in CFR47 Pt 15 / IC RSS-Restricted Band  
 PK-U - U-NII: Maximum Peak  
 ADR - U-NII AD primary method, RMS average

**HARMONICS AND SPURIOUS EMISSIONS TEST DATA**

Mode	Freq. [MHz]	Antenna	Frequency [GHz]	Reading [dBuV]	Detector Mode	ANT Factor	Loss [dB]	DC Corr [dB]	Result [dBuV/m]	AV Limit [dBuV/m]	AV Margin [dB]	PK Limit [dBuV/m]	PK Margin [dB]	Non-Restricted [dBuV/m]	Margin [dB]	Azimuth [Degs]	Height [cm]	Polarity		
802.11a	5500	MIMO	6.600	40.28	PK-U	36.50	-26.30	0.00	50.48	-	-	-	-	68.20	-17.72	293	106	H		
			6.599	40.48	PK-U	36.50	-26.30	0.00	50.68	-	-	-	-	68.20	-17.52	81	103	V		
			* 11.0007	36.64	PK-U	38.50	-21.20	0.00	53.94	-	-	-	74.00	-20.06	-	-	99	101	H	
			* 11.00204	24.56	ADR	38.50	-21.20	0.15	42.01	54.00	-11.99	-	-	-	-	-	99	101	H	
			* 11.00056	35.93	PK-U	38.50	-21.20	0.00	53.23	-	-	-	74.00	-20.77	-	-	341	100	V	
			* 10.99991	24.74	ADR	38.50	-21.20	0.15	42.19	54.00	-11.81	-	-	-	-	-	341	100	V	
			16.492	33.29	PK-U	42.00	-19.30	0.00	55.99	-	-	-	-	-	-	68.20	-12.21	360	100	H
			16.499	33.06	PK-U	42.00	-19.30	0.00	55.76	-	-	-	-	-	-	68.20	-12.44	360	100	V
			6.696	41.36	PK-U	36.40	-26.80	0.00	50.96	-	-	-	-	-	-	68.20	-17.24	262	103	H
			6.696	41.61	PK-U	36.40	-26.90	0.00	51.11	-	-	-	-	-	-	68.20	-17.09	83	100	V
			* 11.15621	34.05	PK-U	38.60	-21.40	0.00	51.25	-	-	-	74.00	-22.75	-	-	360	100	H	
			* 11.16749	34.17	PK-U	38.60	-21.50	0.00	51.27	-	-	-	74.00	-22.73	-	-	360	100	V	
	16.731	31.88	PK-U	42.30	-18.80	0.00	55.38	-	-	-	-	-	-	68.20	-12.82	360	100	H		
	16.738	32.31	PK-U	42.30	-18.80	0.00	55.81	-	-	-	-	-	-	68.20	-12.39	360	100	V		
	6.840	39.62	PK-U	36.20	-26.50	0.00	49.32	-	-	-	-	-	-	68.20	-18.88	283	100	H		
	6.840	39.42	PK-U	36.20	-26.50	0.00	49.12	-	-	-	-	-	-	68.20	-19.08	86	100	V		
	* 11.39368	32.83	PK-U	38.60	-21.40	0.00	50.03	-	-	-	74.00	-23.97	-	-	0	100	H			
	* 11.4083	33.05	PK-U	38.60	-21.50	0.00	50.15	-	-	-	74.00	-23.85	-	-	360	100	V			
	17.110	31.96	PK-U	42.30	-18.00	0.00	56.26	-	-	-	-	-	-	68.20	-11.94	0	100	H		
	17.106	31.33	PK-U	42.30	-18.00	0.00	55.63	-	-	-	-	-	-	68.20	-12.57	360	100	V		
	6.864	39.04	PK-U	36.20	-26.50	0.00	48.74	-	-	-	-	-	-	68.20	-19.46	280	103	H		
	6.864	39.33	PK-U	36.20	-26.50	0.00	49.03	-	-	-	-	-	-	68.20	-19.17	80	106	V		
	* 11.44172	32.61	PK-U	38.60	-21.30	0.00	49.91	-	-	-	74.00	-24.09	-	-	360	100	H			
	* 11.44865	32.66	PK-U	38.60	-21.30	0.00	49.96	-	-	-	74.00	-24.04	-	-	360	100	V			
	17.166	32.80	PK-U	42.20	-17.90	0.00	57.10	-	-	-	-	-	-	68.20	-11.10	360	100	H		
	17.153	31.91	PK-U	42.20	-18.00	0.00	56.11	-	-	-	-	-	-	68.20	-12.09	360	100	V		
	6.841	39.32	PK-U	36.20	-26.50	0.00	49.02	-	-	-	-	-	-	68.20	-19.18	280	114	H		
	6.840	39.30	PK-U	36.20	-26.50	0.00	49.00	-	-	-	-	-	-	68.20	-19.20	87	100	V		
	* 11.39543	32.94	PK-U	38.60	-21.40	0.00	50.14	-	-	-	74.00	-23.86	-	-	0	100	H			
	* 11.40368	32.16	PK-U	38.60	-21.40	0.00	49.36	-	-	-	74.00	-24.64	-	-	360	100	V			
	17.101	31.74	PK-U	42.30	-18.00	0.00	56.04	-	-	-	-	-	-	68.20	-12.16	0	100	H		
	17.108	31.43	PK-U	42.30	-17.90	0.00	55.83	-	-	-	-	-	-	68.20	-12.37	360	100	V		
	802.11ax (HE20) 4RU Spot-Check	5700	MIMO	6.841	39.32	PK-U	36.20	-26.50	0.00	49.02	-	-	-	-	68.20	-19.18	280	114	H	
				6.840	39.30	PK-U	36.20	-26.50	0.00	49.00	-	-	-	-	68.20	-19.20	87	100	V	
				* 11.39543	32.94	PK-U	38.60	-21.40	0.00	50.14	-	-	-	74.00	-23.86	-	0	100	H	
				* 11.40368	32.16	PK-U	38.60	-21.40	0.00	49.36	-	-	-	74.00	-24.64	-	360	100	V	
				17.101	31.74	PK-U	42.30	-18.00	0.00	56.04	-	-	-	-	68.20	-12.16	0	100	H	
				17.108	31.43	PK-U	42.30	-17.90	0.00	55.83	-	-	-	-	68.20	-12.37	360	100	V	

Note1. PK-U - U-NII: Maximum Peak / ADR - U-NII AD primary method, RMS average  
 Note2. \* - indicates frequency in CFR47 Pt 15 / IC RSS-Restricted Band



### 11.4. TX ABOVE 1GHz 2Tx MODE IN THE 5.8 GHz BAND

**BANDEDGE (WORST CASE: 802.11ax HE20 / 5825 MHz)**

**HORIZONTAL PEAK DATA**

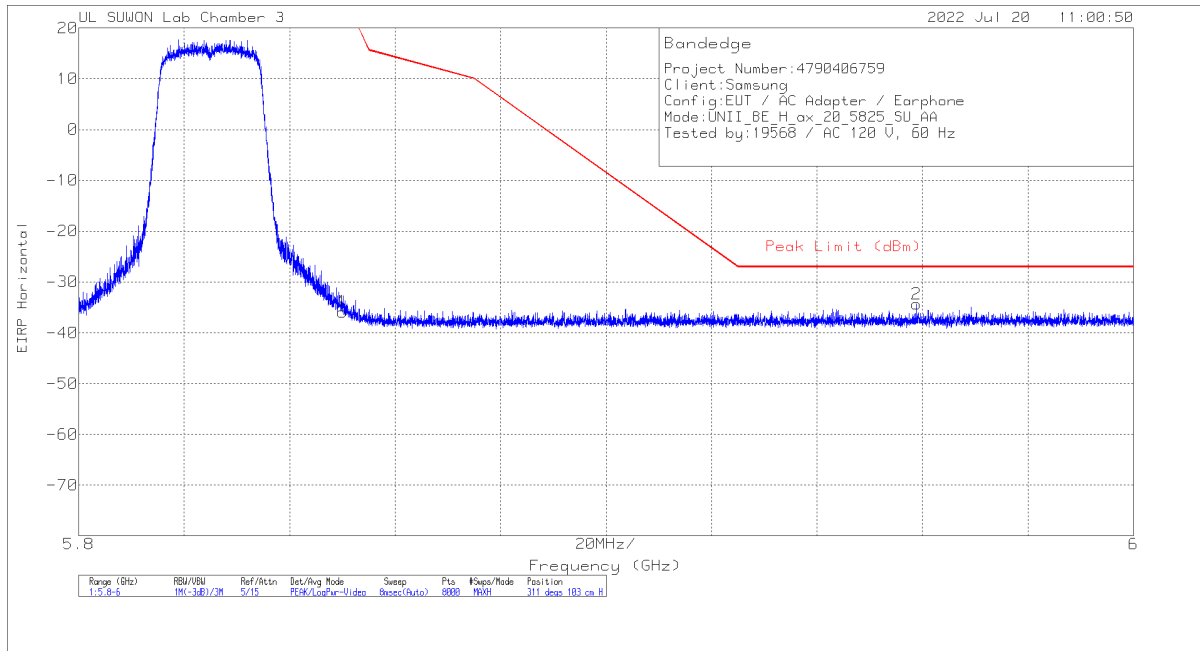

**Trace Markers**

Marker	Frequency (GHz)	Meter Reading (dBm)	Det	3117_00218957	10dB_ATT[dB]	Conversion Factor (dB)	DC Corr (dB)	Corrected Reading EIRP	Peak Limit (dBm)	PK Margin (dB)	Azimuth (Degs)	Height (cm)	Polarity
1	5.85001	-64.27	Pk		-19.3	11.8	0	-35.87	26.99	-62.86	311	103	H
2	5.95889	-62.95	Pk		-19.2	11.8	0	-34.35	-27	-7.35	311	103	H

Pk - Peak detector

**BANDEDGE TEST DATA**

Mode	Freq. [MHz]	Antenna	Frequency [GHz]	Reading [dBm]	Detector Mode	ANT Factor	Loss [dB]	Conv. F [dB]	DC Corr [dB]	Result [dBm]	PK Limit [dBm]	PK Margin [dB]	Azimuth [Degs]	Height [cm]	Polarity
802.11a	5745	MIMO	5.72500	-60.78	Pk	35.60	-19.50	11.80	0.00	-32.88	27.00	-59.88	241	100	H
			5.63423	-62.69	Pk	35.50	-19.80	11.80	0.00	-35.19	-27.00	-8.19	241	100	H
			5.72500	-60.92	Pk	35.60	-19.50	11.80	0.00	-33.02	27.00	-60.02	288	100	V
			5.64418	-63.05	Pk	35.50	-19.80	11.80	0.00	-35.55	-27.00	-8.55	288	100	V
			5.85001	-58.38	Pk	35.90	-19.30	11.80	0.00	-29.98	26.99	-56.97	309	100	H
	5825	MIMO	5.98960	-63.85	Pk	36.00	-19.20	11.80	0.00	-35.25	-27.00	-8.25	309	100	H
			5.85001	-59.78	Pk	35.90	-19.30	11.80	0.00	-31.38	26.99	-58.37	62	103	V
			5.99847	-63.24	Pk	36.00	-19.20	11.80	0.00	-34.64	-27.00	-7.64	62	103	V
			5.72500	-63.22	Pk	35.60	-19.50	11.80	0.00	-35.32	27.00	-62.32	262	270	H
			5.63719	-63.27	Pk	35.50	-19.80	11.80	0.00	-35.77	-27.00	-8.77	262	270	H
802.11n (HT20)	5745	MIMO	5.72500	-64.07	Pk	35.60	-19.50	11.80	0.00	-36.17	27.00	-63.17	57	101	V
			5.63449	-63.97	Pk	35.50	-19.80	11.80	0.00	-36.47	-27.00	-9.47	57	101	V
			5.85001	-66.49	Pk	35.90	-19.30	11.80	0.00	-38.09	26.99	-65.08	311	100	H
			5.97572	-63.51	Pk	36.00	-19.20	11.80	0.00	-34.91	-27.00	-7.91	311	100	H
			5.85001	-65.53	Pk	35.90	-19.30	11.80	0.00	-37.13	26.99	-64.12	64	103	V
	5825	MIMO	5.99650	-63.50	Pk	36.00	-19.20	11.80	0.00	-34.90	-27.00	-7.90	64	103	V
			5.72500	-63.75	Pk	35.60	-19.50	11.80	0.00	-35.85	27.00	-62.85	262	314	H
			5.63178	-63.40	Pk	35.50	-19.90	11.80	0.00	-36.00	-27.00	-9.00	262	314	H
			5.72500	-64.36	Pk	35.60	-19.50	11.80	0.00	-36.46	27.00	-63.46	61	100	V
			5.63113	-63.80	Pk	35.50	-19.90	11.80	0.00	-36.40	-27.00	-9.40	61	100	V
802.11n (HT40)	5755	MIMO	5.85001	-66.43	Pk	35.90	-19.30	11.80	0.00	-38.03	26.99	-65.02	304	100	H
			5.99482	-63.79	Pk	36.00	-19.20	11.80	0.00	-35.19	-27.00	-8.19	304	100	H
			5.85001	-66.52	Pk	35.90	-19.30	11.80	0.00	-38.12	26.99	-65.11	66	103	V
			5.96842	-63.47	Pk	36.00	-19.30	11.80	0.00	-34.97	-27.00	-7.97	66	103	V
			5.72500	-64.55	Pk	35.60	-19.50	11.80	0.00	-36.65	27.00	-63.65	309	103	H
	5775 (Lower Side)	MIMO	5.63020	-63.17	Pk	35.50	-19.90	11.80	0.00	-35.77	-27.00	-8.77	309	103	H
			5.72500	-65.71	Pk	35.60	-19.50	11.80	0.00	-37.81	27.00	-64.81	63	100	V
			5.64145	-63.98	Pk	35.50	-19.80	11.80	0.00	-36.48	-27.00	-9.48	63	100	V
			5.85001	-66.38	Pk	35.90	-19.30	11.80	0.00	-37.98	26.99	-64.97	312	103	H
			5.96194	-63.48	Pk	36.00	-19.20	11.80	0.00	-34.88	-27.00	-7.88	312	103	H
5775 (Upper Side)	MIMO	5.85001	-65.21	Pk	35.90	-19.30	11.80	0.00	-36.81	26.99	-63.80	60	104	V	
		5.95817	-63.52	Pk	36.00	-19.20	11.80	0.00	-34.92	-27.00	-7.92	60	104	V	
		5.72500	-58.12	Pk	35.60	-19.50	11.80	0.00	-30.22	27.00	-57.22	240	100	H	
		5.62671	-63.25	Pk	35.50	-19.90	11.80	0.00	-35.85	-27.00	-8.85	240	100	H	
		5.72500	-59.98	Pk	35.60	-19.50	11.80	0.00	-32.08	27.00	-59.08	62	100	V	
802.11ax (HE20)	5745	MIMO	5.62706	-63.55	Pk	35.50	-19.90	11.80	0.00	-36.15	-27.00	-9.15	62	100	V
			5.85001	-64.27	Pk	35.90	-19.30	11.80	0.00	-35.87	26.99	-62.86	311	103	H
			5.95889	-62.95	Pk	36.00	-19.20	11.80	0.00	-34.35	-27.00	-7.35	311	103	H
			5.85001	-63.38	Pk	35.90	-19.30	11.80	0.00	-34.98	26.99	-61.97	59	104	V
			5.93559	-63.63	Pk	36.00	-19.30	11.80	0.00	-35.13	-27.00	-8.13	59	104	V
	5755	MIMO	5.72500	-63.16	Pk	35.60	-19.50	11.80	0.00	-35.26	27.00	-62.26	239	100	H
			5.62884	-63.55	Pk	35.50	-19.90	11.80	0.00	-36.15	-27.00	-9.15	239	100	H
			5.72500	-62.83	Pk	35.60	-19.50	11.80	0.00	-34.93	27.00	-61.93	61	100	V
			5.63599	-63.50	Pk	35.50	-19.80	11.80	0.00	-36.00	-27.00	-9.00	61	100	V
			5.85001	-65.32	Pk	35.90	-19.30	11.80	0.00	-36.92	26.99	-63.91	314	101	H
5795	MIMO	5.94224	-63.19	Pk	36.00	-19.30	11.80	0.00	-34.69	-27.00	-7.69	314	101	H	
		5.85001	-66.07	Pk	35.90	-19.30	11.80	0.00	-37.67	26.99	-64.66	62	105	V	
		5.96124	-63.71	Pk	36.00	-19.20	11.80	0.00	-35.11	-27.00	-8.11	62	105	V	
		5.72500	-64.98	Pk	35.60	-19.50	11.80	0.00	-37.08	27.00	-64.08	239	100	H	
		5.64779	-63.45	Pk	35.50	-19.80	11.80	0.00	-35.95	-27.00	-8.95	239	100	H	
802.11ax (HE40)	5775 (Lower Side)	MIMO	5.72500	-64.83	Pk	35.60	-19.50	11.80	0.00	-36.93	27.00	-63.93	61	100	V
			5.64471	-63.79	Pk	35.50	-19.80	11.80	0.00	-36.29	-27.00	-9.29	61	100	V
			5.85001	-65.90	Pk	35.90	-19.30	11.80	0.00	-37.50	26.99	-64.49	312	110	H
			5.93522	-63.31	Pk	36.00	-19.30	11.80	0.00	-34.81	-27.00	-7.81	312	110	H
			5.85001	-65.88	Pk	35.90	-19.30	11.80	0.00	-37.48	26.99	-64.47	59	105	V
	5775 (Upper Side)	MIMO	5.95709	-63.72	Pk	36.00	-19.20	11.80	0.00	-35.12	-27.00	-8.12	59	105	V

Note. Pk - Peak detector

**HARMONICS AND SPURIOUS EMISSIONS(WORST CASE: 802.11a / 5825 MHz)**  
**5825 MHz HORIZONTAL**

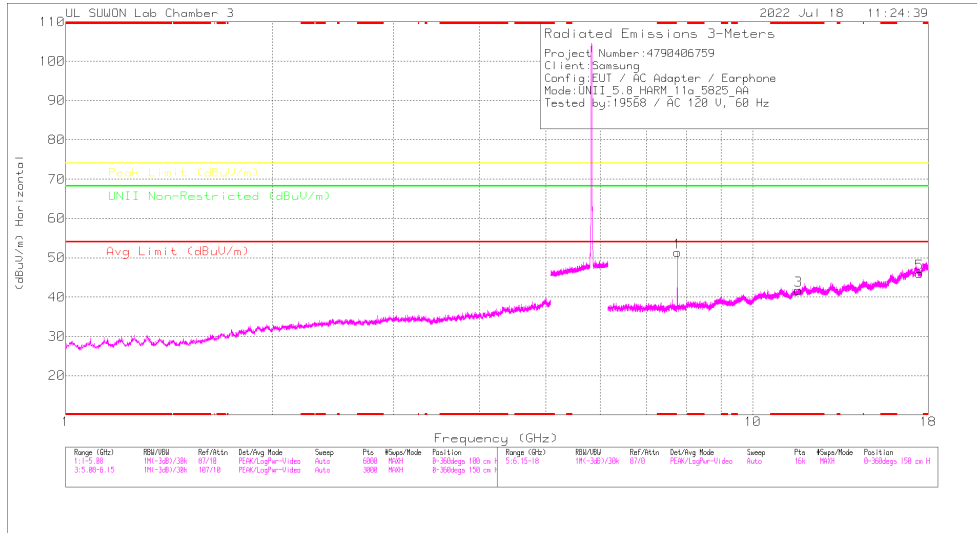

**5825 MHz VERTICAL**

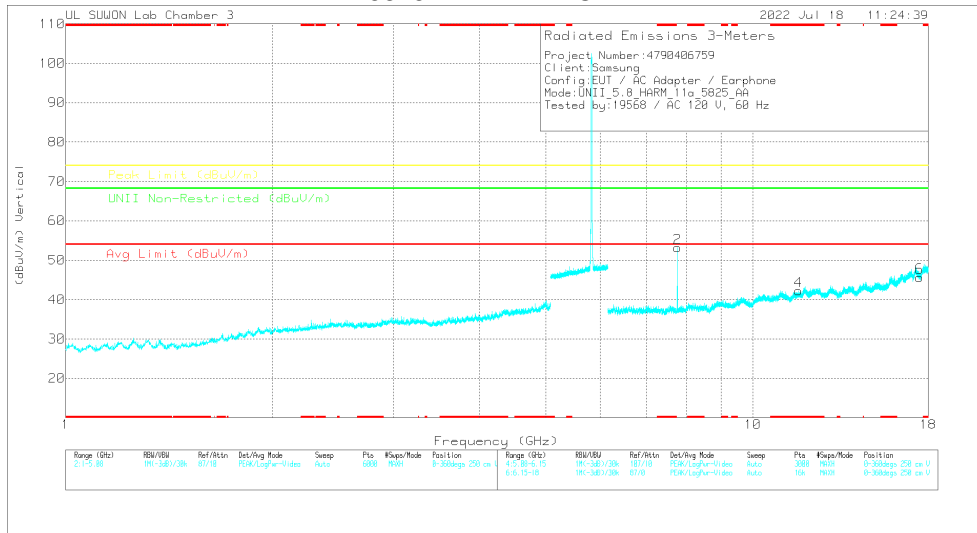

Note: Emission was scanned up to 40GHz; No emissions were detected above the noise floor which was at least 20dB below the specification limit.

**5825 MHz DATA**

**Radiated Emissions**

Frequency (GHz)	Main Reading (dBuV)	Det	317_00218657	6GHz_HPSIS	DC Corr (dB)	Corrected Reading (dBuV/m)	Avg Limit (dBuV/m)	Margin (dB)	Peak Limit (dBuV/m)	Margin (dB)	UNII Non-Restricted (dBuV/m)	Margin (dB)	Altitude (m)	Height (m)	Polarity
7.76648	42.83	PK-U	36.3	-24.6	0	54.53	-	-	-	-	68.2	-13.67	326	121	H
7.76678	44.77	PK-U	36.3	-24.6	0	56.47	-	-	-	-	68.2	-11.73	184	126	V
11.85624	35.17	PK-U	38.8	-21.5	0	52.57	-	-	74	-21.43	-	-	360	100	H
11.84478	34.98	PK-U	38.8	-21.5	0	52.28	-	-	74	-21.72	-	-	360	100	V
17.47532	31.03	PK-U	42	-16.8	0	56.23	-	-	-	-	68.2	-11.97	0	100	H
17.48498	32.05	PK-U	42	-16.8	0	57.25	-	-	-	-	68.2	-10.95	360	100	V

\* - indicates frequency in CFR47 Pt 15 / IC RSS-Restricted Band  
 PK-U - U-NII: Maximum Peak

**HARMONICS AND SPURIOUS EMISSIONS TEST DATA**

Mode	Freq. [MHz]	Antenna	Frequency [GHz]	Reading [dBuV]	Detector Mode	ANT Factor	Loss [dB]	DC Corr [dB]	Result [dBuV/m]	AV Limit [dBuV/m]	AV Margin [dB]	PK Limit [dBuV/m]	PK Margin [dB]	Non-Restricted [dBuV/m]	Margin [dB]	Azimuth [Degs]	Height [cm]	Polarity	
802.11a	5745	MIMO	6.894	39.92	PK-U	36.20	-26.60	0.00	49.52	-	-	-	-	68.20	-18.68	278	101	H	
			6.894	39.50	PK-U	36.20	-26.60	0.00	49.10	-	-	-	-	68.20	-19.10	81	106	V	
			* 11.499	33.11	PK-U	38.70	-21.40	0.00	50.41	-	-	74.00	-23.59	-	-	0	100	H	
			* 11.49509	33.26	PK-U	38.70	-21.40	0.00	50.56	-	-	74.00	-23.44	-	-	0	100	V	
			17.226	32.47	PK-U	42.10	-17.20	0.00	57.37	-	-	-	-	-	68.20	-10.83	0	100	H
			17.239	32.74	PK-U	42.10	-17.10	0.00	57.74	-	-	-	-	-	68.20	-10.46	0	100	V
	5785	MIMO	6.942	39.10	PK-U	36.20	-26.30	0.00	49.00	-	-	-	-	68.20	-19.20	0	110	H	
			6.942	26.83	PK-U	36.20	-26.30	0.00	36.73	-	-	-	-	68.20	-31.47	83	103	V	
			* 11.57448	33.81	PK-U	38.80	-21.60	0.00	51.01	-	-	74.00	-22.99	-	-	0	100	H	
			* 11.57159	33.53	PK-U	38.80	-21.60	0.00	50.73	-	-	74.00	-23.27	-	-	0	100	V	
			17.355	31.20	PK-U	42.00	-17.20	0.00	56.00	-	-	-	-	-	68.20	-12.20	0	100	H
			17.361	31.04	PK-U	42.00	-17.30	0.00	55.74	-	-	-	-	-	68.20	-12.46	0	100	V
	5825	MIMO	7.766	42.83	PK-U	36.30	-24.60	0.00	54.53	-	-	-	-	68.20	-13.67	326	121	H	
			7.767	44.77	PK-U	36.30	-24.60	0.00	56.47	-	-	-	-	68.20	-11.73	184	126	V	
			* 11.65623	35.17	PK-U	38.90	-21.50	0.00	52.57	-	-	74.00	-21.43	-	-	360	100	H	
			* 11.64479	34.98	PK-U	38.80	-21.50	0.00	52.28	-	-	74.00	-21.72	-	-	360	100	V	
			17.475	31.03	PK-U	42.00	-16.80	0.00	56.23	-	-	-	-	-	68.20	-11.97	0	100	H
			17.485	32.05	PK-U	42.00	-16.80	0.00	57.25	-	-	-	-	-	68.20	-10.95	360	100	V
802.11ax (HE20) 4RU Spot-check	5785	MIMO	6.942	38.75	PK-U	36.20	-26.30	0.00	48.65	-	-	-	-	68.20	-19.55	360	119	H	
			6.942	38.71	PK-U	36.20	-26.30	0.00	48.61	-	-	-	-	68.20	-19.59	176	163	V	
			* 11.57439	34.33	PK-U	38.80	-21.60	0.00	51.53	-	-	74.00	-22.47	-	-	0	100	H	
			* 11.57828	34.20	PK-U	38.80	-21.60	0.00	51.40	-	-	74.00	-22.60	-	-	360	100	V	
			17.351	31.26	PK-U	42.00	-17.20	0.00	56.06	-	-	-	-	-	68.20	-12.14	0	100	H
			17.355	31.50	PK-U	42.00	-17.20	0.00	56.30	-	-	-	-	-	68.20	-11.90	360	100	V

Note1. PK-U - U-NII: Maximum Peak / ADR - U-NII AD primary method, RMS average  
 Note2. \* - indicates frequency in CFR47 Pt 15 / IC RSS-Restricted Band

## 11.5. Spurious Emissions for Simultaneous Transmission

### 11.5.1. Worst test case RSDB condition

Case 1	2.4 GHz WLAN ANT1 + ANT2	5GHz WLAN ANT1 + ANT2
Mode	802.11g	802.11a
Channel	10	64
Frequency[MHz]	2457	5320
Tone	-	-
RU	-	-
Data Rate	6 Mbps	6 Mbps
Axis (Worst)		X

#### **NOTE**

The lowest margin condition among the channels and modes were selected for test. Low, mid, and high channels of 2.4GH WLAN were tested, and the worst case configuration & data were listed in the test report.

### 11.5.2. Test Results

#### Spurious emission for Simultaneous Transmission Case1. - Z axis

#### HORIZONTAL

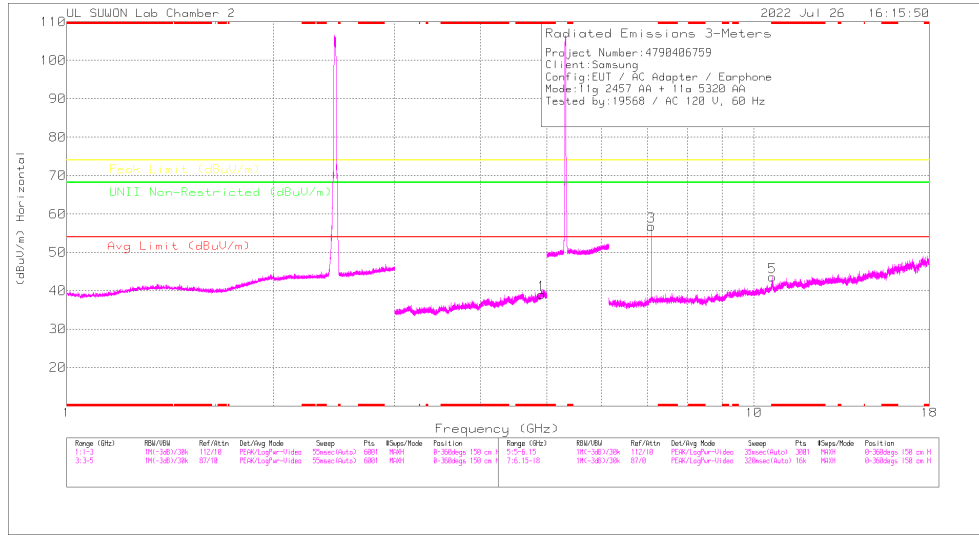

#### VERTICAL

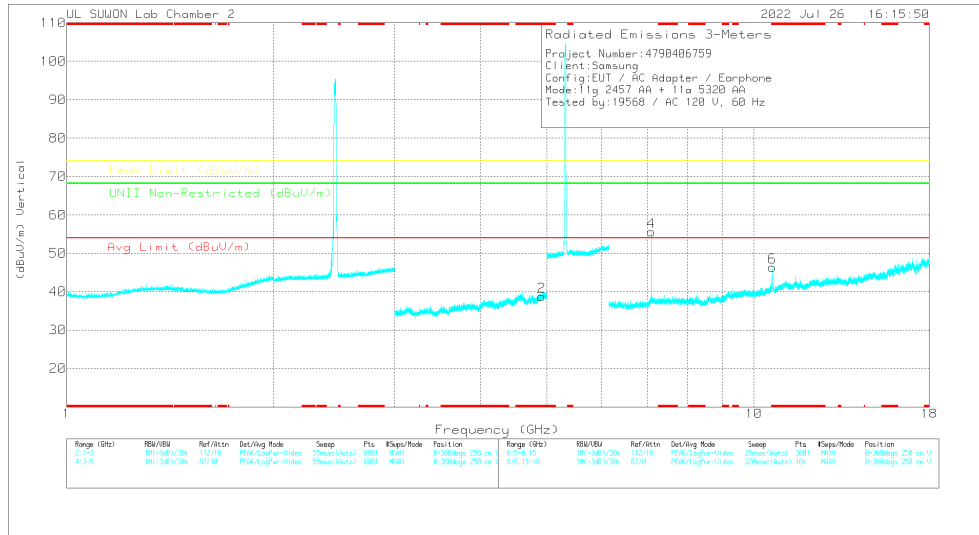

#### Radiated Emissions

Frequency (GHz)	Major Reading (dBuV)	Det	317_00160724	5GHz_HFdB	DC Corr (dB)	Corrected Reading (dBuV/m)	Avg Limit (dBuV/m)	Margin (dB)	Peak Limit (dBuV/m)	Margin (dB)	UNII Non-Restricted (dBuV/m)	Margin (dB)	Asmth (Degs)	Height (cm)	Polarity	
* 4.92324	40.77	PK2	34.1	-26	.5	49.37	-	-	74	-24.63	-	-	-	360	100	H
* 4.90436	41.44	PK2	34.1	-26.2	.5	49.84	-	-	74	-24.16	-	-	-	360	100	V

\* - indicates frequency in CFR47 Pt 15 / IC RSS-Restricted Band  
 PK2 - KDB558074 Method: Maximum Peak

Frequency (GHz)	Major Reading (dBuV)	Det	317_00160724	5GHz_HFdB	DC Corr (dB)	Corrected Reading (dBuV/m)	Avg Limit (dBuV/m)	Margin (dB)	Peak Limit (dBuV/m)	Margin (dB)	UNII Non-Restricted (dBuV/m)	Margin (dB)	Asmth (Degs)	Height (cm)	Polarity
7.09347	46.26	PK-U	36.1	-23.5	0	59.86	-	-	-	-	66.2	-9.34	342	111	H
7.09338	45.24	PK-U	36.1	-23.5	0	57.84	-	-	-	-	66.2	-10.36	41	106	V
* 10.64088	37.12	PK-U	37.9	-19.3	0	55.72	-	-	74	-18.28	-	-	91	264	H
* 10.64013	24.74	ADR	37.9	-19.3	.15	43.49	54	-10.51	-	-	-	-	91	264	H
* 10.64093	38.48	PK-U	37.9	-19.3	0	57.08	-	-	74	-16.92	-	-	312	106	V
* 10.64016	27.42	ADR	37.9	-19.3	.15	46.17	54	-7.63	-	-	-	-	312	106	V

\* - indicates frequency in CFR47 Pt 15 / IC RSS-Restricted Band  
 PK-U - U-NII: Maximum Peak  
 ADR - U-NII AD primary method, RMS average

## 12. WORST-CASE BELOW 1 GHz SPURIOUS EMISSIONS 30 TO 1000 MHz (WORST-CASE CONFIGURATION, HORIZONTAL)

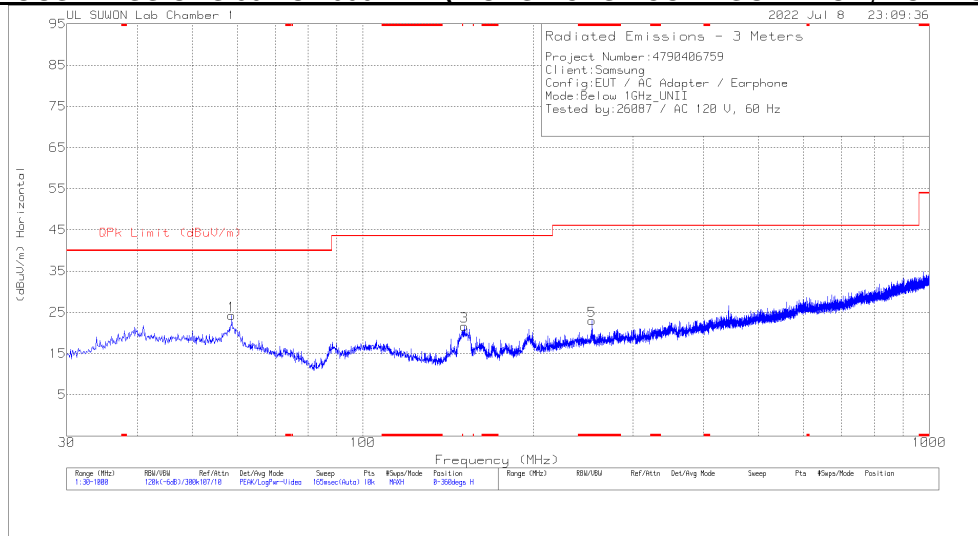

## SPURIOUS EMISSIONS 30 TO 1000 MHz (WORST-CASE CONFIGURATION, VERTICAL)

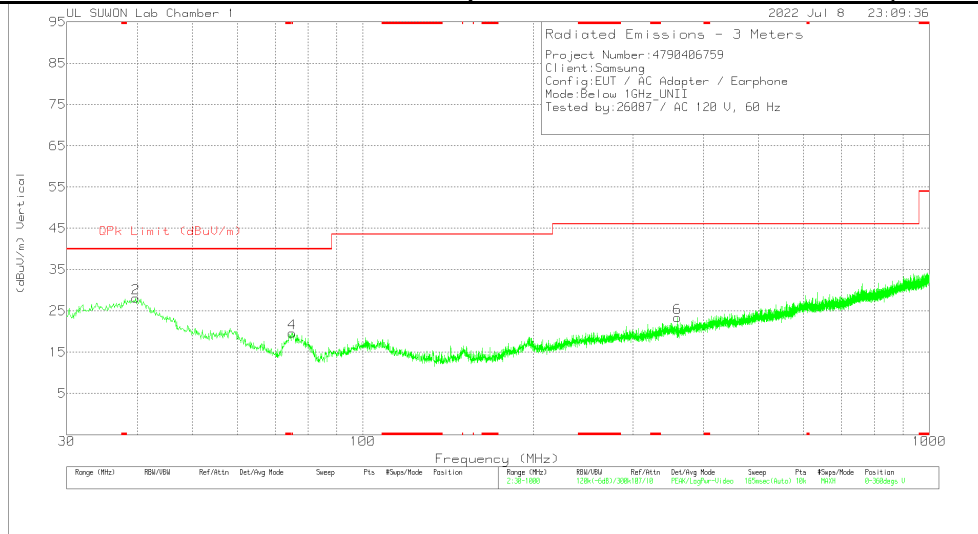

### Trace Markers

Marker	Frequency (MHz)	Meter Reading (dBuV)	Det	VULB9163_750	Below_1G[dB]	DC Corr (dB)	Corrected Reading (dBuV/m)	QPk Limit (dBuV/m)	Margin (dB)	Azimuth (Degs)	Height (cm)	Polarity
1	58.712	36.1	Pk	18.9	-30.8	0	24.2	40	-15.8	0-360	300	H
3	150.959	37.31	Pk	14	-29.7	0	21.61	43.52	-21.91	0-360	100	H
5	* 254.07	33.42	Pk	18.5	-28.9	0	23.02	46.02	-23	0-360	100	H
2	39.7	40.65	Pk	18.6	-31.1	0	28.15	40	-11.85	0-360	200	V
4	* 75.008	36.86	Pk	13.4	-30.6	0	19.66	40	-20.34	0-360	200	V
6	359.121	31.46	Pk	20.2	-28.3	0	23.36	46.02	-22.66	0-360	200	V

\* - indicates frequency in CFR47 Pt 15 / IC RSS-Restricted Band  
 Pk - Peak detector

### 13. AC POWER LINE CONDUCTED EMISSIONS

#### LIMITS

FCC §15.207 (a)  
IC RSS-GEN Clause 8.8

Frequency of Emission (MHz)	Conducted Limit (dBuV)	
	Quasi-peak	Average
0.15-0.5	66 to 56 <sup>*</sup>	56 to 46 <sup>*</sup>
0.5-5	56	46
5-30	60	50

<sup>\*</sup>Decreases with the logarithm of the frequency.

#### TEST PROCEDURE

The EUT is placed on a non-conducting table 40 cm from the vertical ground plane and 80 cm above the horizontal ground plane. The EUT is configured in accordance with ANSI C63.10.

The receiver is set to a resolution bandwidth of 9 kHz. Peak detection is used unless otherwise noted as quasi-peak or average.

Line conducted data is recorded for both NEUTRAL and HOT lines.

#### RESULTS



**WORST EMISSIONS(C to C)**

**LINE 1 DATA**

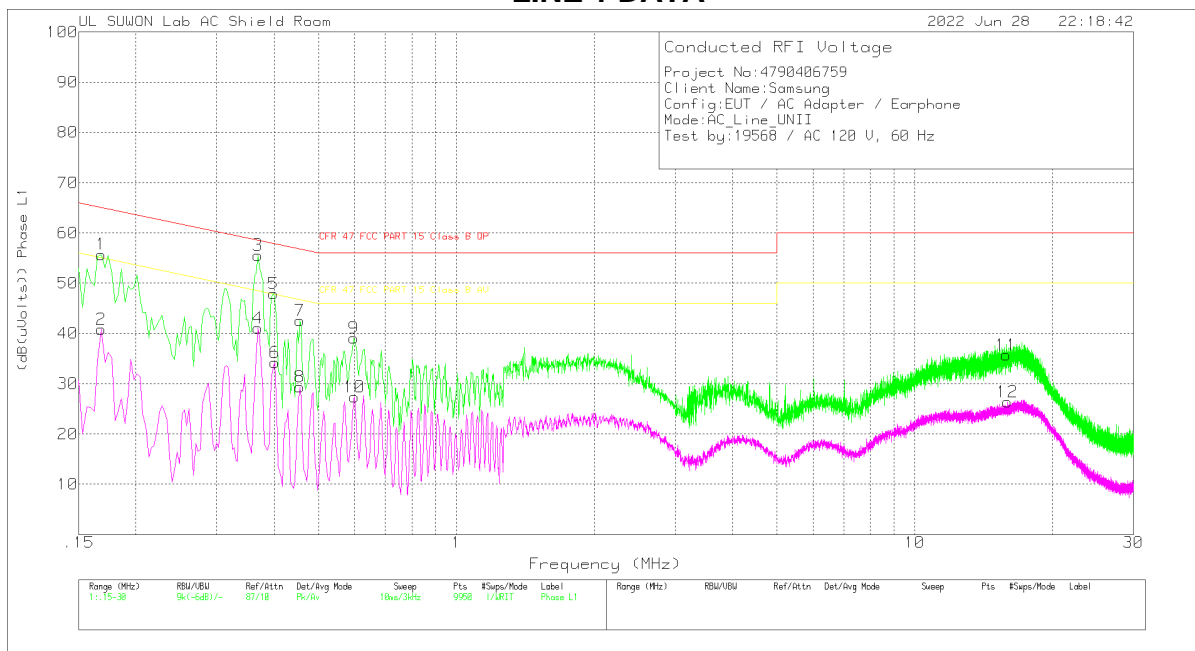

**Trace Markers**

**Range 1: Phase L1 .15 - 30MHz**

Marker	Frequency (MHz)	Meter Reading (dBuV)	Det	101836_With EX_L1[dB]	CABLELOS S(dB)	Corrected Reading (dB(uVolts))	CFR 47 FCC PART 15 Class B QP	Margin (dB)	CFR 47 FCC PART 15 Class B AV	Margin (dB)
1	.168	45.63	Pk	10	.1	55.73	65.06	-9.33	-	-
2	.168	30.72	Av	10	.1	40.82	-	-	55.06	-14.24
3	.369	45.6	Pk	9.8	.2	55.6	58.52	-2.92	-	-7.38
4	.369	31.14	Av	9.8	.2	41.14	-	-	48.52	-7.38
5	.399	37.94	Pk	9.8	.2	47.94	57.87	-9.93	-	-
6	.402	24.2	Av	9.8	.2	34.2	-	-	47.81	-13.61
7	.456	32.48	Pk	9.9	.2	42.58	56.77	-14.19	-	-
8	.456	19.3	Av	9.9	.2	29.4	-	-	46.77	-17.37
9	.597	29.07	Pk	9.8	.2	39.07	56	-16.93	-	-
10	.6	17.33	Av	9.8	.2	27.33	-	-	46	-18.67
11	15.84	25.38	Pk	10	.4	35.78	60	-24.22	-	-
12	15.927	16.02	Av	10	.4	26.42	-	-	50	-23.58

Pk - Peak detector

Av - Average detection

**Quasi-Peak Emissions**

**Range 1: Phase L1 .15 - 30MHz**

Frequency (MHz)	Meter Reading (dBuV)	Det	101836_With EX_L1[dB]	CABLELOS S(dB)	Corrected Reading (dB(uVolts))	CFR 47 FCC PART 15 Class B QP	Margin (dB)	CFR 47 FCC PART 15 Class B AV	Margin (dB)
.16875	38.22	Qp	10	.1	48.32	65.02	-16.7	-	-
.36915	43.89	Qp	9.8	.2	53.89	58.52	-4.63	-	-
.39825	36.52	Qp	9.8	.2	46.52	57.89	-11.37	-	-

Qp - Quasi-Peak detector

LINE 2 DATA

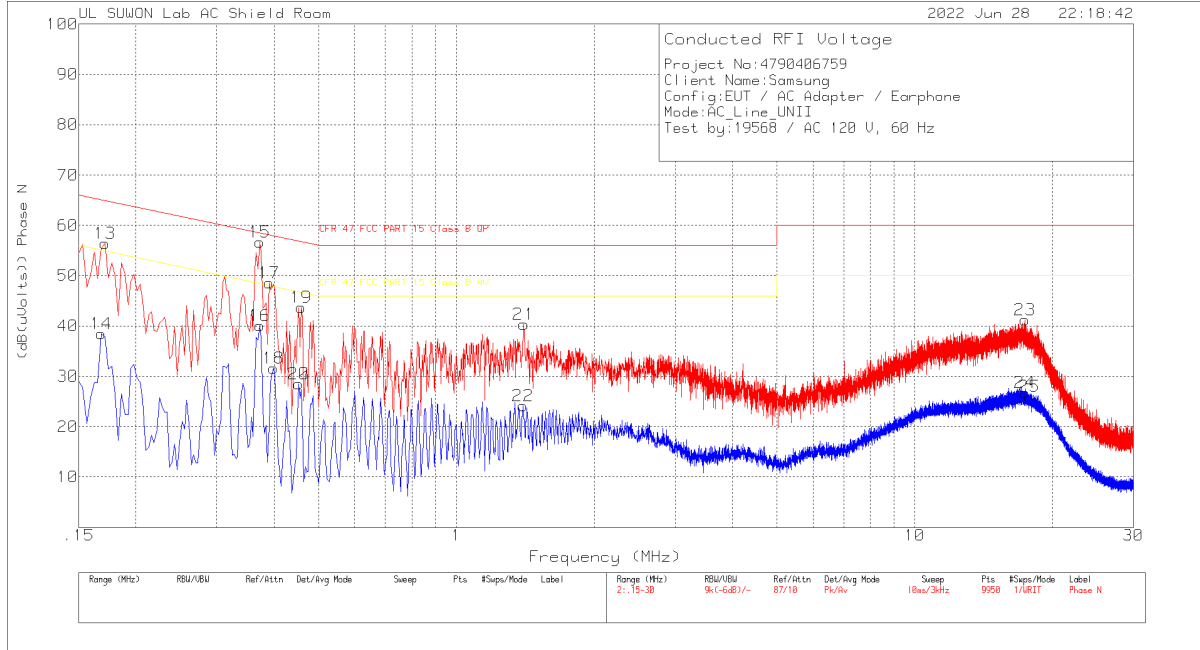

Trace Markers

Range 2: Phase N .15 - 30MHz

Marker	Frequency (MHz)	Meter Reading (dBuV)	Det	101836_With EX_N[dB]	CABLELOS S(dB)	Corrected Reading (dB(uVolts))	CFR 47 FCC PART 15 Class B QP	Margin (dB)	CFR 47 FCC PART 15 Class B AV	Margin (dB)
13	.171	46.25	Pk	10	.2	56.45	64.91	-8.46	-	-
14	.168	28.34	Av	10	.1	38.44	-	-	55.06	-16.62
15	.372	46.68	Pk	9.8	.2	56.68	58.46	-1.78	-	-
16	.372	30.14	Av	9.8	.2	40.14	-	-	48.46	-8.32
17	.39	38.59	Pk	9.8	.2	48.59	58.06	-9.47	-	-
18	.399	21.58	Av	9.8	.2	31.58	-	-	47.87	-16.29
19	.459	33.55	Pk	9.9	.2	43.65	56.71	-13.06	-	-
20	.453	18.36	Av	9.9	.2	28.46	-	-	46.82	-18.36
21	1.404	30.34	Pk	9.7	.3	40.34	56	-15.66	-	-
22	1.398	14.17	Av	9.7	.3	24.17	-	-	46	-21.83
23	17.403	30.59	Pk	10.2	.4	41.19	60	-18.81	-	-
24	17.385	16.13	Av	10.2	.4	26.73	-	-	50	-23.27
25	17.787	15.36	Av	10.2	.4	25.96	-	-	50	-24.04

Pk - Peak detector  
 Av - Average detection

Quasi-Peak Emissions

Range 2: Phase N .15 - 30MHz

Frequency (MHz)	Meter Reading (dBuV)	Det	101836_With EX_N[dB]	CABLELOS S(dB)	Corrected Reading (dB(uVolts))	CFR 47 FCC PART 15 Class B QP	Margin (dB)	CFR 47 FCC PART 15 Class B AV	Margin (dB)
.17115	44.41	Qp	10	.2	54.61	64.9	-10.29	-	-
.37125	44.75	Qp	9.8	.2	54.75	58.47	-3.72	-	-
.39075	29.38	Qp	9.8	.2	39.38	58.05	-18.67	-	-

Qp - Quasi-Peak detector

**WORST EMISSIONS(C to A)**

**LINE 1 DATA**

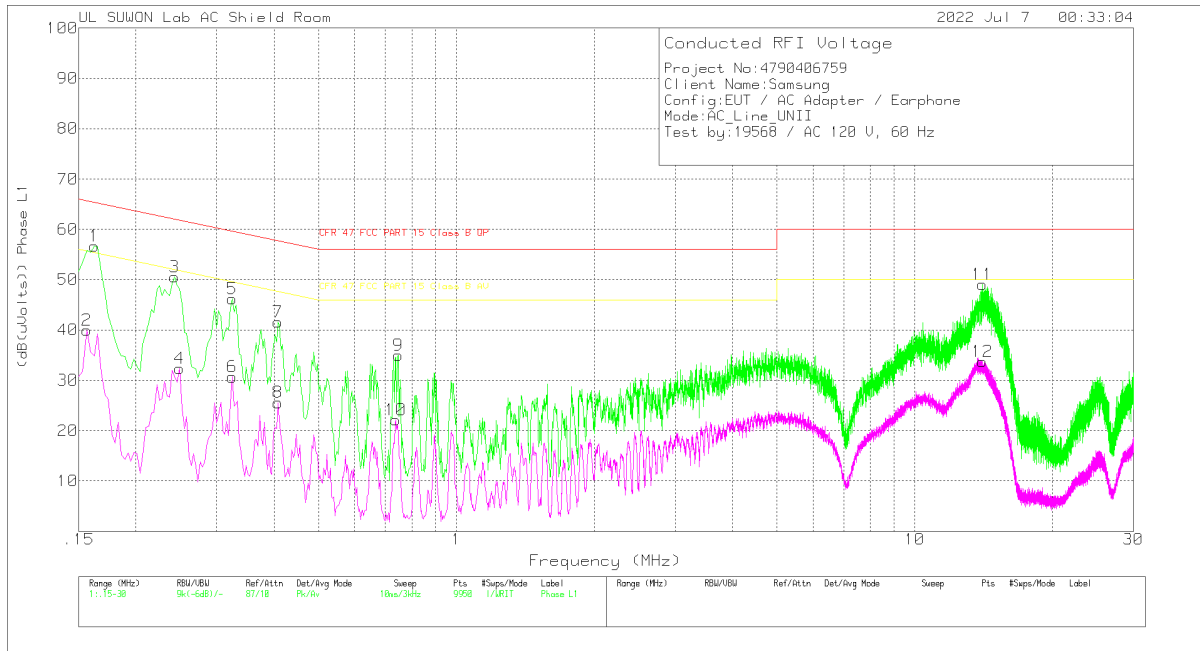

**Trace Markers**

Range 1: Phase L1 .15 - 30MHz

Marker	Frequency (MHz)	Meter Reading (dBuV)	Det	101836_With EX_L1[dB]	CABLELOS S(dB)	Corrected Reading (dB(uVolts))	CFR 47 FCC PART 15 Class B QP	Margin (dB)	CFR 47 FCC PART 15 Class B AV	Margin (dB)
1	.162	46.72	Pk	9.9	.1	56.72	65.36	-8.64	-	-
2	.156	30.11	Av	9.8	.1	40.01	-	-	55.67	-15.66
3	.243	40.7	Pk	9.6	.2	50.5	61.99	-11.49	-	-
4	.249	22.61	Av	9.6	.2	32.41	-	-	51.79	-19.38
5	.324	36.3	Pk	9.7	.2	46.2	59.6	-13.4	-	-
6	.324	20.78	Av	9.7	.2	30.68	-	-	49.6	-18.92
7	.408	31.54	Pk	9.8	.2	41.54	57.69	-16.15	-	-
8	.408	15.57	Av	9.8	.2	25.57	-	-	47.69	-22.12
9	.747	25	Pk	9.8	.2	35	56	-21	-	-
10	.738	12.17	Av	9.8	.2	22.17	-	-	46	-23.83
11	14.064	38.62	Pk	10	.4	49.02	60	-10.98	-	-
12	14.049	23.37	Av	10	.4	33.77	-	-	50	-16.23

Pk - Peak detector

Av - Average detection

**Quasi-Peak Emissions**

Range 1: Phase L1 .15 - 30MHz

Frequency (MHz)	Meter Reading (dBuV)	Det	101836_With EX_L1[dB]	CABLELOS S(dB)	Corrected Reading (dB(uVolts))	CFR 47 FCC PART 15 Class B QP	Margin (dB)	CFR 47 FCC PART 15 Class B AV	Margin (dB)
.16125	43.18	Qp	9.9	.1	53.18	65.4	-12.22	-	-

Qp - Quasi-Peak detector

### LINE 2 DATA

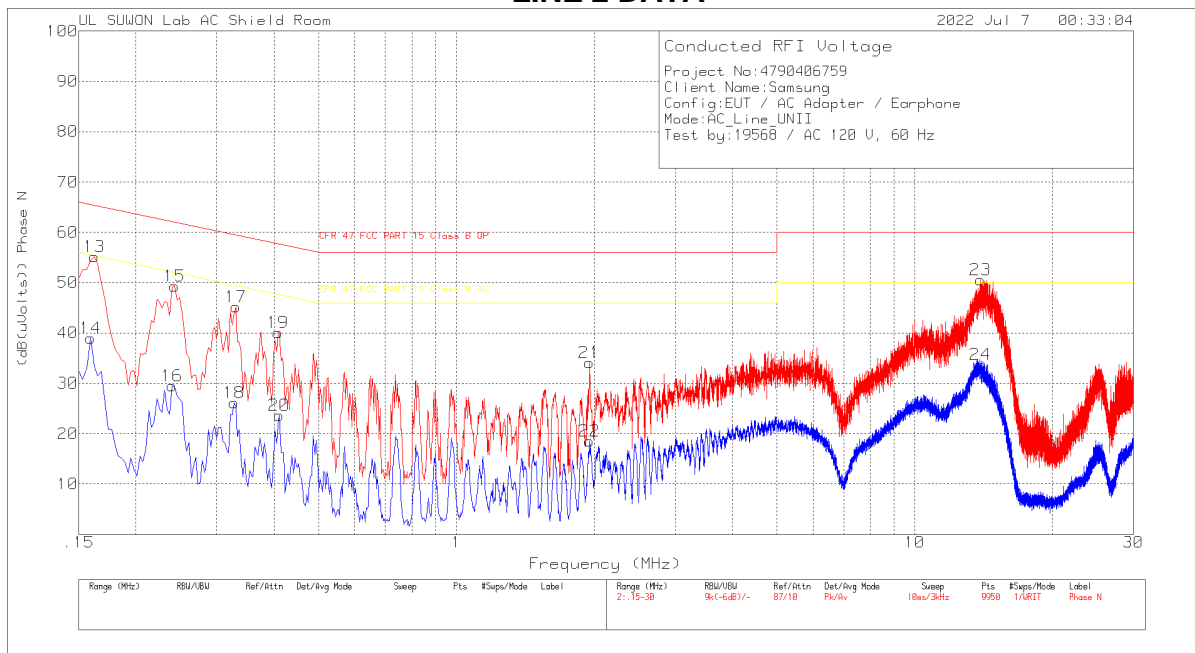

### Trace Markers

#### Range 2: Phase N .15 - 30MHz

Marker	Frequency (MHz)	Meter Reading (dBuV)	Det	101836_With EX_N[dB]	CABLELOSS S(dB)	Corrected Reading (dB(uVolts))	CFR 47 FCC PART 15 Class B QP	Margin (dB)	CFR 47 FCC PART 15 Class B AV	Margin (dB)
13	.162	45.15	Pk	9.9	.1	55.15	65.36	-10.21	-	-
14	.159	29.06	Av	9.8	.1	38.96	-	-	55.52	-16.56
15	.243	39.55	Pk	9.6	.2	49.35	61.99	-12.64	-	-
16	.24	19.58	Av	9.7	.2	29.48	-	-	52.1	-22.62
17	.33	35.14	Pk	9.8	.2	45.14	59.45	-14.31	-	-
18	.327	16.24	Av	9.7	.2	26.14	-	-	49.53	-23.39
19	.408	30.09	Pk	9.8	.2	40.09	57.69	-17.6	-	-
20	.411	13.6	Av	9.8	.2	23.6	-	-	47.63	-24.03
21	1.953	24.07	Pk	9.7	.3	34.07	56	-21.93	-	-
22	1.953	8.58	Av	9.7	.3	18.58	-	-	46	-27.42
23	13.902	40.14	Pk	10	.4	50.54	60	-9.46	-	-
24	13.908	23.35	Av	10	.4	33.75	-	-	50	-16.25

Pk - Peak detector  
 Av - Average detection

### Quasi-Peak Emissions

#### Range 2: Phase N .15 - 30MHz

Frequency (MHz)	Meter Reading (dBuV)	Det	101836_With EX_N[dB]	CABLELOSS (dB)	Corrected Reading (dB(uVolts))	CFR 47 FCC PART 15 Class B QP	Margin (dB)	CFR 47 FCC PART 15 Class B AV	Margin (dB)
13.9013	33.4	Qp	10	.4	43.8	60	-16.2	-	-

Qp - Quasi-Peak detector

## 14. DYNAMIC FREQUENCY SELECTION

### 14.1. OVERVIEW

#### 14.1.1. LIMITS

#### FCC

§15.407 (h), FCC KDB 905462 D02 “COMPLIANCE MEASUREMENT PROCEDURES FOR UNLICENSED-NATIONAL INFORMATION INFRASTRUCTURE DEVICES OPERATING IN THE 5250-5350 MHz AND 5470-5725 MHz BANDS INCORPORATING DYNAMIC FREQUENCY SELECTION” and KDB 905462 D03 “U-NII CLIENT DEVICES WITHOUT RADAR DETECTION CAPABILITY”.

**Table 1: Applicability of DFS requirements prior to use of a channel**

Requirement	Operational Mode		
	Master	Client (without radar detection)	Client (with radar detection)
Non-Occupancy Period	Yes	Not required	Yes
DFS Detection Threshold	Yes	Not required	Yes
Channel Availability Check Time	Yes	Not required	Not required
U-NII Detection Bandwidth	Yes	Not required	Yes

**Table 2: Applicability of DFS requirements during normal operation**

Requirement	Operational Mode		
	Master	Client (without DFS)	Client (with DFS)
DFS Detection Threshold	Yes	Not required	Yes
Channel Closing Transmission Time	Yes	Yes	Yes
Channel Move Time	Yes	Yes	Yes
U-NII Detection Bandwidth	Yes	Not required	Yes

Additional requirements for devices with multiple bandwidth modes	Master Device or Client with Radar DFS	Client (without DFS)
U-NII Detection Bandwidth and Statistical Performance Check	All BW modes must be tested	Not required
Channel Move Time and Channel Closing Transmission Time	Test using widest BW mode available	Test using the widest BW mode available for the link
All other tests	Any single BW mode	Not required
<b>Note:</b> Frequencies selected for statistical performance check (Section 7.8.4) should include several frequencies within the radar detection bandwidth and frequencies near the edge of the radar detection bandwidth. For 802.11 devices it is suggested to select frequencies in all 20 MHz channel blocks and a null frequency between the bonded 20 MHz channel blocks.		

**Table 3: Interference Threshold values, Master or Client incorporating In-Service Monitoring**

Maximum Transmit Power	Value (see notes)
E.I.R.P. $\geq$ 200 mill watt	-64 dBm
E.I.R.P. < 200 mill watt and power spectral density < 10 dBm/MHz	-62 dBm
E.I.R.P. < 200 mill watt that do not meet power spectral density requirement	-64 dBm
<p><b>Note 1:</b> This is the level at the input of the receiver assuming a 0 dBi receive antenna  <b>Note 2:</b> Throughout these test procedures an additional 1 dB has been added to the amplitude of the test transmission waveforms to account for variations in measurement equipment. This will ensure that the test signal is at or above the detection threshold level to trigger a DFS response.  <b>Note 3:</b> E.I.R.P. is based on the highest antenna gain. For MIMO devices refer to KDB publication 662911 D01.</p>	

**Table 4: DFS Response requirement values**

Parameter	Value
<i>Non-occupancy period</i>	30 minutes
<i>Channel Availability Check Time</i>	60 seconds
<i>Channel Move Time</i>	10 seconds (See Note 1)
<i>Channel Closing Transmission Time</i>	200 milliseconds + approx. 60 milliseconds over remaining 10 second period. (See Notes 1 and 2)
<i>U-NII Detection Bandwidth</i>	Minimum 100% of the U- NII 99% transmission power bandwidth. (See Note 3)
<p><b>Note 1:</b> <i>Channel Move Time</i> and the <i>Channel Closing Transmission Time</i> should be performed with Radar Type 0. The measurement timing begins at the end of the Radar Type 0 burst.  <b>Note 2:</b> The <i>Channel Closing Transmission Time</i> is comprised of 200 milliseconds starting at the beginning of the <i>Channel Move Time</i> plus any additional intermittent control signals required to facilitate a <i>Channel</i> move (an aggregate of 60 milliseconds) during the remainder of the 10 second period. The aggregate duration of control signals will not count quiet periods in between transmissions.  <b>Note 3:</b> During the <i>U-NII Detection Bandwidth</i> detection test, radar type 0 should be used. For each frequency step the minimum percentage of detection is 90 percent. Measurements are performed with no data traffic.</p>	

**Table 5 – Short Pulse Radar Test Waveforms**

Radar Type	Pulse Width (usec)	PRI (usec)	Pulses	Minimum Percentage of Successful Detection	Minimum Trials
0	1	1428	18	See Note 1	See Note 1
1	1	Test A: 15 unique PRI values randomly selected from the list of 23 PRI values in table 5a	Roundup: $\{(1/360) \times (19 \times 10^6 \text{ PRI}_{\text{usec}})\}$	60%	30
		Test B: 15 unique PRI values randomly selected within the range of 518-3066 usec. With a minimum increment of 1 usec, excluding PRI values selected in Test A			
2	1-5	150-230	23-29	60%	30
3	6-10	200-500	16-18	60%	30
4	11-20	200-500	12-16	60%	30
Aggregate (Radar Types 1-4)				80%	120
<b>Note 1:</b> Short Pulse Radar Type 0 should be used for the <i>Detection Bandwidth</i> test, <i>Channel Move Time</i> , and <i>Channel Closing Time</i> tests.					

**Table 6 – Long Pulse Radar Test Signal**

Radar Waveform Type	Pulse Width (μsec)	Chirp Width (MHz)	PRI (μsec)	Pulses per Burst	Number of Bursts	Minimum Percentage of Successful Detection	Minimum Trials
5	50-100	5-20	1000-2000	1-3	8-20	80%	30

**Table 7 – Frequency Hopping Radar Test Signal**

Radar Waveform Type	Pulse Width (μsec)	PRI (μsec)	Pulses per Hop	Hopping Rate (kHz)	Hopping Sequence Length (msec)	Minimum Percentage of Successful Detection	Minimum Trials
6	1	333	9	0.333	300	70%	30

### 14.1.2. TEST AND MEASUREMENT SYSTEM

#### CONDUCTED METHOD SYSTEM BLOCK DIAGRAM

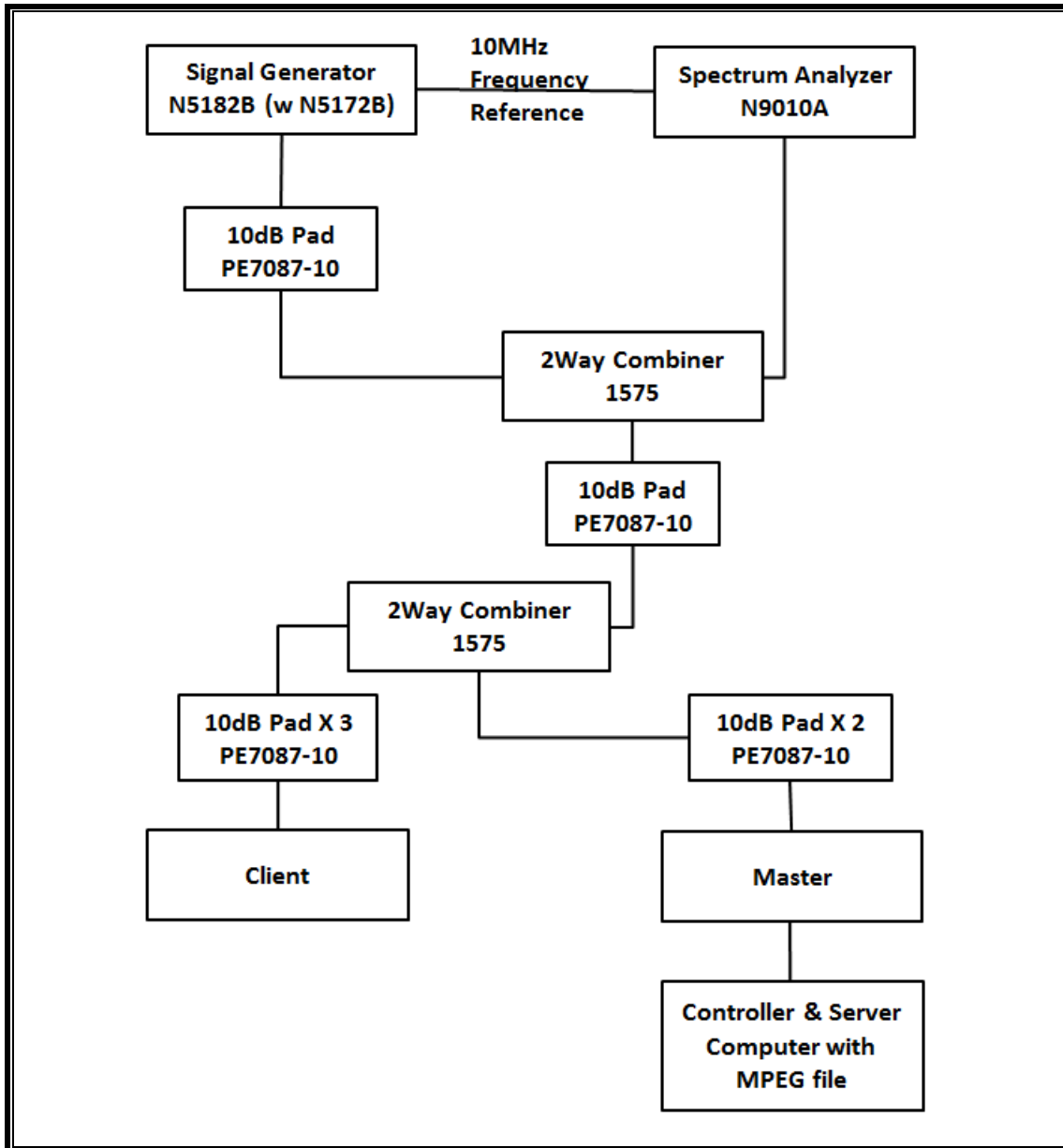



## **SYSTEM OVERVIEW**

The short pulse and long pulse signal generating system utilizes the Keysite Signal Studio for Pulse Building as N5172B. The Vector Signal Generator has been validated by the NTIA. The hopping signal generating system utilizes the CCS simulated hopping method and system, which has been validated by the DoD, FCC and NTIA. The software selects waveform parameters from within the bounds of the signal type on a random basis using uniform distribution.

The short pulse types 1, 2, 3 and 4, and the long pulse type 5 parameters are randomized at run-time.

The hopping type 6 pulse parameters are fixed while the hopping sequence is based on the August 2005 NTIA Hopping Frequency List. The initial starting point randomized at run-time and each subsequent starting point is incremented by 475. Each frequency in the 100-length segment is compared to the boundaries of the EUT Detection Bandwidth and the software creates a hopping burst pattern in accordance with Section 7.4.1.3 Method #2 Simulated Frequency Hopping Radar Waveform Generating Subsystem of KDB 905462 D02. The frequency of the signal generator is incremented in 1 MHz steps from  $F_L$  to  $F_H$  for each successive trial. This incremental sequence is repeated as required to generate a minimum of 30 total trials and to maintain a uniform frequency distribution over the entire Detection Bandwidth.

The signal monitoring equipment consists of a spectrum analyzer. The aggregate ON time is calculated by multiplying the number of bins above a threshold during a particular observation period by the dwell time per bin, with the analyzer set to peak detection and max hold.

## **SYSTEM CALIBRATION**

A 50-ohm load is connected in place of the spectrum analyzer, and the spectrum analyzer is connected to a horn antenna via a coaxial cable, with the reference level offset set to (horn antenna gain – coaxial cable loss). The signal generator is set to CW mode. The amplitude of the signal generator is adjusted to yield a level of –64 dBm as measured on the spectrum analyzer.

Without changing any of the instrument settings, the spectrum analyzer is reconnected to the Common port of the Spectrum Analyzer Combiner/Divider. The Reference Level Offset of the spectrum analyzer is adjusted so that the displayed amplitude of the signal is –64 dBm.

The spectrum analyzer displays the level of the signal generator as received at the antenna ports of the Master Device. The interference detection threshold may be varied from the calibrated value of –64 dBm and the spectrum analyzer will still indicate the level as received by the Master Device.

**ADJUSTMENT OF DISPLAYED TRAFFIC LEVEL**

A link is established between the Master and Slave and the distance between the units is adjusted as needed to provide a suitable received level at the Master and Slave devices. The video test file is streamed to generate WLAN traffic. The monitoring antenna is adjusted so that the WLAN traffic level, as displayed on the spectrum analyzer, is at lower amplitude than the radar detection threshold.

**TEST AND MEASUREMENT EQUIPMENT**

The following test and measurement equipment was utilized for the DFS tests documented in this report:

TEST EQUIPMENT LIST				
Description	Manufacturer	Model	S/N	Next Cal Due
Spectrum Analyzer, 7 GHz	Agilent / HP	N9010A	MY54200580	08-02-22
Vector Signal Generator, 6GHz	Agilent / HP	N5182B	MY53051241	08-02-22
Combiner	WEINSCHTEL	WA1534	UL001	01-11-23
Combiner	WEINSCHTEL	WA1535	UL002	01-11-23

**14.1.3. SETUP OF EUT**

**CONDUCTED METHOD EUT TEST SETUP**

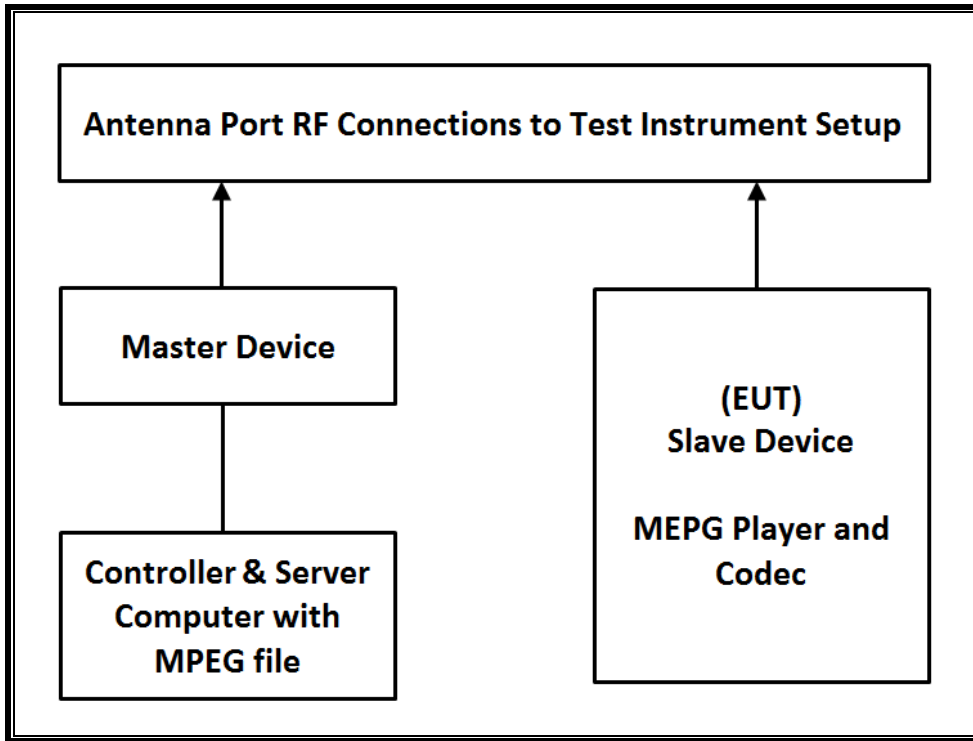

**SUPPORT EQUIPMENT**

The following support equipment was utilized for the DFS tests documented in this report:

PERIPHERAL SUPPORT EQUIPMENT LIST				
Description	Manufacturer	Model	Serial Number	FCC ID
Wireless Access Point	Cisco	AIR-CAP3702E-A-K9	FTX182276QX	LDK102087
Notebook PC (Controller/Server)	HP	HP EliteDesk 800 G1 TWR	CZC4125J25	DoC

#### **14.1.4. DESCRIPTION OF EUT**

The EUT operates over the 5250-5350 MHz and 5470-5725 MHz ranges.

The EUT is a Slave Device without Radar Detection.

The highest power level of the widest bandwidth (802.11ac VHT80) within these bands is 13.66 dBm in the 5250-5350 MHz band and 13.51 dBm in the 5470-5725 MHz band.

The antenna assembly utilized two antenna.

Gain of ANT1 : -5.0 dBi for UNII 2A and -4.1 dBi for UNII 2C.

Gain of ANT2 : -2.9 dBi for UNII 2A and -2.6 dBi for UNII 2C.

The rated output power of the Master unit is > 23dBm (EIRP). Therefore the required interference threshold level is -64 dBm. After correction for procedural adjustments, the required conducted threshold at the antenna port is  $-64 + 1 = -63$  dBm.

The calibrated radiated DFS Detection Threshold level is set to -64 dBm. The tested level is lower than the required level hence it provides a margin to the limit.

The EUT uses one transmitter/receiver chain connected to an antenna to perform radiated tests. WLAN traffic that meets or exceeds the minimum required loading was generated by transferring a data stream from the controller/server PC to the EUT using iPerf version 2.0.5 software package.

TPC is not required since the maximum EIRP is less than 500 mW (27 dBm).

The EUT utilizes the 802.11 architecture. Three nominal channel bandwidths are implemented: 20 MHz, 40 MHz and 80 MHz.

The software installed in the access point is 12.4(25d)JA1.

#### **UNIFORM CHANNEL SPREADING**

This requirement is not applicable to Slave radio devices.

#### **CHANNEL PUNCTURING(802.11ax)**

This EUT does not support channel puncturing.

#### **OVERVIEW OF MASTER DEVICE WITH RESPECT TO §15.407 (h) REQUIREMENTS**

The Master Device is a Cisco Access Point, FCC ID: LDK102087. The minimum antenna gain for the Master Device is 6 dBi.

The rated output power of the Master unit is > 23dBm (EIRP). Therefore the required interference threshold level is -64 dBm. After correction for procedural adjustments, the required radiated threshold at the antenna port is  $-64 + 1 = -63$  dBm.

The calibrated radiated DFS Detection Threshold level is set to -64 dBm. The tested level is lower than the required level hence it provides a margin to the limit.

## 14.2. RESULTS FOR 80 MHz BANDWIDTH (UNII-2A BAND)

### 14.2.1. TEST CHANNEL

All tests were performed at a channel center frequency of 5290 MHz.

### 14.2.2. RADAR WAVEFORM AND TRAFFIC

#### RADAR WAVEFORM

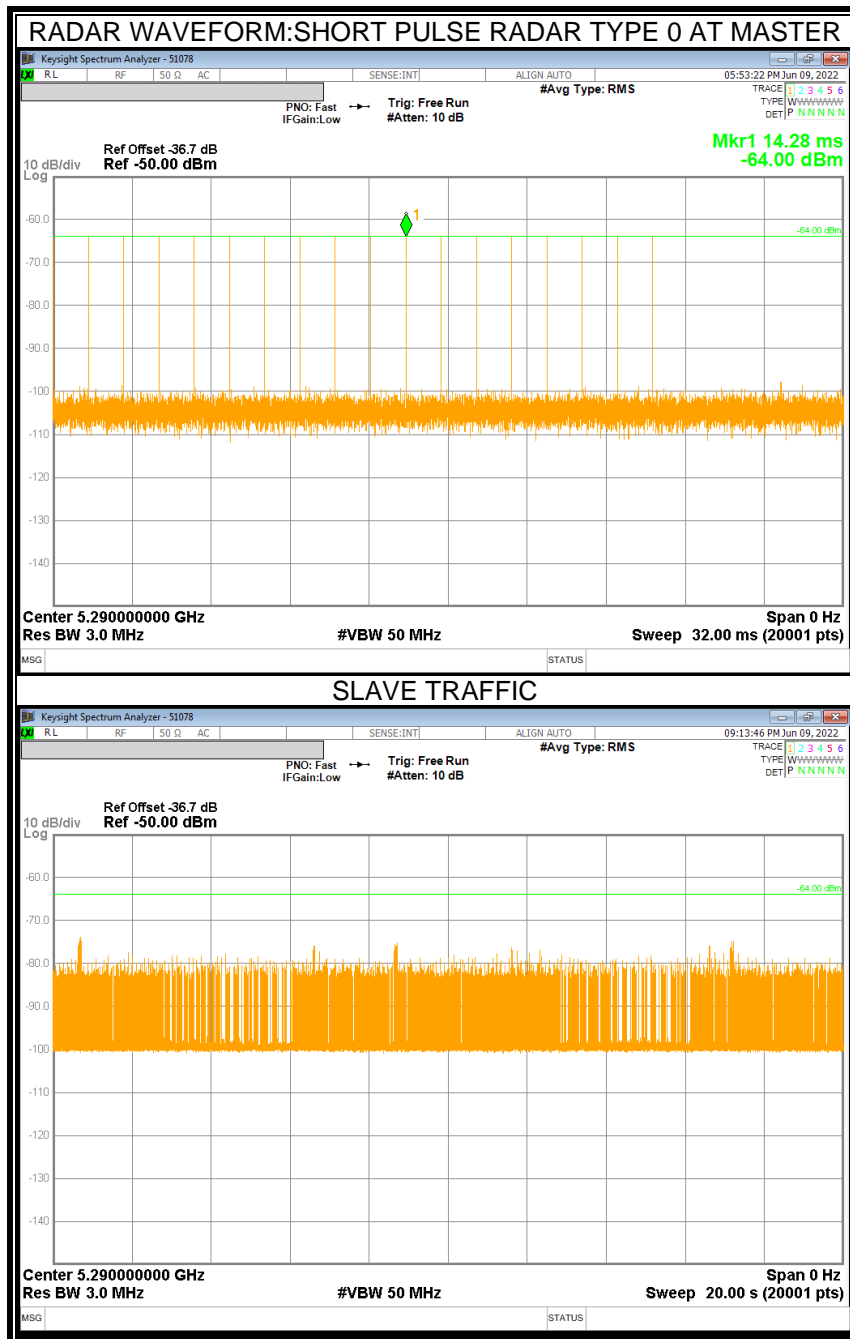

### 14.2.3. OVERLAPPING CHANNEL TESTS

#### RESULTS

These tests are not applicable.

### 14.2.4. MOVE AND CLOSING TIME

#### REPORTING NOTES

The reference marker is set at the end of last radar pulse.

The delta marker is set at the end of the last WLAN transmission following the radar pulse. This delta is the channel move time.

The aggregate channel closing transmission time is calculated as follows:

Aggregate Transmission Time =  
(Number of analyzer bins showing transmission) \* (dwell time per bin)

The observation period over which the aggregate time is calculated begins at (Reference Marker + 200 msec) and ends no earlier than (Reference Marker + 10 sec).

#### RESULTS

Channel Move Time (sec)	Limit (sec)
0.702	10

Aggregate Channel Closing Transmission Time (msec)	Limit (msec)
8.250	60

**MOVE TIME & CHANNEL CLOSING TIME**

**AGGREGATE CHANNEL CLOSING TRANSMISSION TIME**

No transmissions are observed during the aggregate monitoring period.

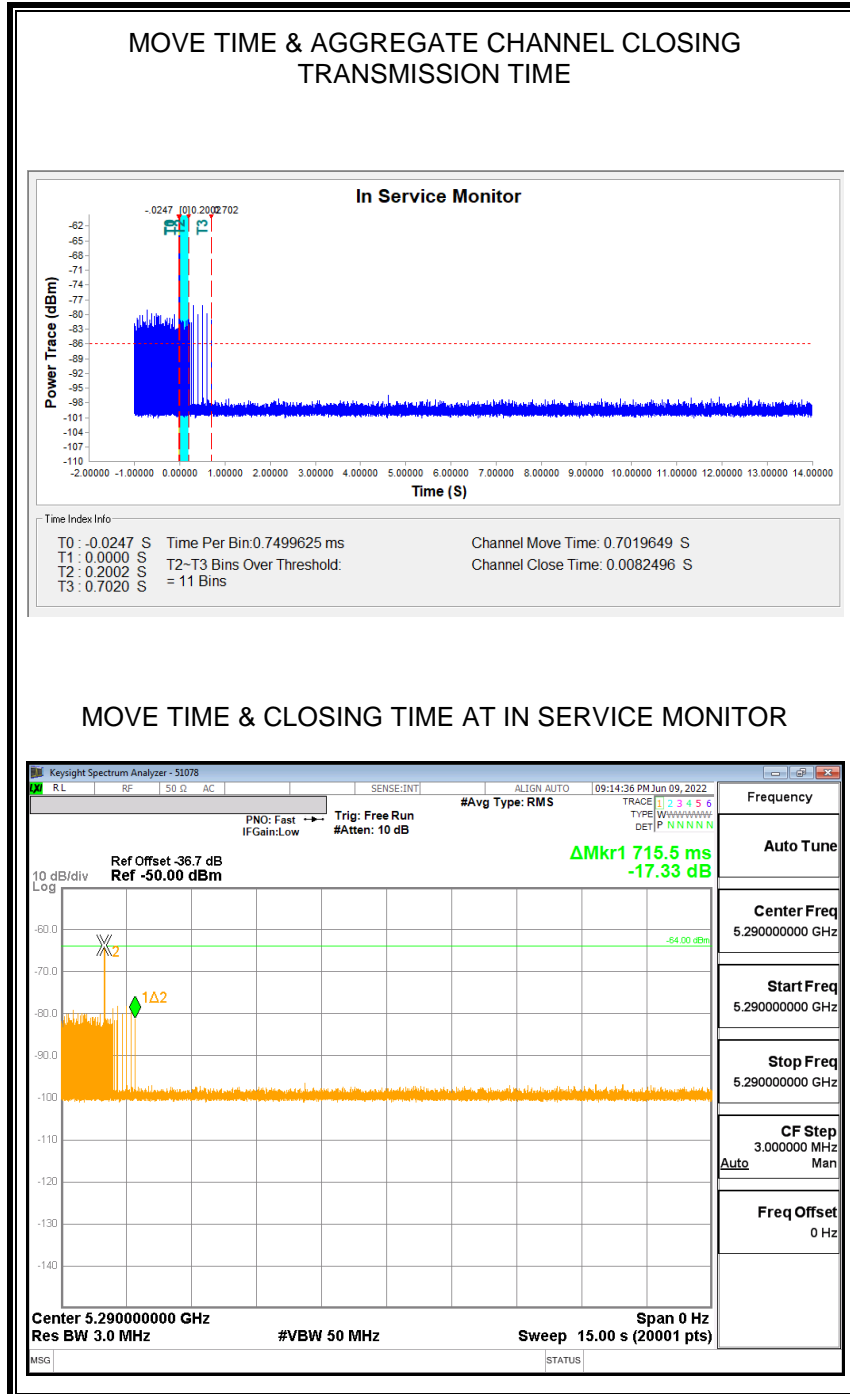

**NON-OCCUPANCY PERIOD**

**RESULTS**

No EUT transmissions were observed on the test channel during the 10-minute observation time.

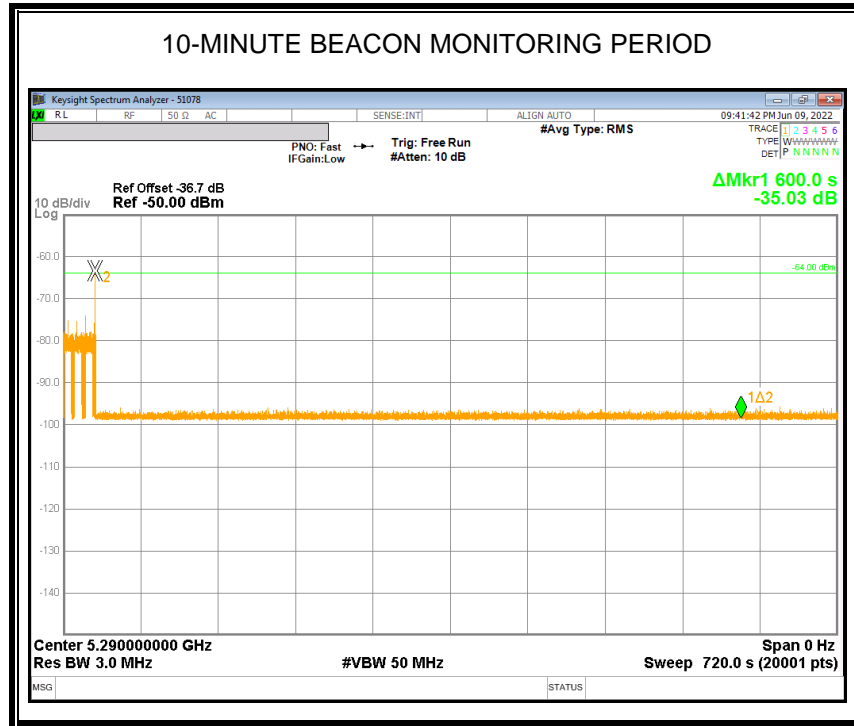



### 14.3. RESULTS FOR 80 MHz BANDWIDTH (UNII-2C BAND)

#### 14.3.1. TEST CHANNEL

All tests were performed at a channel center frequency of 5530 MHz.

#### 14.3.2. RADAR WAVEFORM AND TRAFFIC

##### RADAR WAVEFORM



### 14.3.3. OVERLAPPING CHANNEL TESTS

#### RESULTS

These tests are not applicable.

### 14.3.4. MOVE AND CLOSING TIME

#### REPORTING NOTES

The reference marker is set at the end of last radar pulse.

The delta marker is set at the end of the last WLAN transmission following the radar pulse. This delta is the channel move time.

The aggregate channel closing transmission time is calculated as follows:

Aggregate Transmission Time =  
(Number of analyzer bins showing transmission) \* (dwell time per bin)

The observation period over which the aggregate time is calculated begins at (Reference Marker + 200 msec) and ends no earlier than (Reference Marker + 10 sec).

#### RESULTS

Channel Move Time (sec)	Limit (sec)
0.730	10

Aggregate Channel Closing Transmission Time (msec)	Limit (msec)
6.750	60

**MOVE TIME & CHANNEL CLOSING TIME**

**AGGREGATE CHANNEL CLOSING TRANSMISSION TIME**

No transmissions are observed during the aggregate monitoring period.

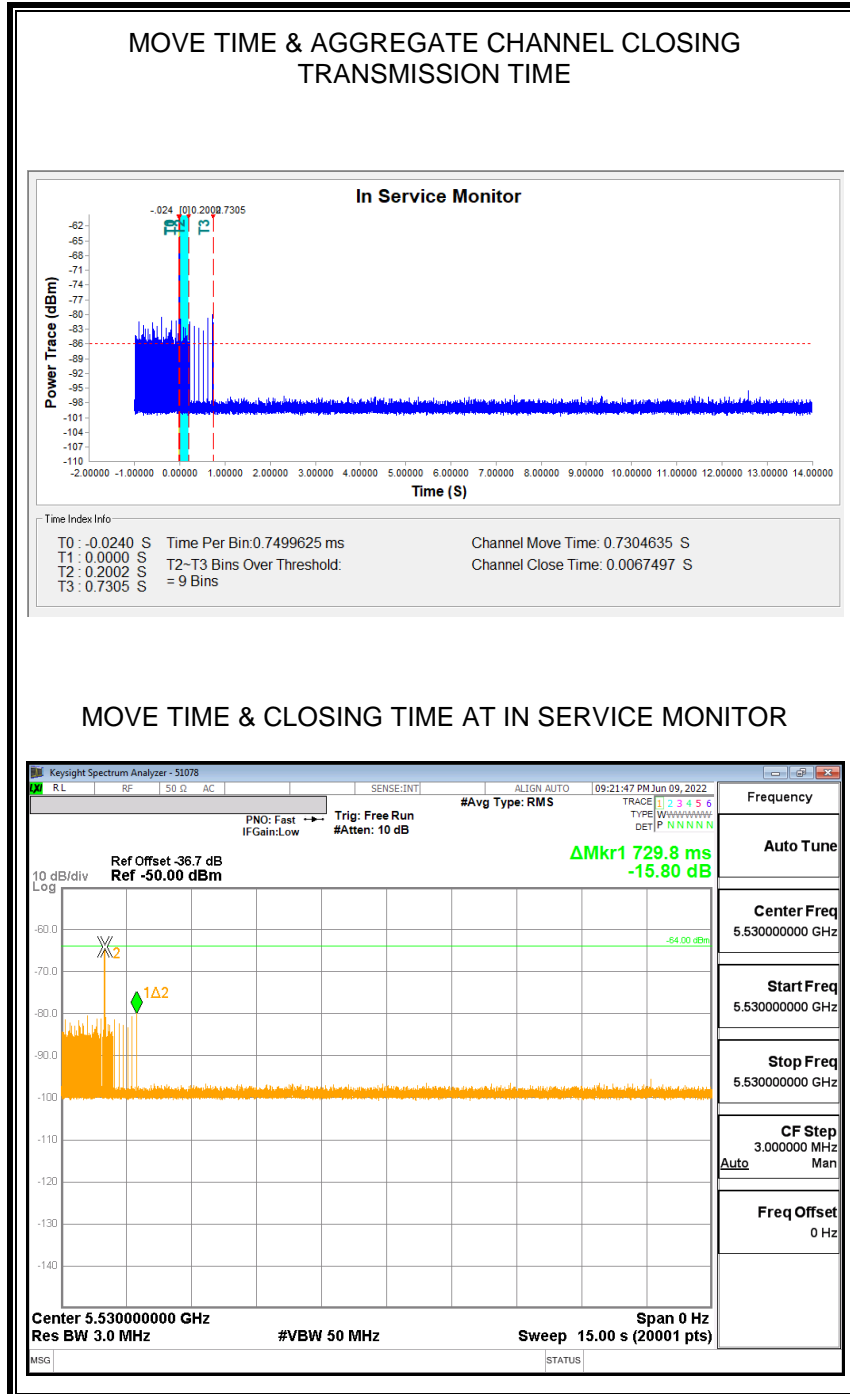

**NON-OCCUPANCY PERIOD**

**RESULTS**

No EUT transmissions were observed on the test channel during the 10-minute observation time.

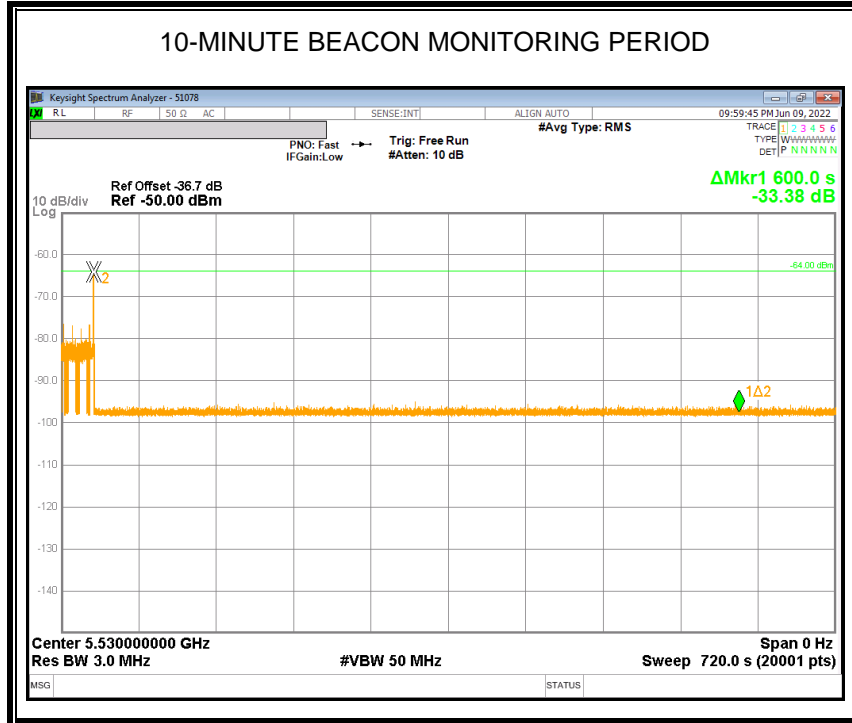

# 15. SPOT-CHECK TEST RESULT

## UNII-1

### BANDEDGE (WORST CASE: 802.11n HT40 MIMO / 5190 MHz)

#### HORIZONTAL PEAK AND AVERAGE DATA

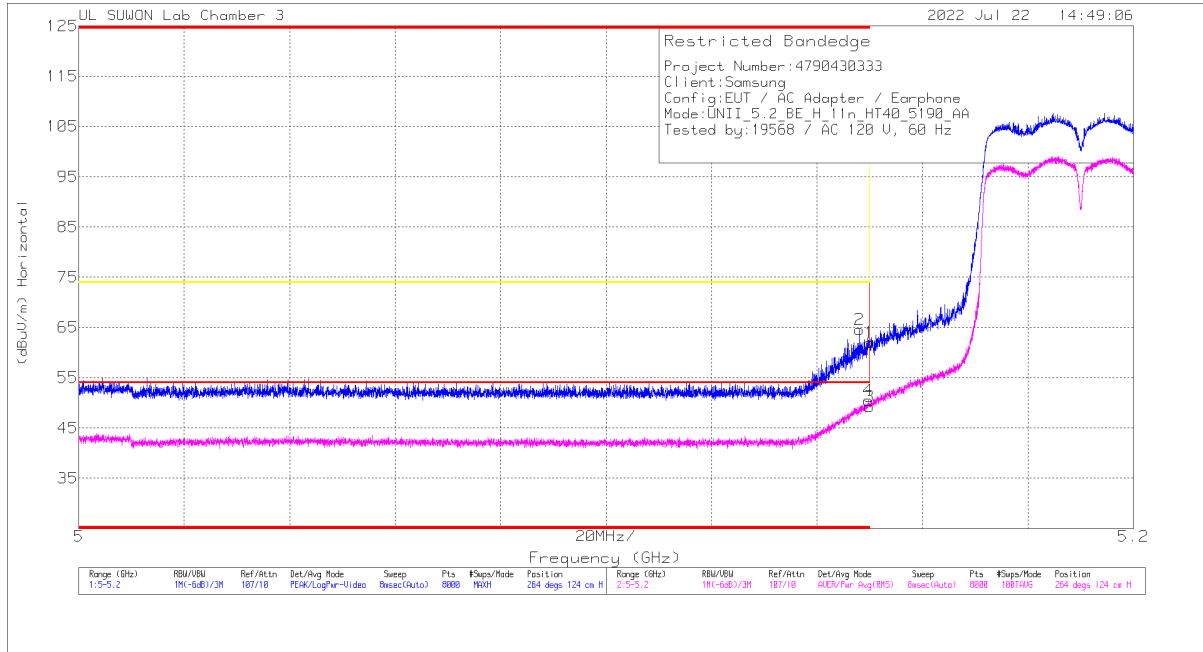

#### Trace Markers

Marker	Frequency (GHz)	Meter Reading (dBuV)	Det	3117_00218957	10dB_ATT[dB]	DC Cor (dB)	Corrected Reading (dBuV/m)	Average Limit (dBuV/m)	Margin (dB)	Peak Limit (dBuV/m)	PK Margin (dB)	Acimuth (Degs)	Height (cm)	Polarity
1	* 5.14999	47.72	Pk		-20.6	0	61.92	-	-	74	-12.08	264	124	H
2	* 5.14812	50.4	Pk		-20.6	0	64.6	-	-	74	-9.4	264	124	H
3	* 5.14999	35.04	RMS		-20.6	0	49.24	54	-4.76	-	-	264	124	H
4	* 5.14974	36.33	RMS		-20.6	0	50.53	54	-3.47	-	-	264	124	H

\* - indicates frequency in CFR47 Pt 15 / IC RSS-Restricted Band  
 Pk - Peak detector  
 RMS - RMS detection