

UNII Straddle Ch. IEEE 802.11ax HE40(SU) mode PSD

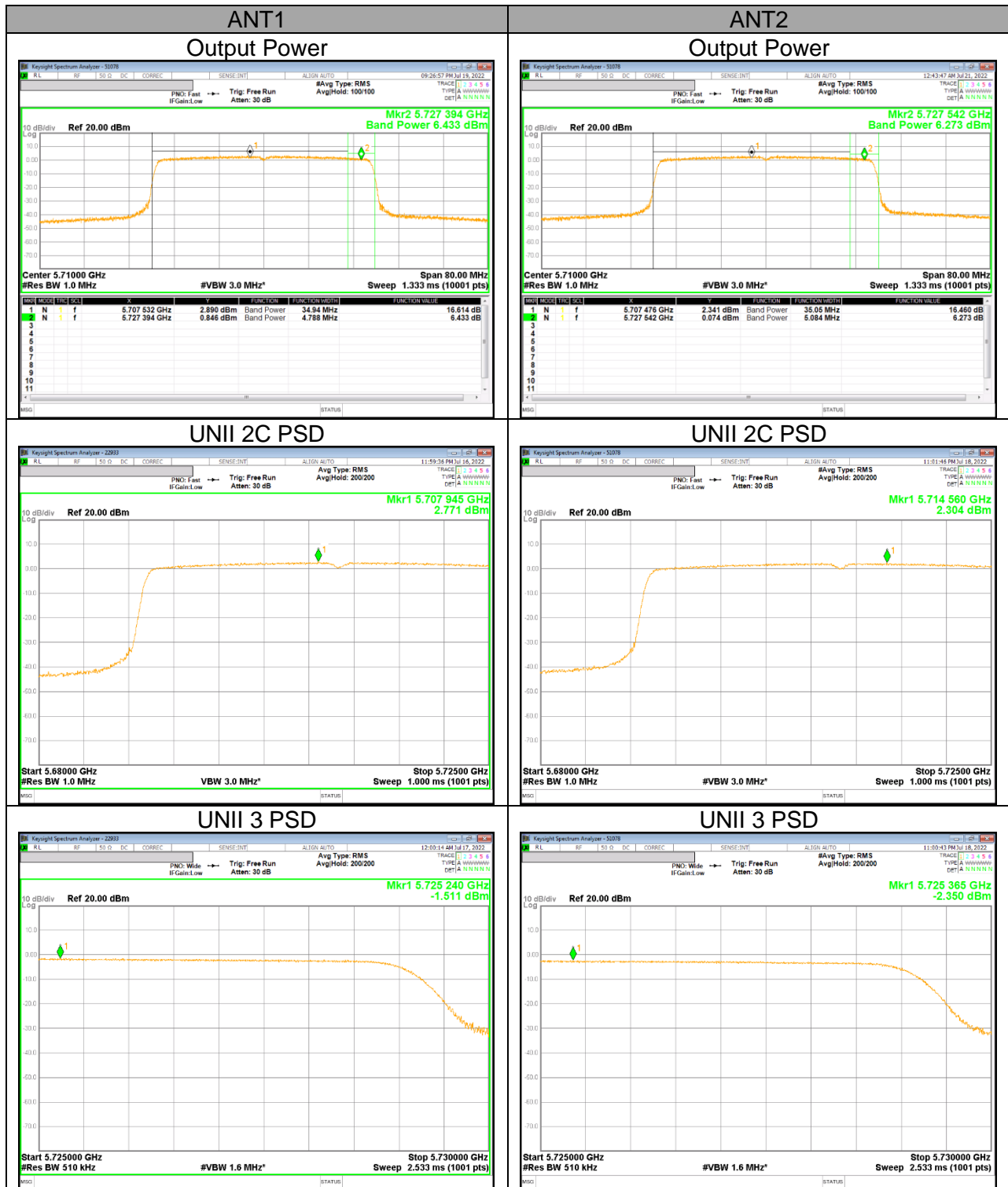

UNII Straddle Ch. IEEE 802.11ax HE80(SU) mode PSD

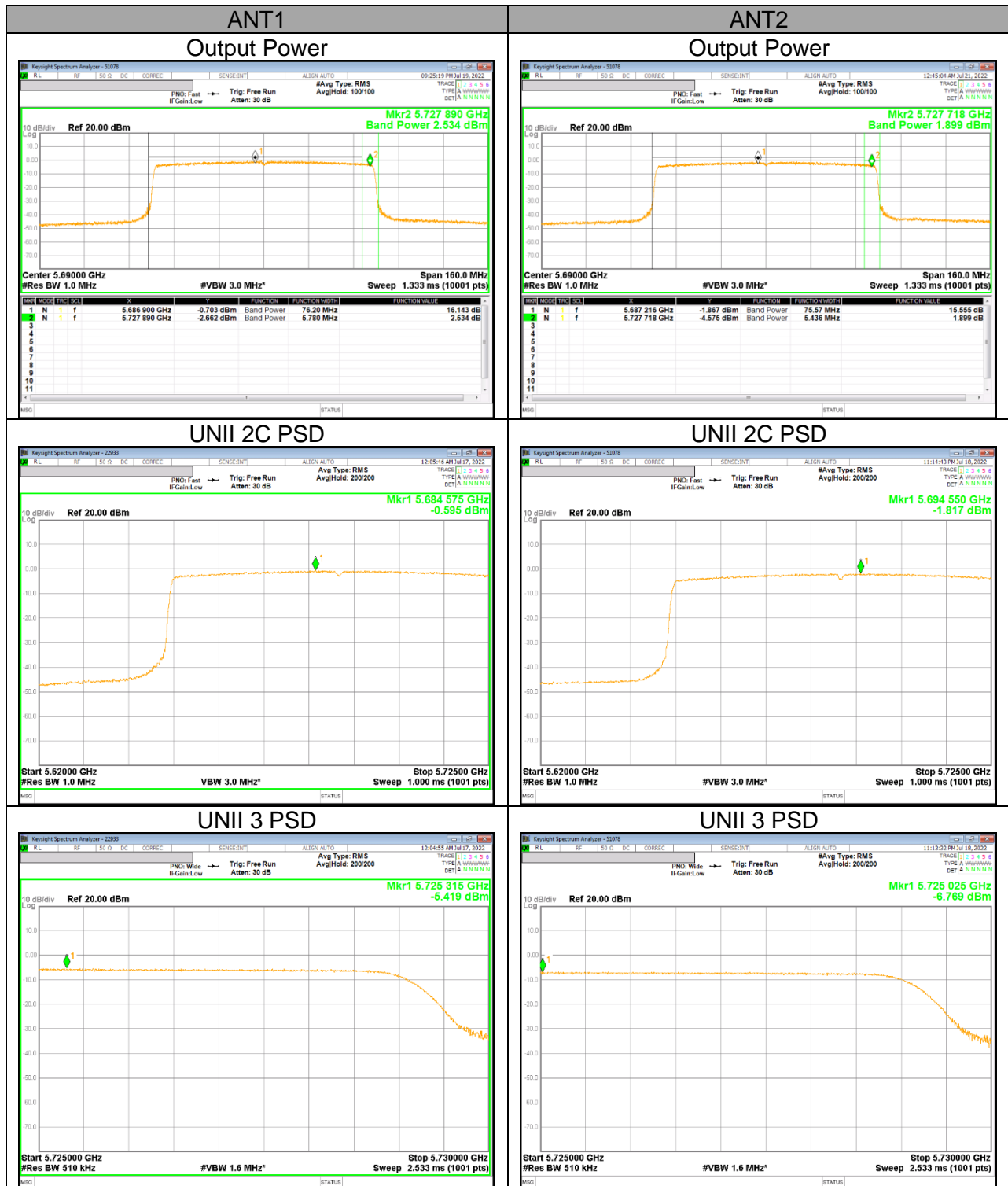

UNII Straddle Ch. IEEE 802.11ax HE20(6RU) mode PSD



UNII Straddle Ch. IEEE 802.11ax HE40(15RU) mode PSD

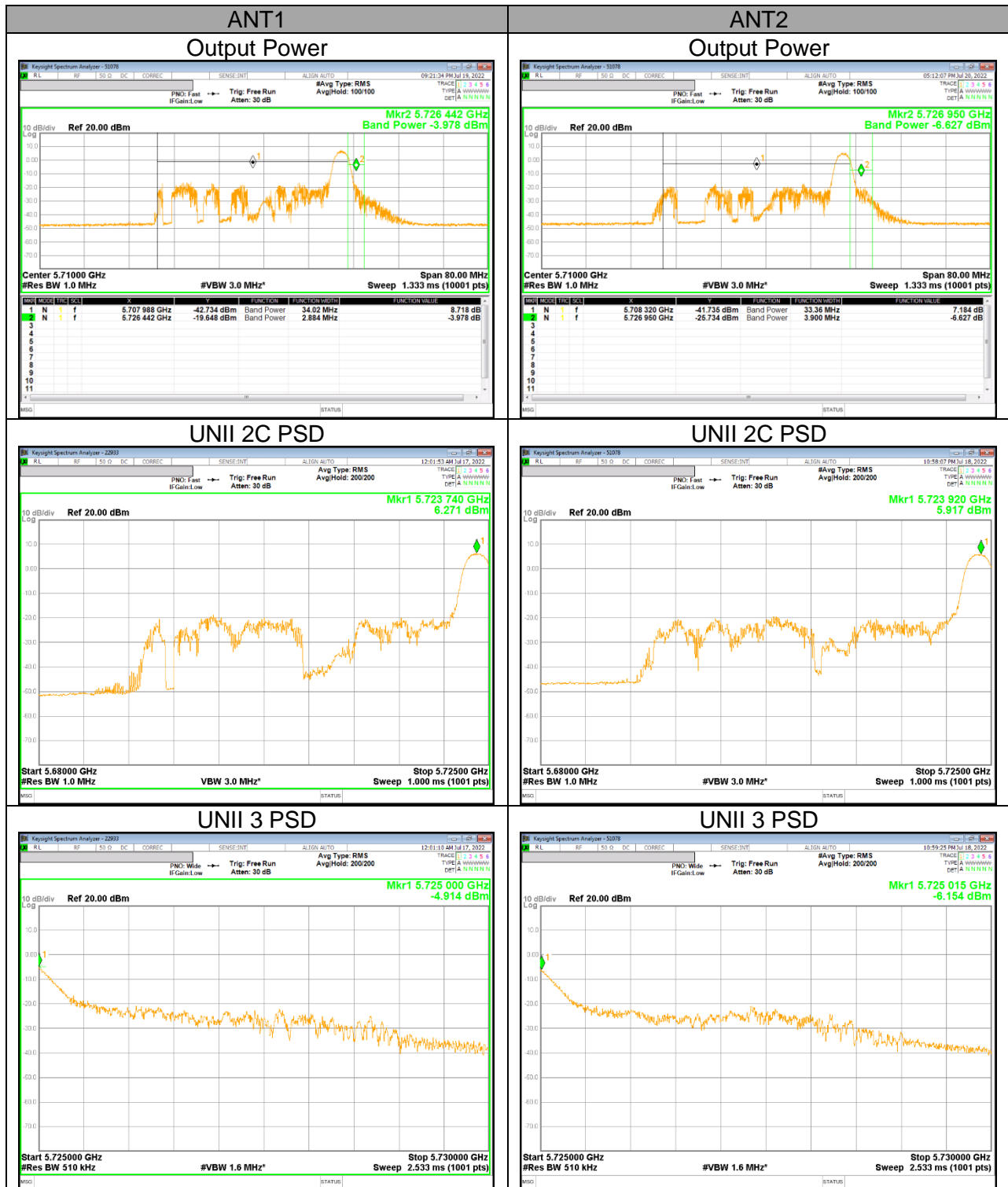

UNII Straddle Ch. IEEE 802.11ax HE80(34RU) mode PSD

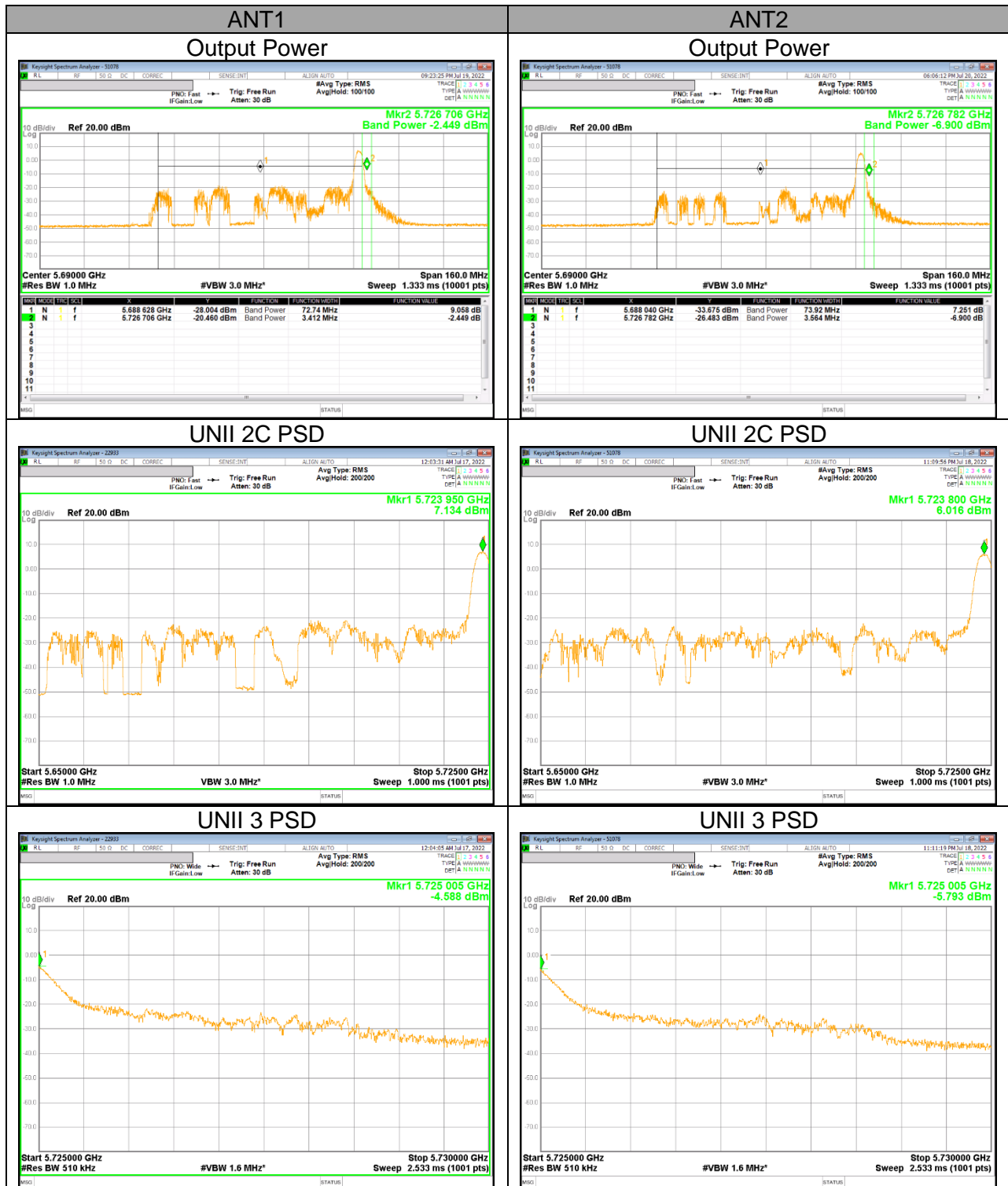

11. TRANSMITTER ABOVE 1 GHz

LIMITS

FCC §15.205 and §15.209

Limits for radiated disturbance of an intentional radiator		
Frequency range (MHz)	Limits (µV/m)	Measurement Distance (m)
0.009 – 0.490	2400 / F (kHz)	300
0.490 – 1.705	24000 / F (kHz)	30
1.705 – 30.0	30	30
30 – 88	100**	3
88 - 216	150**	3
216 – 960	200**	3
Above 960	500	3

** Except as provided in paragraph (g), fundamental emissions from intentional radiators operating under this section shall not be located in the frequency bands 54-72 MHz, 76-88 MHz, 174-216 MHz or 470-806 MHz. However, operation within these frequency bands is permitted under other sections of this part, e.g. §§ 15.231 and 15.241.

FCC Part 15.205 (a) : Only spurious emissions are permitted in any of the frequency bands listed below :

MHz	MHz	MHz	MHz	GHz	GHz
0.009 ~ 0.110	8.41425 ~ 8.41475	108 ~ 121.94	1300 ~ 1427	4.5 ~ 5.15	14.47 ~ 14.5
0.495 ~ 0.505	12.29 ~ 12.293	123 ~ 138	1435 ~ 1626.5	5.35 ~ 5.46	15.35 ~ 16.2
2.1735 ~ 2.1905	12.51975 ~ 12.52025	149.9 ~ 150.05	1645.5 ~ 1646.5	7.25 ~ 7.75	17.7 ~ 21.4
4.125 ~ 4.128	12.57675 ~ 12.57725	156.52475 ~ 156.52525	1660 ~ 1710	8.025 ~ 8.5	22.01 ~ 23.12
4.17725 ~ 4.17775	13.36 ~ 13.41	156.7 ~ 156.9	1718.8 ~ 1722.2	9.0 ~ 9.2	23.6 ~ 24.0
4.20725 ~ 4.20775	16.42 ~ 16.423	162.0125 ~ 167.17	2200 ~ 2300	9.3 ~ 9.5	31.2 ~ 31.8
6.215 ~ 6.218	16.69475 ~ 16.69525	167.72 ~ 173.2	2310 ~ 2390	10.6 ~ 12.7	36.43 ~ 36.5
6.26775 ~ 6.26825	16.80425 ~ 16.80475	240 ~ 285	2483.5 ~ 2500	13.25 ~ 13.4	Above 38.6
6.31175 ~ 6.31225	25.5 ~ 25.67	322 ~ 335.4	2655 ~ 2900		
8.291 ~ 8.294	37.5 ~ 38.25	399.90 ~ 410	3260 ~ 3267		
8.362 ~ 8.366	73 ~ 74.6	608 ~ 614	3332 ~ 3339		
8.37625 ~ 8.38675	74.8 ~ 75.2	960 ~ 1240	3345.8 ~ 3358 3600 ~ 4400		

▪ FCC Part 15.205(b) : The field strength of emissions appearing within these frequency bands shall not exceed the limits shown in §15.209. At frequencies equal to or less than 1000 MHz, compliance with the limits in §15.209 shall be demonstrated using measurement instrumentation employing a CISPR quasi-peak detector. Above 1000 MHz, compliance with the emission limits in §15.209 shall be demonstrated based on the average value of the measured emissions. The provisions in §15.35 apply to these measurements.

FCC §15.407 (b)

(b) Undesirable emission limits. Except as shown in paragraph (b)(7) of this section, the maximum emissions outside of the frequency bands of operation shall be attenuated in accordance with the following limits:

- (1) For transmitters operating in the 5.15-5.25 GHz band: All emissions outside of the 5.15-5.35 GHz band shall not exceed an e.i.r.p. of -27 dBm/MHz.
- (2) For transmitters operating in the 5.25-5.35 GHz band: All emissions outside of the 5.15-5.35 GHz band shall not exceed an e.i.r.p. of -27 dBm/MHz.
- (3) For transmitters operating in the 5.47-5.725 GHz band: All emissions outside of the 5.47-5.725 GHz band shall not exceed an e.i.r.p. of -27 dBm/MHz.
- (4) For transmitters operating solely in the 5.850-5.895 GHz band or operating on a channel that spans across 5.725-5.895 GHz:

(iii) For a client device or indoor access point or subordinate device, all emissions below 5.725 GHz shall not exceed an e.i.r.p. of -27 dBm/MHz at 5.65 GHz increasing linearly to 10 dBm/MHz at 5.7 GHz, and from 5.7 GHz increasing linearly to a level of 15.6 dBm/MHz at 5.72 GHz, and from 5.72 GHz increasing linearly to a level of 27 dBm/MHz at 5.725 GHz

- (5) The emission measurements shall be performed using a minimum resolution bandwidth of 1 MHz. A lower resolution bandwidth may be employed near the band edge, when necessary,
provided the measured energy is integrated to show the total power over 1 MHz.
- (6) Unwanted emissions below 1 GHz must comply with the general field strength limits set forth in §15.209. Further, any U-NII devices using an AC power line are required to comply also with the conducted limits set forth in §15.207.
- (7) The provisions of §15.205 apply to intentional radiators operating under this section.
- (8) When measuring the emission limits, the nominal carrier frequency shall be adjusted as close to the upper and lower frequency band edges as the design of the equipment permits.

Note

- Limit translation to field strength level (FCC §15.407)

$$E[\text{dBuV/m}] = \text{EIRP}[\text{dBm}] + 95.2 = -27\text{dBm} + 95.2 = 68.2\text{dBuV/m}$$

$$E[\text{dBuV/m}] = \text{EIRP}[\text{dBm}] + 95.2 = -17\text{dBm} + 95.2 = 78.2\text{dBuV/m}$$

TEST PROCEDURE

The EUT is placed on a non-conducting table 80 cm above the ground plane for below 1GHz and 100 cm for above 1GHz. The antenna to EUT distance is 3 meters. The EUT is configured in accordance with ANSI C63.10. The EUT is set to transmit in a continuous mode.

For measurements below 1 GHz the resolution bandwidth is set to 100 kHz for peak detection measurements or 120 kHz for quasi-peak detection measurements. Peak detection is used unless otherwise noted as quasi-peak.

Reference to KDB 789033 D02 v02r01 UNII part G) 6) c) Method AD:

For measurements above 1 GHz the resolution bandwidth is set to 1 MHz; the video bandwidth is set to 3 MHz for peak measurements and add duty cycle factor to the reading offset for average measurements.

Pre-scans to detect harmonic and spurious emissions, the resolution bandwidth is set to 1 MHz; the video bandwidth is set to 30 kHz for peak measurements.

The spectrum from 1GHz to 40 GHz is investigated with the transmitter set to the lowest, middle, and highest channels in each applicable band.
(From 30MHz to 1GHz, test was performed with the EUT set to transmit at the channel with highest output power)

The frequency range of interest is monitored at a fixed antenna height and EUT azimuth. The EUT is rotated through 360 degrees to maximize emissions received. The antenna is scanned from 1 to 4 meters above the ground plane to further maximize the emission. Measurements are made with the antenna polarized in both the vertical and the horizontal positions.

Note : Emission was pre-scanned from 9kHz to 30MHz; No emissions were detected which was at least 20dB below the specification limit (consider distance correction factor).
Per FCC part 15.31(o), test results were not reported.

Although these tests were performed other than open field test site, adequate comparison measurements were confirmed against 30 m open are test site.
Therefore sufficient tests were made to demonstrate that the alternative site produces results that correlate with the one of tests made in an open field based on KDB 414788.

11.1. TX ABOVE 1GHz 2Tx MODE IN THE 5.2GHz BAND

BANDEDGE (WORST CASE: 802.11ax HE80 / 5210 MHz)

HORIZONTAL PEAK AND AVERAGE DATA

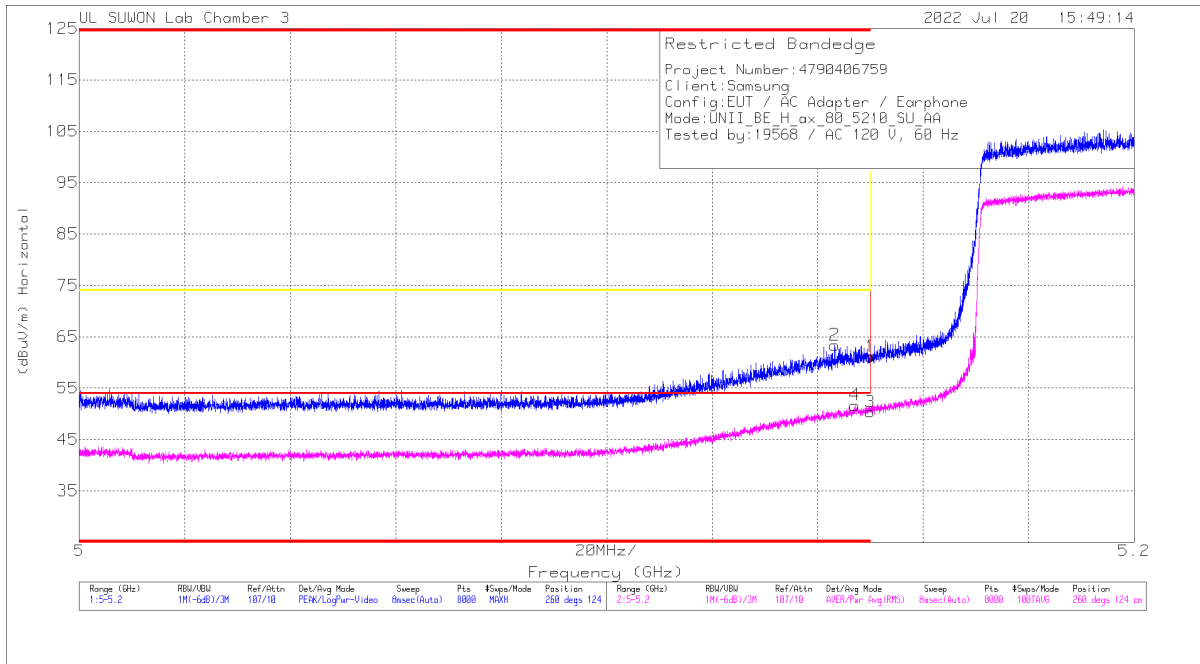

Trace Markers

Marker	Frequency (GHz)	Meter Reading (dBuV)	Det	3117_00218957	10dB_ATT[dB]	DC Corr (dB)	Corrected Reading (dBuV/m)	Average Limit (dBuV/m)	Margin (dB)	Peak Limit (dBuV/m)	PK Margin (dB)	Acimuth (Degs)	Height (cm)	Polarity
1	* 5.14999	46.97	Pk	34.8	-20.6	0	61.17	-	-	74	-12.83	260	124	H
2	* 5.14322	49.2	Pk	34.8	-20.6	0	63.4	-	-	74	-10.6	260	124	H
3	* 5.14999	36.21	RMS	34.8	-20.6	0	50.41	54	-3.59	-	-	260	124	H
4	* 5.14704	37.46	RMS	34.8	-20.6	0	51.68	54	-2.32	-	-	260	124	H

* - indicates frequency in CFR47 Pt 15 / IC RSS-Restricted Band

Pk - Peak detector

RMS - RMS detection

HARMONICS AND SPURIOUS EMISSIONS(WORST CASE: 802.11a / 5180 MHz)
5180 MHz HORIZONTAL

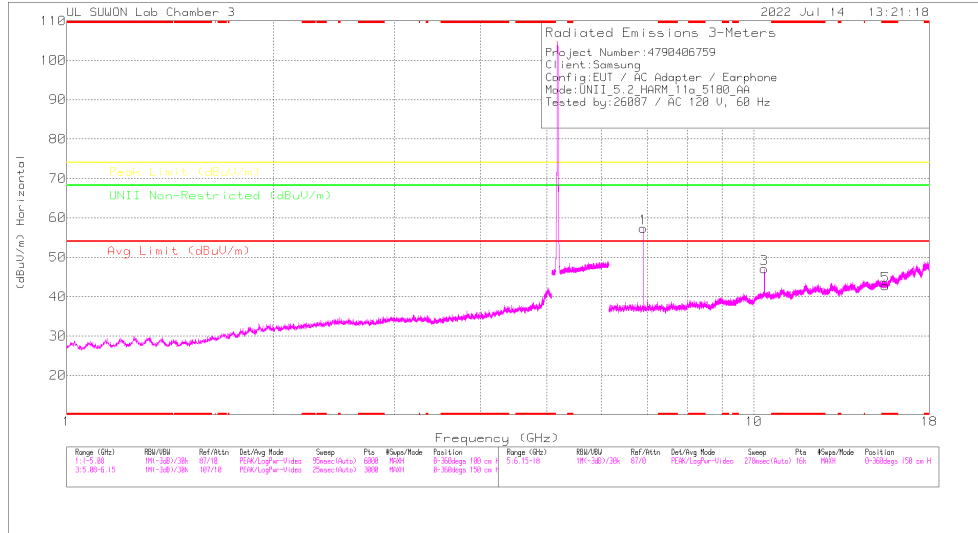

5180 MHz VERTICAL

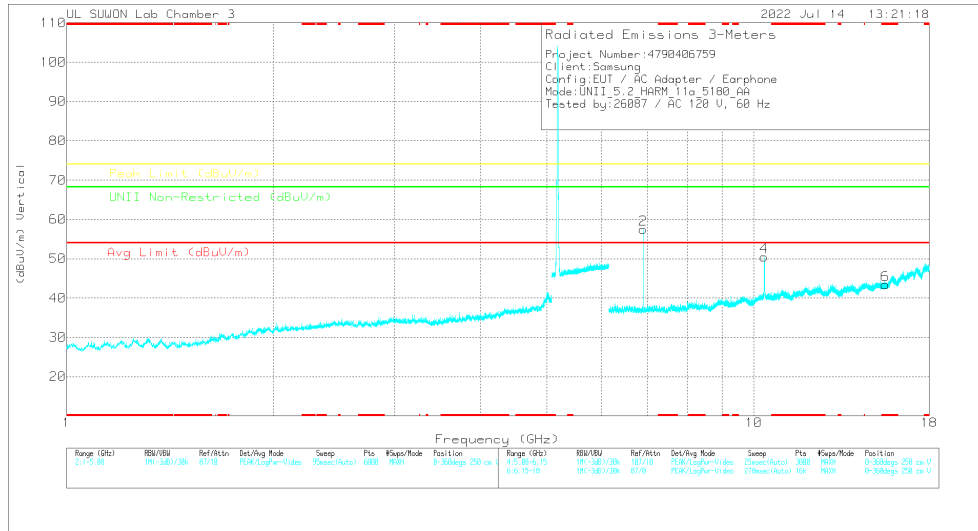

Note: Emission was scanned up to 40GHz; No emissions were detected above the noise floor which was at least 20dB below the specification limit.

5180 MHz DATA

Radiated Emissions

Frequency (GHz)	Meas Reading (dBuV)	Det	317_0021867	60Hz HF[dB]	DC Corr (dB)	Concord Reading (dBuV/m)	Avg Limit (dBuV/m)	Margin (dB)	Peak Limit (dBuV/m)	Margin (dB)	UNII Non-Restricted (dBuV/m)	Margin (dB)	Azimuth (Deg)	Height (cm)	Polarity
6.90661	49.71	PK-U	36.2	-26.5	0	59.41	-	-	-	-	68.2	-8.79	359	112	H
6.90661	48.65	PK-U	36.2	-26.5	0	58.35	-	-	-	-	68.2	-9.85	42	100	V
10.36151	40.95	PK-U	38.1	-21	0	59.05	-	-	-	-	68.2	-10.15	237	103	H
10.36155	43.27	PK-U	38.1	-21	0	60.37	-	-	-	-	68.2	-7.83	79	103	V
* 15.53587	33.86	PK-U	40.2	-21.4	0	52.66	-	-	74	-21.34	-	-	360	100	H
* 15.53339	34.04	PK-U	40.2	-21.4	0	52.84	-	-	74	-21.16	-	-	0	100	V

* - indicates frequency in CFR47 Pt 15 / IC RSS-Restricted Band
 PK-U - U-NII: Maximum Peak

HARMONICS AND SPURIOUS EMISSIONS TEST DATA

Mode	Freq. [MHz]	Antenna	Frequency [GHz]	Reading [dBuV]	Detector Mode	ANT Factor	Loss [dB]	DC Corr [dB]	Result [dBuV/m]	AV Limit [dBuV/m]	AV Margin [dB]	PK Limit [dBuV/m]	PK Margin [dB]	Non-Restricted [dBuV/m]	Margin [dB]	Azimuth [Degs]	Height [cm]	Polarity
802.11a	5180	MIMO	6.907	49.71	PK-U	36.20	-26.50	0.00	59.41	-	-	-	-	68.20	-9.79	359	112	H
			6.907	48.65	PK-U	36.20	-26.50	0.00	58.35	-	-	-	-	68.20	-9.85	42	100	V
			10.362	40.95	PK-U	38.10	-21.00	0.00	58.05	-	-	-	-	68.20	-10.15	237	103	H
			10.362	43.27	PK-U	38.10	-21.00	0.00	60.37	-	-	-	-	68.20	-7.83	79	103	V
			* 15.53587	33.86	PK-U	40.20	-21.40	0.00	52.66	-	-	74.00	-21.34	-	-	360	100	H
	* 15.5339	34.04	PK-U	40.20	-21.40	0.00	52.84	-	-	74.00	-21.16	-	-	0	100	V		
	5200	MIMO	6.933	49.25	PK-U	36.20	-26.40	0.00	59.05	-	-	-	-	68.20	-9.15	360	102	H
			6.933	49.08	PK-U	36.20	-26.40	0.00	58.88	-	-	-	-	68.20	-9.32	86	105	V
			10.401	40.97	PK-U	38.10	-21.10	0.00	57.97	-	-	-	-	68.20	-10.23	236	101	H
			10.401	42.42	PK-U	38.10	-21.10	0.00	59.42	-	-	-	-	68.20	-8.78	83	105	V
			* 15.59863	33.90	PK-U	40.30	-21.20	0.00	53.00	-	-	74.00	-21.00	-	-	360	100	H
	* 15.59551	33.67	PK-U	40.30	-21.20	0.00	52.77	-	-	74.00	-21.23	-	-	0	100	V		
	5240	MIMO	6.987	48.20	PK-U	36.20	-26.00	0.00	58.40	-	-	-	-	68.20	-9.80	341	130	H
			6.987	47.91	PK-U	36.20	-26.00	0.00	58.11	-	-	-	-	68.20	-10.09	85	103	V
			10.482	39.62	PK-U	38.20	-21.20	0.00	56.62	-	-	-	-	68.20	-11.58	235	100	H
10.485			42.42	PK-U	38.20	-21.20	0.00	59.42	-	-	-	-	68.20	-8.78	326	103	V	
* 15.72673			33.86	PK-U	40.50	-20.90	0.00	53.46	-	-	74.00	-20.54	-	-	360	100	H	
* 15.72591	33.89	PK-U	40.50	-20.90	0.00	53.49	-	-	74.00	-20.51	-	-	360	100	V			
802.11ax (HE20) 4RU Spot-Check	5180	MIMO	6.907	49.31	PK-U	36.20	-26.50	0.00	59.01	-	-	-	-	68.20	-9.19	357	141	H
			6.906	48.71	PK-U	36.20	-26.50	0.00	58.41	-	-	-	-	68.20	-9.79	79	105	V
			10.358	39.27	PK-U	38.10	-21.00	0.00	56.37	-	-	-	-	68.20	-11.83	79	100	H
			10.360	41.27	PK-U	38.10	-21.00	0.00	58.37	-	-	-	-	68.20	-9.83	284	116	V
			* 15.54023	26.53	PK-U	40.20	-21.40	0.00	45.33	-	-	74.00	-28.67	-	-	360	100	H
* 15.54182	34.77	PK-U	40.20	-21.40	0.00	53.57	-	-	74.00	-20.43	-	-	0	100	V			
802.11ax (HE40) 9RU Spot-Check	5190	MIMO	6.920	49.07	PK-U	36.20	-26.50	0.00	58.77	-	-	-	-	68.20	-9.43	356	128	H
			6.920	48.68	PK-U	36.20	-26.50	0.00	58.38	-	-	-	-	68.20	-9.82	81	101	V
			10.383	39.85	PK-U	38.10	-20.90	0.00	57.05	-	-	-	-	68.20	-11.15	80	100	H
			10.382	41.44	PK-U	38.10	-20.90	0.00	58.64	-	-	-	-	68.20	-9.56	304	101	V
			* 15.5765	33.79	PK-U	40.30	-21.40	0.00	52.69	-	-	74.00	-21.31	-	-	0	100	H
* 15.5794	34.76	PK-U	40.30	-21.40	0.00	53.66	-	-	74.00	-20.34	-	-	0	100	V			
802.11ax (HE80) 0RU Spot-Check	5210	MIMO	6.947	48.91	PK-U	36.20	-26.30	0.00	58.81	-	-	-	-	68.20	-9.39	356	119	H
			6.947	48.55	PK-U	36.20	-26.30	0.00	58.45	-	-	-	-	68.20	-9.75	39	107	V
			10.344	39.34	PK-U	38.00	-21.10	0.00	56.24	-	-	-	-	68.20	-11.96	80	100	H
			10.344	41.08	PK-U	38.00	-21.10	0.00	57.98	-	-	-	-	68.20	-10.22	287	101	V
			* 15.63059	25.06	PK-U	40.40	-21.10	0.00	44.36	-	-	74.00	-29.64	-	-	360	100	H
* 15.63799	33.36	PK-U	40.40	-21.20	0.00	52.56	-	-	74.00	-21.44	-	-	0	100	V			

Note1. PK-U - U-NII: Maximum Peak
 Note2. * - indicates frequency in CFR47 Pt 15 / IC RSS-Restricted Band

11.2. TX ABOVE 1GHz 2Tx MODE IN THE 5.3GHz BAND

BANDEDGE (WORST CASE: 802.11ax HE40 / 5310 MHz)

HORIZONTAL PEAK AND AVERAGE DATA

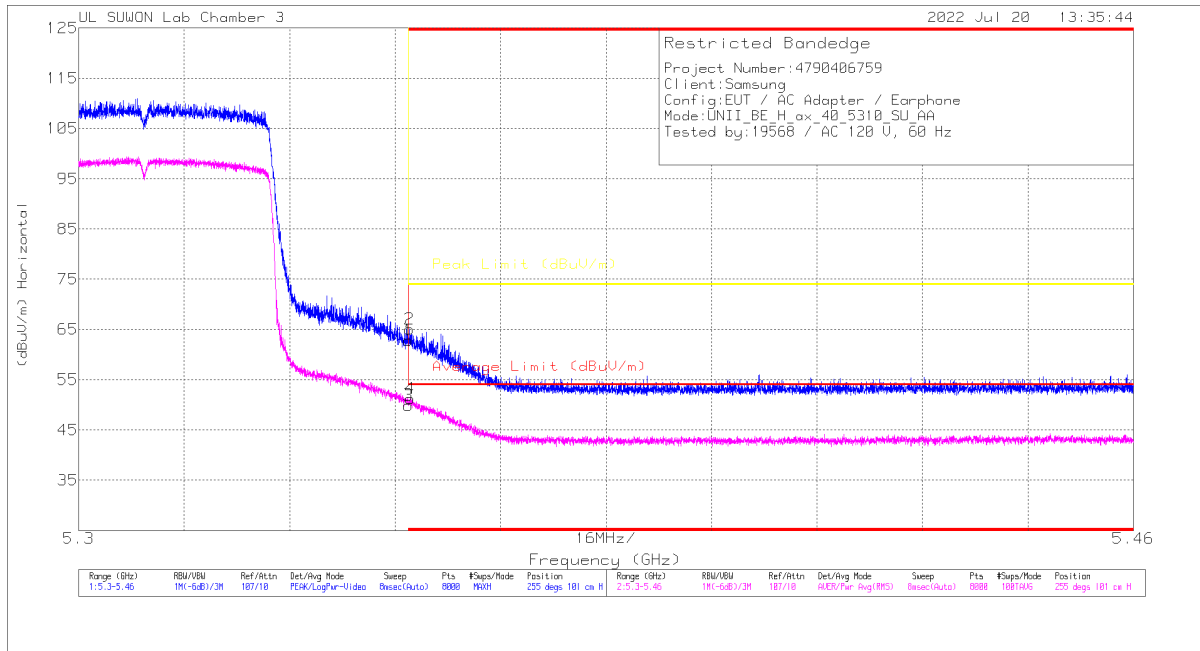

Trace Markers

Marker	Frequency (GHz)	Meter Reading (dBuV)	Det	3117_00218957	10dB_ATT[dB]	DC Cor (dB)	Corrected Reading (dBuV/m)	Average Limit (dBuV/m)	Margin (dB)	Peak Limit (dBuV/m)	PK Margin (dB)	Azimuth (Degs)	Height (cm)	Polarity
1	* 5.35001	47.95	Pk	35.1	-20.2	0	62.95	-	-	74	-11.15	255	101	H
2	* 5.35021	50.16	Pk	35.1	-20.2	0	65.06	-	-	74	-8.94	255	101	H
3	* 5.35001	35.04	RMS	35.1	-20.2	0	49.94	54	-4.06	-	-	255	101	H
4	* 5.35025	36.4	RMS	35.1	-20.2	0	51.3	54	-2.7	-	-	255	101	H

* - indicates frequency in CFR47 Pt 15 / IC RSS-Restricted Band

Pk - Peak detector

RMS - RMS detection

HARMONICS AND SPURIOUS EMISSIONS(WORST CASE: 802.11a / 5320 MHz)

5320 MHz HORIZONTAL

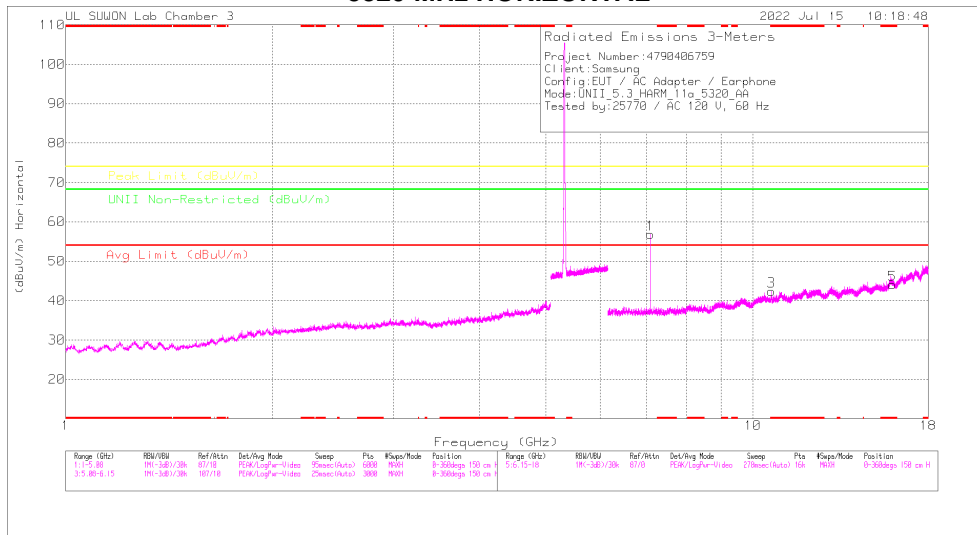

5320 MHz VERTICAL

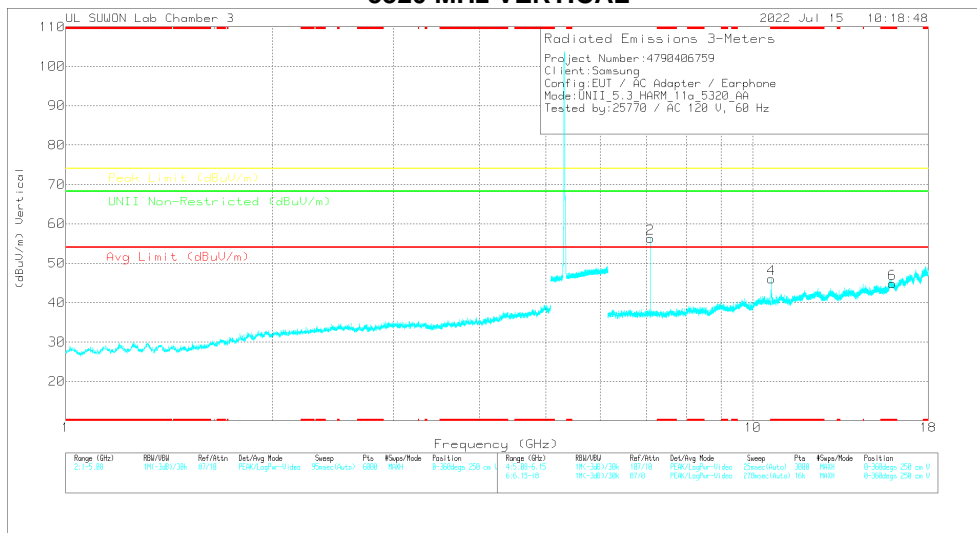

Note: Emission was scanned up to 40GHz; No emissions were detected above the noise floor which was at least 20dB below the specification limit.

5320 MHz DATA

Radiated Emissions

Frequency (GHz)	Meas Reading (dBuV)	Det	317_0021867	6GHz_HPSdB	DC Corr (dB)	Corrected Reading (dBuV/m)	Avg Limit (dBuV/m)	Margin (dB)	Peak Limit (dBuV/m)	Margin (dB)	UNII Non-Restricted (dBuV/m)	Margin (dB)	Azimuth (Deg)	Height (cm)	Polarity
7.09333	48.79	PK-U	36.2	-26	0	58.99	-	-	-	-	68.2	-9.21	344	135	H
7.09325	48.02	PK-U	36.2	-26	0	58.22	-	-	-	-	68.2	-9.98	65	102	V
* 10.64018	35.69	PK-U	38.3	-21.1	0	52.89	-	-	74	-21.11	-	-	309	379	H
* 10.64	24.45	ADR	38.3	-21.1	-15	41.8	54	-12.2	-	-	-	-	308	379	H
* 10.64046	40.4	PK-U	38.3	-21.1	0	57.6	-	-	74	-16.4	-	-	326	100	V
* 10.64031	29.77	ADR	38.3	-21.1	-15	47.12	54	-6.88	-	-	-	-	326	100	V
* 15.96625	33.74	PK-U	40.9	-20.4	0	54.24	-	-	74	-19.76	-	-	360	100	H
* 15.96932	33.65	PK-U	40.9	-20.4	0	54.15	-	-	74	-19.85	-	-	360	100	V

* - indicates frequency in CFR47 Pt 15 / IC RSS-Restricted Band
 PK-U - U-NII: Maximum Peak
 ADR - U-NII AD primary method, RMS average

HARMONICS AND SPURIOUS EMISSIONS TEST DATA

Mode	Freq. [MHz]	Antenna	Frequency [GHz]	Reading [dBuV]	Detector Mode	ANT Factor	Loss [dB]	DC Corr [dB]	Result [dBuV/m]	AV Limit [dBuV/m]	AV Margin [dB]	PK Limit [dBuV/m]	PK Margin [dB]	Non-Restricted [dBuV/m]	Margin [dB]	Azimuth [Degs]	Height [cm]	Polarity		
802.11a	5260	MIMO	7.013	48.58	PK-U	36.20	-25.90	0.00	58.88	-	-	-	-	68.20	-9.32	339	130	H		
			* 7.013	48.05	PK-U	36.20	-25.90	0.00	58.35	-	-	-	-	-	68.20	-9.85	44	100	V	
			10.522	39.30	PK-U	38.20	-21.10	0.00	56.40	-	-	-	-	-	68.20	-11.80	233	103	H	
			* 10.521	42.15	PK-U	38.20	-21.10	0.00	59.25	-	-	-	-	-	68.20	-8.95	324	103	V	
			* 15.79041	34.18	PK-U	40.60	-20.80	0.00	53.98	-	-	-	74.00	-20.02	-	-	-	360	100	H
			* 15.78004	34.10	PK-U	40.60	-20.80	0.00	53.90	-	-	-	74.00	-20.10	-	-	-	360	100	V
	5300	MIMO	7.066	48.90	PK-U	36.20	-25.90	0.00	59.20	-	-	-	-	-	68.20	-9.00	343	106	H	
			* 7.067	48.08	PK-U	36.20	-25.90	0.00	58.38	-	-	-	-	-	68.20	-9.82	46	100	V	
			* 11.62602	34.28	PK-U	38.80	-21.50	0.00	51.58	-	-	-	74.00	-22.42	-	-	-	236	101	H
			* 11.58556	22.64	ADR	38.80	-21.60	0.15	39.99	54.00	-14.01	-	-	-	-	-	-	236	101	H
			* 11.75977	33.69	PK-U	39.00	-21.50	0.00	51.19	-	-	-	74.00	-22.81	-	-	-	325	100	V
			* 11.57395	22.52	ADR	38.80	-21.60	0.15	39.87	54.00	-14.13	-	-	-	-	-	-	325	100	V
			* 15.90317	33.86	PK-U	40.80	-20.30	0.00	54.36	-	-	-	74.00	-19.64	-	-	-	0	100	H
			* 15.90904	33.96	PK-U	40.80	-20.30	0.00	54.46	-	-	-	74.00	-19.54	-	-	-	360	100	V
			7.093	48.79	PK-U	36.20	-26.00	0.00	58.99	-	-	-	-	-	-	68.20	-9.21	344	135	H
			* 7.093	48.02	PK-U	36.20	-26.00	0.00	58.22	-	-	-	-	-	-	68.20	-9.98	65	102	V
			* 10.64018	35.69	PK-U	38.30	-21.10	0.00	52.89	-	-	-	74.00	-21.11	-	-	-	309	379	H
			* 10.64	24.45	ADR	38.30	-21.10	0.15	41.80	54.00	-12.20	-	-	-	-	-	-	309	379	H
	* 10.64046	40.40	PK-U	38.30	-21.10	0.00	57.60	-	-	-	74.00	-16.40	-	-	-	326	100	V		
	* 10.64031	29.77	ADR	38.30	-21.10	0.15	47.12	54.00	-6.88	-	-	-	-	-	-	326	100	V		
	* 15.95625	33.74	PK-U	40.90	-20.40	0.00	54.24	-	-	-	74.00	-19.76	-	-	-	360	100	H		
	* 15.96932	33.65	PK-U	40.90	-20.40	0.00	54.15	-	-	-	74.00	-19.85	-	-	-	360	100	V		
	802.11ax (HE20) 4RU Spot-Check	5300	MIMO	7.066	45.06	PK-U	36.20	-25.90	0.00	55.36	-	-	-	-	68.20	-12.84	341	130	H	
				* 7.066	47.61	PK-U	36.20	-25.90	0.00	57.91	-	-	-	-	-	68.20	-10.29	40	107	V
* 11.77809				34.06	PK-U	39.00	-21.60	0.00	51.46	-	-	-	74.00	-22.54	-	-	-	360	100	H
* 11.5724				33.86	PK-U	38.80	-21.60	0.00	51.06	-	-	-	74.00	-22.94	-	-	-	360	100	V
* 15.89259				34.08	PK-U	40.80	-20.30	0.00	54.58	-	-	-	74.00	-19.42	-	-	-	360	100	H
* 15.90249				33.50	PK-U	40.80	-20.30	0.00	54.00	-	-	-	74.00	-20.00	-	-	-	360	100	V

Note1. PK-U - U-NII: Maximum Peak / ADR - U-NII AD primary method, RMS average
 Note2. * - indicates frequency in CFR47 Pt 15 / IC RSS-Restricted Band

11.3. TX ABOVE 1GHz 2Tx MODE IN THE 5.5 GHz BAND

BANDEDGE (WORST CASE: 802.11a / 5700 MHz)

HORIZONTAL PEAK AND AVERAGE DATA

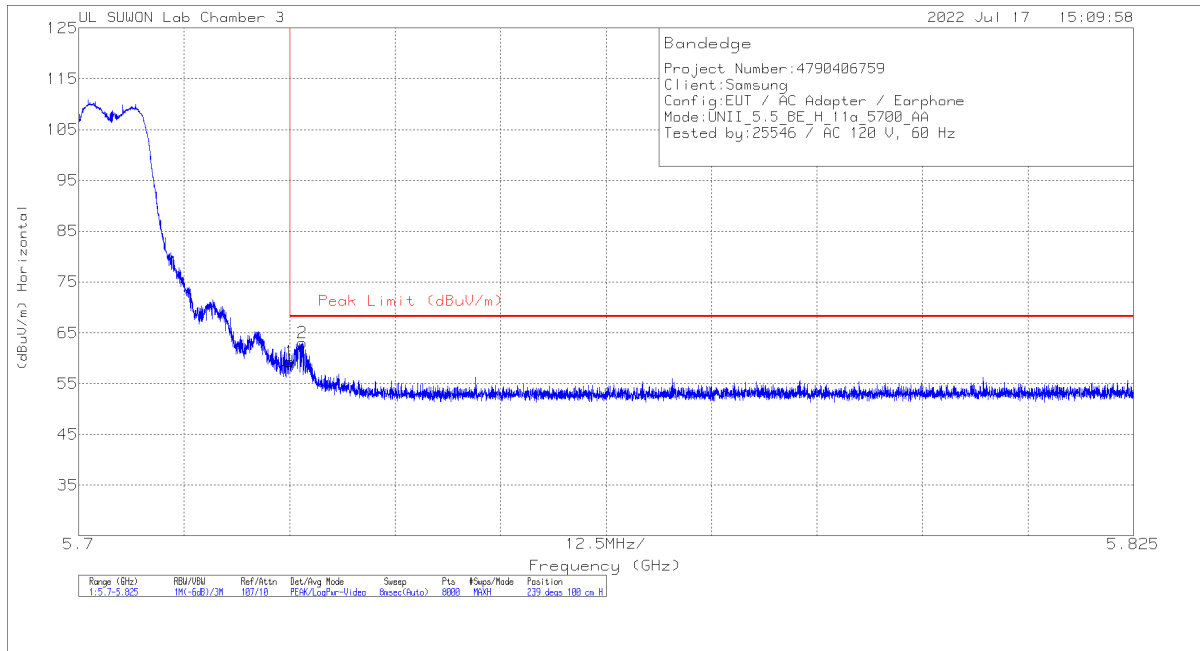

Trace Markers

Marker	Frequency (GHz)	Meter Reading (dBuV)	Det	3117_00218957	10dB_ATT[dB]	DC Corr (dB)	Corrected Reading (dBuV/m)	Peak Limit (dBuV/m)	PK Margin (dB)	Azimuth (Degs)	Height (cm)	Polarity
1	5.725	43.09	Pk	35.7	-19.5	0	59.29	68.2	-8.91	239	100	H
2	5.72649	46.78	Pk	35.7	-19.5	0	62.98	68.2	-5.22	239	100	H

Pk - Peak detector

HARMONICS AND SPURIOUS EMISSIONS(WORST CASE: 802.11a / 5500 MHz)
5500 MHz HORIZONTAL

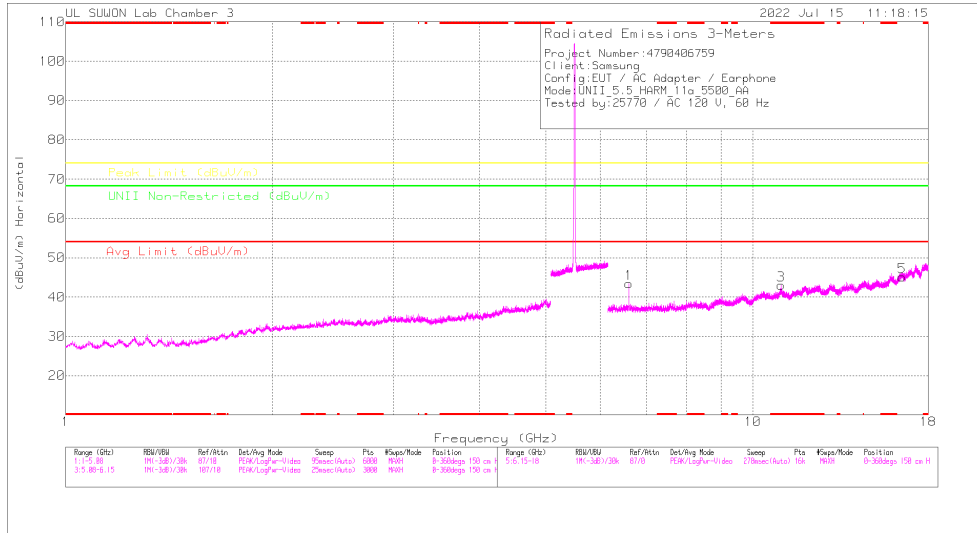

5500 MHz VERTICAL

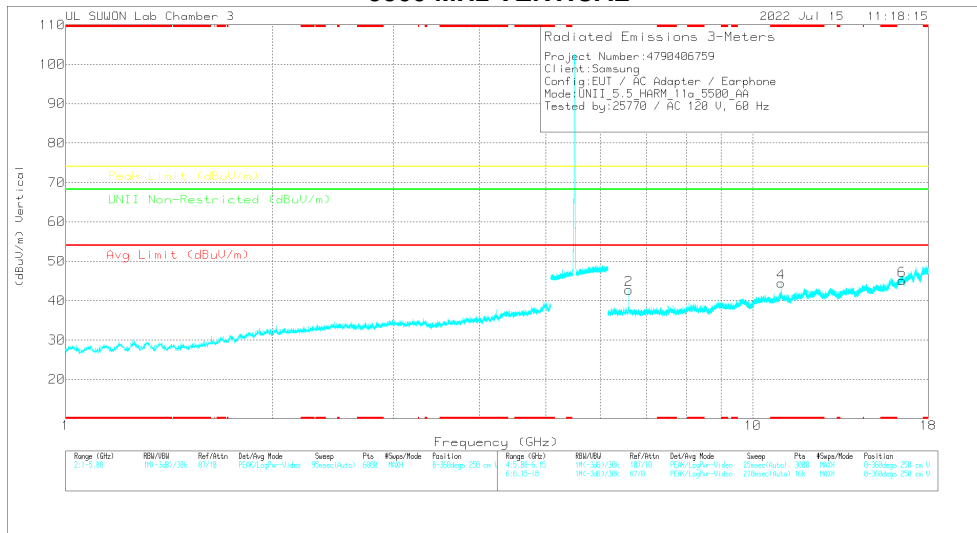

Note. Emission was scanned up to 40GHz; No emissions were detected above the noise floor which was at least 20dB below the specification limit.

5500 MHz DATA

Radiated Emissions

Frequency (GHz)	Meas Reading (dBuV)	Det	317_0021867	6GHz_HPSDR	DC Corr (dB)	Corrected Reading (dBuV/m)	Avg Limit (dBuV/m)	Margin (dB)	Peak Limit (dBuV/m)	Margin (dB)	UNII Non-Restricted (dBuV/m)	Margin (dB)	Admth (Chg)	Height (cm)	Polarity
6.60003	40.28	PK-U	36.5	-26.3	0	50.48	-	-	-	-	68.2	-17.72	293	106	H
6.59945	40.48	PK-U	36.5	-26.3	0	50.68	-	-	-	-	68.2	-17.52	81	103	V
* 11.0007	36.64	PK-U	38.5	-21.2	0	53.84	-	-	74	-20.06	-	-	99	101	H
* 11.00034	24.56	ADR	38.5	-21.2	15	42.01	54	-11.99	-	-	-	-	99	101	H
* 11.00056	35.93	PK-U	38.5	-21.2	0	53.23	-	-	74	-20.77	-	-	341	100	V
* 10.99981	24.74	ADR	38.5	-21.2	-15	42.19	54	-11.81	-	-	-	-	341	100	V
16.49208	33.29	PK-U	42	-19.3	0	55.99	-	-	-	-	68.2	-12.21	360	100	H
16.49906	33.06	PK-U	42	-19.3	0	55.76	-	-	-	-	68.2	-12.44	360	100	V

* - indicates frequency in CFR47 Pt 15 / IC RSS-Restricted Band
 PK-U - U-NII: Maximum Peak
 ADR - U-NII AD primary method, RMS average

HARMONICS AND SPURIOUS EMISSIONS TEST DATA

Mode	Freq. [MHz]	Antenna	Frequency [GHz]	Reading [dBuV]	Detector Mode	ANT Factor	Loss [dB]	DC Corr [dB]	Result [dBuV/m]	AV Limit [dBuV/m]	AV Margin [dB]	PK Limit [dBuV/m]	PK Margin [dB]	Non-Restricted [dBuV/m]	Margin [dB]	Azimuth [Degs]	Height [cm]	Polarity		
802.11a	5500	MIMO	6.600	40.28	PK-U	36.50	-26.30	0.00	50.48	-	-	-	-	68.20	-17.72	293	106	H		
			6.599	40.48	PK-U	36.50	-26.30	0.00	50.68	-	-	-	-	68.20	-17.52	81	103	V		
			* 11.0007	36.64	PK-U	38.50	-21.20	0.00	53.94	-	-	-	74.00	-20.06	-	-	99	101	H	
			* 11.00204	24.56	ADR	38.50	-21.20	0.15	42.01	54.00	-11.99	-	-	-	-	-	99	101	H	
			* 11.00056	35.93	PK-U	38.50	-21.20	0.00	53.23	-	-	-	74.00	-20.77	-	-	341	100	V	
			* 10.99991	24.74	ADR	38.50	-21.20	0.15	42.19	54.00	-11.81	-	-	-	-	-	341	100	V	
			16.492	33.29	PK-U	42.00	-19.30	0.00	55.99	-	-	-	-	-	-	68.20	-12.21	360	100	H
			16.499	33.06	PK-U	42.00	-19.30	0.00	55.76	-	-	-	-	-	-	68.20	-12.44	360	100	V
			6.696	41.36	PK-U	36.40	-26.80	0.00	50.96	-	-	-	-	-	-	68.20	-17.24	262	103	H
			6.696	41.61	PK-U	36.40	-26.90	0.00	51.11	-	-	-	-	-	-	68.20	-17.09	83	100	V
			* 11.15621	34.05	PK-U	38.60	-21.40	0.00	51.25	-	-	-	74.00	-22.75	-	-	360	100	H	
			* 11.16749	34.17	PK-U	38.60	-21.50	0.00	51.27	-	-	-	74.00	-22.73	-	-	360	100	V	
	16.731	31.88	PK-U	42.30	-18.80	0.00	55.38	-	-	-	-	-	-	68.20	-12.82	360	100	H		
	16.738	32.31	PK-U	42.30	-18.80	0.00	55.81	-	-	-	-	-	-	68.20	-12.39	360	100	V		
	6.840	39.62	PK-U	36.20	-26.50	0.00	49.32	-	-	-	-	-	-	68.20	-18.88	283	100	H		
	6.840	39.42	PK-U	36.20	-26.50	0.00	49.12	-	-	-	-	-	-	68.20	-19.08	86	100	V		
	* 11.39368	32.83	PK-U	38.60	-21.40	0.00	50.03	-	-	-	74.00	-23.97	-	-	0	100	H			
	* 11.4083	33.05	PK-U	38.60	-21.50	0.00	50.15	-	-	-	74.00	-23.85	-	-	360	100	V			
	17.110	31.96	PK-U	42.30	-18.00	0.00	56.26	-	-	-	-	-	-	68.20	-11.94	0	100	H		
	17.106	31.33	PK-U	42.30	-18.00	0.00	55.63	-	-	-	-	-	-	68.20	-12.57	360	100	V		
	6.864	39.04	PK-U	36.20	-26.50	0.00	48.74	-	-	-	-	-	-	68.20	-19.46	280	103	H		
	6.864	39.33	PK-U	36.20	-26.50	0.00	49.03	-	-	-	-	-	-	68.20	-19.17	80	106	V		
	* 11.44172	32.61	PK-U	38.60	-21.30	0.00	49.91	-	-	-	74.00	-24.09	-	-	360	100	H			
	* 11.44865	32.66	PK-U	38.60	-21.30	0.00	49.96	-	-	-	74.00	-24.04	-	-	360	100	V			
	17.166	32.80	PK-U	42.20	-17.90	0.00	57.10	-	-	-	-	-	-	68.20	-11.10	360	100	H		
	17.153	31.91	PK-U	42.20	-18.00	0.00	56.11	-	-	-	-	-	-	68.20	-12.09	360	100	V		
	802.11ax (HE20) 4RU Spot-Check	5700	MIMO	6.841	39.32	PK-U	36.20	-26.50	0.00	49.02	-	-	-	-	68.20	-19.18	280	114	H	
	6.840			39.30	PK-U	36.20	-26.50	0.00	49.00	-	-	-	-	-	68.20	-19.20	87	100	V	
	* 11.39543			32.94	PK-U	38.60	-21.40	0.00	50.14	-	-	-	74.00	-23.86	-	-	0	100	H	
	* 11.40368			32.16	PK-U	38.60	-21.40	0.00	49.36	-	-	-	74.00	-24.64	-	-	360	100	V	
	17.101			31.74	PK-U	42.30	-18.00	0.00	56.04	-	-	-	-	-	-	68.20	-12.16	0	100	H
	17.108			31.43	PK-U	42.30	-17.90	0.00	55.83	-	-	-	-	-	-	68.20	-12.37	360	100	V

Note1. PK-U - U-NII: Maximum Peak / ADR - U-NII AD primary method, RMS average
 Note2. * - indicates frequency in CFR47 Pt 15 / IC RSS-Restricted Band

11.4. TX ABOVE 1GHz 2Tx MODE IN THE 5.8 GHz BAND

BANDEDGE (WORST CASE: 802.11ax HE20 / 5825 MHz)

HORIZONTAL PEAK DATA

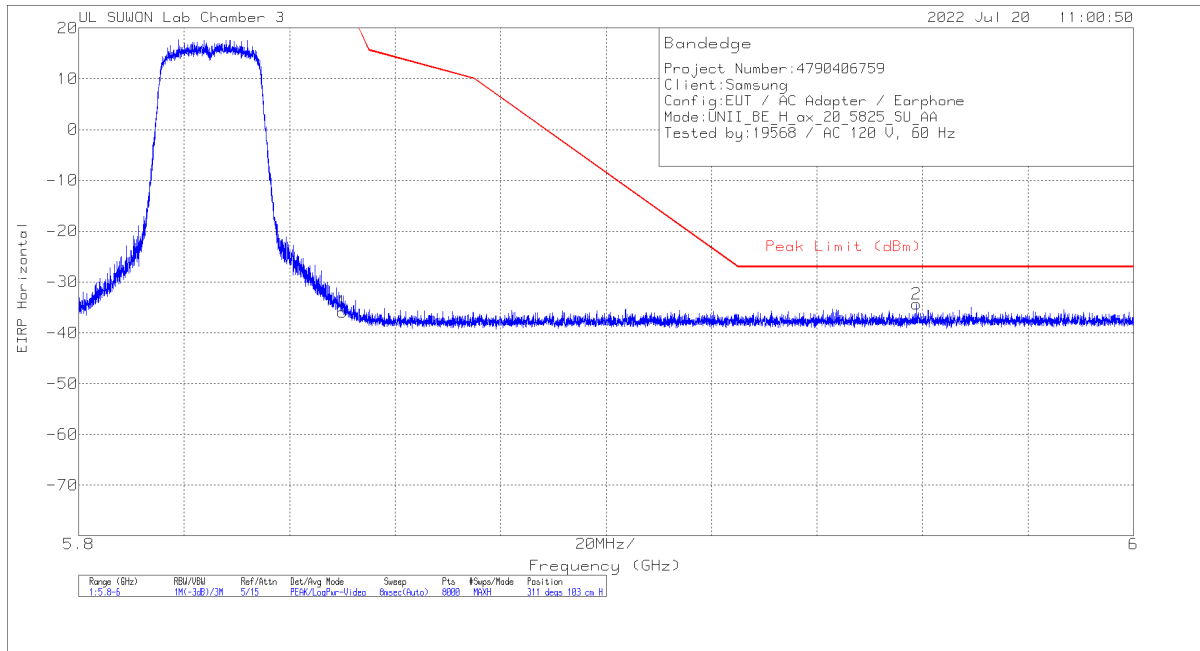

Trace Markers

Marker	Frequency (GHz)	Meter Reading (dBm)	Det	3117_00218957	10dB_ATT[dB]	Conversion Factor (dB)	DC Corr (dB)	Corrected Reading EIRP	Peak Limit (dBm)	PK Margin (dB)	Azimuth (Degs)	Height (cm)	Polarity
1	5.85001	-64.27	Pk		-19.3	11.8	0	-35.87	26.99	-62.86	311	103	H
2	5.95889	-62.95	Pk		-19.2	11.8	0	-34.35	-27	-7.35	311	103	H

Pk - Peak detector

HARMONICS AND SPURIOUS EMISSIONS(WORST CASE: 802.11a / 5825 MHz)
5825 MHz HORIZONTAL

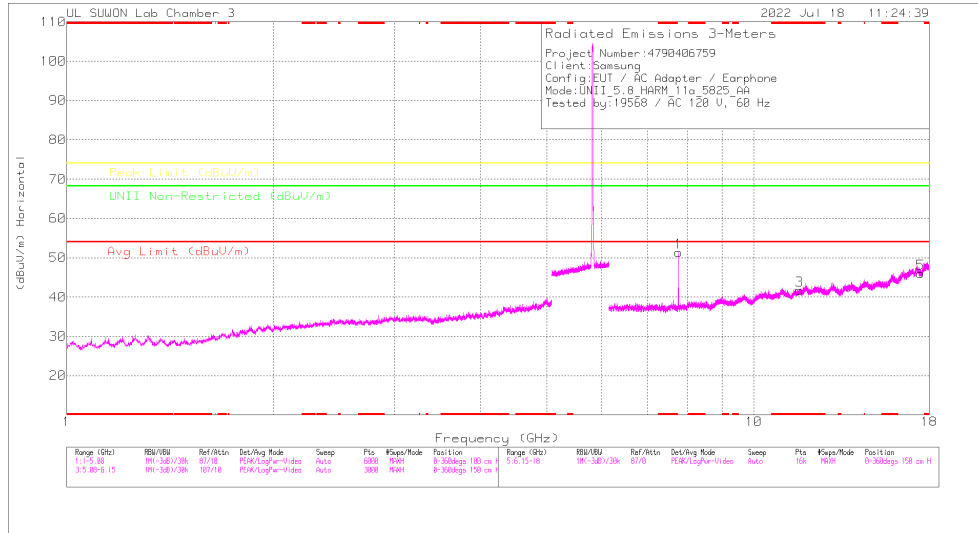

5825 MHz VERTICAL

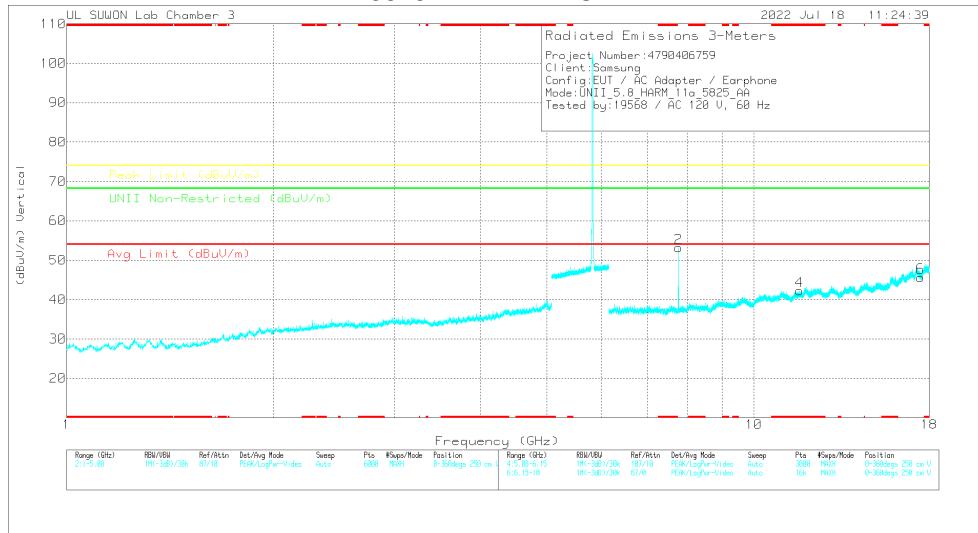

Note: Emission was scanned up to 40GHz; No emissions were detected above the noise floor which was at least 20dB below the specification limit.

5825 MHz DATA

Radiated Emissions

Frequency (GHz)	Meas Reading (dBuV)	Det	317_00218657	6GHz_HPSDR	DC Corr (dB)	Corrected Reading (dBuV/m)	Avg Limit (dBuV/m)	Margin (dB)	Peak Limit (dBuV/m)	Margin (dB)	UNII Non-Restricted (dBuV/m)	Margin (dB)	Azimuth (Deg)	Height (cm)	Polarity
7.76648	42.83	PK-U	36.3	-24.6	0	54.53	-	-	-	-	68.2	-13.67	326	121	H
7.76678	44.77	PK-U	36.3	-24.6	0	56.47	-	-	-	-	68.2	-11.73	184	126	V
11.85624	35.17	PK-U	38.8	-21.5	0	32.57	-	-	74	-21.43	-	-	360	100	H
11.84478	34.98	PK-U	38.8	-21.5	0	32.28	-	-	74	-21.72	-	-	360	100	V
17.47532	31.03	PK-U	42	-16.8	0	56.23	-	-	-	-	68.2	-11.97	0	100	H
17.48498	32.05	PK-U	42	-16.8	0	57.25	-	-	-	-	68.2	-10.95	360	100	V

* - indicates frequency in CFR47 Pt 15 / IC RSS-Restricted Band
 PK-U - U-NII: Maximum Peak

HARMONICS AND SPURIOUS EMISSIONS TEST DATA

Mode	Freq. [MHz]	Antenna	Frequency [GHz]	Reading [dBuV]	Detector Mode	ANT Factor	Loss [dB]	DC Corr [dB]	Result [dBuV/m]	AV Limit [dBuV/m]	AV Margin [dB]	PK Limit [dBuV/m]	PK Margin [dB]	Non-Restricted [dBuV/m]	Margin [dB]	Azimuth [Degs]	Height [cm]	Polarity	
802.11a	5745	MIMO	6.894	39.92	PK-U	36.20	-26.60	0.00	49.52	-	-	-	-	68.20	-18.68	278	101	H	
			6.894	39.50	PK-U	36.20	-26.60	0.00	49.10	-	-	-	-	68.20	-19.10	81	106	V	
			* 11.499	33.11	PK-U	38.70	-21.40	0.00	50.41	-	-	74.00	-23.59	-	-	0	100	H	
			* 11.49509	33.26	PK-U	38.70	-21.40	0.00	50.56	-	-	74.00	-23.44	-	-	0	100	V	
			17.226	32.47	PK-U	42.10	-17.20	0.00	57.37	-	-	-	-	-	68.20	-10.83	0	100	H
			17.239	32.74	PK-U	42.10	-17.10	0.00	57.74	-	-	-	-	-	68.20	-10.46	0	100	V
	5785	MIMO	6.942	39.10	PK-U	36.20	-26.30	0.00	49.00	-	-	-	-	68.20	-19.20	0	110	H	
			6.942	26.83	PK-U	36.20	-26.30	0.00	36.73	-	-	-	-	68.20	-31.47	83	103	V	
			* 11.57448	33.81	PK-U	38.80	-21.60	0.00	51.01	-	-	74.00	-22.99	-	-	0	100	H	
			* 11.57159	33.53	PK-U	38.80	-21.60	0.00	50.73	-	-	74.00	-23.27	-	-	0	100	V	
			17.355	31.20	PK-U	42.00	-17.20	0.00	56.00	-	-	-	-	-	68.20	-12.20	0	100	H
			17.361	31.04	PK-U	42.00	-17.30	0.00	55.74	-	-	-	-	-	68.20	-12.46	0	100	V
	5825	MIMO	7.766	42.83	PK-U	36.30	-24.60	0.00	54.53	-	-	-	-	68.20	-13.67	326	121	H	
			7.767	44.77	PK-U	36.30	-24.60	0.00	56.47	-	-	-	-	68.20	-11.73	184	126	V	
			* 11.65623	35.17	PK-U	38.90	-21.50	0.00	52.57	-	-	74.00	-21.43	-	-	360	100	H	
			* 11.64479	34.98	PK-U	38.80	-21.50	0.00	52.28	-	-	74.00	-21.72	-	-	360	100	V	
			17.475	31.03	PK-U	42.00	-16.80	0.00	56.23	-	-	-	-	-	68.20	-11.97	0	100	H
			17.485	32.05	PK-U	42.00	-16.80	0.00	57.25	-	-	-	-	-	68.20	-10.95	360	100	V
802.11ax (HE20) 4RU Spot-check	5785	MIMO	6.942	38.75	PK-U	36.20	-26.30	0.00	48.65	-	-	-	-	68.20	-19.55	360	119	H	
			6.942	38.71	PK-U	36.20	-26.30	0.00	48.61	-	-	-	-	68.20	-19.59	176	163	V	
			* 11.57439	34.33	PK-U	38.80	-21.60	0.00	51.53	-	-	74.00	-22.47	-	-	0	100	H	
			* 11.57828	34.20	PK-U	38.80	-21.60	0.00	51.40	-	-	74.00	-22.60	-	-	360	100	V	
			17.351	31.26	PK-U	42.00	-17.20	0.00	56.06	-	-	-	-	-	68.20	-12.14	0	100	H
			17.355	31.50	PK-U	42.00	-17.20	0.00	56.30	-	-	-	-	-	68.20	-11.90	360	100	V

Note1. PK-U - U-NII: Maximum Peak / ADR - U-NII AD primary method, RMS average
 Note2. * - indicates frequency in CFR47 Pt 15 / IC RSS-Restricted Band

11.5. Spurious Emissions for Simultaneous Transmission

11.5.1. Worst test case RSDB condition

Case 1	2.4 GHz WLAN ANT1 + ANT2	5GHz WLAN ANT1 + ANT2
Mode	802.11g	802.11a
Channel	10	64
Frequency[MHz]	2457	5320
Tone	-	-
RU	-	-
Data Rate	6 Mbps	6 Mbps
Axis (Worst)		X

NOTE

The lowest margin condition among the channels and modes were selected for test. Low, mid, and high channels of 2.4GH WLAN were tested, and the worst case configuration & data were listed in the test report.

11.5.2. Test Results

Spurious emission for Simultaneous Transmission Case1. – Z axis

HORIZONTAL

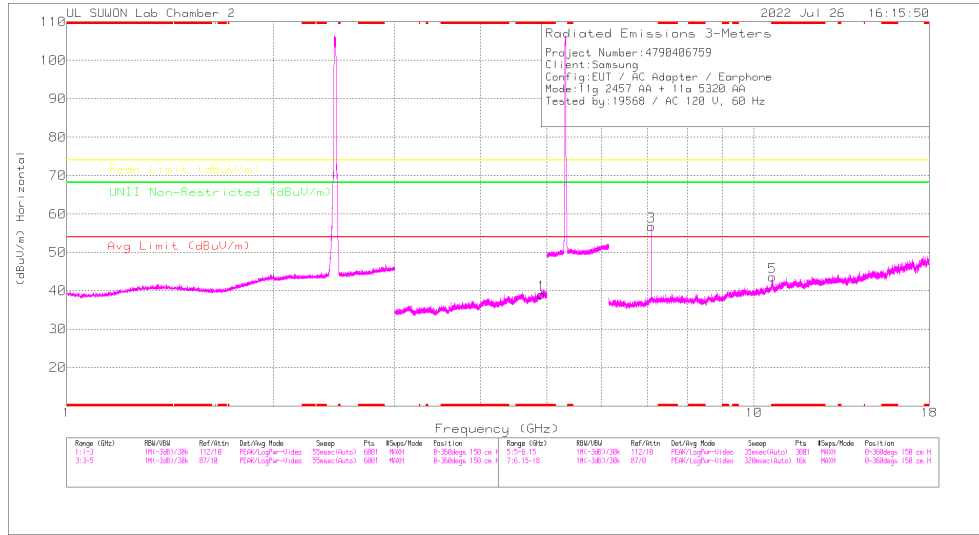

VERTICAL

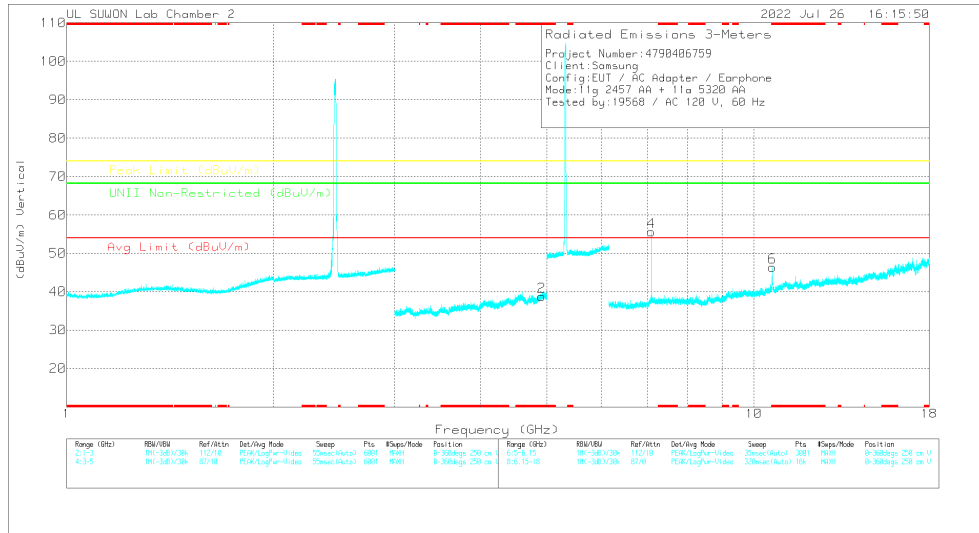

Radiated Emissions

Frequency (GHz)	Major Reading (dBuV)	Det	317_00168724	ISGZ_LFdB	DC Corr (dB)	Corrected Reading (dBuV/m)	Avg Limit (dBuV/m)	Margin (dB)	Peak Limit (dBuV/m)	Margin (dB)	UNII Non-Restricted (dBuV/m)	Margin (dB)	Asmth (Degs)	Height (cm)	Polarity
* 4.92324	40.77	PK2	34.1	-26	.5	49.37	-	-	74	-24.63	-	-	360	100	H
* 4.90436	41.44	PK2	34.1	-26.2	.5	49.84	-	-	74	-24.16	-	-	360	100	V

* - indicates frequency in CFR47 Pt 15 / IC RSS-Restricted Band
 PK2 - KDB558074 Method: Maximum Peak

Frequency (GHz)	Major Reading (dBuV)	Det	317_00168724	ISGZ_LFdB	DC Corr (dB)	Corrected Reading (dBuV/m)	Avg Limit (dBuV/m)	Margin (dB)	Peak Limit (dBuV/m)	Margin (dB)	UNII Non-Restricted (dBuV/m)	Margin (dB)	Asmth (Degs)	Height (cm)	Polarity
7.09347	46.26	PK-U	36.1	-23.5	0	58.86	-	-	-	-	66.2	-9.34	342	111	H
7.09338	45.24	PK-U	36.1	-23.5	0	57.84	-	-	-	-	66.2	-10.36	41	106	V
* 10.64088	37.12	PK-U	37.9	-19.3	0	55.72	-	74	-	-18.28	-	-	91	264	H
* 10.64013	24.74	ADR	37.9	-19.3	.15	43.49	54	-10.51	-	-	-	-	91	264	H
* 10.64093	38.48	PK-U	37.9	-19.3	0	57.08	-	-	74	-16.92	-	-	312	106	V
* 10.64016	27.42	ADR	37.9	-19.3	.15	46.17	54	-7.63	-	-	-	-	312	106	V

* - indicates frequency in CFR47 Pt 15 / IC RSS-Restricted Band
 PK-U - U-NII: Maximum Peak
 ADR - U-NII AD primary method, RMS average

12. WORST-CASE BELOW 1 GHz SPURIOUS EMISSIONS 30 TO 1000 MHz (WORST-CASE CONFIGURATION, HORIZONTAL)

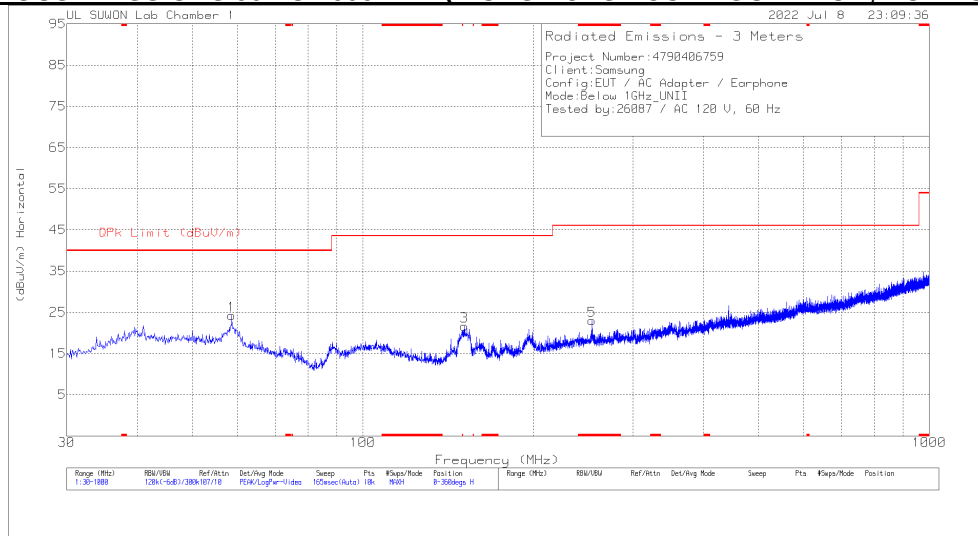

SPURIOUS EMISSIONS 30 TO 1000 MHz (WORST-CASE CONFIGURATION, VERTICAL)

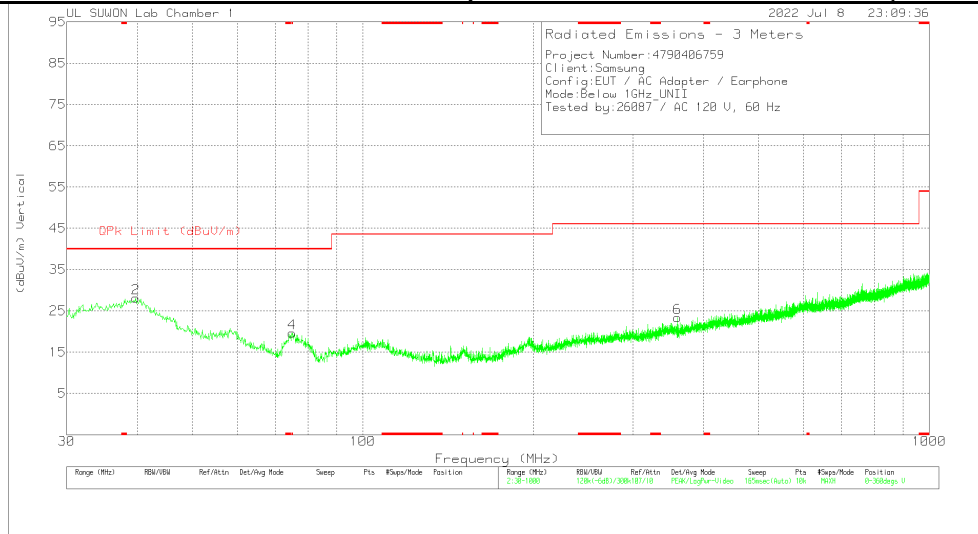

Trace Markers

Marker	Frequency (MHz)	Meter Reading (dBuV)	Det	VULB9163_750	Below_1G[dB]	DC Corr (dB)	Corrected Reading (dBuV/m)	OPK Limit (dBuV/m)	Margin (dB)	Azimuth (Degs)	Height (cm)	Polarity
1	58.712	36.1	Pk	18.9	-30.8	0	24.2	40	-15.8	0-360	300	H
3	150.959	37.31	Pk	14	-29.7	0	21.61	43.52	-21.91	0-360	100	H
5	* 254.07	33.42	Pk	18.5	-28.9	0	23.02	46.02	-23	0-360	100	H
2	39.7	40.65	Pk	18.6	-31.1	0	28.15	40	-11.85	0-360	200	V
4	* 75.008	36.86	Pk	13.4	-30.6	0	19.66	40	-20.34	0-360	200	V
6	359.121	31.46	Pk	20.2	-28.3	0	23.36	46.02	-22.66	0-360	200	V

* - indicates frequency in CFR47 Pt 15 / IC RSS-Restricted Band
 Pk - Peak detector

13. AC POWER LINE CONDUCTED EMISSIONS

LIMITS

FCC §15.207 (a)

Frequency of Emission (MHz)	Conducted Limit (dBuV)	
	Quasi-peak	Average
0.15-0.5	66 to 56	56 to 46
0.5-5	56	46
5-30	60	50

*Decreases with the logarithm of the frequency.

TEST PROCEDURE

The EUT is placed on a non-conducting table 40 cm from the vertical ground plane and 80 cm above the horizontal ground plane. The EUT is configured in accordance with ANSI C63.10.

The receiver is set to a resolution bandwidth of 9 kHz. Peak detection is used unless otherwise noted as quasi-peak or average.

Line conducted data is recorded for both NEUTRAL and HOT lines.

RESULTS

WORST EMISSIONS(C to C)

LINE 1 DATA

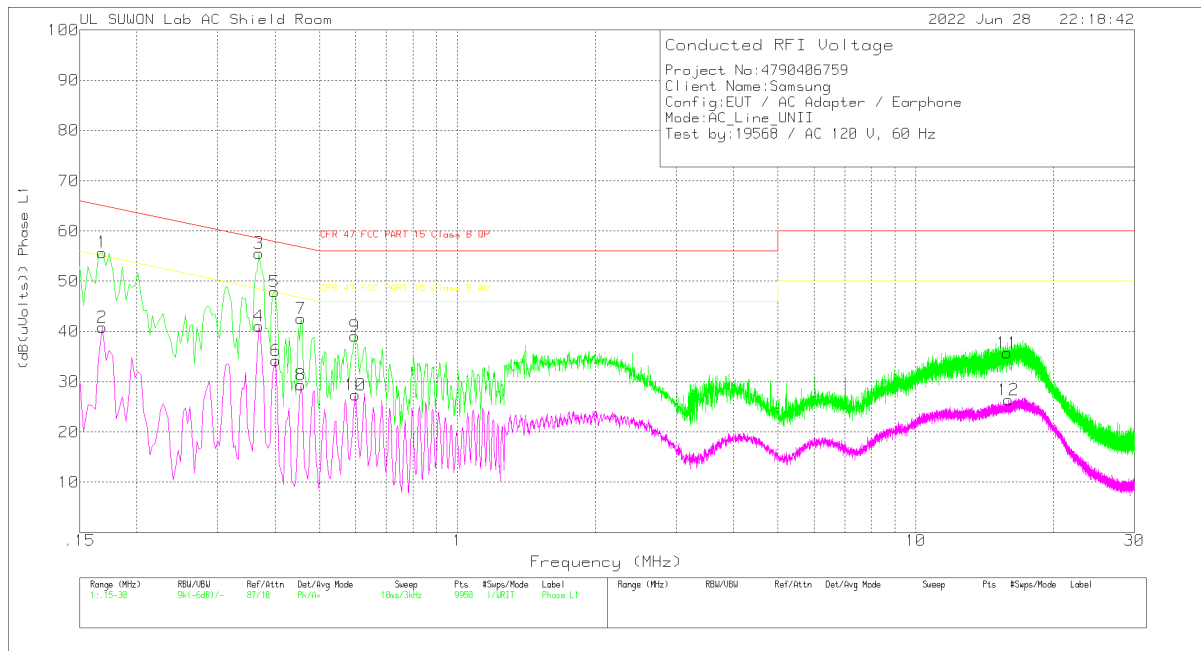

Trace Markers

Range 1: Phase L1 .15 - 30MHz

Marker	Frequency (MHz)	Meter Reading (dBuV)	Det	101836_With EX_L1[dB]	CABLELOS S(dB)	Corrected Reading (dB(uVolts))	CFR 47 FCC PART 15 Class B QP	Margin (dB)	CFR 47 FCC PART 15 Class B AV	Margin (dB)
1	.168	45.63	Pk	10	.1	55.73	65.06	-9.33	-	-
2	.168	30.72	Av	10	.1	40.82	-	-	55.06	-14.24
3	.369	45.6	Pk	9.8	.2	55.6	58.52	-2.92	-	-7.38
4	.369	31.14	Av	9.8	.2	41.14	-	-	48.52	-7.38
5	.399	37.94	Pk	9.8	.2	47.94	57.87	-9.93	-	-
6	.402	24.2	Av	9.8	.2	34.2	-	-	47.81	-13.61
7	.456	32.48	Pk	9.9	.2	42.58	56.77	-14.19	-	-
8	.456	19.3	Av	9.9	.2	29.4	-	-	46.77	-17.37
9	.597	29.07	Pk	9.8	.2	39.07	56	-16.93	-	-
10	.6	17.33	Av	9.8	.2	27.33	-	-	46	-18.67
11	15.84	25.38	Pk	10	.4	35.78	60	-24.22	-	-
12	15.927	16.02	Av	10	.4	26.42	-	-	50	-23.58

Pk - Peak detector

Av - Average detection

Quasi-Peak Emissions

Range 1: Phase L1 .15 - 30MHz

Frequency (MHz)	Meter Reading (dBuV)	Det	101836_With EX_L1[dB]	CABLELOS S(dB)	Corrected Reading (dB(uVolts))	CFR 47 FCC PART 15 Class B QP	Margin (dB)	CFR 47 FCC PART 15 Class B AV	Margin (dB)
.16875	38.22	Qp	10	.1	48.32	65.02	-16.7	-	-
.36915	43.89	Qp	9.8	.2	53.89	58.52	-4.63	-	-
.39825	36.52	Qp	9.8	.2	46.52	57.89	-11.37	-	-

Qp - Quasi-Peak detector

LINE 2 DATA

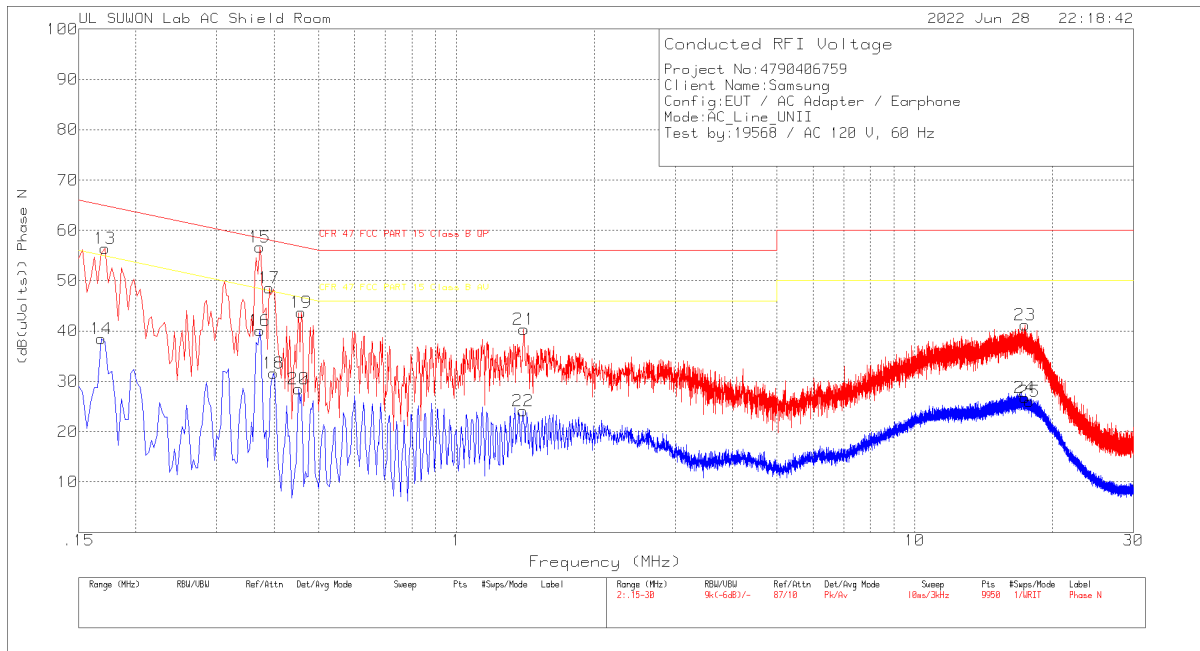

Trace Markers

Range 2: Phase N .15 - 30MHz

Marker	Frequency (MHz)	Meter Reading (dBuV)	Det	101836_With EX_N[dB]	CABLELOS S(dB)	Corrected Reading (dB(uVolts))	CFR 47 FCC PART 15 Class B QP	Margin (dB)	CFR 47 FCC PART 15 Class B AV	Margin (dB)
13	.171	46.25	Pk	10	.2	56.45	64.91	-8.46	-	-
14	.168	28.34	Av	10	.1	38.44	-	-	55.06	-16.62
15	.372	46.68	Pk	9.8	.2	56.68	58.46	-1.78	-	-
16	.372	30.14	Av	9.8	.2	40.14	-	-	48.46	-8.32
17	.39	38.59	Pk	9.8	.2	48.59	58.06	-9.47	-	-
18	.399	21.58	Av	9.8	.2	31.58	-	-	47.87	-16.29
19	.459	33.55	Pk	9.9	.2	43.65	56.71	-13.06	-	-
20	.453	18.36	Av	9.9	.2	28.46	-	-	46.82	-18.36
21	1.404	30.34	Pk	9.7	.3	40.34	56	-15.66	-	-
22	1.398	14.17	Av	9.7	.3	24.17	-	-	46	-21.83
23	17.403	30.59	Pk	10.2	.4	41.19	60	-18.81	-	-
24	17.385	16.13	Av	10.2	.4	26.73	-	-	50	-23.27
25	17.787	15.36	Av	10.2	.4	25.96	-	-	50	-24.04

Pk - Peak detector
 Av - Average detection

Quasi-Peak Emissions

Range 2: Phase N .15 - 30MHz

Frequency (MHz)	Meter Reading (dBuV)	Det	101836_With EX_N[dB]	CABLELOS S(dB)	Corrected Reading (dB(uVolts))	CFR 47 FCC PART 15 Class B QP	Margin (dB)	CFR 47 FCC PART 15 Class B AV	Margin (dB)
.17115	44.41	Qp	10	.2	54.61	64.9	-10.29	-	-
.37125	44.75	Qp	9.8	.2	54.75	58.47	-3.72	-	-
.39075	29.38	Qp	9.8	.2	39.38	58.05	-18.67	-	-

Qp - Quasi-Peak detector

WORST EMISSIONS(C to A)

LINE 1 DATA

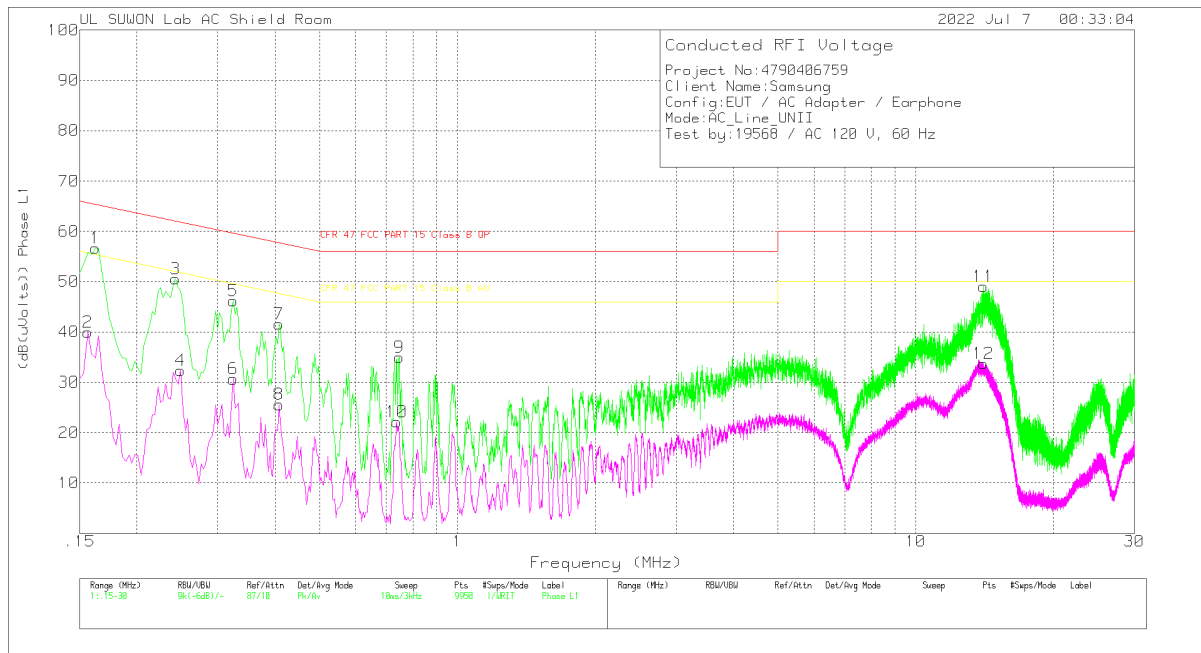

Trace Markers

Range 1: Phase L1 .15 - 30MHz

Marker	Frequency (MHz)	Meter Reading (dBuV)	Det	101836_With EX_L1[dB]	CABLELOS S(dB)	Corrected Reading (dB(uVolts))	CFR 47 FCC PART 15 Class B QP	Margin (dB)	CFR 47 FCC PART 15 Class B AV	Margin (dB)
1	.162	46.72	Pk	9.9	.1	56.72	65.36	-8.64	-	-
2	.156	30.11	Av	9.8	.1	40.01	-	-	55.67	-15.66
3	.243	40.7	Pk	9.6	.2	50.5	61.99	-11.49	-	-
4	.249	22.61	Av	9.6	.2	32.41	-	-	51.79	-19.38
5	.324	36.3	Pk	9.7	.2	46.2	59.6	-13.4	-	-
6	.324	20.78	Av	9.7	.2	30.68	-	-	49.6	-18.92
7	.408	31.54	Pk	9.8	.2	41.54	57.69	-16.15	-	-
8	.408	15.57	Av	9.8	.2	25.57	-	-	47.69	-22.12
9	.747	25	Pk	9.8	.2	35	56	-21	-	-
10	.738	12.17	Av	9.8	.2	22.17	-	-	46	-23.83
11	14.064	38.62	Pk	10	.4	49.02	60	-10.98	-	-
12	14.049	23.37	Av	10	.4	33.77	-	-	50	-16.23

Pk - Peak detector

Av - Average detection

Quasi-Peak Emissions

Range 1: Phase L1 .15 - 30MHz

Frequency (MHz)	Meter Reading (dBuV)	Det	101836_With EX_L1[dB]	CABLELOS S(dB)	Corrected Reading (dB(uVolts))	CFR 47 FCC PART 15 Class B QP	Margin (dB)	CFR 47 FCC PART 15 Class B AV	Margin (dB)
.16125	43.18	Qp	9.9	.1	53.18	65.4	-12.22	-	-

Qp - Quasi-Peak detector

LINE 2 DATA

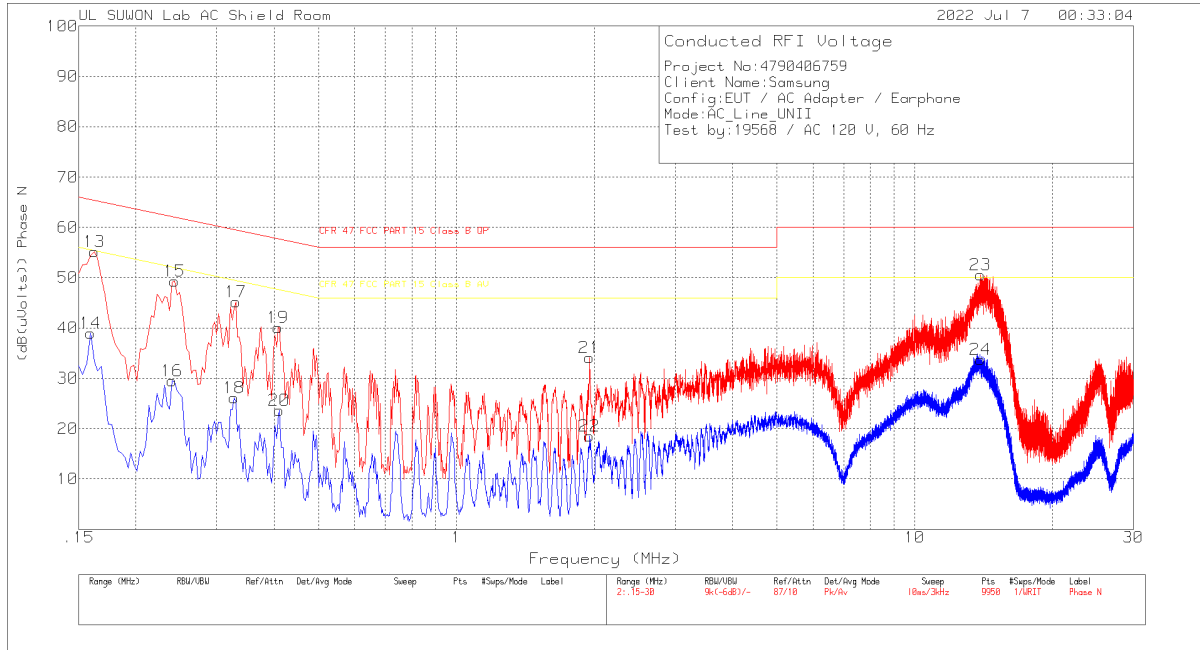

Trace Markers

Range 2: Phase N .15 - 30MHz

Marker	Frequency (MHz)	Meter Reading (dBuV)	Det	101836_With EX_N[dB]	CABLELOSS S(dB)	Corrected Reading (dB(uVolts))	CFR 47 FCC PART 15 Class B QP	Margin (dB)	CFR 47 FCC PART 15 Class B AV	Margin (dB)
13	.162	45.15	Pk	9.9	.1	55.15	65.36	-10.21	-	-
14	.159	29.06	Av	9.8	.1	38.96	-	-	55.52	-16.56
15	.243	39.55	Pk	9.6	.2	49.35	61.99	-12.64	-	-
16	.24	19.58	Av	9.7	.2	29.48	-	-	52.1	-22.62
17	.33	35.14	Pk	9.8	.2	45.14	59.45	-14.31	-	-
18	.327	16.24	Av	9.7	.2	26.14	-	-	49.53	-23.39
19	.408	30.09	Pk	9.8	.2	40.09	57.69	-17.6	-	-
20	.411	13.6	Av	9.8	.2	23.6	-	-	47.63	-24.03
21	1.953	24.07	Pk	9.7	.3	34.07	56	-21.93	-	-
22	1.953	8.58	Av	9.7	.3	18.58	-	-	46	-27.42
23	13.902	40.14	Pk	10	.4	50.54	60	-9.46	-	-
24	13.908	23.35	Av	10	.4	33.75	-	-	50	-16.25

Pk - Peak detector
 Av - Average detection

Quasi-Peak Emissions

Range 2: Phase N .15 - 30MHz

Frequency (MHz)	Meter Reading (dBuV)	Det	101836_With EX_N[dB]	CABLELOSS (dB)	Corrected Reading (dB(uVolts))	CFR 47 FCC PART 15 Class B QP	Margin (dB)	CFR 47 FCC PART 15 Class B AV	Margin (dB)
13.9013	33.4	Qp	10	.4	43.8	60	-16.2	-	-

Qp - Quasi-Peak detector

14. DYNAMIC FREQUENCY SELECTION

14.1. OVERVIEW

14.1.1. LIMITS

FCC

§15.407 (h), FCC KDB 905462 D02 “COMPLIANCE MEASUREMENT PROCEDURES FOR UNLICENSED-NATIONAL INFORMATION INFRASTRUCTURE DEVICES OPERATING IN THE 5250-5350 MHz AND 5470-5725 MHz BANDS INCORPORATING DYNAMIC FREQUENCY SELECTION” and KDB 905462 D03 “U-NII CLIENT DEVICES WITHOUT RADAR DETECTION CAPABILITY”.

Table 1: Applicability of DFS requirements prior to use of a channel

Requirement	Operational Mode		
	Master	Client (without radar detection)	Client (with radar detection)
Non-Occupancy Period	Yes	Not required	Yes
DFS Detection Threshold	Yes	Not required	Yes
Channel Availability Check Time	Yes	Not required	Not required
U-NII Detection Bandwidth	Yes	Not required	Yes

Table 2: Applicability of DFS requirements during normal operation

Requirement	Operational Mode		
	Master	Client (without DFS)	Client (with DFS)
DFS Detection Threshold	Yes	Not required	Yes
Channel Closing Transmission Time	Yes	Yes	Yes
Channel Move Time	Yes	Yes	Yes
U-NII Detection Bandwidth	Yes	Not required	Yes

Additional requirements for devices with multiple bandwidth modes	Master Device or Client with Radar DFS	Client (without DFS)
U-NII Detection Bandwidth and Statistical Performance Check	All BW modes must be tested	Not required
Channel Move Time and Channel Closing Transmission Time	Test using widest BW mode available	Test using the widest BW mode available for the link
All other tests	Any single BW mode	Not required

Note: Frequencies selected for statistical performance check (Section 7.8.4) should include several frequencies within the radar detection bandwidth and frequencies near the edge of the radar detection bandwidth. For 802.11 devices it is suggested to select frequencies in all 20 MHz channel blocks and a null frequency between the bonded 20 MHz channel blocks.

Table 3: Interference Threshold values, Master or Client incorporating In-Service Monitoring

Maximum Transmit Power	Value (see notes)
E.I.R.P. \geq 200 mill watt	-64 dBm
E.I.R.P. < 200 mill watt and power spectral density < 10 dBm/MHz	-62 dBm
E.I.R.P. < 200 mill watt that do not meet power spectral density requirement	-64 dBm
<p>Note 1: This is the level at the input of the receiver assuming a 0 dBi receive antenna Note 2: Throughout these test procedures an additional 1 dB has been added to the amplitude of the test transmission waveforms to account for variations in measurement equipment. This will ensure that the test signal is at or above the detection threshold level to trigger a DFS response. Note 3: E.I.R.P. is based on the highest antenna gain. For MIMO devices refer to KDB publication 662911 D01.</p>	

Table 4: DFS Response requirement values

Parameter	Value
<i>Non-occupancy period</i>	30 minutes
<i>Channel Availability Check Time</i>	60 seconds
<i>Channel Move Time</i>	10 seconds (See Note 1)
<i>Channel Closing Transmission Time</i>	200 milliseconds + approx. 60 milliseconds over remaining 10 second period. (See Notes 1 and 2)
<i>U-NII Detection Bandwidth</i>	Minimum 100% of the U- NII 99% transmission power bandwidth. (See Note 3)
<p>Note 1: <i>Channel Move Time</i> and the <i>Channel Closing Transmission Time</i> should be performed with Radar Type 0. The measurement timing begins at the end of the Radar Type 0 burst. Note 2: The <i>Channel Closing Transmission Time</i> is comprised of 200 milliseconds starting at the beginning of the <i>Channel Move Time</i> plus any additional intermittent control signals required to facilitate a <i>Channel</i> move (an aggregate of 60 milliseconds) during the remainder of the 10 second period. The aggregate duration of control signals will not count quiet periods in between transmissions. Note 3: During the <i>U-NII Detection Bandwidth</i> detection test, radar type 0 should be used. For each frequency step the minimum percentage of detection is 90 percent. Measurements are performed with no data traffic.</p>	

Table 5 – Short Pulse Radar Test Waveforms

Radar Type	Pulse Width (usec)	PRI (usec)	Pulses	Minimum Percentage of Successful Detection	Minimum Trials
0	1	1428	18	See Note 1	See Note 1
1	1	Test A: 15 unique PRI values randomly selected from the list of 23 PRI values in table 5a	Roundup: $\{(1/360) \times (19 \times 10^6 \text{ PRI}_{\text{usec}})\}$	60%	30
		Test B: 15 unique PRI values randomly selected within the range of 518-3066 usec. With a minimum increment of 1 usec, excluding PRI values selected in Test A			
2	1-5	150-230	23-29	60%	30
3	6-10	200-500	16-18	60%	30
4	11-20	200-500	12-16	60%	30
Aggregate (Radar Types 1-4)				80%	120
Note 1: Short Pulse Radar Type 0 should be used for the <i>Detection Bandwidth</i> test, <i>Channel Move Time</i> , and <i>Channel Closing Time</i> tests.					

Table 6 – Long Pulse Radar Test Signal

Radar Waveform Type	Pulse Width (μsec)	Chirp Width (MHz)	PRI (μsec)	Pulses per Burst	Number of Bursts	Minimum Percentage of Successful Detection	Minimum Trials
5	50-100	5-20	1000-2000	1-3	8-20	80%	30

Table 7 – Frequency Hopping Radar Test Signal

Radar Waveform Type	Pulse Width (μsec)	PRI (μsec)	Pulses per Hop	Hopping Rate (kHz)	Hopping Sequence Length (msec)	Minimum Percentage of Successful Detection	Minimum Trials
6	1	333	9	0.333	300	70%	30

14.1.2. TEST AND MEASUREMENT SYSTEM

CONDUCTED METHOD SYSTEM BLOCK DIAGRAM

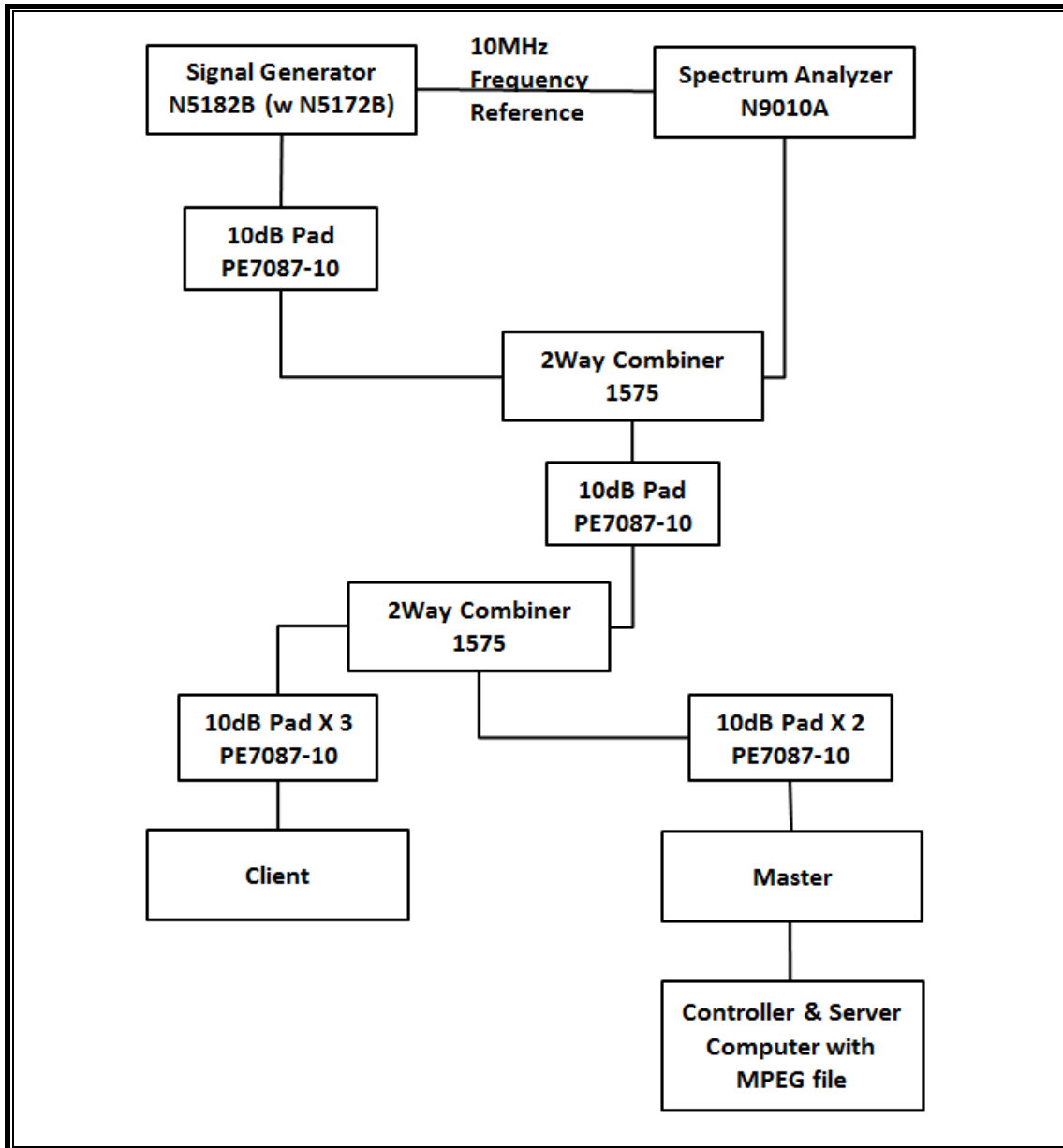

SYSTEM OVERVIEW

The short pulse and long pulse signal generating system utilizes the Keysite Signal Studio for Pulse Building as N5172B. The Vector Signal Generator has been validated by the NTIA. The hopping signal generating system utilizes the CCS simulated hopping method and system, which has been validated by the DoD, FCC and NTIA. The software selects waveform parameters from within the bounds of the signal type on a random basis using uniform distribution.

The short pulse types 1, 2, 3 and 4, and the long pulse type 5 parameters are randomized at run-time.

The hopping type 6 pulse parameters are fixed while the hopping sequence is based on the August 2005 NTIA Hopping Frequency List. The initial starting point randomized at run-time and each subsequent starting point is incremented by 475. Each frequency in the 100-length segment is compared to the boundaries of the EUT Detection Bandwidth and the software creates a hopping burst pattern in accordance with Section 7.4.1.3 Method #2 Simulated Frequency Hopping Radar Waveform Generating Subsystem of KDB 905462 D02. The frequency of the signal generator is incremented in 1 MHz steps from F_L to F_H for each successive trial. This incremental sequence is repeated as required to generate a minimum of 30 total trials and to maintain a uniform frequency distribution over the entire Detection Bandwidth.

The signal monitoring equipment consists of a spectrum analyzer. The aggregate ON time is calculated by multiplying the number of bins above a threshold during a particular observation period by the dwell time per bin, with the analyzer set to peak detection and max hold.

SYSTEM CALIBRATION

A 50-ohm load is connected in place of the spectrum analyzer, and the spectrum analyzer is connected to a horn antenna via a coaxial cable, with the reference level offset set to (horn antenna gain – coaxial cable loss). The signal generator is set to CW mode. The amplitude of the signal generator is adjusted to yield a level of –64 dBm as measured on the spectrum analyzer.

Without changing any of the instrument settings, the spectrum analyzer is reconnected to the Common port of the Spectrum Analyzer Combiner/Divider. The Reference Level Offset of the spectrum analyzer is adjusted so that the displayed amplitude of the signal is –64 dBm.

The spectrum analyzer displays the level of the signal generator as received at the antenna ports of the Master Device. The interference detection threshold may be varied from the calibrated value of –64 dBm and the spectrum analyzer will still indicate the level as received by the Master Device.

ADJUSTMENT OF DISPLAYED TRAFFIC LEVEL

A link is established between the Master and Slave and the distance between the units is adjusted as needed to provide a suitable received level at the Master and Slave devices. The video test file is streamed to generate WLAN traffic. The monitoring antenna is adjusted so that the WLAN traffic level, as displayed on the spectrum analyzer, is at lower amplitude than the radar detection threshold.

TEST AND MEASUREMENT EQUIPMENT

The following test and measurement equipment was utilized for the DFS tests documented in this report:

TEST EQUIPMENT LIST				
Description	Manufacturer	Model	S/N	Next Cal Due
Spectrum Analyzer, 7 GHz	Agilent / HP	N9010A	MY54200580	08-02-22
Vector Signal Generator, 6GHz	Agilent / HP	N5182B	MY53051241	08-02-22
Combiner	WEINSCHTEL	WA1534	UL001	01-11-23
Combiner	WEINSCHTEL	WA1535	UL002	01-11-23

14.1.3. SETUP OF EUT

CONDUCTED METHOD EUT TEST SETUP

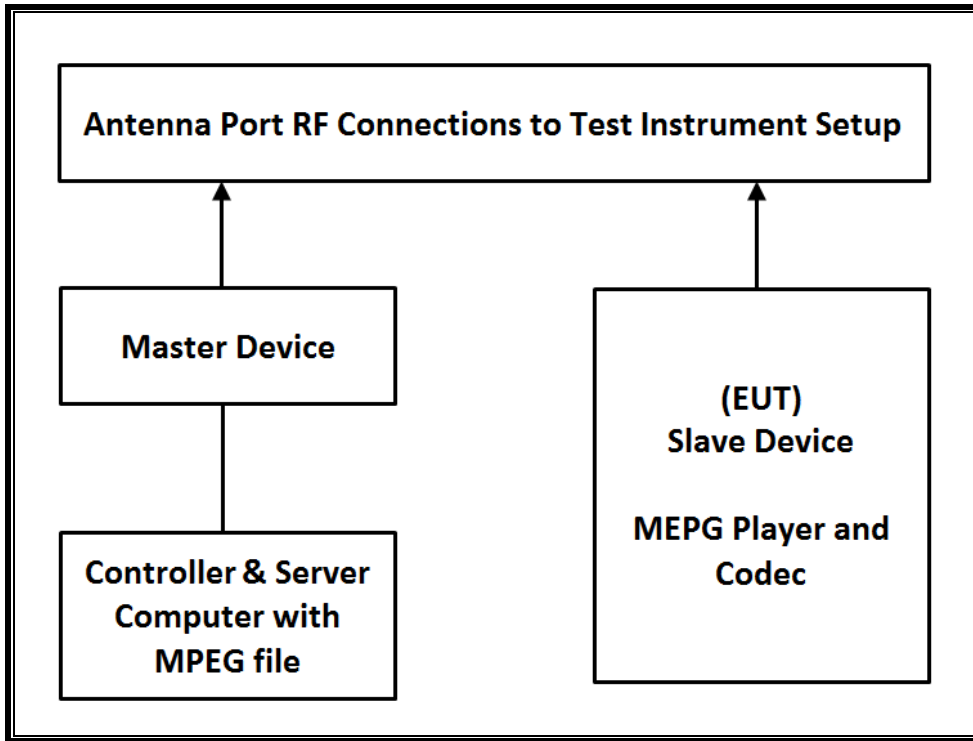

SUPPORT EQUIPMENT

The following support equipment was utilized for the DFS tests documented in this report:

PERIPHERAL SUPPORT EQUIPMENT LIST				
Description	Manufacturer	Model	Serial Number	FCC ID
Wireless Access Point	Cisco	AIR-CAP3702E-A-K9	FTX182276QX	LDK102087
Notebook PC (Controller/Server)	HP	HP EliteDesk 800 G1 TWR	CZC4125J25	DoC

14.1.4. DESCRIPTION OF EUT

The EUT operates over the 5250-5350 MHz and 5470-5725 MHz ranges.

The EUT is a Slave Device without Radar Detection.

The highest power level of the widest bandwidth (802.11ac VHT80) within these bands is 13.66 dBm in the 5250-5350 MHz band and 13.51 dBm in the 5470-5725 MHz band.

The antenna assembly utilized two antenna.

Gain of ANT1 : -5.0 dBi for UNII 2A and -4.1 dBi for UNII 2C.

Gain of ANT2 : -2.9 dBi for UNII 2A and -2.6 dBi for UNII 2C.

The rated output power of the Master unit is > 23dBm (EIRP). Therefore the required interference threshold level is -64 dBm. After correction for procedural adjustments, the required conducted threshold at the antenna port is $-64 + 1 = -63$ dBm.

The calibrated radiated DFS Detection Threshold level is set to -64 dBm. The tested level is lower than the required level hence it provides a margin to the limit.

The EUT uses one transmitter/receiver chain connected to an antenna to perform radiated tests. WLAN traffic that meets or exceeds the minimum required loading was generated by transferring a data stream from the controller/server PC to the EUT using iPerf version 2.0.5 software package.

TPC is not required since the maximum EIRP is less than 500 mW (27 dBm).

The EUT utilizes the 802.11 architecture. Three nominal channel bandwidths are implemented: 20 MHz, 40 MHz and 80 MHz.

The software installed in the access point is 12.4(25d)JA1.

UNIFORM CHANNEL SPREADING

This requirement is not applicable to Slave radio devices.

CHANNEL PUNCTURING(802.11ax)

This EUT does not support channel puncturing.

OVERVIEW OF MASTER DEVICE WITH RESPECT TO §15.407 (h) REQUIREMENTS

The Master Device is a Cisco Access Point, FCC ID: LDK102087. The minimum antenna gain for the Master Device is 6 dBi.

The rated output power of the Master unit is > 23dBm (EIRP). Therefore the required interference threshold level is -64 dBm. After correction for procedural adjustments, the required radiated threshold at the antenna port is $-64 + 1 = -63$ dBm.

The calibrated radiated DFS Detection Threshold level is set to -64 dBm. The tested level is lower than the required level hence it provides a margin to the limit.

14.2. RESULTS FOR 80 MHz BANDWIDTH (UNII-2A BAND)

14.2.1. TEST CHANNEL

All tests were performed at a channel center frequency of 5290 MHz.

14.2.2. RADAR WAVEFORM AND TRAFFIC

RADAR WAVEFORM



14.2.3. OVERLAPPING CHANNEL TESTS

RESULTS

These tests are not applicable.

14.2.4. MOVE AND CLOSING TIME

REPORTING NOTES

The reference marker is set at the end of last radar pulse.

The delta marker is set at the end of the last WLAN transmission following the radar pulse. This delta is the channel move time.

The aggregate channel closing transmission time is calculated as follows:

Aggregate Transmission Time =
(Number of analyzer bins showing transmission) * (dwell time per bin)

The observation period over which the aggregate time is calculated begins at (Reference Marker + 200 msec) and ends no earlier than (Reference Marker + 10 sec).

RESULTS

Channel Move Time (sec)	Limit (sec)
0.702	10

Aggregate Channel Closing Transmission Time (msec)	Limit (msec)
8.250	60

MOVE TIME & CHANNEL CLOSING TIME

AGGREGATE CHANNEL CLOSING TRANSMISSION TIME

No transmissions are observed during the aggregate monitoring period.

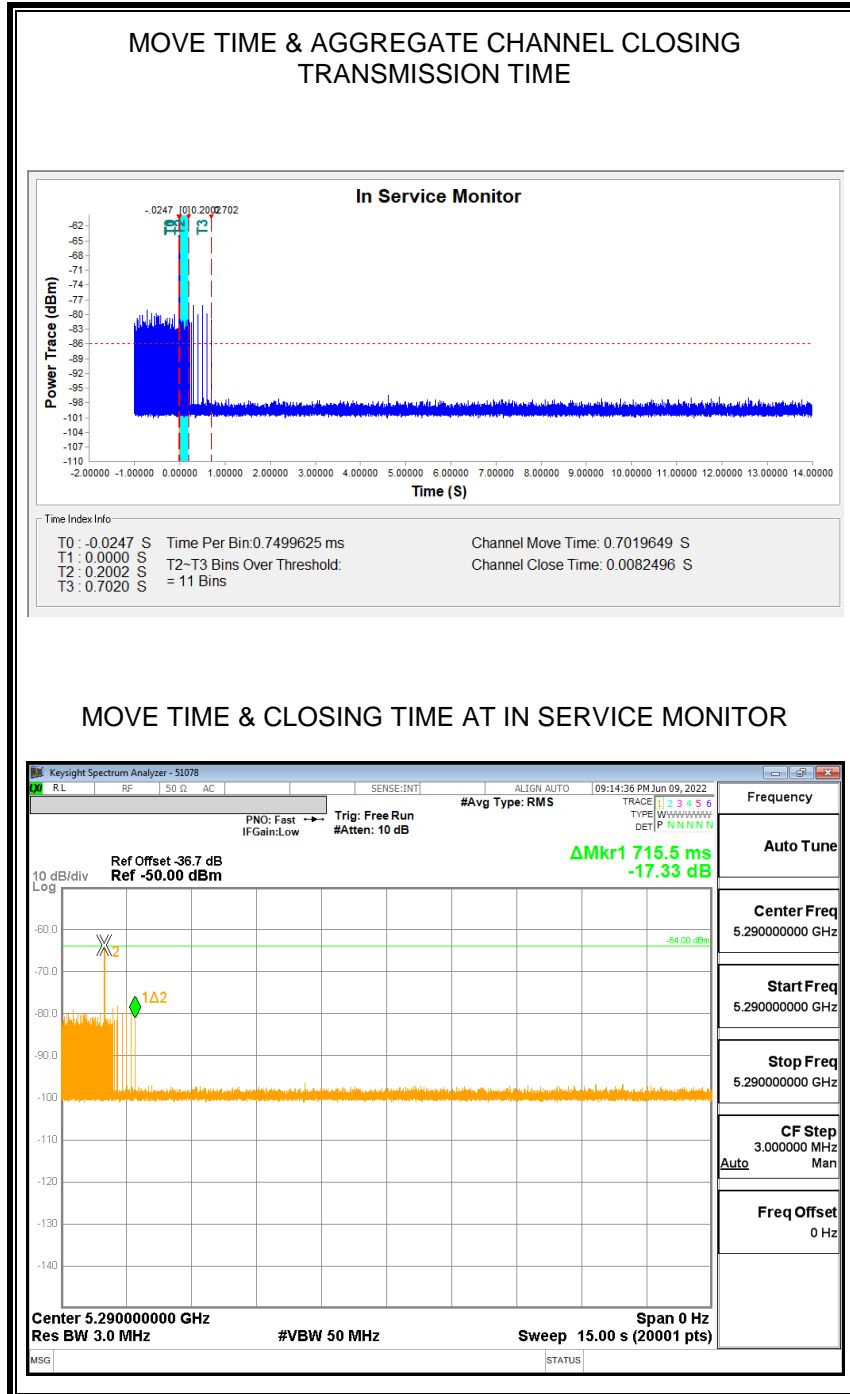

NON-OCCUPANCY PERIOD

RESULTS

No EUT transmissions were observed on the test channel during the 10-minute observation time.

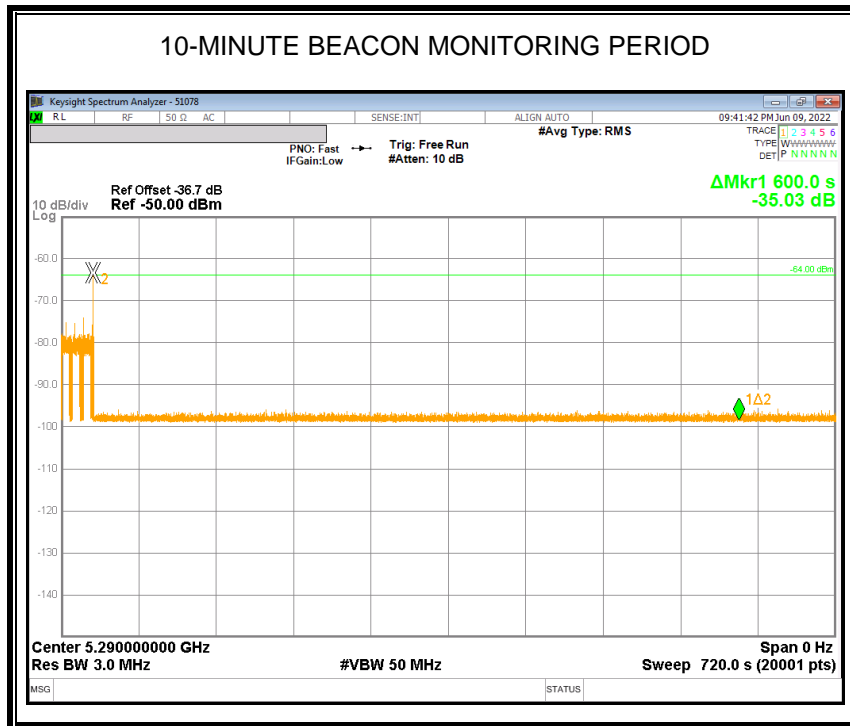

14.3. RESULTS FOR 80 MHz BANDWIDTH (UNII-2C BAND)

14.3.1. TEST CHANNEL

All tests were performed at a channel center frequency of 5530 MHz.

14.3.2. RADAR WAVEFORM AND TRAFFIC

RADAR WAVEFORM

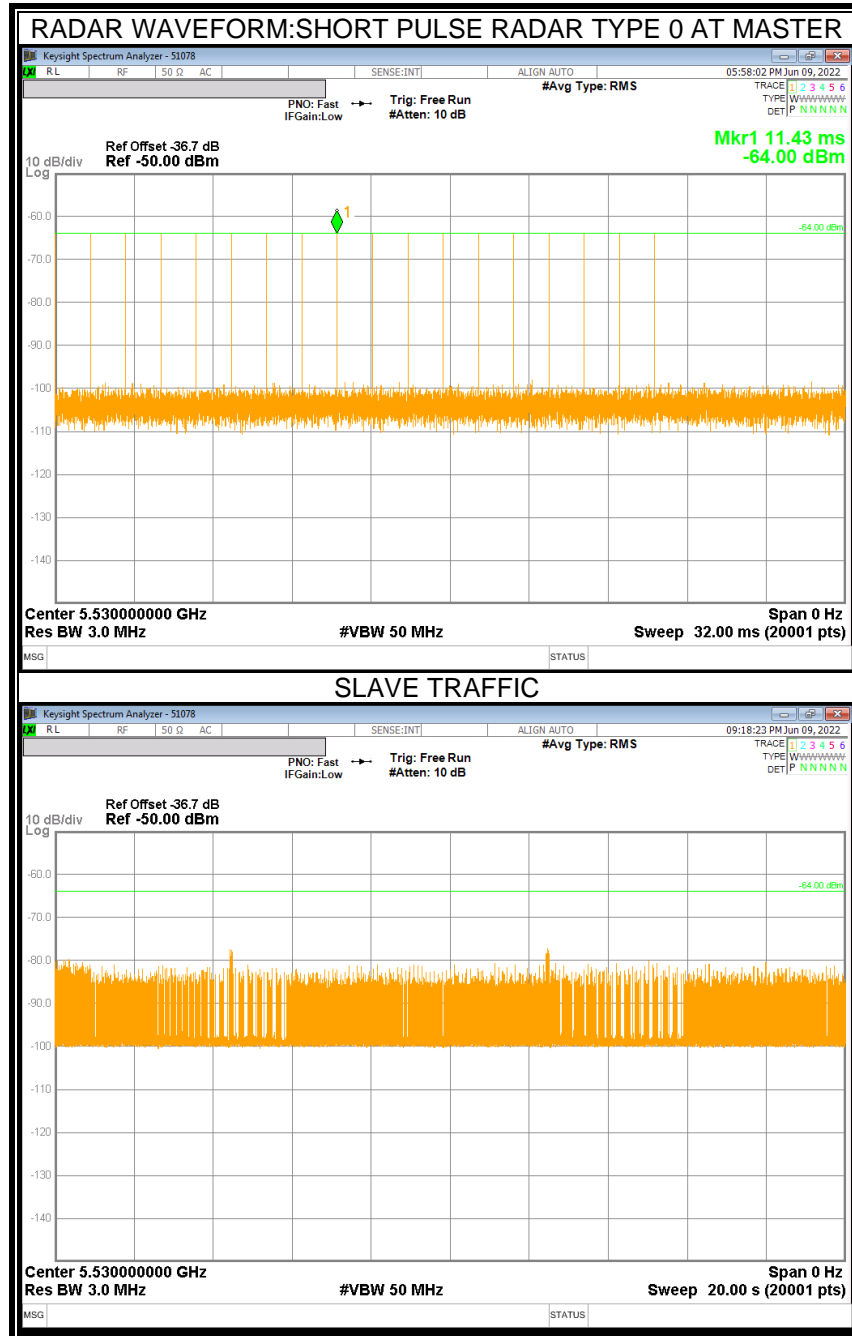

14.3.3. OVERLAPPING CHANNEL TESTS

RESULTS

These tests are not applicable.

14.3.4. MOVE AND CLOSING TIME

REPORTING NOTES

The reference marker is set at the end of last radar pulse.

The delta marker is set at the end of the last WLAN transmission following the radar pulse. This delta is the channel move time.

The aggregate channel closing transmission time is calculated as follows:

Aggregate Transmission Time =
(Number of analyzer bins showing transmission) * (dwell time per bin)

The observation period over which the aggregate time is calculated begins at (Reference Marker + 200 msec) and ends no earlier than (Reference Marker + 10 sec).

RESULTS

Channel Move Time (sec)	Limit (sec)
0.730	10

Aggregate Channel Closing Transmission Time (msec)	Limit (msec)
6.750	60

MOVE TIME & CHANNEL CLOSING TIME

AGGREGATE CHANNEL CLOSING TRANSMISSION TIME

No transmissions are observed during the aggregate monitoring period.

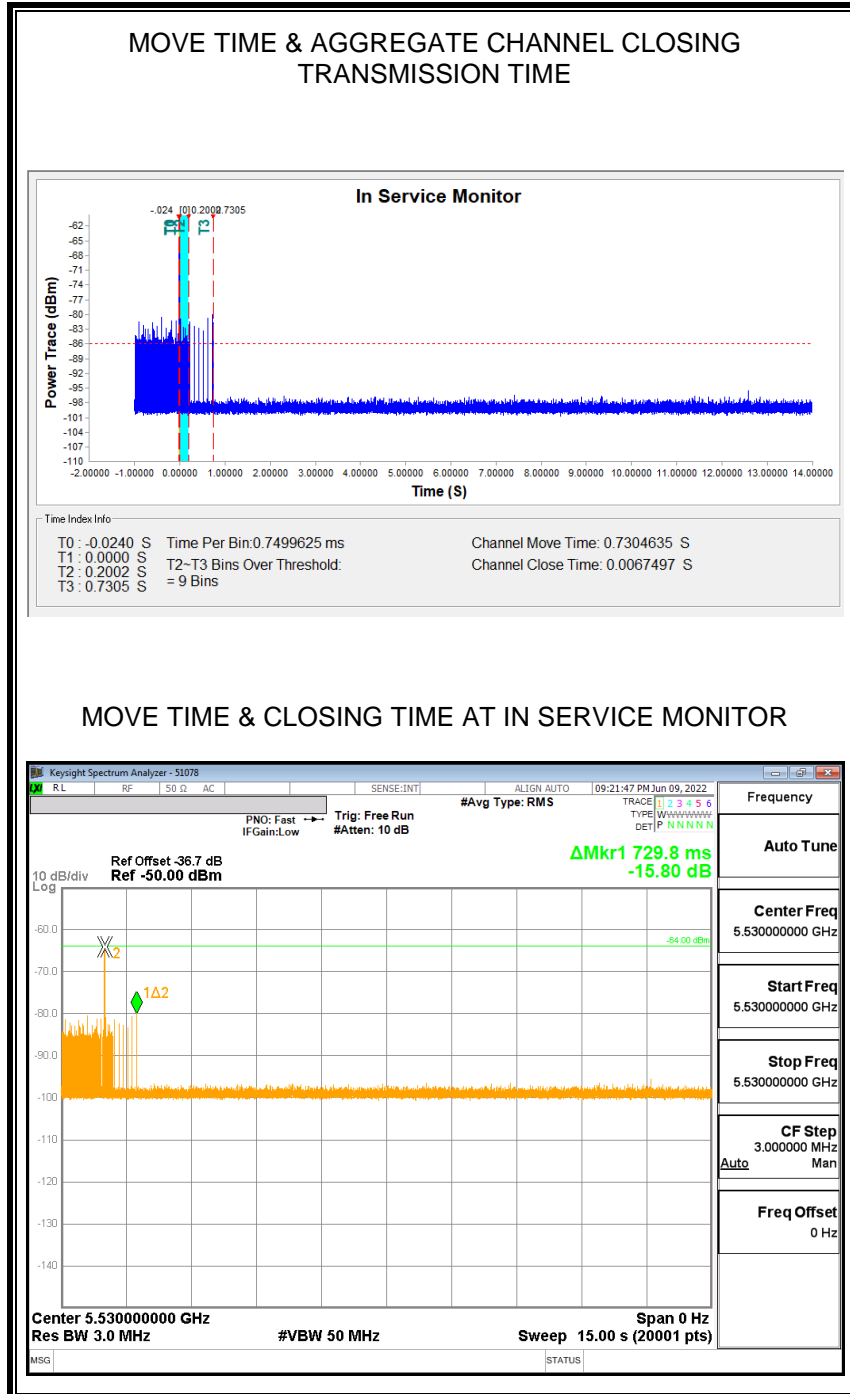

NON-OCCUPANCY PERIOD

RESULTS

No EUT transmissions were observed on the test channel during the 10-minute observation time.

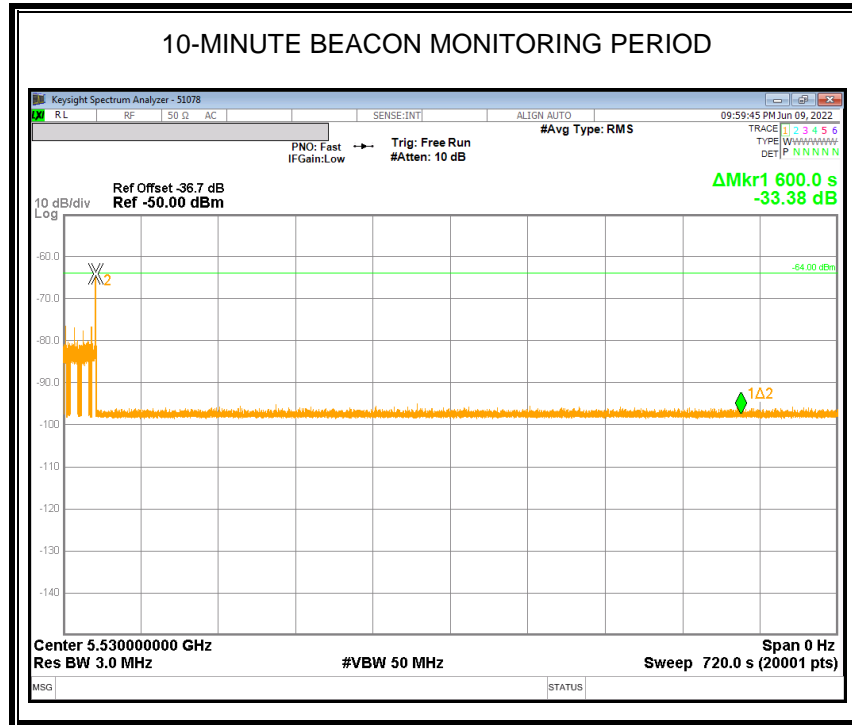

15. SPOT-CHECK TEST RESULT

UNII-1

BANDEDGE (WORST CASE: 802.11n HT40 MIMO / 5190 MHz)

HORIZONTAL PEAK AND AVERAGE DATA

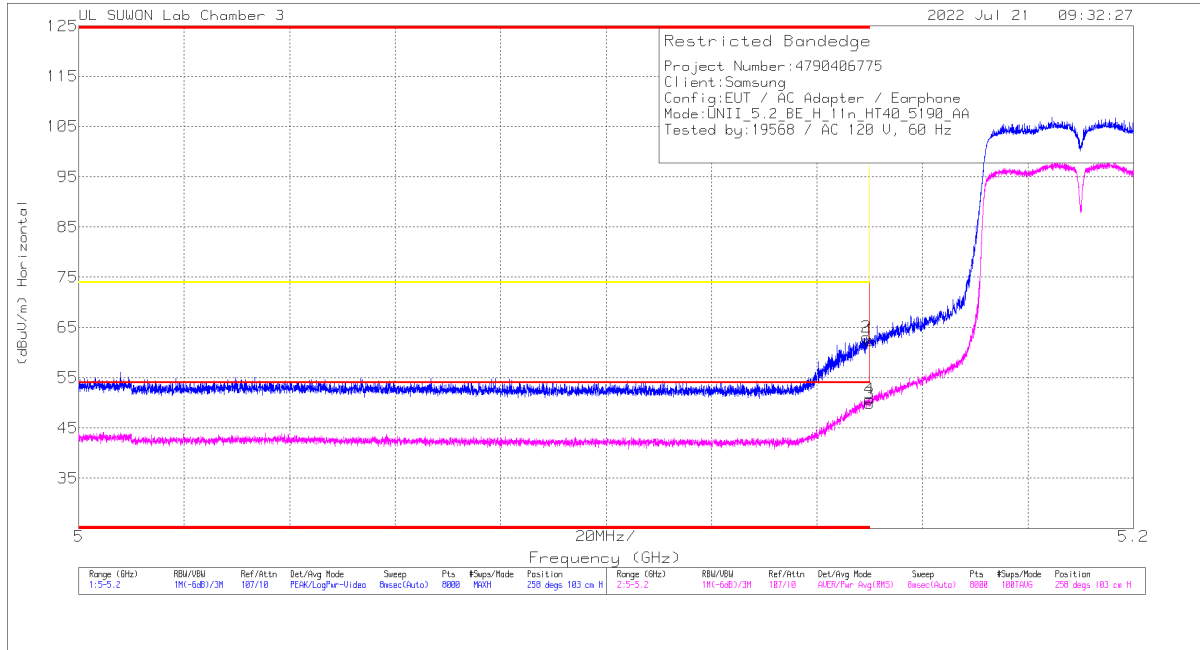

Trace Markers

Marker	Frequency (GHz)	Meter Reading (dBuV)	Det	3117_00218957	10dB_ATT[dB]	DC Corr (dB)	Corrected Reading (dBuV/m)	Average Limit (dBuV/m)	Margin (dB)	Peak Limit (dBuV/m)	Pk Margin (dB)	Acimuth (Degs)	Height (cm)	Polarity
1	* 5.14999	48.21	Pk	34.8	-20.6	0	62.41	-	-	74	-11.59	258	103	H
2	* 5.14942	48.94	Pk	34.8	-20.6	0	63.14	-	-	74	-10.86	258	103	H
3	* 5.14999	35.63	RMS	34.8	-20.6	0	49.83	54	-4.17	-	-	258	103	H
4	* 5.14994	36.51	RMS	34.8	-20.6	0	50.71	54	-3.29	-	-	258	103	H

* - indicates frequency in CFR47 Pt 15 / IC RSS-Restricted Band
 Pk - Peak detector
 RMS - RMS detection

HARMONICS AND SPURIOUS EMISSIONS(WORST CASE: 802.11a MIMO / 5180 MHz)

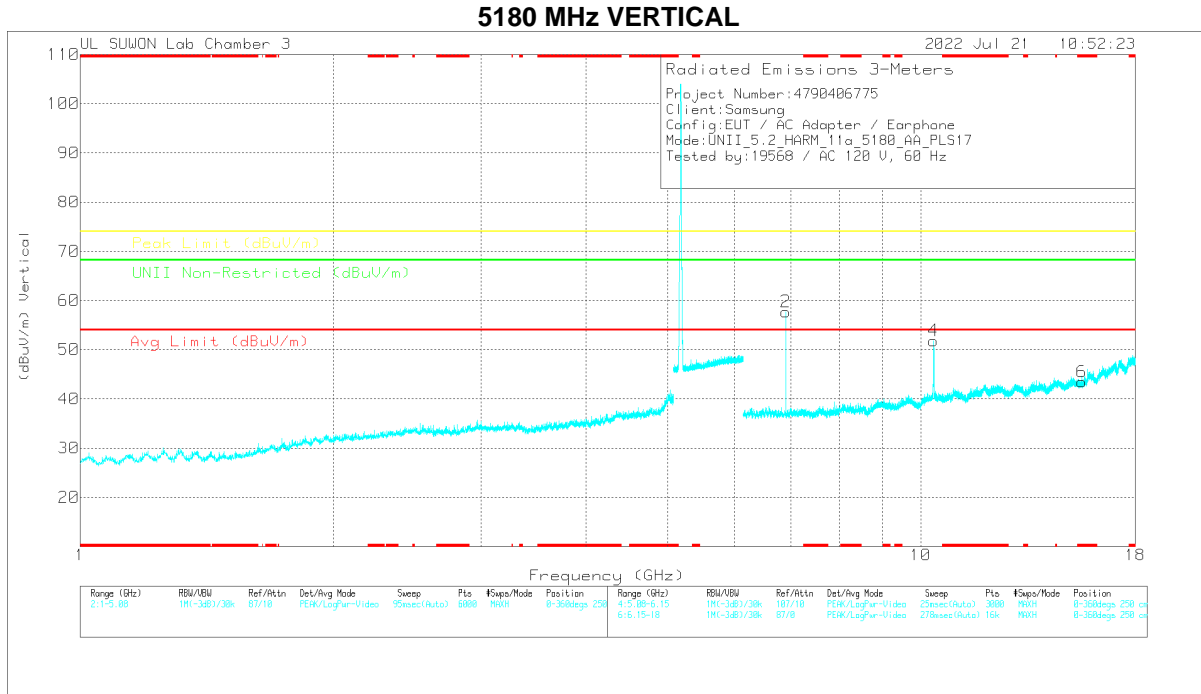

Note: Emission was scanned up to 40GHz; No emissions were detected above the noise floor which was at least 20dB below the specification limit.

Radiated Emissions

Frequency (GHz)	Main Reading (dBuV)	Det	317_0021867	6GHz_HPS(B)	DC Corr (dB)	Corrected Reading (dBuV/m)	Avg Limit (dBuV/m)	Margin (dB)	Peak Limit (dBuV/m)	Margin (dB)	UNII Non-Restricted (dBuV/m)	Margin (dB)	Azimuth (Degs)	Height (cm)	Polarity
6.90676	49.01	PK-U	36.2	-26.5	0	58.71	-	-	-	-	68.2	-9.49	280	104	H
6.90673	48.82	PK-U	36.2	-26.5	0	58.52	-	-	-	-	68.2	-9.68	81	113	V
10.36156	41.38	PK-U	38.1	-21	0	58.48	-	-	-	-	68.2	-9.72	225	100	H
10.35982	45.29	PK-U	38.1	-21	0	62.39	-	-	-	-	68.2	-5.81	310	103	V
* 15.53386	34.52	PK-U	40.2	-21.4	0	53.32	-	-	74	-20.68	-	-	0	100	H
* 15.53756	34.07	PK-U	40.2	-21.4	0	52.87	-	-	74	-21.13	-	-	360	100	V

* - indicates frequency in CFR47 Pt 15 / IC RSS-Restricted Band
 PK-U - U-NII: Maximum Peak

UNII-1(ax)
BANDEDGE (WORST CASE: 802.11ax HE80(SU) MIMO / 5210 MHz)

HORIZONTAL PEAK AND AVERAGE DATA

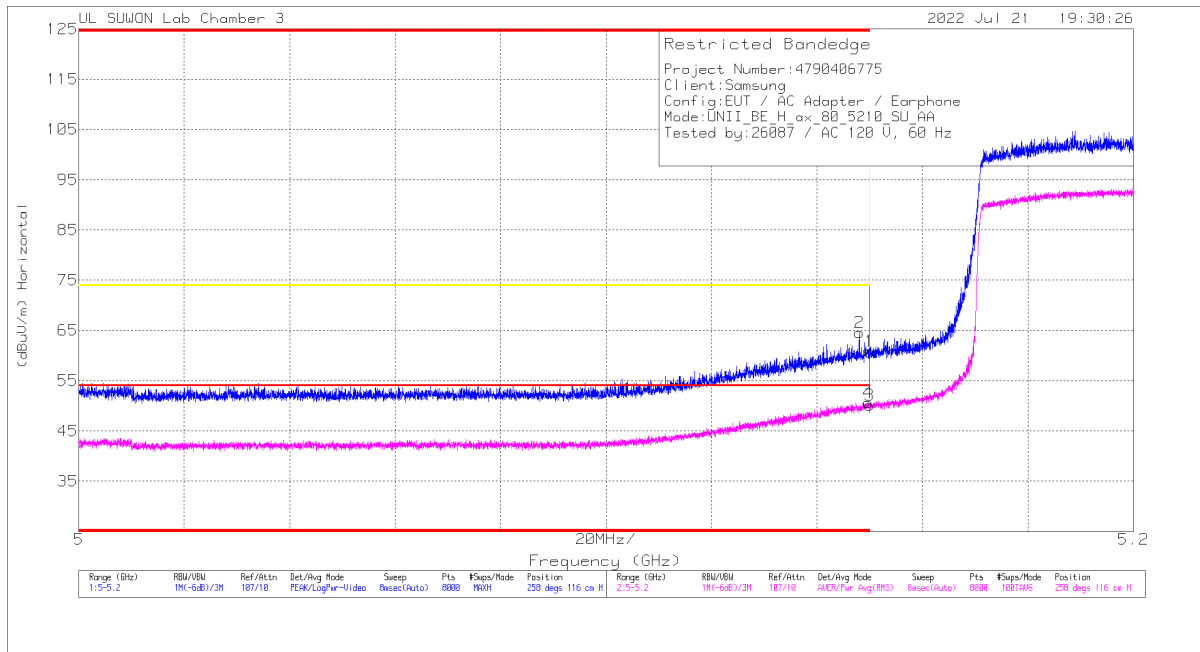

Trace Markers

Marker	Frequency (GHz)	Meter Reading (dBuV)	Det	3117_00218957	10dB_ATT(dB)	DC Corr (dB)	Corrected Reading (dBuV/m)	Average Limit (dBuV/m)	Margin (dB)	Peak Limit (dBuV/m)	PK Margin (dB)	Azimuth (Degs)	Height (cm)	Polarity
1	* 5.14999	46.59	Pk	34.8	-20.6	0	60.79	-	-	74	-13.21	258	116	H
2	* 5.14802	50.36	Pk	34.8	-20.6	0	64.56	-	-	74	-9.44	258	116	H
3	* 5.14999	35.89	RMS	34.8	-20.6	0	50.09	54	-3.91	-	-	258	116	H
4	* 5.14972	36.48	RMS	34.8	-20.6	0	50.68	54	-3.32	-	-	258	116	H

* - indicates frequency in CFR47 Pt 15 / IC RSS-Restricted Band
 Pk - Peak detector
 RMS - RMS detection

HARMONICS AND SPURIOUS EMISSIONS(WORST CASE: 802.11ax HE20(4RU) MIMO / 5180 MHz)

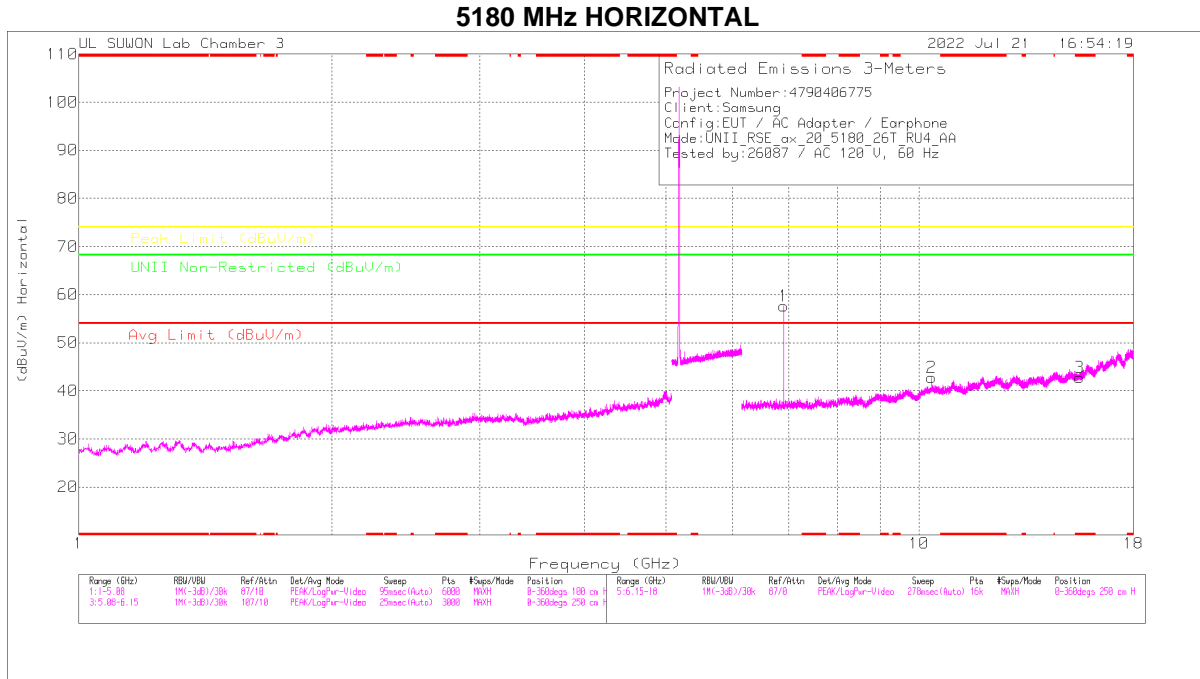

Note: Emission was scanned up to 40GHz; No emissions were detected above the noise floor which was at least 20dB below the specification limit.

Radiated Emissions

Frequency (GHz)	Max Reading (dBuV)	Det	317_00218957	6GHz_HF(S)	DC Corr (dB)	Corrected Reading (dBuV)	Avg Limit (dBuV/m)	Margin (dB)	Peak Limit (dBuV/m)	Margin (dB)	UNII Non-Restricted (dBuV/m)	Margin (dB)	Azimuth (Degs)	Height (m)	Polarity
6.9066	49.18	PK-U	36.2	-26.5	0	58.88	-	-	-	-	68.2	-9.32	358	127	H

* - indicates frequency in CFR47 Pt 15 / IC RSS-Restricted Band
 PK-U - U-NII: Maximum Peak

UNII-2A
BANDEDGE (WORST CASE: 802.11n HT40 MIMO / 5310 MHz)

HORIZONTAL PEAK AND AVERAGE DATA

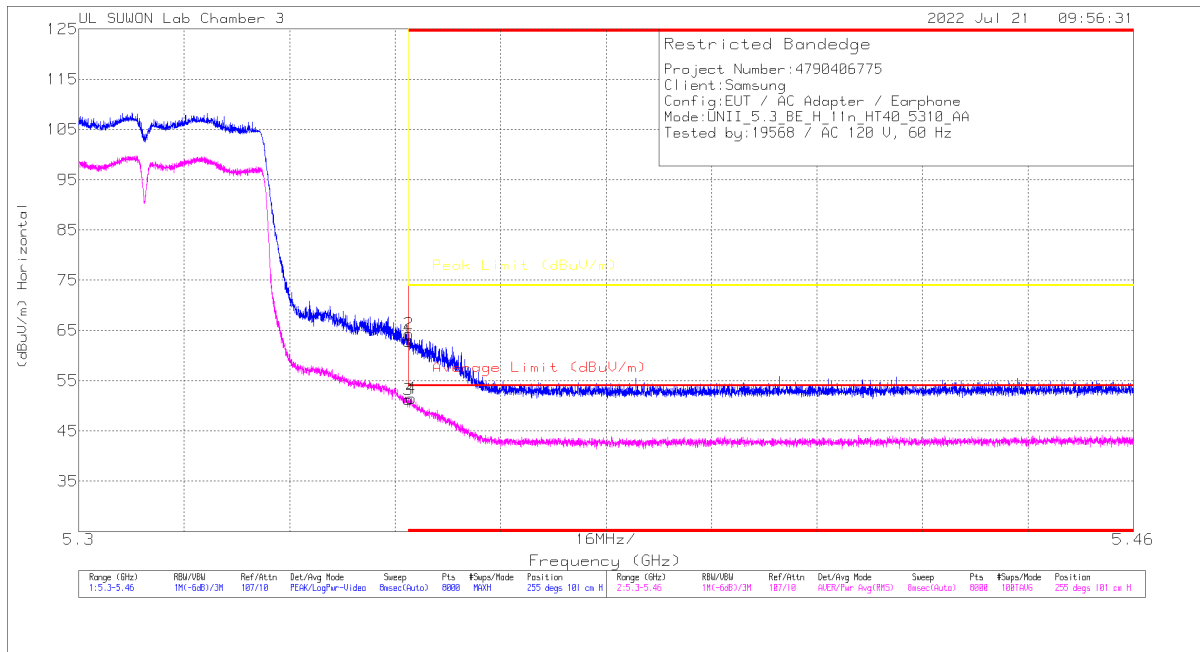

Trace Markers

Marker	Frequency (GHz)	Meter Reading (dBuV)	Det	3117_00218957	10dB_ATT[dB]	DC Corr (dB)	Corrected Reading (dBuV/m)	Average Limit (dBuV/m)	Margin (dB)	Peak Limit (dBuV/m)	PK Margin (dB)	Azimuth (Degs)	Height (cm)	Polarity
1	* 5.35001	47.91	Pk	35.1	-20.2	0	62.81	-	-	74	-11.19	255	101	H
2	* 5.35007	49.43	Pk	35.1	-20.2	0	64.33	-	-	74	-9.67	255	101	H
3	* 5.35001	36.31	RMS	35.1	-20.2	0	51.21	54	-2.79	-	-	255	101	H
4	* 5.35047	36.57	RMS	35.1	-20.2	0	51.47	54	-2.53	-	-	255	101	H

* - indicates frequency in CFR47 Pt 15 / IC RSS-Restricted Band
 Pk - Peak detector
 RMS - RMS detection

HARMONICS AND SPURIOUS EMISSIONS(WORST CASE: 802.11a MIMO / 5320 MHz)

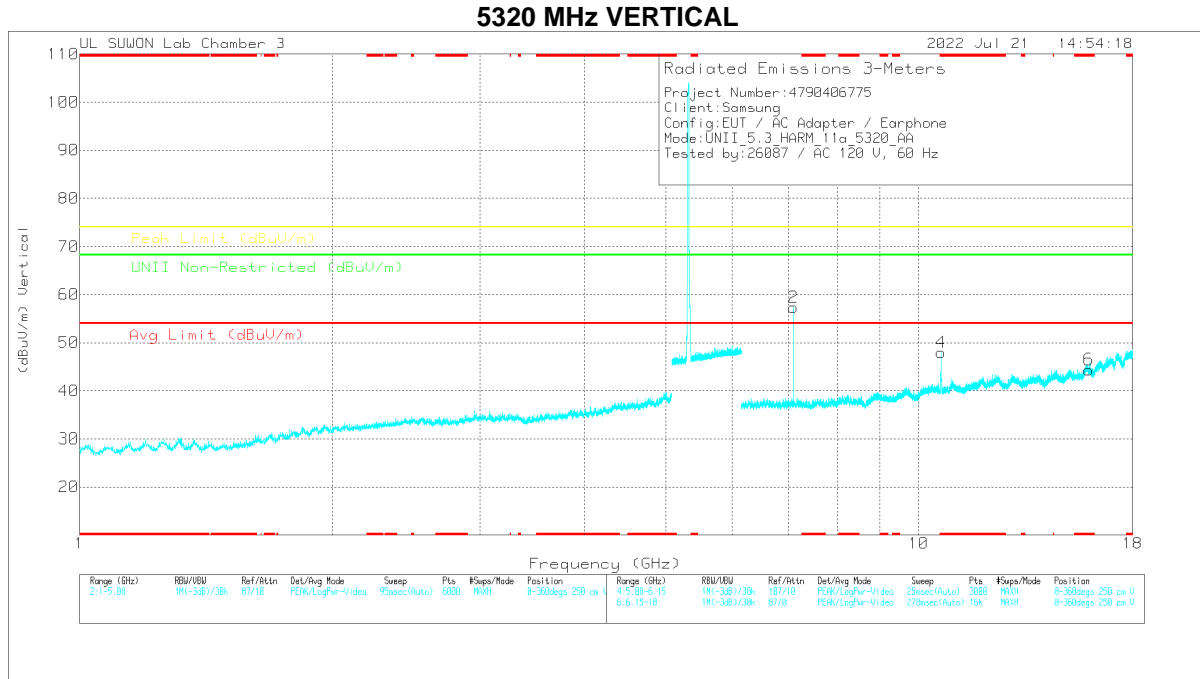

Note: Emission was scanned up to 40GHz; No emissions were detected above the noise floor which was at least 20dB below the specification limit.

Radiated Emissions

Frequency (GHz)	Mask Reading (dBu)	Det	317_00218967	6GHz_HPS(S)	DC Corr (dB)	Corrected Reading (dBu/m)	Avg Limit (dBu/m)	Margin (dB)	Peak Limit (dBu/m)	Margin (dB)	UNII Non-Restricted (dBu/m)	Margin (dB)	Acmtch (Steps)	Height (cm)	Polarity
* 10.64065	39.69	PK-U	38.3	-21.1	0	58.59	-	-	74	-17.11	-	-	327	101	V
* 10.64019	29.41	ADR	38.3	-21.1	.15	46.76	54	-7.24	-	-	-	-	327	101	V

* - indicates frequency in CFR47 Pt 15 / IC RSS-Restricted Band
 PK-U - U-NII: Maximum Peak
 ADR - U-NII AD primary method, RMS average

UNII-2A(ax)
BANDEDGE (WORST CASE: 802.11ax HE40(SU) MIMO / 5310 MHz)

HORIZONTAL PEAK AND AVERAGE DATA

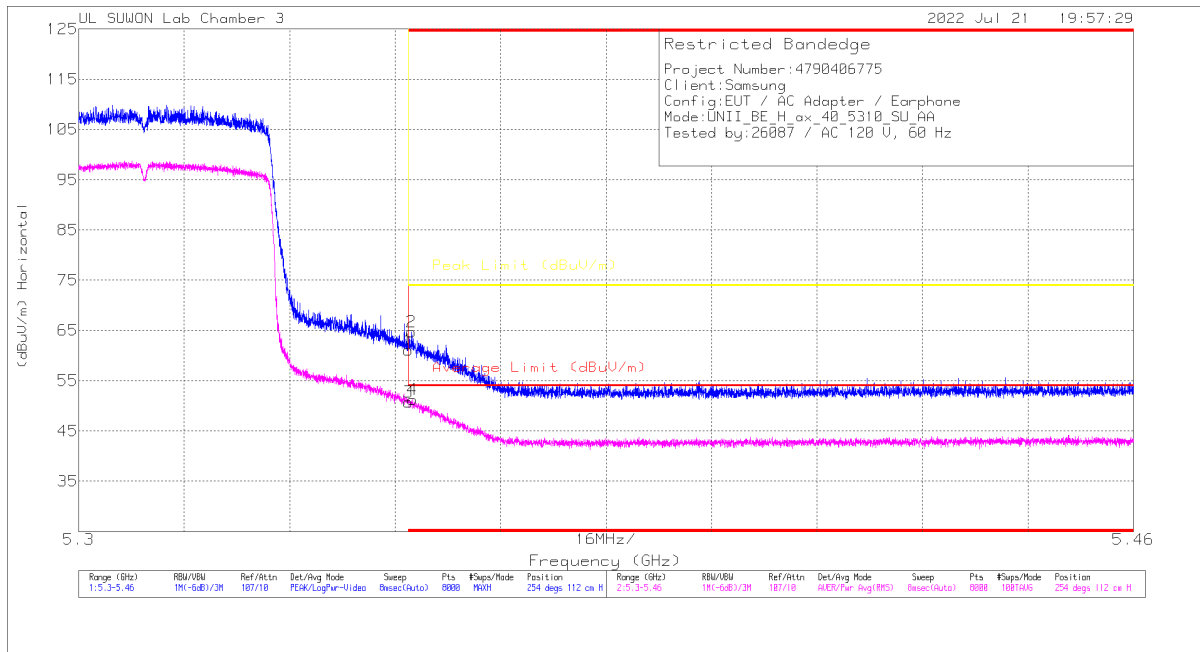

Trace Markers

Marker	Frequency (GHz)	Meter Reading (dBuV)	Det	3117_00218957	10dB_ATT[dB]	DC Corr (dB)	Corrected Reading (dBuV/m)	Average Limit (dBuV/m)	Margin (dB)	Peak Limit (dBuV/m)	PK Margin (dB)	Azimuth (Degs)	Height (cm)	Polarity
1	* 5.35001	46.25	Pk	35.1	-20.2	0	61.15	-	-	74	-12.85	254	112	H
2	* 5.35049	49.86	Pk	35.1	-20.2	0	64.76	-	-	74	-9.24	254	112	H
3	* 5.35001	35.84	RMS	35.1	-20.2	0	50.74	54	-3.26	-	-	254	112	H
4	* 5.35067	36.39	RMS	35.1	-20.2	0	51.29	54	-2.71	-	-	254	112	H

* - indicates frequency in CFR47 Pt 15 / IC RSS-Restricted Band
 Pk - Peak detector
 RMS - RMS detection

HARMONICS AND SPURIOUS EMISSIONS(WORST CASE: 802.11ax HE20(4RU) MIMO / 5300 MHz)

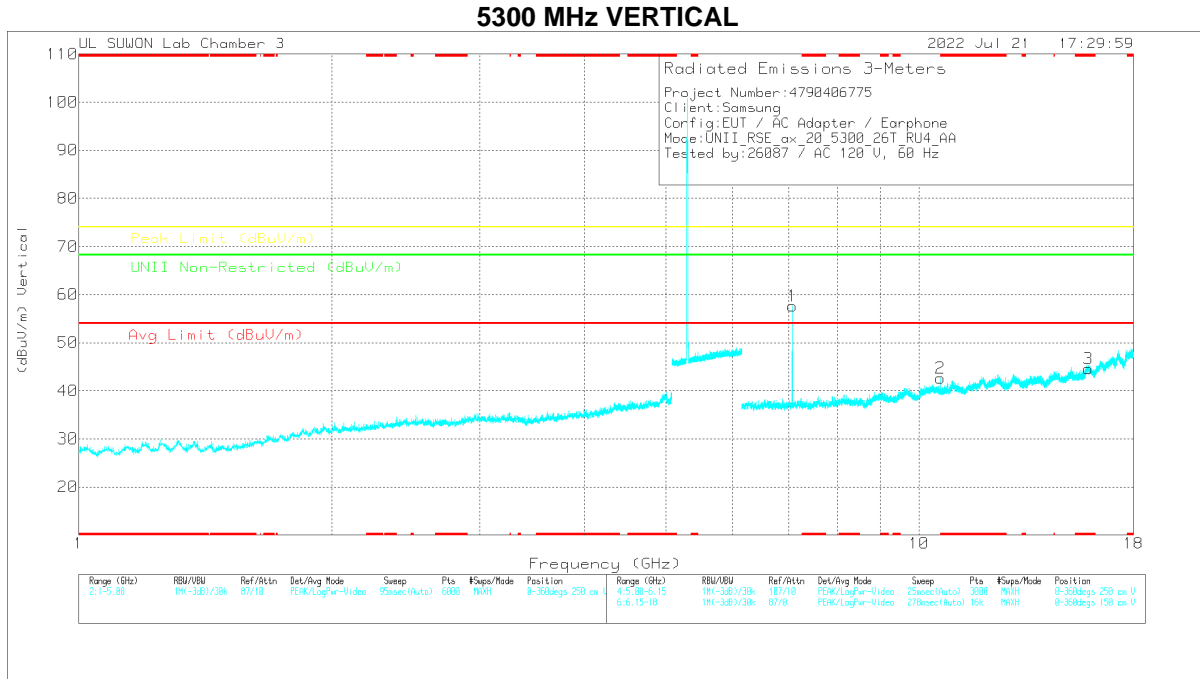

Note: Emission was scanned up to 40GHz; No emissions were detected above the noise floor which was at least 20dB below the specification limit.

Radiated Emissions

Frequency (GHz)	Meas Reading (dBuV)	Det	3117_00218957	6GHz_HFVdB	DC Corr (dB)	Corrected Reading (dBuV)	Avg Limit (dBV/m)	Margin (dB)	Peak Limit (dBV/m)	Margin (dB)	UNII Non-Restricted (dBuV/m)	Margin (dB)	Azimuth (Deg)	Height (m)	Polarity
7.06668	48.02	PK-U	36.2	-25.3	0	58.32	-	-	-	-	68.2	-9.88	45	100	V

* - indicates frequency in CFR47 Pt 15 / IC RSS-Restricted Band
 PK-U - U-NII: Maximum Peak

UNII-2C
BANDEDGE (WORST CASE: 802.11a MIMO / 5700 MHz)

HORIZONTAL PEAK AND AVERAGE DATA

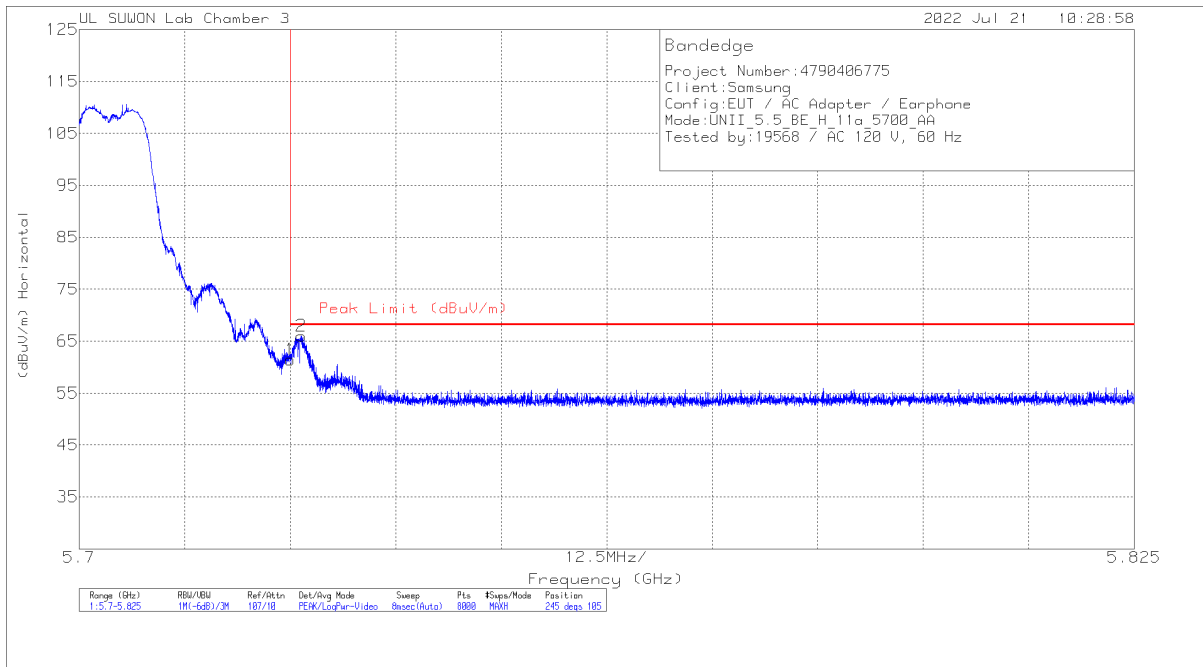

Trace Markers

Marker	Frequency (GHz)	Meter Reading (dBuV)	Det	3117_00218957	10dB_ATT[dB]	DC Corr (dB)	Corrected Reading (dBuV/m)	Peak Limit (dBuV/m)	PK Margin (dB)	Azimuth (Degs)	Height (cm)	Polarity
1	5.725	45.25	Pk	35.7	-19.5	0	61.45	68.2	-6.75	245	105	H
2	5.72632	49.79	Pk	35.7	-19.5	0	65.99	68.2	-2.21	245	105	H

Pk - Peak detector

HARMONICS AND SPURIOUS EMISSIONS(WORST CASE: 802.11a MIMO / 5500 MHz)

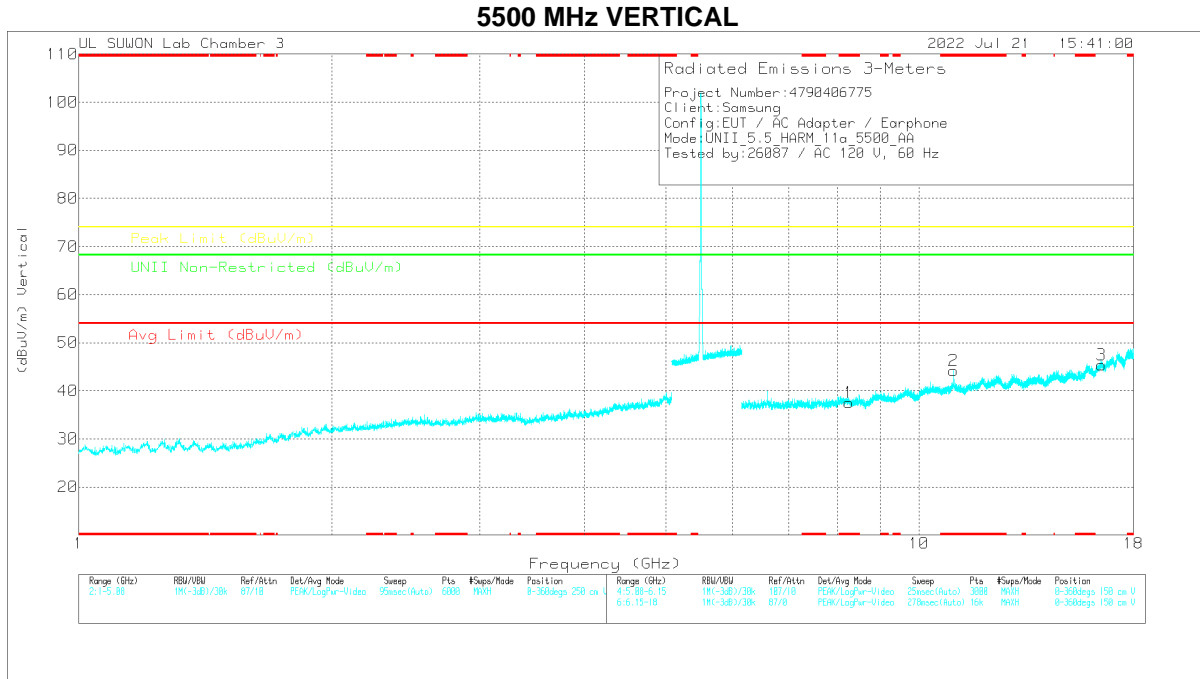

Note: Emission was scanned up to 40GHz; No emissions were detected above the noise floor which was at least 20dB below the specification limit.

Radiated Emissions

Frequency (GHz)	Mean Reading (dBuV)	Det	317_0021867	6GHz_HPS(B)	DC Corr (dB)	Corrected Reading (dBuV/m)	Avg Limit (dBuV/m)	Margin (dB)	Peak Limit (dBuV/m)	Margin (dB)	UNII Non-Restricted (dBuV/m)	Margin (dB)	Azimuth (Deg)	Height (cm)	Polarity
* 11.00144	36.37	PK-U	38.5	-21.2	0	53.67	-	-	74	-20.33	-	-	70	124	V
* 11.00193	24.71	ADR	38.5	-21.2	.17	42.18	54	-11.82	-	-	-	-	70	124	V

* - indicates frequency in CFR47 Pt 15 / IC RSS-Restricted Band
 PK-U - U-NII: Maximum Peak
 ADR - U-NII AD primary method, RMS average

UNII-2C(ax)
BANDEDGE (WORST CASE: 802.11ax HE80(SU) MIMO / 5530 MHz)

HORIZONTAL PEAK AND AVERAGE DATA

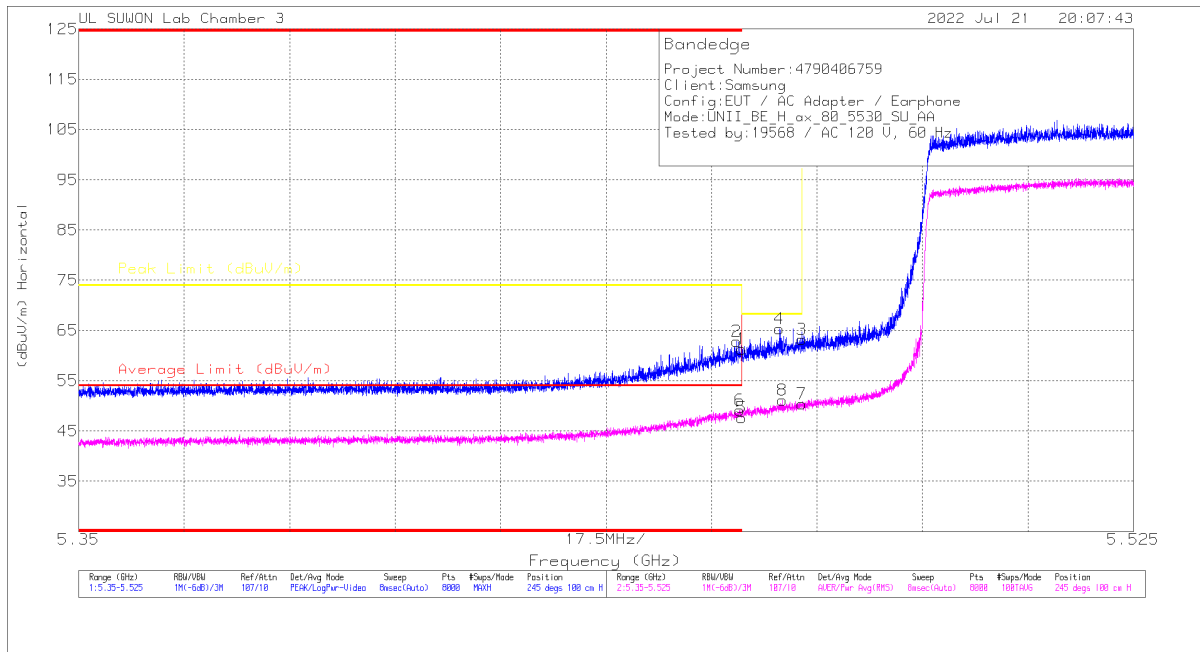

Trace Markers

Marker	Frequency (GHz)	Meas Reading (dBuV)	Det	3117_00218957	10dB_ATT(dB)	DC Corr (dB)	Corrected Reading (dBuV/m)	Average Limit (dBuV/m)	Margin (dB)	Peak Limit (dBuV/m)	PK Margin (dB)	Azimuth (Degs)	Height (cm)	Polarity
1	* 5.45998	46.09	PK	35.3	-20.1	0	61.29	-	-	74	-12.71	245	100	H
2	* 5.45917	47.83	PK	35.3	-20.1	0	62.83	-	-	74	-11.17	245	100	H
3	5.46998	48.04	PK	35.3	-20.1	0	63.24	-	-	68.2	-4.96	245	100	H
4	5.46626	49.86	PK	35.3	-20.1	0	65.06	-	-	68.2	-3.14	245	100	H
5	* 5.45998	32.42	RMS	35.3	-20.1	0	47.62	54	-6.38	-	-	245	100	H
6	* 5.45974	33.92	RMS	35.3	-20.1	0	49.12	54	-4.88	-	-	245	100	H
7	5.46998	35.13	RMS	35.3	-20.1	0	50.33	-	-	-	-	245	100	H
8	5.46676	35.91	RMS	35.3	-20.1	0	51.11	-	-	-	-	245	100	H

* - indicates frequency in CFR47 Pt 15 / IC RSS-Restricted Band
 PK - Peak detector
 RMS - RMS detection

HARMONICS AND SPURIOUS EMISSIONS(WORST CASE: 802.11ax HE20(4RU) MIMO / 5700 MHz)

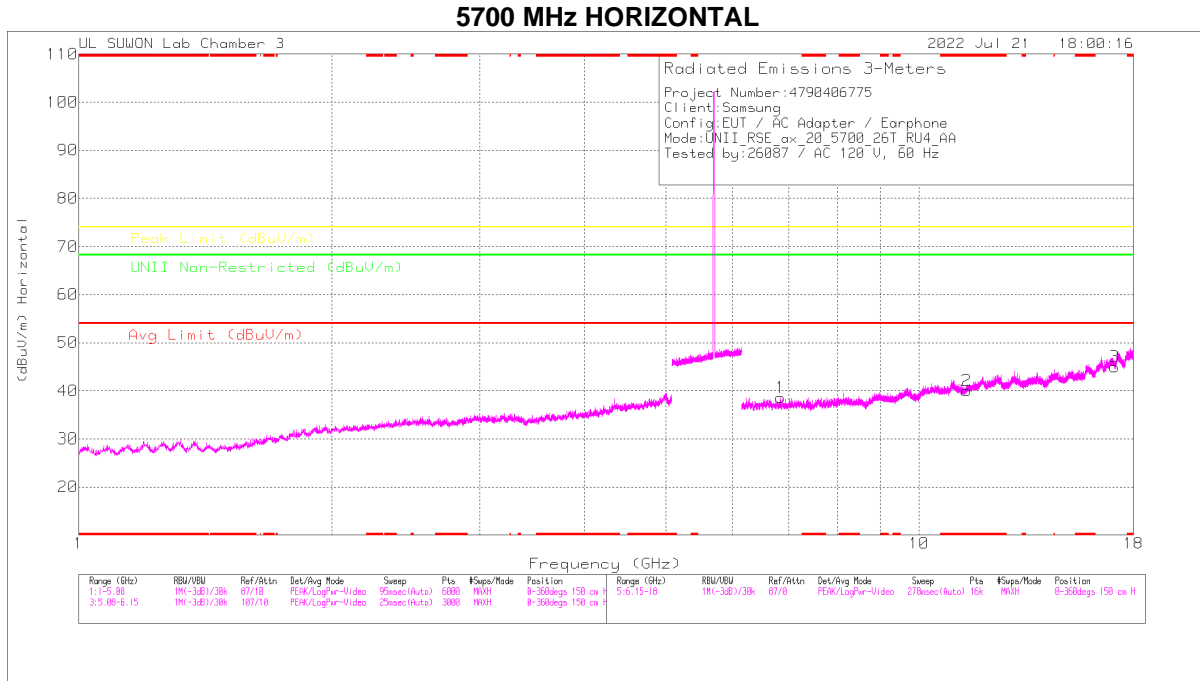

Note: Emission was scanned up to 40GHz; No emissions were detected above the noise floor which was at least 20dB below the specification limit.

Radiated Emissions

Frequency (GHz)	Mean Reading (dBm)	Det	3117_00218957	6GHz_HPSdB	DC Corr (dB)	Corrected Reading (dBm)	Avg Limit (dBm)	Margin (dB)	Peak Limit (dBm)	Margin (dB)	UNII Non-Restricted (dBm)	Margin (dB)	Azimuth (Deg)	Height (m)	Polarity
6.83998	-37.9	PK-U	36.2	-26.5	0	-47.6	-	-	-	-	68.2	-20.6	277	112	H

* - indicates frequency in CFR47 Pt 15 / IC RSS-Restricted Band
 PK-U - U-NII: Maximum Peak

UNII-3
BANDEDGE (WORST CASE: 802.11a MIMO / 5825 MHz)

VERTICAL PEAK AND AVERAGE DATA

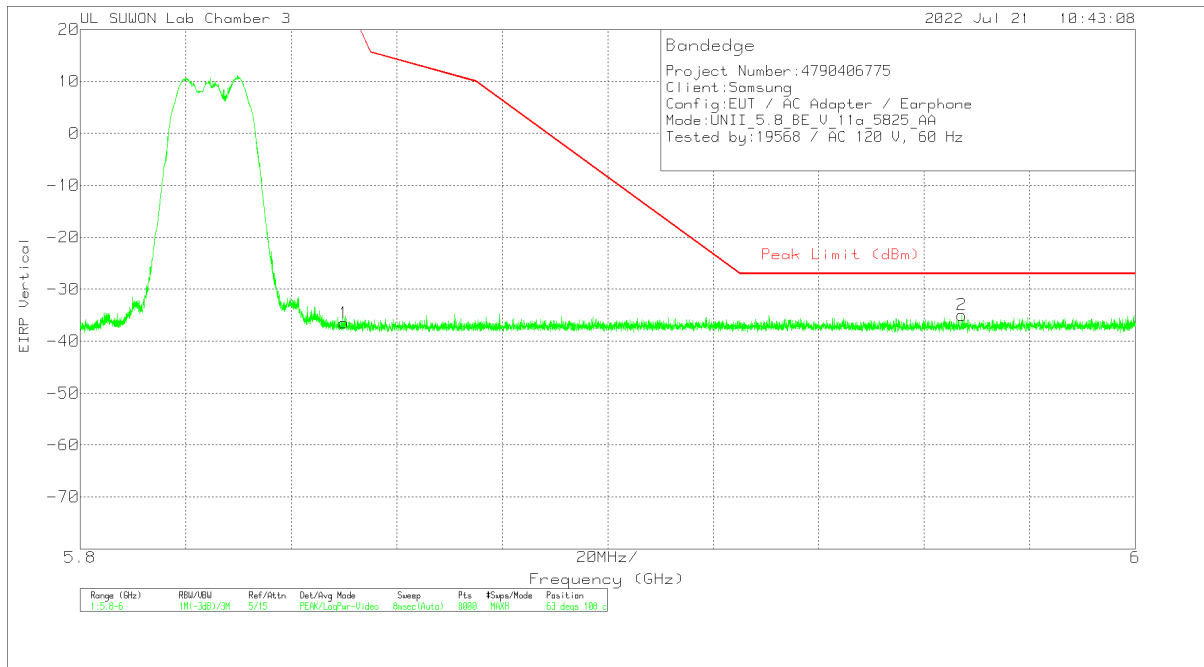

Trace Markers

Marker	Frequency (GHz)	Meter Reading (dBm)	Det	3117_00218957	10dB_ATT[dB]	Conversion Factor (dB)	DC Corr (dB)	Corrected Reading EIRP	Peak Limit (dBm)	PK Margin (dB)	Azimuth (Degs)	Height (cm)	Polarity
1	5.85001	-64.91	Pk		-19.3	11.8	0	-36.51	26.99	-63.5	63	108	V
2	5.96715	-63.47	Pk		-19.3	11.8	0	-34.97	-27	-7.97	63	108	V

Pk - Peak detector

HARMONICS AND SPURIOUS EMISSIONS(WORST CASE: 802.11a MIMO / 5825 MHz)

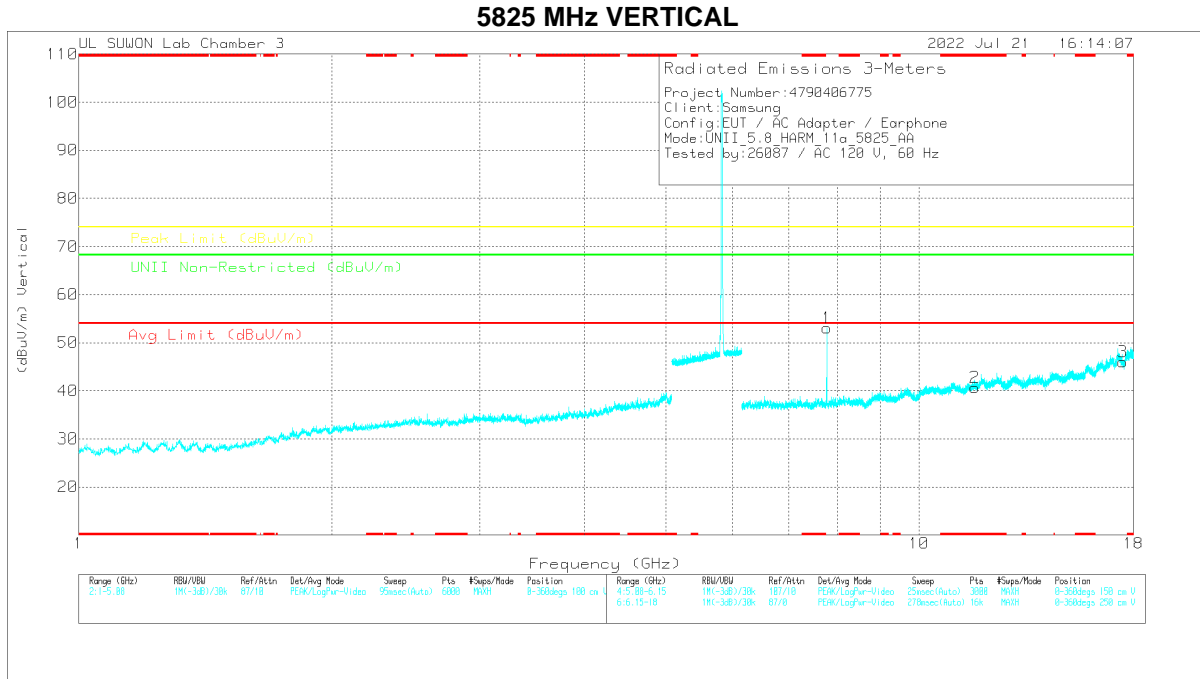

Note: Emission was scanned up to 40GHz; No emissions were detected above the noise floor which was at least 20dB below the specification limit.

Radiated Emissions

Frequency (GHz)	Max Reading (dBuV)	Det	317_00218957	6GHz_HF(S)	DC Corr (dB)	Corrected Reading (dBuV)	Avg Limit (dBuV/m)	Margin (dB)	Peak Limit (dBuV/m)	Margin (dB)	UNII Non-Restricted (dBuV/m)	Margin (dB)	Admth (Deg)	Height (cm)	Polarity
7.7668	44.71	PK-U	36.3	-24.6	0	56.41	-	-	-	-	68.2	-11.79	169	116	V

* - indicates frequency in CFR47 Pt 15 / IC RSS-Restricted Band
 PK-U - U-NII: Maximum Peak

UNII-3(ax)
BANDEDGE (WORST CASE: 802.11ax HE20(SU) MIMO / 5825 MHz)

HORIZONTAL PEAK AND AVERAGE DATA

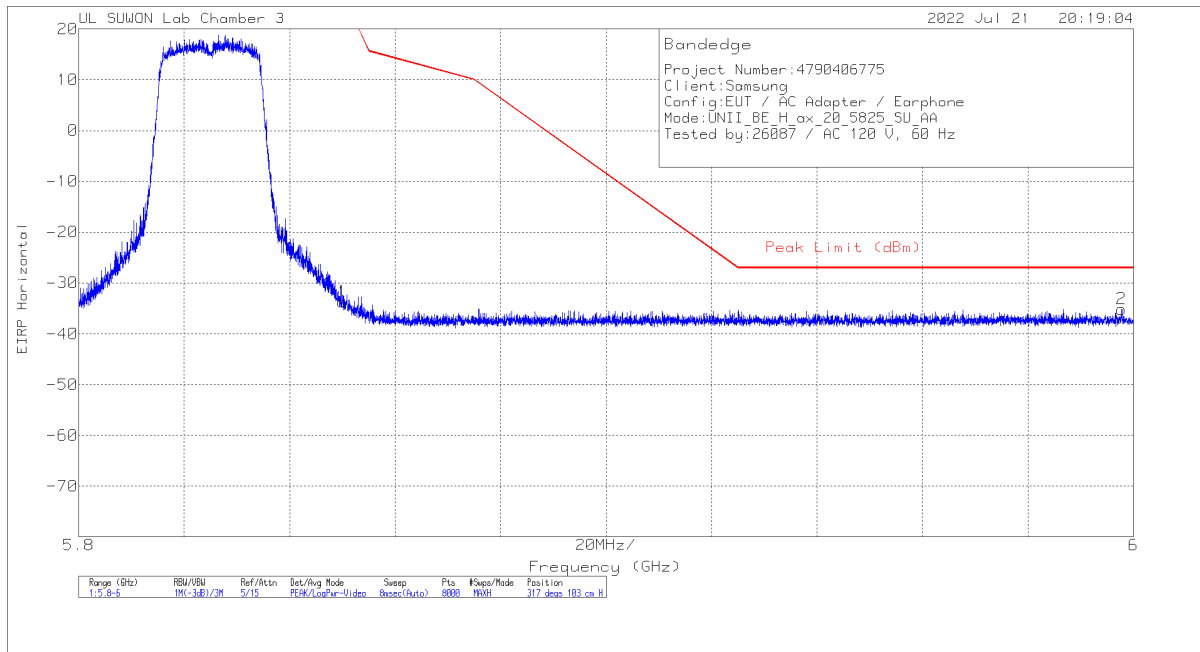

Trace Markers

Marker	Frequency (GHz)	Meter Reading (dBm)	Det	3117_00218957	10dB_ATT[dB]	Conversion Factor (dB)	DC Corr (dB)	Corrected Reading EIRP	Peak Limit (dBm)	PK Margin (dB)	Azimuth (Degs)	Height (cm)	Polarity
1	5.85001	-62.06	Pk	35.9	-19.3	11.8	0	-33.66	26.99	-60.65	317	103	H
2	5.99775	-63.73	Pk	36	-19.2	11.8	0	-35.13	-27	-8.13	317	103	H

Pk - Peak detector

HARMONICS AND SPURIOUS EMISSIONS(WORST CASE: 802.11ax HE20(4RU) MIMO / 5785 MHz)

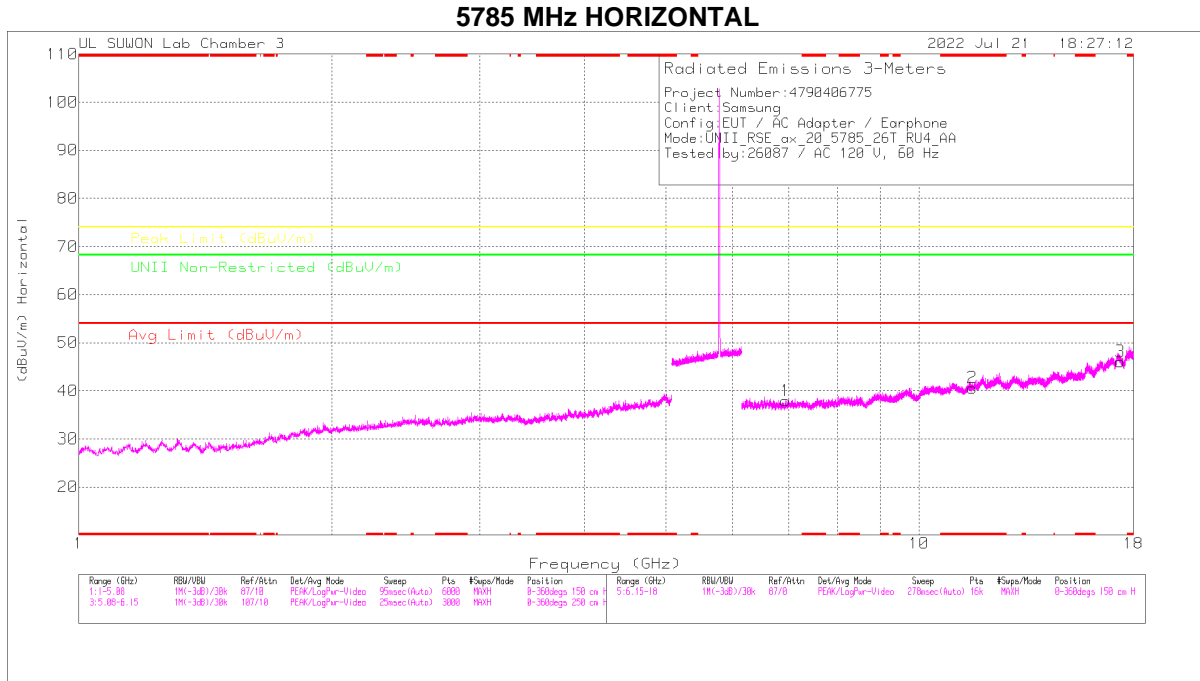

Note: Emission was scanned up to 40GHz; No emissions were detected above the noise floor which was at least 20dB below the specification limit.

Radiated Emissions

Frequency (GHz)	Meas Reading (dBuV)	Det	3117_00218957	60Hz_HFVdB	DC Corr (dB)	Corrected Reading (dBuV/m)	Avg Limit (dBV/m)	Margin (dB)	Peak Limit (dBV/m)	Margin (dB)	UNII Non-Restricted (dBV/m)	Margin (dB)	Azimuth (Degs)	Height (cm)	Polarity
6.84136	37.93	PK-U	36.2	-26.3	0	47.93	-	-	-	-	68.2	-20.37	358	122	H

* - indicates frequency in CFR47 Pt 15 / IC RSS-Restricted Band
 PK-U - U-NII: Maximum Peak

CHANNEL MOVE & CLOSING TIME

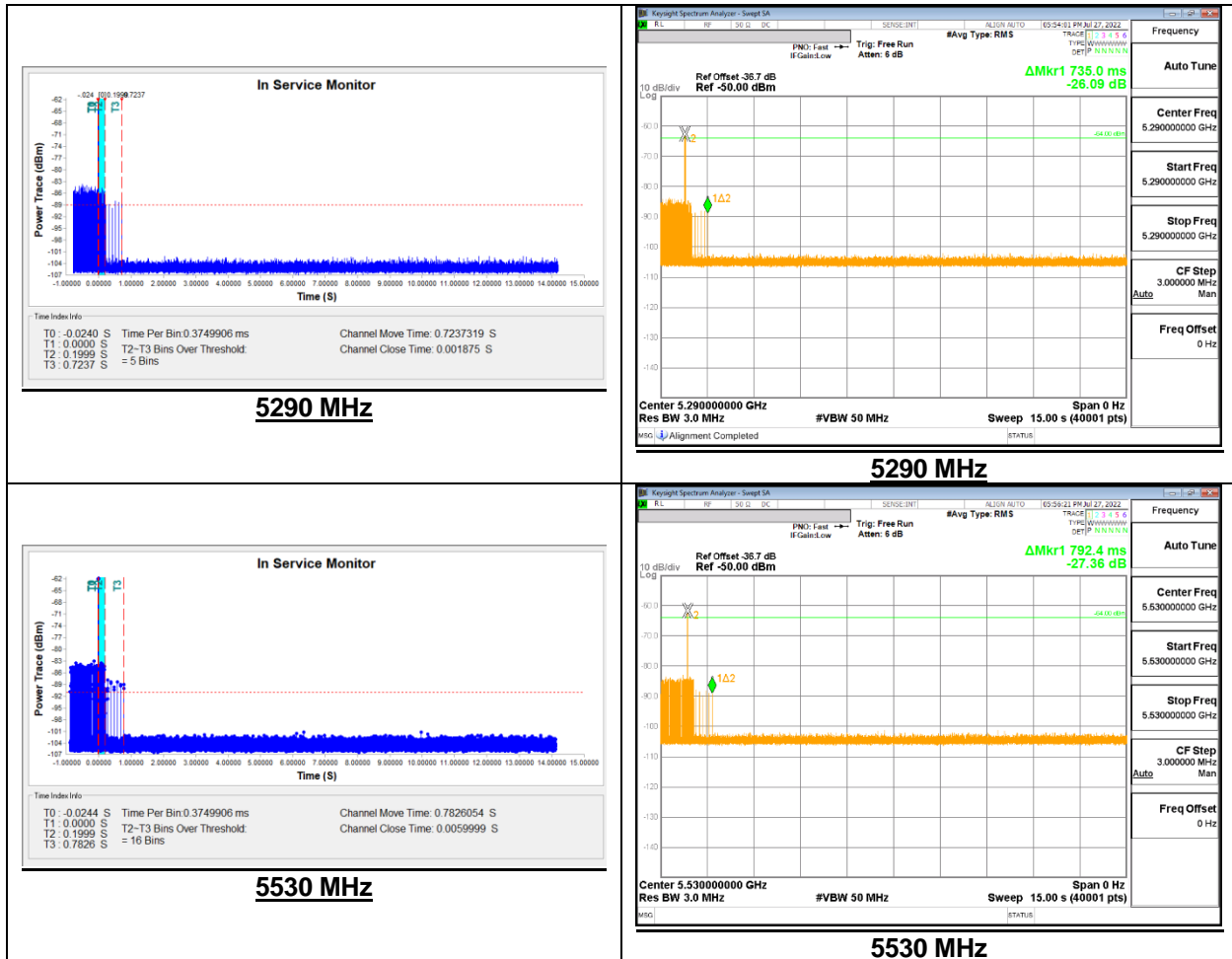

END OF TEST REPORT