

**11.3.3.TX ABOVE 1GHz 802.11n HT40 MODE IN THE 5.5GHz BAND
 RESTRICTED BANDEDGE (LOW CHANNEL)**

HORIZONTAL PEAK AND AVERAGE PLOT

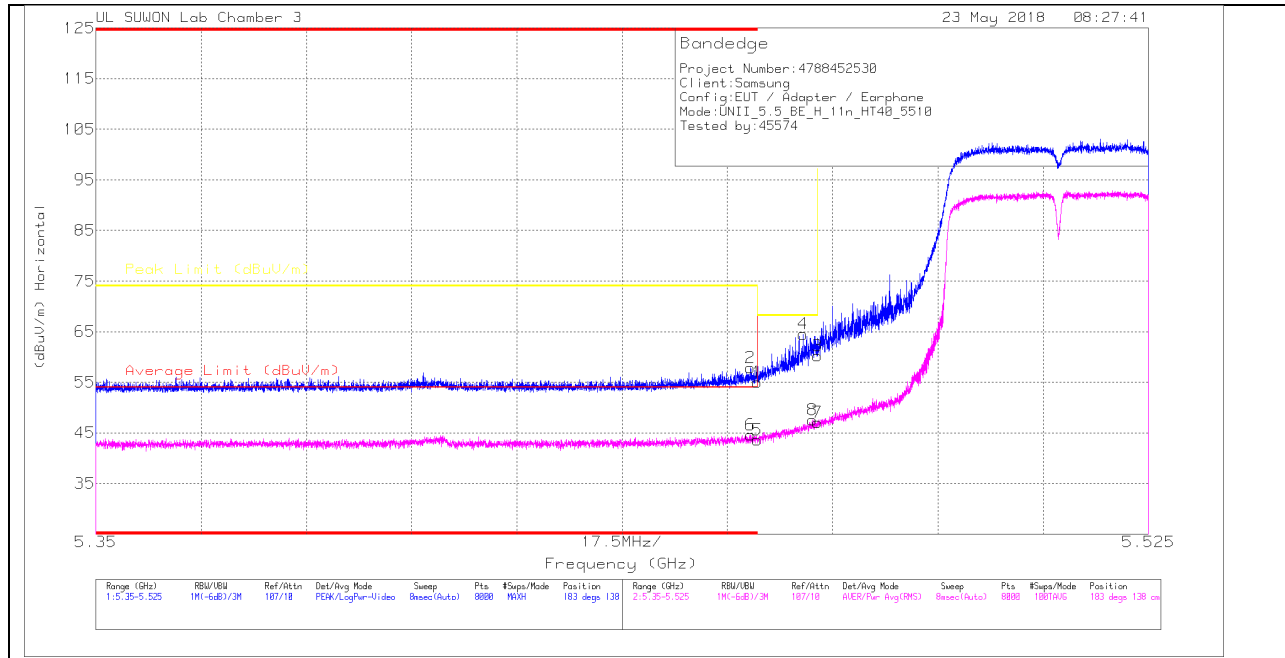

HORIZONTAL DATA

Trace Markers

Marker	Frequency (GHz)	Meter Reading (dBuV)	Det	3117(00205959)	1008_ATT[0dB]	DC Corr (dB)	Corrected Reading (dBuV/m)	Average Limit (dBuV/m)	Margin (dB)	Peak Limit (dBuV/m)	PK Margin (dB)	Azimuth (Degs)	Height (cm)	Polarity
1	* 5.46	39.07	Pk	34.3	-18.4	0	54.97	-	-	74	-19.03	183	138	H
2	* 5.459	41.96	Pk	34.3	-18.4	0	57.86	-	-	74	-16.14	183	138	H
3	5.47	44.3	Pk	34.3	-18.4	0	60.2	-	-	68.2	-8	183	138	H
4	5.468	48.61	Pk	34.3	-18.4	0	64.51	-	-	68.2	-3.69	183	138	H
5	* 5.46	27.92	RMS	34.3	-18.8	.17	43.59	54	-10.41	-	-	183	138	H
6	* 5.459	28.94	RMS	34.3	-18.8	.17	44.61	54	-9.39	-	-	183	138	H

* - indicates frequency in CFR47 Pt 15 / IC RSS-Restricted Band

Pk - Peak detector

RMS - RMS detection

VERTICAL PEAK AND AVERAGE PLOT

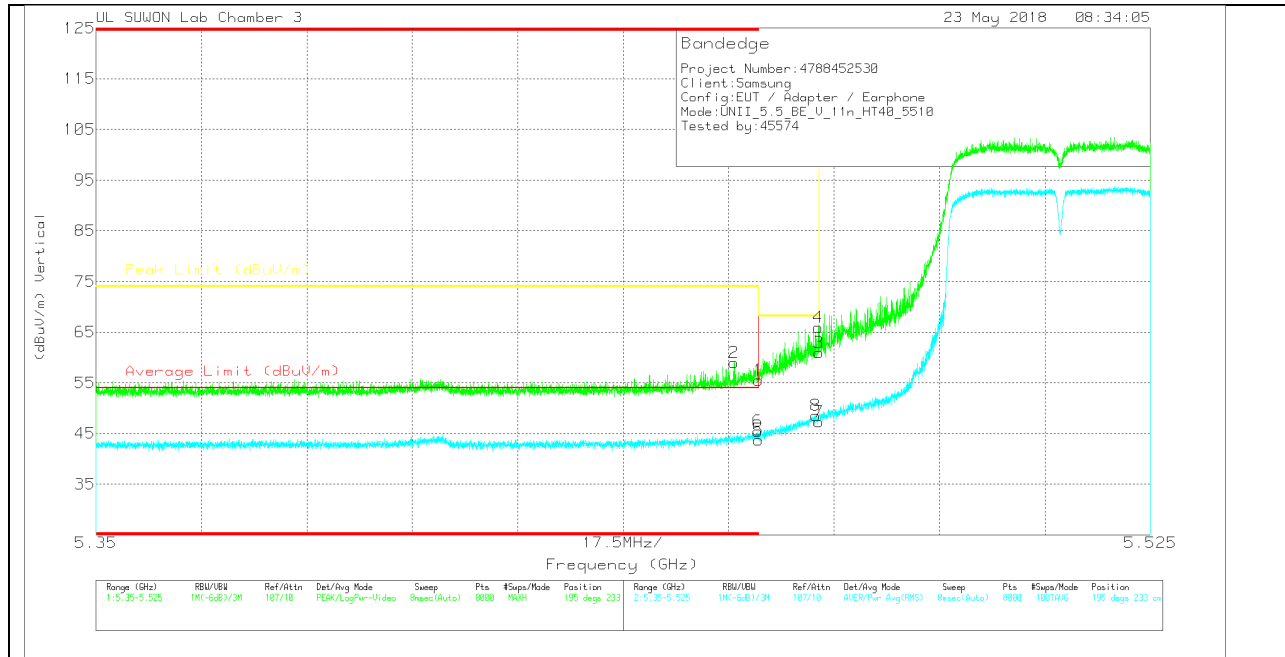

VERTICAL DATA

Trace Markers

Marker	Frequency (GHz)	Meter Reading (dBuV)	Det	3117(00205959)	10dB_ATT[dB]	DC Corr (dB)	Corrected Reading (dBuV/m)	Average Limit (dBuV/m)	Margin (dB)	Peak Limit (dBuV/m)	PK Margin (dB)	Azimuth (Degs)	Height (cm)	Polarity
1	* 5.46	39.57	Pk	34.3	-18.4	0	55.47	-	-	74	-18.53	195	233	V
2	* 5.456	43.05	Pk	34.3	-18.4	0	58.95	-	-	74	-15.05	195	233	V
3	5.47	45.08	Pk	34.3	-18.4	0	60.98	-	-	68.2	-7.22	195	233	V
4	5.47	49.98	Pk	34.3	-18.4	0	65.88	-	-	68.2	-2.32	195	233	V
5	* 5.46	28.1	RMS	34.3	-18.8	.17	43.77	54	-10.23	-	-	195	233	V
6	* 5.46	29.8	RMS	34.3	-18.8	.17	45.47	54	-8.53	-	-	195	233	V

* - indicates frequency in CFR47 Pt 15 / IC RSS-Restricted Band

Pk - Peak detector

RMS - RMS detection

AUTHORIZED BANDEGE (HIGH CHANNEL)

HORIZONTAL PEAK AND AVERAGE PLOT

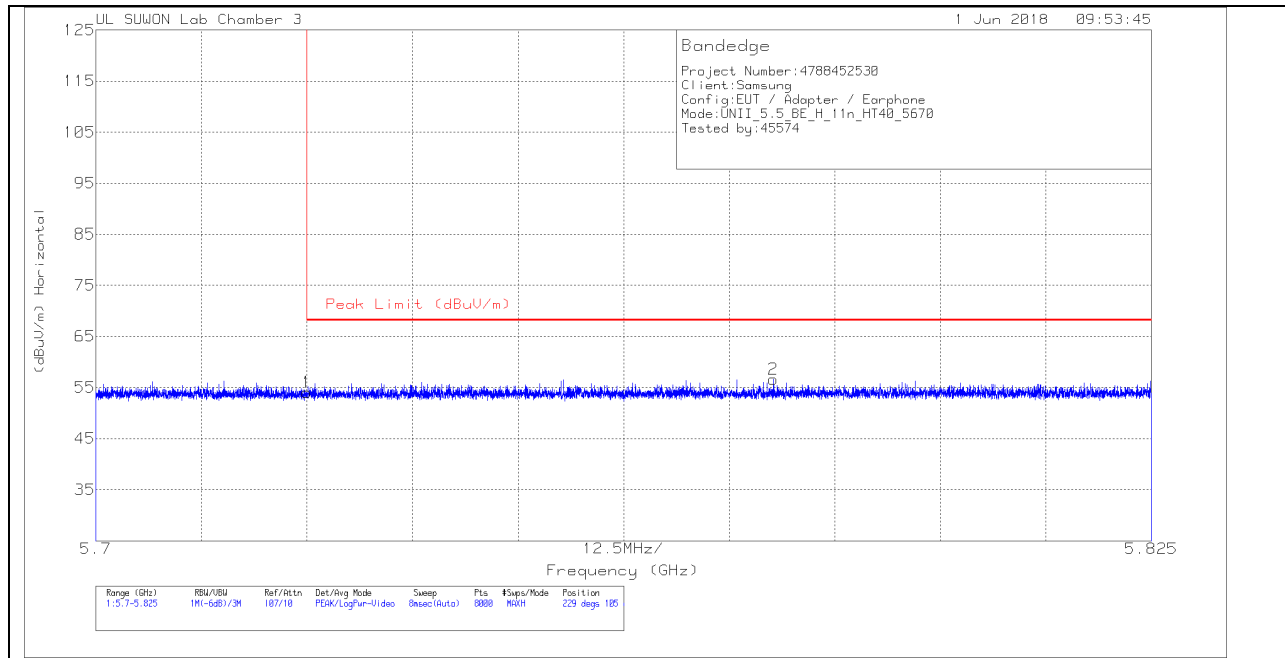

HORIZONTAL DATA

Trace Markers

Marker	Frequency (GHz)	Meter Reading (dBuV)	Det	3117[00205959]	10dB_ATT[dB]	Corrected Reading (dBuV/m)	Peak Limit (dBuV/m)	PK Margin (dB)	Azimuth (Degs)	Height (cm)	Polarity
1	5.725	37.28	Pk	34.7	-17.9	54.08	68.2	-14.12	229	105	H
2	5.78	39.49	Pk	34.7	-17.6	56.59	68.2	-11.61	229	105	H

Pk - Peak detector

VERTICAL PEAK AND AVERAGE PLOT

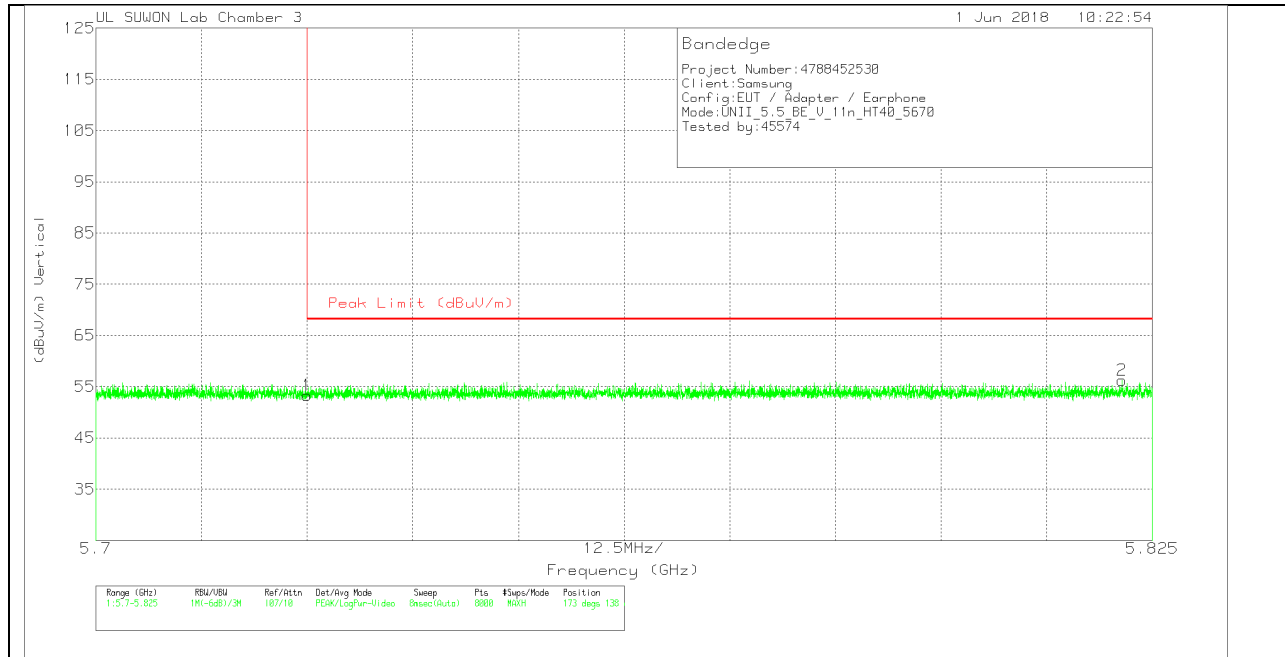

VERTICAL DATA

Trace Markers

Marker	Frequency (GHz)	Meter Reading (dBuV)	Det	3117[00205959]	10dB_ATT[dB]	Corrected Reading (dBuV/m)	Peak Limit (dBuV/m)	PK Margin (dB)	Azimuth (Degs)	Height (cm)	Polarity
1	5.725	36.47	Pk	34.7	-17.9	53.27	68.2	-14.93	173	138	V
2	5.821	39.06	Pk	34.8	-17.6	56.26	68.2	-11.94	173	138	V

Pk - Peak detector

HARMONICS AND SPURIOUS EMISSIONS

LOW CHANNEL HORIZONTAL

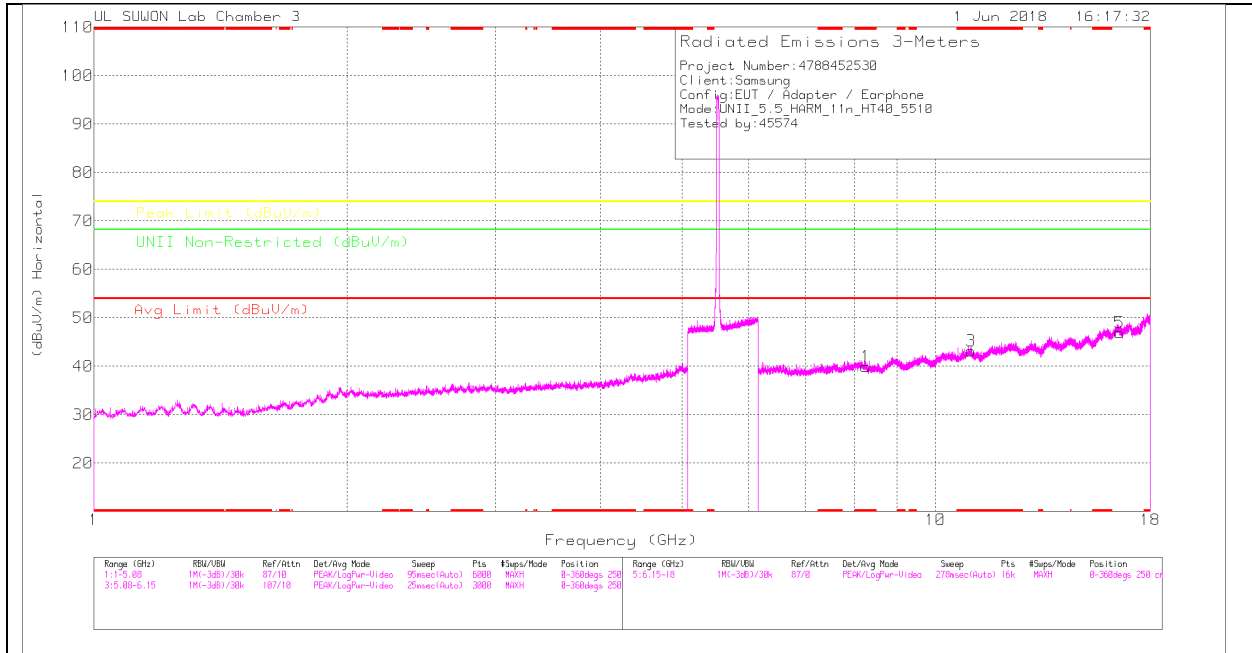

LOW CHANNEL VERTICAL

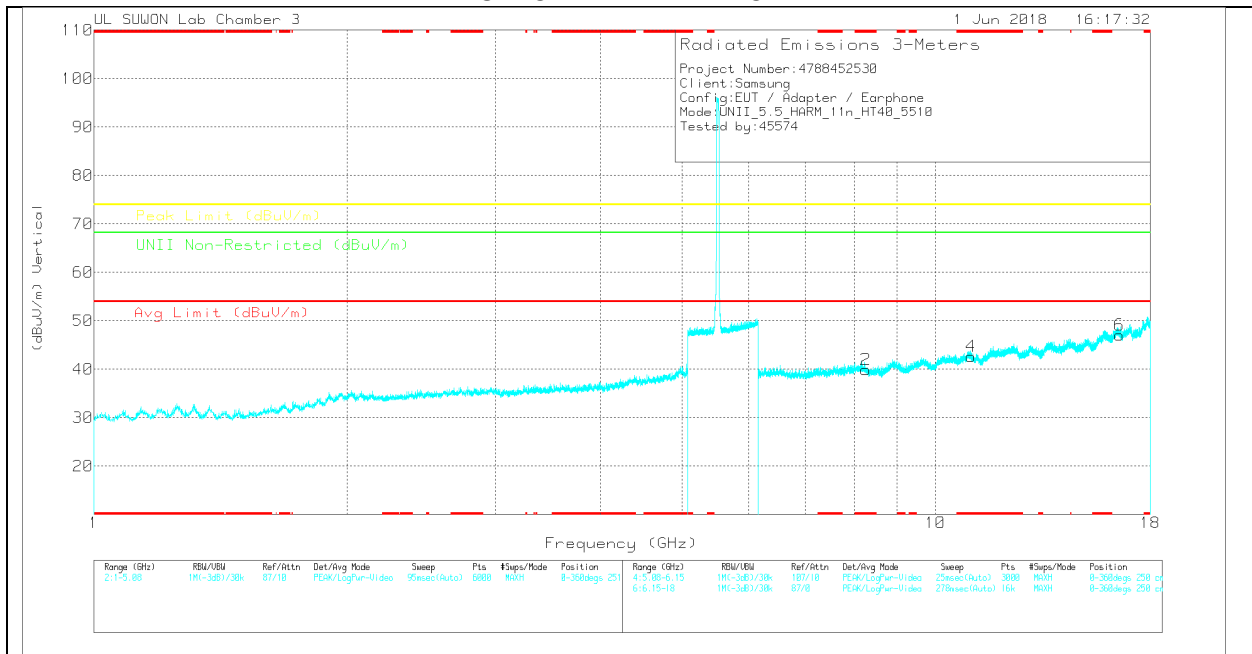

Note: Emission was scanned up to 40GHz; No emissions were detected above the noise floor which was at least 20dB below the specification limit.

LOW CHANNEL DATA

Trace Markers

Marker	Frequency (GHz)	Meter Reading (dBuV)	Det	317(00209959)	6GHz_HF(dB)	DC Corr (dB)	Corrected Reading (dBuV/m)	Avg Limit (dBuV/m)	Margin (dB)	Peak Limit (dBuV/m)	Margin (dB)	UNE Non-Restricted (dBuV/m)	Margin (dB)	Azimuth (Degs)	Height (cm)	Polarity
1	* 8.265	26.16	PK	35.8	-22	0	39.96	-	-	74	-34.04	-	-	0-360	250	H
3	* 11.02	25	PK	37.8	-19.6	0	43.2	-	-	74	-30.8	-	-	0-360	250	H
5	16.531	22.81	PK	41.4	-17.3	0	46.91	-	-	-	-	68.2	-21.29	0-360	150	H
2	* 8.265	26.08	PK	35.8	-22	0	39.88	-	-	74	-34.12	-	-	0-360	149	V
4	* 11.021	24.39	PK	37.8	-19.6	0	42.59	-	-	74	-31.41	-	-	0-360	250	V
6	16.531	23	PK	41.4	-17.3	0	47.1	-	-	-	-	68.2	-21.1	0-360	149	V

* - indicates frequency in CFR47 Pt 15 / IC RSS-Restricted Band
 PK – Peak Detector

Note: Only peak measurement was performed. Because peak measurement result of unwanted emission is less than average limit (54dBuV/m).

MID CHANNEL HORIZONTAL

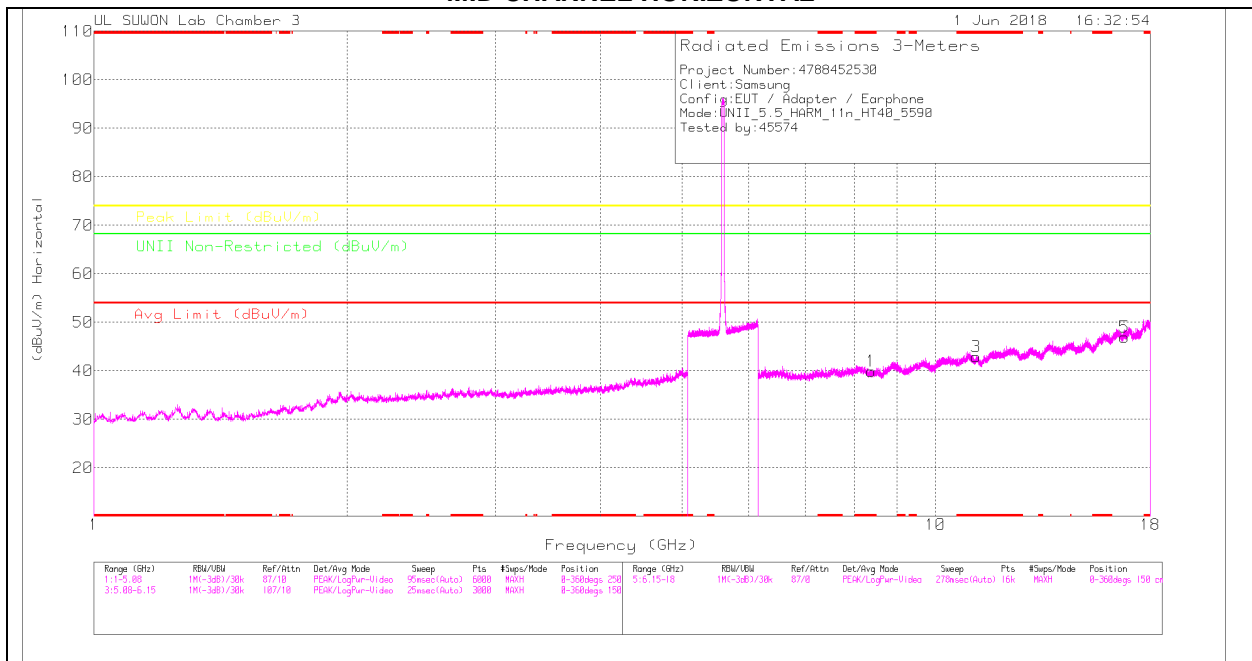

MID CHANNEL VERTICAL

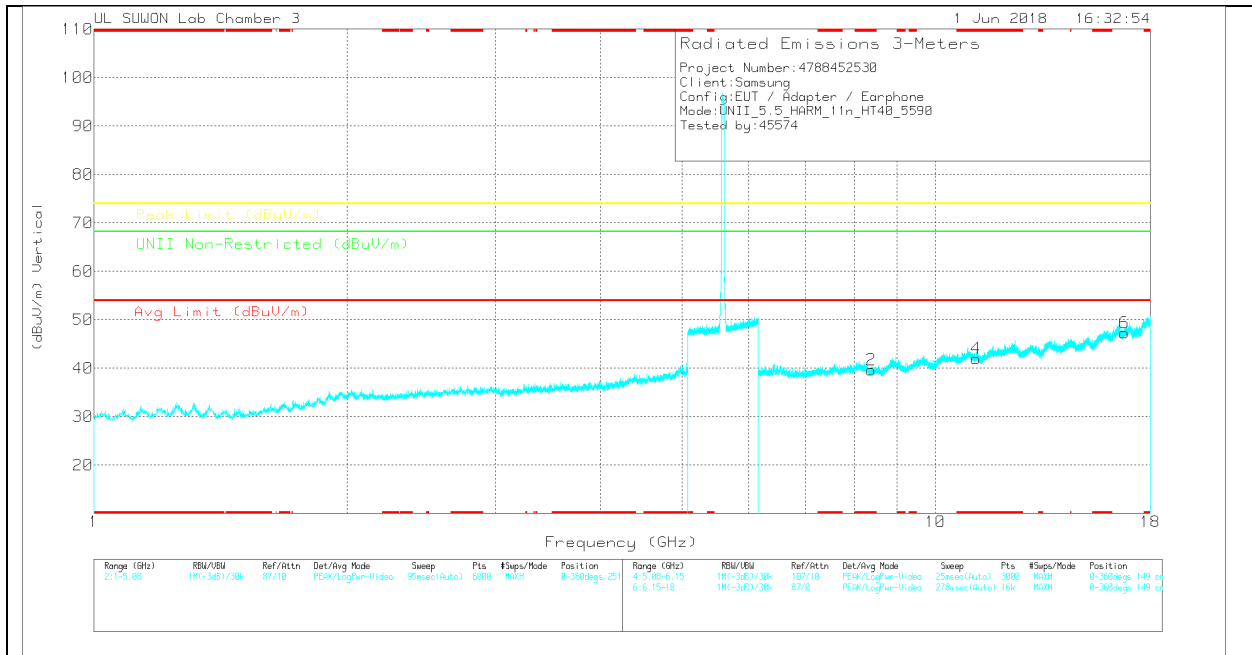

Note: Emission was scanned up to 40GHz; No emissions were detected above the noise floor which was at least 20dB below the specification limit.

MID CHANNEL DATA

Trace Markers

Marker	Frequency (GHz)	Meter Reading (dBμV)	Det	3117(0020959)	GHz_HF[dB]	DC Corr (dB)	Corrected Reading (dBμV/m)	Avg Limit (dBμV/m)	Margin (dB)	Peak Limit (dBμV/m)	Margin (dB)	Limit Non-Restricted (dBμV/m)	Margin (dB)	Azimuth (Degs)	Height (cm)	Polarity
1	* 8.385	25.91	PK	35.8	-21.8	0	39.91	-	-	74	-34.09	-	-	0-360	150	H
3	* 11.18	24.68	PK	37.9	-19.7	0	42.88	-	-	74	-31.12	-	-	0-360	250	H
5	16.77	22.09	PK	41.5	-16.7	0	46.89	-	-	-	-	68.2	-21.31	0-360	250	H
2	* 8.386	25.67	PK	35.8	-21.8	0	39.67	-	-	74	-34.33	-	-	0-360	149	V
4	* 11.181	23.72	PK	37.9	-19.6	0	42.02	-	-	74	-31.98	-	-	0-360	250	V
6	16.77	22.52	PK	41.5	-16.7	0	47.32	-	-	-	-	68.2	-20.88	0-360	149	V

* - indicates frequency in CFR47 Pt 15 / IC RSS-Restricted Band
 PK – Peak detector

Note: Only peak measurement was performed. Because peak measurement result of unwanted emission is less than average limit (54dBuV/m).

HIGH CHANNEL HORIZONTAL

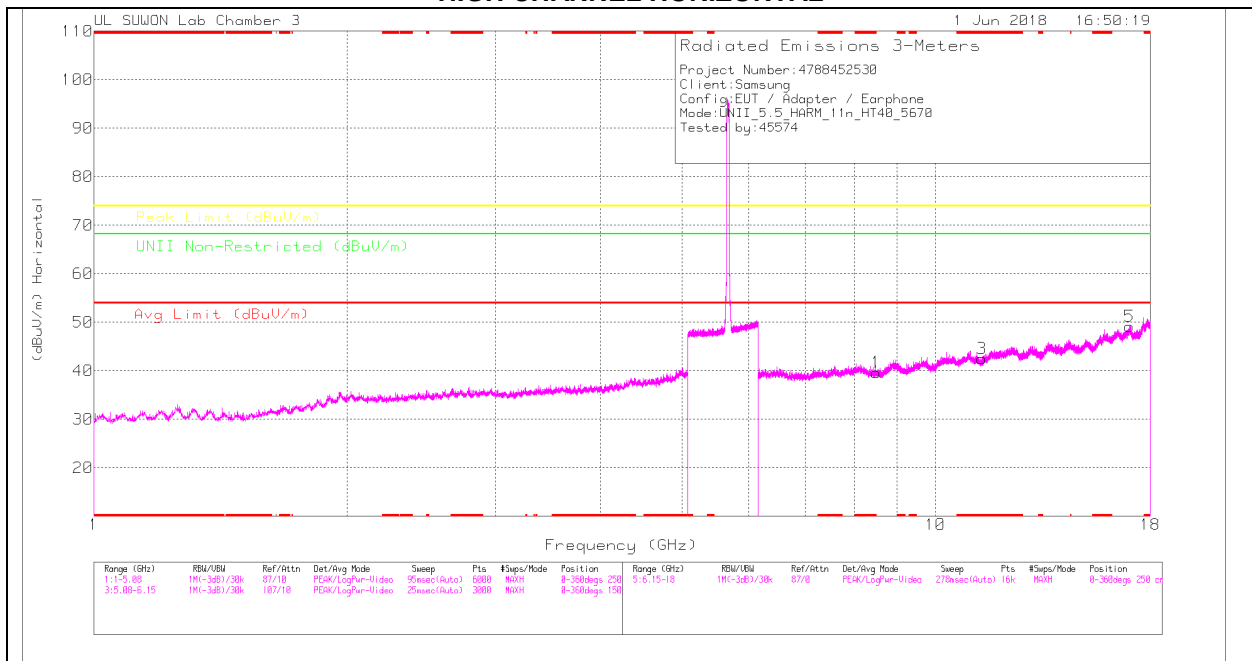

HIGH CHANNEL VERTICAL

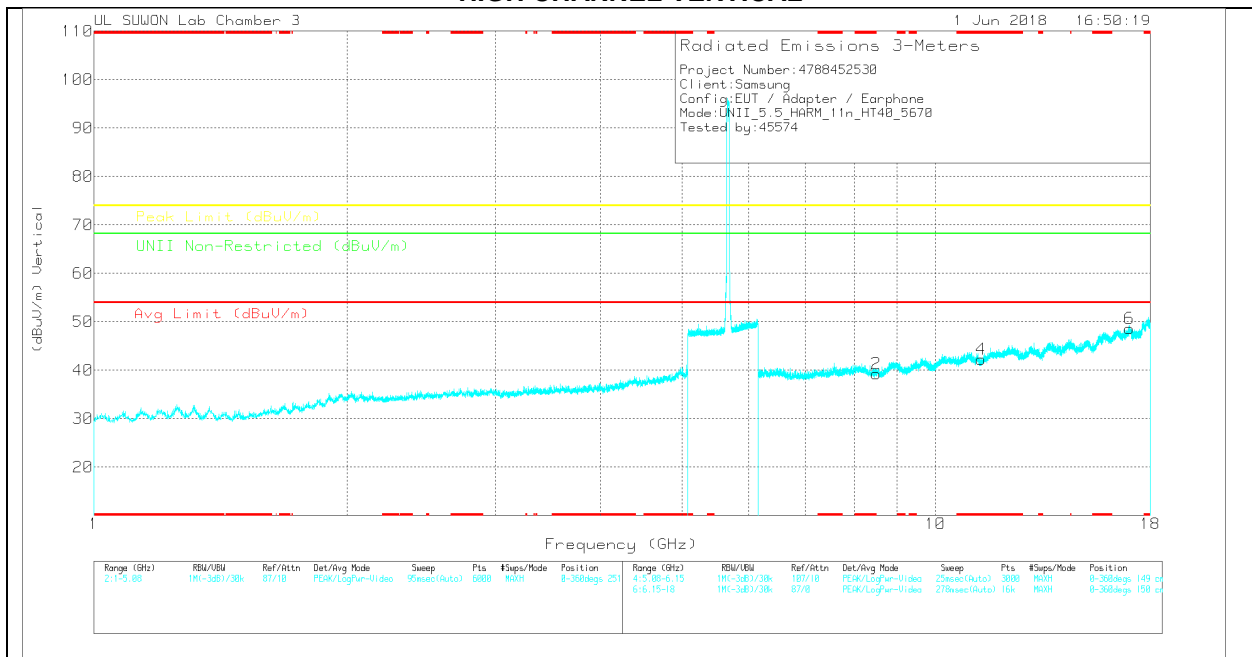

Note: Emission was scanned up to 40GHz; No emissions were detected above the noise floor which was at least 20dB below the specification limit.

HIGH CHANNEL DATA

Trace Markers

Marker	Frequency (GHz)	Meter Reading (dBuV)	Det	317(00209959)	6GHz_HF(dB)	DC Corr (dB)	Corrected Reading (dBuV/m)	Avg Limit (dBuV/m)	Margin (dB)	Peak Limit (dBuV/m)	Margin (dB)	UNE Non-Restricted (dBuV/m)	Margin (dB)	Azimuth (Degs)	Height (cm)	Polarity
1	8.505	25.19	PK	35.8	-21.3	0	39.69	-	-	-	-	68.2	-28.51	0-360	250	H
3	*11.342	24.47	PK	37.9	-19.8	0	42.57	-	-	74	-31.43	-	-	0-360	150	H
5	17.01	23.91	PK	41.2	-16	0	49.11	-	-	-	-	68.2	-19.09	0-360	150	H
2	8.505	24.78	PK	35.8	-21.3	0	39.28	-	-	-	-	68.2	-28.92	0-360	250	V
4	*11.34	24.11	PK	37.9	-19.8	0	42.21	-	-	74	-31.79	-	-	0-360	250	V
6	17.01	23.4	PK	41.2	-16	0	48.6	-	-	-	-	68.2	-19.6	0-360	250	V

* - indicates frequency in CFR47 Pt 15 / IC RSS-Restricted Band
 PK – Peak Detector

Note: Only peak measurement was performed. Because peak measurement result of unwanted emission is less than average limit (54dBuV/m).

**11.3.4. TX ABOVE 1GHz 802.11ac VHT80 MODE IN THE 5.5GHz BAND
 RESTRICTED BANDEDGE (LOW CHANNEL)**

HORIZONTAL PEAK AND AVERAGE PLOT

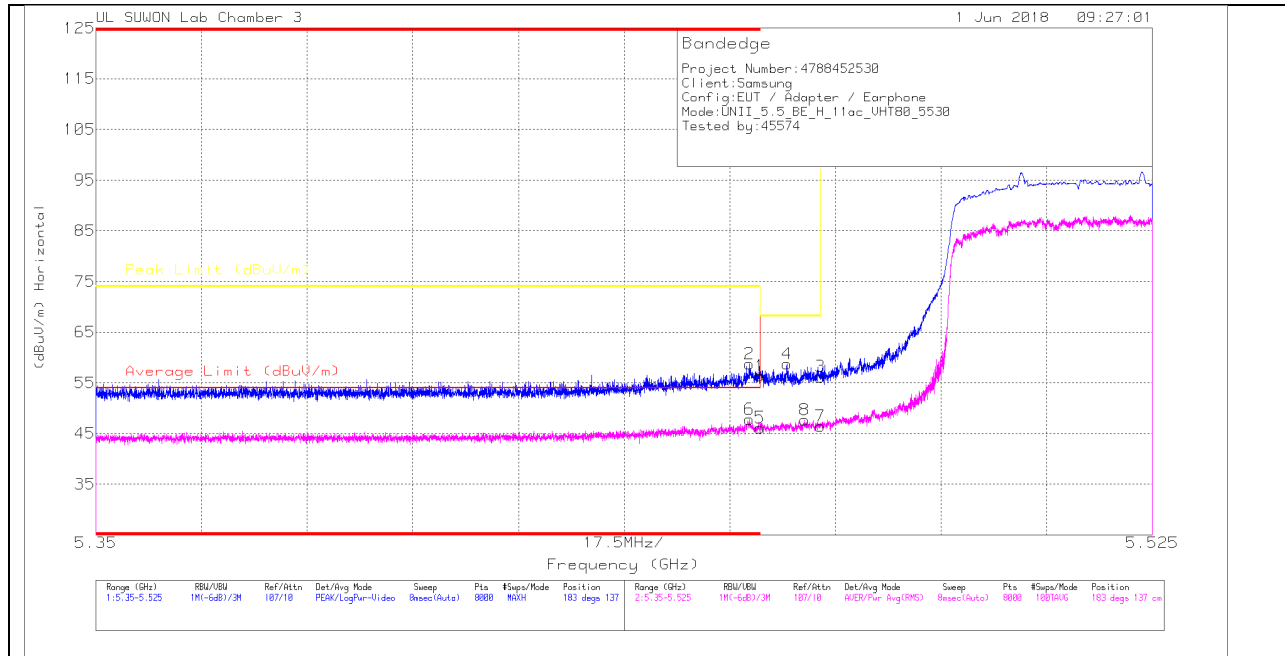

HORIZONTAL DATA

Trace Markers

Marker	Frequency (GHz)	Meter Reading (dBuV)	Det	3117(00205959)	100B_ATT[dB]	DC Corr (dB)	Corrected Reading (dBuV/m)	Average Limit (dBuV/m)	Margin (dB)	Peak Limit (dBuV/m)	PK Margin (dB)	Azimuth (Degs)	Height (cm)	Polarity
1	* 5.46	40.5	Pk	34.3	-18.4	0	56.4	-	-	74	-17.6	183	137	H
2	* 5.458	42.72	Pk	34.3	-18.3	0	58.72	-	-	74	-15.28	183	137	H
3	5.47	40.29	Pk	34.3	-18.4	0	56.19	-	-	68.2	-12.01	183	137	H
4	5.465	42.89	Pk	34.3	-18.4	0	58.79	-	-	68.2	-9.41	183	137	H
5	* 5.46	29.16	RMS	34.3	-18.8	1.47	46.13	54	-7.87	-	-	183	137	H
6	* 5.458	30.8	RMS	34.3	-18.8	1.47	47.77	54	-6.23	-	-	183	137	H

* - indicates frequency in CFR47 Pt 15 / IC RSS-Restricted Band

Pk - Peak detector

RMS - RMS detection

VERTICAL PEAK AND AVERAGE PLOT

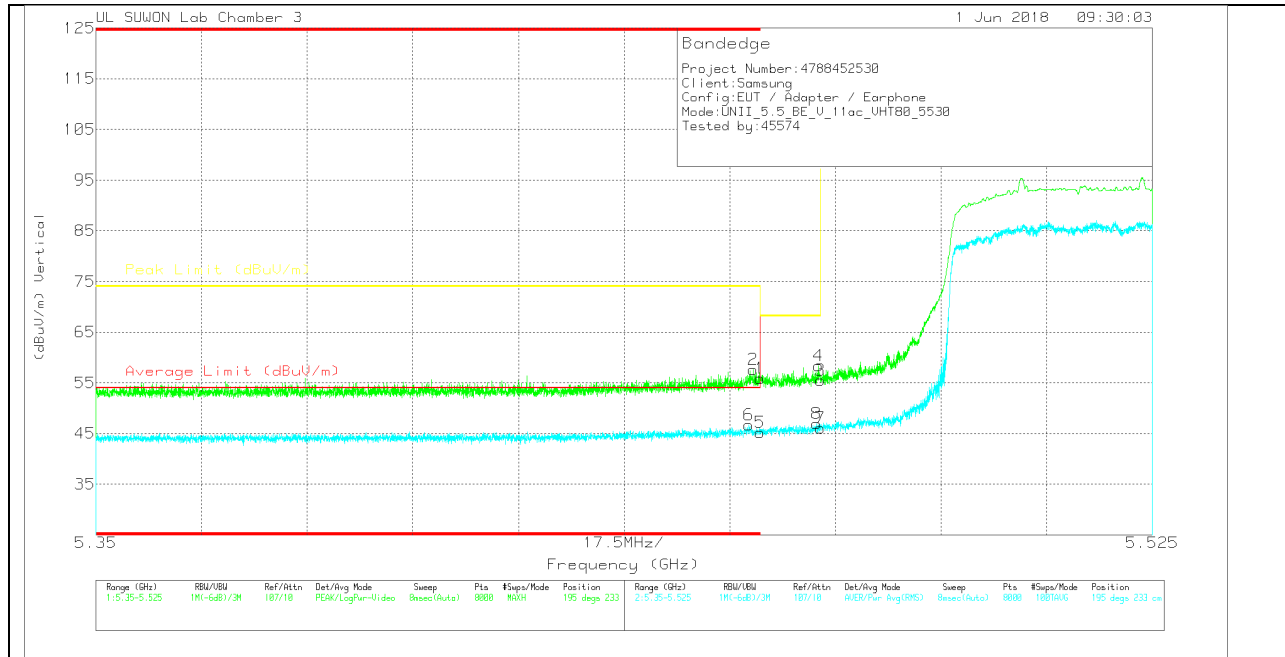

VERTICAL DATA

Trace Markers

Marker	Frequency (GHz)	Meter Reading (dBuV)	Det	3117(00205959)	10dB_ATT[dB]	DC Corr (dB)	Corrected Reading (dBuV/m)	Average Limit (dBuV/m)	Margin (dB)	Peak Limit (dBuV/m)	PK Margin (dB)	Asmuth (Degs)	Height (cm)	Polarity
1	* 5.46	40.01	Pk	34.3	-18.4	0	55.91	-	-	74	-18.09	195	233	V
2	* 5.459	41.76	Pk	34.3	-18.4	0	57.66	-	-	74	-16.34	195	233	V
3	5.47	39.64	Pk	34.3	-18.4	0	55.54	-	-	68.2	-12.66	195	233	V
4	5.47	42.41	Pk	34.3	-18.4	0	58.31	-	-	68.2	-9.89	195	233	V
5	* 5.46	28.24	RMS	34.3	-18.8	1.47	45.21	54	-8.79	-	-	195	233	V
6	* 5.458	29.71	RMS	34.3	-18.8	1.47	46.68	54	-7.32	-	-	195	233	V

* - indicates frequency in CFR47 Pt 15 / IC RSS-Restricted Band

Pk - Peak detector

RMS - RMS detection

HARMONICS AND SPURIOUS EMISSIONS

LOW CHANNEL HORIZONTAL

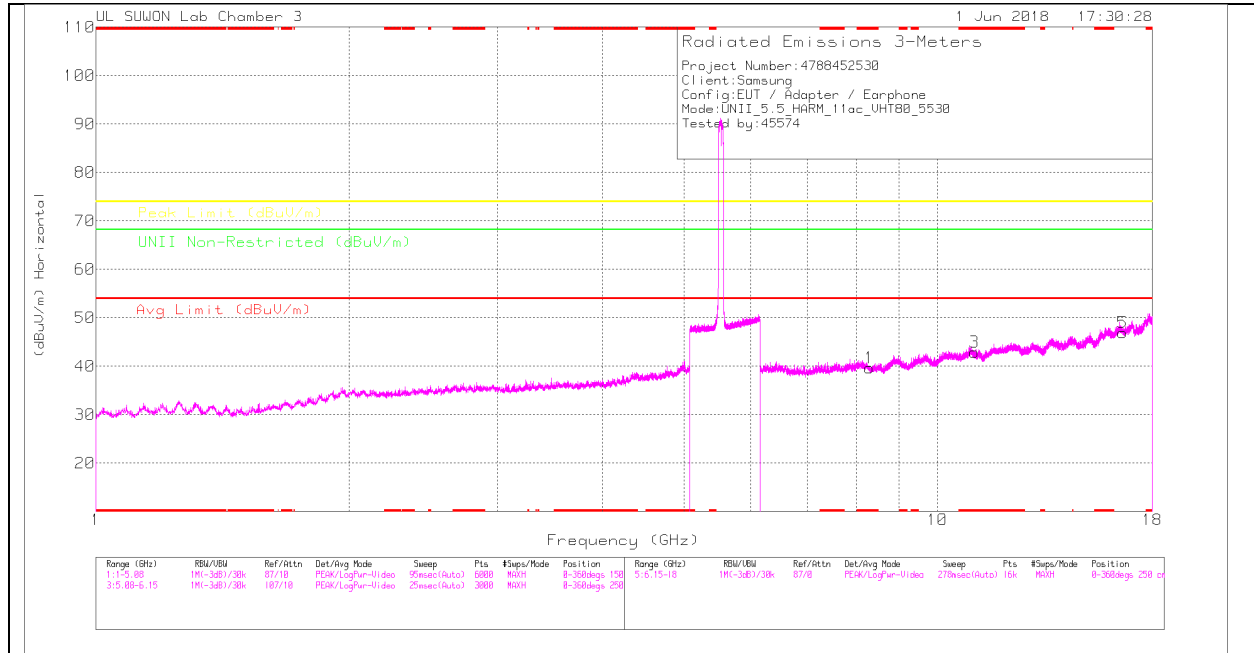

LOW CHANNEL VERTICAL

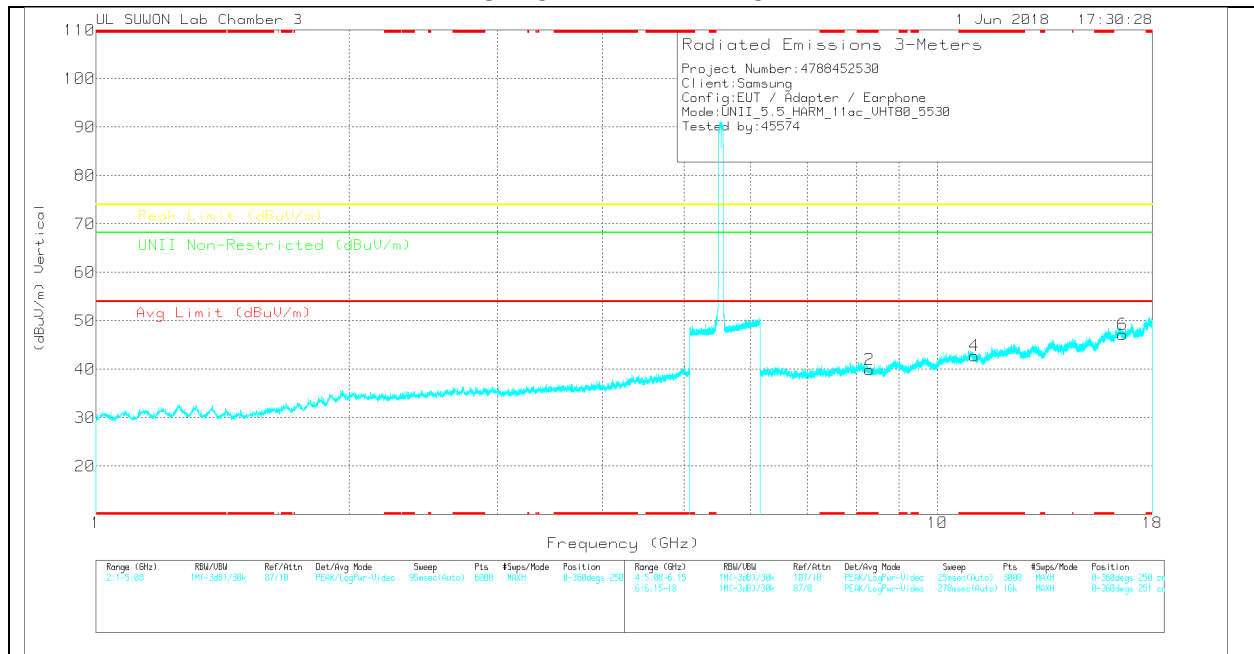

Note: Emission was scanned up to 40GHz; No emissions were detected above the noise floor which was at least 20dB below the specification limit.

LOW CHANNEL DATA

Trace Markers

Marker	Frequency (GHz)	Meter Reading (dBμV)	Det	3117(00209959)	6GHz_HF(dB)	DC Corr (dB)	Corrected Reading (dBμV/m)	Avg Limit (dBμV/m)	Margin (dB)	Peak Limit (dBμV/m)	Margin (dB)	UNE Non-Restricted (dBμV/m)	Margin (dB)	Azimuth (Degs)	Height (cm)	Polarity
1	* 8.296	25.82	PK	35.8	-21.9	0	39.72	-	-	74	-34.28	-	-	0-360	250	H
3	* 11.061	24.65	PK	37.8	-19.5	0	42.95	-	-	74	-31.05	-	-	0-360	250	H
5	16.59	22.82	PK	41.4	-17.3	0	46.92	-	-	-	-	68.2	-21.28	0-360	150	H
2	* 8.296	26	PK	35.8	-21.9	0	39.9	-	-	74	-34.1	-	-	0-360	251	V
4	* 11.06	24.48	PK	37.8	-19.5	0	42.78	-	-	74	-31.22	-	-	0-360	149	V
6	16.59	23.07	PK	41.4	-17.3	0	47.17	-	-	-	-	68.2	-21.03	0-360	251	V

* - indicates frequency in CFR47 Pt 15 / IC RSS-Restricted Band
 PK – Peak detector

Note: Only peak measurement was performed. Because peak measurement result of unwanted emission is less than average limit (54dBuV/m).

HIGH CHANNEL HORIZONTAL

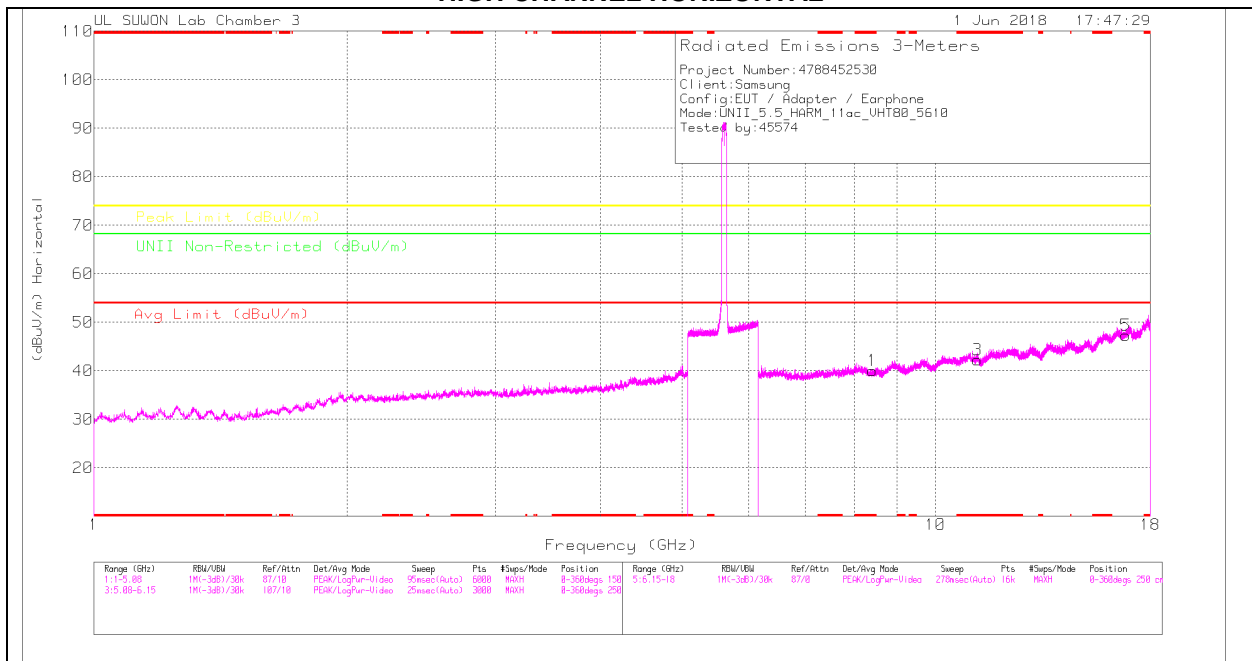

HIGH CHANNEL VERTICAL

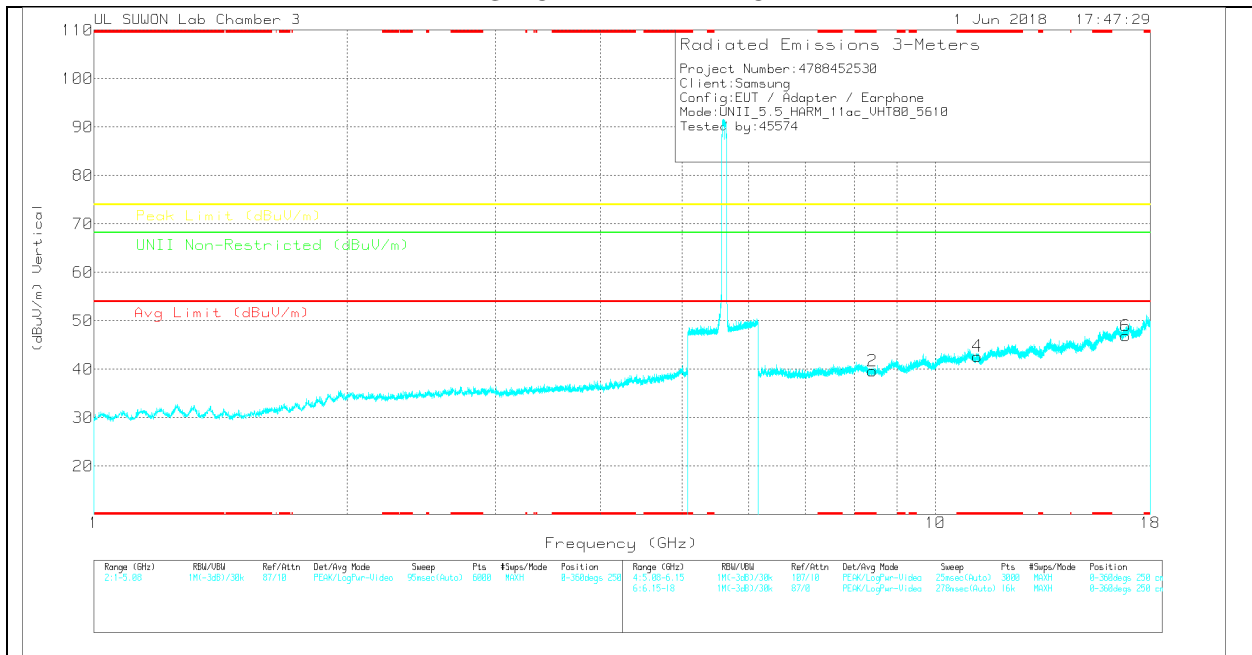

Note: Emission was scanned up to 40GHz; No emissions were detected above the noise floor which was at least 20dB below the specification limit.

HIGH CHANNEL DATA

Trace Markers

Marker	Frequency (GHz)	Meter Reading (dBuV)	Det	317(00209959)	GHz_HF(dB)	DC Corr (dB)	Corrected Reading (dBuV/m)	Avg Limit (dBuV/m)	Margin (dB)	Peak Limit (dBuV/m)	Margin (dB)	UNE Non-Restricted (dBuV/m)	Margin (dB)	Azimuth (Degs)	Height (cm)	Polarity
1	* 8.415	25.95	PK	35.8	-21.7	0	40.05	-	-	74	-33.95	-	-	0-360	150	H
3	* 11.221	23.91	PK	37.9	-19.5	0	42.31	-	-	74	-31.69	-	-	0-360	150	H
5	16.83	22.31	PK	41.4	-16.4	0	47.31	-	-	-	-	68.2	-20.89	0-360	250	H
2	* 8.416	25.48	PK	35.8	-21.6	0	39.68	-	-	74	-34.32	-	-	0-360	250	V
4	* 11.221	24.31	PK	37.9	-19.5	0	42.71	-	-	74	-31.29	-	-	0-360	150	V
6	16.83	21.97	PK	41.4	-16.4	0	46.97	-	-	-	-	68.2	-21.23	0-360	250	V

* - indicates frequency in CFR47 Pt 15 / IC RSS-Restricted Band
 PK – Peak Detector

Note: Only peak measurement was performed. Because peak measurement result of unwanted emission is less than average limit (54dBuV/m).

11.4. 5.8 GHz

**11.4.1. TX ABOVE 1GHz 802.11a MODE IN THE 5.8GHz BAND
 BANDEDGE (LOW CHANNEL)**

HORIZONTAL PEAK PLOT

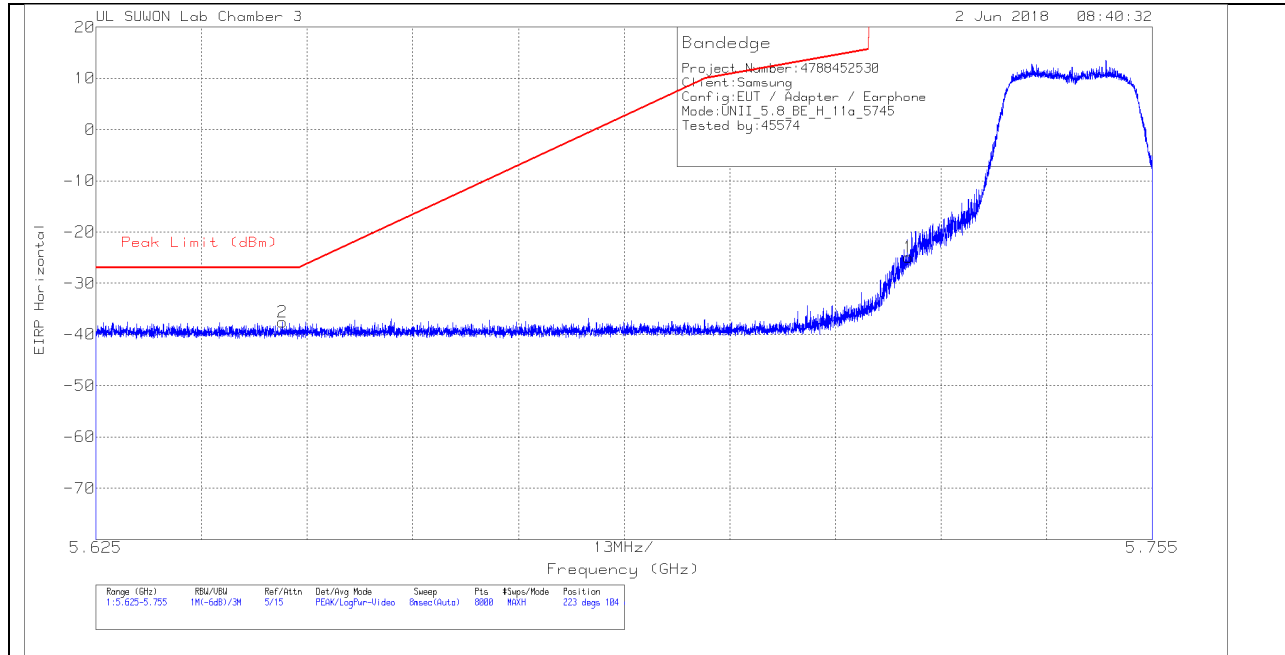

HORIZONTAL DATA

Trace Markers

Marker	Frequency (GHz)	Meter Reading (dBm)	Det	3117[00205959]	10dB_ATT[dB]	Conversion Factor (dB)	Corrected Reading EIRP	Peak Limit (dBm)	PK Margin (dB)	Azimuth (Degs)	Height (cm)	Polarity
1	5.725	-53.56	Pk	34.7	-17.9	11.8	-24.96	278.95	-303.91	223	104	H
2	5.648	-65.76	Pk	34.5	-18.1	11.8	-37.56	-27	-10.56	223	104	H

Pk - Peak detector

VERTICAL PEAK PLOT

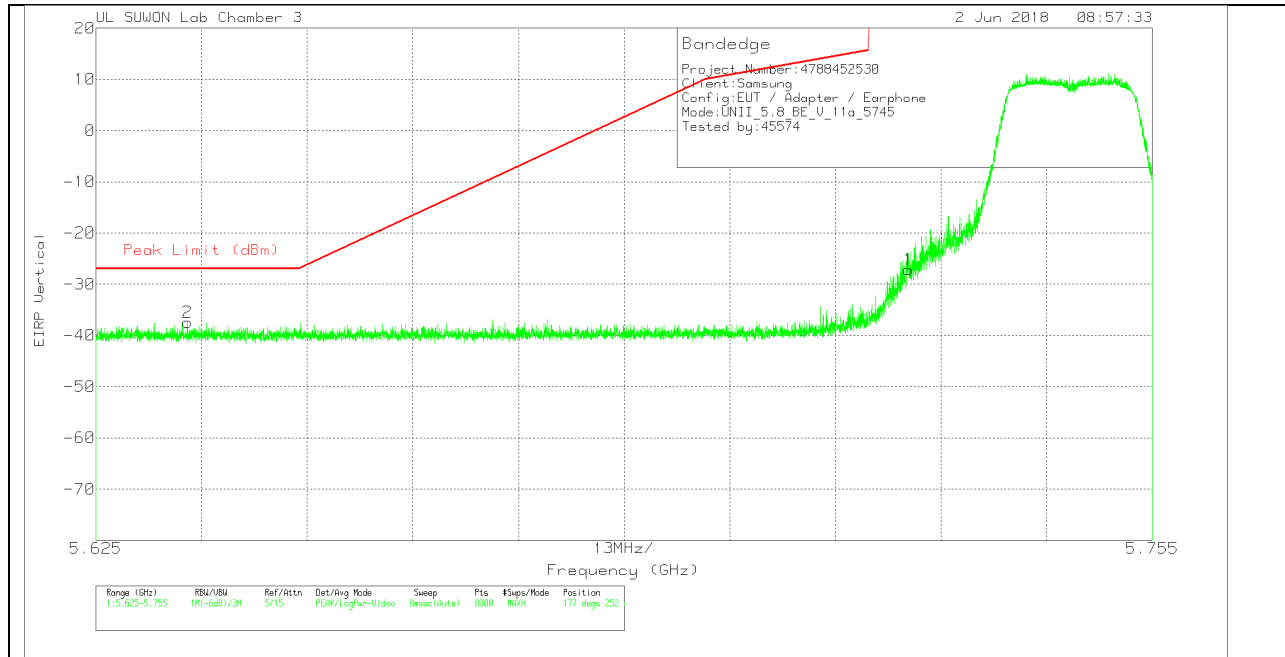

VERTICAL DATA

Trace Markers

Marker	Frequency (GHz)	Meter Reading (dBm)	Det	3117[00205959]	10dB_ATT[dB]	Conversion Factor (dB)	Corrected Reading EIRP	Peak Limit (dBm)	PK Margin (dB)	Azimuth (Degs)	Height (cm)	Polarity
1	5.725	-55.76	Pk	34.7	-17.9	11.8	-27.16	278.95	-306.11	177	252	V
2	5.636	-65.55	Pk	34.5	-18.2	11.8	-37.45	-27	-10.45	177	252	V

Pk - Peak detector

BANDEDGE (HIGH CHANNEL)

HORIZONTAL PEAK PLOT

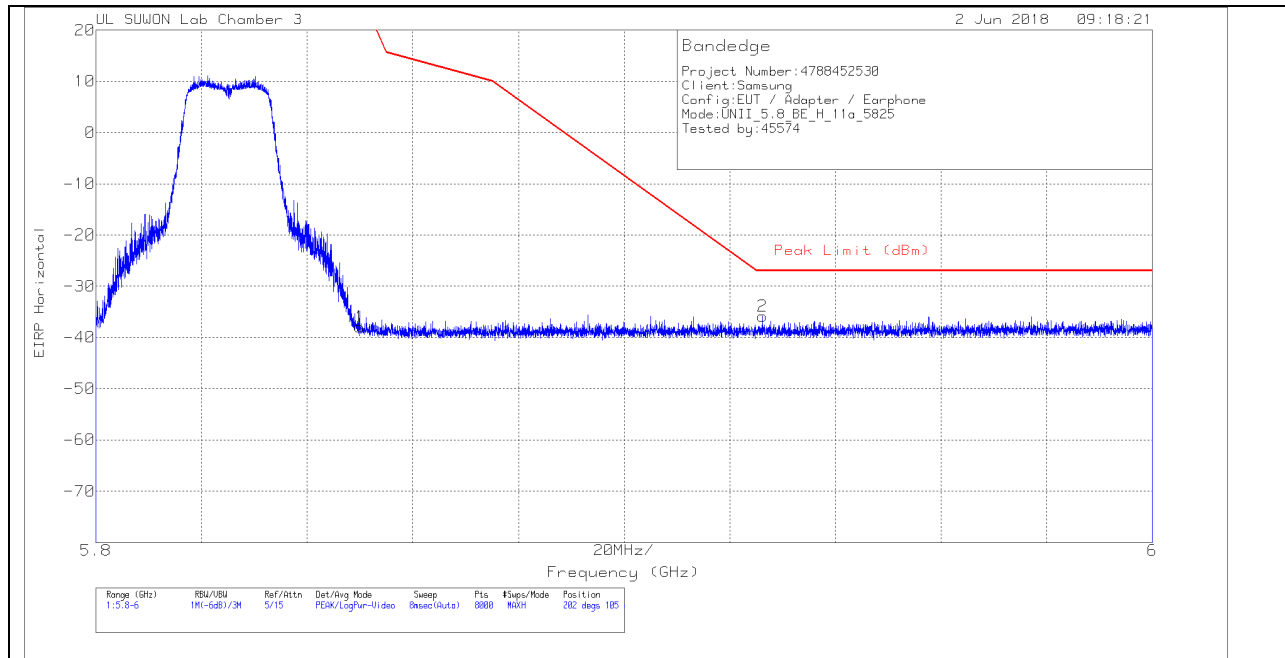

HORIZONTAL DATA

Trace Markers

Marker	Frequency (GHz)	Meter Reading (dBm)	Det	3117[00205959]	10dB_ATT[dB]	Conversion Factor (dB)	Corrected Reading EIRP	Peak Limit (dBm)	PK Margin (dB)	Azimuth (Degs)	Height (cm)	Polarity
1	5.85	-67.05	Pk	34.9	-17.6	11.8	-37.95	26.99	-64.94	202	105	H
2	5.926	-65.08	Pk	35	-17.6	11.8	-35.88	-27	-8.88	202	105	H

Pk - Peak detector

VERTICAL PEAK PLOT

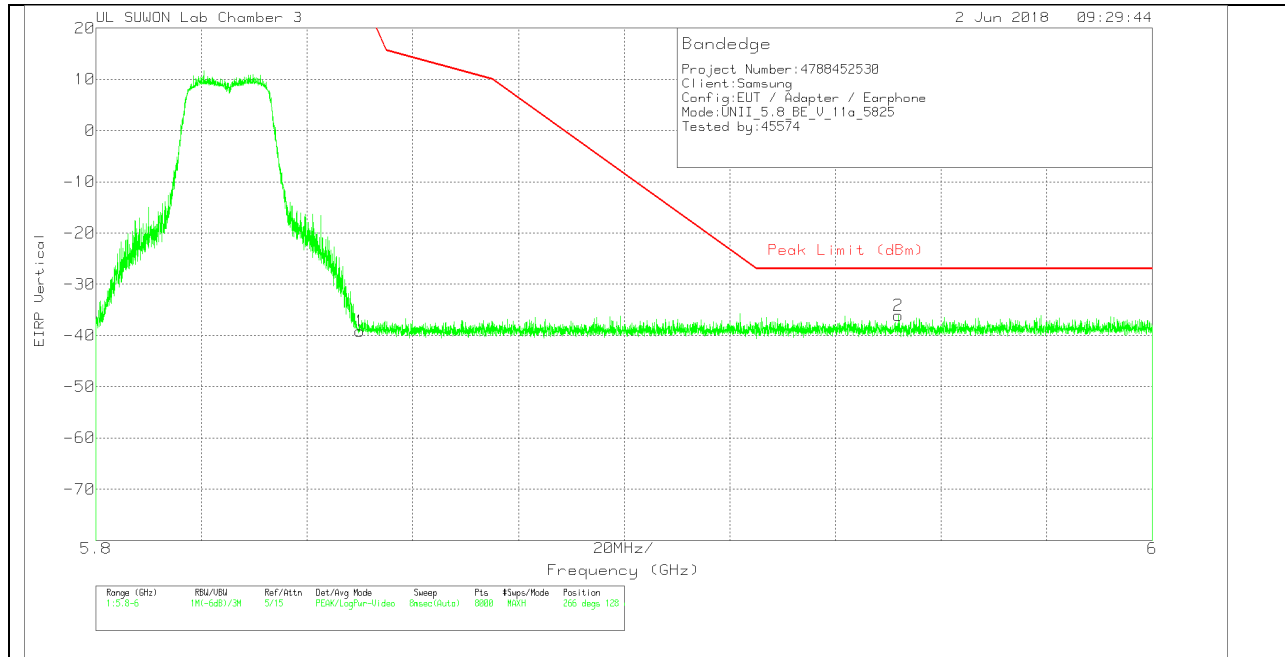

VERTICAL DATA

Trace Markers

Marker	Frequency (GHz)	Meter Reading (dBm)	Det	3117[00205959]	10dB_ATT[dB]	Conversion Factor (dB)	Corrected Reading EIRP	Peak Limit (dBm)	PK Margin (dB)	Azimuth (Degs)	Height (cm)	Polarity
1	5.85	-68.29	Pk	34.9	-17.6	11.8	-39.19	26.99	-66.18	266	128	V
2	5.952	-65.24	Pk	35	-17.6	11.8	-36.04	-27	-9.04	266	128	V

Pk - Peak detector

LOW CHANNEL HORIZONTAL

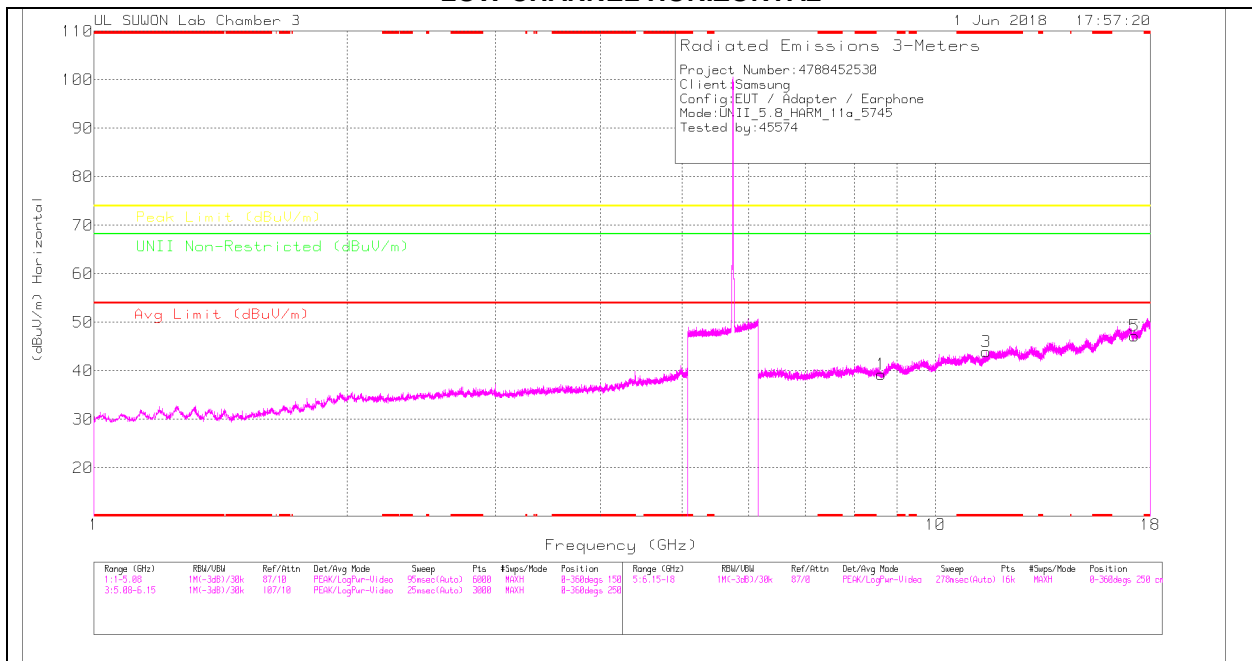

LOW CHANNEL VERTICAL

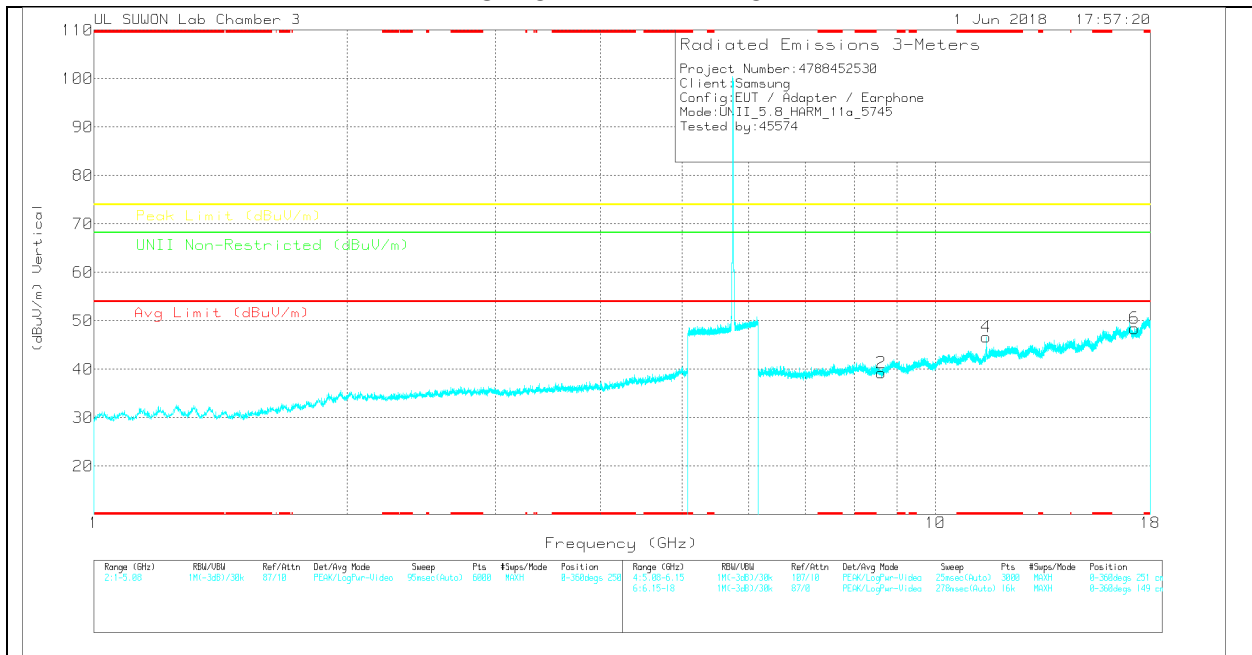

Note: Emission was scanned up to 40GHz; No emissions were detected above the noise floor which was at least 20dB below the specification limit.

LOW CHANNEL DATA

Trace Markers

Marker	Frequency (GHz)	Meter Reading (dBm)	Det	3117(0209959)	6GHz_HF(dB)	DC Corr (dB)	Corrected Reading (dBuV/m)	Avg Limit (dBuV/m)	Margin (dB)	Peak Limit (dBuV/m)	Margin (dB)	U/Ni Non-Restricted (dBuV/m)	Margin (dB)	Azimuth (Degs)	Height (cm)	Polarity
1	8.617	24.97	PK	35.8	-21.5	0	39.27	-	-	-	-	68.2	-28.93	0-360	150	H
3	*11.492	25.57	PK	38	-19.6	0	43.97	-	-	74	-30.03	-	-	0-360	150	H
5	17.234	21.84	PK	40.7	-15.3	0	47.24	-	-	-	-	68.2	-20.96	0-360	250	H
2	8.618	25	PK	35.8	-21.5	0	39.3	-	-	-	-	68.2	-28.9	0-360	250	V
4	*11.489	28.24	PK	39	-19.6	0	46.64	-	-	74	-27.36	-	-	0-360	250	V
6	17.236	23.03	PK	40.7	-15.3	0	48.43	-	-	-	-	68.2	-19.77	0-360	149	V

* - indicates frequency in CFR47 Pt 15 / IC RSS-Restricted Band
 PK – Peak detector

Radiated Emissions

Frequency (GHz)	Meter Reading (dBm)	Det	3117(0209959)	6GHz_HF(dB)	DC Corr (dB)	Corrected Reading (dBuV/m)	Avg Limit (dBuV/m)	Margin (dB)	Peak Limit (dBuV/m)	Margin (dB)	U/Ni Non-Restricted (dBuV/m)	Margin (dB)	Azimuth (Degs)	Height (cm)	Polarity
*11.49	36.15	PK-U	38	-19.6	0	54.55	-	-	74	-19.45	-	-	214	188	H
*11.492	24.43	ADR	38	-19.6	0	42.83	54	-11.17	-	-	-	-	214	188	H
*11.496	38.9	PK-U	38	-19.5	0	57.4	-	-	74	-16.6	-	-	223	236	V
*11.491	26.93	ADR	38	-19.5	0	45.43	54	-8.57	-	-	-	-	223	236	V

* - indicates frequency in CFR47 Pt 15 / IC RSS-Restricted Band
 PK-U - U-NII: Maximum Peak
 ADR - U-NII AD primary method, RMS average

MID CHANNEL HORIZONTAL

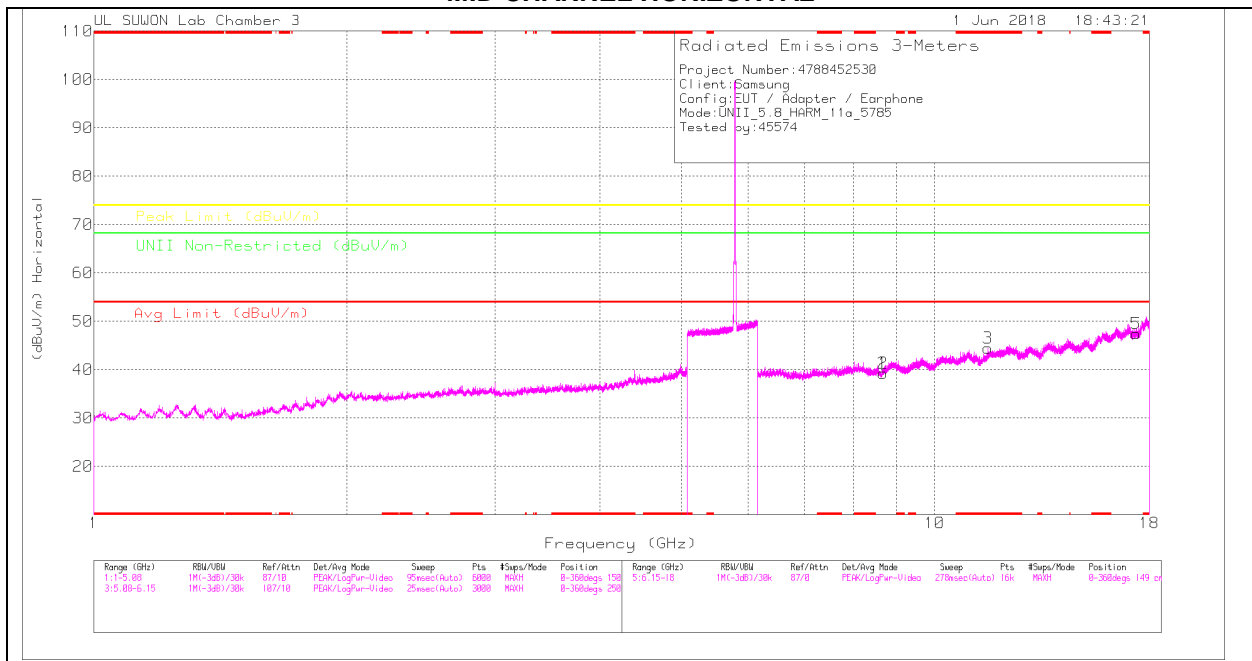

MID CHANNEL VERTICAL

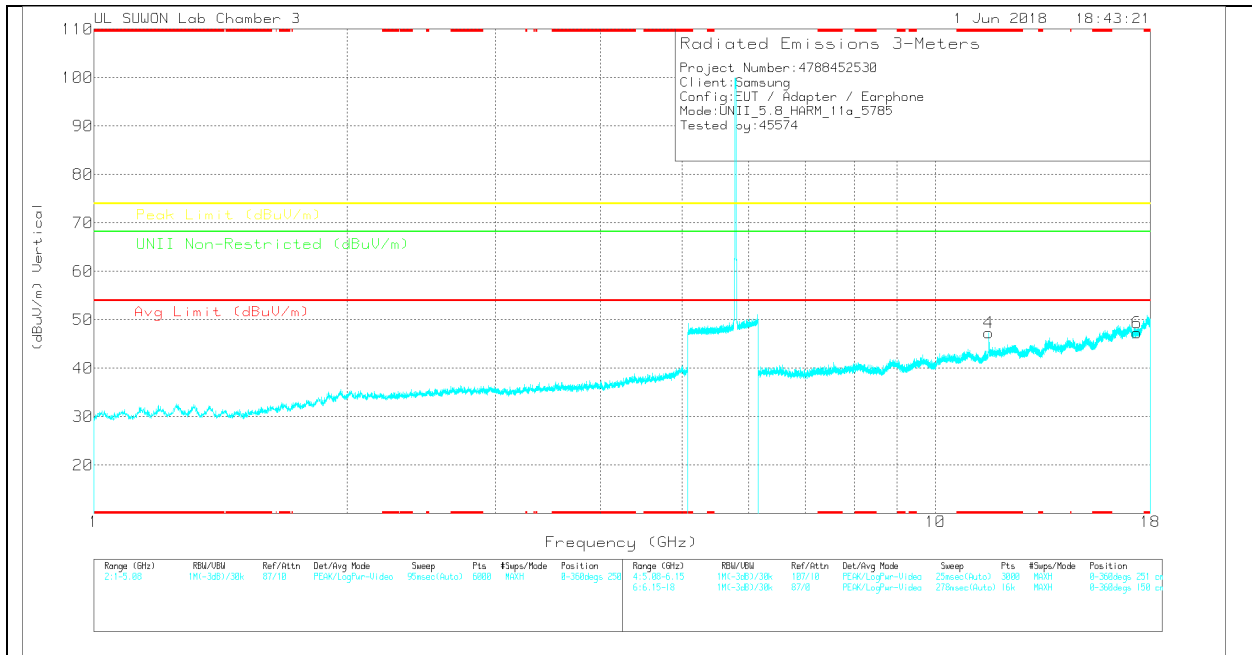

Note: Emission was scanned up to 40GHz; No emissions were detected above the noise floor which was at least 20dB below the specification limit.

MID CHANNEL DATA

Trace Markers

Marker	Frequency (GHz)	Meter Reading (dBuV)	Det	3117[0020959]	6GHz_HF[dB]	DC Corr (dB)	Corrected Reading (dBuV/m)	Avg Limit (dBuV/m)	Margin (dB)	Peak Limit (dBuV/m)	Margin (dB)	UNII Non-Restricted (dBuV/m)	Margin (dB)	Azimuth (Degs)	Height (cm)	Polarity
1	8.677	24.71	PK	35.9	-21.3	0	39.31	-	-	-	-	68.2	-28.89	0-360	149	H
2	8.677	24.71	PK	35.9	-21.3	0	39.31	-	-	-	-	68.2	-28.89	0-360	149	H
3	*11.575	26.12	PK	38.1	-19.8	0	44.42	-	-	74	-29.58	-	-	0-360	149	H
5	17.354	22.04	PK	40.8	-15.4	0	47.44	-	-	-	-	68.2	-20.76	0-360	149	H
4	*11.567	28.98	PK	38.1	-19.8	0	47.28	-	-	74	-26.72	-	-	0-360	251	V
6	17.356	21.81	PK	40.8	-15.3	0	47.31	-	-	-	-	68.2	-20.89	0-360	251	V

* - indicates frequency in CFR47 Pt 15 / IC RSS-Restricted Band
 PK – Peak Detector

Radiated Emissions

Frequency (GHz)	Meter Reading (dBuV)	Det	3117[0020959]	6GHz_HF[dB]	DC Corr (dB)	Corrected Reading (dBuV/m)	Avg Limit (dBuV/m)	Margin (dB)	Peak Limit (dBuV/m)	Margin (dB)	UNII Non-Restricted (dBuV/m)	Margin (dB)	Azimuth (Degs)	Height (cm)	Polarity
*11.568	33.76	PK-U	38.1	-19.7	0	52.16	-	-	74	-21.84	-	-	214	188	H
*11.569	24.6	ADR	38.1	-19.7	0	43	54	-11	-	-	-	-	214	188	H
*11.56	36.43	PK-U	38.1	-19.8	0	54.73	-	-	74	-19.27	-	-	223	236	V
*11.567	27.54	ADR	38.1	-19.8	0	45.84	54	-8.16	-	-	-	-	223	236	V

* - indicates frequency in CFR47 Pt 15 / IC RSS-Restricted Band
 PK-U - U-NII: Maximum Peak
 ADR - U-NII AD primary method, RMS average

HIGH CHANNEL HORIZONTAL

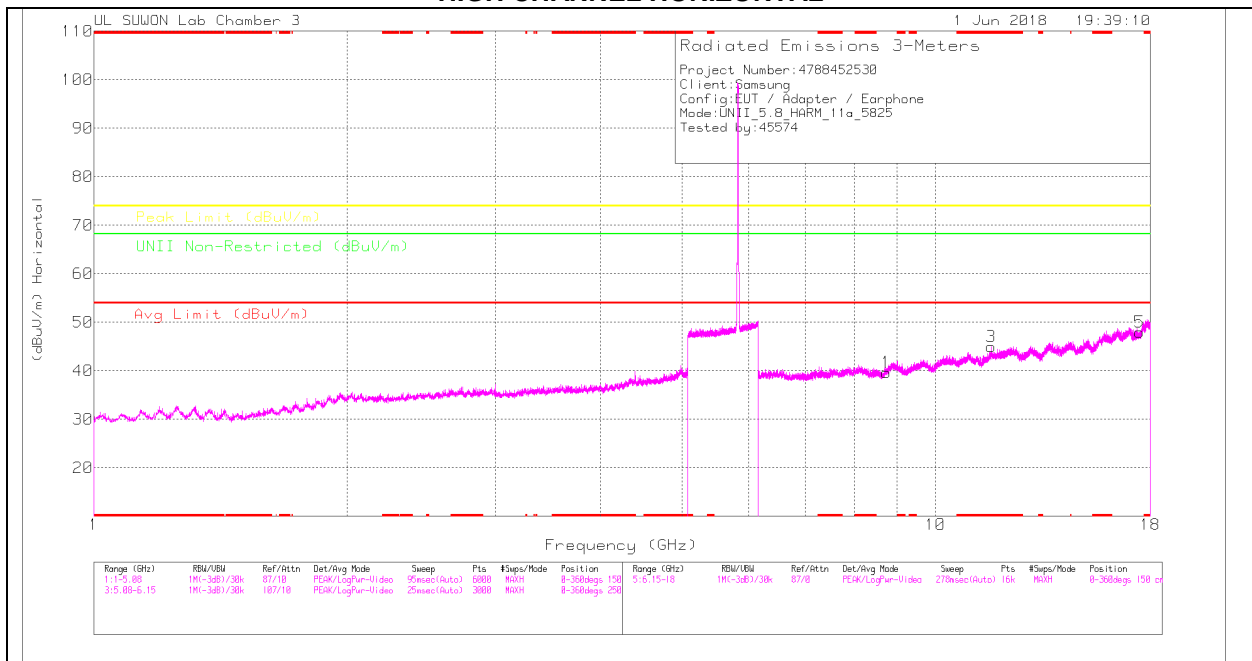

HIGH CHANNEL VERTICAL

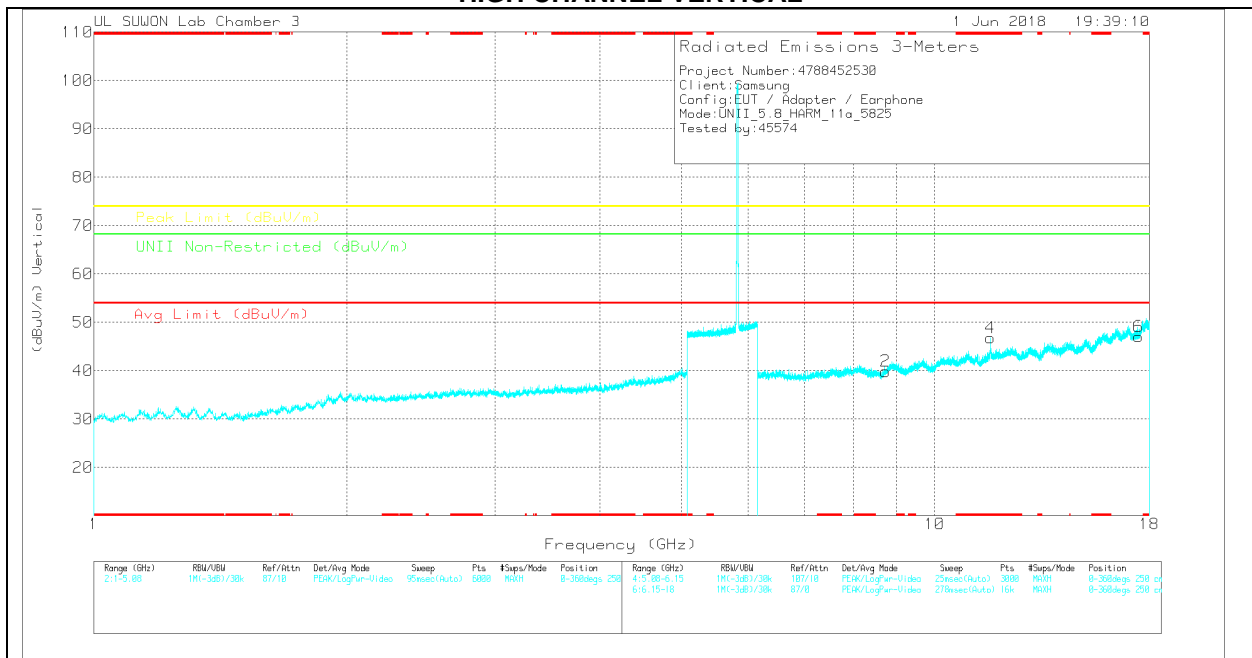

Note: Emission was scanned up to 40GHz; No emissions were detected above the noise floor which was at least 20dB below the specification limit.

HIGH CHANNEL DATA

Trace Markers

Marker	Frequency (GHz)	Meter Reading (dBm)	Det	3117(00209959)	6GHz_HF(dB)	DC Corr (dB)	Corrected Reading (dBuV/m)	Avg Limit (dBuV/m)	Margin (dB)	Peak Limit (dBuV/m)	Margin (dB)	U/NR Non-Restricted (dBuV/m)	Margin (dB)	Azimuth (Degs)	Height (cm)	Polarity
1	8.737	24.86	PK	35.9	-21.1	0	39.66	-	-	-	-	68.2	-28.54	0-360	250	H
3	*11.645	26.4	PK	38.2	-19.6	0	45	-	-	74	-29	-	-	0-360	250	H
5	17.474	21.89	PK	41	-14.9	0	47.99	-	-	-	-	68.2	-20.21	0-360	150	H
2	8.737	25.06	PK	35.9	-21.1	0	39.86	-	-	-	-	68.2	-28.34	0-360	149	V
4	*11.644	28.25	PK	38.2	-19.6	0	46.85	-	-	74	-27.15	-	-	0-360	250	V
6	17.476	21	PK	41	-14.9	0	47.1	-	-	-	-	68.2	-21.1	0-360	149	V

* - indicates frequency in CFR47 Pt 15 / IC RSS-Restricted Band
 PK – Peak Detector

Radiated Emissions

Frequency (GHz)	Meter Reading (dBm)	Det	3117(00209959)	6GHz_HF(dB)	DC Corr (dB)	Corrected Reading (dBuV/m)	Avg Limit (dBuV/m)	Margin (dB)	Peak Limit (dBuV/m)	Margin (dB)	U/NR Non-Restricted (dBuV/m)	Margin (dB)	Azimuth (Degs)	Height (cm)	Polarity
*11.658	32.88	PK-U	38.3	-19.7	0	51.48	-	-	74	-22.52	-	-	214	188	H
*11.648	24.47	ADR	38.2	-19.7	0	42.97	54	-11.03	-	-	-	-	214	188	H
*11.656	35.06	PK-U	38.2	-19.6	0	53.66	-	-	74	-20.34	-	-	223	236	V
*11.65	26.86	ADR	38.2	-19.7	0	45.36	54	-8.64	-	-	-	-	223	236	V

* - indicates frequency in CFR47 Pt 15 / IC RSS-Restricted Band
 PK-U - U-NII: Maximum Peak
 ADR - U-NII AD primary method, RMS average

**11.4.2.TX ABOVE 1GHz 802.11n HT20 MODE IN THE 5.8GHz BAND
 BANDEDGE (LOW CHANNEL)**

HORIZONTAL PEAK PLOT

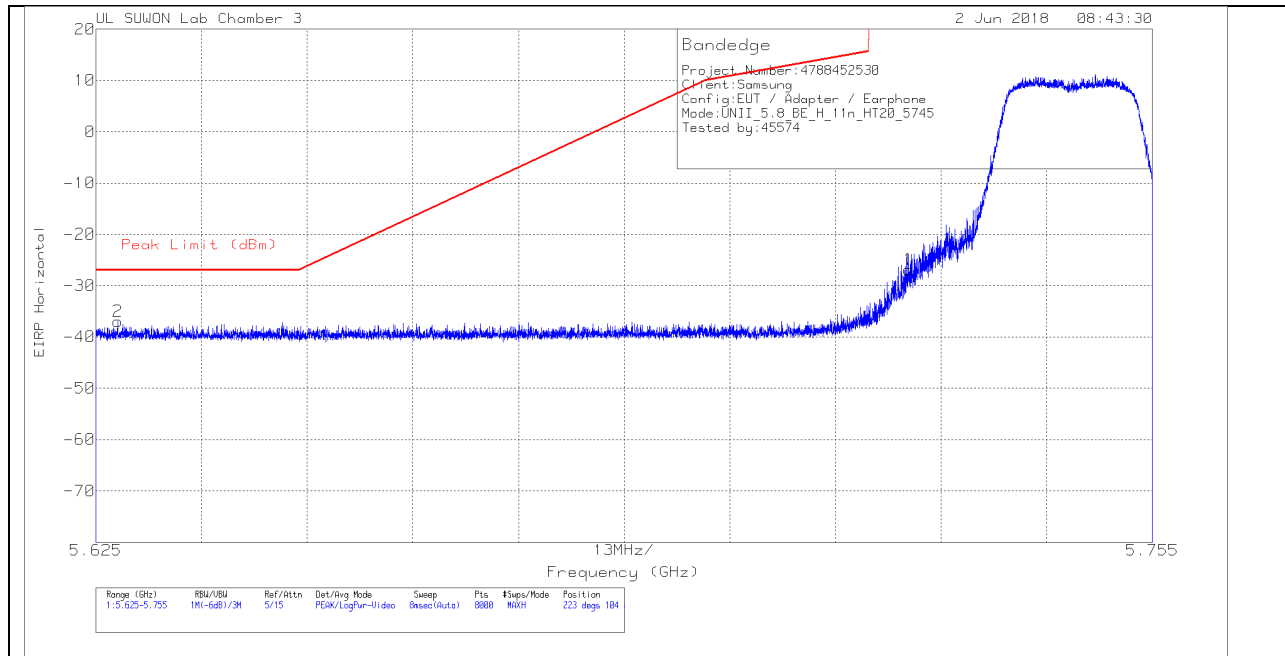

HORIZONTAL DATA

Trace Markers

Marker	Frequency (GHz)	Meter Reading (dBm)	Det	3117[00205959]	10dB_ATT[dB]	Conversion Factor (dB)	Corrected Reading EIRP	Peak Limit (dBm)	PK Margin (dB)	Azimuth (Degs)	Height (cm)	Polarity
1	5.725	-55.43	Pk	34.7	-17.9	11.8	-26.83	278.95	-305.78	223	104	H
2	5.628	-65.13	Pk	34.5	-18.1	11.8	-36.93	-27	-9.93	223	104	H

Pk - Peak detector

VERTICAL PEAK PLOT

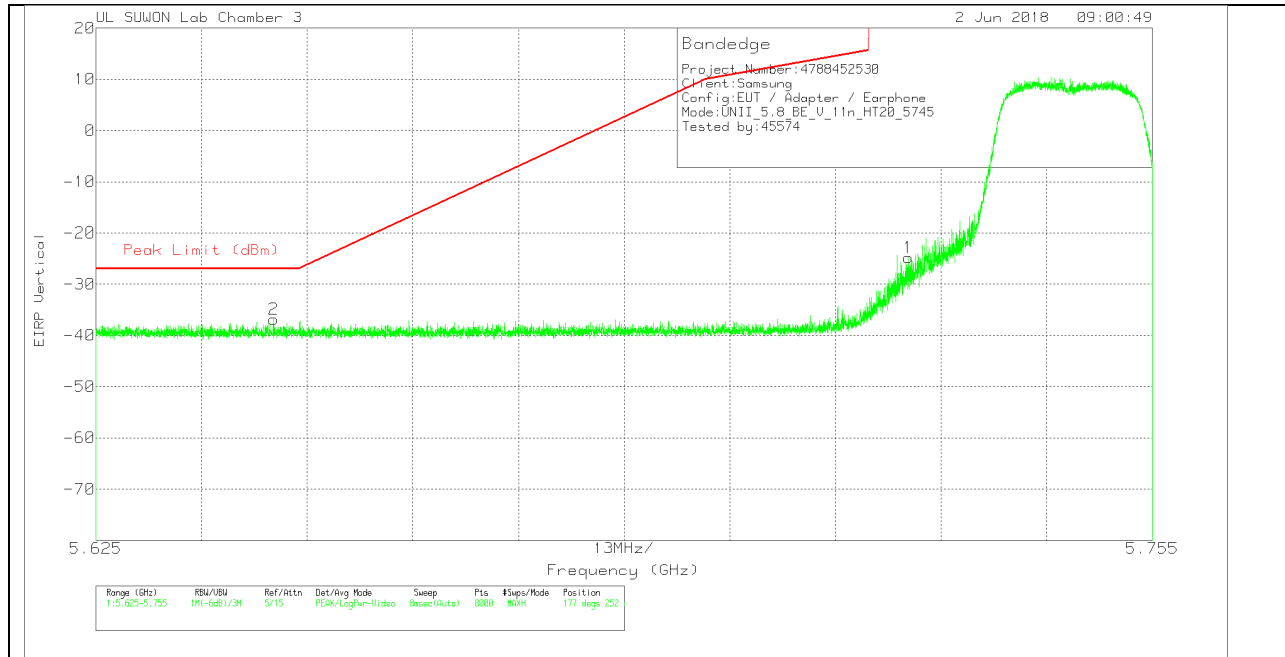

VERTICAL DATA

Trace Markers

Marker	Frequency (GHz)	Meter Reading (dBm)	Det	3117[00205959]	10dB_ATT[dB]	Conversion Factor (dB)	Corrected Reading EIRP	Peak Limit (dBm)	PK Margin (dB)	Azimuth (Degs)	Height (cm)	Polarity
1	5.725	-53.34	Pk	34.7	-17.9	11.8	-24.74	278.95	-303.69	177	252	V
2	5.647	-65.07	Pk	34.5	-18.1	11.8	-36.87	-27	-9.87	177	252	V

Pk - Peak detector

BANDEDGE (HIGH CHANNEL)

HORIZONTAL PEAK AND AVERAGE PLOT

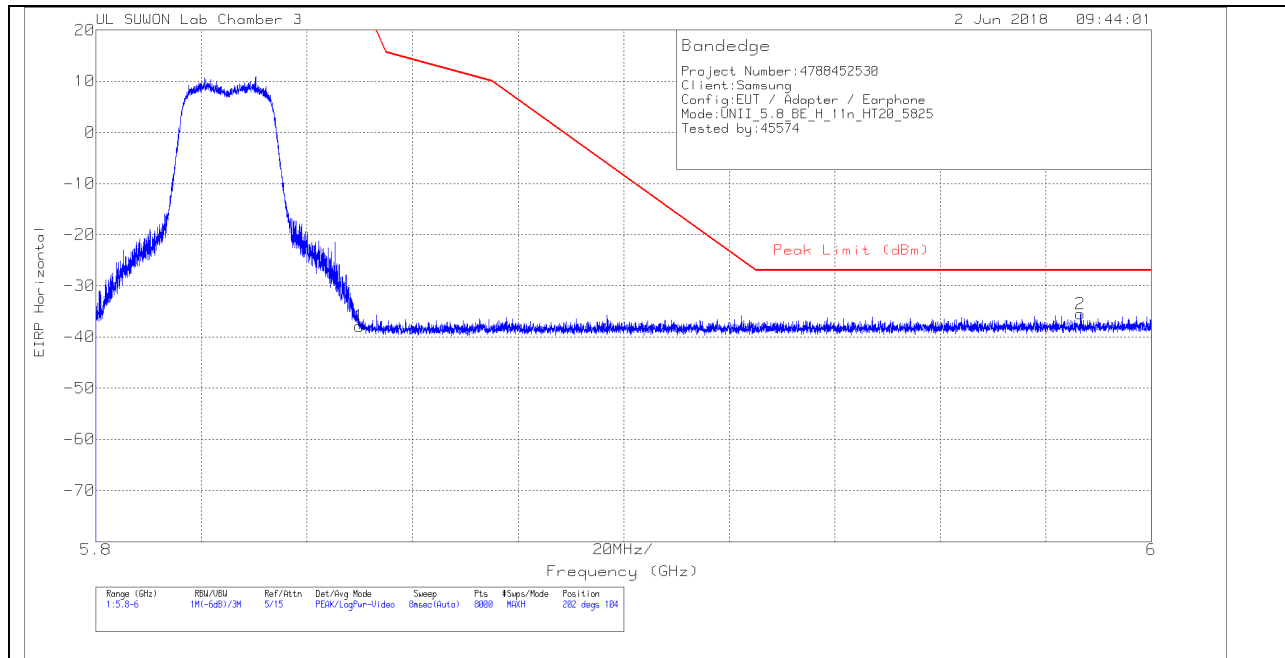

HORIZONTAL DATA

Trace Markers

Marker	Frequency (GHz)	Meter Reading (dBm)	Det	3117[00205959]	10dB_ATT[dB]	Conversion Factor (dB)	Corrected Reading EIRP	Peak Limit (dBm)	PK Margin (dB)	Azimuth (Degs)	Height (cm)	Polarity
1	5.85	-66.97	Pk	34.9	-17.6	11.8	-37.87	26.99	-64.86	202	104	H
2	5.987	-64.86	Pk	35.1	-17.5	11.8	-35.46	-27	-8.46	202	104	H

Pk - Peak detector

VERTICAL PEAK PLOT

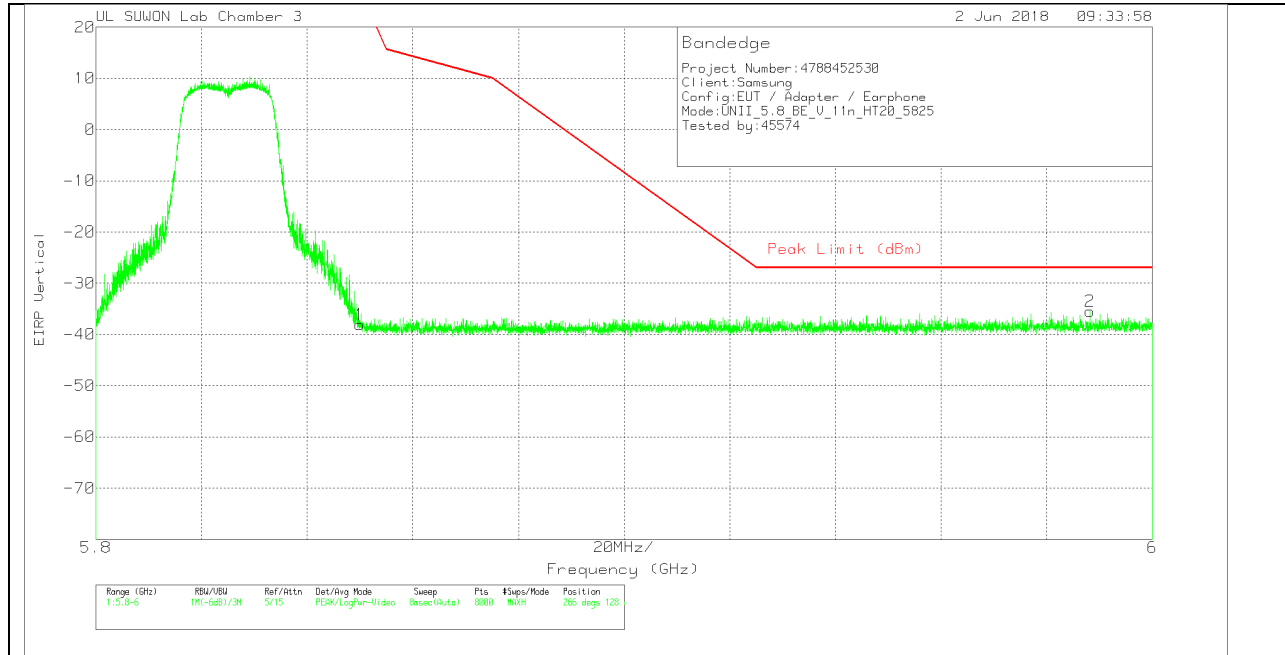

VERTICAL DATA

Trace Markers

Marker	Frequency (GHz)	Meter Reading (dBm)	Det	3117[00205959]	10dB_ATT[dB]	Conversion Factor (dB)	Corrected Reading EIRP	Peak Limit (dBm)	PK Margin (dB)	Azimuth (Degs)	Height (cm)	Polarity
1	5.85	-67.18	Pk	34.9	-17.6	11.8	-38.08	26.99	-65.07	266	128	V
2	5.988	-64.93	Pk	35.1	-17.5	11.8	-35.53	-27	-8.53	266	128	V

Pk - Peak detector

LOW CHANNEL HORIZONTAL

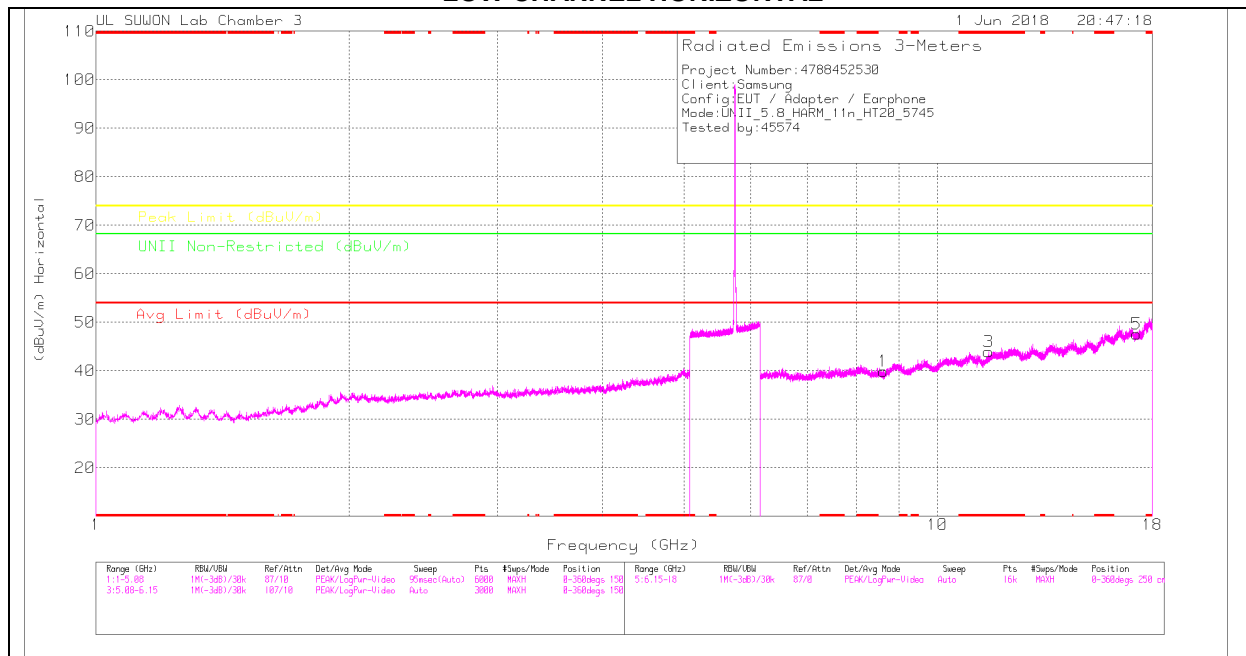

LOW CHANNEL VERTICAL

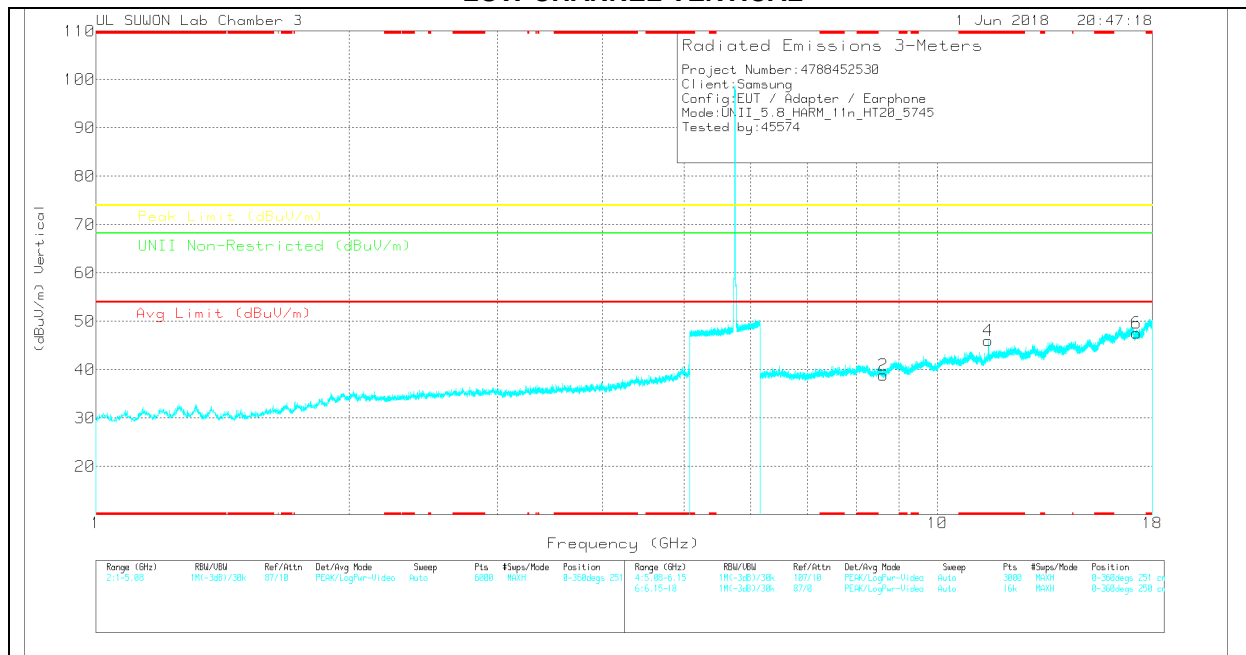

Note: Emission was scanned up to 40GHz; No emissions were detected above the noise floor which was at least 20dB below the specification limit.

LOW CHANNEL DATA

Trace Markers

Marker	Frequency (GHz)	Meter Reading (dBm)	Det	3117(0020959)	6GHz_HF(dB)	DC Corr (dB)	Corrected Reading (dBuV/m)	Avg Limit (dBuV/m)	Margin (dB)	Peak Limit (dBuV/m)	Margin (dB)	UHF Non-Restricted (dBuV/m)	Margin (dB)	Azimuth (Degs)	Height (cm)	Polarity
1	8.617	25.61	PK	35.8	-21.5	0	39.91	-	-	-	-	68.2	-28.29	0-360	150	H
3	*11.498	25.56	PK	38	-19.6	0	43.96	-	-	74	-30.04	-	-	0-360	150	H
5	17.241	22.08	PK	40.7	-15.2	0	47.58	-	-	-	-	68.2	-20.62	0-360	250	H
2	8.617	24.58	PK	35.8	-21.5	0	38.88	-	-	-	-	68.2	-29.32	0-360	250	V
4	*11.49	27.59	PK	38	-19.6	0	45.99	-	-	74	-28.01	-	-	0-360	250	V
6	17.237	22.14	PK	40.7	-15.3	0	47.54	-	-	-	-	68.2	-20.66	0-360	149	V

* - indicates frequency in CFR47 Pt 15 / IC RSS-Restricted Band
 PK – Peak Detector

Radiated Emissions

Frequency (GHz)	Meter Reading (dBm)	Det	3117(0020959)	6GHz_HF(dB)	DC Corr (dB)	Corrected Reading (dBuV/m)	Avg Limit (dBuV/m)	Margin (dB)	Peak Limit (dBuV/m)	Margin (dB)	UHF Non-Restricted (dBuV/m)	Margin (dB)	Azimuth (Degs)	Height (cm)	Polarity
*11.492	33.26	PK-U	38	-19.6	0	51.66	-	-	74	-22.34	-	-	214	188	H
*11.496	23.76	ADR	38	-19.5	0	42.26	54	-11.74	-	-	-	-	214	188	H
*11.485	34.36	PK-U	38	-19.6	0	52.76	-	-	74	-21.24	-	-	223	236	V
*11.49	25.5	ADR	38	-19.6	0	43.9	54	-10.1	-	-	-	-	223	236	V

* - indicates frequency in CFR47 Pt 15 / IC RSS-Restricted Band
 PK-U - U-NII: Maximum Peak
 ADR - U-NII AD primary method, RMS average

MID CHANNEL HORIZONTAL

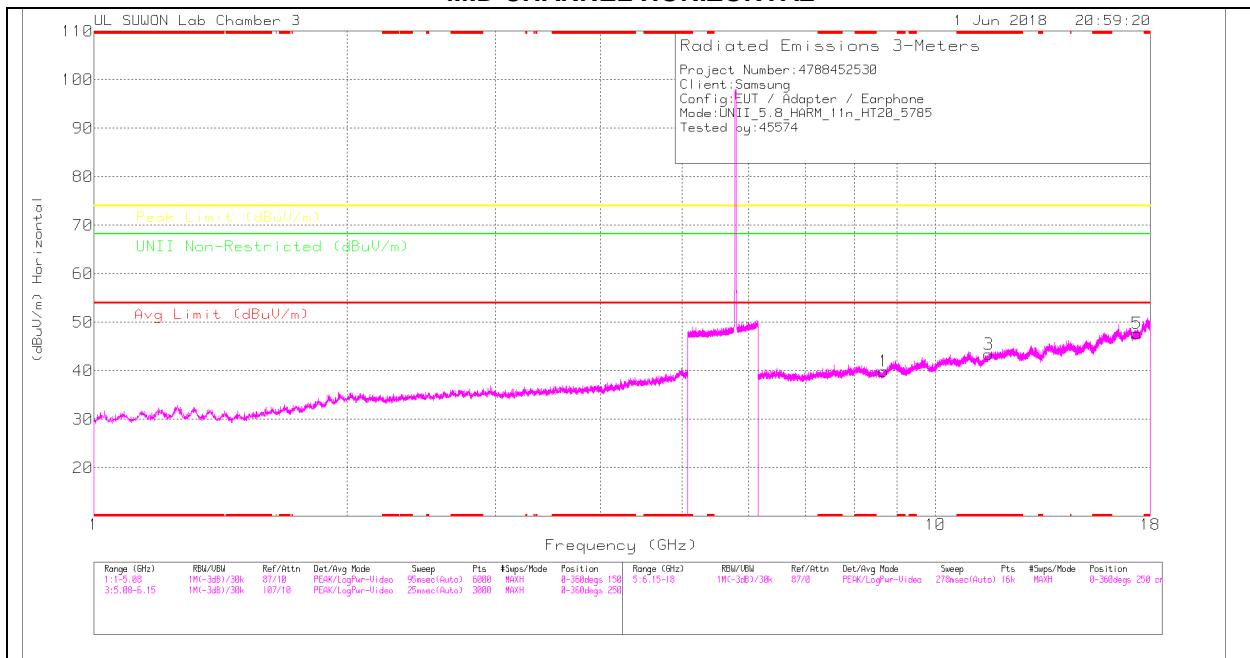

MID CHANNEL VERTICAL

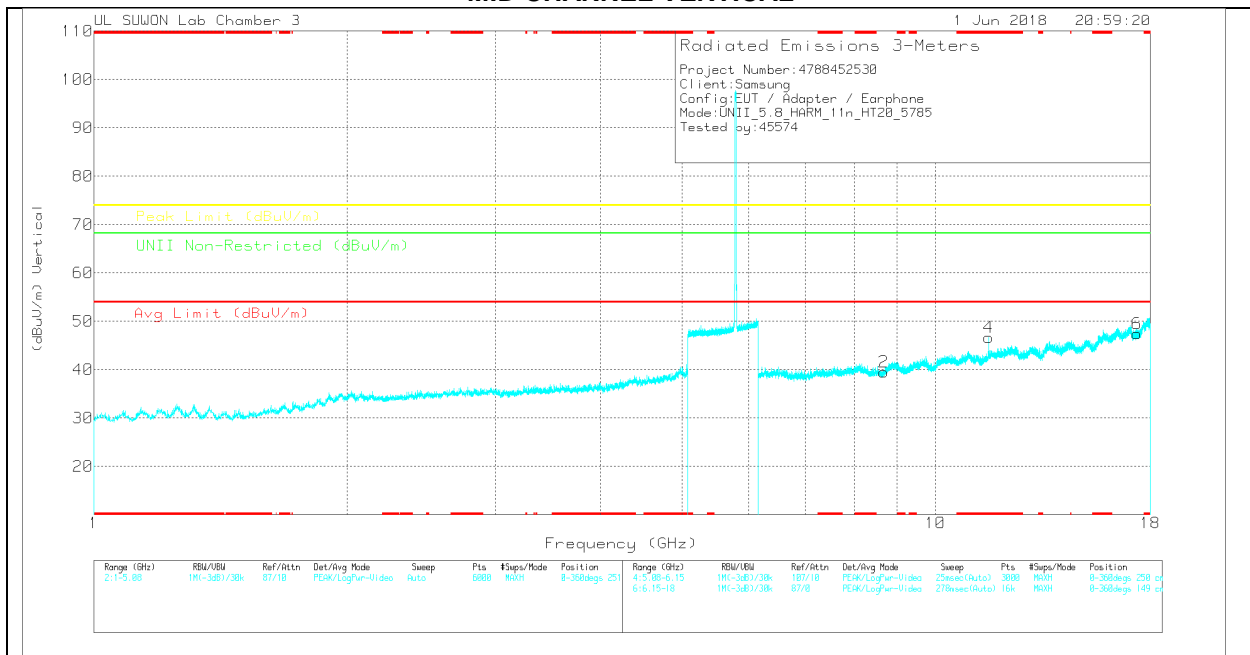

Note: Emission was scanned up to 40GHz; No emissions were detected above the noise floor which was at least 20dB below the specification limit.

MID CHANNEL DATA

Trace Markers

Marker	Frequency (GHz)	Meter Reading (dBuV)	Det	3117[0020959]	6GHz_HF[dB]	DC Corr (dB)	Corrected Reading (dBuV/m)	Avg Limit (dBuV/m)	Margin (dB)	Peak Limit (dBuV/m)	Margin (dB)	UNII Non-Restricted (dBuV/m)	Margin (dB)	Azimuth (Degs)	Height (cm)	Polarity
1	8.679	25.38	PK	35.9	-21.3	0	39.98	-	-	-	-	68.2	-28.22	0-360	250	H
3	* 11.57	25.11	PK	38.1	-19.8	0	43.41	-	-	74	-30.59	-	-	0-360	250	H
5	17.356	22.21	PK	40.8	-15.3	0	47.71	-	-	-	-	68.2	-20.49	0-360	250	H
2	8.676	24.99	PK	35.9	-21.3	0	39.59	-	-	-	-	68.2	-28.61	0-360	149	V
4	* 11.567	28.34	PK	38.1	-19.8	0	46.64	-	-	74	-27.36	-	-	0-360	251	V
6	17.356	22	PK	40.8	-15.3	0	47.5	-	-	-	-	68.2	-20.7	0-360	149	V

* - indicates frequency in CFR47 Pt 15 / IC RSS-Restricted Band
 PK – Peak Detector

Radiated Emissions

Frequency (GHz)	Meter Reading (dBuV)	Det	3117[0020959]	6GHz_HF[dB]	DC Corr (dB)	Corrected Reading (dBuV/m)	Avg Limit (dBuV/m)	Margin (dB)	Peak Limit (dBuV/m)	Margin (dB)	UNII Non-Restricted (dBuV/m)	Margin (dB)	Azimuth (Degs)	Height (cm)	Polarity
* 11.59	32.69	PK-U	38.1	-19.8	0	50.99	-	-	74	-23.01	-	-	214	188	H
* 11.564	23.4	ADR	38.1	-19.8	0	41.7	54	-12.3	-	-	-	-	214	188	H
* 11.568	34.76	PK-U	38.1	-19.8	0	53.06	-	-	74	-20.94	-	-	223	236	V
* 11.57	25.84	ADR	38.1	-19.8	0	44.14	54	-9.86	-	-	-	-	223	236	V

* - indicates frequency in CFR47 Pt 15 / IC RSS-Restricted Band
 PK-U - U-NII: Maximum Peak
 ADR - U-NII AD primary method, RMS average

HIGH CHANNEL HORIZONTAL

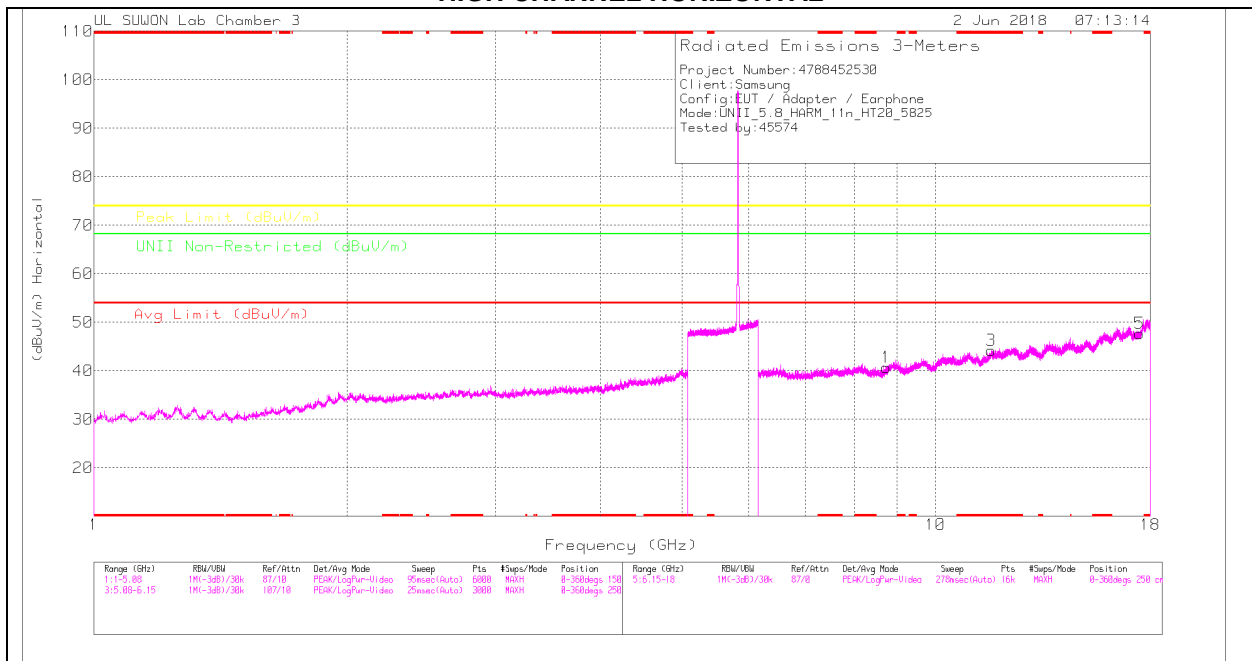

HIGH CHANNEL VERTICAL

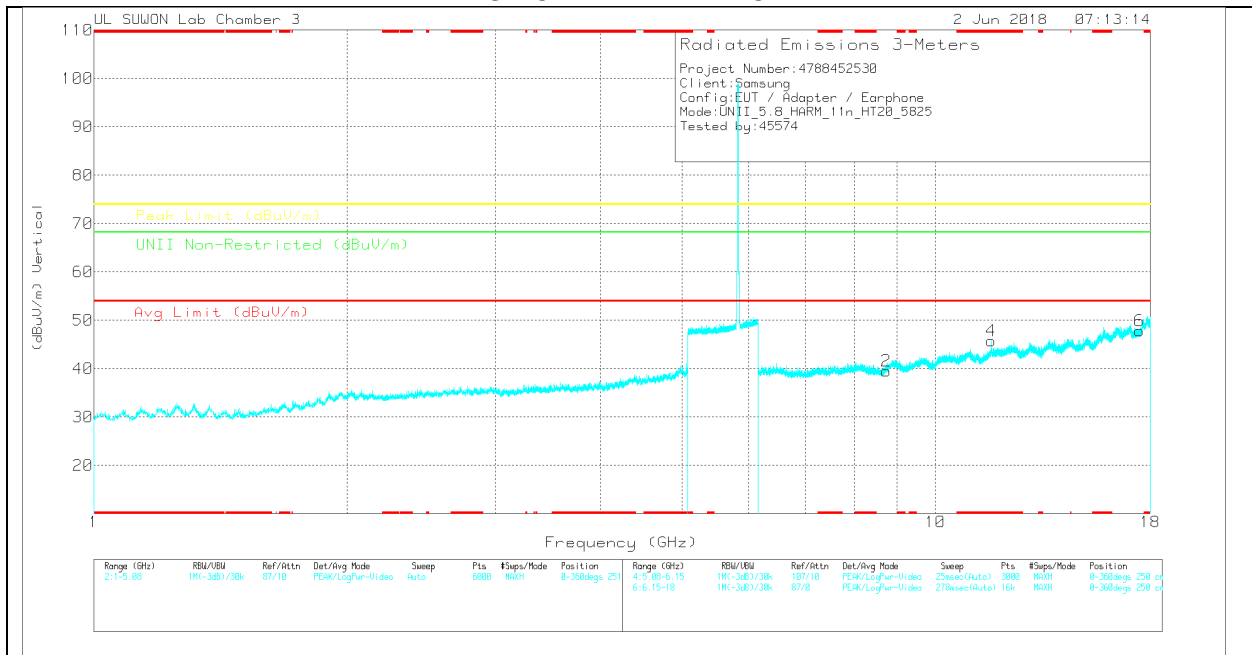

Note: Emission was scanned up to 40GHz; No emissions were detected above the noise floor which was at least 20dB below the specification limit.

HIGH CHANNEL DATA

Trace Markers

Marker	Frequency (GHz)	Meter Reading (dBμV)	Det	3117(0020959)	6GHz_HF(dB)	DC Corr (dB)	Corrected Reading (dBμV/m)	Avg Limit (dBμV/m)	Margin (dB)	Peak Limit (dBμV/m)	Margin (dB)	U-NII Non-Restricted (dBμV/m)	Margin (dB)	Azimuth (Degs)	Height (cm)	Polarity
1	8.737	25.93	PK	35.9	-21.1	0	40.73	-	-	-	-	68.2	-27.47	0-360	250	H
3	* 11.65	25.69	PK	38.2	-19.7	0	44.19	-	-	74	-29.81	-	-	0-360	250	H
5	17.479	21.59	PK	41	-14.9	0	47.69	-	-	-	-	68.2	-20.51	0-360	150	H
2	8.737	24.69	PK	35.9	-21.1	0	39.49	-	-	-	-	68.2	-28.71	0-360	250	V
4	* 11.647	27.24	PK	38.2	-19.7	0	45.74	-	-	74	-28.26	-	-	0-360	250	V
6	17.475	21.78	PK	41	-14.9	0	47.88	-	-	-	-	68.2	-20.32	0-360	149	V

* - indicates frequency in CFR47 Pt 15 / IC RSS-Restricted Band
 PK – Peak Detector

Radiated Emissions

Frequency (GHz)	Meter Reading (dBμV)	Det	3117(0020959)	6GHz_HF(dB)	DC Corr (dB)	Corrected Reading (dBμV/m)	Avg Limit (dBμV/m)	Margin (dB)	Peak Limit (dBμV/m)	Margin (dB)	U-NII Non-Restricted (dBμV/m)	Margin (dB)	Azimuth (Degs)	Height (cm)	Polarity
* 11.65	35.69	PK-U	38.2	-19.7	0	54.19	-	-	74	-19.81	-	-	223	236	V
* 11.649	26.44	ADR	38.2	-19.7	0	44.94	54	-9.06	-	-	-	-	223	236	V

* - indicates frequency in CFR47 Pt 15 / IC RSS-Restricted Band
 PK-U - U-NII: Maximum Peak
 ADR - U-NII AD primary method, RMS average

**11.4.3.TX ABOVE 1GHz 802.11n HT40 MODE IN THE 5.8GHz BAND
 BANDEDGE (LOW CHANNEL)**

HORIZONTAL PEAK PLOT

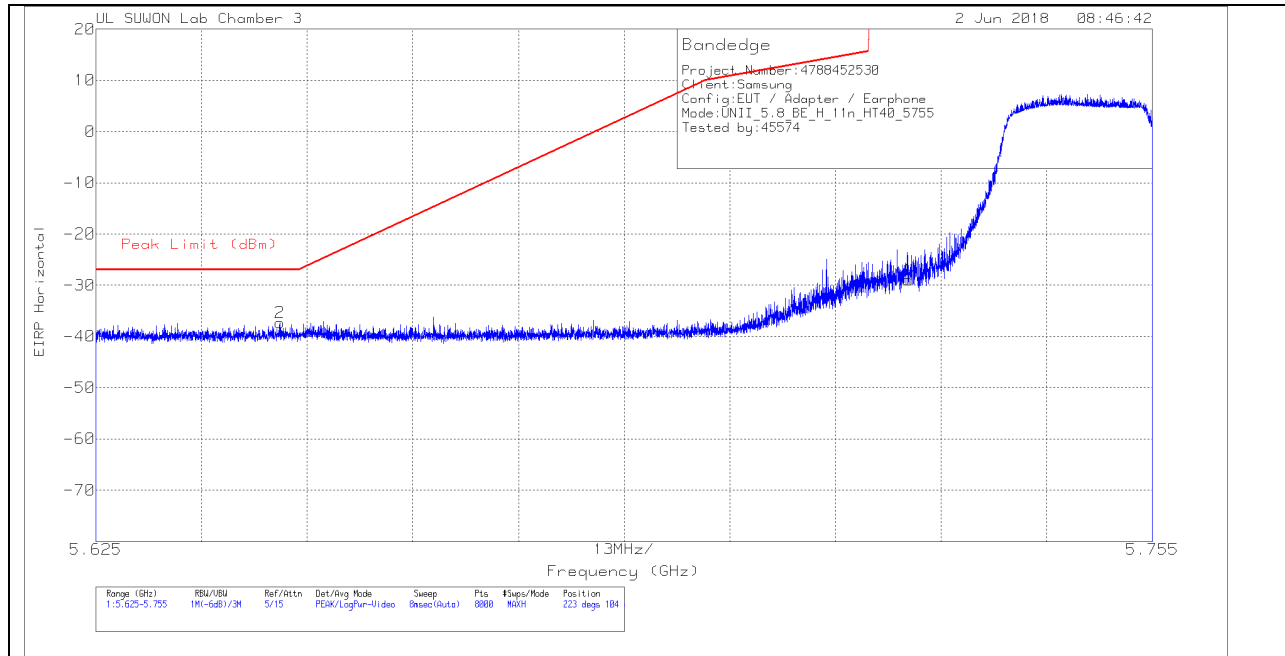

HORIZONTAL DATA

Trace Markers

Marker	Frequency (GHz)	Meter Reading (dBm)	Det	3117[00205959]	10dB_ATT[dB]	Conversion Factor (dB)	Corrected Reading EIRP	Peak Limit (dBm)	PK Margin (dB)	Azimuth (Degs)	Height (cm)	Polarity
1	5.725	-57.58	Pk	34.7	-17.9	11.8	-28.98	278.95	-307.93	223	104	H
2	5.648	-65.48	Pk	34.5	-18.1	11.8	-37.28	-27	-10.28	223	104	H

Pk - Peak detector

VERTICAL PEAK PLOT

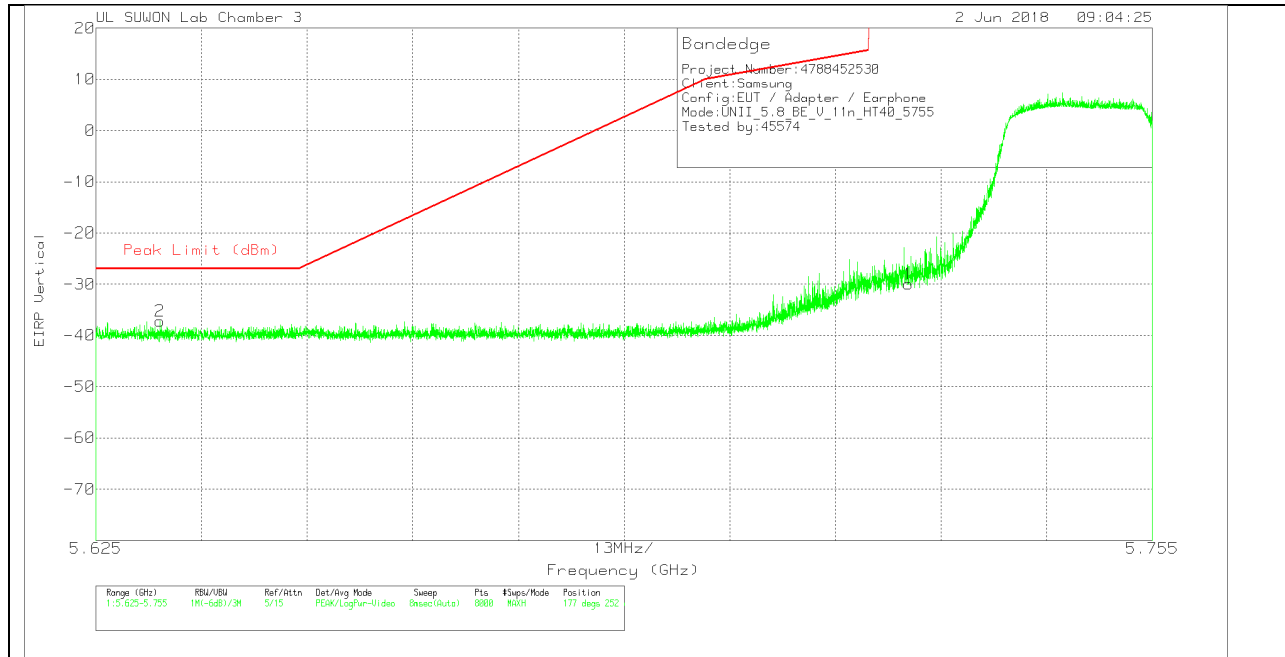

VERTICAL DATA

Trace Markers

Marker	Frequency (GHz)	Meter Reading (dBm)	Det	3117[00205959]	10dB_ATT[dB]	Conversion Factor (dB)	Corrected Reading EIRP	Peak Limit (dBm)	PK Margin (dB)	Azimuth (Degs)	Height (cm)	Polarity
1	5.725	-58.53	Pk	34.7	-17.9	11.8	-29.93	278.95	-308.88	177	252	V
2	5.633	-65.31	Pk	34.5	-18.2	11.8	-37.21	-27	-10.21	177	252	V

Pk - Peak detector

BANDEDGE (HIGH CHANNEL)

HORIZONTAL PEAK PLOT

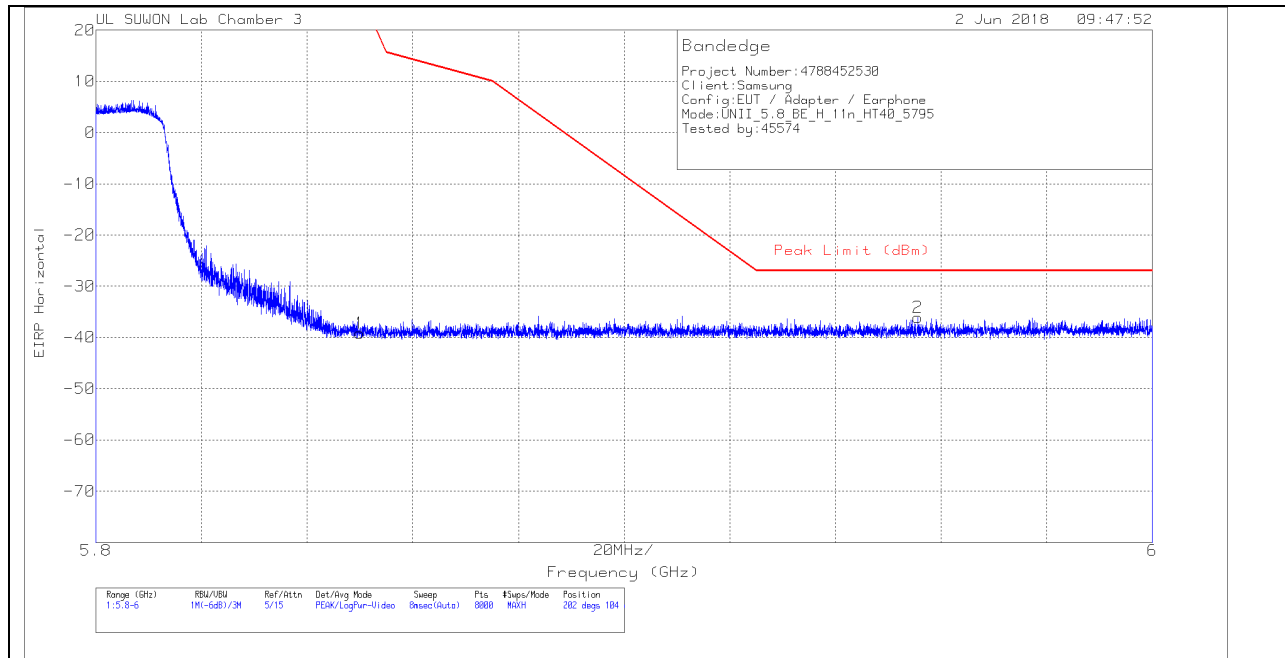

HORIZONTAL DATA

Trace Markers

Marker	Frequency (GHz)	Meter Reading (dBm)	Det	3117[00205959]	10dB_ATT[dB]	Conversion Factor (dB)	Corrected Reading EIRP	Peak Limit (dBm)	PK Margin (dB)	Azimuth (Degs)	Height (cm)	Polarity
1	5.85	-68.25	Pk	34.9	-17.6	11.8	-39.15	26.99	-66.14	202	104	H
2	5.956	-65.34	Pk	35	-17.5	11.8	-36.04	-27	-9.04	202	104	H

Pk - Peak detector

VERTICAL PEAK PLOT

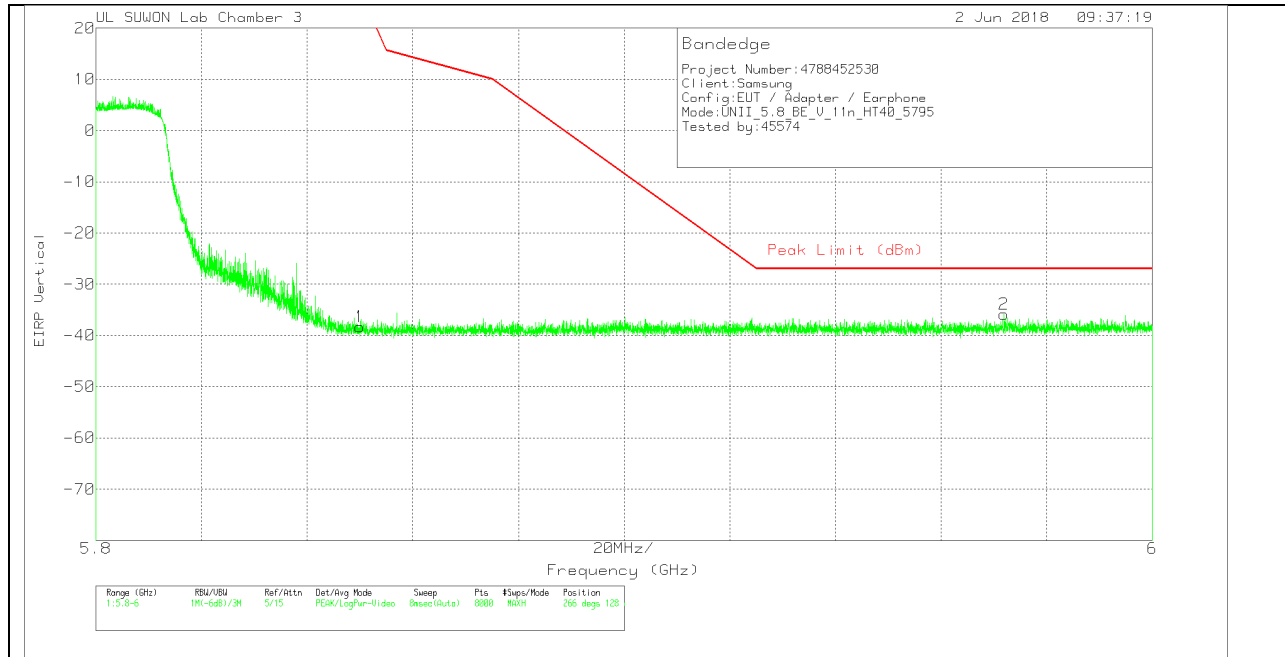

VERTICAL DATA

Trace Markers

Marker	Frequency (GHz)	Meter Reading (dBm)	Det	3117[00205959]	10dB_ATT[dB]	Conversion Factor (dB)	Corrected Reading EIRP	Peak Limit (dBm)	PK Margin (dB)	Azimuth (Degs)	Height (cm)	Polarity
1	5.85	-67.37	Pk	34.9	-17.6	11.8	-38.27	26.99	-65.26	266	128	V
2	5.972	-65.19	Pk	35.1	-17.5	11.8	-35.79	-27	-8.79	266	128	V

Pk - Peak detector

LOW CHANNEL HORIZONTAL

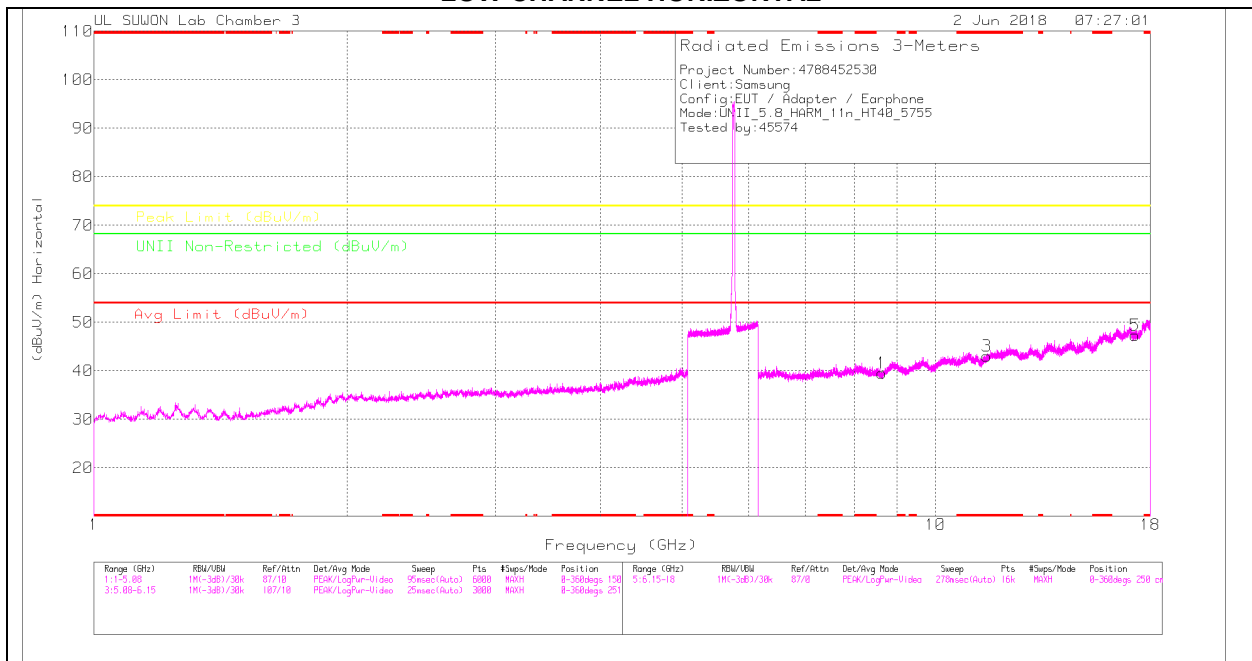

LOW CHANNEL VERTICAL

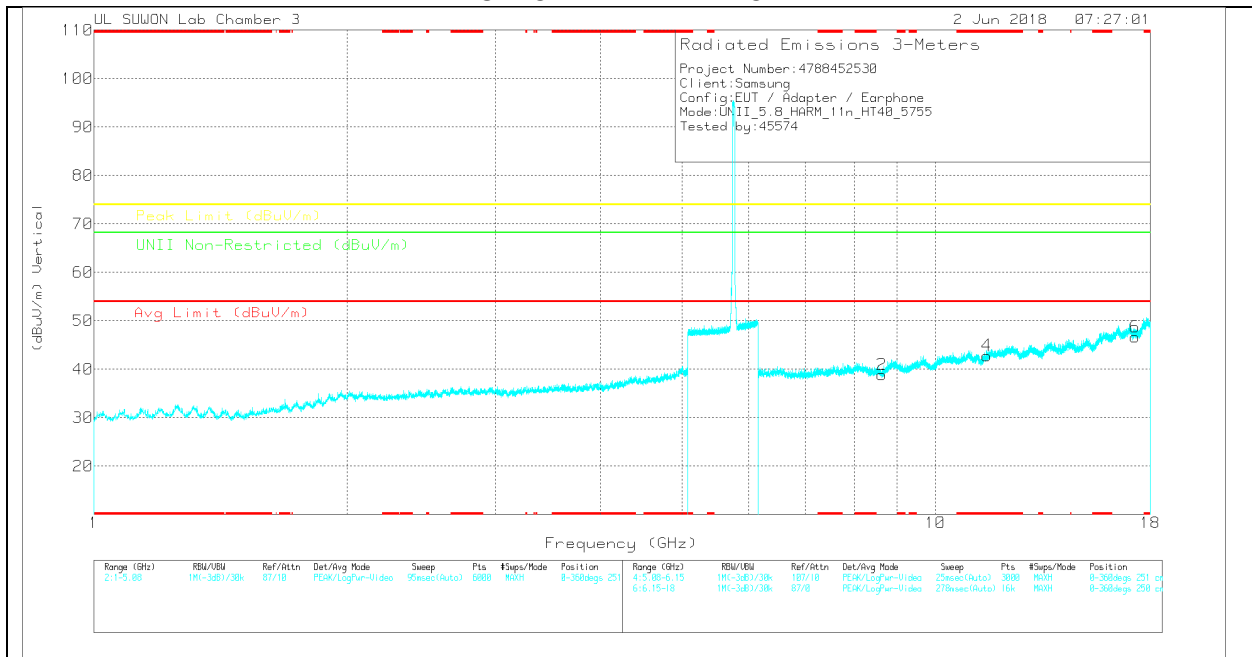

Note: Emission was scanned up to 40GHz; No emissions were detected above the noise floor which was at least 20dB below the specification limit.

LOW CHANNEL DATA

Trace Markers

Marker	Frequency (GHz)	Meter Reading (dBuV)	Det	3117(0020959)	6GHz_HP[dB]	DC Corr (dB)	Corrected Reading (dBuV/m)	Agc Limit (dBuV/m)	Margin (dB)	Peak Limit (dBuV/m)	Margin (dB)	Limit Non-Restricted (dBuV/m)	Margin (dB)	Azimuth (Degs)	Height (cm)	Polarity
1	8.633	25.18	PK	35.9	-21.5	0	39.58	-	-	-	-	68.2	-28.62	0-360	250	H
3	*11.51	24.51	PK	38	-19.5	0	43.01	-	-	74	-30.99	-	-	0-360	150	H
5	17.265	21.71	PK	40.7	-15.1	0	47.31	-	-	-	-	68.2	-20.89	0-360	150	H
2	8.633	24.5	PK	35.9	-21.5	0	38.9	-	-	-	-	68.2	-29.3	0-360	250	V
4	*11.51	24.34	PK	38	-19.5	0	42.84	-	-	74	-31.16	-	-	0-360	149	V
6	17.265	21.08	PK	40.7	-15.1	0	46.68	-	-	-	-	68.2	-21.52	0-360	250	V

* - indicates frequency in CFR47 Pt 15 / IC RSS-Restricted Band
 PK – Peak Detector

Note: Only peak measurement was performed. Because peak measurement result of unwanted emission is less than average limit (54dBuV/m).

HIGH CHANNEL HORIZONTAL

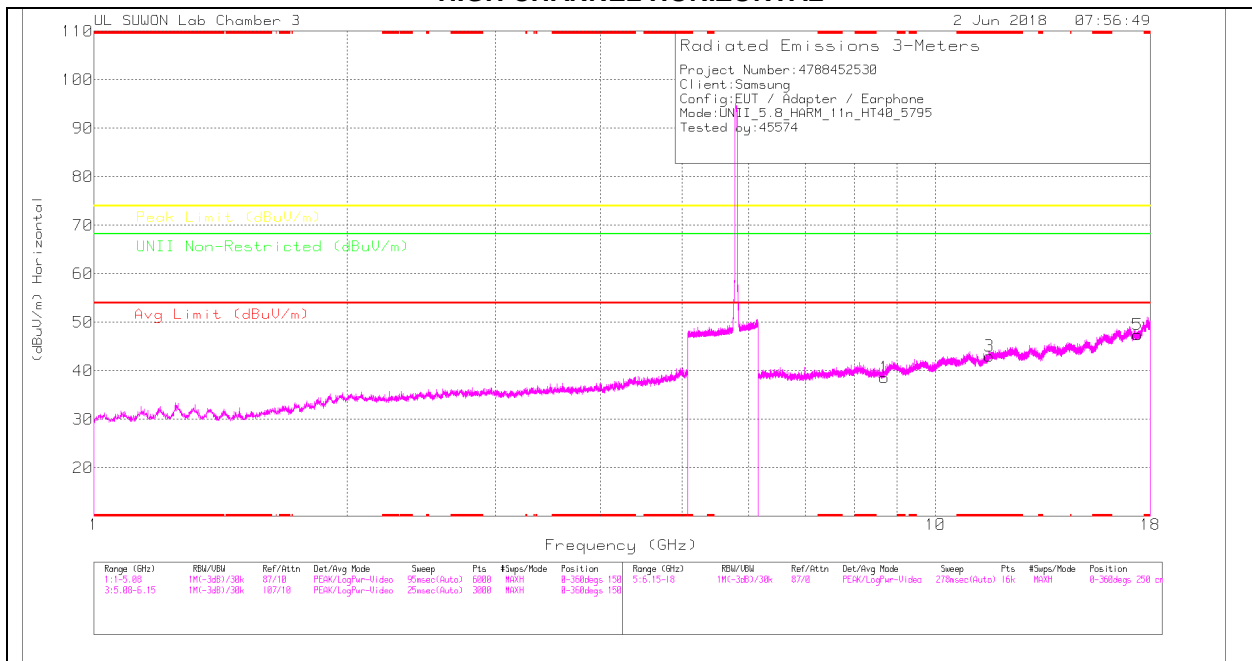

HIGH CHANNEL VERTICAL

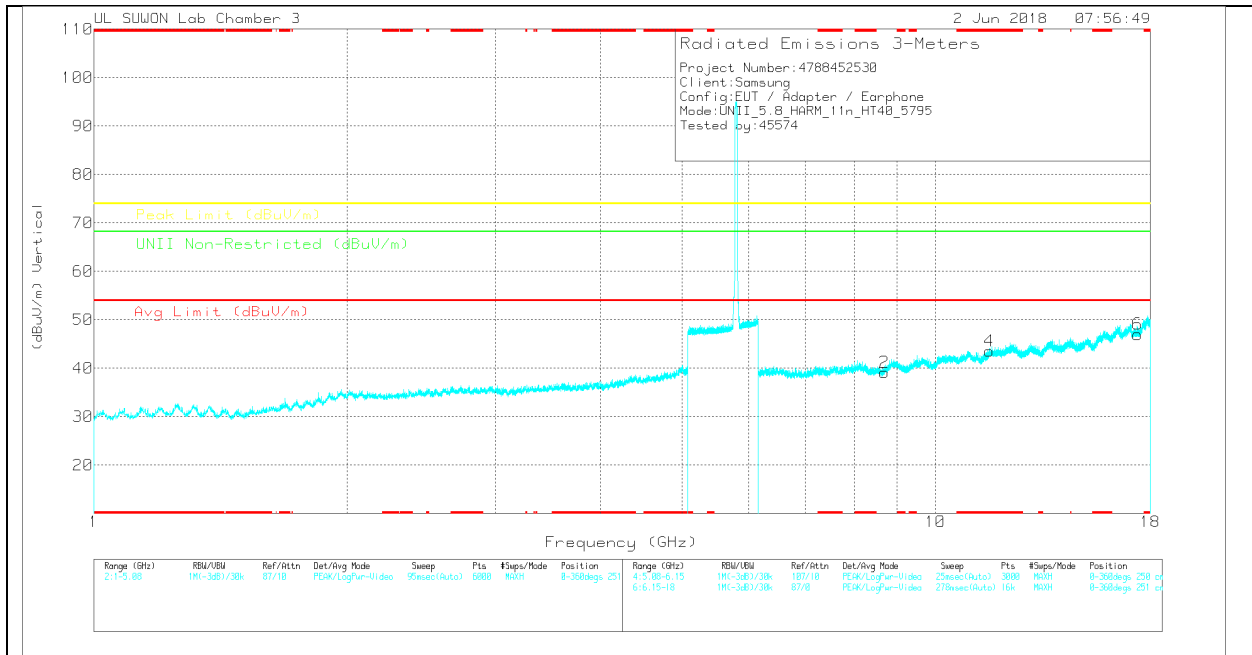

Note: Emission was scanned up to 40GHz; No emissions were detected above the noise floor which was at least 20dB below the specification limit.

HIGH CHANNEL DATA

Trace Markers

Marker	Frequency (GHz)	Meter Reading (dBuV)	Det	3117(0020959)	6GHz_HP[dB]	DC Corr (dB)	Corrected Reading (dBuV/m)	Avg Limit (dBuV/m)	Margin (dB)	Peak Limit (dBuV/m)	Margin (dB)	Limit Non-Restricted (dBuV/m)	Margin (dB)	Azimuth (Degs)	Height (cm)	Polarity
1	8.693	24.03	PK	35.9	-21.3	0	38.63	-	-	-	-	68.2	-29.57	0-360	150	H
3	* 11.59	24.75	PK	38.1	-19.8	0	43.05	-	-	74	-30.95	-	-	0-360	150	H
5	17.384	21.88	PK	40.9	-15.3	0	47.48	-	-	-	-	68.2	-20.72	0-360	150	H
2	8.693	24.58	PK	35.9	-21.3	0	39.18	-	-	-	-	68.2	-29.02	0-360	251	V
4	* 11.59	25.24	PK	38.1	-19.8	0	43.54	-	-	74	-30.46	-	-	0-360	251	V
6	17.384	21.4	PK	40.9	-15.3	0	47	-	-	-	-	68.2	-21.2	0-360	149	V

* - indicates frequency in CFR47 Pt 15 / IC RSS-Restricted Band
 PK – Peak Detector

Note: Only peak measurement was performed. Because peak measurement result of unwanted emission is less than average limit (54dBuV/m).

11.4.4. TX ABOVE 1GHz 802.11ac VHT80 MODE IN THE 5.8GHz BAND

BANDEDGE (Lower side)

HORIZONTAL PEAK PLOT

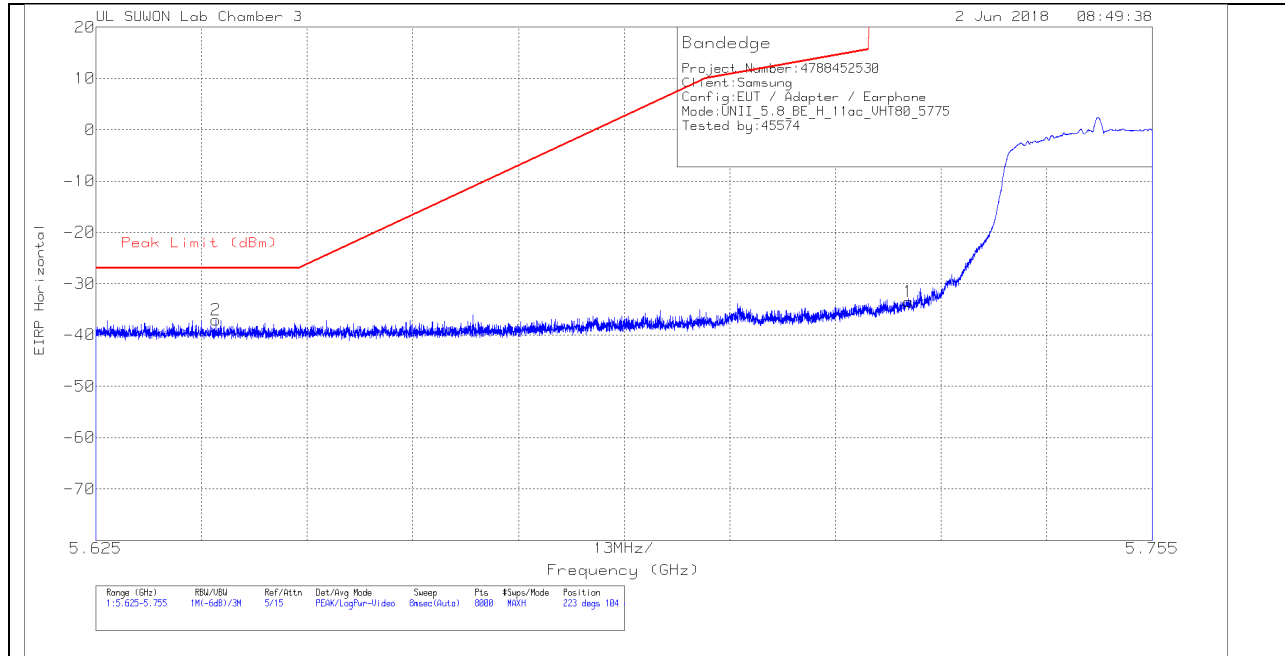

HORIZONTAL DATA

Trace Markers

Marker	Frequency (GHz)	Meter Reading (dBm)	Det	3117[00205959]	10dB_ATT[dB]	Conversion Factor (dB)	Corrected Reading EIRP	Peak Limit (dBm)	PK Margin (dB)	Azimuth (Degs)	Height (cm)	Polarity
1	5.725	-62.14	Pk	34.7	-17.9	11.8	-33.54	278.95	-312.49	223	104	H
2	5.64	-65.24	Pk	34.5	-18.1	11.8	-37.04	-27	-10.04	223	104	H

Pk - Peak detector

VERTICAL PEAK PLOT

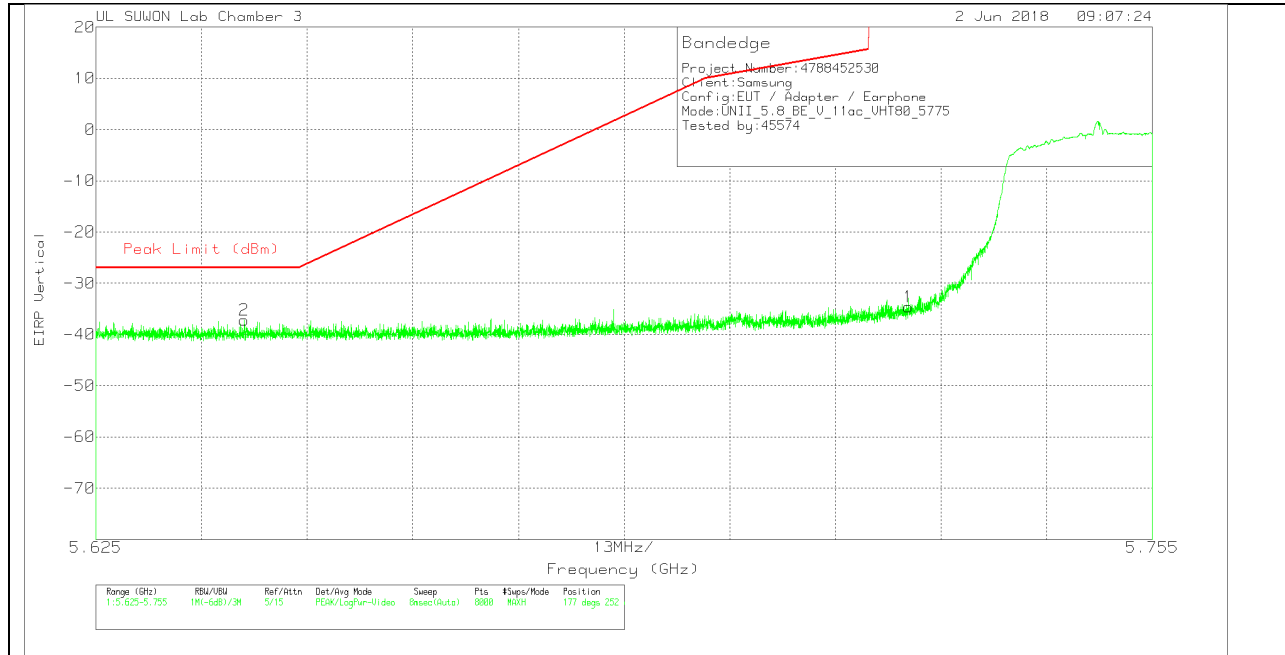

VERTICAL DATA

Trace Markers

Marker	Frequency (GHz)	Meter Reading (dBm)	Det	3117[00205959]	10dB_ATT[dB]	Conversion Factor (dB)	Corrected Reading EIRP	Peak Limit (dBm)	PK Margin (dB)	Azimuth (Degs)	Height (cm)	Polarity
1	5.725	-63.21	Pk	34.7	-17.9	11.8	-34.61	278.95	-313.56	177	252	V
2	5.643	-65.4	Pk	34.5	-18.1	11.8	-37.2	-27	-10.2	177	252	V

Pk - Peak detector

BANDEDGE (Upper side)

HORIZONTAL PEAK PLOT

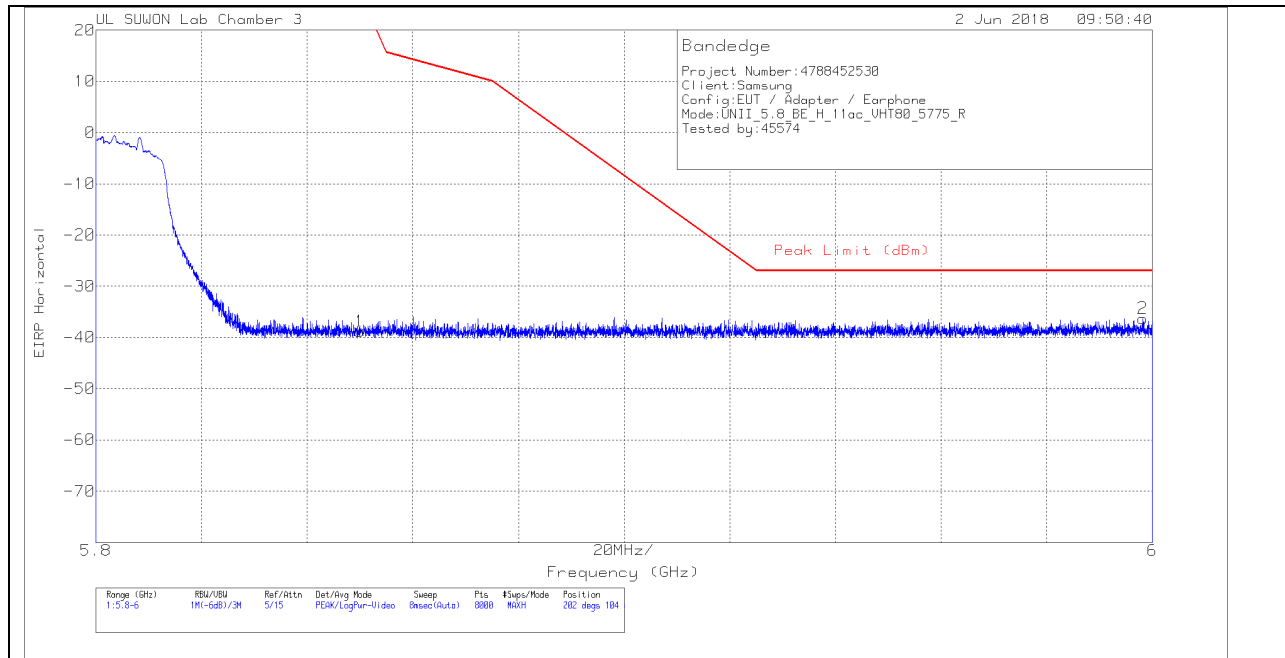

HORIZONTAL DATA

Trace Markers

Marker	Frequency (GHz)	Meter Reading (dBm)	Det	3117[00205959]	10dB_ATT[dB]	Conversion Factor (dB)	Corrected Reading EIRP	Peak Limit (dBm)	PK Margin (dB)	Azimuth (Degs)	Height (cm)	Polarity
1	5.85	-67.93	Pk	34.9	-17.6	11.8	-38.83	26.99	-65.82	202	104	H
2	5.998	-65.68	Pk	35.1	-17.5	11.8	-36.28	-27	-9.28	202	104	H

Pk - Peak detector

VERTICAL PEAK PLOT

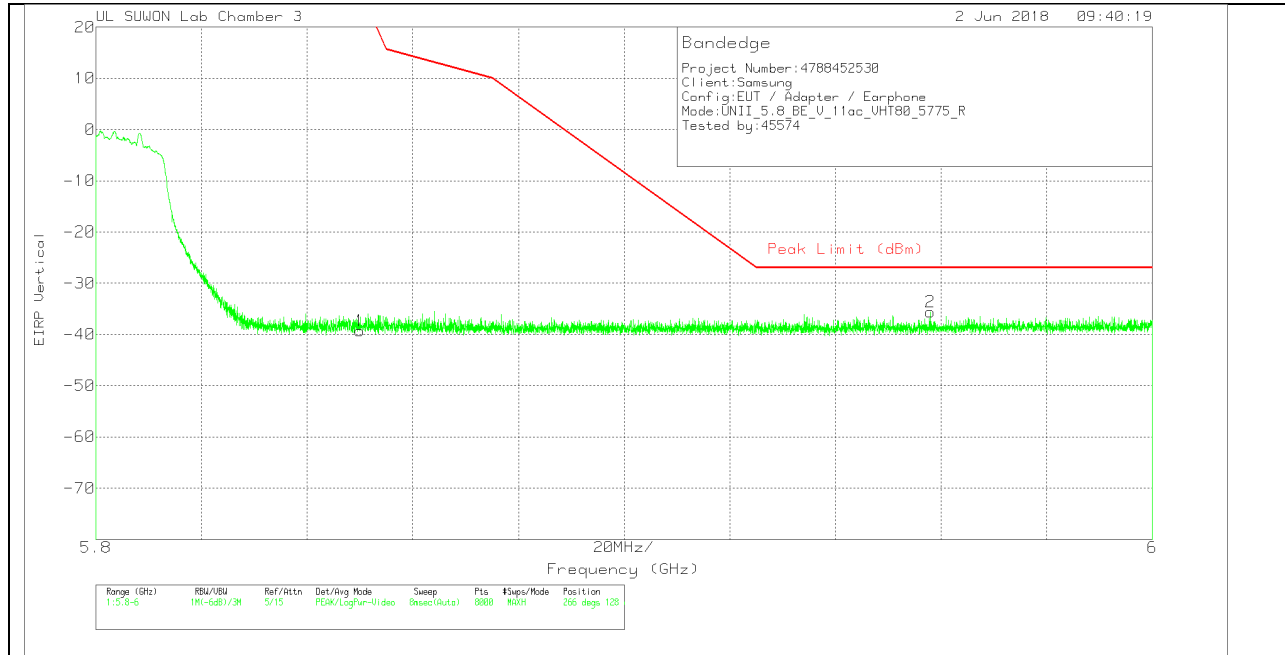

VERTICAL DATA

Trace Markers

Marker	Frequency (GHz)	Meter Reading (dBm)	Det	3117[00205959]	10dB_ATT[dB]	Conversion Factor (dB)	Corrected Reading EIRP	Peak Limit (dBm)	PK Margin (dB)	Azimuth (Degs)	Height (cm)	Polarity
1	5.85	-68.4	Pk	34.9	-17.6	11.8	-39.3	26.99	-66.29	266	128	V
2	5.958	-64.88	Pk	35	-17.5	11.8	-35.58	-27	-8.58	266	128	V

Pk - Peak detector

MID CHANNEL HORIZONTAL

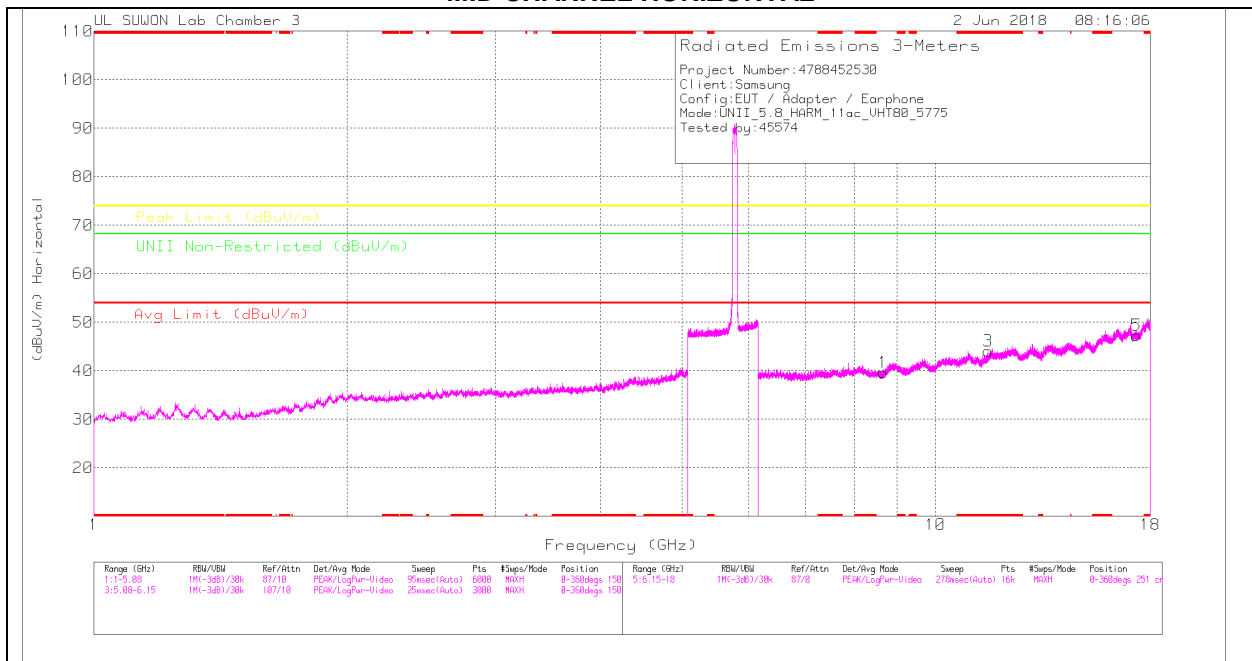

MID CHANNEL VERTICAL

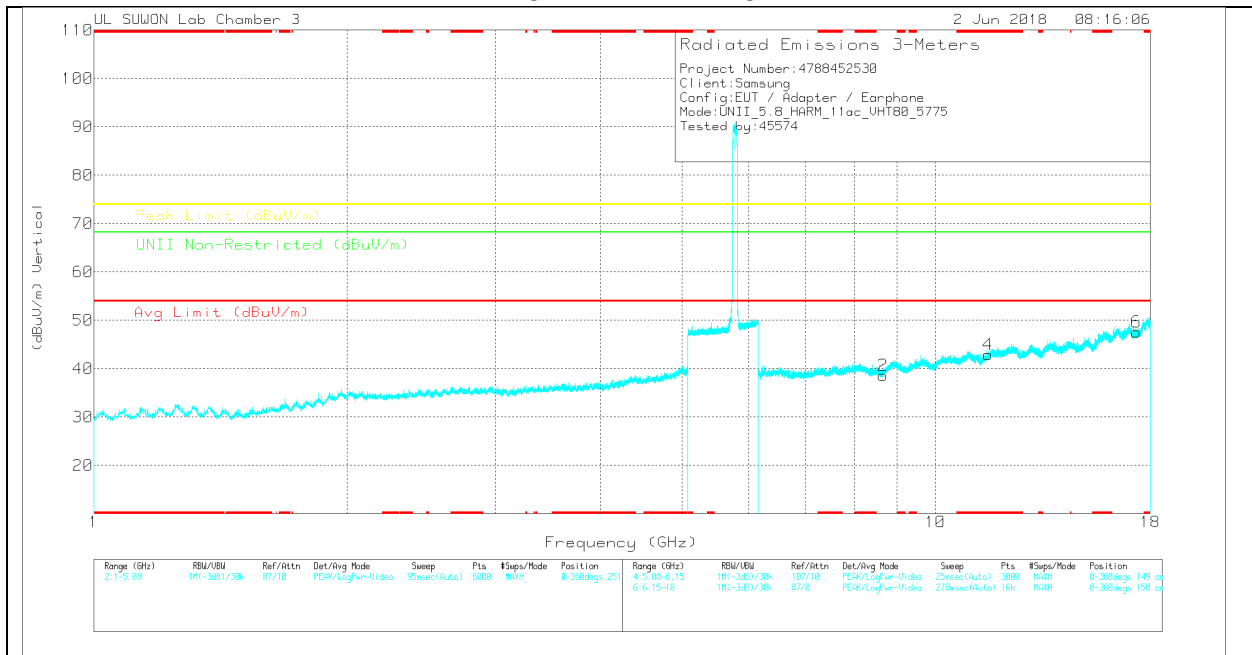

Note: Emission was scanned up to 40GHz; No emissions were detected above the noise floor which was at least 20dB below the specification limit.

MID CHANNEL DATA

Trace Markers

Marker	Frequency (GHz)	Meter Reading (dBuV)	Det	3117(00209959)	6GHz_HF(dB)	DC Corr (dB)	Corrected Reading (dBuV/m)	Avg Limit (dBuV/m)	Margin (dB)	Peak Limit (dBuV/m)	Margin (dB)	UNE Non-Restricted (dBuV/m)	Margin (dB)	Azimuth (Degs)	Height (cm)	Polarity
1	8.662	25.14	PK	35.9	-21.4	0	39.54	-	-	-	-	68.2	-28.56	0-360	150	H
3	* 11.55	25.7	PK	38.1	-19.7	0	44.1	-	-	74	-29.9	-	-	0-360	150	H
5	17.325	21.88	PK	40.8	-15.4	0	47.28	-	-	-	-	68.2	-20.92	0-360	150	H
2	8.662	24.18	PK	35.9	-21.4	0	38.68	-	-	-	-	68.2	-29.52	0-360	150	V
4	* 11.551	24.57	PK	38.1	-19.8	0	42.87	-	-	74	-31.13	-	-	0-360	251	V
6	17.325	22.09	PK	40.8	-15.3	0	47.59	-	-	-	-	68.2	-20.61	0-360	251	V

* - indicates frequency in CFR47 Pt 15 / IC RSS-Restricted Band
 PK – Peak detector

Note: Only peak measurement was performed. Because peak measurement result of unwanted emission is less than average limit (54dBuV/m).

12. WORST-CASE BELOW 1 GHz

SPURIOUS EMISSIONS 30 TO 1000 MHz (WORST-CASE CONFIGURATION, HORIZONTAL)

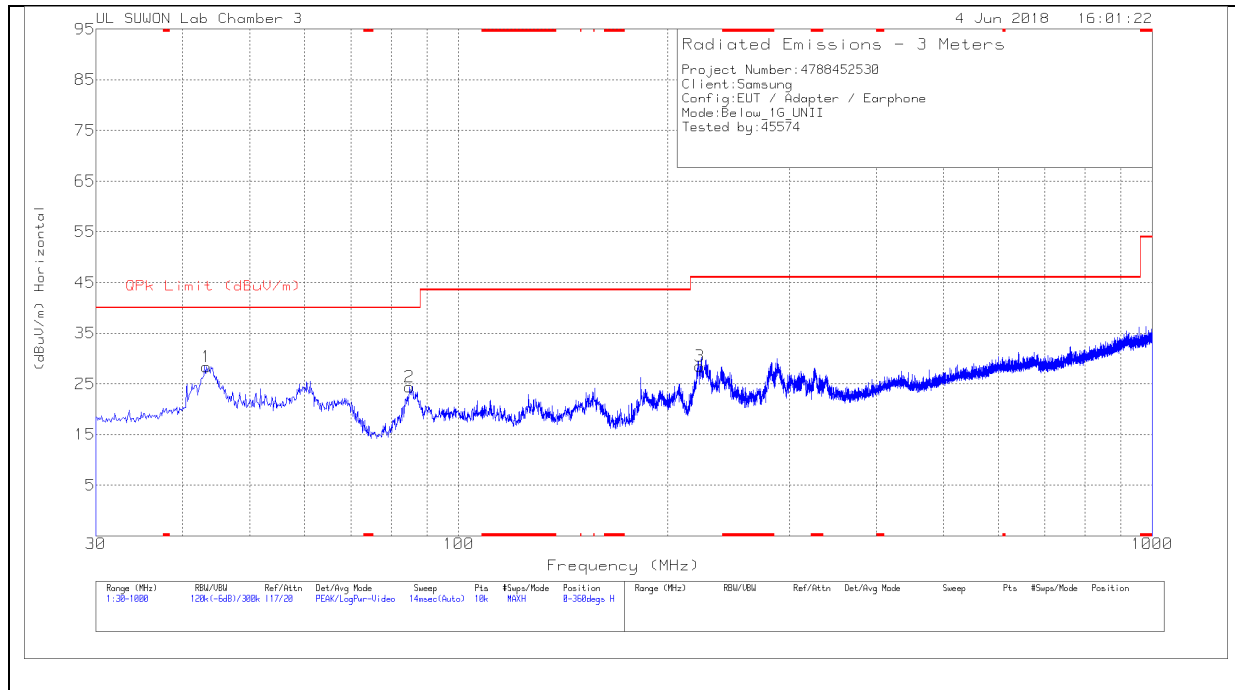

SPURIOUS EMISSIONS 30 TO 1000 MHz (WORST-CASE CONFIGURATION, VERTICAL)

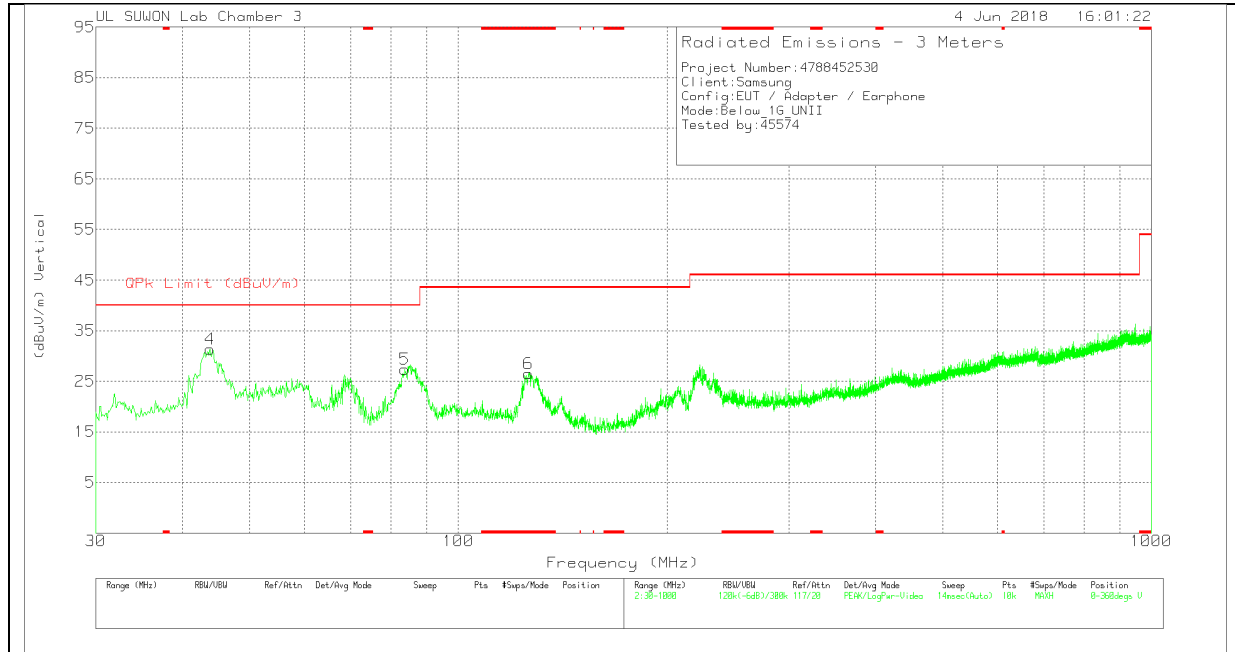

Trace Markers

Marker	Frequency (MHz)	Meter Reading (dBuV)	Det	VULB9163-845	30-1000MHz[dB]	Corrected Reading (dBuV/m)	QPk Limit (dBuV/m)	Margin (dB)	Azimuth (Degs)	Height (cm)	Polarity
1	43.2904	40.56	Pk	19.7	-31.9	28.36	40	-11.64	0-360	200	H
2	85.0047	41.66	Pk	14.4	-31.7	24.36	40	-15.64	0-360	200	H
3	222.6619	42.21	Pk	17.3	-31	28.51	46.02	-17.51	0-360	100	H
4	43.8724	43.49	Pk	19.8	-32	31.29	40	-8.71	0-360	100	V
5	83.6465	45.17	Pk	14	-31.8	27.37	40	-12.63	0-360	100	V
6	* 126.2339	42.67	Pk	15.2	-31.4	26.47	43.52	-17.05	0-360	100	V

* - indicates frequency in CFR47 Pt 15 / IC RSS-Restricted Band
 Pk - Peak detector

13. AC POWER LINE CONDUCTED EMISSIONS

LIMITS

FCC §15.207 (a)
IC RSS-GEN Clause 8.8

Frequency of Emission (MHz)	Conducted Limit (dBuV)	
	Quasi-peak	Average
0.15-0.5	66 to 56 *	56 to 46 *
0.5-5	56	46
5-30	60	50

* Decreases with the logarithm of the frequency.

TEST PROCEDURE

The EUT is placed on a non-conducting table 40 cm from the vertical ground plane and 80 cm above the horizontal ground plane. The EUT is configured in accordance with ANSI C63.10.

The receiver is set to a resolution bandwidth of 9 kHz. Peak detection is used unless otherwise noted as quasi-peak or average.

Line conducted data is recorded for both NEUTRAL and HOT lines.

RESULTS

LINE 1 PLOT

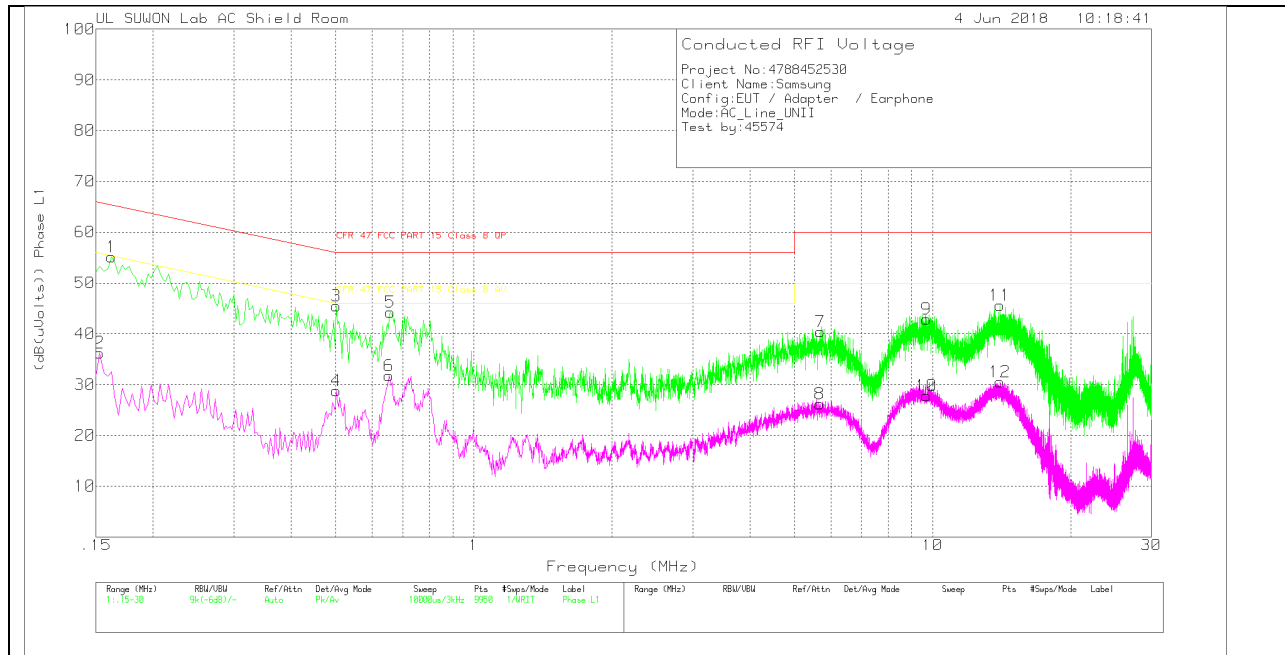

LINE 1 RESULTS

Trace Markers

Range 1: Phase L1 .15 - 30MHz

Marker	Frequency (MHz)	Meter Reading (dBuV)	Det	101837_L1_wit h extension	CABLELOSS(dB)	Corrected Reading (dB(uVolts))	CFR 47 FCC PART 15 Class B QP	Margin (dB)	CFR 47 FCC PART 15 Class B AV	Margin (dB)
1	.162	45.07	Pk	10	.1	55.17	65.36	-10.19	-	-
2	.153	26.17	Av	10	.1	36.27	-	-	55.84	-19.57
3	.501	35.55	Pk	9.7	.2	45.45	56	-10.55	-	-
4	.501	18.92	Av	9.7	.2	28.82	-	-	46	-17.18
5	.657	34.28	Pk	9.8	.2	44.28	56	-11.72	-	-
6	.654	21.79	Av	9.8	.2	31.79	-	-	46	-14.21
7	5.688	30.44	Pk	9.7	.3	40.44	60	-19.56	-	-
8	5.685	16.24	Av	9.7	.3	26.24	-	-	50	-23.76
9	9.711	32.7	Pk	9.8	.4	42.9	60	-17.1	-	-
10	9.705	17.64	Av	9.8	.4	27.84	-	-	50	-22.16
11	14.04	35.42	Pk	9.8	.4	45.62	60	-14.38	-	-
12	14.034	20.27	Av	9.8	.4	30.47	-	-	50	-19.53

Pk - Peak detector

Av - Average detection

LINE 2 PLOT

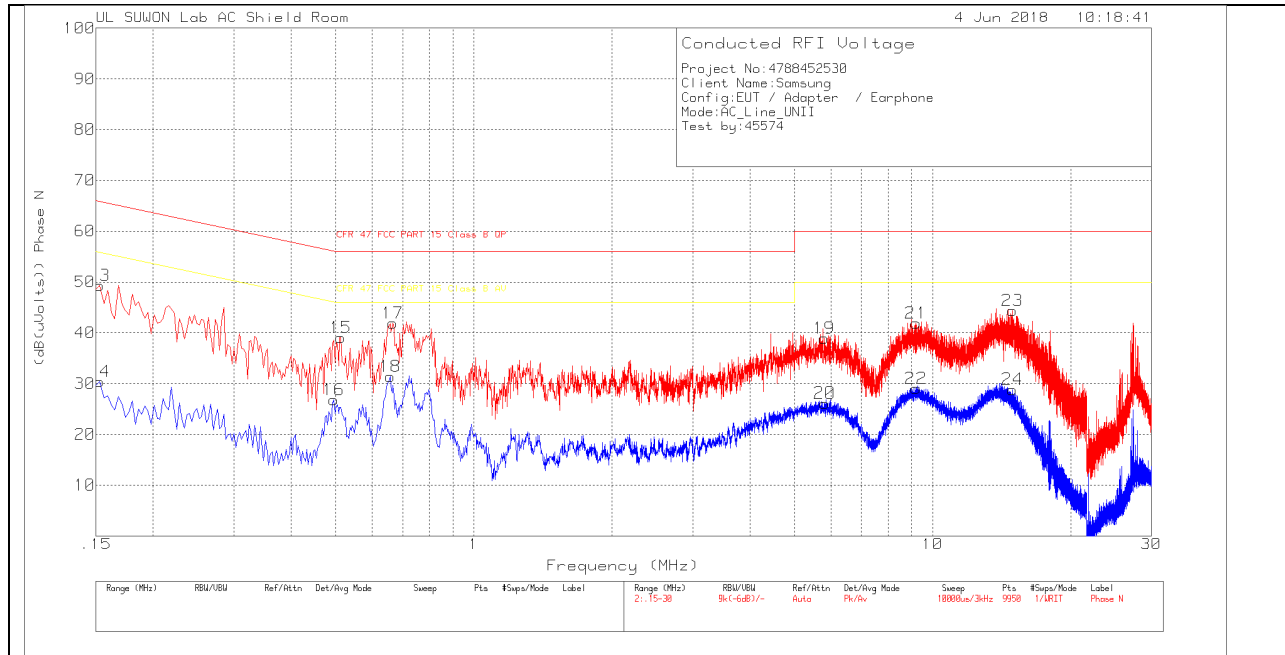

LINE 2 RESULTS

Trace Markers

Range 2: Phase N .15 - 30MHz

Marker	Frequency (MHz)	Meter Reading (dBuV)	Det	101837_N_with extension	CABLELOSS(dB)	Corrected Reading (dB(uVolts))	CFR 47 FCC PART 15 Class B QP	Margin (dB)	CFR 47 FCC PART 15 Class B AV	Margin (dB)
13	.153	39.24	Pk	10	.1	49.34	65.84	-16.5	-	-
14	.153	20.26	Av	10	.1	30.36	-	-	55.84	-25.48
15	.513	29.1	Pk	9.8	.2	39.1	56	-16.9	-	-
16	.495	16.79	Av	9.8	.2	26.79	-	-	46.08	-19.29
17	.666	31.9	Pk	9.8	.2	41.9	56	-14.1	-	-
18	.657	21.4	Av	9.8	.2	31.4	-	-	46	-14.6
19	5.805	28.78	Pk	9.8	.3	38.88	60	-21.12	-	-
20	5.82	16.03	Av	9.8	.3	26.13	-	-	50	-23.87
21	9.21	31.69	Pk	9.8	.4	41.89	60	-18.11	-	-
22	9.21	18.8	Av	9.8	.4	29	-	-	50	-21
23	14.94	34.09	Pk	9.9	.4	44.39	60	-15.61	-	-
24	14.94	18.55	Av	9.9	.4	28.85	-	-	50	-21.15

Pk - Peak detector
 Av - Average detection

14. DYNAMIC FREQUENCY SELECTION

14.1. OVERVIEW

14.1.1. LIMITS

FCC

§15.407 (h), FCC KDB 905462 D02 “Compliance measurement procedures for unlicensed-national information infrastructure devices operating in the 5250-5350 MHz and 5470-5725 MHz bands incorporating dynamic frequency selection” and KDB 905462 D03 “U-NII client devices without radar detection capability”.

INDUSTRY CANADA

IC RSS-247 is closely harmonized with FCC Part 15 DFS rules. The deviations are as follows:

RSS-247 Issue §6.3

Note: For the band 5600–5650 MHz, no operation is permitted.

Until further notice, devices subject to this annex shall not be capable of transmitting in the band 5600–5650 MHz. This restriction is for the protection of Environment Canada weather radars operating in this band.

Requirement	Operational Mode		
	Master	Client (without radar detection)	Client (with radar detection)
Non-Occupancy Period	Yes	Not required	Yes
DFS Detection Threshold	Yes	Not required	Yes
Channel Availability Check Time	Yes	Not required	Not required
U-NII Detection Bandwidth	Yes	Not required	Yes

Table 2: Applicability of DFS requirements during normal operation

Requirement	Operational Mode		
	Master	Client (without DFS)	Client (with DFS)
DFS Detection Threshold	Yes	Not required	Yes
Channel Closing Transmission Time	Yes	Yes	Yes
Channel Move Time	Yes	Yes	Yes
U-NII Detection Bandwidth	Yes	Not required	Yes

Additional requirements for devices with multiple bandwidth modes	Master Device or Client with Radar DFS	Client (without DFS)
U-NII Detection Bandwidth and Statistical Performance Check	All BW modes must be tested	Not required
Channel Move Time and Channel Closing Transmission Time	Test using widest BW mode available	Test using the widest BW mode available for the link
All other tests	Any single BW mode	Not required

Note: Frequencies selected for statistical performance check (Section 7.8.4) should include several frequencies within the radar detection bandwidth and frequencies near the edge of the radar detection bandwidth. For 802.11 devices it is suggested to select frequencies in all 20 MHz channel blocks and a null frequency between the bonded 20 MHz channel blocks.

Table 3: Interference Threshold values, Master or Client incorporating In-Service Monitoring

Maximum Transmit Power	Value (see notes)
E.I.R.P. \geq 200 mill watt	-64 dBm
E.I.R.P. < 200 mill watt and power spectral density < 10 dBm/MHz	-62 dBm
E.I.R.P. < 200 mill watt that do not meet power spectral density requirement	-64 dBm
<p>Note 1: This is the level at the input of the receiver assuming a 0 dBi receive antenna</p> <p>Note 2: Throughout these test procedures an additional 1 dB has been added to the amplitude of the test transmission waveforms to account for variations in measurement equipment. This will ensure that the test signal is at or above the detection threshold level to trigger a DFS response.</p> <p>Note 3: E.I.R.P. is based on the highest antenna gain. For MIMO devices refer to KDB publication 662911 D01.</p>	

Table 4: DFS Response requirement values

Parameter	Value
<i>Non-occupancy period</i>	30 minutes
<i>Channel Availability Check Time</i>	60 seconds
<i>Channel Move Time</i>	10 seconds (See Note 1)
<i>Channel Closing Transmission Time</i>	200 milliseconds + approx. 60 milliseconds over remaining 10 second period. (See Notes 1 and 2)
<i>U-NII Detection Bandwidth</i>	Minimum 100% of the U- NII 99% transmission power bandwidth. (See Note 3)
<p>Note 1: <i>Channel Move Time</i> and the <i>Channel Closing Transmission Time</i> should be performed with Radar Type 0. The measurement timing begins at the end of the Radar Type 0 burst.</p> <p>Note 2: The <i>Channel Closing Transmission Time</i> is comprised of 200 milliseconds starting at the beginning of the <i>Channel Move Time</i> plus any additional intermittent control signals required to facilitate a <i>Channel</i> move (an aggregate of 60 milliseconds) during the remainder of the 10 second period. The aggregate duration of control signals will not count quiet periods in between transmissions.</p> <p>Note 3: During the <i>U-NII Detection Bandwidth</i> detection test, radar type 0 should be used. For each frequency step the minimum percentage of detection is 90 percent. Measurements are performed with no data traffic.</p>	

Radar Type	Pulse Width (usec)	PRI (usec)	Pulses	Minimum Percentage of Successful Detection	Minimum Trials
0	1	1428	18	See Note 1	See Note 1
1	1	Test A: 15 unique PRI values randomly selected from the list of 23 PRI values in table 5a	Roundup: $\{(1/360) \times (19 \times 10^6 \text{ PRI}_{\text{usec}})\}$	60%	30
		Test B: 15 unique PRI values randomly selected within the range of 518-3066 usec. With a minimum increment of 1 usec, excluding PRI values selected in Test A			
2	1-5	150-230	23-29	60%	30
3	6-10	200-500	16-18	60%	30
4	11-20	200-500	12-16	60%	30
Aggregate (Radar Types 1-4)				80%	120
Note 1: Short Pulse Radar Type 0 should be used for the <i>Detection Bandwidth</i> test, <i>Channel Move Time</i> , and <i>Channel Closing Time</i> tests.					

Table 6 – Long Pulse Radar Test Signal

Radar Waveform Type	Pulse Width (μsec)	Chirp Width (MHz)	PRI (μsec)	Pulses per Burst	Number of Bursts	Minimum Percentage of Successful Detection	Minimum Trials
5	50-100	5-20	1000-2000	1-3	8-20	80%	30

Table 7 – Frequency Hopping Radar Test Signal

Radar Waveform Type	Pulse Width (μsec)	PRI (μsec)	Pulses per Hop	Hopping Rate (kHz)	Hopping Sequence Length (msec)	Minimum Percentage of Successful Detection	Minimum Trials
6	1	333	9	0.333	300	70%	30

14.1.2. TEST AND MEASUREMENT SYSTEM

CONDUCTED METHOD SYSTEM BLOCK DIAGRAM

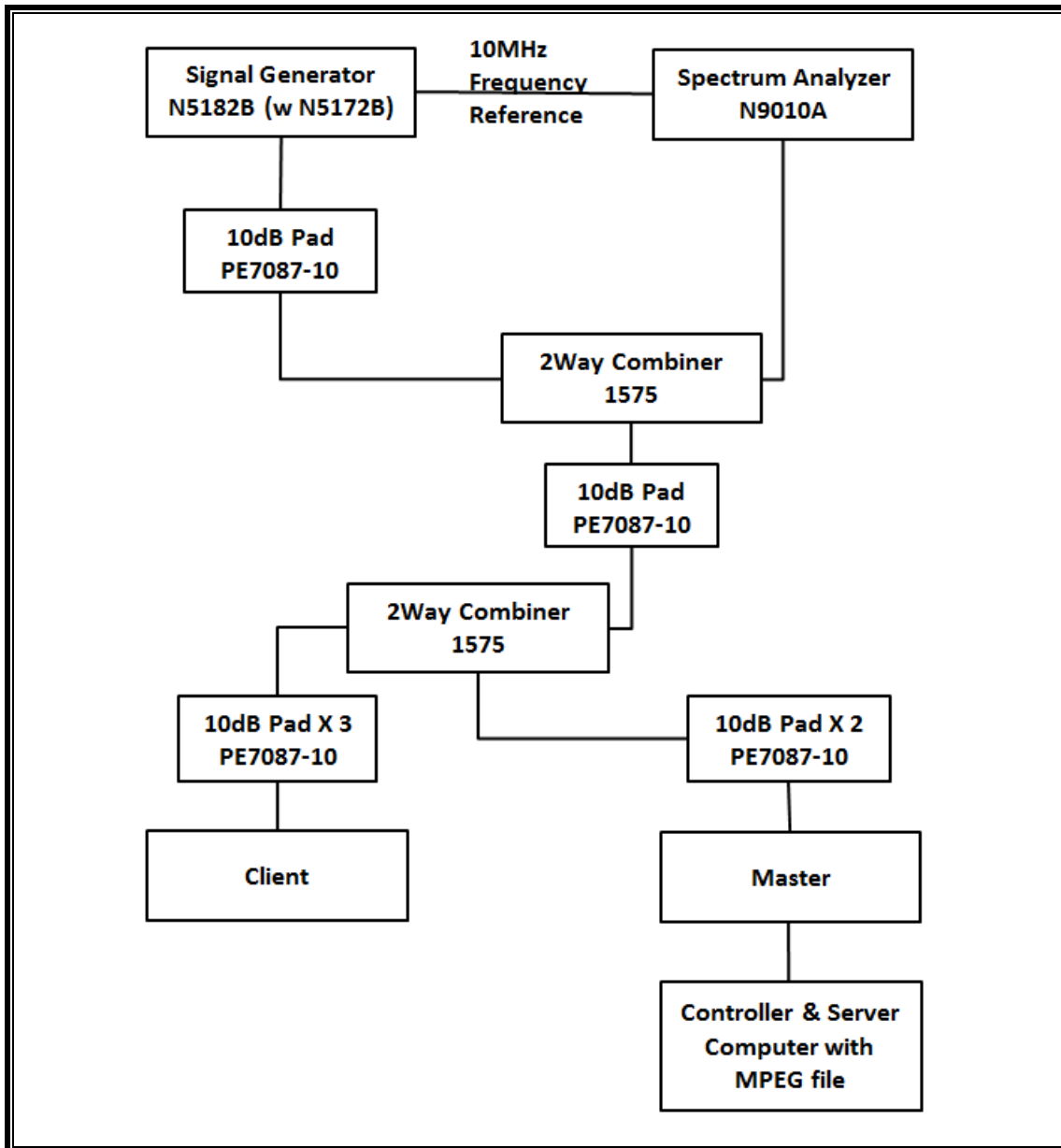

SYSTEM OVERVIEW

The short pulse and long pulse signal generating system utilizes the Keysite Signal Studio for Pulse Building as N5172B. The Vector Signal Generator has been validated by the NTIA. The hopping signal generating system utilizes the CCS simulated hopping method and system, which has been validated by the DoD, FCC and NTIA. The software selects waveform parameters from within the bounds of the signal type on a random basis using uniform distribution.

The short pulse types 1, 2, 3 and 4, and the long pulse type 5 parameters are randomized at run-time.

The hopping type 6 pulse parameters are fixed while the hopping sequence is based on the August 2005 NTIA Hopping Frequency List. The initial starting point randomized at run-time and each subsequent starting point is incremented by 475. Each frequency in the 100-length segment is compared to the boundaries of the EUT Detection Bandwidth and the software creates a hopping burst pattern in accordance with Section 7.4.1.3 Method #2 Simulated Frequency Hopping Radar Waveform Generating Subsystem of KDB 905462 D02. The frequency of the signal generator is incremented in 1 MHz steps from F_L to F_H for each successive trial. This incremental sequence is repeated as required to generate a minimum of 30 total trials and to maintain a uniform frequency distribution over the entire Detection Bandwidth.

The signal monitoring equipment consists of a spectrum analyzer. The aggregate ON time is calculated by multiplying the number of bins above a threshold during a particular observation period by the dwell time per bin, with the analyzer set to peak detection and max hold.

SYSTEM CALIBRATION

A 50-ohm load is connected in place of the spectrum analyzer, and the spectrum analyzer is connected to a horn antenna via a coaxial cable, with the reference level offset set to (horn antenna gain – coaxial cable loss). The signal generator is set to CW mode. The amplitude of the signal generator is adjusted to yield a level of –64 dBm as measured on the spectrum analyzer.

Without changing any of the instrument settings, the spectrum analyzer is reconnected to the Common port of the Spectrum Analyzer Combiner/Divider. The Reference Level Offset of the spectrum analyzer is adjusted so that the displayed amplitude of the signal is –64 dBm.

The spectrum analyzer displays the level of the signal generator as received at the antenna ports of the Master Device. The interference detection threshold may be varied from the calibrated value of –64 dBm and the spectrum analyzer will still indicate the level as received by the Master Device.

ADJUSTMENT OF DISPLAYED TRAFFIC LEVEL

A link is established between the Master and Slave and the distance between the units is adjusted as needed to provide a suitable received level at the Master and Slave devices. The video test file is streamed to generate WLAN traffic. The monitoring antenna is adjusted so that the WLAN traffic level, as displayed on the spectrum analyzer, is at lower amplitude than the radar detection threshold.

TEST AND MEASUREMENT EQUIPMENT

The following test and measurement equipment was utilized for the DFS tests documented in this report:

TEST EQUIPMENT LIST				
Description	Manufacturer	Model	S/N	Cal Due
Spectrum Analyzer, 7 GHz	Agilent / HP	N9010A	MY54200580	08-07-18
Vector Signal Generator, 6GHz	Agilent / HP	N5182B	MY53051241	08-07-18

14.1.3. SETUP OF EUT

CONDUCTED METHOD EUT TEST SETUP

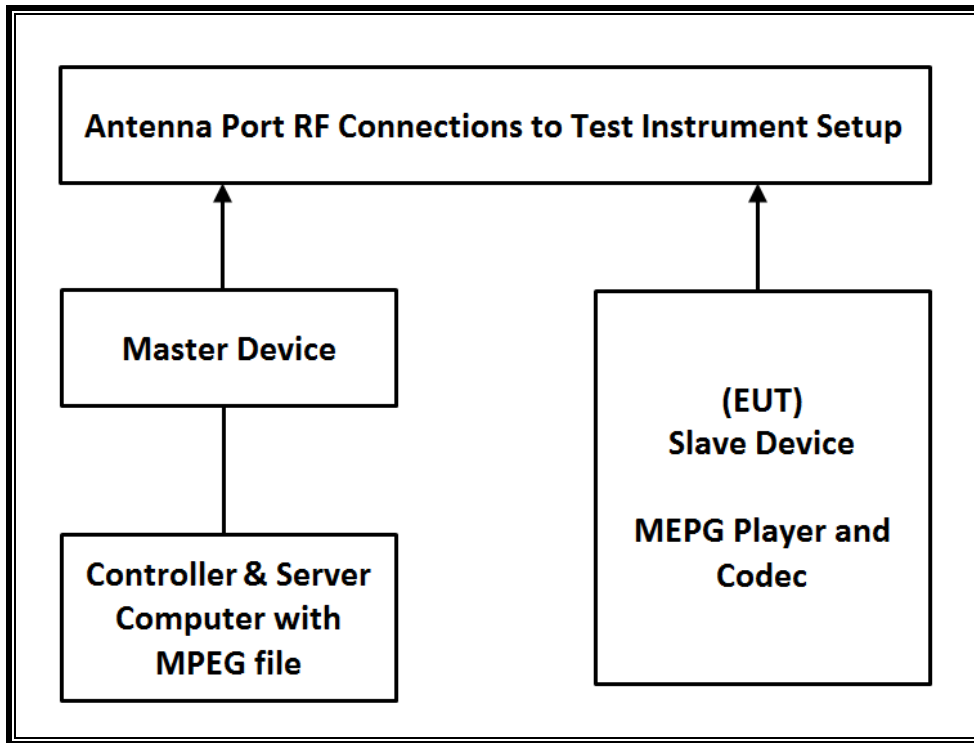

SUPPORT EQUIPMENT

The following support equipment was utilized for the DFS tests documented in this report:

PERIPHERAL SUPPORT EQUIPMENT LIST				
Description	Manufacturer	Model	Serial Number	FCC ID
Wireless Access Point	Cisco	AIR-CAP3702E-A-K9	FTX182276QX	LDK102087
PC (Controller/Server)	HP	HP EliteDesk 800 G1 TWR	CZC4125J25	DoC

14.1.4. DESCRIPTION OF EUT

The EUT operates over the 5250-5350 MHz and 5470-5725 MHz ranges.

The EUT is a Slave Device without Radar Detection.

The highest power level within these bands is 16.54 dBm in the 5250-5350 MHz band and 16.97 dBm in the 5470-5725 MHz band.

The antenna gain assembly utilized with the EUT are -0.8 dBi in the 5250-5350 MHz band and 0.3 dBi in the 5470-5725 MHz band.

The rated output power of the Master unit is > 23dBm (EIRP). Therefore the required interference threshold level is -64 dBm. After correction for procedural adjustments, the required conducted threshold at the antenna port is $-64 + 1 = -63$ dBm.

The calibrated radiated DFS Detection Threshold level is set to -64 dBm. The tested level is lower than the required level hence it provides a margin to the limit.

The EUT uses one transmitter/receiver chain connected to an antenna to perform radiated tests.

WLAN traffic that meets or exceeds the minimum required loading was generated by transferring a data stream from the controller/server PC to the EUT using iPerf version 2.0.5 software package.

TPC is not required since the maximum EIRP is less than 500 mW (27 dBm).

The EUT utilizes the 802.11a/n/ac architecture. Three nominal channel bandwidths are implemented: 20 MHz, 40 MHz and 80MHz.

The software installed in the access point is 12.4(25d)JA1.

UNIFORM CHANNEL SPREADING

This requirement is not applicable to Slave radio devices.

OVERVIEW OF MASTER DEVICE WITH RESPECT TO §15.407 (h) REQUIREMENTS

The Master Device is a Cisco Access Point, FCC ID: LDK102087. The minimum antenna gain for the Master Device is 6 dBi.

The rated output power of the Master unit is > 23dBm (EIRP). Therefore the required interference threshold level is -64 dBm. After correction for procedural adjustments, the required radiated threshold at the antenna port is $-64 + 1 = -63$ dBm.

The calibrated radiated DFS Detection Threshold level is set to -64 dBm. The tested level is lower than the required level hence it provides a margin to the limit.

14.2. RESULTS FOR 20 MHz BANDWIDTH

14.2.1. TEST CHANNEL

All tests were performed at a channel center frequency of 5500 MHz.

14.2.2. RADAR WAVEFORM AND TRAFFIC

RADAR WAVEFORM

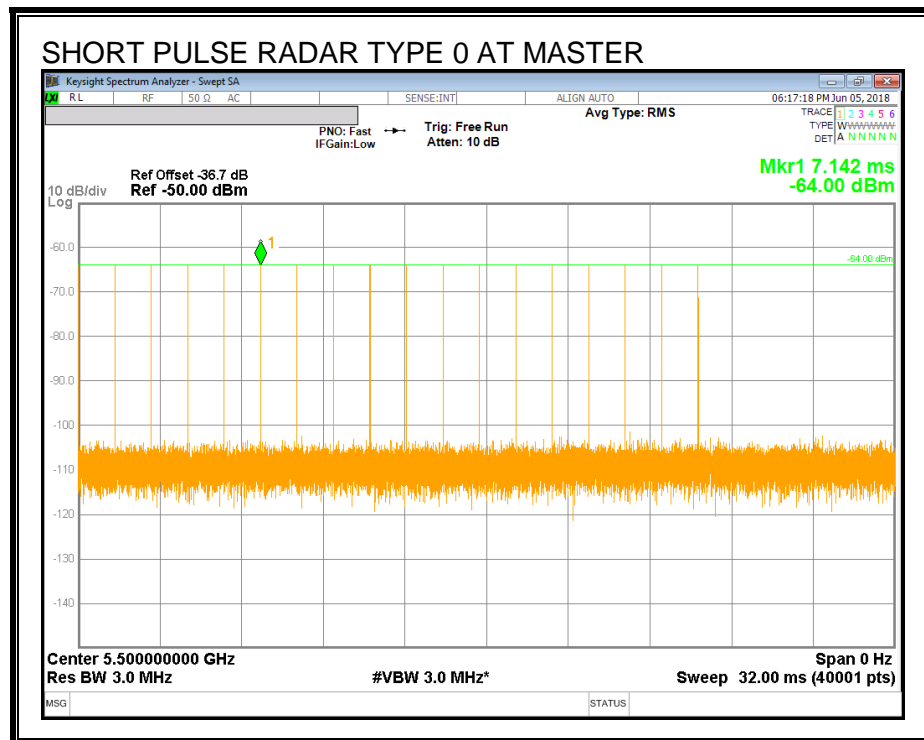

TRAFFIC

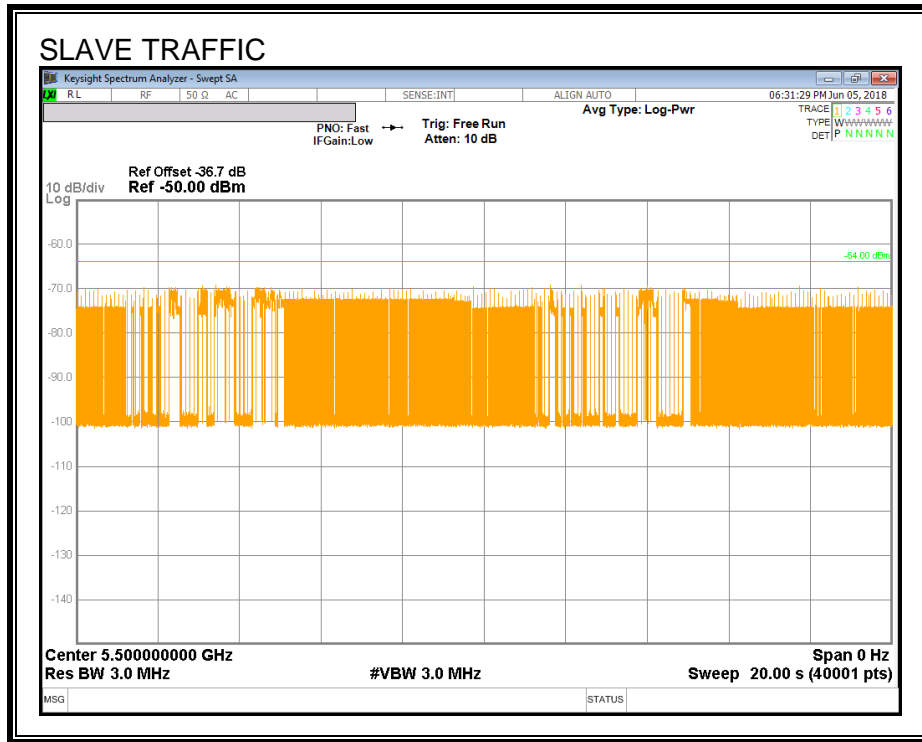

14.2.3. OVERLAPPING CHANNEL TESTS

RESULTS

These tests are not applicable.

14.2.4. MOVE AND CLOSING TIME

REPORTING NOTES

The reference marker is set at the end of last radar pulse.

The delta marker is set at the end of the last WLAN transmission following the radar pulse. This delta is the channel move time.

The aggregate channel closing transmission time is calculated as follows:

Aggregate Transmission Time =
(Number of analyzer bins showing transmission) * (dwell time per bin)

The observation period over which the aggregate time is calculated begins at (Reference Marker + 200 msec) and ends no earlier than (Reference Marker + 10 sec).

RESULTS

Channel Move Time (sec)	Limit (sec)
0.792	10

Aggregate Channel Closing Transmission Time (msec)	Limit (msec)
4.125	60

MOVE TIME & CHANNEL CLOSING TIME

AGGREGATE CHANNEL CLOSING TRANSMISSION TIME

No transmissions are observed during the aggregate monitoring period.

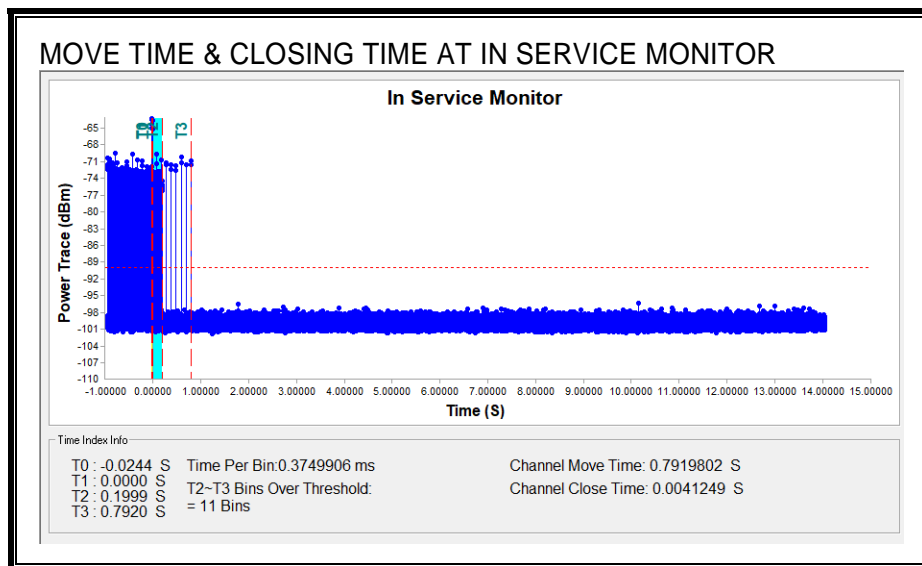
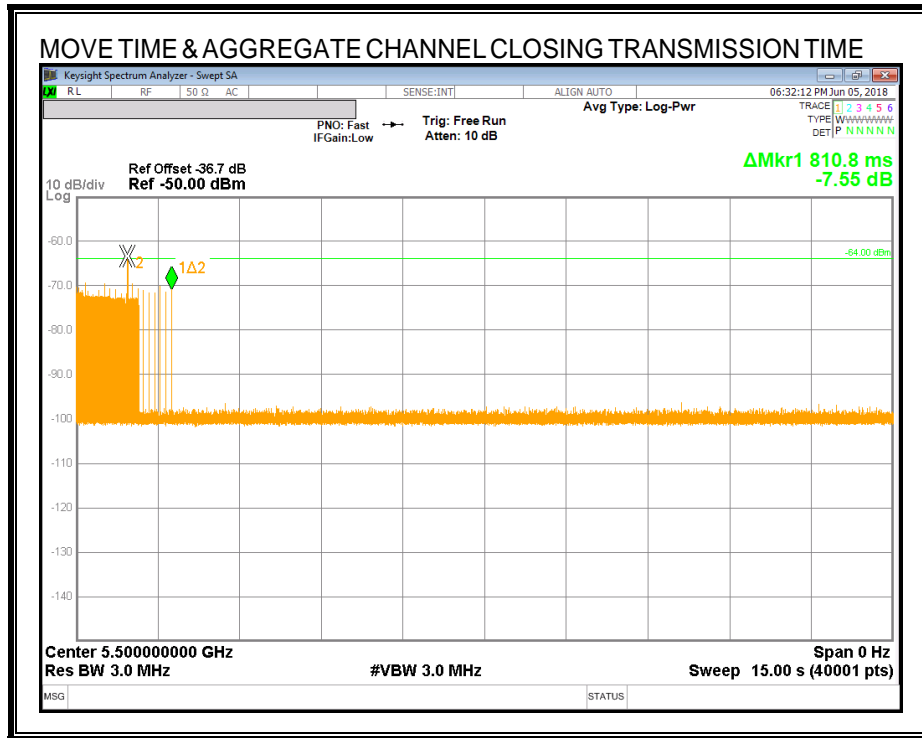

RESULTS

No EUT transmissions were observed on the test channel during the 10-minute observation time.

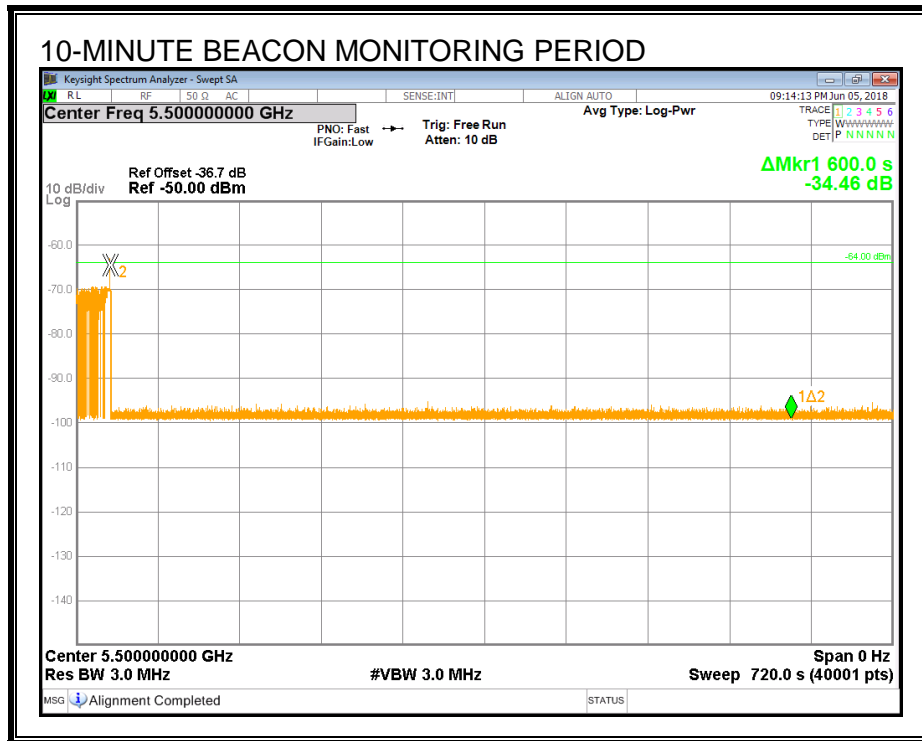

14.3. RESULTS FOR 40 MHz BANDWIDTH

14.3.1. TEST CHANNEL

All tests were performed at a channel center frequency of 5530 MHz.

14.3.2. RADAR WAVEFORM AND TRAFFIC

RADAR WAVEFORM

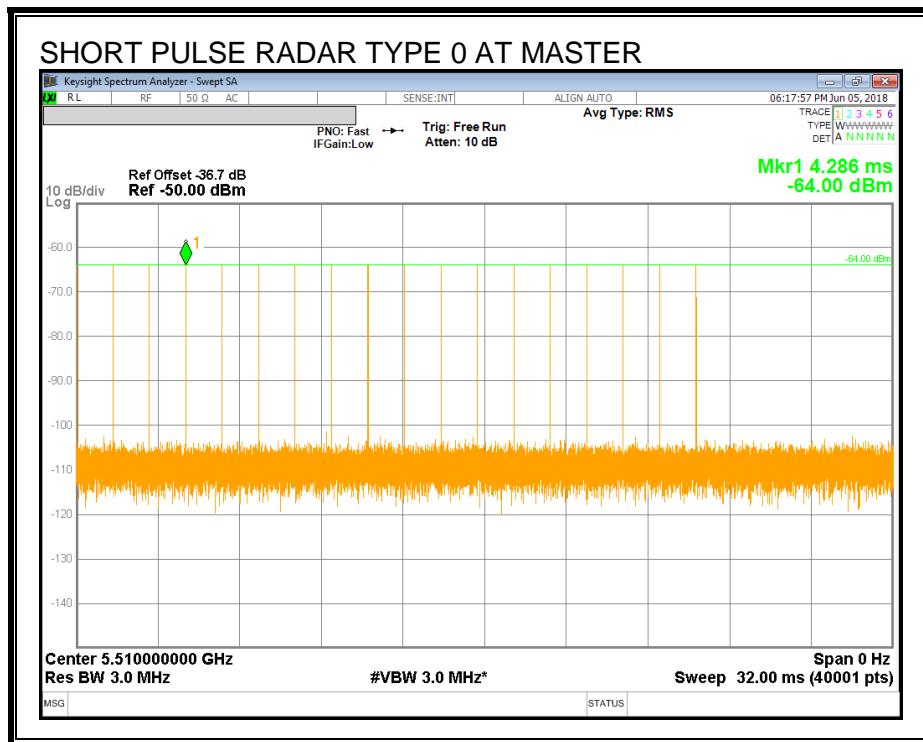

TRAFFIC

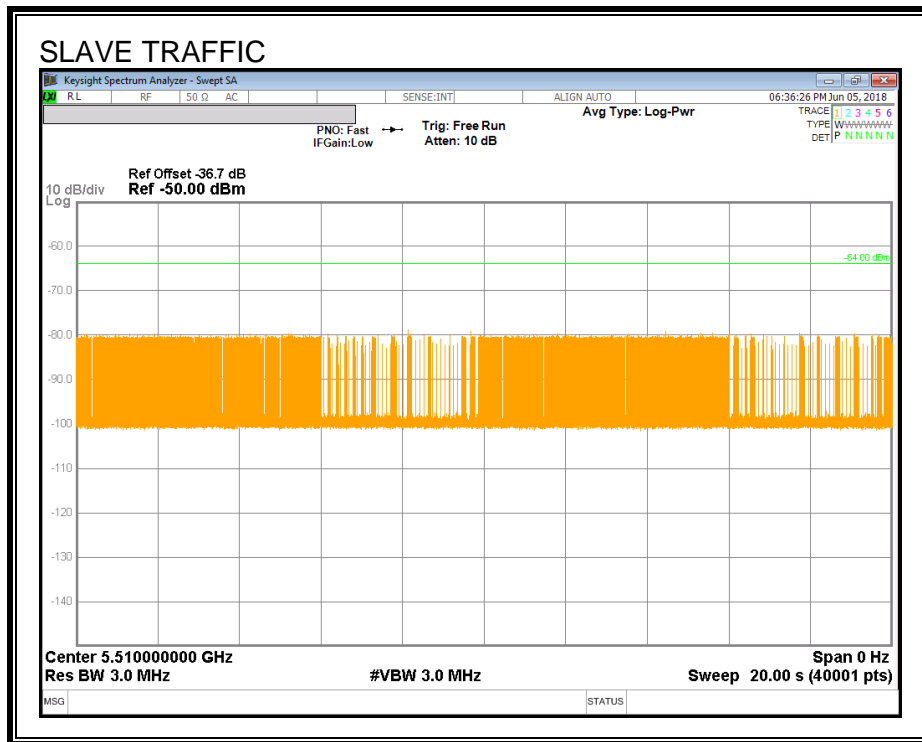

14.3.3. OVERLAPPING CHANNEL TESTS

RESULTS

These tests are not applicable.

14.3.4. MOVE AND CLOSING TIME

REPORTING NOTES

The reference marker is set at the end of last radar pulse.

The delta marker is set at the end of the last WLAN transmission following the radar pulse. This delta is the channel move time.

The aggregate channel closing transmission time is calculated as follows:

Aggregate Transmission Time =
(Number of analyzer bins showing transmission) * (dwell time per bin)

The observation period over which the aggregate time is calculated begins at (Reference Marker + 200 msec) and ends no earlier than (Reference Marker + 10 sec).

RESULTS

Channel Move Time (sec)	Limit (sec)
0.807	10

Aggregate Channel Closing Transmission Time (msec)	Limit (msec)
4.125	60

MOVE TIME & CHANNEL CLOSING TIME

AGGREGATE CHANNEL CLOSING TRANSMISSION TIME

No transmissions are observed during the aggregate monitoring period.

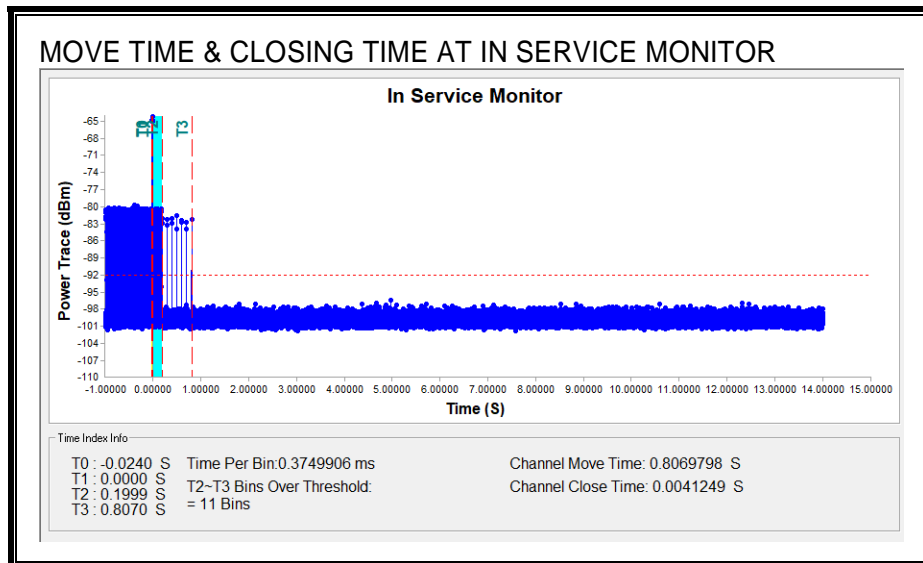
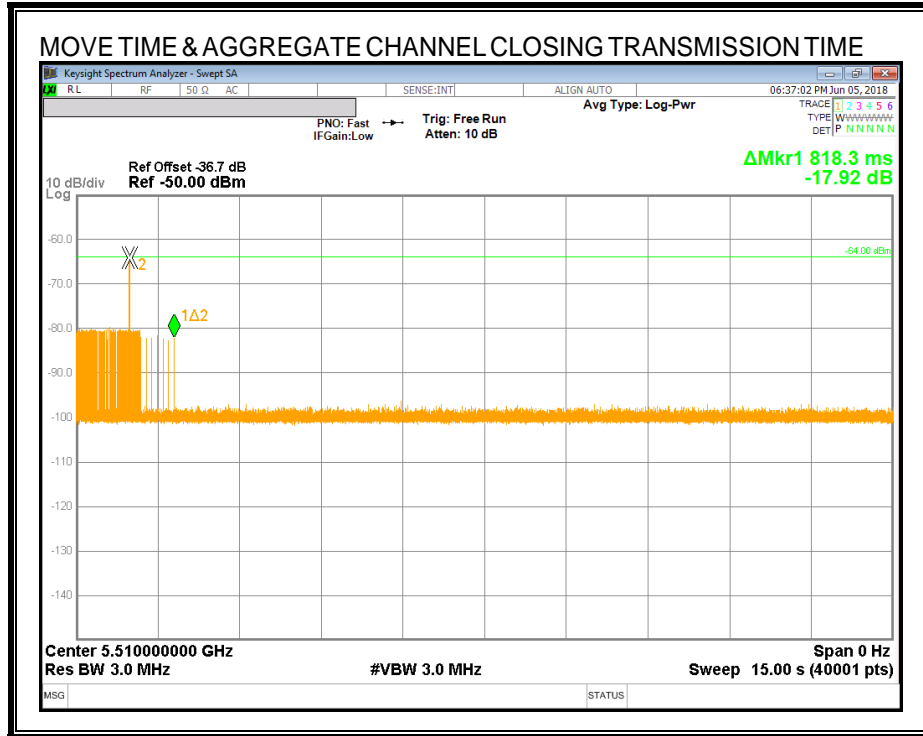

RESULTS

No EUT transmissions were observed on the test channel during the 10-minute observation time.

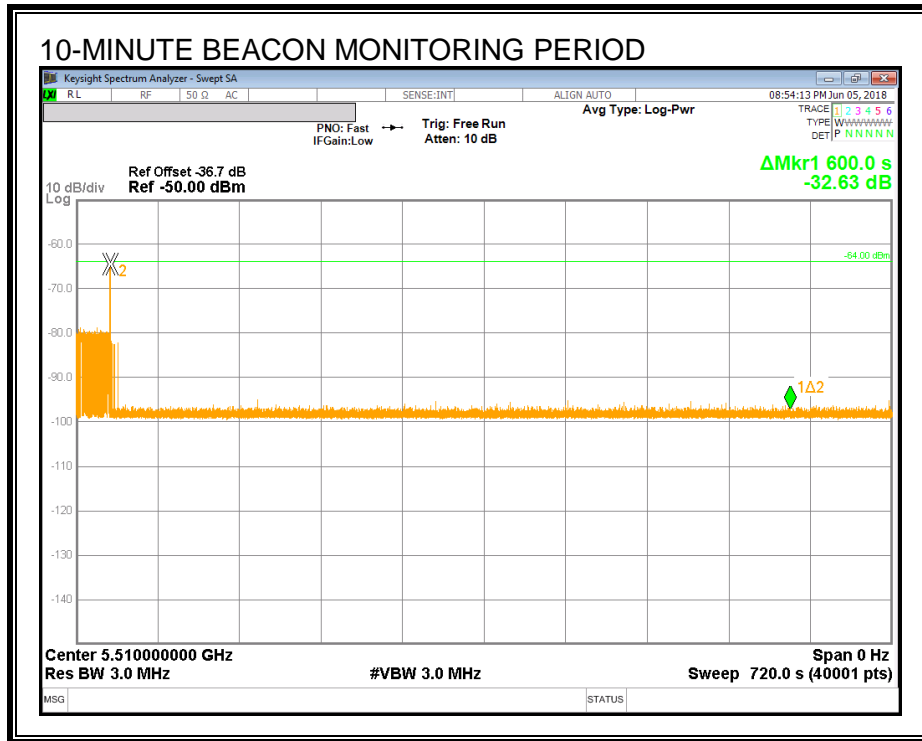

14.4. RESULTS FOR 80 MHz BANDWIDTH

14.4.1. TEST CHANNEL

All tests were performed at a channel center frequency of 5530 MHz.

14.4.2. RADAR WAVEFORM AND TRAFFIC

RADAR WAVEFORM

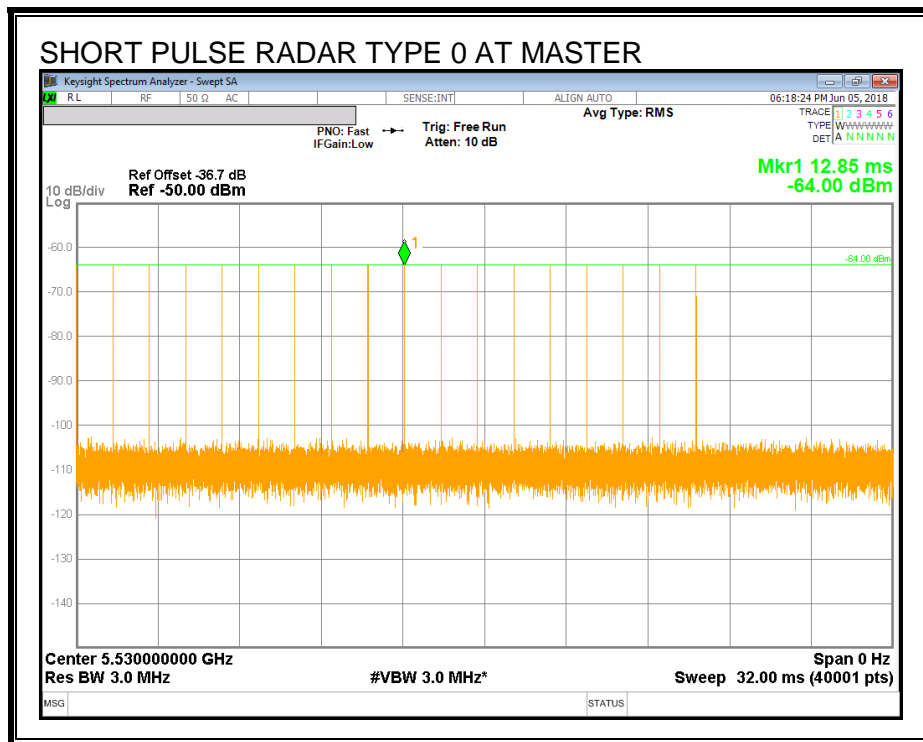

TRAFFIC

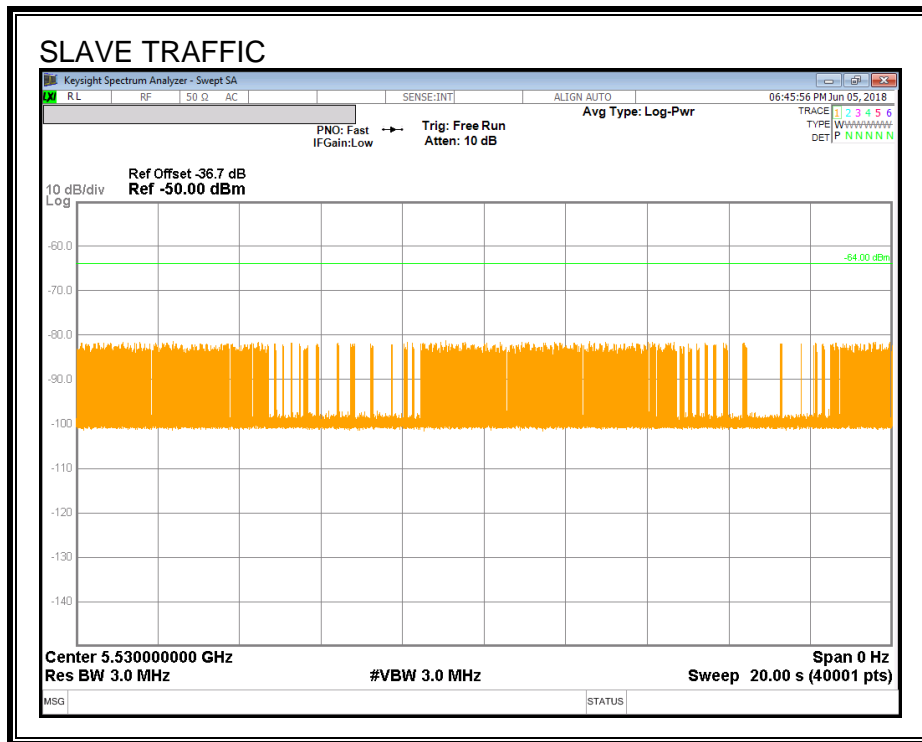

14.4.3. OVERLAPPING CHANNEL TESTS

RESULTS

These tests are not applicable.

14.4.4. MOVE AND CLOSING TIME

REPORTING NOTES

The reference marker is set at the end of last radar pulse.

The delta marker is set at the end of the last WLAN transmission following the radar pulse. This delta is the channel move time.

The aggregate channel closing transmission time is calculated as follows:

Aggregate Transmission Time =
(Number of analyzer bins showing transmission) * (dwell time per bin)

The observation period over which the aggregate time is calculated begins at (Reference Marker + 200 msec) and ends no earlier than (Reference Marker + 10 sec).

RESULTS

Channel Move Time (sec)	Limit (sec)
0.393	10

Aggregate Channel Closing Transmission Time (msec)	Limit (msec)
0.375	60

MOVE TIME & CHANNEL CLOSING TIME

AGGREGATE CHANNEL CLOSING TRANSMISSION TIME

No transmissions are observed during the aggregate monitoring period.

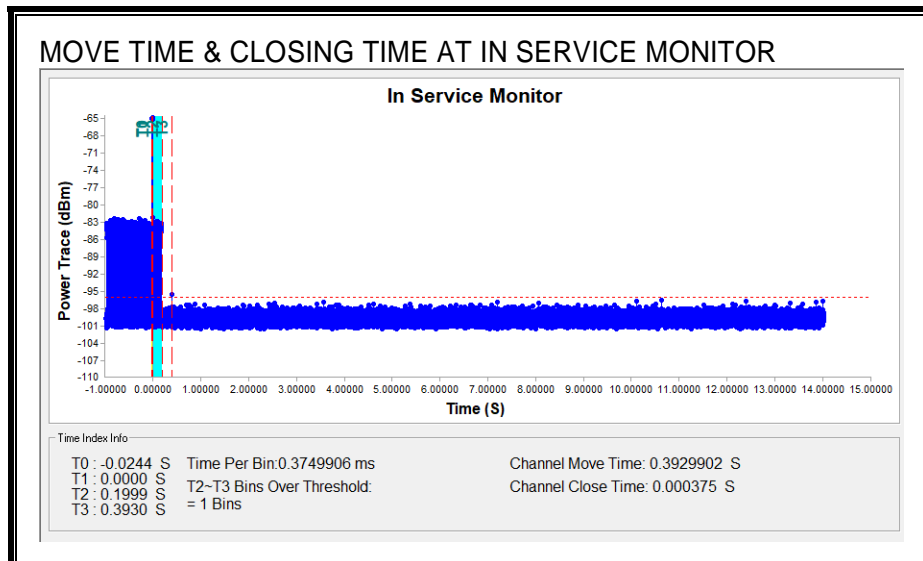
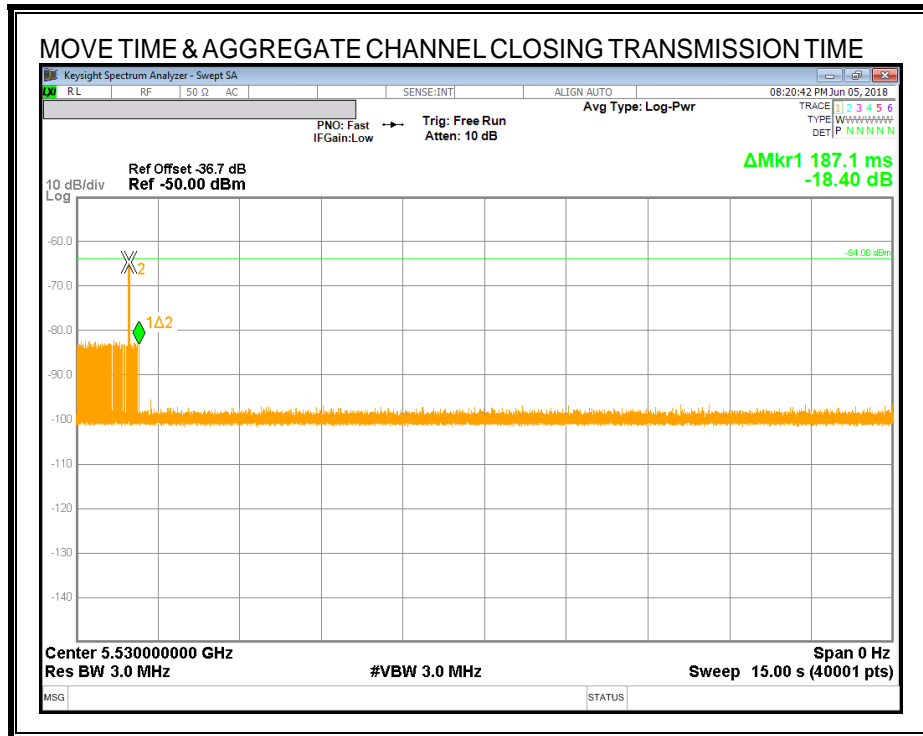

RESULTS

No EUT transmissions were observed on the test channel during the 10-minute observation time.

