



**FCC 47 CFR PART 15 SUBPART E
INDUSTRY CANADA RSS-247 ISSUE 2**

UNII

CERTIFICATION TEST REPORT

FOR

BT/BLE, DTS/UNII a/b/g/n/ac and ANT+ Tablet

MODEL NUMBER : SM-T590

FCC ID: A3LSMT590

IC : 649E-SMT590

REPORT NUMBER: 4788494706-E4V3

ISSUE DATE: JUL 07, 2018

Prepared for

**SAMSUNG ELECTRONICS CO., LTD.
129 SAMSUNG-RO, YEONGTONG-GU, SUWON-SI,
GYEONGGI-DO, 16677, KOREA**

Prepared by

UL Korea, Ltd.

26th floor, 152, Teheran-ro, Gangnam-gu Seoul, 06236, Korea

Suwon Test Site: UL Korea, Ltd. Suwon Laboratory

**218 Maeyeong-ro, Yeongtong-gu,
Suwon-si, Gyeonggi-do, 16675, Korea**

TEL: (031) 337-9902

FAX: (031) 213-5433



ACCREDITED*

Testing
Laboratory

TL-637

Revision History

<u>Rev.</u>	<u>Issue Date</u>	<u>Revisions</u>	<u>Revised By</u>
V1	06/22/18	Initial issue	Junwhan Lee
V2	06/27/18	Updated to address TCB's question	Junwhan Lee
V3	07/07/18	Updated to address TCB's question	Junwhan Lee

TABLE OF CONTENTS

1. ATTESTATION OF TEST RESULTS	7
1.1. INTRODUCTION OF TEST DATA REUSE.....	8
1.2. DIFFERENCE.....	8
1.3. SPOT CHECK VERIFICATION DATA	8
1.4. REFERENCE DETAIL	9
2. TEST METHODOLOGY	10
3. FACILITIES AND ACCREDITATION	10
4. CALIBRATION AND UNCERTAINTY	10
4.1. MEASURING INSTRUMENT CALIBRATION	10
4.2. SAMPLE CALCULATION	10
4.3. MEASUREMENT UNCERTAINTY.....	11
5. EQUIPMENT UNDER TEST.....	12
5.1. DESCRIPTION OF EUT	12
5.1. MAXIMUM OUTPUT POWER.....	12
5.2. DESCRIPTION OF AVAILABLE ANTENNAS	13
5.3. WORST-CASE CONFIGURATION AND MODE.....	13
5.4. DESCRIPTION OF TEST SETUP.....	14
6. TEST AND MEASUREMENT EQUIPMENT	16
7. SUMMARY TABLE	17
8. MEASUREMENT METHODS	18
9. REFERENCE MEASUREMENTS RESULTS	19
9.1. ON TIME AND DUTY CYCLE RESULTS.....	19
9.2. DUTY CYCLE PLOTS	19
9.3. 26 dB BANDWIDTH.....	22
9.3.1. 802.11a MODE IN THE 5.2 GHz BAND.....	22
9.3.2. 802.11n HT20 MODE IN THE 5.2 GHz BAND	22
9.3.3. 802.11n HT40 MODE IN THE 5.2 GHz BAND	22
9.3.4. 802.11n VHT80 MODE IN THE 5.2 GHz BAND.....	23
9.3.5. 802.11a MODE IN THE 5.3 GHz BAND.....	23
9.3.6. 802.11n HT20 MODE IN THE 5.3 GHz BAND	23
9.3.7. 802.11n HT40 MODE IN THE 5.3 GHz BAND	23
9.3.8. 802.11ac VHT80 MODE IN THE 5.3 GHz BAND	23
9.3.9. 802.11a MODE IN THE 5.5 GHz BAND.....	24
9.3.10. 802.11n HT20 MODE IN THE 5.5 GHz BAND	24
9.3.11. 802.11n HT40 MODE IN THE 5.5 GHz BAND	24

9.3.12.	802.11ac VHT80 MODE IN THE 5.5 GHz BAND	24
9.3.13.	802.11a MODE IN THE 5.8 GHz BAND	25
9.3.14.	802.11n HT20 MODE IN THE 5.8 GHz BAND	25
9.3.15.	802.11n HT40 MODE IN THE 5.8 GHz BAND	25
9.3.16.	802.11ac VHT80 MODE IN THE 5.8 GHz BAND	25
9.3.17.	26 dB BANDWIDTH PLOTS	26
9.4.	99% BANDWIDTH	38
9.4.1.	802.11a MODE IN THE 5.2 GHz BAND	38
9.4.2.	802.11n HT20 MODE IN THE 5.2 GHz BAND	38
9.4.3.	802.11n HT40 MODE IN THE 5.2 GHz BAND	38
9.4.4.	802.11n VHT80 MODE IN THE 5.2 GHz BAND	39
9.4.5.	802.11a MODE IN THE 5.3 GHz BAND	39
9.4.6.	802.11n HT20 MODE IN THE 5.3 GHz BAND	39
9.4.7.	802.11n HT40 MODE IN THE 5.3 GHz BAND	39
9.4.8.	802.11ac VHT80 MODE IN THE 5.3 GHz BAND	39
9.4.9.	802.11a MODE IN THE 5.5 GHz BAND	40
9.4.10.	802.11n HT20 MODE IN THE 5.5 GHz BAND	40
9.4.11.	802.11n HT40 MODE IN THE 5.5 GHz BAND	40
9.4.12.	802.11ac VHT80 MODE IN THE 5.5 GHz BAND	40
9.4.13.	802.11a MODE IN THE 5.8 GHz BAND	41
9.4.14.	802.11n HT20 MODE IN THE 5.8 GHz BAND	41
9.4.15.	802.11n HT40 MODE IN THE 5.8 GHz BAND	41
9.4.16.	802.11ac VHT80 MODE IN THE 5.8 GHz BAND	41
9.4.17.	99% BANDWIDTH PLOTS	42
10.	ANTENNA PORT TEST RESULTS	54
10.1.	6 dB BANDWIDTH	54
10.1.1.	802.11a MODE IN THE 5.8 GHz BAND	55
10.1.2.	802.11n HT20 MODE IN THE 5.8 GHz BAND	55
10.1.3.	802.11n HT40 MODE IN THE 5.8 GHz BAND	55
10.1.4.	802.11n VHT80 MODE IN THE 5.8 GHz BAND	55
10.1.5.	6 dB BANDWIDTH PLOTS	56
10.2.	OUTPUT POWER AND PPSD	59
10.2.1.	802.11a MODE IN THE 5.2 GHz BAND	61
10.2.2.	802.11n HT20 MODE IN THE 5.2 GHz BAND	62
10.2.3.	802.11n HT40 MODE IN THE 5.2 GHz BAND	63
10.2.4.	802.11ac VHT80 MODE IN THE 5.2 GHz BAND	64
10.2.5.	802.11a MODE IN THE 5.3 GHz BAND	65
10.2.6.	802.11n HT20 MODE IN THE 5.3 GHz BAND	66
10.2.7.	802.11n HT40 MODE IN THE 5.3 GHz BAND	67
10.2.8.	802.11ac VHT80 MODE IN THE 5.3 GHz BAND	68
10.2.9.	802.11a MODE IN THE 5.5 GHz BAND	69
10.2.10.	802.11n HT20 MODE IN THE 5.5 GHz BAND	70
10.2.11.	802.11n HT40 MODE IN THE 5.5 GHz BAND	71
10.2.12.	802.11ac VHT80 MODE IN THE 5.5 GHz BAND	72
10.2.13.	802.11a MODE IN THE 5.8 GHz BAND	73
10.2.14.	802.11n HT20 MODE IN THE 5.8 GHz BAND	74
10.2.15.	802.11n HT40 MODE IN THE 5.8 GHz BAND	75
10.2.16.	802.11ac VHT80 MODE IN THE 5.8 GHz BAND	76
10.2.17.	PPSD PLOTS	77

11. TRANSMITTER ABOVE 1 GHz.....89

- 11.1. 5.2 GHz.....91
 - 11.1.1. TX Above 1GHz 802.11a MODE IN THE 5.2GHz BAND91
 - 11.1.2. TX Above 1GHz 802.11n HT20 MODE IN THE 5.2GHz BAND.....99
 - 11.1.3. TX Above 1GHz 802.11n HT40 MODE IN THE 5.2GHz BAND.....107
 - 11.1.4. TX ABOVE 1GHz 802.11ac VHT80 MODE IN THE 5.2GHz BAND.....113
- 11.2. 5.3 GHz.....117
 - 11.2.1. TX ABOVE 1 GHz 802.11a MODE IN THE 5.3 GHz BAND117
 - 11.2.2. TX ABOVE 1GHz 802.11n HT20 MODE IN THE 5.3GHz BAND.....125
 - 11.2.3. TX ABOVE 1GHz 802.11n HT40 MODE IN THE 5.3GHz BAND.....133
 - 11.2.4. TX ABOVE 1GHz 802.11ac VHT80 MODE IN THE 5.3GHz BAND.....139
 - RESTRICTED BANDEDGE (High CHANNEL).....139
- 11.3. 5.5-5.6 GHz.....143
 - 11.3.1. TX ABOVE 1 GHz 802.11a MODE IN THE 5.5 GHz BAND143
 - 11.3.2. TX ABOVE 1GHz 802.11n HT20 MODE IN THE 5.5GHz BAND.....153
 - 11.3.3. TX ABOVE 1GHz 802.11n HT40 MODE IN THE 5.5GHz BAND.....163
 - 11.3.4. TX ABOVE 1GHz 802.11ac VHT80 MODE IN THE 5.5GHz BAND.....173
- 11.4. 5.8 GHz.....179
 - 11.4.1. TX ABOVE 1GHz 802.11a MODE IN THE 5.8GHz BAND179
 - 11.4.2. TX ABOVE 1GHz 802.11n HT20 MODE IN THE 5.8GHz BAND.....189
 - 11.4.3. TX ABOVE 1GHz 802.11n HT40 MODE IN THE 5.8GHz BAND.....199
 - 11.4.4. TX ABOVE 1GHz 802.11ac VHT80 MODE IN THE 5.8GHz BAND.....207

12. WORST-CASE BELOW 1 GHz213

13. AC POWER LINE CONDUCTED EMISSIONS215

14. DYNAMIC FREQUENCY SELECTION.....220

- 14.1. OVERVIEW.....220
 - 14.1.1. LIMITS.....220
 - 14.1.2. TEST AND MEASUREMENT SYSTEM.....224
 - 14.1.3. SETUP OF EUT.....227
 - 14.1.4. DESCRIPTION OF EUT228
- 14.2. RESULTS FOR 20 MHz BANDWIDTH.....229
 - 14.2.1. TEST CHANNEL229
 - 14.2.2. RADAR WAVEFORM AND TRAFFIC.....229
 - 14.2.3. OVERLAPPING CHANNEL TESTS.....231
 - 14.2.4. MOVE AND CLOSING TIME231
- 14.3. RESULTS FOR 40 MHz BANDWIDTH.....234
 - 14.3.1. TEST CHANNEL234
 - 14.3.2. RADAR WAVEFORM AND TRAFFIC.....234
 - 14.3.3. OVERLAPPING CHANNEL TESTS.....236
 - 14.3.4. MOVE AND CLOSING TIME236
- 14.4. RESULTS FOR 80 MHz BANDWIDTH.....239
 - 14.4.1. TEST CHANNEL239
 - 14.4.2. RADAR WAVEFORM AND TRAFFIC.....239
 - 14.4.3. OVERLAPPING CHANNEL TESTS.....241
 - 14.4.4. MOVE AND CLOSING TIME241

1. ATTESTATION OF TEST RESULTS

COMPANY NAME: SAMSUNG ELECTRONICS CO., LTD.
EUT DESCRIPTION: BT/BLE, DTS/UNII a/b/g/n/ac and ANT+ Tablet
MODEL NUMBER: SM-T590
SERIAL NUMBER: R32K1000WAB (RADIATED, Original);
R32K400E4CK (CONDUCTED, Original)
R32K5005EDZ (RADIATED, Spot check)
DATE TESTED: MAY 04, 2018 - JUN 05, 2018 (Original)
JUN 16, 2018 (Spot check)

APPLICABLE STANDARDS	
STANDARD	TEST RESULTS
CFR 47 Part 15 Subpart E	Pass
INDUSTRY CANADA RSS-247 Issue 2	Pass
INDUSTRY CANADA RSS-GEN Issue 5	Pass

UL Korea, Ltd. tested the above equipment in accordance with the requirements set forth in the above standards. All indications of Pass/Fail in this report are opinions expressed by UL Korea, Ltd. based on interpretations and/or observations of test results. Measurement Uncertainties were not taken into account and are published for informational purposes only. The test results show that the equipment tested is capable of demonstrating compliance with the requirements as documented in this report.

Note: The results documented in this report apply only to the tested sample, under the conditions and modes of operation as described herein. This document may not be altered or revised in any way unless done so by UL Korea, Ltd. and all revisions are duly noted in the revisions section. Any alteration of this document not carried out by UL Korea, Ltd. will constitute fraud and shall nullify the document. This report must not be used by the client to claim product certification, approval, or endorsement by IAS, any agency of the Federal Government, or any agency of any government.

Approved & Released For
UL Korea, Ltd. By:



SungGil Park
Suwon Lab Engineer
UL Korea, Ltd.

Tested By:



Junwhan Lee
Suwon Lab Engineer
UL Korea, Ltd.

1.1. INTRODUCTION OF TEST DATA REUSE

This report referenced from the FCC ID: A3LSMT595 NII WLAN(FCC CFR 47 Part 15C). And the applicant takes full responsibility that the test data as referenced in this report represent compliance for this FCC ID.

1.2. DIFFERENCE

The FCC ID: A3LSMT590(IC : 649E-SMT590, Model number : SM-T590), shares the same enclosure and circuit board as FCC ID: A3LSMT595 (Model number : SM-T595). The WLAN antennas and surrounding circuitry and layout are identical between these two units.

After confirming through preliminary radiated emissions that the performance of the FCC ID: A3LSMT595 (Model number : SM-T595) remains representative of FCC ID: A3LSMT590(IC : 649E-SMT590, Model number : SM-T590). The test data of FCC ID: A3LSMT595 (Model number : SM-T595) being submitted for this application to cover WLAN features.

Model number, SM-T595, is not certified for ISED certification.

1.3. SPOT CHECK VERIFICATION DATA

(Worst case of the radiated spurious and band edge emissions)

Band	Test Item	Mode	Frequency	Test Limit	Original model	Spot check model	Deviation	Remark
					SM-T595 Results	SM-T590 Results		
					FCC ID : A3LSMT595	FCC ID : A3LSMT590 IC : 649E-SMT590		
UNII WLAN (5GHz)	Band Edge	802.11n HT40	5190 MHz	54 dBuV/m	49.67 dBuV/m	47.92 dBuV/m	-1.75 dB	
	RSE	802.11 a	5200 MHz	68.2 dBuV/m	44.00 dBuV/m	42.89 dBuV/m	-1.11 dB	
	Band Edge	802.11 n HT40	5310 MHz	54 dBuV/m	48.28 dBuV/m	46.70 dBuV/m	-1.58 dB	
	RSE	802.11 a	5320 MHz	54 dBuV/m	44.95 dBuV/m	42.24 dBuV/m	-2.71 dB	
	Band Edge	802.11n HT40	5510 MHz	68.2 dBuV/m	65.88 dBuV/m	60.91 dBuV/m	-4.97 dB	
	RSE	802.11 a	5500 MHz	54 dBuV/m	44.98 dBuV/m	44.24 dBuV/m	-0.74 dB	
	Band Edge	802.11n HT20	5825 MHz	-27 dBm	-35.46 dBm	-35.38 dBm	0.08 dB	
	RSE	802.11 a	5785 MHz	54 dBuV/m	45.84 dBuV/m	44.14 dBuV/m	-1.70 dB	

Comparison of two models, upper deviation is within 3dB range and all test results are under FCC Technical Limits.

1.4. REFERENCE DETAIL

Reference application that contains the reused reference data.

Equipment Class	Reference FCC ID (Reference Model number)	Type Grant/Permissive Change	Reference Application	Folder Test/RF Exposure	Report Title / Section
DTS	A3LSMT595 (SM-T595)	Grant	4788452530-E1V2	Test	FCC Report DTS WLAN / All sections
			4788452530-E2V2	Test	FCC Report BLE All sections
DSS	A3LSMT595 (SM-T595)	Grant	4788452530-E3V2	Test	FCC Report BT / All sections
DXX	A3LSMT595 (SM-T595)	Grant	4788452530-E5V2	Test	FCC Report ANT+ / All sections
NII	A3LSMT595 (SM-T595)	Grant	4788452530-E4V2	Test	FCC Report UNII WLAN / All sections

2. TEST METHODOLOGY

The tests documented in this report were performed in accordance with following methods.

1. FCC CFR 47 Part 2.
2. FCC CFR 47 Part 15.
3. IC RSS-GEN Issue 5.
4. IC RSS-247 Issue 2.
5. KDB 789033 D02 General UNII Test Procedures New Rules v02r01
6. KDB 905462 D02 UNII DFS Compliance Procedures New Rules v02
7. KDB 905462 D03 UNII Clients Without Radar Detection New Rules v01r02
8. ANSI C63.10-2013.

3. FACILITIES AND ACCREDITATION

The test sites and measurement facilities used to collect data are located at 218 Maeyeong-ro, Yeongtong-gu, Suwon-si, Gyeonggi-do, 16675, Korea. Line conducted emissions are measured only at the 218 address. The following table identifies which facilities were utilized for radiated emission measurements documented in this report. Specific facilities are also identified in the test results sections.

218 Maeyeong-ro	
<input type="checkbox"/>	Chamber 1
<input type="checkbox"/>	Chamber 2
<input checked="" type="checkbox"/>	Chamber 3

UL Korea, Ltd. is accredited by IAS, Laboratory Code TL-637. The full scope of accreditation can be viewed at <http://www.iasonline.org/PDF/TL/TL-637.pdf>.

4. CALIBRATION AND UNCERTAINTY

4.1. MEASURING INSTRUMENT CALIBRATION

The measuring equipment utilized to perform the tests documented in this report has been calibrated in accordance with the manufacturer's recommendations, and is traceable to recognized national standards.

4.2. SAMPLE CALCULATION

Where relevant, the following sample calculation is provided:

$$\begin{aligned} \text{Field Strength (dBuV/m)} &= \text{Measured Voltage (dBuV)} + \text{Antenna Factor (dB/m)} + \\ &\text{Cable Loss (dB)} - \text{Preamp Gain (dB)} \\ 36.5 \text{ dBuV} + 18.7 \text{ dB/m} + 0.6 \text{ dB} - 26.9 \text{ dB} &= 28.9 \text{ dBuV/m} \end{aligned}$$

4.3. MEASUREMENT UNCERTAINTY

Where relevant, the following measurement uncertainty levels have been estimated for tests performed on the apparatus:

PARAMETER	UNCERTAINTY
Conducted Disturbance, 0.15 to 30 MHz	2.32 dB
Radiated Disturbance, Below 1GHz	3.86 dB
Radiated Disturbance, Above 1 GHz	5.97 dB

Uncertainty figures are valid to a confidence level of 95%.

5. EQUIPMENT UNDER TEST

5.1. DESCRIPTION OF EUT

The EUT is a BT/BLE, DTS/UNII a/b/g/n/ac and ANT+ Tablet.
 This test report addresses the NII (UNII) operational mode.

5.1. MAXIMUM OUTPUT POWER

The transmitter has a maximum total conducted average output power as follows:

Frequency Range [MHz]	Mode	Output Power [dBm]	Output Power [mW]
5180 - 5240	802.11a	16.78	47.64
	802.11n HT20	15.70	37.15
5190 - 5230	802.11n HT40	15.63	36.56
5210	802.11ac VHT80	13.42	21.98
5260 - 5320	802.11a	16.54	45.08
	802.11n HT20	15.49	35.40
5270 - 5310	802.11n HT40	15.82	38.19
5290	802.11ac VHT80	13.41	21.93
5500 - 5700	802.11a	16.97	49.77
	802.11n HT20	15.58	36.14
5510 - 5670	802.11n HT40	15.63	36.56
5530 - 5610	802.11ac VHT80	13.42	21.98
5745 - 5825	802.11a	16.98	49.89
	802.11n HT20	15.87	38.64
5755 - 5795	802.11n HT40	15.68	36.98
5775	802.11ac VHT80	13.84	24.21

5.2. DESCRIPTION OF AVAILABLE ANTENNAS

The radio utilizes an internal antenna, with a maximum gain of:

Frequency Range [MHz]	Antenna Gain [dBi]
UNII 1 5150 – 5250	0.2
UNII 2A 5250 – 5350	-0.8
UNII 2C 5470 – 5725	0.3
UNII 3 5725 – 5850	-0.3

5.3. WORST-CASE CONFIGURATION AND MODE

Radiated emission below 1GHz and power line conducted emission were performed with the EUT set to transmit at the channel with highest output power as worst-case scenario.

Radiated emission above 1GHz was performed with the EUT set to transmit low/mid/high channels.

The fundamental of the EUT was investigated in three orthogonal orientations X,Y,Z, it was determined that the Y orientation was worst-case orientation; therefore, all final radiated testing was performed with the EUT in the Y orientation.

Based on the baseline scan, the worst-case data rates were:

802.11a mode: 6 Mbps
802.11n HT20 mode: MCS0
802.11n HT40 mode: MCS0
802.11ac VHT80 mode: MCS0

Test data for 802.11ac VHT20 mode and 802.11 ac VHT40 mode are covered by 802.11n HT20 mode and 802.11n HT40 mode due to lower maximum power.

Note : All radiated and power line conducted tests were performed connected with earphone and charger for evaluation of worst case mode.

5.4. DESCRIPTION OF TEST SETUP

SUPPORT EQUIPMENT

Support Equipment List				
Description	Manufacturer	Model	Serial Number	FCC ID
Charger	SAMSUNG	EP-TA20EWE	R37JCWL0FR5DK3	N/A
Data Cable	SAMSUNG	EP-DN930CWE	N/A	N/A
Earphone	SAMSUNG	EO-EG920BW	N/A	N/A

I/O CABLES

I/O Cable List						
Cable No	Port	# of identical ports	Connector Type	Cable Type	Cable Length (m)	Remarks
1	DC Power	1	C Type	Shielded	1.1m	N/A
2	Audio	2	Mini-Jack	Unshielded	1.2m	N/A

TEST SETUP

The EUT is a stand-alone unit during the tests.
Test software in hidden menu exercised the EUT to enable NII mode.

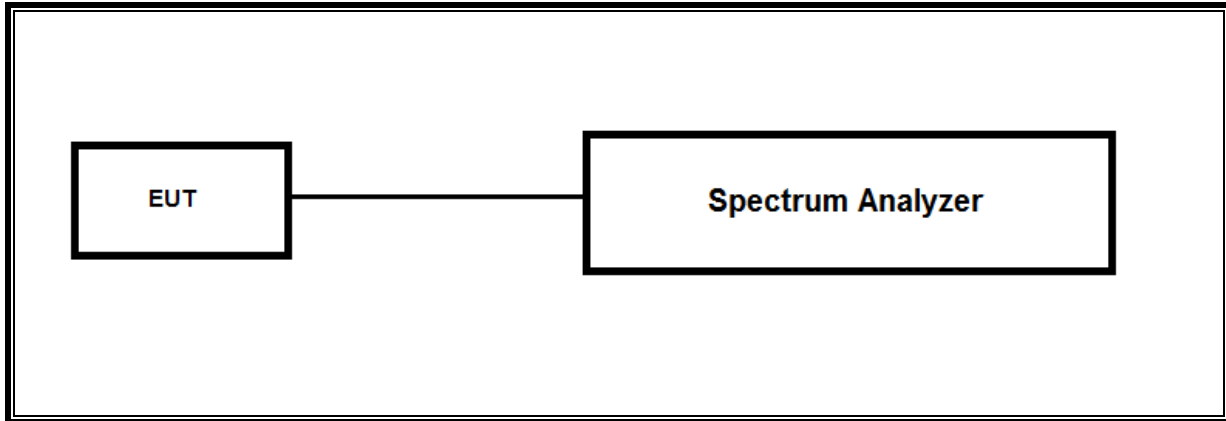

SETUP DIAGRAM FOR TESTS (RADIATED TEST SETUP)

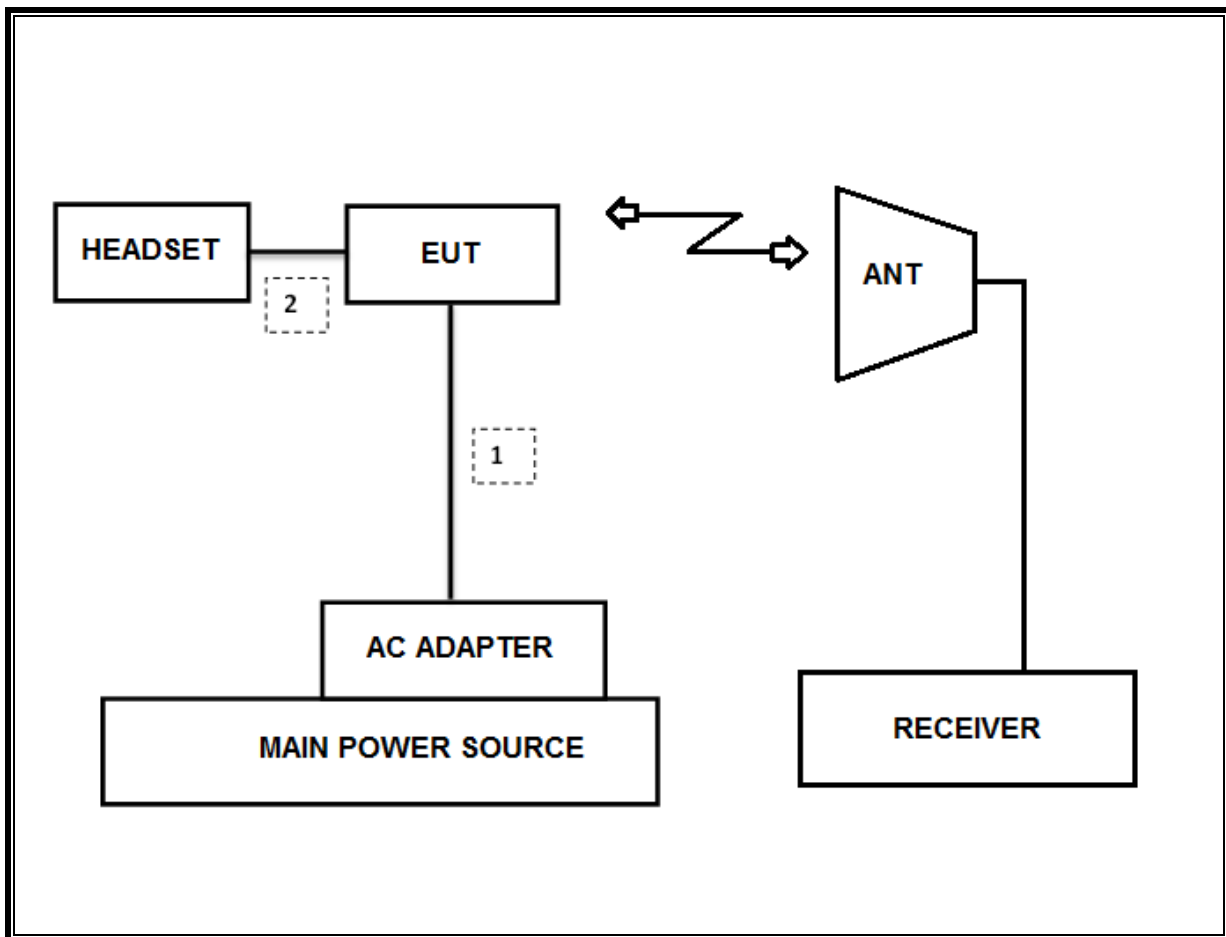

6. TEST AND MEASUREMENT EQUIPMENT

The following test and measurement equipment was utilized for the tests documented in this report:

Test Equipment List				
Description	Manufacturer	Model	S/N	Cal Due
Antenna, Bilog, 30MHz-1GHz	SCHWARZBECK	VULB9163	750	08-31-19
Antenna, Bilog, 30MHz-1GHz	SCHWARZBECK	VULB9163	749	09-14-19
Antenna, Bilog, 30MHz-1GHz	SCHWARZBECK	VULB9163	845	08-31-19
Antenna, Horn, 18 GHz	ETS	3115	00167211	10-14-18
Antenna, Horn, 18 GHz	ETS	3115	00161451	03-10-19
Antenna, Horn, 18 GHz	ETS	3117	00168724	05-31-19
Antenna, Horn, 18 GHz	ETS	3117	00168717	05-31-19
Antenna, Horn, 18 GHz	ETS	3117	00205959	11-29-18
Antenna, Horn, 40 GHz	ETS	3116C	00166155	12-04-19
Antenna, Horn, 40 GHz	ETS	3116C	00168645	12-04-19
Antenna, Horn, 40 GHz	ETS	3116C-PA	00168841	11-13-19
Preamplifier, 1000 MHz	Sonoma	310N	341282	08-09-18
Preamplifier, 1000 MHz	Sonoma	310N	351741	08-07-18
Preamplifier, 1000 MHz	Sonoma	310N	370599	08-10-18
Preamplifier, 18 GHz	Miteq	AFS42-00101800-25-S-42	1876511	08-08-18
Preamplifier, 18 GHz	Miteq	AFS42-00101800-25-S-42	1896138	08-08-18
Preamplifier, 18 GHz	Miteq	AFS42-00101800-25-S-42	2029169	08-11-18
Spectrum Analyzer, 44 GHz	Agilent / HP	N9030A	MY54170614	08-08-18
Spectrum Analyzer, 44 GHz	Agilent / HP	N9030A	MY54490312	08-08-18
Average Power Sensor	Agilent / HP	U2000	MY54270007	08-08-18
Attenuator	PASTERNAK	PE7087-10	A001	08-08-18
Attenuator	PASTERNAK	PE7087-10	A008	08-08-18
Attenuator	PASTERNAK	PE7087-10	2	08-10-18
Attenuator	PASTERNAK	PE7087-10	A009	08-08-18
EMI Test Receive, 40 GHz	R&S	ESU40	100439	08-08-18
EMI Test Receive, 40 GHz	R&S	ESU40	100457	08-08-18
EMI Test Receive, 44 GHz	R&S	ESW44	101590	08-09-18
EMI Test Receive, 3 GHz	R&S	ESR3	101832	08-07-18
Low Pass Filter 5GHz	Micro-Tronics	LPS17541	009	08-08-18
Low Pass Filter 5GHz	Micro-Tronics	LPS17541	015	08-08-18
Low Pass Filter 5GHz	Micro-Tronics	LPS17541	020	08-11-18
High Pass Filter 3GHz	Micro-Tronics	HPM17543	010	08-08-18
High Pass Filter 3GHz	Micro-Tronics	HPM17543	015	08-08-18
High Pass Filter 3GHz	Micro-Tronics	HPM17543	020	08-11-18
High Pass Filter 6GHz	Micro-Tronics	HPS17542	009	08-08-18
High Pass Filter 6GHz	Micro-Tronics	HPS17542	016	08-08-18
High Pass Filter 6GHz	Micro-Tronics	HPS17542	021	08-11-18
LISN	R&S	ENV-216	101837	08-09-18
UL Software				
Description	Manufacturer	Model	Version	
Radiated software	UL	UL EMC	Ver 9.5	
AC Line Conducted software	UL	UL EMC	Ver 9.5	

7. SUMMARY TABLE

FCC Part Section	RSS Section	Test Description	Test Limit	Test Condition	Test Result
15.407(e)	RSS-247 6.2.4.1	6dB Band width (5.8Ghz)	500KHz	Condcuted	PASS
15.407 (a)(2)	RSS-247 6.2.1.1 6.2.2.1 6.2.3.1	TX Cond. Power 5.15-2.25, 5.25-5.35 & 5.47-5.725	<24dBm or 11+10Log(OBW)		PASS
15.407 (a)(3)	RSS-247 6.2.4.1	TX Cond. Power 5.725-5.825	< 30dBm or 17+10Log(OBW)		PASS
15.407 (a)(5)	RSS-247 6.2.1.1 6.2.2.1 6.2.3.1	PSD (5.2,5.3,5.5GHz)	<11dBm		PASS
15.407 (a)(5)	RSS-247 6.2.4.1	PSD (5.8GHz)	30dBm per 500kHz		PASS
15.207 (a)	RSS-GEN Clause 8.8	AC Power Line conducted emissions	Section 10		Radiated
15.407 (b) & 15.209	RSS-GEN Clause 7 & 8.9	Radiated Spurious Emission	< 54dBuV/m	PASS	
15.407 (h)(2)	RSS-247 6.3	Dynamic Frequency Selection	N/A	Condcuted	PASS

8. MEASUREMENT METHODS

On-Time and Duty Cycle : KDB 789033 D02 v02r01, Section B.

6dB Emission BW : KDB 789033 D02 v02r01, Section C.2.

26dB Emission BW : KDB 789033 D02 v02r01, Section C.1.

99% Occupied BW : KDB 789033 D02 v02r01, Section D.

Conducted Output Power : KDB 789033 D02 v02r01, Section E.3.a(Method PM)

Power Spectral Density : KDB 789033 D02 v02r01, Section F.

Unwanted emissions in restricted bands : KDB 789033 D02 v02r01, Section G.

Unwanted emissions in non-restricted bands : KDB 789033 D02 v02r01, Section G.

AC Power Line Conducted Emission : ANSI C63.10-2013, Section 6.2.

9. REFERENCE MEASUREMENTS RESULTS

LIMITS

None; for reporting purposes only.

PROCEDURE

KDB 789033 D02 v02r01 Zero-Span Spectrum Analyzer Method.

9.1. ON TIME AND DUTY CYCLE RESULTS

Mode	ON Time B [msec]	Period [msec]	Duty Cycle x [linear]	Duty Cycle [%]	Duty Cycle Correction Factor [dB]	1/T Minimum VBW [kHz]
802.11a	5.484	5.582	0.982	98.2%	0.00	0.010
802.11n HT20	5.067	5.166	0.981	98.1%	0.00	0.010
802.11n HT40	2.455	2.555	0.961	96.1%	0.17	0.407
802.11ac VHT80	0.248	0.348	0.713	71.3%	1.47	4.032

9.2. DUTY CYCLE PLOTS

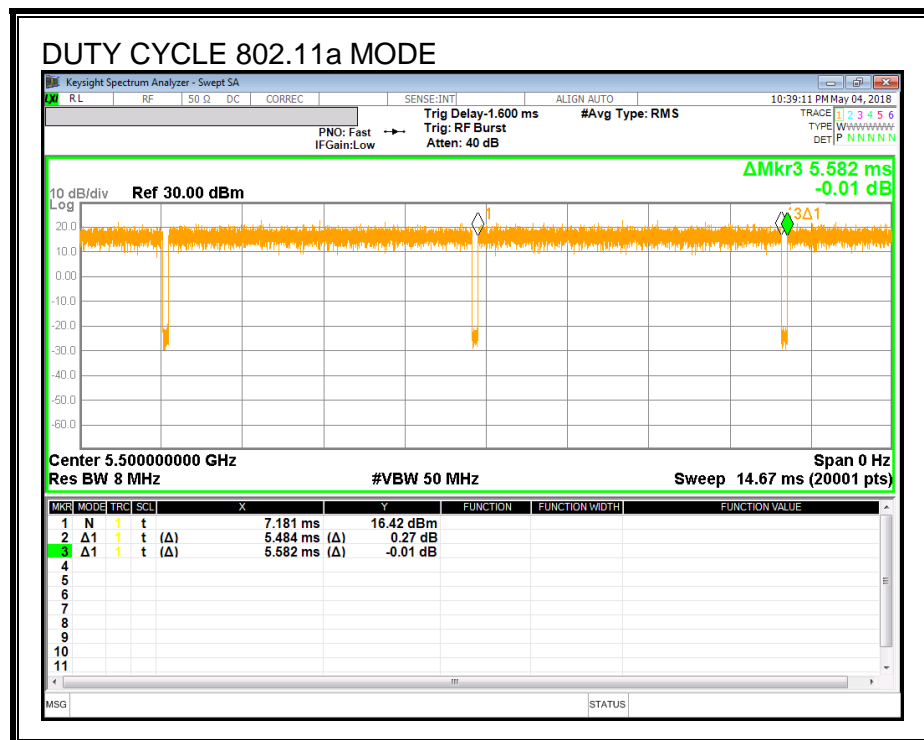

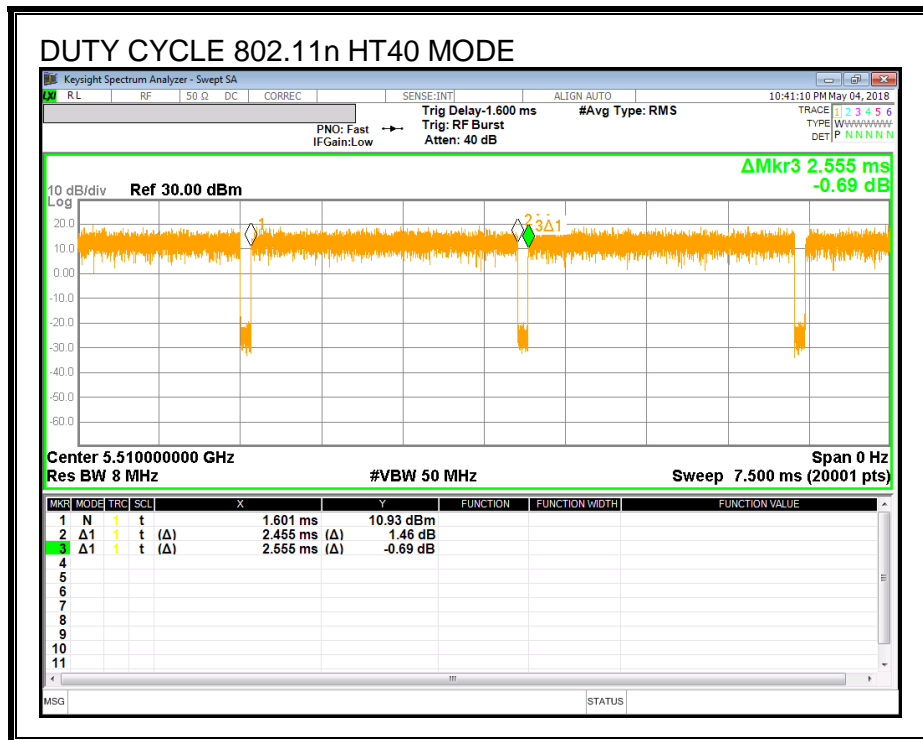
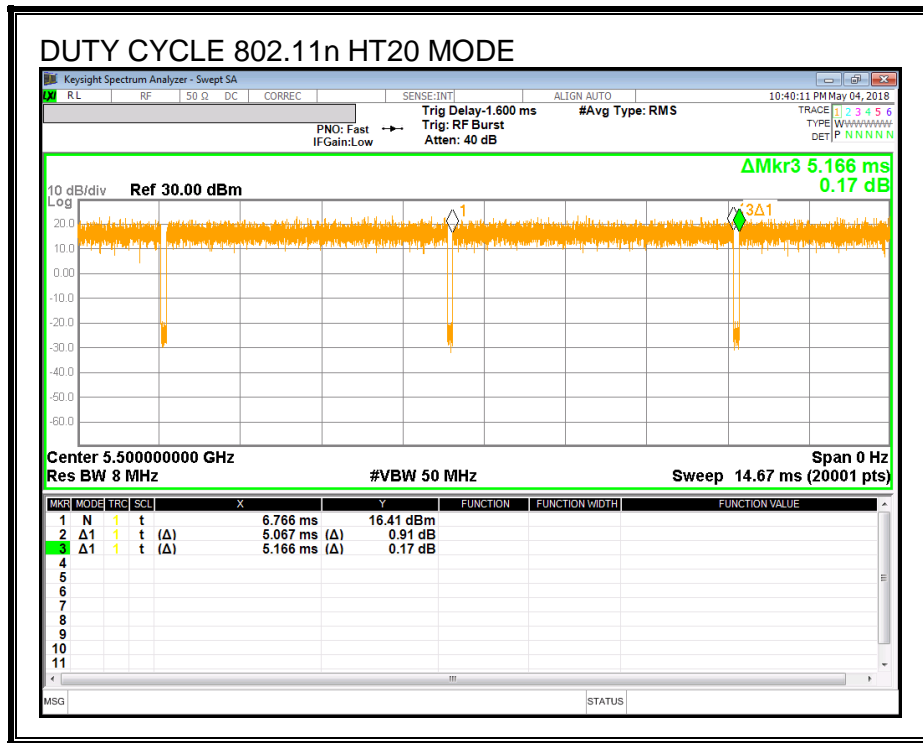

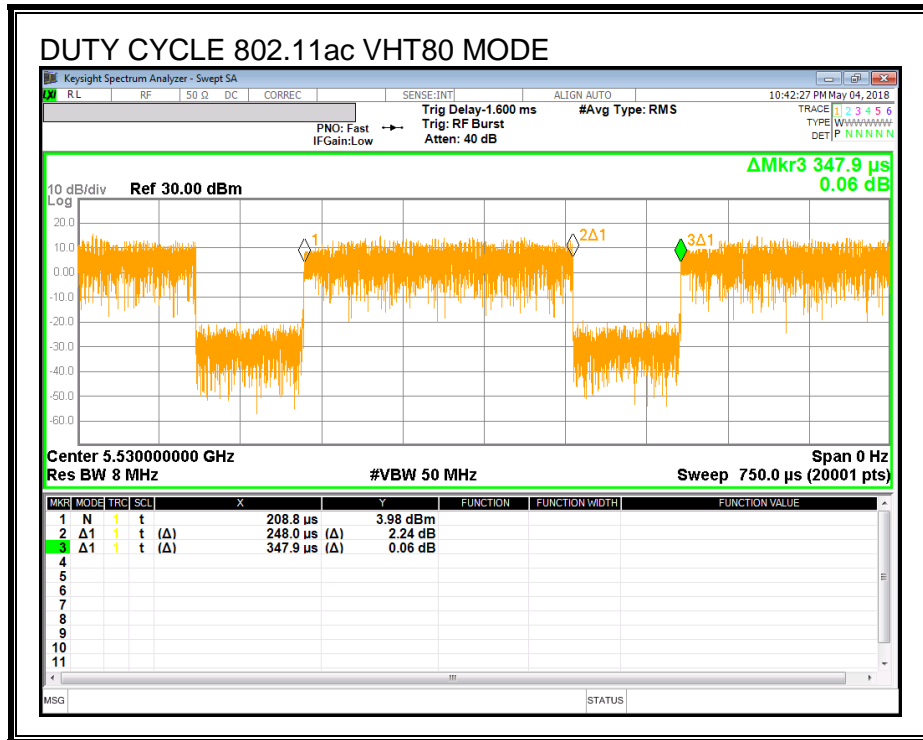

9.3. 26 dB BANDWIDTH

LIMITS

None; for reporting purposes only.

TEST PROCEDURE

Reference to 789033 D02 General UNII Test Procedures New Rules v01r03: The transmitter output is connected to a spectrum analyzer with the RBW set to approximately 1% of EBW, the VBW > RBW, peak detector and max hold.

RESULTS

9.3.1. 802.11a MODE IN THE 5.2 GHz BAND

Channel	Frequency [MHz]	26 dB Bandwidth [MHz]
Low	5180	20.42
Mid	5200	20.87
High	5240	20.30
Worst		20.87

9.3.2. 802.11n HT20 MODE IN THE 5.2 GHz BAND

Channel	Frequency [MHz]	26 dB Bandwidth [MHz]
Low	5180	20.50
Mid	5200	20.71
High	5240	20.80
Worst		20.80

9.3.3. 802.11n HT40 MODE IN THE 5.2 GHz BAND

Channel	Frequency [MHz]	26 dB Bandwidth [MHz]
Low	5190	42.84
High	5230	42.96
Worst		42.96

9.3.4. 802.11n VHT80 MODE IN THE 5.2 GHz BAND

Channel	Frequency [MHz]	26 dB Bandwidth [MHz]
Mid	5210	83.94
Worst		83.94

9.3.5. 802.11a MODE IN THE 5.3 GHz BAND

Channel	Frequency [MHz]	26 dB Bandwidth [MHz]
Low	5260	20.51
Mid	5300	20.40
High	5320	20.50
Worst		20.51

9.3.6. 802.11n HT20 MODE IN THE 5.3 GHz BAND

Channel	Frequency [MHz]	26 dB Bandwidth [MHz]
Low	5260	21.08
Mid	5300	20.87
High	5320	21.00
Worst		21.08

9.3.7. 802.11n HT40 MODE IN THE 5.3 GHz BAND

Channel	Frequency [MHz]	26 dB Bandwidth [MHz]
Low	5270	42.31
High	5310	42.61
Worst		42.61

9.3.8. 802.11ac VHT80 MODE IN THE 5.3 GHz BAND

Channel	Frequency [MHz]	26 dB Bandwidth [MHz]
Middle	5290	84.53
Worst		84.53

9.3.9. 802.11a MODE IN THE 5.5 GHz BAND

Channel	Frequency [MHz]	26 dB Bandwidth [MHz]
Low	5500	20.01
Mid	5580	20.86
High	5700	20.67
Worst		20.86

9.3.10. 802.11n HT20 MODE IN THE 5.5 GHz BAND

Channel	Frequency [MHz]	26 dB Bandwidth [MHz]
Low	5500	20.99
Mid	5580	20.87
High	5700	21.01
Worst		21.01

9.3.11. 802.11n HT40 MODE IN THE 5.5 GHz BAND

Channel	Frequency [MHz]	26 dB Bandwidth [MHz]
Low	5510	42.39
Mid	5590	42.53
High	5670	43.19
Worst		43.19

9.3.12. 802.11ac VHT80 MODE IN THE 5.5 GHz BAND

Channel	Frequency [MHz]	26 dB Bandwidth
		[MHz]
Low	5530	83.88
High	5610	83.06
Worst		83.88

9.3.13. 802.11a MODE IN THE 5.8 GHz BAND

Channel	Frequency [MHz]	26 dB Bandwidth [MHz]
Low	5745	20.21
Mid	5785	20.59
High	5825	20.80
Worst		20.80

9.3.14. 802.11n HT20 MODE IN THE 5.8 GHz BAND

Channel	Frequency [MHz]	26 dB Bandwidth [MHz]
Low	5745	20.56
Mid	5785	20.94
High	5825	20.94
Worst		20.94

9.3.15. 802.11n HT40 MODE IN THE 5.8 GHz BAND

Channel	Frequency [MHz]	26 dB Bandwidth [MHz]
Low	5755	41.93
High	5795	42.80
Worst		42.80

9.3.16. 802.11ac VHT80 MODE IN THE 5.8 GHz BAND

Channel	Frequency [MHz]	26 dB Bandwidth [MHz]
Middle	5775	83.91
Worst		83.91

UNII 5.2 GHz IEEE 802.11a mode



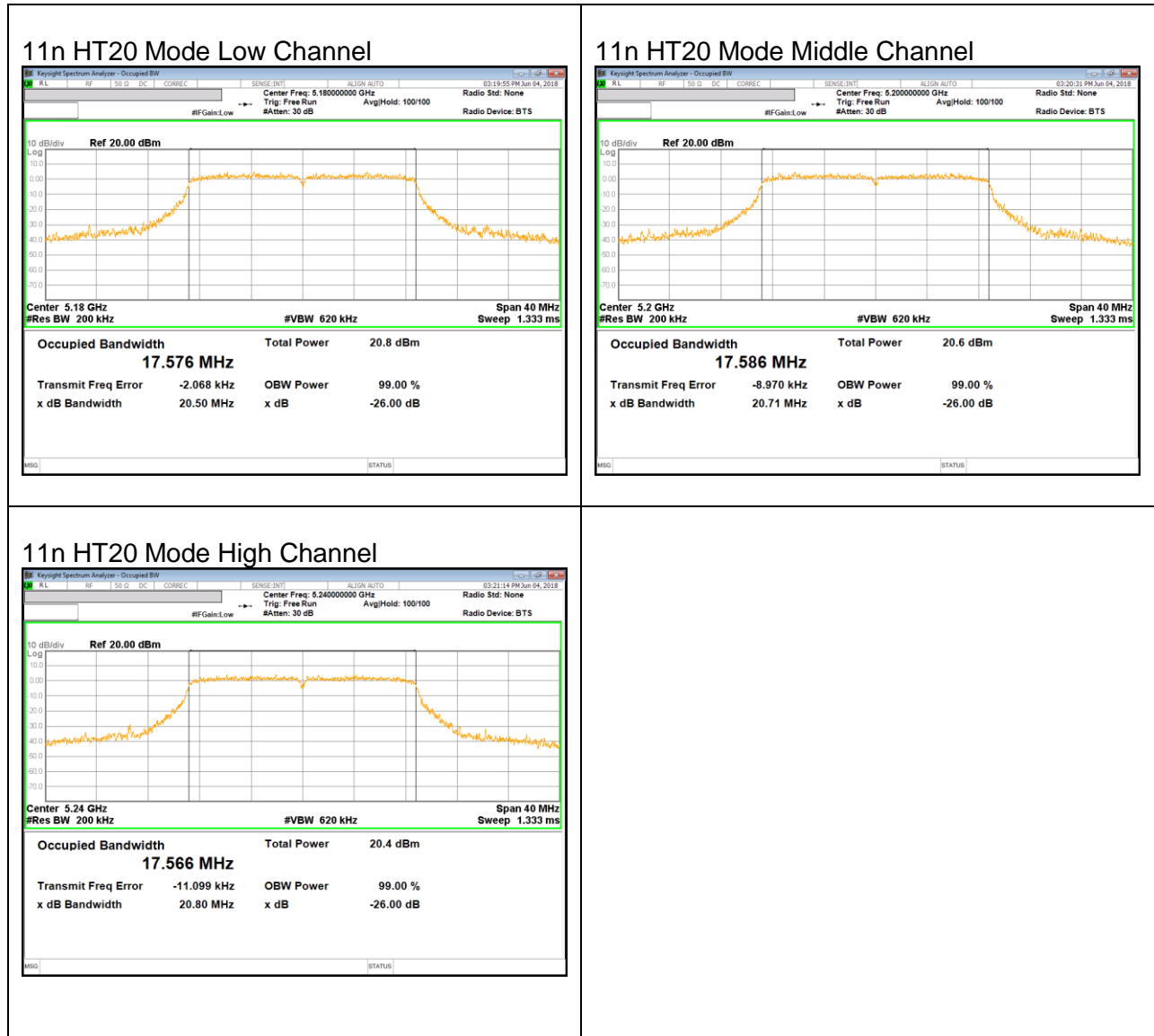

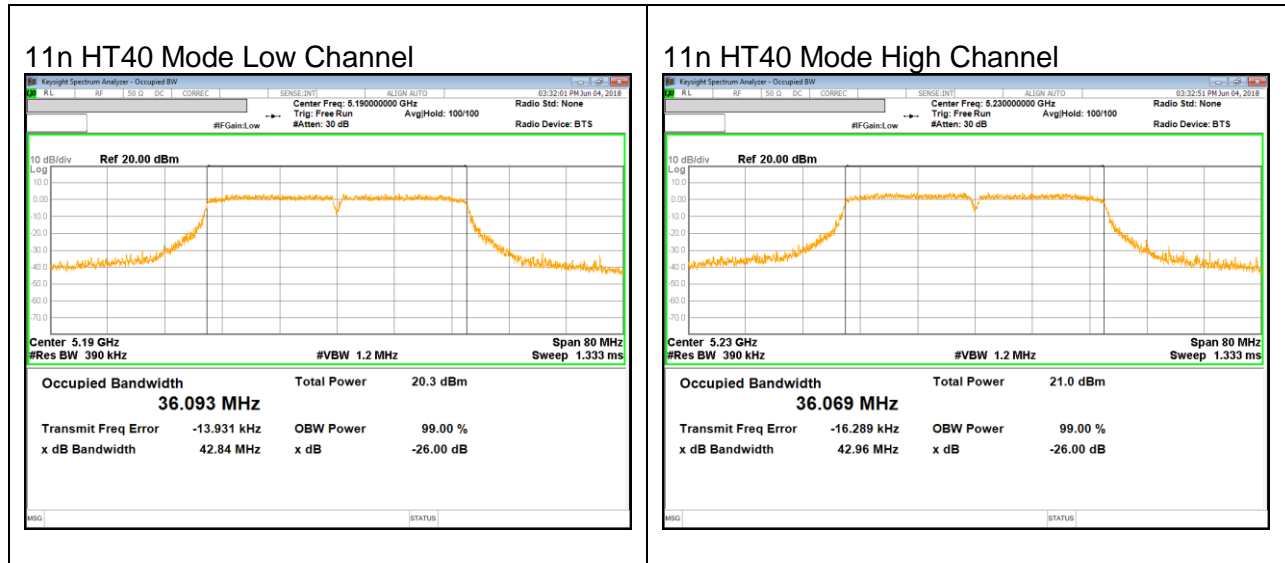

UNII 5.2 GHz IEEE 802.11ac VHT80 mode

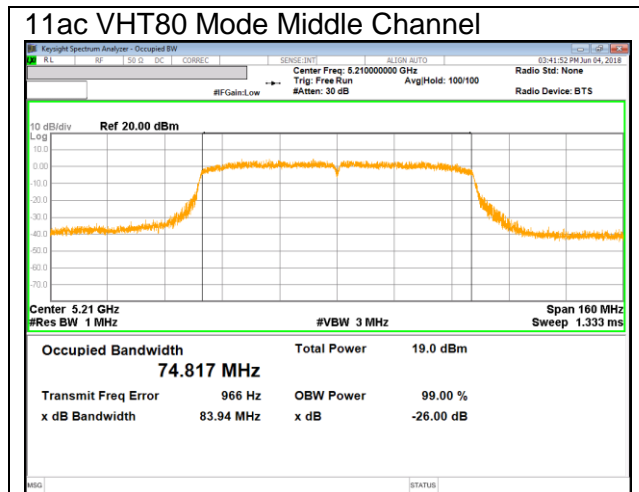

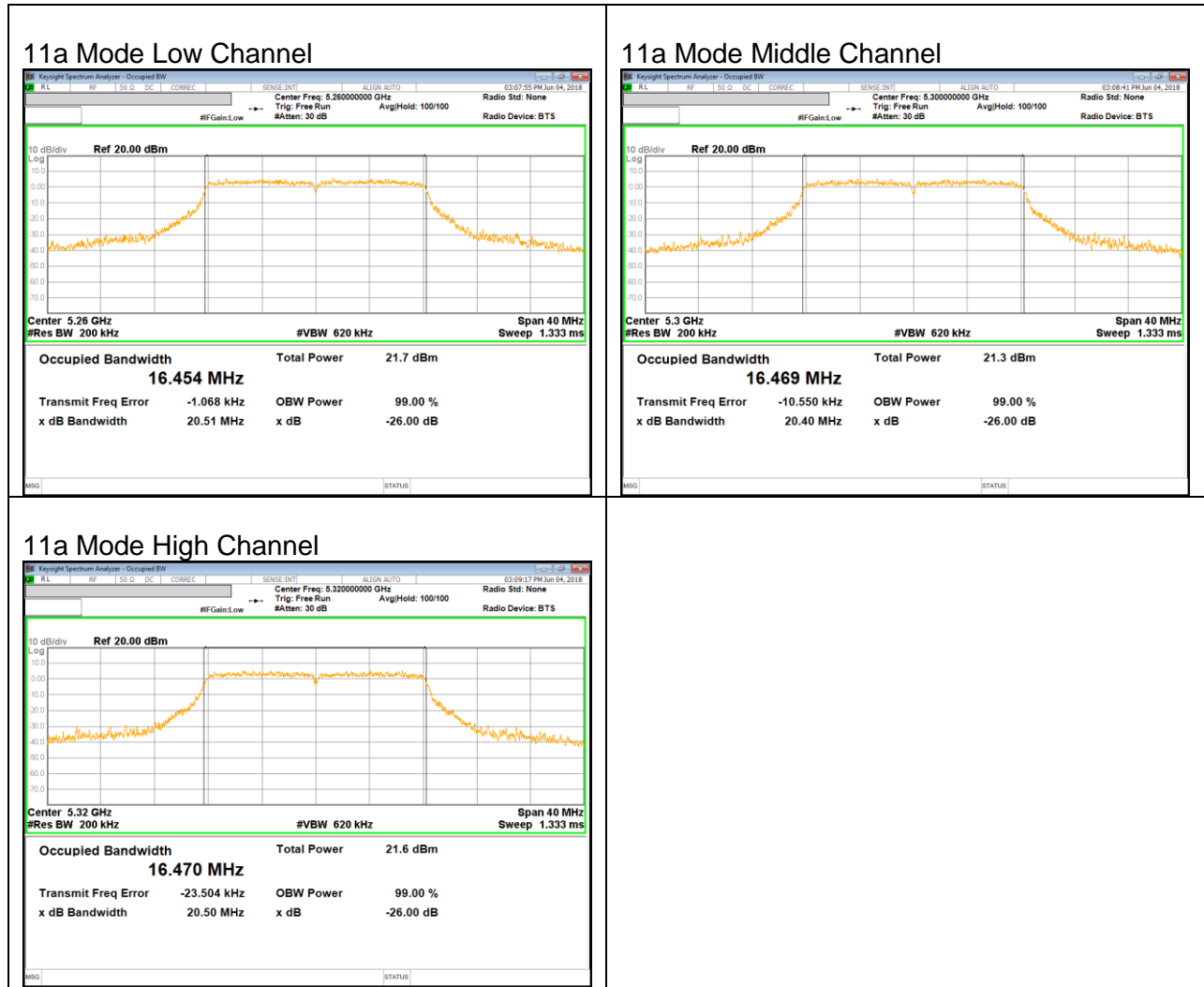

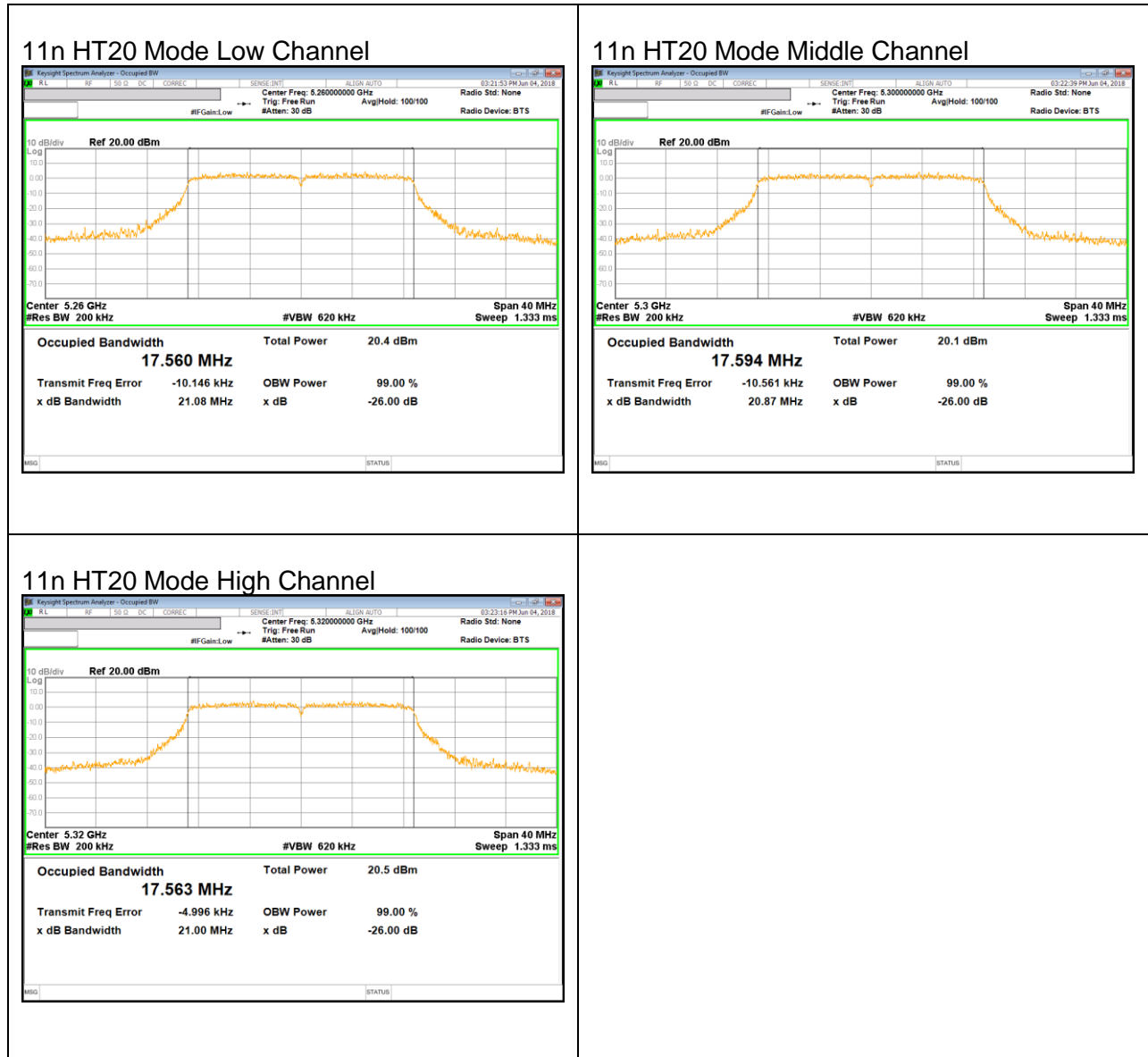

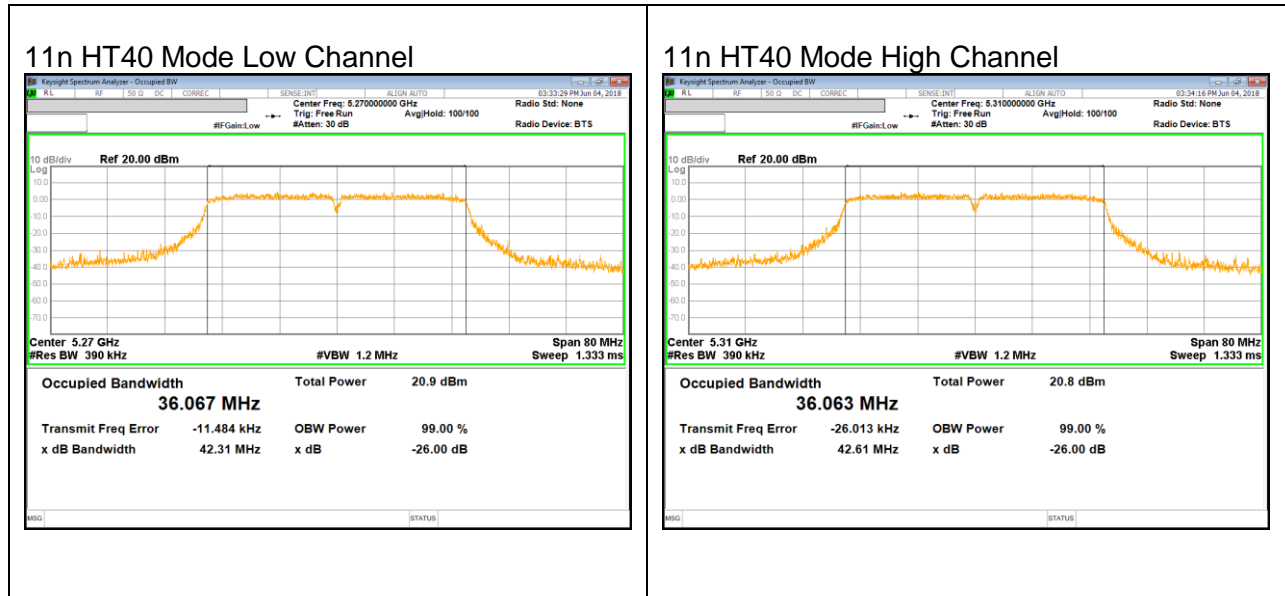

UNII 5.3 GHz IEEE 802.11ac VHT80 mode

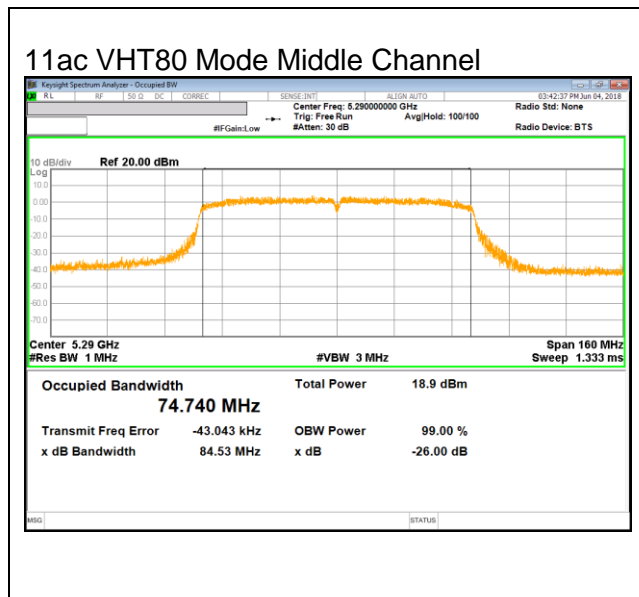

11a Mode Low Channel

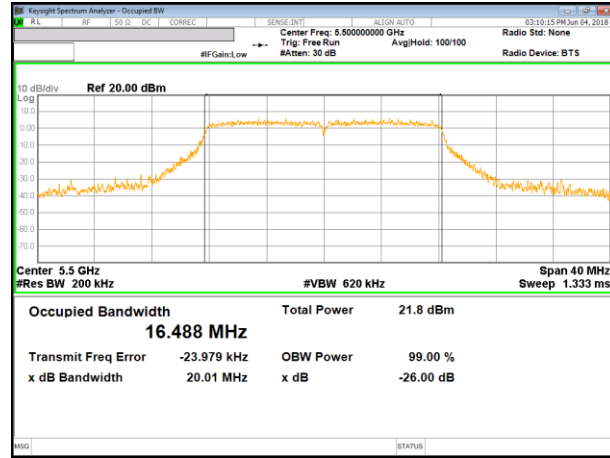

11a Mode Middle Channel

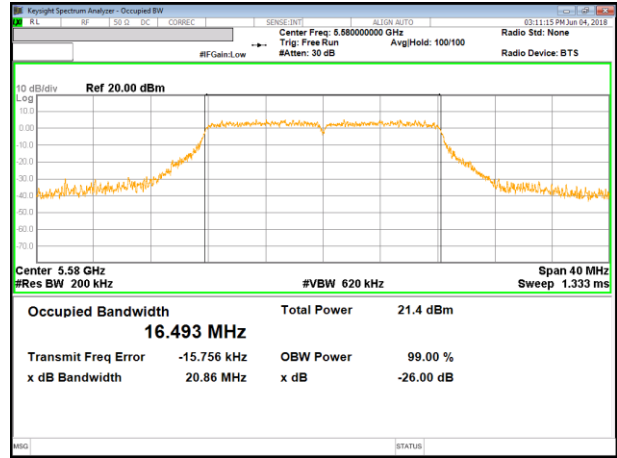

11a Mode High Channel

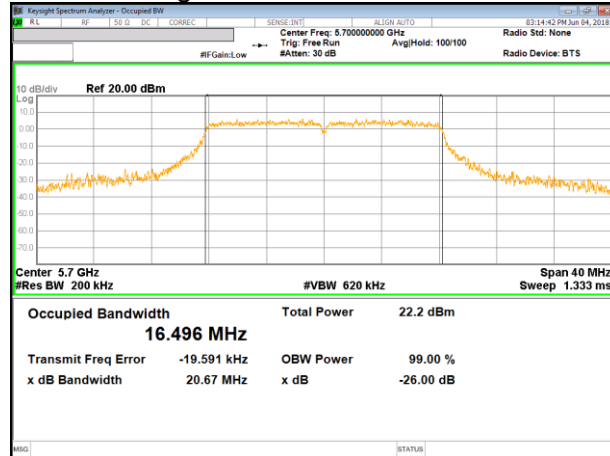

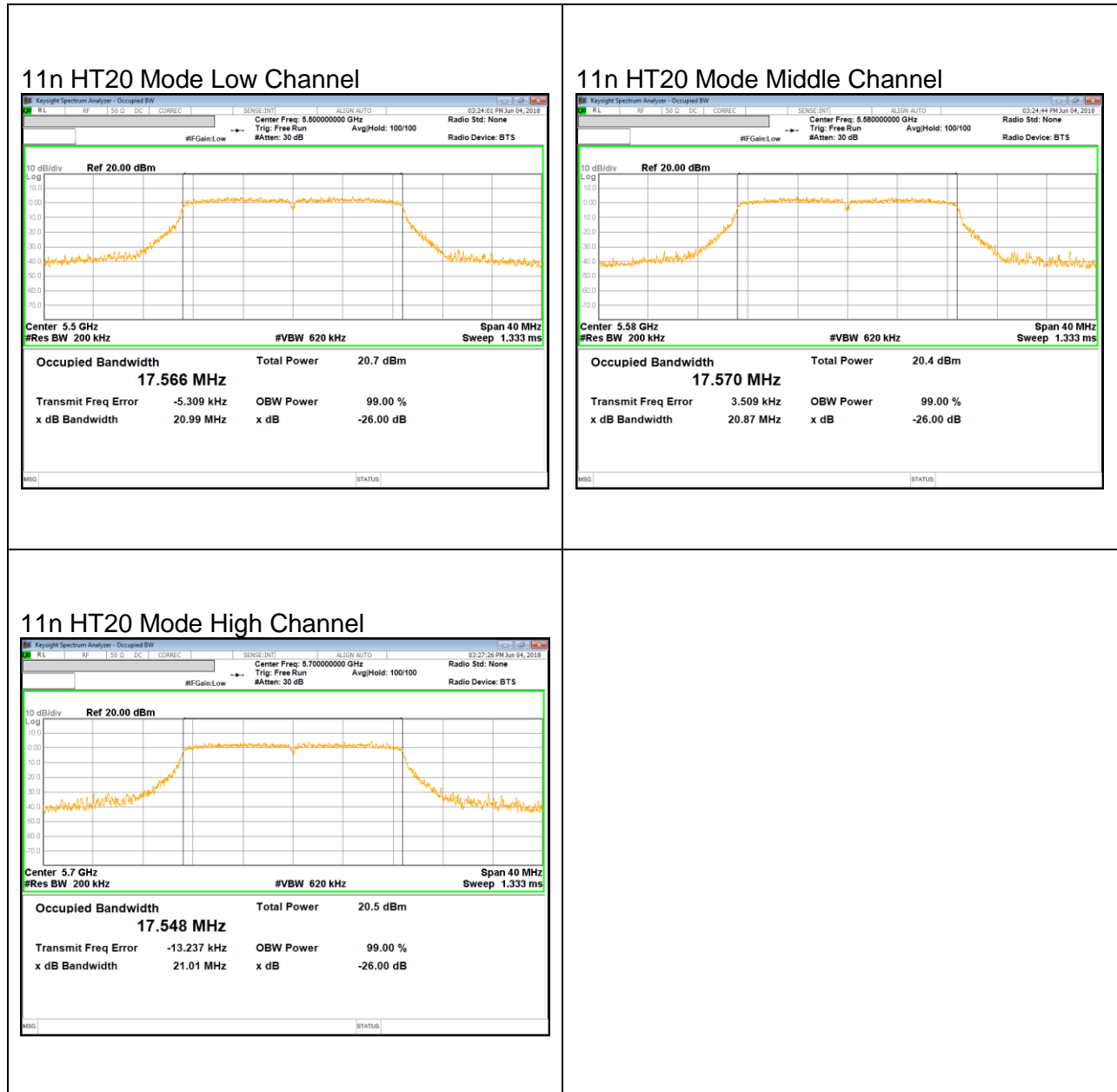

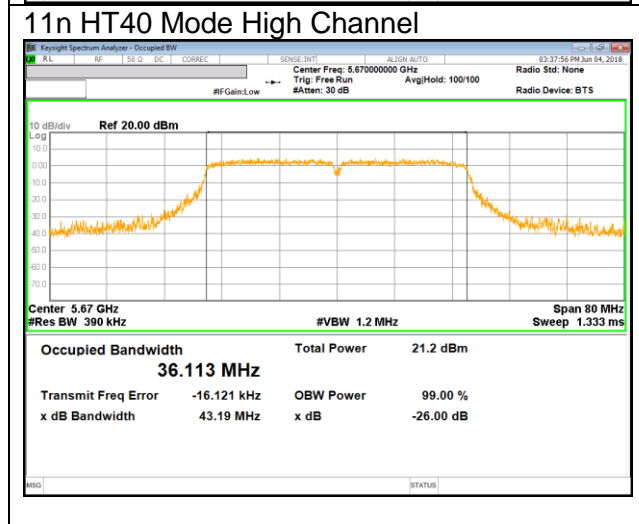
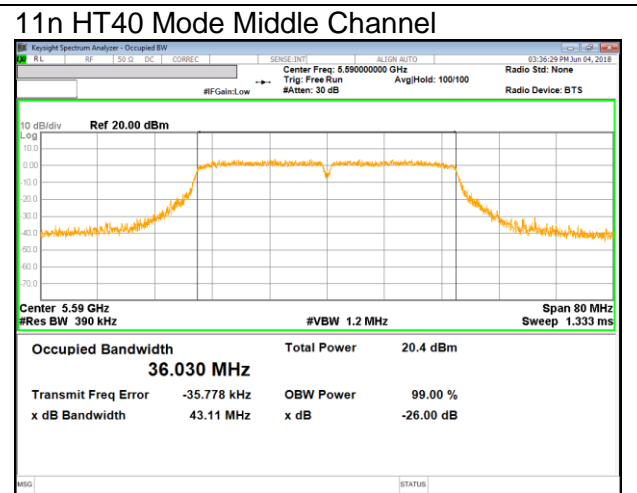
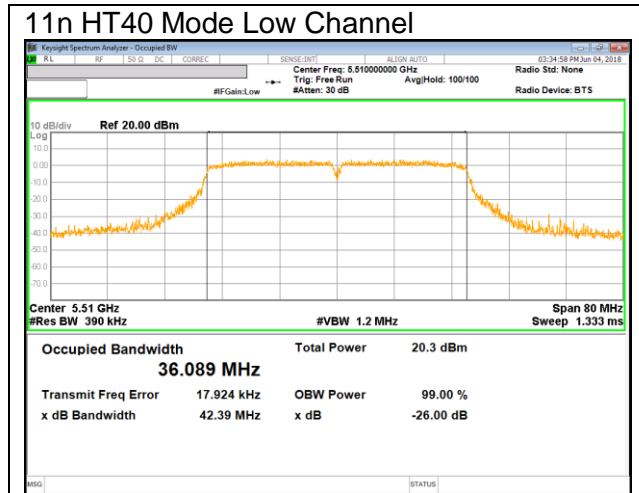

UNII 5.5 GHz IEEE 802.11ac VHT80 mode

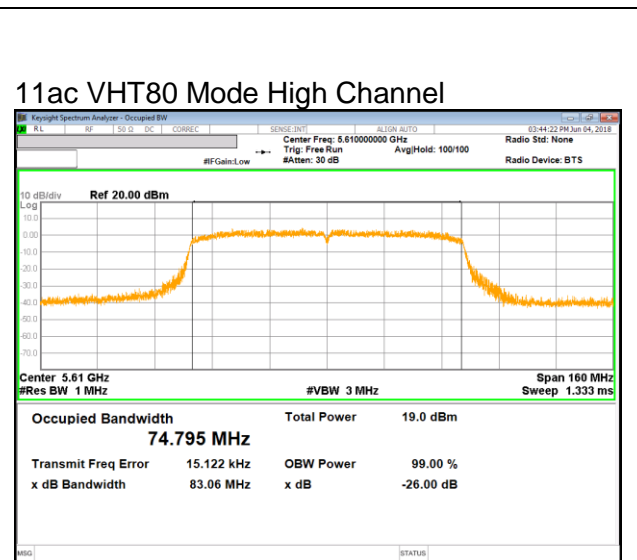
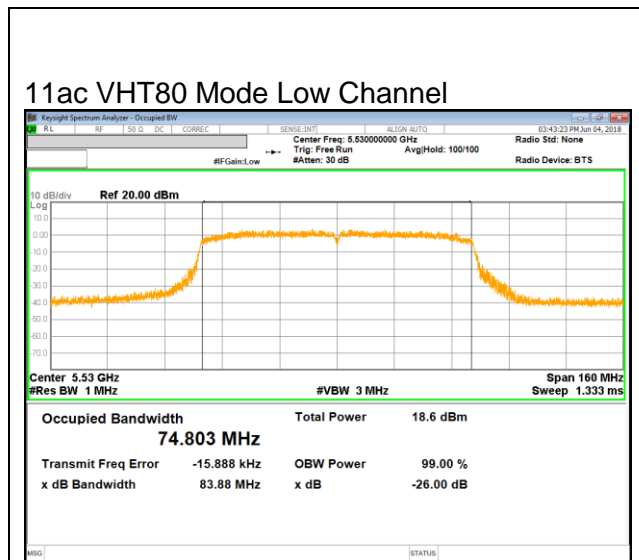

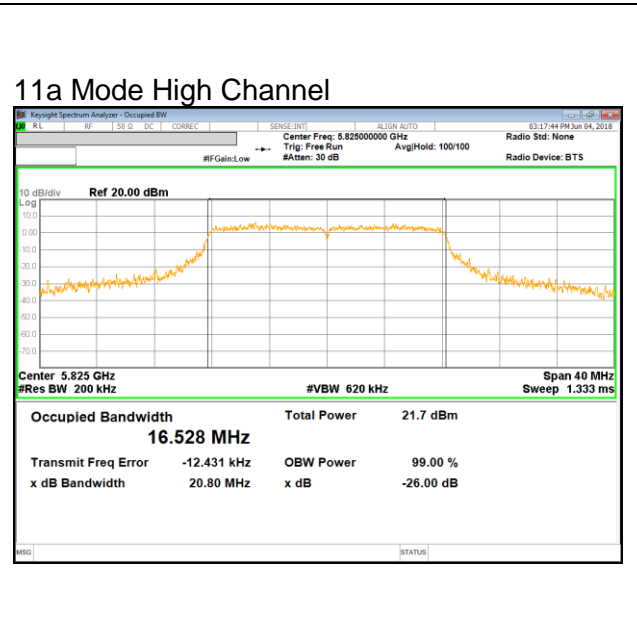
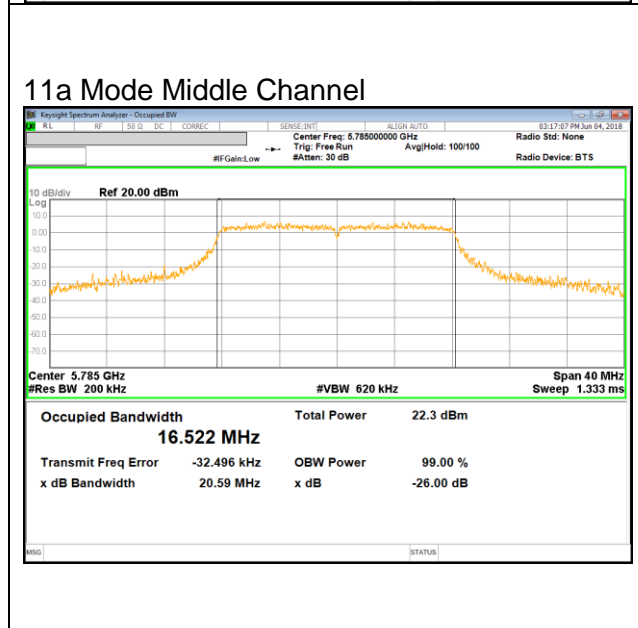
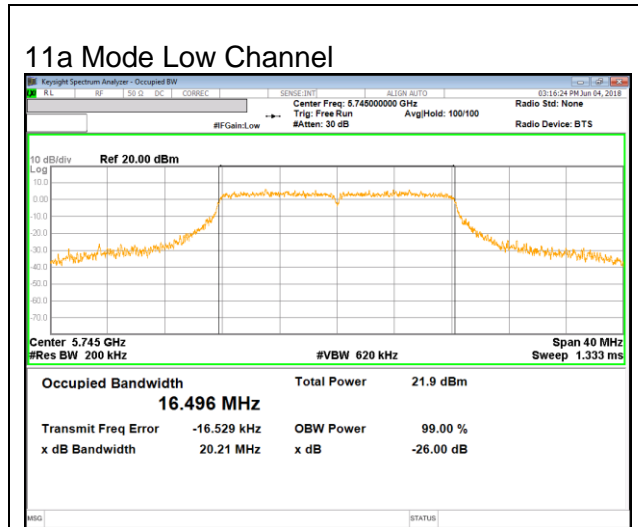

11n HT20 Mode Low Channel

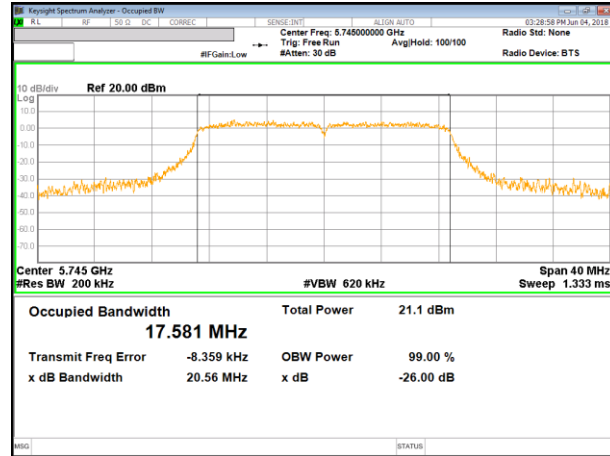

11n HT20 Mode Middle Channel

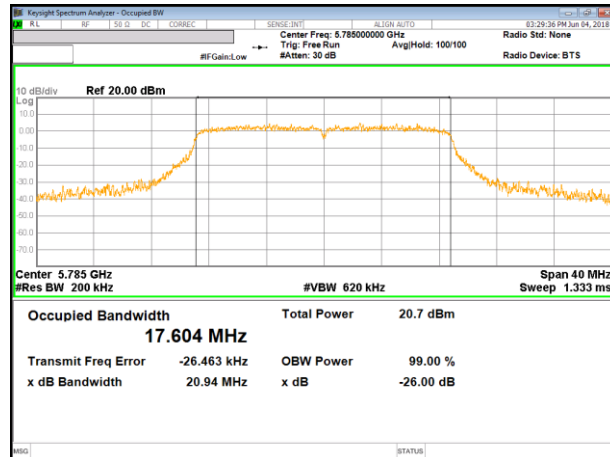

11n HT20 Mode High Channel

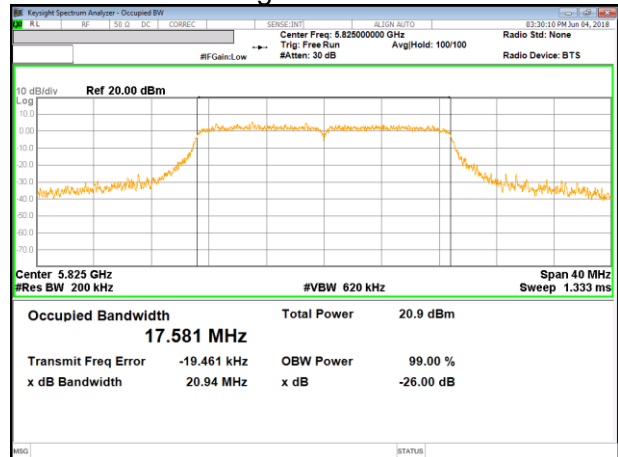

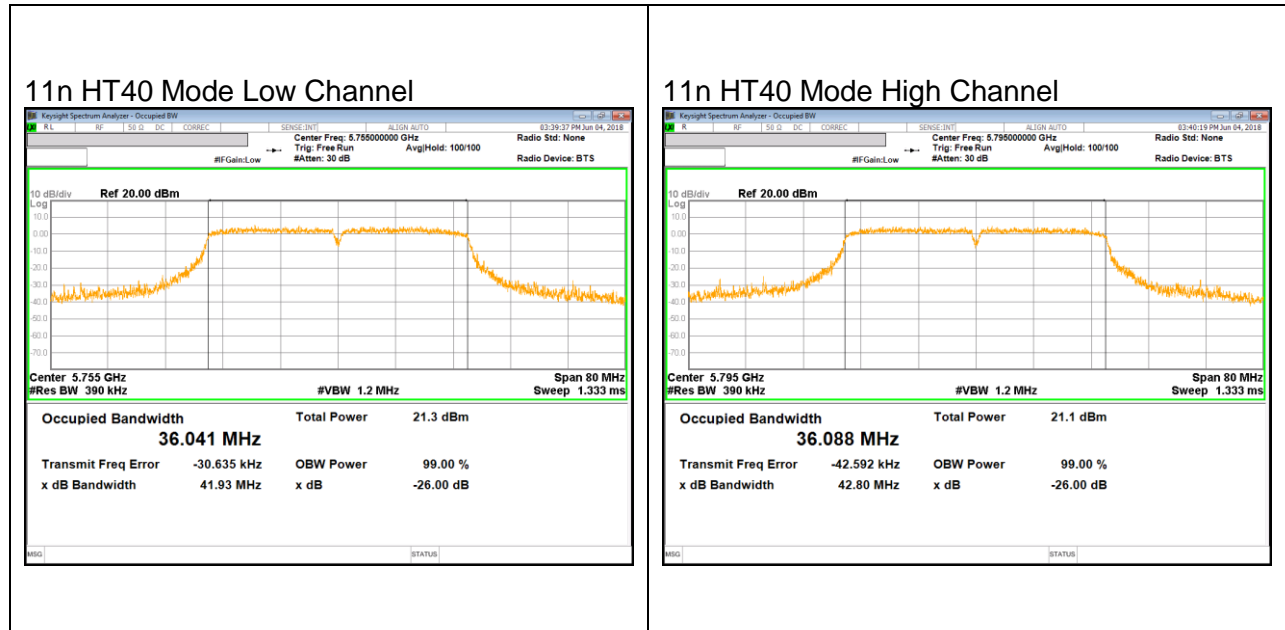

UNII 5.8 GHz IEEE 802.11ac VHT80 mode

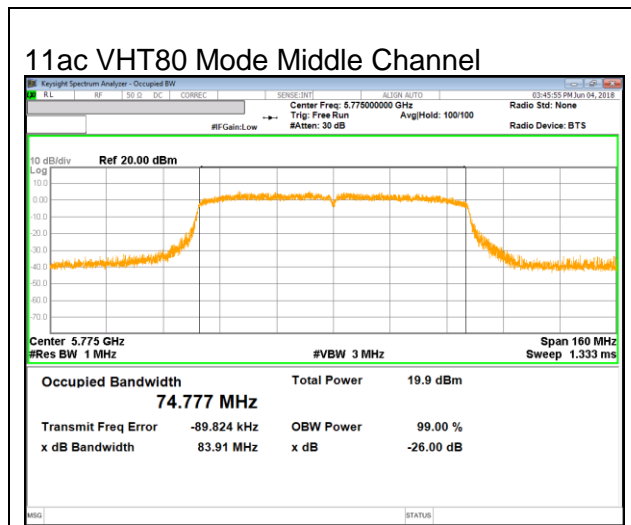

9.4. 99% BANDWIDTH

LIMITS

None; for reporting purposes only.

TEST PROCEDURE

Reference to 789033 D02 General UNII Test Procedures New Rules v01r02: The transmitter output is connected to a spectrum analyzer with the RBW set to approximately 1% to 5% of OBW, the VBW $\geq 3 \times$ RBW, single sweep.

RESULTS

9.4.1. 802.11a MODE IN THE 5.2 GHz BAND

Channel	Frequency [MHz]	99% Bandwidth [MHz]
Low	5180	16.45
Mid	5200	16.44
High	5240	16.46
Worst		16.46

9.4.2. 802.11n HT20 MODE IN THE 5.2 GHz BAND

Channel	Frequency [MHz]	99% Bandwidth [MHz]
Low	5180	17.61
Mid	5200	17.59
High	5240	17.57
Worst		17.61

9.4.3. 802.11n HT40 MODE IN THE 5.2 GHz BAND

Channel	Frequency [MHz]	99% Bandwidth [MHz]
Low	5190	35.98
High	5230	36.00
Worst		36.00

9.4.4. 802.11n VHT80 MODE IN THE 5.2 GHz BAND

Channel	Frequency [MHz]	99% Bandwidth [MHz]
Mid	5210	74.93
Worst		74.93

9.4.5. 802.11a MODE IN THE 5.3 GHz BAND

Channel	Frequency [MHz]	99% Bandwidth [MHz]
Low	5260	16.45
Mid	5300	16.46
High	5320	16.44
Worst		16.46

9.4.6. 802.11n HT20 MODE IN THE 5.3 GHz BAND

Channel	Frequency [MHz]	99% Bandwidth [MHz]
Low	5260	17.59
Mid	5300	17.61
High	5320	17.61
Worst		17.61

9.4.7. 802.11n HT40 MODE IN THE 5.3 GHz BAND

Channel	Frequency [MHz]	99% Bandwidth [MHz]
Low	5270	36.07
High	5310	36.00
Worst		36.07

9.4.8. 802.11ac VHT80 MODE IN THE 5.3 GHz BAND

Channel	Frequency [MHz]	99% Bandwidth [MHz]
Middle	5290	74.75
Worst		74.75

9.4.9. 802.11a MODE IN THE 5.5 GHz BAND

Channel	Frequency [MHz]	99% Bandwidth [MHz]
Low	5500	16.45
Mid	5580	16.42
High	5700	16.47
Worst		16.47

9.4.10. 802.11n HT20 MODE IN THE 5.5 GHz BAND

Channel	Frequency [MHz]	99% Bandwidth [MHz]
Low	5500	17.59
Mid	5580	17.57
High	5700	17.61
Worst		17.61

9.4.11. 802.11n HT40 MODE IN THE 5.5 GHz BAND

Channel	Frequency [MHz]	99% Bandwidth [MHz]
Low	5510	35.99
Mid	5590	36.01
High	5670	36.09
Worst		36.09

9.4.12. 802.11ac VHT80 MODE IN THE 5.5 GHz BAND

Channel	Frequency [MHz]	99% Bandwidth
		[MHz]
Low	5530	74.71
High	5610	74.72
Worst		74.71

9.4.13. 802.11a MODE IN THE 5.8 GHz BAND

Channel	Frequency [MHz]	99% Bandwidth [MHz]
Low	5745	16.45
Mid	5785	16.46
High	5825	16.45
Worst		16.46

9.4.14. 802.11n HT20 MODE IN THE 5.8 GHz BAND

Channel	Frequency [MHz]	99% Bandwidth [MHz]
Low	5745	17.60
Mid	5785	17.60
High	5825	17.60
Worst		17.60

9.4.15. 802.11n HT40 MODE IN THE 5.8 GHz BAND

Channel	Frequency [MHz]	99% Bandwidth [MHz]
Low	5755	36.07
High	5795	36.03
Worst		36.07

9.4.16. 802.11ac VHT80 MODE IN THE 5.8 GHz BAND

Channel	Frequency [MHz]	99% Bandwidth [MHz]
Middle	5775	74.75
Worst		74.75

UNII 5.2 GHz IEEE 802.11a mode



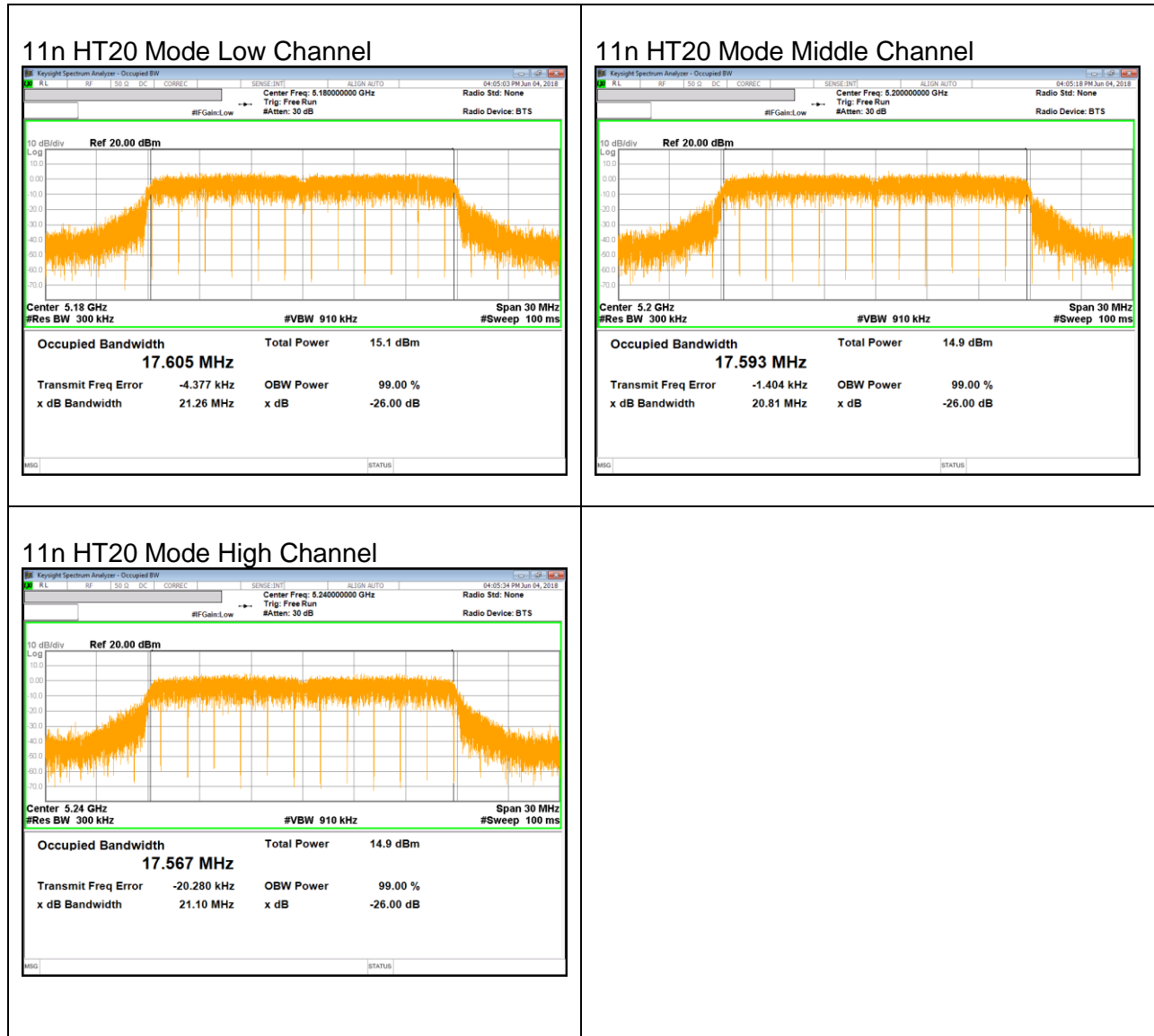

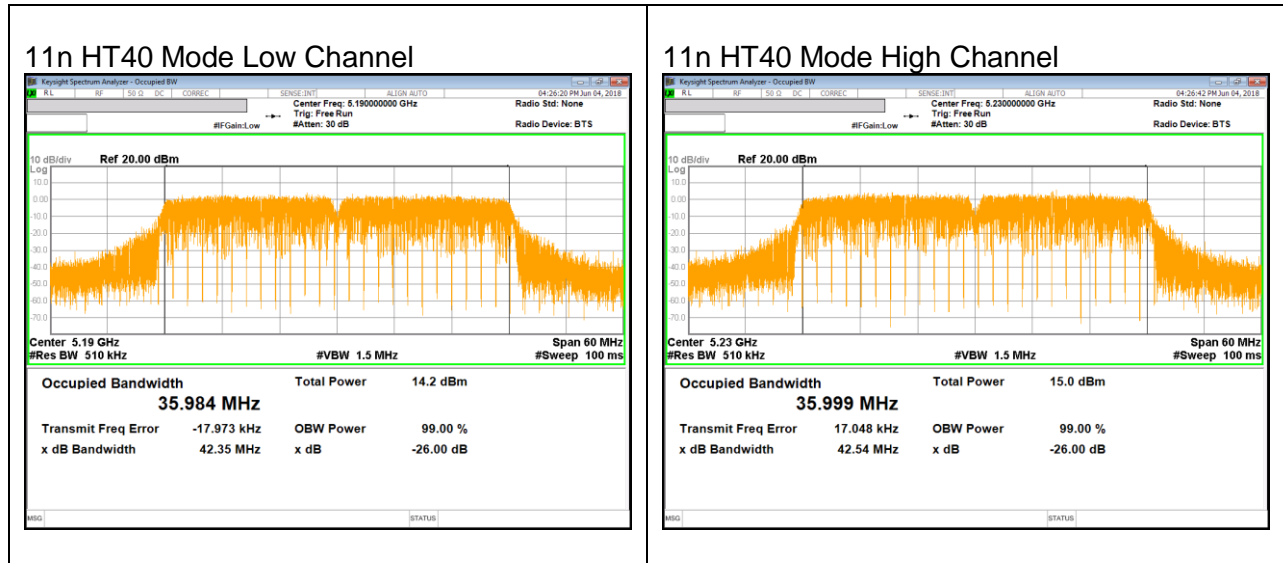

UNII 5.2 GHz IEEE 802.11ac VHT80 mode

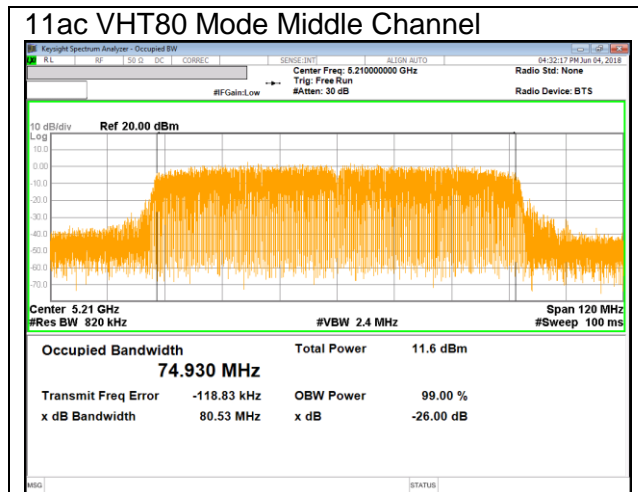



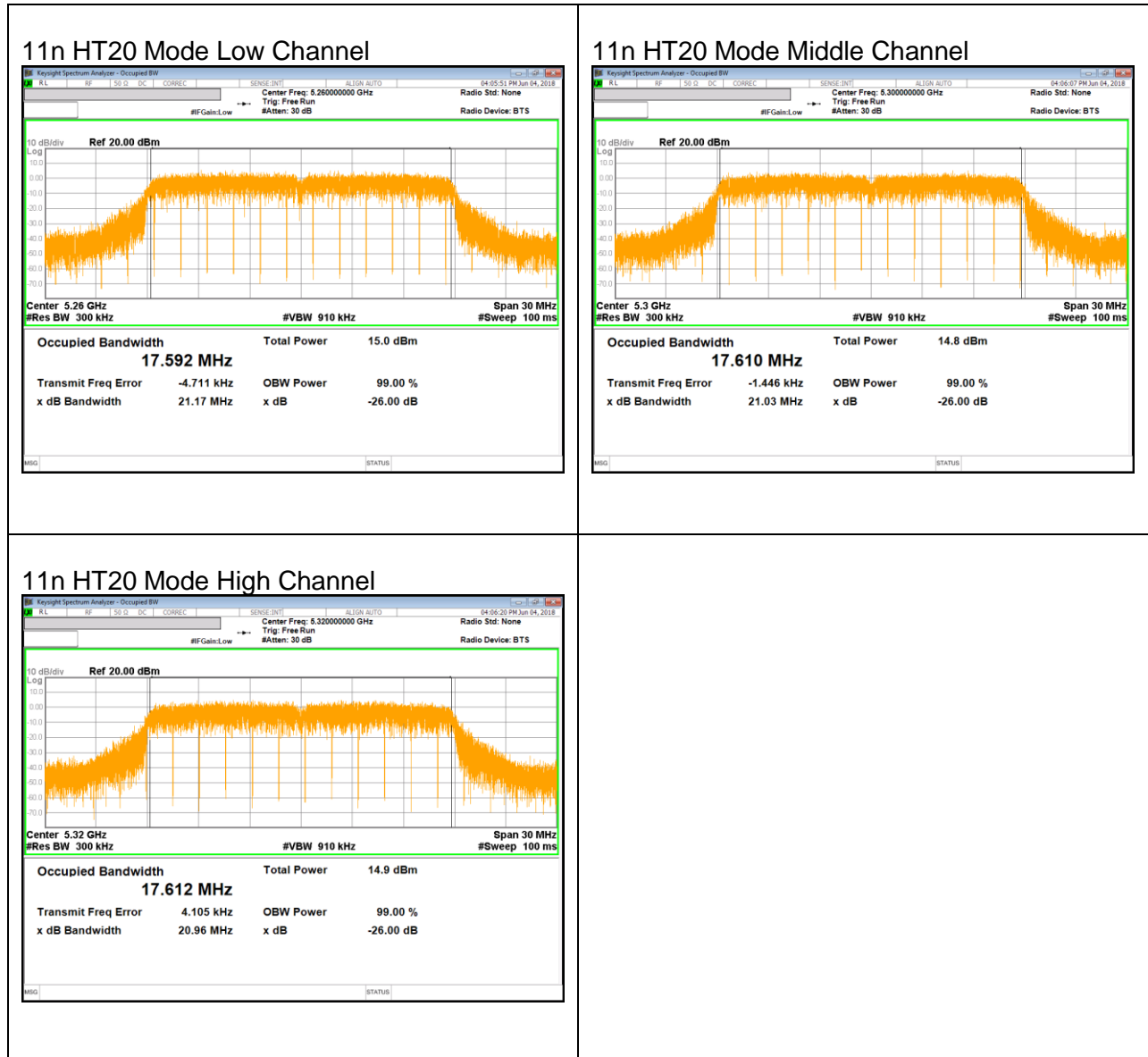

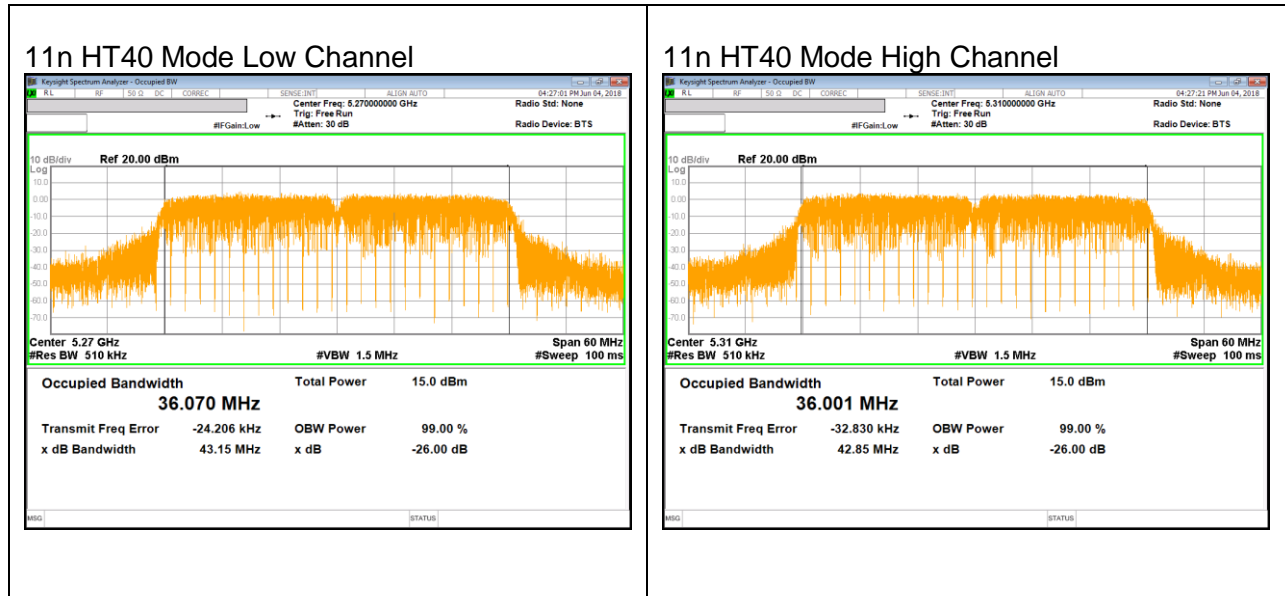

UNII 5.3 GHz IEEE 802.11ac VHT80 mode

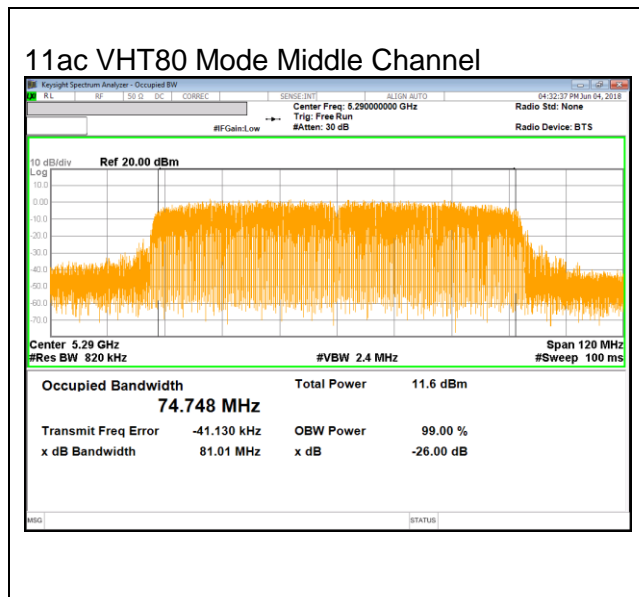

11a Mode Low Channel

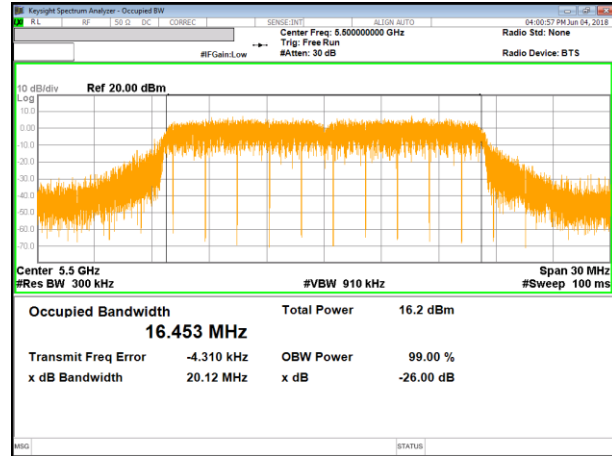

11a Mode Middle Channel

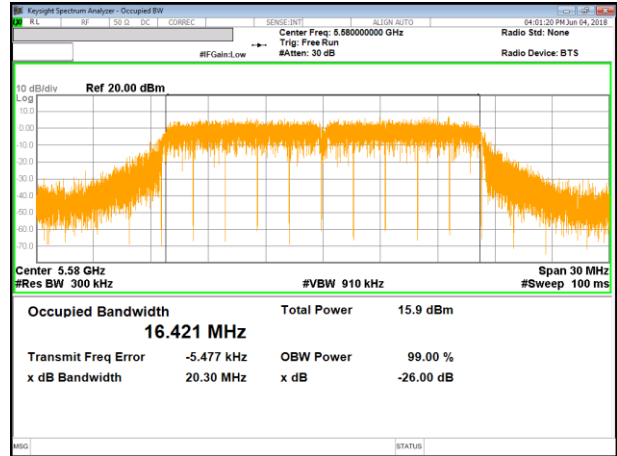

11a Mode High Channel

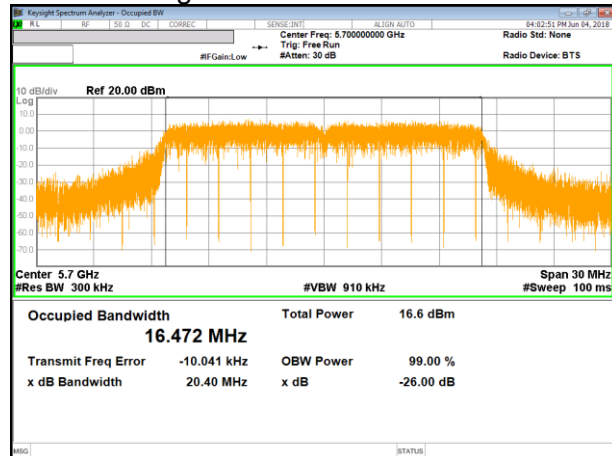

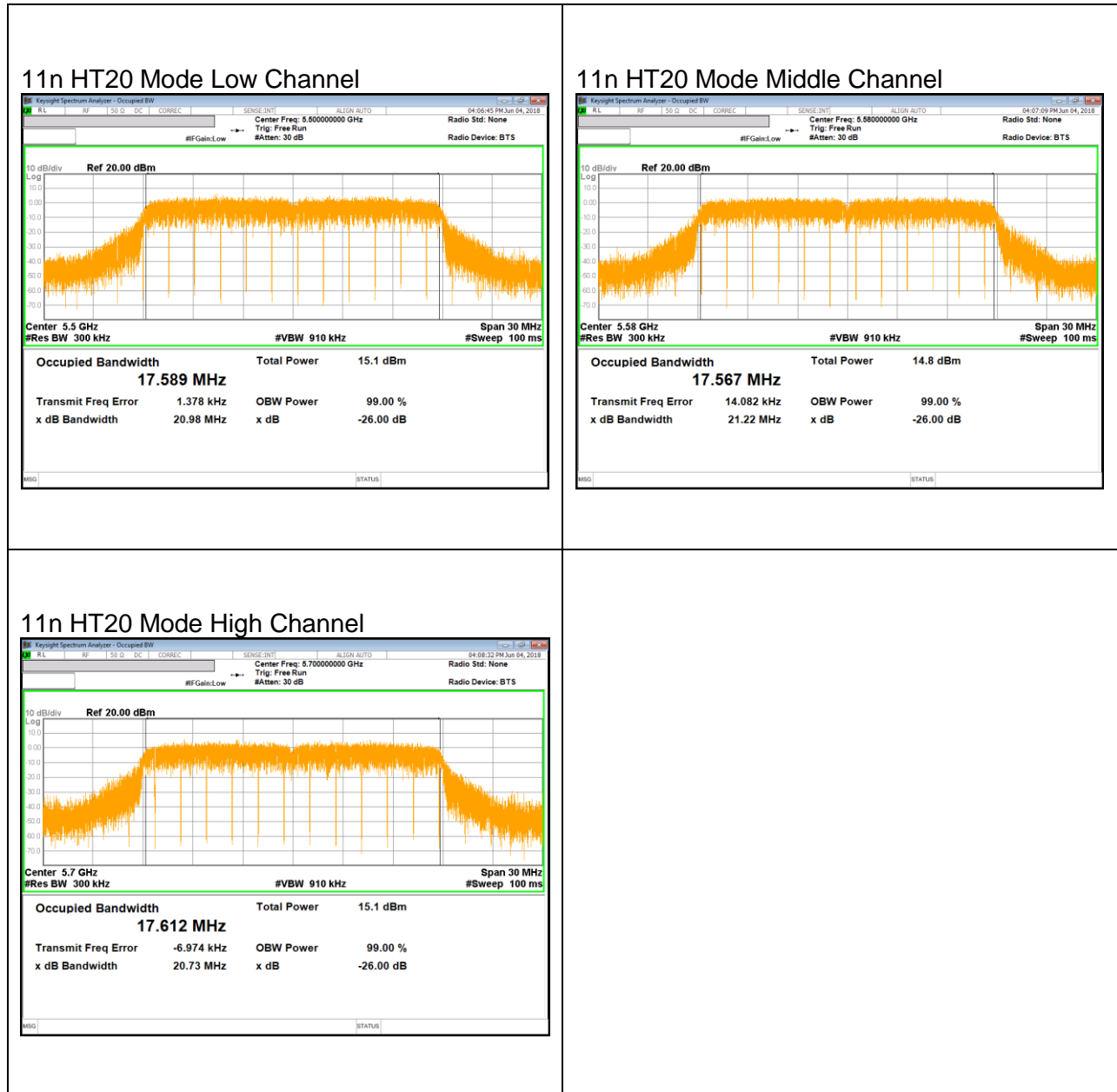

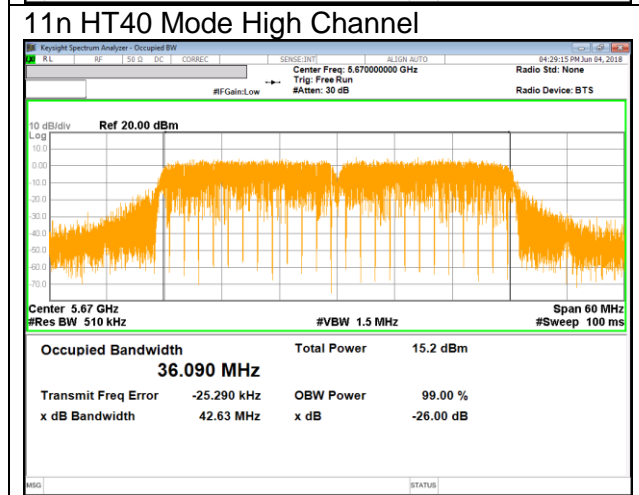
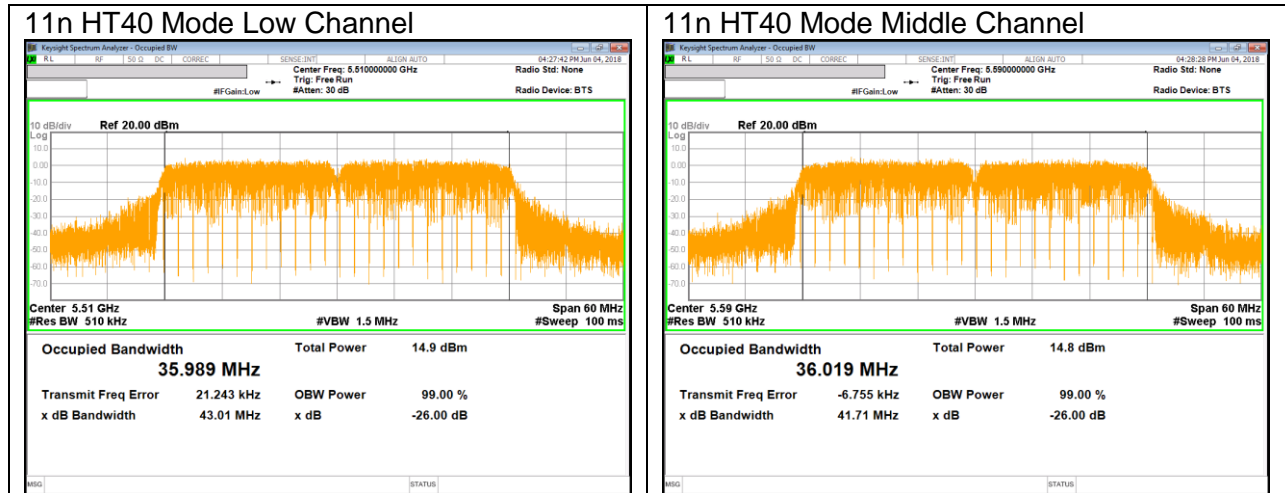

UNII 5.5 GHz IEEE 802.11ac VHT80 mode

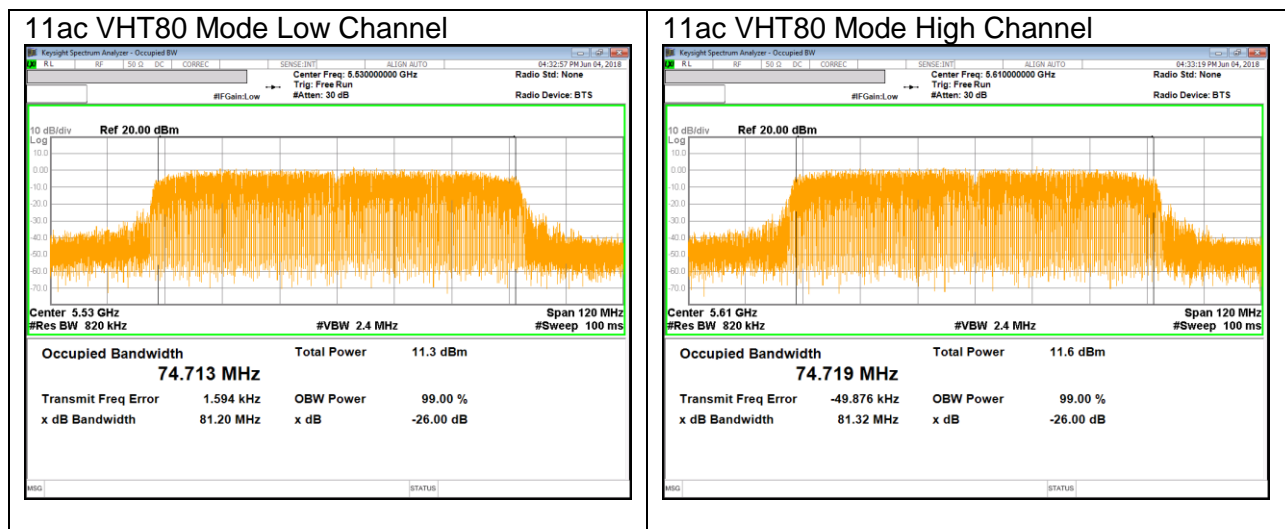

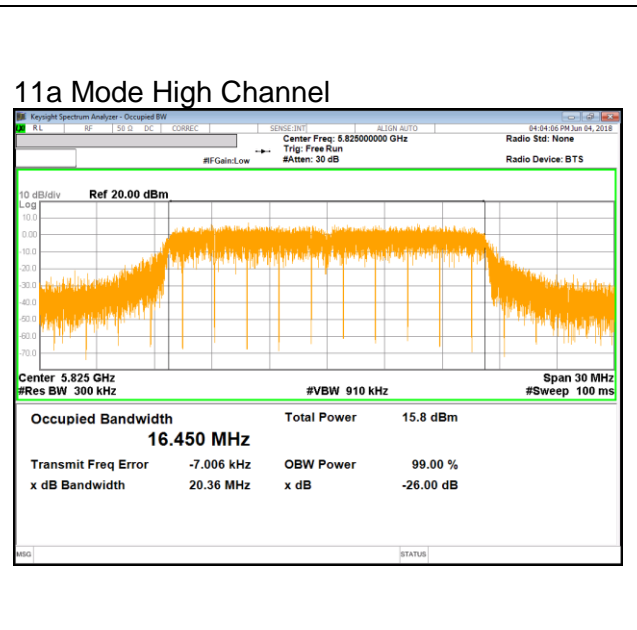
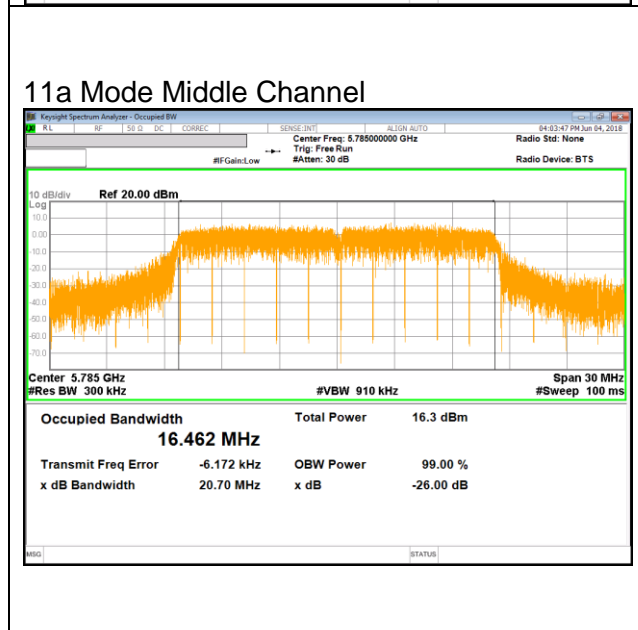
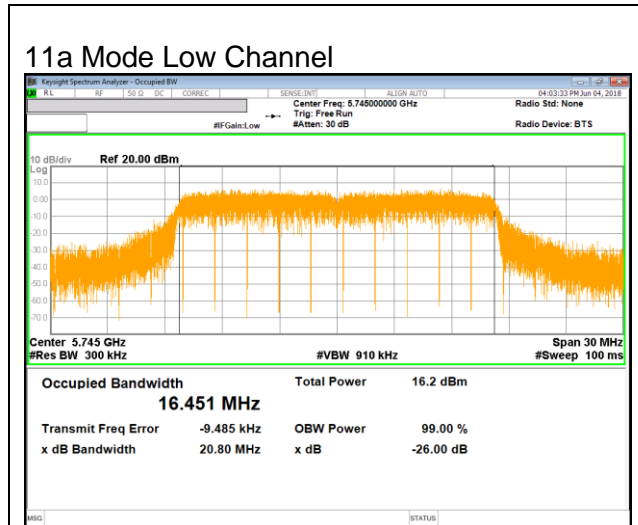

UNII 5.8 GHz IEEE 802.11n HT20 mode

11n HT20 Mode Low Channel

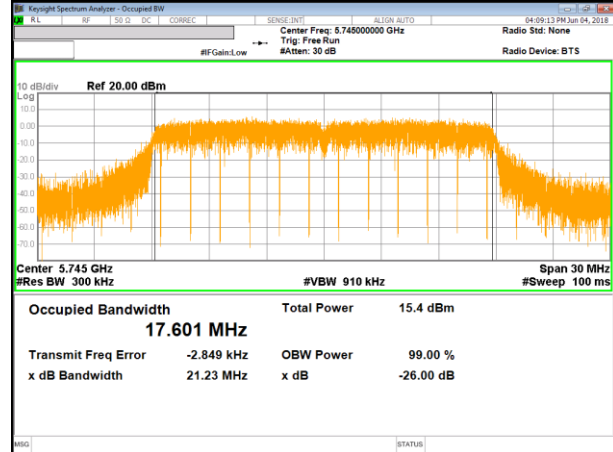

11n HT20 Mode Middle Channel

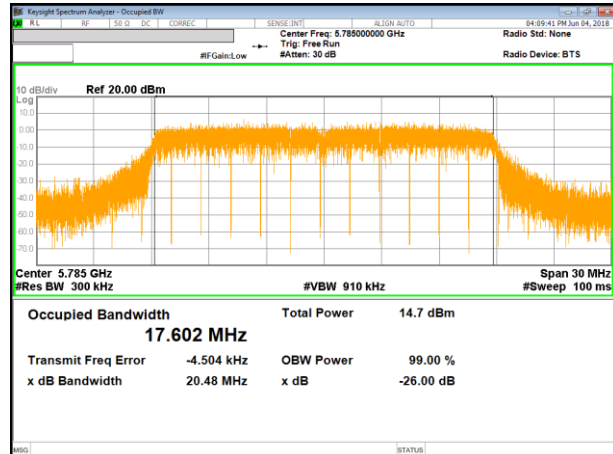

11n HT20 Mode High Channel

