



**FCC 47 CFR PART 15 SUBPART E**

**UNII**

**CERTIFICATION TEST REPORT**

**FOR**

**WCDMA/LTE Tablet + BT/BLE, DTS/UNII a/b/g/n and ANT+**

**MODEL NUMBER : SM-T387V, SM-T387VK**

**FCC ID: A3LSMT387V**

**REPORT NUMBER: 4788481138-E4V3**

**ISSUE DATE: JUL 03, 2018**

*Prepared for*  
**SAMSUNG ELECTRONICS CO., LTD.**  
**129 SAMSUNG-RO, YEONGTONG-GU, SUWON-SI,**  
**GYEONGGI-DO, 16677, KOREA**

*Prepared by*  
**UL Korea, Ltd.**  
**26th floor, 152, Teheran-ro, Gangnam-gu Seoul, 06236, Korea**

**Suwon Test Site: UL Korea, Ltd. Suwon Laboratory**  
**218 Maeyeong-ro, Yeongtong-gu,**  
**Suwon-si, Gyeonggi-do, 16675, Korea**  
**TEL: (031) 337-9902**  
**FAX: (031) 213-5433**



**ACCREDITED\***

Testing  
Laboratory

**TL-637**

Revision History

<u>Rev.</u>	<u>Issue Date</u>	<u>Revisions</u>	<u>Revised By</u>
V1	06/26/18	Initial issue	Junwhan Lee
V2	06/29/18	Updated to address TCB's question	Junwhan Lee
V3	07/03/18	Updated to address TCB's question	Junwhan Lee

## TABLE OF CONTENTS

<b>1. ATTESTATION OF TEST RESULTS .....</b>	<b>6</b>
<b>2. TEST METHODOLOGY .....</b>	<b>7</b>
<b>3. FACILITIES AND ACCREDITATION .....</b>	<b>7</b>
<b>4. CALIBRATION AND UNCERTAINTY .....</b>	<b>7</b>
4.1. MEASURING INSTRUMENT CALIBRATION .....	7
4.2. SAMPLE CALCULATION .....	7
4.3. MEASUREMENT UNCERTAINTY.....	8
<b>5. EQUIPMENT UNDER TEST .....</b>	<b>9</b>
5.1. DESCRIPTION OF EUT .....	9
5.1. MAXIMUM OUTPUT POWER.....	9
5.2. DESCRIPTION OF AVAILABLE ANTENNAS .....	10
5.3. WORST-CASE CONFIGURATION AND MODE.....	10
5.4. DESCRIPTION OF TEST SETUP.....	12
<b>6. TEST AND MEASUREMENT EQUIPMENT .....</b>	<b>14</b>
<b>7. SUMMARY TABLE .....</b>	<b>15</b>
<b>8. MEASUREMENT METHODS .....</b>	<b>16</b>
<b>9. REFERENCE MEASUREMENTS RESULTS .....</b>	<b>17</b>
9.1. ON TIME AND DUTY CYCLE RESULTS.....	17
9.2. DUTY CYCLE PLOTS .....	17
9.3. 26 dB BANDWIDTH.....	19
9.3.1. 802.11a MODE IN THE 5.2 GHz BAND.....	19
9.3.2. 802.11n HT20 MODE IN THE 5.2 GHz BAND .....	19
9.3.3. 802.11n HT40 MODE IN THE 5.2 GHz BAND .....	19
9.3.4. 802.11a MODE IN THE 5.3 GHz BAND.....	20
9.3.5. 802.11n HT20 MODE IN THE 5.3 GHz BAND .....	20
9.3.6. 802.11n HT40 MODE IN THE 5.3 GHz BAND .....	20
9.3.7. 802.11a MODE IN THE 5.5 GHz BAND.....	21
9.3.8. 802.11n HT20 MODE IN THE 5.5 GHz BAND .....	21
9.3.9. 802.11n HT40 MODE IN THE 5.5 GHz BAND .....	21
9.3.10. 802.11a MODE IN THE 5.8 GHz BAND.....	22
9.3.11. 802.11n HT20 MODE IN THE 5.8 GHz BAND .....	22
9.3.12. 802.11n HT40 MODE IN THE 5.8 GHz BAND .....	22
9.3.13. 26 dB BANDWIDTH PLOTS .....	23
9.4. 99% BANDWIDTH.....	35
9.4.1. 802.11a MODE IN THE 5.2 GHz BAND.....	35
9.4.2. 802.11n HT20 MODE IN THE 5.2 GHz BAND .....	35

9.4.3.	802.11n HT40 MODE IN THE 5.2 GHz BAND .....	35
9.4.4.	802.11a MODE IN THE 5.3 GHz BAND.....	36
9.4.5.	802.11n HT20 MODE IN THE 5.3 GHz BAND .....	36
9.4.6.	802.11n HT40 MODE IN THE 5.3 GHz BAND .....	36
9.4.7.	802.11a MODE IN THE 5.5 GHz BAND.....	37
9.4.8.	802.11n HT20 MODE IN THE 5.5 GHz BAND .....	37
9.4.9.	802.11n HT40 MODE IN THE 5.5 GHz BAND .....	37
9.4.10.	802.11a MODE IN THE 5.8 GHz BAND.....	38
9.4.11.	802.11n HT20 MODE IN THE 5.8 GHz BAND .....	38
9.4.12.	802.11n HT40 MODE IN THE 5.8 GHz BAND .....	38
9.4.13.	99% BANDWIDTH PLOTS .....	39
<b>10.</b>	<b>ANTENNA PORT TEST RESULTS .....</b>	<b>51</b>
10.1.	6 dB BANDWIDTH .....	51
10.1.1.	802.11a MODE IN THE 5.8 GHz BAND.....	52
10.1.2.	802.11n HT20 MODE IN THE 5.8 GHz BAND .....	52
10.1.3.	802.11n HT40 MODE IN THE 5.8 GHz BAND .....	52
10.1.4.	6 dB BANDWIDTH PLOTS .....	53
10.2.	OUTPUT POWER AND PPSD.....	56
10.2.1.	802.11a MODE IN THE 5.2 GHz BAND.....	57
10.2.2.	802.11n HT20 MODE IN THE 5.2 GHz BAND .....	58
10.2.3.	802.11n HT40 MODE IN THE 5.2 GHz BAND .....	59
10.2.4.	802.11a MODE IN THE 5.3 GHz BAND.....	60
10.2.5.	802.11n HT20 MODE IN THE 5.3 GHz BAND .....	61
10.2.6.	802.11n HT40 MODE IN THE 5.3 GHz BAND .....	62
10.2.7.	802.11a MODE IN THE 5.5 GHz BAND.....	63
10.2.8.	802.11n HT20 MODE IN THE 5.5 GHz BAND .....	64
10.2.9.	802.11n HT40 MODE IN THE 5.5 GHz BAND .....	65
10.2.10.	802.11a MODE IN THE 5.8 GHz BAND.....	66
10.2.11.	802.11n HT20 MODE IN THE 5.8 GHz BAND .....	67
10.2.12.	802.11n HT40 MODE IN THE 5.8 GHz BAND .....	68
10.2.13.	PPSD PLOTS .....	69
<b>11.</b>	<b>TRANSMITTER ABOVE 1 GHz.....</b>	<b>81</b>
11.1.	5.2 GHz.....	83
11.1.1.	TX Above 1GHz 802.11a MODE IN THE 5.2GHz BAND .....	83
11.1.2.	TX Above 1GHz 802.11n HT20 MODE IN THE 5.2GHz BAND .....	91
11.1.3.	TX Above 1GHz 802.11n HT40 MODE IN THE 5.2GHz BAND .....	99
11.2.	5.3 GHz.....	105
11.2.1.	TX ABOVE 1 GHz 802.11a MODE IN THE 5.3 GHz BAND .....	105
11.2.2.	TX ABOVE 1GHz 802.11n HT20 MODE IN THE 5.3GHz BAND.....	113
11.2.3.	TX ABOVE 1GHz 802.11n HT40 MODE IN THE 5.3GHz BAND.....	121
11.3.	5.5-5.6 GHz.....	127
11.3.1.	TX ABOVE 1 GHz 802.11a MODE IN THE 5.5 GHz BAND .....	127
11.3.2.	TX ABOVE 1GHz 802.11n HT20 MODE IN THE 5.5GHz BAND.....	137
11.3.3.	TX ABOVE 1GHz 802.11n HT40 MODE IN THE 5.5GHz BAND.....	147
11.4.	5.8 GHz.....	157
11.4.1.	TX ABOVE 1GHz 802.11a MODE IN THE 5.8GHz BAND .....	157

---

11.4.2. TX ABOVE 1GHz 802.11n HT20 MODE IN THE 5.8GHz BAND.....	167
11.4.3. TX ABOVE 1GHz 802.11n HT40 MODE IN THE 5.8GHz BAND.....	177
<b>12. WORST-CASE BELOW 1 GHz .....</b>	<b>185</b>
<b>13. AC POWER LINE CONDUCTED EMISSIONS.....</b>	<b>187</b>
<b>14. DYNAMIC FREQUENCY SELECTION.....</b>	<b>192</b>
14.1. OVERVIEW.....	192
14.1.1. LIMITS.....	192
14.1.1. TEST AND MEASUREMENT SYSTEM.....	196
14.1.2. DESCRIPTION OF EUT .....	200
14.2. RESULTS FOR 20 MHz BANDWIDTH.....	201
14.2.1. TEST CHANNEL .....	201
14.2.2. RADAR WAVEFORM AND TRAFFIC.....	201
14.2.3. MOVE AND CLOSING TIME .....	203
14.3. RESULTS FOR 40 MHz BANDWIDTH.....	206
14.3.1. TEST CHANNEL .....	206
14.3.2. RADAR WAVEFORM AND TRAFFIC.....	206
14.3.3. OVERLAPPING CHANNEL TESTS.....	208
14.3.4. MOVE AND CLOSING TIME .....	208
<b>15. SETUP PHOTOS.....</b>	<b>211</b>

# 1. ATTESTATION OF TEST RESULTS

**COMPANY NAME:** SAMSUNG ELECTRONICS CO., LTD.  
**EUT DESCRIPTION:** WCDMA/LTE Tablet + BT/BLE, DTS/UNII a/b/g/n and ANT+  
**MODEL NUMBER:** SM-T387V, SM-T387VK  
**SERIAL NUMBER:** R32K500LPHM (CONDUCTED)  
R32K400HC9R (RADIATED);  
**DATE TESTED:** MAY 04, 2018 - JUN 25, 2018

APPLICABLE STANDARDS	
STANDARD	TEST RESULTS
CFR 47 Part 15 Subpart E	Pass

UL Korea, Ltd. tested the above equipment in accordance with the requirements set forth in the above standards. All indications of Pass/Fail in this report are opinions expressed by UL Korea, Ltd. based on interpretations and/or observations of test results. Measurement Uncertainties were not taken into account and are published for informational purposes only. The test results show that the equipment tested is capable of demonstrating compliance with the requirements as documented in this report.

**Note:** The results documented in this report apply only to the tested sample, under the conditions and modes of operation as described herein. This document may not be altered or revised in any way unless done so by UL Korea, Ltd. and all revisions are duly noted in the revisions section. Any alteration of this document not carried out by UL Korea, Ltd. will constitute fraud and shall nullify the document. This report must not be used by the client to claim product certification, approval, or endorsement by IAS, any agency of the Federal Government, or any agency of any government.

Approved & Released For  
UL Korea, Ltd. By:



SungGil Park  
Suwon Lab Engineer  
UL Korea, Ltd.

Tested By:



Junwhan Lee  
Suwon Lab Engineer  
UL Korea, Ltd.

## 2. TEST METHODOLOGY

The tests documented in this report were performed in accordance with following methods.

1. FCC CFR 47 Part 2.
2. FCC CFR 47 Part 15.
3. KDB 789033 D02 General UNII Test Procedures New Rules v02r01
4. KDB 905462 D02 UNII DFS Compliance Procedures New Rules v02
5. KDB 905462 D03 UNII Clients Without Radar Detection New Rules v01r02
6. ANSI C63.10-2013.

## 3. FACILITIES AND ACCREDITATION

The test sites and measurement facilities used to collect data are located at 218 Maeyeong-ro, Yeongtong-gu, Suwon-si, Gyeonggi-do, 16675, Korea. Line conducted emissions are measured only at the 218 address. The following table identifies which facilities were utilized for radiated emission measurements documented in this report. Specific facilities are also identified in the test results sections.

218 Maeyeong-ro	
<input checked="" type="checkbox"/>	Chamber 1
<input type="checkbox"/>	Chamber 2
<input checked="" type="checkbox"/>	Chamber 3

UL Korea, Ltd. is accredited by IAS, Laboratory Code TL-637. The full scope of accreditation can be viewed at <http://www.iasonline.org/PDF/TL/TL-637.pdf>.

## 4. CALIBRATION AND UNCERTAINTY

### 4.1. MEASURING INSTRUMENT CALIBRATION

The measuring equipment utilized to perform the tests documented in this report has been calibrated in accordance with the manufacturer's recommendations, and is traceable to recognized national standards.

### 4.2. SAMPLE CALCULATION

Where relevant, the following sample calculation is provided:

$$\begin{aligned} \text{Field Strength (dBuV/m)} &= \text{Measured Voltage (dBuV)} + \text{Antenna Factor (dB/m)} + \\ &\text{Cable Loss (dB)} - \text{Preamp Gain (dB)} \\ 36.5 \text{ dBuV} + 18.7 \text{ dB/m} + 0.6 \text{ dB} - 26.9 \text{ dB} &= 28.9 \text{ dBuV/m} \end{aligned}$$

### 4.3. MEASUREMENT UNCERTAINTY

Where relevant, the following measurement uncertainty levels have been estimated for tests performed on the apparatus:

PARAMETER	UNCERTAINTY
Conducted Disturbance, 0.15 to 30 MHz	2.32 dB
Radiated Disturbance, Below 1GHz	3.86 dB
Radiated Disturbance, Above 1 GHz	5.97 dB

Uncertainty figures are valid to a confidence level of 95%.



## 5. EQUIPMENT UNDER TEST

### 5.1. DESCRIPTION OF EUT

The EUT is a WCDMA/LTE Tablet + BT/BLE, DTS/UNII a/b/g/n and ANT+. This test report addresses the NII (UNII) operational mode.

#### 5.1. MAXIMUM OUTPUT POWER

The transmitter has a maximum total conducted average output power as follows:

Frequency Range [MHz]	Mode	Output Power [dBm]	Output Power [mW]
5180 - 5240	802.11a	16.66	46.34
	802.11n HT20	15.64	36.64
5190 - 5230	802.11n HT40	11.57	14.35
5260 - 5320	802.11a	16.12	40.93
	802.11n HT20	15.11	32.43
5270 - 5310	802.11n HT40	11.51	14.16
5500 - 5700	802.11a	14.03	25.29
	802.11n HT20	14.17	26.12
5510 - 5710	802.11n HT40	10.33	10.79
5745 - 5825	802.11a	16.64	46.13
	802.11n HT20	15.67	36.90
5755 - 5795	802.11n HT40	11.43	13.90

## 5.2. DESCRIPTION OF AVAILABLE ANTENNAS

The radio utilizes an internal antenna, with a maximum gain of:

Frequency Range [MHz]	Antenna Gain [dBi]
UNII 1 5150 – 5250	-2.7
UNII 2A 5250 – 5350	-2.1
UNII 2C 5470 – 5725	-1.9
UNII 3 5725 – 5850	-4.9

## 5.3. WORST-CASE CONFIGURATION AND MODE

Radiated emission below 1GHz and power line conducted emission were performed with the EUT set to transmit at the channel with highest output power as worst-case scenario.

Radiated emission above 1GHz was performed with the EUT set to transmit low/mid/high channels.

The fundamental of the EUT was investigated in three orthogonal orientations X,Y,Z, it was determined that the Y orientation was worst-case orientation; therefore, all final radiated testing was performed with the EUT in the Y orientation.

Based on the baseline scan, the worst-case data rates were:

802.11a mode: 6 Mbps

802.11n HT20 mode: MCS0

802.11n HT40 mode: MCS0

Note : All radiated and power line conducted tests were performed connected with earphone and charger for evaluation of worst case mode.

## 5.4. DESCRIPTION OF TEST SETUP

### SUPPORT EQUIPMENT

Support Equipment List				
Description	Manufacturer	Model	Serial Number	FCC ID
Charger	SAMSUNG	EP-TA50JWE	DK4K227VS/A-E	N/A
Data Cable	SAMSUNG	EP-DG915UWZ	N/A	N/A
Earphone	SAMSUNG	EHS64AVFWE	N/A	N/A

### I/O CABLES

I/O Cable List						
Cable No	Port	# of identical ports	Connector Type	Cable Type	Cable Length (m)	Remarks
1	DC Power	1	Mini-USB	Shielded	1.2m	N/A
2	Audio	2	Mini-Jack	Unshielded	1.2m	N/A

### TEST SETUP

The EUT is a stand-alone unit during the tests.  
 Test software in hidden menu exercised the EUT to enable NII mode.

**SETUP DIAGRAM FOR TESTS (CONDUCTED TEST SETUP)**

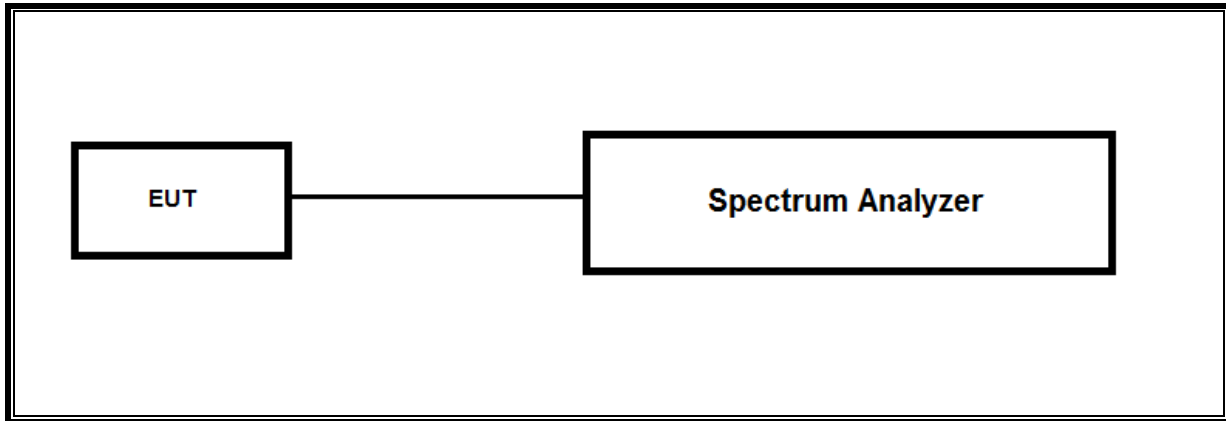

**SETUP DIAGRAM FOR TESTS (RADIATED TEST SETUP)**

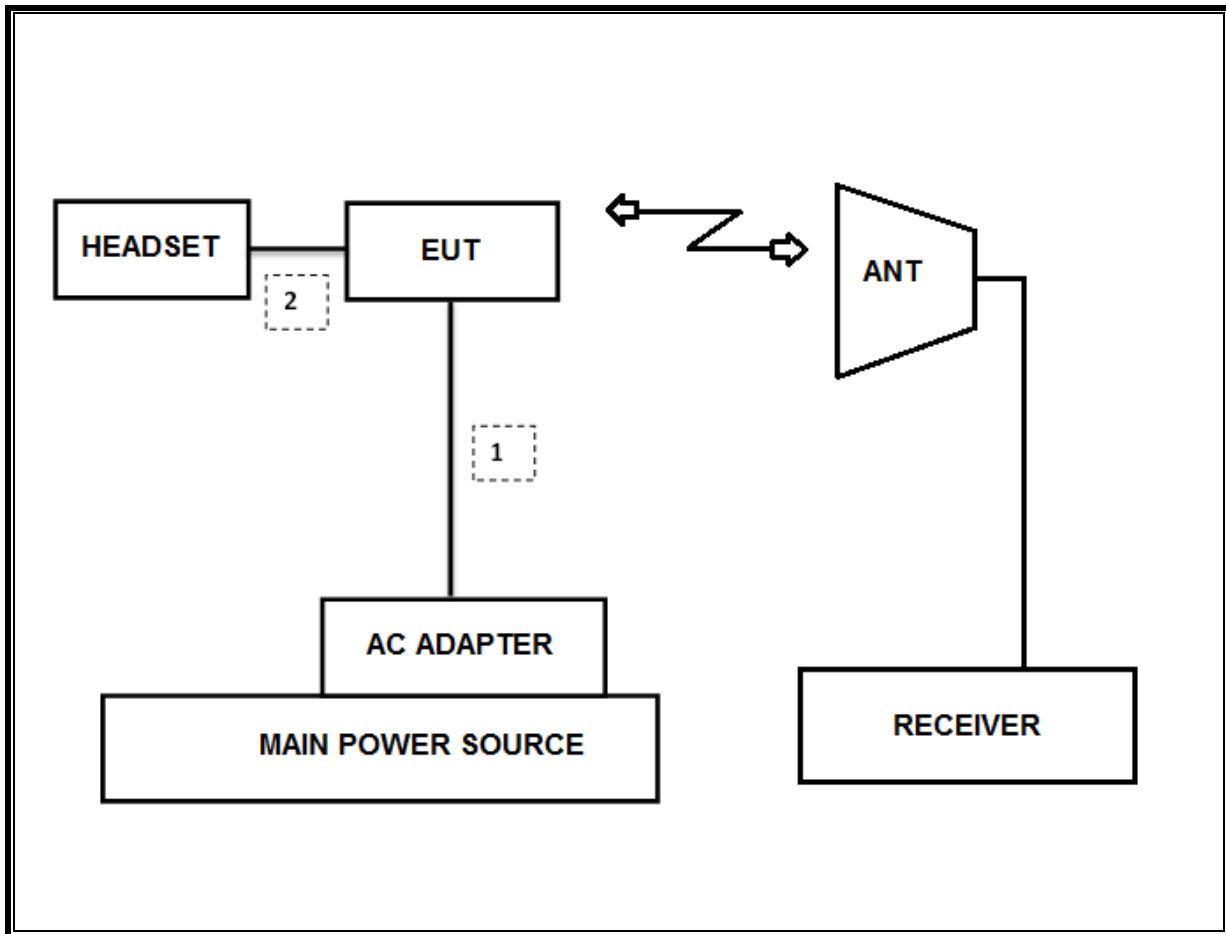

## 6. TEST AND MEASUREMENT EQUIPMENT

The following test and measurement equipment was utilized for the tests documented in this report:

Test Equipment List				
Description	Manufacturer	Model	S/N	Cal Due
Antenna, Bilog, 30MHz-1GHz	SCHWARZBECK	VULB9163	750	08-31-19
Antenna, Bilog, 30MHz-1GHz	SCHWARZBECK	VULB9163	749	09-14-19
Antenna, Bilog, 30MHz-1GHz	SCHWARZBECK	VULB9163	845	08-31-19
Antenna, Horn, 18 GHz	ETS	3115	00167211	10-14-18
Antenna, Horn, 18 GHz	ETS	3115	00161451	03-10-19
Antenna, Horn, 18 GHz	ETS	3117	00168724	05-31-19
Antenna, Horn, 18 GHz	ETS	3117	00168717	05-31-19
Antenna, Horn, 18 GHz	ETS	3117	00205959	11-29-18
Antenna, Horn, 40 GHz	ETS	3116C	00166155	12-04-19
Antenna, Horn, 40 GHz	ETS	3116C	00168645	12-04-19
Antenna, Horn, 40 GHz	ETS	3116C-PA	00168841	11-13-19
Preamplifier, 1000 MHz	Sonoma	310N	341282	08-09-18
Preamplifier, 1000 MHz	Sonoma	310N	351741	08-07-18
Preamplifier, 1000 MHz	Sonoma	310N	370599	08-10-18
Preamplifier, 18 GHz	Miteq	AFS42-00101800-25-S-42	1876511	08-08-18
Preamplifier, 18 GHz	Miteq	AFS42-00101800-25-S-42	1896138	08-08-18
Preamplifier, 18 GHz	Miteq	AFS42-00101800-25-S-42	2029169	08-11-18
Spectrum Analyzer, 44 GHz	Agilent / HP	N9030A	MY54170614	08-08-18
Spectrum Analyzer, 44 GHz	Agilent / HP	N9030A	MY54490312	08-08-18
Average Power Sensor	Agilent / HP	U2000	MY54270007	08-08-18
Attenuator	PASTERNAK	PE7087-10	A001	08-08-18
Attenuator	PASTERNAK	PE7087-10	A008	08-08-18
Attenuator	PASTERNAK	PE7087-10	2	08-10-18
Attenuator	PASTERNAK	PE7087-10	A009	08-08-18
EMI Test Receive, 40 GHz	R&S	ESU40	100439	08-08-18
EMI Test Receive, 40 GHz	R&S	ESU40	100457	08-08-18
EMI Test Receive, 44 GHz	R&S	ESW44	101590	08-09-18
EMI Test Receive, 3 GHz	R&S	ESR3	101832	08-07-18
Low Pass Filter 5GHz	Micro-Tronics	LPS17541	009	08-08-18
Low Pass Filter 5GHz	Micro-Tronics	LPS17541	015	08-08-18
Low Pass Filter 5GHz	Micro-Tronics	LPS17541	020	08-11-18
High Pass Filter 3GHz	Micro-Tronics	HPM17543	010	08-08-18
High Pass Filter 3GHz	Micro-Tronics	HPM17543	015	08-08-18
High Pass Filter 3GHz	Micro-Tronics	HPM17543	020	08-11-18
High Pass Filter 6GHz	Micro-Tronics	HPS17542	009	08-08-18
High Pass Filter 6GHz	Micro-Tronics	HPS17542	016	08-08-18
High Pass Filter 6GHz	Micro-Tronics	HPS17542	021	08-11-18
LISN	R&S	ENV-216	101837	08-09-18
UL Software				
Description	Manufacturer	Model	Version	
Radiated software	UL	UL EMC	Ver 9.5	
AC Line Conducted software	UL	UL EMC	Ver 9.5	

## 7. SUMMARY TABLE

FCC Part Section	Test Description	Test Limit	Test Condition	Test Result
15.407(e)	6dB Band width (5.8Ghz)	500KHz	Condcuted	PASS
15.407 (a)(2)	TX Cond. Power 5.15-2.25, 5.25-5.35 & 5.47-5.725	<24dBm or 11+10Log(OBW)		PASS
15.407 (a)(3)	TX Cond. Power 5.725-5.825	< 30dBm or 17+10Log(OBW)		PASS
15.407 (a)(5)	PSD (5.2,5.3,5.5GHz)	<11dBm		PASS
15.407 (a)(5)	PSD (5.8GHz)	30dBm per 500kHz		PASS
15.207 (a)	AC Power Line conducted emissions	Section 10	Radiated	PASS
15.407 (b) & 15.209	Radiated Spurious Emission	< 54dBuV/m		PASS
15.407 (h)(2)	Dynamic Frequency Selection	N/A	Condcuted	PASS

---

## 8. MEASUREMENT METHODS

On-Time and Duty Cycle : KDB 789033 D02 v02r01, Section B.

6dB Emission BW : KDB 789033 D02 v02r01, Section C.2.

26dB Emission BW : KDB 789033 D02 v02r01, Section C.1.

99% Occupied BW : KDB 789033 D02 v02r01, Section D.

Conducted Output Power : KDB 789033 D02 v02r01, Section E.3.a(Method PM)

Power Spectral Density : KDB 789033 D02 v02r01, Section F.

Unwanted emissions in restricted bands : KDB 789033 D02 v02r01, Section G.

Unwanted emissions in non-restricted bands : KDB 789033 D02 v02r01, Section G.

AC Power Line Conducted Emission : ANSI C63.10-2013, Section 6.2.



## 9. REFERENCE MEASUREMENTS RESULTS

### LIMITS

None; for reporting purposes only.

### PROCEDURE

KDB 789033 D02 v02r01 Zero-Span Spectrum Analyzer Method.

### 9.1. ON TIME AND DUTY CYCLE RESULTS

Mode	ON Time B [msec]	Period [msec]	Duty Cycle x [linear]	Duty Cycle [%]	Duty Cycle Correction Factor [dB]	1/T Minimum VBW [kHz]
802.11a	5.484	5.582	0.982	98.2%	0.00	0.010
802.11n HT20	5.067	5.166	0.981	98.1%	0.00	0.010
802.11n HT40	2.455	2.555	0.961	96.1%	0.17	0.407

### 9.2. DUTY CYCLE PLOTS

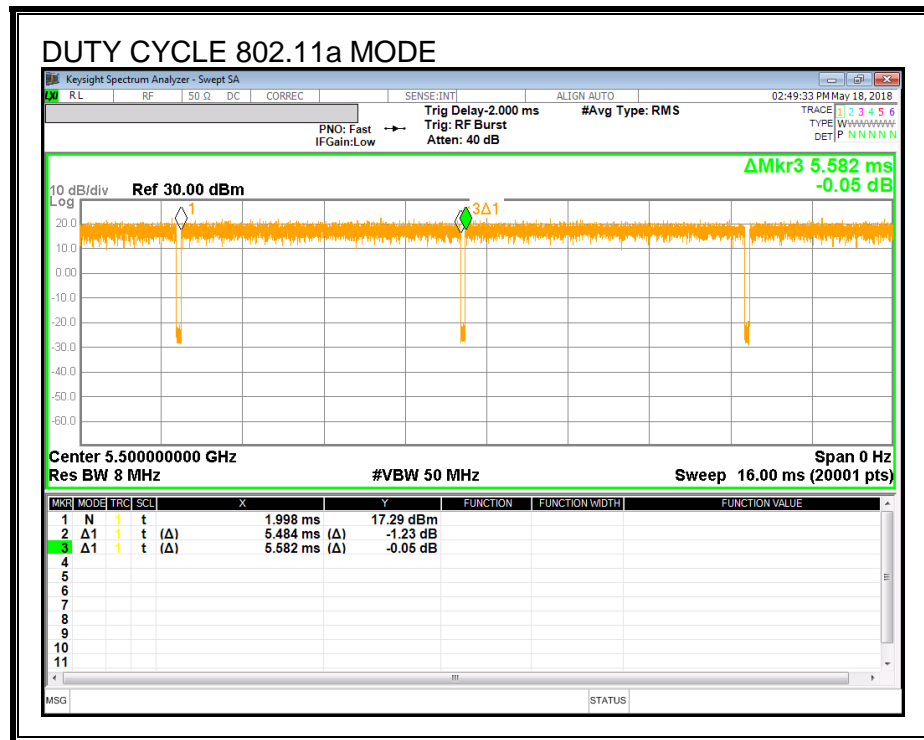

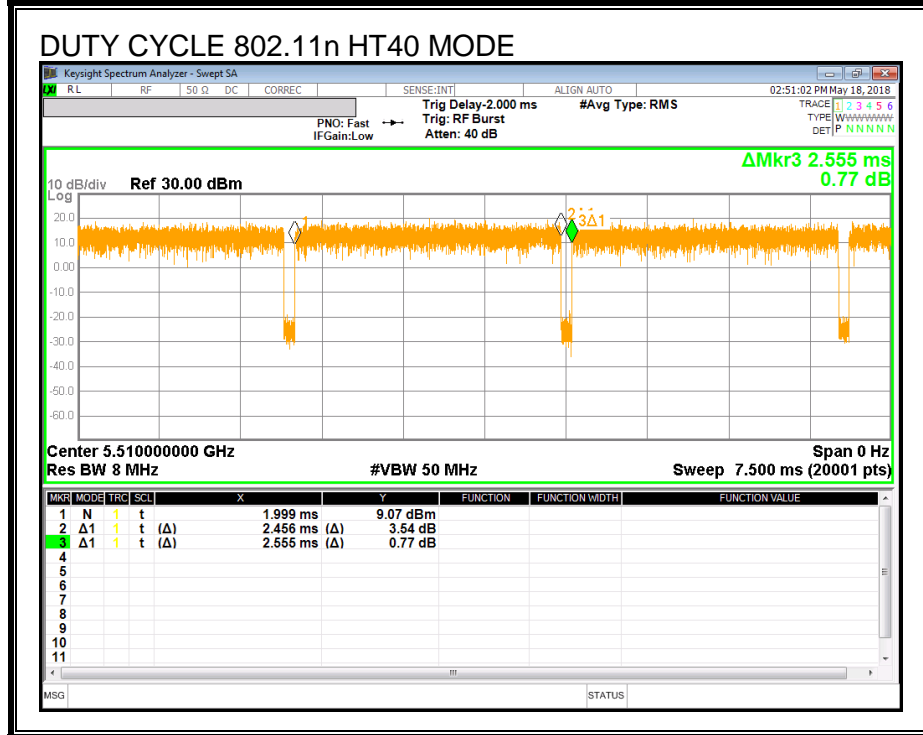
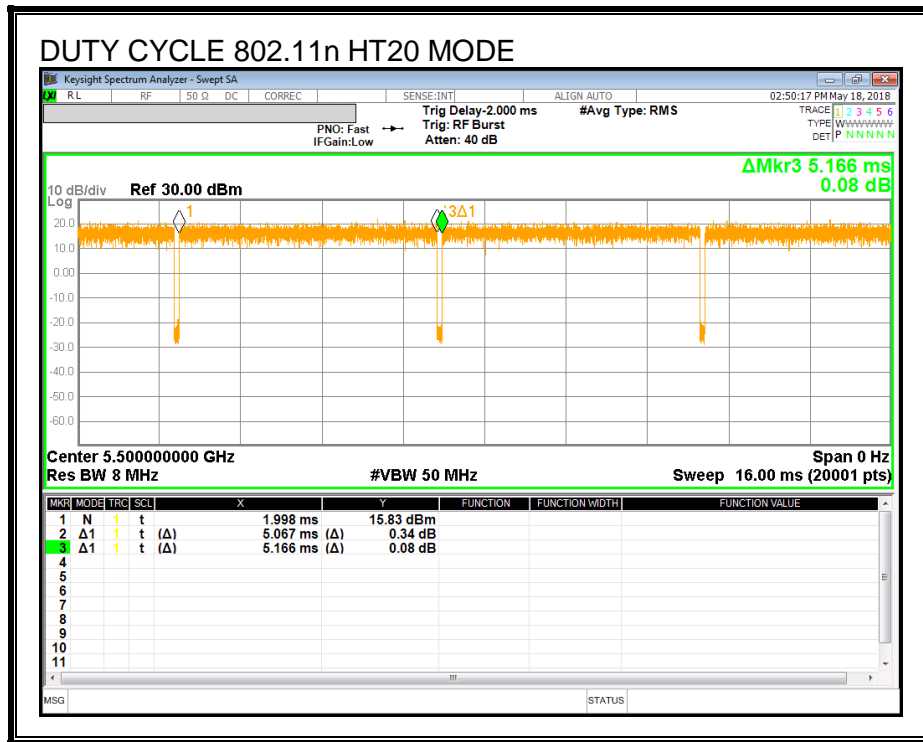

### 9.3. 26 dB BANDWIDTH

#### LIMITS

None; for reporting purposes only.

#### TEST PROCEDURE

Reference to 789033 D02 General UNII Test Procedures New Rules v01r03: The transmitter output is connected to a spectrum analyzer with the RBW set to approximately 1% of EBW, the VBW > RBW, peak detector and max hold.

#### RESULTS

##### 9.3.1. 802.11a MODE IN THE 5.2 GHz BAND

Channel	Frequency [MHz]	26 dB Bandwidth [MHz]
Low	5180	35.30
Mid	5200	36.27
High	5240	35.74
Worst		36.27

##### 9.3.2. 802.11n HT20 MODE IN THE 5.2 GHz BAND

Channel	Frequency [MHz]	26 dB Bandwidth [MHz]
Low	5180	33.47
Mid	5200	33.27
High	5240	31.91
Worst		33.47

##### 9.3.3. 802.11n HT40 MODE IN THE 5.2 GHz BAND

Channel	Frequency [MHz]	26 dB Bandwidth [MHz]
Low	5190	42.31
High	5230	43.84
Worst		43.84

**9.3.4. 802.11a MODE IN THE 5.3 GHz BAND**

Channel	Frequency [MHz]	26 dB Bandwidth [MHz]
Low	5260	34.05
Mid	5300	32.91
High	5320	34.70
Worst		34.70

**9.3.5. 802.11n HT20 MODE IN THE 5.3 GHz BAND**

Channel	Frequency [MHz]	26 dB Bandwidth [MHz]
Low	5260	29.92
Mid	5300	31.30
High	5320	30.84
Worst		31.30

**9.3.6. 802.11n HT40 MODE IN THE 5.3 GHz BAND**

Channel	Frequency [MHz]	26 dB Bandwidth [MHz]
Low	5270	42.79
High	5310	44.01
Worst		44.01

**9.3.7. 802.11a MODE IN THE 5.5 GHz BAND**

Channel	Frequency [MHz]	26 dB Bandwidth [MHz]
Low	5500	22.35
Mid	5580	21.99
High	5700	25.16
Worst		25.16

**9.3.8. 802.11n HT20 MODE IN THE 5.5 GHz BAND**

Channel	Frequency [MHz]	26 dB Bandwidth [MHz]
Low	5500	22.34
Mid	5580	26.50
High	5700	27.12
Worst		27.12

**9.3.9. 802.11n HT40 MODE IN THE 5.5 GHz BAND**

Channel	Frequency [MHz]	26 dB Bandwidth [MHz]
Low	5510	43.84
Mid	5590	42.14
High	5670	43.25
Worst		43.84

**9.3.10. 802.11a MODE IN THE 5.8 GHz BAND**

Channel	Frequency [MHz]	26 dB Bandwidth [MHz]
Low	5745	36.16
Mid	5785	37.24
High	5825	38.87
Worst		38.87

**9.3.11. 802.11n HT20 MODE IN THE 5.8 GHz BAND**

Channel	Frequency [MHz]	26 dB Bandwidth [MHz]
Low	5745	35.79
Mid	5785	37.47
High	5825	36.01
Worst		37.47

**9.3.12. 802.11n HT40 MODE IN THE 5.8 GHz BAND**

Channel	Frequency [MHz]	26 dB Bandwidth [MHz]
Low	5755	43.28
High	5795	43.25
Worst		43.28

### 9.3.13. 26 dB BANDWIDTH PLOTS

#### UNII 5.2 GHz IEEE 802.11a mode

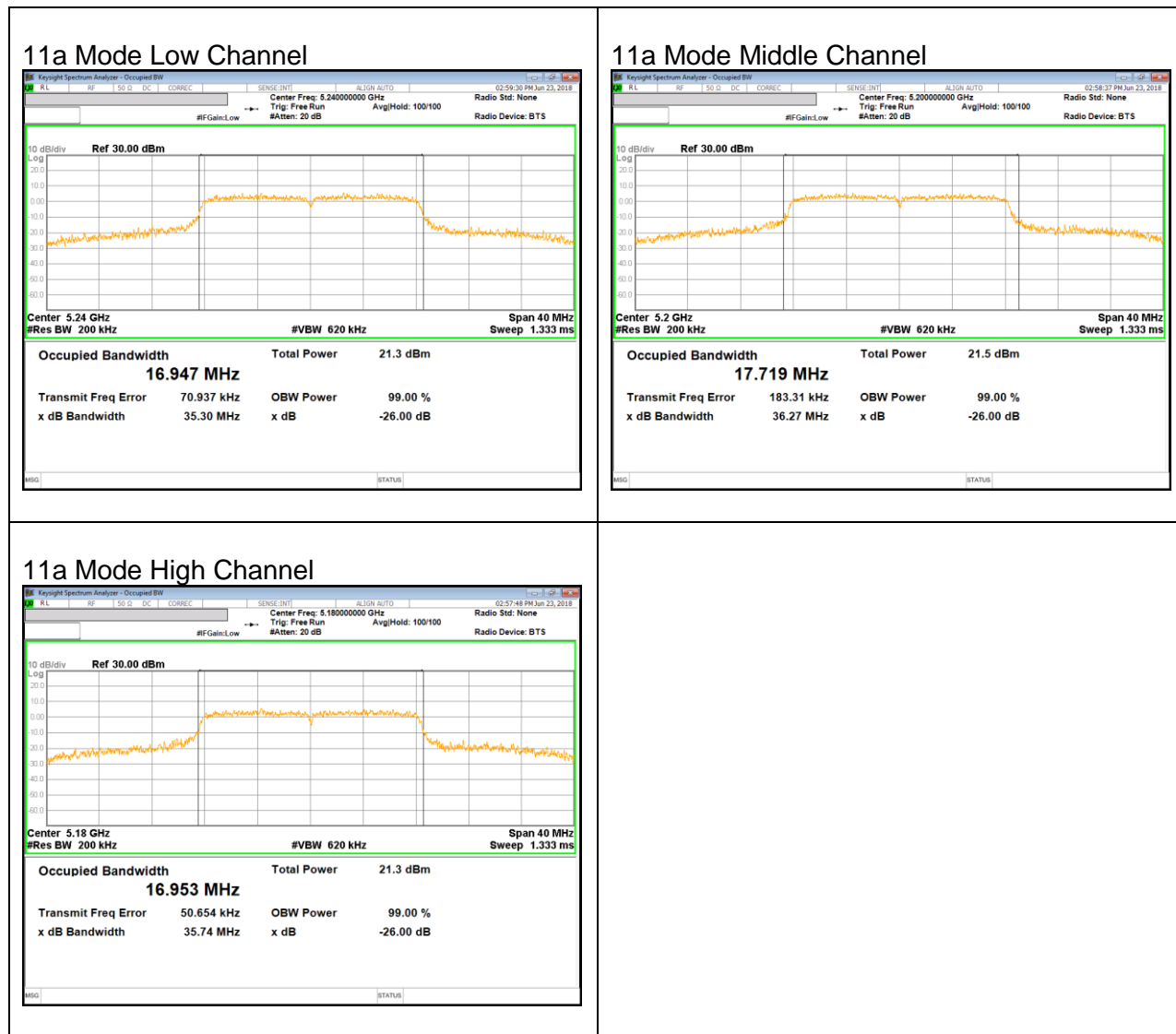

**UNII 5.2 GHz IEEE 802.11n HT20 mode**

**11n HT20 Mode Low Channel**

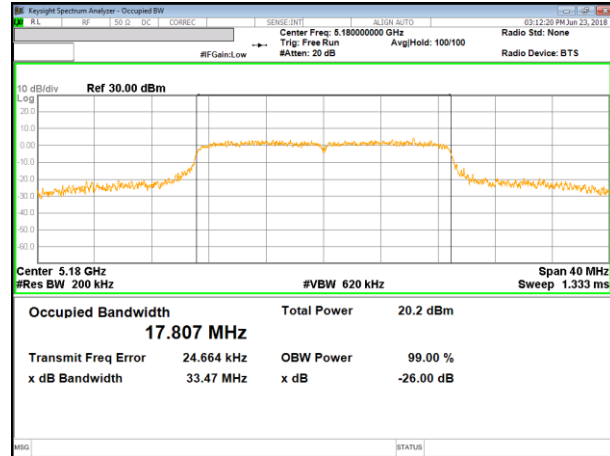

**11n HT20 Mode Middle Channel**

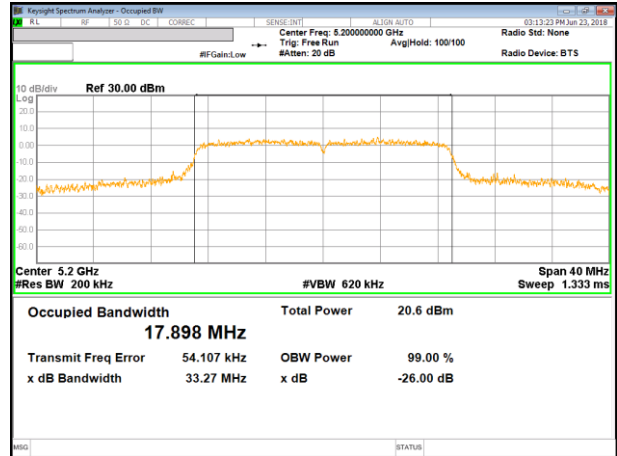

**11n HT20 Mode High Channel**

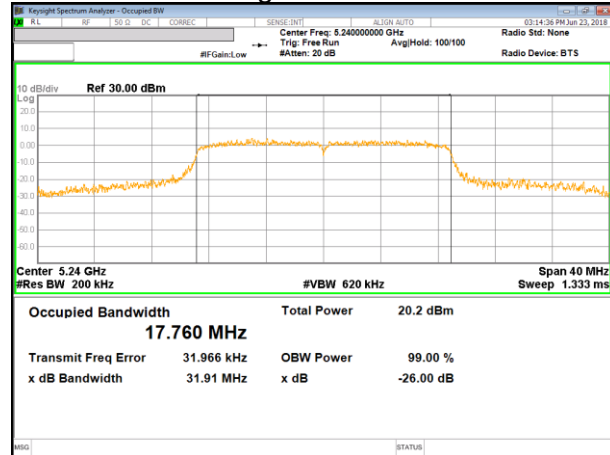



**UNII 5.2 GHz IEEE 802.11n HT40 mode**

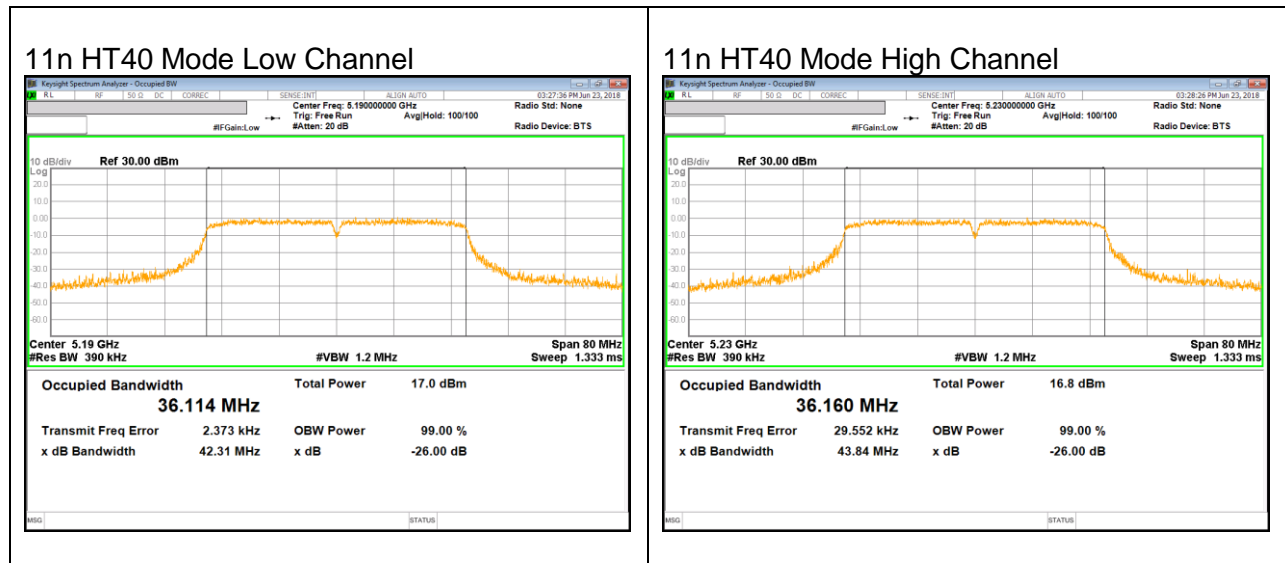

**UNII 5.3 GHz IEEE 802.11a mode**

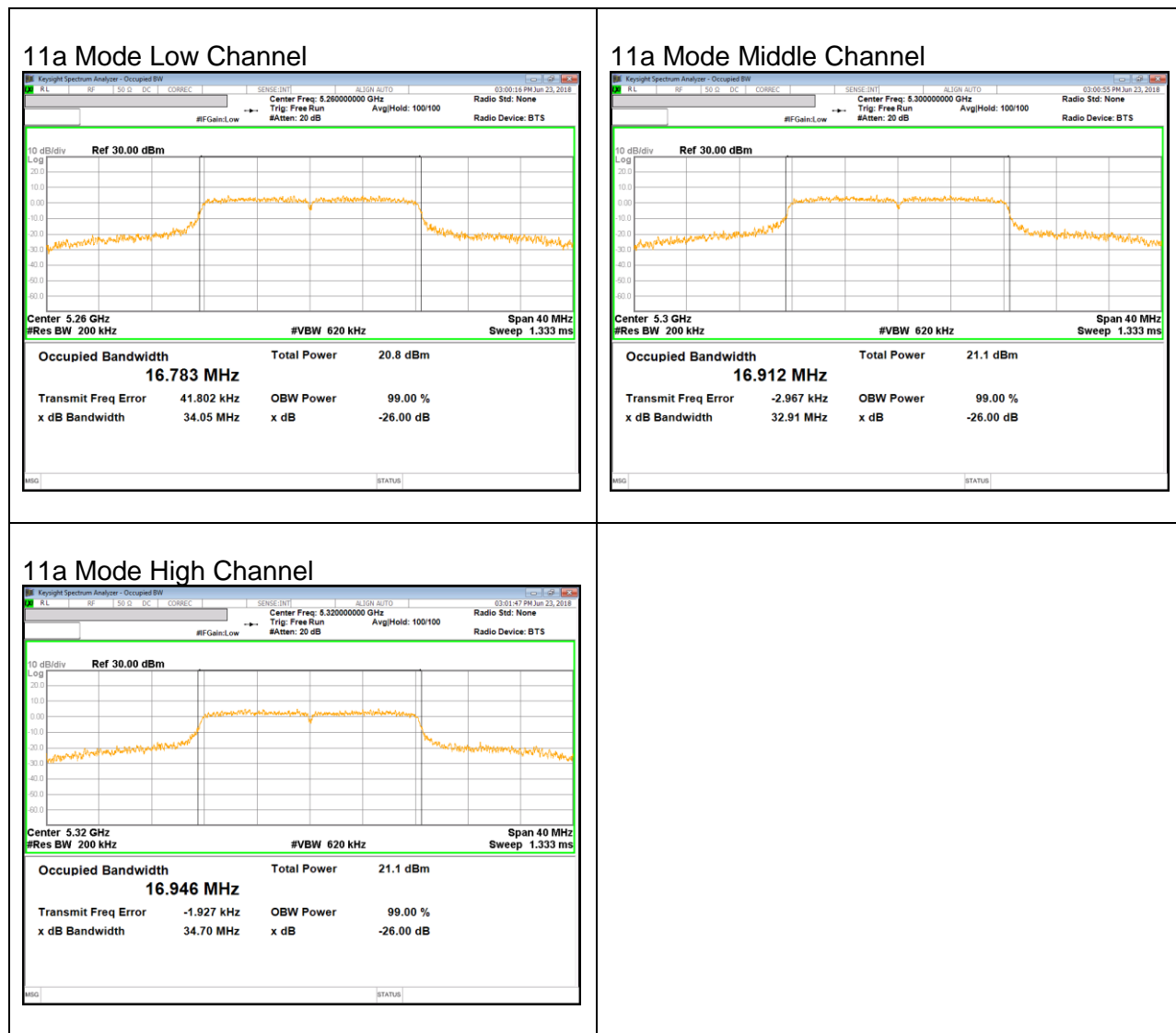

**UNII 5.3 GHz IEEE 802.11n HT20 mode**

11n HT20 Mode Low Channel

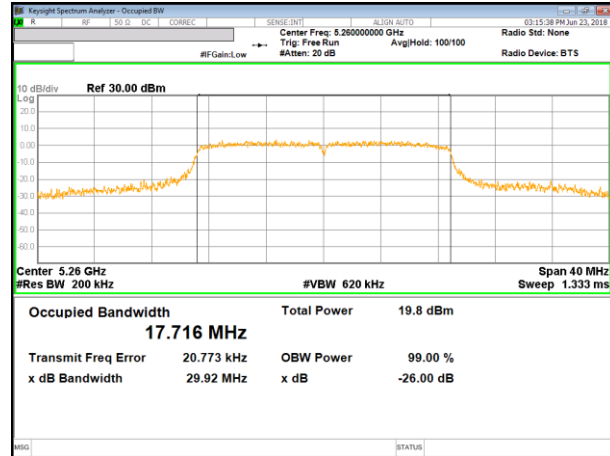

11n HT20 Mode Middle Channel

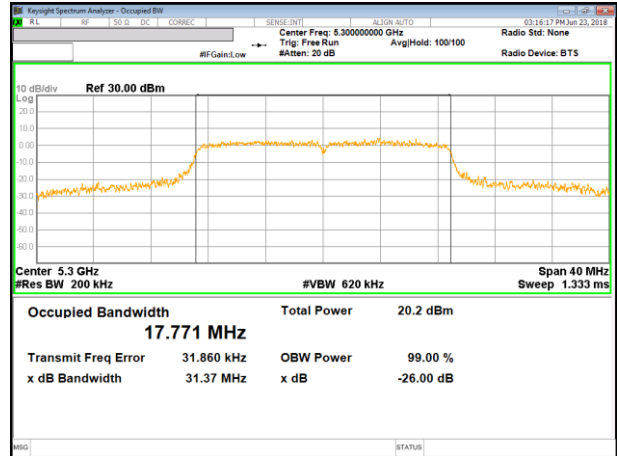

11n HT20 Mode High Channel

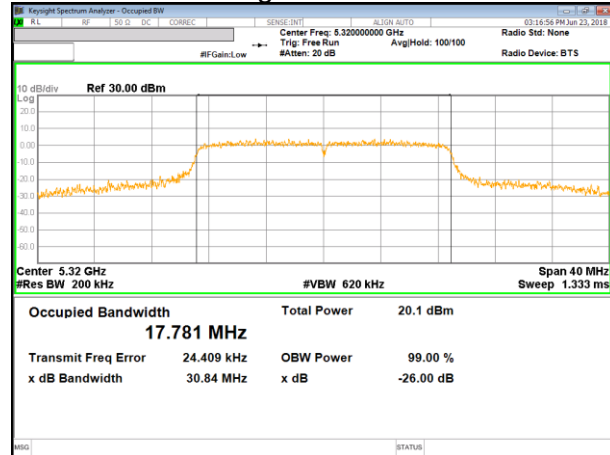

**UNII 5.3 GHz IEEE 802.11n HT40 mode**

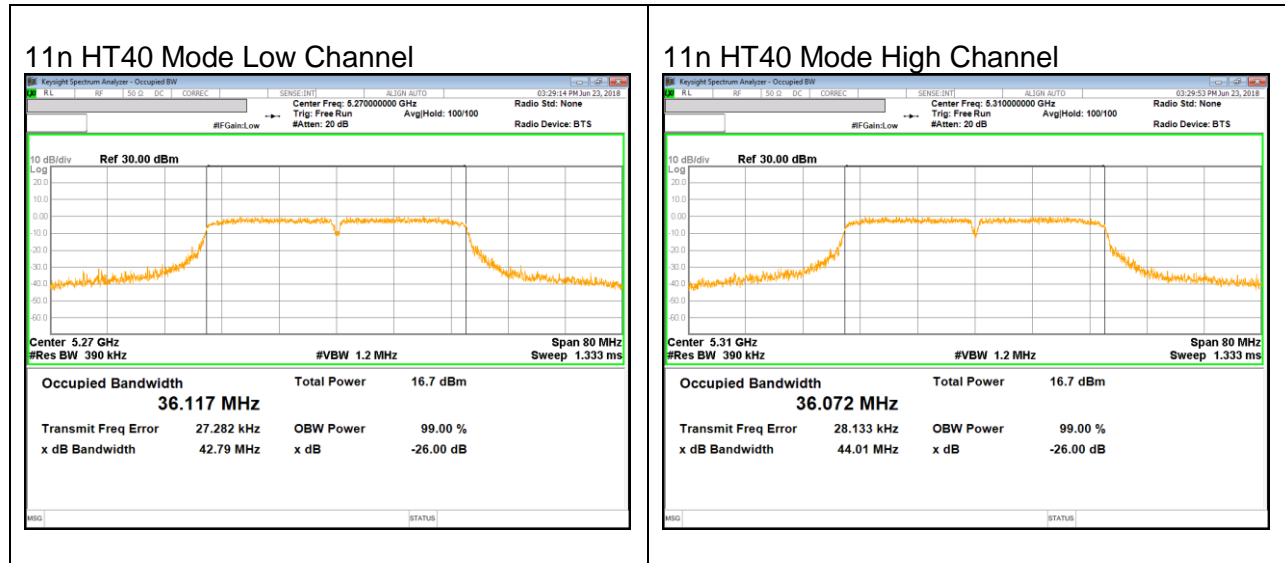

**UNII 5.5 GHz IEEE 802.11a mode**

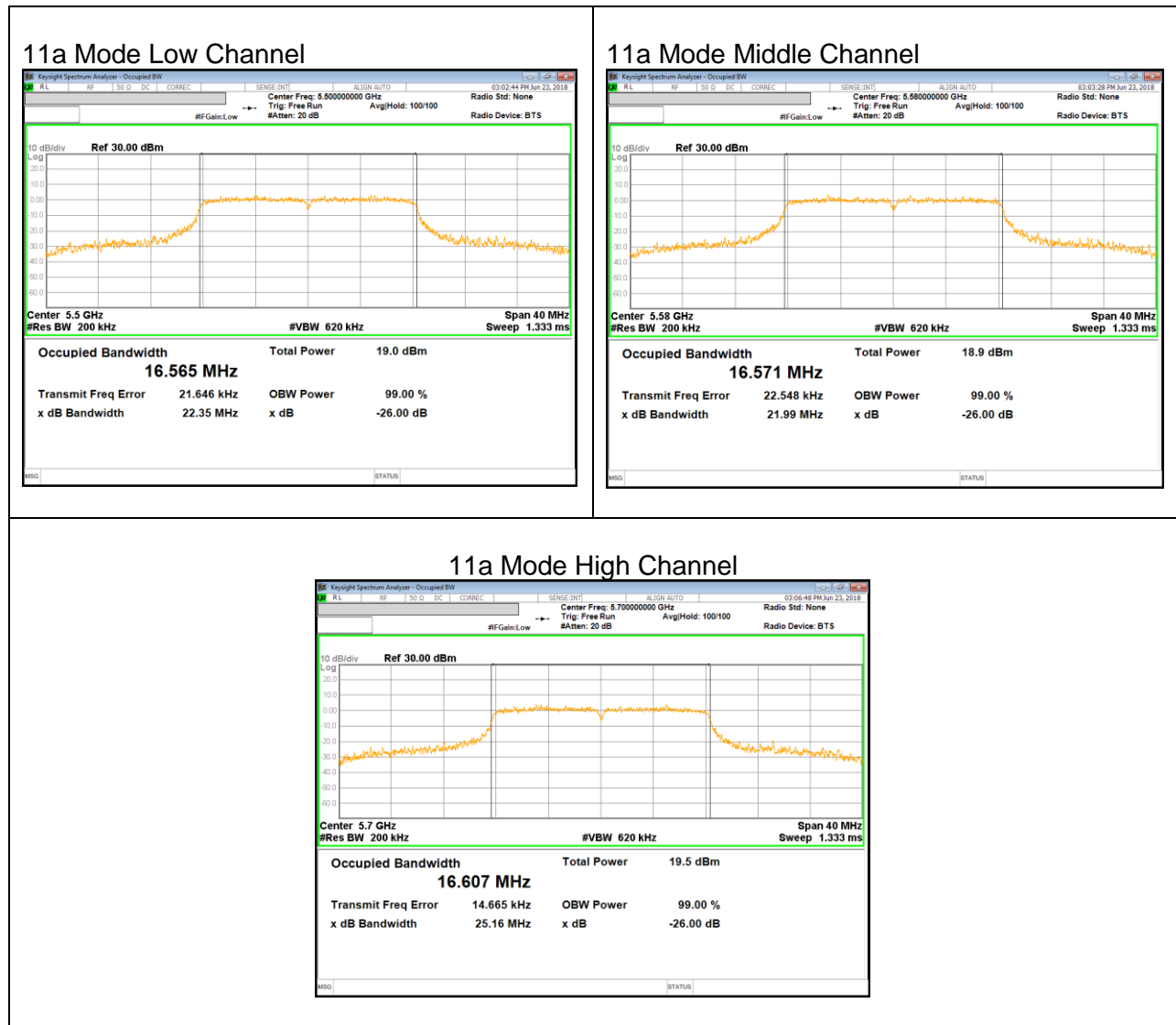

**UNII 5.5 GHz IEEE 802.11n HT20 mode**

11n HT20 Mode Low Channel

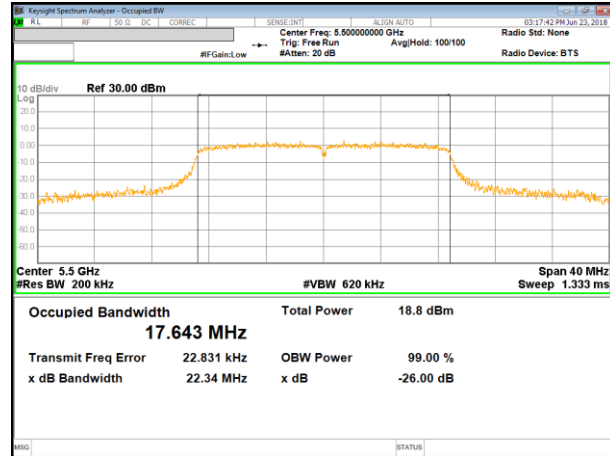

11n HT20 Mode Middle Channel

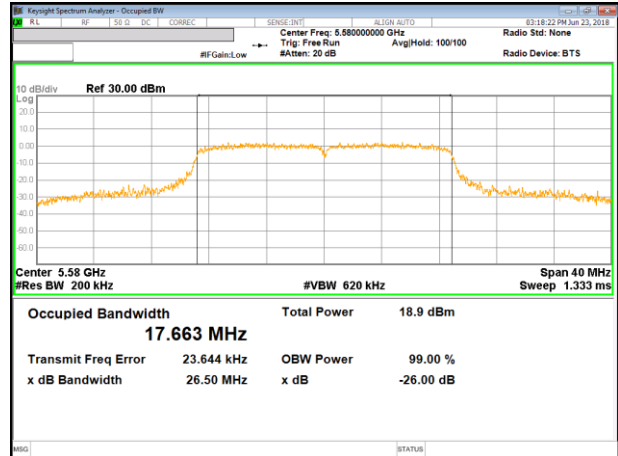

11n HT20 Mode High Channel

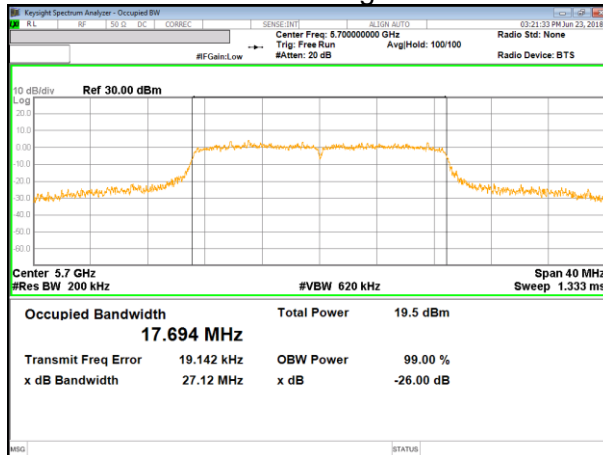

**UNII 5.5 GHz IEEE 802.11n HT40 mode**

11n HT40 Mode Low Channel

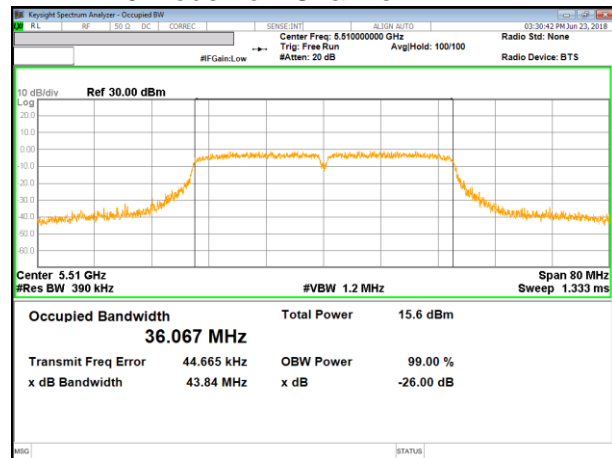

11n HT40 Mode Middle Channel

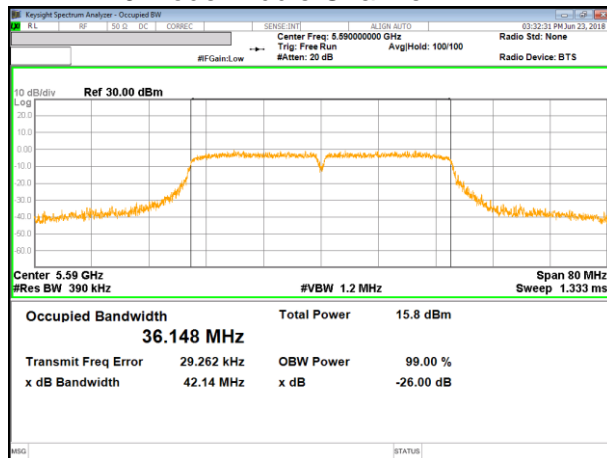

11n HT40 Mode High Channel

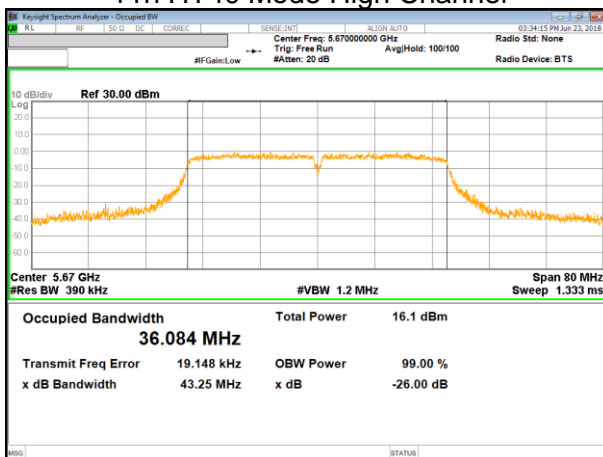

**UNII 5.8 GHz IEEE 802.11a mode**

**11a Mode Low Channel**

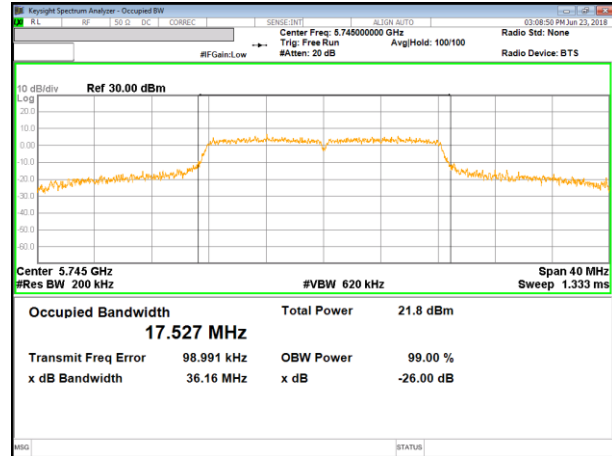

**11a Mode Middle Channel**

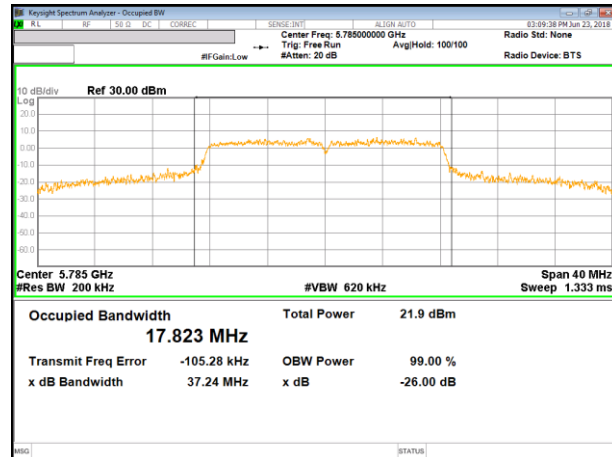

**11a Mode High Channel**

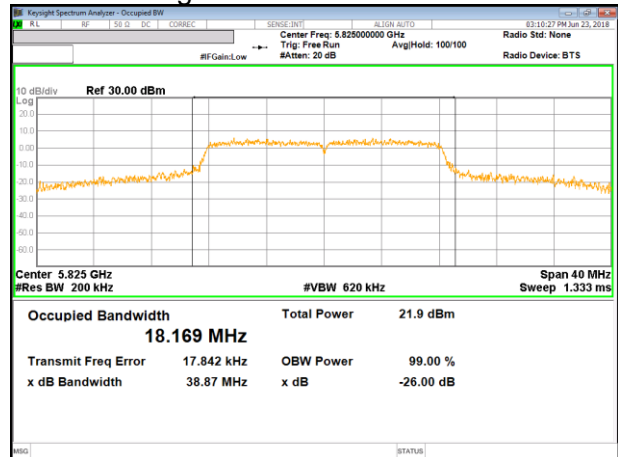



**UNII 5.8 GHz IEEE 802.11n HT20 mode**

**11n HT20 Mode Low Channel**

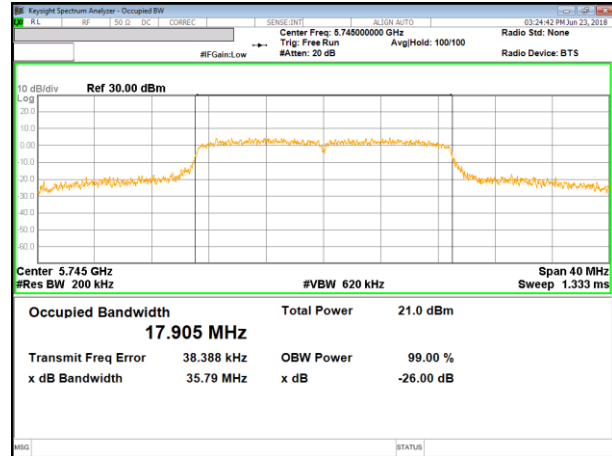

**11n HT20 Mode Middle Channel**

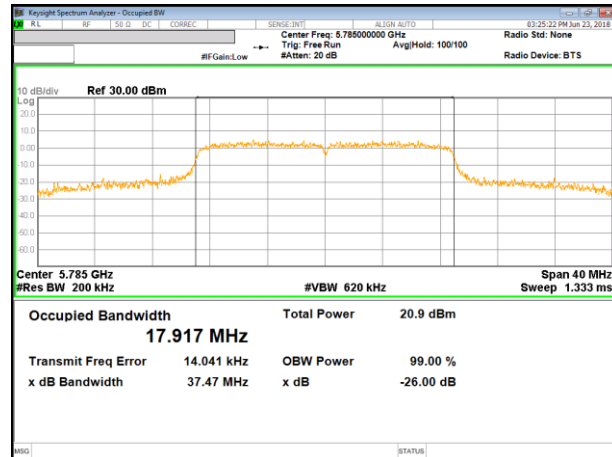

**11n HT20 Mode High Channel**

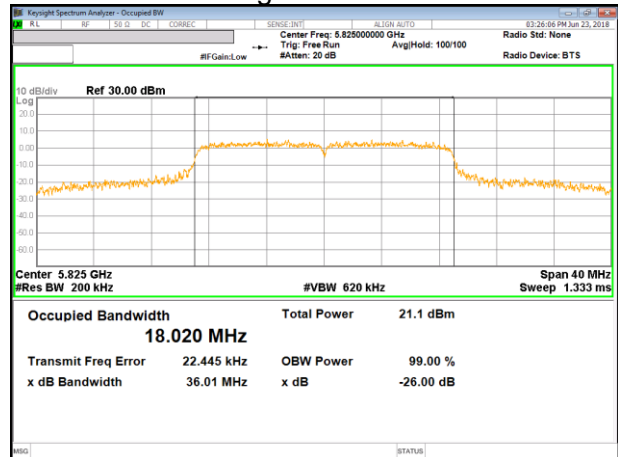

**UNII 5.8 GHz IEEE 802.11n HT40 mode**

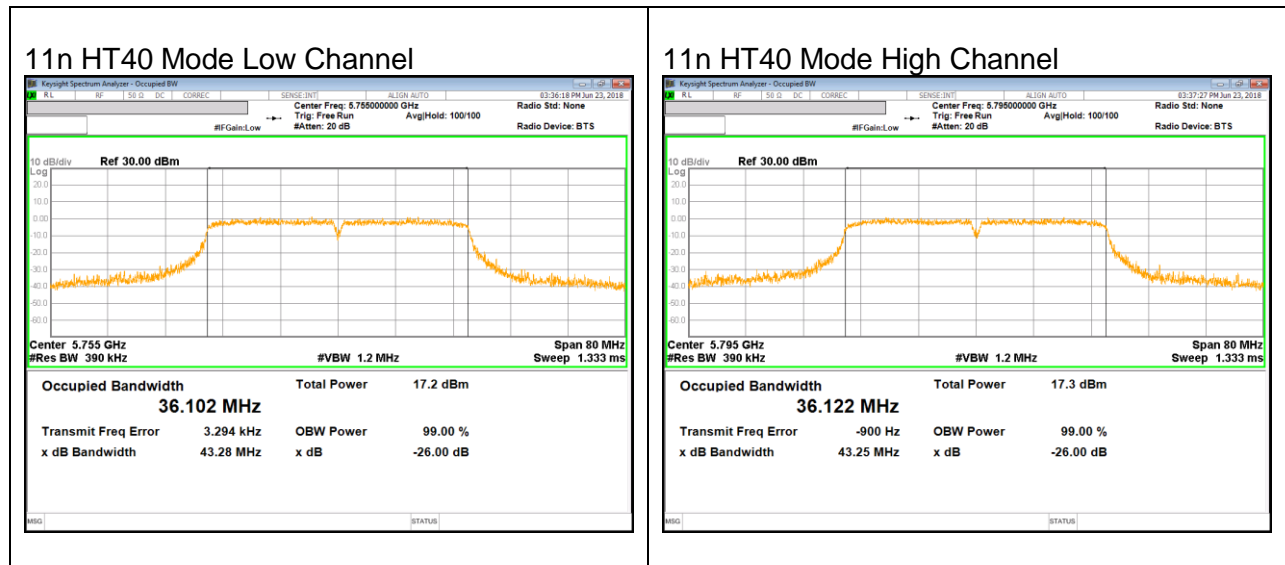

## 9.4. 99% BANDWIDTH

### LIMITS

None; for reporting purposes only.

### TEST PROCEDURE

Reference to 789033 D02 General UNII Test Procedures New Rules v01r02: The transmitter output is connected to a spectrum analyzer with the RBW set to approximately 1% to 5% of OBW, the VBW  $\geq 3 \times$  RBW, single sweep.

### RESULTS

#### 9.4.1. 802.11a MODE IN THE 5.2 GHz BAND

Channel	Frequency [MHz]	99% Bandwidth [MHz]
Low	5180	16.54
Mid	5200	16.57
High	5240	16.52
Worst		16.57

#### 9.4.2. 802.11n HT20 MODE IN THE 5.2 GHz BAND

Channel	Frequency [MHz]	99% Bandwidth [MHz]
Low	5180	17.65
Mid	5200	17.63
High	5240	17.62
Worst		17.65

#### 9.4.3. 802.11n HT40 MODE IN THE 5.2 GHz BAND

Channel	Frequency [MHz]	99% Bandwidth [MHz]
Low	5190	36.07
High	5230	36.12
Worst		36.12

**9.4.4. 802.11a MODE IN THE 5.3 GHz BAND**

Channel	Frequency [MHz]	99% Bandwidth [MHz]
Low	5260	16.53
Mid	5300	16.52
High	5320	16.54
Worst		16.54

**9.4.5. 802.11n HT20 MODE IN THE 5.3 GHz BAND**

Channel	Frequency [MHz]	99% Bandwidth [MHz]
Low	5260	17.64
Mid	5300	17.65
High	5320	17.64
Worst		17.65

**9.4.6. 802.11n HT40 MODE IN THE 5.3 GHz BAND**

Channel	Frequency [MHz]	99% Bandwidth [MHz]
Low	5270	36.02
High	5310	36.06
Worst		36.06

**9.4.7. 802.11a MODE IN THE 5.5 GHz BAND**

Channel	Frequency [MHz]	99% Bandwidth [MHz]
Low	5500	16.46
Mid	5580	16.45
High	5700	16.50
Worst		16.50

**9.4.8. 802.11n HT20 MODE IN THE 5.5 GHz BAND**

Channel	Frequency [MHz]	99% Bandwidth [MHz]
Low	5500	17.63
Mid	5580	17.61
High	5700	17.63
Worst		17.63

**9.4.9. 802.11n HT40 MODE IN THE 5.5 GHz BAND**

Channel	Frequency [MHz]	99% Bandwidth [MHz]
Low	5510	36.04
Mid	5590	36.13
High	5670	36.01
Worst		36.13

**9.4.10. 802.11a MODE IN THE 5.8 GHz BAND**

Channel	Frequency [MHz]	99% Bandwidth [MHz]
Low	5745	16.55
Mid	5785	16.59
High	5825	16.61
Worst		16.61

**9.4.11. 802.11n HT20 MODE IN THE 5.8 GHz BAND**

Channel	Frequency [MHz]	99% Bandwidth [MHz]
Low	5745	17.66
Mid	5785	17.68
High	5825	17.69
Worst		17.69

**9.4.12. 802.11n HT40 MODE IN THE 5.8 GHz BAND**

Channel	Frequency [MHz]	99% Bandwidth [MHz]
Low	5755	36.06
High	5795	36.03
Worst		36.06

### 9.4.13. 99% BANDWIDTH PLOTS

#### UNII 5.2 GHz IEEE 802.11a mode

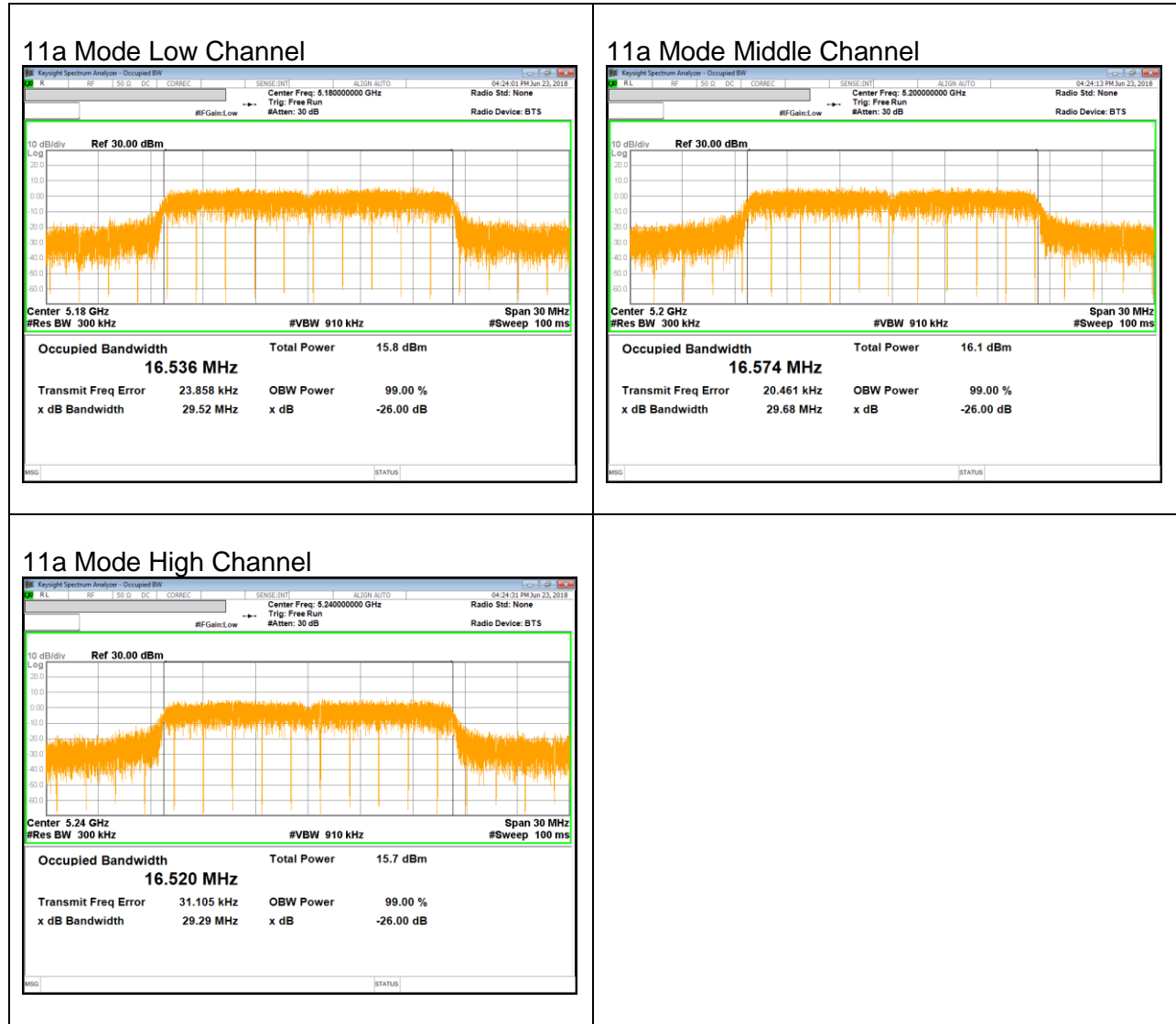

**UNII 5.2 GHz IEEE 802.11n HT20 mode**

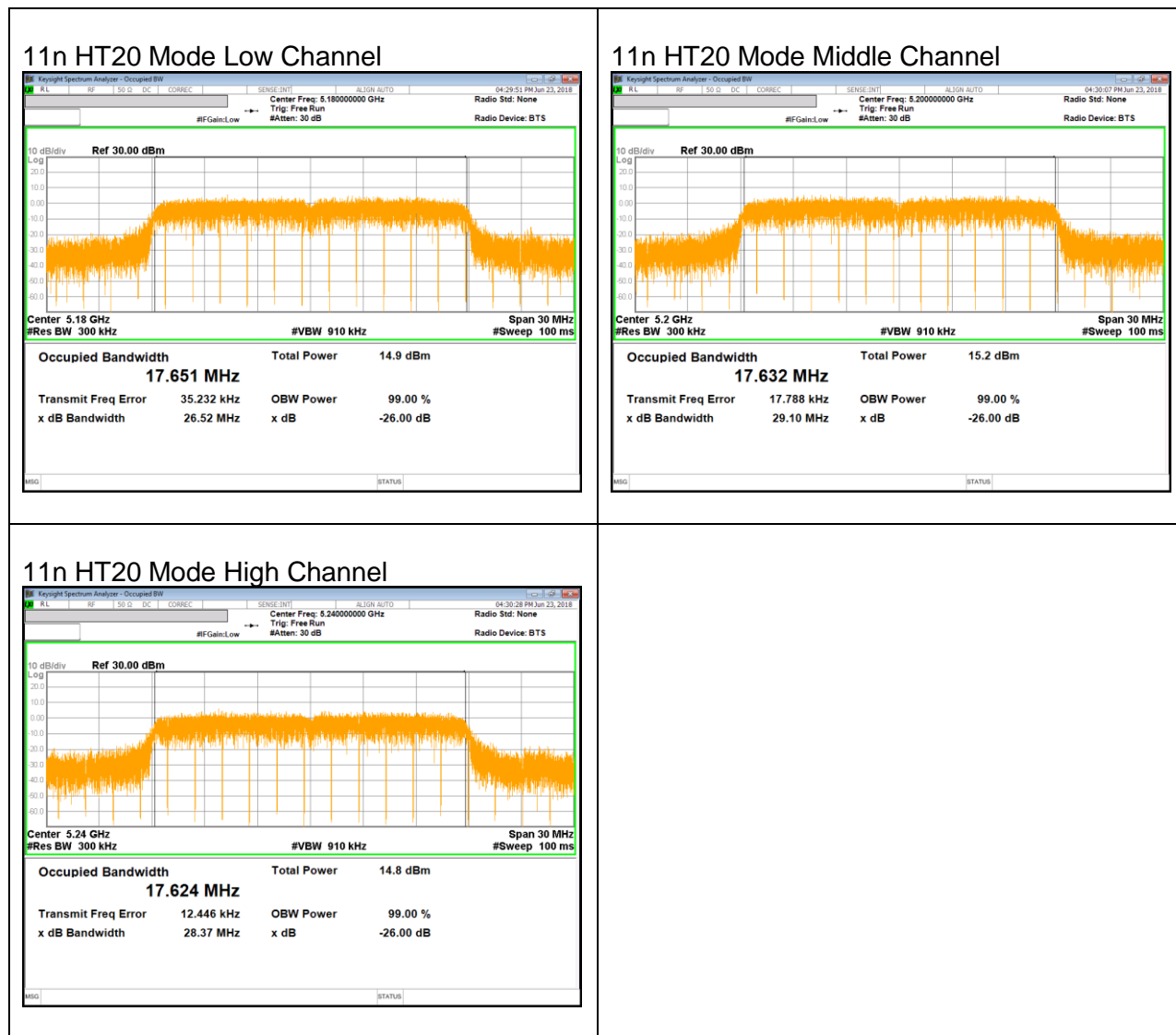



**UNII 5.2 GHz IEEE 802.11n HT40 mode**

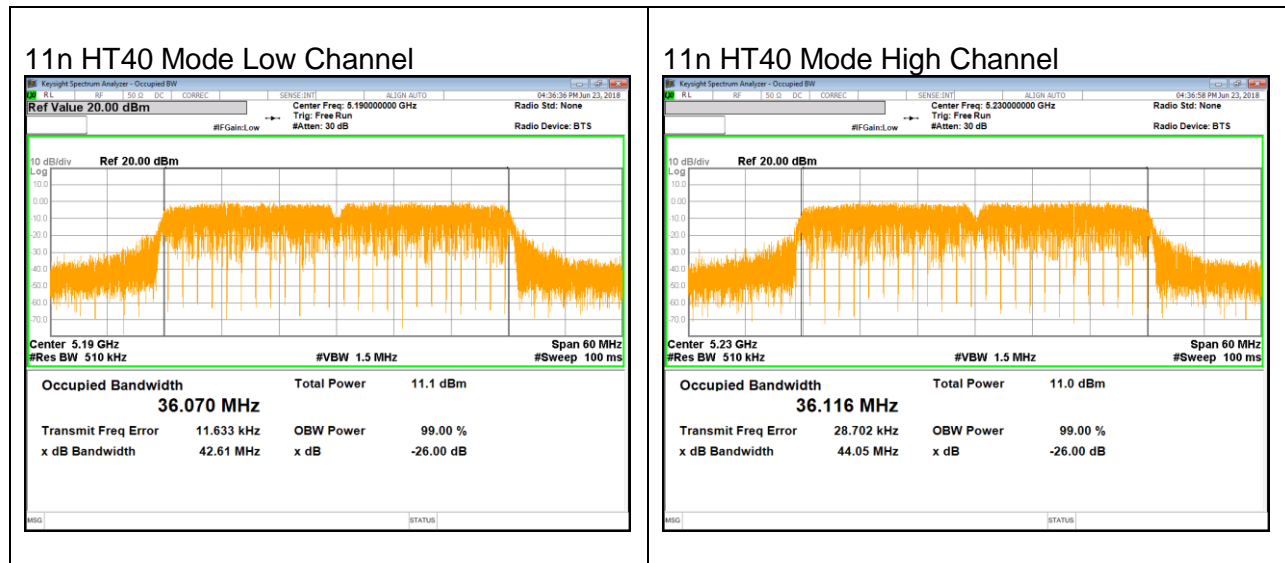

**UNII 5.3 GHz IEEE 802.11a mode**



**UNII 5.3 GHz IEEE 802.11n HT20 mode**

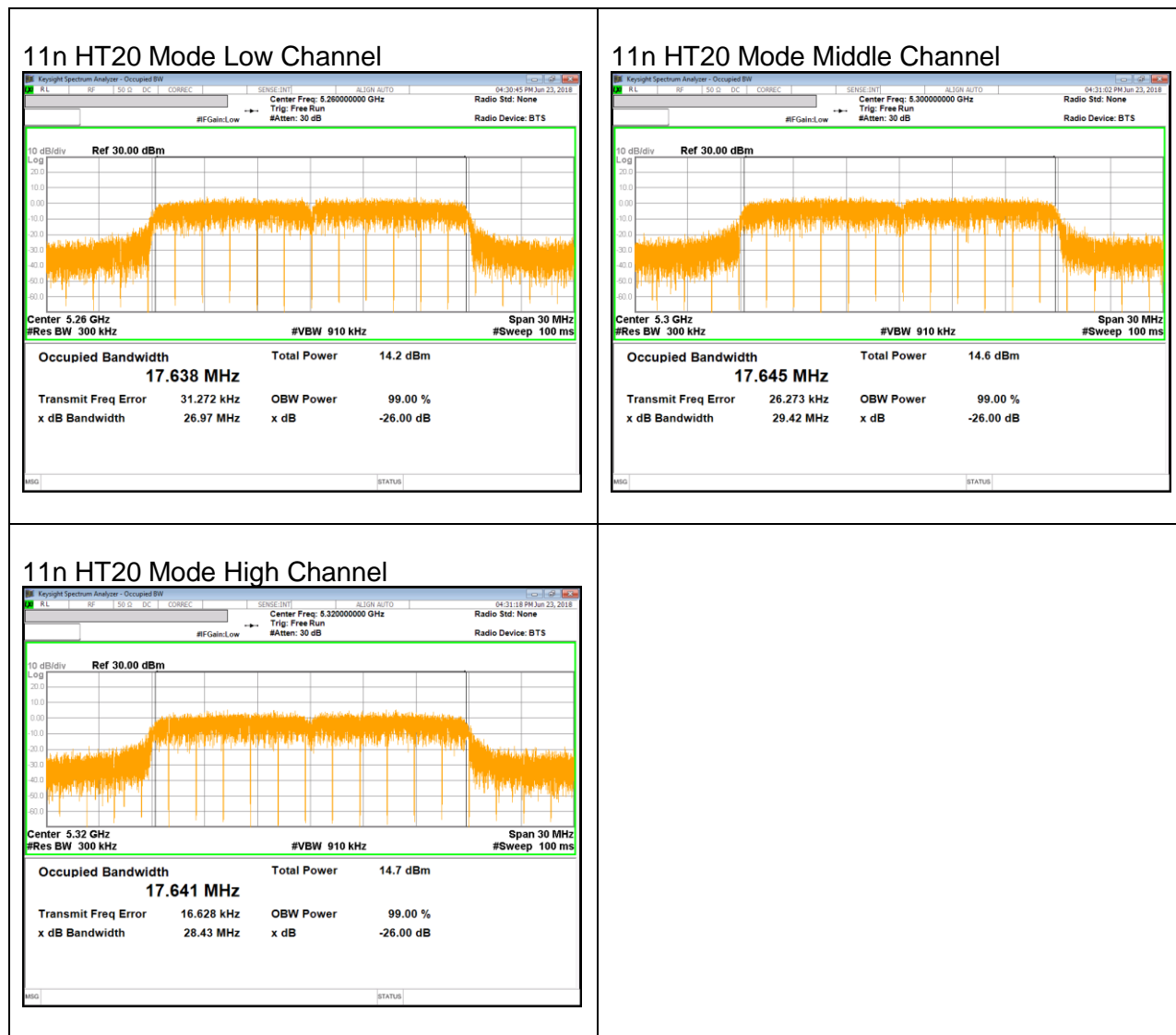

**UNII 5.3 GHz IEEE 802.11n HT40 mode**

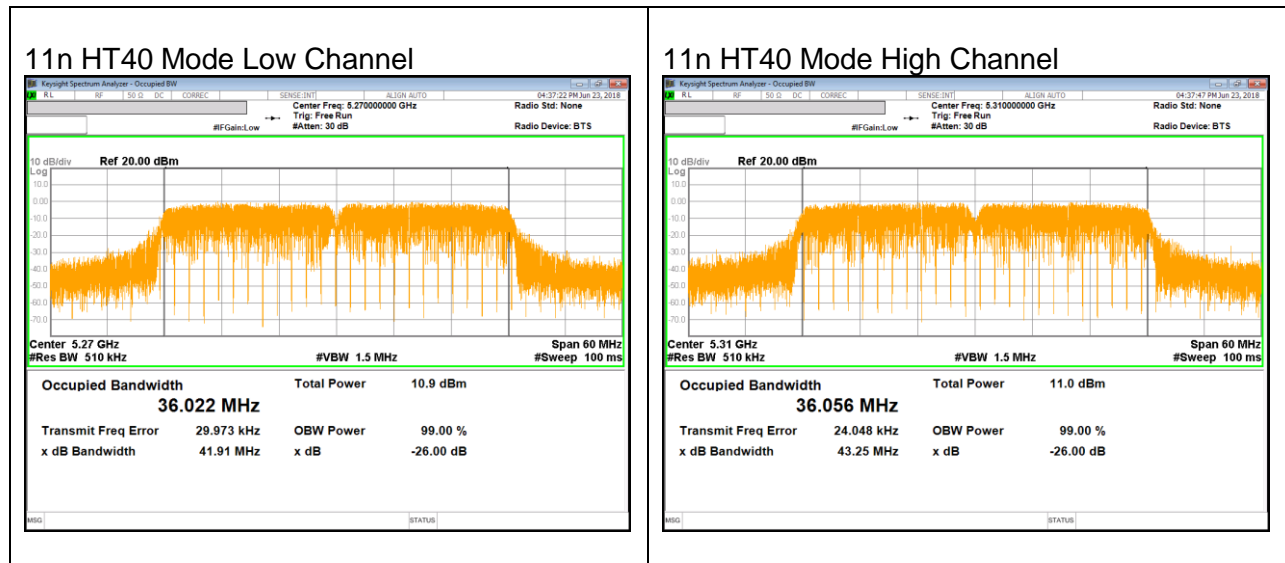

**UNII 5.5 GHz IEEE 802.11a mode**



**UNII 5.5 GHz IEEE 802.11n HT20 mode**

11n HT20 Mode Low Channel

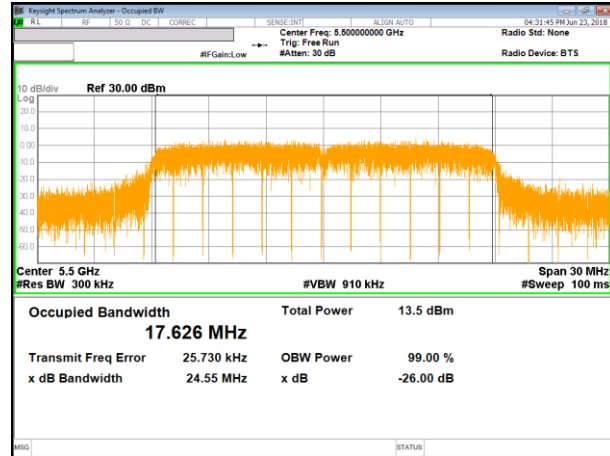

11n HT20 Mode Middle Channel

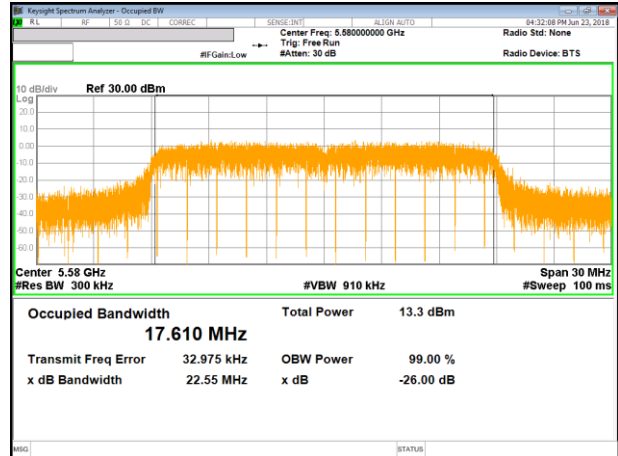

11n HT20 Mode High Channel

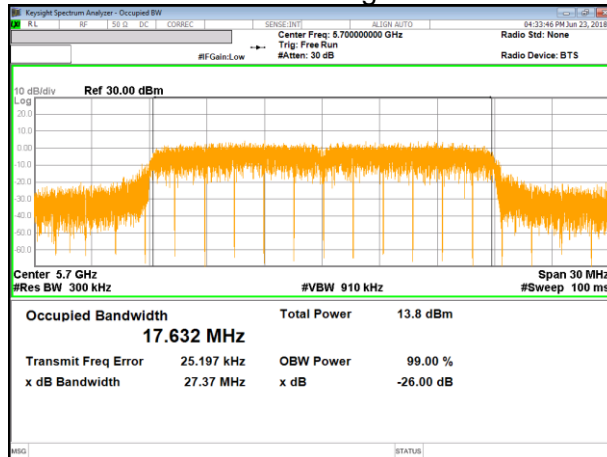

**UNII 5.5 GHz IEEE 802.11n HT40 mode**

11n HT40 Mode Low Channel

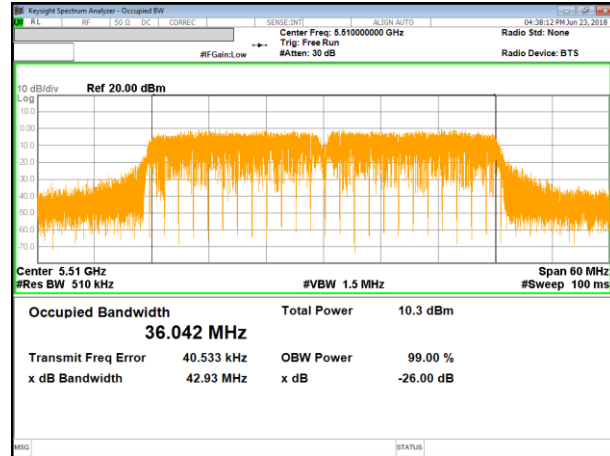

11n HT40 Mode Middle Channel

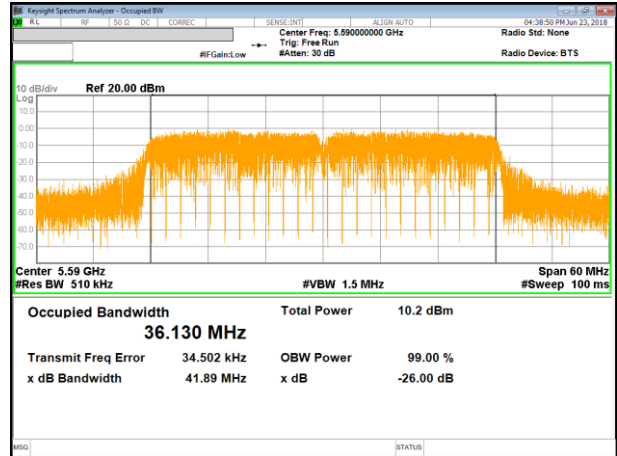

11n HT40 Mode High Channel

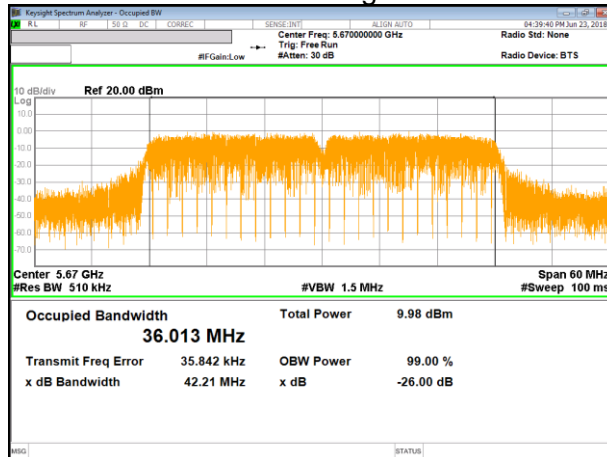

**UNII 5.8 GHz IEEE 802.11a mode**

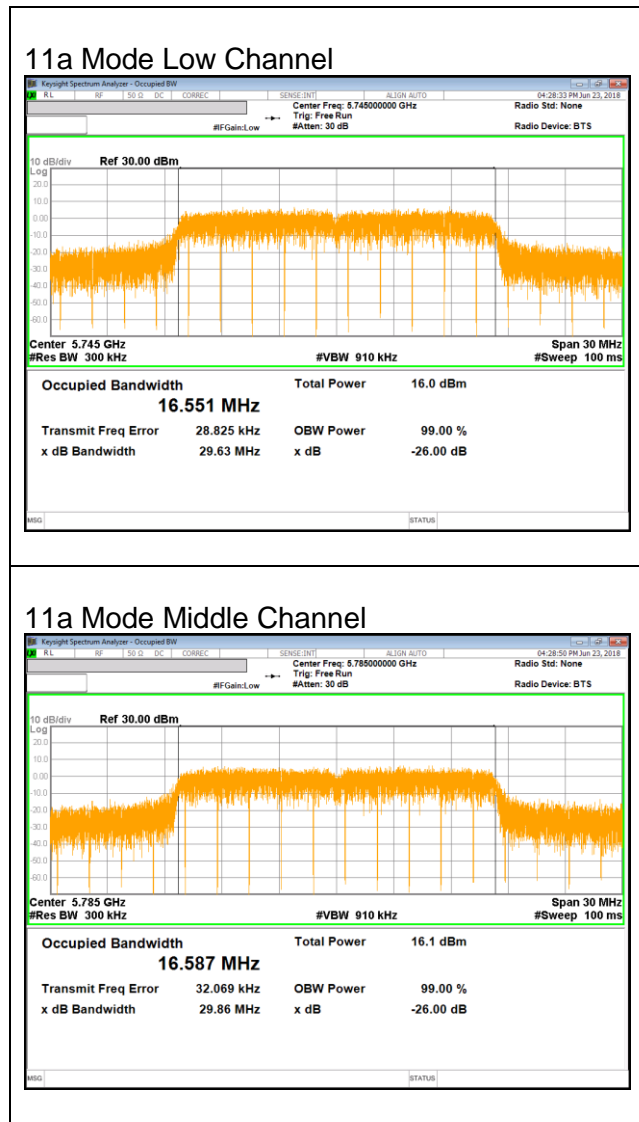



**UNII 5.8 GHz IEEE 802.11n HT20 mode**

**11n HT20 Mode Low Channel**

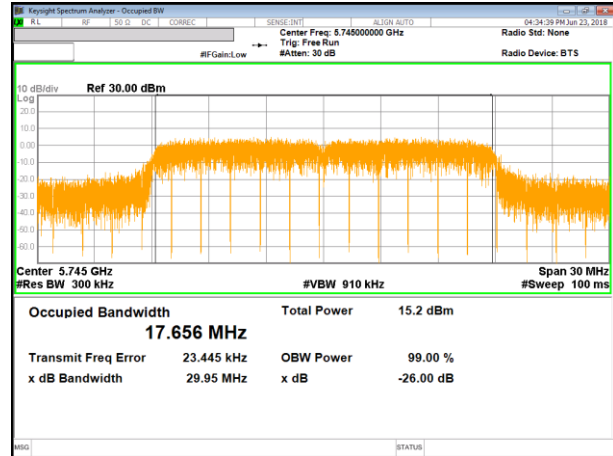

**11n HT20 Mode Middle Channel**

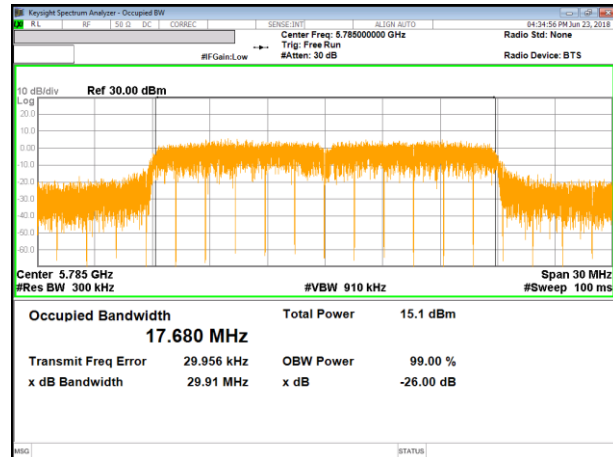

**11n HT20 Mode High Channel**

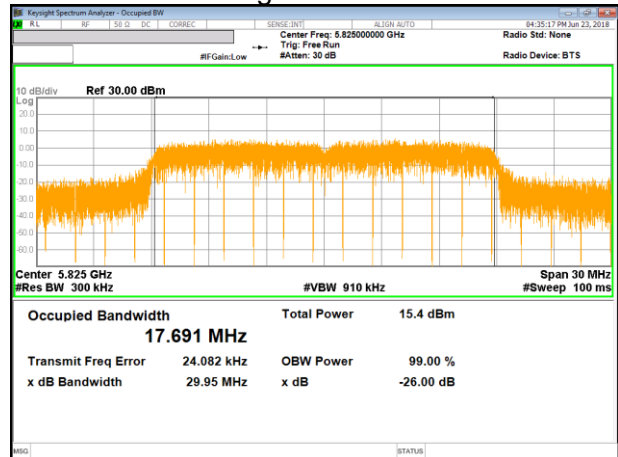

**UNII 5.8 GHz IEEE 802.11n HT40 mode**

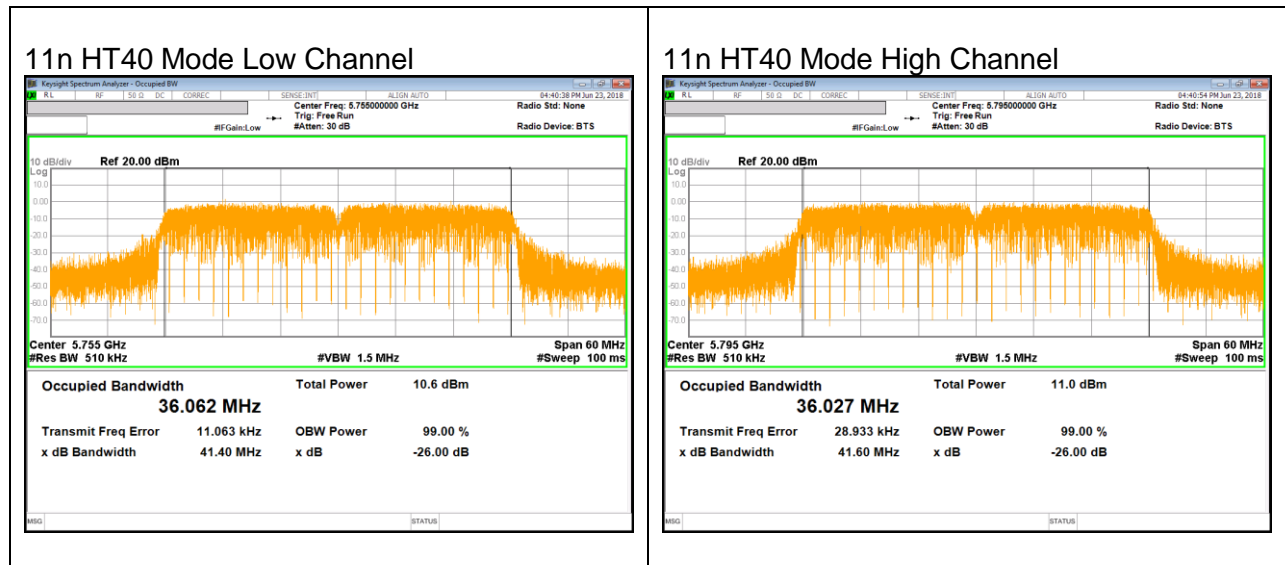

## 10. ANTENNA PORT TEST RESULTS

### 10.1. 6 dB BANDWIDTH

#### LIMITS

FCC §15.407 (e)

The minimum 6 dB bandwidth shall be at least 500 kHz.

#### TEST PROCEDURE

Reference to 789033 D02 General UNII Test Procedures New Rules v01r03: The transmitter output is connected to a spectrum analyzer with the RBW set to 100KHz, the VBW  $\geq 3 \times$  RBW, peak detector and max hold.

#### RESULTS

**10.1.1. 802.11a MODE IN THE 5.8 GHz BAND**

Channel	Frequency [MHz]	6 dB Bandwidth [MHz]	Minimum Limit [MHz]
Low	5745	16.32	0.5
Mid	5785	16.30	0.5
High	5825	15.42	0.5
Worst		16.32	

**10.1.2. 802.11n HT20 MODE IN THE 5.8 GHz BAND**

Channel	Frequency [MHz]	6 dB Bandwidth [MHz]	Minimum Limit [MHz]
Low	5745	17.11	0.5
Mid	5785	16.65	0.5
High	5825	17.30	0.5
Worst		17.30	

**10.1.3. 802.11n HT40 MODE IN THE 5.8 GHz BAND**

Channel	Frequency [MHz]	6 dB Bandwidth [MHz]	Minimum Limit [MHz]
Low	5755	34.99	0.5
High	5795	35.27	0.5
Worst		35.27	

### 10.1.4. 6 dB BANDWIDTH PLOTS

#### UNII 5.8 GHz IEEE 802.11a mode

