



FCC CFR47 PART 15 SUBPART C

Bluetooth

CERTIFICATION TEST REPORT

FOR

WCDMA/LTE Tablet + BT/BLE, DTS/UNII a/b/g/n and ANT+

MODEL NUMBER : SM-T387T

FCC ID: A3LSMT387T

REPORT NUMBER: 4788549592-E3V1

ISSUE DATE: JUL 25, 2018

Prepared for
SAMSUNG ELECTRONICS CO., LTD.
129 SAMSUNG-RO, YEONGTONG-GU, SUWON-SI,
GYEONGGI-DO, 16677, KOREA

Prepared by
UL Korea, Ltd.
26th floor, 152, Teheran-ro, Gangnam-gu Seoul, 06236, Korea

Suwon Test Site: UL Korea, Ltd. Suwon Laboratory
218 Maeyeong-ro, Yeongtong-gu,
Suwon-si, Gyeonggi-do, 16675, Korea
TEL: (031) 337-9902
FAX: (031) 213-5433



ACCREDITED*

Testing
Laboratory

TL-637

Revision History

<u>Rev.</u>	<u>Issue Date</u>	<u>Revisions</u>	<u>Revised By</u>
V1	07/25/18	Initial issue	Hoonpyo Lee

TABLE OF CONTENTS

1. ATTESTATION OF TEST RESULTS	5
2. TEST METHODOLOGY	6
3. FACILITIES AND ACCREDITATION	8
4. CALIBRATION AND UNCERTAINTY	8
4.1. MEASURING INSTRUMENT CALIBRATION	8
4.2. SAMPLE CALCULATION	8
4.3. MEASUREMENT UNCERTAINTY.....	9
5. EQUIPMENT UNDER TEST	10
5.1. DESCRIPTION OF EUT	10
5.1. MAXIMUM OUTPUT POWER.....	10
5.2. DESCRIPTION OF AVAILABLE ANTENNAS	10
5.3. WORST-CASE CONFIGURATION AND MODE.....	10
5.4. DESCRIPTION OF TEST SETUP.....	11
6. MEASUREMENT METHODS	13
7. TEST AND MEASUREMENT EQUIPMENT	14
8. REFERENCE MEASUREMENT RESULTS.....	15
8.1. ON TIME AND DUTY CYCLE RESULTS.....	15
8.2. 20 dB AND 99% BANDWIDTH	16
8.2.1. BASIC DATA RATE GFSK MODULATION	16
8.2.2. ENHANCED DATA RATE Pi/4-DQPSK MODULATION.....	16
8.2.3. ENHANCED DATA RATE 8PSK MODULATION	16
8.2.4. 20 dB AND 99% BANDWIDTH PLOTS.....	17
9. SUMMARY TABLE	20
10. ANTENNA PORT TEST RESULTS	21
10.1. HOPPING FREQUENCY SEPARATION.....	21
10.2. NUMBER OF HOPPING CHANNELS	22
10.3. AVERAGE TIME OF OCCUPANCY	26
10.4. OUTPUT POWER.....	34
10.4.1. BASIC DATA RATE GFSK MODULATION	34
10.4.2. ENHANCED DATA RATE Pi/4-DPSK MODULATION.....	34
10.4.3. ENHANCED DATA RATE 8PSK MODULATION.....	34
10.4.4. OUTPUT POWER PLOTS	35
10.5. AVERAGE POWER	38

10.5.1.	BASIC DATA RATE GFSK MODULATION	38
10.5.2.	DATA RATE PI/4-DQPSK MODULATION.....	38
10.5.3.	ENHANCED DATA RATE 8PSK MODULATION.....	38
10.6.	CONDUCTED SPURIOUS EMISSIONS	39
10.6.1.	BASIC DATA RATE GFSK MODULATION	40
11.	RADIATED TEST RESULTS	52
11.1.	LIMITS AND PROCEDURE.....	52
11.2.	TRANSMITTER ABOVE 1 GHz.....	54
11.2.1.	BASIC DATA RATE GFSK MODULATION	54
11.2.2.	ENHANCED DATA RATE 8PSK MODULATION.....	64
11.3.	WORST-CASE BELOW 1 GHz	74
12.	AC POWER LINE CONDUCTED EMISSIONS	76
13.	SETUP PHOTOS	81

1. ATTESTATION OF TEST RESULTS

COMPANY NAME: SAMSUNG ELECTRONICS CO., LTD.
EUT DESCRIPTION: WCDMA/LTE Tablet + BT/BLE, DTS/UNII a/b/g/n and ANT+
MODEL NUMBER: SM-T387T
SERIAL NUMBER: R32K500LY6E (RADIATED, Original);
R32K500M0TM (CONDUCTED, Original);
R32K500K31T (RADIATED, Spot check);
DATE TESTED: JUN 05, 2018 - JUN 24, 2018 (Original);
JUL 24, 2018 (Spot check);

APPLICABLE STANDARDS	
STANDARD	TEST RESULTS
CFR 47 Part 15 Subpart C	Pass

UL Korea, Ltd. tested the above equipment in accordance with the requirements set forth in the above standards. All indications of Pass/Fail in this report are opinions expressed by UL Korea, Ltd. based on interpretations and/or observations of test results. Measurement Uncertainties were not taken into account and are published for informational purposes only. The test results show that the equipment tested is capable of demonstrating compliance with the requirements as documented in this report.

Note: The results documented in this report apply only to the tested sample, under the conditions and modes of operation as described herein. This document JUN not be altered or revised in any way unless done so by UL Korea, Ltd. and all revisions are duly noted in the revisions section. Any alteration of this document not carried out by UL Korea, Ltd. will constitute fraud and shall nullify the document. This report must not be used by the client to claim product certification, approval, or endorsement by IAS, any agency of the Federal Government, or any agency of any government.

Approved & Released For
UL Korea, Ltd. By:

Tested By:



SungGil Park
Suwon Lab Engineer
UL Korea, Ltd.

Hoonpyo Lee
Suwon Lab Engineer
UL Korea, Ltd.

1.1. INTRODUCTION OF TEST DATA REUSE

This report referenced from the FCC ID: A3LSMT387V DSS BT(FCC CFR 47 Part 15C). And the applicant takes full responsibility that the test data as referenced in this report represent compliance for this FCC ID.

1.2. DIFFERENCE

The FCC ID: A3LSMT387T shares the same enclosure and circuit board as FCC ID: A3LSMT387V. The BT antennas and surrounding circuitry and layout are identical between these two units.

After confirming through preliminary radiated emissions that the performance of the FCC ID: A3LSMT387V remains representative of FCC ID: A3LSMT387T. The test data of FCC ID: A3LSMT387V being submitted for this application to cover BT features.

1.3. SPOT CHECK VERIFICATION DATA

(Worst case of the radiated spurious and band edge emissions)

Band	Test Item	Mode	Frequency	Test Limit	Original model	Spot check model	Deviation	Remark
					SM-T387V Results	SM-T387T Results		
					FCC ID : A3LSMT387V	FCC ID : A3LSMT387T		
DSS BT (2.4GHz)	Band Edge	GFSK	2480 MHz	54 dBuV/m	41.27 dBuV/m	40.17 dBuV/m	-1.10 dB	
	RSE	GFSK	2402 MHz	54 dBuV/m	36.88 dBuV/m	35.55 dBuV/m	-1.33 dB	

Comparison of two models, upper deviation is within 3dB range and all test results are under FCC Technical Limits.

1.4. REFERENCE DETAIL

Reference application that contains the reused reference data.

Equipment Class	Reference FCC ID	Type Grant/Permissive Change	Reference Application	Folder Test/RF Exposure	Report Title / Section
DTS	A3LSMT387V	Grant	4788481138-E1V2	Test	FCC Report DTS WLAN / All sections
			4788481138-E2V2	Test	FCC Report BLE All sections
DSS	A3LSMT387V	Grant	4788481138-E3V2	Test	FCC Report UNII WLAN / All sections
NII	A3LSMT387V	Grant	4788481138-E4V3	Test	FCC Report UNII WLAN / All sections
DXX	A3LSMT387V	Grant	4788481138-E5V2	Test	FCC Report ANT+ / All sections
PCE	A3LSMT387V	Grant	4788481138-E6V2	Test	FCC Report WWAN / All sections (for WCDMA B2/B5, LTE Band 2/4/5/7)

2. TEST METHODOLOGY

The tests documented in this report were performed in accordance with following methods.

1. FCC CFR 47 Part 2.
2. FCC CFR 47 Part 15.
3. FCC DA 00-705 Filing and measurement guidelines for FHSS systems
4. ANSI C63.10-2013.

3. FACILITIES AND ACCREDITATION

The test sites and measurement facilities used to collect data are located at 218 Maeyeong-ro, Yeongtong-gu, Suwon-si, Gyeonggi-do, 16675, Korea. Line conducted emissions are measured only at the 218 address. The following table identifies which facilities were utilized for radiated emission measurements documented in this report. Specific facilities are also identified in the test results sections.

218 Maeyeong-ro	
<input checked="" type="checkbox"/>	Chamber 1
<input type="checkbox"/>	Chamber 2
<input checked="" type="checkbox"/>	Chamber 3

UL Korea, Ltd. is accredited by IAS, Laboratory Code TL-637. The full scope of accreditation can be viewed at <http://www.iasonline.org/PDF/TL/TL-637.pdf>.

4. CALIBRATION AND UNCERTAINTY

4.1. MEASURING INSTRUMENT CALIBRATION

The measuring equipment utilized to perform the tests documented in this report has been calibrated in accordance with the manufacturer's recommendations, and is traceable to recognized national standards.

4.2. SAMPLE CALCULATION

Where relevant, the following sample calculation is provided:

$$\begin{aligned} \text{Field Strength (dBuV/m)} &= \text{Measured Voltage (dBuV)} + \text{Antenna Factor (dB/m)} + \\ &\text{Cable Loss (dB)} - \text{Preamplifier Gain (dB)} \\ 36.5 \text{ dBuV} + 18.7 \text{ dB/m} + 0.6 \text{ dB} - 26.9 \text{ dB} &= 28.9 \text{ dBuV/m} \end{aligned}$$

4.3. MEASUREMENT UNCERTAINTY

Where relevant, the following measurement uncertainty levels have been estimated for tests performed on the apparatus:

PARAMETER	UNCERTAINTY
Conducted Disturbance, 0.15 to 30 MHz	2.32 dB
Radiated Disturbance, Below 1GHz	3.86 dB
Radiated Disturbance, Above 1 GHz	5.97 dB

Uncertainty figures are valid to a confidence level of 95%.

5. EQUIPMENT UNDER TEST

5.1. DESCRIPTION OF EUT

The EUT is a WCDMA/LTE Tablet + BT/BLE, DTS/UNII a/b/g/n and ANT+. This test report addresses the DSS (BT) operational mode.

5.1. MAXIMUM OUTPUT POWER

The transmitter has a maximum conducted output power as follows:

Frequency Range [MHz]	Mode	Power Mode	Output Power [dBm]	Output Power [mW]
2402 - 2480	Basic GFSK	Average	9.041	8.019
		Peak	9.334	8.578
	Enhanced Pi/4-DPSK	Average	8.815	7.612
		Peak	11.042	12.712
	Enhanced 8PSK	Average	8.816	7.614
		Peak	11.689	14.754

5.2. DESCRIPTION OF AVAILABLE ANTENNAS

The radio utilizes an internal antenna, with a maximum gain of -2.70 dBi.

5.3. WORST-CASE CONFIGURATION AND MODE

Radiated emission below 1GHz and power line conducted emission were performed with the EUT set to transmit at the channel with highest output power as worst-case scenario.

Radiated emission above 1GHz was performed with the EUT set to transmit low/mid/high channels.

The fundamental of the EUT was investigated in three orthogonal orientations X, Y and Z it was determined that Y orientation was worst-case orientation; therefore, all final radiated testing was performed with the EUT in Y orientation.

Note: GFSK, Pi/4-DQPSK, 8PSK average Power are all investigated, The GFSK & 8PSK Power are the worst case. Testing is based on this mode to showing compliance. For average power data please refer to section 9.5. All radiated and power line conducted tests were performed connected with earphone and charger for evaluation of worst case mode.

5.4. DESCRIPTION OF TEST SETUP

SUPPORT EQUIPMENT

Support Equipment List				
Description	Manufacturer	Model	Serial Number	FCC ID
Charger	SAMSUNG	EP-TA50JWE	DK4K227VS/A-E	N/A
Data Cable	SAMSUNG	EP-DG915UWZ	N/A	N/A
Earphone	SAMSUNG	EHS64AVFWE	N/A	N/A

I/O CABLES

I/O Cable List						
Cable No	Port	# of identical ports	Connector Type	Cable Type	Cable Length (m)	Remarks
1	DC Power	1	Mini-USB	Shielded	1.2m	N/A
2	Audio	2	Mini-Jack	Unshielded	1.2m	N/A

TEST SETUP

The EUT is continuously communicating to the Bluetooth tester during the tests.
 Test software enable BT communications.

SETUP DIAGRAM FOR TESTS (CONDUCTED TEST SETUP)

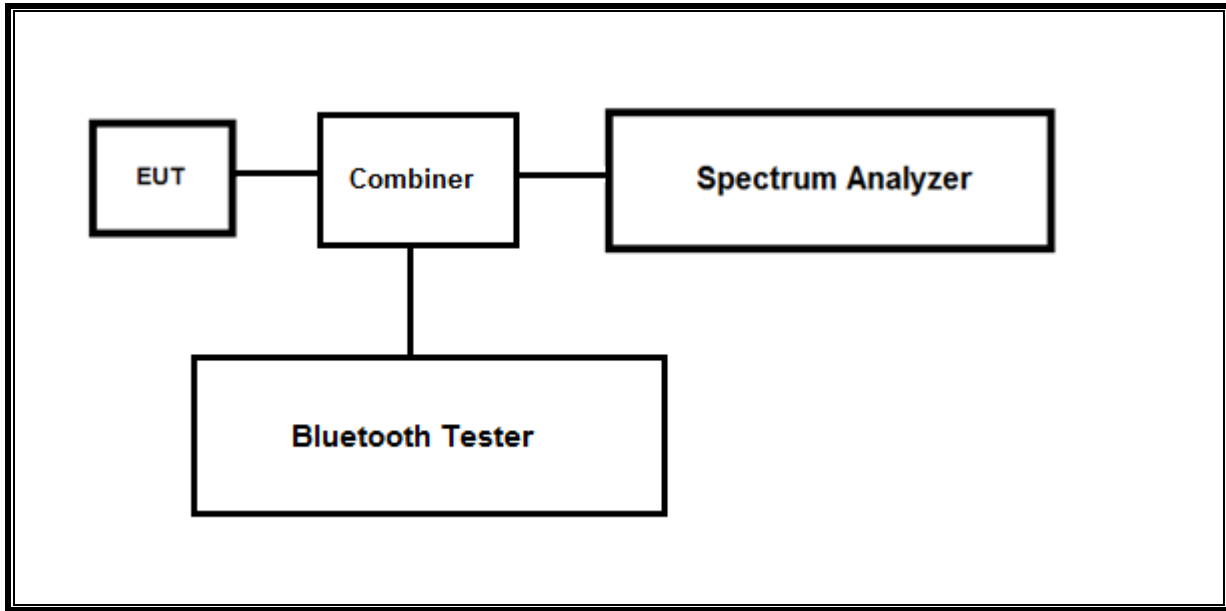

SETUP DIAGRAM FOR TESTS (RADIATED TEST SETUP)

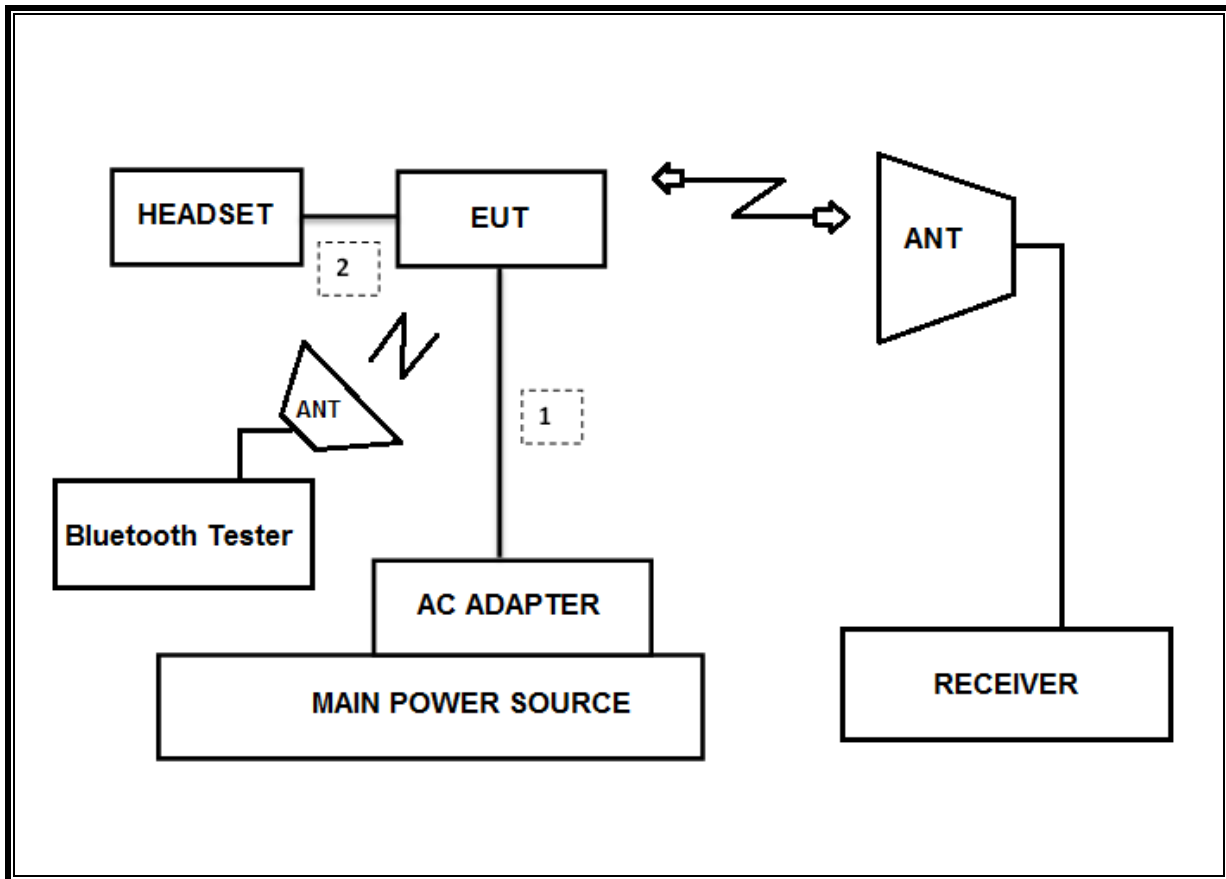

6. MEASUREMENT METHODS

20dB BW : ANSI C63.10, Section 6.9.2

99% BW : ANSI C63.10, Section 6.9.3

HOPPING FREQUENCY SEPARATION : ANSI C63.10, Section 7.8.2

NUMBER OF HOPPING CHANNELS : ANSI C63.10, Section 7.8.3

AVERAGE TIME OF OCCUPANCY : ANSI C63.10, Section 7.8.4

OUTPUT POWER : ANSI C63.10, Section 7.8.5.

Out-of-band EMISSIONS (Conducted) : ANSI C63.10, Section 7.8.6, 7.8.8

Out-of-band EMISSIONS IN NON-RESTRICTED BANDS: ANSI C63.10, Section 6.

Out-of-band EMISSIONS IN RESTRICTED BANDS : ANSI C63.10, Section 6.

AC Power Line Conducted Emission : ANSI C63.10-2013, Section 6.2.

7. TEST AND MEASUREMENT EQUIPMENT

The following test and measurement equipment was utilized for the tests documented in this report:

Test Equipment List				
Description	Manufacturer	Model	S/N	Cal Due
Antenna, Bilog, 30MHz-1GHz	SCHWARZBECK	VULB9163	750	08-31-19
Antenna, Bilog, 30MHz-1GHz	SCHWARZBECK	VULB9163	749	09-14-19
Antenna, Bilog, 30MHz-1GHz	SCHWARZBECK	VULB9163	845	08-31-19
Antenna, Horn, 18 GHz	ETS	3115	00167211	10-14-18
Antenna, Horn, 18 GHz	ETS	3115	00161451	03-10-19
Antenna, Horn, 18 GHz	ETS	3117	00168724	05-31-19
Antenna, Horn, 18 GHz	ETS	3117	00168717	05-31-19
Antenna, Horn, 18 GHz	ETS	3117	00205959	11-29-18
Antenna, Horn, 40 GHz	ETS	3116C	00166155	12-04-19
Antenna, Horn, 40 GHz	ETS	3116C	00168645	12-04-19
Antenna, Horn, 40 GHz	ETS	3116C-PA	00168841	11-13-19
Preamplifier, 1000 MHz	Sonoma	310N	341282	08-09-18
Preamplifier, 1000 MHz	Sonoma	310N	351741	08-07-18
Preamplifier, 1000 MHz	Sonoma	310N	370599	08-10-18
Preamplifier, 18 GHz	Miteq	AFS42-00101800-25-S-42	1876511	08-08-18
Preamplifier, 18 GHz	Miteq	AFS42-00101800-25-S-42	1896138	08-08-18
Preamplifier, 18 GHz	Miteq	AFS42-00101800-25-S-42	2029169	08-11-18
Spectrum Analyzer, 44 GHz	Agilent / HP	N9030A	MY54170614	08-08-18
Spectrum Analyzer, 44 GHz	Agilent / HP	N9030A	MY54490312	08-08-18
Average Power Sensor	Agilent / HP	U2000	MY54270007	08-08-18
Bluetooth Tester	TESCOM	TC-3000C	3000C000546	08-08-18
Combiner	WEINCHEL	1575	2152	08-08-18
Attenuator	PASTERNAK	PE7087-10	A001	08-08-18
Attenuator	PASTERNAK	PE7087-10	A008	08-08-18
Attenuator	PASTERNAK	PE7087-10	2	08-10-18
EMI Test Receive, 40 GHz	R&S	ESU40	100439	08-08-18
EMI Test Receive, 40 GHz	R&S	ESU40	100457	08-08-18
EMI Test Receive, 44 GHz	R&S	ESW44	101590	08-09-18
EMI Test Receive, 3 GHz	R&S	ESR3	101832	08-07-18
Low Pass Filter 5GHz	Micro-Tronics	LPS17541	009	08-08-18
Low Pass Filter 5GHz	Micro-Tronics	LPS17541	015	08-08-18
Low Pass Filter 5GHz	Micro-Tronics	LPS17541	020	08-11-18
High Pass Filter 3GHz	Micro-Tronics	HPM17543	010	08-08-18
High Pass Filter 3GHz	Micro-Tronics	HPM17543	015	08-08-18
High Pass Filter 3GHz	Micro-Tronics	HPM17543	020	08-11-18
High Pass Filter 6GHz	Micro-Tronics	HPS17542	009	08-08-18
High Pass Filter 6GHz	Micro-Tronics	HPS17542	016	08-08-18
High Pass Filter 6GHz	Micro-Tronics	HPS17542	021	08-11-18
LISN	R&S	ENV-216	101837	08-09-18
UL Software				
Description	Manufacturer	Model	Version	
Radiated software	UL	UL EMC	Ver 9.5	
AC Line Conducted software	UL	UL EMC	Ver 9.5	

8. REFERENCE MEASUREMENT RESULTS

8.1. ON TIME AND DUTY CYCLE RESULTS

LIMITS

None: for reporting purposes only.

Mode	ON Time B [msec]	Period [msec]	Duty Cycle x [linear]	Duty Cycle [%]	Duty Cycle Correction Factor [dB]	1/T Minimum VBW [kHz]
2400MHz Bands						
BT	2.884	3.750	0.769	76.9%	1.14	0.347

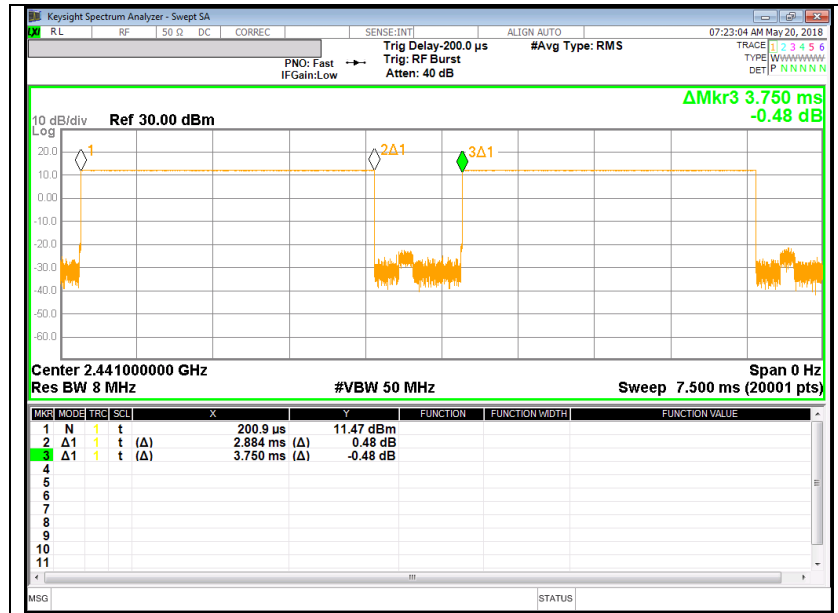

[DH5]

8.2. 20 dB AND 99% BANDWIDTH

LIMITS

None; for reporting purposes only.

TEST PROCEDURE

The transmitter output is connected to a spectrum analyzer. The RBW is set to $\geq 1\%$ of the 20 dB bandwidth. The VBW is set to \geq RBW. The sweep time is coupled.

RESULTS

8.2.1. BASIC DATA RATE GFSK MODULATION

Channel	Frequency [MHz]	20 dB Bandwidth [kHz]	99% Bandwidth [kHz]
Low	2402	890.2	870.19
Mid	2441	968.8	868.48
High	2480	942.4	896.90
Worst		968.8	896.90

8.2.2. ENHANCED DATA RATE Pi/4-DQPSK MODULATION

Channel	Frequency [MHz]	20 dB Bandwidth [MHz]	99% Bandwidth [MHz]
Low	2402	1.227	1.130
Mid	2441	1.299	1.163
High	2480	1.303	1.162
Worst		1.303	1.163

8.2.3. ENHANCED DATA RATE 8PSK MODULATION

Channel	Frequency [MHz]	20 dB Bandwidth [MHz]	99% Bandwidth [MHz]
Low	2402	1.259	1.161
Mid	2441	1.263	1.160
High	2480	1.262	1.161
Worst		1.263	1.161

8.2.4. 20 dB AND 99% BANDWIDTH PLOTS

GFSK BANDWIDTH

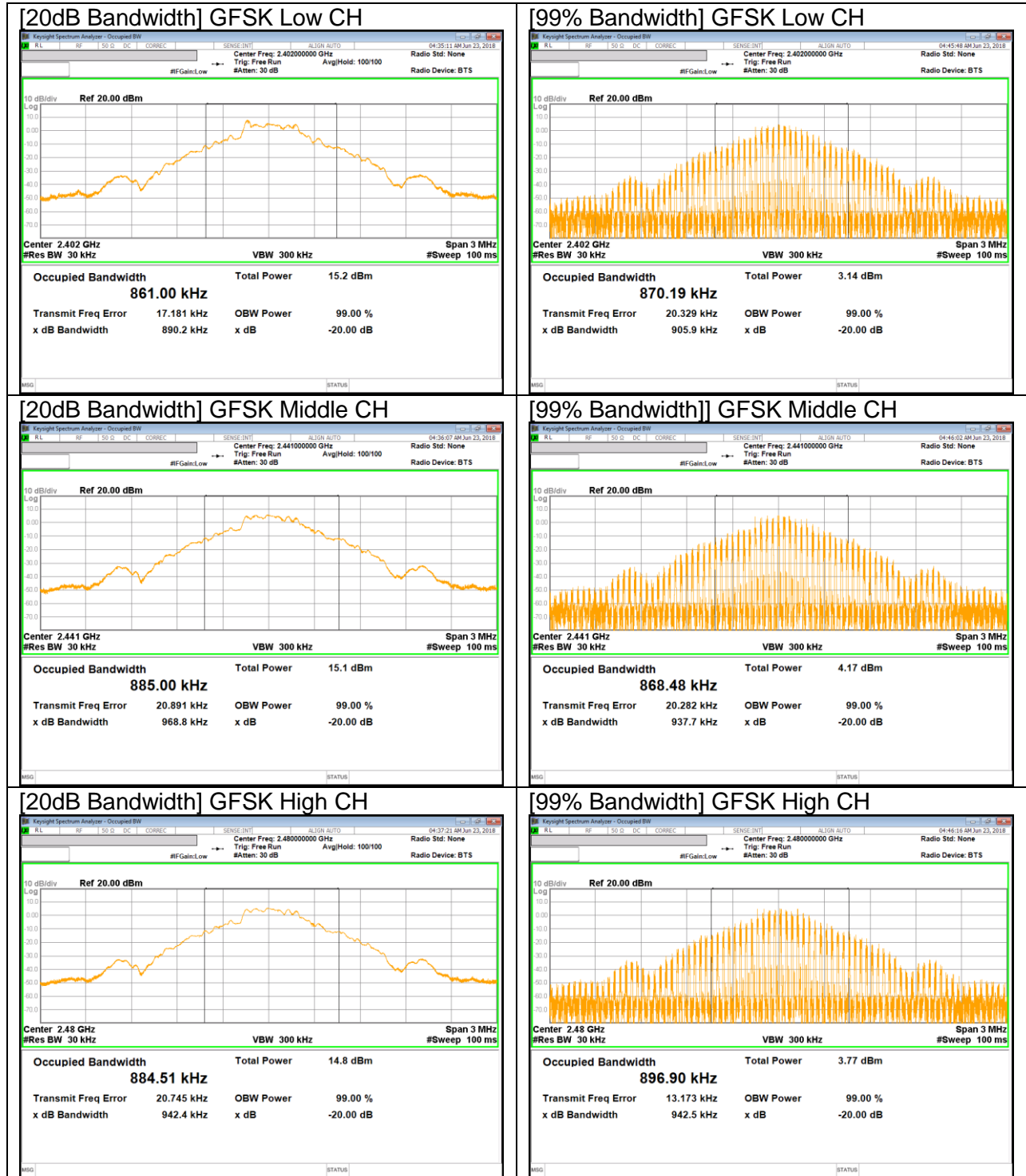

Pi/4-DQPSK BANDWIDTH

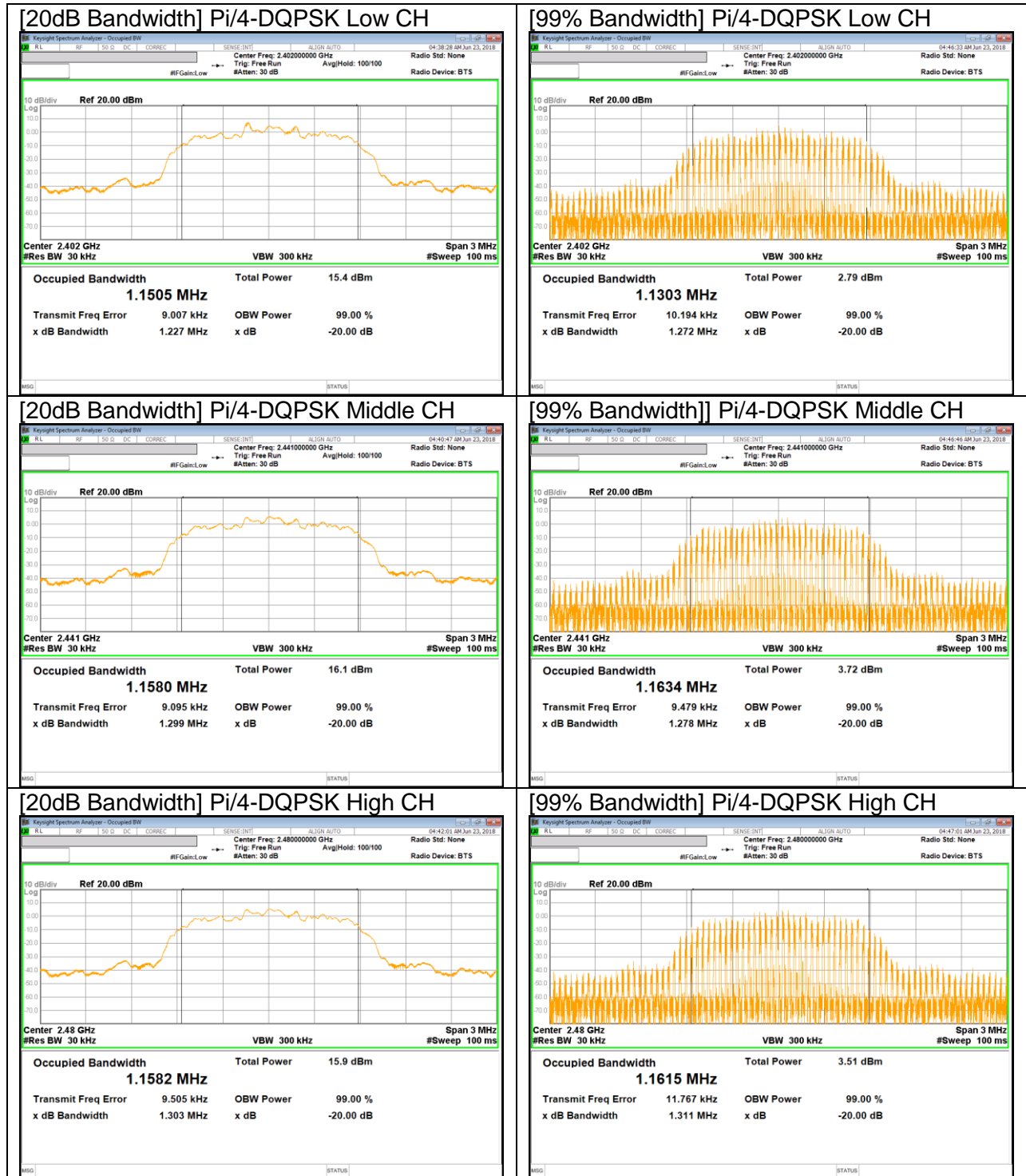

8PSK BANDWIDTH

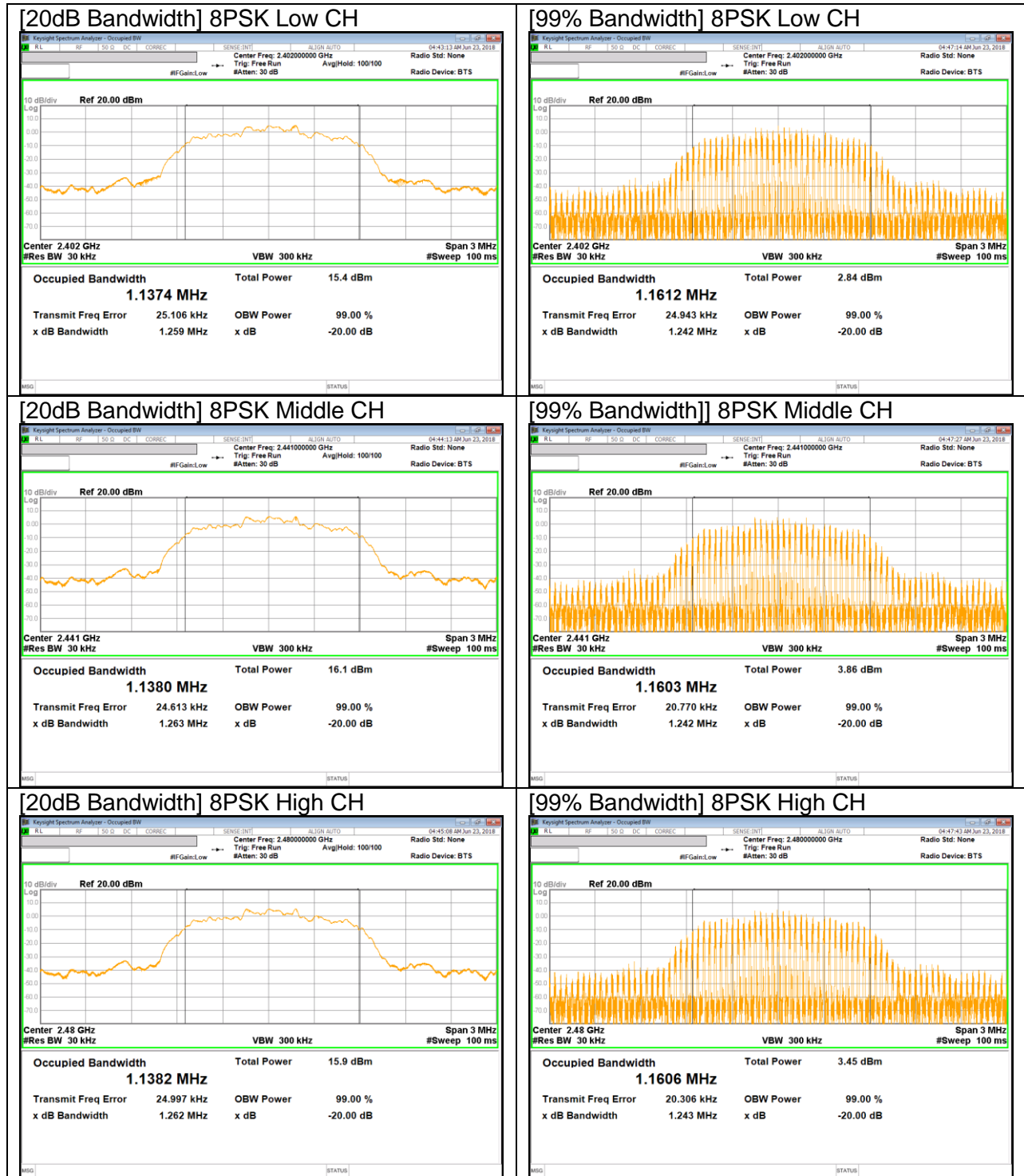

9. SUMMARY TABLE

FCC Part Section	Test Description	Test Limit	Test Condition	Test Result
2.1051, 15.247 (d)	Band Edge / Conducted Spurious Emission	-20dBc	Conducted	Pass
15.247 (b)(1)	TX conducted output power	<30dBm		Pass
15.247 (a)(1)	Hopping frequency separation	> two-thirds of the 20 dB bandwidth		Pass
15.247 (a)(1)(iii)	Number of Hopping channels	More than 15 non-overlapping channels		Pass
15.247 (a)(1)(iii)	Avg Time of Occupancy	< 0.4sec		Pass
15.207 (a)	AC Power Line conducted emissions	Section 10	Power Line conducted	Pass
15.205, 15.209	Radiated Spurious Emission	< 54dBuV/m	Radiated	Pass

10. ANTENNA PORT TEST RESULTS

10.1. HOPPING FREQUENCY SEPARATION

LIMIT

FCC §15.247 (a) (1)

Frequency hopping systems shall have hopping channel carrier frequencies separated by a minimum of 25 kHz or the 20 dB bandwidth of the hopping channel, whichever is greater.

Alternatively, frequency hopping systems operating in the 2400-2483.5 MHz band JUN have hopping channel carrier frequencies that are separated by 25 kHz or two-thirds of the 20 dB bandwidth of the hopping channel, whichever is greater, provided the systems operate with an output power no greater than 125 mW.

TEST PROCEDURE

The transmitter output is connected to a spectrum analyzer. The RBW is set to 300 kHz and the VBW is set to 300 kHz. The sweep time is coupled.

RESULTS

HOPPING FREQUENCY SEPARATION PLOT

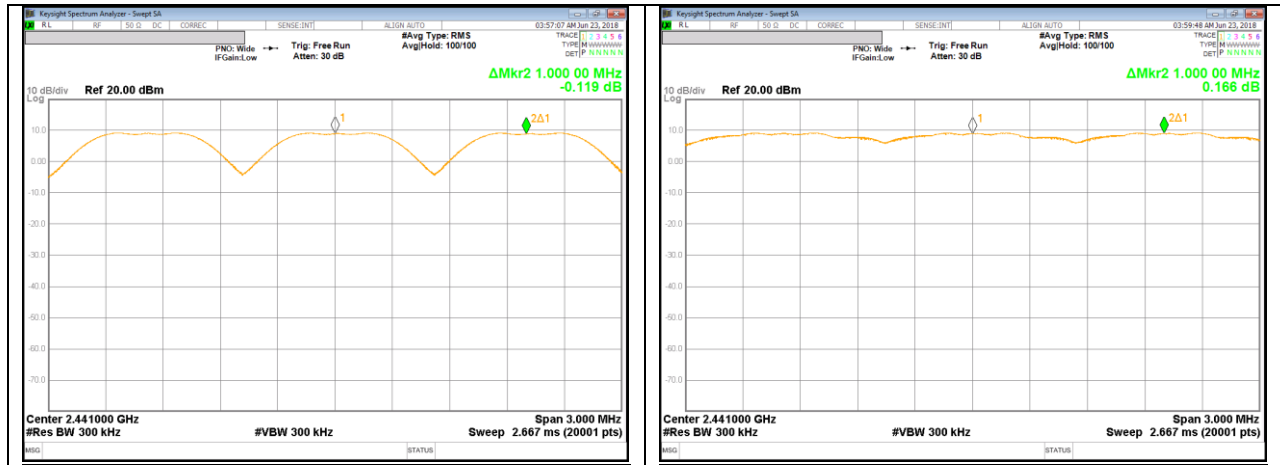

[GFSK]

[8PSK]

10.2. NUMBER OF HOPPING CHANNELS

LIMIT

FCC §15.247 (a) (1) (iii)

Frequency hopping systems in the 2400 – 2483.5 MHz band shall use at least 15 non-overlapping channels.

TEST PROCEDURE

The transmitter output is connected to a spectrum analyzer. The span is set to cover the entire authorized band, in either a single sweep or in multiple contiguous sweeps. The RBW is set to a maximum of 1 % of the span. The analyzer is set to Max Hold.

RESULTS

Normal Mode: 79 Channels observed.

NUMBER OF HOPPING CHANNELS PLOTS[GFSK]

NUMBER OF HOPPING CHANNELS (100 MHZ SPAN)

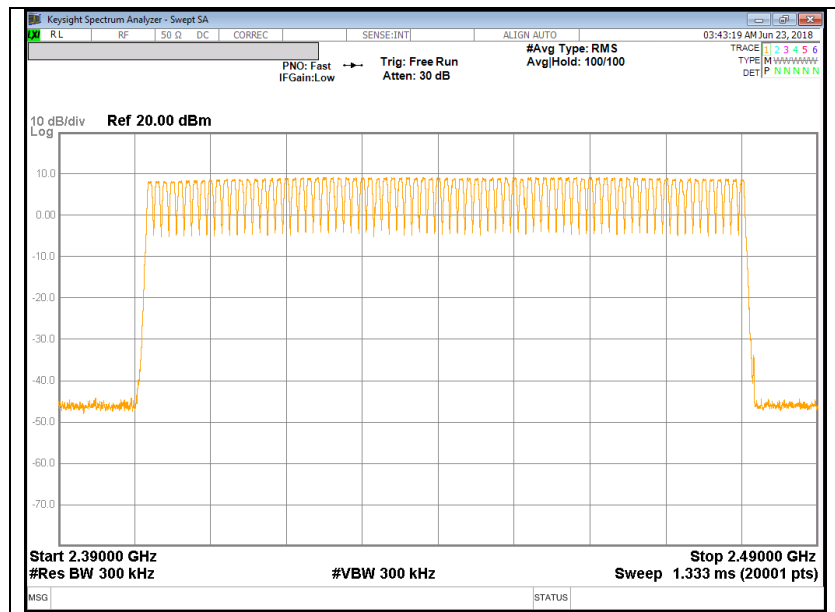

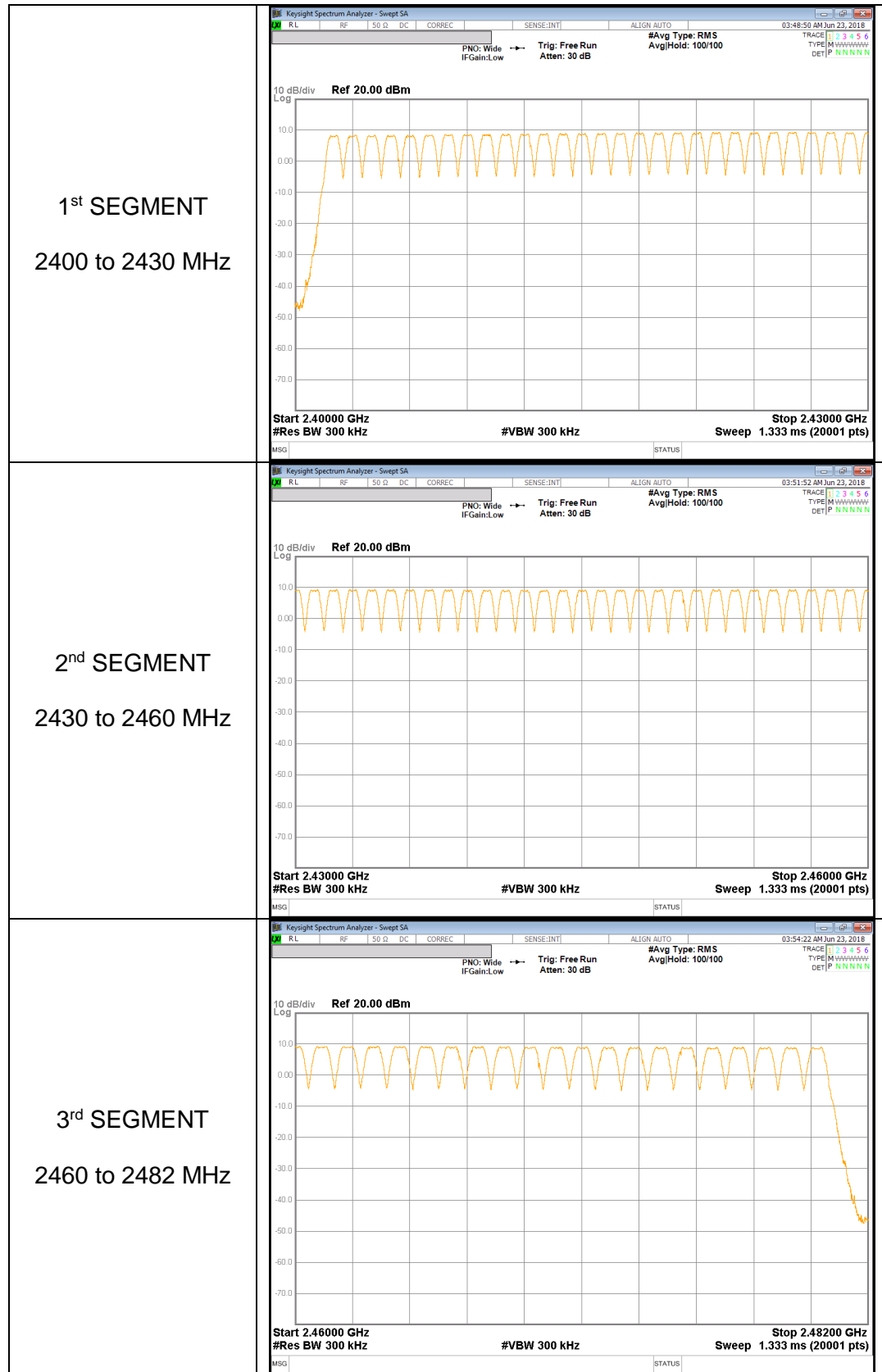

NUMBER OF HOPPING CHANNELS PLOTS[8PSK]

NUMBER OF HOPPING CHANNELS (100 MHZ SPAN)

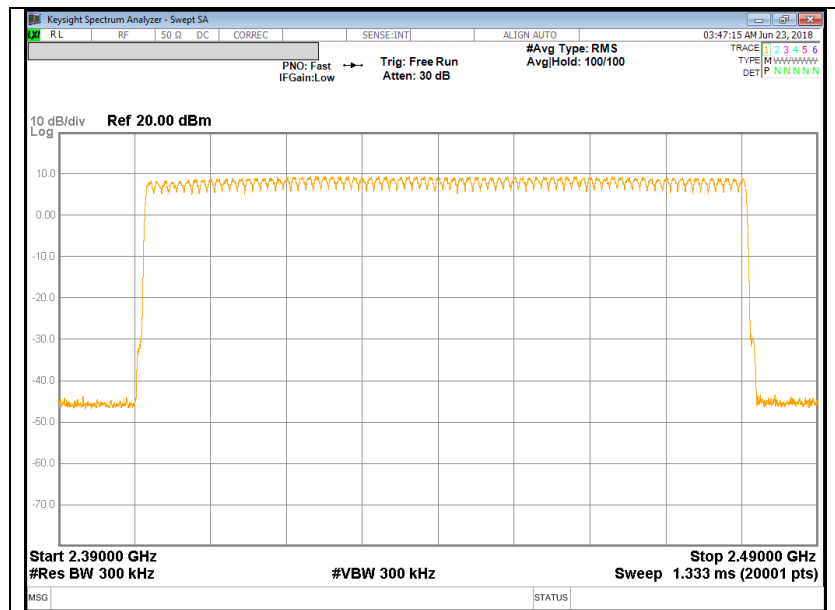

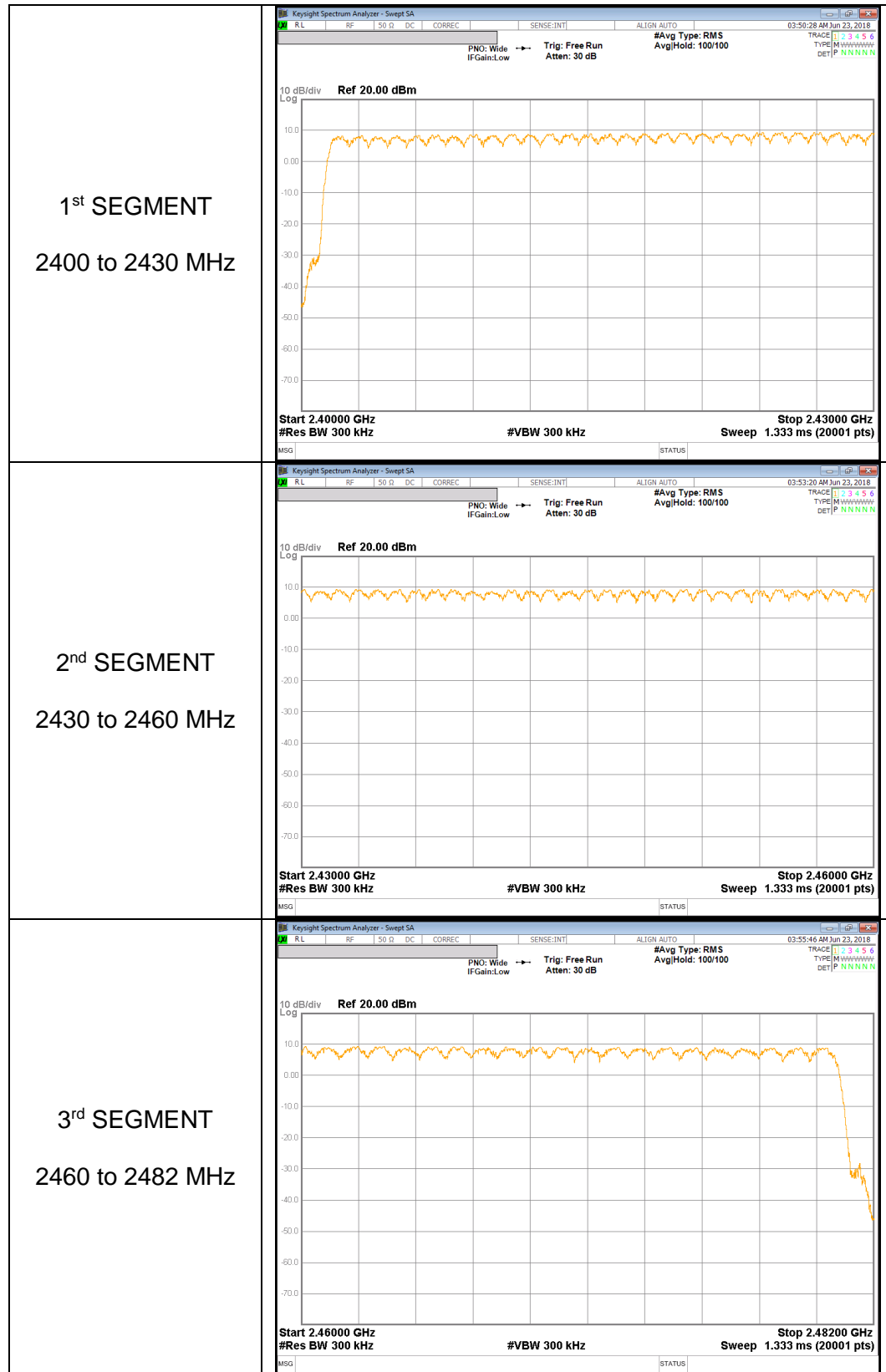

10.3. AVERAGE TIME OF OCCUPANCY

LIMIT

FCC §15.247 (a) (1) (iii)

The average time of occupancy on any channel shall not be greater than 0.4 seconds within a period of 0.4 seconds multiplied by the number of hopping channels employed.

TEST PROCEDURE

The transmitter output is connected to a spectrum analyzer. The span is set to 0 Hz, centered on a single, selected hopping channel. The width of a single pulse is measured in a fast scan. The number of pulses is measured in a 3.16 second scan, to enable resolution of each occurrence.

The average time of occupancy in the specified 31.6 second period (79 channels * 0.4 s) is equal to 10 * (# of pulses in 3.16 s) * pulse width.

For AFH mode, the average time of occupancy in the specified 8 second period (20 channels * 0.4 seconds) is equal to 10 * (# of pulses in 0.8 s) * pulse width.

RESULTS[GFSK]

	Width [msec]	Pulses in 3.16 seconds	of Occupancy [sec]	[sec]	[sec]
GFSK Normal					
DH1	0.380	32	0.121600	0.4	-0.2784
DH3	1.636	16	0.261760	0.4	-0.1382
DH5	2.884	12	0.346080	0.4	-0.0539
GFSK AFH					
DH Packet	Pulse Width [msec]	Number of Pulses in 0.8 seconds	Average Time of Occupancy [sec]	Limit [sec]	Margin [sec]
DH1	0.380	8	0.030400	0.4	-0.3696
DH3	1.636	4	0.065440	0.4	-0.3346
DH5	2.884	3	0.086520	0.4	-0.3135

DH1

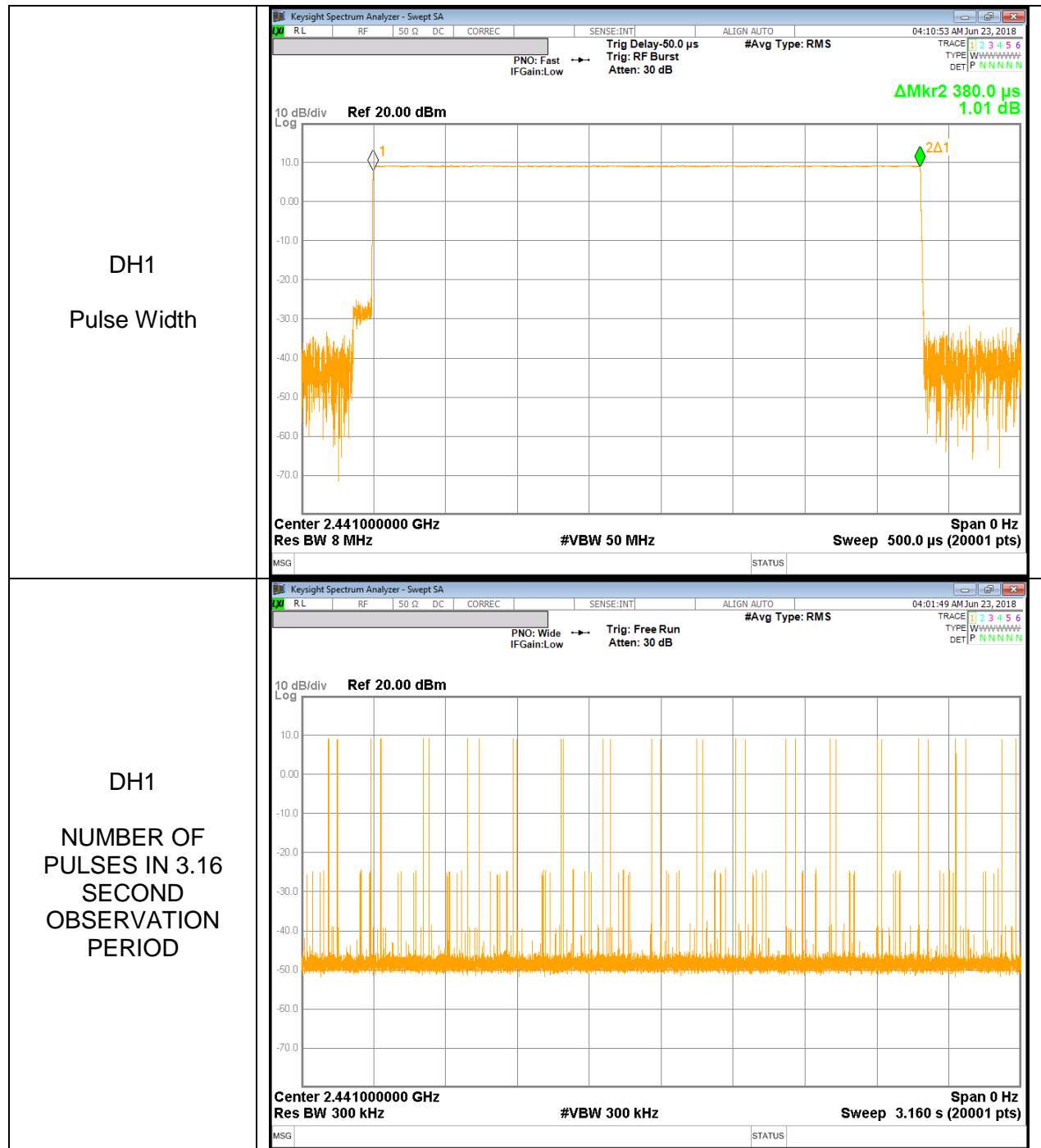

DH3

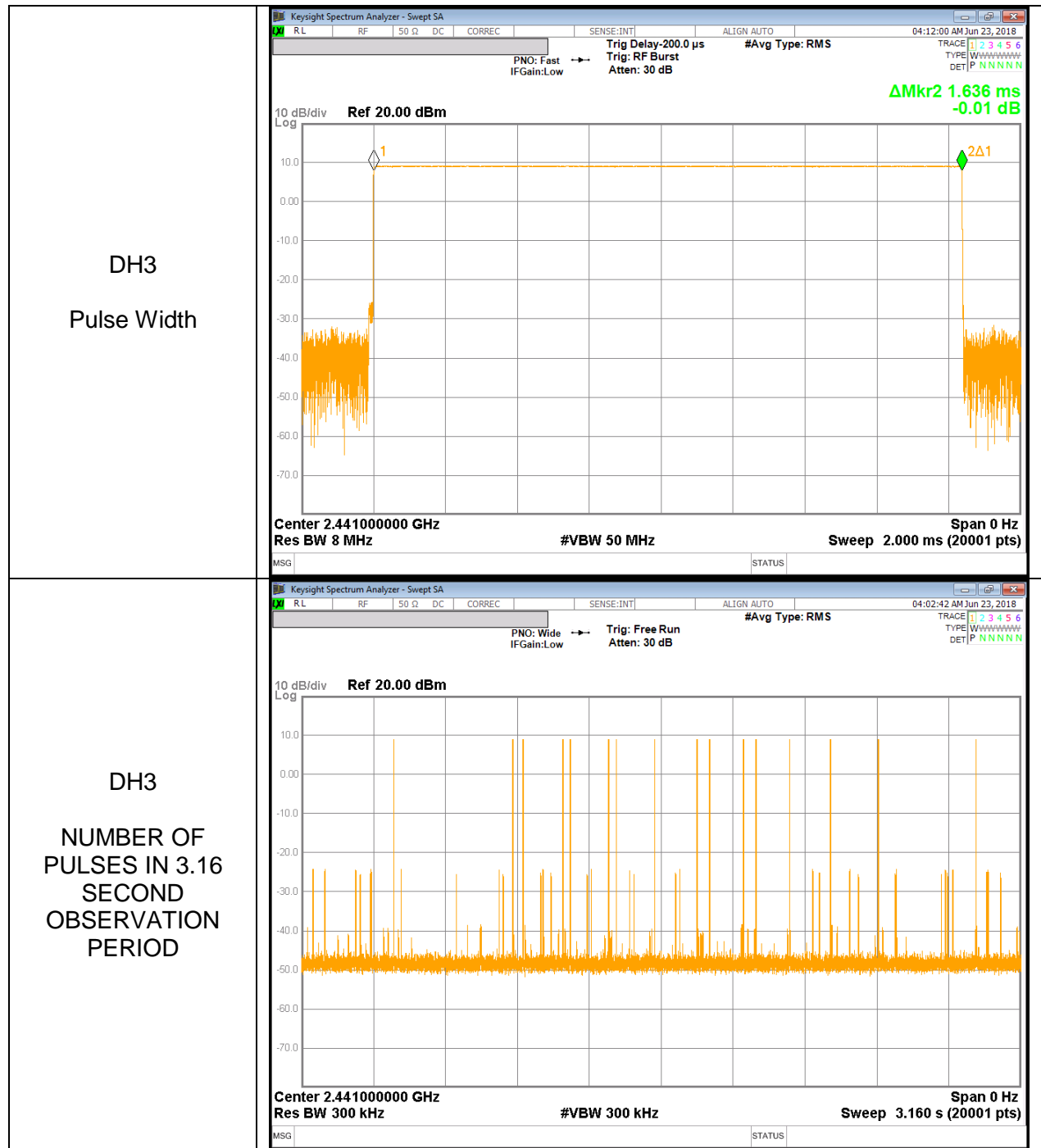

DH5

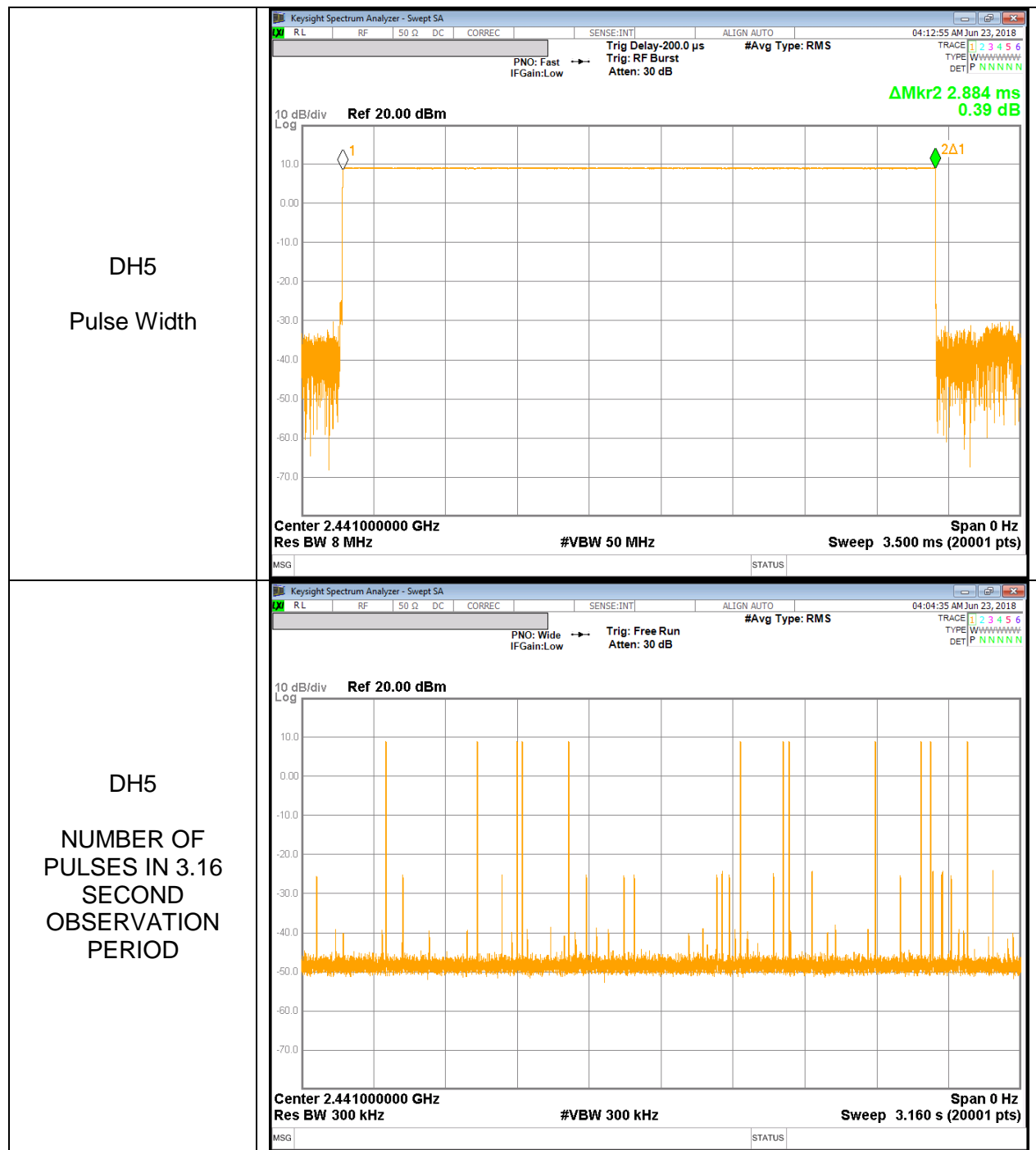

RESULTS[8PSK]

	Width [msec]	Pulses in 3.16 seconds	of Occupancy [sec]	[sec]	[sec]
GFSK Normal					
DH1	0.386	32	0.123552	0.4	-0.2764
DH3	1.637	16	0.261920	0.4	-0.1381
DH5	2.888	12	0.346560	0.4	-0.0534
GFSK AFH					
DH Packet	Pulse Width [msec]	Number of Pulses in 0.8 seconds	Average Time of Occupancy [sec]	Limit [sec]	Margin [sec]
GFSK AFH					
DH1	0.386	8	0.030888	0.4	-0.3691
DH3	1.637	4	0.065480	0.4	-0.3345
DH5	2.888	3	0.086640	0.4	-0.3134

DH1

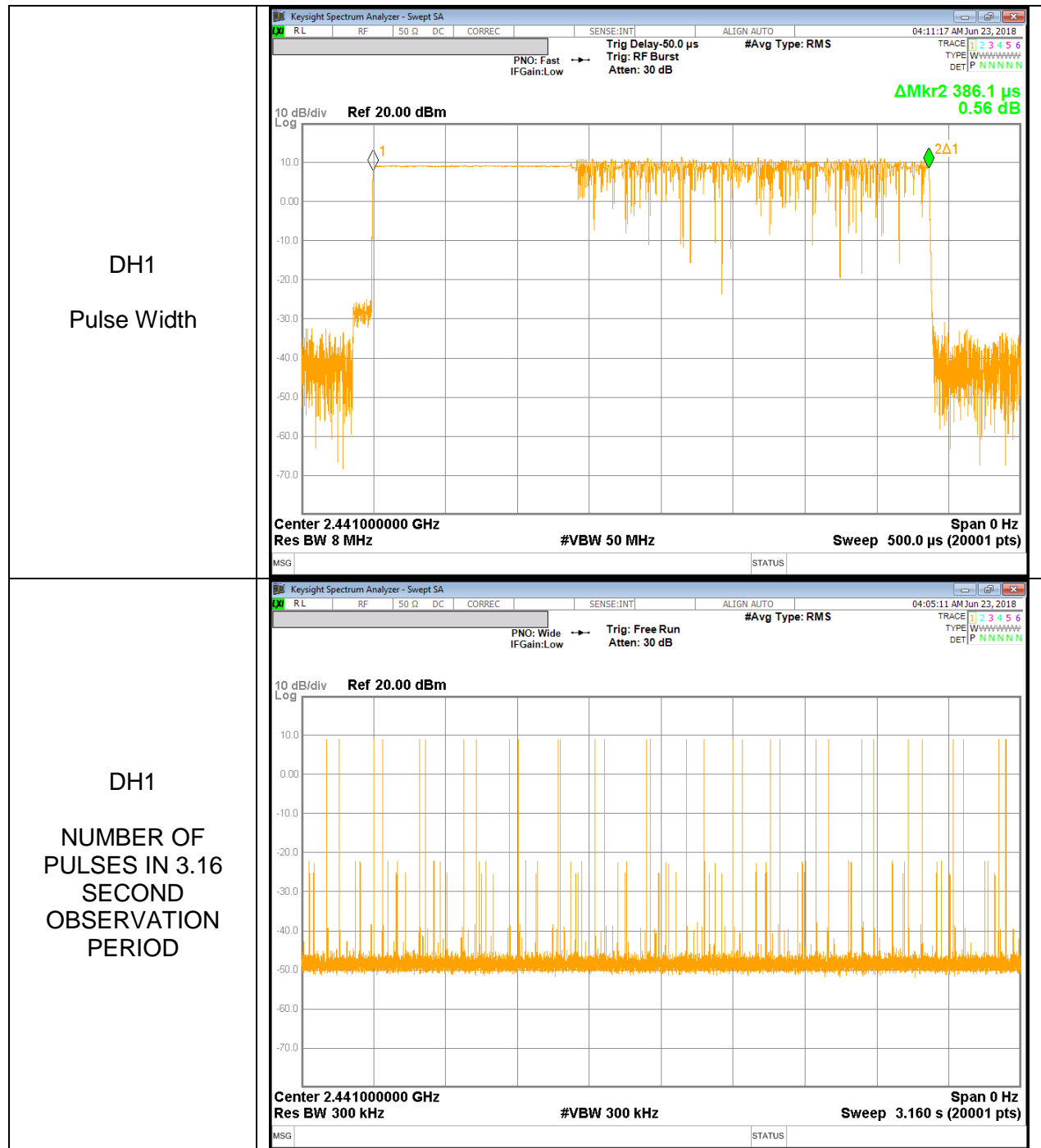

DH3

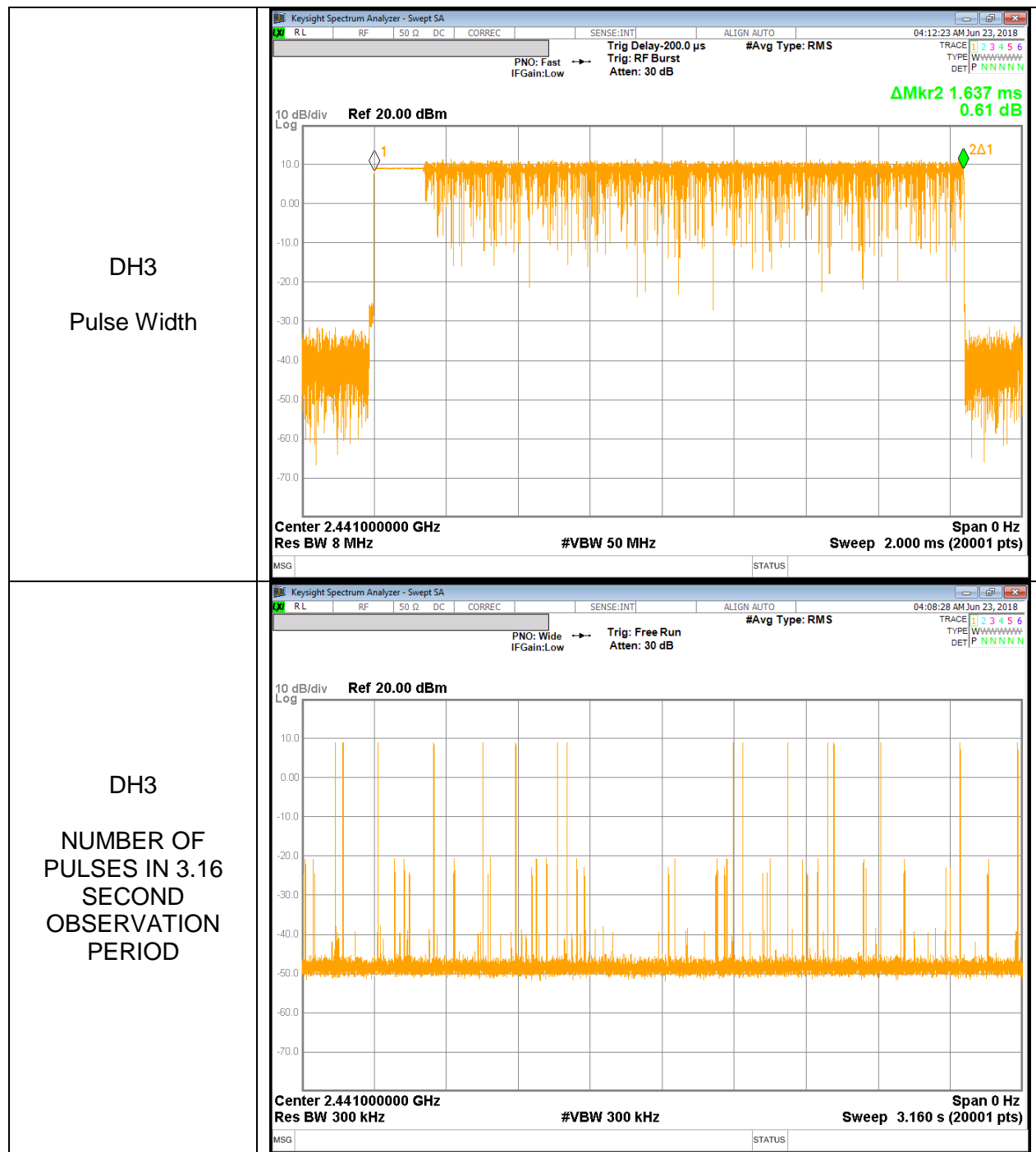

DH5

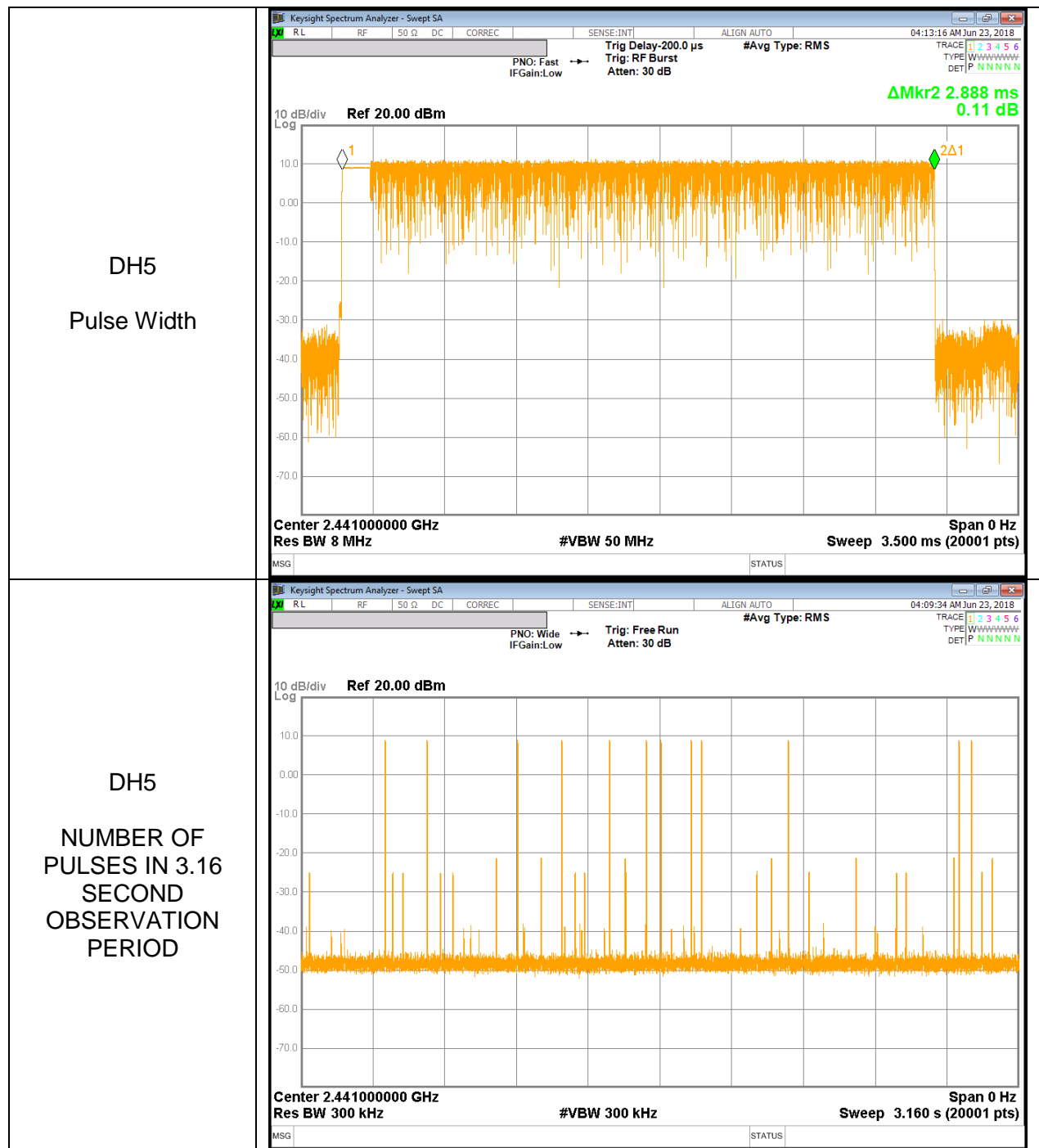

10.4. OUTPUT POWER

LIMIT

§15.247 (b) (1)

The maximum antenna gain is less than 6 dBi, therefore the limit is 21 dBm.

TEST PROCEDURE

The transmitter output is connected to a spectrum analyzer the analyzer bandwidth is set to a value greater than the 20 dB bandwidth of the EUT.

RESULTS

10.4.1. BASIC DATA RATE GFSK MODULATION

Channel	Frequency [MHz]	Output Power [dBm]	Limit [dBm]	Margin [dB]
Low	2402	8.634	21	-12.366
Middle	2441	9.531	21	-11.469
High	2480	9.334	21	-11.666
Worst		9.531	21	-11.469

10.4.2. ENHANCED DATA RATE Pi/4-DPSK MODULATION

Channel	Frequency [MHz]	Output Power [dBm]	Limit [dBm]	Margin [dB]
Low	2402	10.168	21	-10.832
Middle	2441	11.042	21	-9.958
High	2480	10.862	21	-10.138
Worst		11.042	21	-9.958

10.4.3. ENHANCED DATA RATE 8PSK MODULATION

Channel	Frequency [MHz]	Output Power [dBm]	Limit [dBm]	Margin [dB]
Low	2402	10.759	21	-10.241
Middle	2441	11.689	21	-9.311
High	2480	11.472	21	-9.528
Worst		11.689	21	-9.311

10.4.4. OUTPUT POWER PLOTS

GFSK OUTPUT POWER

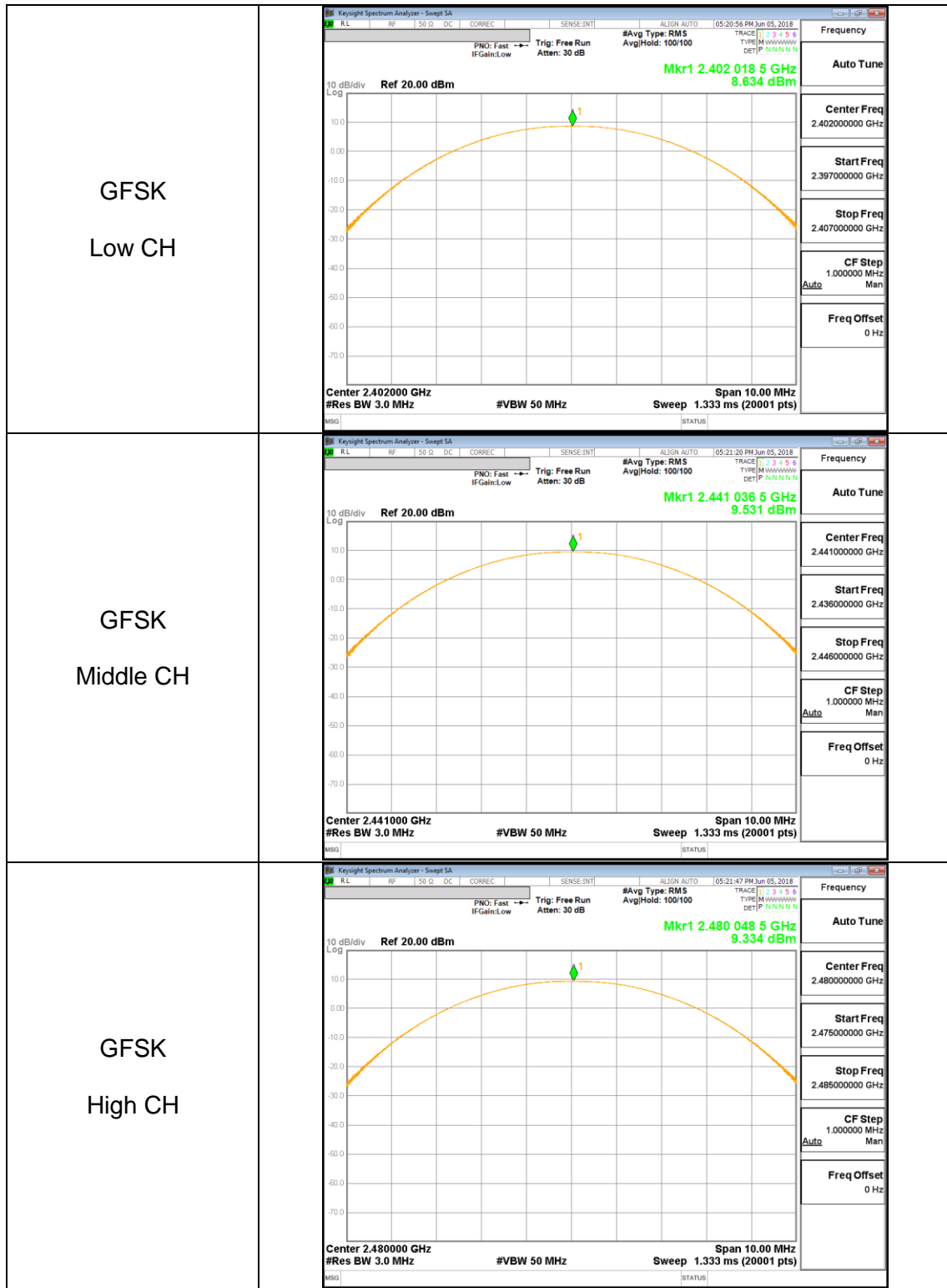

Pi/4-DPSK OUTPUT POWER

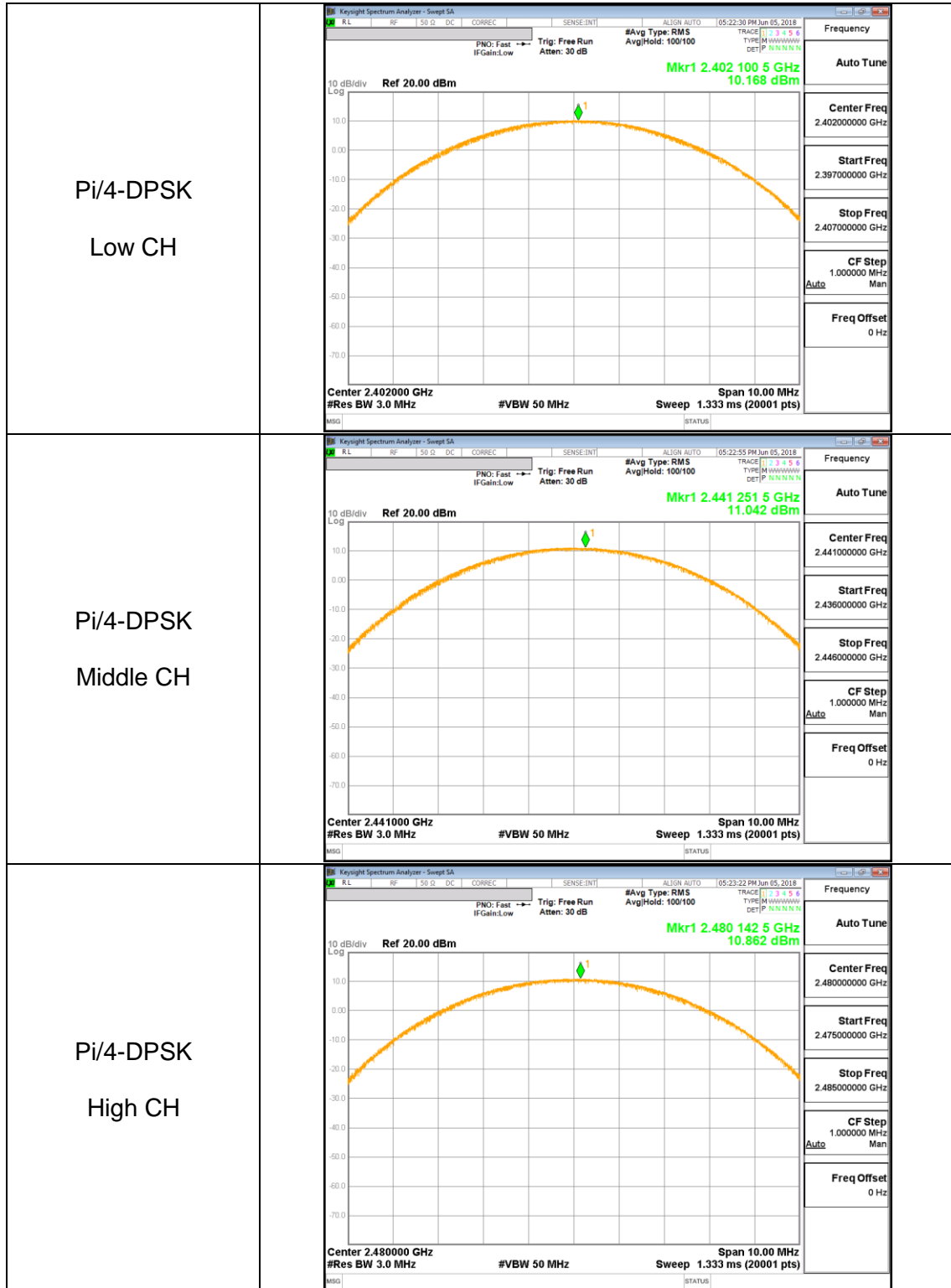

8PSK OUTPUT POWER

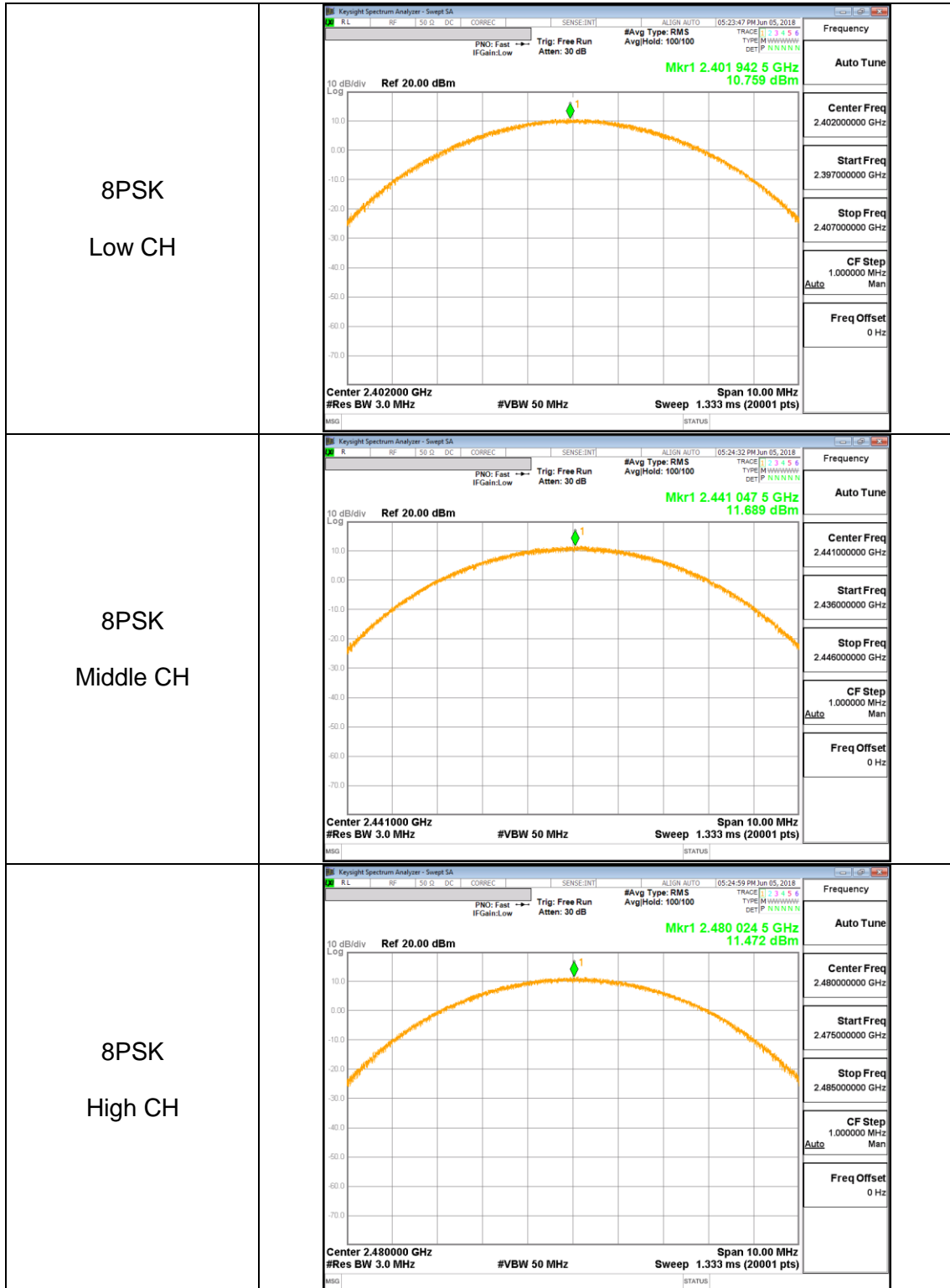

10.5. AVERAGE POWER

LIMIT

None; for reporting purposes only.

TEST PROCEDURE

The transmitter output is connected to a power meter.

RESULTS

The cable assembly insertion loss was entered as an offset in the power meter to allow for direct reading of power.

10.5.1. BASIC DATA RATE GFSK MODULATION

Channel	Frequency [MHz]	AV power [dBm]	AV power [mW]
Low	2402	8.380	6.89
Middle	2441	9.248	8.41
High	2480	9.041	8.02

10.5.2. DATA RATE PI/4-DQPSK MODULATION

Channel	Frequency [MHz]	AV power [dBm]	AV power [mW]
Low	2402	7.931	6.21
Middle	2441	8.815	7.61
High	2480	8.606	7.25

10.5.3. ENHANCED DATA RATE 8PSK MODULATION

Channel	Frequency [MHz]	AV power [dBm]	AV power [mW]
Low	2402	7.933	6.21
Middle	2441	8.816	7.61
High	2480	8.620	7.28

10.6. CONDUCTED SPURIOUS EMISSIONS

LIMITS

FCC §15.247 (d)

Limit = -20 dBc

TEST PROCEDURE

The transmitter output is connected to a spectrum analyzer. The resolution bandwidth is set to 100 kHz. The video bandwidth is set to 300 kHz.

The spectrum from 30 MHz to 26 GHz is investigated with the transmitter set to the lowest, middle, and highest channels.

The bandedges at 2.4 and 2.4835 GHz are investigated with the transmitter set to the normal hopping mode.

RESULTS

10.6.1. BASIC DATA RATE GFSK MODULATION

GFSK Mode

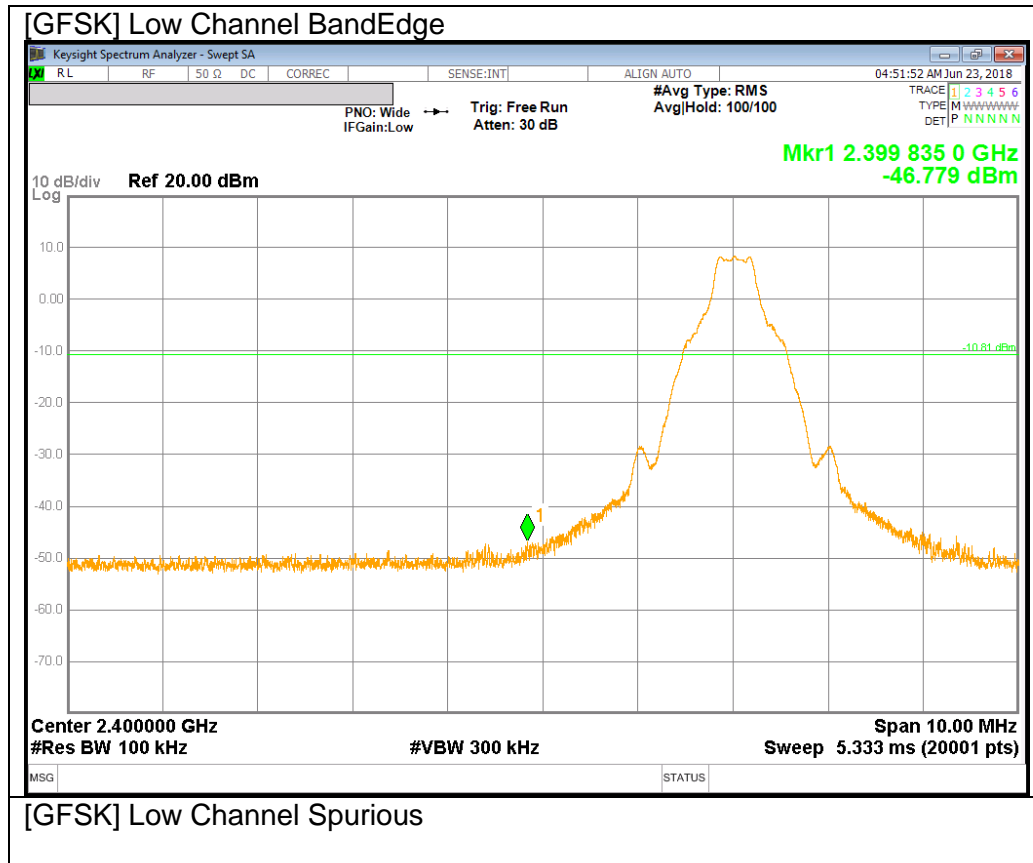

[GFSK] Low Channel Spurious

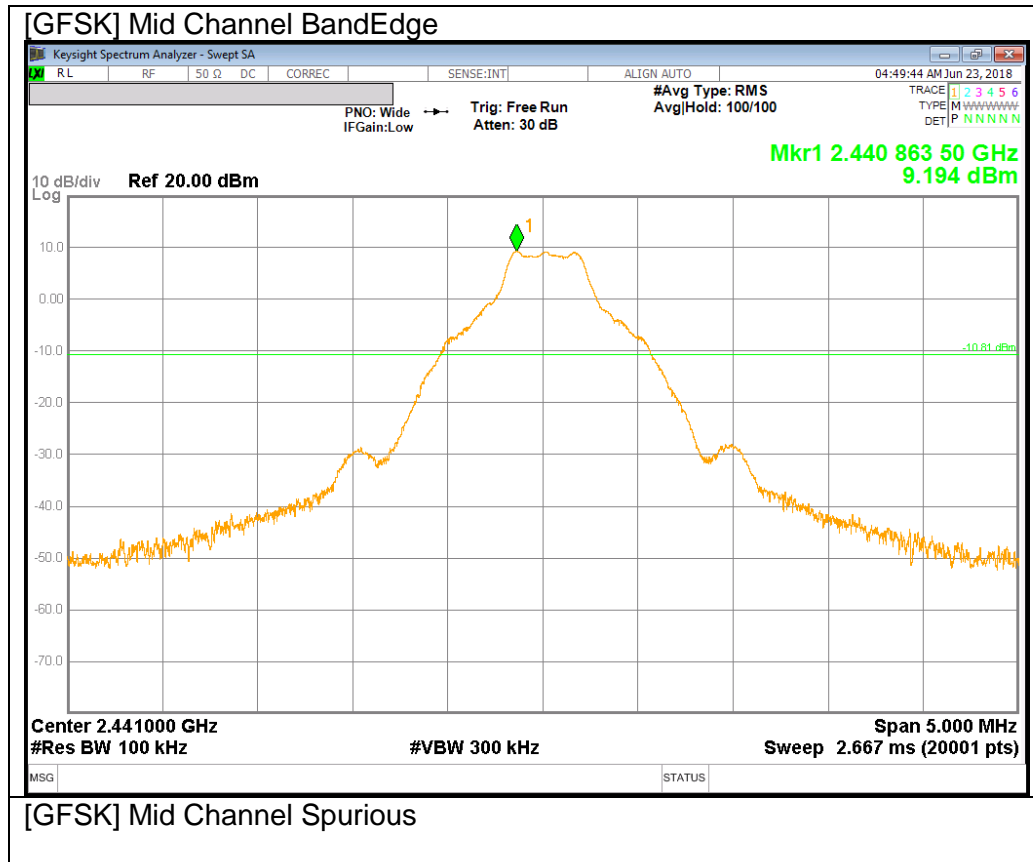

[GFSK] Mid Channel Spurious

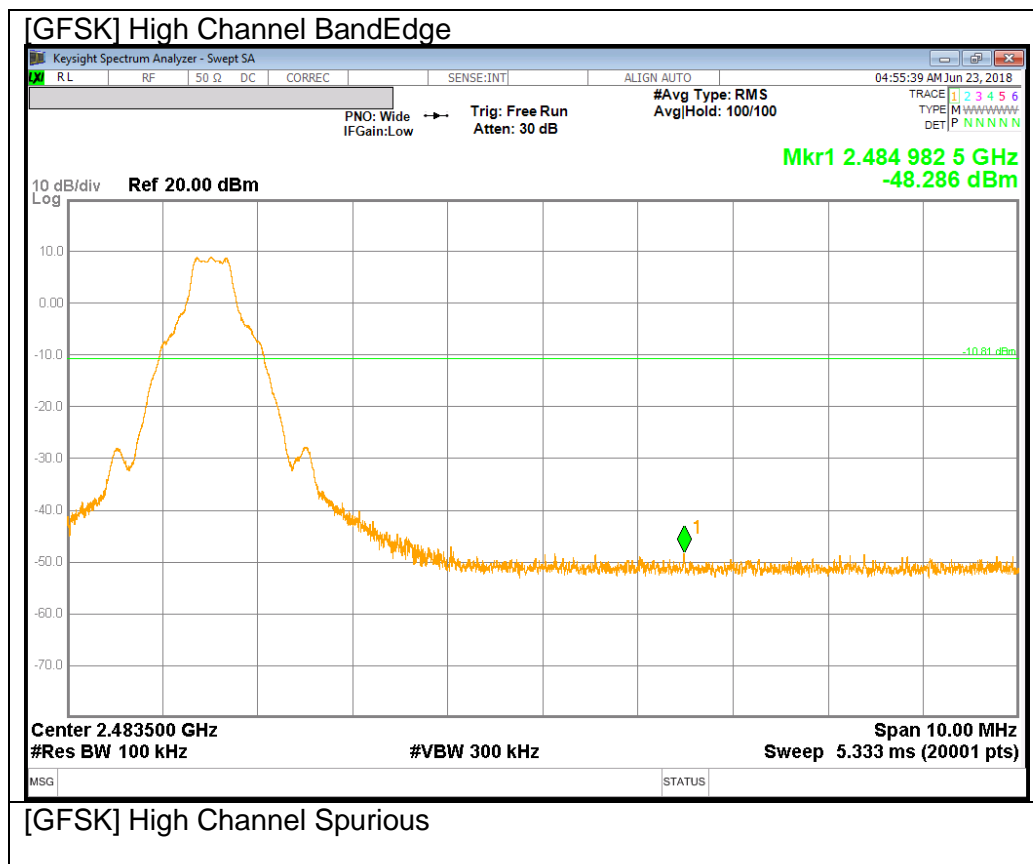

[GFSK] High Channel Spurious

BandEdge Emission at GFSK Hopping Mode

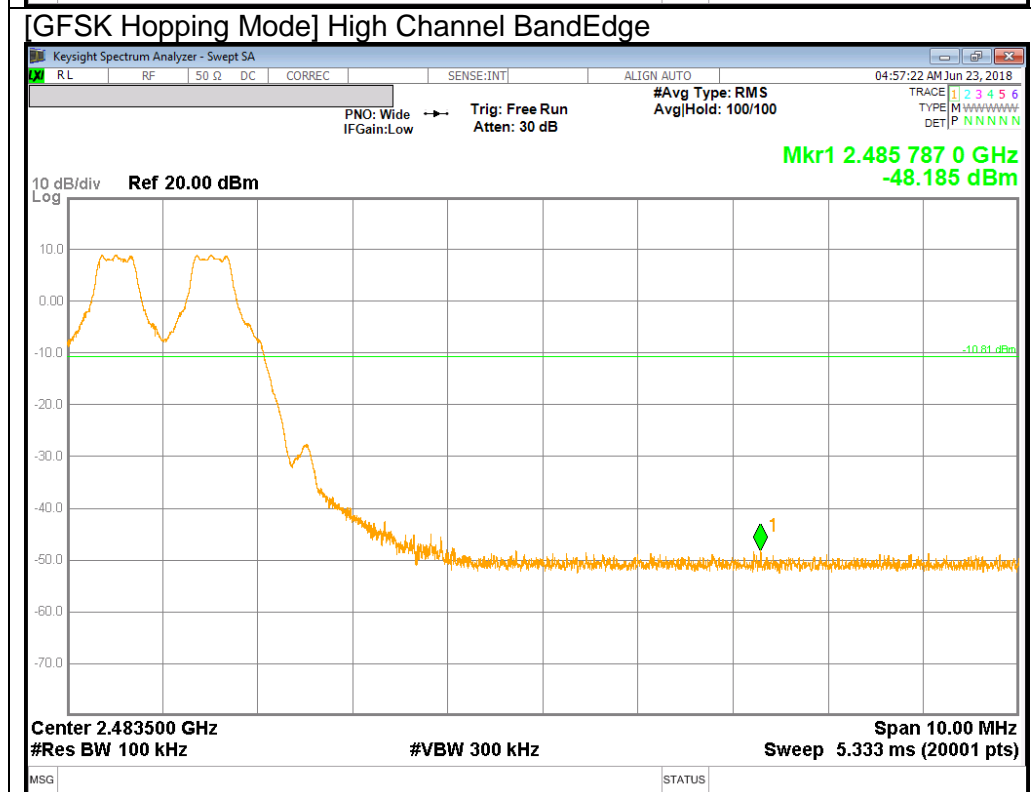
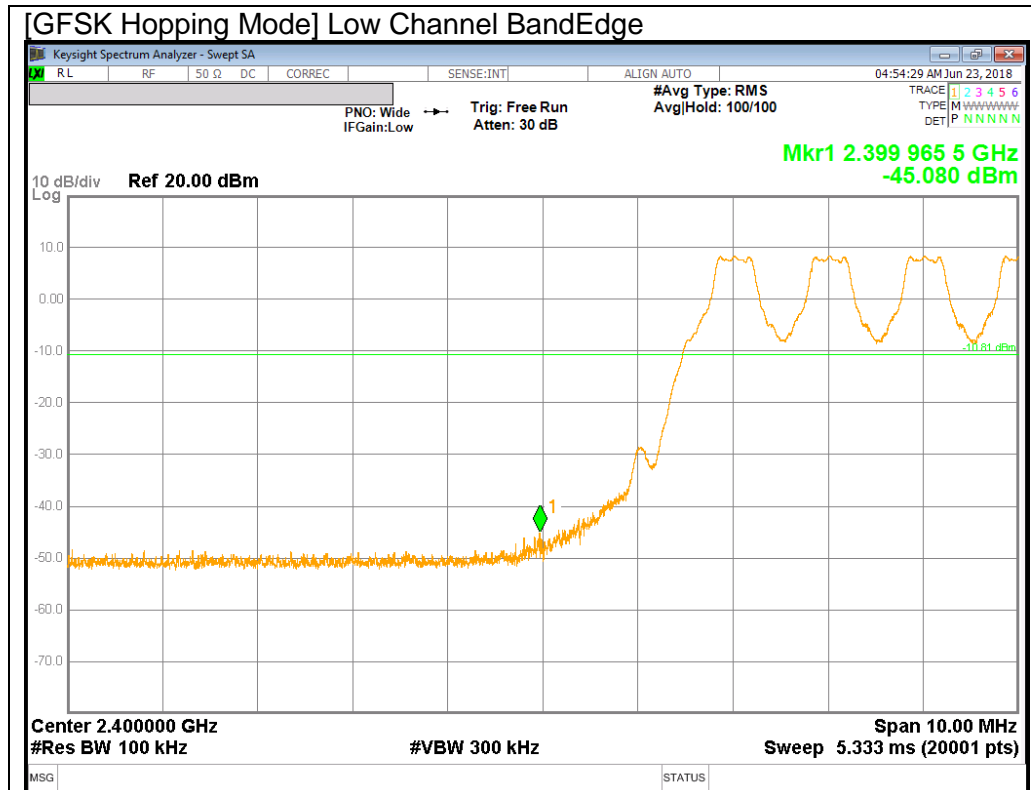

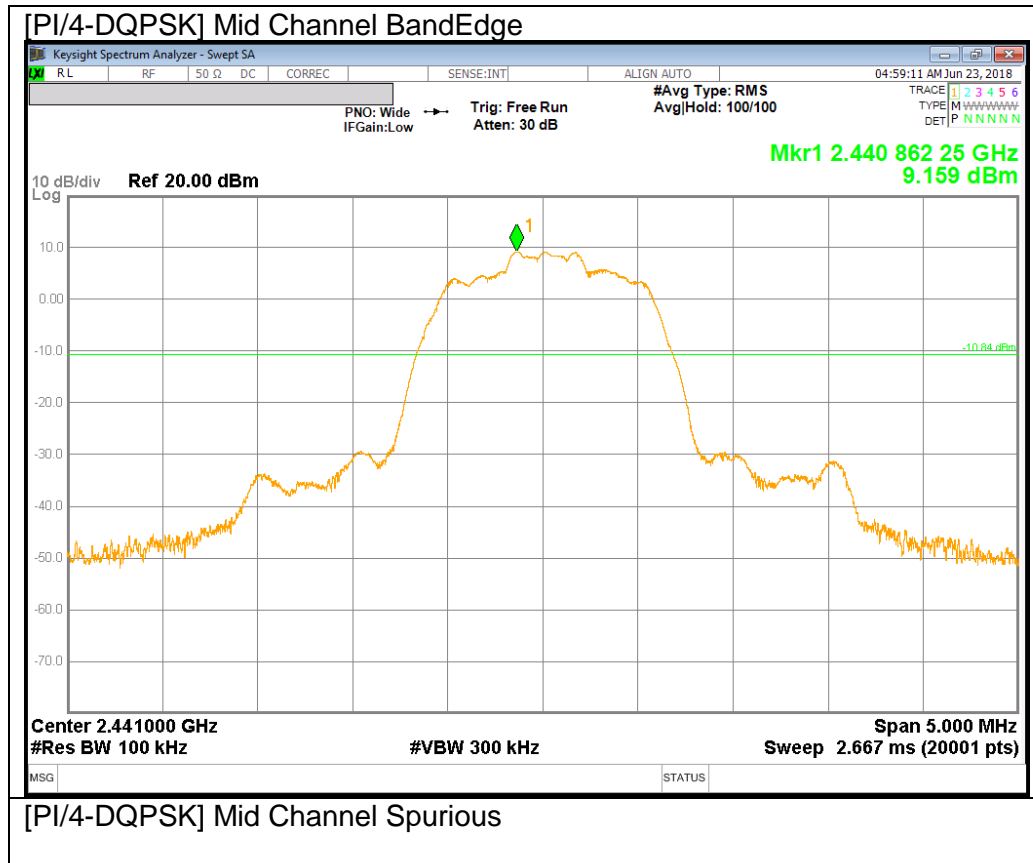

[PI/4-DQPSK] Mid Channel Spurious

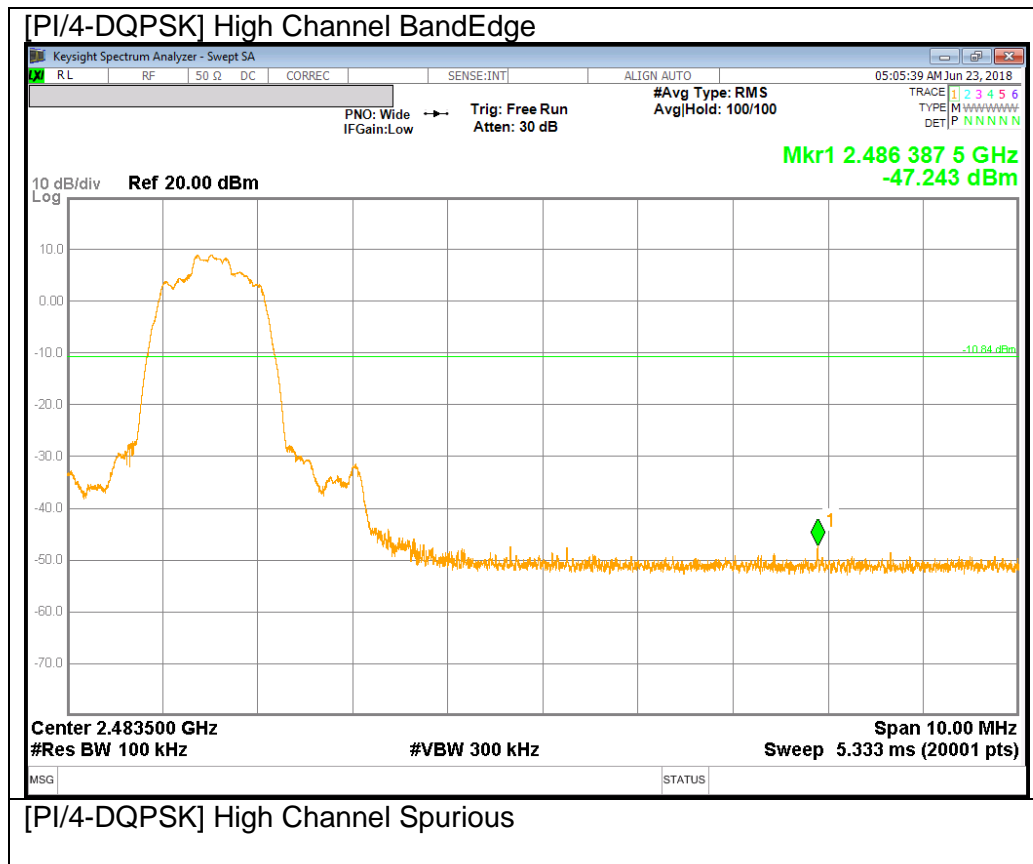

BandEdge Emission at PI/4-DQPSK Hopping Mode

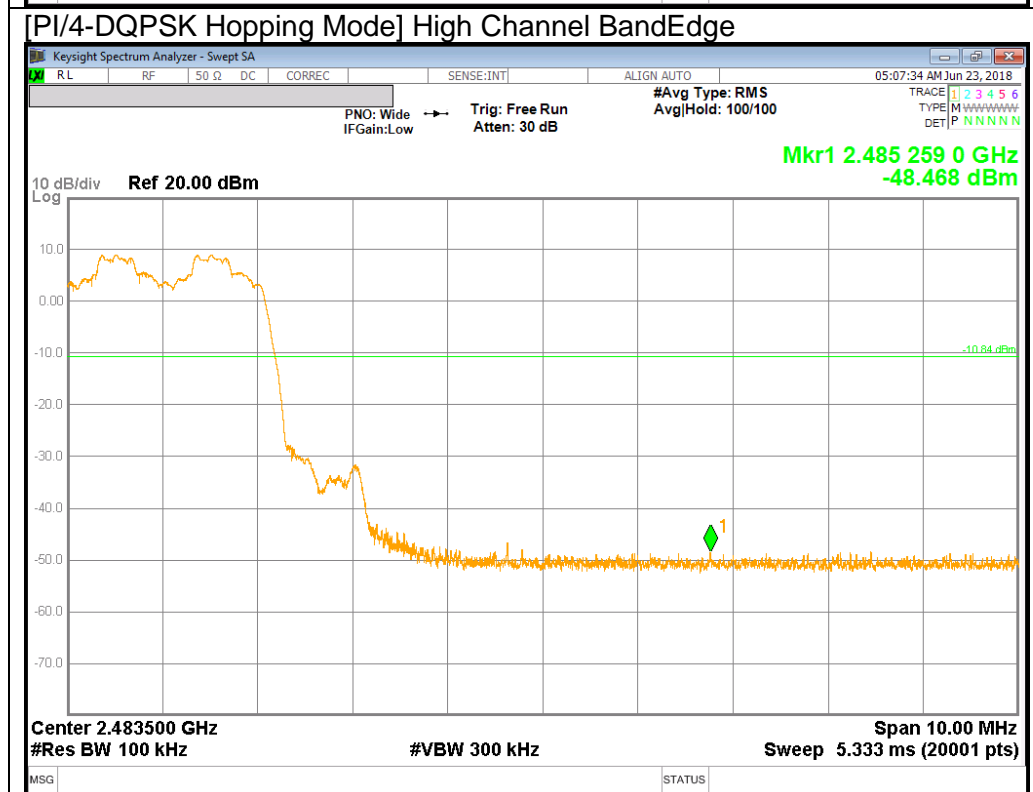
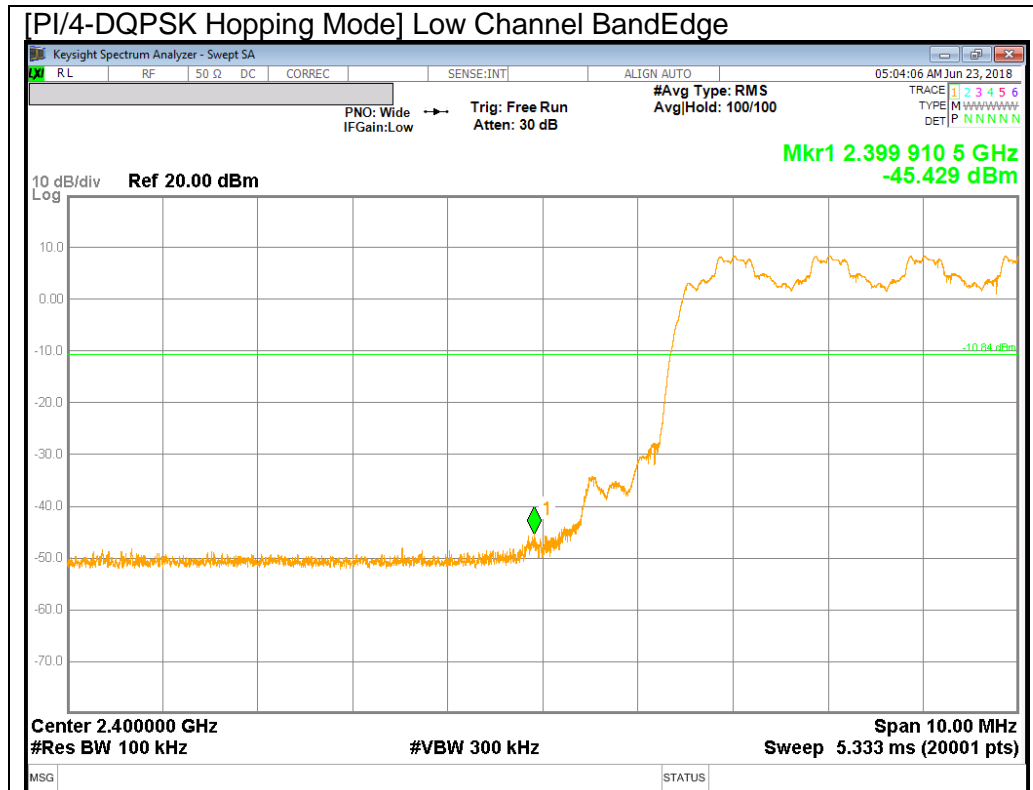

8PSK Mode

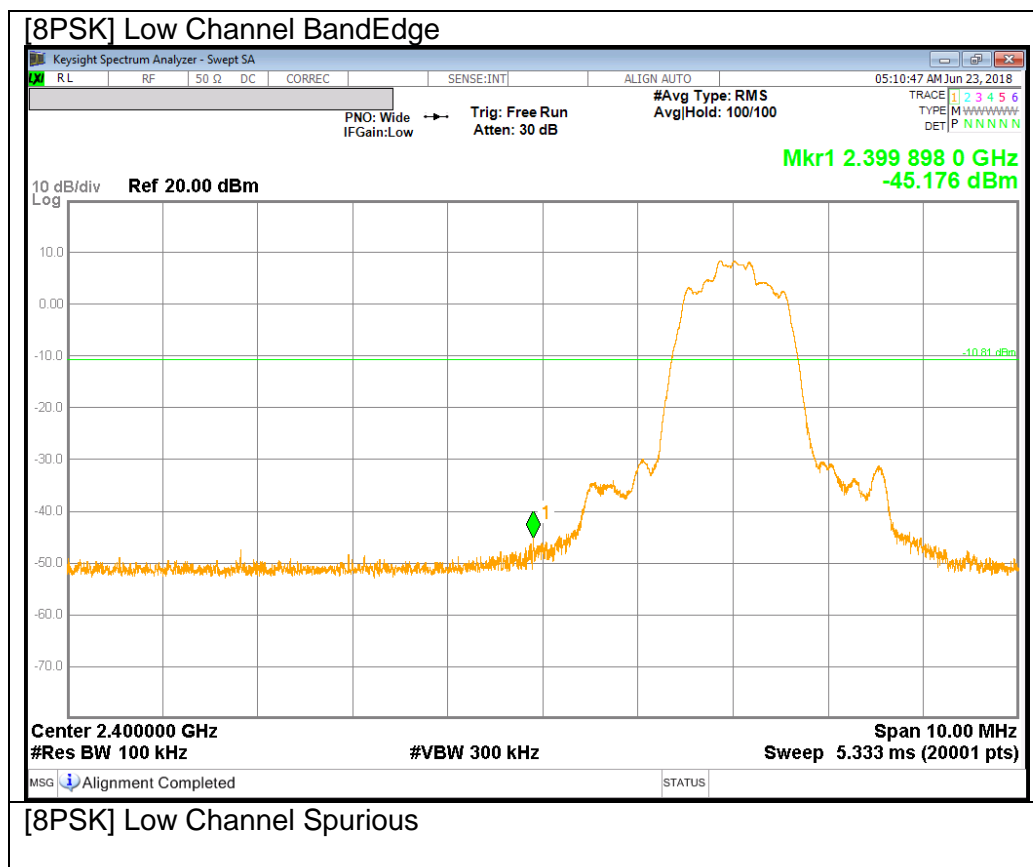

[8PSK] Low Channel Spurious

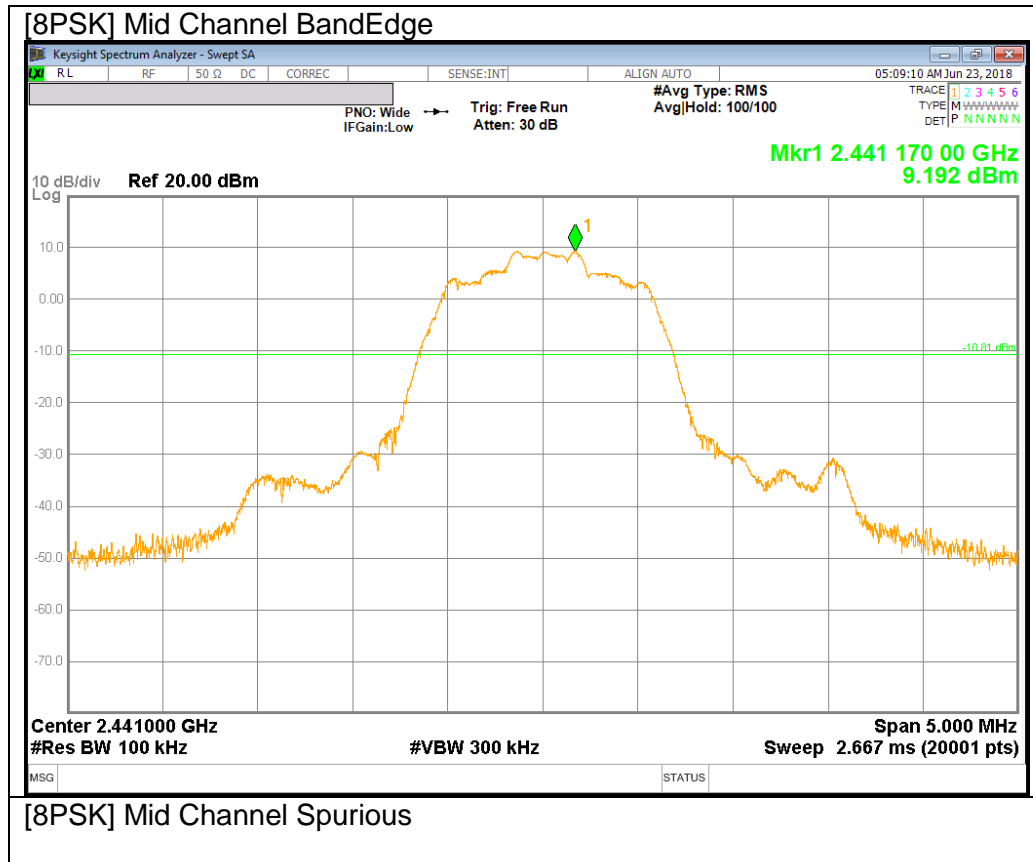

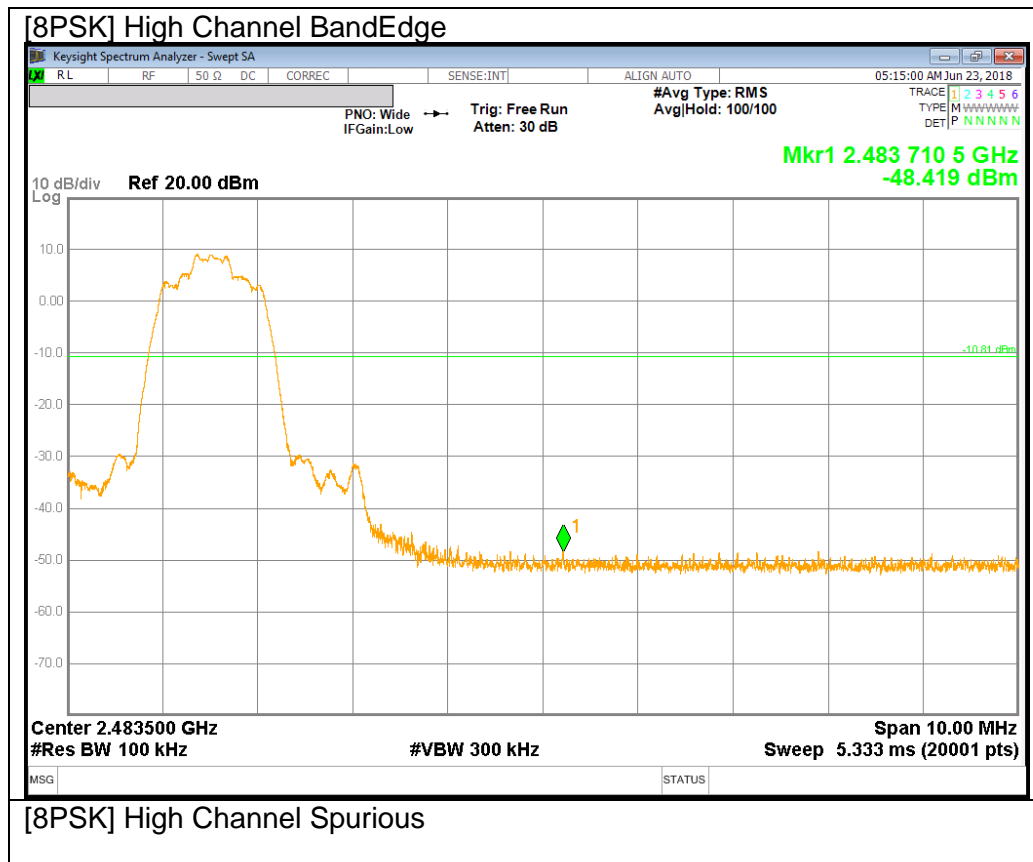

[8PSK] High Channel Spurious

BandEdge Emission at 8PSK Hopping Mode

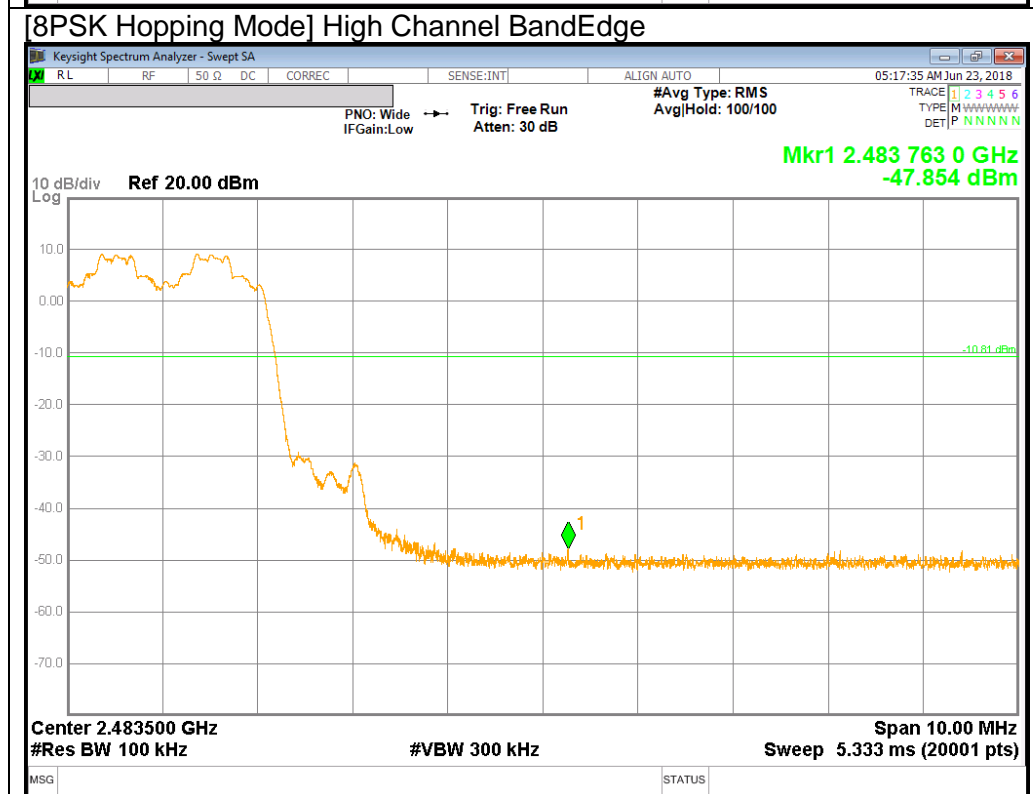
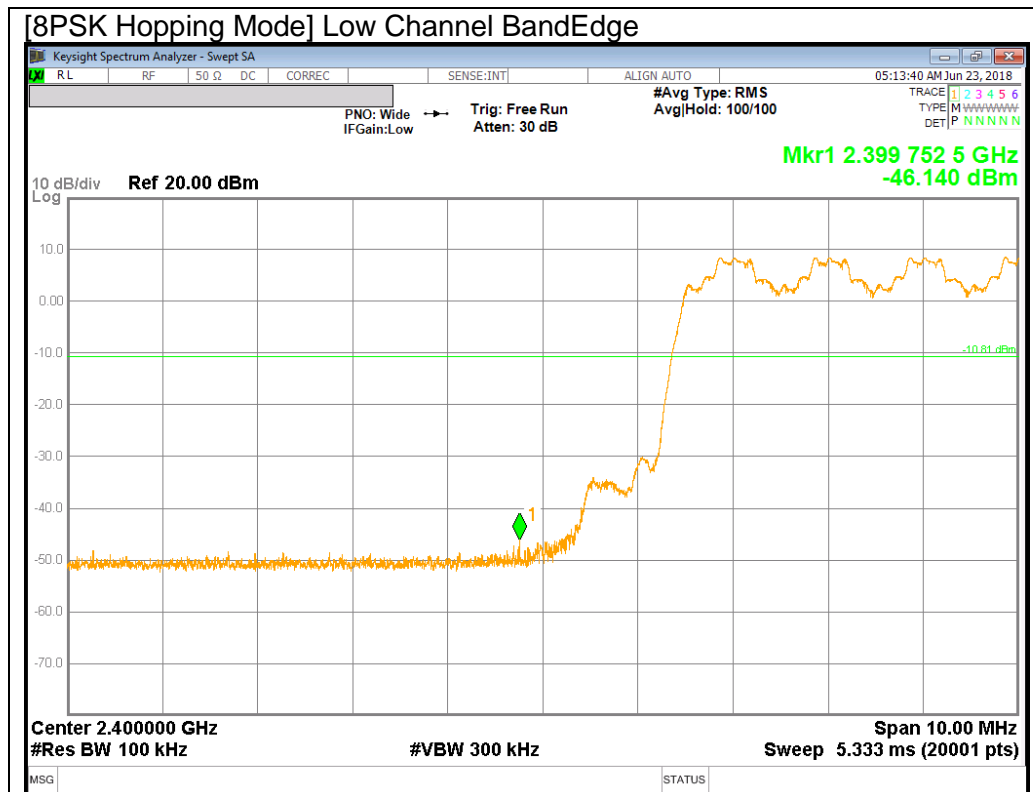

11. RADIATED TEST RESULTS

11.1. LIMITS AND PROCEDURE

LIMITS

FCC §15.205 and §15.209

Limits for radiated disturbance of an intentional radiator		
Frequency range (MHz)	Limits (µV/m)	Measurement Distance (m)
0.009 – 0.490	2400 / F (kHz)	300
0.490 – 1.705	24000 / F (kHz)	30
1.705 – 30.0	30	30
30 – 88	100**	3
88 - 216	150**	3
216 – 960	200**	3
Above 960	500	3

** Except as provided in paragraph (g), fundamental emissions from intentional radiators operating under this section shall not be located in the frequency bands 54-72 MHz, 76-88 MHz, 174-216 MHz or 470-806 MHz. However, operation within these frequency bands is permitted under other sections of this part, e.g. §§ 15.231 and 15.241.

TEST PROCEDURE

The EUT is placed on a non-conducting table 80 cm above the ground plane for below 1GHz and 150 cm for above 1GHz. The EUT is configured in accordance with ANSI C63.10. The EUT is set to transmit in a continuous mode.

For measurements below 1 GHz the resolution bandwidth is set to 100 kHz for peak detection measurements or 120 kHz for quasi-peak detection measurements. Peak detection is used unless otherwise noted as quasi-peak.

For measurements above 1 GHz the resolution bandwidth is set to 1 MHz; the video bandwidth is set to 3 MHz for peak measurements.(Pre-scans to detect harmonic and spurious emissions, the resolution bandwidth is set to 1 MHz; the video bandwidth is set to 30 KHz for peak measurements.)

For band edge measurements above 1 GHz the resolution bandwidth is set to 1 MHz, then the video bandwidth is set to 3 MHz for peak measurements and 1/T (on time) for average measurement.

$$\text{GFSK} = 1/T = 1 / 0.002884\text{S} = 347\text{Hz}.$$

The minimum VBW was 347Hz, but test receiver(ESU40) couldn't set value 347Hz. Due to this reason, testing VBW was set to 500Hz(Worst cases).

The spectrum from 1GHz to 26 GHz is investigated with the transmitter set to the lowest, middle, and highest channels in the 2.4 GHz band.
(From 30MHz to 1GHz, test was performed with the EUT set to transmit at the channel with highest output power)

The frequency range of interest is monitored at a fixed antenna height and EUT azimuth. The EUT is rotated through 360 degrees to maximize emissions received. The antenna is scanned from 1 to 4 meters above the ground plane to further maximize the emission. Measurements are made with the antenna polarized in both the vertical and the horizontal positions.

Note : Emission was pre-scanned from 9KHz to 30MHz; No emissions were detected which was at least 20dB below the specification limit (consider distance correction factor).
Per FCC part 15.31(o), test results were not reported.

Although these tests were performed other than open area test site, adequate comparison measurements were confirmed against 30 m open are test site.
Therefore sufficient tests were made to demonstrate that the alternative site produces results that correlate with the one of tests made in an open field based on KDB 414788.

11.2. TRANSMITTER ABOVE 1 GHz

11.2.1. BASIC DATA RATE GFSK MODULATION

RESTRICTED BANDEDGE (LOW CHANNEL)

HORIZONTAL PEAK AND AVERAGE PLOT

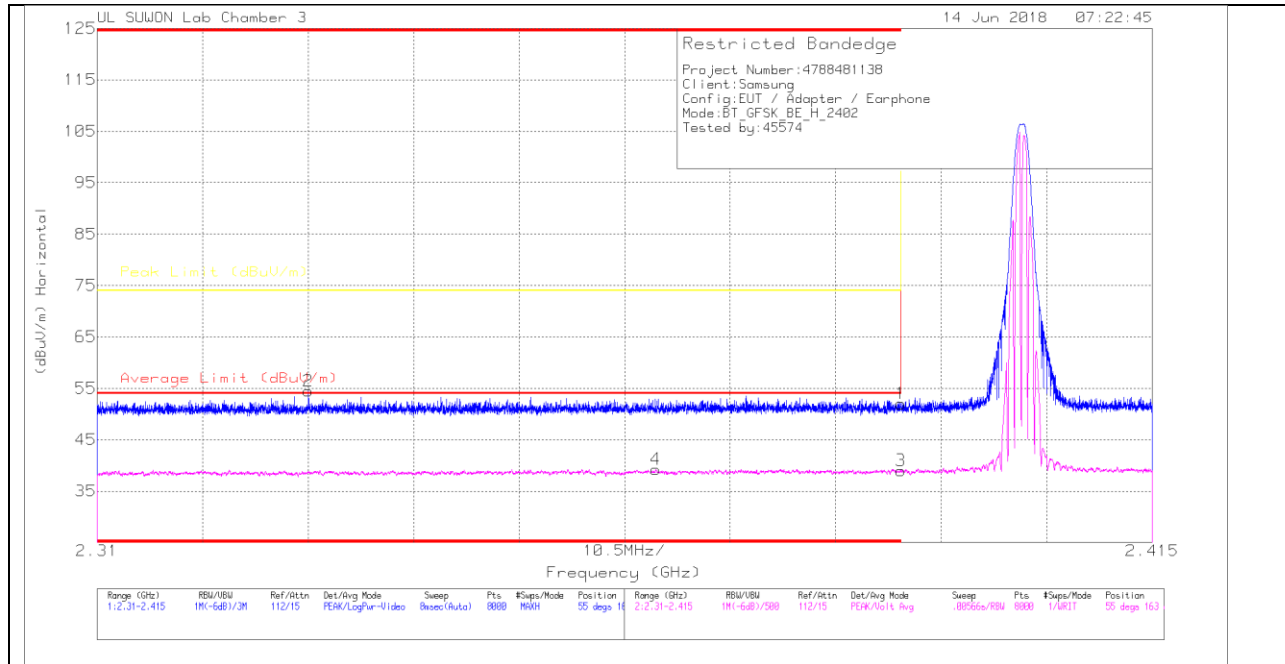

HORIZONTAL DATA

Trace Markers

Marker	Frequency (GHz)	Meter Reading (dBuV)	Det	3117[00205959]	10dB_ATT[dB]	Corrected Reading (dBuV/m)	Average Limit (dBuV/m)	Margin (dB)	Peak Limit (dBuV/m)	PK Margin (dB)	Azimuth (Degs)	Height (cm)	Polarity
1	* 2.39	43.49	Pk	31.8	-23.3	51.99	-	-	74	-22.01	55	163	H
2	* 2.331	46.18	Pk	31.6	-23.3	54.48	-	-	74	-19.52	55	163	H
3	* 2.39	30.48	VA1T	31.8	-23.3	38.98	54	-15.02	-	-	55	163	H
4	* 2.366	30.73	VA1T	31.7	-23.2	39.23	54	-14.77	-	-	55	163	H

* - indicates frequency in CFR47 Pt 15 / IC RSS-Restricted Band

Pk - Peak detector

VA1T - FHSS: Linear Voltage Average VB=1/Ton where: Ton is transmit duration

VERTICAL PEAK AND AVERAGE PLOT

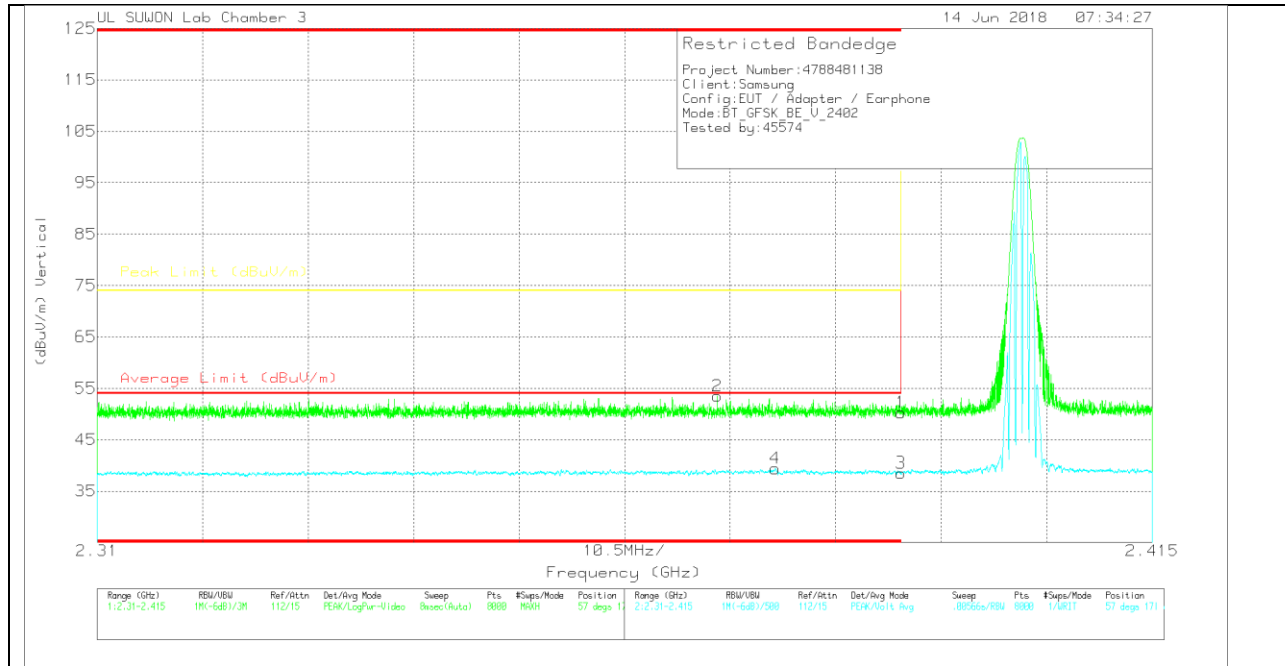

VERTICAL DATA

Trace Markers

Marker	Frequency (GHz)	Meter Reading (dBuV)	Det	3117[00205959]	10dB_ATT[dB]	Corrected Reading (dBuV/m)	Average Limit (dBuV/m)	Margin (dB)	Peak Limit (dBuV/m)	PK Margin (dB)	Azimuth (Degs)	Height (cm)	Polarity
1	* 2.39	41.79	Pk	31.8	-23.3	50.29	-	-	74	-23.71	57	171	V
2	* 2.372	44.99	Pk	31.7	-23.2	53.49	-	-	74	-20.51	57	171	V
3	* 2.39	30	VA1T	31.8	-23.3	38.5	54	-15.5	-	-	57	171	V
4	* 2.377	30.81	VA1T	31.8	-23.2	39.41	54	-14.59	-	-	57	171	V

* - indicates frequency in CFR47 Pt 15 / IC RSS-Restricted Band

Pk - Peak detector

VA1T - FHSS: Linear Voltage Average $VB=1/Ton$ where: Ton is transmit duration

AUTHORIZED BANDEDGE (HIGH CHANNEL)

HORIZONTAL PEAK AND AVERAGE PLOT

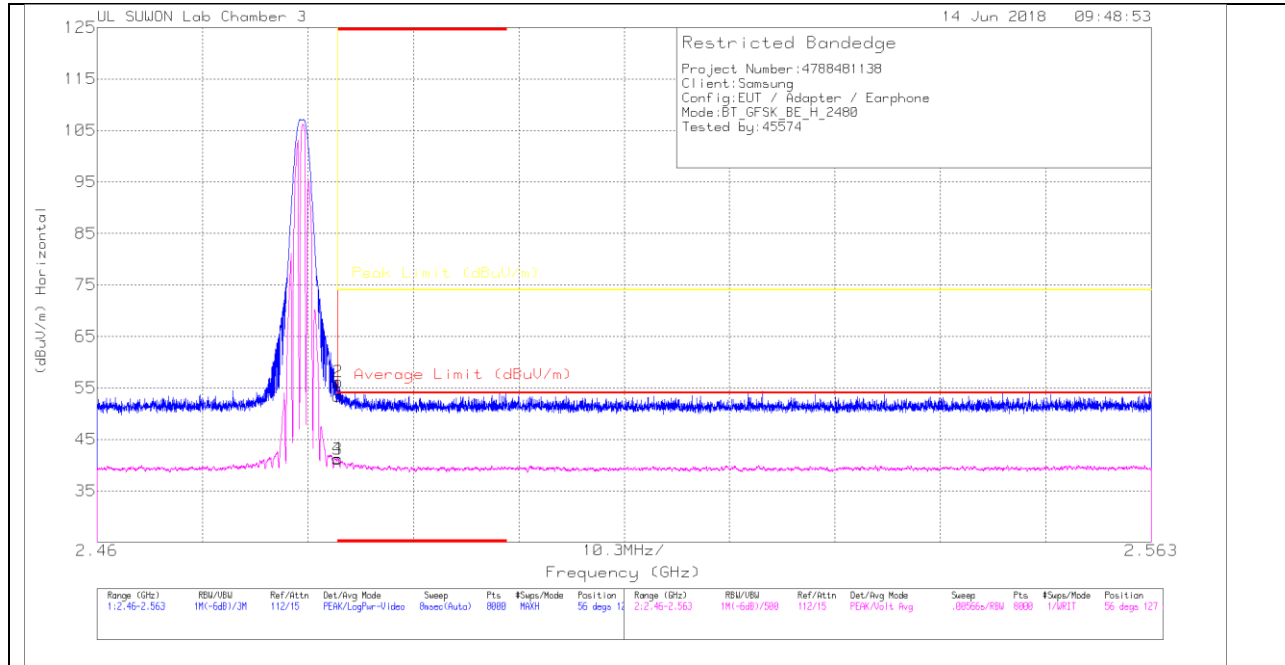

HORIZONTAL DATA

Trace Markers

Marker	Frequency (GHz)	Meter Reading (dBuV)	Det	3117(00205959)	10dB_ATT[dB]	Corrected Reading (dBuV/m)	Average Limit (dBuV/m)	Margin (dB)	Peak Limit (dBuV/m)	PK Margin (dB)	Azimuth (Degs)	Height (cm)	Polarity
1	* 2.484	44.26	Pk		-23	53.36	-	-	74	-20.64	56	127	H
2	* 2.484	47.05	Pk		-23	56.15	-	-	74	-17.85	56	127	H
3	* 2.484	32.07	VA1T		-23	41.17	54	-12.83	-	-	56	127	H
4	* 2.484	32.17	VA1T		-23	41.27	54	-12.73	-	-	56	127	H

* - indicates frequency in CFR47 Pt 15 / IC RSS-Restricted Band

Pk - Peak detector

VA1T - FHSS: Linear Voltage Average $V_B=1/T_{on}$ where: T_{on} is transmit duration

VERTICAL PEAK AND AVERAGE PLOT

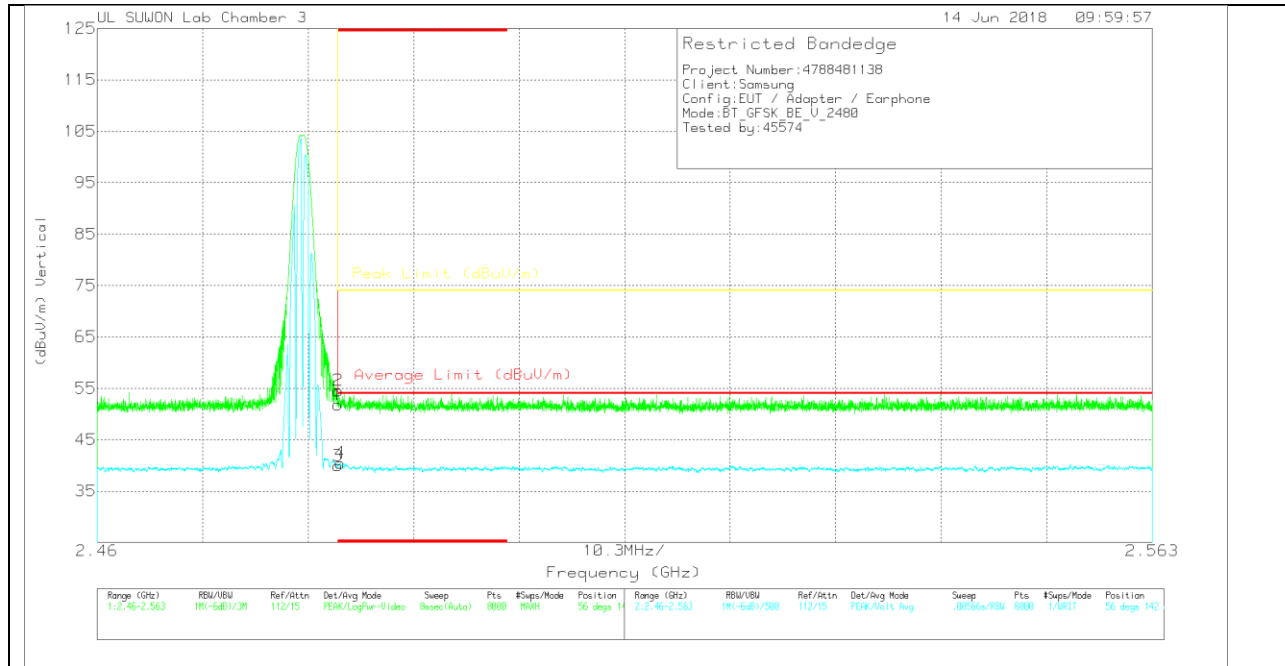

VERTICAL DATA

Trace Markers

Marker	Frequency (GHz)	Meter Reading (dBuV)	Det	3117[00205959]	10dB_ATT[dB]	Corrected Reading (dBuV/m)	Average Limit (dBuV/m)	Margin (dB)	Peak Limit (dBuV/m)	PK Margin (dB)	Azimuth (Degs)	Height (cm)	Polarity
1	* 2.484	42.67	Pk	32.1	-23	51.77	-	-	74	-22.23	56	142	V
2	* 2.484	45.46	Pk	32.1	-23	54.56	-	-	74	-19.44	56	142	V
3	* 2.484	30.85	VA1T	32.1	-23	39.95	54	-14.05	-	-	56	142	V
4	* 2.484	31.45	VA1T	32.1	-23.1	40.45	54	-13.55	-	-	56	142	V

* - indicates frequency in CFR47 Pt 15 / IC RSS-Restricted Band

Pk - Peak detector

VA1T - FHSS: Linear Voltage Average VB=1/Ton where: Ton is transmit duration

HARMONICS AND SPURIOUS EMISSIONS

LOW CHANNEL HORIZONTAL

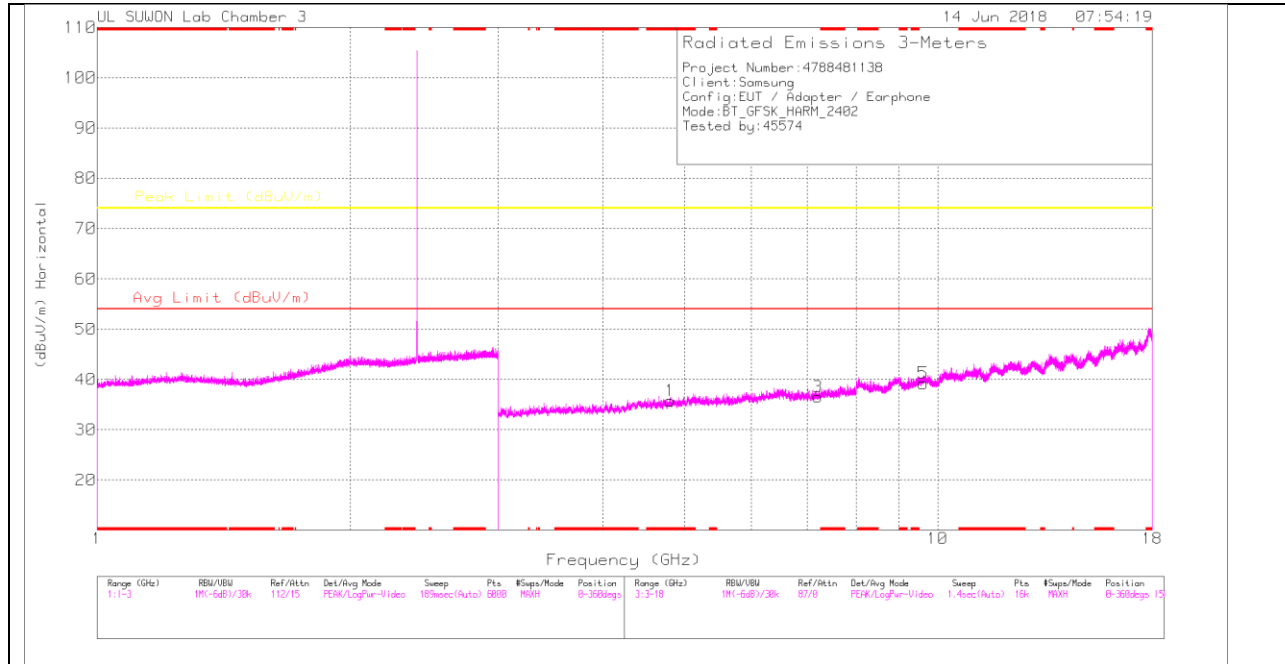

LOW CHANNEL VERTICAL

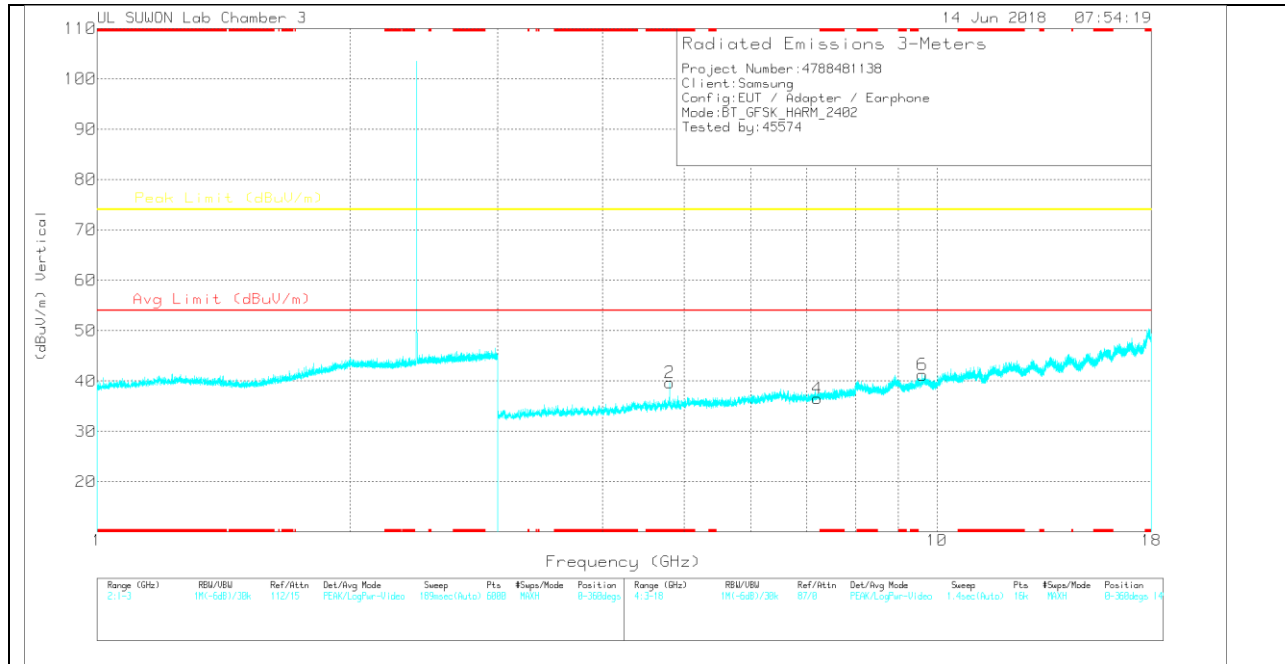

Note: Emission was scanned up to 26GHz; No emissions were detected above the noise floor which was at least 20dB below the specification limit.

LOW CHANNEL DATA

Trace Markers

Marker	Frequency (GHz)	Meter Reading (dBuV)	Det	3117[00205959]	3GHz_HP[dB]	Corrected Reading (dBuV/m)	Avg Limit (dBuV/m)	Margin (dB)	Peak Limit (dBuV/m)	Margin (dB)	Azimuth (Degs)	Height (cm)	Polarity
1	* 4.804	30.03	PK	33.9	-28.2	35.73	-	-	74	-38.27	0-360	250	H
3	7.207	24.91	PK	35.6	-24	36.51	-	-	74	-37.49	0-360	250	H
5	9.609	22.42	PK	36.7	-19.9	39.22	-	-	74	-34.78	0-360	150	H
2	* 4.804	33.97	PK	33.9	-28.2	39.67	-	-	74	-34.33	0-360	250	V
4	7.207	24.9	PK	35.6	-24	36.5	-	-	74	-37.5	0-360	250	V
6	9.609	24.44	PK	36.7	-19.9	41.24	-	-	74	-32.76	0-360	250	V

* - indicates frequency in CFR47 Pt 15 / IC RSS-Restricted Band
 PK – Peak Detector

Radiated Emissions

Frequency (GHz)	Meter Reading (dBuV)	Det	3117[00205959]	3GHz_HP[dB]	Corrected Reading (dBuV/m)	Avg Limit (dBuV/m)	Margin (dB)	Peak Limit (dBuV/m)	Margin (dB)	Azimuth (Degs)	Height (cm)	Polarity
* 4.804	40.55	PKFH	33.9	-28.2	46.25	-	-	74	-27.75	319	308	V
* 4.804	31.08	VA1T	33.9	-28.1	36.88	54	-17.12	-	-	319	308	V

* - indicates frequency in CFR47 Pt 15 / IC RSS-Restricted Band
 PKFH - FHSS: RB=100k/1MHz VB=3 x RB, Peak
 VA1T - FHSS: Linear Voltage Average VB=1/Ton where: Ton is transmit duration

MID CHANNEL HORIZONTAL

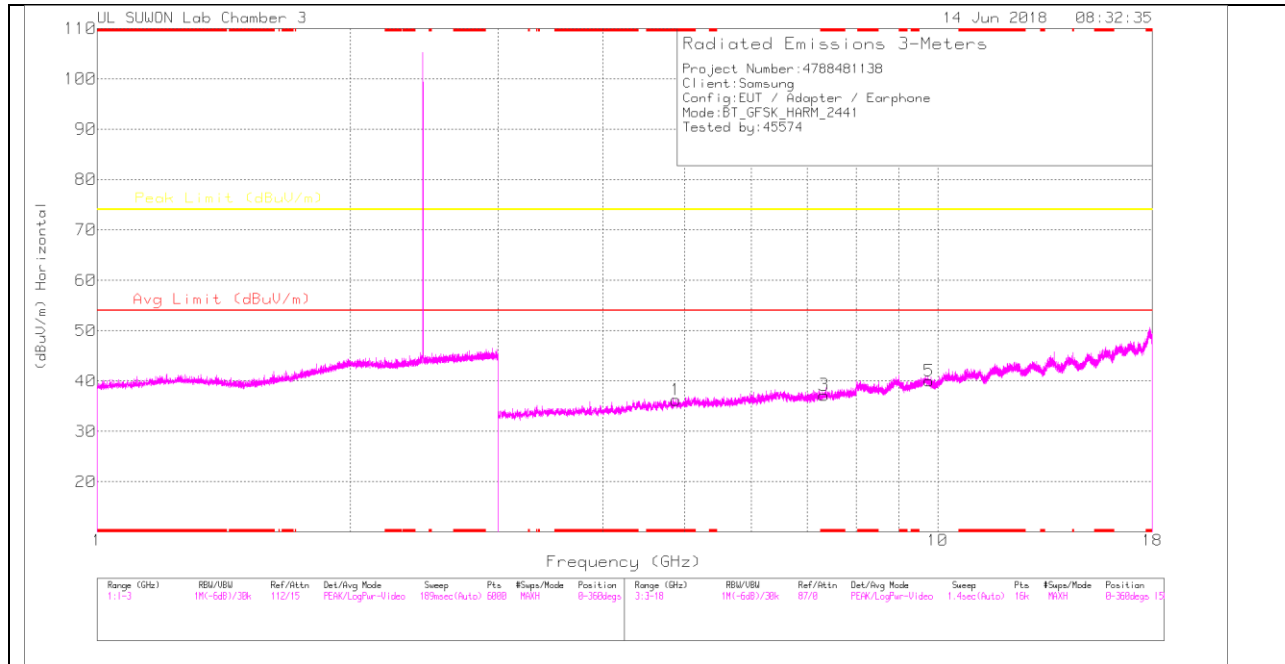

MID CHANNEL VERTICAL

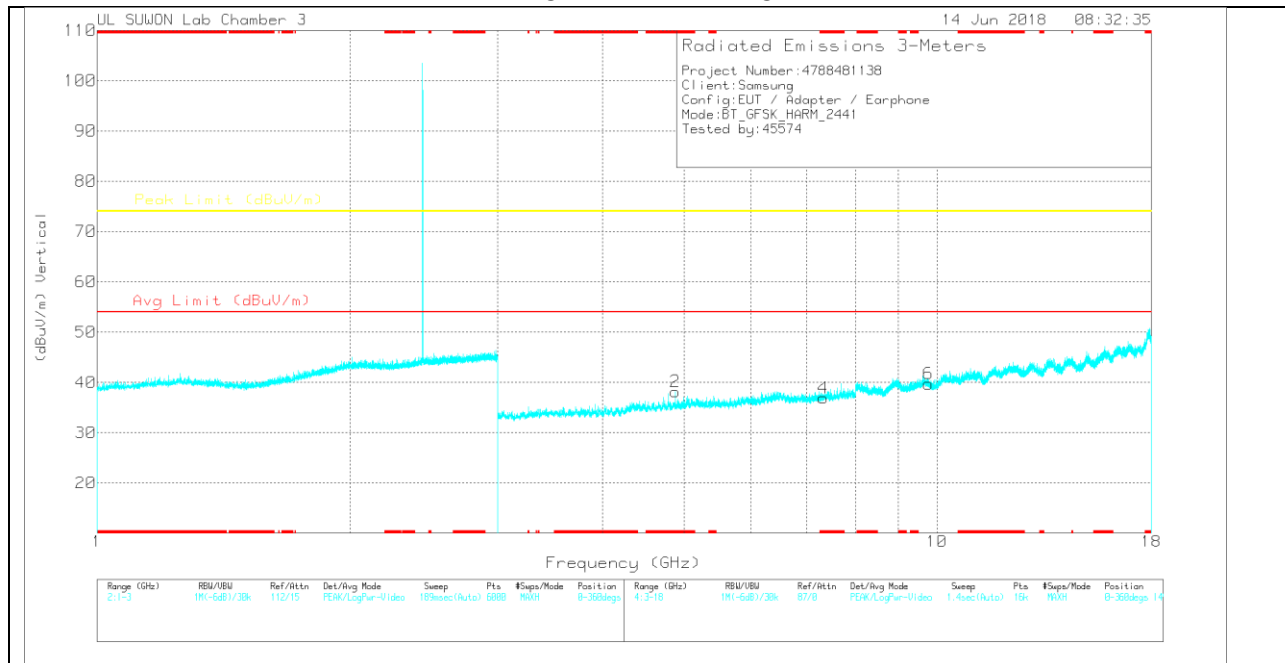

Note: Emission was scanned up to 26GHz; No emissions were detected above the noise floor which was at least 20dB below the specification limit.

MID CHANNEL DATA

Trace Markers

Marker	Frequency (GHz)	Meter Reading (dBuV)	Det	3117[00205959]	3GHz_HP[dB]	Corrected Reading (dBuV/m)	Avg Limit (dBuV/m)	Margin (dB)	Peak Limit (dBuV/m)	Margin (dB)	Azimuth (Degs)	Height (cm)	Polarity
1	* 4.884	31.13	PK	34	-28.9	36.23	-	-	74	-37.77	0-360	150	H
3	* 7.323	24.99	PK	35.6	-23.4	37.19	-	-	74	-36.81	0-360	150	H
5	9.764	22.63	PK	36.9	-19.5	40.03	-	-	74	-33.97	0-360	150	H
2	* 4.882	33.07	PK	34	-28.9	38.17	-	-	74	-35.83	0-360	149	V
4	* 7.323	24.71	PK	35.6	-23.4	36.91	-	-	74	-37.09	0-360	250	V
6	9.764	22.33	PK	36.9	-19.5	39.73	-	-	74	-34.27	0-360	250	V

* - indicates frequency in CFR47 Pt 15 / IC RSS-Restricted Band
 PK – Peak Detector

Radiated Emissions

Frequency (GHz)	Meter Reading (dBuV)	Det	3117[00205959]	3GHz_HP[dB]	Corrected Reading (dBuV/m)	Avg Limit (dBuV/m)	Margin (dB)	Peak Limit (dBuV/m)	Margin (dB)	Azimuth (Degs)	Height (cm)	Polarity
* 4.882	40.83	PKFH	34	-28.9	45.93	-	-	74	-28.07	197	106	V
* 4.882	29.93	VA1T	34	-28.9	35.03	54	-18.97	-	-	197	106	V

* - indicates frequency in CFR47 Pt 15 / IC RSS-Restricted Band
 PKFH - FHSS: RB=100k/1MHz VB=3 x RB, Peak
 VA1T - FHSS: Linear Voltage Average VB=1/Ton where: Ton is transmit duration

HIGH CHANNEL HORIZONTAL

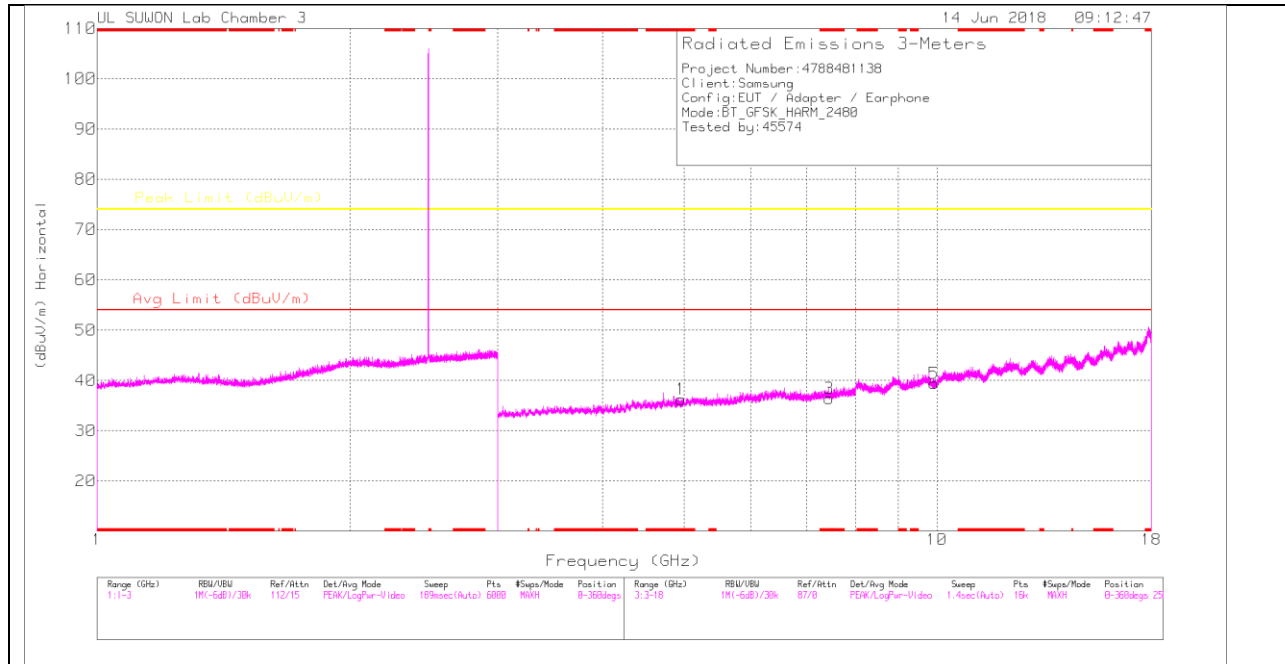

HIGH CHANNEL VERTICAL

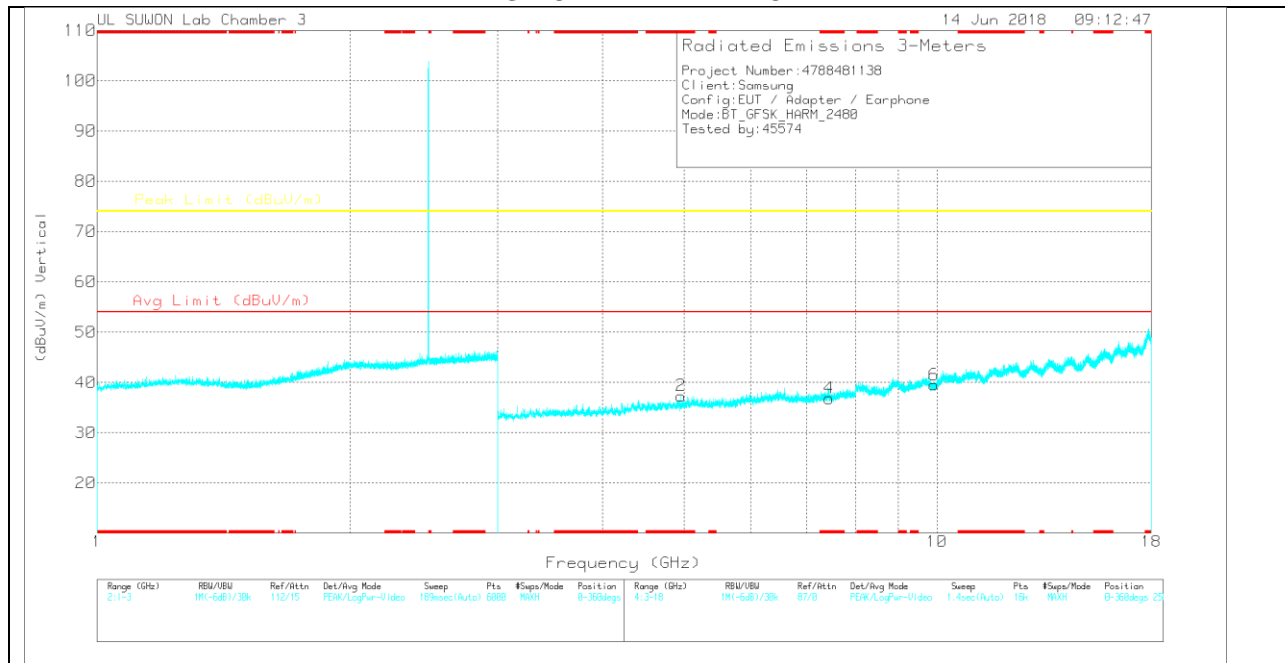

Note: Emission was scanned up to 26GHz; No emissions were detected above the noise floor which was at least 20dB below the specification limit.

HIGH CHANNEL DATA

Trace Markers

Marker	Frequency (GHz)	Meter Reading (dBuV)	Det	3117[00205959]	3GHz_HP[dB]	Corrected Reading (dBuV/m)	Avg Limit (dBuV/m)	Margin (dB)	Peak Limit (dBuV/m)	Margin (dB)	Azimuth (Degs)	Height (cm)	Polarity
1	* 4.959	30.64	PK	34.1	-28.5	36.24	-	-	74	-37.76	0-360	150	H
3	* 7.44	24	PK	35.6	-23.2	36.4	-	-	74	-37.6	0-360	150	H
5	9.921	22.09	PK	37	-19.7	39.39	-	-	74	-34.61	0-360	250	H
2	* 4.959	31.74	PK	34.1	-28.5	37.34	-	-	74	-36.66	0-360	250	V
4	* 7.44	24.45	PK	35.6	-23.2	36.85	-	-	74	-37.15	0-360	250	V
6	9.92	22.2	PK	37	-19.7	39.5	-	-	74	-34.5	0-360	149	V

* - indicates frequency in CFR47 Pt 15 / IC RSS-Restricted Band
 PK – Peak Detector

11.2.2. ENHANCED DATA RATE 8PSK MODULATION RESTRICTED BANDEDGE (LOW CHANNEL)

HORIZONTAL PEAK AND AVERAGE PLOT

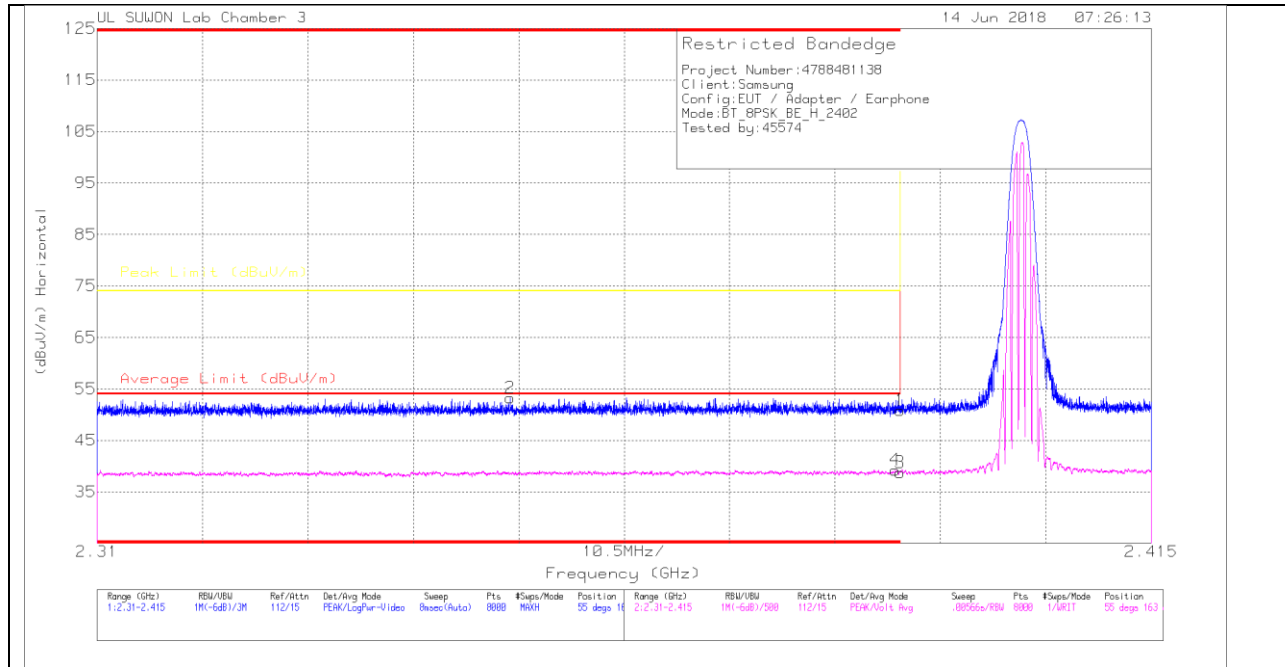

HORIZONTAL DATA

Trace Markers

Marker	Frequency (GHz)	Meter Reading (dBuV)	Det	3117(00205959)	10dB_ATT[dB]	Corrected Reading (dBuV/m)	Average Limit (dBuV/m)	Margin (dB)	Peak Limit (dBuV/m)	PK Margin (dB)	Azimuth (Degs)	Height (cm)	Polarity
1	* 2.39	42.34	Pk	31.8	-23.3	50.84	-	-	74	-23.16	55	163	H
2	* 2.351	44.87	Pk	31.7	-23.3	53.27	-	-	74	-20.73	55	163	H
3	* 2.39	30.25	VA1T	31.8	-23.3	38.75	54	-15.25	-	-	55	163	H
4	* 2.389	30.76	VA1T	31.8	-23.3	39.26	54	-14.74	-	-	55	163	H

* - indicates frequency in CFR47 Pt 15 / IC RSS-Restricted Band

Pk - Peak detector

VA1T - FHSS: Linear Voltage Average $V_B=1/T_{on}$ where: T_{on} is transmit duration

VERTICAL PEAK AND AVERAGE PLOT

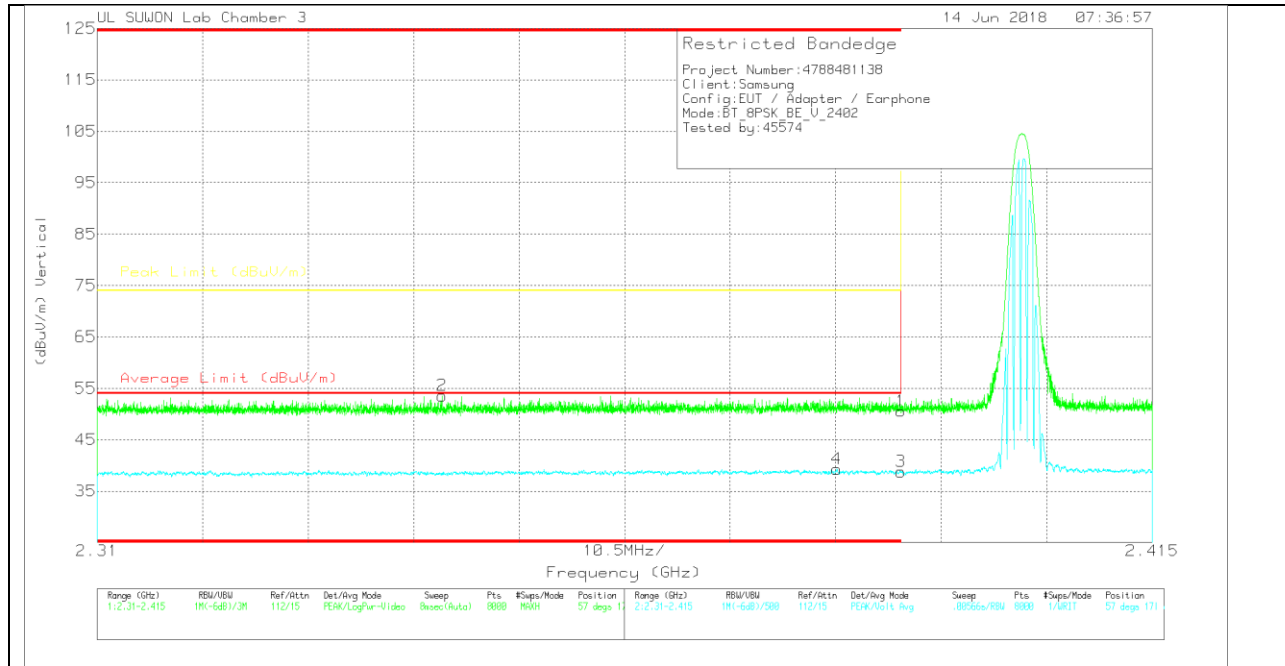

VERTICAL DATA

Trace Markers

Marker	Frequency (GHz)	Meter Reading (dBuV)	Det	3117[00205959]	10dB_ATT[dB]	Corrected Reading (dBuV/m)	Average Limit (dBuV/m)	Margin (dB)	Peak Limit (dBuV/m)	PK Margin (dB)	Azimuth (Degs)	Height (cm)	Polarity
1	* 2.39	42.05	Pk	31.8	-23.3	50.55	-	-	74	-23.45	57	171	V
2	* 2.344	45.17	Pk	31.7	-23.3	53.57	-	-	74	-20.43	57	171	V
3	* 2.39	30.29	VA1T	31.8	-23.3	38.79	54	-15.21	-	-	57	171	V
4	* 2.384	30.79	VA1T	31.8	-23.3	39.29	54	-14.71	-	-	57	171	V

* - indicates frequency in CFR47 Pt 15 / IC RSS-Restricted Band

Pk - Peak detector

VA1T - FHSS: Linear Voltage Average VB=1/Ton where: Ton is transmit duration

AUTHORIZED BANDEDGE (HIGH CHANNEL)

HORIZONTAL PEAK AND AVERAGE PLOT

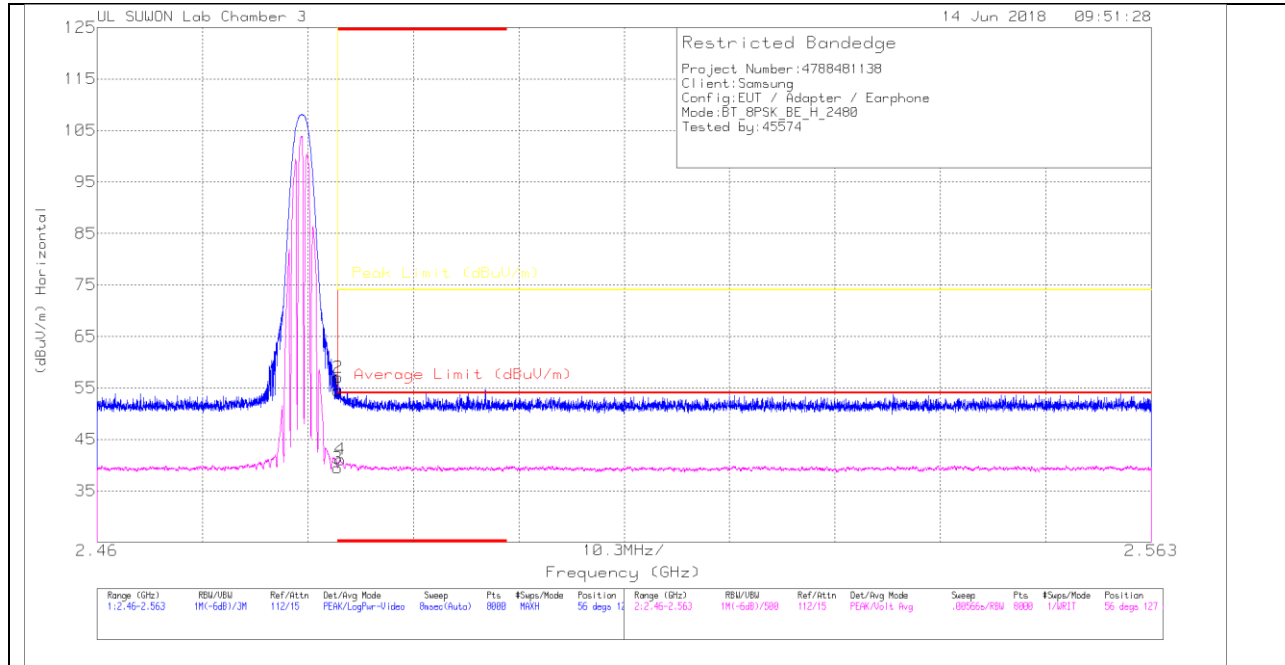

HORIZONTAL DATA

Trace Markers

Marker	Frequency (GHz)	Meter Reading (dBuV)	Det	3117(00205959)	10dB_ATT[dB]	Corrected Reading (dBuV/m)	Average Limit (dBuV/m)	Margin (dB)	Peak Limit (dBuV/m)	PK Margin (dB)	Azimuth (Degs)	Height (cm)	Polarity
1	* 2.484	45.35	Pk	32.1	-23	54.45	-	-	74	-19.55	56	127	H
2	* 2.484	47.95	PK	32.1	-23	57.05	-	-	74	-16.95	56	127	H
3	* 2.484	30.33	VA1T	32.1	-23	39.43	54	-14.57	-	-	56	127	H
4	* 2.484	32.11	VA1T	32.1	-23.1	41.11	54	-12.89	-	-	56	127	H

* - indicates frequency in CFR47 Pt 15 / IC RSS-Restricted Band

Pk - Peak detector

VA1T - FHSS: Linear Voltage Average $V_B=1/T_{on}$ where: T_{on} is transmit duration

VERTICAL PEAK AND AVERAGE PLOT

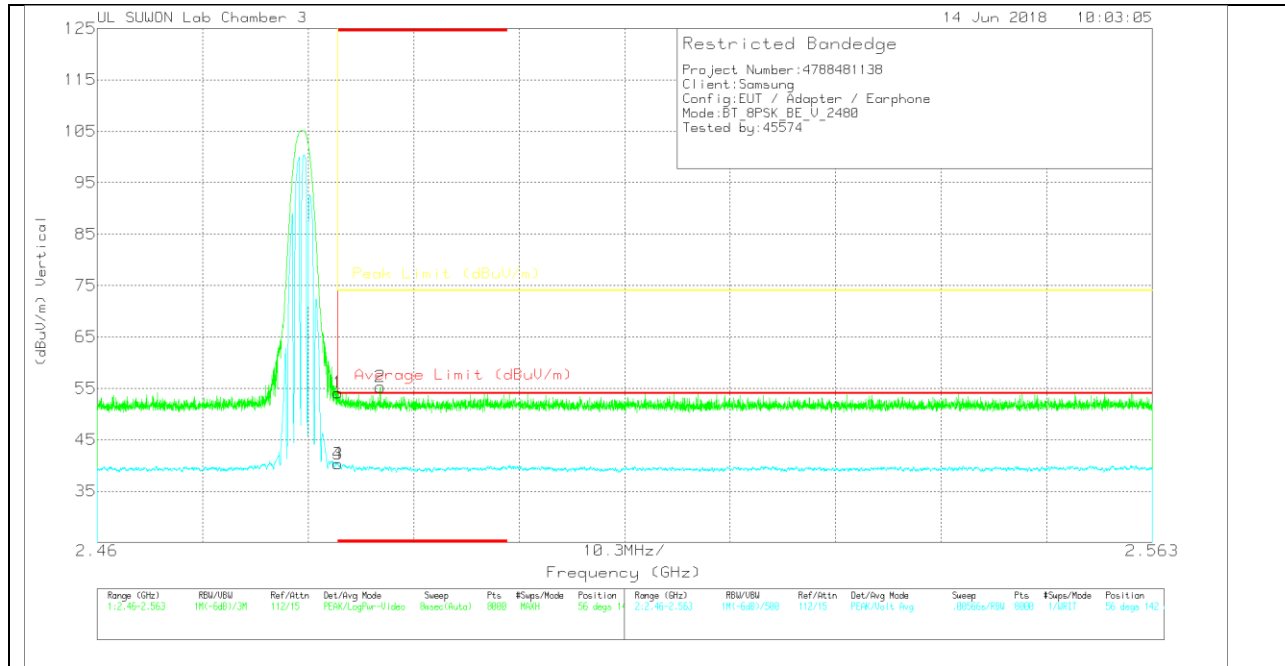

VERTICAL DATA

Trace Markers

Marker	Frequency (GHz)	Meter Reading (dBuV)	Det	3117[00205959]	10dB_ATT[dB]	Corrected Reading (dBuV/m)	Average Limit (dBuV/m)	Margin (dB)	Peak Limit (dBuV/m)	PK Margin (dB)	Azimuth (Degs)	Height (cm)	Polarity
1	* 2.484	45.03	Pk	32.1	-23	54.13	-	-	74	-19.87	56	142	V
2	* 2.488	46.28	Pk	32.1	-23.1	55.28	-	-	74	-18.72	56	142	V
3	* 2.484	31.21	VA1T	32.1	-23	40.31	54	-13.69	-	-	56	142	V
4	* 2.484	31.23	VA1T	32.1	-23	40.33	54	-13.67	-	-	56	142	V

* - indicates frequency in CFR47 Pt 15 / IC RSS-Restricted Band

Pk - Peak detector

VA1T - FHSS: Linear Voltage Average VB=1/Ton where: Ton is transmit duration

HARMONICS AND SPURIOUS EMISSIONS

LOW CHANNEL HORIZONTAL

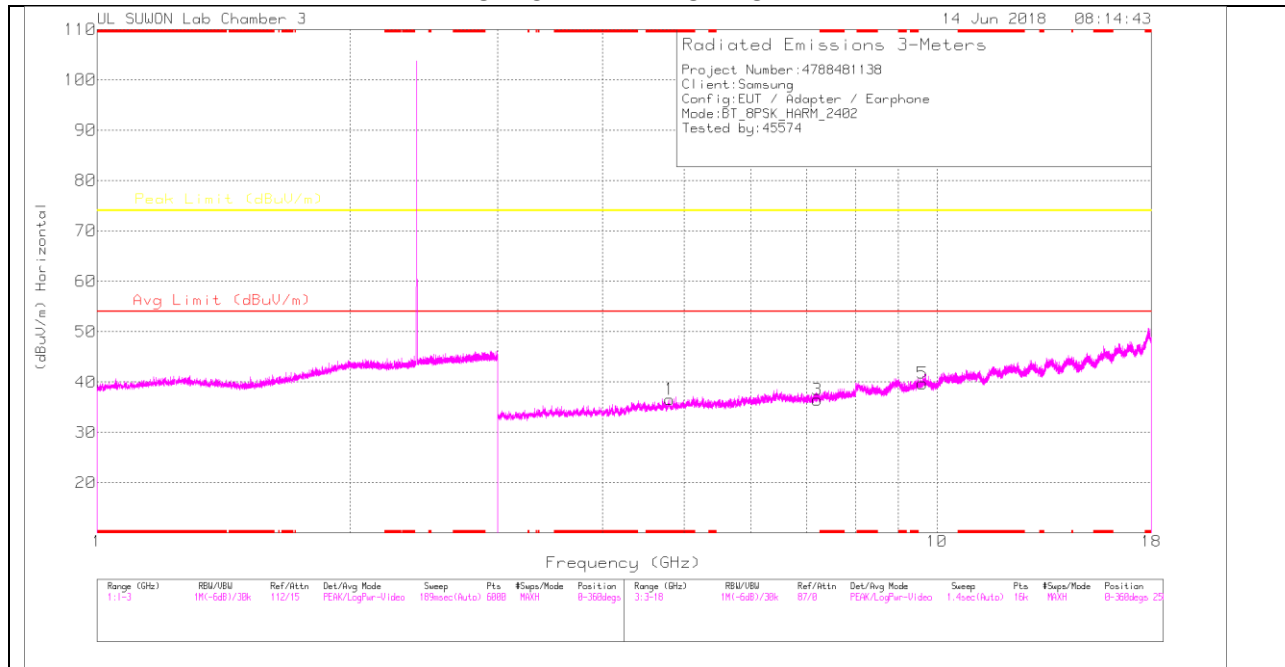

LOW CHANNEL VERTICAL

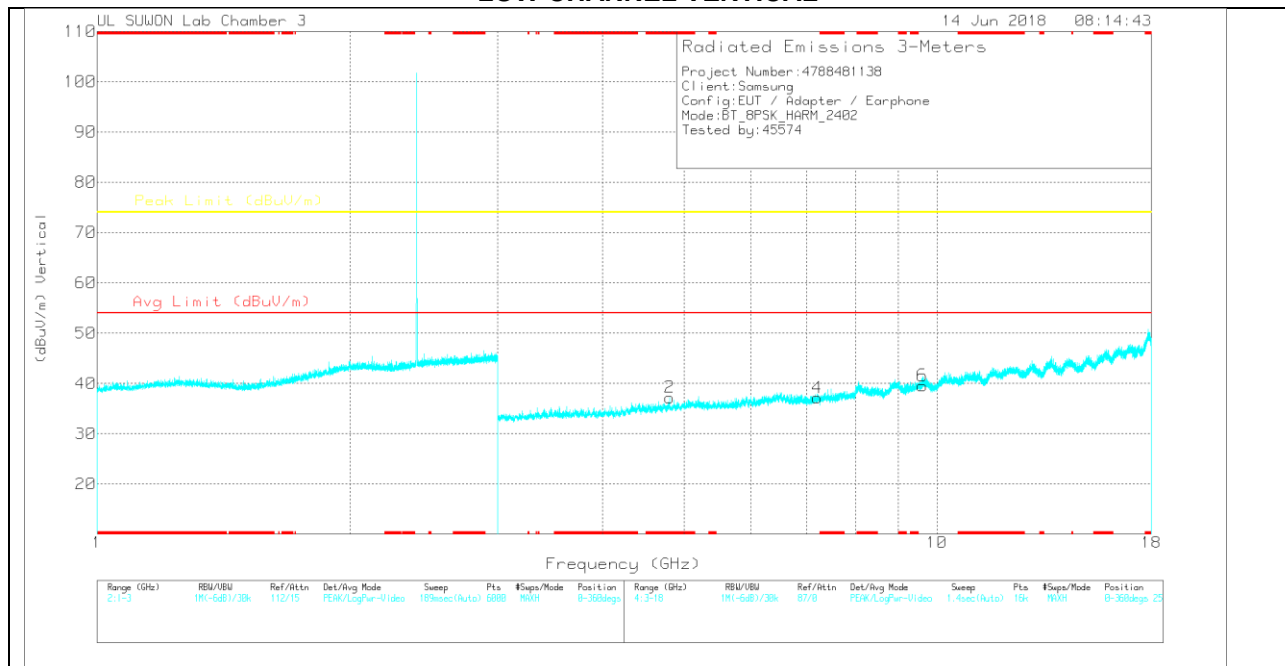

Note: Emission was scanned up to 26GHz; No emissions were detected above the noise floor which was at least 20dB below the specification limit.

LOW CHANNEL DATA

Trace Markers

Marker	Frequency (GHz)	Meter Reading (dBuV)	Det	3117[00205959]	3GHz_HP[dB]	Corrected Reading (dBuV/m)	Avg Limit (dBuV/m)	Margin (dB)	Peak Limit (dBuV/m)	Margin (dB)	Azimuth (Degs)	Height (cm)	Polarity
1	* 4.804	30.86	PK	33.9	-28.2	36.56	-	-	74	-37.44	0-360	150	H
3	7.207	24.88	PK	35.6	-24	36.48	-	-	74	-37.52	0-360	250	H
5	9.609	22.93	PK	36.7	-19.9	39.73	-	-	74	-34.27	0-360	250	H
2	* 4.804	31.52	PK	33.9	-28.2	37.22	-	-	74	-36.78	0-360	251	V
4	7.207	25.53	PK	35.6	-24	37.13	-	-	74	-36.87	0-360	251	V
6	9.609	22.76	PK	36.7	-19.9	39.56	-	-	74	-34.44	0-360	149	V

* - indicates frequency in CFR47 Pt 15 / IC RSS-Restricted Band

PK – Peak Detector

Note: Only peak measurement was performed. Because peak measurement result of unwanted emission is less than average limit (54dBuV/m).