



FCC 47 CFR PART 15 SUBPART E

UNII

CERTIFICATION TEST REPORT

FOR

WCDMA/LTE Tablet + BT/BLE, DTS/UNII a/b/g/n and ANT+

MODEL NUMBER : SM-T387T

FCC ID: A3LSMT387T

REPORT NUMBER: 4788549592-E4V2

ISSUE DATE: AUG 01, 2018

Prepared for
SAMSUNG ELECTRONICS CO., LTD.
129 SAMSUNG-RO, YEONGTONG-GU, SUWON-SI,
GYEONGGI-DO, 16677, KOREA

Prepared by
UL Korea, Ltd.
26th floor, 152, Teheran-ro, Gangnam-gu Seoul, 06236, Korea

Suwon Test Site: UL Korea, Ltd. Suwon Laboratory
218 Maeyeong-ro, Yeongtong-gu,
Suwon-si, Gyeonggi-do, 16675, Korea
TEL: (031) 337-9902
FAX: (031) 213-5433



ACCREDITED*

Testing
Laboratory

TL-637

Revision History

<u>Rev.</u>	<u>Issue Date</u>	<u>Revisions</u>	<u>Revised By</u>
V1	07/25/18	Initial issue	Junwhan Lee
V2	08/01/18	Updated to address TCB's question	Junwhan Lee

TABLE OF CONTENTS

1. ATTESTATION OF TEST RESULTS	6
1.1. INTRODUCTION OF TEST DATA REUSE.....	7
1.2. DIFFERENCE.....	7
1.3. SPOT CHECK VERIFICATION DATA	7
1.4. REFERENCE DETAIL	8
2. TEST METHODOLOGY	9
3. FACILITIES AND ACCREDITATION	9
4. CALIBRATION AND UNCERTAINTY	9
4.1. MEASURING INSTRUMENT CALIBRATION	9
4.2. SAMPLE CALCULATION	9
4.3. MEASUREMENT UNCERTAINTY.....	10
5. EQUIPMENT UNDER TEST	11
5.1. DESCRIPTION OF EUT	11
5.1. MAXIMUM OUTPUT POWER.....	11
5.2. DESCRIPTION OF AVAILABLE ANTENNAS	12
5.3. WORST-CASE CONFIGURATION AND MODE.....	12
5.4. DESCRIPTION OF TEST SETUP.....	13
6. TEST AND MEASUREMENT EQUIPMENT	15
7. SUMMARY TABLE	16
8. MEASUREMENT METHODS	17
9. REFERENCE MEASUREMENTS RESULTS	18
9.1. ON TIME AND DUTY CYCLE RESULTS.....	18
9.2. DUTY CYCLE PLOTS	18
9.3. 26 dB BANDWIDTH.....	20
9.3.1. 802.11a MODE IN THE 5.2 GHz BAND.....	20
9.3.2. 802.11n HT20 MODE IN THE 5.2 GHz BAND	20
9.3.3. 802.11n HT40 MODE IN THE 5.2 GHz BAND	20
9.3.4. 802.11a MODE IN THE 5.3 GHz BAND.....	21
9.3.5. 802.11n HT20 MODE IN THE 5.3 GHz BAND	21
9.3.6. 802.11n HT40 MODE IN THE 5.3 GHz BAND	21
9.3.7. 802.11a MODE IN THE 5.5 GHz BAND.....	22
9.3.8. 802.11n HT20 MODE IN THE 5.5 GHz BAND	22
9.3.9. 802.11n HT40 MODE IN THE 5.5 GHz BAND	22
9.3.10. 802.11a MODE IN THE 5.8 GHz BAND.....	23

9.3.11.	802.11n HT20 MODE IN THE 5.8 GHz BAND	23
9.3.12.	802.11n HT40 MODE IN THE 5.8 GHz BAND	23
9.3.13.	26 dB BANDWIDTH PLOTS	24
9.4.	99% BANDWIDTH.....	36
9.4.1.	802.11a MODE IN THE 5.2 GHz BAND.....	36
9.4.2.	802.11n HT20 MODE IN THE 5.2 GHz BAND	36
9.4.3.	802.11n HT40 MODE IN THE 5.2 GHz BAND	36
9.4.4.	802.11a MODE IN THE 5.3 GHz BAND.....	37
9.4.5.	802.11n HT20 MODE IN THE 5.3 GHz BAND	37
9.4.6.	802.11n HT40 MODE IN THE 5.3 GHz BAND	37
9.4.7.	802.11a MODE IN THE 5.5 GHz BAND.....	38
9.4.8.	802.11n HT20 MODE IN THE 5.5 GHz BAND	38
9.4.9.	802.11n HT40 MODE IN THE 5.5 GHz BAND	38
9.4.10.	802.11a MODE IN THE 5.8 GHz BAND.....	39
9.4.11.	802.11n HT20 MODE IN THE 5.8 GHz BAND	39
9.4.12.	802.11n HT40 MODE IN THE 5.8 GHz BAND	39
9.4.13.	99% BANDWIDTH PLOTS	40
10.	ANTENNA PORT TEST RESULTS.....	52
10.1.	6 dB BANDWIDTH.....	52
10.1.1.	802.11a MODE IN THE 5.8 GHz BAND.....	53
10.1.2.	802.11n HT20 MODE IN THE 5.8 GHz BAND	53
10.1.3.	802.11n HT40 MODE IN THE 5.8 GHz BAND	53
10.1.4.	6 dB BANDWIDTH PLOTS	54
10.2.	OUTPUT POWER AND PPSD.....	57
10.2.1.	802.11a MODE IN THE 5.2 GHz BAND.....	58
10.2.2.	802.11n HT20 MODE IN THE 5.2 GHz BAND	59
10.2.3.	802.11n HT40 MODE IN THE 5.2 GHz BAND	60
10.2.4.	802.11a MODE IN THE 5.3 GHz BAND.....	61
10.2.5.	802.11n HT20 MODE IN THE 5.3 GHz BAND	62
10.2.6.	802.11n HT40 MODE IN THE 5.3 GHz BAND	63
10.2.7.	802.11a MODE IN THE 5.5 GHz BAND.....	64
10.2.8.	802.11n HT20 MODE IN THE 5.5 GHz BAND	65
10.2.9.	802.11n HT40 MODE IN THE 5.5 GHz BAND	66
10.2.10.	802.11a MODE IN THE 5.8 GHz BAND.....	67
10.2.11.	802.11n HT20 MODE IN THE 5.8 GHz BAND	68
10.2.12.	802.11n HT40 MODE IN THE 5.8 GHz BAND	69
10.2.13.	PPSD PLOTS	70
11.	TRANSMITTER ABOVE 1 GHz.....	82
11.1.	5.2 GHz.....	84
11.1.1.	TX Above 1GHz 802.11a MODE IN THE 5.2GHz BAND	84
11.1.2.	TX Above 1GHz 802.11n HT20 MODE IN THE 5.2GHz BAND.....	92
11.1.3.	TX Above 1GHz 802.11n HT40 MODE IN THE 5.2GHz BAND.....	100
11.2.	5.3 GHz.....	106
11.2.1.	TX ABOVE 1 GHz 802.11a MODE IN THE 5.3 GHz BAND	106
11.2.2.	TX ABOVE 1GHz 802.11n HT20 MODE IN THE 5.3GHz BAND.....	114
11.2.3.	TX ABOVE 1GHz 802.11n HT40 MODE IN THE 5.3GHz BAND.....	122

11.3.	5.5-5.6 GHz.....	128
11.3.1.	TX ABOVE 1 GHz 802.11a MODE IN THE 5.5 GHz BAND	128
11.3.2.	TX ABOVE 1GHz 802.11n HT20 MODE IN THE 5.5GHz BAND.....	138
11.3.3.	TX ABOVE 1GHz 802.11n HT40 MODE IN THE 5.5GHz BAND.....	148
11.4.	5.8 GHz.....	158
11.4.1.	TX ABOVE 1GHz 802.11a MODE IN THE 5.8GHz BAND	158
11.4.2.	TX ABOVE 1GHz 802.11n HT20 MODE IN THE 5.8GHz BAND.....	168
11.4.3.	TX ABOVE 1GHz 802.11n HT40 MODE IN THE 5.8GHz BAND.....	178
12.	WORST-CASE BELOW 1 GHz	186
13.	AC POWER LINE CONDUCTED EMISSIONS	188
14.	DYNAMIC FREQUENCY SELECTION.....	193
14.1.	OVERVIEW.....	193
14.1.1.	LIMITS.....	193
14.1.1.	TEST AND MEASUREMENT SYSTEM.....	197
14.1.2.	DESCRIPTION OF EUT	201
14.2.	RESULTS FOR 20 MHz BANDWIDTH.....	202
14.2.1.	TEST CHANNEL	202
14.2.2.	RADAR WAVEFORM AND TRAFFIC.....	202
14.2.3.	MOVE AND CLOSING TIME	204
14.3.	RESULTS FOR 40 MHz BANDWIDTH.....	207
14.3.1.	TEST CHANNEL	207
14.3.2.	RADAR WAVEFORM AND TRAFFIC.....	207
14.3.3.	OVERLAPPING CHANNEL TESTS.....	209
14.3.4.	MOVE AND CLOSING TIME	209
15.	SETUP PHOTOS.....	212

1. ATTESTATION OF TEST RESULTS

COMPANY NAME: SAMSUNG ELECTRONICS CO., LTD.
EUT DESCRIPTION: WCDMA/LTE Tablet + BT/BLE, DTS/UNII a/b/g/n and ANT+
MODEL NUMBER: SM-T387T
SERIAL NUMBER: R32K500LPHM (RADIATED, Original);
R32K400HC9R (CONDUCTED, Original);
R32K500K31T (RADIATED, Spot check);
DATE TESTED: MAY 04, 2018 - JUN 25, 2018 (Original);
JUL 24, 2018 (Spot check);

APPLICABLE STANDARDS	
STANDARD	TEST RESULTS
CFR 47 Part 15 Subpart E	Pass

UL Korea, Ltd. tested the above equipment in accordance with the requirements set forth in the above standards. All indications of Pass/Fail in this report are opinions expressed by UL Korea, Ltd. based on interpretations and/or observations of test results. Measurement Uncertainties were not taken into account and are published for informational purposes only. The test results show that the equipment tested is capable of demonstrating compliance with the requirements as documented in this report.

Note: The results documented in this report apply only to the tested sample, under the conditions and modes of operation as described herein. This document may not be altered or revised in any way unless done so by UL Korea, Ltd. and all revisions are duly noted in the revisions section. Any alteration of this document not carried out by UL Korea, Ltd. will constitute fraud and shall nullify the document. This report must not be used by the client to claim product certification, approval, or endorsement by IAS, any agency of the Federal Government, or any agency of any government.

Approved & Released For
UL Korea, Ltd. By:



SungGil Park
Suwon Lab Engineer
UL Korea, Ltd.

Tested By:



Junwhan Lee
Suwon Lab Engineer
UL Korea, Ltd.

1.1. INTRODUCTION OF TEST DATA REUSE

This report referenced from the FCC ID: A3LSMT387V UNII WLAN(FCC CFR 47 Part 15C). And the applicant takes full responsibility that the test data as referenced in this report represent compliance for this FCC ID.

1.2. DIFFERENCE

The FCC ID: A3LSMT387T shares the same enclosure and circuit board as FCC ID: A3LSMT387V. The UNII antennas and surrounding circuitry and layout are identical between these two units.

After confirming through preliminary radiated emissions that the performance of the FCC ID: A3LSMT387V remains representative of FCC ID: A3LSMT387T. The test data of FCC ID: A3LSMT387V being submitted for this application to cover UNII features.

1.3. SPOT CHECK VERIFICATION DATA (Worst case of the radiated spurious and band edge emissions)

Band	Test Item	Mode	Frequency	Test Limit	Original model	Spot check model	Deviation	Remark
					SM-T387V Results	SM-T387T Results		
					FCC ID : A3LSMT387V	FCC ID : A3LSMT387T		
UNII WLAN (5GHz)	Band Edge	11n HT40	5190 MHz	54 dBuV/m	49.84 dBuV/m	49.52 dBuV/m	-0.32 dB	
	RSE	11n HT40	5230 MHz	68.2 dBuV/m	43.15 dBuV/m	42.14 dBuV/m	-1.01 dB	
	Band Edge	11n HT40	5310 MHz	54 dBuV/m	51.57 dBuV/m	51.89 dBuV/m	0.32 dB	
	RSE	11n HT20	5260 MHz	68.2 dBuV/m	42.27 dBuV/m	42.60 dBuV/m	0.33 dB	
	Band Edge	11n HT40	5510 MHz	68.2 dBuV/m	64.41 dBuV/m	64.99 dBuV/m	0.58 dB	
	RSE	11a	5700 MHz	54 dBuV/m	42.74 dBuV/m	42.98 dBuV/m	0.24 dB	
	Band Edge	11a	5825 MHz	-27 dBm	-34.78 dBm	-35.38 dBm	-0.60 dB	
	RSE	11a	5825 MHz	54 dBuV/m	46.89 dBuV/m	47.08 dBuV/m	0.19 dB	

Comparison of two models, upper deviation is within 3dB range and all test results are under FCC Technical Limits.

1.4. REFERENCE DETAIL

Reference application that contains the reused reference data.

Equipment Class	Reference FCC ID	Type Grant/Permissive Change	Reference Application	Folder Test/RF Exposure	Report Title / Section
DTS	A3LSMT387V	Grant	4788481138-E1V2	Test	FCC Report DTS WLAN / All sections
			4788481138-E2V2	Test	FCC Report BLE All sections
DSS	A3LSMT387V	Grant	4788481138-E3V2	Test	FCC Report UNII WLAN / All sections
NII	A3LSMT387V	Grant	4788481138-E4V3	Test	FCC Report UNII WLAN / All sections
DXX	A3LSMT387V	Grant	4788481138-E5V2	Test	FCC Report ANT+ / All sections
PCE	A3LSMT387V	Grant	4788481138-E6V2	Test	FCC Report WWAN / All sections (for WCDMA B2/B5, LTE Band 2/4/5/7)

2. TEST METHODOLOGY

The tests documented in this report were performed in accordance with following methods.

1. FCC CFR 47 Part 2.
2. FCC CFR 47 Part 15.
3. KDB 789033 D02 General UNII Test Procedures New Rules v02r01
4. KDB 905462 D02 UNII DFS Compliance Procedures New Rules v02
5. KDB 905462 D03 UNII Clients Without Radar Detection New Rules v01r02
6. ANSI C63.10-2013.

3. FACILITIES AND ACCREDITATION

The test sites and measurement facilities used to collect data are located at 218 Maeyeong-ro, Yeongtong-gu, Suwon-si, Gyeonggi-do, 16675, Korea. Line conducted emissions are measured only at the 218 address. The following table identifies which facilities were utilized for radiated emission measurements documented in this report. Specific facilities are also identified in the test results sections.

218 Maeyeong-ro	
<input checked="" type="checkbox"/>	Chamber 1
<input type="checkbox"/>	Chamber 2
<input checked="" type="checkbox"/>	Chamber 3

UL Korea, Ltd. is accredited by IAS, Laboratory Code TL-637. The full scope of accreditation can be viewed at <http://www.iasonline.org/PDF/TL/TL-637.pdf>.

4. CALIBRATION AND UNCERTAINTY

4.1. MEASURING INSTRUMENT CALIBRATION

The measuring equipment utilized to perform the tests documented in this report has been calibrated in accordance with the manufacturer's recommendations, and is traceable to recognized national standards.

4.2. SAMPLE CALCULATION

Where relevant, the following sample calculation is provided:

$$\begin{aligned} \text{Field Strength (dBuV/m)} &= \text{Measured Voltage (dBuV)} + \text{Antenna Factor (dB/m)} + \\ &\text{Cable Loss (dB)} - \text{Preamp Gain (dB)} \\ 36.5 \text{ dBuV} + 18.7 \text{ dB/m} + 0.6 \text{ dB} - 26.9 \text{ dB} &= 28.9 \text{ dBuV/m} \end{aligned}$$

4.3. MEASUREMENT UNCERTAINTY

Where relevant, the following measurement uncertainty levels have been estimated for tests performed on the apparatus:

PARAMETER	UNCERTAINTY
Conducted Disturbance, 0.15 to 30 MHz	2.32 dB
Radiated Disturbance, Below 1GHz	3.86 dB
Radiated Disturbance, Above 1 GHz	5.97 dB

Uncertainty figures are valid to a confidence level of 95%.

5. EQUIPMENT UNDER TEST

5.1. DESCRIPTION OF EUT

The EUT is a WCDMA/LTE Tablet + BT/BLE, DTS/UNII a/b/g/n and ANT+.
 This test report addresses the NII (UNII) operational mode.

5.1. MAXIMUM OUTPUT POWER

The transmitter has a maximum total conducted average output power as follows:

Frequency Range [MHz]	Mode	Output Power [dBm]	Output Power [mW]
5180 - 5240	802.11a	16.66	46.34
	802.11n HT20	15.64	36.64
5190 - 5230	802.11n HT40	11.57	14.35
5260 - 5320	802.11a	16.12	40.93
	802.11n HT20	15.11	32.43
5270 - 5310	802.11n HT40	11.51	14.16
5500 - 5700	802.11a	14.03	25.29
	802.11n HT20	14.17	26.12
5510 - 5670	802.11n HT40	10.33	10.79
5745 - 5825	802.11a	16.64	46.13
	802.11n HT20	15.67	36.90
5755 - 5795	802.11n HT40	11.43	13.90

5.2. DESCRIPTION OF AVAILABLE ANTENNAS

The radio utilizes an internal antenna, with a maximum gain of:

Frequency Range [MHz]	Antenna Gain [dBi]
UNII 1 5150 – 5250	-2.7
UNII 2A 5250 – 5350	-2.1
UNII 2C 5470 – 5725	-1.9
UNII 3 5725 – 5850	-4.9

5.3. WORST-CASE CONFIGURATION AND MODE

Radiated emission below 1GHz and power line conducted emission were performed with the EUT set to transmit at the channel with highest output power as worst-case scenario.

Radiated emission above 1GHz was performed with the EUT set to transmit low/mid/high channels.

The fundamental of the EUT was investigated in three orthogonal orientations X,Y,Z, it was determined that the Y orientation was worst-case orientation; therefore, all final radiated testing was performed with the EUT in the Y orientation.

Based on the baseline scan, the worst-case data rates were:

802.11a mode: 6 Mbps
802.11n HT20 mode: MCS0
802.11n HT40 mode: MCS0

Note : All radiated and power line conducted tests were performed connected with earphone and charger for evaluation of worst case mode.

5.4. DESCRIPTION OF TEST SETUP

SUPPORT EQUIPMENT

Support Equipment List				
Description	Manufacturer	Model	Serial Number	FCC ID
Charger	SAMSUNG	EP-TA50JWE	DK4K227VS/A-E	N/A
Data Cable	SAMSUNG	EP-DG915UWZ	N/A	N/A
Earphone	SAMSUNG	EHS64AVFWE	N/A	N/A

I/O CABLES

I/O Cable List						
Cable No	Port	# of identical ports	Connector Type	Cable Type	Cable Length (m)	Remarks
1	DC Power	1	Mini-USB	Shielded	1.2m	N/A
2	Audio	2	Mini-Jack	Unshielded	1.2m	N/A

TEST SETUP

The EUT is a stand-alone unit during the tests.
 Test software in hidden menu exercised the EUT to enable NII mode.

SETUP DIAGRAM FOR TESTS (CONDUCTED TEST SETUP)

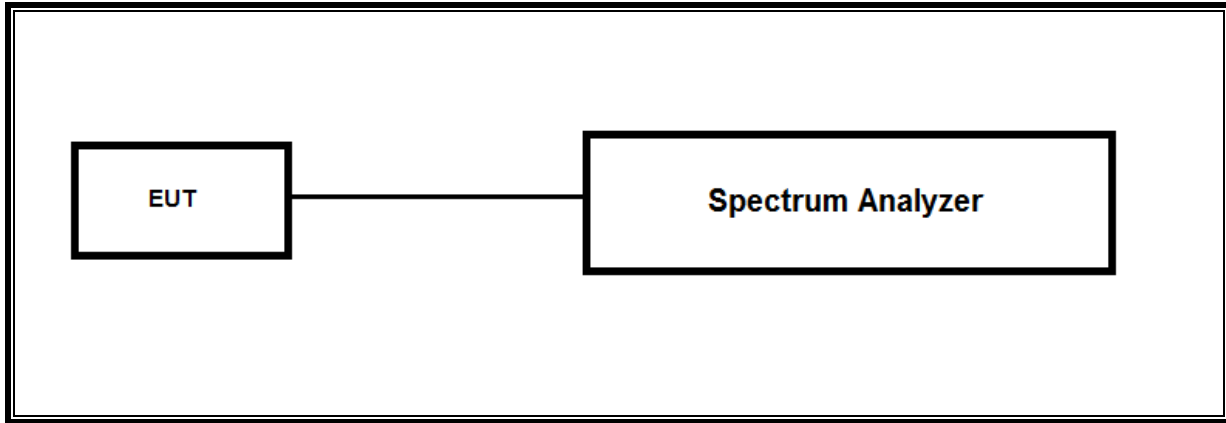

SETUP DIAGRAM FOR TESTS (RADIATED TEST SETUP)

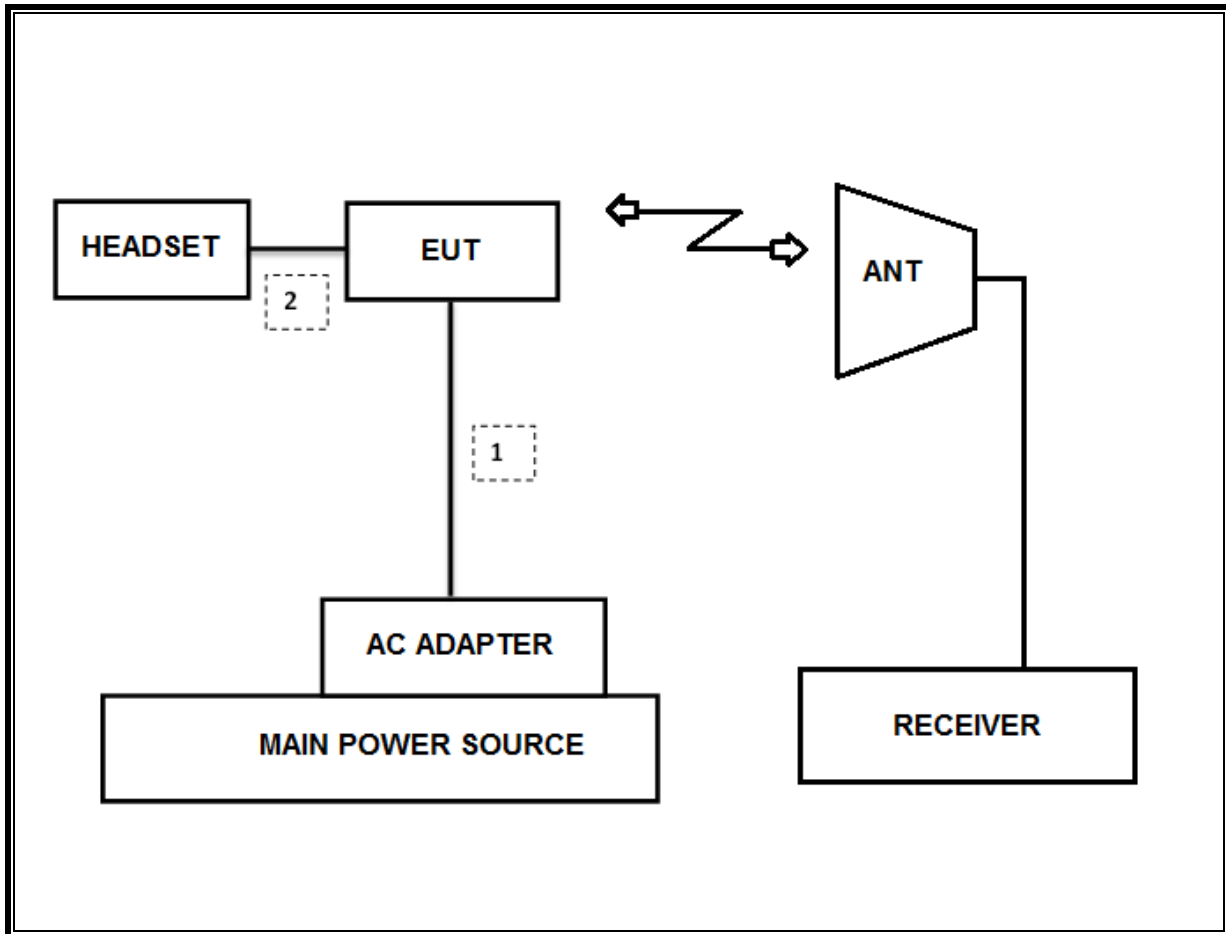

6. TEST AND MEASUREMENT EQUIPMENT

The following test and measurement equipment was utilized for the tests documented in this report:

Test Equipment List				
Description	Manufacturer	Model	S/N	Cal Due
Antenna, Bilog, 30MHz-1GHz	SCHWARZBECK	VULB9163	750	08-31-19
Antenna, Bilog, 30MHz-1GHz	SCHWARZBECK	VULB9163	749	09-14-19
Antenna, Bilog, 30MHz-1GHz	SCHWARZBECK	VULB9163	845	08-31-19
Antenna, Horn, 18 GHz	ETS	3115	00167211	10-14-18
Antenna, Horn, 18 GHz	ETS	3115	00161451	03-10-19
Antenna, Horn, 18 GHz	ETS	3117	00168724	05-31-19
Antenna, Horn, 18 GHz	ETS	3117	00168717	05-31-19
Antenna, Horn, 18 GHz	ETS	3117	00205959	11-29-18
Antenna, Horn, 40 GHz	ETS	3116C	00166155	12-04-19
Antenna, Horn, 40 GHz	ETS	3116C	00168645	12-04-19
Antenna, Horn, 40 GHz	ETS	3116C-PA	00168841	11-13-19
Preamplifier, 1000 MHz	Sonoma	310N	341282	08-09-18
Preamplifier, 1000 MHz	Sonoma	310N	351741	08-07-18
Preamplifier, 1000 MHz	Sonoma	310N	370599	08-10-18
Preamplifier, 18 GHz	Miteq	AFS42-00101800-25-S-42	1876511	08-08-18
Preamplifier, 18 GHz	Miteq	AFS42-00101800-25-S-42	1896138	08-08-18
Preamplifier, 18 GHz	Miteq	AFS42-00101800-25-S-42	2029169	08-11-18
Spectrum Analyzer, 44 GHz	Agilent / HP	N9030A	MY54170614	08-08-18
Spectrum Analyzer, 44 GHz	Agilent / HP	N9030A	MY54490312	08-08-18
Average Power Sensor	Agilent / HP	U2000	MY54270007	08-08-18
Attenuator	PASTERNAK	PE7087-10	A001	08-08-18
Attenuator	PASTERNAK	PE7087-10	A008	08-08-18
Attenuator	PASTERNAK	PE7087-10	2	08-10-18
Attenuator	PASTERNAK	PE7087-10	A009	08-08-18
EMI Test Receive, 40 GHz	R&S	ESU40	100439	08-08-18
EMI Test Receive, 40 GHz	R&S	ESU40	100457	08-08-18
EMI Test Receive, 44 GHz	R&S	ESW44	101590	08-09-18
EMI Test Receive, 3 GHz	R&S	ESR3	101832	08-07-18
Low Pass Filter 5GHz	Micro-Tronics	LPS17541	009	08-08-18
Low Pass Filter 5GHz	Micro-Tronics	LPS17541	015	08-08-18
Low Pass Filter 5GHz	Micro-Tronics	LPS17541	020	08-11-18
High Pass Filter 3GHz	Micro-Tronics	HPM17543	010	08-08-18
High Pass Filter 3GHz	Micro-Tronics	HPM17543	015	08-08-18
High Pass Filter 3GHz	Micro-Tronics	HPM17543	020	08-11-18
High Pass Filter 6GHz	Micro-Tronics	HPS17542	009	08-08-18
High Pass Filter 6GHz	Micro-Tronics	HPS17542	016	08-08-18
High Pass Filter 6GHz	Micro-Tronics	HPS17542	021	08-11-18
LISN	R&S	ENV-216	101837	08-09-18
UL Software				
Description	Manufacturer	Model	Version	
Radiated software	UL	UL EMC	Ver 9.5	
AC Line Conducted software	UL	UL EMC	Ver 9.5	

7. SUMMARY TABLE

FCC Part Section	Test Description	Test Limit	Test Condition	Test Result
15.407(e)	6dB Band width (5.8Ghz)	500KHz	Condcuted	PASS
15.407 (a)(2)	TX Cond. Power 5.15-2.25, 5.25-5.35 & 5.47-5.725	<24dBm or 11+10Log(OBW)		PASS
15.407 (a)(3)	TX Cond. Power 5.725-5.825	< 30dBm or 17+10Log(OBW)		PASS
15.407 (a)(5)	PSD (5.2,5.3,5.5GHz)	<11dBm		PASS
15.407 (a)(5)	PSD (5.8GHz)	30dBm per 500kHz		PASS
15.207 (a)	AC Power Line conducted emissions	Section 10	Radiated	PASS
15.407 (b) & 15.209	Radiated Spurious Emission	< 54dBuV/m		PASS
15.407 (h)(2)	Dynamic Frequency Selection	N/A	Condcuted	PASS

8. MEASUREMENT METHODS

On-Time and Duty Cycle : KDB 789033 D02 v02r01, Section B.

6dB Emission BW : KDB 789033 D02 v02r01, Section C.2.

26dB Emission BW : KDB 789033 D02 v02r01, Section C.1.

99% Occupied BW : KDB 789033 D02 v02r01, Section D.

Conducted Output Power : KDB 789033 D02 v02r01, Section E.3.a(Method PM)

Power Spectral Density : KDB 789033 D02 v02r01, Section F.

Unwanted emissions in restricted bands : KDB 789033 D02 v02r01, Section G.

Unwanted emissions in non-restricted bands : KDB 789033 D02 v02r01, Section G.

AC Power Line Conducted Emission : ANSI C63.10-2013, Section 6.2.

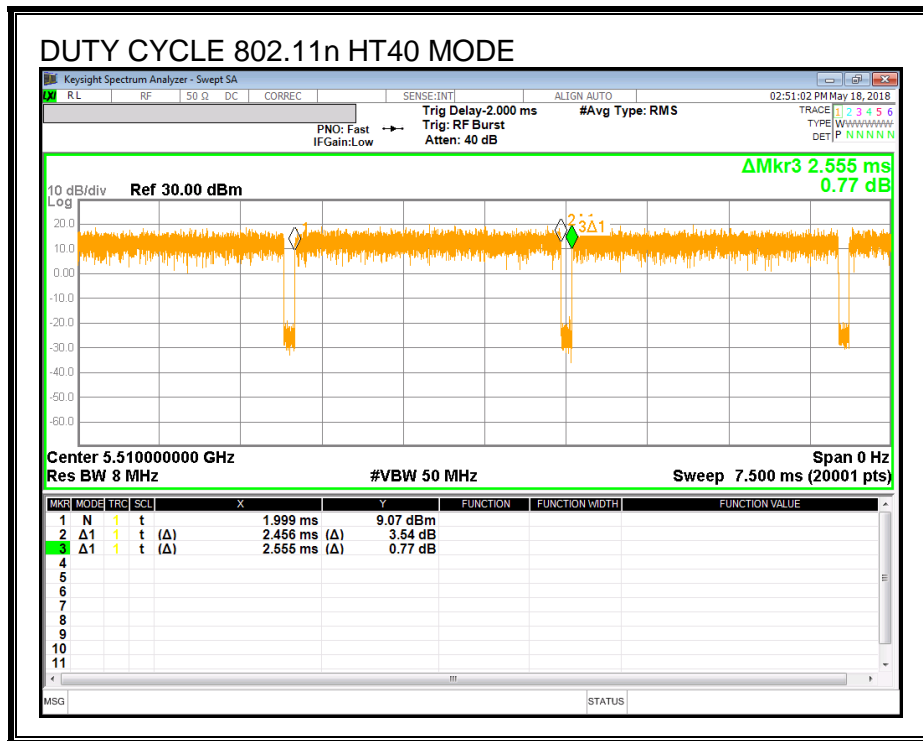
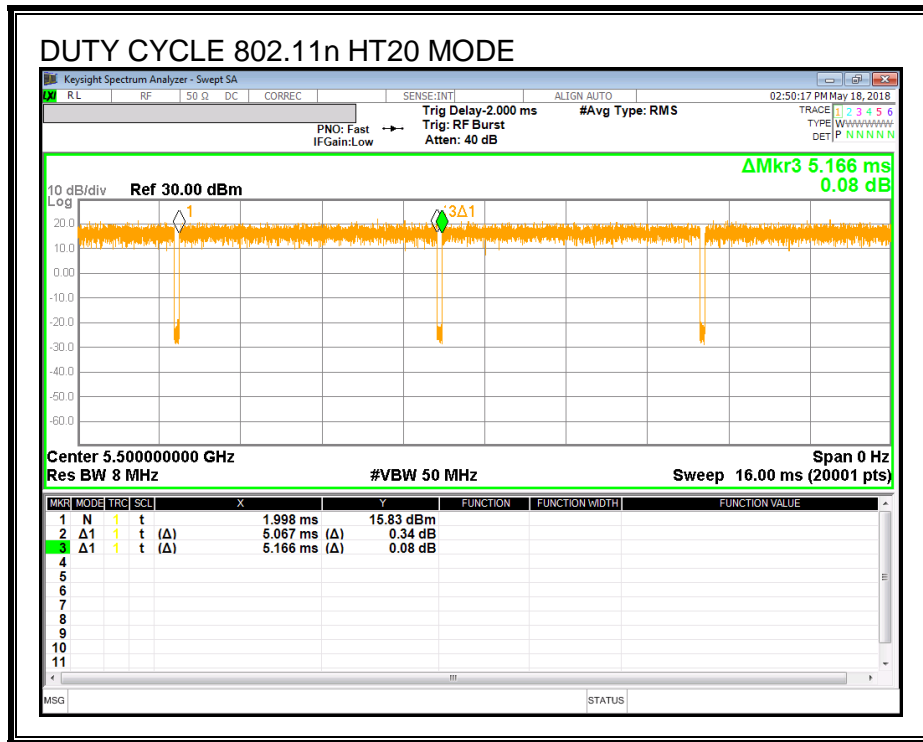

9.3. 26 dB BANDWIDTH

LIMITS

None; for reporting purposes only.

TEST PROCEDURE

Reference to 789033 D02 General UNII Test Procedures New Rules v01r03: The transmitter output is connected to a spectrum analyzer with the RBW set to approximately 1% of EBW, the VBW > RBW, peak detector and max hold.

RESULTS

9.3.1. 802.11a MODE IN THE 5.2 GHz BAND

Channel	Frequency [MHz]	26 dB Bandwidth [MHz]
Low	5180	35.30
Mid	5200	36.27
High	5240	35.74
Worst		36.27

9.3.2. 802.11n HT20 MODE IN THE 5.2 GHz BAND

Channel	Frequency [MHz]	26 dB Bandwidth [MHz]
Low	5180	33.47
Mid	5200	33.27
High	5240	31.91
Worst		33.47

9.3.3. 802.11n HT40 MODE IN THE 5.2 GHz BAND

Channel	Frequency [MHz]	26 dB Bandwidth [MHz]
Low	5190	42.31
High	5230	43.84
Worst		43.84

9.3.4. 802.11a MODE IN THE 5.3 GHz BAND

Channel	Frequency [MHz]	26 dB Bandwidth [MHz]
Low	5260	34.05
Mid	5300	32.91
High	5320	34.70
Worst		34.70

9.3.5. 802.11n HT20 MODE IN THE 5.3 GHz BAND

Channel	Frequency [MHz]	26 dB Bandwidth [MHz]
Low	5260	29.92
Mid	5300	31.37
High	5320	30.84
Worst		31.37

9.3.6. 802.11n HT40 MODE IN THE 5.3 GHz BAND

Channel	Frequency [MHz]	26 dB Bandwidth [MHz]
Low	5270	42.79
High	5310	44.01
Worst		44.01

9.3.7. 802.11a MODE IN THE 5.5 GHz BAND

Channel	Frequency [MHz]	26 dB Bandwidth [MHz]
Low	5500	22.35
Mid	5580	21.99
High	5700	25.16
Worst		25.16

9.3.8. 802.11n HT20 MODE IN THE 5.5 GHz BAND

Channel	Frequency [MHz]	26 dB Bandwidth [MHz]
Low	5500	22.34
Mid	5580	26.50
High	5700	27.12
Worst		27.12

9.3.9. 802.11n HT40 MODE IN THE 5.5 GHz BAND

Channel	Frequency [MHz]	26 dB Bandwidth [MHz]
Low	5510	43.84
Mid	5590	42.14
High	5670	43.25
Worst		43.84

9.3.10. 802.11a MODE IN THE 5.8 GHz BAND

Channel	Frequency [MHz]	26 dB Bandwidth [MHz]
Low	5745	36.16
Mid	5785	37.24
High	5825	38.87
Worst		38.87

9.3.11. 802.11n HT20 MODE IN THE 5.8 GHz BAND

Channel	Frequency [MHz]	26 dB Bandwidth [MHz]
Low	5745	35.79
Mid	5785	37.47
High	5825	36.01
Worst		37.47

9.3.12. 802.11n HT40 MODE IN THE 5.8 GHz BAND

Channel	Frequency [MHz]	26 dB Bandwidth [MHz]
Low	5755	43.28
High	5795	43.25
Worst		43.28

9.3.13. 26 dB BANDWIDTH PLOTS

UNII 5.2 GHz IEEE 802.11a mode



UNII 5.2 GHz IEEE 802.11n HT20 mode

11n HT20 Mode Low Channel

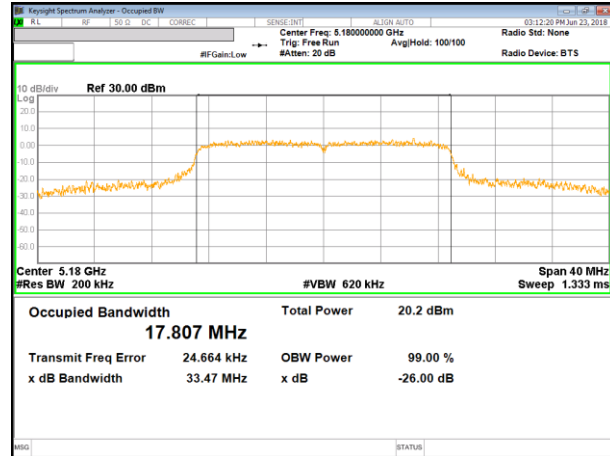

11n HT20 Mode Middle Channel

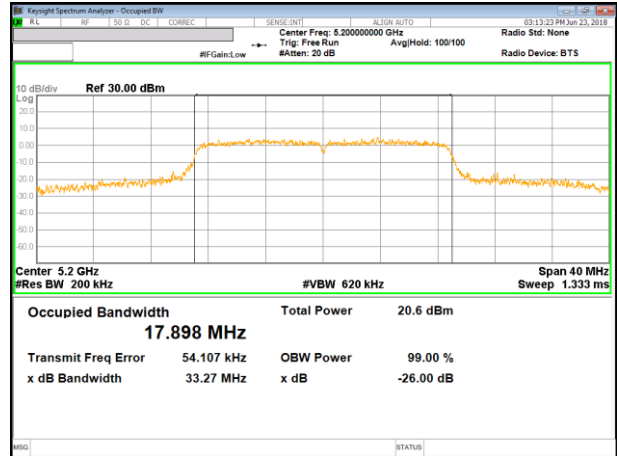

11n HT20 Mode High Channel

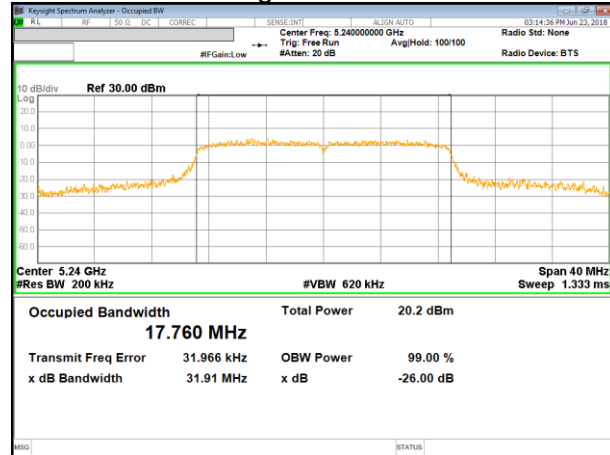

UNII 5.2 GHz IEEE 802.11n HT40 mode

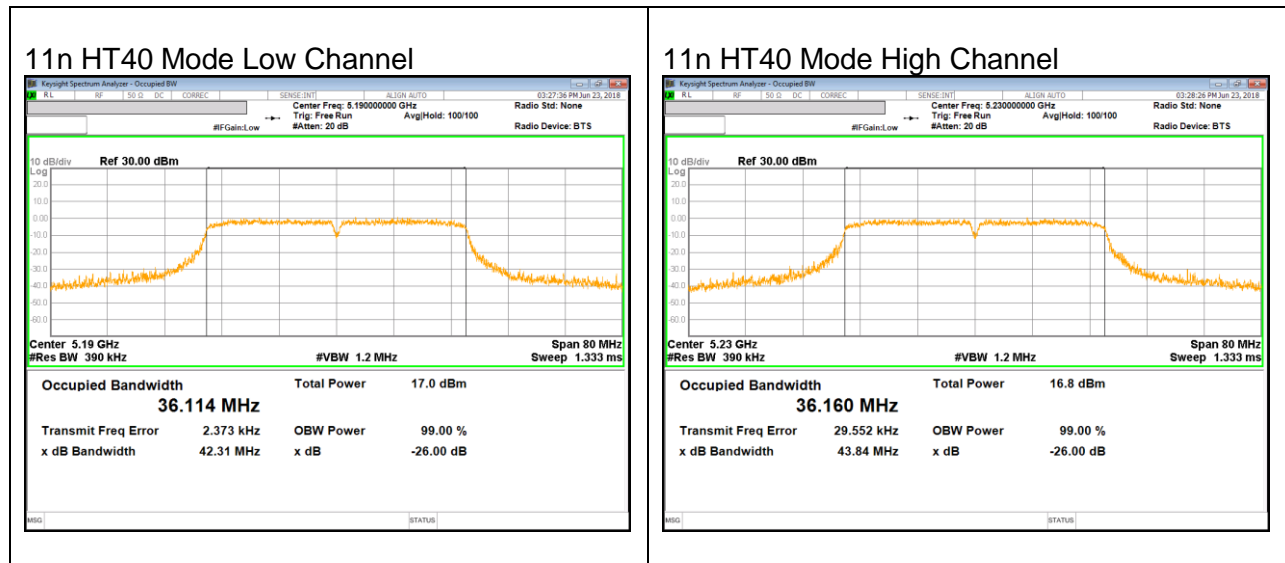

UNII 5.3 GHz IEEE 802.11a mode



UNII 5.3 GHz IEEE 802.11n HT20 mode

11n HT20 Mode Low Channel

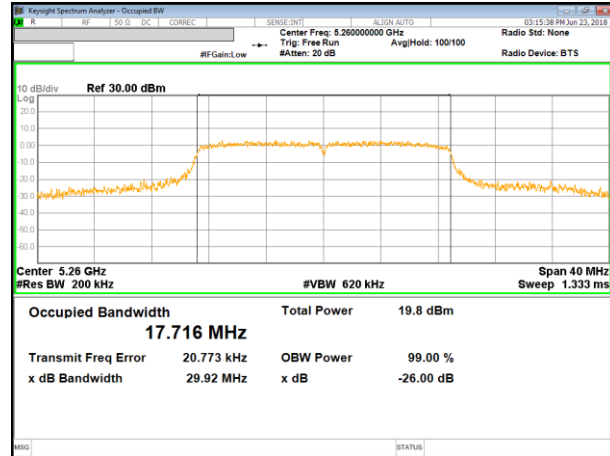

11n HT20 Mode Middle Channel

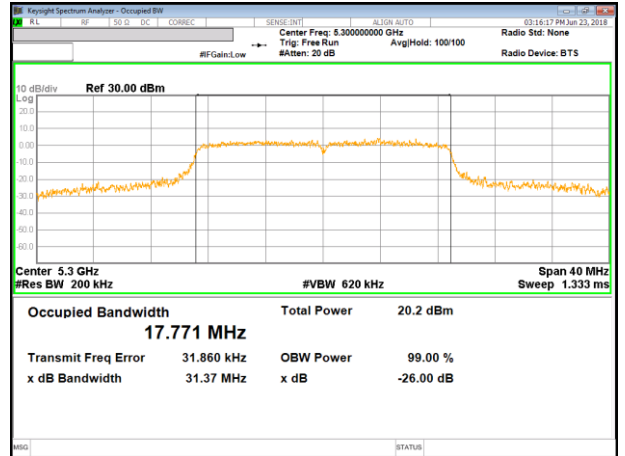

11n HT20 Mode High Channel

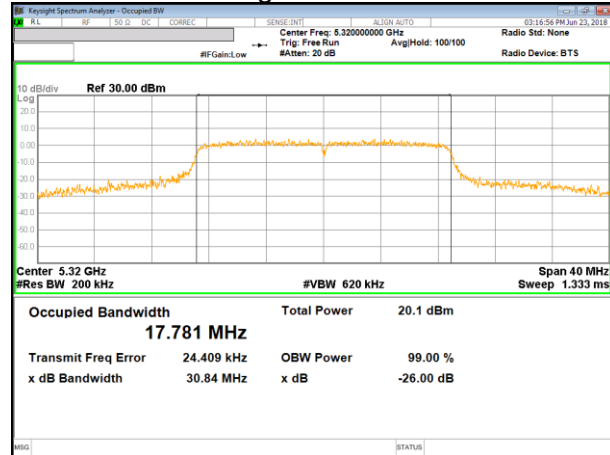

UNII 5.3 GHz IEEE 802.11n HT40 mode

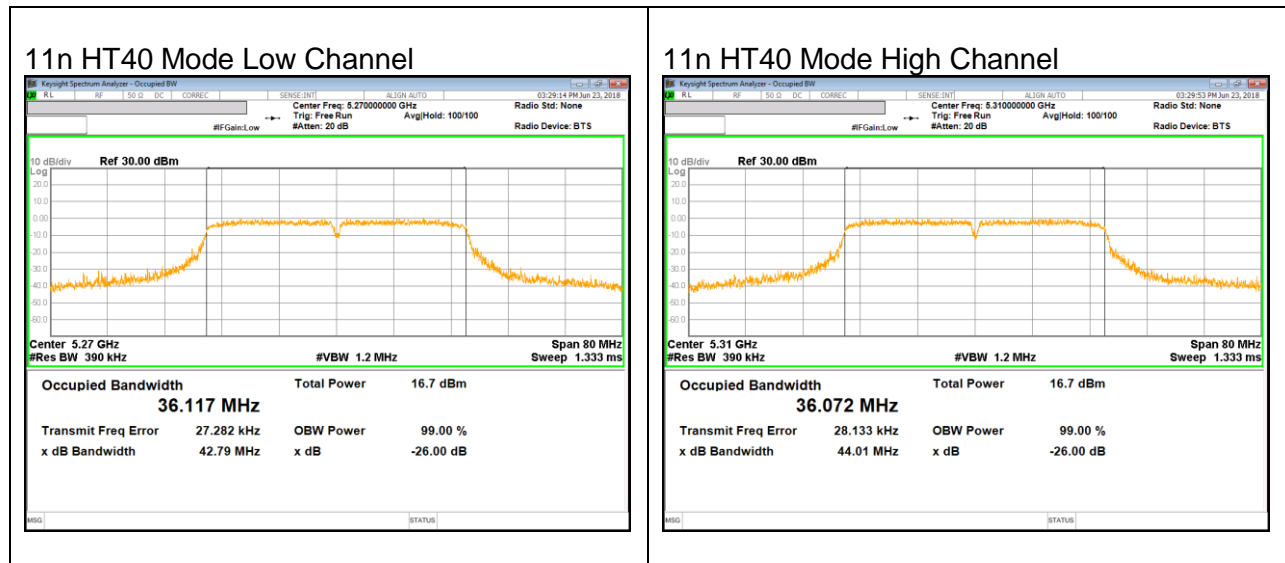

UNII 5.5 GHz IEEE 802.11a mode

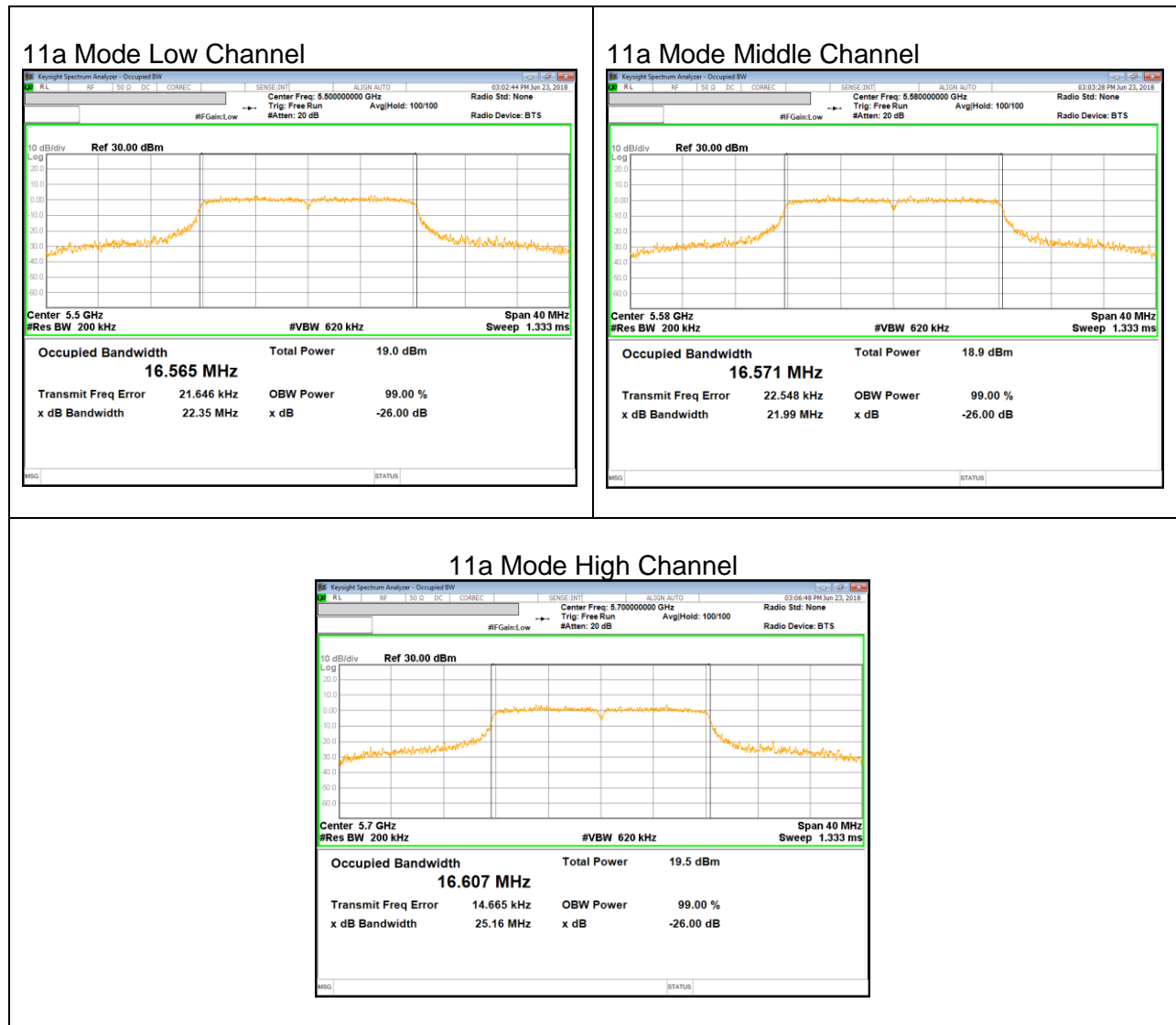

UNII 5.5 GHz IEEE 802.11n HT20 mode

11n HT20 Mode Low Channel

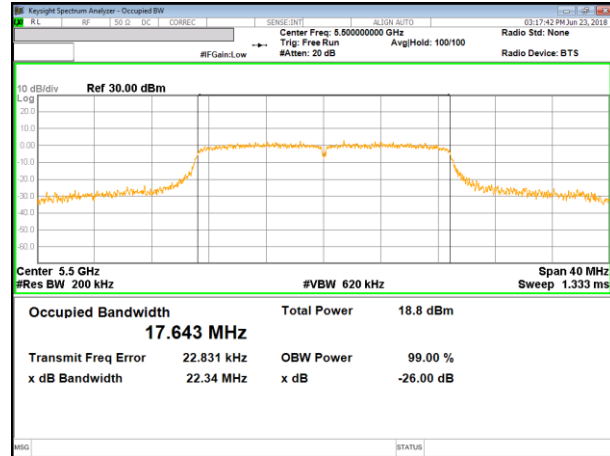

11n HT20 Mode Middle Channel

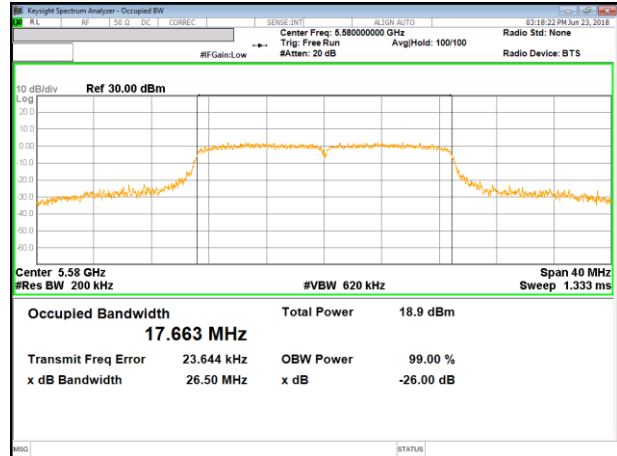

11n HT20 Mode High Channel

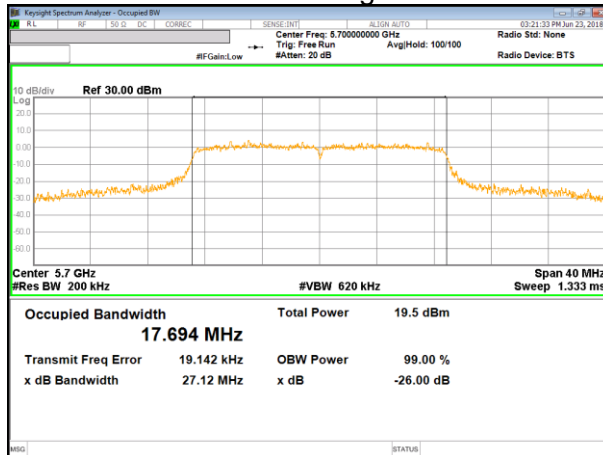

UNII 5.5 GHz IEEE 802.11n HT40 mode

11n HT40 Mode Low Channel

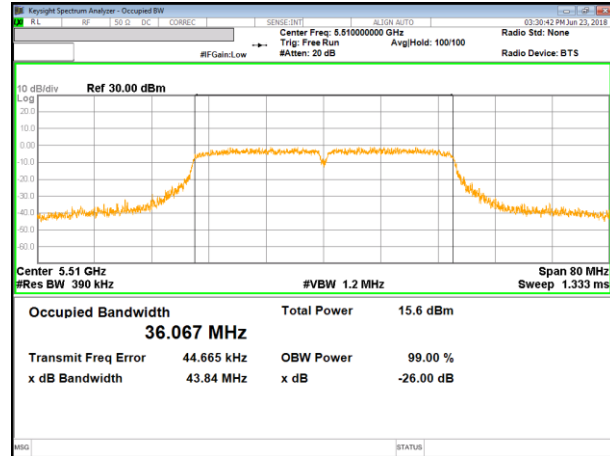

11n HT40 Mode Middle Channel

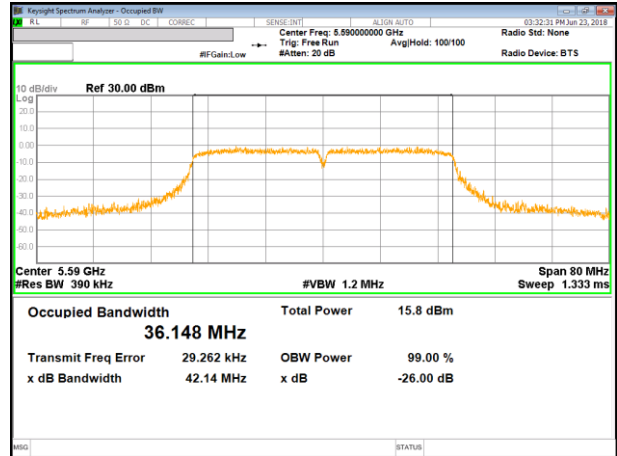

11n HT40 Mode High Channel

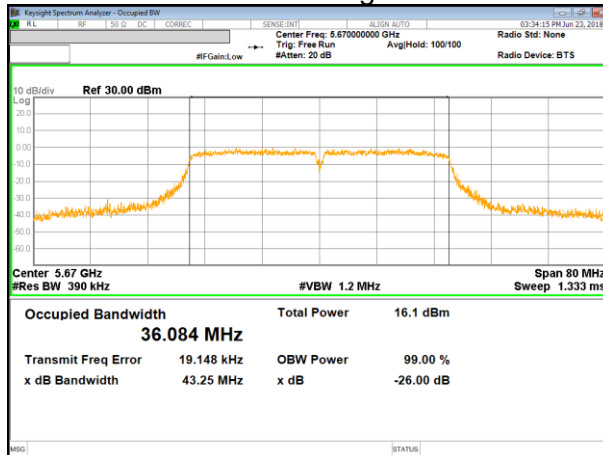

UNII 5.8 GHz IEEE 802.11a mode

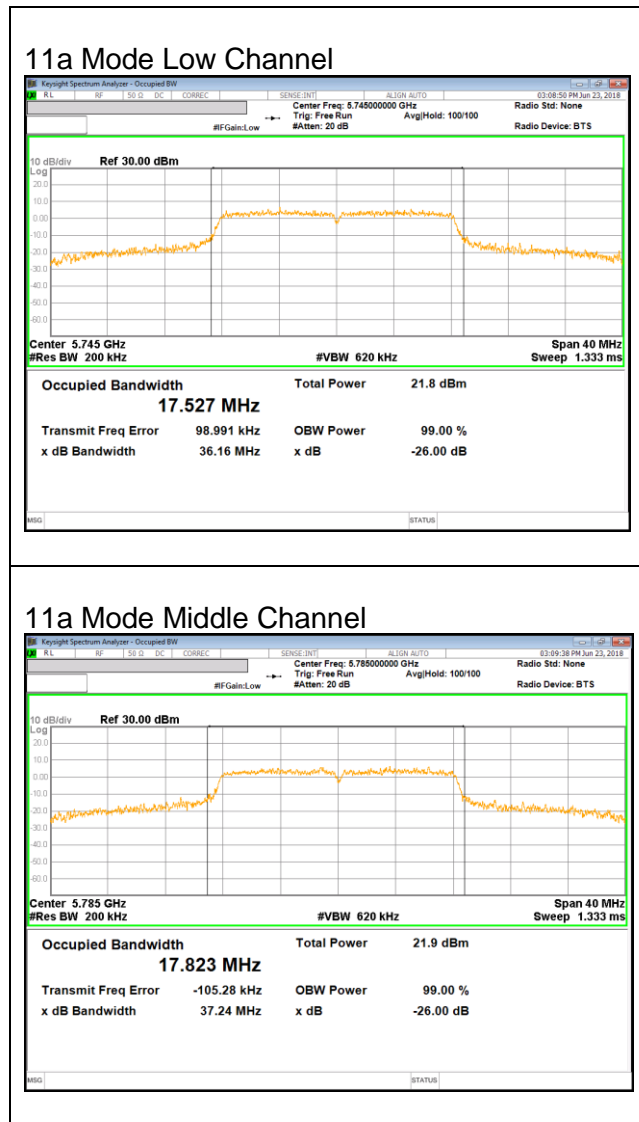

UNII 5.8 GHz IEEE 802.11n HT20 mode

11n HT20 Mode Low Channel

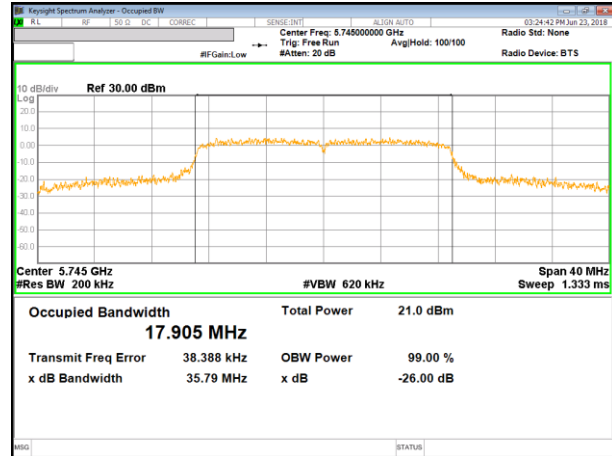

11n HT20 Mode Middle Channel

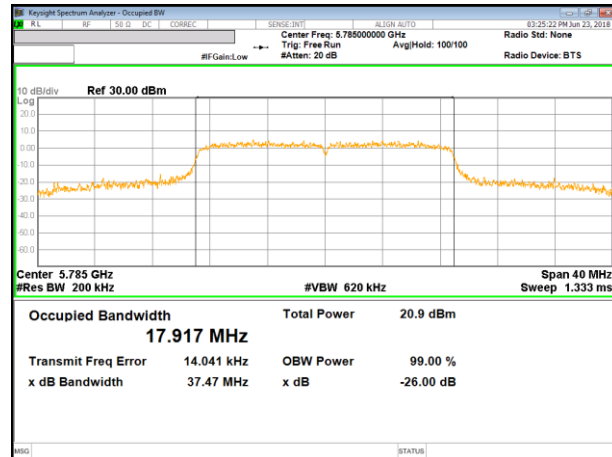

11n HT20 Mode High Channel

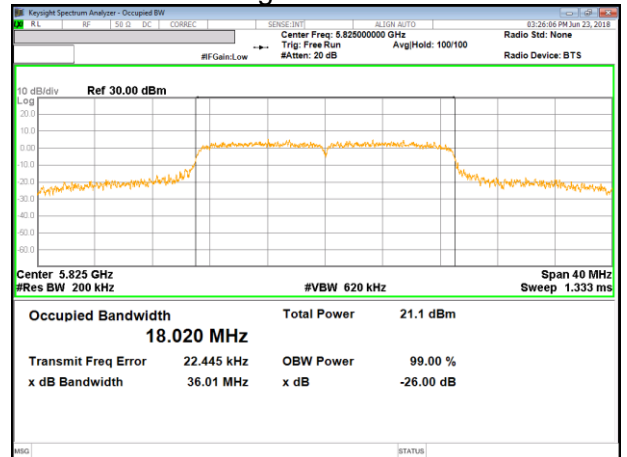

UNII 5.8 GHz IEEE 802.11n HT40 mode

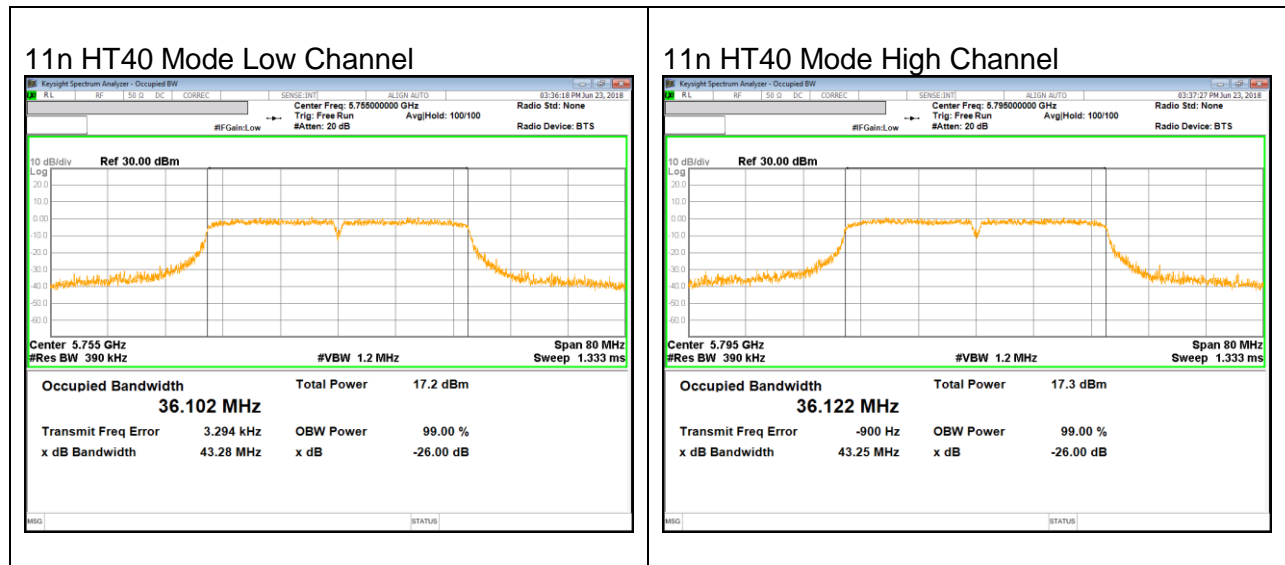

9.4. 99% BANDWIDTH

LIMITS

None; for reporting purposes only.

TEST PROCEDURE

Reference to 789033 D02 General UNII Test Procedures New Rules v01r02: The transmitter output is connected to a spectrum analyzer with the RBW set to approximately 1% to 5% of OBW, the VBW >= 3 x RBW, single sweep.

RESULTS

9.4.1. 802.11a MODE IN THE 5.2 GHz BAND

Channel	Frequency [MHz]	99% Bandwidth [MHz]
Low	5180	16.54
Mid	5200	16.57
High	5240	16.52
Worst		16.57

9.4.2. 802.11n HT20 MODE IN THE 5.2 GHz BAND

Channel	Frequency [MHz]	99% Bandwidth [MHz]
Low	5180	17.65
Mid	5200	17.63
High	5240	17.62
Worst		17.65

9.4.3. 802.11n HT40 MODE IN THE 5.2 GHz BAND

Channel	Frequency [MHz]	99% Bandwidth [MHz]
Low	5190	36.07
High	5230	36.12
Worst		36.12

9.4.4. 802.11a MODE IN THE 5.3 GHz BAND

Channel	Frequency [MHz]	99% Bandwidth [MHz]
Low	5260	16.53
Mid	5300	16.52
High	5320	16.54
Worst		16.54

9.4.5. 802.11n HT20 MODE IN THE 5.3 GHz BAND

Channel	Frequency [MHz]	99% Bandwidth [MHz]
Low	5260	17.64
Mid	5300	17.65
High	5320	17.64
Worst		17.65

9.4.6. 802.11n HT40 MODE IN THE 5.3 GHz BAND

Channel	Frequency [MHz]	99% Bandwidth [MHz]
Low	5270	36.02
High	5310	36.06
Worst		36.06

9.4.7. 802.11a MODE IN THE 5.5 GHz BAND

Channel	Frequency [MHz]	99% Bandwidth [MHz]
Low	5500	16.46
Mid	5580	16.45
High	5700	16.50
Worst		16.50

9.4.8. 802.11n HT20 MODE IN THE 5.5 GHz BAND

Channel	Frequency [MHz]	99% Bandwidth [MHz]
Low	5500	17.63
Mid	5580	17.61
High	5700	17.63
Worst		17.63

9.4.9. 802.11n HT40 MODE IN THE 5.5 GHz BAND

Channel	Frequency [MHz]	99% Bandwidth [MHz]
Low	5510	36.04
Mid	5590	36.13
High	5670	36.01
Worst		36.13

9.4.10. 802.11a MODE IN THE 5.8 GHz BAND

Channel	Frequency [MHz]	99% Bandwidth [MHz]
Low	5745	16.55
Mid	5785	16.59
High	5825	16.61
Worst		16.61

9.4.11. 802.11n HT20 MODE IN THE 5.8 GHz BAND

Channel	Frequency [MHz]	99% Bandwidth [MHz]
Low	5745	17.66
Mid	5785	17.68
High	5825	17.69
Worst		17.69

9.4.12. 802.11n HT40 MODE IN THE 5.8 GHz BAND

Channel	Frequency [MHz]	99% Bandwidth [MHz]
Low	5755	36.06
High	5795	36.03
Worst		36.06

9.4.13. 99% BANDWIDTH PLOTS

UNII 5.2 GHz IEEE 802.11a mode



UNII 5.2 GHz IEEE 802.11n HT20 mode



UNII 5.2 GHz IEEE 802.11n HT40 mode

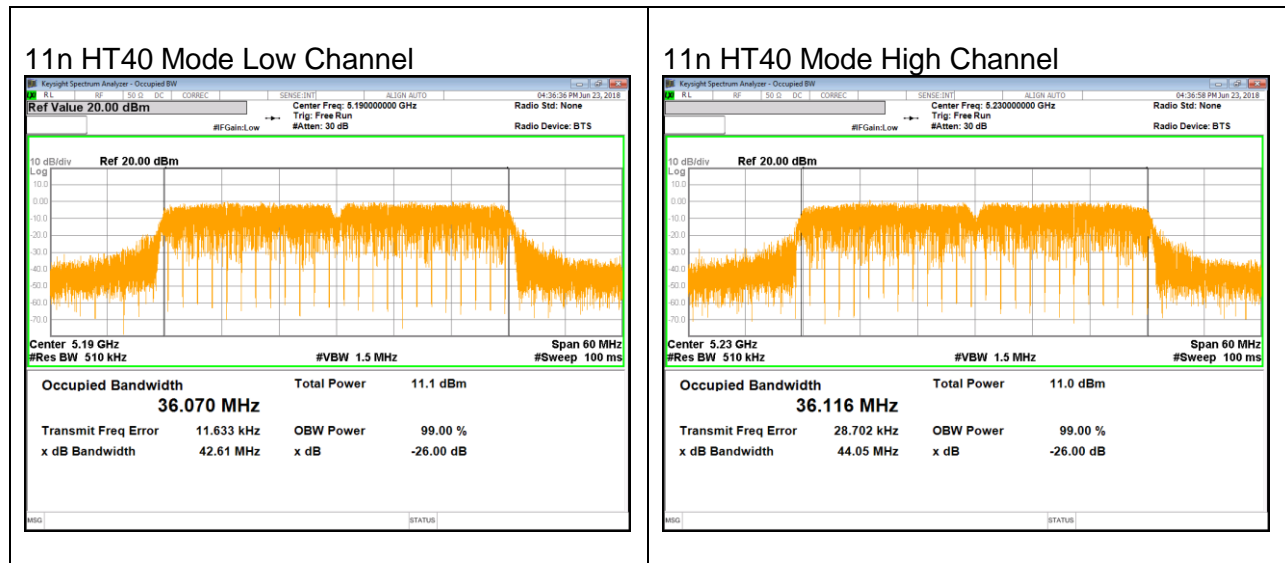

UNII 5.3 GHz IEEE 802.11a mode



UNII 5.3 GHz IEEE 802.11n HT20 mode

11n HT20 Mode Low Channel

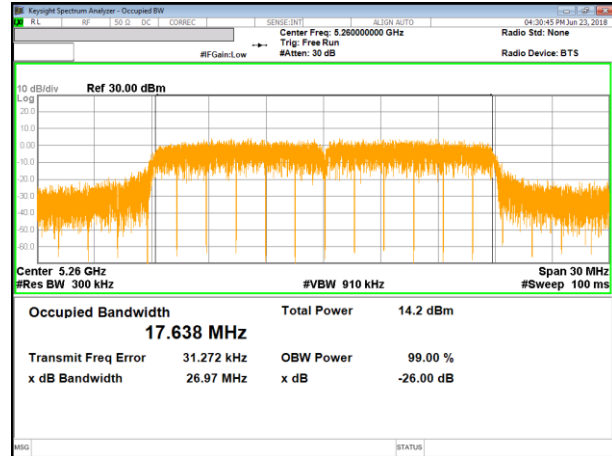

11n HT20 Mode Middle Channel

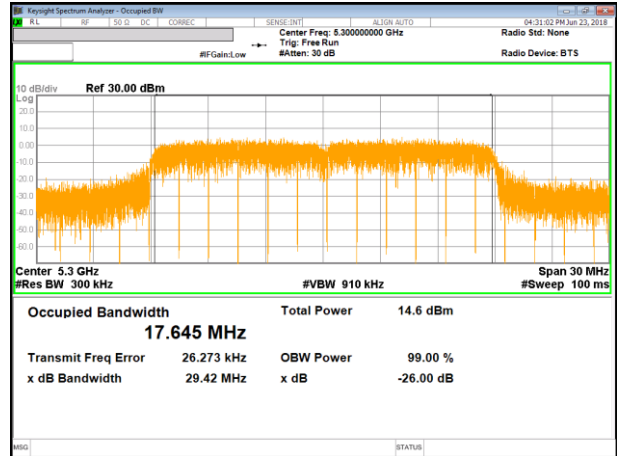

11n HT20 Mode High Channel

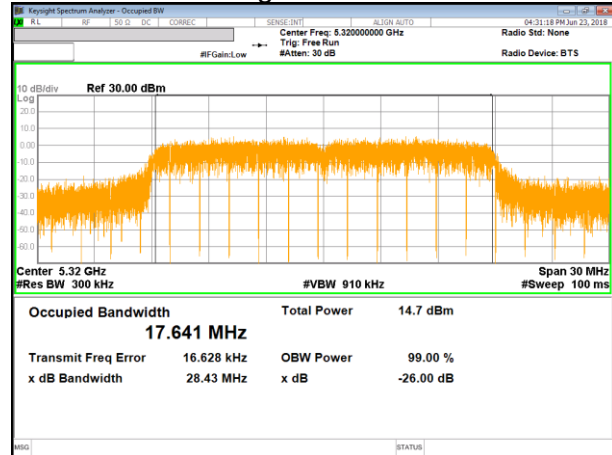

UNII 5.3 GHz IEEE 802.11n HT40 mode

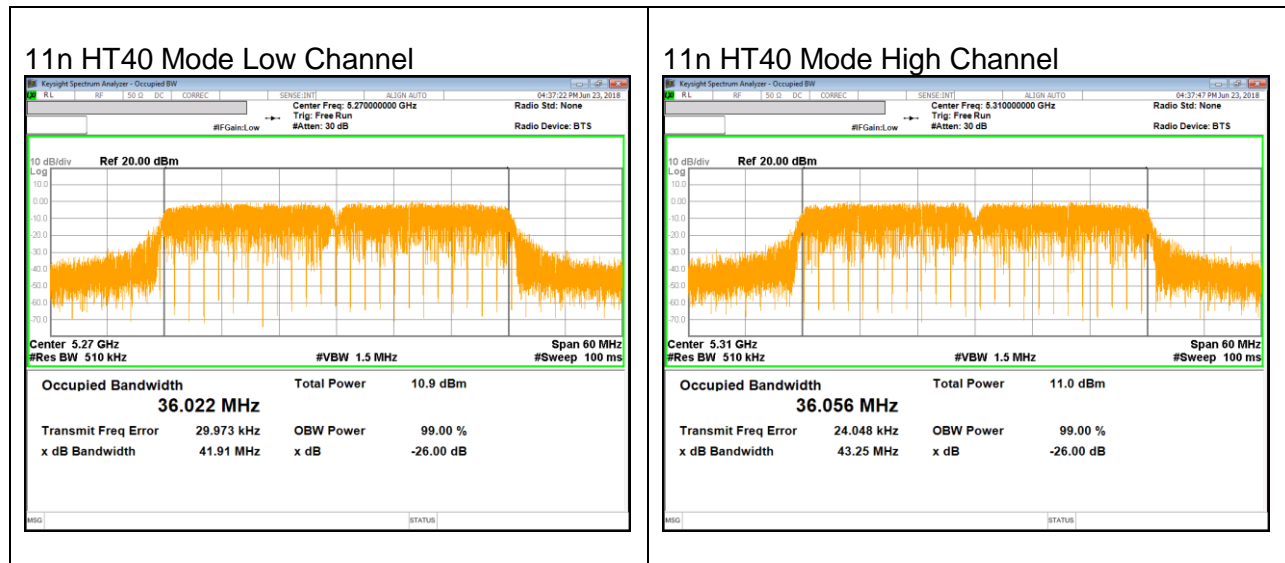

UNII 5.5 GHz IEEE 802.11a mode



UNII 5.5 GHz IEEE 802.11n HT20 mode

11n HT20 Mode Low Channel

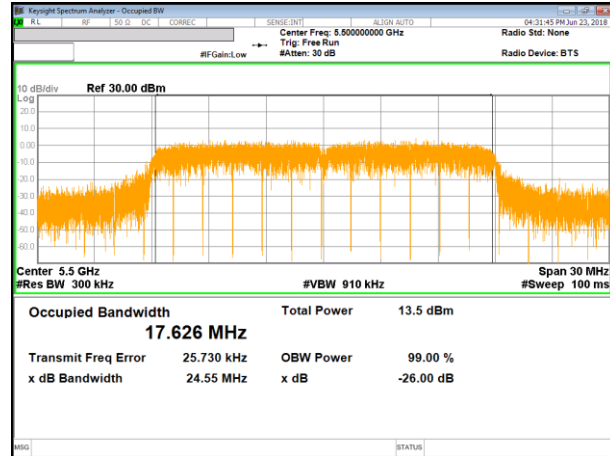

11n HT20 Mode Middle Channel

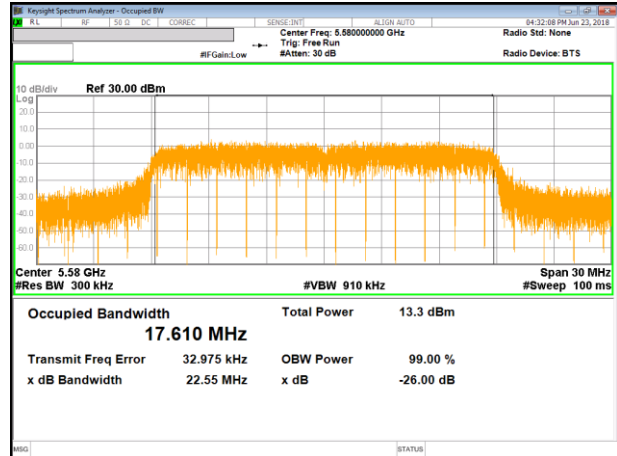

11n HT20 Mode High Channel

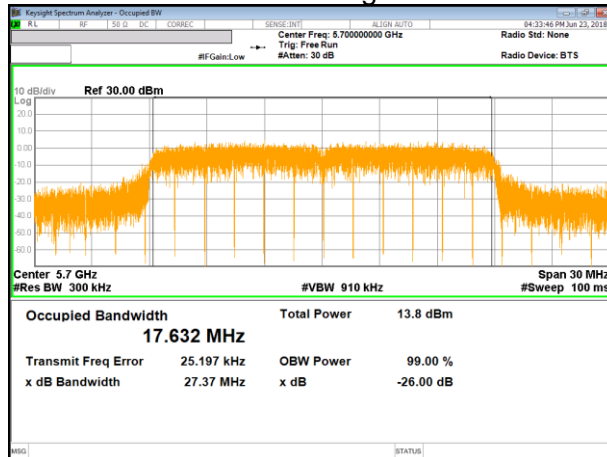

UNII 5.5 GHz IEEE 802.11n HT40 mode

11n HT40 Mode Low Channel

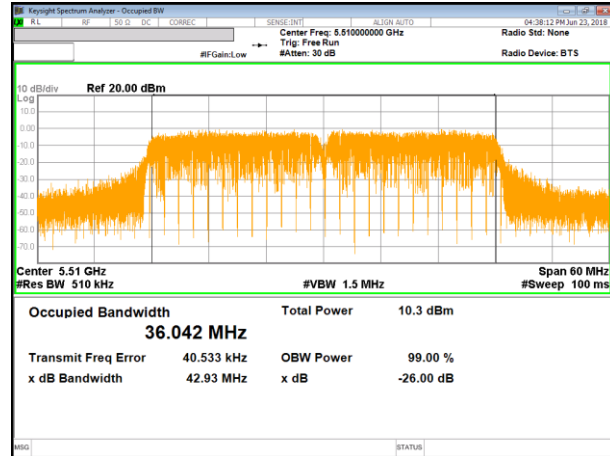

11n HT40 Mode Middle Channel

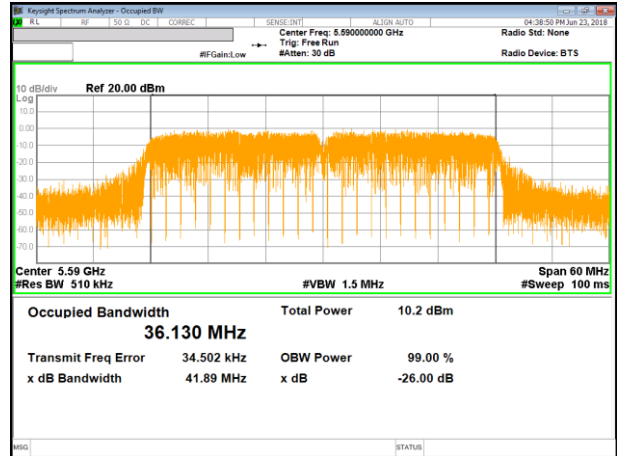

11n HT40 Mode High Channel

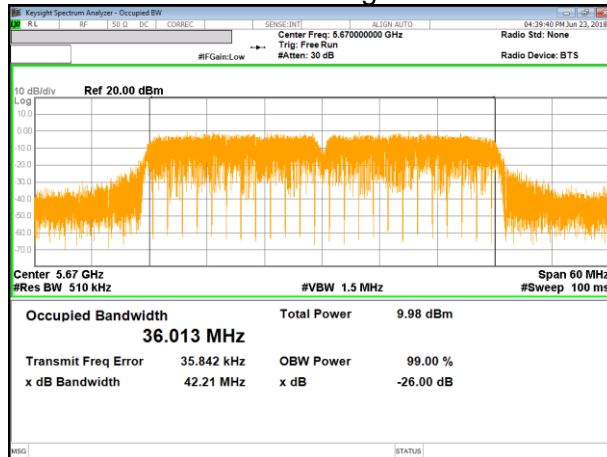

UNII 5.8 GHz IEEE 802.11a mode

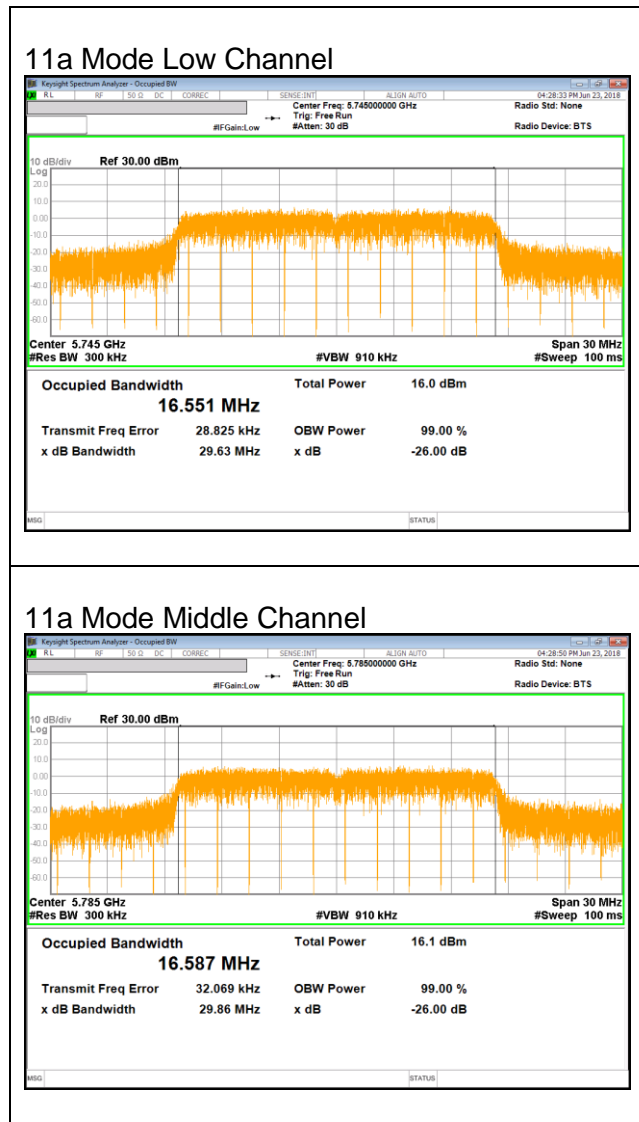

UNII 5.8 GHz IEEE 802.11n HT20 mode

11n HT20 Mode Low Channel

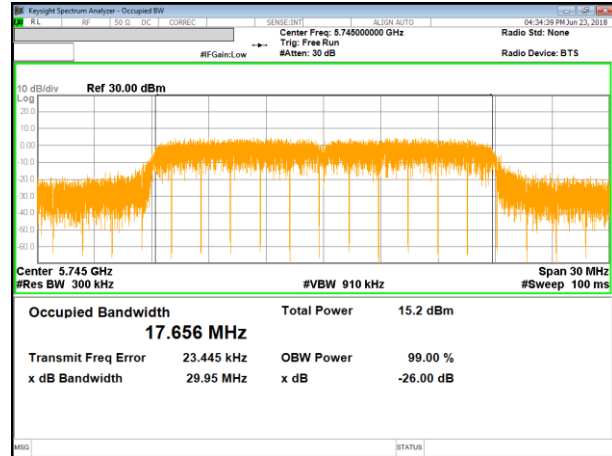

11n HT20 Mode Middle Channel

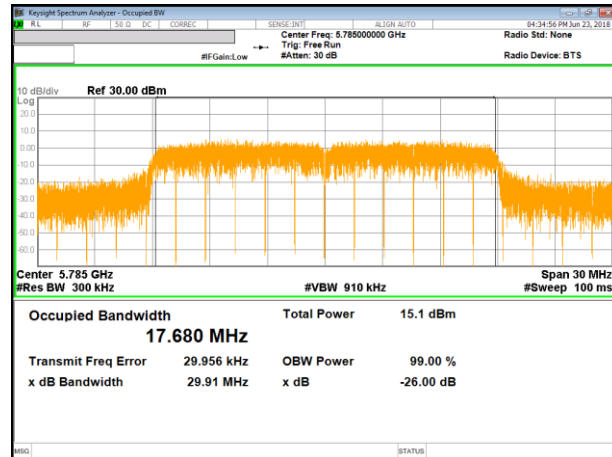

11n HT20 Mode High Channel

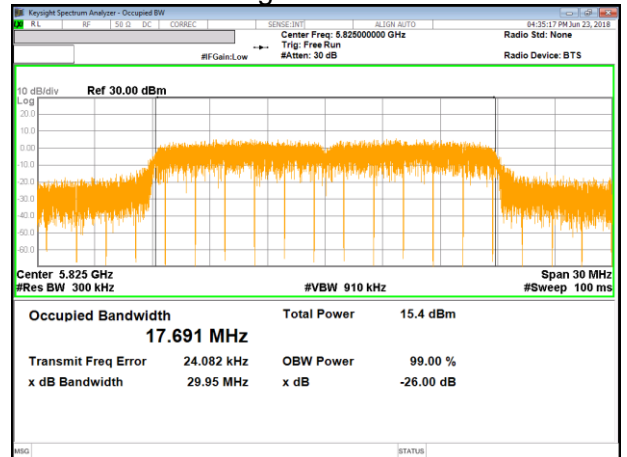

UNII 5.8 GHz IEEE 802.11n HT40 mode

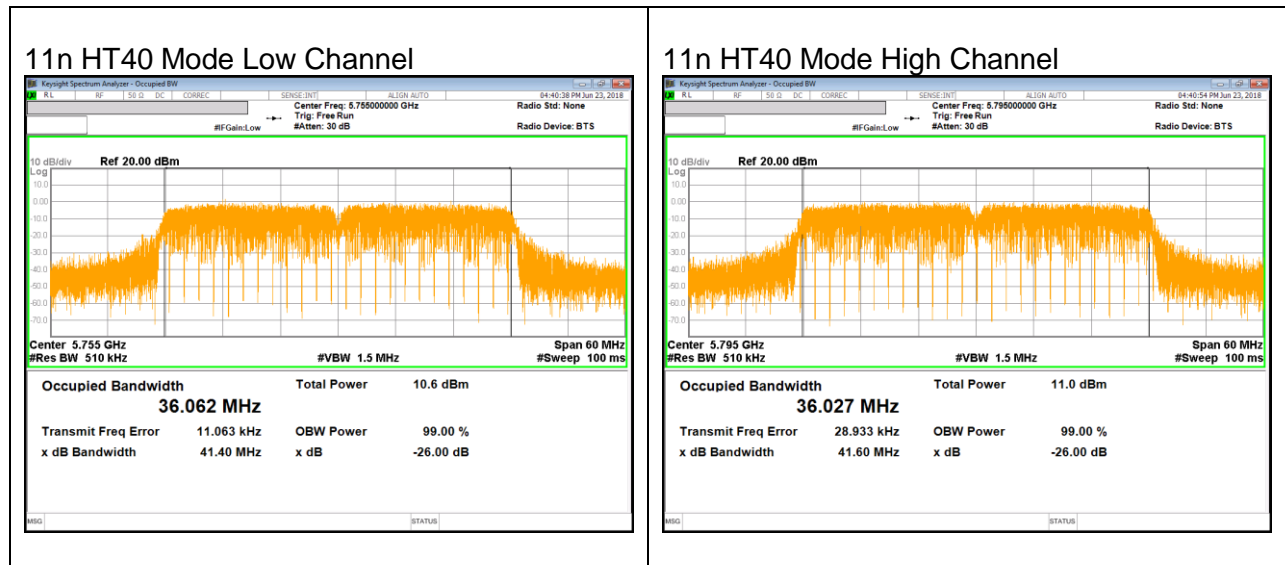

10. ANTENNA PORT TEST RESULTS

10.1. 6 dB BANDWIDTH

LIMITS

FCC §15.407 (e)

The minimum 6 dB bandwidth shall be at least 500 kHz.

TEST PROCEDURE

Reference to 789033 D02 General UNII Test Procedures New Rules v01r03: The transmitter output is connected to a spectrum analyzer with the RBW set to 100KHz, the VBW $\geq 3 \times$ RBW, peak detector and max hold.

RESULTS

10.1.1. 802.11a MODE IN THE 5.8 GHz BAND

Channel	Frequency [MHz]	6 dB Bandwidth [MHz]	Minimum Limit [MHz]
Low	5745	16.32	0.5
Mid	5785	16.30	0.5
High	5825	15.42	0.5
Worst		16.32	

10.1.2. 802.11n HT20 MODE IN THE 5.8 GHz BAND

Channel	Frequency [MHz]	6 dB Bandwidth [MHz]	Minimum Limit [MHz]
Low	5745	17.11	0.5
Mid	5785	16.65	0.5
High	5825	17.30	0.5
Worst		17.30	

10.1.3. 802.11n HT40 MODE IN THE 5.8 GHz BAND

Channel	Frequency [MHz]	6 dB Bandwidth [MHz]	Minimum Limit [MHz]
Low	5755	34.99	0.5
High	5795	35.27	0.5
Worst		35.27	

10.1.4. 6 dB BANDWIDTH PLOTS

UNII 5.8 GHz IEEE 802.11a mode



UNII 5.8 GHz IEEE 802.11n HT20 mode

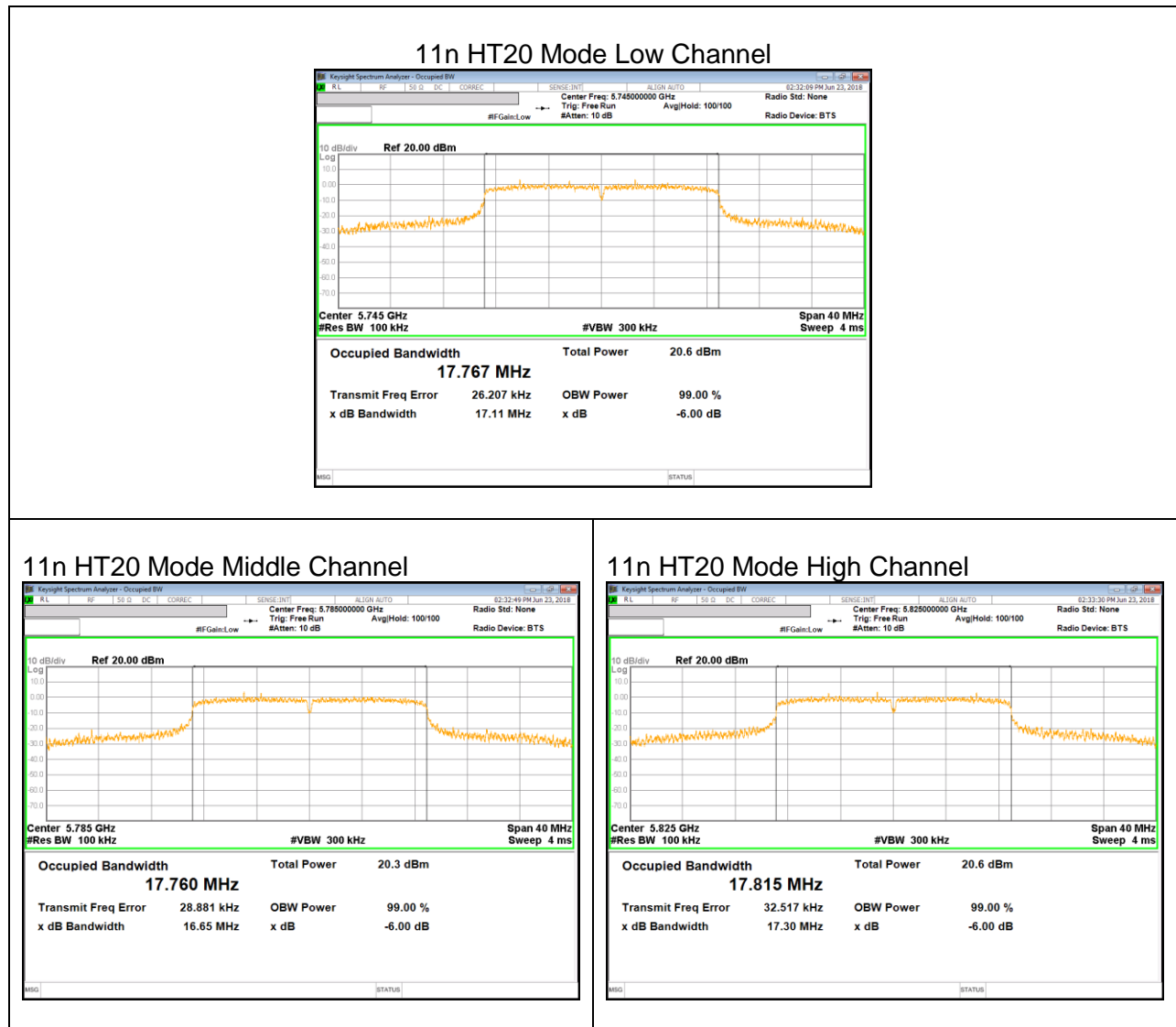

UNII 5.8 GHz IEEE 802.11n HT40 mode

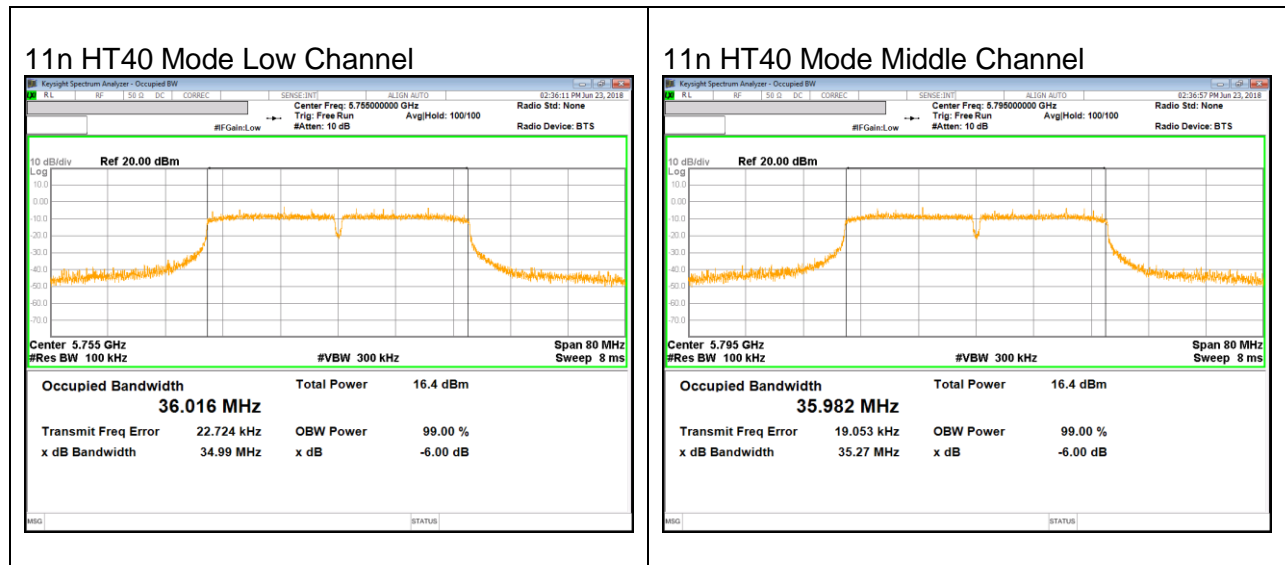

10.2. OUTPUT POWER AND PPSD

LIMITS

FCC §15.407 (a) (1) (2) (3)

For the band 5.15–5.25 GHz, the maximum conducted output power over the frequency band of operation shall not exceed 250 mW provided the maximum antenna gain does not exceed 6 dBi. In addition, the maximum power spectral density shall not exceed 11 dBm in any 1 megahertz band. If transmitting antennas of directional gain greater than 6 dBi are used, both the maximum conducted output power and the maximum power spectral density shall be reduced by the amount in dB that the directional gain of the antenna exceeds 6 dBi.

For the 5.25-5.35 GHz and 5.47-5.725 GHz bands, the maximum conducted output power over the frequency bands of operation shall not exceed the lesser of 250 mW or $11 \text{ dBm} + 10 \log B$, where B is the 26 dB emission bandwidth in megahertz. In addition, the maximum power spectral density shall not exceed 11 dBm in any 1 megahertz band. If transmitting antennas of directional gain greater than 6 dBi are used, both the maximum conducted output power and the maximum power spectral density shall be reduced by the amount in dB that the directional gain of the antenna exceeds 6 dBi.

For the band 5.725-5.85 GHz, the maximum conducted output power over the frequency band of operation shall not exceed 1 W. In addition, the maximum power spectral density shall not exceed 30 dBm in any 500-kHz band.

TEST PROCEDURE

KDB 789033 Method SA-1 and SA-2 are used for PPSD. RBW set to 1MHz (500kHz for the band 5.725-5.85 GHz, the VBW $\geq 3 \times$ RBW, RMS detector and trace averaging). Peak marker value of the spectrum is used for PSD. Add duty cycle correction factor for HT40.

KDB 789033 Method PM is used for output power.

DIRECTIONAL ANTENNA GAIN

There is only one transmitter output therefore the directional gain is equal to the antenna gain.

5 GHz

Frequency Band [MHz]	Antenna Gain [dBi]
5150 - 5250	-2.70
5250 - 5350	-2.10
5470 - 5725	-1.90
5725 - 5850	-4.90

RESULTS

10.2.1. 802.11a MODE IN THE 5.2 GHz BAND

Bandwidth and Antenna Gain

Channel	Frequency [MHz]	Min 26 dB BW [MHz]	Min 99% BW [MHz]	Directional Gain for Power [dBi]	Directional Gain for PPSD [dBi]
Low	5180	35.30	16.54	-2.70	-2.70
Mid	5200	36.27	16.57	-2.70	-2.70
High	5240	35.74	16.52	-2.70	-2.70

Limits

Channel	Frequency [MHz]	FCC Power Limit [dBm]	IC EIRP Limit [dBm]	Max IC Power Limit [dBm]	Power Limit [dBm]	FCC PPSD Limit [dBm]	IC eirp PSD Limit [dBm]	PPSD Limit [dBm]
Low	5180	24.00	22.18	24.88	22.18	11.00	12.70	11.00
Mid	5200	24.00	22.19	24.89	22.19	11.00	12.70	11.00
High	5240	24.00	22.18	24.88	22.18	11.00	12.70	11.00

Duty Cycle CF [dB]	0.00	Included in Calculations of Corr'd Power & PPSD
---------------------------	------	--

Output Power Results

Channel	Frequency [MHz]	Meas Power [dBm]	Total Corr'd Power [dBm]	Power Limit [dBm]	Power Margin [dB]
Low	5180	16.25	16.25	22.18	-5.93
Mid	5200	16.66	16.66	22.19	-5.53
High	5240	16.15	16.15	22.18	-6.03

PPSD Results

Channel	Frequency [MHz]	Meas PPSD [dBm]	Total Corr'd PPSD [dBm]	PPSD Limit [dBm]	PPSD Margin [dB]
Low	5180	5.25	5.25	11.00	-5.75
Mid	5200	5.54	5.54	11.00	-5.47
High	5240	5.45	5.45	11.00	-5.55

10.2.2. 802.11n HT20 MODE IN THE 5.2 GHz BAND

Bandwidth and Antenna Gain

Channel	Frequency [MHz]	Min 26 dB BW [MHz]	Min 99% BW [MHz]	Directional Gain for Power [dBi]	Directional Gain for PPSD [dBi]
Low	5180	33.47	17.65	-2.70	-2.70
Mid	5200	33.27	17.63	-2.70	-2.70
High	5240	31.91	17.62	-2.70	-2.70

Limits

Channel	Frequency [MHz]	FCC Power Limit [dBm]	IC EIRP Limit [dBm]	Max IC Power Limit [dBm]	Power Limit [dBm]	FCC PPSD Limit [dBm]	IC eirp PSD Limit [dBm]	PPSD Limit [dBm]
Low	5180	24.00	22.47	25.17	22.47	11.00	12.70	11.00
Mid	5200	24.00	22.46	25.16	22.46	11.00	12.70	11.00
High	5240	24.00	22.46	25.16	22.46	11.00	12.70	11.00

Duty Cycle CF [dB]	0.00	Included in Calculations of Corr'd Power & PPSD
---------------------------	------	--

Output Power Results

Channel	Frequency [MHz]	Meas Power [dBm]	Total Corr'd Power [dBm]	Power Limit [dBm]	Power Margin [dB]
Low	5180	15.29	15.29	22.47	-7.18
Mid	5200	15.64	15.64	22.46	-6.82
High	5240	15.13	15.13	22.46	-7.33

PPSD Results

Channel	Frequency [MHz]	Meas PPSD [dBm]	Total Corr'd PPSD [dBm]	PPSD Limit [dBm]	PPSD Margin [dB]
Low	5180	4.13	4.13	11.00	-6.87
Mid	5200	4.62	4.62	11.00	-6.38
High	5240	3.90	3.90	11.00	-7.10

10.2.3. 802.11n HT40 MODE IN THE 5.2 GHz BAND

Bandwidth and Antenna Gain					
Channel	Frequency [MHz]	Min 26 dB BW [MHz]	Min 99% BW [MHz]	Directional Gain for Power [dBi]	Directional Gain for PPSD [dBi]
Low	5190	42.31	36.07	-2.70	-2.70
High	5230	43.84	36.12	-2.70	-2.70

Limits

Channel	Frequency [MHz]	FCC Power Limit [dBm]	IC EIRP Limit [dBm]	Max IC Power Limit [dBm]	Power Limit [dBm]	FCC PPSD Limit [dBm]	IC eirp PSD Limit [dBm]	PPSD Limit [dBm]
Low	5190	24.00	23.00	25.70	23.00	11.00	12.70	11.00
High	5230	24.00	23.00	25.70	23.00	11.00	12.70	11.00

Duty Cycle CF [dB]	0.17	Included in Calculations of Corr'd Power & PPSD
---------------------------	------	--

Output Power Results

Channel	Frequency [MHz]	Meas Power [dBm]	Total Corr'd Power [dBm]	Power Limit [dBm]	Power Margin [dB]
Low	5190	11.40	11.57	23.00	-11.60
High	5230	11.16	11.33	23.00	-11.84

PPSD Results

Channel	Frequency [MHz]	Meas PPSD [dBm]	Total Corr'd PPSD [dBm]	PPSD Limit [dBm]	PPSD Margin [dB]
Low	5190	-2.53	-2.35	11.00	-13.53
High	5230	-2.96	-2.79	11.00	-13.96

10.2.4. 802.11a MODE IN THE 5.3 GHz BAND

Bandwidth and Antenna Gain

Channel	Frequency [MHz]	Min 26 dB BW [MHz]	Min 99% BW [MHz]	Directional Gain for Power [dBi]	Directional Gain for PPSD [dBi]
Low	5260	34.05	16.53	-2.10	-2.10
Mid	5300	32.91	16.52	-2.10	-2.10
High	5320	34.70	16.54	-2.10	-2.10

Limits

Channel	Frequency [MHz]	FCC Power Limit [dBm]	IC EIRP Limit [dBm]	Max IC Power Limit [dBm]	Power Limit [dBm]	FCC PPSD Limit [dBm]	IC eirp PSD Limit [dBm]	PPSD Limit [dBm]
Low	5260	24.00	23.18	29.18	23.18	11.00	11.00	11.00
Mid	5300	24.00	23.18	29.18	23.18	11.00	11.00	11.00
High	5320	24.00	23.18	29.18	23.18	11.00	11.00	11.00

Duty Cycle CF [dB]	0.00	Included in Calculations of Corr'd Power & PPSD
---------------------------	------	--

Output Power Results

Channel	Frequency [MHz]	Meas Power [dBm]	Total Corr'd Power [dBm]	Power Limit [dBm]	Power Margin [dB]
Low	5260	15.75	15.75	23.18	-7.43
Mid	5300	16.09	16.09	23.18	-7.09
High	5320	16.12	16.12	23.18	-7.06

PPSD Results

Channel	Frequency [MHz]	Meas PPSD [dBm]	Total Corr'd PPSD [dBm]	PPSD Limit [dBm]	PPSD Margin [dB]
Low	5260	4.94	4.94	11.00	-6.06
Mid	5300	5.32	5.32	11.00	-5.68
High	5320	5.55	5.55	11.00	-5.45

10.2.5. 802.11n HT20 MODE IN THE 5.3 GHz BAND

Bandwidth and Antenna Gain

Channel	Frequency [MHz]	Min 26 dB BW [MHz]	Min 99% BW [MHz]	Directional Gain for Power [dBi]	Directional Gain for PPSD [dBi]
Low	5260	29.92	17.64	-2.10	-2.10
Mid	5300	31.30	17.65	-2.10	-2.10
High	5320	30.84	17.64	-2.10	-2.10

Limits

Channel	Frequency [MHz]	FCC Power Limit [dBm]	IC EIRP Limit [dBm]	Max IC Power Limit [dBm]	Power Limit [dBm]	FCC PPSD Limit [dBm]	IC eirp PSD Limit [dBm]	PPSD Limit [dBm]
Low	5260	24.00	22.46	29.46	22.46	11.00	11.00	11.00
Mid	5300	24.00	22.47	29.47	22.47	11.00	11.00	11.00
High	5320	24.00	22.47	29.47	22.47	11.00	11.00	11.00

Duty Cycle CF [dB]	0.00	Included in Calculations of Corr'd Power & PPSD
---------------------------	------	--

Output Power Results

Channel	Frequency [MHz]	Meas Power [dBm]	Total Corr'd Power [dBm]	Power Limit [dBm]	Power Margin [dB]
Low	5260	14.90	14.90	22.46	-7.56
Mid	5300	15.03	15.03	22.47	-7.44
High	5320	15.11	15.11	22.47	-7.36

PPSD Results

Channel	Frequency [MHz]	Meas PPSD [dBm]	Total Corr'd PPSD [dBm]	PPSD Limit [dBm]	PPSD Margin [dB]
Low	5260	3.48	3.48	11.00	-7.52
Mid	5300	4.18	4.18	11.00	-6.82
High	5320	4.16	4.16	11.00	-6.84

10.2.6. 802.11n HT40 MODE IN THE 5.3 GHz BAND

Bandwidth and Antenna Gain

Channel	Frequency [MHz]	Min 26 dB BW [MHz]	Min 99% BW [MHz]	Directional Gain for Power [dBi]	Directional Gain for PPSD [dBi]
Low	5270	42.79	36.02	-2.10	-2.10
High	5310	44.01	36.06	-2.10	-2.10

Limits

Channel	Frequency [MHz]	FCC Power Limit [dBm]	IC EIRP Limit [dBm]	Max IC Power Limit [dBm]	Power Limit [dBm]	FCC PPSD Limit [dBm]	IC eirp PSD Limit [dBm]	PPSD Limit [dBm]
Low	5270	24.00	23.00	30.00	23.00	11.00	11.00	11.00
High	5310	24.00	23.00	30.00	23.00	11.00	11.00	11.00

Duty Cycle CF [dB]	0.17	Included in Calculations of Corr'd Power & PPSD
---------------------------	------	--

Output Power Results

Channel	Frequency [MHz]	Meas Power [dBm]	Total Corr'd Power [dBm]	Power Limit [dBm]	Power Margin [dB]
Low	5270	11.29	11.46	23.00	-11.71
High	5310	11.34	11.51	23.00	-11.66

PPSD Results

Channel	Frequency [MHz]	Meas PPSD [dBm]	Total Corr'd PPSD [dBm]	PPSD Limit [dBm]	PPSD Margin [dB]
Low	5270	-2.83	-2.65	11.00	-13.83
High	5310	-2.91	-2.73	11.00	-13.91

10.2.7. 802.11a MODE IN THE 5.5 GHz BAND

Bandwidth and Antenna Gain

Channel	Frequency [MHz]	Min 26 dB BW [MHz]	Min 99% BW [MHz]	Directional Gain for Power [dBi]	Directional Gain for PPSD [dBi]
Low	5500	22.35	16.46	-1.90	-1.90
Mid	5580	21.99	16.45	-1.90	-1.90
High	5700	25.16	16.50	-1.90	-1.90

Limits

Channel	Frequency [MHz]	FCC Power Limit [dBm]	IC EIRP Limit [dBm]	Max IC Power Limit [dBm]	Power Limit [dBm]	FCC PPSD Limit [dBm]	IC eirp PSD Limit [dBm]	PPSD Limit [dBm]
Low	5500	24.00	22.16	29.16	22.16	11.00	11.00	11.00
Mid	5580	24.00	22.16	29.16	22.16	11.00	11.00	11.00
High	5700	24.00	22.18	29.18	22.18	11.00	11.00	11.00

Duty Cycle CF [dB]	0.00	Included in Calculations of Corr'd Power & PPSD
---------------------------	------	--

Output Power Results

Channel	Frequency [MHz]	Meas Power [dBm]	Total Corr'd Power [dBm]	Power Limit [dBm]	Power Margin [dB]
Low	5500	13.63	13.63	22.16	-8.53
Mid	5580	13.47	13.47	22.16	-8.69
High	5700	14.03	14.03	22.18	-8.15

PPSD Results

Channel	Frequency [MHz]	Meas PPSD [dBm]	Total Corr'd PPSD [dBm]	PPSD Limit [dBm]	PPSD Margin [dB]
Low	5500	3.30	3.30	11.00	-7.70
Mid	5580	2.81	2.81	11.00	-8.19
High	5700	3.40	3.40	11.00	-7.60

10.2.8. 802.11n HT20 MODE IN THE 5.5 GHz BAND

Bandwidth and Antenna Gain

Channel	Frequency [MHz]	Min 26 dB BW [MHz]	Min 99% BW [MHz]	Directional Gain for Power [dBi]	Directional Gain for PPSD [dBi]
Low	5500	22.34	17.63	-1.90	-1.90
Mid	5580	26.50	17.61	-1.90	-1.90
High	5700	27.12	17.63	-1.90	-1.90

Limits

Channel	Frequency [MHz]	FCC Power Limit [dBm]	IC EIRP Limit [dBm]	Max IC Power Limit [dBm]	Power Limit [dBm]	FCC PPSD Limit [dBm]	IC eirp PSD Limit [dBm]	PPSD Limit [dBm]
Low	5500	24.00	22.46	29.46	22.46	11.00	11.00	11.00
Mid	5580	24.00	22.46	29.46	22.46	11.00	11.00	11.00
High	5700	24.00	22.46	29.46	22.46	11.00	11.00	11.00

Duty Cycle CF [dB]	0.00	Included in Calculations of Corr'd Power & PPSD
---------------------------	------	--

Output Power Results

Channel	Frequency [MHz]	Meas Power [dBm]	Total Corr'd Power [dBm]	Power Limit [dBm]	Power Margin [dB]
Low	5500	14.06	14.06	22.46	-8.40
Mid	5580	13.93	13.93	22.46	-8.53
High	5700	14.17	14.17	22.46	-8.29

PPSD Results

Channel	Frequency [MHz]	Meas PPSD [dBm]	Total Corr'd PPSD [dBm]	PPSD Limit [dBm]	PPSD Margin [dB]
Low	5500	2.75	2.75	11.00	-8.25
Mid	5580	2.67	2.67	11.00	-8.33
High	5700	3.54	3.54	11.00	-7.46

10.2.9. 802.11n HT40 MODE IN THE 5.5 GHz BAND

Bandwidth and Antenna Gain

Channel	Frequency [MHz]	Min 26 dB BW [MHz]	Min 99% BW [MHz]	Directional Gain for Power [dBi]	Directional Gain for PPSD [dBi]
Low	5510	43.84	36.04	-1.90	-1.90
Mid	5590	42.14	36.13	-1.90	-1.90
High	5670	43.25	36.01	-1.90	-1.90

Limits

Channel	Frequency [MHz]	FCC Power Limit [dBm]	IC EIRP Limit [dBm]	Max IC Power Limit [dBm]	Power Limit [dBm]	FCC PPSD Limit [dBm]	IC eirp PSD Limit [dBm]	PPSD Limit [dBm]
Low	5510	24.00	23.00	30.00	23.00	11.00	11.00	11.00
Mid	5590	24.00	23.00	30.00	23.00	11.00	11.00	11.00
High	5670	24.00	23.00	30.00	23.00	11.00	11.00	11.00
Duty Cycle CF [dB]		0.17	Included in Calculations of Corr'd Power & PPSD					

Output Power Results

Channel	Frequency [MHz]	Meas Power [dBm]	Total Corr'd Power [dBm]	Power Limit [dBm]	Power Margin [dB]
Low	5510	10.16	10.33	23.00	-12.84
Mid	5590	10.08	10.25	23.00	-12.92
High	5670	9.86	10.03	23.00	-13.14

PPSD Results

Channel	Frequency [MHz]	Meas PPSD [dBm]	Total Corr'd PPSD [dBm]	PPSD Limit [dBm]	PPSD Margin [dB]
Low	5510	-3.50	-3.32	11.00	-14.50
Mid	5590	-3.13	-2.96	11.00	-14.13
High	5670	-3.40	-3.22	11.00	-14.40

10.2.10. 802.11a MODE IN THE 5.8 GHz BAND

Bandwidth and Antenna Gain

Channel	Frequency [MHz]	Min 26 dB BW [MHz]	Min 99% BW [MHz]	Directional Gain for Power [dBi]	Directional Gain for PPSD [dBi]
Low	5745	36.16	16.55	-4.90	-4.90
Mid	5785	37.24	16.59	-4.90	-4.90
High	5825	38.87	16.61	-4.90	-4.90

Limits

Channel	Frequency [MHz]	FCC Power Limit [dBm]	IC EIRP Limit [dBm]	Max IC Power Limit [dBm]	Power Limit [dBm]	FCC PPSD Limit [dBm]	IC eirp PSD Limit [dBm]	PPSD Limit [dBm]
Low	5745	30.00	30.00	34.90	30.00	30.00	30.00	30.00
Mid	5785	30.00	30.00	34.90	30.00	30.00	30.00	30.00
High	5825	30.00	30.00	34.90	30.00	30.00	30.00	30.00

Duty Cycle CF [dB]	0.00	Included in Calculations of Corr'd Power & PPSD
---------------------------	------	--

Output Power Results

Channel	Frequency [MHz]	Meas Power [dBm]	Total Corr'd Power [dBm]	Power Limit [dBm]	Power Margin [dB]
Low	5745	16.46	16.46	30.00	-13.54
Mid	5785	16.44	16.44	30.00	-13.56
High	5825	16.64	16.64	30.00	-13.36

PPSD Results

Channel	Frequency [MHz]	Meas PPSD [dBm]	Total Corr'd PPSD [dBm]	PPSD Limit [dBm]	PPSD Margin [dB]
Low	5745	2.84	2.84	30.00	-27.16
Mid	5785	2.94	2.94	30.00	-27.06
High	5825	2.91	2.91	30.00	-27.09

10.2.11. 802.11n HT20 MODE IN THE 5.8 GHz BAND

Bandwidth and Antenna Gain

Channel	Frequency [MHz]	Min 26 dB BW [MHz]	Min 99% BW [MHz]	Directional Gain for Power [dBi]	Directional Gain for PPSD [dBi]
Low	5745	35.79	17.66	-4.90	-4.90
Mid	5785	37.47	17.68	-4.90	-4.90
High	5825	36.01	17.69	-4.90	-4.90

Limits

Channel	Frequency [MHz]	FCC Power Limit [dBm]	IC EIRP Limit [dBm]	Max IC Power Limit [dBm]	Power Limit [dBm]	FCC PPSD Limit [dBm]	IC eirp PSD Limit [dBm]	PPSD Limit [dBm]
Low	5745	30.00	30.00	34.90	30.00	30.00	30.00	30.00
Mid	5785	30.00	30.00	34.90	30.00	30.00	30.00	30.00
High	5825	30.00	30.00	34.90	30.00	30.00	30.00	30.00

Duty Cycle CF [dB]	0.00	Included in Calculations of Corr'd Power & PPSD
---------------------------	------	--

Output Power Results

Channel	Frequency [MHz]	Meas Power [dBm]	Total Corr'd Power [dBm]	Power Limit [dBm]	Power Margin [dB]
Low	5745	15.54	15.54	30.00	-14.46
Mid	5785	15.55	15.55	30.00	-14.45
High	5825	15.67	15.67	30.00	-14.33

PPSD Results

Channel	Frequency [MHz]	Meas PPSD [dBm]	Total Corr'd PPSD [dBm]	PPSD Limit [dBm]	PPSD Margin [dB]
Low	5745	1.89	1.89	30.00	-28.11
Mid	5785	1.75	1.75	30.00	-28.26
High	5825	1.98	1.98	30.00	-28.02

10.2.12. 802.11n HT40 MODE IN THE 5.8 GHz BAND

Bandwidth and Antenna Gain

Channel	Frequency [MHz]	Min 26 dB BW [MHz]	Min 99% BW [MHz]	Directional Gain for Power [dBi]	Directional Gain for PPSD [dBi]
Low	5755	36.10	36.06	-4.90	-4.90
High	5795	36.12	36.03	-4.90	-4.90

Limits

Channel	Frequency [MHz]	FCC Power Limit [dBm]	IC EIRP Limit [dBm]	Max IC Power Limit [dBm]	Power Limit [dBm]	FCC PPSD Limit [dBm]	IC eirp PSD Limit [dBm]	PPSD Limit [dBm]
Low	5755	30.00	30.00	34.90	30.00	30.00	30.00	30.00
High	5795	30.00	30.00	34.90	30.00	30.00	30.00	30.00

Duty Cycle CF [dB]	0.17	Included in Calculations of Corr'd Power & PPSD
---------------------------	------	--

Output Power Results

Channel	Frequency [MHz]	Meas Power [dBm]	Total Corr'd Power [dBm]	Power Limit [dBm]	Power Margin [dB]
Low	5755	10.95	11.12	30.00	-19.05
High	5795	11.26	11.43	30.00	-18.74

PPSD Results

Channel	Frequency [MHz]	Meas PPSD [dBm]	Total Corr'd PPSD [dBm]	PPSD Limit [dBm]	PPSD Margin [dB]
Low	5755	-5.28	-5.10	30.00	-35.28
High	5795	-5.21	-5.03	30.00	-35.21