



FCC CFR47 PART 15 SUBPART C

DTS Wireless LAN

CERTIFICATION TEST REPORT

FOR

WCDMA/LTE Tablet + BT/BLE, DTS/UNII a/b/g/n and ANT+

MODEL NUMBER : SM-T387T

FCC ID: A3LSMT387T

REPORT NUMBER: 4788549592-E1V1

ISSUE DATE: JUL 25, 2018

Prepared for
SAMSUNG ELECTRONICS CO., LTD.
129 SAMSUNG-RO, YEONGTONG-GU, SUWON-SI,
GYEONGGI-DO, 16677, KOREA

Prepared by
UL Korea, Ltd.
26th floor, 152, Teheran-ro, Gangnam-gu Seoul, 06236, Korea

Suwon Test Site: UL Korea, Ltd. Suwon Laboratory
218 Maeyeong-ro, Yeongtong-gu,
Suwon-si, Gyeonggi-do, 16675, Korea
TEL: (031) 337-9902
FAX: (031) 213-5433



Testing
Laboratory

TL-637

Revision History

<u>Rev.</u>	<u>Issue Date</u>	<u>Revisions</u>	<u>Revised By</u>
V1	07/25/18	Initial issue	Hoonpyo Lee

TABLE OF CONTENTS

1. ATTESTATION OF TEST RESULTS	5
1.1. INTRODUCTION OF TEST DATA REUSE	6
1.2. DIFFERENCE	6
1.3. SPOT CHECK VERIFICATION DATA.....	6
1.4. REFERENCE DETAIL.....	7
2. TEST METHODOLOGY	8
3. FACILITIES AND ACCREDITATION	8
4. CALIBRATION AND UNCERTAINTY	8
4.1. MEASURING INSTRUMENT CALIBRATION.....	8
4.2. SAMPLE CALCULATION.....	8
4.3. MEASUREMENT UNCERTAINTY	8
5. EQUIPMENT UNDER TEST	9
5.1. DESCRIPTION OF EUT.....	9
5.2. MAXIMUM OUTPUT POWER.....	9
5.3. DESCRIPTION OF AVAILABLE ANTENNAS	9
5.4. WORST-CASE CONFIGURATION AND MODE	9
5.5. DESCRIPTION OF TEST SETUP	10
6. TEST AND MEASUREMENT EQUIPMENT	12
7. REFERENCE MEASUREMENT RESULTS.....	13
7.1. ON TIME AND DUTY CYCLE RESULTS.....	13
7.1. 99% BANDWIDTH	14
7.1.1. 802.11b MODE IN THE 2.4 GHz BAND.....	14
7.1.2. 802.11g MODE IN THE 2.4 GHz BAND.....	14
7.1.3. 802.11n HT20 MODE IN THE 2.4 GHz BAND	14
7.1.4. 99% BANDWIDTH PLOTS	15
8. MEASUREMENT METHODS	20
9. SUMMARY TABLE	21
10. ANTENNA PORT TEST RESULTS	22
10.1. 6 dB BANDWIDTH.....	22
10.1.1. 802.11b MODE IN THE 2.4 GHz BAND.....	23
10.1.1.1. 802.11g MODE IN THE 2.4 GHz BAND.....	23
10.1.2. 802.11n HT20 MODE IN THE 2.4 GHz BAND	23
10.1.3. 6 dB BANDWIDTH PLOTS.....	24
10.2. OUTPUT POWER.....	29

10.2.1.	802.11b MODE IN THE 2.4 GHz BAND.....	30
10.2.2.	802.11g MODE IN THE 2.4 GHz BAND.....	31
10.2.3.	802.11n HT20 MODE IN THE 2.4 GHz BAND.....	32
10.3.	<i>PSD</i>	33
10.3.1.	802.11b MODE IN THE 2.4 GHz BAND.....	34
10.3.2.	802.11g MODE IN THE 2.4 GHz BAND.....	34
10.3.3.	802.11n HT20 MODE IN THE 2.4 GHz BAND.....	34
10.3.4.	PSD PLOTS.....	35
10.4.	<i>OUT-OF-BAND EMISSIONS</i>	40
10.4.1.	802.11b MODE IN THE 2.4 GHz BAND.....	41
10.4.2.	802.11g MODE IN THE 2.4 GHz BAND.....	45
10.4.3.	802.11n HT20 MODE IN THE 2.4 GHz BAND.....	51
11.	RADIATED TEST RESULTS	57
11.1.	<i>LIMITS AND PROCEDURE</i>	57
11.2.	<i>TRANSMITTER ABOVE 1 GHz</i>	59
11.2.1.	TX ABOVE 1 GHz 802.11b MODE IN THE 2.4 GHz BAND.....	59
11.2.2.	TX ABOVE 1 GHz 802.11g MODE IN THE 2.4 GHz BAND.....	71
11.2.3.	TX ABOVE 1 GHz 802.11n HT20 MODE IN THE 2.4 GHz BAND.....	87
11.3.	<i>WORST-CASE BELOW 1 GHz</i>	103
12.	AC POWER LINE CONDUCTED EMISSIONS	105
13.	SETUP PHOTOS	110

1. ATTESTATION OF TEST RESULTS

COMPANY NAME: SAMSUNG ELECTRONICS CO., LTD.
EUT DESCRIPTION: WCDMA/LTE Tablet + BT/BLE, DTS/UNII a/b/g/n and ANT+
MODEL NUMBER: SM-T387T
SERIAL NUMBER: R32K500LPHM (RADIATED, Original);
R32K400HC9R (CONDUCTED, Original);
R32K500K31T (RADIATED, Spot check);
DATE TESTED: MAY 21, 2018 - JUN 25, 2018 (Original);
JUL 13, 2018 - JUL 24, 2018 (Spot check);

APPLICABLE STANDARDS	
STANDARD	TEST RESULTS
CFR 47 Part 15 Subpart C	Pass

UL Korea, Ltd. tested the above equipment in accordance with the requirements set forth in the above standards. All indications of Pass/Fail in this report are opinions expressed by UL Korea, Ltd. based on interpretations and/or observations of test results. Measurement Uncertainties were not taken into account and are published for informational purposes only. The test results show that the equipment tested is capable of demonstrating compliance with the requirements as documented in this report.

Note: The results documented in this report apply only to the tested sample, under the conditions and modes of operation as described herein. This document may not be altered or revised in any way unless done so by UL Korea, Ltd. and all revisions are duly noted in the revisions section. Any alteration of this document not carried out by UL Korea, Ltd. will constitute fraud and shall nullify the document. This report must not be used by the client to claim product certification, approval, or endorsement by IAS, any agency of the Federal Government, or any agency of any government.

Approved & Released For
UL Korea, Ltd. By:

Tested By:



SungGil Park
Suwon Lab Engineer
UL Korea, Ltd.

Hoonpyo Lee
Suwon Lab Engineer
UL Korea, Ltd.

1.1. INTRODUCTION OF TEST DATA REUSE

This report referenced from the FCC ID: A3LSMT387V DTS WLAN(FCC CFR 47 Part 15C). And the applicant takes full responsibility that the test data as referenced in this report represent compliance for this FCC ID.

1.2. DIFFERENCE

The FCC ID: A3LSMT387T shares the same enclosure and circuit board as FCC ID: A3LSMT387V. The WLAN antennas and surrounding circuitry and layout are identical between these two units.

After confirming through preliminary radiated emissions that the performance of the FCC ID: A3LSMT387V remains representative of FCC ID: A3LSMT387T. The test data of FCC ID: A3LSMT387V being submitted for this application to cover WLAN features.

1.3. SPOT CHECK VERIFICATION DATA (Worst case of the radiated spurious and band edge emissions)

Band	Test Item	Mode	Frequency	Test Limit	Original model	Spot check model	Deviation	Remark
					SM-T387V Results	SM-T387T Results		
					FCC ID : A3LSMT387V	FCC ID : A3LSMT387T		
DTS WLAN (2.4GHz)	Band Edge	802.11b	2412 MHz	54 dBuV/m	48.73 dBuV/m	46.48 dBuV/m	-2.25 dB	
	RSE	802.11b	2412 MHz	54 dBuV/m	50.14 dBuV/m	50.62 dBuV/m	0.48 dB	
	Band Edge	802.11g	2462 MHz	54 dBuV/m	48.05 dBuV/m	48.44 dBuV/m	0.39 dB	
	RSE	802.11g	2457 MHz	54 dBuV/m	37.20 dBuV/m	36.50 dBuV/m	-0.70 dB	
	Band Edge	802.11n	2462 MHz	54 dBuV/m	50.71 dBuV/m	51.70 dBuV/m	0.99 dB	
	RSE	802.11n	2437 MHz	54 dBuV/m	35.67 dBuV/m	36.49 dBuV/m	0.82 dB	

Comparison of two models, upper deviation is within 3dB range and all test results are under FCC Technical Limits.

1.4. REFERENCE DETAIL

Reference application that contains the reused reference data.

Equipment Class	Reference FCC ID	Type Grant/Permissive Change	Reference Application	Folder Test/RF Exposure	Report Title / Section
DTS	A3LSMT387V	Grant	4788481138-E1V2	Test	FCC Report DTS WLAN / All sections
			4788481138-E2V2	Test	FCC Report BLE All sections
DSS	A3LSMT387V	Grant	4788481138-E3V2	Test	FCC Report UNII WLAN / All sections
NII	A3LSMT387V	Grant	4788481138-E4V3	Test	FCC Report UNII WLAN / All sections
DXX	A3LSMT387V	Grant	4788481138-E5V2	Test	FCC Report ANT+ / All sections
PCE	A3LSMT387V	Grant	4788481138-E6V2	Test	FCC Report WWAN / All sections (for WCDMA B2/B5, LTE Band 2/4/5/7)

2. TEST METHODOLOGY

The tests documented in this report were performed in accordance with following methods.

1. FCC CFR 47 Part 2.
2. FCC CFR 47 Part 15.
3. KDB 558074 D01 DTS Meas Guidance v04.
4. ANSI C63.10-2013.

3. FACILITIES AND ACCREDITATION

The test sites and measurement facilities used to collect data are located at 218 Maeyeong-ro, Yeongtong-gu, Suwon-si, Gyeonggi-do, 16675, Korea. Line conducted emissions are measured only at the 218 address. The following table identifies which facilities were utilized for radiated emission measurements documented in this report. Specific facilities are also identified in the test results sections.

218 Maeyeong-ro	
<input checked="" type="checkbox"/>	Chamber 1
<input type="checkbox"/>	Chamber 2
<input checked="" type="checkbox"/>	Chamber 3

UL Korea, Ltd. is accredited by IAS, Laboratory Code TL-637. The full scope of accreditation can be viewed at <http://www.iasonline.org/PDF/TL/TL-637.pdf>.

4. CALIBRATION AND UNCERTAINTY

4.1. MEASURING INSTRUMENT CALIBRATION

The measuring equipment utilized to perform the tests documented in this report has been calibrated in accordance with the manufacturer's recommendations, and is traceable to recognized national standards.

4.2. SAMPLE CALCULATION

Where relevant, the following sample calculation is provided:

$$\begin{aligned} \text{Field Strength (dBuV/m)} &= \text{Measured Voltage (dBuV)} + \text{Antenna Factor (dB/m)} + \\ &\text{Cable Loss (dB)} - \text{Preamp Gain (dB)} \\ 36.5 \text{ dBuV} + 18.7 \text{ dB/m} + 0.6 \text{ dB} - 26.9 \text{ dB} &= 28.9 \text{ dBuV/m} \end{aligned}$$

4.3. MEASUREMENT UNCERTAINTY

Where relevant, the following measurement uncertainty levels have been estimated for tests performed on the apparatus:

PARAMETER	UNCERTAINTY
Conducted Disturbance, 0.15 to 30 MHz	2.32 dB
Radiated Disturbance, Below 1GHz	3.86 dB
Radiated Disturbance, Above 1 GHz	5.97 dB

Uncertainty figures are valid to a confidence level of 95%.

5. EQUIPMENT UNDER TEST

5.1. DESCRIPTION OF EUT

The EUT is a WCDMA/LTE Tablet + BT/BLE, DTS/UNII a/b/g/n and ANT+
This test report addresses the DTS (WLAN) operational mode.

5.2. MAXIMUM OUTPUT POWER

The transmitter has a maximum total conducted average output power as follows:

Frequency Range [MHz]	Mode	Output Power [dBm]	Output Power [mW]
2412 - 2462	802.11b	20.50	112.20
	802.11g	18.11	64.71
	802.11n HT20	17.11	51.40

5.3. DESCRIPTION OF AVAILABLE ANTENNAS

The radio utilizes an internal antennas, with a antenna's maximum gain of -2.70 dBi.

5.4. WORST-CASE CONFIGURATION AND MODE

Radiated emission below 1GHz and power line conducted emission were performed with the EUT set to transmit at the channel with highest output power as worst-case scenario.

Radiated emission above 1GHz was performed with the EUT set to transmit low/mid/high Channels.

The fundamental of the EUT was investigated in three orthogonal orientations X, Y and Z it was determined that Y orientation was worst-case orientation; therefore, all final radiated testing was performed with the EUT in Y orientation.

Based on the baseline scan, the worst-case data rates were:

802.11b mode: 1 Mbps
802.11g mode: 6 Mbps
802.11n HT20 mode: MCS0

Note : All radiated and power line conducted tests were performed connected with earphone and charger for evaluation of worst case mode.

5.5. DESCRIPTION OF TEST SETUP

SUPPORT EQUIPMENT

Support Equipment List				
Description	Manufacturer	Model	Serial Number	FCC ID
Charger	SAMSUNG	EP-TA50JWE	DK4K227VS/A-E	N/A
Data Cable	SAMSUNG	EP-DG915UWZ	N/A	N/A
Earphone	SAMSUNG	EHS64AVFWE	N/A	N/A

I/O CABLES

I/O Cable List						
Cable No	Port	# of identical ports	Connector Type	Cable Type	Cable Length (m)	Remarks
1	DC Power	1	Mini-USB	Shielded	1.2m	N/A
2	Audio	2	Mini-Jack	Unshielded	1.2m	N/A

TEST SETUP

The EUT is a stand-alone unit during the tests.
Test software in hidden menu exercised the EUT to enable DTS mode.

SETUP DIAGRAM FOR TESTS (CONDUCTED TEST SETUP)

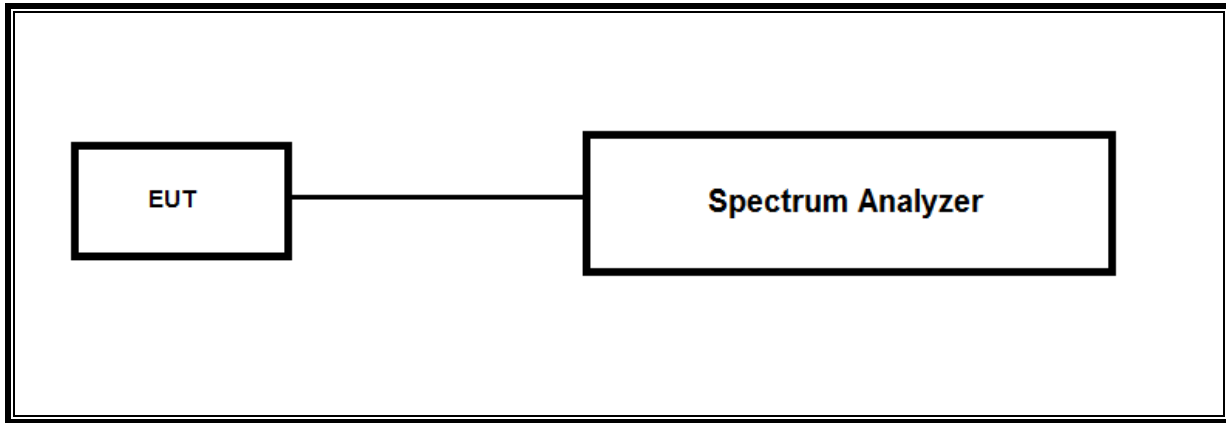

SETUP DIAGRAM FOR TESTS (RADIATED TEST SETUP)

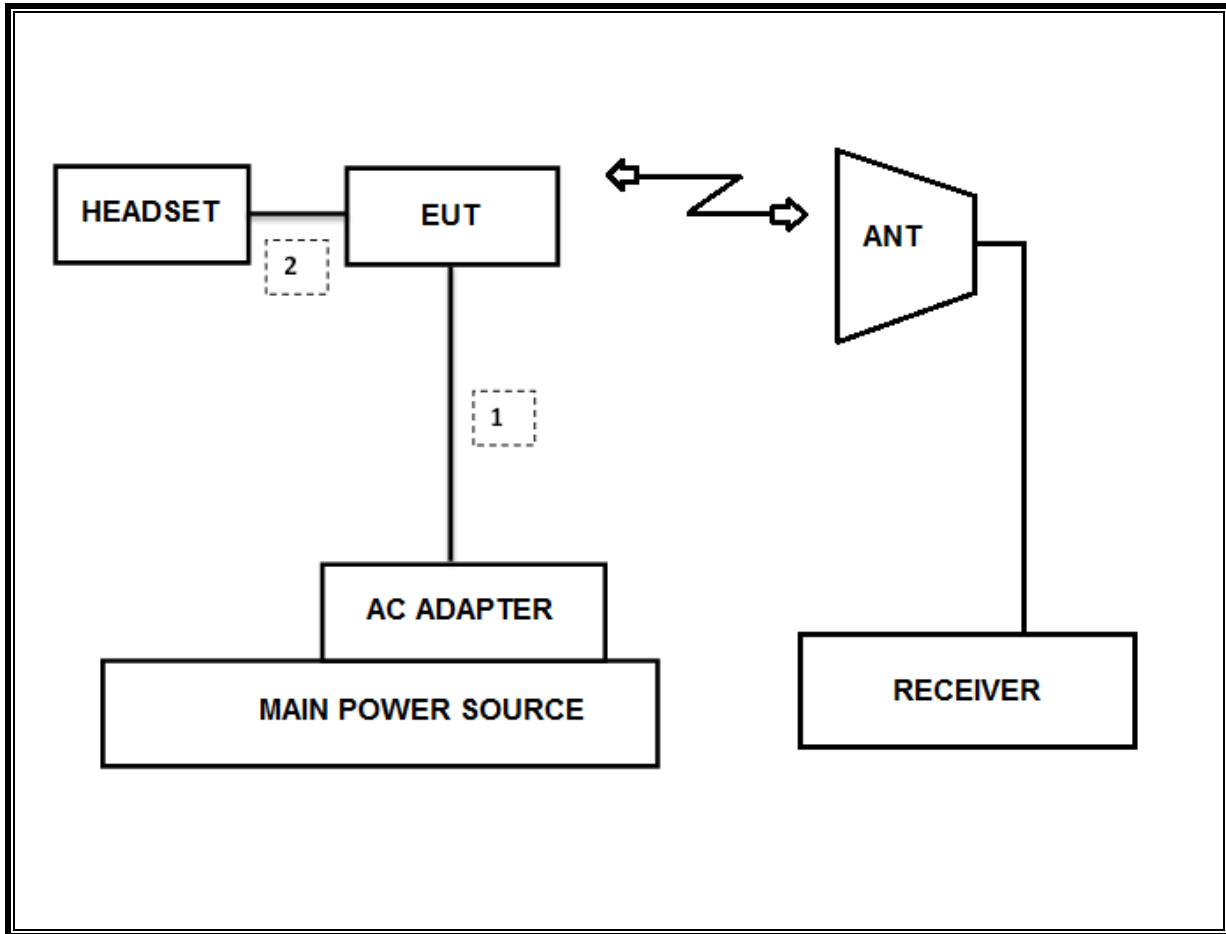

6. TEST AND MEASUREMENT EQUIPMENT

The following test and measurement equipment was utilized for the tests documented in this report:

Test Equipment List				
Description	Manufacturer	Model	S/N	Cal Due
Antenna, Bilog, 30MHz-1GHz	SCHWARZBECK	VULB9163	750	08-31-19
Antenna, Bilog, 30MHz-1GHz	SCHWARZBECK	VULB9163	749	09-14-19
Antenna, Bilog, 30MHz-1GHz	SCHWARZBECK	VULB9163	845	08-31-19
Antenna, Horn, 18 GHz	ETS	3115	00167211	10-14-18
Antenna, Horn, 18 GHz	ETS	3115	00161451	03-10-19
Antenna, Horn, 18 GHz	ETS	3117	00168724	05-31-19
Antenna, Horn, 18 GHz	ETS	3117	00168717	05-31-19
Antenna, Horn, 18 GHz	ETS	3117	00205959	11-29-18
Antenna, Horn, 40 GHz	ETS	3116C	00166155	12-04-19
Antenna, Horn, 40 GHz	ETS	3116C	00168645	12-04-19
Antenna, Horn, 40 GHz	ETS	3116C-PA	00168841	11-13-19
Preamplifier, 1000 MHz	Sonoma	310N	341282	08-09-18
Preamplifier, 1000 MHz	Sonoma	310N	351741	08-07-18
Preamplifier, 1000 MHz	Sonoma	310N	370599	08-10-18
Preamplifier, 18 GHz	Miteq	AFS42-00101800-25-S-42	1876511	08-08-18
Preamplifier, 18 GHz	Miteq	AFS42-00101800-25-S-42	1896138	08-08-18
Preamplifier, 18 GHz	Miteq	AFS42-00101800-25-S-42	2029169	08-11-18
Spectrum Analyzer, 44 GHz	Agilent / HP	N9030A	MY54170614	08-08-18
Spectrum Analyzer, 44 GHz	Agilent / HP	N9030A	MY54490312	08-08-18
Spectrum Analyzer, 43.5 GHz	R&S	FSW43	104089	08-11-18
Average Power Sensor	Agilent / HP	U2000	MY54270007	08-08-18
Attenuator	PASTERNAK	PE7087-10	A001	08-08-18
Attenuator	PASTERNAK	PE7087-10	A008	08-08-18
Attenuator	PASTERNAK	PE7087-10	2	08-10-18
Attenuator	PASTERNAK	PE7087-10	A009	08-08-18
EMI Test Receive, 40 GHz	R&S	ESU40	100439	08-08-18
EMI Test Receive, 40 GHz	R&S	ESU40	100457	08-08-18
EMI Test Receive, 44 GHz	R&S	ESW44	101590	08-09-18
EMI Test Receive, 3 GHz	R&S	ESR3	101832	08-07-18
Low Pass Filter 5GHz	Micro-Tronics	LPS17541	009	08-08-18
Low Pass Filter 5GHz	Micro-Tronics	LPS17541	015	08-08-18
Low Pass Filter 5GHz	Micro-Tronics	LPS17541	020	08-11-18
High Pass Filter 3GHz	Micro-Tronics	HPM17543	010	08-08-18
High Pass Filter 3GHz	Micro-Tronics	HPM17543	015	08-08-18
High Pass Filter 3GHz	Micro-Tronics	HPM17543	020	08-11-18
High Pass Filter 6GHz	Micro-Tronics	HPS17542	009	08-08-18
High Pass Filter 6GHz	Micro-Tronics	HPS17542	016	08-08-18
High Pass Filter 6GHz	Micro-Tronics	HPS17542	021	08-11-18
LISN	R&S	ENV-216	101837	08-09-18
UL Software				
Description	Manufacturer	Model	Version	
Radiated software	UL	UL EMC	Ver 9.5	

7. REFERENCE MEASUREMENT RESULTS

7.1. ON TIME AND DUTY CYCLE RESULTS

LIMITS

None; for reporting purposes only.

Mode	ON Time B [msec]	Period [msec]	Duty Cycle x [linear]	Duty Cycle [%]	Duty Cycle Correction Factor [dB]	1/T Minimum VBW [kHz]
2400MHz Bands						
802.11b	32.95	33.05	0.997	99.7%	0.00	0.010
802.11g	5.484	5.582	0.982	98.2%	0.00	0.010
802.11n HT20	5.067	5.166	0.981	98.1%	0.00	0.010

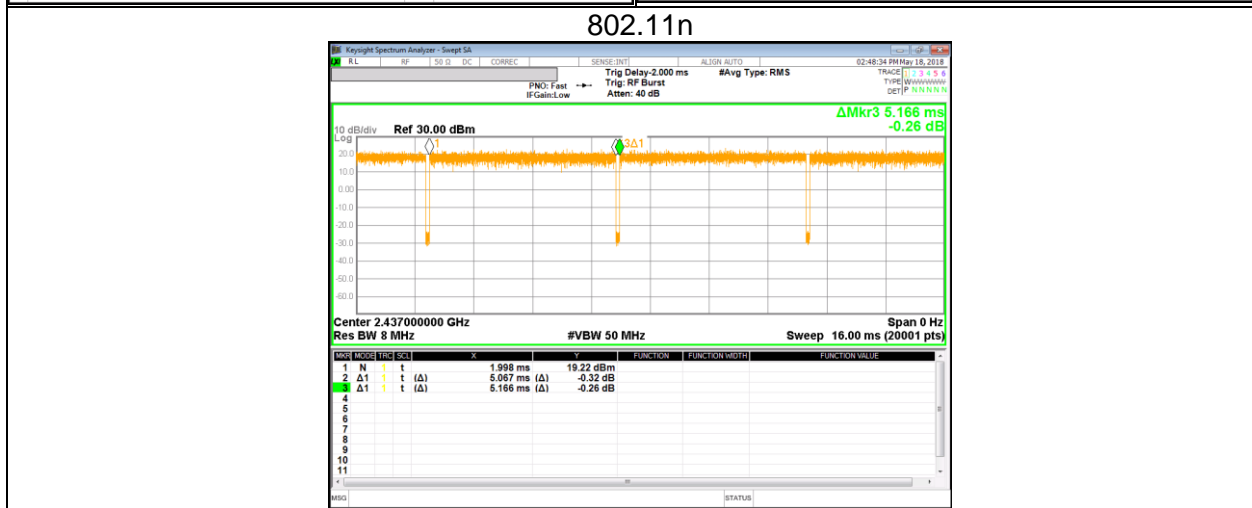

7.1. 99% BANDWIDTH

LIMITS

None; for reporting purposes only.

RESULTS

7.1.1. 802.11b MODE IN THE 2.4 GHz BAND

Channel	Frequency [MHz]	99% Bandwidth [MHz]
1	2412	13.291
6	2437	13.300
10	2457	12.999
11	2462	12.848
Worst		13.300

7.1.2. 802.11g MODE IN THE 2.4 GHz BAND

Channel	Frequency [MHz]	99% Bandwidth [MHz]
1	2412	16.422
2	2417	16.437
3	2422	16.494
6	2437	16.484
10	2457	16.498
11	2462	16.400
Worst		16.498

7.1.3. 802.11n HT20 MODE IN THE 2.4 GHz BAND

Channel	Frequency [MHz]	99% Bandwidth [MHz]
1	2412	17.549
2	2417	17.613
3	2422	17.613
6	2437	17.615
10	2457	17.636
11	2462	17.564
Worst		17.636

7.1.4. 99% BANDWIDTH PLOTS

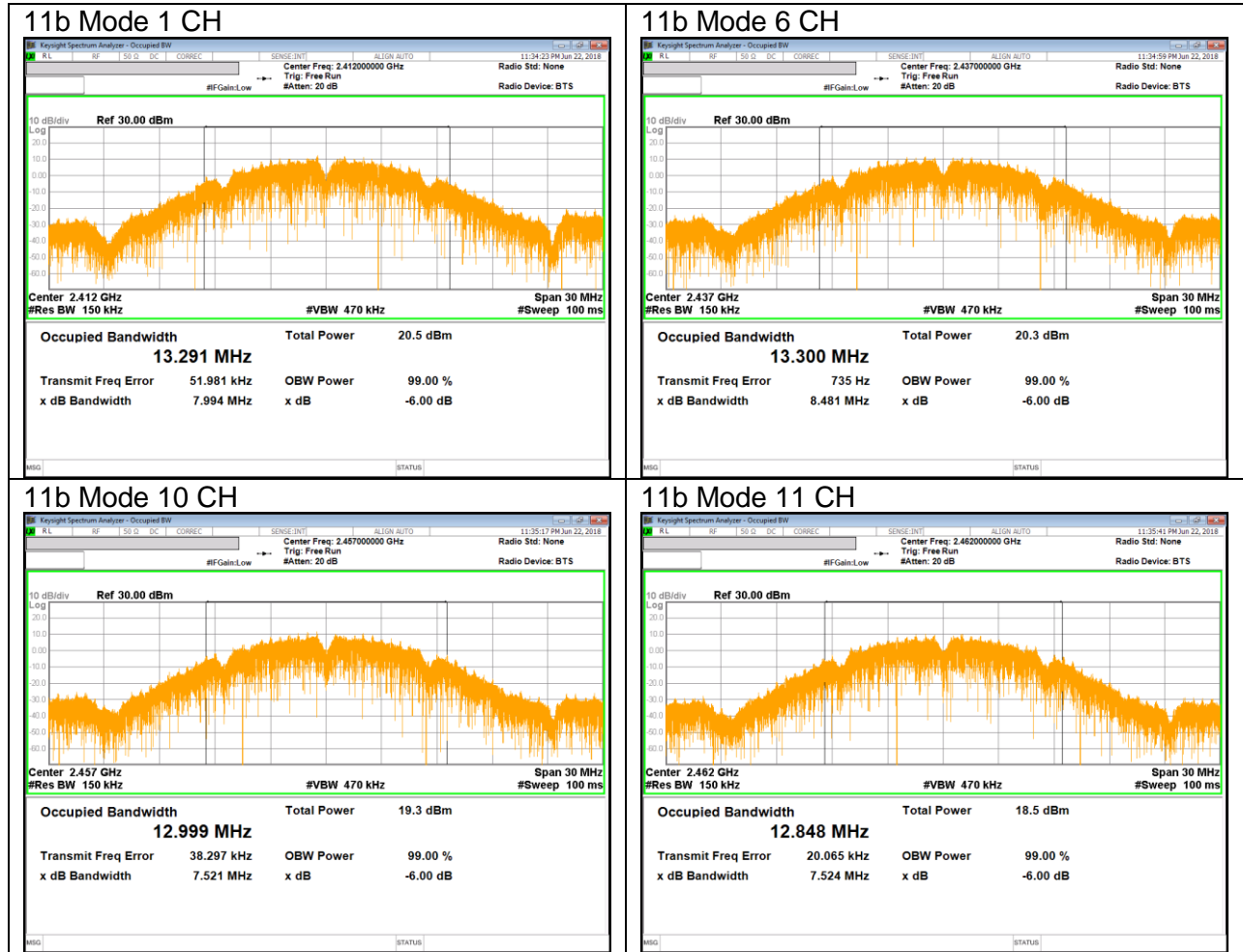



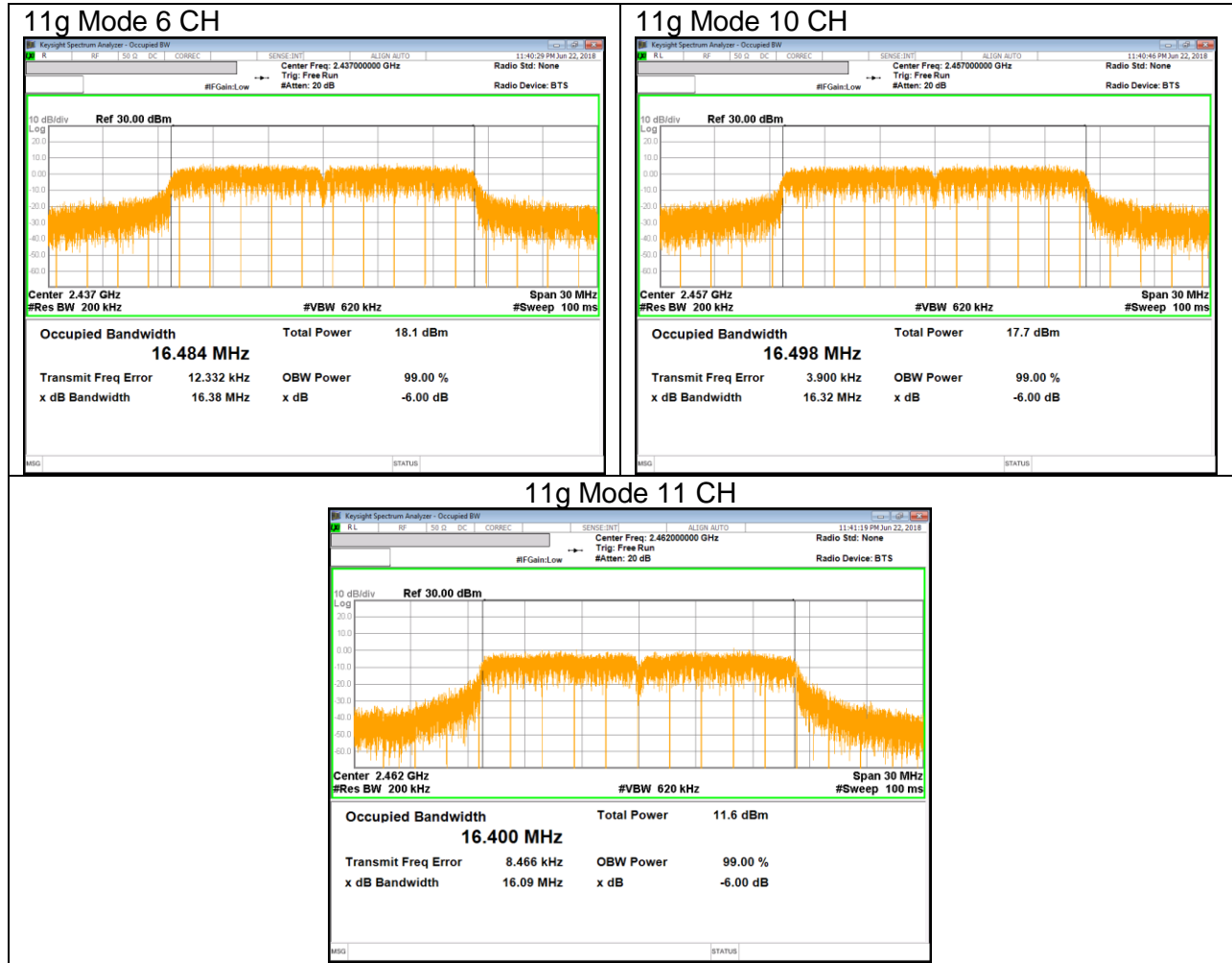

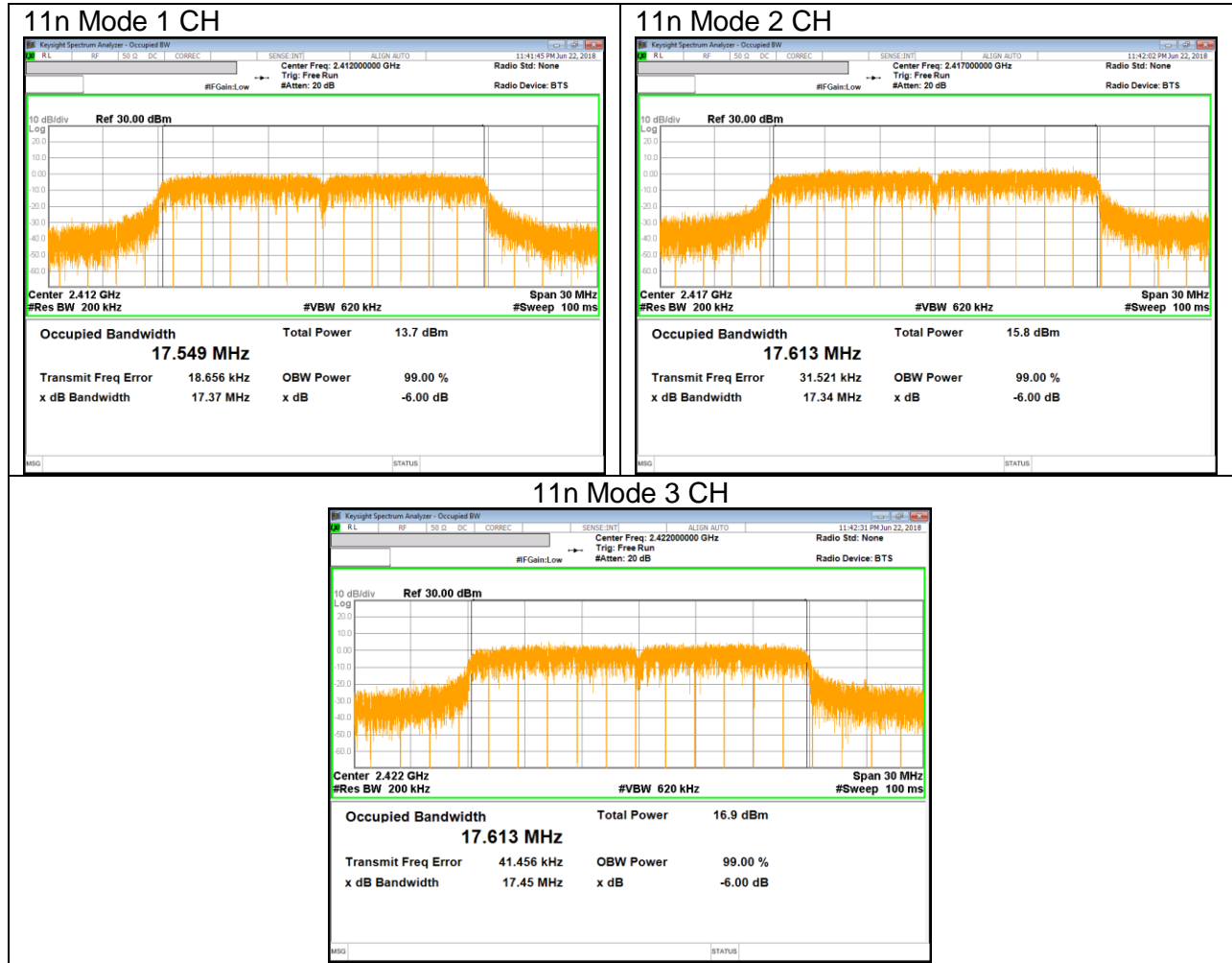

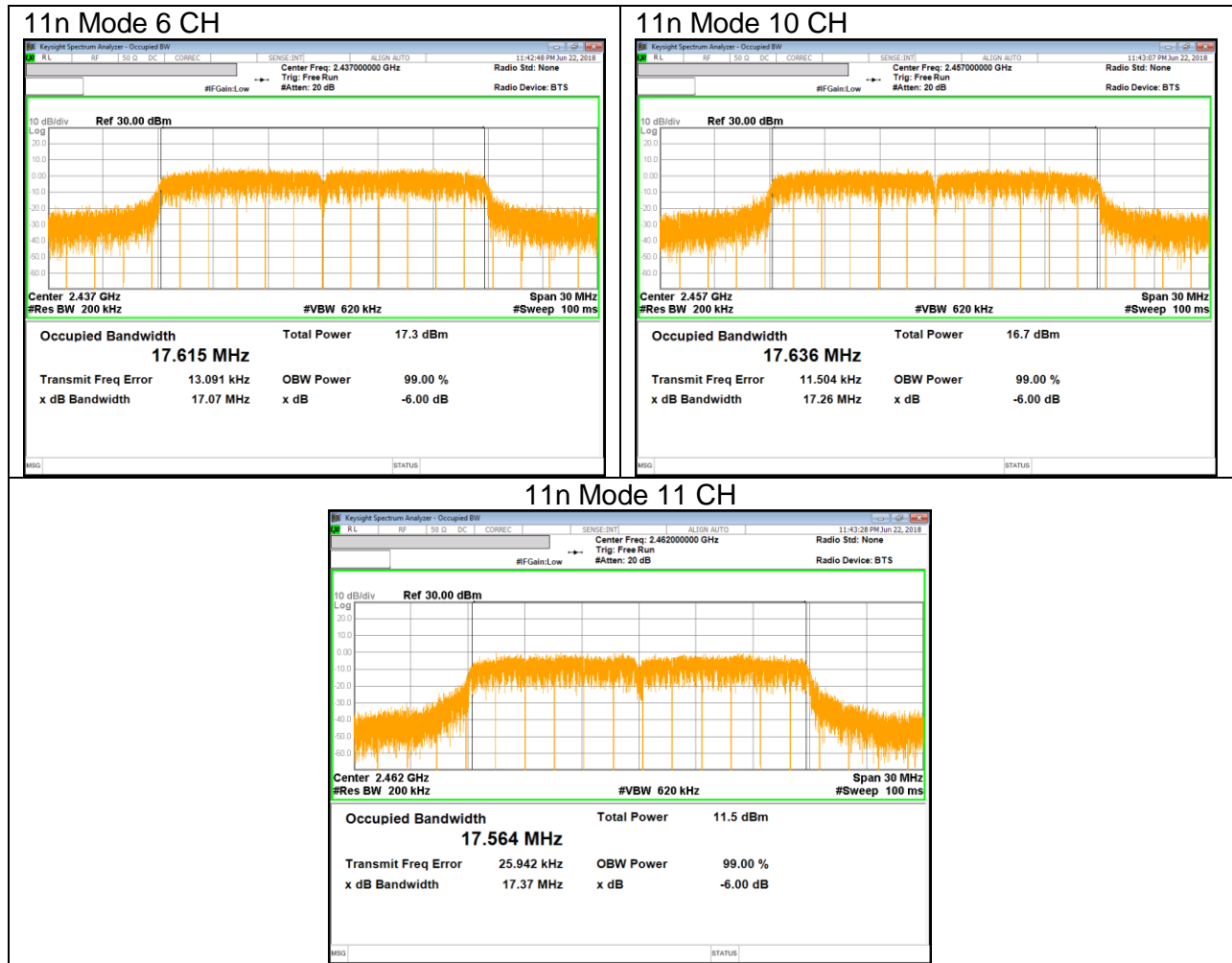

8. MEASUREMENT METHODS

6 dB BW : KDB 558074 D01 v04, Section 8.2.

OUTPUT POWER : KDB 558074 D01 v04, Section 9.2.3.1.

POWER SPECTRAL DENSITY : KDB 558074 D01 v04, Section 10.3./10.5.

Out-of-band EMISSIONS (Conducted) : KDB 558074 D01 v04, Section 11.1, 11.2.

Out-of-band EMISSIONS IN NON-RESTRICTED BANDS: KDB 558074 D01 v04, Section 11.0.

Out-of-band EMISSIONS IN RESTRICTED BANDS : KDB 558074 D01 v04, Section 12.1.

AC Power Line Conducted Emission : ANSI C63.10-2013, Section 6.2.

9. SUMMARY TABLE

FCC Part Section	Test Description	Test Limit	Test Condition	Test Result
15.247 (a)(2)	Occupied Band width (6dB)	>500KHz	Conducted	Pass
2.1051, 15.247 (d)	Band Edge / Conducted Spurious Emission	-30dBc		Pass
15.247 (b)(3)	TX conducted output power	<30dBm		Pass
15.247 (e)	PSD	<8dBm		Pass
15.207 (a)	AC Power Line conducted emissions	Section 10	Power Line conducted	Pass
15.205, 15.209	Radiated Spurious Emission	< 54dBuV/m	Radiated	Pass

10. ANTENNA PORT TEST RESULTS

10.1. 6 dB BANDWIDTH

LIMITS

FCC §15.247 (a) (2)

The minimum 6 dB bandwidth shall be at least 500 kHz.

TEST PROCEDURE

Reference to KDB 558074 D01 DTS Meas Guidance v04: The transmitter output is connected to a spectrum analyzer with the RBW set to 100kHz, the VBW $\geq 3 \times$ RBW, peak detector and max hold.

RESULTS**10.1.1.802.11b MODE IN THE 2.4 GHz BAND**

Channel	Frequency [MHz]	6 dB Bandwidth [MHz]	Minimum Limit [MHz]
1	2412	8.021	0.5
6	2437	8.045	0.5
10	2457	8.029	0.5
11	2462	7.538	0.5
Worst		7.538	0.5

10.1.1.1. 802.11g MODE IN THE 2.4 GHz BAND

Channel	Frequency [MHz]	6 dB Bandwidth [MHz]	Minimum Limit [MHz]
1	2412	16.060	0.5
2	2417	15.900	0.5
3	2422	15.890	0.5
6	2437	16.280	0.5
10	2457	16.280	0.5
11	2462	16.280	0.5
Worst		15.890	0.5

10.1.2.802.11n HT20 MODE IN THE 2.4 GHz BAND

Channel	Frequency [MHz]	6 dB Bandwidth [MHz]	Minimum Limit [MHz]
1	2412	16.770	0.5
2	2417	16.280	0.5
3	2422	16.320	0.5
6	2437	16.870	0.5
10	2457	16.800	0.5
11	2462	16.840	0.5
Worst		16.280	0.5

10.1.3. 6 dB BANDWIDTH PLOTS









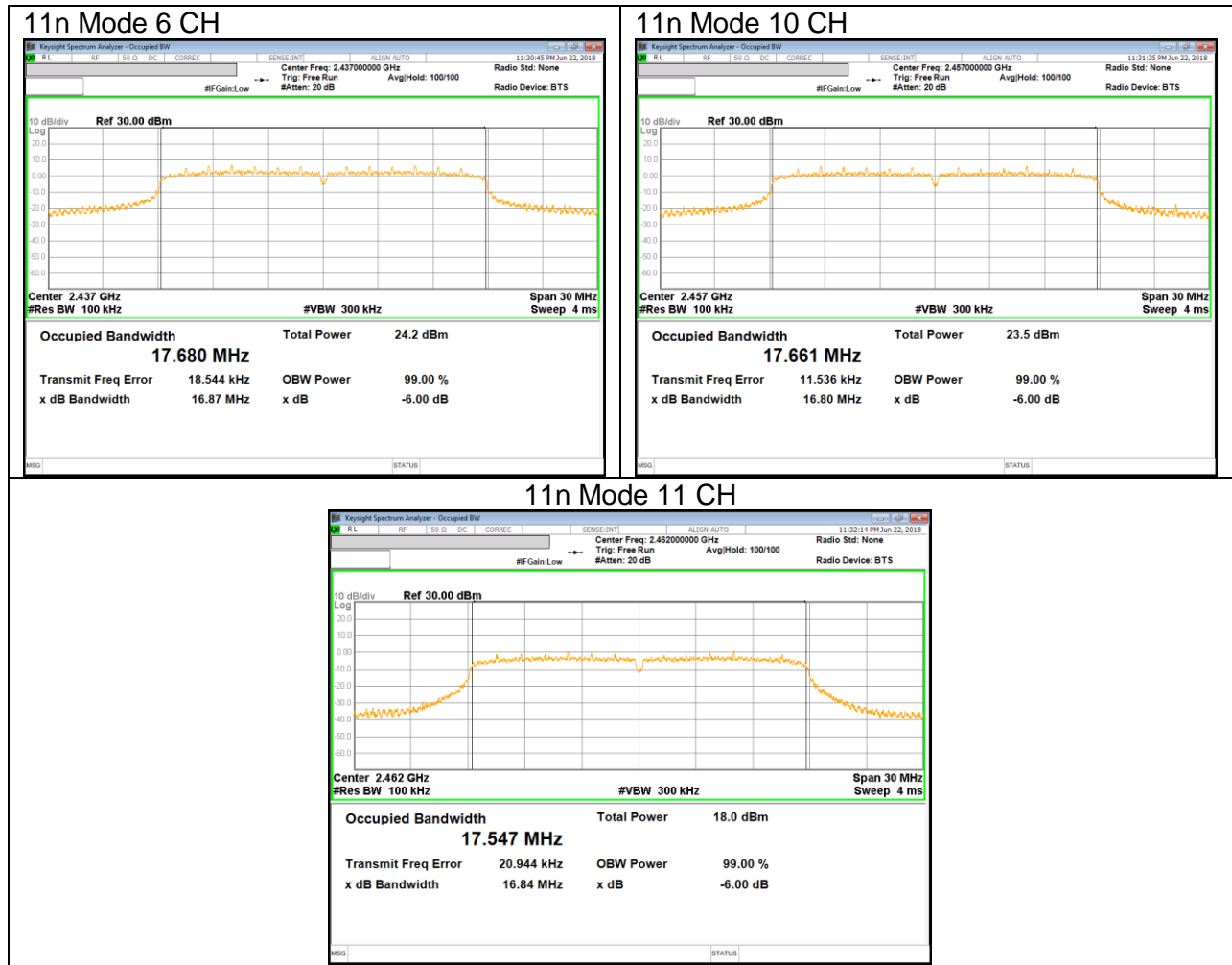

10.2. OUTPUT POWER

LIMITS

FCC §15.247

For systems using digital modulation in the 902–928 MHz, 2400–2483.5 MHz, and 5725–5850 MHz bands: 1 Watt, based on the use of antennas with directional gains that do not exceed 6 dBi. If transmitting antennas of directional gain greater than 6 dBi are used, the conducted output power from the intentional radiator shall be reduced by the amount in dB that the directional gain of the antenna exceeds 6 dBi.

DIRECTIONAL ANTENNA GAIN

There is only one transmitter output therefore the directional gain is equal to the antenna gain.

TEST PROCEDURE

The transmitter output is connected to a power meter.

The cable assembly insertion loss was entered as an offset in the power meter to allow for direct reading of power.

Output power measurement was performed utilizing the “§9.2.3.1 AVGPM” under KDB558074 D01 DTS Meas Guidance v04.

Duty cycle correction factor is not added to the average output power results for duty cycle factor > 98%. (All mode)

RESULTS

10.2.1.802.11b MODE IN THE 2.4 GHz BAND

Limits

Channel	Frequency [MHz]	Directional Gain Primary [dBi]	FCC Power Limit [dBm]	Max Power [dBm]
1	2412	-2.70	30.00	30.00
6	2437	-2.70	30.00	30.00
10	2457	-2.70	30.00	30.00
11	2462	-2.70	30.00	30.00

Results

Channel	Frequency [MHz]	Meas Power [dBm]	Total Power [dBm]	Power Limit [dBm]	Margin [dB]
1	2412	20.50	20.50	30.00	-9.50
6	2437	20.37	20.37	30.00	-9.63
10	2457	19.62	19.62	30.00	-10.38
11	2462	18.62	18.62	30.00	-11.38
Worst			20.50	30.00	-9.50

10.2.2.802.11g MODE IN THE 2.4 GHz BAND

Limits

Channel	Frequency [MHz]	Directional Gain Primary [dBi]	FCC Power Limit [dBm]	Max Power [dBm]
1	2412	-2.70	30.00	30.00
2	2417	-2.70	30.00	30.00
3	2422	-2.70	30.00	30.00
6	2437	-2.70	30.00	30.00
10	2457	-2.70	30.00	30.00
11	2462	-2.70	30.00	30.00

Results

Channel	Frequency [MHz]	Meas Power [dBm]	Total Power [dBm]	Power Limit [dBm]	Margin [dB]
1	2412	13.70	13.70	30.00	-16.30
2	2417	16.73	16.73	30.00	-13.27
3	2422	17.90	17.90	30.00	-12.10
6	2437	18.11	18.11	30.00	-11.89
10	2457	17.62	17.62	30.00	-12.38
11	2462	11.66	11.66	30.00	-18.34
Worst			18.11	30.00	-11.89

10.2.3.802.11n HT20 MODE IN THE 2.4 GHz BAND

Limits

Channel	Frequency [MHz]	Directional Gain Primary [dBi]	FCC Power Limit [dBm]	Max Power [dBm]
1	2412	-2.70	30.00	30.00
2	2417	-2.70	30.00	30.00
3	2422	-2.70	30.00	30.00
6	2437	-2.70	30.00	30.00
10	2457	-2.70	30.00	30.00
11	2462	-2.70	30.00	30.00

Results

Channel	Frequency [MHz]	Meas Power [dBm]	Total Power [dBm]	Power Limit [dBm]	Margin [dB]
1	2412	13.67	13.67	30.00	-16.33
2	2417	15.66	15.66	30.00	-14.34
3	2422	16.85	16.85	30.00	-13.15
6	2437	17.11	17.11	30.00	-12.89
10	2457	16.70	16.70	30.00	-13.30
11	2462	11.64	11.64	30.00	-18.36
Worst			17.11	30.00	-12.89

10.3. PSD

LIMITS

FCC §15.247

The power spectral density conducted from the transmitter to the antenna shall not be greater than 8 dBm in any 3 kHz band during any time interval of continuous transmission.

TEST PROCEDURE

Power Spectral Density was performed utilizing the "Method §10.3 AVGPS-1 (802.11 b/g/n mode) under KDB558074 D01 DTS Meas Guidance v04.

RESULTS

10.3.1.802.11b MODE IN THE 2.4 GHZ BAND

PSD Results

Channel	Frequency [MHz]	PSD Meas [dBm]	Duty Factor [dB]	Final PSD [dBm/3kHz]	Limit [dBm/3kHz]	Margin [dB]
1	2412	-10.500	0.00	-10.500	8.00	-18.500
6	2437	-10.811	0.00	-10.811	8.00	-18.811
10	2457	-11.500	0.00	-11.500	8.00	-19.500
11	2462	-12.284	0.00	-12.284	8.00	-20.284

10.3.2.802.11g MODE IN THE 2.4 GHZ BAND

PSD Results

Channel	Frequency [MHz]	PSD Meas [dBm]	Duty Factor [dB]	Final PSD [dBm/3kHz]	Limit [dBm/3kHz]	Margin [dB]
1	2412	-20.168	0.00	-20.168	8.00	-28.168
2	2417	-17.099	0.00	-17.099	8.00	-25.099
3	2422	-15.854	0.00	-15.854	8.00	-23.854
6	2437	-16.058	0.00	-16.058	8.00	-24.058
10	2457	-16.407	0.00	-16.407	8.00	-24.407
11	2462	-22.396	0.00	-22.396	8.00	-30.396

10.3.3.802.11n HT20 MODE IN THE 2.4 GHZ BAND

PSD Results

Channel	Frequency [MHz]	PSD Meas [dBm]	Duty Factor [dB]	Final PSD [dBm/3kHz]	Limit [dBm/3kHz]	Margin [dB]
1	2412	-20.038	0.00	-20.038	8.00	-28.038
2	2417	-18.321	0.00	-18.321	8.00	-26.321
3	2422	-17.332	0.00	-17.332	8.00	-25.332
6	2437	-16.841	0.00	-16.841	8.00	-24.841
10	2457	-17.428	0.00	-17.428	8.00	-25.428
11	2462	-22.161	0.00	-22.161	8.00	-30.161

10.3.4.PSD PLOTS

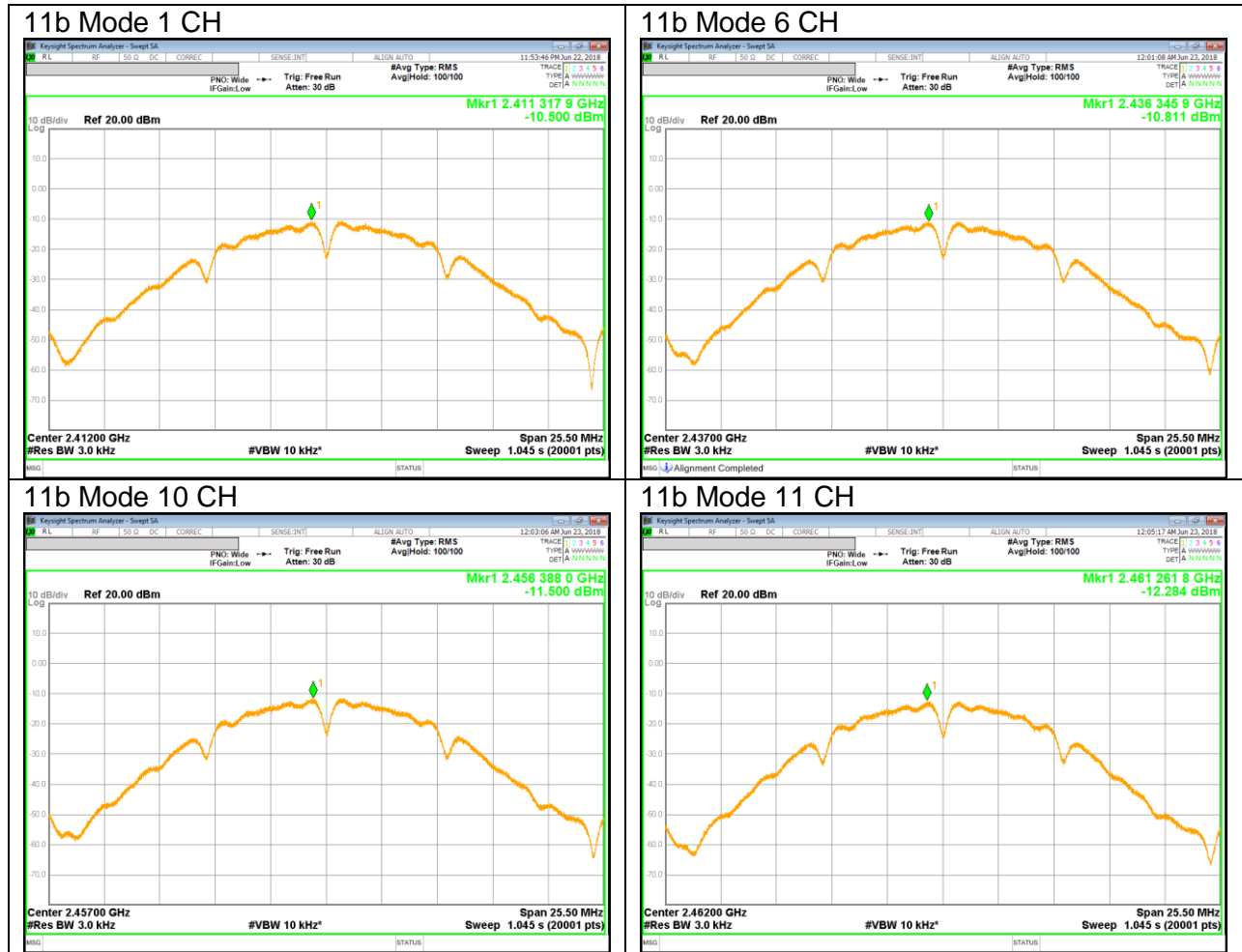

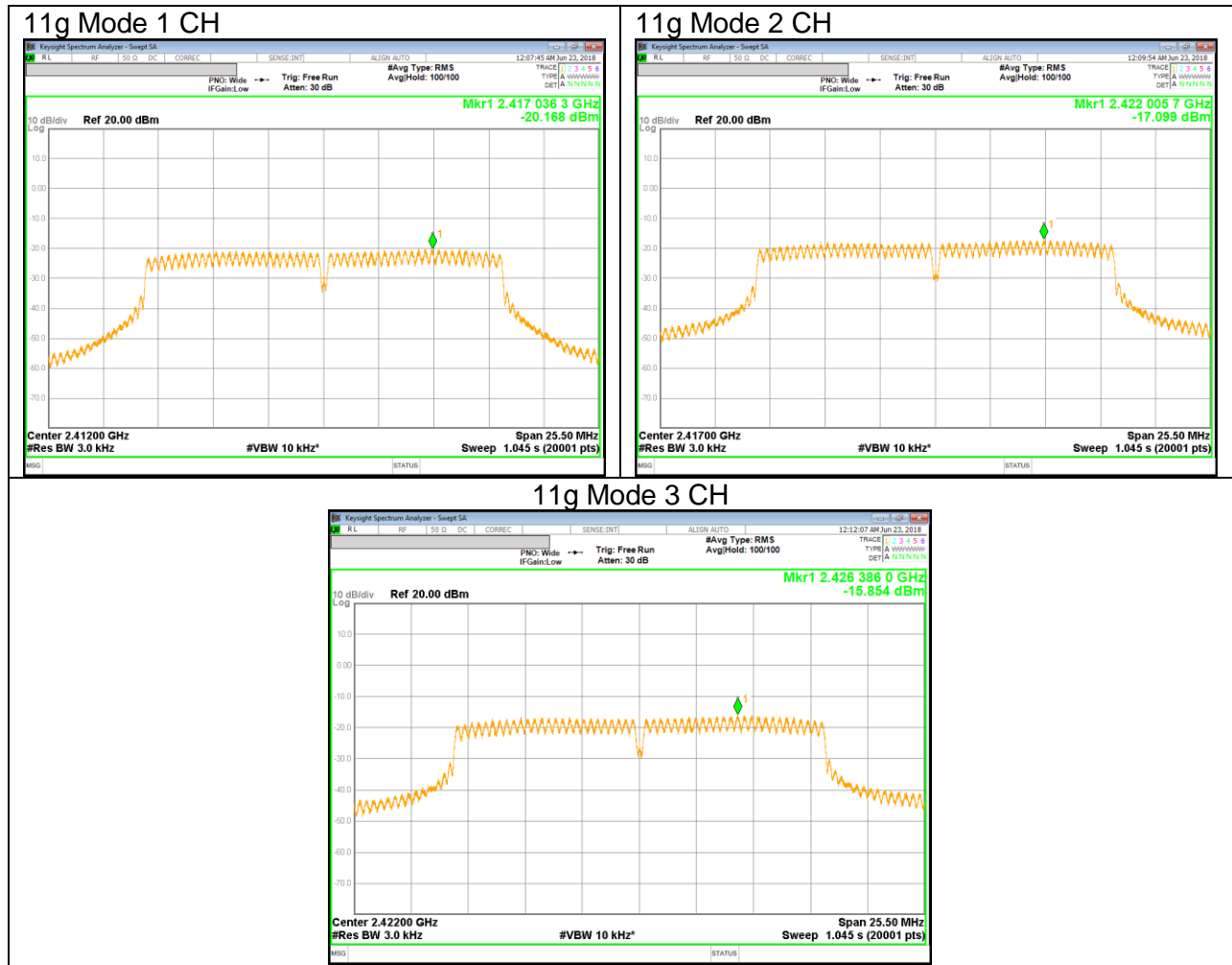

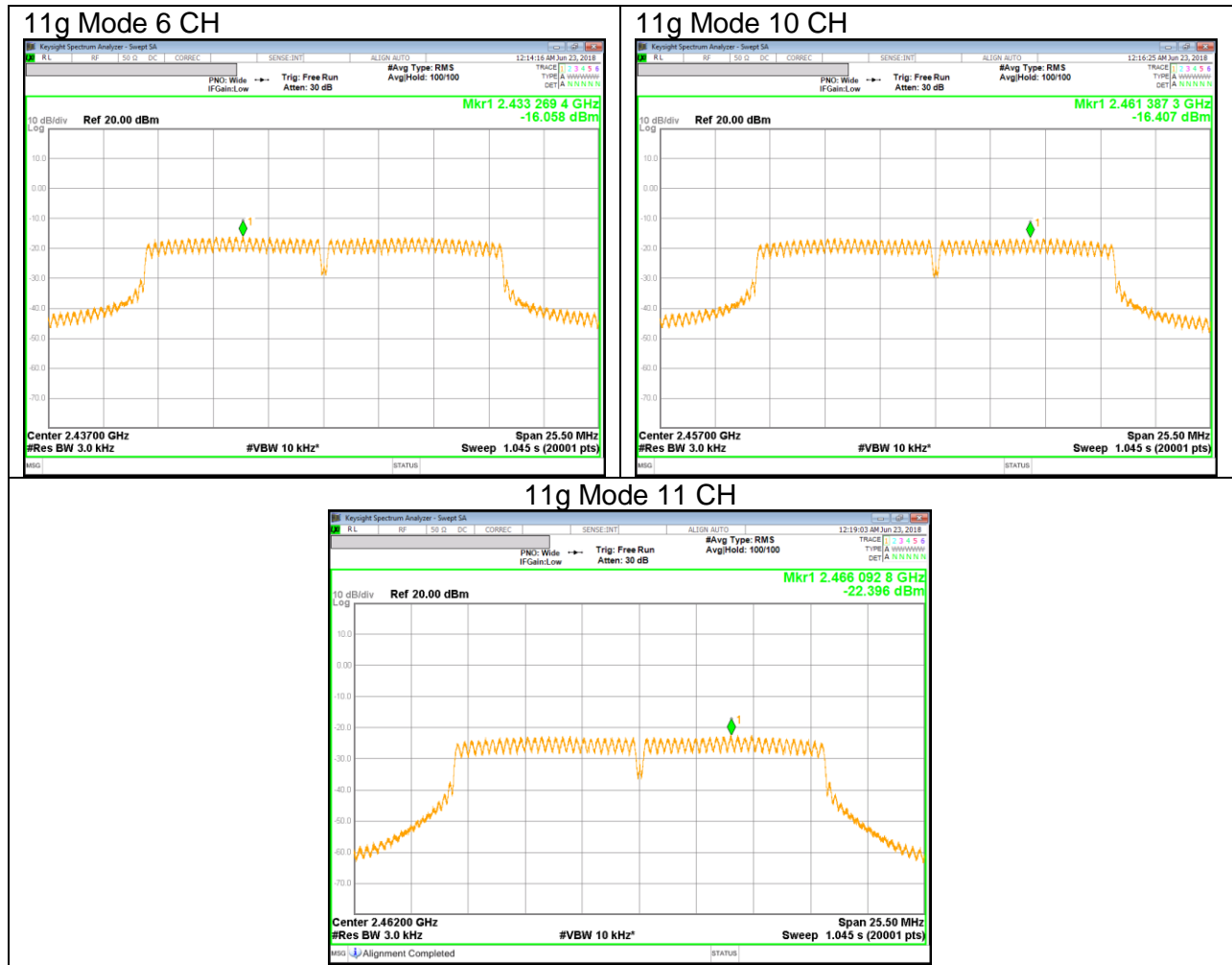

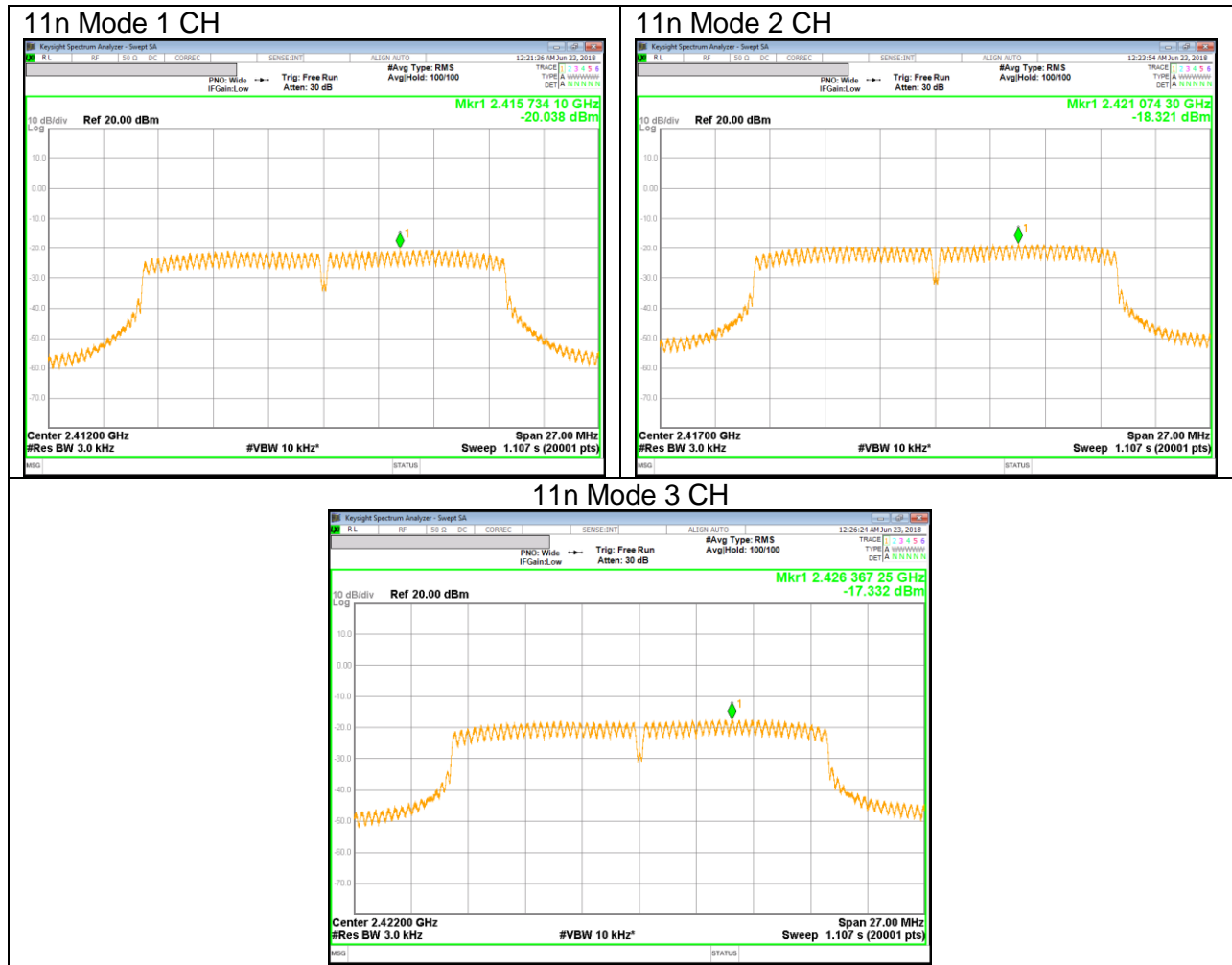

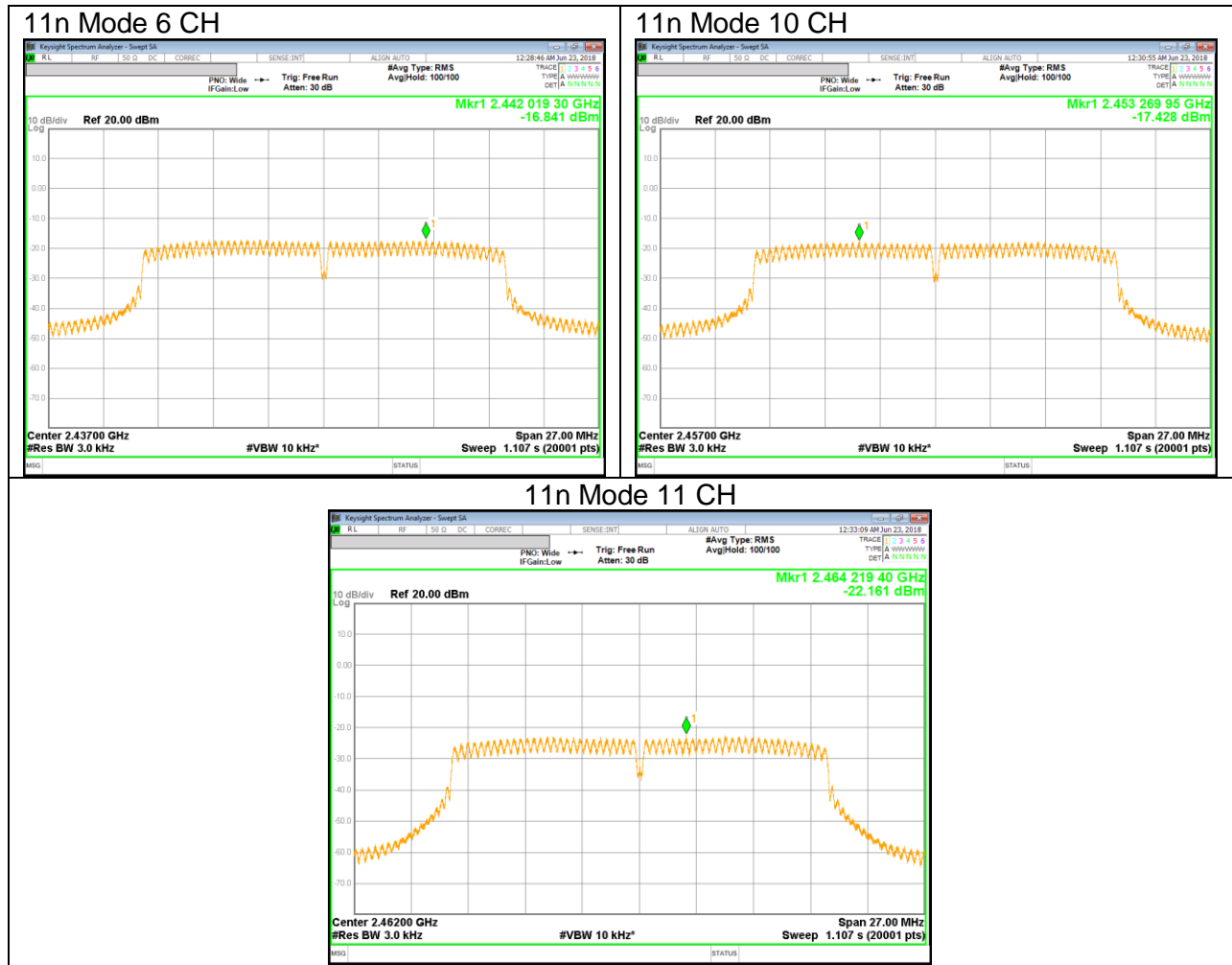

10.4. OUT-OF-BAND EMISSIONS

LIMITS

FCC §15.247 (d)

In any 100 kHz bandwidth outside the frequency band in which the spread spectrum or digitally modulated intentional radiator is operating, the radio frequency power that is produced by the intentional radiator shall be at least 20 dB below that in the 100 kHz bandwidth within the band that contains the highest level of the desired power, based on either an RF conducted or a radiated measurement, provided the transmitter demonstrates compliance with the peak conducted power limits. If the transmitter complies with the conducted power limits based on the use of RMS averaging over a time interval, as permitted under paragraph (b)(3) of this section, the attenuation required under this paragraph shall be 30 dB instead of 20 dB. Attenuation below the general limits specified in §15.209(a) is not required.

TEST PROCEDURE

The transmitter output is connected to a spectrum analyzer with RBW = 100 kHz, VBW = 300 kHz, peak detector, and max hold. Measurements utilizing these settings are made of the in-band reference level, bandedge, out-of-band emissions (where measurements to the general radiated limits will not be made)

RESULTS

10.4.1.802.11b MODE IN THE 2.4 GHz BAND

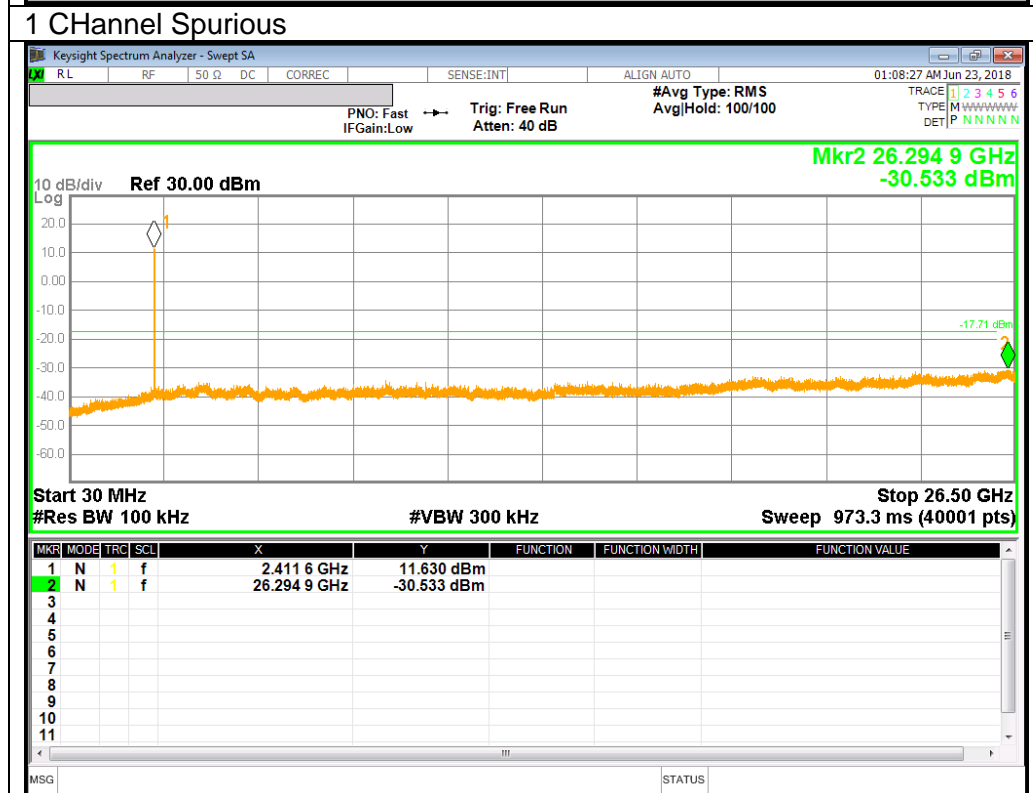
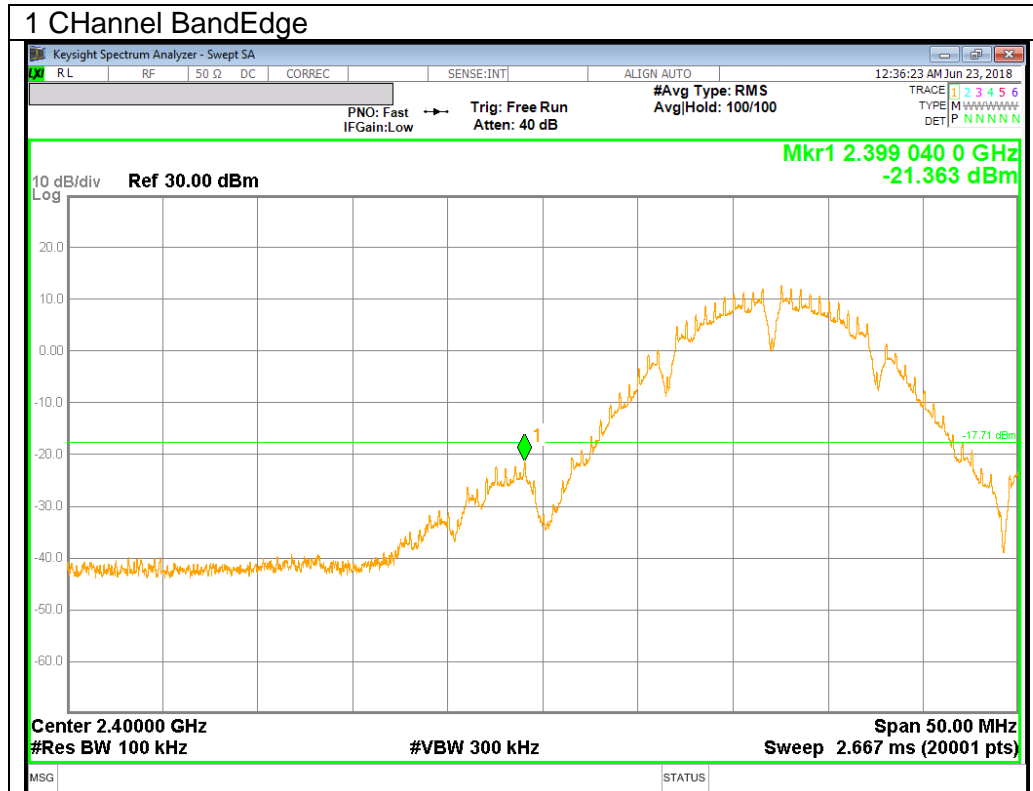

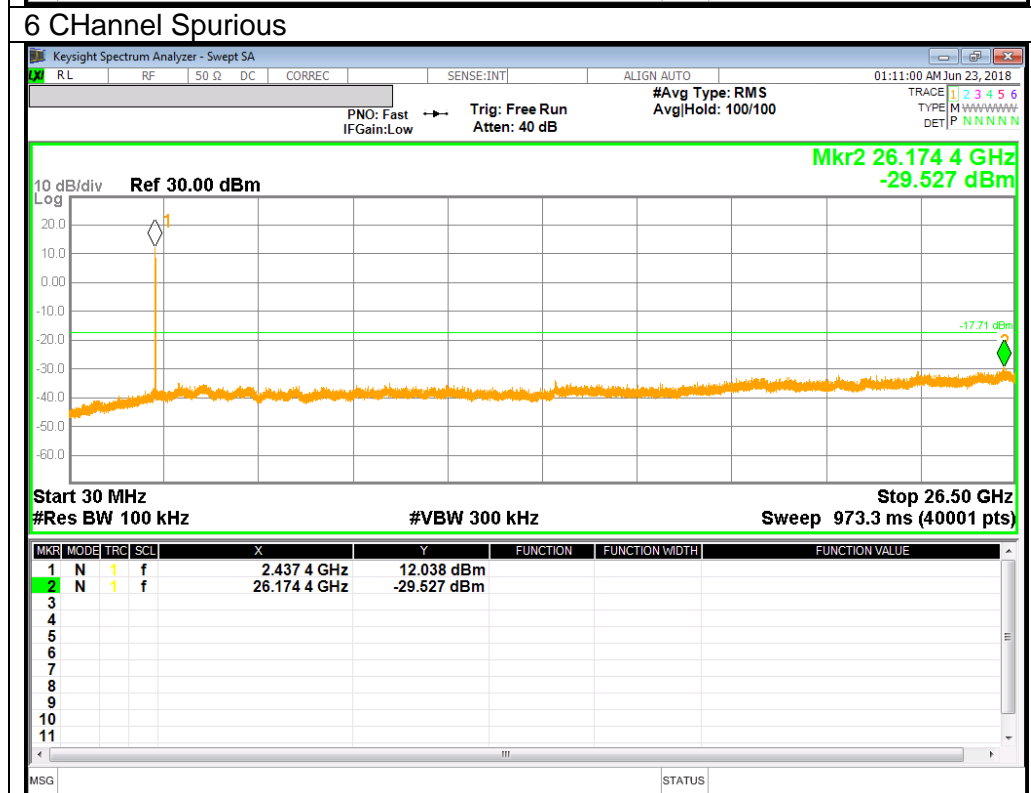
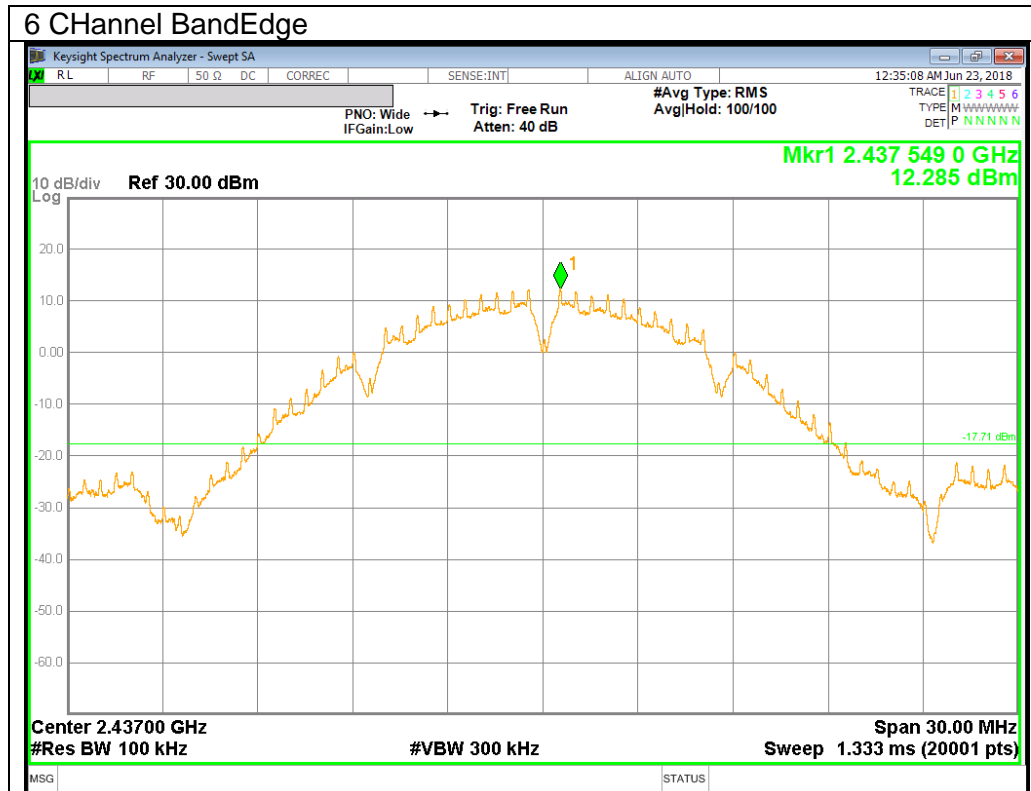

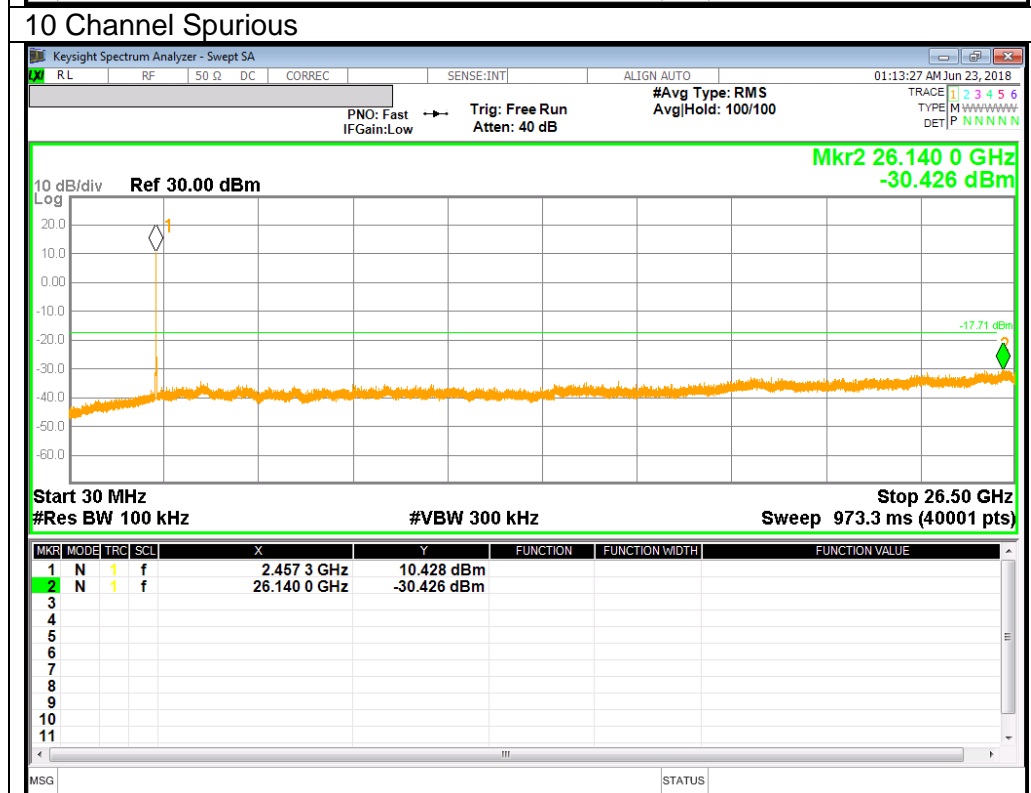
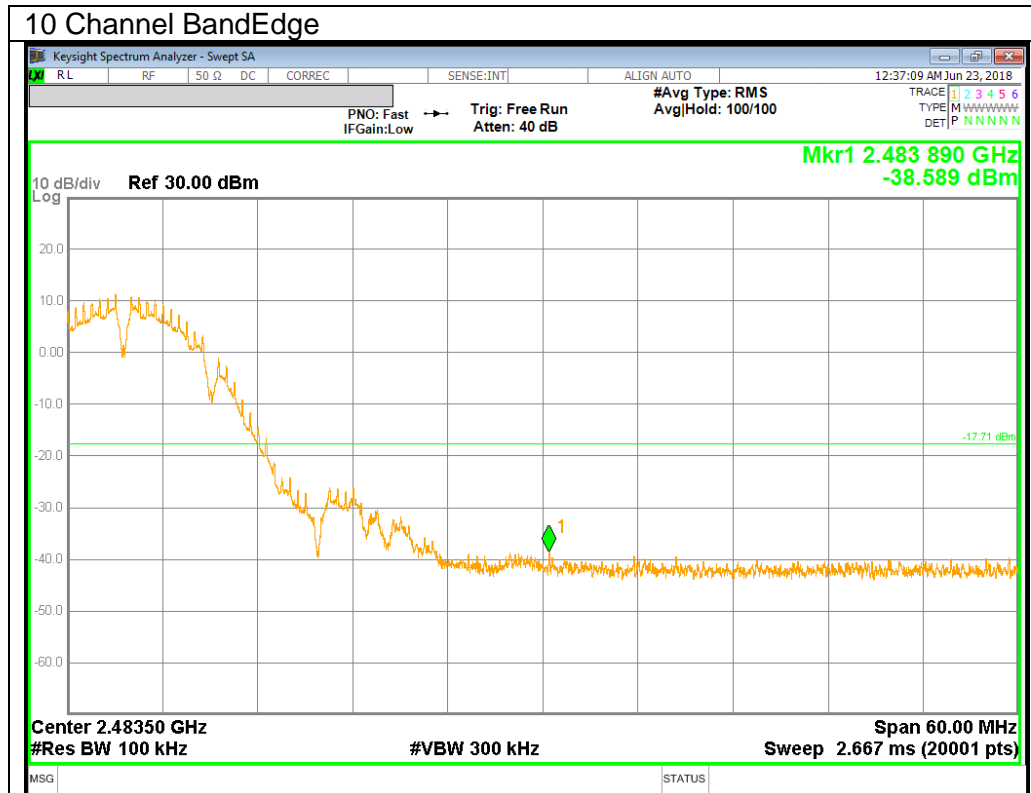

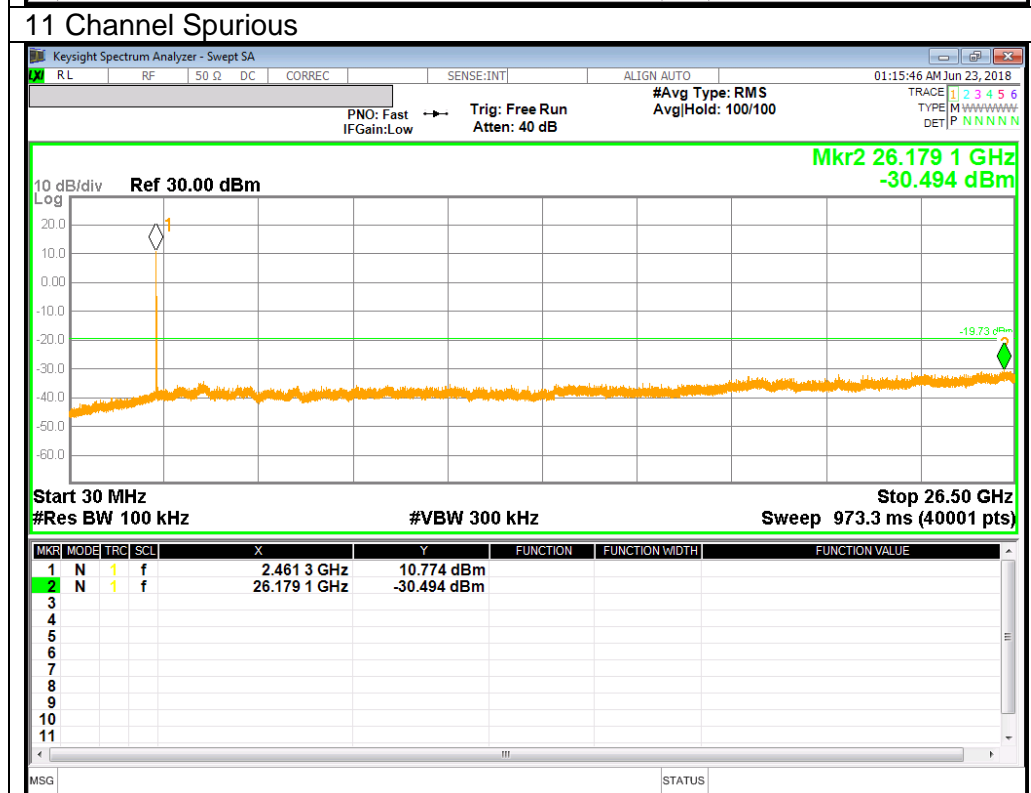
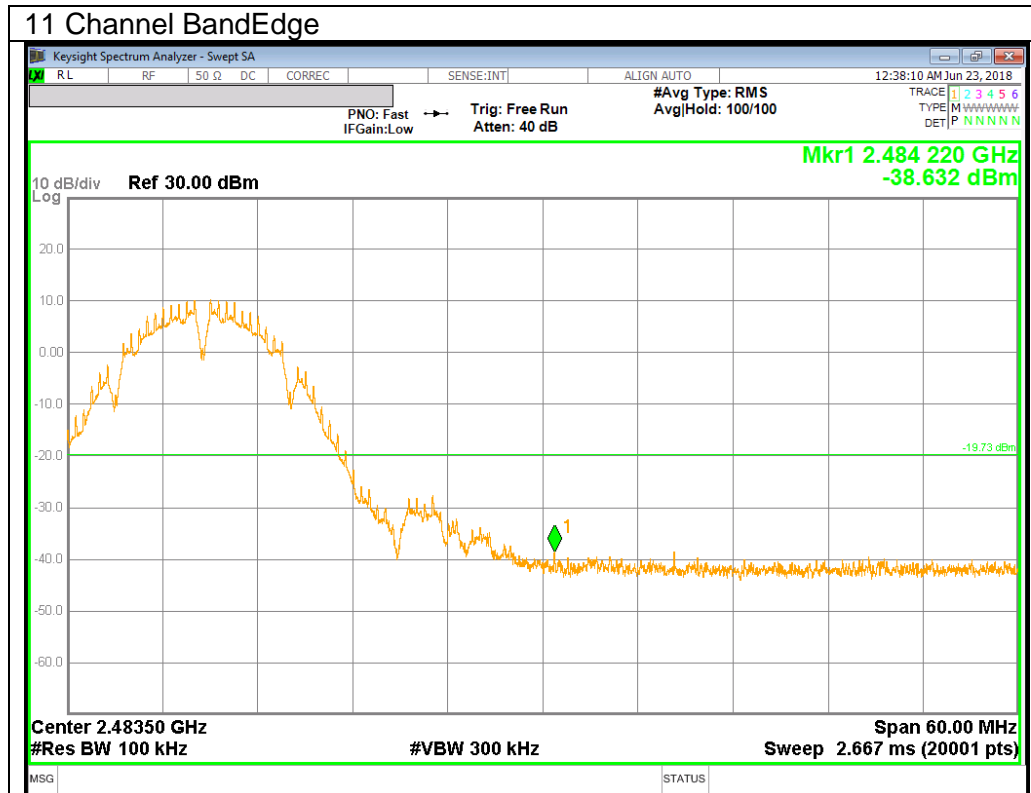

10.4.2.802.11g MODE IN THE 2.4 GHz BAND

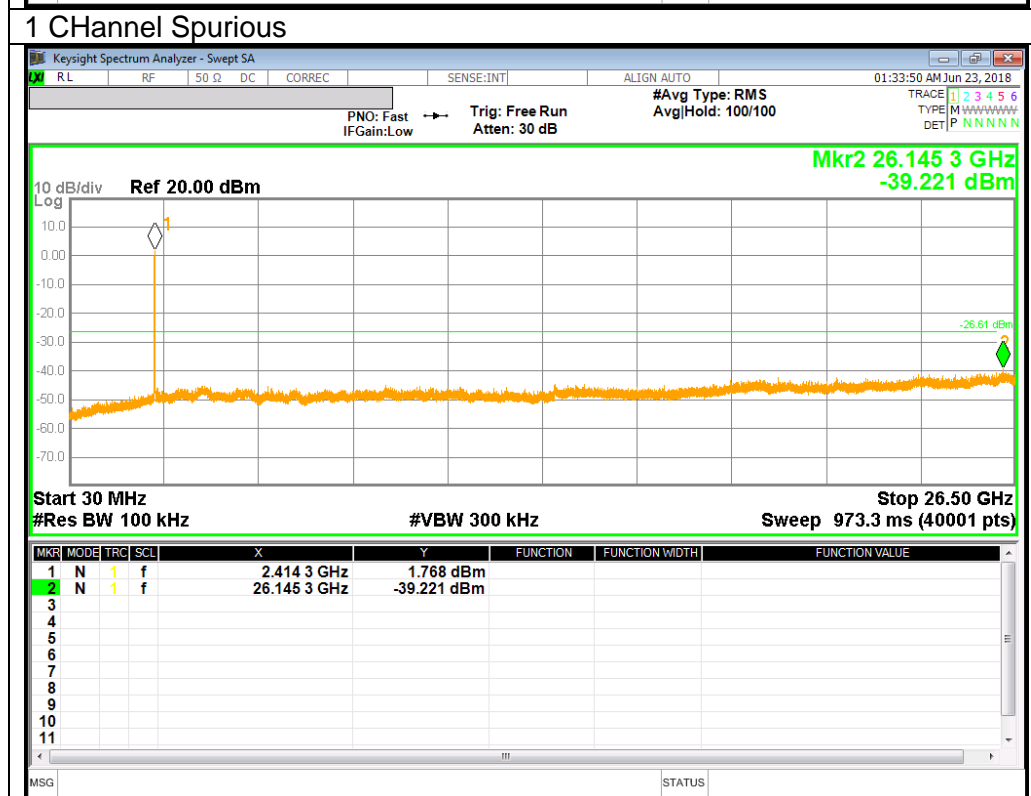
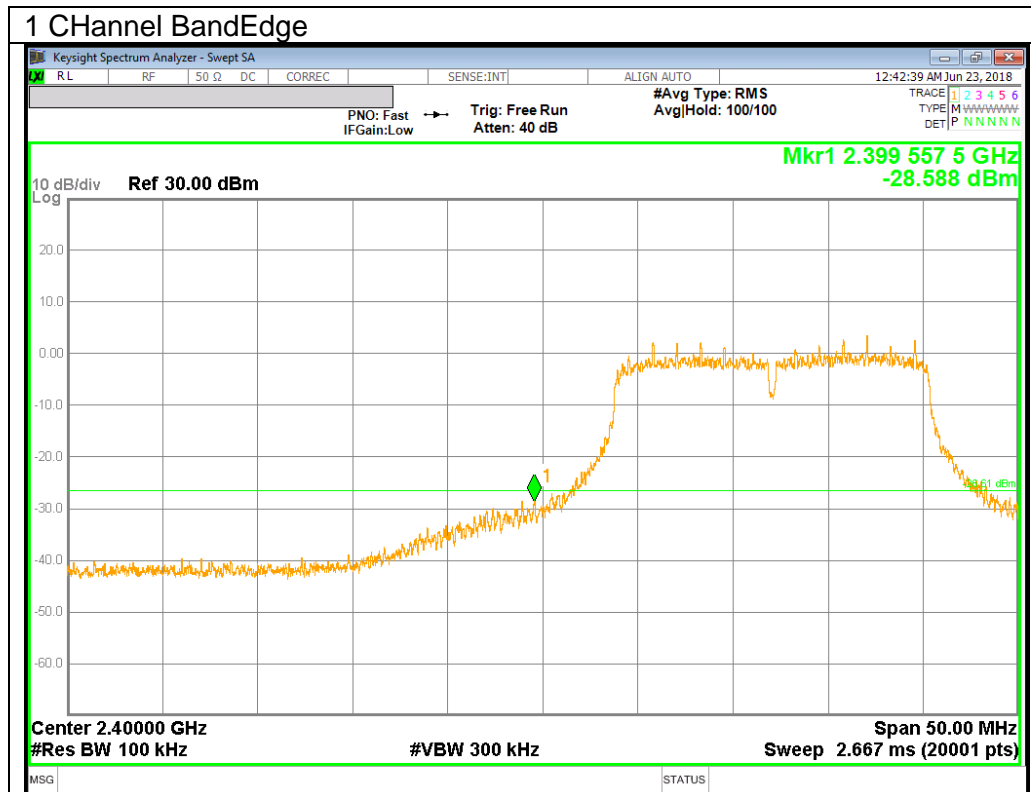

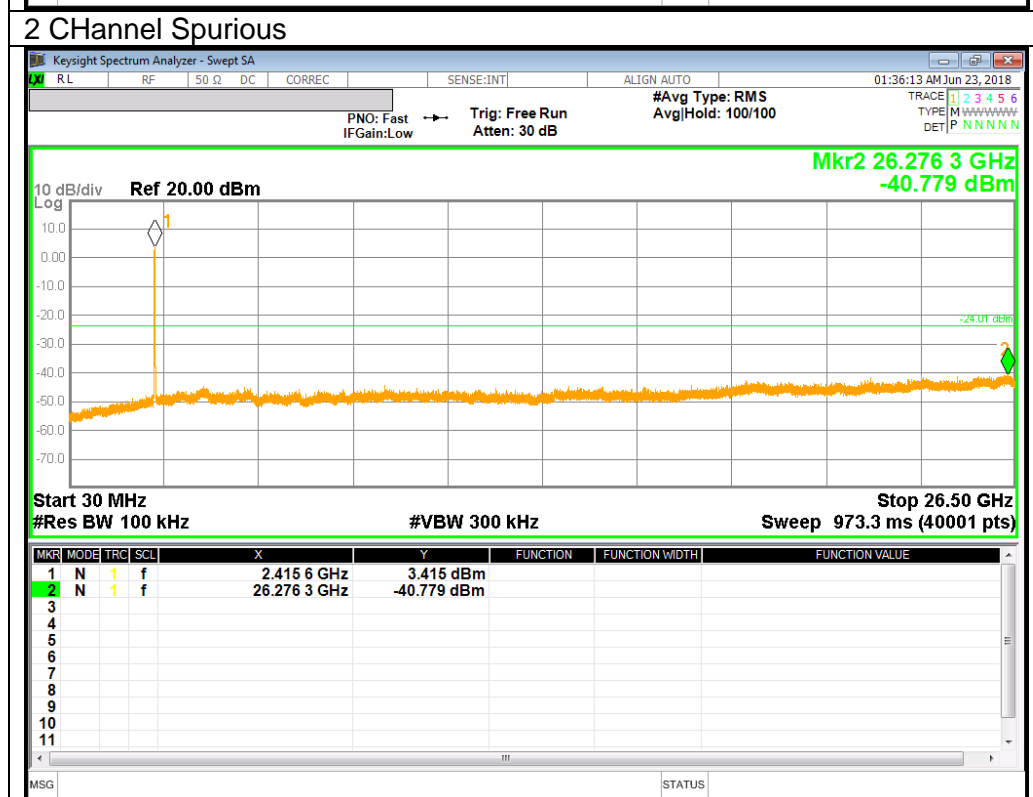
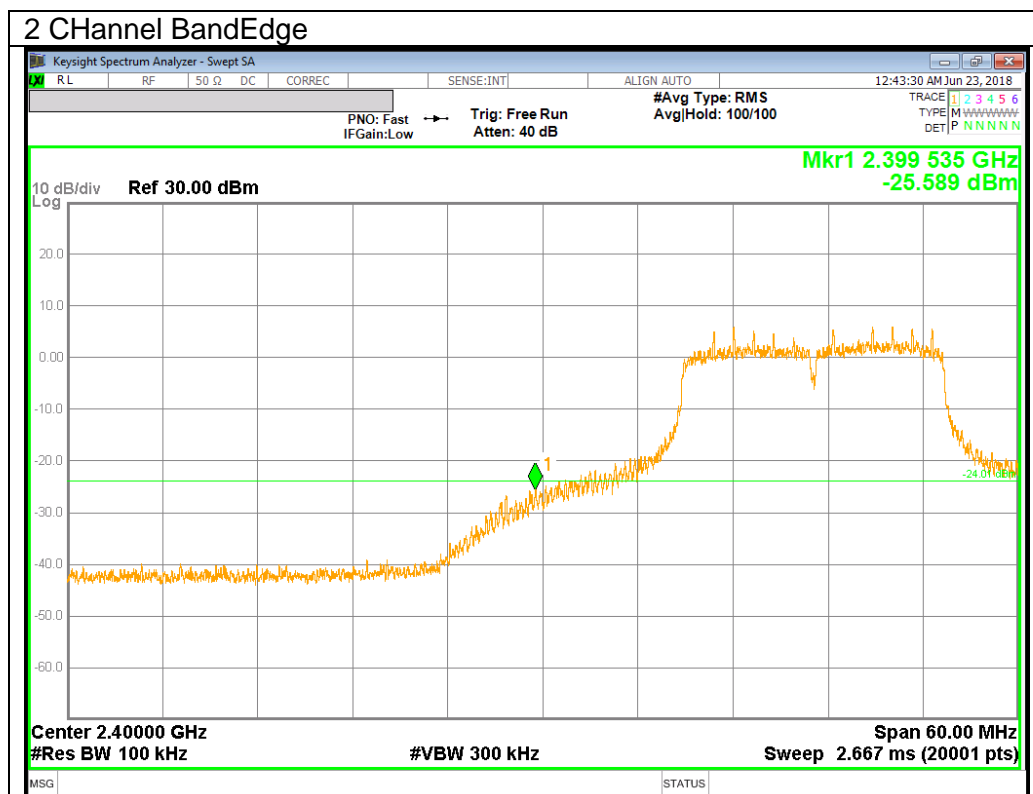

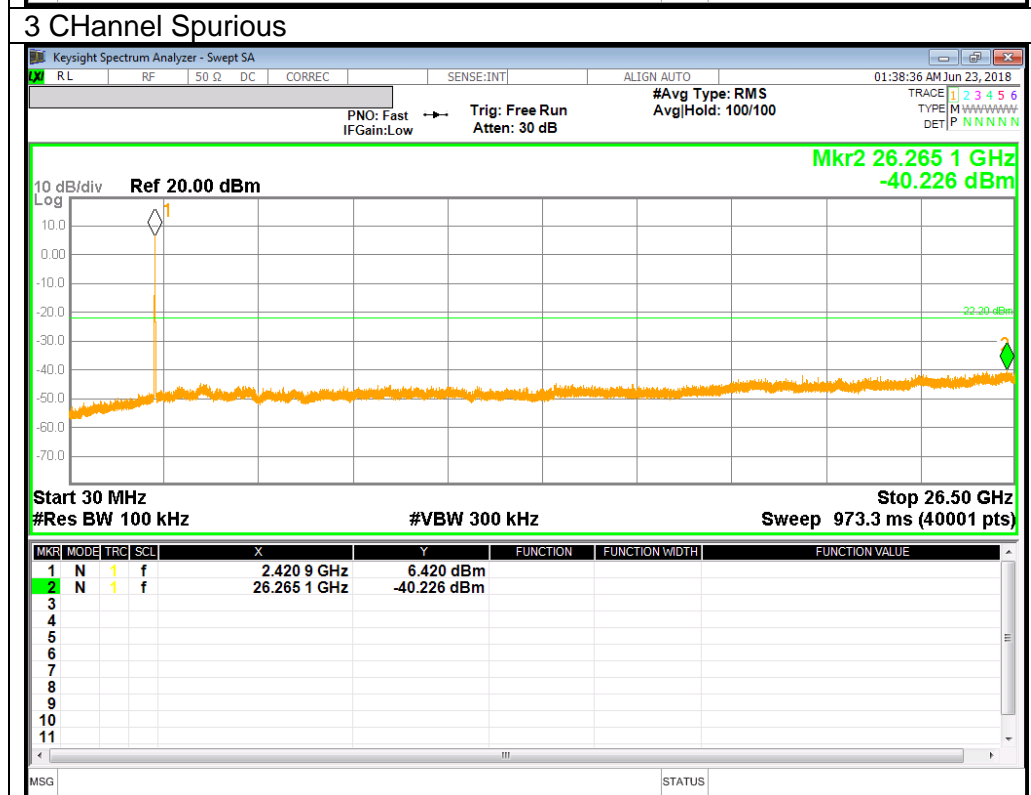
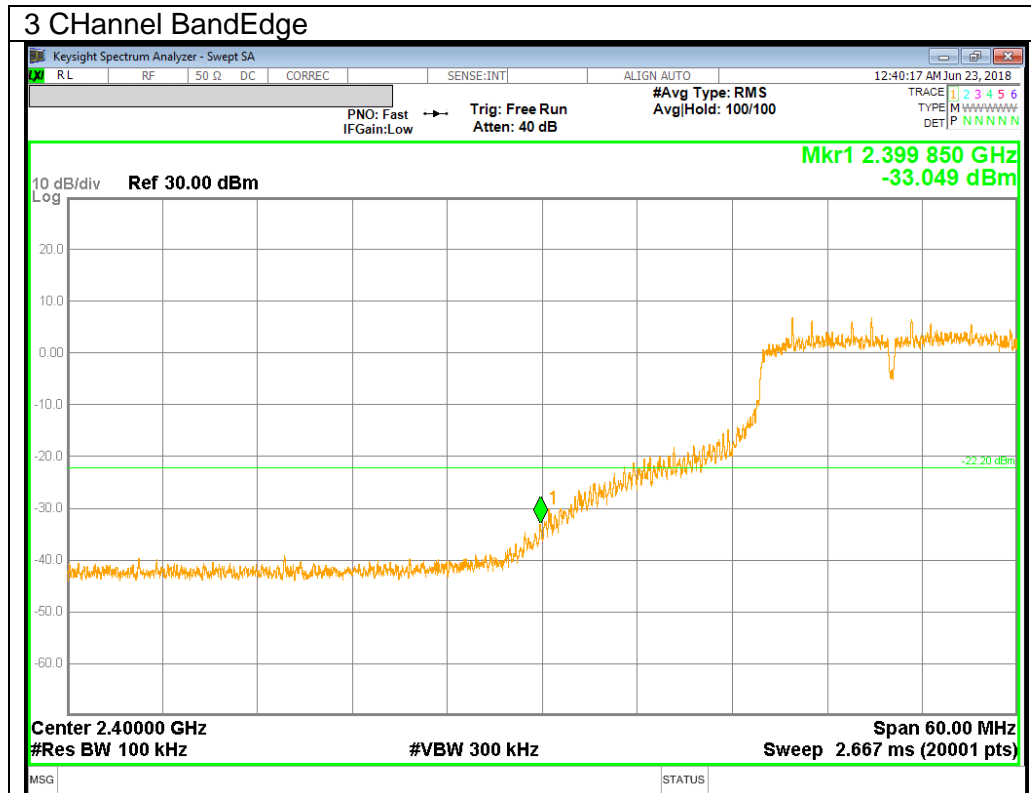

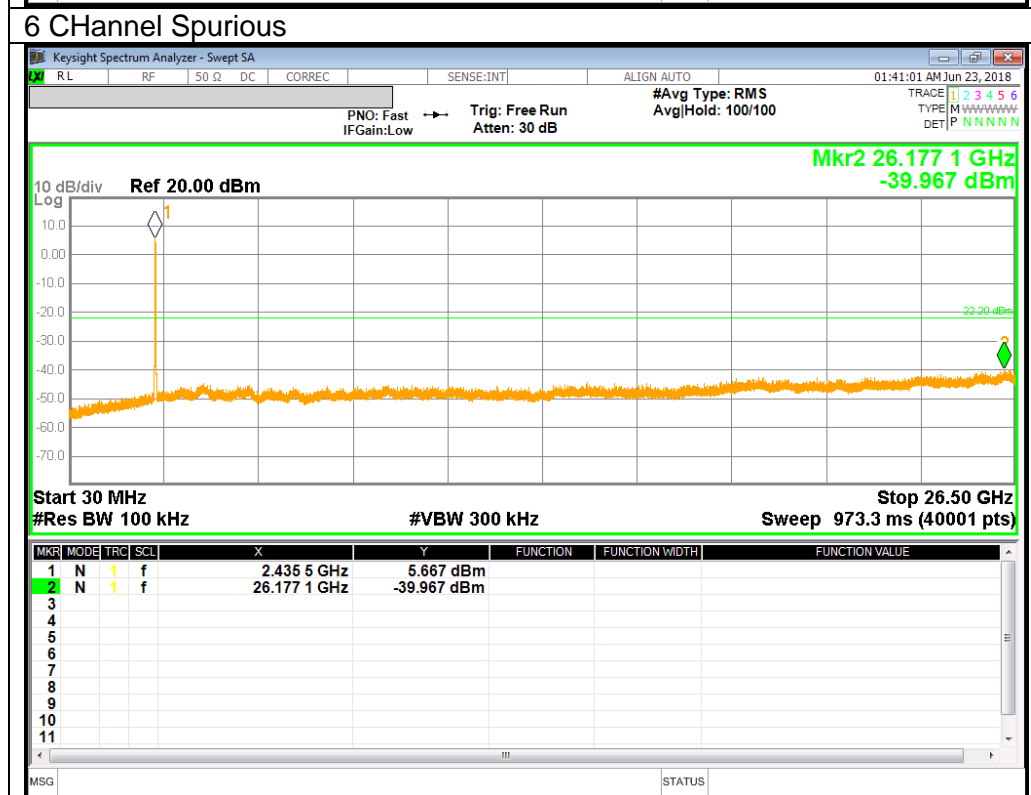
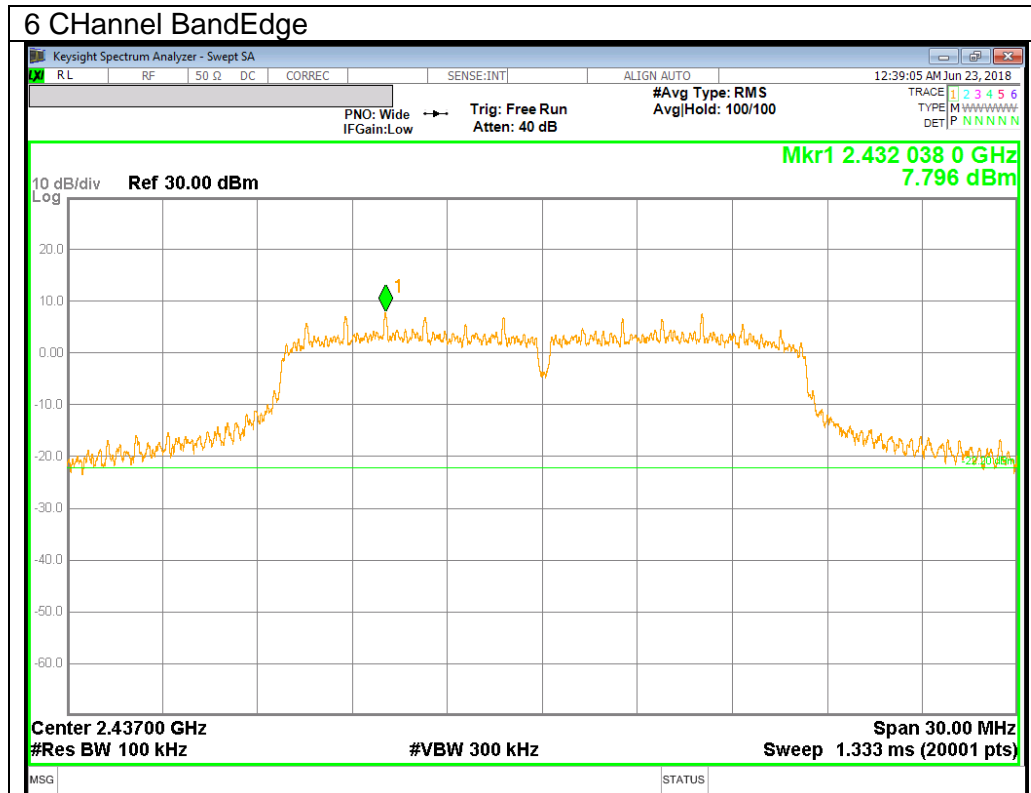

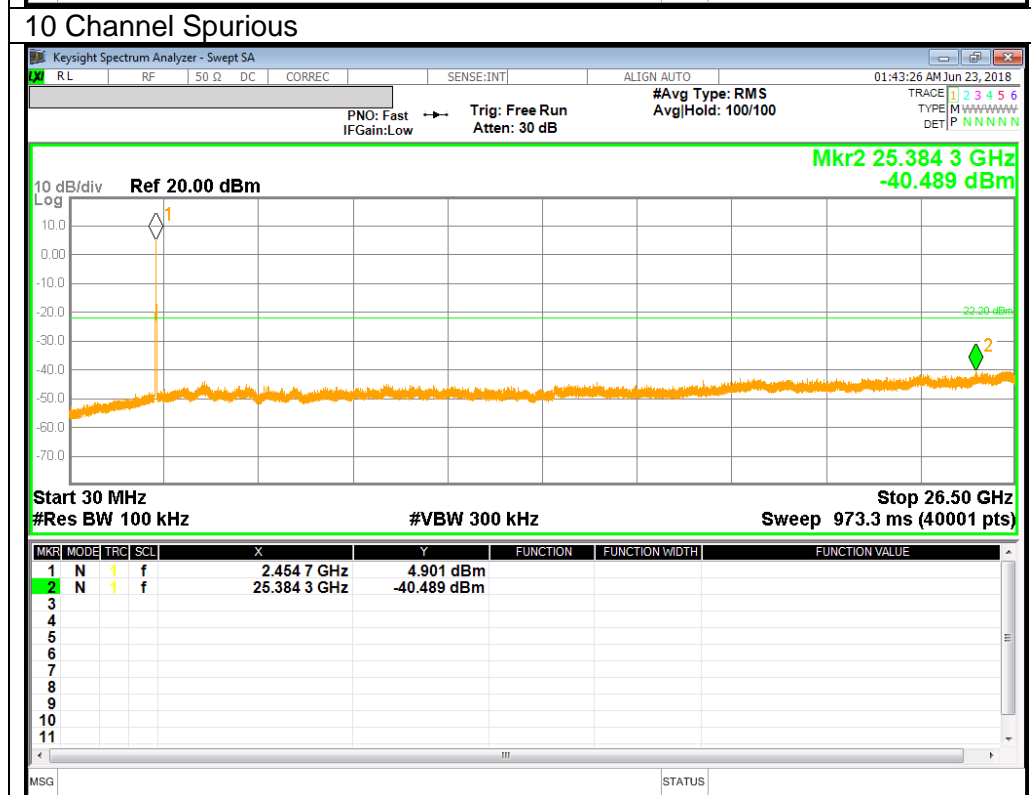
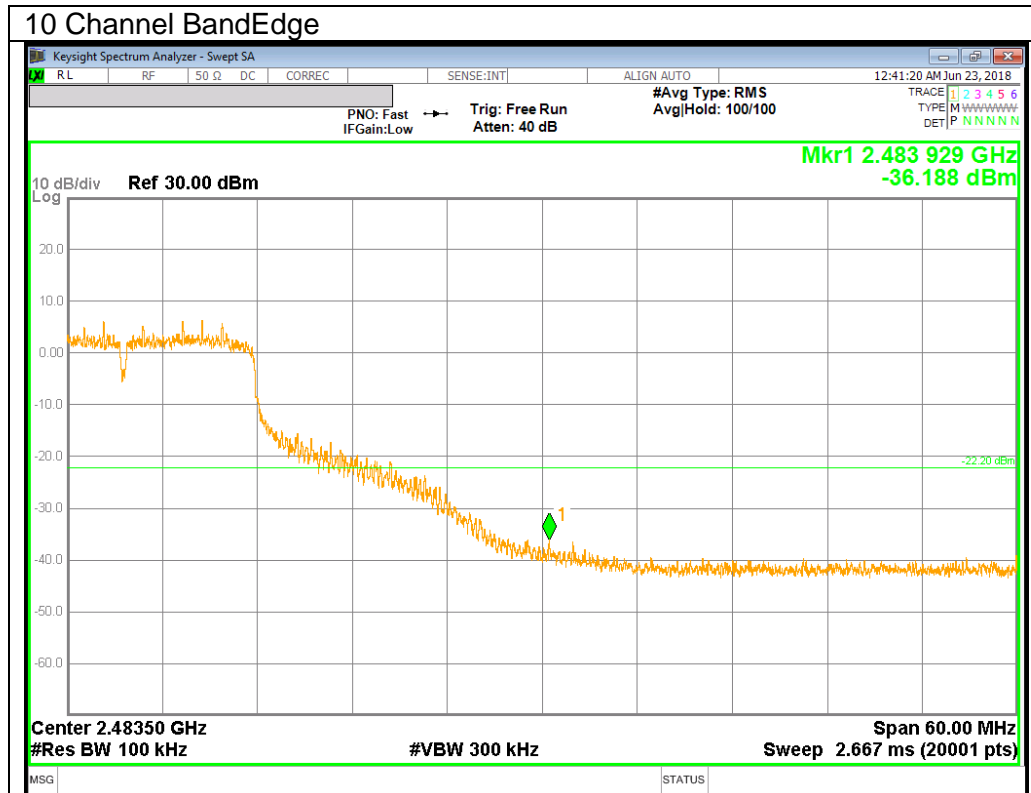

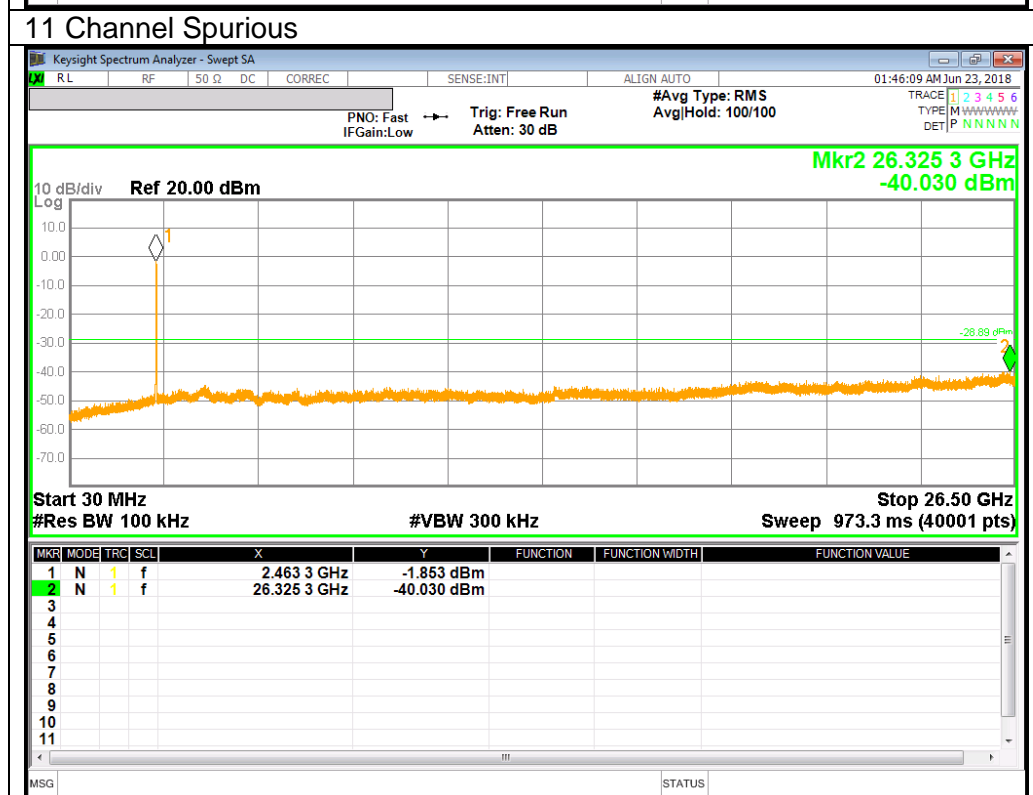
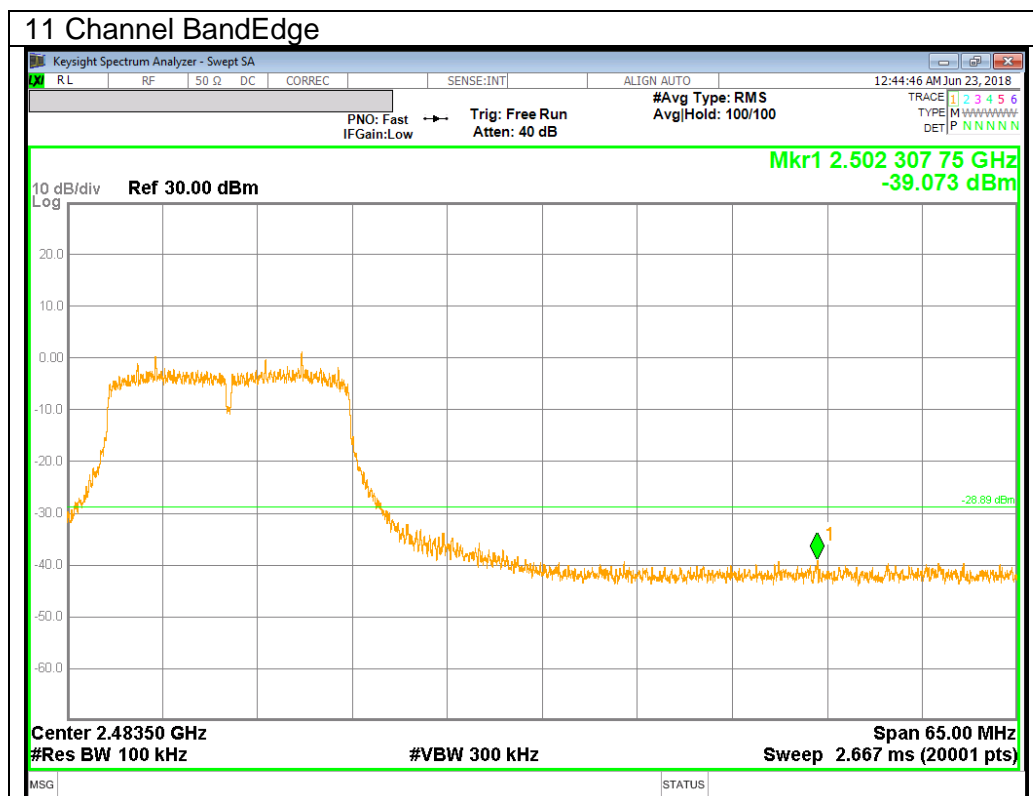

10.4.3.802.11n HT20 MODE IN THE 2.4 GHz BAND

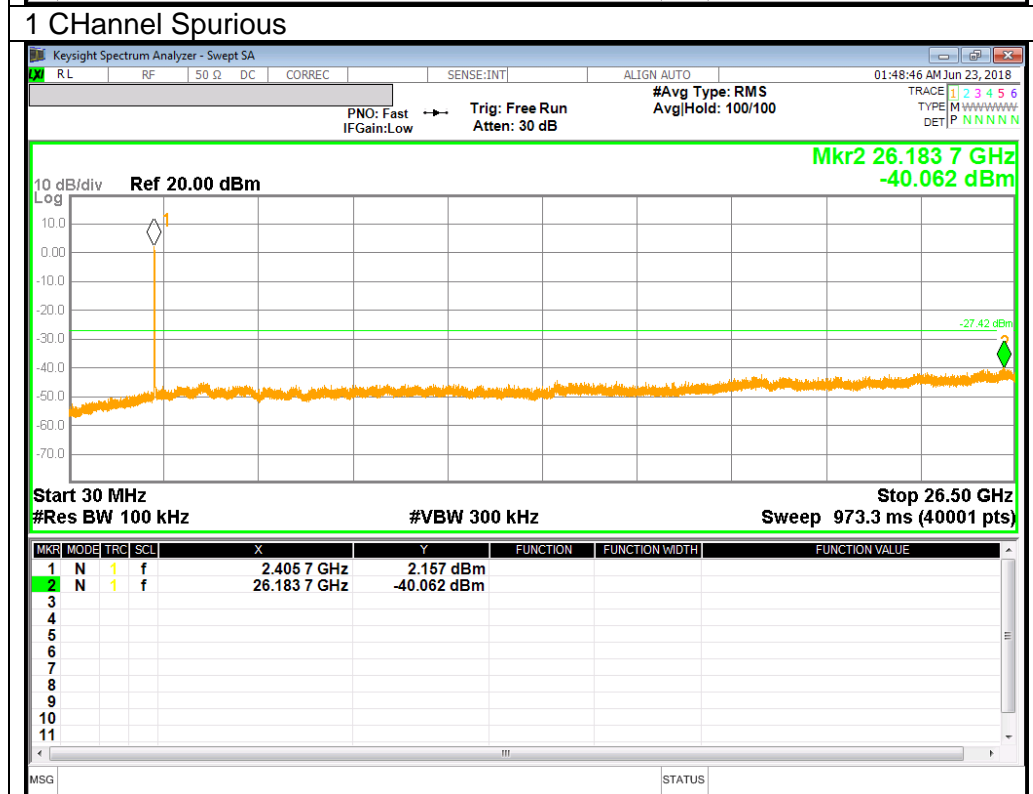
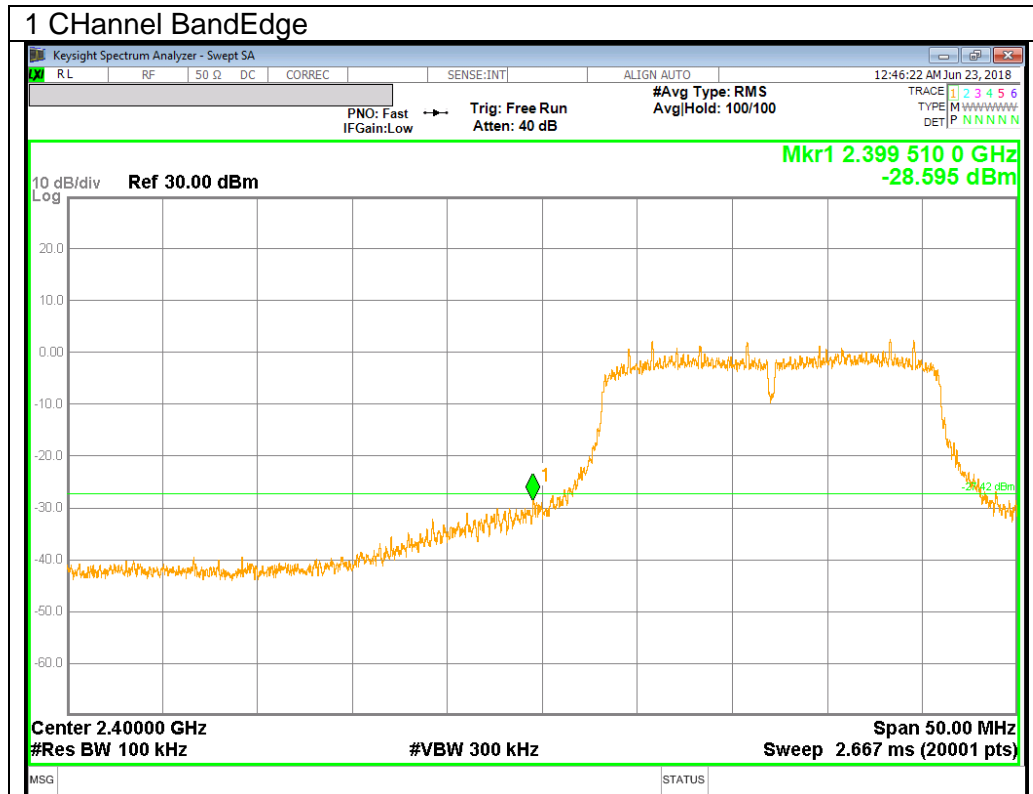

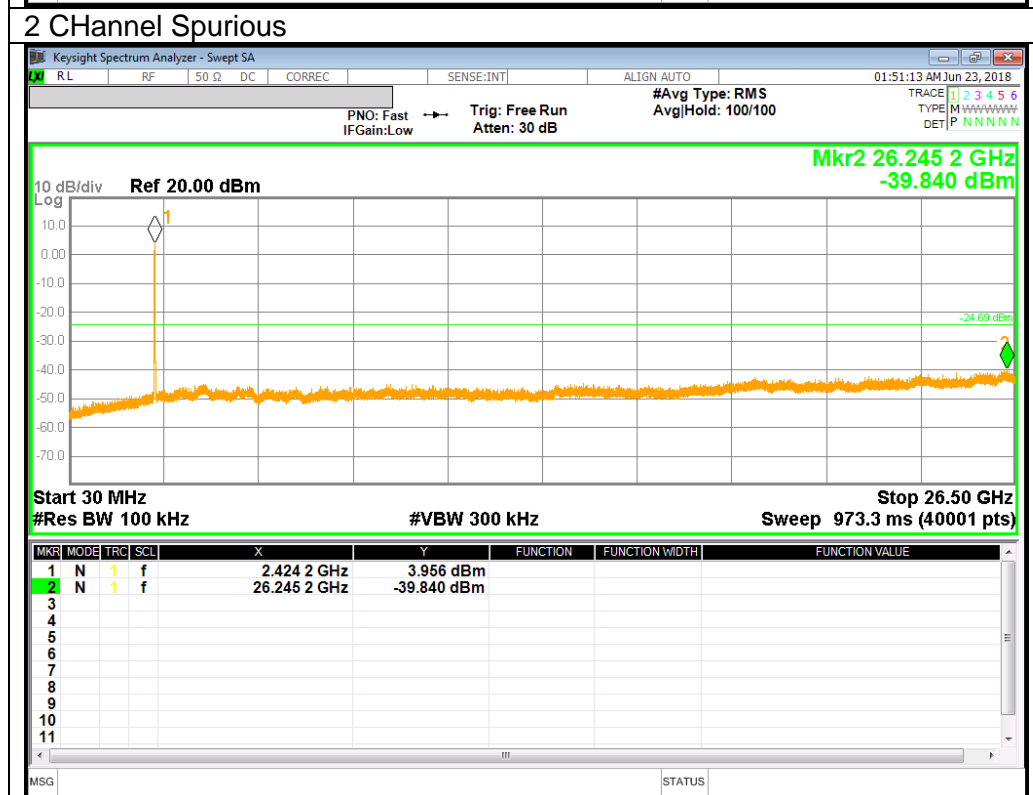
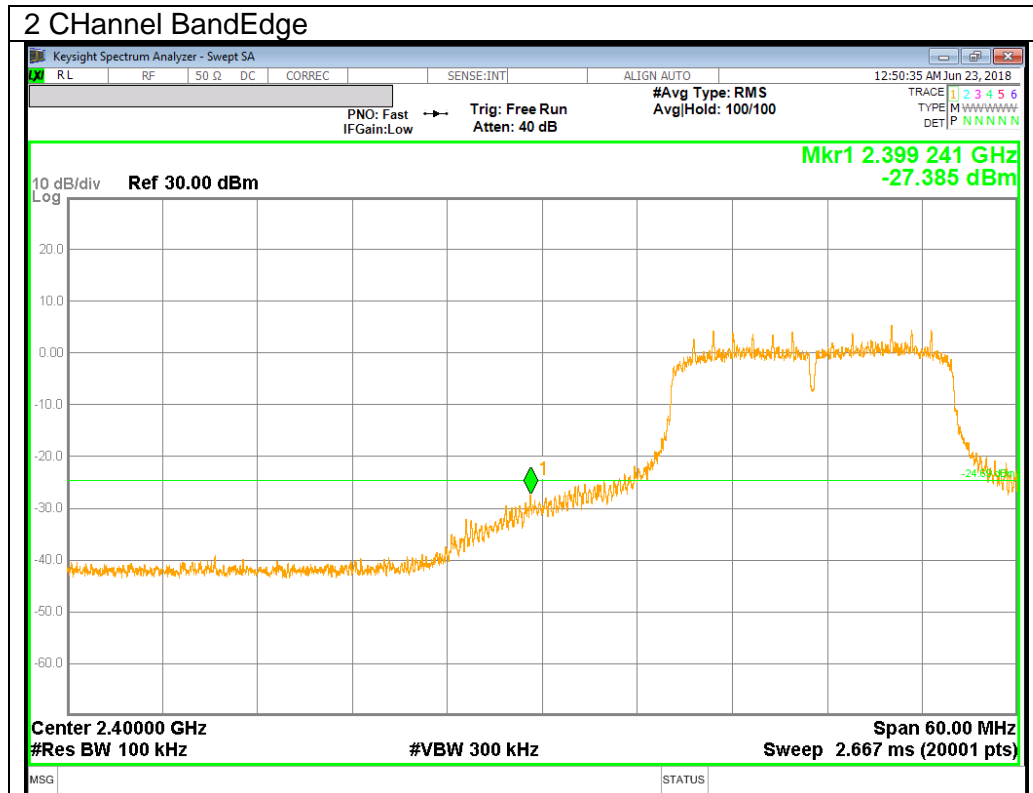

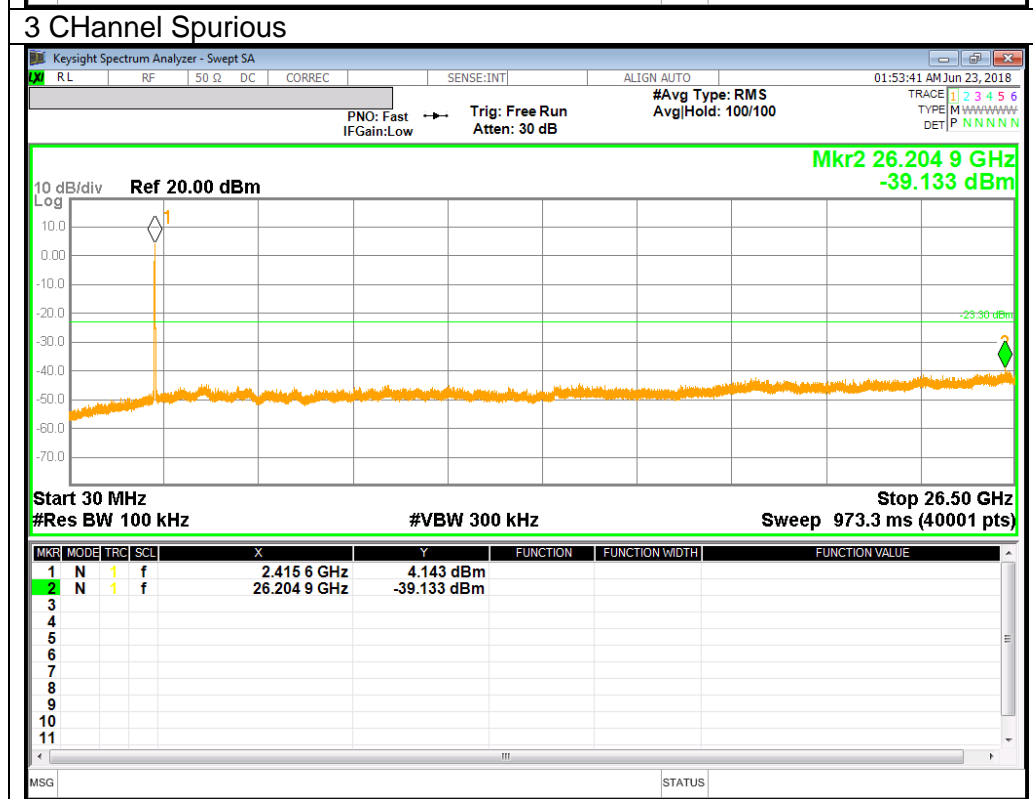
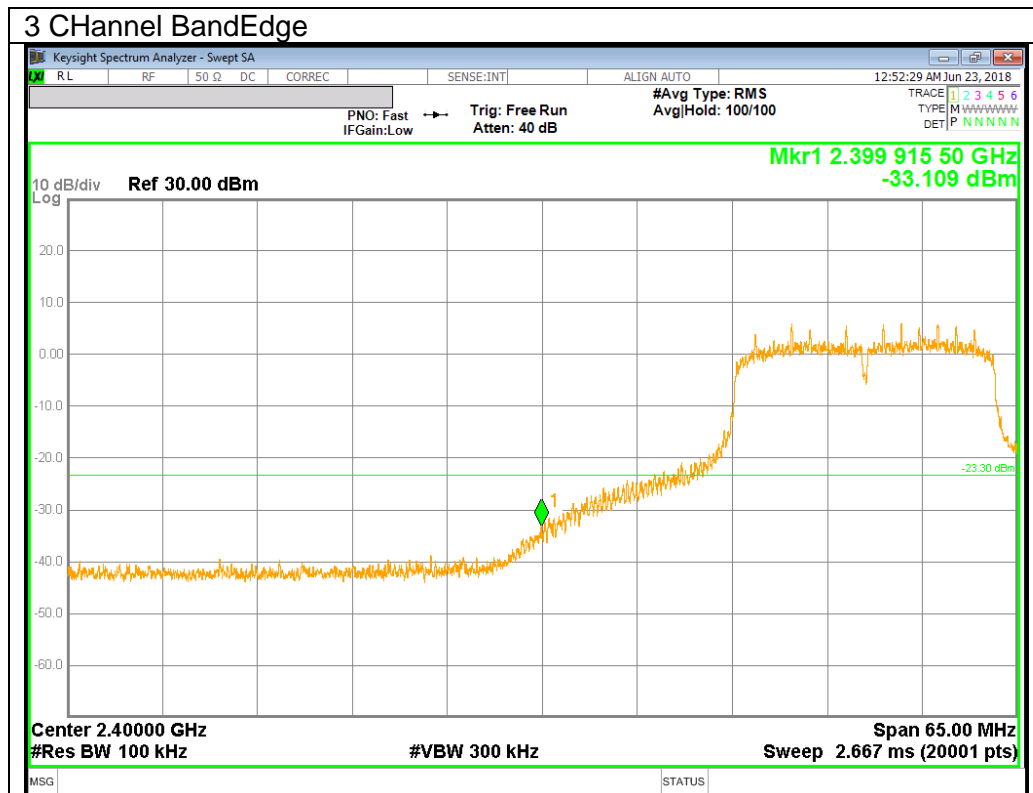

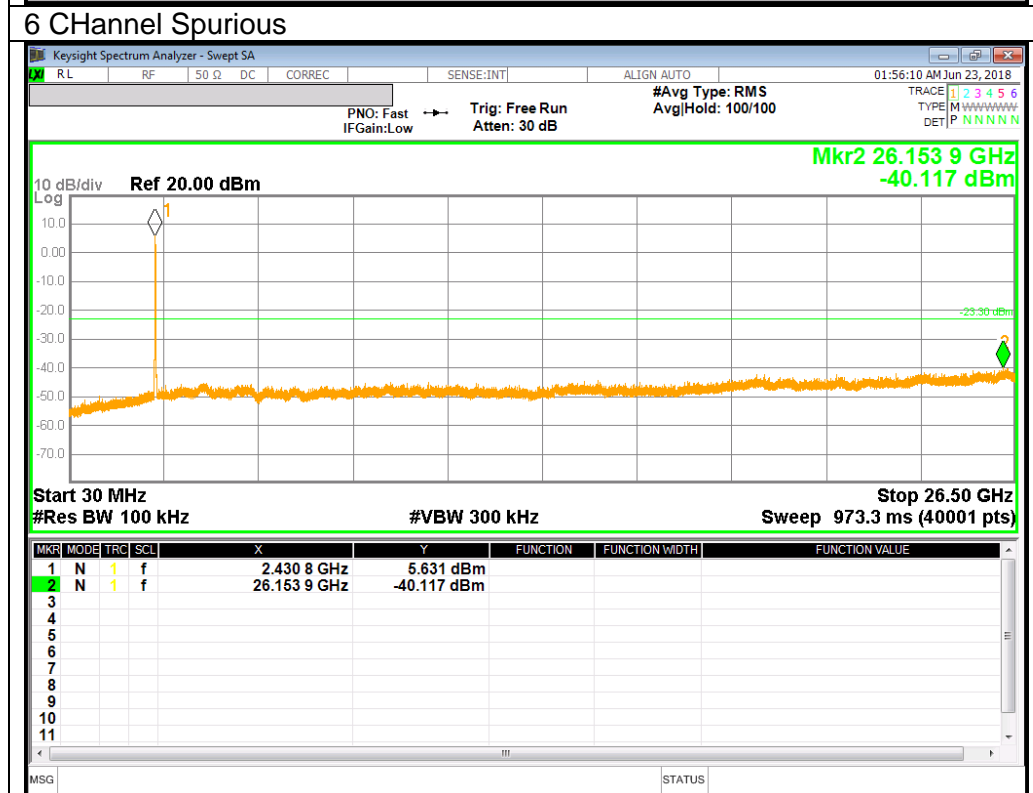
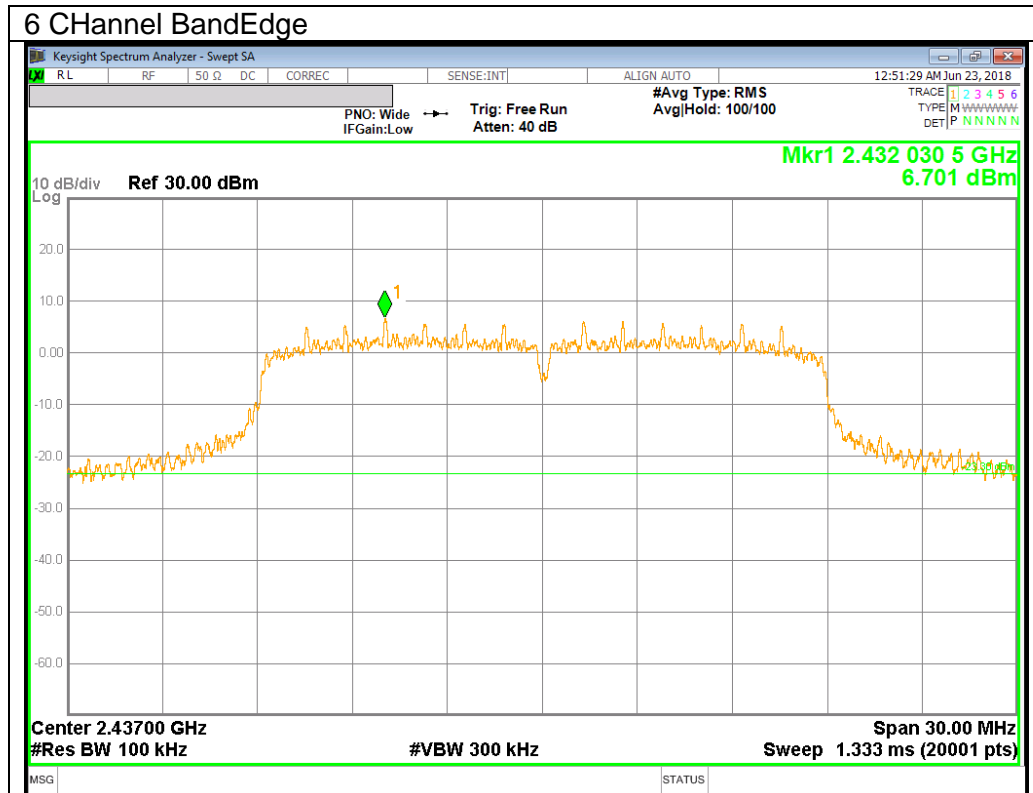

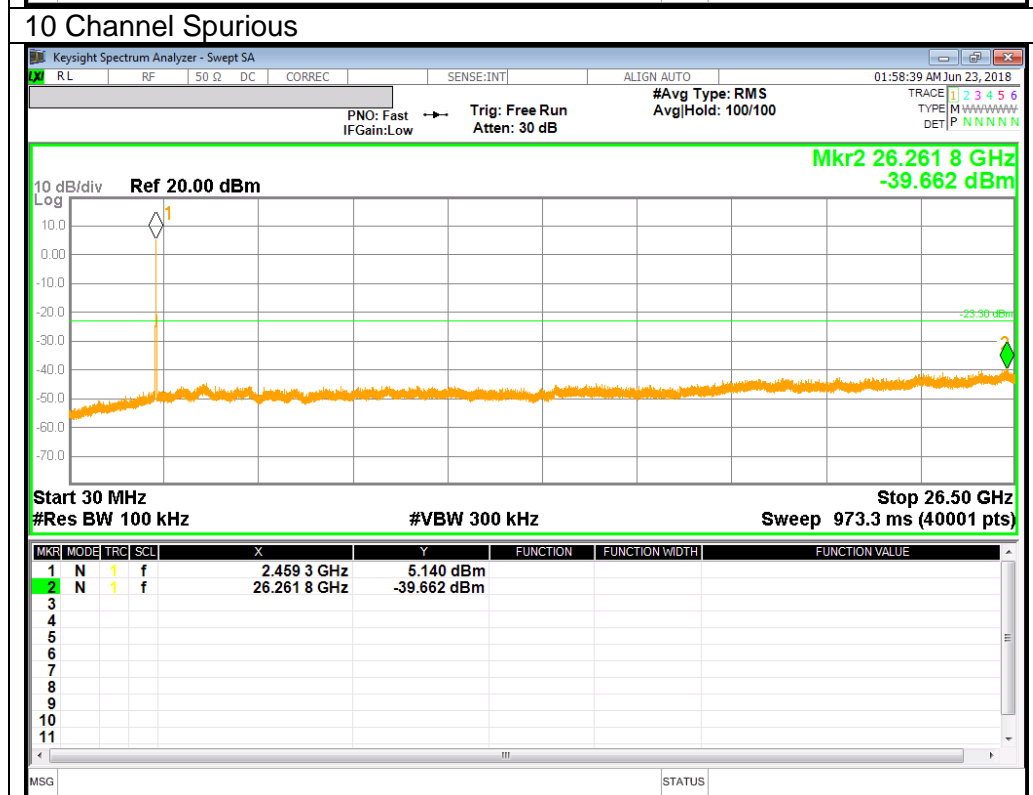
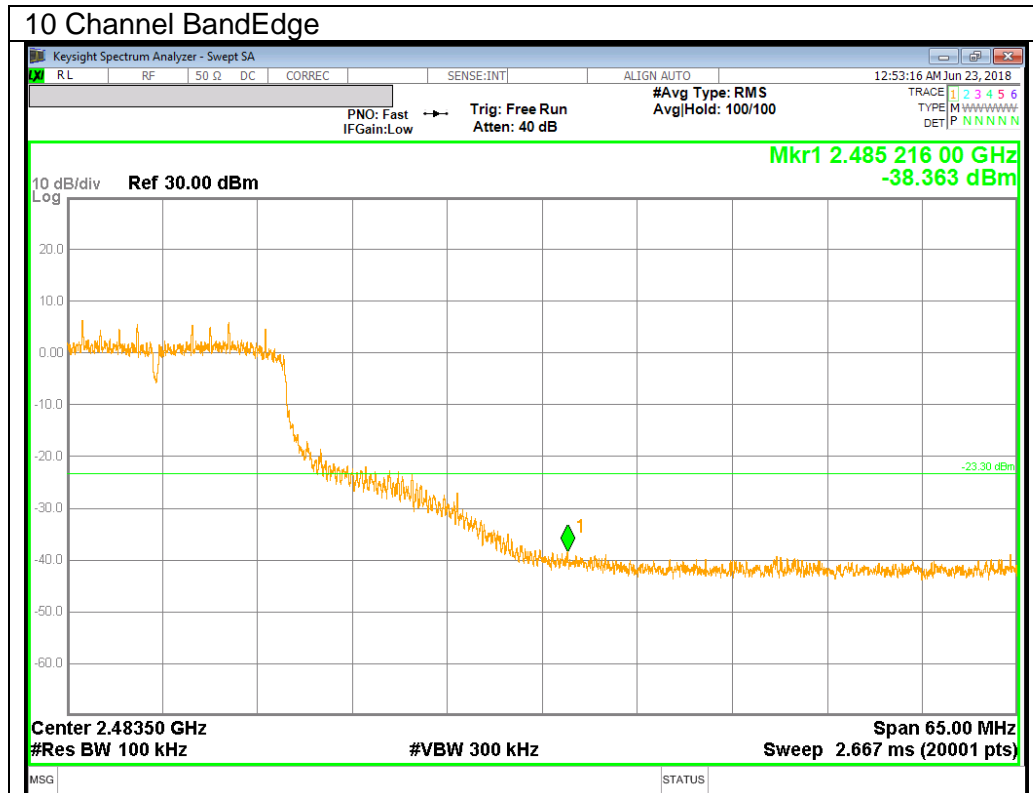

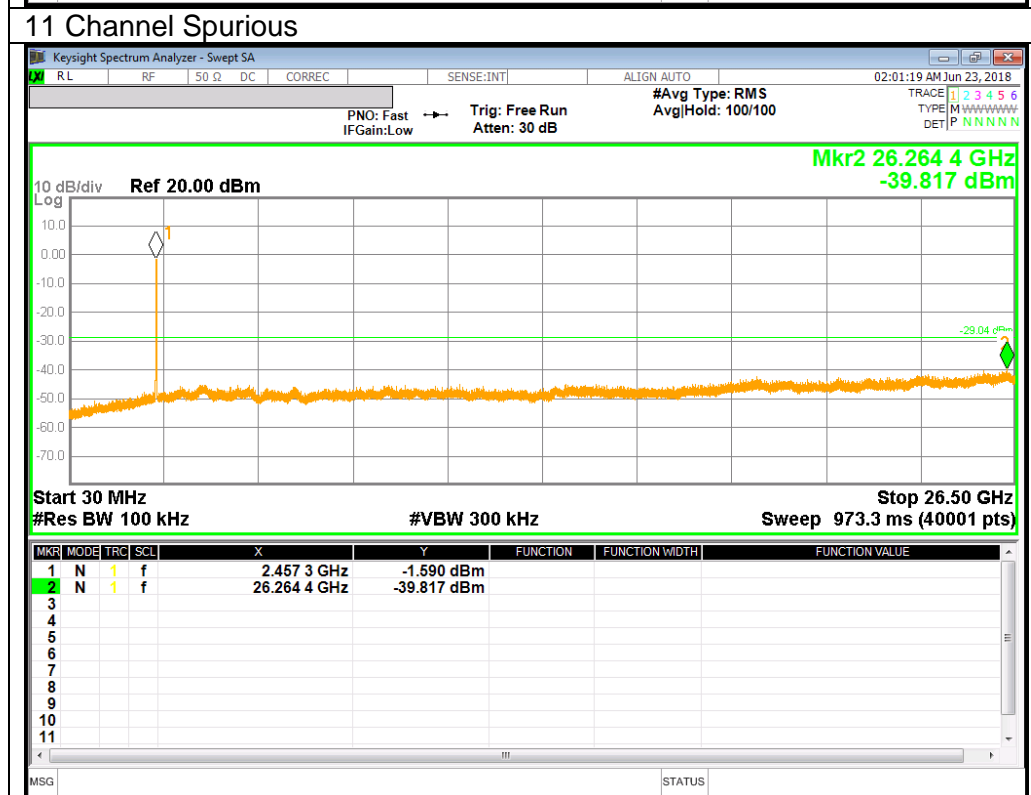
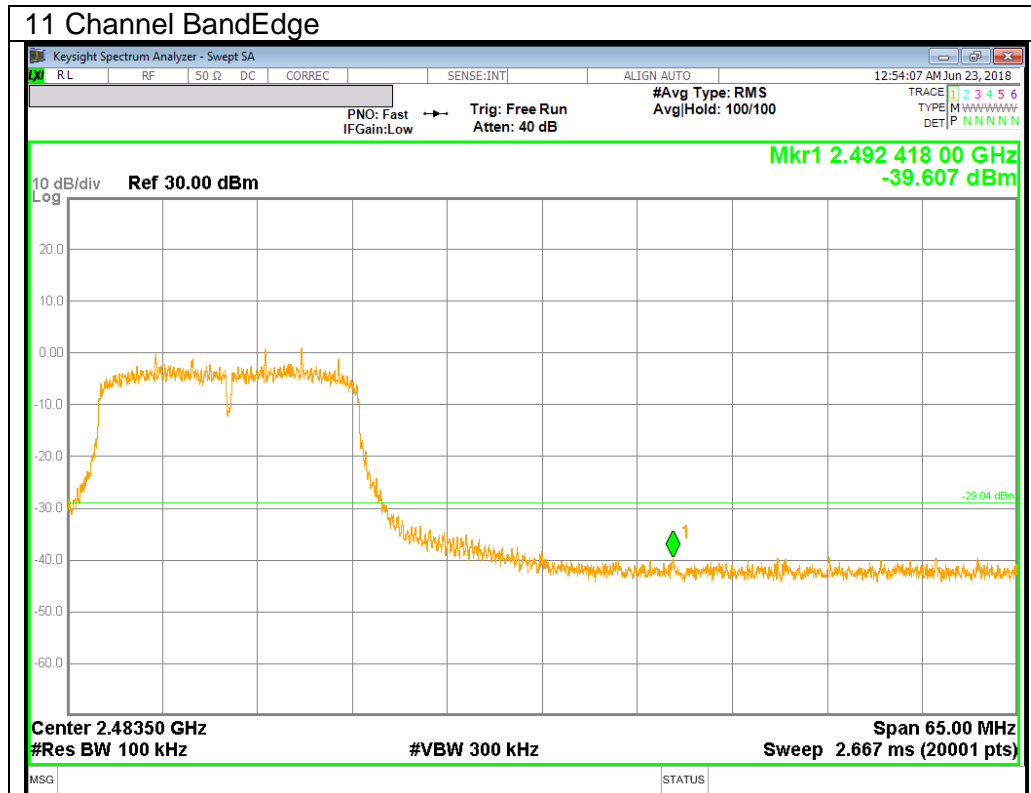

11. RADIATED TEST RESULTS

11.1. LIMITS AND PROCEDURE

LIMITS

FCC §15.205 and §15.209

Limits for radiated disturbance of an intentional radiator		
Frequency range (MHz)	Limits (µV/m)	Measurement Distance (m)
0.009 – 0.490	2400 / F (kHz)	300
0.490 – 1.705	24000 / F (kHz)	30
1.705 – 30.0	30	30
30 – 88	100**	3
88 - 216	150**	3
216 – 960	200**	3
Above 960	500	3

** Except as provided in paragraph (g), fundamental emissions from intentional radiators operating under this section shall not be located in the frequency bands 54-72 MHz, 76-88 MHz, 174-216 MHz or 470-806 MHz. However, operation within these frequency bands is permitted under other sections of this part, e.g. §§ 15.231 and 15.241.

TEST PROCEDURE

The EUT is placed on a non-conducting table 80 cm above the ground plane for below 1GHz and 150 cm for above 1GHz. The antenna to EUT distance is 3 meters. The EUT is configured in accordance with ANSI C63.10. The EUT is set to transmit in a continuous mode.

For measurements below 1 GHz the resolution bandwidth is set to 100 kHz for peak detection measurements or 120 kHz for quasi-peak detection measurements. Peak detection is used unless otherwise noted as quasi-peak.

For measurements above 1 GHz the resolution bandwidth is set to 1 MHz; the video bandwidth is set to 3 MHz for peak measurements and add duty cycle factor for average measurements. (Restricted bandedge, Final detection of spurious harmonic emissions)
Duty cycle factor= $10\log(1/x)$ For this sample B mode = 0dB (duty cycle >98%); G mode = 0dB (duty cycle >98%); N mode = 0dB (duty cycle >98%).

Pre-scans to detect harmonic and spurious emissions, the resolution bandwidth is set to 1 MHz; the video bandwidth is set to 30 KHz for peak measurements.

The spectrum from 1 GHz to 26 GHz is investigated with the transmitter set to the lowest, middle, and highest channels in each applicable band.
(From 30MHz to 1GHz, test was performed with the EUT set to transmit at the channel with highest output power)

The frequency range of interest is monitored at a fixed antenna height and EUT azimuth. The EUT is rotated through 360 degrees to maximize emissions received. The antenna is scanned from 1 to 4 meters above the ground plane to further maximize the emission. Measurements are made with the antenna polarized in both the vertical and the horizontal positions.

11.2. TRANSMITTER ABOVE 1 GHz

11.2.1.TX ABOVE 1 GHz 802.11b MODE IN THE 2.4 GHz BAND

RESTRICTED BANDEDGE (1 CHANNEL)

HORIZONTAL PEAK AND AVERAGE PLOT

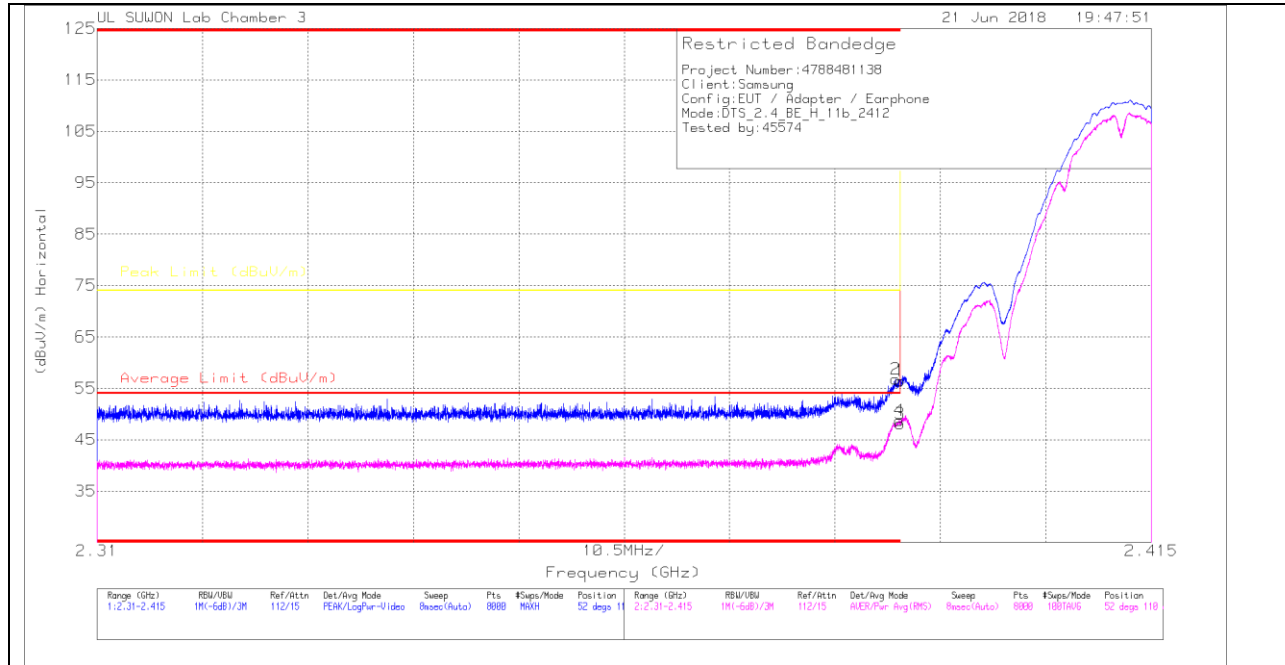

HORIZONTAL DATA

Trace Markers

Marker	Frequency (GHz)	Meter Reading (dBuV)	Det	3117(00205959)	10dB_ATT(dB)	DC Corr (dB)	Corrected Reading (dBuV/m)	Average Limit (dBuV/m)	Margin (dB)	Peak Limit (dBuV/m)	PK Margin (dB)	Azimuth (Degs)	Height (cm)	Polarity
1	* 2.39	47.95	Pk	31.8	-23.3	0	56.45	-	-	74	-17.55	52	110	H
2	* 2.39	48.29	Pk	31.8	-23.3	0	56.79	-	-	74	-17.21	52	110	H
3	* 2.39	39.61	RMS	31.8	-23.3	0	48.11	54	-5.89	-	-	52	110	H
4	* 2.39	40.23	RMS	31.8	-23.3	0	48.73	54	-5.27	-	-	52	110	H

* - indicates frequency in CFR47 Pt 15 / IC RSS-Restricted Band

Pk - Peak detector

RMS - RMS detection

VERTICAL PEAK AND AVERAGE PLOT

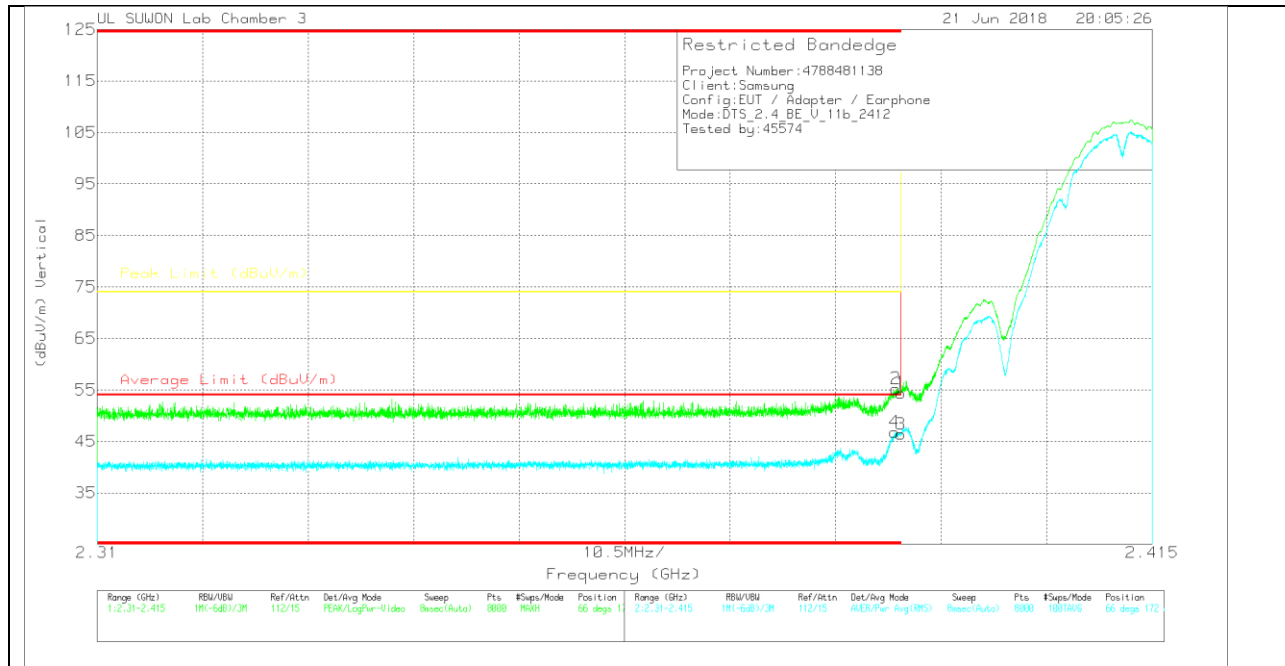

VERTICAL DATA

Trace Markers

Marker	Frequency (GHz)	Meter Reading (dBuV)	Det	3117(00205959)	10dB_ATT(dB)	DC Corr (dB)	Corrected Reading (dBuV/m)	Average Limit (dBuV/m)	Margin (dB)	Peak Limit (dBuV/m)	PK Margin (dB)	Azimuth (Degs)	Height (cm)	Polarity
1	* 2.39	45.91	PK	31.8	-23.3	0	54.41	-	-	74	-19.59	66	172	V
2	* 2.389	46.76	PK	31.8	-23.3	0	55.26	-	-	74	-18.74	66	172	V
3	* 2.39	37.91	RMS	31.8	-23.3	0	46.41	54	-7.59	-	-	66	172	V
4	* 2.389	38.31	RMS	31.8	-23.3	0	46.81	54	-7.19	-	-	66	172	V

* - indicates frequency in CFR47 Pt 15 / IC RSS-Restricted Band

PK - Peak detector

RMS - RMS detection

AUTHORIZED BANDEDGE (10 CHANNEL)

HORIZONTAL PEAK AND AVERAGE PLOT

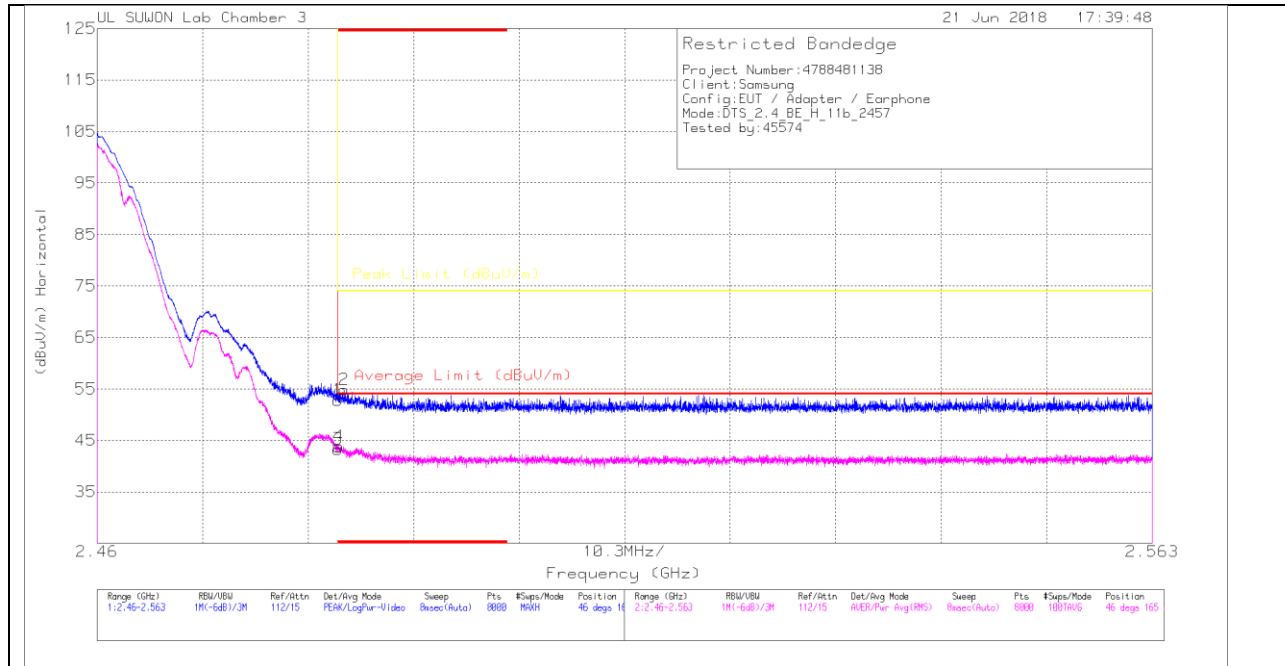

HORIZONTAL DATA

Trace Markers

Marker	Frequency (GHz)	Meter Reading (dBuV)	Det	311700005959	1008_ATT[dB]	DC Corr (dB)	Corrected Reading (dBuV/m)	Average Limit (dBuV/m)	Margin (dB)	Peak Limit (dBuV/m)	PK Margin (dB)	Azimuth (Degs)	Height (cm)	Polarity
1	* 2.484	43.71	Pk	32.1	-23	0	52.81	-	-	74	-21.19	46	165	H
2	* 2.484	45.83	PK	32.1	-23.1	0	54.83	-	-	74	-19.17	46	165	H
3	* 2.484	34.19	RMS	32.1	-23	0	43.29	54	-10.71	-	-	46	165	H
4	* 2.484	34.71	RMS	32.1	-23	0	43.81	54	-10.19	-	-	46	165	H

* - indicates frequency in CFR47 Pt 15 / IC RSS-Restricted Band

Pk - Peak detector

RMS - RMS detection

VERTICAL PEAK AND AVERAGE PLOT

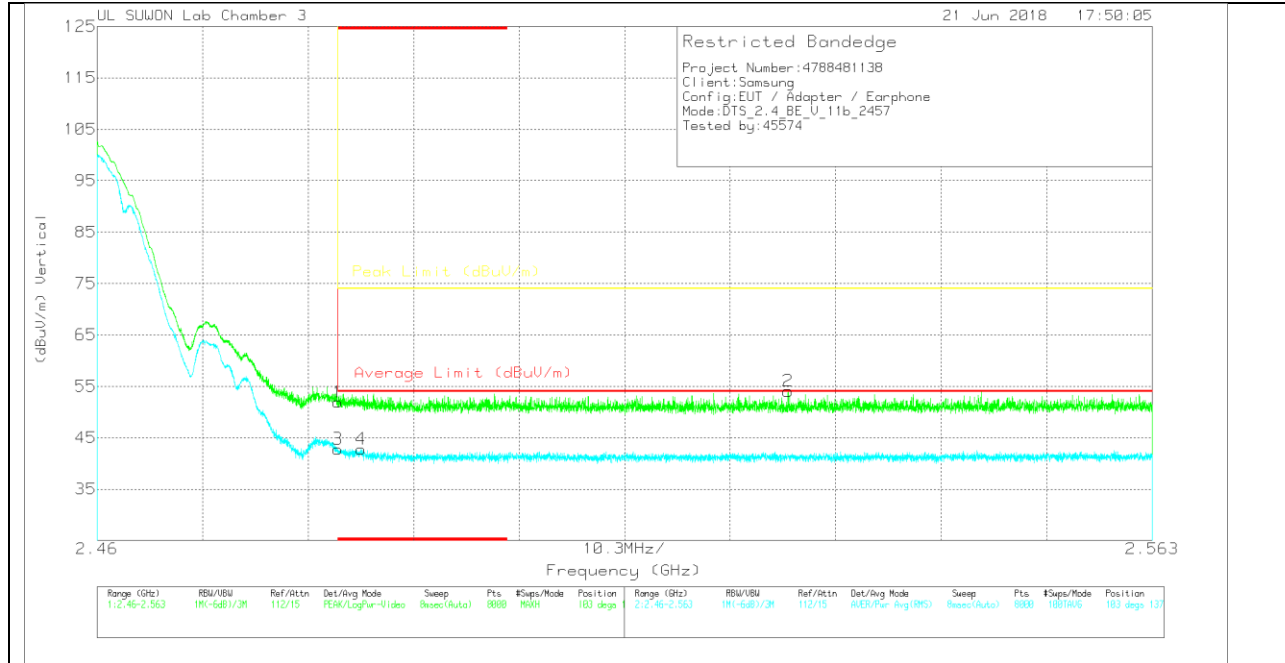

VERTICAL DATA

Trace Markers

Marker	Frequency (GHz)	Meter Reading (dBuV)	Det	3117(00205959)	10dB_ATT[dB]	DC Corr (dB)	Corrected Reading (dBuV/m)	Average Limit (dBuV/m)	Margin (dB)	Peak Limit (dBuV/m)	PK Margin (dB)	Azimuth (Degs)	Height (cm)	Polarity
1	* 2.484	42.78	Pk		-23	0	51.88	-	-	74	-22.12	103	137	V
2	2.527	44.96	Pk		-23	0	54.06	-	-	74	-19.94	103	137	V
3	* 2.484	33.68	RMS		-23	0	42.78	54	-11.22	-	-	103	137	V
4	* 2.486	33.79	RMS		-23.1	0	42.79	54	-11.21	-	-	103	137	V

* - indicates frequency in CFR47 Pt 15 / IC RSS-Restricted Band

Pk - Peak detector

RMS - RMS detection

AUTHORIZED BANDEDGE (11 CHANNEL)

HORIZONTAL PEAK AND AVERAGE PLOT

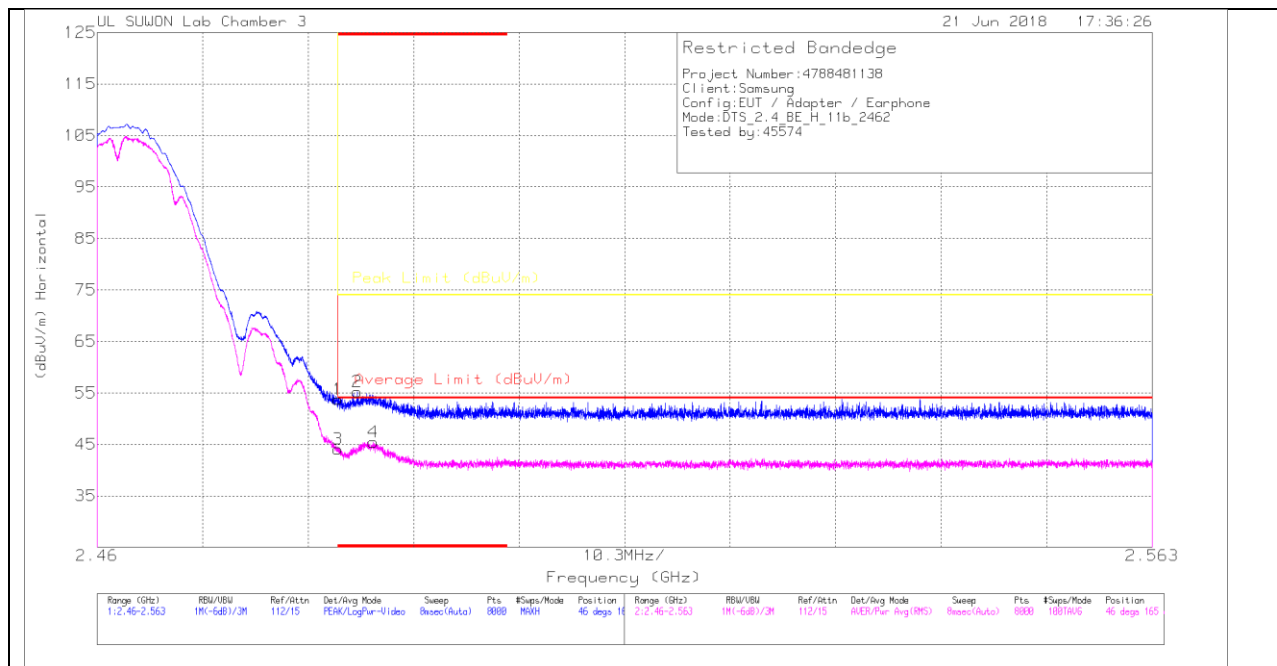

HORIZONTAL DATA

Trace Markers

Marker	Frequency (GHz)	Meter Reading (dBu/m)	Det	3117(00205959)	10dB_ATT[dB]	DC Corr (dB)	Corrected Reading (dBu/m)	Average Limit (dBu/m)	Margin (dB)	Peak Limit (dBu/m)	PK Margin (dB)	Azimuth (Degs)	Height (cm)	Polarity
1	* 2.484	44.66	PK	32.1	-23	0	53.76	-	-	74	-20.24	46	165	H
2	* 2.485	46.19	PK	32.1	-23.1	0	55.19	-	-	74	-18.81	46	165	H
3	* 2.484	34.99	RMS	32.1	-23	0	44.09	54	-9.91	-	-	46	165	H
4	* 2.487	36.41	RMS	32.1	-23.1	0	45.41	54	-8.59	-	-	46	165	H

* - indicates frequency in CFR47 Pt 15 / IC RSS-Restricted Band

PK - Peak detector

RMS - RMS detection