

EMC TEST REPORT



Project No.	LBE20230516	Issue No.	1
Applicant	Name of organization	Samsung Electronics Co., Ltd.	
	Address	(Maetan-dong) 129, Samsung-ro, Yeongtong-gu, Suwon-si, Gyeonggi-do, 16677, Korea	
	Date of receipt	September 18, 2023	
EUT	Type of device	<input checked="" type="checkbox"/> All other receivers subject to Part 15 <input checked="" type="checkbox"/> Class B personal computers and peripherals <input checked="" type="checkbox"/> Other Class B digital devices and peripherals <input type="checkbox"/> FM Broadcast Receiver	
	Equipment authorization	<input checked="" type="checkbox"/> Certification <input type="checkbox"/> Supplier's Declaration of Conformity	
	FCC ID	A3LSMS921B	
	Kind of product	Mobile Phone	
	Model No.	SM-S921B/DS	
	Variant Model No.	Refer to clause 4.6	
	Manufacturer	Samsung Electronics Vietnam Co., Ltd. Yenphong 1 - I.P Yenphong Commune, Yenphong Dist., Bac Ninh Province, Vietnam Samsung Electronics Vietnam THAI NGUYEN Co., Ltd. Yen Binh Industrial Zone Pho Ten Dist., Thai Nguyen Province, Vietnam Samsung Electronics Co., LTD. 302, 3 Gongdan 3-ro, Gumi-si, Gyengsangbuk-do, 39388, Republic of Korea	
Applied Standards	47 CFR Part 15, Subpart B, Class B / ANSI C63.4-2014		
Test Period	September 19, 2023 ~ October 10, 2023		
Issue date	October 19, 2023		
Test result : Complied			
The equipment under test has found to be compliant with the applied standards. (Refer to the attached test result for more detail.)			
Tested by : Sung-Wook Choi 		Reviewed by : Chang-Eun Park 	
The test results in this report only apply to the tested sample. This report must not be reproduced, except in full, without written permission from Global CS center. * Not KOLAS report			
Samsung Electronics Co., Ltd., Global CS Center (Maetan dong) 129, Samsung-ro, Yeongtong-Gu, Suwon-Si, Gyeonggi-Do 16677, Korea			

Table of Contents

1. Report Information	3
1.1 Revision history	3
2. Summary of test results	3
2.1 Emission.....	3
3. General Information	3
3.1 Test facility	3
4. Test Setup configuration	4
4.1 Test Peripherals	4
4.2 EUT operating mode	5
4.3 Details of Sampling.....	5
4.4 Used cable description	6
4.5 Test arrangement	7
4.6 EUT Description.....	10
4.7 EUT Frequencies	10
4.8 Test configuration and condition	11
4.9 Measurement uncertainty	11
5. Results of individual test	12
5.1 Conducted Emission	12
5.2 Radiated Emission.....	17

1. Report Information

1.1 Revision history

No.	Date of Issue	Revised detailed information
Issue 0	October 13, 2023	There are no revisions and this version is basic test report.
Issue 1	October 19, 2023	Deleted LTE & 5G NR bands.(10page 4.6 EUT description) → LTE FDD32, 5G NR n75

※ Remark

Only compliance with Part 15B (Section 15.107 Conducted limits) requirements for the receiver part of the licensed transmitter (equipment code CXX) is covered by this report.

2. Summary of test results

2.1 Emission

The EUT has been tested according to the following specifications:

Applied	Test type	Applied standard	Result
■	Conducted Emission (Mains port)	47 CFR Part 15 Subpart B / ANSI C63.4-2014 (Class B)	Complied
■	Radiated Emission		Complied

3. General Information

3.1 Test facility

The Global CS Center is located on Samsung Electronics Co., Ltd. at (Maetan-dong) 129, Samsung-ro, Yeongtong-gu, Suwon-si, Gyeonggi-do, 16677, Korea.

All testing are performed in Semi-anechoic chambers conforming to the site attenuation characteristics defined by ANSI C63.4, CISPR 32, CISPR 16-1-4 and Shielded rooms. And all antennas are properly calibrated using ANSI C63.5:2017.

The Global CS Center is an ISO/IEC 17025 accredited testing laboratory by the National Radio Research Agency with designation No. KR0004. for EMC testing.

4. Test Setup configuration

4.1 Test Peripherals

The cables used for these peripherals are either permanently attached by the peripheral manufacturer or coupled with an assigned cable as defined below.

The following is a listing of the EUT and peripherals utilized during the performance of EMC test:

Description	Model No.	Serial No.	Manufacturer / Trademark	FCC ID
Mobile Phone	SM-S921B/DS	-	SAMSUNG	A3LSMS921B
Headset	EO-IC100	-	CRESYN	-
Data Cable	EP-DN980	-	RF TECH	-
Laptop Computer	Latitude5580	1WYRYM2	Dell	SDoC
Laptop Computer	Latitude5580	D3HRYM2	Dell	SDoC
Laptop AC Adapter	LA65NM130	5DEA	Dell	SDoC
Laptop AC Adapter	LA65NM130	5B3C	Dell	SDoC
Mouse	AA-SM7PCPB	CN57BA5903634ADV 8JJCD4371	SAMSUNG	SDoC
Mouse	SMH-210UB	TAKGA05788Z	SAMSUNG	SDoC
Router	DIR-806A	RF0F1D8018454	D-Link	SDoC
Router	DIR-806A	RF0F1D8011504	D-Link	SDoC
Travel Adapter	EP-TA800	R37TBEVAAPASEB	SoluM	-
DP Monitor	27UD88	711NTQD8H004	LG	SDoC
DP Monitor Power Supply	LCAP31	EH8NN629490055062	LG	SDoC
DP Cable	NEXT-JCA141	BW2K1709000770	YCN	-

4.2 EUT operating mode

To achieve compliance applied standard specification including CXX, JAB and JBP requirement, the following mode(s) were made during compliance testing:

4.2.1 Conducted Emission

No.	Operating mode
1	Camera (Rear) + Charging (w/TA) + Cellular receiver (LTE FDD26 Center Frequency)
2	Camera (Front) + Charging (w/TA)
3	Video + Audio playback from internal memory + Charging (w/TA)
4	USB data communication with PC (from internal memory)

4.2.2 Radiated Emission

No.	Operating mode
1	Camera (Rear) + Charging (w/TA)
2	Camera (Front) (w/Headset)
3	Video + Audio playback from internal memory (w/Headset)
4	Video + Audio playback from internal memory + Display out (w/ USB to Direct DP cable)
5	USB data communication with PC (from internal memory)

4.3 Details of Sampling

Customer selected, single unit.

4.4 Used cable description

The EUT is configured, installed, arranged and operated in a manner consistent with typical applications. Interface cables/loads/devices are connected to at least one of each type of interface port of the EUT, and where practical, each cable shall be terminated in a device typical of actual usage. The type(s) of interconnecting cables to be used and the interface port (of the EUT) to which these were connected:

Connected cable	Length [m]	Shielded [Y/N]	Note
Data Cable	1.0	Y	From EUT to Laptop Computer or Travel Adapter
Headset	1.2	N	For EUT
Power	1.8	N	From Laptop Computer to AC Adapter
Power	1.5	N	For Laptop AC Adapter
LAN	1.5	N	From Laptop Computer to Router
USB	0.8	Y	From Laptop Computer to Router for DC Power
USB	1.8	Y	From Laptop Computer to Mouse
DP Cable	1.1	Y	From EUT to DP Monitor
Power	1.2	N	From DP Monitor to Power Supply
Power	2.2	N	For DP Monitor Power Supply

4.5 Test arrangement

4.5.1 Conducted Emission

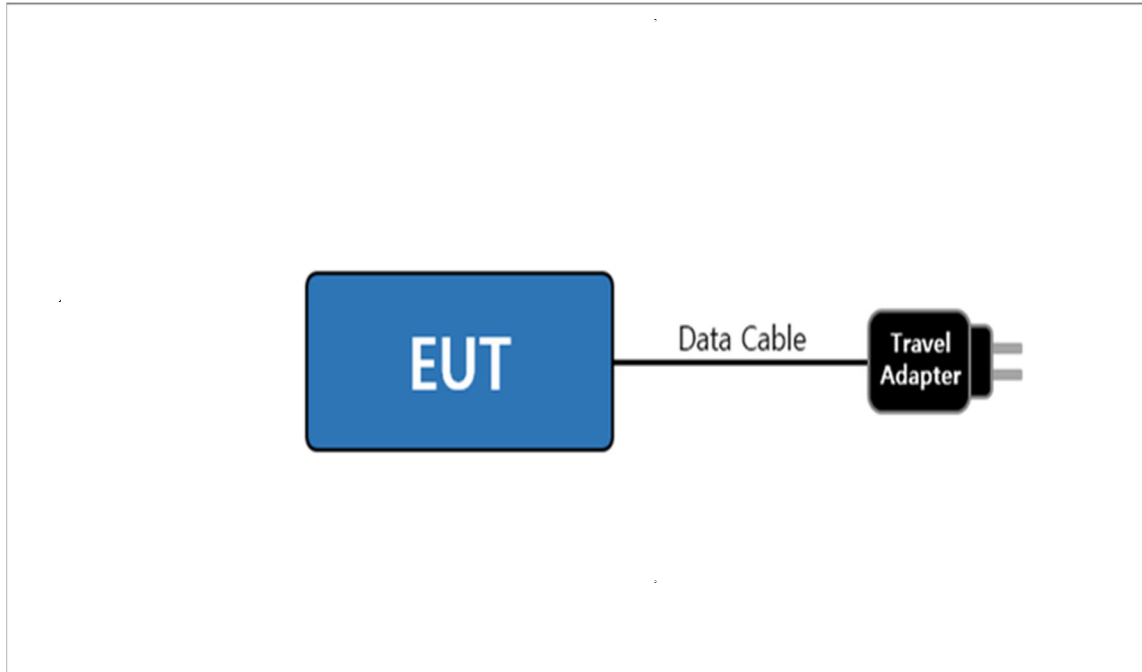

[Mode 1 – 3]

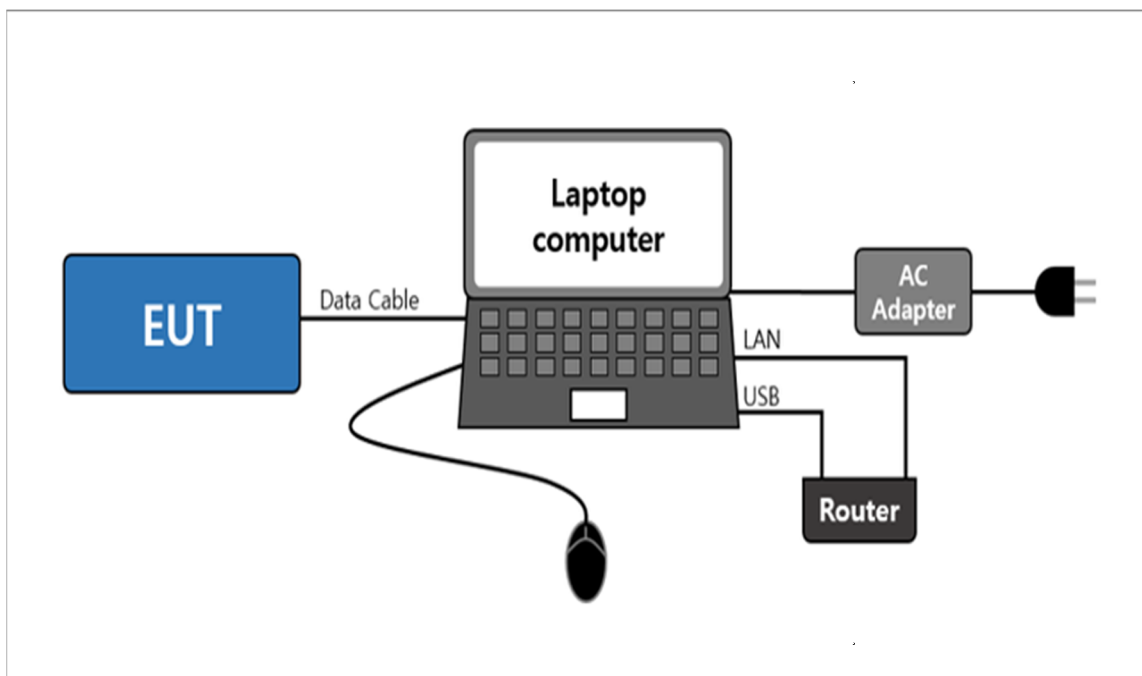

[Mode 4]

4.5.2 Radiated Emission

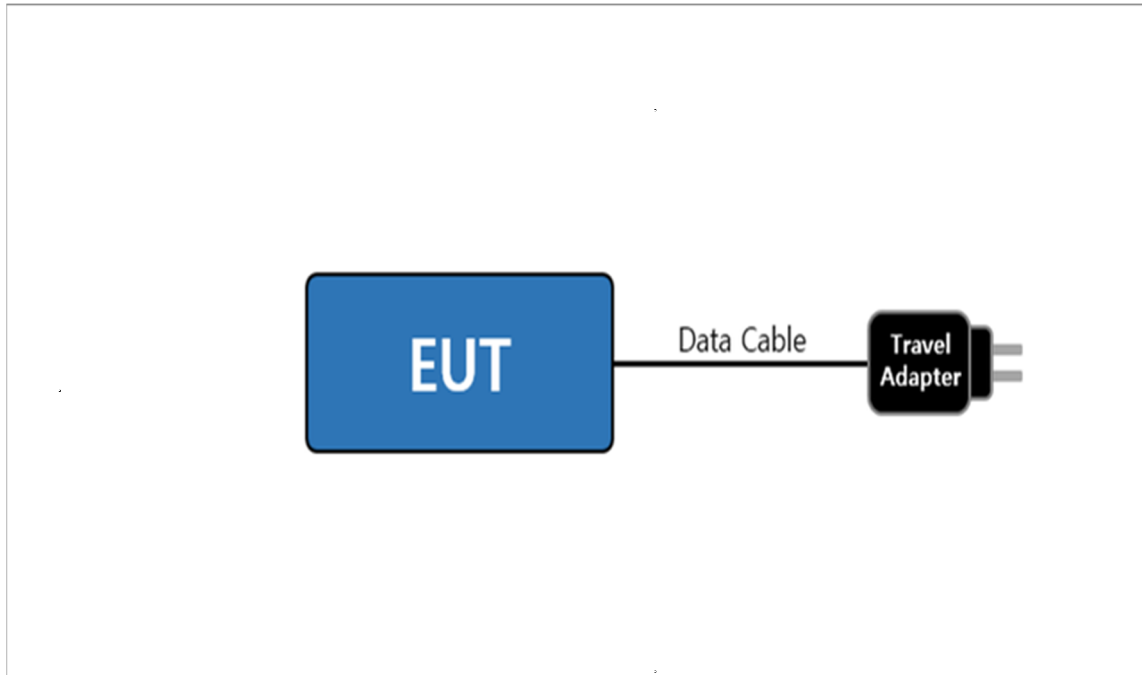

[Mode 1]

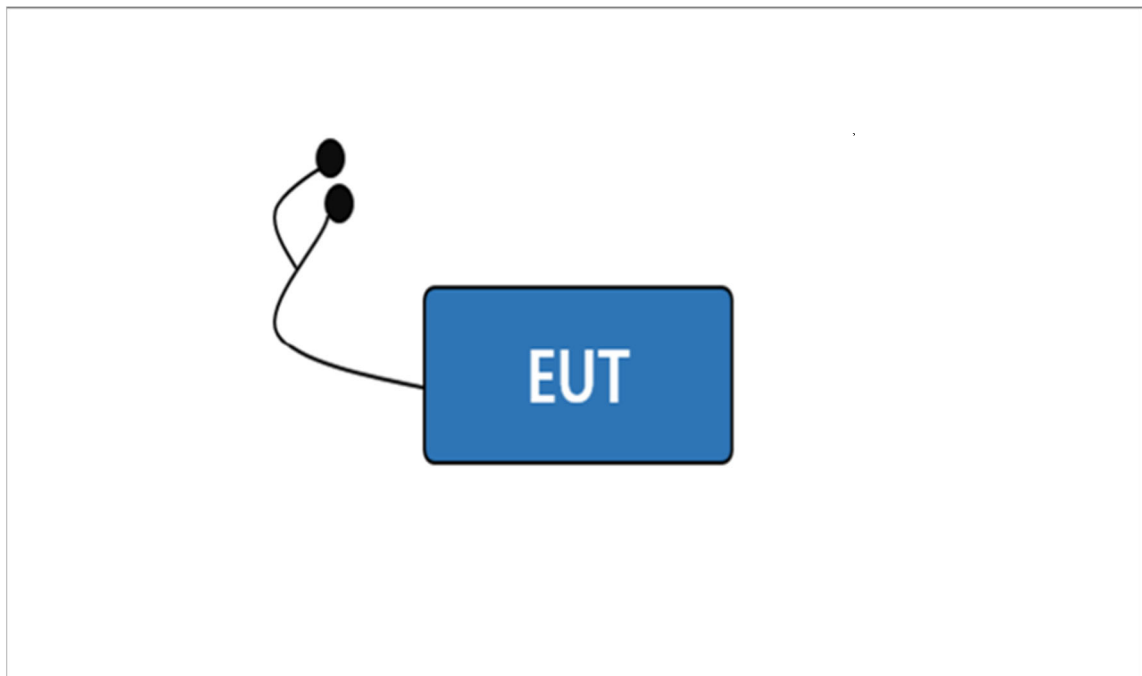

[Mode 2 – 3]

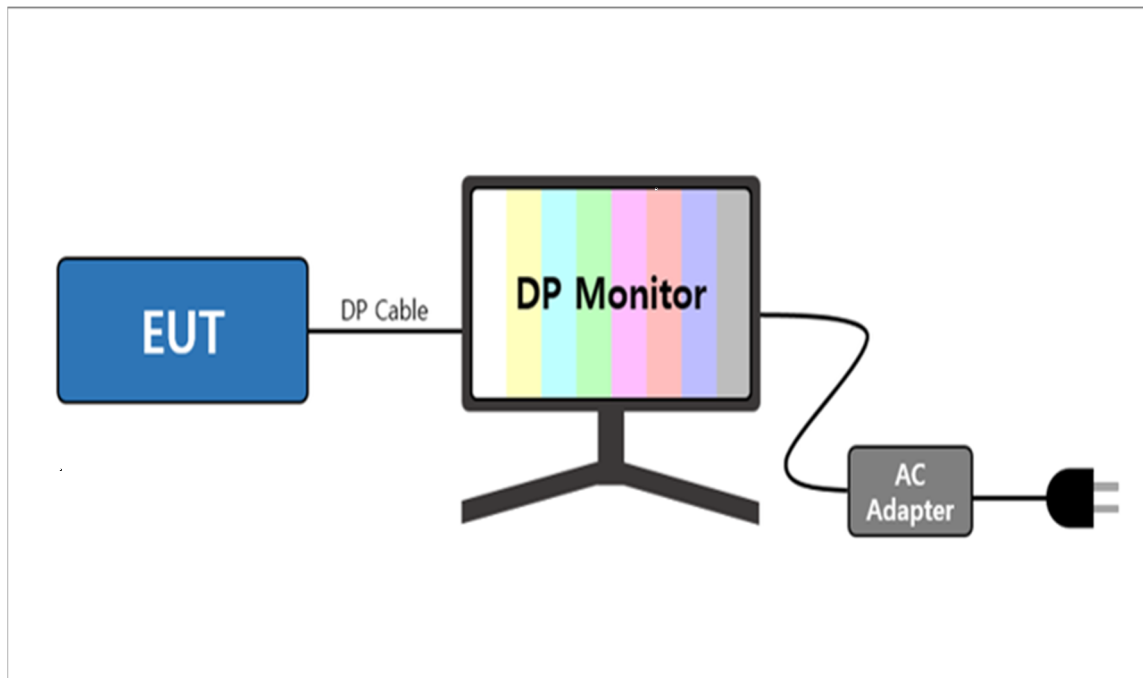

[Mode 4]

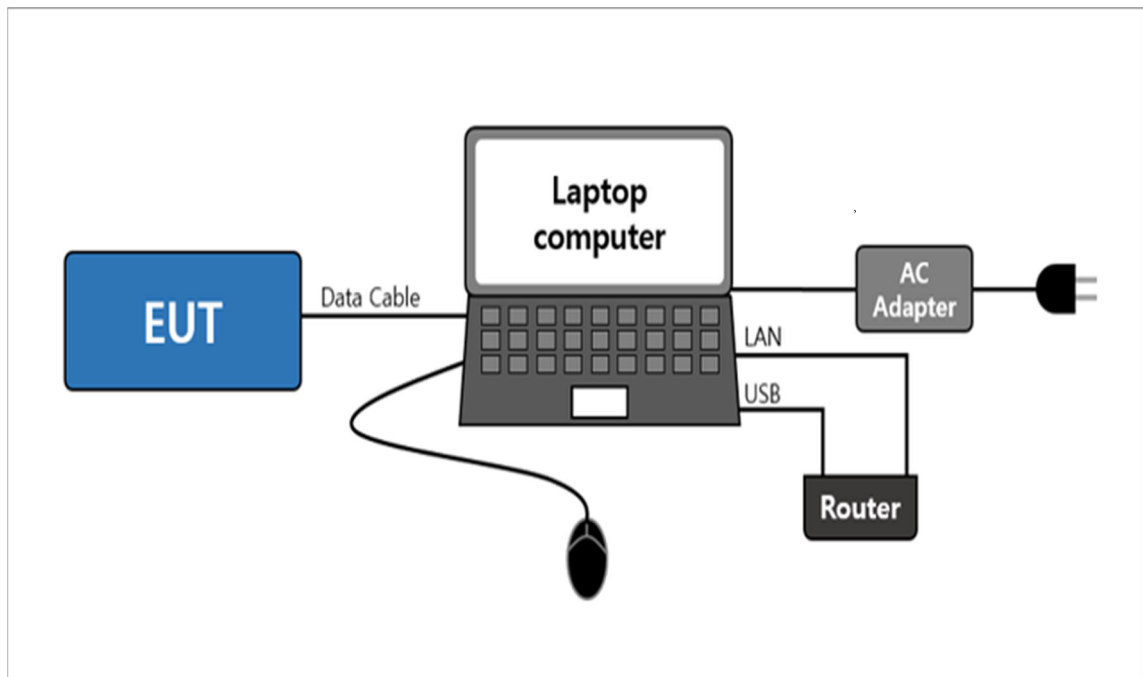

[Mode 5]

4.6 EUT Description

The EUT is a bar type mobile phone which can operate on GSM 850/900/1800/1900, WCDMA FDD 1/2/4/5/8, LTE FDD 1/2/3/4/5/7/8/12/13/17/18/19/20/25/26/28/66, LTE TDD 38/39/40/41, 5G NR n1/2/3/5/7/8/12/20/25/26/28/38/40/41/66/77/78 and incorporates a Bluetooth, Wi-Fi (802.11 b/g/n/a/ac/ax), Camera, Audio, Video, GNSS, DP, NFC, Wireless Charging and Wireless power sharing.

4.6.1 The variant models

- SM-S921B

4.7 EUT Frequencies

The highest frequencies (Generated and used)	Frequency [MHz]
Wi-Fi	7 125

4.8 Test configuration and condition

The system was configured for testing in a typical fashion that a customer would normally use. Cables were attached to each of the available I/O Ports. Where applicable, peripherals were attached to the I/O cables.

All the external I/O ports are exercised, as well as internal and the external microSD card(if available), by writing and reading arbitrary data or charging with TA.

The EUT was investigated in three orientations and the worst case orientation is reported.

For the AC conducted emissions test, the conducted emissions of receiver modes which operate within the frequency range of 30-960 MHz were compared through preliminary tests. However, no significant differences were found to affect the conducted emission, so the test result for one representative receiver frequency band (LTE FDD26) were reported.

The video and audio(1 kHz sound) were repetitively played with the headset connected.

The video and audio(1 kHz sound) were played on monitor through display out function using direct DP cable.

The camera of the EUT was operated continuously.

Power source for the EUT operating was supplied by CVCF.

- Test Voltage : AC 120 V, 60 Hz

4.9 Measurement uncertainty

Where relevant, the following measurement uncertainty levels have been estimated for tests performed on the apparatus : (According to CISPR 16-4-2 and UKAS M3003)

Test type		Measurement uncertainty (C.L. approximately 95 %, $k = 2$)
Conducted Emission	AC Mains	2.82 dB
Radiated Emission (Below 1 GHz)	Horizontal	4.88 dB
	Vertical	4.52 dB
Radiated Emission (Above 1 GHz)	Horizontal	5.18 dB
	Vertical	5.18 dB

* Remark

- 1) The values for uncertainty of conducted and radiated emissions are less than the Corresponding values of Ucispr given in CISPR 16-4-2. Therefore no adjustment of measurement results is necessary when comparing them with the relevant limits.

5. Results of individual test

5.1 Conducted Emission

The EUT is connected to a LISN via travel adapter. If the EUT is connected to the Laptop Computer USB port, the Laptop AC adapter is connected to a LISN.

Both conducted lines are measured in Quasi-Peak and CISPR-Average mode, including the worst-case data points for each tested configuration. The EUT measured in accordance with the methods described in standards.

Limits for Conducted emission at the mains ports of Class B

Frequency range Limits [MHz]	Resolution Bandwidth [kHz]	Limits [dB(μ V)]	
		Quasi-peak	Average
0.15 to 0.50	9	66 to 56	56 to 46
0.50 to 5	9	56	46
5 to 30	9	60	50

NOTE 1 The lower limit shall apply at the transition frequency.

NOTE 2 The limit decreases linearly with the logarithm of the frequency in the range 0.15 MHz to 0.50 MHz.

5.1.1 Test instrumentation

EMC No.	Test Instrument	Model name	Manufacturer	Serial No.	Next Calibration	
					Date	Interval (Month)
E5I-006	LTE Communicator	CMW500	R&S	132728	2024-04-05	12
E5I-127	Two-Line V-Network	ENV216	R&S	102061	2024-01-20	12
E5I-247	EMI Test Receiver	ESW8	R&S	103124	2024-07-21	12
-	Test software	EMC32	R&S	Ver 10.60.20	-	-

5.1.2 Temperature and humidity condition

Test date	2023-10-10	Test engineer	Sung-Wook Choi
Climate condition	Ambient temperature	(23.2 \pm 1.0) °C	Limit (15.0 to 35.0) °C
	Humidity	(45.4 \pm 1.0) % R.H.	Limit (25.0 to 75.0) % R.H.
	Atmospheric pressure	(101.8 \pm 1.0) kPa	Limit (86.0 to 106.0) kPa
Test place	Shield Room (SR8)		

5.1.3 Test Results

□ Operating Mode 1: AC Mains

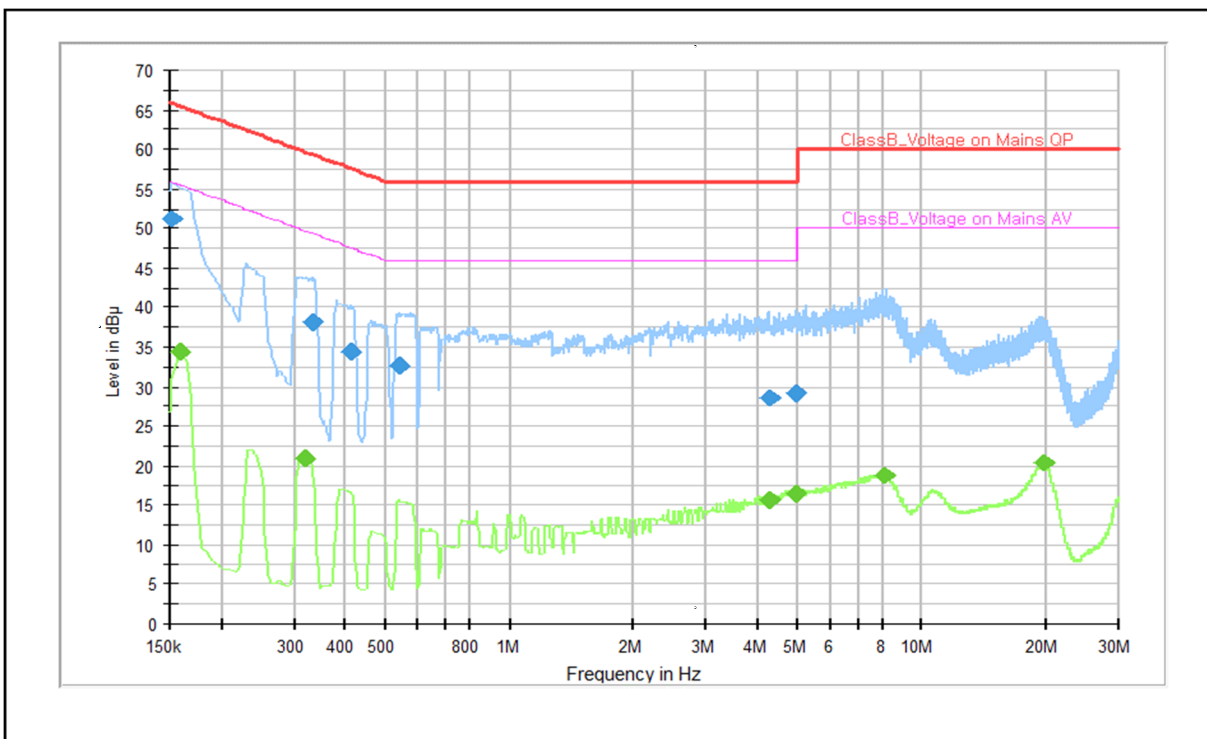

Note 1) Two graphs measured for both Live(L1) and Neutral(N) of the LISN are combined into one graph.

QP / CAV final measurement results table:

Frequency (MHz)	QP (dBµV)	CAV (dBµV)	Limit (dBµV)	Margin (dB)	Line	Corr. (dB)
0.152	51.2	---	65.9	14.7	L1	10.0
0.159	---	34.5	55.5	21.0	N	10.1
0.319	---	21.0	49.7	28.7	N	10.0
0.335	38.2	---	59.3	21.1	L1	10.1
0.413	34.5	---	57.6	23.1	L1	10.2
0.542	32.7	---	56.0	23.3	L1	10.2
4.268	---	15.7	46.0	30.3	N	9.9
4.299	28.6	---	56.0	27.4	N	9.9
4.952	---	16.4	46.0	29.6	N	9.9
4.974	29.2	---	56.0	26.8	N	9.9
8.158	---	18.7	50.0	31.3	N	10.0
19.860	---	20.3	50.0	29.7	N	10.6

Note 2) Level (QP and/or CAV) = Meter Reading (QP and/or CAV) + Corr. (LISN Insertion Loss + Cable Loss)
 Margin (QP and/or CAV) = Limit – Level (QP and/or CAV)
 QP = Quasi-Peak, CAV = CISPR-Average, Corr. = Correction Factor

□ Operating Mode 2: AC Mains

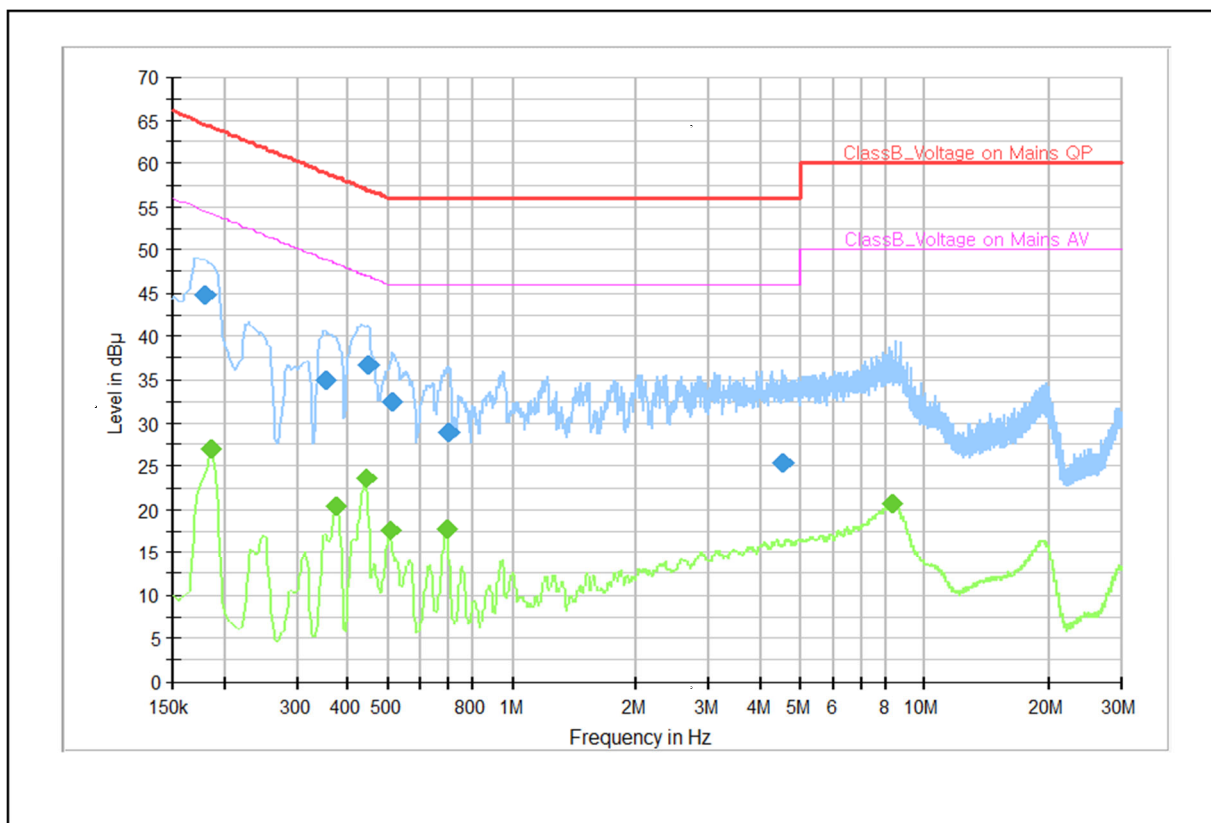

Note 1) Two graphs measured for both Live(L1) and Neutral(N) of the LISN are combined into one graph.

QP / CAV final measurement results table:

Frequency (MHz)	QP (dBµV)	CAV (dBµV)	Limit (dBµV)	Margin (dB)	Line	Corr. (dB)
0.179	44.7	---	64.5	19.8	L1	10.3
0.186	---	27.0	54.2	27.2	N	10.2
0.353	35.1	---	58.9	23.8	L1	10.1
0.375	---	20.4	48.4	28.0	N	10.2
0.440	---	23.7	47.1	23.4	N	10.2
0.447	36.8	---	56.9	20.1	L1	10.2
0.506	---	17.7	46.0	28.3	N	10.2
0.512	32.5	---	56.0	23.5	L1	10.2
0.695	---	17.8	46.0	28.2	N	10.1
0.704	28.9	---	56.0	27.1	N	10.1
4.544	25.3	---	56.0	30.7	N	9.9
8.356	---	20.8	50.0	29.2	N	10.0

Note 2) Level (QP and/or CAV) = Meter Reading (QP and/or CAV) + Corr. (LISN Insertion Loss + Cable Loss)
 Margin (QP and/or CAV) = Limit – Level (QP and/or CAV)
 QP = Quasi-Peak, CAV = CISPR-Average, Corr. = Correction Factor

□ **Operating Mode 3: AC Mains**

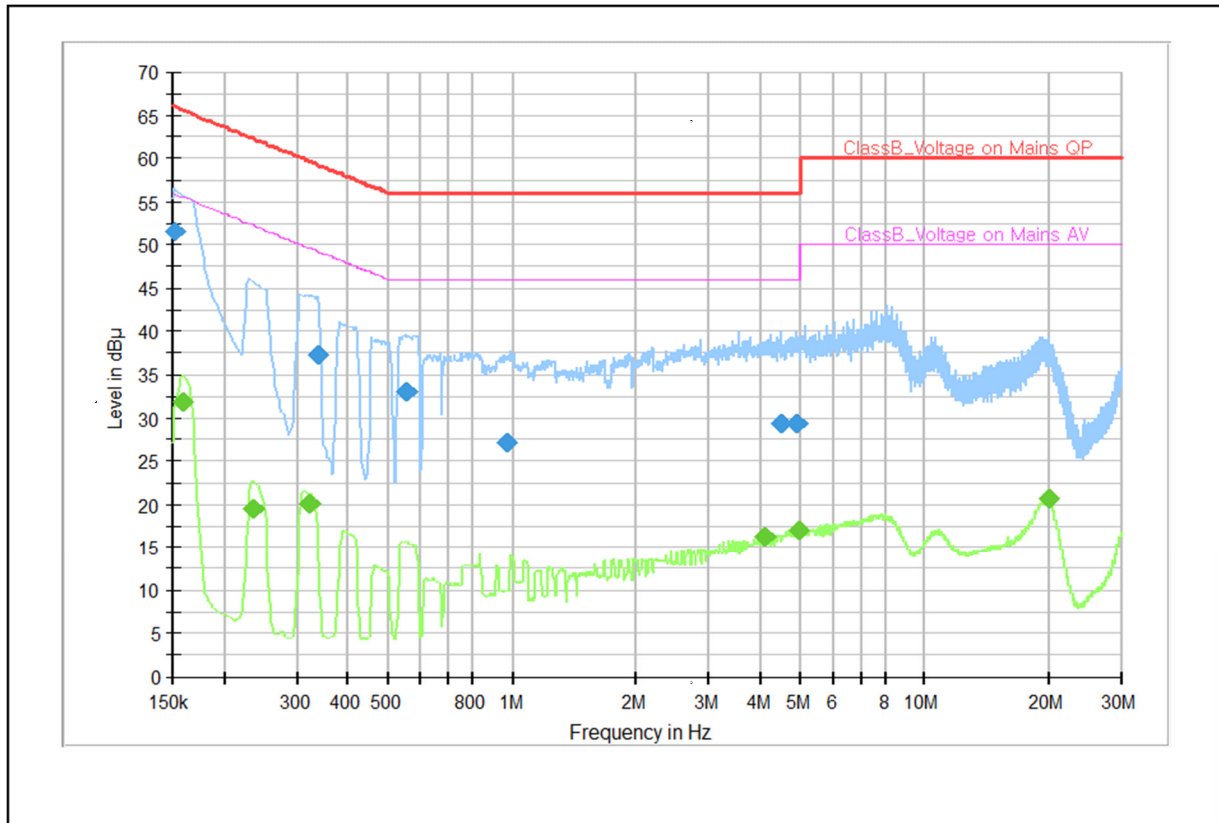

Note 1) Two graphs measured for both Live(L1) and Neutral(N) of the LISN are combined into one graph.

QP / CAV final measurement results table:

Frequency (MHz)	QP (dBµV)	CAV (dBµV)	Limit (dBµV)	Margin (dB)	Line	Corr. (dB)
0.152	51.6	---	65.9	14.3	L1	10.0
0.159	---	31.9	55.5	23.6	N	10.1
0.236	---	19.6	52.3	32.7	N	9.9
0.321	---	20.1	49.7	29.6	N	10.0
0.337	37.4	---	59.3	21.9	L1	10.1
0.553	33.1	---	56.0	22.9	L1	10.2
0.976	27.1	---	56.0	28.9	N	9.9
4.115	---	16.3	46.0	29.7	N	9.9
4.470	29.3	---	56.0	26.7	N	9.9
4.891	29.3	---	56.0	26.7	N	9.9
4.956	---	17.1	46.0	28.9	N	9.9
19.921	---	20.8	50.0	29.2	N	10.6

Note 2) Level (QP and/or CAV) = Meter Reading (QP and/or CAV) + Corr. (LISN Insertion Loss + Cable Loss)
 Margin (QP and/or CAV) = Limit – Level (QP and/or CAV)
 QP = Quasi-Peak, CAV = CISPR-Average, Corr. = Correction Factor

□ **Operating Mode 4: AC Mains**

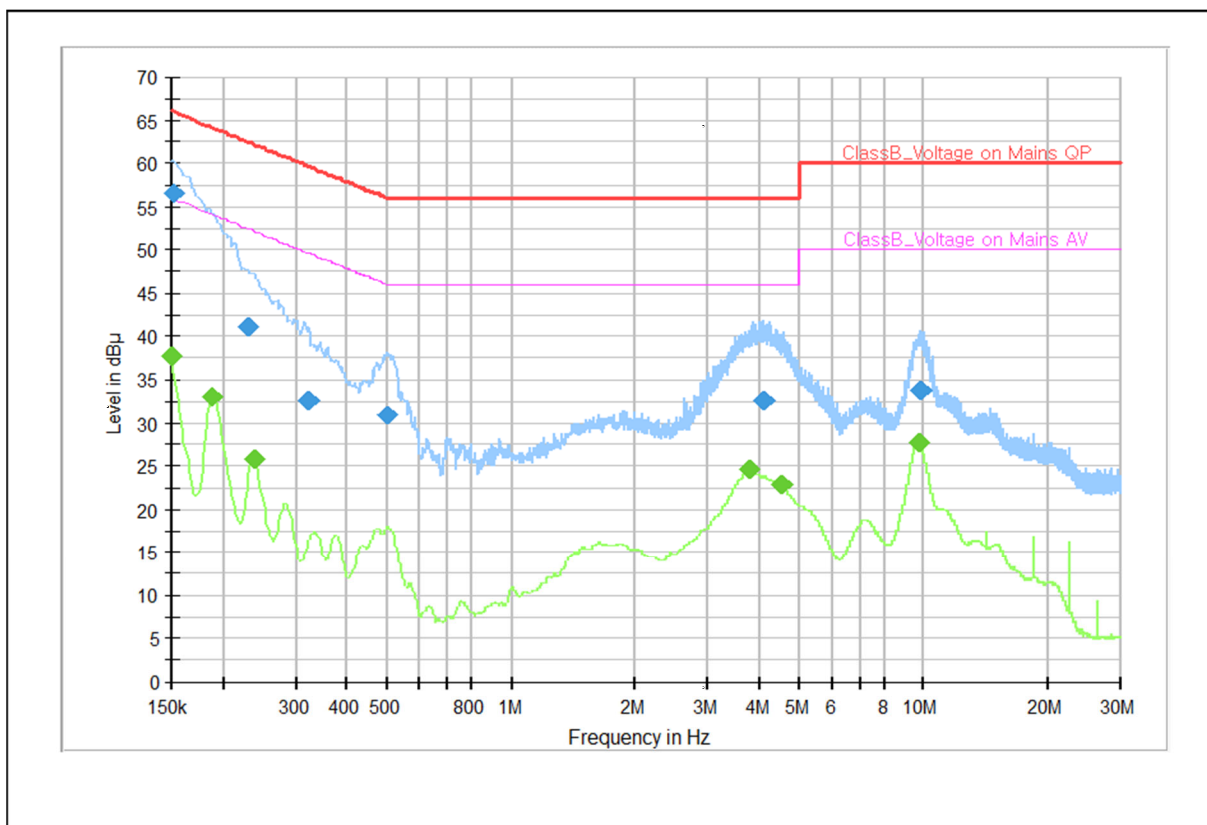

Note 1) Two graphs measured for both Live(L1) and Neutral(N) of the LISN are combined into one graph.

QP / CAV final measurement results table:

Frequency (MHz)	QP (dBµV)	CAV (dBµV)	Limit (dBµV)	Margin (dB)	Line	Corr. (dB)
0.150	---	37.7	56.0	18.3	N	9.9
0.152	56.5	---	65.9	9.4	N	9.9
0.188	---	33.1	54.1	21.0	L1	10.0
0.231	41.0	---	62.4	21.4	N	9.8
0.238	---	25.8	52.2	26.4	L1	9.8
0.323	32.7	---	59.6	26.9	L1	9.9
0.501	30.9	---	56.0	25.1	L1	10.0
3.773	---	24.7	46.0	21.3	N	9.8
4.106	32.7	---	56.0	23.3	L1	9.8
4.538	---	22.8	46.0	23.2	L1	9.8
9.789	---	27.7	50.0	22.3	L1	9.8
9.816	33.8	---	60.0	26.2	L1	9.8

Note 2) Level (QP and/or CAV) = Meter Reading (QP and/or CAV) + Corr. (LISN Insertion Loss + Cable Loss)
 Margin (QP and/or CAV) = Limit – Level (QP and/or CAV)
 QP = Quasi-Peak, CAV = CISPR-Average, Corr. = Correction Factor

5.2 Radiated Emission

The following data lists the significant emission frequencies, measured levels, correction factors (for antenna and cables), orientation of table, polarization and height of antenna, the corrected reading, the limit, and the amount of margin.

Peak measurements were made over the changeable frequency range 30 MHz to 1 GHz at a measurement distance of 10 m for the following antenna and turntable arrangements:

Antenna Height [cm]	Antenna Polarization	Resolution Bandwidth [kHz]	Video Bandwidth [kHz]	Turntable position [degrees]
100 ~ 400	Horizontal, Vertical	120	300	Continuous

Measurements within 6 dB of the limit were then maximized by adjusting turntable position.

Final measurements were made using quasi-peak detector.

Peak/CISPR-Average measurements were made over the changeable frequency range 1 GHz to 40 GHz or 5th harmonics of the highest frequency generated or used in the device or on which the device operates or tunes at a measurement distance of 3 m for the following antenna and turntable arrangements. The measurements above 1 GHz were performed with the bore-sighting antenna aimed at the EUT.

Antenna Height [cm]	Antenna Polarization	Resolution Bandwidth [MHz]	Video Bandwidth [MHz]	Turntable position [degrees]
100 ~ 400	Horizontal, Vertical	1	3	Continuous

Measurements within 6 dB of the limit were then maximized by adjusting turntable position.

Final measurements were made using peak and CISPR-average detectors.

Limits for Radiated emission of Class B at a measuring distance of 3 m and 10 m

Frequency range Limits [MHz]	Field Strength		
	3 m [$\mu\text{V/m}$]	3 m [dB($\mu\text{V/m}$)]	10 m [dB($\mu\text{V/m}$)]
30 to 88	100	40.0	29.5
88 to 216	150	43.5	33.0
216 to 960	200	46.0	35.5
Above 960	500	54.0	43.5

Note) Distance correction formula from D1(3m) to D2(10m)

: Limit at D2 = Limit at D1 + 20Log(D1 /D2)

Results checked manually; and points close to the limit line were re-measured.

5.2.1 Test instrumentation

EMC No.	Test Instrument	Model name	Manufacturer	Serial No.	Next Calibration	
					Date	Interval (Month)
E5I-021	EMI Test Receiver	ESU40	R&S	100376	2024-01-30	12
E5I-017	EMI Test Receiver	ESU8	R&S	100483	2024-01-27	12
E5I-248	EMI Test Receiver	ESW44	R&S	103129	2024-07-21	12
E5I-070	BiLog Antenna	CBL6112D	TESEQ	35383	2025-07-21	24
E5I-228	6 dB Fixed Attenuator	8491B-006	Agilent	58358	2025-07-21	24
E5I-121	BiLog Antenna	CBL6112D	TESEQ	36999	2025-07-21	24
E5I-137	6 dB Fixed Attenuator	8491A	Keysight	MY52462298	2025-07-21	24
E5I-093	Preamplifier	310N	SONOMA	273122	2024-01-17	12
E5I-094	Preamplifier	310N	SONOMA	282363	2024-01-17	12
E5I-035	Horn Antenna	HF907	R&S	100506	2023-10-25	12
E5I-039	Signal Conditioning Unit	SCU-18	R&S	10211	2024-04-05	12
E5I-243	WideBand Horn Antenna	QMS-00880	STEATITE	25187	2023-11-23	12
E5I-042	Signal Conditioning Unit	SCU-40A	R&S	10004	2024-09-21	12
-	Test software	EP7RE	TOYO	Ver 8.0.20	-	-
-	Test software	EMC32	R&S	Ver 10.60.20	-	-

5.2.2 Temperature and humidity condition

Test date	2023-09-19, 2023-10-05	Test engineer	Sung-Wook Choi
Climate condition	Ambient temperature	(22.3 ± 1.0) °C	Limit (15.0 to 35.0) °C
	Humidity	(51.8 ± 1.0) % R.H.	Limit (25.0 to 75.0) % R.H.
	Atmospheric pressure	(101.0 ± 1.0) kPa	Limit (86.0 to 106.0) kPa
Test place	Semi-Anechoic Chamber (SAC5)		

5.2.3 Test Results

□ Operating Mode 1

- Frequencies below 1 GHz

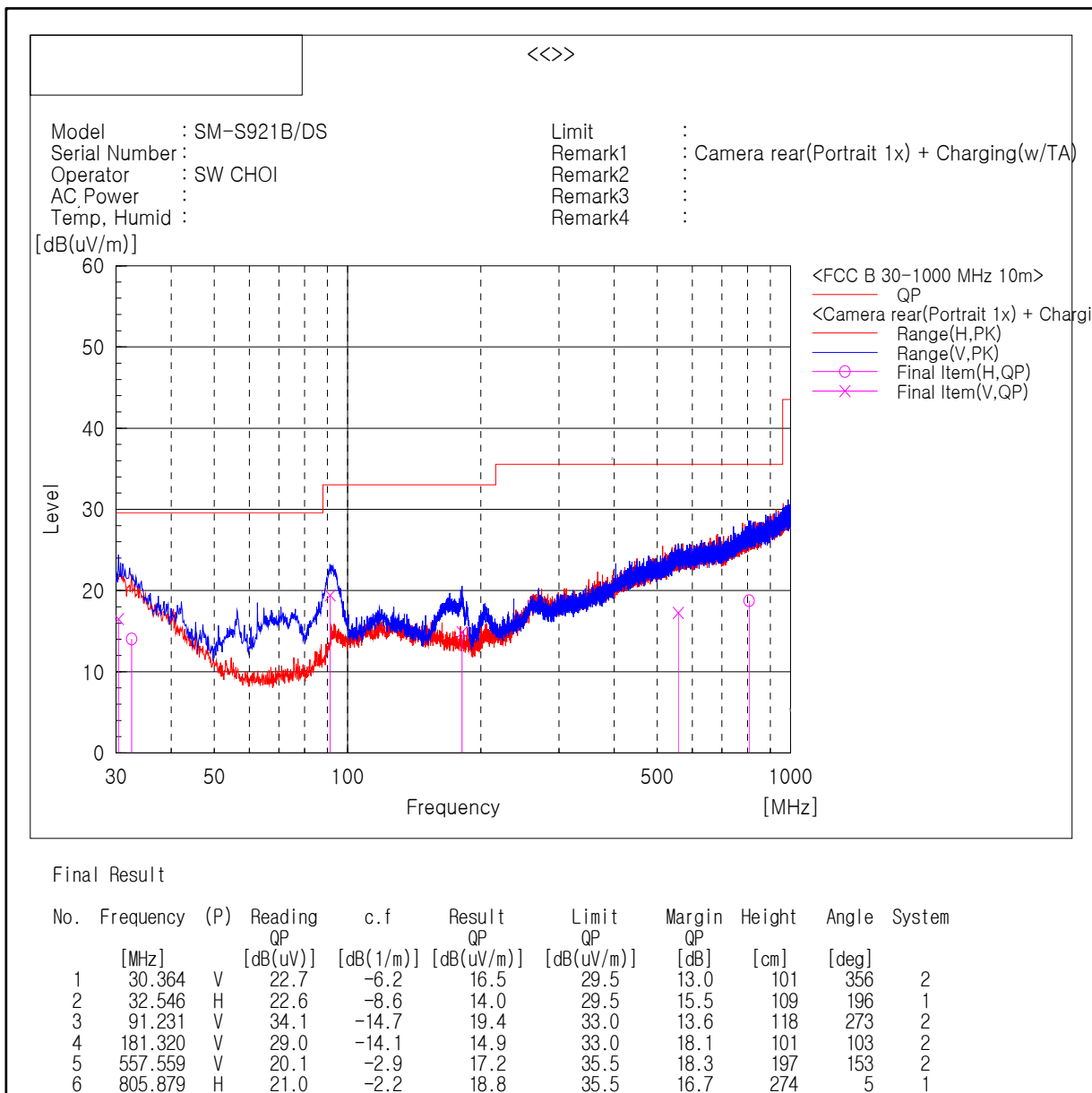

Note1) Result (QP) = Reading (QP) + c.f (Antenna Factor + Cable Loss - Amp. Gain)

Margin (QP) = Limit – Level (QP)

QP = Quasi-Peak, c.f = Correction Factor

- Frequencies above 1 GHz

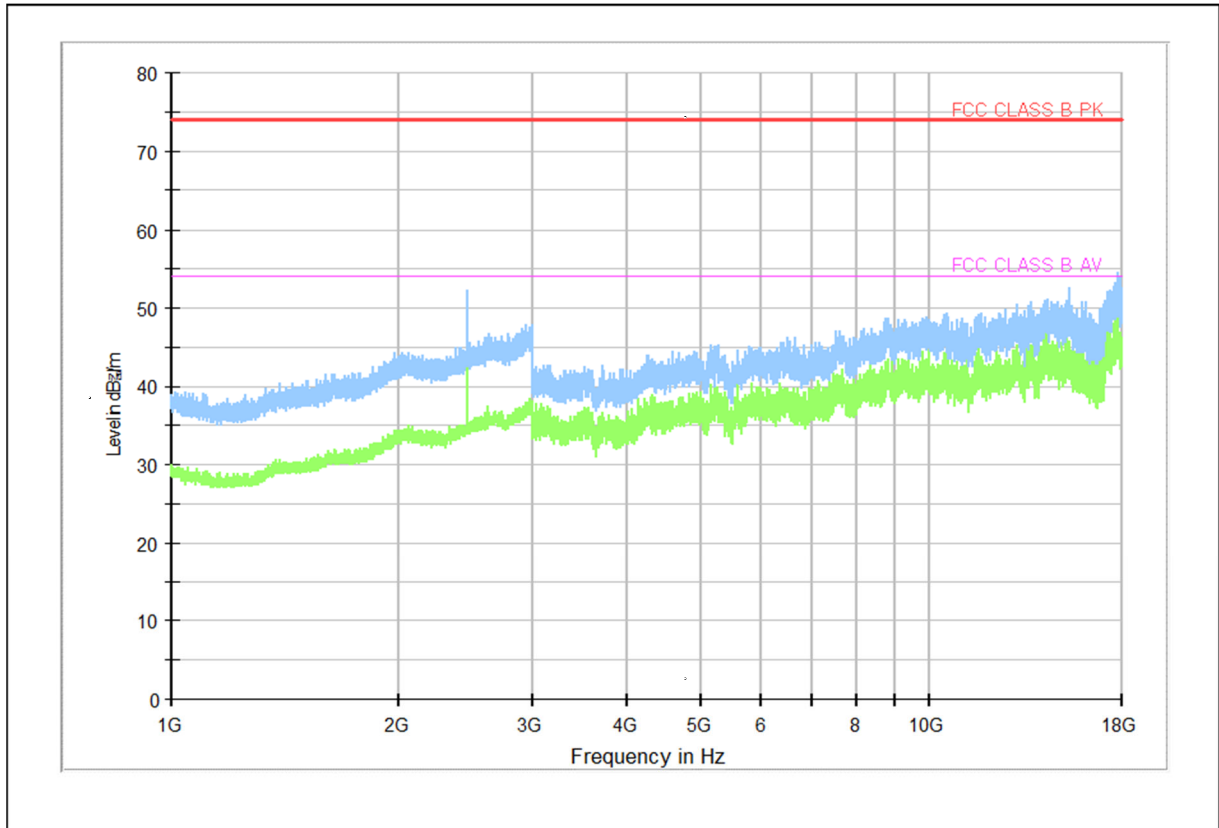

Note 1) We have also tested from 18 GHz to 40 GHz and found no emissions.

Note 2) Level (PK and/or CAV) = Reading (PK and/or CAV) + Corr. (Antenna Factor + Cable Loss - Amp. Gain)

Margin (PK and/or CAV) = Limit – Level (PK and/or CAV)

PK = Peak, CAV = CISPR-Average, Corr. = Correction Factor

Note 3) Radiated emissions (Tx / Rx frequency) from the transceiver shall be ignored.

- Data transmission in the 2.4 GHz ISM band (Bluetooth/Wi-Fi)

: Operating frequencies (2 400 ~ 2 483.5) MHz

□ Operating Mode 2

- Frequencies below 1 GHz

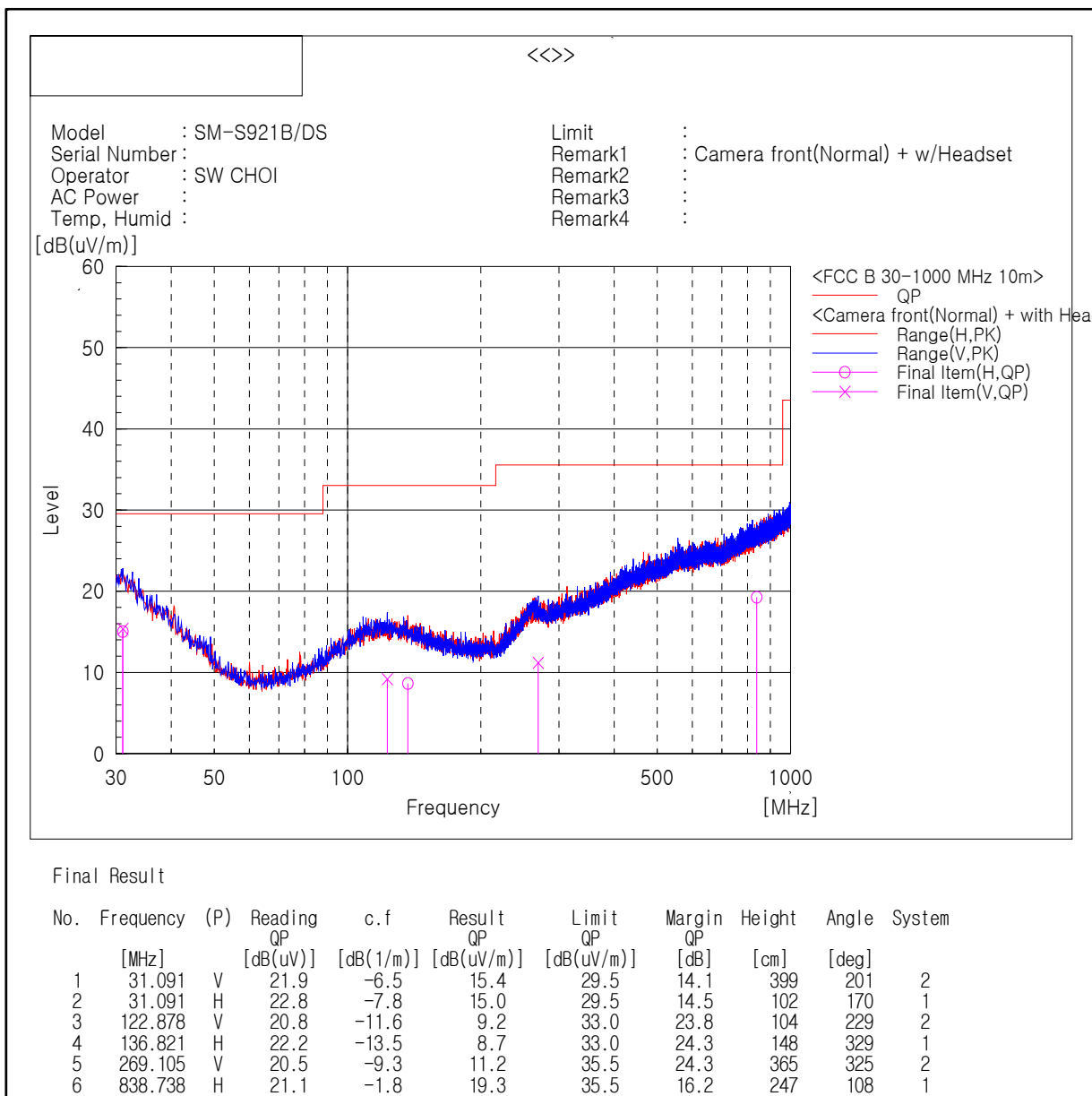

Note1) Result (QP) = Reading (QP) + c.f (Antenna Factor + Cable Loss - Amp. Gain)

Margin (QP) = Limit - Level (QP)

QP = Quasi-Peak, c.f = Correction Factor

- Frequencies above 1 GHz

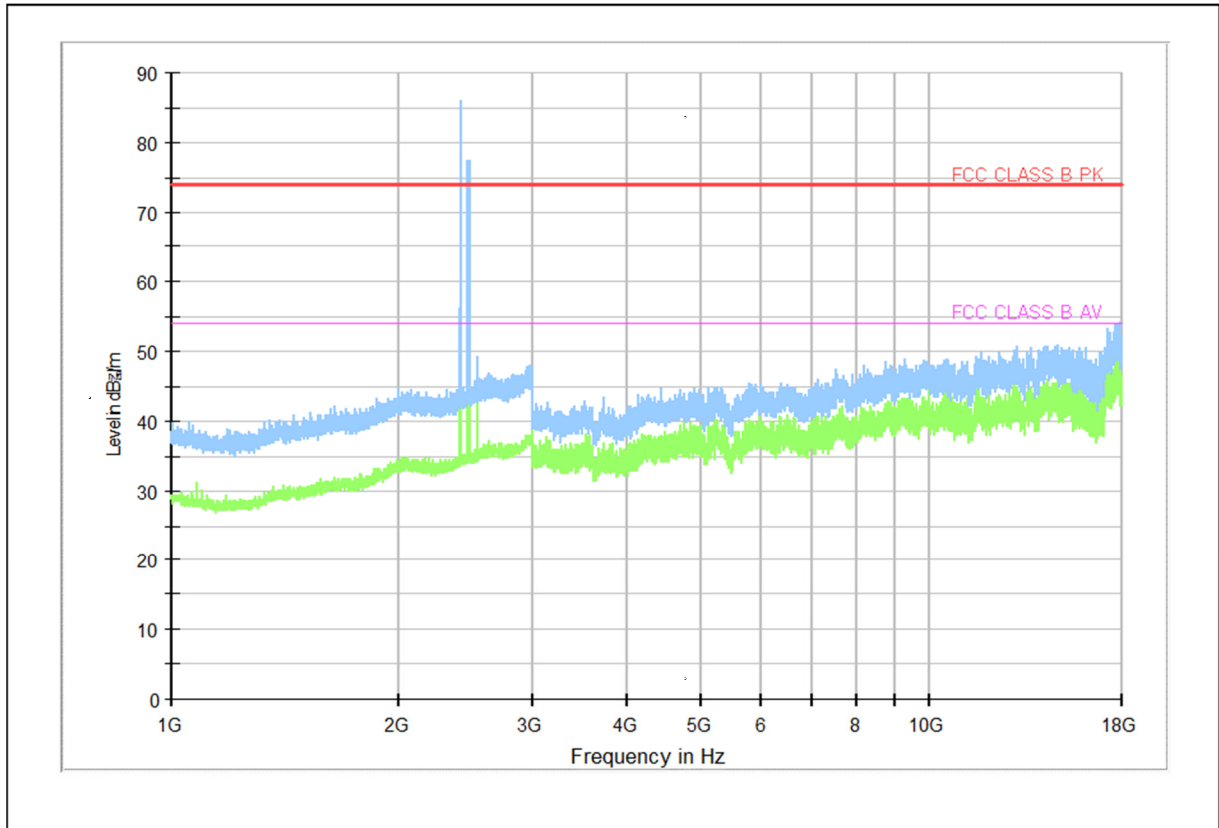

Note 1) We have also tested from 18 GHz to 40 GHz and found no emissions.

Note 2) Level (PK and/or CAV) = Reading (PK and/or CAV) + Corr. (Antenna Factor + Cable Loss - Amp. Gain)

Margin (PK and/or CAV) = Limit – Level (PK and/or CAV)

PK = Peak, CAV = CISPR-Average, Corr. = Correction Factor

Note 3) Radiated emissions (Tx / Rx frequency) from the transceiver shall be ignored.

- Data transmission in the 2.4 GHz ISM band (Bluetooth/Wi-Fi)

: Operating frequencies (2 400 ~ 2 483.5) MHz

□ Operating Mode 3

- Frequencies below 1 GHz

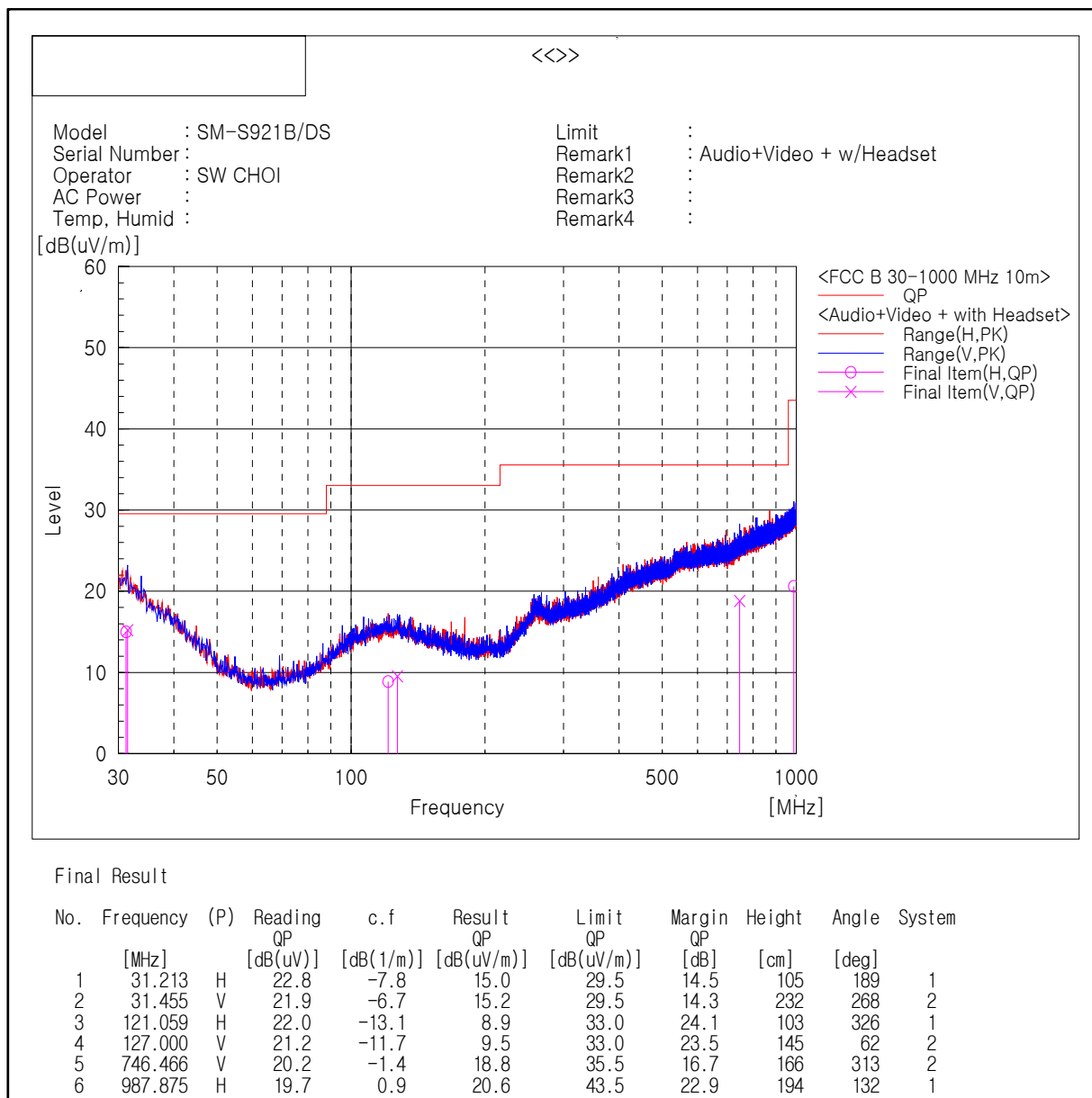

Note1) Result (QP) = Reading (QP) + c.f (Antenna Factor + Cable Loss - Amp. Gain)

Margin (QP) = Limit - Level (QP)

QP = Quasi-Peak, c.f = Correction Factor

- Frequencies above 1 GHz

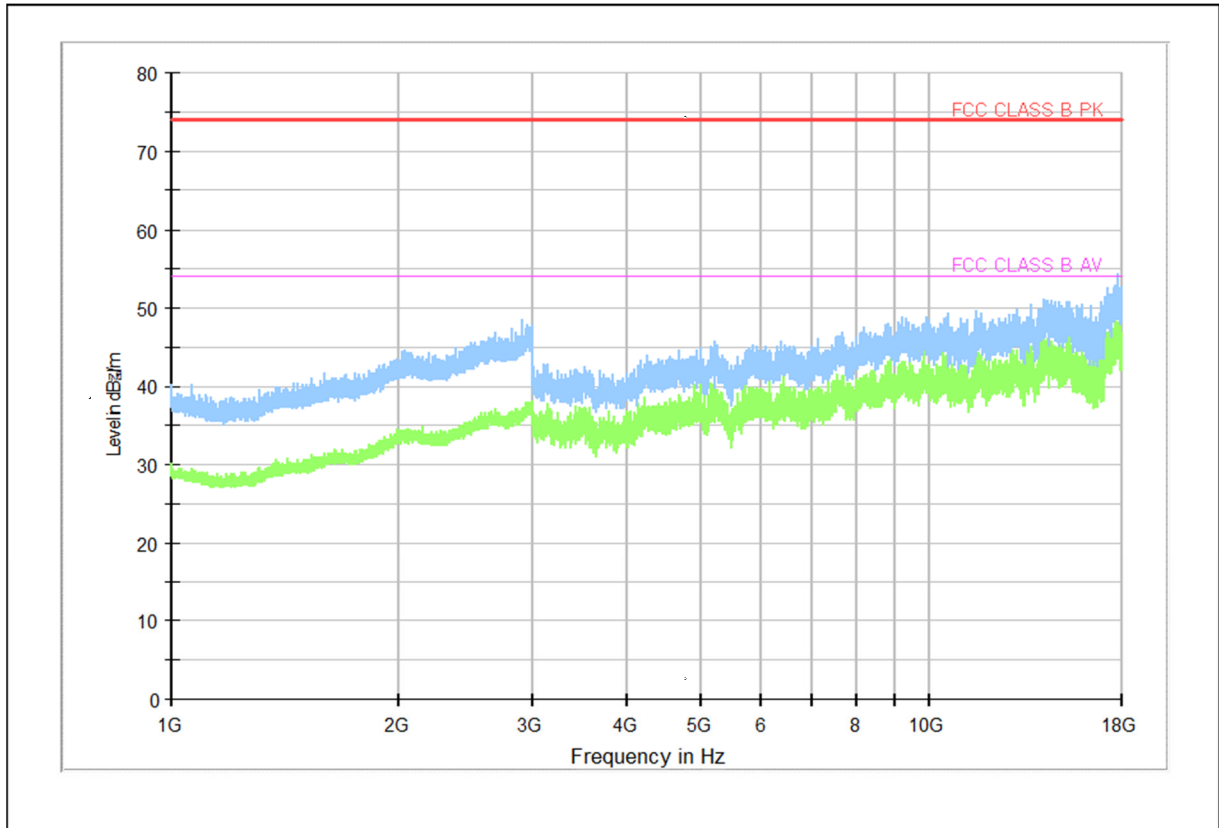

Note 1) We have also tested from 18 GHz to 40 GHz and found no emissions.

Note 2) Level (PK and/or CAV) = Reading (PK and/or CAV) + Corr. (Antenna Factor + Cable Loss - Amp. Gain)

Margin (PK and/or CAV) = Limit – Level (PK and/or CAV)

PK = Peak, CAV = CISPR-Average, Corr. = Correction Factor

□ Operating Mode 4

- Frequencies below 1 GHz

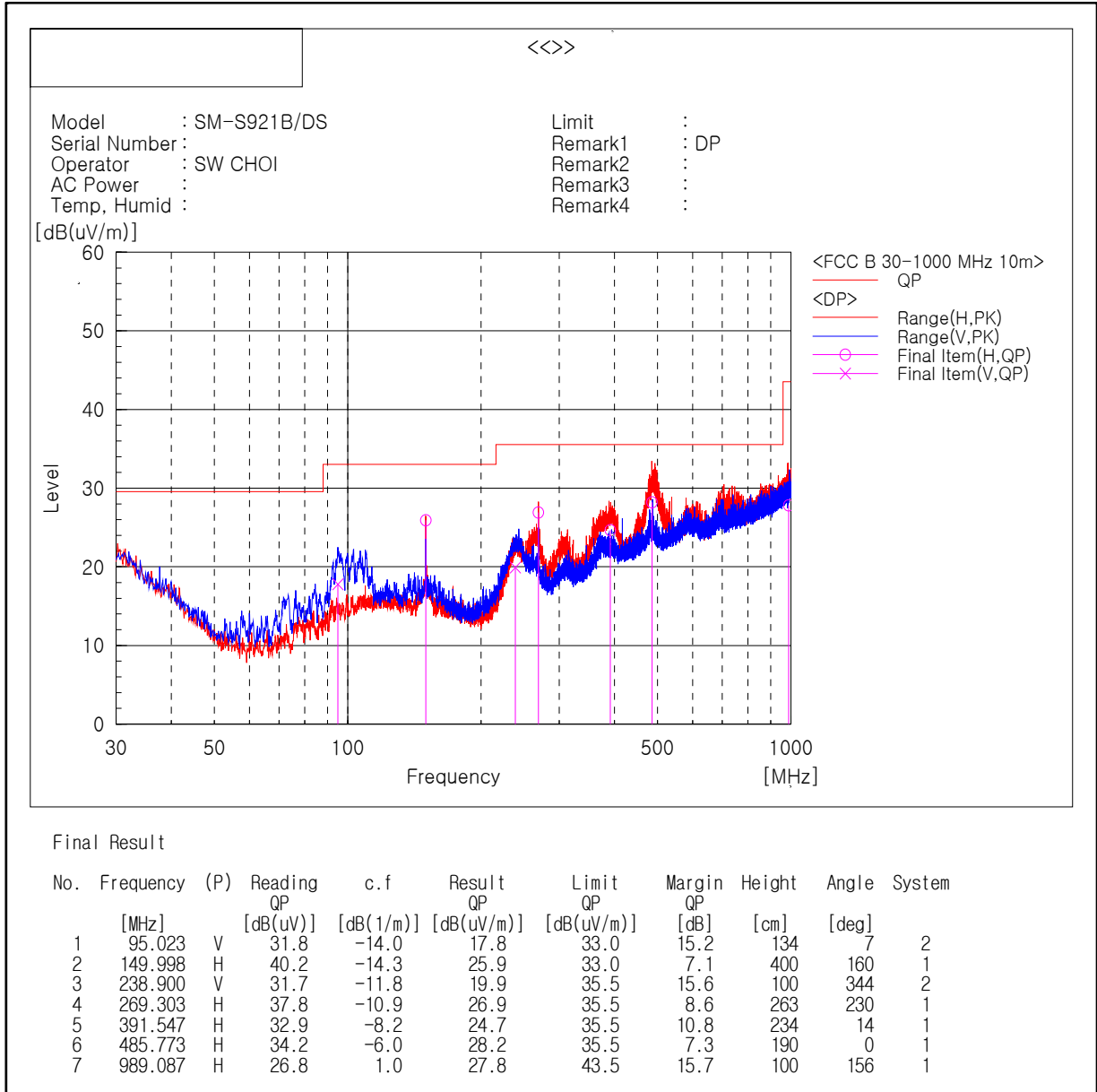

Note1) Result (QP) = Reading (QP) + c.f (Antenna Factor + Cable Loss - Amp. Gain)

Margin (QP) = Limit - Level (QP)

QP = Quasi-Peak, c.f = Correction Factor

- Frequencies above 1 GHz

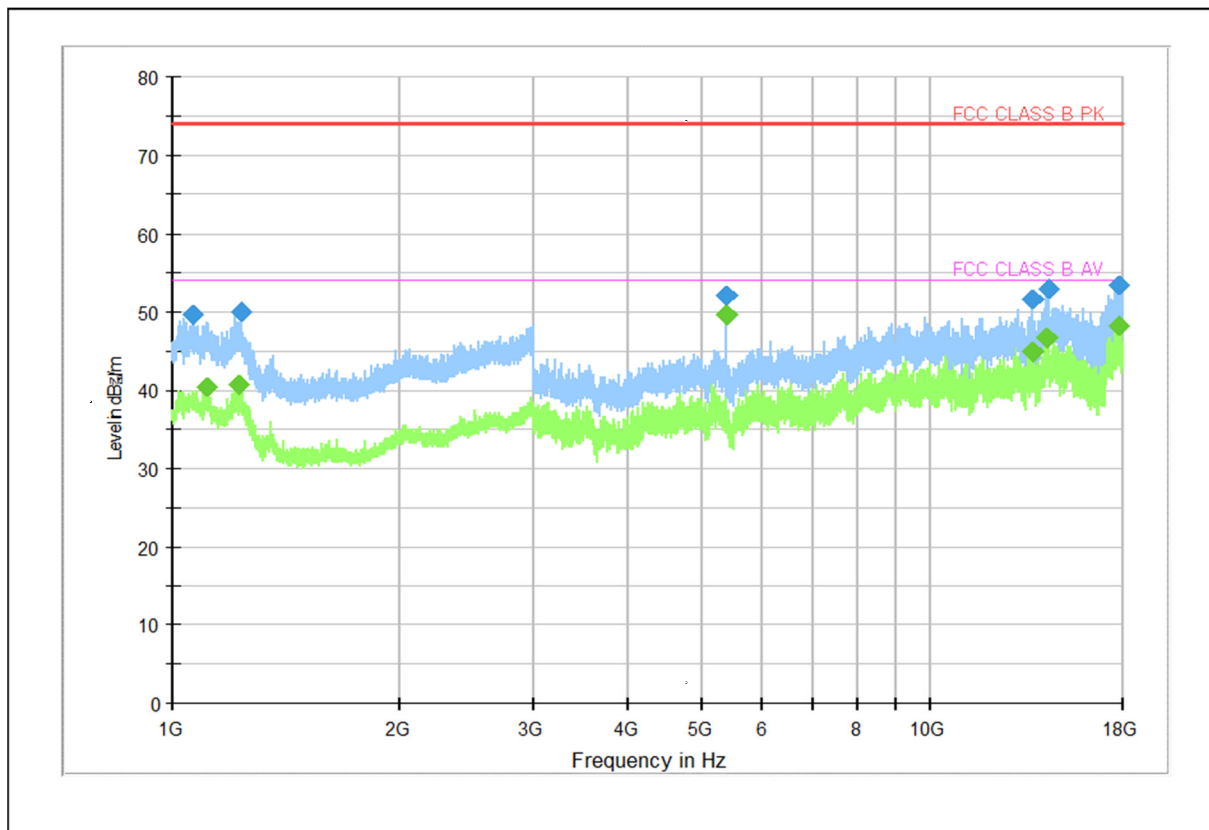

Frequency (MHz)	PK (dBµV/m)	CAV (dBµV/m)	Limit (dBµV/m)	Margin (dB)	Height (cm)	Pol	Azimuth (deg)	Corr. (dB)
1 065.000	49.56	---	74.00	24.44	101.00	H	246.00	10.10
1 112.200	---	40.42	54.00	13.58	103.00	H	235.00	9.80
1 220.800	---	40.58	54.00	13.42	100.00	H	239.00	10.20
1 229.000	49.96	---	74.00	24.04	101.00	H	231.00	10.30
5 400.000	---	49.62	54.00	4.38	100.00	H	124.00	12.10
5 400.000	52.01	---	74.00	21.99	102.00	H	127.00	12.10
13 628.000	51.63	---	74.00	22.37	100.00	V	64.00	34.20
13 634.500	---	44.91	54.00	9.09	100.00	V	180.00	34.20
14 231.000	---	46.79	54.00	7.21	104.00	V	349.00	36.40
14 328.500	52.95	---	74.00	21.05	101.00	H	0.00	36.70
17 798.500	---	48.23	54.00	5.77	100.00	H	238.00	40.80
17 799.000	53.42	---	74.00	20.58	103.00	V	74.00	40.80

Note 1) We have also tested from 18 GHz to 40 GHz and found no emissions.

Note 2) Level (PK and/or CAV) = Reading (PK and/or CAV) + Corr. (Antenna Factor + Cable Loss - Amp. Gain)

Margin (PK and/or CAV) = Limit – Level (PK and/or CAV)

PK = Peak, CAV = CISPR-Average, Corr. = Correction Factor

□ Operating Mode 5

- Frequencies below 1 GHz

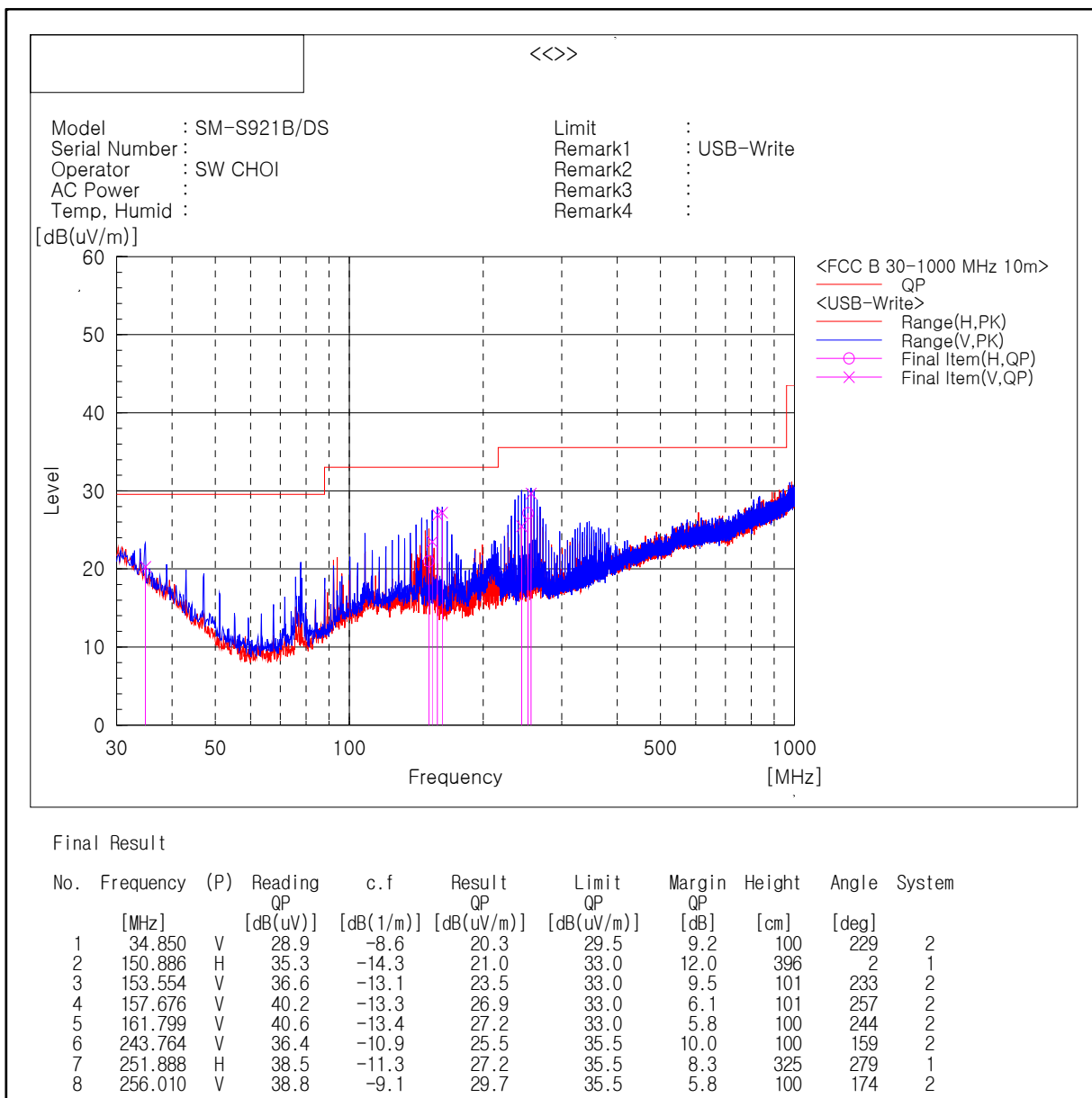

Note1) Result (QP) = Reading (QP) + c.f (Antenna Factor + Cable Loss - Amp. Gain)

Margin (QP) = Limit - Level (QP)

QP = Quasi-Peak, c.f = Correction Factor

- Frequencies above 1 GHz

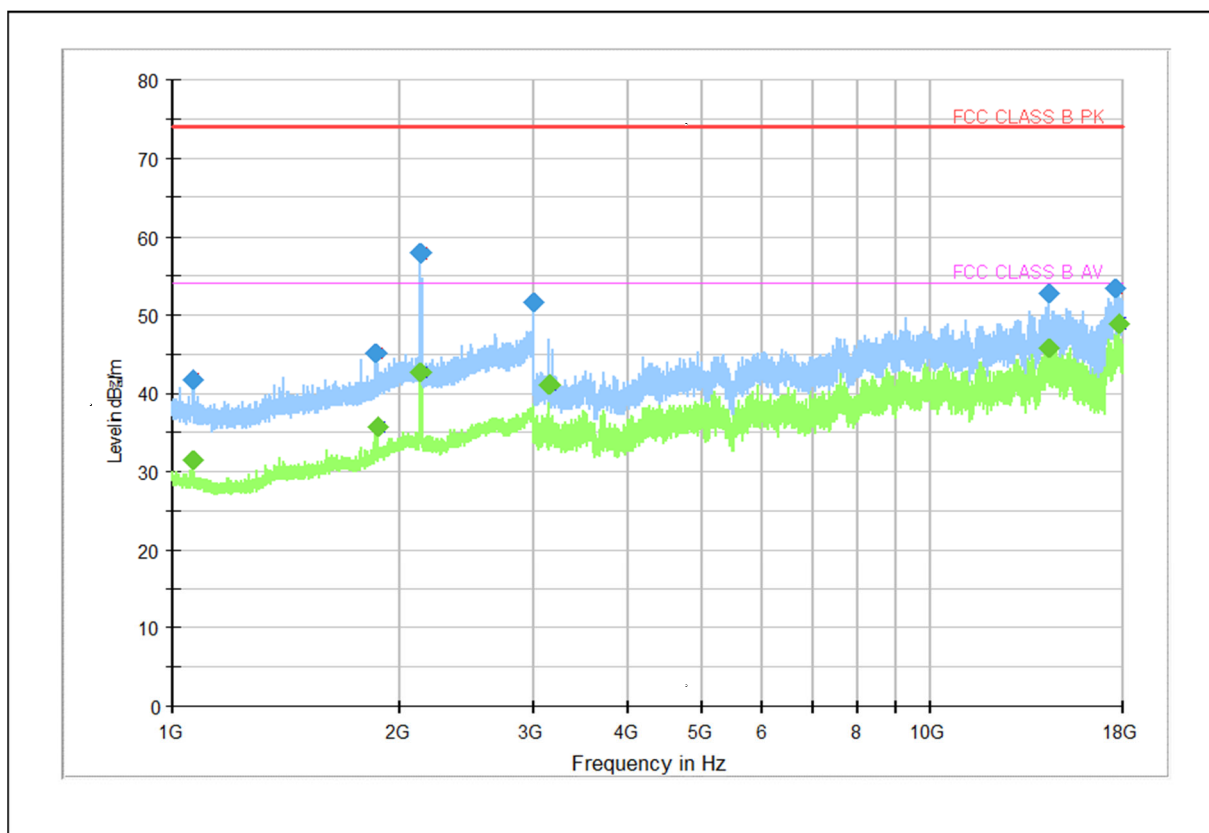

Frequency (MHz)	PK (dBµV/m)	CAV (dBµV/m)	Limit (dBµV/m)	Margin (dB)	Height (cm)	Pol	Azimuth (deg)	Corr. (dB)
1 061.400	41.88	---	74.00	32.12	101.00	V	62.00	10.00
1 062.400	---	31.62	54.00	22.38	103.00	V	73.00	10.10
1 861.600	45.11	---	74.00	28.89	100.00	V	19.00	15.20
1 867.200	---	35.70	54.00	18.30	101.00	V	353.00	15.40
2 126.400	---	42.66	54.00	11.34	100.00	V	148.00	17.00
2 127.000	57.77	---	74.00	16.23	102.00	V	154.00	17.00
2 994.000	51.51	---	74.00	22.49	105.00	V	0.00	21.40
3 148.500	---	41.14	54.00	12.86	100.00	V	321.00	6.10
14 321.000	---	45.71	54.00	8.29	101.00	V	45.00	36.70
14 325.500	52.69	---	74.00	21.31	100.00	H	152.00	36.70
17 545.500	53.34	---	74.00	20.66	102.00	H	199.00	40.40
17 788.500	---	48.96	54.00	5.04	100.00	H	294.00	40.70

Note 1) We have also tested from 18 GHz to 40 GHz and found no emissions.

Note 2) Level (PK and/or CAV) = Reading (PK and/or CAV) + Corr. (Antenna Factor + Cable Loss - Amp. Gain)

Margin (PK and/or CAV) = Limit – Level (PK and/or CAV)

PK = Peak, CAV = CISPR-Average, Corr. = Correction Factor