

FCC ID: A3LSMS918U

Power Density Simulation Report

Revision A

November 07, 2022

SAMSUNG ELECTRONICS

1. Simulation methodology for Power Density (PD)

1.1 Simulation tool

1.1.1 Tool description

For the simulation approach to calculating power density (PD) evaluation for mobile phone with mmWave antenna modules, ANSYS Electromagnetics suite version 2022.R1 (HFSS) is used. ANSYS HFSS is one of several commercial tools for 3D full-wave electromagnetic simulation used for antenna and RF structure design of high frequency component. ANSYS Electromagnetics suite version 2022.R1 (HFSS) is implemented based on Finite Element Method (FEM), which operates in the frequency domain.

1.1.2 Mesh and Convergence criteria

To solve the PD analysis using FEM, volume area containing simulated objects should be subdivided into electrically small parts that are called finite elements as the unknown functions. To subdivide system, the adaptive mesh technique in ANSYS Electromagnetics suite version 2022.R1 (HFSS) is used. ANSYS Electromagnetics suite version 2022.R1 (HFSS) starts to refine the initial mesh based on wavelength and calculate the error to iterative process for adaptive mesh refinement. The determination parameter of the number of iteration in ANSYS Electromagnetics suite version 2022.R1 (HFSS) is defined as convergence criteria, delta S, and the iterative adaptive mesh process repeats until the delta S is met. In ANSYS Electromagnetics suite version 2022.R1 (HFSS), the accuracy of converged results depends on the delta S. Figure 1 is an example of adaptive mesh of the device (cross-section of top view).

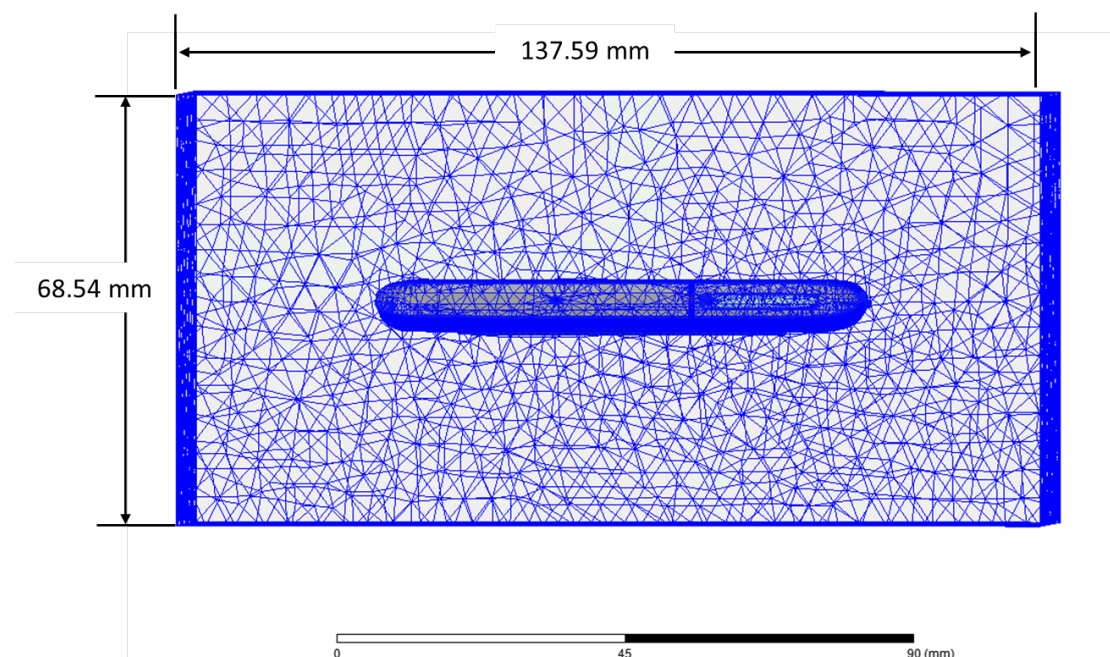

Figure 1 Example of the adaptive mesh technique (Top view)

1.1.3 Power density calculation

After solving 3D full-wave electromagnetic simulation, various kinds of physical quantities can be obtained. To calculate PD evaluation, two physical quantities, an electric field (\vec{E}) and a magnetic field (\vec{H}) are needed. The actual consumption power can be expressed as the real term of the Poynting vector (\vec{S}) from the cross product of \vec{E} and complex conjugation of \vec{H} as shown below:

$$\langle \vec{S} \rangle = \text{Re} \left(\frac{1}{2} \vec{E} \times \vec{H}^* \right)$$

$\langle \vec{S} \rangle$ can be expressed as point power density based on a peak value of each spatial point on mesh grids, and obtained directly from ANSYS Electromagnetics suite version 2022.R1 (HFSS).

From the point power density $\langle \vec{S} \rangle$, the spatial-averaged power density (PD_{av}) on an evaluated area (A) can be derived as shown below:

$$PD_{av} = \frac{1}{A} \int_A \langle \vec{S} \rangle \cdot ds = \frac{1}{2A_{av}} \iint_{A_{av}} \| \text{Re}\{E \times H^*\} \| dA$$

, where the spatial-averaged power density (PD_{av}) is total power density value considering on x, y and z components of point power density $\langle \vec{S} \rangle$ and the evaluated area (A) is 4cm^2 .

1.2 Simulation setup

1.2.1 3D modeling

Figure 2 shows the simulation model which is mounted two mmWave antenna modules. The simulation modeling includes most of the entire structure of device itself such as PCB, metal frame, battery, cables, and legacy antennas as well as mmWave antenna modules called as Ant M and Ant N. The modeling contains the entire EUT to enable a Smart transmit GEN2, as well. Ant M is placed on the left side and antennas are facing the back side, and Ant N is placed on the right side and antennas are facing the right side of the device.

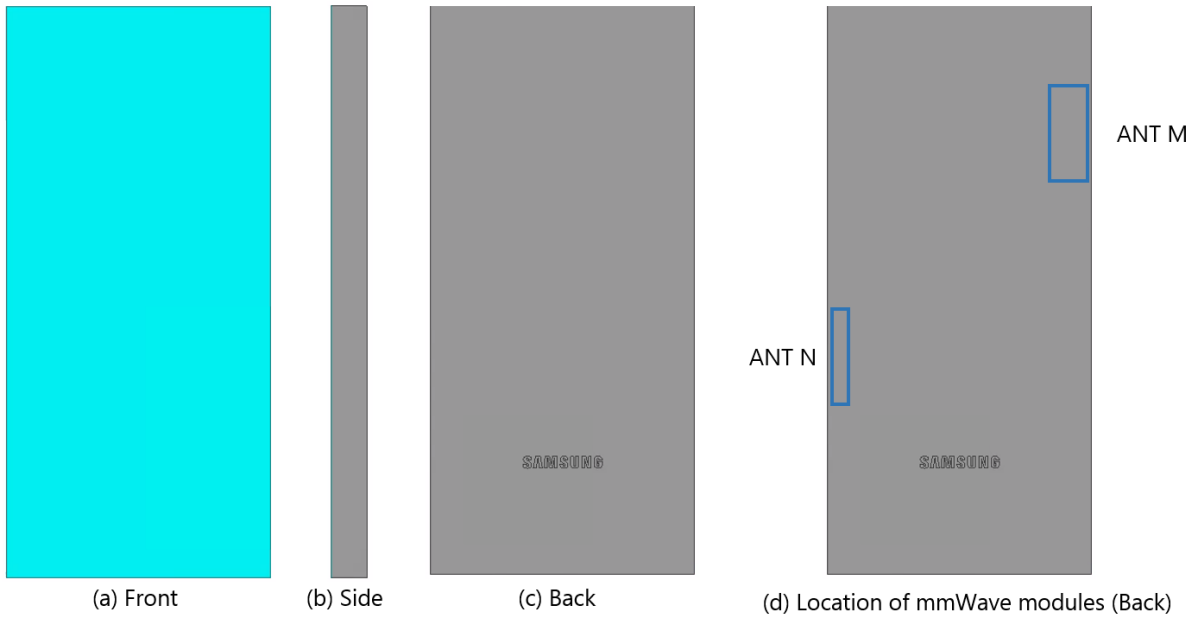

Figure 2 Simulation model which is mounted two mmWave antenna modules

1.2.2 PD evaluation planes

Table 1 shows the PD evaluation planes for each mmWave antenna module and Figure 3 shows the PD evaluation planes and truncation area of the simulation model to find worst case of beamforming cases.

Please note that the “right” and “left” edge of mentioned in this report are defined from the perspective of looking at the device from the front side.

Table 1. PD evaluation planes

Module	Front	Back	Left From Front View	Right From Front View	Top	Bottom
	S1	S2	S3	S4	S5	S6
Ant M	O	O	O	O	O	O
Ant N	O	O	O	O	O	O

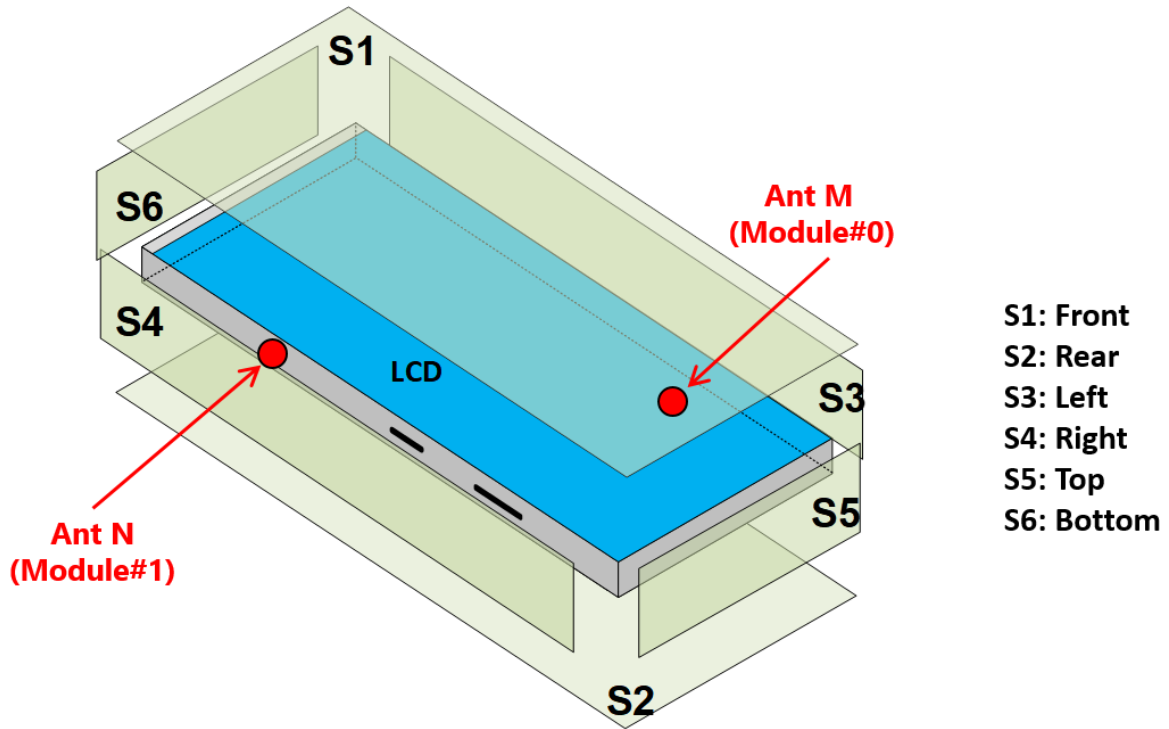

Figure 3. PD evaluation planes

1.2.3 Boundary condition

To simulate electromagnetic tool based on FEM, the boundary condition allows electromagnetic waves to be electrically open at the boundary and radiated far away without reflection. ANSYS Electromagnetics suite version 2022.R1 (HFSS) can support the absorbing boundary condition (ABC) for radiation boundary and make normally a quarter wave length from the radiating structure. In this report, to cover all beamforming cases of mmWave antenna modules, 40 mm spacing from the device for each surfaces were adopted. This distance is sufficiently large enough for “Qualcomm MG script” to extract valid E- and H-fields from all adjacent exposure surfaces of the EUT.

1.2.4 Source excitation condition

The number of antenna ports of ANT M and ANT N for source excitation are the same. The antenna port of ANT M and N is divided into 10 ports for n261 and n258 1 x 5 patch array antennas, 10 ports for n260 1 x 5 patch array antennas. In the 10 ports included in each patch antenna, 5 ports are divided into vertical polarization feeding, and the other 5 ports are divided into horizontal polarization feeding.

Figure 4 shows the ANT M module structure and surrounding structure. The ANT M module is encrypted in the ANSYS Electromagnetics suite (HFSS) and can only check the feeding position.

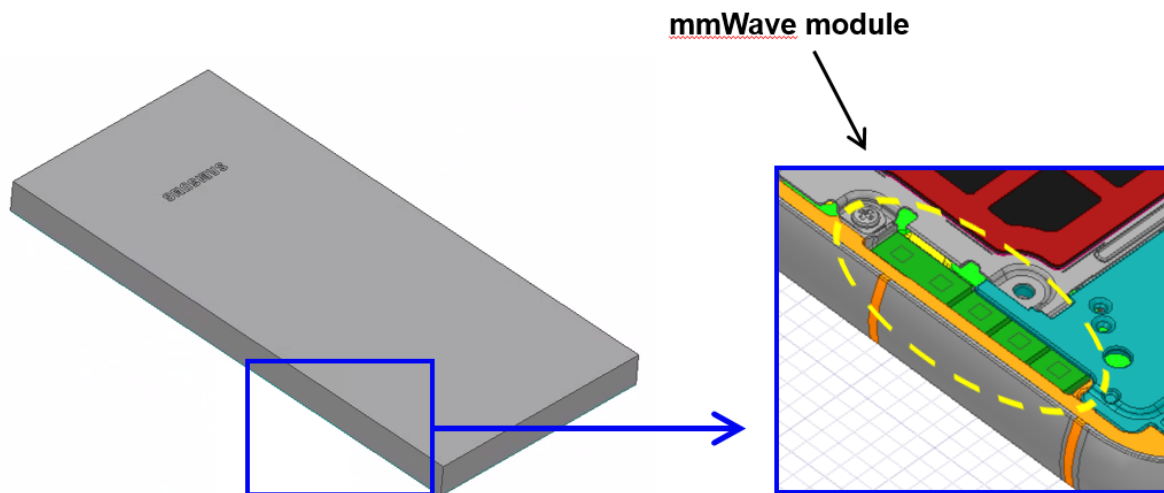

Figure 4. mmWave module (ANT M)

After finishing 3D full wave electromagnetic simulation of modeling structure, the magnitude and phase information can be loaded for each port by using “Edit Sources” function in ANSYS Electromagnetics suite (HFSS). Figure 5 shows an example of antenna port excitations.

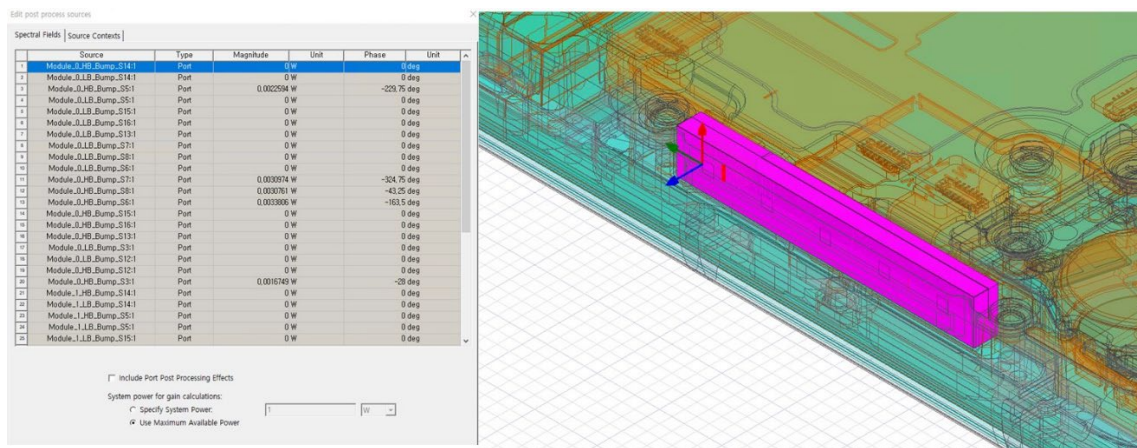

Figure 5. An example of port excitation (ANT N)

Since ANSYS Electromagnetics suite (HFSS) uses FEM solver based on frequency domain analysis method, the input source for the port excitation applies sinusoidal waveform for each frequency.

1.2.5 Condition of simulation completion

The simulation completion condition of ANSYS Electromagnetics suite (HFSS) is defined as delta S. The ANSYS Electromagnetics suite (HFSS) calculates the S-parameter for the mesh conditions of each step and determines whether to proceed with the operation of the next step by comparing the difference

between the S-parameters in the previous step. A difference between the previous step and the current step of S-parameter is expressed as delta S, and the delta S generally sets 0.02. The simulation result of this report is the result of setting delta S to 0.02.

2. Simulation verification

2.1 Spatial-averaged power density and `sim.power_limit`

As mentioned in the previous chapter, the Poynting vector (\vec{S}) can be obtained through cross product of an electric field (\vec{E}) and complex conjugate of a magnetic field (\vec{H}). The real term of the Poynting vector can be described as the point power density or peak power density. Using the point power density, the spatial-averaged power density can be obtained by the integral of 4 cm^2 at 2.5 mm intervals of the point power density result. Figure 6 shows examples of the distribution plot of point power density and the averaged power density.

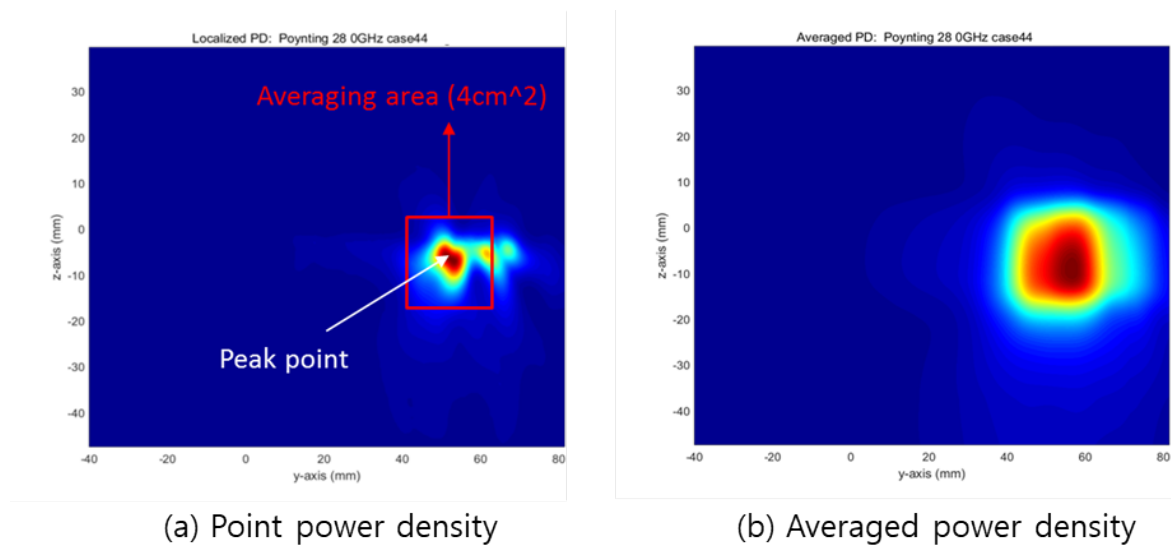

Figure 6. Power density distribution (Example)

For the Smart transmit GEN2, the “Qualcomm MG script” were used to extract E- and H-fields from the validated simulation and to assess the mutual coupling between all the mmWave antenna modules and all the beams in the codebook to determine the backoff value for each mmWave module. Note the assessment and backoff value derivation are automated with “Qualcomm MG script”. Once the script is done with assessment, it will provide the `sim.power_limit` (backoff is already included) for all the beams for all three channels for the specified `PD_design_target`. This mode take the minimum `sim.power_limit` out of all three channels (low, mid and high) and use the resulted `sim.power_limit`.

2.2 Comparison between simulation, measurement

In this section, the simulated-power density distributions and measured-power density distributions are compared to each mmWave antenna. Furthermore, to verify the Smart transmit GEN2, the PD distributions printing out from the “Qualcomm MG script” are added.

Based on comparison of power density distributions, the power densities of simulated, measured and the “Qualcomm MG Script” have a good correlation. The discrepancy in amplitude between the “Qualcomm MG Script” 4cm² averaged power density and measured 4cm² averaged power density is considered as housing influence and used in determining input power limit for each beam for RF exposure compliance.

The input powers per each active port are listed below for both Simulation and Measurement validation and power density characterization. For Simulation, these values were entered directly into HFSS model. For measurement, FTM S/W was used to input these values for each active port also.

Mode/Band	Antenna	Input Power (dBm)	
		SISO	MIMO
5G NR n261	M Patch	6.0	6.0
	N Patch	6.0	6.0
5G NR n260	M Patch	6.0	6.0
	N Patch	6.0	6.0
5G NR n258	M Patch	6.0	6.0
	N Patch	6.0	6.0

* The below simulation and measurement result were performed at 2mm evaluation distance and 28GHz / 38.5GHz / 24.8 GHz. The *input.power.limit* was determined based on below results.

Band	Channel	Module	Type(P or D)	Side	Beam ID	PLS (10 dBm)	Sim. PD (mW/cm2)	Meas. PD (mW/cm2) * Circle Avg		
n261	Mid Ch. 2077891 (27923.5 MHz)	M	Patch	Rear	36	60	1.516	0.742		
				Left			0.934	0.531		
				Rear	155		2.375	1.29		
				Left	164		1.652	0.941		
		N	Patch	Rear	39		0.855	0.47		
				Right	32		1.587	0.566		
				Rear	169		0.429	0.199		
				Right	161		0.649	0.368		
n260	Mid Ch. 2253331 (38449.9 MHz)	M	Patch	Rear	37	60	1.396	0.493		
				Left	24		0.724	0.301		
				Rear	154		1.506	0.564		
				Left	153		0.729	0.305		
		N	Patch	Right	32		1.952	1.02		
				Front			0.910	0.502		
				Right	158		1.591	0.782		
				Front	167		0.729	0.292		
n258	Mid Ch. 2025833 (24800.04 MHz)	M	Patch	Rear	35	60	1.625	0.539		
				Left			1.082	0.323		
				Rear	165		2.050	0.913		
				Left			1.298	0.778		
		N	Patch	Rear	41		1.061	0.519		
				Right	30		1.374	0.562		
				Rear	161		0.339	0.24		
				Right			0.435	0.242		

● Table 2-1, n261 ANT M-Patch

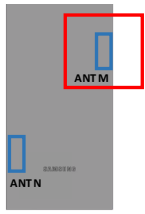
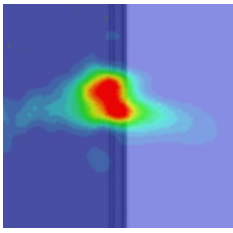
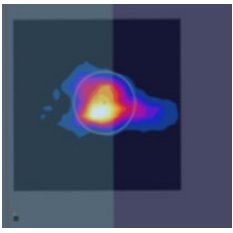
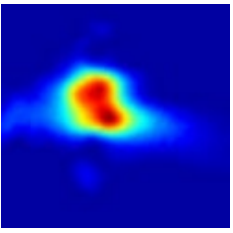
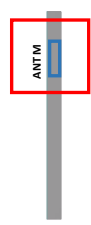
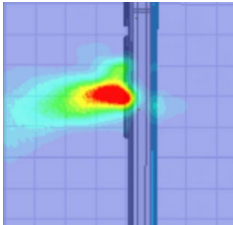
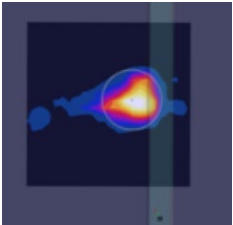
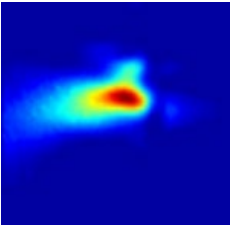
Beam ID	Surface	View	Simulated PD	Measured PD	Print out from Qualcomm MG Script
36	S2 (Rear)				
	S3 (Left)				

● Table 2-2, n261 ANT M-Patch

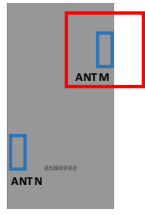
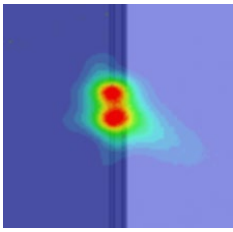
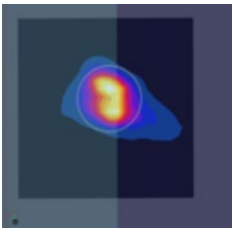
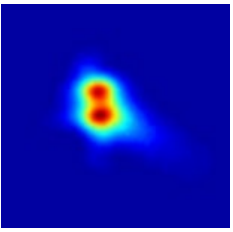
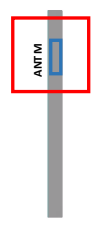
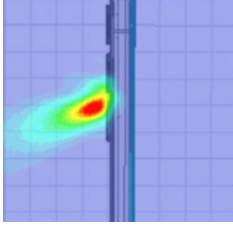
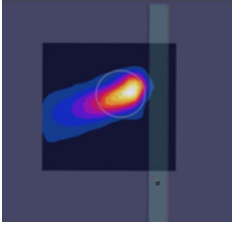
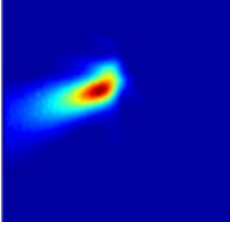
Beam ID	Surface	View	Simulated PD	Measured PD	Print out from Qualcomm MG Script
155	S2 (Rear)				
164	S3 (Left)				

● Table 2-3, n261 ANT N-Patch

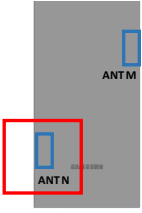
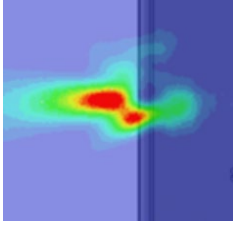
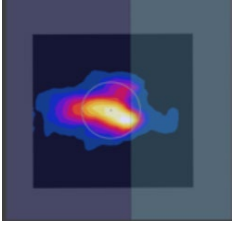
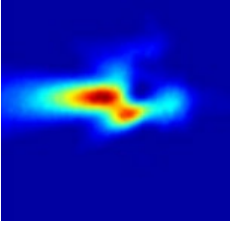
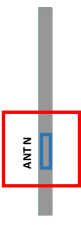
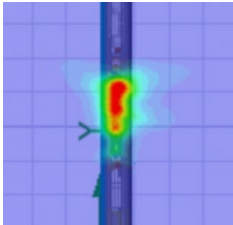
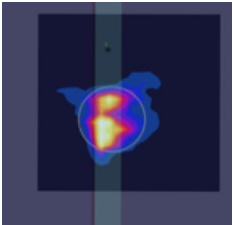
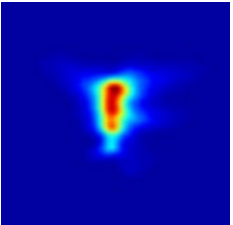
Beam ID	Surface	View	Simulated PD	Measured PD	Print out from Qualcomm MG Script
39	S2 (Rear)				
32	S4 (Right)				

● Table 2-4, n261 ANT N-Patch

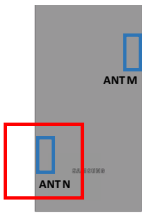
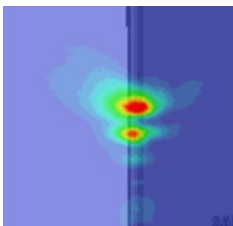
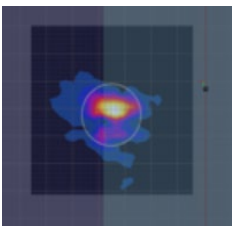
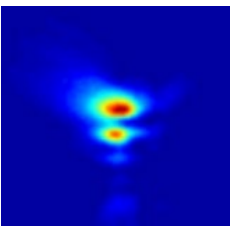
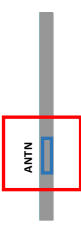
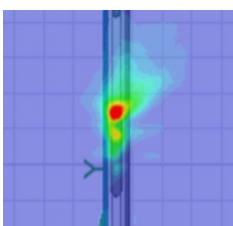
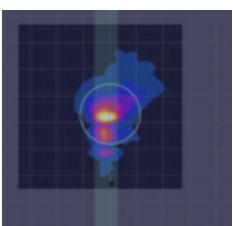
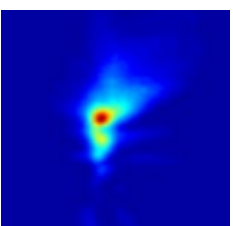
Beam ID	Surface	View	Simulated PD	Measured PD	Print out from Qualcomm MG Script
169	S2 (Rear)				
161	S4 (Right)				

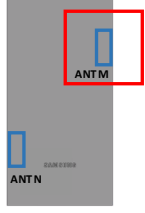
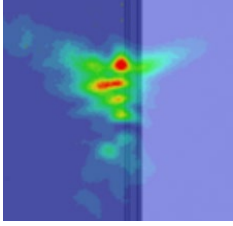
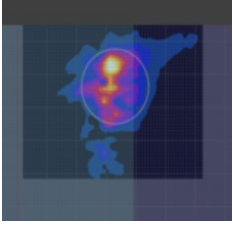
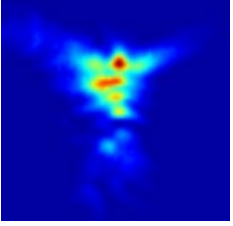
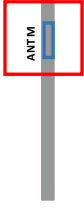
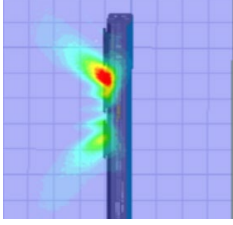
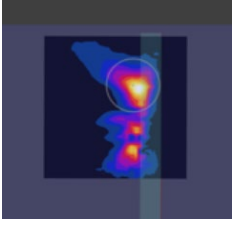
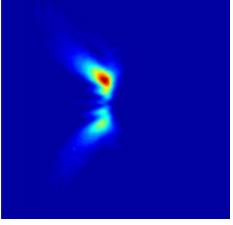

- Table 2-5, n260 ANT M-Patch

Beam ID	Surface	View	Simulated PD	Measured PD	Print out from Qualcomm MG Script
37	S2 (Rear)				
24	S3 (Left)				

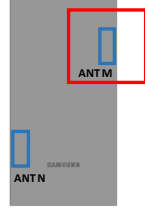
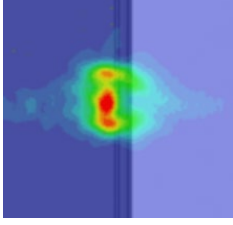
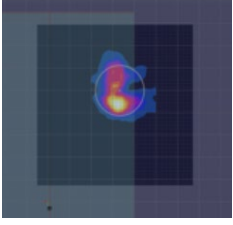
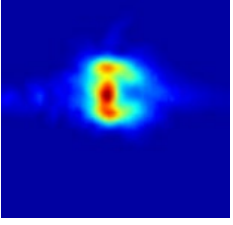
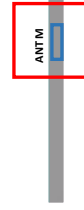
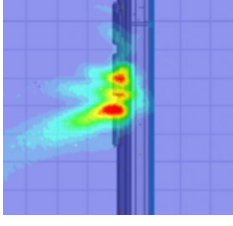
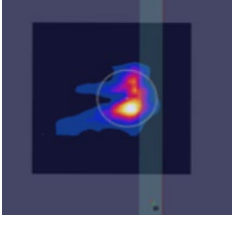
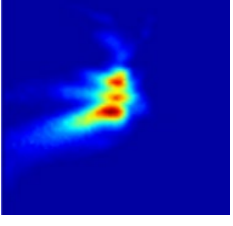
- Table 2-6, n260 ANT M-Patch

Beam ID	Surface	View	Simulated PD	Measured PD	Print out from Qualcomm MG Script
154	S2 (Rear)				
153	S3 (Left)				

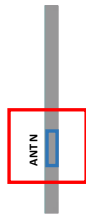
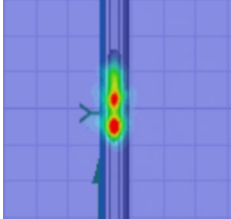
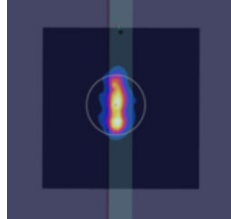
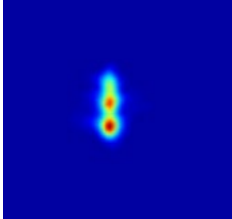
● Table 2-7, n260 ANT N-Patch

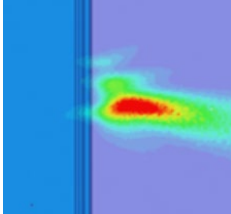
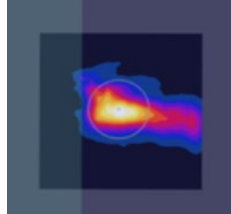
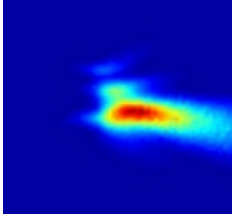
Beam ID	Surface	View	Simulated PD	Measured PD	Print out from Qualcomm MG Script
32	S4 (Right)				
	S1 (Front)				

● Table 2-8, n260 ANT N-Patch

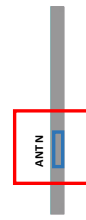
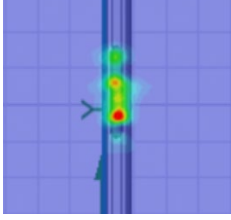
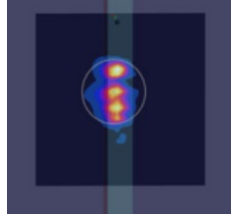
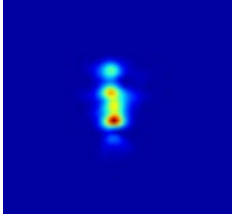
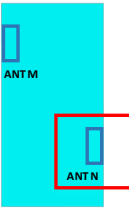
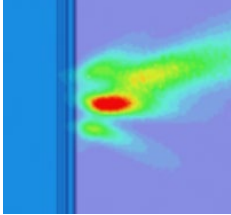
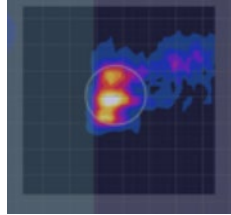
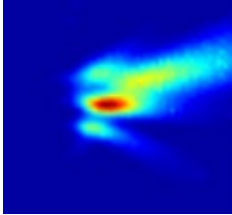
Beam ID	Surface	View	Simulated PD	Measured PD	Print out from Qualcomm MG Script
158	S4 (Right)				
167	S1 (Front)				

● Table 2-9, n258 ANT M-Patch

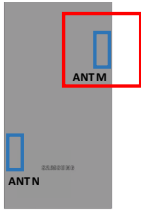
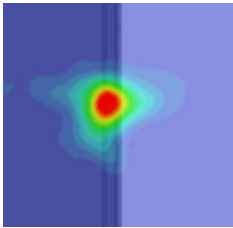
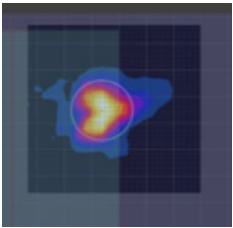
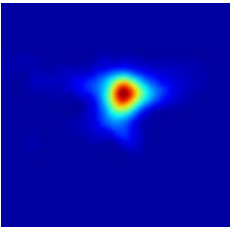
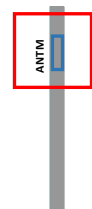
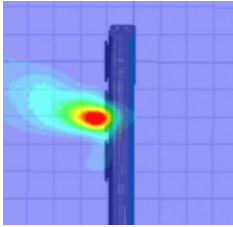
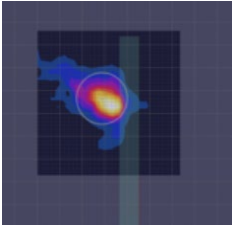
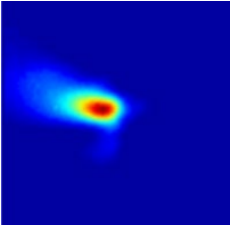
Beam ID	Surface	View	Simulated PD	Measured PD	Print out from Qualcomm MG Script
35	S2 (Rear)				
	S3 (Left)				

● Table 2-10, n258 ANT M-Patch

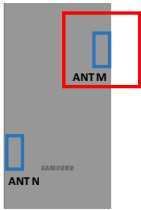
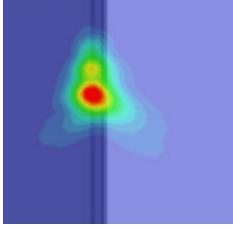
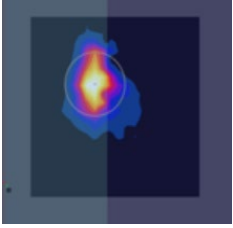
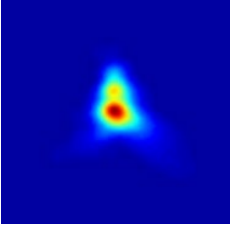
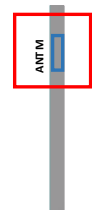
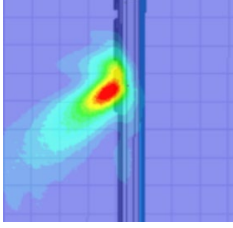
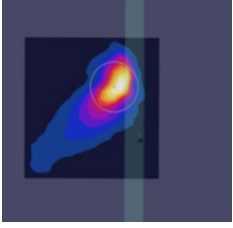
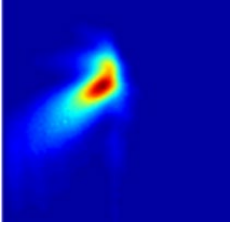
Beam ID	Surface	View	Simulated PD	Measured PD	Print out from Qualcomm MG Script
165	S2 (Rear)				
	S3 (Left)				

● Table 2-11, n258 ANT N-Patch

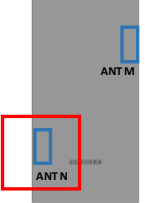
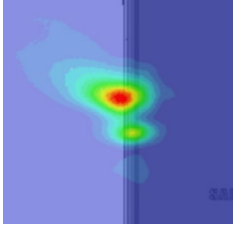
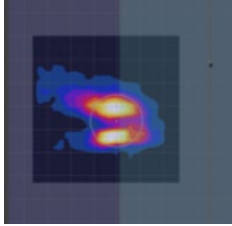
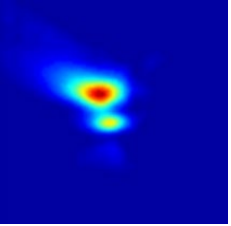
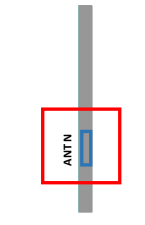
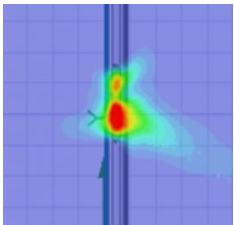
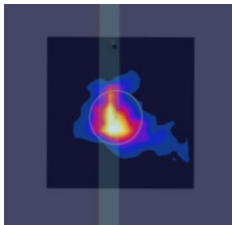
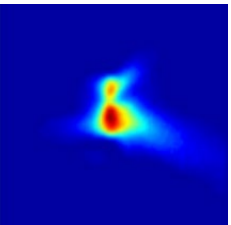
Beam ID	Surface	View	Simulated PD	Measured PD	Print out from Qualcomm MG Script
41	S2 (Rear)				
	S4 (Right)				

● Table 2-12, n258 ANT N-Patch

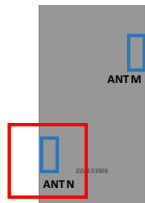
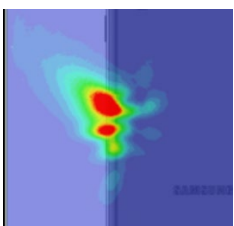
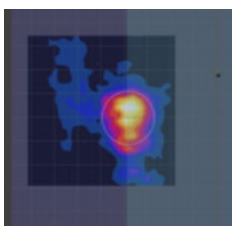
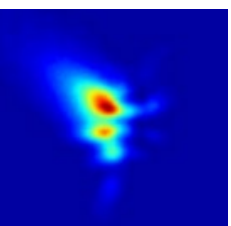
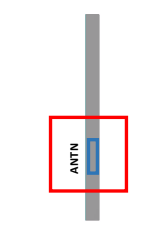
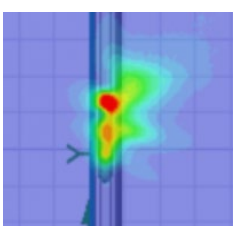
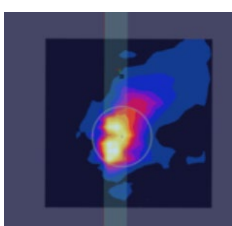
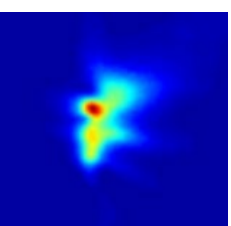
Beam ID	Surface	View	Simulated PD	Measured PD	Print out from Qualcomm MG Script
161	S2 (Rear)				
	S4 (Right)				

The Smart transmit GEN2 cannot be finalized until the additional verifications are performed and passed. Follow the below steps for verifications in the mid channel:

VERIFICATION 1: Use “Qualcomm MG script” to print the PD plots for all the beams selected and evaluated for model validation.

- Throughout above comparisons (Table 2-1 to 2-12), the model validation including MG script were verified.

VERIFICATION 2: Contribution factors from Qualcomm MG script and from HFSS for selected beams, and normalized combined PD verification, for A3LSMS918U device with 2 QTMs. The printed contribution factor from Qualcomm MG Script was within 2% numerical tolerance of the simulated contribution factor. Additionally, the normalized combined PD is < 1.0.

[n261 band]

Worst-case surface:					S2 (Back)	
Worst-case location (x,y,z) in meters:					Worst 4cm2 PD value location is -0.03607m, 0.11280m, -0.01269m	
PD design target (W/m ²)					6.31	
Values printed from Qualcomm MG Script					Values obtained by OEM using EM simulation tool	
QTM #	Beam ID	c(i,j) i = beam ID j = QTM #	Backoff factor b _j	verification.sim. power limit (before backoffs) [dBm]	simulated 4cm2 PD(i,j) at (-0.03607m, 0.11280m, -0.01269m) at verification.sim.power limit on S2	C _{simulated(i,j)} = 4cm ² PD(i,j)/ PD_design_target
0	140	0.9992	0.955	4.09	6.30539	0.9993
1	169	0.0197	0.8913	6.20	0.12419	0.0197
Verify 1:		$C(i,j) = C_{simulated}(i,j), i = 140, 169; j = 0, 1$				
Verify 2:		$b_0 * c(140,0) + b_1 * c(169,1) = 0.955 * 0.9992 + 0.8913 * 0.0197 = 0.9718 \leq 1$				

[n260 band]

Worst-case surface:					S4 (Right)	
Worst-case location (x,y,z) in meters:					Worst 4cm2 PD value location is 0.04152m, 0.06280m, -0.00469m	
PD design target (W/m ²)					6.31	
Values printed from Qualcomm MG Script					Values obtained by OEM using EM simulation tool	
QTM #	Beam ID	c(i,j) i = beam ID j = QTM #	Backoff factor b _j	verification.sim. power limit (before backoffs) [dBm]	simulated 4cm2 PD(i,j) at (0.04152m, 0.06280m, - 0.00469m) at verification.sim.power limit on S4	C _{simulated(i,j)} = 4cm ² PD(i,j)/ PD_design_target
0	25	0.0061	0.955	3.91	0.03871	0.0061
1	145	0.9998	0.8913	6.88	6.31827	1.0013
Verify 1:		$C(i,j) = C_{simulated}(i,j), i = 25, 145; j = 0, 1$				
Verify 2:		$b_0 * c(25,0) + b_1 * c(145,1) = 0.955 * 0.0061 + 0.8913 * 0.9998 = 0.8969 \leq 1$				

[n258 band]

Worst-case surface:				S2 (Back)		
Worst-case location (x,y,z) in meters:				Worst 4cm2 PD value location is 0.03593m, 0.07080m, -0.01269m		
PD design target (W/m ²)				6.31		
Values printed from Qualcomm MG Script				Values obtained by OEM using EM simulation tool		
QTM #	Beam ID	c(ij) i = beam ID j = QTM #	Backoff factor b _j	verification.sim. power _{limit} (before backoffs) [dBm]	simulated 4cm2 PD(ij) at (0.03593m, 0.07080m, -0.01269m) at verification.sim.power _{limit} on S2	C _{simulated} (ij)= 4cm ² PD(ij)/ PD_design_target
0	13	0.0733	0.955	9.59	0.46293	0.0734
1	145	0.9933	0.8913	11.81	6.27328	0.9942
Verify 1: $C(i,j) = C_{simulated}(i,j), i = 13, 145; j = 0, 1$						
Verify 2: $b_0 * c(13,0) + b_1 * c(145,1) = 0.955 * 0.0733 + 0.8913 * 0.9933 = 0.9553 \leq 1$						

VERIFICATION3: Measured 4cm² PD on worst surface and combined PD at worst-case location for A3LSMS918U device with 2 QTMS. The device should be measured at the reference power level and scaled to the input.power.limit. The combined PD should be less than or equal to the *PD_Design_Target* within the uncertainty at the reference power level.

[n261 band]

QTM #	Beam ID	c(i,j) i = beam ID j = QTM #	Dominant surface	4cm ² PD at input.power.limit on QTM dominant surface (W/m ²)	input.power.limit (before permanent backoff)	Measured PD at reference power level on Beam Dominant Surface (mW/cm ²)
0	140	0.9992	S2 (Back)	4.181	5.7	4.181
1	169	0.0197	S4 (Right)	4.324	7.5	4.324
combined PD at the worst-case location (x,y,z)				$c(140,0)*\text{meas.}4\text{cm}^2\text{PD}(140,0) + c(169,1)*\text{meas.}4\text{cm}^2\text{PD}(169,1)$ $= 0.9992*4.181 + 0.0197*4.324 = 4.263 \text{ W/m}^2$		
PD_design_target + uncertainty at reference power level of 0.63 dB				$= 6.310*10^{(0.63/10)} = 7.295 \text{ W/m}^2$		
Verify				combined PD < PD_design_target + uncertainty at reference power level		

[n260 band]

QTM #	Beam ID	c(i,j) i = beam ID j = QTM #	Dominant surface	4cm ² PD at input.power.limit on QTM dominant surface (W/m ²)	input.power.limit (before permanent backoff)	Measured PD at reference power level on Beam Dominant Surface (mW/cm ²)
0	25	0.0061	S2 (Back)	3.114	6.2	3.114
1	145	0.9998	S4 (Right)	4.016	7.3	4.016
combined PD at the worst-case location (x,y,z)				$c(25,0)*\text{meas.}4\text{cm}^2\text{PD}(25,0) + c(145,1)*\text{meas.}4\text{cm}^2\text{PD}(145,1)$ $= 0.0061*3.114 + 0.9998*4.016 = 4.034 \text{ W/m}^2$		
PD_design_target + uncertainty at reference power level of 0.63 dB				$= 6.310*10^{(0.63/10)} = 7.295 \text{ W/m}^2$		
Verify				combined PD < PD_design_target + uncertainty at reference power level		

[n258 band]

QTM #	Beam ID	c(i,j) i = beam ID j = QTM #	Dominant surface	4cm ² PD at input.power.limit on QTM dominant surface (W/m ²)	input.power.limit (before permanent backoff)	Measured PD at reference power level on Beam Dominant Surface (mW/cm ²)
0	13	0.0733	S2 (Back)	2.470	10.3	2.470
1	145	0.9933	S2 (Back)	1.755	10.9	1.755
combined PD at the worst-case location (x,y,z)				$c(13,0)*\text{meas.}4\text{cm}^2\text{PD}(13,0) + c(145,1)*\text{meas.}4\text{cm}^2\text{PD}(145,1)$ $= 0.0733*2.47 + 0.9933*1.755 = 1.924 \text{ W/m}^2$		
PD_design_target + uncertainty at reference power level of 0.63 dB				$= 6.310*10^{(0.63/10)} = 7.295 \text{ W/m}^2$		
Verify				combined PD < PD_design_target + uncertainty at reference power level		

- M-patch High CH

No.	Model	Type	Beam ID 1	Beam ID 2	Feed no.	4x42 F500(WaveC)						max ratio out of all beams										max ratio out of all beams																																																																																
						4x42 F500(WaveC)						4.2%					10.0%					67.7%					1.7%					28.5%					3.9%					4.2%					67.7%																																																							
						54(Right)	53(L)R	55(Top)	54(Bottom)	53(R)R	55(Bottom)	Ratio (Right 20m)/((surface 20m))	Ratio (Left 20m)/((surface 20m))	Ratio (Top 20m)/((surface 20m))	Ratio (Bottom 20m)/((surface 20m))	Ratio (Floor 20m)/((surface 20m))	Ratio (Roof 20m)/((surface 20m))	54(Right)	53(L)R	55(Top)	54(Bottom)	53(R)R	55(Bottom)	Ratio (Right 20m)/((surface 20m))	Ratio (Left 20m)/((surface 20m))	Ratio (Top 20m)/((surface 20m))	Ratio (Bottom 20m)/((surface 20m))	Ratio (Floor 20m)/((surface 20m))	Ratio (Roof 20m)/((surface 20m))	54(Right)	53(L)R	55(Top)	54(Bottom)	53(R)R	55(Bottom)	Ratio (Right 20m)/((surface 20m))	Ratio (Left 20m)/((surface 20m))	Ratio (Top 20m)/((surface 20m))	Ratio (Bottom 20m)/((surface 20m))	Ratio (Floor 20m)/((surface 20m))	Ratio (Roof 20m)/((surface 20m))	54(Right)	53(L)R	55(Top)	54(Bottom)	53(R)R	55(Bottom)	Ratio (Right 20m)/((surface 20m))	Ratio (Left 20m)/((surface 20m))	Ratio (Top 20m)/((surface 20m))	Ratio (Bottom 20m)/((surface 20m))	Ratio (Floor 20m)/((surface 20m))	Ratio (Roof 20m)/((surface 20m))																																																	
1	1	1	0.01	0.02	0.03	0.04	0.05	0.06	0.07	0.08	0.09	0.10	0.11	0.12	0.13	0.14	0.15	0.16	0.17	0.18	0.19	0.20	0.21	0.22	0.23	0.24	0.25	0.26	0.27	0.28	0.29	0.30	0.31	0.32	0.33	0.34	0.35	0.36	0.37	0.38	0.39	0.40	0.41	0.42	0.43	0.44	0.45	0.46	0.47	0.48	0.49	0.50	0.51	0.52	0.53	0.54	0.55	0.56	0.57	0.58	0.59	0.60	0.61	0.62	0.63	0.64	0.65	0.66	0.67	0.68	0.69	0.70	0.71	0.72	0.73	0.74	0.75	0.76	0.77	0.78	0.79	0.80	0.81	0.82	0.83	0.84	0.85	0.86	0.87	0.88	0.89	0.90	0.91	0.92	0.93	0.94	0.95	0.96	0.97	0.98	0.99	1.00

3.1.2 Ant N– Patch Antenna

Table 6 to Table 8 show the PD simulation evaluation of Ant N patch antenna at 28GHz / 39GHz / 24GHz for the corresponding evaluation plane specified in Table 1.

Table 6. PD of Ant N – patch antenna (28GHz – n261)

- N-patch Low CH

No.	Model	Type	Beam ID 1	Beam ID 2	Feed no.	4x42 F500(WaveC)						max ratio out of all beams										max ratio out of all beams																																																																																
						4x42 F500(WaveC)						10.0%					40.2%					79.2%					67.7%					1.7%					28.5%					3.9%					4.2%					67.7%																																																		
						54(Right)	53(L)R	55(Top)	54(Bottom)	53(R)R	55(Bottom)	Ratio (Right 20m)/((surface 20m))	Ratio (Left 20m)/((surface 20m))	Ratio (Top 20m)/((surface 20m))	Ratio (Bottom 20m)/((surface 20m))	Ratio (Floor 20m)/((surface 20m))	Ratio (Roof 20m)/((surface 20m))	54(Right)	53(L)R	55(Top)	54(Bottom)	53(R)R	55(Bottom)	Ratio (Right 20m)/((surface 20m))	Ratio (Left 20m)/((surface 20m))	Ratio (Top 20m)/((surface 20m))	Ratio (Bottom 20m)/((surface 20m))	Ratio (Floor 20m)/((surface 20m))	Ratio (Roof 20m)/((surface 20m))	54(Right)	53(L)R	55(Top)	54(Bottom)	53(R)R	55(Bottom)	Ratio (Right 20m)/((surface 20m))	Ratio (Left 20m)/((surface 20m))	Ratio (Top 20m)/((surface 20m))	Ratio (Bottom 20m)/((surface 20m))	Ratio (Floor 20m)/((surface 20m))	Ratio (Roof 20m)/((surface 20m))	54(Right)	53(L)R	55(Top)	54(Bottom)	53(R)R	55(Bottom)	Ratio (Right 20m)/((surface 20m))	Ratio (Left 20m)/((surface 20m))	Ratio (Top 20m)/((surface 20m))	Ratio (Bottom 20m)/((surface 20m))	Ratio (Floor 20m)/((surface 20m))	Ratio (Roof 20m)/((surface 20m))	54(Right)	53(L)R	55(Top)	54(Bottom)	53(R)R	55(Bottom)	Ratio (Right 20m)/((surface 20m))	Ratio (Left 20m)/((surface 20m))	Ratio (Top 20m)/((surface 20m))	Ratio (Bottom 20m)/((surface 20m))	Ratio (Floor 20m)/((surface 20m))	Ratio (Roof 20m)/((surface 20m))																																					
1	1	1	0.01	0.02	0.03	0.04	0.05	0.06	0.07	0.08	0.09	0.10	0.11	0.12	0.13	0.14	0.15	0.16	0.17	0.18	0.19	0.20	0.21	0.22	0.23	0.24	0.25	0.26	0.27	0.28	0.29	0.30	0.31	0.32	0.33	0.34	0.35	0.36	0.37	0.38	0.39	0.40	0.41	0.42	0.43	0.44	0.45	0.46	0.47	0.48	0.49	0.50	0.51	0.52	0.53	0.54	0.55	0.56	0.57	0.58	0.59	0.60	0.61	0.62	0.63	0.64	0.65	0.66	0.67	0.68	0.69	0.70	0.71	0.72	0.73	0.74	0.75	0.76	0.77	0.78	0.79	0.80	0.81	0.82	0.83	0.84	0.85	0.86	0.87	0.88	0.89	0.90	0.91	0.92	0.93	0.94	0.95	0.96	0.97	0.98	0.99	1.00

- N-patch High CH

No.	Module	Type	Beam ID 1	Beam ID 2	Lead no.	4x42 (F100/W60x2)						new ratio out of all ratios						4x62 (F100/W60x2) or 1000x evaluation distance						new ratio out of all ratios													
						4x42 (F100/W60x2)						100%		1.5%		3.2%		5.6%		8.1%		4x62 (F100/W60x2) or 1000x evaluation distance						100%		1.5%		3.2%		5.6%		8.1%	
						S16right	S16left	S17top	S17bottom	S18left	S18right	Top 2mm/(area surface Zmm)	Right 2mm/(area surface Zmm)	Left 2mm/(area surface Zmm)	Bottom 2mm/(area surface Zmm)	Top 2mm/(area surface Zmm)	Right 2mm/(area surface Zmm)	Left 2mm/(area surface Zmm)	Bottom 2mm/(area surface Zmm)	S16right	S16left	S17top	S17bottom	S18left	S18right	Top 2mm/(area surface Zmm)	Right 2mm/(area surface Zmm)	Left 2mm/(area surface Zmm)	Bottom 2mm/(area surface Zmm)	Top 2mm/(area surface Zmm)	Right 2mm/(area surface Zmm)	Left 2mm/(area surface Zmm)	Bottom 2mm/(area surface Zmm)	Top 2mm/(area surface Zmm)	Right 2mm/(area surface Zmm)	Left 2mm/(area surface Zmm)	Bottom 2mm/(area surface Zmm)
1001						100.0%	100.0%	100.0%	100.0%	100.0%	100.0%	100.0%	100.0%	100.0%	100.0%	100.0%	100.0%	100.0%	100.0%	100.0%	100.0%	100.0%	100.0%	100.0%	100.0%	100.0%	100.0%	100.0%	100.0%	100.0%	100.0%	100.0%	100.0%	100.0%	100.0%	100.0%	

- N_patch High CH

No.	Module	Type	Beam ID-1	Beam ID-2	Wind dir	max rate out of all beams													max rate out of all beams																					
						4x42 (F100Wx42)						4x42 (F100Wx42)						4x42 (F100Wx42) or 3x60 (evaluation distance)						4x42 (F100Wx42)						4x42 (F100Wx42)										
						S1(Split)	S1(L)	S1(R)	S1(Sum)	S1(Fwd)	S1(Bwd)	S1(Tot)	S2(Split)	S2(L)	S2(R)	S2(Sum)	S2(Fwd)	S2(Bwd)	S2(Tot)	S3(Split)	S3(L)	S3(R)	S3(Sum)	S3(Fwd)	S3(Bwd)	S3(Tot)	S4(Split)	S4(L)	S4(R)	S4(Sum)	S4(Fwd)	S4(Bwd)	S4(Tot)	S5(Split)	S5(L)	S5(R)	S5(Sum)	S5(Fwd)	S5(Bwd)	S5(Tot)
						[Rate]	[Rate]	[Rate]	[Rate]	[Rate]	[Rate]	[Rate]	[Rate]	[Rate]	[Rate]	[Rate]	[Rate]	[Rate]	[Rate]	[Rate]	[Rate]	[Rate]	[Rate]	[Rate]	[Rate]	[Rate]	[Rate]	[Rate]	[Rate]	[Rate]	[Rate]	[Rate]	[Rate]	[Rate]	[Rate]	[Rate]	[Rate]	[Rate]	[Rate]	[Rate]
1001						0.000	0.000	0.000	0.000	0.000	0.000	0.000	0.000	0.000	0.000	0.000	0.000	0.000	0.000	0.000	0.000	0.000	0.000	0.000	0.000	0.000	0.000	0.000	0.000	0.000	0.000	0.000	0.000	0.000	0.000	0.000	0.000			
1002						0.000	0.000	0.000	0.000	0.000	0.000	0.000	0.000	0.000	0.000	0.000	0.000	0.000	0.000	0.000	0.000	0.000	0.000	0.000	0.000	0.000	0.000	0.000	0.000	0.000	0.000	0.000	0.000	0.000	0.000	0.000	0.000	0.000		