

## HEARING AID COMPATIBILITY

**Applicant Name:**  
 Samsung Electronics Co., Ltd.  
 129, Samsung-ro, Maetan dong,  
 Yeongtong-gu, Suwon-si  
 Gyeonggi-do 16677, Korea

**Date of Testing:**  
 2/21/2022 – 2/24/2022  
**Test Site/Location:**  
 PCTEST, Columbia, MD, USA  
**Test Report Serial No.:**  
 1M2112090152-03.A3L  
**Date of Issue:**  
 3/15/2022

<b>FCC ID:</b>	<b>A3LSMS908U</b>
<b>APPLICANT:</b>	<b>SAMSUNG ELECTRONICS CO., LTD.</b>

**Scope of Test:** Audio Band Magnetic Testing (T-Coil)  
**Application Type:** Class II Permissive Change  
**FCC Rule Part(s):** CFR §20.19(b)  
**HAC Standard:** ANSI C63.19-2011  
 285076 D01 HAC Guidance v05  
 285076 D02 T-Coil testing for CMRS IP v03  
**DUT Type:** Portable Handset  
**Model:** SM-S908U  
**Additional Model(s):** SM-S908U1  
**Test Device Serial No.:** *Pre-Production Sample [S/N: 1252M]*  
**Class II Permissive Change(s):** See FCC change documents.



<b>C63.19-2011 HAC Category:</b>	<b>T4 (SIGNAL TO NOISE CATEGORY, NR TDD n48 ONLY)</b>
----------------------------------	---

This report and category pertain only to NR TDD n48 modes supported by this wireless portable device. The overall category rating of the device is determined by the lowest rating obtained over all air interfaces supported by the device. This wireless portable device has been shown to be hearing-aid compatible under the above rated category, specified in ANSI/IEEE Std. C63.19-2011 and has been tested in accordance with the specified measurement procedures. Hearing-Aid Compatibility is based on the assumption that all production units will be designed electrically identical to the device tested in this report. Test results reported herein relate only to the item(s) tested. North America bands only.

I attest to the accuracy of data. All measurements reported herein were performed by me or were made under my supervision and are correct to the best of my knowledge and belief. I assume full responsibility for the completeness of these measurements and vouch for the qualifications of all persons taking them.

  
 Randy Ortanez  
 President





<b>FCC ID:</b> A3LSMS908U		<b>HAC (T-COIL) TEST REPORT</b>		<b>Approved by:</b> Quality Manager
<b>Filename:</b> 1M2112090152-03.A3L	<b>Test Dates:</b> 2/21/2022 – 2/24/2022	<b>DUT Type:</b> Portable Handset		Page 1 of 45

# TABLE OF CONTENTS

---

1.	INTRODUCTION .....	3
2.	DUT DESCRIPTION.....	4
3.	ANSI C63.19-2011 PERFORMANCE CATEGORIES .....	6
4.	METHOD OF MEASUREMENT .....	8
5.	VONR TEST SYSTEM SETUP AND DUT CONFIGURATION.....	17
6.	OTT VOIP TEST SYSTEM AND DUT CONFIGURATION .....	19
7.	T-COIL TEST SUMMARY .....	20
8.	MEASUREMENT UNCERTAINTY .....	24
9.	EQUIPMENT LIST.....	25
10.	TEST DATA.....	26
11.	CALIBRATION CERTIFICATES.....	33
12.	CONCLUSION.....	40
13.	REFERENCES .....	41
14.	TEST SETUP PHOTOGRAPHS .....	43

<b>FCC ID:</b> A3LSMS908U	 <small>Head to the point of delivery</small>	<b>HAC (T-COIL) TEST REPORT</b>		<b>Approved by:</b> Quality Manager
<b>Filename:</b> 1M2112090152-03.A3L	<b>Test Dates:</b> 2/21/2022 – 2/24/2022	<b>DUT Type:</b> Portable Handset	Page 2 of 45	

# 1. INTRODUCTION

On July 10, 2003, the Federal Communications Commission (FCC) adopted new rules requiring wireless manufacturers and service providers to provide digital wireless phones that are compatible with hearing aids. The FCC has modified the exemption for wireless phones under the Hearing Aid Compatibility Act of 1998 (HAC Act) in WT Docket 01-309 RM-8658<sup>1</sup> to extend the benefits of wireless telecommunications to individuals with hearing disabilities. These benefits encompass business, social and emergency communications, which increase the value of the wireless network for everyone. An estimated more than 10% of the population in the United States show signs of hearing impairment and of that fraction, almost 80% use hearing aids. Approximately 500 million people worldwide and 30 million people in the United States suffer from hearing loss.

## Compatibility Tests Involved:

The standard calls for wireless communications devices to be measured for:

- RF Electric-field emissions
- T-coil mode, magnetic-signal strength in the audio band
- T-coil mode, magnetic-signal frequency response through the audio band
- T-coil mode, magnetic-signal and noise articulation index

The hearing aid must be measured for:

- RF immunity in microphone mode
- RF immunity in T-coil mode

In the following tests and results, this report includes the evaluation for a wireless communications device.

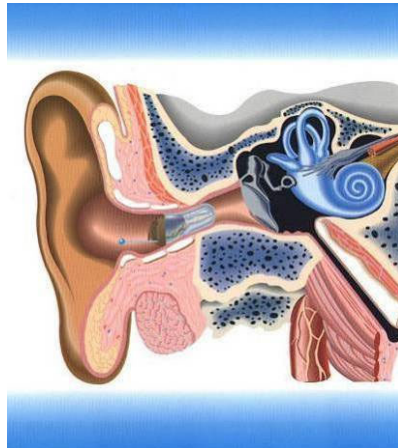



Figure 1-1 Hearing Aid *in-vitu*



<sup>1</sup> FCC Rule & Order, WT Docket 01-309 RM-8658

FCC ID: A3LSMS908U		HAC (T-COIL) TEST REPORT		Approved by: Quality Manager
Filename: 1M2112090152-03.A3L	Test Dates: 2/21/2022 – 2/24/2022	DUT Type: Portable Handset		Page 3 of 45

## 2. DUT DESCRIPTION



FCC ID: A3LSMS908U  
Applicant: Samsung Electronics Co., Ltd.  
129, Samsung-ro, Maetan dong,  
Yeongtong-gu, Suwon-si  
Gyeonggi-do 16677, Korea  
Model: SM-S908U  
Additional Model(s): SM-S908U1  
Serial Number: 1252M  
HW Version: REV1.0  
SW Version: S908USQU0AUJV  
Antenna: Internal Antenna  
DUT Type: Portable Handset

<b>FCC ID:</b> A3LSMS908U	 <b>PCTEST</b> <small>Head to the point of @ device</small>	<b>HAC (T-COIL) TEST REPORT</b>		<b>Approved by:</b> Quality Manager
<b>Filename:</b> 1M2112090152-03.A3L	<b>Test Dates:</b> 2/21/2022 – 2/24/2022	<b>DUT Type:</b> Portable Handset		Page 4 of 45



© 2022 PCTEST

REV 3.5.M  
8/18/2020

© 2022 PCTEST All rights reserved. Unless otherwise specified, no part of this report may be reproduced or utilized in any part, form or by any means, electronic or mechanical, including photocopying and microfilm, without permission in writing from PCTEST. If you have any questions about this international copyright or have an enquiry about obtaining additional rights to this report or assembly of contents thereof, please contact [INFO@PCTEST.COM](mailto:INFO@PCTEST.COM).

**Table 2-1**  
**A3LSMS908U HAC Air Interfaces**

Air-Interface	Band (MHz)	Type Transport	HAC Tested	Simultaneous But Not Tested	Name of Voice Service	Audio Codec Evaluated
GSM	850	VO	No <sup>3</sup>	Yes: WIFI or BT	CMRS Voice <sup>1</sup>	EFR
	1900					
	GPRS/EDGE	VD				
UMTS	850	VD	No <sup>3</sup>	Yes: WIFI or BT	CMRS Voice <sup>1</sup>	NB AMR, WB AMR
	1700					
	1900					
	HSPA	VD				
LTE (FDD)	680 (B71)	VD	No <sup>3</sup>	Yes: NR, WIFI or BT	VoLTE <sup>1</sup> , Google Duo <sup>2</sup>	VoLTE: NB AMR, WB AMR, EVS Google Duo: OPUS
	700 (B12)					
	780 (B13)					
	790 (B14)					
	850 (B5)					
	850 (B26)					
	1700 (B4)					
	1700 (B66)					
	1900 (B2)					
	1900 (B25)					
	2300 (B30)					
2500 (B7)						
LTE (TDD)	2600 (B41)	VD	No <sup>3</sup>	Yes: NR, WIFI or BT	VoLTE <sup>1</sup> , Google Duo <sup>2</sup>	VoLTE: NB AMR, WB AMR, EVS Google Duo: OPUS
	2600 (B38)					
	3600 (B48)					
NR (FDD)	680 (n71)	VD	No <sup>3</sup>	Yes: LTE, WIFI or BT	VoNR <sup>2</sup> , Google Duo <sup>2</sup>	VoNR: NB AMR, WB AMR, EVS Google Duo: OPUS
	700 (n12)					
	850 (n5)					
	1700 (n66)					
	1900 (n2)					
	1900 (n25)					
	2300 (n30)					
2500 (n7)						
NR (TDD)	2600 (n41)	VD	No <sup>3</sup>	Yes: LTE, WIFI or BT	VoNR <sup>2</sup> , Google Duo <sup>2</sup>	VoNR: NB AMR, WB AMR, EVS Google Duo: OPUS
	2600 (n38)					
	3500 (n77, DoD)					
	3600 (n48)					
	3700 (n77)					
	24500 (n258)					
	28000 (n261)					
39000 (n260)						
WIFI	2450	VD	No <sup>3</sup>	Yes: GSM, UMTS, LTE, or NR	VoWIFI <sup>2</sup> , Google Duo <sup>2</sup>	VoWIFI: NB AMR, WB AMR, EVS Google Duo: OPUS
	5200 (U-NII 1)					
	5300 (U-NII 2A)					
	5500 (U-NII 2C)					
	5800 (U-NII 3)					
	5900 (U-NII 4)					
	6175 (U-NII 5)					
	6475 (U-NII 6)					
	6700 (U-NII 7)					
7000 (U-NII 8)						
BT	2450	DT	No	Yes: GSM, UMTS, LTE, or NR	N/A	N/A
Type Transport VO = Voice Only DT = Digital Data - Not intended for Voice Services VD = CMRS and/or IP Voice over Data Transport			Notes: 1. Reference level in accordance with 7.4.2.1 of ANSI C63.19-2011 and July 2012 C63 VoLTE Interpretation. 2. Reference level is -20dBm0 in accordance with FCC KDB 285076 D02 3. This report pertain to NR n48 only. For full data, please refer to the original certification test report (S/N: 1M2109090102-28-R1.A3L).			

<b>FCC ID:</b> A3LSMS908U		<b>HAC (T-COIL) TEST REPORT</b>		<b>Approved by:</b> Quality Manager
<b>Filename:</b> 1M2112090152-03.A3L	<b>Test Dates:</b> 2/21/2022 – 2/24/2022	<b>DUT Type:</b> Portable Handset	Page 5 of 45	

### 3. ANSI C63.19-2011 PERFORMANCE CATEGORIES

#### I. MAGNETIC COUPLING

##### Axial and Radial Field Intensity

All orientations of the magnetic field, in the axial and radial position along the measurement plane shall be  $\geq -18$  dB(A/m) at 1 kHz in a 1/3 octave band filter per §8.3.1.

##### Frequency Response

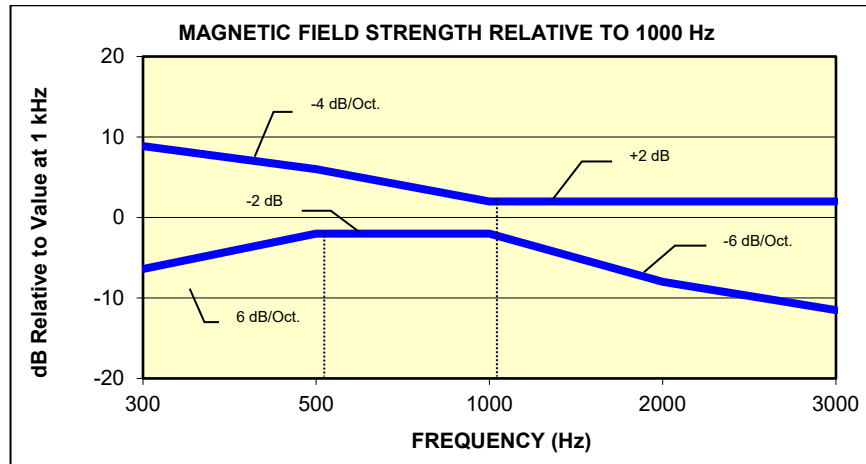

The frequency response of the axial component of the magnetic field shall follow the response curve specified in EIA RS-504-1983, over the frequency range 300 Hz – 3000 Hz per §8.3.2.

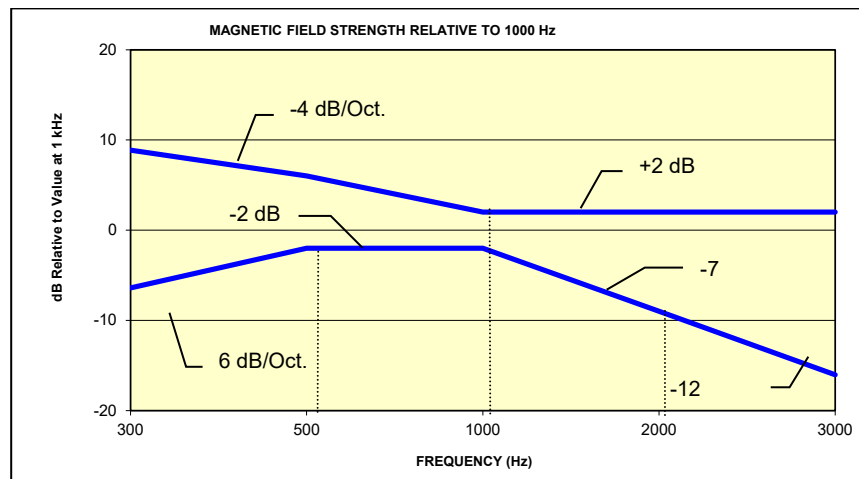

**Figure 3-1**  
Magnetic field frequency response for Wireless Devices with an axial field  $\leq -15$  dB(A/m) at 1 kHz



**Figure 3-2**  
Magnetic Field frequency response for wireless devices with an axial field that exceeds  $-15$  dB(A/m) at 1 kHz

FCC ID: A3LSMS908U	 PCTEST Proud to be part of 	HAC (T-COIL) TEST REPORT	 Approved by: Quality Manager
Filename: 1M2112090152-03.A3L	Test Dates: 2/21/2022 – 2/24/2022	DUT Type: Portable Handset	Page 6 of 45

## Signal Quality



The table below provides the signal quality requirement for the intended audio magnetic signal from a wireless device. Only the RF immunity of the hearing aid is measured in T-coil mode. It is assumed that a hearing aid can have no immunity to an interference signal in the audio band, which is the intended reception band for this mode. The only criterion that can be measured is the RF immunity in T-coil mode. This is measured using the same procedure as the audio coupling mode at the same levels.

The signal quality of the axial and radial components of the magnetic field was used to determine the T-coil mode category.

Category	Telephone RF Parameters
	Wireless Device Signal Quality [(Signal + Noise)-to-noise ratio in dB]
T1	0 to 10 dB
T2	10 to 20 dB
T3	20 to 30 dB
T4	> 30 dB

Table 3-1  
**Magnetic Coupling Parameters**

Note: The FCC limit for SNNR is 20dB and the test data margins will indicate a margin from the FCC limit for compliance.

FCC ID: A3LSMS908U	 <b>PCTEST</b> Head to the point of destination	HAC (T-COIL) TEST REPORT		Approved by: Quality Manager
Filename: 1M2112090152-03.A3L	Test Dates: 2/21/2022 – 2/24/2022	DUT Type: Portable Handset		Page 7 of 45

## 4. METHOD OF MEASUREMENT

### I. Test Setup

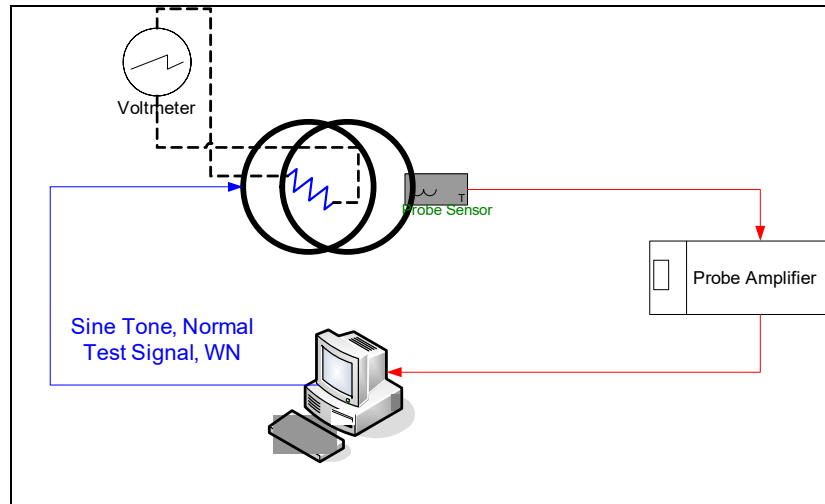

The equipment was connected as shown in an RF-shielded chamber:

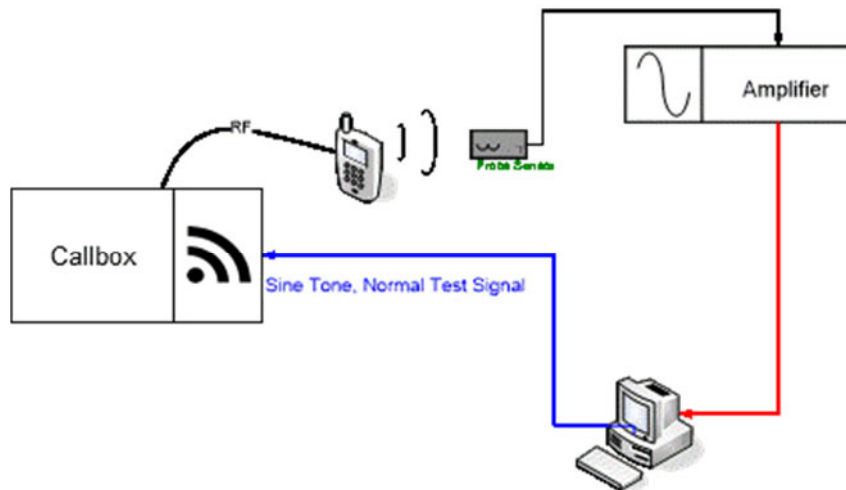

**Figure 4-1**  
**Validation Setup with Helmholtz Coil**



**Figure 4-2**  
**T-Coil Test Setup**

FCC ID: A3LSMS908U	 PCTEST Proud to be part of 	HAC (T-COIL) TEST REPORT		Approved by: Quality Manager
Filename: 1M2112090152-03.A3L	Test Dates: 2/21/2022 – 2/24/2022	DUT Type: Portable Handset		Page 8 of 45



## II. Scanning Mechanism

Manufacturer:	TEM
Accuracy:	± 0.83 cm/meter
Minimum Step Size:	0.1 mm
Maximum speed	6.1 cm/sec
Line Voltage:	115 VAC
Line Frequency:	60 Hz
Material Composite:	Delrin (Acetal)
Data Control:	Parallel Port
Dynamic Range (X-Y-Z):	45 x 31.75 x 47 cm
Dimensions:	36" x 25" x 38"
Operating Area:	36" x 49" x 55"
Reflections:	< -20 dB (in anechoic chamber)

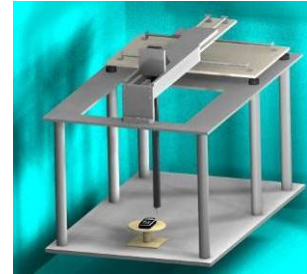



**Figure 4-3**  
RF Near-Field Scanner

## III. 3GPP2 Normal Test Signal (Speech)

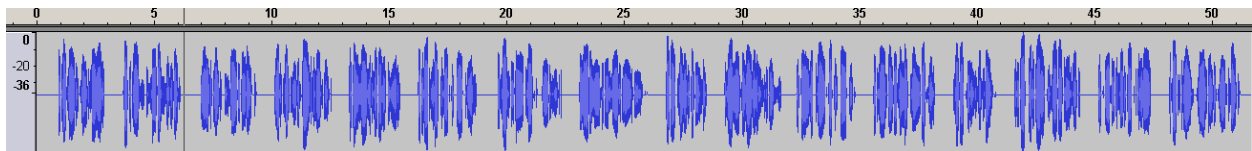
Manufacturer:	3GPP2 (TIA 1042 §3.3.1)
Stimulus Type:	Modified-IRS weighted, multi-talker speech signal, 4 Male and 4 Female speakers (alternating)
Single Sample Duration:	51.62 seconds
Activity Level:	77.4%



**Figure 4-4**  
Temporal Characteristic of Normal Test Signal

FCC ID: A3LSMS908U	 PCTEST Proud to be part of 	HAC (T-COIL) TEST REPORT		Approved by: Quality Manager
Filename: 1M2112090152-03.A3L	Test Dates: 2/21/2022 – 2/24/2022	DUT Type: Portable Handset		Page 9 of 45

© 2022 PCTEST

REV 3.5.M  
8/18/2020

© 2022 PCTEST All rights reserved. Unless otherwise specified, no part of this report may be reproduced or utilized in any part, form or by any means, electronic or mechanical, including photocopying and microfilm, without permission in writing from PCTEST. If you have any questions about this international copyright or have an enquiry about obtaining additional rights to this report or assembly of contents thereof, please contact INFO@PCTEST.COM.

ABM1 Measurement Block Diagram:

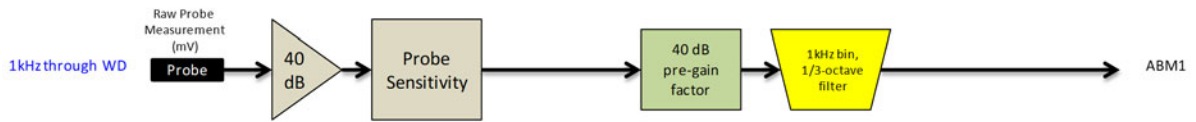

ABM2 Measurement Block Diagram:

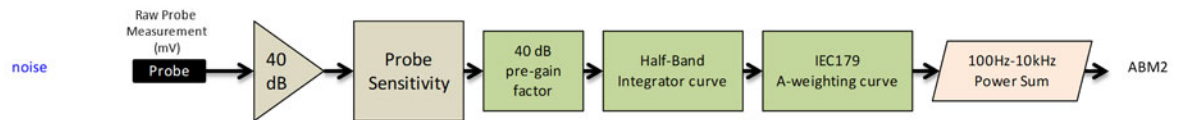

Figure 4-5 Magnetic Measurement Processing Steps

#### IV. Test Procedure

1. Ambient Noise Check per C63.19 §7.3.1
  - a. Ambient interference was monitored using a Real-Time Analyzer between 100-10,000 Hz with 1/3 octave filtering.
  - b. “A-weighting” and Half-Band Integration was applied to the measurements.
  - c. Since this measurement was measured in the same method as ABM2 measurements, this level was verified to be more than 10 dB below the lowest measurement signal (which is the highest ABM2 measurement for a T4 WD). Therefore the maximum noise level for a T4 WD with an ABM1 = -18 dBA/m is:  

$$-18 - 30 - 10 = -58 \text{ dBA/m}$$
2. Measurement System Validation (See Figure 4-1)
  - a. The measurement system including the probe, pre-amplifier and acquisition system were validated as an entire system to ensure the reliability of test measurements.
  - b. ABM1 Validation  
 The magnetic field at the center of the Helmholtz coil is given by the equation (per C63.19 Annex D.10.1):

$$H_c = \frac{NI}{r\sqrt{1.25^3}} = \frac{N\left(\frac{V}{R}\right)}{r\sqrt{1.25^3}}$$



Where  $H_c$  = magnetic field strength in amperes per meter

N = number of turns per coil

For Helmholtz Coil SN: SBI 1052, N=20; r=0.13m; R=10.193Ω and using V=29mV:

$$H_c = \frac{20 \cdot \left(\frac{0.029}{10.193}\right)}{0.13 \cdot \sqrt{1.25^3}} = 0.316 \text{ A/m} \approx -10 \text{ dB(A/m)}$$

Therefore a pure tone of 1kHz was applied into the coils such that 29mV was observed across the resistor. The voltmeter used for measurement was verified to be capable of measurements in the audio band range. This theoretically generates an expected field of -10 dB(A/m) in the center of the Helmholtz coil which was used to validate the probe measurement at -10dB(A/m). This was verified to be within ± 0.5 dB of the -10dB(A/m) value (see Page 22).

FCC ID: A3LSMS908U		HAC (T-COIL) TEST REPORT		Approved by: Quality Manager
Filename: 1M2112090152-03.A3L	Test Dates: 2/21/2022 – 2/24/2022	DUT Type: Portable Handset		Page 10 of 45

c. Frequency Response Validation

The frequency response through the Helmholtz Coil was verified to be within 0.5 dB relative to 1kHz, between 300 – 3000 Hz using the Normal signal as shown below:

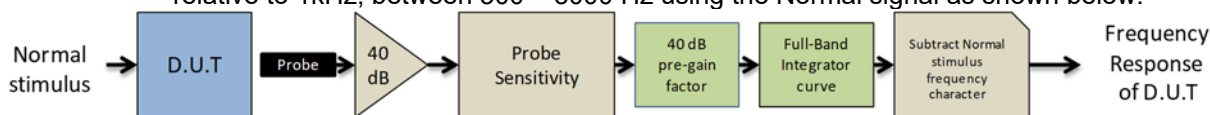

Figure 4-6 Frequency Response Validation

d. ABM2 Measurement Validation

WD noise measurements are filtered with A-weighting and Half-Band Integration over a frequency range of 100Hz – 10kHz to process ABM2 measurements. Below is the verification of the system processing A-weighting and Half-Band integration between system input to output within 0.5 dB of the theoretical result:

Table 4-1  
ABM2 Frequency Response Validation

f (Hz)	HBI, A - Measured (dB re 1kHz)	HBI, A - Theoretical (dB re 1kHz)	dB Var.
100	-16.180	-16.170	-0.010
125	-13.257	-13.250	-0.007
160	-10.347	-10.340	-0.007
200	-8.017	-8.010	-0.007
250	-5.925	-5.920	-0.005
315	-4.045	-4.040	-0.005
400	-2.405	-2.400	-0.005
500	-1.212	-1.210	-0.002
630	-0.349	-0.350	0.001
800	0.071	0.070	0.001
1000	0.000	0.000	0.000
1250	-0.503	-0.500	-0.003
1600	-1.513	-1.510	-0.003
2000	-2.778	-2.780	0.002
2500	-4.316	-4.320	0.004
3150	-6.166	-6.170	0.004
4000	-8.322	-8.330	0.008
5000	-10.573	-10.590	0.017
6300	-13.178	-13.200	0.022
8000	-16.241	-16.270	0.029
10000	-19.495	-19.520	0.025

FCC ID: A3LSMS908U	PCTEST Proud to be part of Samsung	HAC (T-COIL) TEST REPORT		Approved by: Quality Manager
Filename: 1M2112090152-03.A3L	Test Dates: 2/21/2022 – 2/24/2022	DUT Type: Portable Handset		Page 11 of 45

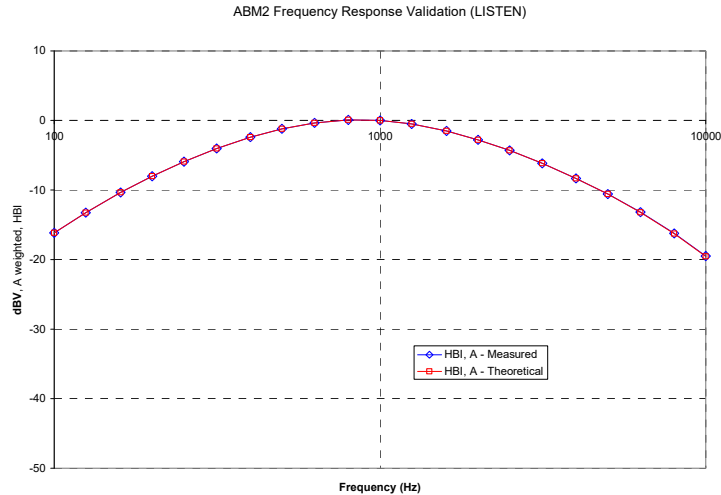

**Figure 4-7**  
**ABM2 Frequency Response Validation**

The ABM2 result is a power sum from 100Hz to 10kHz with half-band integration and A-weighting. To verify the power sum measurement, a power sum over the full band was measured and verified to track with the source level (See Figure 4-8). Therefore the setup in this step was used to verify the power sum post-processing for ABM2 measurements. See below block diagram:

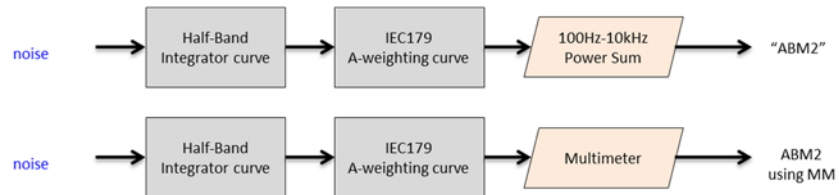



**Figure 4-8**  
**ABM2 Validation Block Diagram**

The power summed output results for a known input were compared to the multi-meter results to verify any deviation in the post-processing implemented with the power-sum.

**Table 4-2**  
**ABM2 Power Sum Validation**

WN Input (dBV)	Power Sum (dBV)	Multimeter-Full (dBV)	Dev (dB)
-60	-60.36	-60.2	0.16
-50	-50.19	-50.13	0.06
-40	-40.14	-40.03	0.11
-30	-30.13	-30.01	0.12
-20	-20.12	-20	0.12
-10	-10.14	-10	0.14

<b>FCC ID:</b> A3LSMS908U		<b>HAC (T-COIL) TEST REPORT</b>		<b>Approved by:</b> Quality Manager
<b>Filename:</b> 1M2112090152-03.A3L	<b>Test Dates:</b> 2/21/2022 – 2/24/2022	<b>DUT Type:</b> Portable Handset		Page 12 of 45

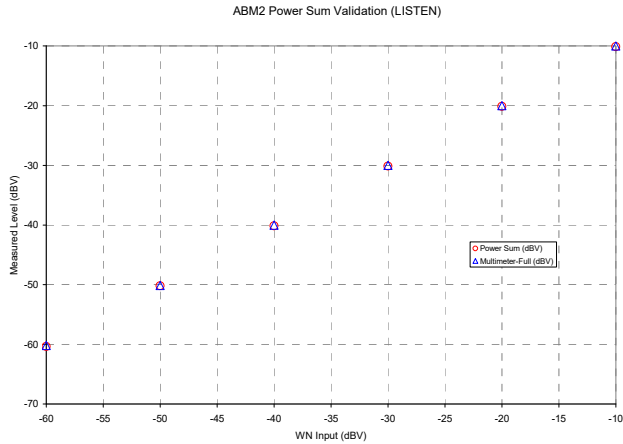
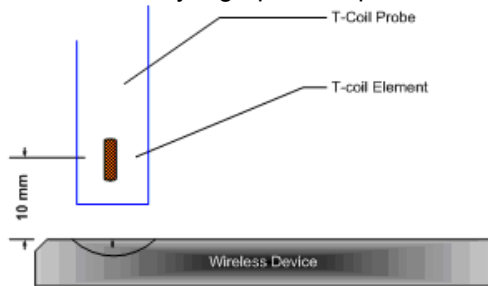

**Figure 4-9**  
**ABM2 Power Sum Validation**

3. Measurement Test Setup

a. Fine scan above the WD (TEM)

- i. A multitone signal was applied to the handset such that the phone acoustic output was stable within 1dB over the probe settling time and with the acoustic output level at the C63.19 specified levels (below). The measurement step size was in 2 mm increments at a distance of 10 mm between the surface of the wireless device as shown below (note that in Figure 4-11, the grid is not to scale but merely a graphical representation of the coordinate system in use):



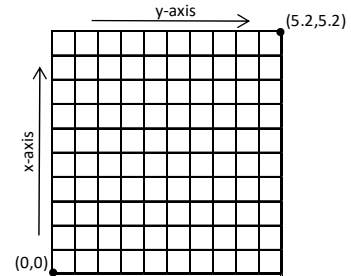

**Figure 4-10**  
**Measurement Distance**





**Figure 4-11**  
**Measurement Grid**

- ii. After scanning, the planar field maximum point was determined. The position of the probe was moved to this location to setup the test using the SoundCheck system.
  - iii. These steps were repeated for all T-coil orientations (axial and radial) per Figure 4-13 after a T-coil orientation was fully measured with the SoundCheck system.
- b. Speech Signal Setup to Base Station Simulator
- i. C63.19 Table 7-1 states audio reference input levels for various technologies:

Standard	Technology	Input Level (dBm0)
TIA/EIA/IS-2000	CDMA	-18
J-STD-007	GSM (217)	-16
T1/T1P1/3GPP	UMTS (WCDMA)	-16
IDEN™	TDMA (22 and 11 Hz)	-18

FCC ID: A3LSMS908U		HAC (T-COIL) TEST REPORT		Approved by: Quality Manager
Filename: 1M2112090152-03.A3L	Test Dates: 2/21/2022 – 2/24/2022	DUT Type: Portable Handset		Page 13 of 45

- ii. See Section 5 for more information regarding CMW500 and CMX500 audio level settings for Voice Over NR (VoNR).
    - iii. See Section 6 for more information regarding audio level settings for Over-The-Top (OTT) Voice Over IP (VoIP) Testing.
  - c. Real-Time Analyzer (RTA)
    - i. The Real-Time Analyzer was configured to analyze measurements using 1/3 Octave band weighted filtering.
  - d. WD Radio Configuration Selection
    - i. The device was chosen to be tested in the worst-case ABM2 condition (NR configuration can be found in Section 5.)
- 4. Signal Quality Data Analysis
  - a. Narrow-band Magnetic Intensity
    - i. The standard specifies a 1kHz 1/3 octave band minimum field intensity for a sine tone. The ABM1 measurements were evaluated at 1kHz with 1/3 octave band filtering over an averaged period of 10 seconds.
  - b. Frequency Response
    - i. The appropriate frequency response curve was measured to curves in Figure 3-1 or Figure 3-2 between 300 – 3000 Hz using digital linear averaging (limit lines chosen according to measurement found in step 4a). A linear average over 3x the length of the artificial voice signal (3x sampling) was performed. A 10 second delay was configured in the measurement process of the stimulus to ensure handset vocoder latency effects and echo cancellation devices (if any) were appropriately stabilized during measurements.
    - ii. The appropriate post-processing was applied according to the system processing chain illustrated in Figure 4-6. All R10 frequencies were plotted with respect to 0dB at 1kHz value and aligned with respect to the EIA-504 mask.
    - iii. The margin is represented by the closest measured data point on the curve to the EIA-504 limit lines, in dB.
  - c. Signal Quality Index
    - i. Ensuring the WD was at maximum RF power, maximum volume, backlight off, display on, maximum contrast setting, keypad lights on (when possible) with no audio signal through the vocoder, the WD was measured over at least 100 Hz – 10,000 Hz, maximized over 5 seconds with a 50ms sample time for the ABM2 measurement (5 second time period is used in noise measurements under standards such as IEEE 269, etc.).
    - ii. After applying half-band integration and A-weighting to the result, a power sum was applied over each 1/3 octave bandwidth frequency for an ABM2 value.
    - iii. This result was subtracted from the ABM1 result in step a, to obtain the Signal Quality.

<b>FCC ID:</b> A3LSMS908U	 <b>PCTEST</b> Proud to be part of 	<b>HAC (T-COIL) TEST REPORT</b>		<b>Approved by:</b> Quality Manager
<b>Filename:</b> 1M2112090152-03.A3L	<b>Test Dates:</b> 2/21/2022 – 2/24/2022	<b>DUT Type:</b> Portable Handset	Page 14 of 45	

## V. Test Setup

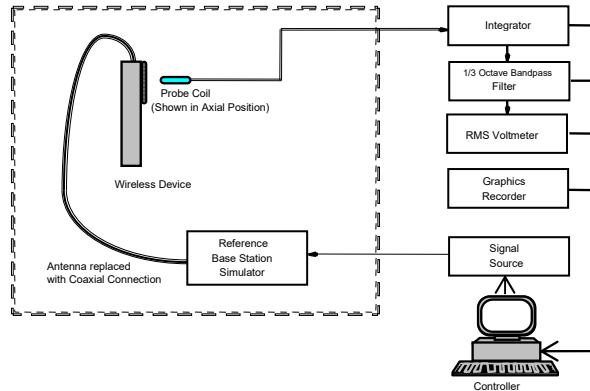

**Figure 4-12**  
**Audio Magnetic Field Test Setup**

Environmental conditions such as temperature and relative humidity are monitored to ensure there are no impacts on system specifications. Proper voltage and power line frequency conditions are maintained with three phase power sources. Environmental noise and reflections are monitored through system checks.

## VI. Deviation from C63.19 Test Procedure

Non-conducted RF connection due to inaccessible RF ports.



## VII. Air Interface Technologies Tested

All air interfaces which support voice capabilities over a managed CMRS or pre-installed OTT VoIP applications were tested for T-coil unless otherwise noted. See Table 2-1 for more details regarding which modes were tested.

## VIII. Wireless Device Channels and Frequencies

### 1. 5G (NR) Modes

The bandwidth from each probe orientation resulting in the worst-case SNNR was additionally tested using low, low-mid, mid-high, and high channels. See Tables 7-2 and 7-3 for NR bandwidths and channels.



FCC ID: A3LSMS908U		HAC (T-COIL) TEST REPORT		Approved by: Quality Manager
Filename: 1M2112090152-03.A3L	Test Dates: 2/21/2022 – 2/24/2022	DUT Type: Portable Handset		Page 15 of 45

## IX. Test Flow

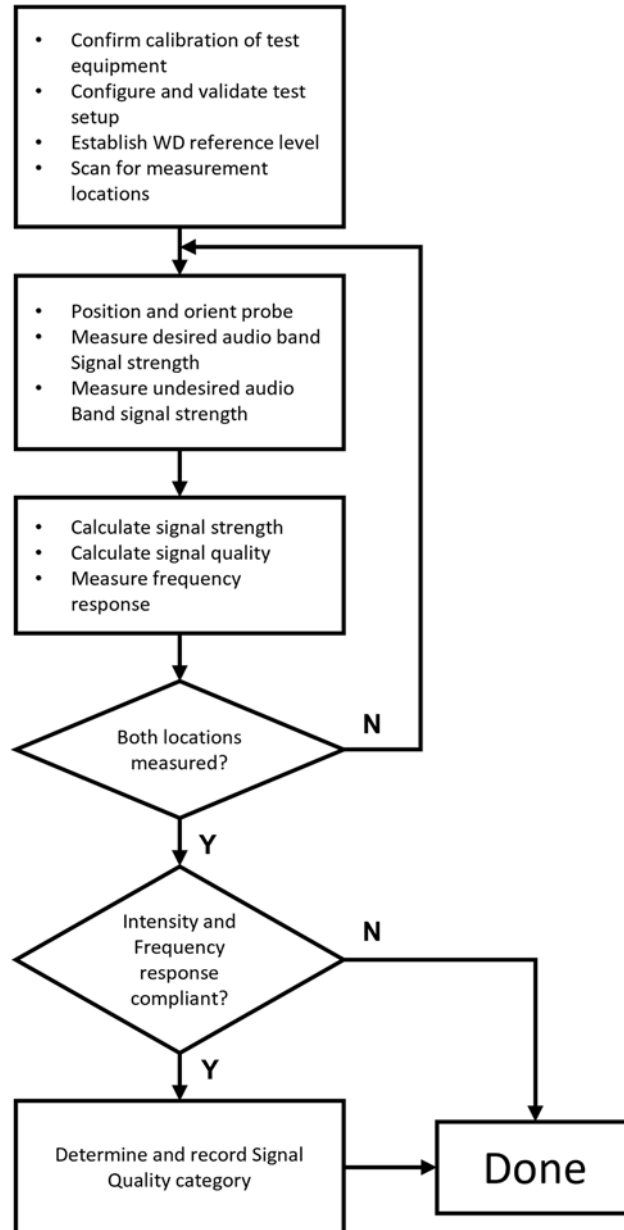
The flow diagram below was followed (From C63.19):



**Figure 4-13**  
**C63.19 T-Coil Signal Test Process**

<b>FCC ID:</b> A3LSMS908U		<b>HAC (T-COIL) TEST REPORT</b>		<b>Approved by:</b> Quality Manager
<b>Filename:</b> 1M2112090152-03.A3L	<b>Test Dates:</b> 2/21/2022 – 2/24/2022	<b>DUT Type:</b> Portable Handset		Page 16 of 45



## 5. VONR TEST SYSTEM SETUP AND DUT CONFIGURATION

### I. Test System Setup for VoNR over IMS T-coil Testing

#### 1. Equipment Setup

The general test setup used for VoNR over IMS is shown below. The callboxes used when performing VoNR over IMS T-coil measurements are CMW500 and CMX500. The Data Application Unit (DAU) of the CMW500 was used to simulate the IP Multimedia Subsystem (IMS) server. The CMX500 provided the baseband signal to perform NR signaling. An external USB audio interface is used to perform the A/D conversion and ensure proper speech input level to the DUT.

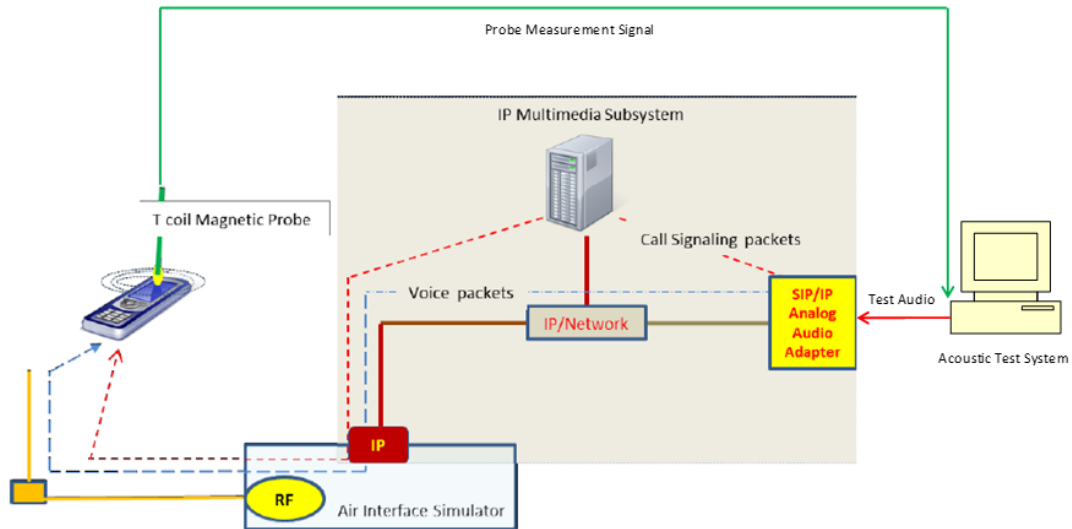



**Figure 5-1**  
**Test Setup for VoNR over IMS T-Coil Measurements**

#### 2. Audio Level Settings

According to KDB 285076 D02 released by the FCC OET regarding the appropriate audio levels to be used for VoNR over IMS T-Coil testing, -20dBm0 shall be used for the normal speech input level<sup>2</sup>. The acoustic test system was manually configured to ensure that the settings for speech input and full scale levels resulted in the -20dBm0 speech input level to the DUT for the VoNR over IMS connection.

<sup>2</sup> FCC Office of Engineering and Technology KDB, "285076 D02 T-Coil Testing for CMRS IP v03," September 13, 2017

<b>FCC ID:</b> A3LSMS908U	 <small>Head to the point of service</small>	<b>HAC (T-COIL) TEST REPORT</b>		<b>Approved by:</b> Quality Manager
<b>Filename:</b> 1M2112090152-03.A3L	<b>Test Dates:</b> 2/21/2022 – 2/24/2022	<b>DUT Type:</b> Portable Handset	Page 17 of 45	



## II. DUT Configuration for VoNR over IMS T-coil Testing

### 1. Radio Configuration

An investigation was performed to determine the waveform, modulation, and RB configuration to be used for testing. The effects of waveform, modulation, and RB configuration were found to be independent of band and bandwidth; therefore, only one band and bandwidth were used for this investigation. DFT-s-OFDM, QPSK, 1RB, 50%RB offset was used for the testing as the worst-case configuration for the handset. Please refer to the Original Certification test report (T-Coil report S/N: 1M2109090102-28-R1.A3L) for full evaluation.

### 2. Codec Configuration

An investigation was performed to determine the audio codec configuration to be used for testing. The effects of codec configuration were found to be independent of radio configuration; therefore, only one radio configuration was used for this investigation. The WB AMR 6.60kbps setting was used for the audio codec on the CMX500/CMW500 for VoNR over IMS T-coil testing. Please refer to the Original Certification test report (T-Coil report S/N: 1M2109090102-28-R1.A3L) for full evaluation.

<b>FCC ID:</b> A3LSMS908U	 <b>PCTEST</b> Proud to be part of 	<b>HAC (T-COIL) TEST REPORT</b>		<b>Approved by:</b> Quality Manager
<b>Filename:</b> 1M2112090152-03.A3L	<b>Test Dates:</b> 2/21/2022 – 2/24/2022	<b>DUT Type:</b> Portable Handset	Page 18 of 45	

## 6. OTT VOIP TEST SYSTEM AND DUT CONFIGURATION

### I. Test System Setup for OTT VoIP T-Coil Testing

#### 1. OTT VoIP Application

Google Duo is a pre-installed application on the DUT which allows for VoIP calls in a held-to-ear scenario. Duo uses the OPUS audio codec and supports a bitrate range of 6kb/s to 75kb/s. All air interfaces capable of a data connection were evaluated with Google Duo.

#### 2. Equipment Setup

A CMW500 callbox was used to perform OTT VoIP T-coil measurements. The Data Application Unit (DAU) of the CMW500 was connected to the internet and allowed for an IP data connection on the DUT. A CMX500 was added to the setup for 5G NR signaling test cases. An auxiliary VoIP unit was used to initiate an OTT VoIP call to the DUT. The auxiliary VoIP unit allowed for the configuration and monitoring of the OTT VoIP codec bitrate during a call. Both high and low bitrate settings were evaluated in to determine the worst-case configuration.

#### 3. Audio Level Settings



According to KDB 285076 D02, the average speech level of -20dBm0 shall be used for protocols not specifically listed in Table 7.1 of ANSI C63.19-2011 or the ANSI C63.19-2011 VoLTE interpretation<sup>3</sup>. The auxiliary VoIP unit allowed for monitoring the signal input level to ensure that the settings for speech input and full-scale levels resulted in the -20dBm0 speech input level to the DUT for the OTT VoIP call.

### II. DUT Configuration for OTT VoIP T-Coil Testing

#### 1. Codec Configuration

An investigation was performed for each applicable data mode to determine the audio codec configuration to be used for testing. The effects of codec configuration were found to be independent of radio configuration; therefore, only one radio configuration for each applicable data mode was used for these investigations. The 6kbps codec setting was used for the audio codec on the auxiliary VoIP unit for OTT VoIP T-Coil testing. Please refer to the Original Certification test report (T-Coil report S/N: 1M2109090102-28-R1.A3L) for full evaluation.

<sup>3</sup> FCC Office of Engineering and Technology KDB, "285076 D02 T-Coil Testing for CMRS IP v03," September 13, 2017

<b>FCC ID:</b> A3LSMS908U	 <b>PCTEST</b> Proud to be part of 	<b>HAC (T-COIL) TEST REPORT</b>		<b>Approved by:</b> Quality Manager
<b>Filename:</b> 1M2112090152-03.A3L	<b>Test Dates:</b> 2/21/2022 – 2/24/2022	<b>DUT Type:</b> Portable Handset		Page 19 of 45

## 7. T-COIL TEST SUMMARY

**Table 7-1  
Consolidated Tabled Results**

		Freq. Response Margin		Magnetic Intensity Verdict		FCC SNNR Verdict		Margin from FCC Limit (dB)	C63.19-2011 Rating
		8.3.2		8.3.1		8.3.4			
C63.19 Section		Axial	Radial	Axial	Radial	Axial	Radial		
NR TDD (OTT VoIP)	n48	PASS	PASS	PASS	PASS	PASS	PASS	-13.06	T4
NR TDD (OTT VoIP)	n48	PASS	PASS	PASS	PASS	PASS	PASS	-27.85	T4

### I. Raw Handset Data

**Table 7-2  
Raw Data Results for NR n48**

Mode	Orientation	Bandwidth	Channel	ABM1 [dB(A/m)]	ABM2 [dB(A/m)]	Ambient Noise [dB(A/m)]	Frequency Response Margin (dB)	S+N/N (dB)	FCC Limit (dB)	Margin from FCC Limit (dB)	C63.19-2011 Rating	Test Coordinates
NR n48	Axial	40MHz	645332	-1.34	-42.29	-58.55	2.00	40.95	20.00	-20.95	T4	1.4, 0.8
		40MHz	643500	-1.17	-42.34		2.00	41.17	20.00	-21.17	T4	
		40MHz	641666	-0.92	-41.34		2.00	40.42	20.00	-20.42	T4	
		40MHz	639834	-1.19	-42.31		2.00	41.12	20.00	-21.12	T4	
		40MHz	638000	-1.22	-42.07		2.00	40.85	20.00	-20.85	T4	
		20MHz	641666	-1.66	-42.19		2.00	40.53	20.00	-20.53	T4	
		10MHz	641666	-1.88	-42.33		2.00	40.45	20.00	-20.45	T4	
	Radial	40MHz	645332	-8.34	-42.29	-58.65	N/A	33.95	20.00	-13.95	T4	1.6, 2.0
		40MHz	643500	-8.25	-42.27			34.02	20.00	-14.02	T4	
		40MHz	641666	-8.43	-41.49			33.06	20.00	-13.06	T4	
		40MHz	639834	-8.28	-42.06			33.78	20.00	-13.78	T4	
		40MHz	638000	-8.29	-41.99			33.70	20.00	-13.70	T4	
		20MHz	641666	-8.25	-43.24			34.99	20.00	-14.99	T4	
		10MHz	641666	-8.66	-42.68			34.02	20.00	-14.02	T4	

**Table 7-3  
Raw Data Results for NR n48 (OTT VoIP)**

Mode	Orientation	Bandwidth	Channel	ABM1 [dB(A/m)]	ABM2 [dB(A/m)]	Ambient Noise [dB(A/m)]	Frequency Response Margin (dB)	S+N/N (dB)	FCC Limit (dB)	Margin from FCC Limit (dB)	C63.19-2011 Rating	Test Coordinates
NR n48	Axial	40MHz	645332	13.45	-43.49	-58.55	1.87	56.94	20.00	-36.94	T4	1.4, 0.8
		40MHz	643500	13.18	-43.13		1.61	56.31	20.00	-36.31	T4	
		40MHz	641666	13.72	-42.22		2.00	55.94	20.00	-35.94	T4	
		40MHz	639834	13.31	-42.70		1.91	56.01	20.00	-36.01	T4	
		40MHz	638000	13.11	-43.37		1.75	56.48	20.00	-36.48	T4	
		20MHz	641666	13.81	-42.71		1.84	56.52	20.00	-36.52	T4	
		10MHz	641666	13.79	-42.54		1.68	56.33	20.00	-36.33	T4	
	Radial	40MHz	641666	4.99	-43.71	-58.65	N/A	48.70	20.00	-28.70	T4	1.6, 2.0
		20MHz	646000	5.59	-43.91			49.50	20.00	-29.50	T4	
		20MHz	643834	5.54	-44.06			49.60	20.00	-29.60	T4	
		20MHz	641666	5.11	-42.74			47.85	20.00	-27.85	T4	
		20MHz	639500	5.60	-43.44			49.04	20.00	-29.04	T4	
		20MHz	637334	5.62	-43.33			48.95	20.00	-28.95	T4	
		10MHz	641666	5.48	-43.71			49.19	20.00	-29.19	T4	

FCC ID: A3LSMS908U	 <small>Head to the point of demand</small>	<b>HAC (T-COIL) TEST REPORT</b>		Approved by: Quality Manager
Filename: 1M2112090152-03.A3L	Test Dates: 2/21/2022 – 2/24/2022	DUT Type: Portable Handset		Page 20 of 45

## II. Test Notes

### A. General



1. Phone Condition: Mute on; Backlight off; Max Volume; Max Contrast
2. 'Radial' orientation refers to radial transverse.
3. Hearing Aid Mode (Phone->Settings->Other Call Settings->Hearing aid compatibility) was set to ON for Frequency Response compliance
4. Speech Signal: Mute on; Backlight off; Max Volume; Max Contrast
5. Bluetooth and WIFI were disabled while testing 5G modes.
6. The Margin from FCC limit column indicates a margin from the FCC limit for compliance (T4).

### B. NR TDD

1. Power Configuration: TPC = "Max Power"
2. Radio Configuration: DFT-s-OFDM, QPSK, 1RB, 50%RB offset
3. Vocoder Configuration: WB AMR 6.60kbps
4. The worst-case band and bandwidth combination for each probe orientation is additionally tested on the low, low-mid, high-mid, and high channels for those combinations. NR n48 at 40MHz is the worst-case for both Axial and Radial probe orientations.
5. The 30MHz bandwidth for NR n48 was not evaluated due to equipment limitations. This bandwidth was internally verified to ensure no significant deviation from other bandwidths.

### C. OTT VoIP

1. Vocoder Configuration: 6kbps
2. NR TDD Configuration:
  - a. Power Configuration: TPC = "Max Power"
  - b. Radio Configuration: DFT-s-OFDM, QPSK, 1RB, 50%RB offset
  - c. The worst-case band and bandwidth combination for each probe orientation is additionally tested on the low, low-mid, high-mid, and high channels for those combinations. NR n48 at 40MHz is the worst-case for Axial probe orientation. NR n48 at 20MHz is the worst-case for Radial probe orientation.
  - d. The 30MHz bandwidth for NR n48 was not evaluated due to equipment limitations. This bandwidth was internally verified to ensure no significant deviation from other bandwidths.

<b>FCC ID:</b> A3LSMS908U	 <b>PCTEST</b> Proud to be part of 	<b>HAC (T-COIL) TEST REPORT</b>		<b>Approved by:</b> Quality Manager
<b>Filename:</b> 1M2112090152-03.A3L	<b>Test Dates:</b> 2/21/2022 – 2/24/2022	<b>DUT Type:</b> Portable Handset	Page 21 of 45	

### III. 1 kHz Vocoder Application Check

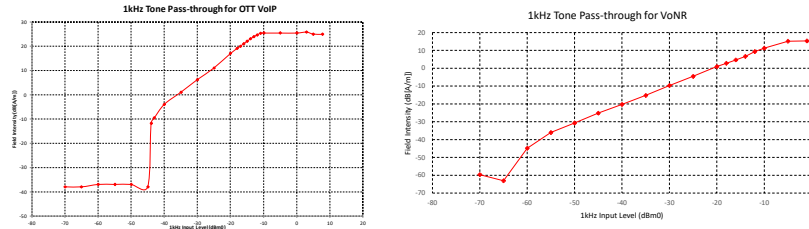



This model was verified to be within the linear region for ABM1 measurements at -20 dBm0 for VoNR over IMS and OTT VoIP. This measurement was taken in the axial configuration above the maximum location.

### IV. T-Coil Validation Test Results

**Table 7-4**  
**Helmholtz Coil Verification Table of Results**

Item	Target	Result	Verdict
<b>Axial</b>			
Magnetic Intensity, -10 dBA/m	-10 ± 0.5 dB	-10.066	<b>PASS</b>
Environmental Noise	< -58 dBA/m	-58.55	<b>PASS</b>
Frequency Response, from limits	> 0 dB	0.60	<b>PASS</b>
<b>Radial</b>			
Magnetic Intensity, -10 dBA/m	-10 ± 0.5 dB	-10.178	<b>PASS</b>
Environmental Noise	< -58 dBA/m	-58.65	<b>PASS</b>
Frequency Response, from limits	> 0 dB	0.70	<b>PASS</b>

FCC ID: A3LSMS908U	 PCTEST Proud to be part of Samsung	HAC (T-COIL) TEST REPORT		Approved by: Quality Manager
Filename: 1M2112090152-03.A3L	Test Dates: 2/21/2022 – 2/24/2022	DUT Type: Portable Handset		Page 22 of 45

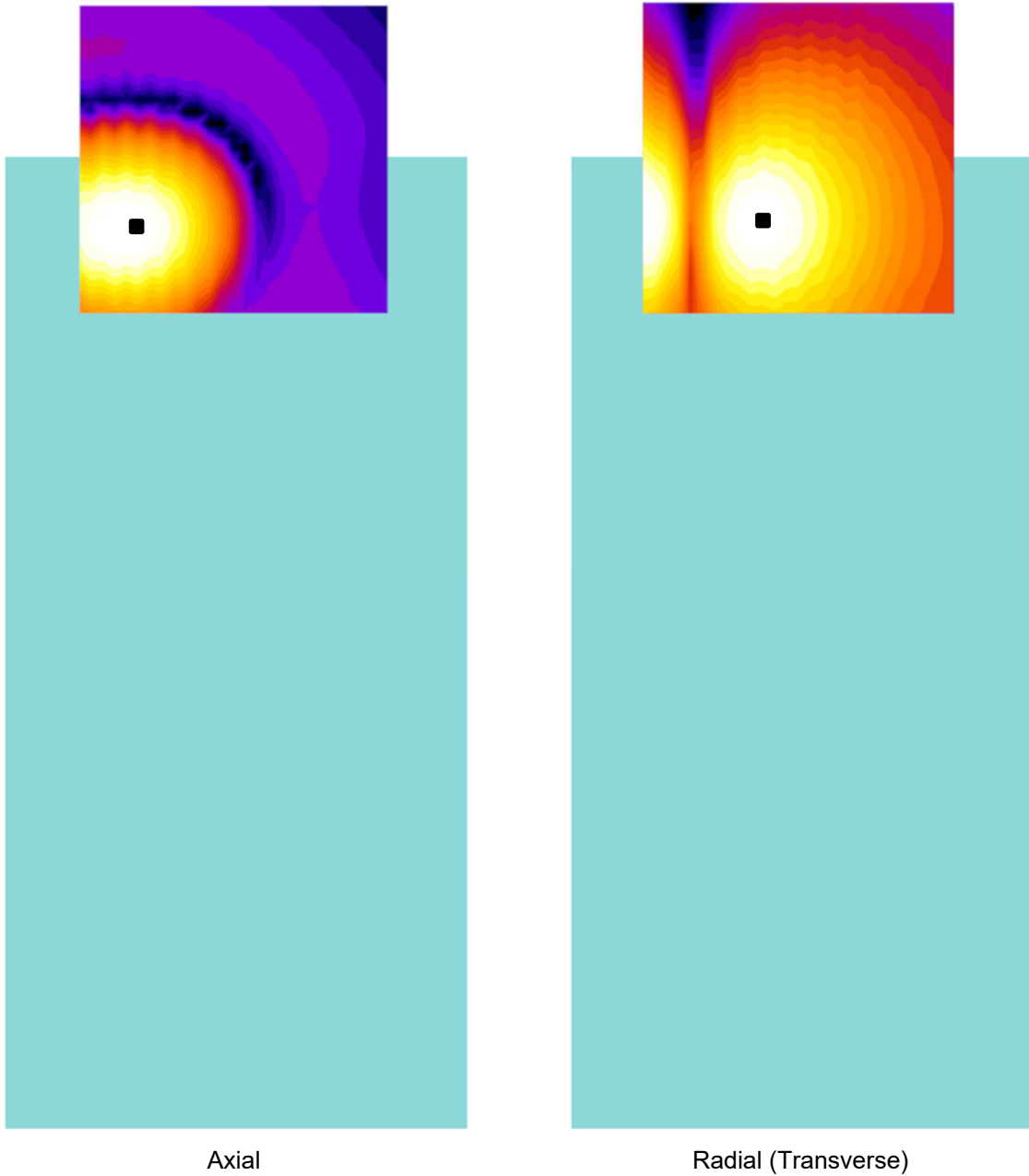

## V. ABM1 Magnetic Field Distribution Scan Overlays



**Figure 7-1**  
**T-Coil Scan Overlay Magnetic Field Distributions**

**Notes:**

1. Final measurement locations are indicated by a black cursor on the contour plots.
2. See Test Setup Photographs for actual WD overlay.

<b>FCC ID:</b> A3LSMS908U	 <small>Head to the point of delivery</small>	<b>HAC (T-COIL) TEST REPORT</b>		<b>Approved by:</b> Quality Manager
<b>Filename:</b> 1M2112090152-03.A3L	<b>Test Dates:</b> 2/21/2022 – 2/24/2022	<b>DUT Type:</b> Portable Handset	Page 23 of 45	

## 8. MEASUREMENT UNCERTAINTY



**Table 8-1  
Uncertainty Estimation Table**

Contribution	Data +/- %	Data +/- dB	Data Type	Probability distribution	Divisor	Standard uncertainty	Standard Uncertainty (dB)
ABM Noise	7.0%	0.29	Std. Dev.	Normal k=1	1.00	7.0%	
RF Reflections	4.7%	0.20	Specification	Rectangular	1.73	2.7%	
Reference Signal Level	12.2%	0.50	Specification	Rectangular	1.73	7.0%	
Positioning Accuracy	10.0%	0.41	Uncertainty	Rectangular	1.73	5.8%	
Probe Coil Sensitivity	12.2%	0.50	Specification	Rectangular	1.73	7.0%	
Probe Linearity	2.4%	0.10	Std. Dev.	Normal k=1	1.00	2.4%	
Cable Loss	2.8%	0.12	Specification	Rectangular	1.73	1.6%	
Frequency Analyzer	5.0%	0.21	Specification	Rectangular	1.73	2.9%	
System Repeatability	5.0%	0.21	Std. Dev.	Normal k=1	1.00	5.0%	
WD Repeatability	9.0%	0.37	Std. Dev.	Normal k=1	1.00	9.0%	
Positioner Accuracy	1.0%	0.04	Specification	Rectangular	1.73	0.6%	
<b>Combined standard uncertainty, <math>u_c</math> (k=1)</b>						17.7%	0.71
<b>Expanded uncertainty (k=2), 95% confidence level</b>						35.3%	1.31

**Notes:**

1. Test equipments are calibrated according to techniques outlined in NIS81, NIS3003 and NIST Tech Note 1297.
2. All equipments have traceability according to NIST. Measurement Uncertainties are defined in further detail in NIS 81 and NIST Tech Note 1297 and UKAS M3003.

Measurement uncertainty reflects the quality and accuracy of a measured result as compared to the true value. Such statements are generally required when stating results of measurements so that it is clear to the intended audience that the results may differ when reproduced by different facilities. Measurement results vary due to the measurement uncertainty of the instrumentation, measurement technique, and test engineer. Most uncertainties are calculated using the tolerances of the instrumentation used in the measurement, the measurement setup variability, and the technique used in performing the test. While not generally included, the variability of the equipment under test also figures into the overall measurement uncertainty. Another component of the overall uncertainty is based on the variability of repeated measurements (so-called Type A uncertainty). This may mean that the Hearing Aid compatibility tests may have to be repeated by taking down the test setup and resetting it up so that there are a statistically significant number of repeat measurements to identify the measurement uncertainty. By combining the repeat measurement results with that of the instrumentation chain using the technique contained in NIS 81 and NIS 3003, the overall measurement uncertainty was estimated.



<b>FCC ID:</b> A3LSMS908U	 <small>Head to the point of delivery</small>	<b>HAC (T-COIL) TEST REPORT</b>		<b>Approved by:</b> Quality Manager
<b>Filename:</b> 1M2112090152-03.A3L	<b>Test Dates:</b> 2/21/2022 – 2/24/2022	<b>DUT Type:</b> Portable Handset	Page 24 of 45	



## 9. EQUIPMENT LIST

**Table 9-1  
Equipment List**

Manufacturer	Model	Description	Cal Date	Cal Interval	Cal Due	Serial Number
Dell	Latitude E6540	SoundCheck Acoustic Analyzer Laptop	9/29/2020	Biennial	9/29/2022	2655082910
Listen	SoundConnect	Microphone Power Supply	9/24/2020	Biennial	9/24/2022	0899-PS150
RME	Fireface UC	Soundcheck Acoustic Analyzer External Audio Interface	9/29/2020	Biennial	9/29/2022	23792992
Rohde & Schwarz	CMW500	Radio Communication Tester	9/24/2021	Annual	9/24/2022	167286
Rohde & Schwarz	CMX500	5G Radio Communication Tester	N/A	N/A	N/A	100298
Seekonk	NC-100	Torque Wrench (8" lb)	8/4/2020	Biennial	8/4/2022	21053
TEM	Axial T-Coil Probe	Axial T-Coil Probe	9/23/2020	Biennial	9/23/2022	TEM-1123
TEM	Radial T-Coil Probe	Radial T-Coil Probe	9/23/2020	Biennial	9/23/2022	TEM-1129
TEM		HAC Positioner	N/A		N/A	N/A
TEM		HAC System Controller with Software	N/A		N/A	N/A
TEM	Helmholtz Coil	Helmholtz Coil	9/23/2020	Biennial	9/23/2022	SBI 1052
YellowTec	YT4211	USB Audio Interface	N/A	N/A	N/A	20000365
Control Company	4040	Therm./ Clock/ Humidity Monitor	3/12/2021	Annual	3/12/2022	210202053
Netgear	XS708E	Ethernet Switch	N/A	N/A	N/A	4FU3875C001A8



<b>FCC ID:</b> A3LSMS908U	 <b>PCTEST</b> Proud to be part of 	<b>HAC (T-COIL) TEST REPORT</b>		<b>Approved by:</b> Quality Manager
<b>Filename:</b> 1M2112090152-03.A3L	<b>Test Dates:</b> 2/21/2022 – 2/24/2022	<b>DUT Type:</b> Portable Handset		Page 25 of 45

© 2022 PCTEST

REV 3.5.M  
8/18/2020

© 2022 PCTEST All rights reserved. Unless otherwise specified, no part of this report may be reproduced or utilized in any part, form or by any means, electronic or mechanical, including photocopying and microfilm, without permission in writing from PCTEST. If you have any questions about this international copyright or have an enquiry about obtaining additional rights to this report or assembly of contents thereof, please contact INFO@PCTEST.COM.

## 10. TEST DATA

<b>FCC ID:</b> A3LSMS908U	 <b>PCTEST</b> <small>Head to the point of demand</small>	<b>HAC (T-COIL) TEST REPORT</b>		<b>Approved by:</b> Quality Manager
<b>Filename:</b> 1M2112090152-03.A3L	<b>Test Dates:</b> 2/21/2022 – 2/24/2022	<b>DUT Type:</b> Portable Handset	Page 26 of 45	

© 2022 PCTEST

REV 3.5.M  
8/18/2020

© 2022 PCTEST All rights reserved. Unless otherwise specified, no part of this report may be reproduced or utilized in any part, form or by any means, electronic or mechanical, including photocopying and microfilm, without permission in writing from PCTEST. If you have any questions about this international copyright or have an enquiry about obtaining additional rights to this report or assembly of contents thereof, please contact [INFO@PCTEST.COM](mailto:INFO@PCTEST.COM).



## Element Hearing-Aid Compatibility Facility

**DUT: HH Coil – SN: SBI 1052**

Type: HH Coil  
Serial: SBI 1052

**Measurement Standard:** ANSI C63.19-2011

**Equipment:**

- Probe: Axial T-Coil Probe – SN: TEM-1123; Calibrated: 9/23/2020
- Helmholtz Coil – SN: SBI 1052; Calibrated: 9/23/2020

**Noise Spectrum**

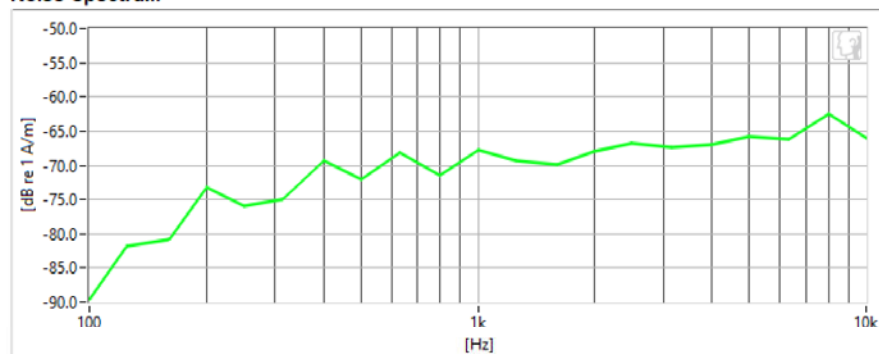

**Frequency Response**

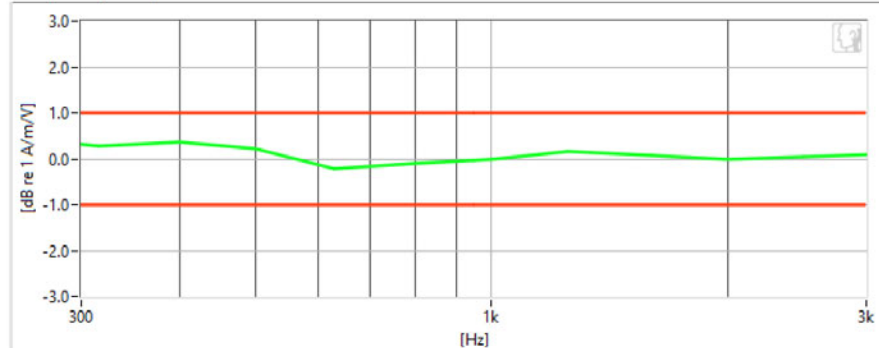

**Results**

Verification 1kHz Intensity	-10.066 dB	✓	Max/Min	-9.5/-10.5
Verification ABM2	-58.55 dB	✓	Maximum	-58.0
Frequency Response Margin	600m dB	✓	Tolerance curves	Aligned Data

FCC ID: A3LSMS908U		HAC (T-COIL) TEST REPORT		Approved by: Quality Manager
Filename: 1M2112090152-03.A3L	Test Dates: 2/21/2022 – 2/24/2022	DUT Type: Portable Handset		Page 27 of 45



**Element Hearing-Aid Compatibility Facility**

**DUT: HH Coil – SN: SBI 1052**

Type: HH Coil  
Serial: SBI 1052

**Measurement Standard:** ANSI C63.19-2011

**Equipment:**

- Probe: Radial T-Coil Probe – SN: TEM-1129; Calibrated: 9/23/2020
- Helmholtz Coil – SN: SBI 1052; Calibrated: 9/23/2020

**Noise Spectrum**

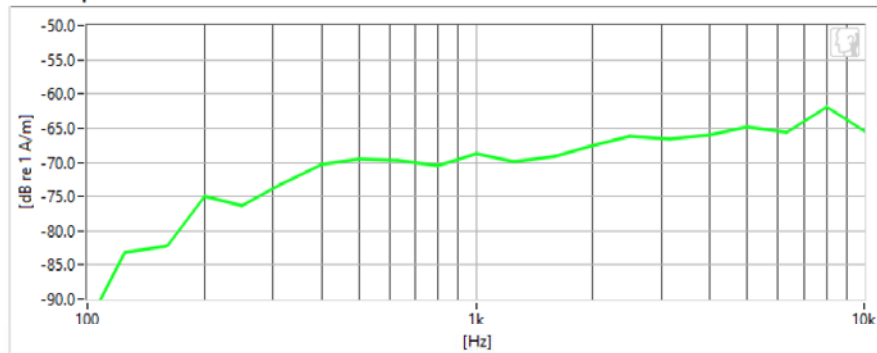

**Frequency Response**

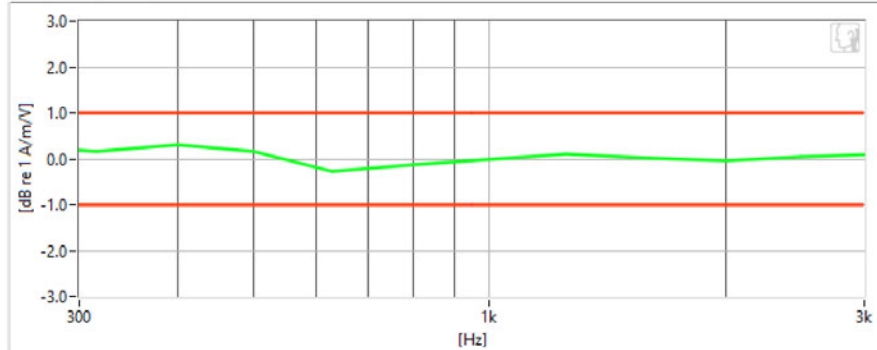

**Results**

Verification 1kHz Intensity	-10.178 dB	✓	Max/Min	-9.5/-10.5
Verification ABM2	-58.65 dB	✓	Maximum	-58.0
Frequency Response Margin	700m dB	✓	Tolerance curves	Aligned Data

<b>FCC ID:</b> A3LSMS908U		<b>HAC (T-COIL) TEST REPORT</b>		<b>Approved by:</b> Quality Manager
<b>Filename:</b> 1M2112090152-03.A3L	<b>Test Dates:</b> 2/21/2022 – 2/24/2022	<b>DUT Type:</b> Portable Handset		Page 28 of 45



**Element Hearing-Aid Compatibility Facility**

**DUT: A3LSMS908U**

Type: Portable Handset  
Serial: 1252M

**Measurement Standard:** ANSI C63.19-2011

**Equipment:**

- Probe: Axial T-Coil Probe – SN: TEM-1123; Calibrated: 09/23/2020

**Test Configuration:**

- Mode: NR n48
- Bandwidth: 40MHz
- Channel: 641666
- Speech Signal: 3GPP2 Normal Test Signal

**Noise Spectrum**

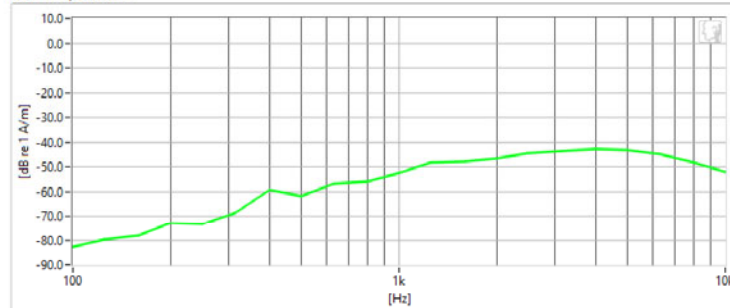

**Frequency Response**

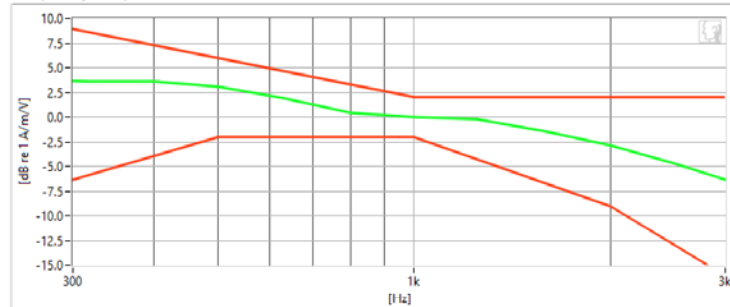

**Results**

ABM1	-920m dB	✓	Minimum	-18.0
ABM2	-41.34 dB	✓	Maximum	0.0
SNNR	40.42 dB	✓	Minimum	20.0
Aligned Response - Normal	2 dB	✓	Tolerance curves	Aligned Data

<b>FCC ID:</b> A3LSMS908U		<b>HAC (T-COIL) TEST REPORT</b>		<b>Approved by:</b> Quality Manager
<b>Filename:</b> 1M2112090152-03.A3L	<b>Test Dates:</b> 2/21/2022 – 2/24/2022	<b>DUT Type:</b> Portable Handset		Page 29 of 45



Proud to be part of 

**Element Hearing-Aid Compatibility Facility**

**DUT: A3LSMS908U**

Type: Portable Handset  
Serial: 1252M

**Measurement Standard:** ANSI C63.19-2011

**Equipment:**

- Probe: Axial T-Coil Probe – SN: TEM-1123; Calibrated: 09/23/2020

**Test Configuration:**

- VoIP Application: Google Duo
- Mode: NR n48
- Bandwidth: 40MHz
- Channel: 641666
- Speech Signal: 3GPP2 Normal Test Signal

**Noise Spectrum**

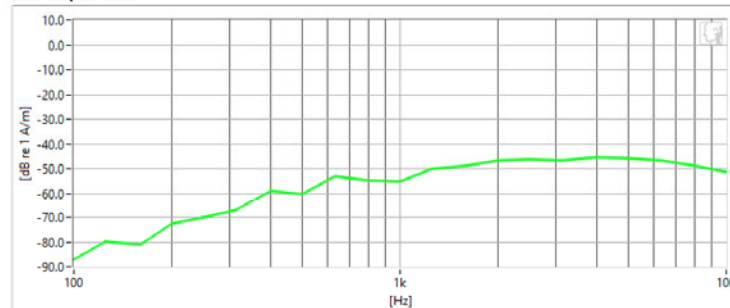

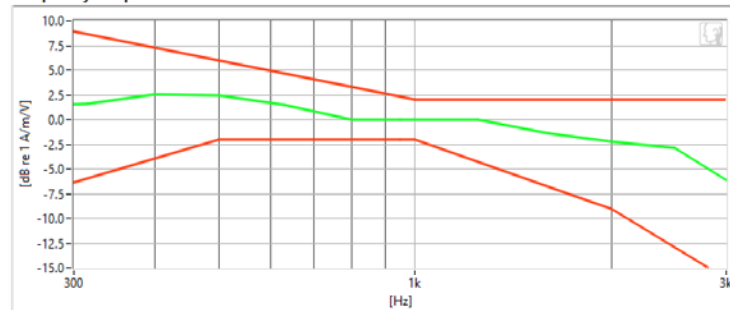

**Frequency Response**



**Results**

ABM1	13.72 dB	✓	Minimum	-18.0
ABM2	-42.22 dB	✓	Maximum	0.0
SNNR	55.94 dB	✓	Minimum	20.0
Aligned Response - Normal	2 dB	✓	Tolerance curves	Aligned Data

FCC ID: A3LSMS908U		HAC (T-COIL) TEST REPORT		Approved by: Quality Manager
Filename: 1M2112090152-03.A3L	Test Dates: 2/21/2022 – 2/24/2022	DUT Type: Portable Handset		Page 30 of 45



## Element Hearing-Aid Compatibility Facility

**DUT: A3LSMS908U**

Type: Portable Handset  
Serial: 1252M

**Measurement Standard:** ANSI C63.19-2011

**Equipment:**

- Probe: Radial T-Coil Probe – SN: TEM-1129; Calibrated: 09/23/2020

**Test Configuration:**

- Mode: NR n48
- Bandwidth: 40MHz
- Channel: 641666

**Noise Spectrum**

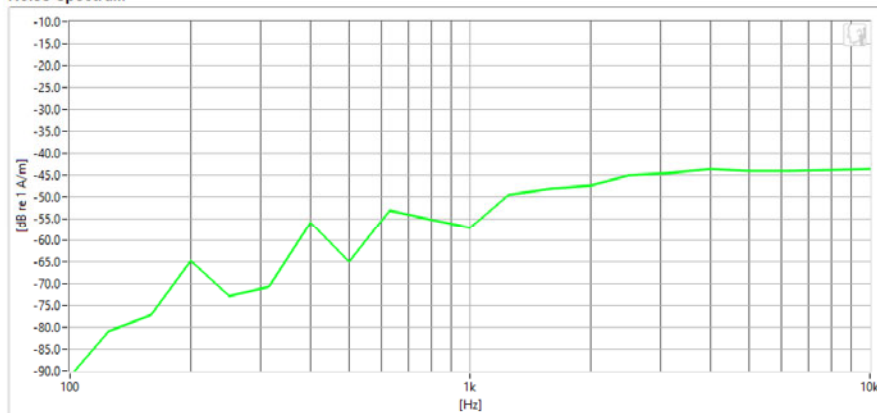

**Results**

ABM1	-8.43 dB	✓	Minimum	-18.0
ABM2	-41.49 dB	✓	Maximum	0.0
SNR	33.06 dB	✓	Minimum	20.0

FCC ID: A3LSMS908U	PCTEST Proud to be part of element	HAC (T-COIL) TEST REPORT		Approved by: Quality Manager
Filename: 1M2112090152-03.A3L	Test Dates: 2/21/2022 – 2/24/2022	DUT Type: Portable Handset		Page 31 of 45



## Element Hearing-Aid Compatibility Facility

**DUT: A3LSMS908U**

Type: Portable Handset  
Serial: 1252M

**Measurement Standard:** ANSI C63.19-2011

**Equipment:**

- Probe: Radial T-Coil Probe – SN: TEM-1129; Calibrated: 09/23/2020

**Test Configuration:**

- VoIP Application: Google Duo
- Mode: NR n48
- Bandwidth: 20MHz
- Channel: 641666

**Noise Spectrum**

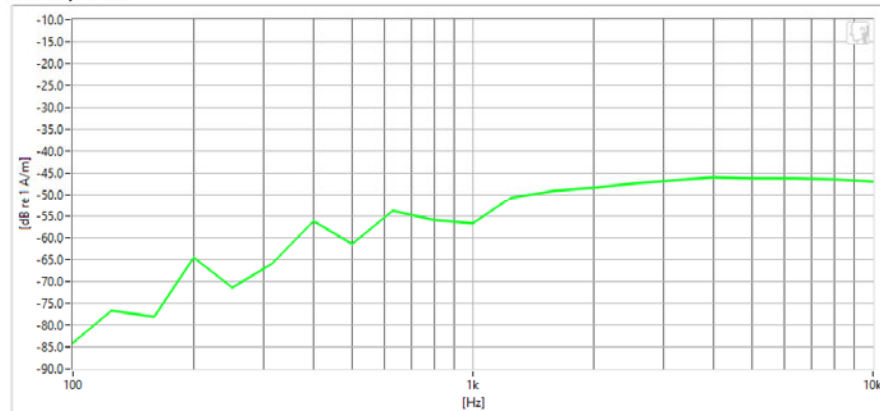



**Results**

ABM1	5.11 dB	✓	Minimum	-18.0
ABM2	-42.75 dB	✓	Maximum	0.0
SNNR	47.85 dB	✓	Minimum	20.0

<b>FCC ID:</b> A3LSMS908U	<b>PCTEST</b> Proud to be part of element	<b>HAC (T-COIL) TEST REPORT</b>		<b>Approved by:</b> Quality Manager
<b>Filename:</b> 1M2112090152-03.A3L	<b>Test Dates:</b> 2/21/2022 – 2/24/2022	<b>DUT Type:</b> Portable Handset		Page 32 of 45



# 11. CALIBRATION CERTIFICATES

<b>FCC ID:</b> A3LSMS908U	 <b>PCTEST</b> <small>Head to the point of demand</small>	<b>HAC (T-COIL) TEST REPORT</b>		<b>Approved by:</b> Quality Manager
<b>Filename:</b> 1M2112090152-03.A3L	<b>Test Dates:</b> 2/21/2022 – 2/24/2022	<b>DUT Type:</b> Portable Handset	Page 33 of 45	

© 2022 PCTEST

REV 3.5.M  
8/18/2020

© 2022 PCTEST All rights reserved. Unless otherwise specified, no part of this report may be reproduced or utilized in any part, form or by any means, electronic or mechanical, including photocopying and microfilm, without permission in writing from PCTEST. If you have any questions about this international copyright or have an enquiry about obtaining additional rights to this report or assembly of contents thereof, please contact [INFO@PCTEST.COM](mailto:INFO@PCTEST.COM).

West Caldwell Calibration Laboratories Inc.

# Certificate of Conformance

for

AXIAL T COIL PROBE

Manufactured by: TEM CONSULTING  
 Model No: AXIAL T COIL PROBE  
 Serial No: TEM-1123  
 Calibration Recall No: 31288

Submitted By:

Customer: ANDREW HARWELL  
 Company: PCTEST ENGINEERING LAB  
 Address: 6660-B DOBBIN ROAD  
 COLUMBIA MD 21045

The subject instrument was calibrated to the indicated specification using standards traceable to the SI through the National Institute of Standards and Technology or to accepted values of natural physical constants. This document certifies that the instrument met the following specification upon its return to the submitter.

West Caldwell Calibration Laboratories Procedure No. AXIAL T C TEM C

*✓*  
10/13/2020

Upon receipt for Calibration, the instrument was found to be:

Within ( X )

tolerance of the indicated specification. See attached Report of Calibration.

The information supplied relates to the calibrated item listed above and statement of conformance for ALL given specifications and standards fall under the decision rule:  $A=(L-(U95))$ , where A is acceptance limit, L is manufacturer specifications and U95 is confidence level of 95% at k=2. This includes but not limited to: 1. Measured value does not meet manufacturer's tolerance, 2. Manufacturer's tolerance is too small compared to calibration and measurement capability uncertainties, 3. Test uncertainty ratio does not meet the 4:1 ratio due to test instrumentation limitations. The decision rule has been communicated and approved by customer during contract

West Caldwell Calibration Laboratories' calibration control system meets the following requirements, ISO 10012-1 MIL STD 45662A, ANSI/NCSL Z540-1, IEC Guide 25, ISO 9001:2015, and ISO 17025

Note: With this Certificate, Report of Calibration is included.

Approved by:

Calibration Date: 23-Sep-20

James Zhu

Certificate No: 31288 - 2

Quality Manager  
ISO/IEC 17025:2017

QA Doc. #1051 Rev. 3.0 5/29/20

Certificate Page 1 of 1

**West Caldwell Calibration Laboratories, Inc.**  
 uncompromised calibration  
 1575 State Route 96, Victor, NY 14564, U.S.A.



Calibration Lab. Cert. # 1533.01

FCC ID: A3LSMS908U	PCTEST Proud to be part of	HAC (T-COIL) TEST REPORT		Approved by: Quality Manager
Filename: 1M2112090152-03.A3L	Test Dates: 2/21/2022 – 2/24/2022	DUT Type: Portable Handset		Page 34 of 45



# REPORT OF CALIBRATION

for

TEM Consulting LP Axial T Coil Probe  
Company: PCTest Engineering Lab

Model No.: Axial T Coil Probe

Serial No.: TEM-1123  
I. D. No.: XXXX

Calibration results:				
Probe Sensitivity measured with Helmholtz Coil		Before & after data same: ...X...		
<i>Helmholtz Coil;</i>				
the number of turns on each coil;	10	No.		
the radius of each coil, in meters;	0.204	m	Laboratory Environment:	
the current in the coils, in amperes.;	0.08	A	Ambient Temperature: 20.7 °C	
<i>Helmholtz Coil Constant;</i>		7.04	A/m/V	Ambient Humidity: 42.1 % RH
<i>Helmholtz Coil magnetic field;</i>		5.71	A/m	Ambient Pressure: 99.094 kPa
Probe Sensitivity at		1000	Hz.	Calibration Date: 23-Sep-2020
was	-60.24	dBV/A/m		Calibration Due:
	0.972	mV/A/m		Report Number: 31288 -2
Probe resistance	898	Ohms		Control Number: 31288
The above listed instrument meets or exceeds the tested manufacturer's specifications.				
This Calibration is traceable through NIST test numbers: 684.07/O-0000001126-20				
The expanded uncertainty of calibration: 0.30dB at 95% confidence level with a coverage factor of k=2.				
Graph represents Probes Frequency Response.				

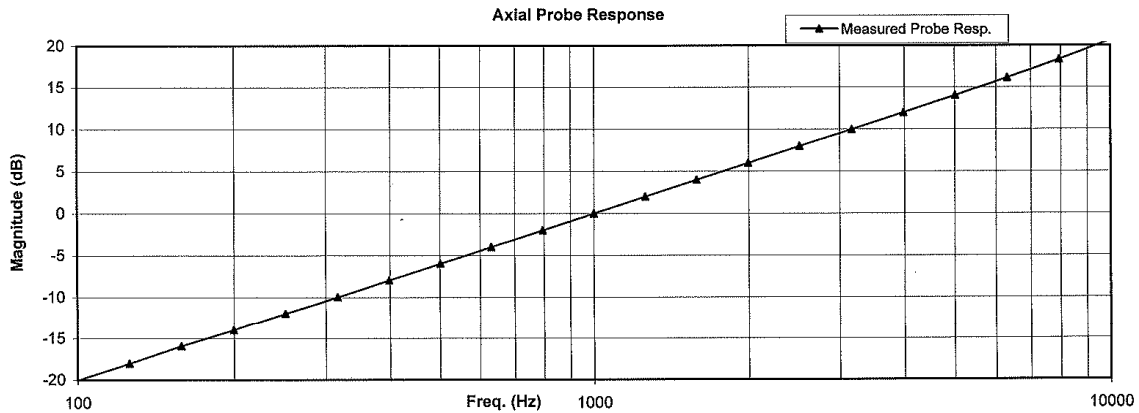

The above listed instrument was checked using calibration procedure documented in West Caldwell Calibration Laboratories Inc. procedure : **Rev. 7.0 Jan. 24, 2014 Doc. # 1038 HCATEMC**  
 Calibration was performed by West Caldwell Calibration Laboratories Inc. under Operating Procedures intended to implement the requirements of ISO10012-1, IEC Guide 25, ANSI/NCSL Z540-1, (MIL-STD-45662A) and ISO 9001:2015, ISO 17025

Cal. Date: 23-Sep-2020  
Calibrated on WCCL system type 9700

Measurements performed by: *James Zhu*  
**James Zhu**

This document shall not be reproduced, except in full, without the written approval from West Caldwell Cal. Labs, Inc.

Rev. 7.0 Jan. 24, 2014 Doc. # 1038 HCATEMC

FCC ID: A3LSMS908U		HAC (T-COIL) TEST REPORT		Approved by: Quality Manager
Filename: 1M2112090152-03.A3L	Test Dates: 2/21/2022 – 2/24/2022	DUT Type: Portable Handset		Page 35 of 45

HCATEMC\_TEM-1123\_Sep-23-2020

West Caldwell Calibration Laboratories Inc.

1575 State Route 96, Victor NY 14564  
Tel. (585) 586-3900 FAX (585) 586-4327

**Calibration Data Record**

TEM Consulting LP Axial T Coil Probe  
Company: PCTest Engineering Lab

for  
Model No.: Axial T Coil Probe

Serial No.: TEM-1123

Test	Function	Tolerance	Measured values			
			Before	Out	Remarks	
1.0	Probe Sensitivity at	1000 Hz.      dBV/A/m	-60.24			
2.0	Probe Level Linearity	dB				
		6	6.03			
		Ref. (0 dB)	0	0.00		
		-6	-6.03			
		-12	-12.05			
3.0	Probe Frequency Response	Hz				
		100	-20.0			
		126	-18.0			
		158	-15.9			
		200	-14.0			
		251	-12.0			
		316	-10.0			
		398	-8.0			
		501	-6.0			
		631	-4.0			
		794	-2.0			
		Ref. (0 dB)	1000	0.0		
			1259	2.0		
			1585	4.0		
			1995	6.0		
			2512	8.0		
			3162	10.0		
	3981	12.0				
	5012	14.0				
	6310	16.1				
	7943	18.3				
	10000	20.7				



Instruments used for calibration:	S/N	Date of Cal.	Traceability No.	Due Date
HP 34401A	S/N US360641	2-Jul-2020	,610119	2-Jul-2021
HP 34401A	S/N US361024	2-Jul-2020	,610119	2-Jul-2021
HP 33120A	S/N US360437	2-Jul-2020	,610119	2-Jul-2021
B&K 2133	S/N 1583254	1-Jul-2020	684.07/O-0000001126-20	1-Jul-2021

Cal. Date: 23-Sep-2020  
Calibrated on WCCL system type 9700

Tested by: James Zhu

This document shall not be reproduced, except in full, without the written approval from West Caldwell Cal. Labs. Inc.

Rev. 7.0 Jan. 24, 2014 Doc. # 1038 HCATEMC

FCC ID: A3LSMS908U		HAC (T-COIL) TEST REPORT		Approved by: Quality Manager
Filename: 1M2112090152-03.A3L	Test Dates: 2/21/2022 – 2/24/2022	DUT Type: Portable Handset		Page 36 of 45

West Caldwell Calibration Laboratories Inc.

# Certificate of Conformance

for

RADIAL T COIL PROBE

Manufactured by: TEM CONSULTING  
Model No: RADIAL T COIL PROBE  
Serial No: TEM-1129  
Calibration Recall No: 31288

Submitted By:

Customer: ANDREW HARWELL  
Company: PCTEST ENGINEERING LAB  
Address: 6660-B DOBBIN ROAD  
COLUMBIA MD 21045

The subject instrument was calibrated to the indicated specification using standards traceable to the SI through the National Institute of Standards and Technology or to accepted values of natural physical constants. This document certifies that the instrument met the following specification upon its return to the submitter.

West Caldwell Calibration Laboratories Procedure No. RADIAL T TEM C

Upon receipt for Calibration, the instrument was found to be:

Within ( X )

tolerance of the indicated specification. See attached Report of Calibration.

The information supplied relates to the calibrated item listed above and statement of conformance for ALL given specifications and standards fall under the decision rule:  $A=(L-(U95))$ , where A is acceptance limit, L is manufacturer specifications and U95 is confidence level of 95% at  $k=2$ . This includes but not limited to: 1. Measured value does not meet manufacturer's tolerance, 2. Manufacturer's tolerance is too small compared to calibration and measurement capability uncertainties, 3. Test uncertainty ratio does not meet the 4:1 ratio due to test instrumentation limitations. The decision rule has been communicated and approved by customer during contract

West Caldwell Calibration Laboratories' calibration control system meets the following requirements, ISO 10012-1 MIL STD 45662A, ANSI/NCSL Z540-1, IEC Guide 25, ISO 9001:2015, and ISO 17025

Note: With this Certificate, Report of Calibration is included.

Approved by:

Calibration Date: 23-Sep-20

James Zhu

Certificate No: 31288 - 1

Quality Manager  
ISO/IEC 17025:2017



QA Doc. #1051 Rev. 3.0 5/29/20

Certificate Page 1 of 1

**West Caldwell Calibration Laboratories, Inc.**  
uncompromised calibration  
1575 State Route 96, Victor, NY 14564, U.S.A.



Calibration Lab. Cert. # 1533.01

FCC ID: A3LSMS908U		HAC (T-COIL) TEST REPORT		Approved by: Quality Manager
Filename: 1M2112090152-03.A3L	Test Dates: 2/21/2022 – 2/24/2022	DUT Type: Portable Handset		Page 37 of 45

© 2022 PCTEST

REV 3.5.M  
8/18/2020

© 2022 PCTEST All rights reserved. Unless otherwise specified, no part of this report may be reproduced or utilized in any part, form or by any means, electronic or mechanical, including photocopying and microfilm, without permission in writing from PCTEST. If you have any questions about this international copyright or have an enquiry about obtaining additional rights to this report or assembly of contents thereof, please contact INFO@PCTEST.COM.



# REPORT OF CALIBRATION

for

TEM Consulting LP Radial T Coil Probe  
Company: PCTest Engineering Lab

Model No.: Radial T Coil Probe

Serial No.: TEM-1129  
I. D. No.: XXXX

Calibration results:

Probe Sensitivity measured with Helmholtz Coil

<i>Helmholtz Coil;</i>		
the number of turns on each coil;	10	No.
the radius of each coil, in meters;	0.204	m
the current in the coils, in amperes.;	0.08	A
<i>Helmholtz Coil Constant;</i>	7.04	A/m/V
<i>Helmholtz Coil magnetic field;</i>	5.70	A/m

Before & after data same: ...X...

Laboratory Environment:	
Ambient Temperature:	20.7 °C
Ambient Humidity:	42.1 % RH
Ambient Pressure:	99.094 kPa
Calibration Date:	23-Sep-2020
Re-calibration Due:	
Report Number:	31288 -1
Control Number:	31288

Probe Sensitivity at	1000	Hz.
was	-60.37	dBV/A/m
	0.959	mV/A/m
Probe resistance	897	Ohms

The above listed instrument meets or exceeds the tested manufacturer's specifications.

This Calibration is traceable through NIST test numbers: 684.07/O-0000001126-20

The expanded uncertainty of calibration: 0.30dB at 95% confidence level with a coverage factor of k=2.

Graph represents Probes Frequency Response.

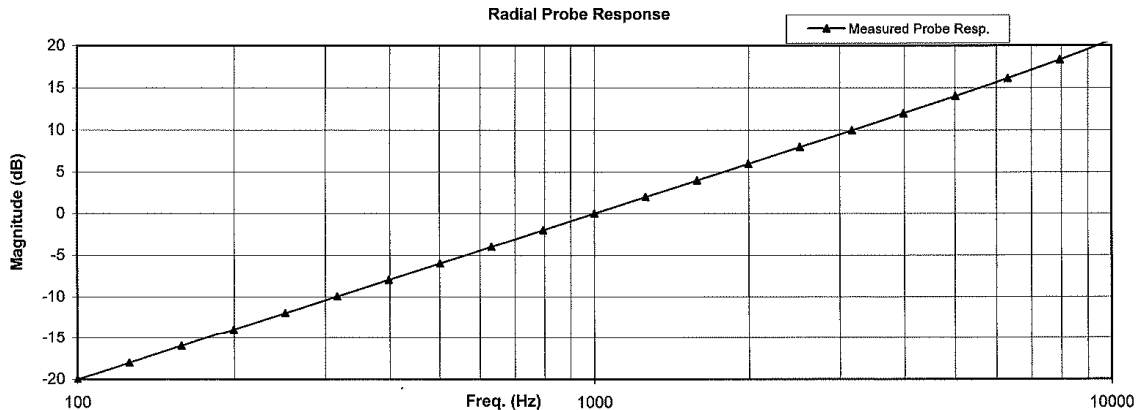

The above listed instrument was checked using calibration procedure documented in West Caldwell

Calibration Laboratories Inc. procedure :

Rev. 7.0 Jan. 24, 2014 Doc. # 1038 HCRTEMC

Calibration was performed by West Caldwell Calibration Laboratories Inc. under Operating Procedures

intended to implement the requirements of ISO10012-1, IEC Guide 25, ANSI/NC SL Z540-1, (MIL-STD-45662A) and ISO 9001:2015, ISO 17025

Cal. Date: 23-Sep-2020

Measurements performed by: *James Zhu*

Calibrated on WCCL system type 9700

James Zhu

This document shall not be reproduced, except in full, without the written approval from West Caldwell Cal. Labs. Inc.

Rev. 7.0 Jan. 24, 2014 Doc. # 1038 HCRTEMC

FCC ID: A3LSMS908U		HAC (T-COIL) TEST REPORT		Approved by: Quality Manager
Filename: 1M2112090152-03.A3L	Test Dates: 2/21/2022 – 2/24/2022	DUT Type: Portable Handset		Page 38 of 45



HCRTEMC\_TEM-1129\_Sep-23-2020

West Caldwell Calibration Laboratories Inc.

1575 State Route 96, Victor NY 14564  
Tel. (585) 586-3900 FAX (585) 586-4327

Calibration Data Record

TEM Consulting LP Radial T Coil Probe  
Company: PCTest Engineering Lab

for  
Model No.: Radial T Coil Probe

Serial No.: TEM-1129

Test	Function	Tolerance	Measured values		
			Before	Out	Remarks
1.0	Probe Sensitivity at	1000 Hz. dBV/A/m	-60.37		
2.0	Probe Level Linearity	Ref. (0 dB)	6	6.04	
			0	0.00	
			-6	-6.03	
			-12	-12.05	
3.0	Probe Frequency Response	Ref. (0 dB)	100	-20.0	
			126	-18.0	
			158	-16.0	
			200	-14.0	
			251	-12.0	
			316	-10.0	
			398	-8.0	
			501	-6.0	
			631	-4.0	
			794	-2.0	
			1000	0.0	
			1259	2.0	
			1585	4.0	
			1995	6.0	
			2512	8.0	
			3162	10.0	
			3981	12.0	
5012	14.0				
6310	16.1				
7943	18.3				
10000	20.7				



Instruments used for calibration:			Date of Cal.	Traceability No.	Due Date
HP	34401A	S/N US360641	2-Jul-2020	,610119	2-Jul-2021
HP	34401A	S/N US361024	2-Jul-2020	,610119	2-Jul-2021
HP	33120A	S/N US360437	2-Jul-2020	,610119	2-Jul-2021
B&K	2133	S/N 1583254	1-Jul-2020	684.07/O-0000001126-20	1-Jul-2021

Cal. Date: 23-Sep-2020  
Calibrated on WCCL system type 9700

Tested by: James Zhu

This document shall not be reproduced, except in full, without the written approval from West Caldwell Cal. Labs, Inc.



Rev. 7.0 Jan. 24, 2014 Doc. # 1038 HCRTEMC

FCC ID: A3LSMS908U		HAC (T-COIL) TEST REPORT		Approved by: Quality Manager
Filename: 1M2112090152-03.A3L	Test Dates: 2/21/2022 – 2/24/2022	DUT Type: Portable Handset		Page 39 of 45

## 12. CONCLUSION

The measurements indicate n48 for the referenced wireless communications device complies with the HAC limits specified in accordance with the ANSI C63.19 Standard and FCC WT Docket No. 01-309 RM-8658. Precise laboratory measures were taken to assure repeatability of the tests. The tested device complies with the requirements in respect to all parameters specific to the test. The test results and statements relate only to the item(s) tested.

The measurement system and techniques presented in this evaluation are proposed in the ANSI standard as a means of best approximating wireless device compatibility with a hearing-aid. The literature is under continual re-construction.

<b>FCC ID:</b> A3LSMS908U	 <b>PCTEST</b> Head to the point of the device	<b>HAC (T-COIL) TEST REPORT</b>		<b>Approved by:</b> Quality Manager
<b>Filename:</b> 1M2112090152-03.A3L	<b>Test Dates:</b> 2/21/2022 – 2/24/2022	<b>DUT Type:</b> Portable Handset		Page 40 of 45

© 2022 PCTEST



REV 3.5.M  
8/18/2020

© 2022 PCTEST All rights reserved. Unless otherwise specified, no part of this report may be reproduced or utilized in any part, form or by any means, electronic or mechanical, including photocopying and microfilm, without permission in writing from PCTEST. If you have any questions about this international copyright or have an enquiry about obtaining additional rights to this report or assembly of contents thereof, please contact [INFO@PCTEST.COM](mailto:INFO@PCTEST.COM).



## 13. REFERENCES

1. ANSI C63.19-2011, American National Standard for Methods of Measurement of Compatibility between Wireless communication devices and Hearing Aids.", New York, NY, IEEE, May 2011
2. FCC Office of Engineering and Technology KDB, "285076 D01 HAC Guidance v05," September 13, 2017
3. FCC Office of Engineering and Technology KDB, "285076 D02 T-Coil Testing for CMRS IP v03," September 13, 2017
4. FCC Public Notice DA 06-1215, *Wireless Telecommunications Bureau and Office of Engineering and Technology Clarify Use of Revised Wireless Phone Hearing Aid Compatibility Standard*, June 6, 2006
5. FCC 3G Review Guidance, Laboratory Division OET FCC, May/June 2006
6. Berger, H. S., "Compatibility Between Hearing Aids and Wireless Devices," Electronic Industries Forum, Boston, MA, May, 1997
7. Berger, H. S., "Hearing Aid and Cellular Phone Compatibility: Working Toward Solutions," *Wireless Telephones and Hearing Aids: New Challenges for Audiology*, Gallaudet University, Washington, D.C., May, 1997 (To be reprinted in the American Journal of Audiology).
8. Berger, H. S., "Hearing Aid Compatibility with Wireless Communications Devices," IEEE International Symposium on Electromagnetic Compatibility, Austin, TX, August, 1997.
9. Bronaugh, E. L., "Simplifying EMI Immunity (Susceptibility) Tests in TEM Cells," in the 1990 IEEE International Symposium on Electromagnetic Compatibility Symposium Record, Washington, D.C., August 1990, pp. 488-491
10. Byrne, D. and Dillon, H., The National Acoustics Laboratory (NAL) New Procedure for Selecting the Gain and Frequency Response of a Hearing Aid, *Ear and Hearing* 7:257-265, 1986.
11. Crawford, M. L., "Measurement of Electromagnetic Radiation from Electronic Equipment using TEM Transmission Cells," U.S. Department of Commerce, National Bureau of Standards, NBSIR 73-306, Feb. 1973.
12. Crawford, M. L., and Workman, J. L., "Using a TEM Cell for EMC Measurements of Electronic Equipment," U.S. Department of Commerce, National Bureau of Standards. Technical Note 1013, July 1981.
13. EHIMA GSM Project, Development phase, Project Report (1<sup>st</sup> part) Revision A. Technical-Audiological Laboratory and Telecom Denmark, October 1993.
14. EHIMA GSM Project, Development phase, Part II Project Report. Technical-Audiological Laboratory and Telecom Denmark, June 1994.
15. EHIMA GSM Project Final Report, Hearing Aids and GSM Mobile Telephones: Interference Problems, Methods of Measurement and Levels of Immunity. Technical-Audiological Laboratory and Telecom Denmark, 1995.
16. HAMPIS Report, Comparison of Mobile phone electromagnetic near field with an upscaled electromagnetic far field, using hearing aid as reference, 21 October 1999.



<b>FCC ID:</b> A3LSMS908U	 <b>PCTEST</b> <small>Head to the point of connection</small>	<b>HAC (T-COIL) TEST REPORT</b>		<b>Approved by:</b> Quality Manager
<b>Filename:</b> 1M2112090152-03.A3L	<b>Test Dates:</b> 2/21/2022 – 2/24/2022	<b>DUT Type:</b> Portable Handset	Page 41 of 45	

© 2022 PCTEST

REV 3.5.M  
8/18/2020

© 2022 PCTEST All rights reserved. Unless otherwise specified, no part of this report may be reproduced or utilized in any part, form or by any means, electronic or mechanical, including photocopying and microfilm, without permission in writing from PCTEST. If you have any questions about this international copyright or have an enquiry about obtaining additional rights to this report or assembly of contents thereof, please contact [INFO@PCTEST.COM](mailto:INFO@PCTEST.COM).

17. Hearing Aids/GSM, Report from OTWIDAM, Technical-Audiological Laboratory and Telecom Denmark, April 1993.
18. IEEE 100, The Authoritative Dictionary of IEEE Standards Terms, Seventh Edition.
19. Joyner, K. H., et. al., Interference to Hearing Aids by the New Digital Mobile Telephone System, Global System for Mobile (GSM) Communication Standard, National Acoustic Laboratory, Australian Hearing Series, Sydney 1993.
20. Joyner, K. H., et. al., Interference to Hearing Aids by the Digital Mobile Telephone System, Global System for Mobile Communications (GSM), NAL Report #131, National Acoustic Laboratory, Australian Hearing Series, Sydney, 1995.
21. Kecker, W. T., Crawford, M. L., and Wilson, W. A., "Construction of a Transverse Electromagnetic Cell", U.S. Department of Commerce, National Bureau of Standards, Technical Note 1011, Nov. 1978.
22. Konigstein, D., and Hansen, D., "A New Family of TEM Cells with enlarged bandwidth and Optimized working Volume," in the Proceedings of the 7<sup>th</sup> International Symposium on EMC, Zurich, Switzerland, March 1987; 50:9, pp. 127-132.
23. Kuk, F., and Hjorstgaard, N. K., "Factors affecting interference from digital cellular telephones," Hearing Journal, 1997; 50:9, pp 32-34.
24. Ma, M. A., and Kanda, M., "Electromagnetic Compatibility and Interference Metrology," U.S. Department of Commerce, National Bureau of Standards, Technical Note 1099, July 1986, pp. 17-43.
25. Ma, M. A., Sreenivashiah, I. , and Chang, D. C., "A Method of Determining the Emission and Susceptibility Levels of Electrically Small Objects Using a TEM Cell," U.S. Department of Commerce, National Bureau of Standards, Technial Note 1040, July 1981.
26. McCandless, G. A., and Lyregaard, P. E., Prescription of Gain/Output (POGO) for Hearing Aids, Hearing Instruments 1:16-21, 1983
27. Skopec, M., "Hearing Aid Electromagnetic Interference from Digital Wireless Telephones, "IEEE Transactions on Rehabilitation Engineering, vol. 6, no. 2, pp. 235-239, June 1998.
28. Technical Report, GSM 05.90, GSM EMC Considerations, European Telecommunications Standards Institute, January 1993.
29. Victorian, T. A., "Digital Cellular Telephone Interference and Hearing Aid Compatibility—an Update," Hearing Journal 1998; 51:10, pp. 53-60
30. Wong, G. S. K., and Embleton, T. F. W., eds., AIP Handbook of Condenser Microphones: Theory, Calibration and Measurements, AIP Press.

<b>FCC ID:</b> A3LSMS908U	 <b>PCTEST</b> Head to the point of delivery	<b>HAC (T-COIL) TEST REPORT</b>		<b>Approved by:</b> Quality Manager
<b>Filename:</b> 1M2112090152-03.A3L	<b>Test Dates:</b> 2/21/2022 – 2/24/2022	<b>DUT Type:</b> Portable Handset	Page 42 of 45	