



PART 2 RF EXPOSURE EVALUATION REPORT

Applicant Name:
Samsung Electronics Co., Ltd.
129, Samsung-ro, Maetan dong,
Yeongtong-gu, Suwon-si
Gyeonggi-do, 16677, Korea

Date of Testing:
10/11/2021 – 11/18/2021
Test Site/Location:
PCTEST, Columbia, MD, USA
Document Serial No.:
1M2109090102-23.A3L (Rev1)

FCC ID: **A3LSMS908U**

APPLICANT: **SAMSUNG ELECTRONICS CO., LTD.**

DUT Type: Portable Handset
Application Type: Certification
FCC Rule Part(s): CFR §2.1093
Model(s): SM-S908U, SM-S908U1
Device Serial Numbers: Pre-Production Samples [SN: 0961M, 0945M]

Note: This revised Test Report supersedes and replaces the previously issued test report on the same subject device for the same type of testing as indicated. Please discard or destroy the previously issued test report(s) and dispose of it accordingly.

I attest to the accuracy of data. All measurements reported herein were performed by me or were made under my supervision and are correct to the best of my knowledge and belief. I assume full responsibility for the completeness of these measurements and vouch for the qualifications of all persons taking them. Test results reported herein relate only to the item(s) tested.



Randy Ortanez
President







FCC ID: A3LSMS908U	 PCTEST Proud to be part of  element	PART 2 RF EXPOSURE EVALUATION REPORT		Approved by: Quality Manager
Document S/N: 1M2109090102-23.A3L (Rev1)	Test Dates: 10/11/2021 – 11/18/2021	DUT Type: Portable Handset	Page 1 of 64	

TABLE OF CONTENTS



1	DEVICE UNDER TEST	3
2	RF EXPOSURE LIMITS	5
3	TIME VARYING TRANSMISSION TEST CASES	7
4	FCC MEASUREMENT PROCEDURES (FREQ < 6 GHZ)	10
5	FCC MEASUREMENT PROCEDURES (FREQ > 6 GHZ)	20
6	MEASUREMENT TEST SETUP (FREQ < 6 GHZ)	27
7	MEASUREMENT TEST SETUP (FREQ > 6 GHZ)	30
8	TEST CONFIGURATIONS (FREQ < 6 GHZ).....	32
9	CONDUCTED TX CASES (FREQ < 6 GHZ).....	36
10	TEST CONFIGURATIONS (FREQ > 6 GHZ).....	51
11	RADIATED POWER TX CASES (FREQ > 6 GHZ).....	53
12	SYSTEM VERIFICATION (FREQ > 6 GHZ)	56
13	EQUIPMENT LIST.....	59
14	MEASUREMENT UNCERTAINTIES.....	60
15	CONCLUSION.....	62
16	REFERENCES	63
APPENDIX A: VERIFICATION PLOTS		
APPENDIX B: TEST SETUP PHOTOGRAPHS		
APPENDIX C: TEST SEQUENCES		
APPENDIX D: TEST PROCEDURES FOR SUB6 NR + NR RADIO		
APPENDIX E: CALIBRATION CERTIFICATES		

FCC ID: A3LSMS908U	 PCTEST <small>Proud to be part of element</small>	PART 2 RF EXPOSURE EVALUATION REPORT		Approved by: Quality Manager
Document S/N: 1M2109090102-23.A3L (Rev1)	Test Dates: 10/11/2021 – 11/18/2021	DUT Type: Portable Handset	Page 2 of 64	

1 DEVICE UNDER TEST

1.1 Device Overview

Band & Mode	Operating Modes	Tx Frequency
GSM/GPRS/EDGE 850	Voice/Data	824.20 - 848.80 MHz
GSM/GPRS/EDGE 1900	Voice/Data	1850.20 - 1909.80 MHz
UMTS 850	Voice/Data	826.40 - 846.60 MHz
UMTS 1750	Voice/Data	1712.4 - 1752.6 MHz
UMTS 1900	Voice/Data	1852.4 - 1907.6 MHz
LTE Band 71	Voice/Data	665.5 - 695.5 MHz
LTE Band 12	Voice/Data	699.7 - 715.3 MHz
LTE Band 13	Voice/Data	779.5 - 784.5 MHz
LTE Band 14	Voice/Data	790.5 - 795.5 MHz
LTE Band 26 (Cell)	Voice/Data	814.7 - 848.3 MHz
LTE Band 5 (Cell)	Voice/Data	824.7 - 848.3 MHz
LTE Band 66 (AWS)	Voice/Data	1710.7 - 1779.3 MHz
LTE Band 4 (AWS)	Voice/Data	1710.7 - 1754.3 MHz
LTE Band 25 (PCS)	Voice/Data	1850.7 - 1914.3 MHz
LTE Band 2 (PCS)	Voice/Data	1850.7 - 1909.3 MHz
LTE Band 30	Voice/Data	2307.5 - 2312.5 MHz
LTE Band 7	Voice/Data	2502.5 - 2567.5 MHz
LTE Band 48	Voice/Data	3552.5 - 3697.5 MHz
LTE Band 41	Voice/Data	2498.5 - 2687.5 MHz
LTE Band 38	Voice/Data	2572.5 - 2617.5 MHz
NR Band n71	Voice/Data	665.5 - 695.5 MHz
NR Band n12	Voice/Data	701.5 - 713.5 MHz
NR Band n5 (Cell)	Voice/Data	826.5 - 846.5 MHz
NR Band n66 (AWS)	Voice/Data	1712.5 - 1777.5 MHz
NR Band n25 (PCS)	Voice/Data	1852.5 - 1912.5 MHz
NR Band n2 (PCS)	Voice/Data	1852.5 - 1907.5 MHz
NR Band n30	Voice/Data	2307.5 - 2312.5 MHz
NR Band n7	Voice/Data	2502.5 - 2567.5 MHz
NR Band n41	Voice/Data	2506.02 - 2679.99 MHz
NR Band n38	Voice/Data	2575 - 2615 MHz
NR Band n77 DoD	Voice/Data	3455.01 - 3544.98 MHz
NR Band n77	Voice/Data	3705 - 3975 MHz
2.4 GHz WLAN	Voice/Data	2412 - 2462 MHz
U-NII-1	Voice/Data	5180 - 5240 MHz
U-NII-2A	Voice/Data	5260 - 5320 MHz
U-NII-2C	Voice/Data	5500 - 5720 MHz
U-NII-3	Voice/Data	5745 - 5825 MHz
U-NII-4	Voice/Data	5845 - 5885 MHz
U-NII-5	Voice/Data	5935 - 6415 MHz
U-NII-6	Voice/Data	6435 - 6525 MHz
U-NII-7	Voice/Data	6535 - 6875 MHz
U-NII-8	Voice/Data	6895 - 7115 MHz
Bluetooth	Data	2402 - 2480 MHz
NFC	Data	13.56 MHz
NR Band n258	Data	24250 - 24450 MHz; 24750 - 25250 MHz
NR Band n260	Data	37000 - 40000 MHz
NR Band n261	Data	27500 - 28350 MHz
UWB	Data	6489.6 - 7987.2 MHz

FCC ID: A3LSMS908U	 PCTEST Proud to be part of 	PART 2 RF EXPOSURE EVALUATION REPORT		Approved by: Quality Manager
Document S/N: 1M210909102-23.A3L (Rev1)	Test Dates: 10/11/2021 – 11/18/2021	DUT Type: Portable Handset	Page 3 of 64	

1.2 Time-Averaging Algorithm for RF Exposure Compliance

This device is enabled with Qualcomm® Smart Transmit feature. This feature performs time averaging algorithm in real time to control and manage transmitting power and ensure the time-averaged RF exposure is in compliance with FCC requirements all the time. DUT contains embedded file system (EFS) version 17 configured for the second generation (GEN2) for Sub6 and mmWave.

The Smart Transmit algorithm maintains the time-averaged transmit power, in turn, time-averaged RF exposure of SAR_design_target or PD_design_target, below the predefined time-averaged power limit (i.e., P_{limit} for sub-6 radio, and input.power.limit for 5G mmW NR), for each characterized technology and band.

Smart Transmit allows the device to transmit at higher power instantaneously, as high as P_{max} , when needed, but enforces power limiting to maintain time-averaged transmit power to P_{limit} for frequencies < 6 GHz and *input.power.limit* for frequencies > 6 GHz.

Note that the device uncertainty for sub-6GHz WWAN is 1.0 dB for this DUT, the device uncertainty for mmW is 2.0 dB, and the reserve power margin is 3 dB.



The purpose of the Part 2 report is to demonstrate the DUT complies with FCC RF exposure requirement under Tx varying transmission scenarios, thereby validity of Qualcomm® Smart Transmit feature implementation in this device. It serves to compliment the Part 0 and Part 1 Test Reports to justify compliance per FCC.

1.3 Part 2 Test Case Reduction for Multiple Filings

Per FCC guidance, number of test cases for Part 2 evaluation can be reduced in the case of multiple filings using the same chipset after full part 2 testing on the first filing. While the same chipset and Smart Transmit algorithm are used in this model, DUT with the final SW was tested for power measurements to verify the integration. The SAR and PD, as described in Section 3, measurements are excluded per FCC guidance.

1.4 Bibliography

Report Type	Report Serial Number
Near Field PD Report (Part 1)	1M2109090102-22.A3L
Near Field PD Part 0 Report	
SAR Part 1 Test Report	1M2109090102-01.A3L
RF Exposure Compliance Summary Report	1M2109090102-24.A3L
RF Exposure Part 0 Test Summary	1M2109090102-21.A3L
WIFI 6GHz RF Exposure	1M2109090102-26.A3L

FCC ID: A3LSMS908U	 PCTEST Proud to be part of 	PART 2 RF EXPOSURE EVALUATION REPORT		Approved by: Quality Manager
Document S/N: 1M2109090102-23.A3L (Rev1)	Test Dates: 10/11/2021 – 11/18/2021	DUT Type: Portable Handset	Page 4 of 64	

2 RF EXPOSURE LIMITS

2.1 Uncontrolled Environment

UNCONTROLLED ENVIRONMENTS are defined as locations where there is the exposure of individuals who have no knowledge or control of their exposure. The general population/uncontrolled exposure limits are applicable to situations in which the general public may be exposed or in which persons who are exposed as a consequence of their employment may not be made fully aware of the potential for exposure or cannot exercise control over their exposure. Members of the general public would come under this category when exposure is not employment-related; for example, in the case of a wireless transmitter that exposes persons in its vicinity.

2.2 Controlled Environment



CONTROLLED ENVIRONMENTS are defined as locations where there is exposure that may be incurred by persons who are aware of the potential for exposure, (i.e. as a result of employment or occupation). In general, occupational/controlled exposure limits are applicable to situations in which persons are exposed as a consequence of their employment, who have been made fully aware of the potential for exposure and can exercise control over their exposure. This exposure category is also applicable when the exposure is of a transient nature due to incidental passage through a location where the exposure levels may be higher than the general population/uncontrolled limits, but the exposed person is fully aware of the potential for exposure and can exercise control over his or her exposure by leaving the area or by some other appropriate means.

2.3 RF Exposure Limits for Frequencies Below 6 GHz

Table 2-1
SAR Human Exposure Specified in ANSI/IEEE C95.1-1992 and Health Canada Safety Code 6

HUMAN EXPOSURE LIMITS		
	UNCONTROLLED ENVIRONMENT <i>General Population</i> (W/kg) or (mW/g)	CONTROLLED ENVIRONMENT <i>Occupational</i> (W/kg) or (mW/g)
Peak Spatial Average SAR Head	1.6	8.0
Whole Body SAR	0.08	0.4
Peak Spatial Average SAR Hands, Feet, Ankle, Wrists, etc.	4.0	20

1. The Spatial Peak value of the SAR averaged over any 1 gram of tissue (defined as a tissue volume in the shape of a cube) and over the appropriate averaging time.
2. The Spatial Average value of the SAR averaged over the whole body.
3. The Spatial Peak value of the SAR averaged over any 10 grams of tissue (defined as a tissue volume in the shape of a cube) and over the appropriate averaging time.

FCC ID: A3LSMS908U	 PCTEST Proud to be part of 	PART 2 RF EXPOSURE EVALUATION REPORT		Approved by: Quality Manager
Document S/N: 1M2109090102-23.A3L (Rev1)	Test Dates: 10/11/2021 – 11/18/2021	DUT Type: Portable Handset		Page 5 of 64

2.4 RF Exposure Limits for Frequencies Above 6 GHz

Per §1.1310 (d)(3), the MPE limits are applied for frequencies above 6 GHz. Power Density is expressed in units of W/m² or mW/cm².

Peak Spatially Averaged Power Density was evaluated over a circular area of 4 cm² per interim FCC Guidance for near-field power density evaluations per October 2018 TCB Workshop notes.

**Table 2-2
Human Exposure Limits Specified in FCC 47 CFR §1.1310**



Human Exposure to Radiofrequency (RF) Radiation Limits		
Frequency Range [MHz]	Power Density [mW/cm ²]	Averaging Time [Minutes]
(A) Limits for Occupational / Controlled Environments		
1,500 – 100,000	5.0	6
(B) Limits for General Population / Uncontrolled Environments		
1,500 – 100,000	1.0	30

Note: 1.0 mW/cm² is 10 W/m²

2.5 Time Averaging Windows for FCC Compliance

Per October 2018 TCB Workshop Notes, the below time-averaging windows can be used for assessing time-averaged exposures for devices that are capable of actively monitoring and adjusting power output over time to comply with exposure limits.

Interim Guidance	Frequency (GHz)	Maximum Averaging Time (sec)
SAR	< 3	100
	3 – 6	60
MPE	6 - 10	30
	10 - 16	14
	16 – 24	8
	24 – 42	4
	42 – 95	2

FCC ID: A3LSMS908U	 PCTEST Proud to be part of 	PART 2 RF EXPOSURE EVALUATION REPORT		Approved by: Quality Manager
Document S/N: 1M2109090102-23.A3L (Rev1)	Test Dates: 10/11/2021 – 11/18/2021	DUT Type: Portable Handset	Page 6 of 64	

3 TIME VARYING TRANSMISSION TEST CASES

To validate the time averaging feature and demonstrate the compliance in Tx varying transmission conditions, the following transmission scenarios are covered in the Part 2 test:



1. During a time-varying Tx power transmission: To prove that the Smart Transmit feature accounts for Tx power variations in time accurately.
2. During a call disconnect and re-establish scenario: To prove that the Smart Transmit feature accounts for history of past Tx power transmissions accurately.
3. During a technology/band handover: To prove that the Smart Transmit feature functions correctly during transitions in technology/band.
4. During a DSI (Device State Index) change: To prove that the Smart Transmit feature functions correctly during transition from one device state (DSI) to another.
5. During an antenna (or beam) switch: To prove that the Smart Transmit feature functions correctly during transitions in antenna (such as AsDiv scenario) or beams (different antenna array configurations) or beams (different antenna array configurations).
6. SAR vs. PD exposure switching during sub-6+mmW transmission: To prove that the Smart Transmit feature functions correctly and ensures total RF exposure compliance during transitions in SAR dominant exposure, SAR+PD exposure, and PD dominant exposure scenarios.
7. During time window switch: To prove that the Smart Transmit feature correctly handles the transition from one time window to another specified by FCC, and maintains the normalized time-averaged RF exposure to be less than normalized FCC limit of 1.0 at all times.
8. SAR exposure switching between two active radios (radio1 and radio2): To prove that the Smart Transmit feature functions correctly and ensures total RF exposure compliance when exposure varies among SAR_radio1 only, SAR_radio1 + SAR_radio2, and SAR_radio2 only scenarios.
9. SAR exposure switching between sub6 radios favor modes: To prove that the Smart Transmit feature functions correctly and ensures total RF exposure compliance when exposure varies among sub6 radio1 + sub6 radio2 and mmW favor mode.

As described in Part 0 report, the RF exposure is proportional to the Tx power for a SAR- and PD-characterized wireless device. Thus, feature validation in Part 2 can be effectively performed through conducted (for $f < 6\text{GHz}$) and radiated (for $f \geq 6\text{GHz}$) power measurement. Therefore, the compliance demonstration under dynamic transmission conditions and feature validation are done in conducted/radiated power measurement setup for transmission scenario 1 through 8.

To add confidence in the feature validation, the time-averaged SAR and PD measurements are also performed but only performed for transmission scenario 1 to avoid the complexity in SAR and PD measurement (such as, for scenario 3 requiring change in SAR probe calibration file to accommodate different bands and/or tissue simulating liquid).

The strategy for testing in Tx varying transmission condition is outlined as follows:

- Demonstrate the total RF exposure averaged over FCC defined time windows does not exceed FCC's SAR and PD limits, through time-averaged power measurements
 - Measure conducted Tx power (for $f < 6\text{GHz}$) versus time, and radiated Tx power (EIRP for $f > 10\text{GHz}$) versus time.
 - Convert it into RF exposure and divide by respective FCC limits to get normalized exposure versus time.
 - Perform running time-averaging over FCC defined time windows.

FCC ID: A3LSMS908U	 PCTEST Proud to be part of 	PART 2 RF EXPOSURE EVALUATION REPORT		Approved by: Quality Manager
Document S/N: 1M2109090102-23.A3L (Rev1)	Test Dates: 10/11/2021 – 11/18/2021	DUT Type: Portable Handset	Page 7 of 64	

- Demonstrate that the total normalized time-averaged RF exposure is less than 1 for all transmission scenarios (i.e., transmission scenarios 1, 2, 3, 4, 5, 6, 7, and 8) at all times.

Mathematical expression:

For < 6 GHz transmission only:

$$1g_or_10gSAR(t) = \frac{conducted_Tx_power(t)}{conducted_Tx_power_P_{limit}} * 1g_or_10gSAR_P_{limit} \quad (1a)$$

$$\frac{\frac{1}{T_{SAR}} \int_{t-T_{SAR}}^t 1g_or_10gSAR(t) dt}{FCC\ SAR\ limit} \leq 1 \quad (1b)$$

For sub-6+mmW transmission:



$$1g_or_10gSAR(t) = \frac{conducted_Tx_power(t)}{conducted_Tx_power_P_{limit}} * 1g_or_10gSAR_P_{limit} \quad (2a)$$

$$4cm^2PD(t) = \frac{radiated_Tx_power(t)}{radiated_Tx_power_input_power_limit} * 4cm^2PD_input_power_limit \quad (2b)$$

$$\frac{\frac{1}{T_{SAR}} \int_{t-T_{SAR}}^t 1g_or_10gSAR(t) dt}{FCC\ SAR\ limit} + \frac{\frac{1}{T_{PD}} \int_{t-T_{PD}}^t 4cm^2PD(t) dt}{FCC\ 4cm^2\ PD\ limit} \leq 1 \quad (2c)$$

where, $conducted_Tx_power(t)$, $conducted_Tx_power_P_{limit}$, and $1g_or_10gSAR_P_{limit}$ correspond to the measured instantaneous conducted Tx power, measured conducted Tx power at P_{limit} , and measured 1gSAR or 10gSAR values at P_{limit} corresponding to sub-6 transmission. Similarly, $radiated_Tx_power(t)$, $radiated_Tx_power_input_power_limit$, and $4cm^2PD_input_power_limit$ correspond to the measured instantaneous radiated Tx power, radiated Tx power at $input_power_limit$ (i.e., radiated power limit), and $4cm^2PD$ value at $input_power_limit$ corresponding to mmW transmission. Both P_{limit} and $input_power_limit$ are the parameters pre-defined in Part 0 and loaded via Embedded File System (EFS) onto the EUT. T_{SAR} is the FCC defined time window for sub-6 radio; T_{PD} is the FCC defined time window for mmW radio.

- Demonstrate the total RF exposure averaged over FCC defined time windows does not exceed FCC's SAR and PD limits, through time-averaged SAR and PD measurements. Note as mentioned earlier, this measurement is performed for transmission scenario 1 only.
 - For sub-6 transmission only, measure instantaneous SAR versus time; for LTE+sub6 NR transmission, request low power (or all-down bits) on LTE so that measured SAR predominantly corresponds to sub6 NR.
 - For LTE + mmW transmission, measure instantaneous E-field versus time for mmW radio and instantaneous conducted power versus time for LTE radio.
 - Convert it into RF exposure and divide by respective FCC limits to obtain normalized exposure versus time.
 - Perform time averaging over FCC defined time window.
 - Demonstrate that the total normalized time-averaged RF exposure is less than 1 for transmission scenario 1 at all times.

FCC ID: A3LSMS908U	 PCTEST Proud to be part of 	PART 2 RF EXPOSURE EVALUATION REPORT		Approved by: Quality Manager
Document S/N: 1M2109090102-23.A3L (Rev1)	Test Dates: 10/11/2021 – 11/18/2021	DUT Type: Portable Handset		Page 8 of 64

Mathematical expression:

- For sub-6 transmission only:

$$1g_or_10gSAR(t) = \frac{pointSAR(t)}{pointSAR_P_{limit}} * 1g_or_10gSAR(t)_P_{limit} \quad (3a)$$

$$\frac{\frac{1}{T_{SAR}} \int_{t-T_{SAR}}^t 1g_or_10gSAR(t) dt}{FCC\ SAR\ limit} \leq 1 \quad (3b)$$

- For LTE+mmW transmission:



$$1g_or_10gSAR(t) = \frac{conducted_Tx_power(t)}{conducted_Tx_power_P_{limit}} * 1g_or_10gSAR_P_{limit} \quad (4a)$$

$$4cm^2\ PD(t) = \frac{[pointE(t)]^2}{[pointE_input.power.limit]^2} * 4cm^2\ PD_input.power.limit \quad (4b)$$

$$\frac{\frac{1}{T_{SAR}} \int_{t-T_{SAR}}^t 1g_or_10gSAR(t) dt}{FCC\ SAR\ limit} + \frac{\frac{1}{T_{PD}} \int_{t-T_{PD}}^t 4cm^2\ PD(t) dt}{FCC\ 4cm^2\ PD\ limit} \leq 1 \quad (4c)$$

where, $pointSAR(t)$, $pointSAR_P_{limit}$, and $1g_or_10gSAR_P_{limit}$ correspond to the measured instantaneous point SAR, measured point SAR at P_{limit} , and measured $1gSAR$ or $10gSAR$ values at P_{limit} corresponding to sub-6 transmission. Similarly, $pointE(t)$, $pointE_input.power.limit$, and $4cm^2\ PD_input.power.limit$ correspond to the measured instantaneous E-field, E-field at $input.power.limit$, and $4cm^2\ PD$ value at $input.power.limit$ corresponding to mmW transmission.

Note: cDASY6 measurement system by Schmid & Partner Engineering AG (SPEAG) of Zurich, Switzerland measures relative E-field, and provides ratio of $\frac{[pointE(t)]^2}{[pointE_input.power.limit]^2}$ versus time.

FCC ID: A3LSMS908U	 PCTEST Proud to be part of 	PART 2 RF EXPOSURE EVALUATION REPORT		Approved by: Quality Manager
Document S/N: 1M2109090102-23.A3L (Rev1)	Test Dates: 10/11/2021 – 11/18/2021	DUT Type: Portable Handset		Page 9 of 64

This chapter provides the test plan and test procedure for validating Qualcomm Smart Transmit feature for sub-6 transmission. The 100 seconds time window for operating $f < 3\text{GHz}$ is used as an example to detail the test procedures in this chapter. The same test plan and test procedures described in this chapter apply to 60 seconds time window for operating $f \geq 3\text{GHz}$.

4.1 Test sequence determination for validation

Following the FCC recommendation, two test sequences having time-variation in Tx power are predefined for sub-6 ($f < 6\text{GHz}$) validation:

- Test sequence 1: request DUT's Tx power to be at maximum power, measured P_{max}^\dagger , for 80s, then requesting for half of the maximum power, i.e., measured $P_{max}/2$, for the rest of the time.
- Test sequence 2: request DUT's Tx power to vary with time. This sequence is generated relative to measured P_{max} , measured P_{limit} and calculated $P_{reserve}$ (= measured P_{limit} in dBm - Reserve_power_margin in dB) of DUT based on measured P_{limit} .

The details for generating these two test sequences is described and listed in Appendix C.

NOTE: For test sequence generation, "measured P_{limit} " and "measured P_{max} " are used instead of the " P_{limit} " specified in EFS entry and " P_{max} " specified for the device, because the Smart Transmit feature operates against the actual power level of the " P_{limit} " that was calibrated for the DUT. The "measured P_{limit} " accurately reflects what the feature is referencing to, therefore, it should be used during feature validation testing. The RF tune up and device-to-device variation are already considered in Part 0 report prior to determining P_{limit} .

4.2 Test configuration selection criteria for validating Smart Transmit feature

For validating the Smart Transmit feature, this section provides the general guidance to select test cases.

4.2.1 Test configuration selection for time-varying Tx power transmission



The Smart Transmit time averaging feature operation is independent of bands, modes, and channels for a given technology. Hence, validation of Smart Transmit in one band/mode/channel per technology is sufficient. Two bands per technology are proposed and selected for this testing to provide high confidence in this validation.

The criteria for the selection are based on the P_{limit} values determined in Part 0 report. Select two bands* in each supported technology that correspond to least** and highest*** P_{limit} values that are less than P_{max} for validating Smart Transmit.

* If one P_{limit} level applies to all the bands within a technology, then only one band needs to be tested. In this case, within the bands having the same P_{limit} , the radio configuration (e.g., # of RBs, channel#) and device position that correspond to the highest measured 1gSAR at P_{limit} shown in Part 1 report is selected.

** In case of multiple bands having the same least P_{limit} within the technology, then select the band having the highest measured 1gSAR at P_{limit} .

*** The band having a higher P_{limit} needs to be properly selected so that the power limiting enforced by Smart Transmit can be validated using the pre-defined test sequences. If the highest P_{limit} in a technology is too high where the power limiting enforcement is not needed when testing with the pre-defined test sequences, then the

FCC ID: A3LSMS908U	 PCTEST Proud to be part of 	PART 2 RF EXPOSURE EVALUATION REPORT		Approved by: Quality Manager
Document S/N: 1M2109090102-23.A3L (Rev1)	Test Dates: 10/11/2021 – 11/18/2021	DUT Type: Portable Handset	Page 10 of 64	

next highest level is checked. This process is continued within the technology until the second band for validation testing is determined.

4.2.2 Test configuration selection for change in call

The criteria to select a test configuration for call-drop measurement is:

- Select technology/band with least P_{limit} among all supported technologies/bands, and select the radio configuration (e.g., # of RBs, channel#) in this technology/band that corresponds to the highest *measured* 1gSAR at P_{limit} listed in Part 1 report.
- In case of multiple bands having same least P_{limit} , then select the band having the highest *measured* 1gSAR at P_{limit} in Part 1 report.

This test is performed with the DUT's Tx power requested to be at maximum power, the above band selection will result in Tx power enforcement (i.e., DUT forced to have Tx power at $P_{reserve}$) for longest duration in one FCC defined time window. The call change (call drop/reestablish) is performed during the Tx power enforcement duration (i.e., during the time when DUT is forced to have Tx power at $P_{reserve}$). One test is sufficient as the feature operation is independent of technology and band.

4.2.3 Test configuration selection for change in technology/band

The selection criteria for this measurement is, for a given antenna, to have DUT switch from a technology/band with lowest P_{limit} within the technology group (in case of multiple bands having the same P_{limit} , then select the band with highest *measured* 1gSAR at P_{limit}) to a technology/band with highest P_{limit} within the technology group, in case of multiple bands having the same P_{limit} , then select the band with lowest *measured* 1gSAR at P_{limit} in Part 1 report, or vice versa.

This test is performed with the DUT's Tx power requested to be at maximum power, the technology/band switch is performed during Tx power enforcement duration (i.e., during the time when DUT is forced to have Tx power at $P_{reserve}$).

4.2.4 Test configuration selection for change in antenna

The criteria to select a test configuration for antenna switch measurement is:

- Whenever possible and supported by the DUT, first select antenna switch configuration within the same technology/band (i.e., same technology and band combination).
- Then, select any technology/band that supports multiple Tx antennas, and has the highest difference in P_{limit} among all supported antennas.
- In case of multiple bands having same difference in P_{limit} among supported antennas, then select the band having the highest *measured* 1gSAR at P_{limit} in Part 1 report.

This test is performed with the DUT's Tx power requested to be at maximum power in selected technology/band, and antenna change is conducted during Tx power enforcement duration (i.e., during the time when DUT is forced to have Tx power at $P_{reserve}$).

4.2.5 Test configuration selection for change in DSI

The criteria to select a test configuration for DSI change test is

- Select a technology/band having the $P_{limit} < P_{max}$ within any technology and DSI group, and for the same technology/band having a different P_{limit} in any other DSI group. Note that the selected DSI transition need to be supported by the device.

This test is performed with the DUT's Tx power requested to be at maximum power in selected technology/band, and DSI change is conducted during Tx power enforcement duration (i.e., during the time when DUT is forced to have Tx power at $P_{reserve}$).

FCC ID: A3LSMS908U	 PCTEST Proud to be part of 	PART 2 RF EXPOSURE EVALUATION REPORT		Approved by: Quality Manager
Document S/N: 1M2109090102-23.A3L (Rev1)	Test Dates: 10/11/2021 – 11/18/2021	DUT Type: Portable Handset	Page 11 of 64	

4.2.6 Test configuration selection for change in time window

FCC specifies different time window for time averaging based on operation frequency. The criteria to select a test configuration for validating Smart Transmit feature and demonstrating the compliance during the change in time window is

- Select any technology/band that has operation frequency classified in one time window defined by FCC (such as 100-seconds time window), and its corresponding P_{limit} is less than P_{max} if possible.
- Select the 2nd technology/band that has operation frequency classified in a different time window defined by FCC (such as 60-seconds time window), and its corresponding P_{limit} is less than P_{max} if possible.
- Note it is preferred both P_{limit} values of two selected technology/band less than corresponding P_{max} , but if not possible, at least one of technologies/bands has its P_{limit} less than P_{max} .

This test is performed with the EUT's Tx power requested to be at maximum power in selected technology/band. Test for one pair of time windows selected is sufficient as the feature operation is the same.

4.2.7 Test configuration selection for SAR exposure switching

If supported, the test configuration for SAR exposure switching should cover



1. SAR exposure switch when two active radios are in the same time window
2. SAR exposure switch when two active radios are in different time windows. One test with two active radios in any two different time windows is sufficient as Smart Transmit operation is the same for RF exposure switch in any combination of two different time windows. For device supporting LTE + mmW NR, this test is covered in SAR vs PD exposure switch validation.

The Smart Transmit time averaging operation is independent of the source of SAR exposure (for example, LTE vs. Sub6 NR) and ensures total time-averaged RF exposure compliance. Hence, validation of Smart Transmit in any one simultaneous SAR transmission scenario (i.e., one combination for LTE + Sub6 NR transmission) is sufficient, where the SAR exposure varies among SAR_{radio1} only, $SAR_{radio1} + SAR_{radio2}$, and SAR_{radio2} only scenarios.

The criteria to select a test configuration for validating Smart Transmit feature during SAR exposure switching scenarios is

- Select any two < 6GHz technologies/bands that the EUT supports simultaneous transmission (for example, LTE+Sub6 NR).
- Among all supported simultaneous transmission configurations, the selection order is
 1. select one configuration where both P_{limit} of radio1 and radio2 is less than their corresponding P_{max} , preferably, with different P_{limits} . If this configuration is not available, then,
 2. select one configuration that has P_{limit} less than its P_{max} for at least one radio. If this can not be found, then,
 3. select one configuration that has P_{limit} of radio1 and radio2 greater than P_{max} but with least $(P_{limit} - P_{max})$ delta.

Test for one simultaneous transmission scenario is sufficient as the feature operation is the same.

FCC ID: A3LSMS908U	 PCTEST Proud to be part of 	PART 2 RF EXPOSURE EVALUATION REPORT		Approved by: Quality Manager
Document S/N: 1M2109090102-23.A3L (Rev1)	Test Dates: 10/11/2021 – 11/18/2021	DUT Type: Portable Handset	Page 12 of 64	

4.3 Test procedures for conducted power measurements

This section provides general conducted power measurement procedures to perform compliance test under dynamic transmission scenarios described in Section 3. In practice, an adjustment can be made in these procedures. The justification/clarification may be provided.

4.3.1 Time-varying Tx power transmission scenario



This test is performed with the two pre-defined test sequences described in Section 4.1 for all the technologies and bands selected in Section 4.2.1. The purpose of the test is to demonstrate the effectiveness of power limiting enforcement and that the time-averaged SAR (corresponding time-averaged Tx power) does not exceed the FCC limit at all times (see Eq. (1a) and (1b)).

Test procedure

1. Measure P_{max} , measure P_{limit} and calculate $P_{reserve}$ (= measured P_{limit} in dBm – $Reserve_power_margin$ in dB) and follow Section 4.1 to generate the test sequences for all the technologies and bands selected in Section 4.2.1. Both test sequence 1 and test sequence 2 are created based on measured P_{max} and measured P_{limit} of the DUT. Test condition to measure P_{max} and P_{limit} is:
 - a. Measure P_{max} with Smart Transmit disabled and callbox set to request maximum power.
 - b. Measure P_{limit} with Smart Transmit enabled and $Reserve_power_margin$ set to 0 dB, callbox set to request maximum power.
2. Set $Reserve_power_margin$ to actual (intended) value (3dB for this DUT based on Part 1 report) and reset power on DUT to enable Smart Transmit, establish radio link in desired radio configuration, with callbox requesting the DUT's Tx power to be at pre-defined test sequence 1, measure and record Tx power versus time, and then convert the conducted Tx power into 1gSAR or 10gSAR value (see Eq. (1a)) using measured P_{limit} from above Step 1. Perform running time average to determine time-averaged power and 1gSAR or 10gSAR versus time as illustrated in Figure 4-1 where using 100-seconds time window as an example.

Note: In Eq.(1a), instantaneous Tx power is converted into instantaneous 1gSAR or 10gSAR value by applying the measured worst-case 1gSAR or 10gSAR value at P_{limit} for the corresponding technology/band/antenna/DSI reported in Part 1 report.

Note: For an easier computation of the running time average, 0 dBm can be added at the beginning of the test sequences the length of the responding time window, for example, add 0dBm for 100-seconds so the running time average can be directly performed starting with the first 100-seconds data using excel spreadsheet. This technique applies to all tests performed in this Part 2 report for easier time-averaged computation using excel spreadsheet.

FCC ID: A3LSMS908U	 PCTEST Proud to be part of 	PART 2 RF EXPOSURE EVALUATION REPORT		Approved by: Quality Manager
Document S/N: 1M2109090102-23.A3L (Rev1)	Test Dates: 10/11/2021 – 11/18/2021	DUT Type: Portable Handset	Page 13 of 64	

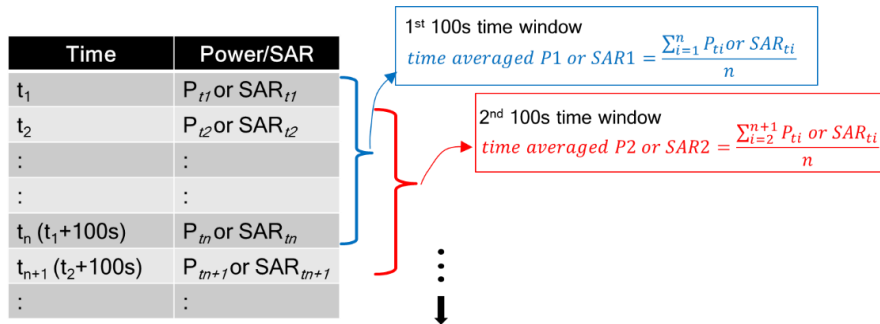

**Figure 4-1
Running Average Illustration**

3. Make one plot containing:
 - a. Instantaneous Tx power versus time measured in Step 2,
 - b. Requested Tx power used in Step 2 (test sequence 1),
 - c. Computed time-averaged power versus time determined in Step 2,
 - d. Time-averaged power limit (corresponding to FCC SAR limit of 1.6 W/kg for 1gSAR or 4.0W/kg for 10gSAR) given by

$$Time\ averaged\ power\ limit = meas.P_{limit} + 10 \times \log\left(\frac{FCC\ SAR\ limit}{meas.SAR_Plimit}\right) \quad (5a)$$



where $meas.P_{limit}$ and $meas.SAR_Plimit$ correspond to measured power at P_{limit} and measured SAR at P_{limit} .

4. Make another plot containing:
 - a. Computed time-averaged 1gSAR or 10gSAR versus time determined in Step 2
 - b. FCC $1gSAR_{limit}$ of 1.6W/kg or FCC $10gSAR_{limit}$ of 4.0W/kg.
5. Repeat Steps 2 ~ 4 for pre-defined test sequence 2 and replace the requested Tx power (test sequence 1) in Step 2 with test sequence 2.
6. Repeat Steps 2 ~ 5 for all the selected technologies and bands.
7. The validation criteria are, at all times, the time-averaged power versus time shown in Step 3 plot shall not exceed the time-averaged power limit (defined in Eq. (5a)), in turn, the time-averaged 1gSAR or 10gSAR versus time shown in Step 4 plot shall not exceed the FCC limit of 1.6 W/kg for 1gSAR or 4.0 W/kg for 10gSAR (i.e., Eq. (1b)).

4.3.2 Change in call scenario

This test is to demonstrate that Smart Transmit feature accurately accounts for the past Tx powers during time-averaging when a new call is established.

The call disconnect and re-establishment needs to be performed during power limit enforcement, i.e., when the DUT's Tx power is at $P_{reserve}$ level, to demonstrate the continuity of RF exposure management and limiting in call change scenario. In other words, the RF exposure averaged over any FCC defined time window (including the time windows containing the call change) doesn't exceed FCC limit of 1.6 W/kg for 1gSAR or 4.0 W/kg for 10gSAR.

FCC ID: A3LSMS908U	 PCTEST Proud to be part of 	PART 2 RF EXPOSURE EVALUATION REPORT		Approved by: Quality Manager
Document S/N: 1M2109090102-23.A3L (Rev1)	Test Dates: 10/11/2021 – 11/18/2021	DUT Type: Portable Handset	Page 14 of 64	

Test procedure

1. Measure P_{limit} for the technology/band selected in Section 4.2.2. Measure P_{limit} with Smart Transmit enabled and *Reserve_power_margin* set to 0 dB, callbox set to request maximum power.
2. Set *Reserve_power_margin* to actual (intended) value and reset power on DUT to enable Smart Transmit.
3. Establish radio link with callbox in the selected technology/band.
4. Request DUT's Tx power at 0 dBm for at least one time window specified for the selected technology/band, followed by requesting DUT's Tx power to be at maximum power for about ~60 seconds, and then drop the call for ~10 seconds. Afterwards, re-establish another call in the same radio configuration (i.e., same technology/band/channel) and continue callbox requesting DUT's Tx power to be at maximum power for the remaining time of at least another full duration of the specified time window. Measure and record Tx power versus time. Once the measurement is done, extract instantaneous Tx power versus time, convert the measured conducted Tx power into 1gSAR or 10gSAR value using Eq. (1a), and then perform the running time average to determine time-averaged power and 1gSAR or 10gSAR versus time.

NOTE: In Eq.(1a), instantaneous Tx power is converted into instantaneous 1gSAR or 10gSAR value by applying the measured worst-case 1gSAR or 10gSAR value at P_{limit} for the corresponding technology/band/antenna/DSI reported in Part 1 report.

5. Make one plot containing: (a) instantaneous Tx power versus time, (b) requested power, (c) computed time-averaged power, (d) time-averaged power limit calculated using Eq.(5a).
6. Make another plot containing: (a) computed time-averaged 1gSAR or 10gSAR versus time, and (b) FCC limit of 1.6 W/kg for 1gSAR or 4.0 W/kg for 10gSAR.

The validation criteria are, at all times, the time-averaged power versus time shall not exceed the time-averaged power limit (defined in Eq.(5a)), in turn, the time-averaged 1gSAR or 10gSAR versus time shall not exceed the FCC limit of 1.6 W/kg for 1gSAR or 4.0 W/kg for 10gSAR (i.e., Eq. (1b)).

4.3.3 Change in technology and band

This test is to demonstrate the correct power control by Smart Transmit during technology switches and/or band handovers.



Similar to the change in call test in Section 4.3.2, to validate the continuity of RF exposure limiting during the transition, the technology and band handover needs to be performed when DUT's Tx power is at $P_{reserve}$ level (i.e., during Tx power enforcement) to make sure that the DUT's Tx power from previous $P_{reserve}$ level to the new $P_{reserve}$ level (corresponding to new technology/band). Since the P_{limit} could vary with technology and band, Eq. (1a) can be written as follows to convert the instantaneous Tx power in 1gSAR or 10gSAR exposure for the two given radios, respectively:

$$1g_or_10gSAR_1(t) = \frac{conducted_Tx_power_1(t)}{conducted_Tx_power_P_{limit_1}} * 1g_or_10gSAR_P_{limit_1} \quad (6a)$$

$$1g_or_10gSAR_2(t) = \frac{conducted_Tx_power_2(t)}{conducted_Tx_power_P_{limit_2}} * 1g_or_10gSAR_P_{limit_2} \quad (6b)$$

$$\frac{1}{T_{SAR}} \left[\int_{t-T_{SAR}}^{t_1} \frac{1g_or_10gSAR_1(t)}{FCC\ SAR\ limit} dt + \int_{t-T_{SAR}}^t \frac{1g_or_10gSAR_2(t)}{FCC\ SAR\ limit} dt \right] \leq 1 \quad (6c)$$

where, $conducted_Tx_power_1(t)$, $conducted_Tx_power_P_{limit_1}$, and $1g_or_10gSAR_P_{limit_1}$ correspond to the measured instantaneous conducted Tx power, measured conducted Tx power at P_{limit_1} , and measured 1gSAR or 10gSAR value at P_{limit} of technology1/band1; $conducted_Tx_power_2(t)$,

FCC ID: A3LSMS908U	 PCTEST Proud to be part of 	PART 2 RF EXPOSURE EVALUATION REPORT		Approved by: Quality Manager
Document S/N: 1M2109090102-23.A3L (Rev1)	Test Dates: 10/11/2021 – 11/18/2021	DUT Type: Portable Handset		Page 15 of 64

$conducted_Tx_power_P_{limit_2}(t)$, and $1g_or_10gSAR_P_{limit_2}$ correspond to the measured instantaneous conducted Tx power, measured conducted Tx power at P_{limit} , and measured 1gSAR or 10gSAR value at P_{limit} of technology2/band2. Transition from technology1/band1 to the technology2/band2 happens at time-instant ' t_i '.

Test procedure

1. Measure P_{limit} for both the technologies and bands selected in Section 4.2.3. Measure P_{limit} with Smart Transmit enabled and *Reserve_power_margin* set to 0 dB, callbox set to request maximum power.
2. Set *Reserve_power_margin* to actual (intended) value and reset power on DUT to enable Smart Transmit
3. Establish radio link with callbox in first technology/band selected.
4. Request DUT's Tx power at 0 dBm for at least one time window specified for the selected technology/band, followed by requesting DUT's Tx power to be at maximum power for about ~60 seconds, and then switch to second technology/band selected. Continue with callbox requesting DUT's Tx power to be at maximum power for the remaining time of at least another full duration of the specified time window. Measure and record Tx power versus time for the full duration of the test.
5. Once the measurement is done, extract instantaneous Tx power versus time, and convert the conducted Tx power into 1gSAR or 10gSAR value using Eq. (6a) and (6b) and corresponding measured P_{limit} values from Step 1 of this section. Perform the running time average to determine time-averaged power and 1gSAR or 10gSAR versus time.

NOTE: In Eq.(6a) & (6b), instantaneous Tx power is converted into instantaneous 1gSAR or 10gSAR value by applying the measured worst-case 1gSAR or 10gSAR value at P_{limit} for the corresponding technology/band/antenna/DSI reported in Part 1 report.

6. Make one plot containing: (a) instantaneous Tx power versus time, (b) requested power, (c) computed time-averaged power, (d) time-averaged power limit calculated using Eq.(5a).
7. Make another plot containing: (a) computed time-averaged 1gSAR or 10gSAR versus time, and (b) FCC limit of 1.6 W/kg for 1gSAR or 4.0 W/kg for 10gSAR.

The validation criteria are, at all times, the time-averaged 1gSAR or 10gSAR versus time shall not exceed the FCC limit of 1.6 W/kg for 1gSAR or 4.0 W/kg for 10gSAR (i.e., Eq. (6c)).



4.3.4 Change in antenna

This test is to demonstrate the correct power control by Smart Transmit during antenna switches from one antenna to another. The test procedure is identical to Section 4.3.3, by replacing technology/band switch operation with antenna switch. The validation criteria are, at all times, the time-averaged 1gSAR or 10gSAR versus time shall not exceed FCC limit of 1.6 W/kg for 1gSAR or 4.0 W/kg for 10gSAR.

NOTE: If the DUT does not support antenna switch within the same technology/band, but has multiple antennas to support different frequency bands, then the antenna switch test is included as part of change in technology and band (Section 4.3.3) test.

4.3.5 Change in DSI

This test is to demonstrate the correct power control by Smart Transmit during DSI switches from one DSI to another. The test procedure is identical to Section 4.3.3, by replacing technology/band switch operation with DSI switch. The validation criteria are, at all times, the time-averaged 1gSAR or 10gSAR versus time shall not exceed FCC limit of 1.6 W/kg for 1gSAR or 4.0 W/kg for 10gSAR.

FCC ID: A3LSMS908U	 PCTEST Proud to be part of 	PART 2 RF EXPOSURE EVALUATION REPORT		Approved by: Quality Manager
Document S/N: 1M2109090102-23.A3L (Rev1)	Test Dates: 10/11/2021 – 11/18/2021	DUT Type: Portable Handset	Page 16 of 64	

4.3.6 Change in time window

This test is to demonstrate the correct power control by Smart Transmit during the change in averaging time window when a specific band handover occurs. FCC specifies time-averaging windows of 100s for Tx frequency < 3GHz, and 60s for Tx frequency between 3GHz and 6GHz.

To validate the continuity of RF exposure limiting during the transition, the band handover test needs to be performed when EUT handovers from operation band less than 3GHz to greater than 3GHz and vice versa. The equations (3a) and (3b) in Section 2 can be written as follows for transmission scenario having change in time window,

$$1gSAR_1(t) = \frac{\text{conducted_Tx_power_1}(t)}{\text{conducted_Tx_power_P}_{limit_1}} * 1g_or\ 10g_SAR_P_{limit_1} \quad (7a)$$

$$1gSAR_2(t) = \frac{\text{conducted_Tx_power_2}(t)}{\text{conducted_Tx_power_P}_{limit_2}} * 1g_or\ 10g_SAR_P_{limit_2} \quad (7b)$$

$$\frac{1}{T_{1SAR}} \left[\int_{t-T_{1SAR}}^{t_1} \frac{1g_or\ 10g_SAR_1(t)}{FCC\ SAR\ limit} dt \right] + \frac{1}{T_{2SAR}} \left[\int_{t-T_{2SAR}}^t \frac{1g_or\ 10g_SAR_2(t)}{FCC\ SAR\ limit} dt \right] \leq 1 \quad (7c)$$



where, *conducted_Tx_power_1(t)*, *conducted_Tx_power_P_{limit_1}(t)*, and *1g_ or 10g_SAR_P_{limit_1}* correspond to the instantaneous Tx power, conducted Tx power at *P_{limit}*, and compliance *1g_ or 10g_SAR* values at *P_{limit_1}* of band1 with time-averaging window '*T_{1SAR}*'; *conducted_Tx_power_2(t)*, *conducted_Tx_power_P_{limit_2}(t)*, and *1g_ or 10g_SAR_P_{limit_2}* correspond to the instantaneous Tx power, conducted Tx power at *P_{limit}*, and compliance *1g_ or 10g_SAR* values at *P_{limit_2}* of band2 with time-averaging window '*T_{2SAR}*'. One of the two bands is less than 3GHz, another is greater than 3GHz. Transition from first band with time-averaging window '*T_{1SAR}*' to the second band with time-averaging window '*T_{2SAR}*' happens at time-instant '*t₁*'.

Test procedure

1. Measure *P_{limit}* for both the technologies and bands selected in Section 4.2.6. Measure *P_{limit}* with Smart Transmit enabled and *Reserve_power_margin* set to 0 dB, callbox set to request maximum power.
2. Set *Reserve_power_margin* to actual (intended) value and enable Smart Transmit

Transition from 100s time window to 60s time window, and vice versa

3. Establish radio link with callbox in the technology/band having 100s time window selected in Section 4.2.6.
4. Request EUT's Tx power to be at 0 dBm for at least 100 seconds, followed by requesting EUT's Tx power to be at maximum power for about ~140 seconds, and then switch to second technology/band (having 60s time window) selected in Section 4.2.6. Continue with callbox requesting EUT's Tx power to be at maximum power for about ~60s in this second technology/band, and then switch back to the first technology/band. Continue with callbox requesting EUT's Tx power to be at maximum power for at least another 100s. Measure and record Tx power versus time for the entire duration of the test.
5. Once the measurement is done, extract instantaneous Tx power versus time, and convert the conducted Tx power into 1gSAR or 10gSAR value (see Eq. (7a) and (7b)) using corresponding technology/band Step 1 result, and then perform 100s running average to determine time-averaged 1gSAR or 10gSAR versus time. Note that in Eq.(7a) & (7b), instantaneous Tx power is converted into instantaneous 1gSAR or 10gSAR value by applying the worst-case 1gSAR or 10gSAR value tested in Part 1 for the selected technologies/bands at *P_{limit}*.
6. Make one plot containing: (a) instantaneous Tx power versus time measured in Step 4.
7. Make another plot containing: (a) instantaneous 1gSAR versus time determined in Step 5, (b) computed time-averaged 1gSAR versus time determined in Step 5, and (c) corresponding regulatory *1gSAR_{limit}* of 1.6W/kg or *10gSAR_{limit}* of 4.0W/kg.

FCC ID: A3LSMS908U	 PCTEST Proud to be part of 	PART 2 RF EXPOSURE EVALUATION REPORT		Approved by: Quality Manager
Document S/N: 1M2109090102-23.A3L (Rev1)	Test Dates: 10/11/2021 – 11/18/2021	DUT Type: Portable Handset		Page 17 of 64

Transition from 60s time window to 100s time window, and vice versa

8. Establish radio link with callbox in the technology/band having 60s time window selected in Section 4.2.6.
9. Request EUT's Tx power to be at 0 dBm for at least 60 seconds, followed by requesting EUT's Tx power to be at maximum power for about ~80 seconds, and then switch to second technology/band (having 100s time window) selected in Section 4.2.6. Continue with callbox requesting EUT's Tx power to be at maximum power for about ~100s in this second technology/band, and then switch back to the first technology/band. Continue with callbox requesting EUT's Tx power to be at maximum power for the remaining time for a total test time of 500 seconds. Measure and record Tx power versus time for the entire duration of the test.
10. Repeat above Step 5~7 to generate the plots



The validation criteria is, at all times, the time-averaged 1gSAR or 10gSAR versus time shall not exceed the regulatory $1gSAR_{limit}$ of 1.6W/kg or $10gSAR_{limit}$ of 4.0W/kg.

4.3.7 SAR exposure switching

This test is to demonstrate that Smart Transmit feature is accurately accounts for switching in exposures among SAR from radio1 only, SAR from both radio1 and radio2, and SAR from radio2 only scenarios, and ensures total time-averaged RF exposure complies with the FCC limit. Here, radio1 represents primary radio (for example, LTE anchor in a NR non-standalone mode call) and radio2 represents secondary radio (for example, sub6 NR or mmW NR). The detailed test procedure for SAR exposure switching in the case of LTE+Sub6 NR non-standalone mode transmission scenario is provided in APPENDIX D:.



Test procedure:

1. Measure conducted Tx power corresponding to P_{limit} for radio1 and radio2 in selected band. Test condition to measure conducted P_{limit} is:
 - Establish device in call with the callbox for radio1 technology/band. Measure conducted Tx power corresponding to radio1 P_{limit} with Smart Transmit enabled and *Reserve_power_margin* set to 0 dB, callbox set to request maximum power.
 - Repeat above step to measure conducted Tx power corresponding to radio2 P_{limit} . If radio2 is dependent on radio1 (for example, non-standalone mode of Sub6 NR requiring radio1 LTE as anchor), then establish radio1 + radio2 call with callbox, and request all down bits for radio1 LTE. In this scenario, with callbox requesting maximum power from radio2 Sub6 NR, measured conducted Tx power corresponds to radio2 P_{limit} (as radio1 LTE is at all-down bits)
2. Set *Reserve_power_margin* to actual (intended) value, with EUT setup for radio1 + radio2 call. In this description, it is assumed that radio2 has lower priority than radio1. Establish device in radio1+radio2 call, and request all-down bits or low power on radio1, with callbox requesting EUT's Tx power to be at maximum power in radio2 for at least one time window. After one time window, set callbox to request EUT's Tx power to be at maximum power on radio1, i.e., all-up bits. Continue radio1+radio2 call with both radios at maximum power for at least one time window, and drop (or request all-down bits on) radio2. Continue radio1 at maximum power for at least one time window. Record the conducted Tx power for both radio1 and radio2 for the entire duration of this test.
3. Once the measurement is done, extract instantaneous Tx power versus time for both radio1 and radio2 links. Convert the conducted Tx power for both these radios into 1gSAR or 10gSAR value (see Eq. (6a) and (6b)) using corresponding technology/band P_{limit} measured in Step 1, and then perform the running time average to determine time-averaged 1gSAR or 10gSAR versus time.

FCC ID: A3LSMS908U	 PCTEST Proud to be part of 	PART 2 RF EXPOSURE EVALUATION REPORT		Approved by: Quality Manager
Document S/N: 1M2109090102-23.A3L (Rev1)	Test Dates: 10/11/2021 – 11/18/2021	DUT Type: Portable Handset		Page 18 of 64

4. Make one plot containing: (a) instantaneous Tx power versus time measured in Step 2.
5. Make another plot containing: (a) instantaneous 1gSAR versus time determined in Step 3, (b) computed time-averaged 1gSAR versus time determined in Step 3, and (c) corresponding regulatory $1gSAR_{limit}$ of 1.6W/kg or $10gSAR_{limit}$ of 4.0W/kg.

The validation criteria is, at all times, the time-averaged 1gSAR or 10gSAR versus time shall not exceed the regulatory $1gSAR_{limit}$ of 1.6W/kg or $10gSAR_{limit}$ of 4.0W/kg.

FCC ID: A3LSMS908U	 PART 2 RF EXPOSURE EVALUATION REPORT 		Approved by: Quality Manager
Document S/N: 1M2109090102-23.A3L (Rev1)	Test Dates: 10/11/2021 – 11/18/2021	DUT Type: Portable Handset	Page 19 of 64

This section provides the test plan and test procedures for validating Qualcomm Smart Transmit feature for mmW transmission. For this EUT, millimeter wave (mmW) transmission is only in non-standalone mode, i.e., it requires an LTE link as anchor.

5.1 Test sequence for validation in mmW NR transmission

In 5G mmW NR transmission, the test sequence for validation is with the callbox requesting EUT's Tx power in 5G mmW NR at maximum power all the time.

5.2 Test configuration selection criteria for validating Smart Transmit feature

5.2.1 Test configuration selection for time-varying Tx power transmission

The Smart Transmit time averaging feature operation is independent of bands, modes, channels, and antenna configurations (beams) for a given technology. Hence, validation of Smart Transmit in any one band/mode/channel per technology is sufficient.

5.2.2 Test configuration selection for change in antenna configuration (beam)

The Smart Transmit time averaging feature operation is independent of bands, modes, channels, and antenna configurations (beams) for a given technology. Hence, validation of Smart Transmit with beam switch between any two beams is sufficient.

5.2.3 Test configuration selection for SAR vs. PD exposure switch during transmission

The Smart Transmit time averaging feature operation is independent of the nature of exposure (SAR vs. PD) and ensures total time-averaged RF exposure compliance. Hence, validation of Smart Transmit in any one band/mode/channel/beam for mmW + sub-6 (LTE) transmission is sufficient, where the exposure varies among SAR dominant scenario, SAR+PD scenario, and PD dominant scenario.

5.2.4 Test configuration selection for switch between sub6 and mmW favor modes

The Smart Transmit time averaging feature operation is independent of the nature of (SAR vs. PD) and ensures total time-averaged RF exposure compliance. Hence, validation of Smart Transmit in any one band/mode/channel/beam for mmW + sub6 NR transmission is sufficient.



5.3 Test procedures for mmW radiated power measurements

Perform conducted power measurement (for $f < 6\text{GHz}$) and radiated power measurement (for $f > 6\text{GHz}$) for LTE + mmW transmission to validate Smart Transmit time averaging feature in the various transmission scenarios described in Section 3.

This section provides general conducted power measurement procedures to perform compliance test under dynamic transmission scenarios described in Section 3. In practice, an adjustment can be made in these procedures. The justification/clarification may be provided.

5.3.1 Time-varying Tx power scenario



The purpose of the test is to demonstrate the effectiveness of power limiting enforcement and that the time-averaged Tx power when converted into RF exposure values does not exceed the FCC limit at all times (see Eq. (2a), (2b) & (2c) in Section 3).

FCC ID: A3LSMS908U	 PCTEST Proud to be part of 	PART 2 RF EXPOSURE EVALUATION REPORT		Approved by: Quality Manager
Document S/N: 1M2109090102-23.A3L (Rev1)	Test Dates: 10/11/2021 – 11/18/2021	DUT Type: Portable Handset		Page 20 of 64

Test procedure:

1. Measure conducted Tx power corresponding to P_{limit} for LTE in selected band, and measure radiated Tx power corresponding to *input.power.limit* in desired mmW band/channel/beam by following below steps:
 - a. Measure radiated power corresponding to mmW *input.power.limit* by setting up the EUT's Tx power in desired band/channel/beam at *input.power.limit* in Factory Test Mode (FTM). This test is performed in a calibrated anechoic chamber. Rotate the EUT to obtain maximum radiated Tx power, keep the EUT in this position and do not disturb the position of the EUT inside the anechoic chamber for the rest of this test.
 - b. Reset EUT to place in online mode and establish radio link in LTE, measure conducted Tx power corresponding to LTE P_{limit} with Smart Transmit enabled and *Reserve_power_margin* set to 0 dB, callbox set to request maximum power.
2. Set *Reserve_power_margin* to actual (intended) value and reset power on EUT to enable Smart Transmit. With EUT setup for a mmW NR call in the desired/selected LTE band and mmW NR band, perform the following steps:
 - a. Establish LTE and mmW NR connection in desired band/channel/beam used in Step 1. As soon as the mmW connection is established, immediately request all-down bits on LTE link. With callbox requesting EUT's Tx power to be at maximum mmW power to test predominantly PD exposure scenario (as SAR exposure is less when LTE's Tx power is at low power).
 - b. After 120s, request LTE to go all-up bits for at least 100s. SAR exposure is dominant. There are two scenarios:
 - i. If $P_{limit} < P_{max}$ for LTE, then the RF exposure margin (provided to mmW NR) gradually runs out (due to high SAR exposure). This results in gradual reduction in the 5G mmW NR transmission power and eventually seized 5G mmW NR transmission when LTE goes to $P_{reserve}$ level.
 - ii. If $P_{limit} \geq P_{max}$ for LTE, then the 5G mmW NR transmission's averaged power should gradually reduce but the mmW NR connection can sustain all the time (assuming TxAGC uncertainty = 0dB).
 - c. Record the conducted Tx power of LTE and radiated Tx power of mmW for the full duration of this test of at least 300s.
3. Once the measurement is done, extract instantaneous Tx power versus time for both LTE and mmW links. Convert the conducted Tx power for LTE into 1gSAR or 10gSAR value using Eq. (2a) and P_{limit} measured in Step 1.b, and then divide by FCC limit of 1.6 W/kg for 1gSAR or 4.0 W/kg for 10gSAR to obtain instantaneous normalized 1gSAR or 10gSAR versus time. Perform 100s running average to determine normalized 100s-averaged 1gSAR or 10gSAR versus time.

NOTE: In Eq.(2a), instantaneous Tx power is converted into instantaneous 1gSAR or 10gSAR value by applying the measured worst-case 1gSAR or 10gSAR value at P_{limit} for the corresponding technology/band/antenna/DSI reported in Part 1 report.
4. Similarly, convert the radiated Tx power for mmW into 4cm²PD value using Eq. (2b) and the radiated Tx power limit (i.e., radiated Tx power at *input.power.limit*) measured in Step 1.a, then divide by FCC 4cm²PD limit of 10W/m² to obtain instantaneous normalized 4cm²PD versus time. Perform 4s running average to determine normalized 4s-averaged 4cm²PD versus time.

FCC ID: A3LSMS908U	 PCTEST Proud to be part of 	PART 2 RF EXPOSURE EVALUATION REPORT		Approved by: Quality Manager
Document S/N: 1M2109090102-23.A3L (Rev1)	Test Dates: 10/11/2021 – 11/18/2021	DUT Type: Portable Handset	Page 21 of 64	

NOTE: In Eq.(2b), instantaneous radiated Tx power is converted into instantaneous 4cm²PD by applying the worst-case 4cm²PD value measured at *input.power.limit* for the selected band/beam in Part 1 report.

5. Make one plot containing: (a) instantaneous conducted Tx power for LTE versus time, (b) computed 100s-averaged conducted Tx power for LTE versus time, (c) instantaneous radiated Tx power for mmW versus time, as measured in Step 2, (d) computed 4s-averaged radiated Tx power for mmW versus time, and (e) time-averaged conducted and radiated power limits for LTE and mmW radio using Eq. (5a) & (5b), respectively:

$$\text{Time averaged LTE power limit} = \text{meas. } P_{\text{limit}} + 10 \times \log\left(\frac{\text{FCC SAR limit}}{\text{meas.SAR}_P\text{limit}}\right) \quad (5a)$$

$$\text{Time averaged mmW NR power limit} = \text{meas. EIRP}_{\text{input.power.limit}} + 10 \times \log\left(\frac{\text{FCC PD limit}}{\text{meas.PD}_{\text{input.power.limit}}}\right) \quad (5b)$$

where *meas. EIRP_{input.power.limit}* and *meas. PD_{input.power.limit}* correspond to measured EIRP at *input.power.limit* and measured power density at *input.power.limit*.

6. Make another plot containing: (a) computed normalized 100s-averaged 1gSAR or 10gSAR versus time determined in Step 3, (b) computed normalized 4s-averaged 4cm²PD versus time determined in Step 4, and (c) corresponding total normalized time-averaged RF exposure (sum of steps (6.a) and (6.b)) versus time.



The validation criteria are, at all times, the total normalized time-averaged RF exposure versus time determined in Step 6.c shall not exceed the normalized limit of 1.0 of FCC requirement (i.e., Eq. (2c)).

5.3.2 Switch in SAR vs. PD exposure during transmission

This test is to demonstrate that Smart Transmit feature is independent of the nature of exposure (SAR vs. PD), accurately accounts for switching in exposures among SAR dominant, SAR+PD, and PD dominant scenarios, and ensures total time-averaged RF exposure compliance.

Test procedure:

1. Measure conducted Tx power corresponding to *P_{limit}* for LTE in selected band, and measure radiated Tx power corresponding to *input.power.limit* in desired mmW band/channel/beam by following below steps:
 - a. Measure radiated power corresponding to *input.power.limit* by setting up the EUT's Tx power in desired band/channel/beam at *input.power.limit* in FTM. This test is performed in a calibrated anechoic chamber. Rotate the EUT to obtain maximum radiated Tx power, keep the EUT in this position and do not disturb the position of the EUT inside the anechoic chamber for the rest of this test.
 - b. Reset EUT to place in online mode and establish radio link in LTE, measure conducted Tx power corresponding to LTE *P_{limit}* with Smart Transmit enabled and *Reserve_power_margin* set to 0 dB, callbox set to request maximum power.
2. Set *Reserve_power_margin* to actual (intended) value and reset power in EUT, with EUT setup for LTE + mmW call, perform the following steps:
 - a. Establish LTE (sub-6) and mmW NR connection with callbox.
 - b. As soon as the mmW connection is established, immediately request all-down bits on LTE link. Continue LTE (all-down bits) + mmW transmission for more than 100s duration to test predominantly PD exposure scenario (as SAR exposure is negligible from all-down bits in LTE).

FCC ID: A3LSMS908U	 PCTEST Proud to be part of 	PART 2 RF EXPOSURE EVALUATION REPORT		Approved by: Quality Manager
Document S/N: 1M2109090102-23.A3L (Rev1)	Test Dates: 10/11/2021 – 11/18/2021	DUT Type: Portable Handset	Page 22 of 64	

- c. After 120s, request LTE to go all-up bits, mmW transmission should gradually run out of RF exposure margin if LTE's $P_{limit} < P_{max}$ and seize mmW transmission (SAR only scenario); or mmW transmission should gradually reduce in Tx power and will sustain the connection if LTE's $P_{limit} > P_{max}$.
 - d. After 75s, request LTE to go all-down bits, mmW transmission should start getting back RF exposure margin and resume transmission again.
 - e. Record the conducted Tx power of LTE and radiated Tx power of mmW for the entire duration of this test of at least 300s.
3. Once the measurement is done, extract instantaneous Tx power versus time for both LTE and mmW links. Convert the conducted Tx power for LTE into 1gSAR or 10gSAR value using Eq. (2a) and P_{limit} measured in Step 1.b, and then divide by FCC limit of 1.6 W/kg for 1gSAR or 4.0 W/kg for 10gSAR to obtain instantaneous normalized 1gSAR or 10gSAR versus time. Perform 100s running average to determine normalized 100s-averaged 1gSAR or 10gSAR versus time.

NOTE: In Eq.(2a), instantaneous Tx power is converted into instantaneous 1gSAR or 10gSAR value by applying the measured worst-case 1gSAR or 10gSAR value at P_{limit} for the corresponding technology/band/antenna/DSI reported in Part 1 report.

4. Similarly, convert the radiated Tx power for mmW into 4cm²PD value using Eq. (2b) and the radiated Tx power limit (i.e., radiated Tx power at *input.power.limit*) measured in Step 1.a, then divide this by FCC 4cm²PD limit of 10W/m² to obtain instantaneous normalized 4cm²PD versus time. Perform 4s running average to determine normalized 4s-averaged 4cm²PD versus time.

NOTE: In Eq.(2b), instantaneous radiated Tx power is converted into instantaneous 4cm²PD by applying the worst-case 4cm²PD value measured at *input.power.limit* for the selected band/beam in Part 1 report.



5. Make one plot containing: (a) instantaneous conducted Tx power for LTE versus time, (b) computed 100s-averaged conducted Tx power for LTE versus time, (c) instantaneous radiated Tx power for mmW versus time, as measured in Step 2, (d) computed 4s-averaged radiated Tx power for mmW versus time, and (e) time-averaged conducted and radiated power limits for LTE and mmW radio using Eq. (5a) & (5b), respectively.
6. Make another plot containing: (a) computed normalized 100s-averaged 1gSAR or 10gSAR versus time determined in Step 3, (b) computed normalized 4s-averaged 4cm²PD versus time determined in Step 4, and (c) corresponding total normalized time-averaged RF exposure (sum of steps (6.a) and (6.b)) versus time.

The validation criteria are, at all times, the total normalized time-averaged RF exposure versus time determined in Step 6.c shall not exceed the normalized limit of 1.0 of FCC requirement (i.e., Eq. (2c)).

5.3.3 Change in antenna configuration (beam)

This test is to demonstrate the correct power control by Smart Transmit during changes in antenna configuration (beam). Since the *input.power.limit* varies with beam, the Eq. (2a), (2b) and (2c) in Section 3 are written as below for transmission scenario having change in beam,

$$1g_or_10gSAR(t) = \frac{conducted_Tx_power(t)}{conducted_Tx_power_P_{limit}} * 1g_or_10gSAR_P_{limit} \quad (8a)$$

FCC ID: A3LSMS908U	 PCTEST Proud to be part of 	PART 2 RF EXPOSURE EVALUATION REPORT		Approved by: Quality Manager
Document S/N: 1M2109090102-23.A3L (Rev1)	Test Dates: 10/11/2021 – 11/18/2021	DUT Type: Portable Handset	Page 23 of 64	

$$4cm^2PD_1(t) = \frac{radiated_Tx_power_1(t)}{radiated_Tx_power_input.power.limit_1} * 4cm^2PD_input.power.limit_1 \quad (8b)$$



$$4cm^2PD_2(t) = \frac{radiated_Tx_power_2(t)}{radiated_Tx_power_input.power.limit_2} * 4cm^2PD_input.power.limit_2 \quad (8c)$$

$$\frac{\frac{1}{T_{SAR}} \int_{t-T_{SAR}}^t 1g_or_10gSAR(t)dt}{FCC\ SAR\ limit} + \frac{\frac{1}{T_{PD}} \left[\int_{t-T_{PD}}^{t_1} 4cm^2PD_1(t)dt + \int_{t_1}^t 4cm^2PD_2(t)dt \right]}{FCC\ 4cm^2\ PD\ limit} \leq 1 \quad (8d)$$

where, *conducted_Tx_power(t)*, *conducted_Tx_power_P_{limit}*, and *1g_or_10gSAR_P_{limit}* correspond to the measured instantaneous conducted Tx power, measured conducted Tx power at *P_{limit}*, and measured *1gSAR* or *10gSAR* values at *P_{limit}* corresponding to LTE transmission. Similarly, *radiated_Tx_power_1(t)*, *radiated_Tx_power_input.power.limit_1*, and *4cm²PD_input.power.limit_1* correspond to the measured instantaneous radiated Tx power, radiated Tx power at *input.power.limit*, and *4cm²PD* value at *input.power.limit* of beam 1; *radiated_Tx_power_2(t)*, *radiated_Tx_power_input.power.limit_2*, and *4cm²PD_input.power.limit_2* correspond to the measured instantaneous radiated Tx power, radiated Tx power at *input.power.limit*, and *4cm²PD* value at *input.power.limit* of beam 2 corresponding to mmW transmission.

Test procedure:

1. Measure conducted Tx power corresponding to *P_{limit}* for LTE in selected band, and measure radiated Tx power corresponding to *input.power.limit* in desired mmW band/channel/beam by following below steps:
 - a. Measure radiated power corresponding to mmW *input.power.limit* by setting up the EUT's Tx power in desired band/channel at *input.power.limit* of beam 1 in FTM. Do not disturb the position of the EUT inside the anechoic chamber for the rest of this test. Repeat this Step 1.a for beam 2.
 - b. Reset EUT to place in online mode and establish radio link in LTE, measure conducted Tx power corresponding to LTE *P_{limit}* with Smart Transmit enabled and *Reserve_power_margin* set to 0 dB, callbox set to request maximum power.
2. Set *Reserve_power_margin* to actual (intended) value and reset power in EUT, With EUT setup for LTE + mmW connection, perform the following steps:
 - a. Establish LTE (sub-6) and mmW NR connection in beam 1. As soon as the mmW connection is established, immediately request all-down bits on LTE link with the callbox requesting EUT's Tx power to be at maximum mmW power.
 - b. After beam 1 continues transmission for at least 20s, request the EUT to change from beam 1 to beam 2, and continue transmitting with beam 2 for at least 20s.
 - c. Record the conducted Tx power of LTE and radiated Tx power of mmW for the entire duration of this test.
3. Once the measurement is done, extract instantaneous Tx power versus time for both LTE and mmW links. Convert the conducted Tx power for LTE into 1gSAR or 10gSAR value using the similar approach described in Step 3 of Section 5.3.2. Perform 100s running average to determine normalized 100s-averaged 1gSAR versus time.

FCC ID: A3LSMS908U	 PCTEST Proud to be part of 	PART 2 RF EXPOSURE EVALUATION REPORT		Approved by: Quality Manager
Document S/N: 1M2109090102-23.A3L (Rev1)	Test Dates: 10/11/2021 – 11/18/2021	DUT Type: Portable Handset	Page 24 of 64	

4. Similarly, convert the radiated Tx power for mmW NR into 4cm²PD value using Eq. (8b), (8c) and the radiated Tx power limits (i.e., radiated Tx power at *input.power.limit*) measured in Step 1.a for beam 1 and beam 2, respectively, and then divide the resulted PD values by FCC 4cm²PD limit of 10W/m² to obtain instantaneous normalized 4cm²PD versus time for beam 1 and beam 2. Perform 4s running average to determine normalized 4s-averaged 4cm²PD versus time.

NOTE: In Eq.(8b) and (8c), instantaneous radiated Tx power of beam 1 and beam 2 is converted into instantaneous 4cm²PD by applying the worst-case 4cm²PD value measured at the *input.power.limit* of beam 1 and beam 2 in Part 1 report, respectively.

5. Since the measured radiated powers for beam 1 and beam 2 in Step 1.a were performed at an arbitrary rotation of EUT in anechoic chamber, repeat Step 1.a of this procedure by rotating the EUT to determine maximum radiated power at *input.power.limit* in FTM mode for both beams separately. Re-scale the measured instantaneous radiated power in Step 2.c by the delta in radiated power measured in Step 5 and the radiated power measured in Step 1.a for plotting purposes in next Step. In other words, this step essentially converts measured instantaneous radiated power during the measurement in Step 2 into maximum instantaneous radiated power for both beams. Perform 4s running average to compute 4s-averaged radiated Tx power. Additionally, use these EIRP values measured at *input.power.limit* at respective peak locations to determine the EIRP limits (using Eq. (5b)) for both these beams.
6. Make one plot containing: (a) instantaneous conducted Tx power for LTE versus time, (b) computed 100s-averaged conducted Tx power for LTE versus time, (c) instantaneous radiated Tx power for mmW versus time, as obtained in Step 5, (d) computed 4s-averaged radiated Tx power for mmW versus time, as obtained in Step 5, and (e) time-averaged conducted and radiated power limits for LTE and mmW radio, respectively.
7. Make another plot containing: (a) computed normalized 100s-averaged 1gSAR versus time determined in Step 3, (b) computed normalized 4s-averaged 4cm²PD versus time determined in Step 4, and (c) corresponding total normalized time-averaged RF exposure (sum of steps (6.a) and (6.b)) versus time.



The validation criteria are, at all times, the total normalized time-averaged RF exposure versus time determined in Step 6.c shall not exceed the normalized limit of 1.0 of FCC requirement (i.e., (8d)).

5.4 Test procedure for switch between sub6 and mmW favor modes

This test is to demonstrate that Smart Transmit feature is independent of the nature of exposure (SAR vs. PD), accurately accounts for switching between sub6 NR favor mode (LTE +sub6 NR non-standalone call) and mmW favor mode (LTE + mmW NR non-standalone call), here LTE and sub6 NR are in different antenna groups.



Test Procedure:

1. Measure conducted Tx power corresponding to P_{limit} for LTE in selected band, and sub6 NR in selected band/antenna, and measure radiated Tx power corresponding to *input.power.limit* in desired mmW band/channel/beam by following below steps:
 - a. Measure conducted Tx power corresponding to P_{limit} for LTE with Smart Transmit enabled and Reserve_power_margin set to 0 dB. Establish device in call with the callbox for LTE in selected band/antenna and callbox set to request maximum power.
 - b. Measure conducted Tx power corresponding to sub6 NR P_{limit} with Smart Transmit enabled and Reserve_power_margin set to 0 dB. Establish LTE + sub6 NR call with callbox, request all down bits for LTE, and callbox set to request maximum power from sub6 NR.

FCC ID: A3LSMS908U	 PCTEST Proud to be part of 	PART 2 RF EXPOSURE EVALUATION REPORT		Approved by: Quality Manager
Document S/N: 1M2109090102-23.A3L (Rev1)	Test Dates: 10/11/2021 – 11/18/2021	DUT Type: Portable Handset	Page 25 of 64	

- c. Measure radiated power corresponding to *input.power.limit* by setting up the EUT's Tx power in desired band/channel/beam at *input.power.limit* in FTM. This test is performed in a calibrated anechoic chamber. Rotate the EUT to obtain maximum radiated Tx power, keep the EUT in this position and do not disturb the position of the EUT inside the anechoic chamber for the rest of this test.
2. Set *Reserve_power_margin* to actual (intended) value and enable Smart Transmit, With EUT setup for desired transmission powers and time durations in below order:
 - a. Establish LTE radio link with callbox in selected LTE band/antenna. Request EUT to transmit at 0 dBm for at least 100 seconds, followed by requesting EUT to transmit at LTE Plimit – 4dB for a time duration of 120 seconds. Measure and record conducted LTE Tx power versus time.
 - b. Add mmW NR link in selected mmW NR band/beam. Request EUT to transmit at maximum Tx power in mmW NR for a time duration of 30 seconds, while LTE is requested to transmit at LTE Plimit – 4dB. Measure and record radiated power of mmW NR versus time while continuing to measure conducted LTE Tx power versus time.
 - c. Handover (or drop link & immediately re-establish) from LTE + mmW NR to LTE + sub6 NR in selected sub6 NR band/antenna. Request EUT to transmit at maximum Tx power in sub6 NR for a time duration of 120 seconds, while LTE is requested to transmit at LTE Plimit – 4dB. Measure and record conducted power of sub6 NR versus time while continuing to measure conducted LTE Tx power versus time.
 - d. Handover (or drop link & immediately re-establish) from LTE + sub6 NR to LTE + mmW NR in selected mmW NR band/beam. Request EUT to transmit at maximum Tx power in mmW NR for a time duration of 120 seconds, while LTE is requested to transmit at LTE Plimit – 4dB. Measure and record radiated power of mmW NR versus time while continuing to measure conducted LTE Tx power versus time.
 3. Once the measurement is done, extract instantaneous Tx power versus time for LTE, sub6 NR and mmW NR links. Convert the conducted Tx power for LTE into 1gSAR value (see Eq. (4a)) using Step 1.b result, and then divide this by regulatory 1gSAR limit of 1.6W/kg to obtain instantaneous normalized 1gSAR versus time. Perform 100s running average to determine normalized 100s-averaged 1gSAR versus time.
 4. Similarly, convert the conducted Tx power for sub6 NR into instantaneous 1gSAR value versus time using Step 1.c result, obtain instantaneous normalized 1gSAR versus time and determine normalized 60s-averaged 1gSAR versus time.
 5. Similarly, convert the radiated Tx power for mmW into 4cm2PD value (see Eq. (4b)) using Step 1.a result, and then divide this by regulatory 4cm2PD limit of 10W/m2 to obtain instantaneous normalized 4cm2PD versus time. Perform 4s running average to determine normalized 4s-averaged 4cm2PD versus time.
 6. Make plot for LTE+FR2 containing: (a) computed normalized 100s-averaged 1gSAR versus time for LTE as determined in Step 3, (b) computed normalized 4s-averaged 4cm2PD versus time for mmW NR as determined in Step 5, and (c) corresponding total normalized time-averaged RF exposure (sum of steps (a) and (b)) versus time
 7. Make another plot for FR1+FR2 containing: (a) computed normalized 60s-averaged 1gSAR versus time for sub6 NR as determined in Step 4, (b) computed normalized 4s-averaged 4cm2PD versus time for mmW NR as determined in Step 5, and (c) corresponding total normalized time-averaged RF exposure (sum of steps (a) and (b)) versus time.

The validation criteria is, at all times, the total normalized time-averaged RF exposure versus time determined in Steps 6 and 7 shall not exceed the normalized limit of 1.0.

FCC ID: A3LSMS908U	 PCTEST Proud to be part of 	PART 2 RF EXPOSURE EVALUATION REPORT		Approved by: Quality Manager
Document S/N: 1M2109090102-23.A3L (Rev1)	Test Dates: 10/11/2021 – 11/18/2021	DUT Type: Portable Handset	Page 26 of 64	

6.1 Conducted Measurement Test setup

Legacy Test Setup

The Rohde & Schwarz CMW500 callbox was used in this test. The test setup schematic is shown in Figure 6-1a (Appendix B – Test Setup Photo 1 and 2) for measurements with a single antenna of DUT, and in Figure 6-1b (Appendix B – Test Setup Photo 3) for measurements involving antenna switch. For single antenna measurement, one port (RF1 COM) of the callbox is connected to the RF port of the DUT using a directional coupler. For technology/band switch measurement, one port (RF1 COM) of the callbox used for signaling two different technologies is connected to a combiner, which is in turn connected to a directional coupler. The other end of the directional coupler is connected to a splitter to connect to two RF ports of the DUT corresponding to the two antennas of interest. In the setups, power meter is used to tap the directional coupler for measuring the conducted output power of the DUT. For all legacy conducted tests, only RF1 COM port of the callbox is used to communicate with the DUT.

Note that for this EUT, antenna switch test is included within time-window switch test as the selected technology/band combinations for the time-window switch test are on two different antennas.

All the path losses from RF port of DUT to the callbox RF COM port and to the power meter are calibrated and automatically entered as offsets in the callbox and the power meter via test scripts on the PC used to control callbox and power meter.

Sub6 NR test setup:



The MT8000A callbox was used in this test. The test setup schematic is the same as the Legacy Test Setup shown in Figure 6-1a (Appendix B – Test Setup Photo 4). One port of the callbox is connected to the RF port of the DUT using a directional coupler. In the setup, the power meter is used to tap the directional coupler for measuring the conducted output power of the DUT.

All the path losses from RF port of DUT to the callbox RF COM port and to the power meter are calibrated and automatically entered as offsets in the callbox and the power meter via test scripts on the PC used to control callbox and power meter.

LTE+Sub6 NR test setup:

LTE conducted port and Sub6 NR conducted port are the same on this EUT, therefore, the LTE and Sub6 NR signals for power meter measurement are performed on separate paths as shown below in Figure 6-1c (Appendix B – Test Setup Photo 5).

All the path losses from RF port of DUT to the callbox RF COM port and to the power meter are calibrated and automatically entered as offsets in the callbox and the power meter via test scripts on the PC used to control callbox and power meter.

FCC ID: A3LSMS908U	 PCTEST Proud to be part of 	PART 2 RF EXPOSURE EVALUATION REPORT		Approved by: Quality Manager
Document S/N: 1M2109090102-23.A3L (Rev1)	Test Dates: 10/11/2021 – 11/18/2021	DUT Type: Portable Handset	Page 27 of 64	

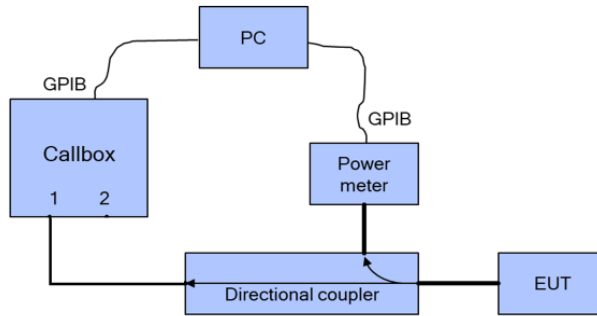

(a) Appendix B – Test Setup Photo 1, 2, and 4

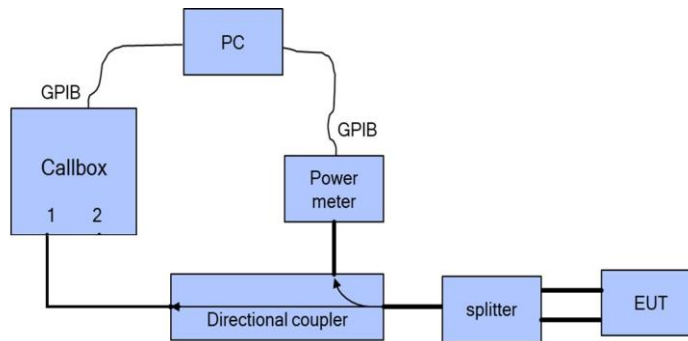

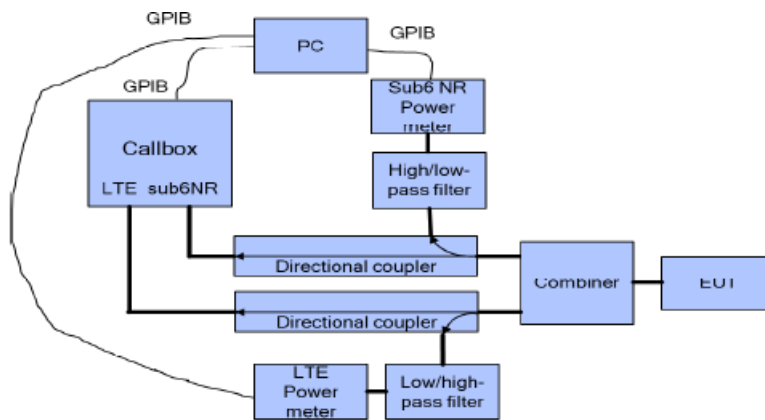

(b) Appendix B – Test Setup Photo 3



(c) Appendix B – Test Setup Photo 5

Figure 6-1
Conducted power measurement setup

FCC ID: A3LSMS908U	 PCTEST Proud to be part of 	PART 2 RF EXPOSURE EVALUATION REPORT		Approved by: Quality Manager
Document S/N: 1M2109090102-23.A3L (Rev1)	Test Dates: 10/11/2021 – 11/18/2021	DUT Type: Portable Handset		Page 28 of 64



Both the callbox and power meter are connected to the PC using GPIB cables. Two test scripts are custom made for automation, and the test duration set in the test scripts is 500 seconds.

For time-varying Tx power measurement, the PC runs the 1st test script to send GPIB commands to control the callbox's requested power versus time, while at the same time to record the conducted power measured at DUT RF port using the power meter. The commands sent to the callbox to request power are:

- 0dBm for 100 seconds
- test sequence 1 or test sequence 2 (defined in Section 4.1 and generated in Section 4.2.1), for 360 seconds
- stay at the last power level of test sequence 1 or test sequence 2 for the remaining time.

Power meter readings are periodically recorded every 100ms. A running average of this measured Tx power over 100 seconds is performed in the post-data processing to determine the 100s-time averaged power.

For call drop, technology/band/antenna switch, and DSI switch tests, after the call is established, the callbox is set to request the DUT's Tx power at 0dBm for 100 seconds while simultaneously starting the 2nd test script runs at the same time to start recording the Tx power measured at DUT RF port using the power meter. After the initial 100 seconds since starting the Tx power recording, the callbox is set to request maximum power from the DUT for the rest of the test. Note that the call drop/re-establish, or technology/band/antenna switch or DSI switch is manually performed when the Tx power of DUT is at $P_{reserve}$ level. See Section 4.3 for detailed test procedure of call drop test, technology/band/antenna switch test and DSI switch test.

FCC ID: A3LSMS908U	 PCTEST Proud to be part of 	PART 2 RF EXPOSURE EVALUATION REPORT		Approved by: Quality Manager
Document S/N: 1M2109090102-23.A3L (Rev1)	Test Dates: 10/11/2021 – 11/18/2021	DUT Type: Portable Handset	Page 29 of 64	

7.1 Radiated Power Measurement Test setup

The Keysight Technologies E7515B UXM callbox is used in this test. The schematic of the setup is shown in Figure 7-1. The UXM callbox has two RF radio heads to up/down convert IF to mmW frequencies, which in turn are connected to two horn antennas for V- and H-polarizations for downlink communication. In the uplink, a directional coupler is used in the path of one of the horn antennas to measure and record radiated power using a Rohde & Schwarz NRP50S power sensor. Note here that the isolation of the directional coupler may not be sufficient to attenuate the downlink signal from the callbox, which will result in high noise floor masking the recording of radiated power from EUT. In that case, either lower the downlink signal strength emanating from the RF radio heads of callbox or add an attenuator between callbox radio heads and directional coupler. Additionally, note that since the measurements performed in this validation are all relative, measurement of EUT's radiated power in one polarization is sufficient. The EUT is placed inside an anechoic chamber with V- and H-pol horn antennas to establish the radio link as shown in Figure 7-1. The callbox's LTE port is directly connected to the EUT's RF port via a directional coupler to measure the EUT's conducted Tx power using a Rohde & Schwarz NRP8S power sensor. Additionally, EUT is connected to the PC via USB connection for sending beam switch command. Care is taken to route the USB cable and RF cable (for LTE connection) away from the EUT's mmW antenna modules.

Setup in Figure 7-1 is used for the test scenario 1, 5 and 6 described in Section 3. The test procedures described in Section 5 are followed. The path losses from the EUT to both the power meters are calibrated and used as offset in the power meter.

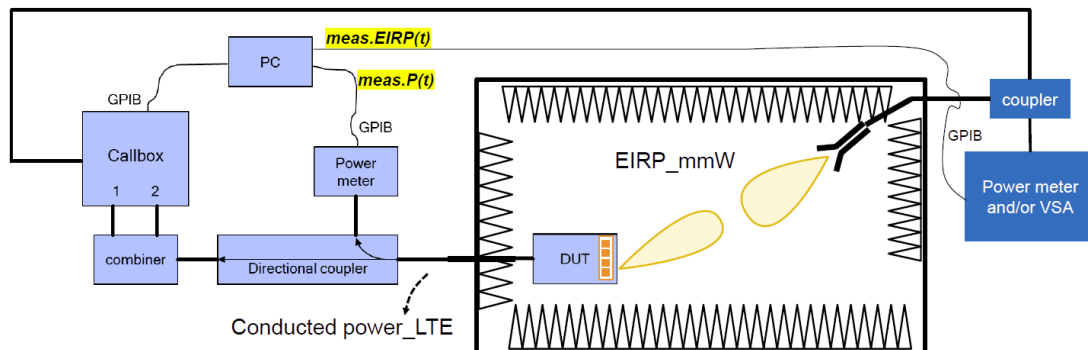





Figure 7-1
mmW NR radiated power measurement setup – Test Setup Photo 13

Both the callbox and power meters are connected to the PC using USB cables. Test scripts are custom made for automation of establishing LTE + mmW call, conducted Tx power recording for LTE and radiated Tx power recording for mmW. These tests are manually stopped after desired time duration. Test script is programmed to set LTE Tx power to all-down bits on the callbox immediately after the mmW link is established, and programmed to set toggle between all-up and all-down bits depending on the transmission scenario being evaluated. Similarly, test script is also programmed to send beam switch command manually to the EUT via USB connection. For all the tests, the callbox is set to request maximum Tx power in mmW NR radio from EUT all the time.

FCC ID: A3LSMS908U	 PCTEST Proud to be part of 	PART 2 RF EXPOSURE EVALUATION REPORT		Approved by: Quality Manager
Document S/N: 1M2109090102-23.A3L (Rev1)	Test Dates: 10/11/2021 – 11/18/2021	DUT Type: Portable Handset		Page 30 of 64

Setup in Figure 7-2 is used for the test scenario 9 described in Section 3. The test procedures described in Section 5 are followed. The path losses from the EUT to both the power meters are calibrated and used as offset in the power meter.

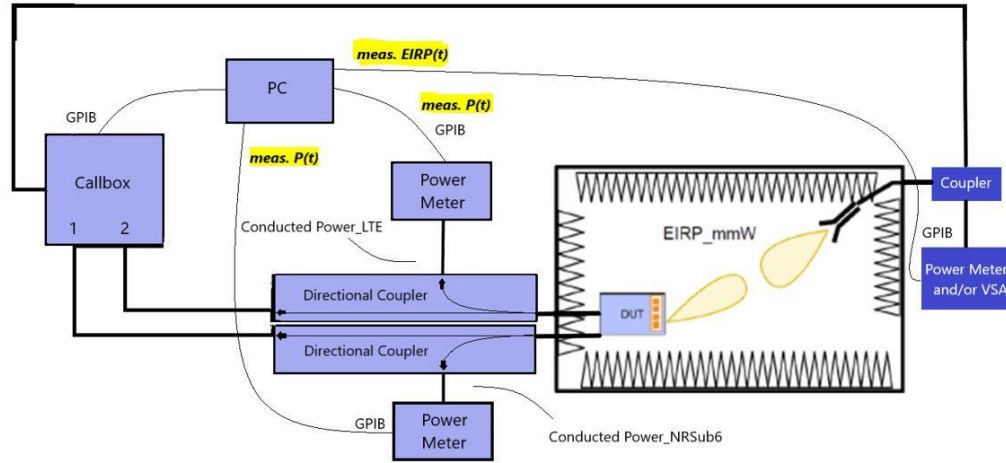

Figure 7-2

sub6 NR vs. mmW NR favor mode power measurement setup – Test Setup Photo 14

Both the callbox and power meters are connected to the PC using USB cables. Test scripts are custom made for automation of establishing LTE + mmW call, LTE + sub6 NR call, and sub6 NR + mmW call conducted Tx powers recording for LTE, sub6 NR and radiated Tx power recording for mmW. These tests are manually stopped after desired time duration. Test script is programmed to set LTE Tx power to all-down bits on the callbox immediately after the mmW link is established and programmed to set toggle between all-up and all-down bits depending on the transmission scenario being evaluated. Similarly, test script is also programmed to send beam switch command manually to the EUT via USB connection. For all the tests, the callbox is set to request maximum Tx power in mmW NR radio from EUT all the time.

Test configurations for this validation are detailed in Section 5.2. Test procedures are listed in Section 5.3.

FCC ID: A3LSMS908U	PCTEST Proud to be part of element	PART 2 RF EXPOSURE EVALUATION REPORT		Approved by: Quality Manager
Document S/N: 1M2109090102-23.A3L (Rev1)	Test Dates: 10/11/2021 – 11/18/2021	DUT Type: Portable Handset		Page 31 of 64

8 TEST CONFIGURATIONS (FREQ < 6 GHZ)



8.1 WWAN (sub-6) transmission

The P_{limit} values, corresponding to 1.0 W/kg (1gSAR) and 2.5 W/kg (10gSAR) of SAR_{design_target} , for technologies and bands supported by DUT are derived in Part 0 report and summarized in Table 8-1. Note all P_{limit} power levels entered in Table 8-1 correspond to average power levels after accounting for duty cycle in the case of TDD modulation schemes.

Table 8-1
 P_{limit} for supported technologies and bands (P_{limit} in EFS file)

Exposure Scenario			Body-Worn	Phablet Max	Phablet Reduced	Head	Hotspot	Earjack	Maximum Tune-Up Output Power*
Averaging Volume			1g	10g	10g	1g	1g	10g	
Spacing			15 mm	12, 8, 6, 0 mm	0 mm	0 mm	10 mm	0 mm	
DSI			0	0	1	2	3	4	
Technology/Band	Antenna	Antenna Group							Pmax
GSM 850	A	AG0	30.9		28.3	32.7	25.5	28.3	25.3
GSM 1900	A	AG0	24.9		22.7	34.5	18.5	22.7	21.6
UMTS 850	A	AG0	29.4		27.8	31.5	26.3	27.8	24.0
UMTS 1750	A	AG0	25.0		19.0	32.9	19.0	19.0	23.0
UMTS 1900	A	AG0	25.6		20.5	33.6	17.5	20.5	23.0
LTE Band 71	A	AG0	31.4		28.9	34.4	29.4	28.9	24.7
LTE Band 12	A	AG0	31.0		28.0	33.0	28.8	28.0	24.5
LTE Band 13	A	AG0	29.7		28.0	31.9	27.0	28.0	24.2
LTE Band 14	A	AG0	29.8		28.1	31.5	26.5	28.1	24.5
LTE Band 26 (Cell)	A	AG0	29.2		27.6	29.5	26.1	27.6	24.5
LTE Band 5 (Cell)	A	AG0	29.2		27.7	31.4	25.9	27.7	24.5
LTE Band 66/4 (AWS)	A	AG0	25.6		20.0	33.0	18.5	20.0	23.8
LTE Band 25/2 (PCS)	A	AG0	24.6		20.5	33.5	17.5	20.5	23.5
LTE Band 30	A	AG0	26.3		21.5	36.8	18.5	21.5	22.5
LTE Band 7	B	AG0	26.3		20.0	36.5	20.0	20.0	23.0
LTE Band 41/38 (PC3)	B	AG0	27.9		20.0	36.7	20.0	20.0	22.0
LTE Band 41 (PC2)	B	AG0	27.9		20.0	36.7	20.0	20.0	22.9
LTE Band 48	F	AG1	17.0		17.0	17.0	17.0	17.0	21.0
NR Band n71	A	AG0	26.4		27.3	32.7	28.4	27.3	24.8
NR Band n12	A	AG0	30.3		27.4	32.1	28.8	27.4	24.7
NR Band n5 (Cell)	A	AG0	28.8		26.4	30.3	25.6	26.4	24.8
NR Band n66 (AWS)	A	AG0	25.2		20.0	32.8	18.5	20.0	23.9
NR Band n66 (AWS)	J	AG1	19.0		19.0	18.0	19.0	19.0	23.5
NR Band n25/2 (PCS)	A	AG0	26.0		20.5	32.4	17.5	20.5	23.5
NR Band n25/2 (PCS)	J	AG1	19.0		19.0	18.0	19.0	19.0	23.5
NR Band n30	A	AG0	25.5		21.5	36.9	18.5	21.5	22.5
NR Band n30	J	AG1	18.0		18.0	18.0	18.0	18.0	22.0
NR Band n7	B	AG0	26.9		20.0	35.8	20.0	20.0	23.0
NR Band n41 SRS 1 (PC3)n38	J	AG1	19.0		19.0	18.0	19.0	19.0	24.0
NR Band n41 SRS 1 (PC2)	J	AG1	19.0		19.0	18.0	19.0	19.0	26.0
NR Band n41 SRS 2 (PC3)	D	AG0	15.5		15.5	15.5	15.5	15.5	18.5
NR Band n41 SRS 2 (PC2)	D	AG0	15.5		15.5	15.5	15.5	15.5	20.5
NR Band n41 SRS 3 (PC3)	E	AG1	14.0		14.0	14.0	14.0	14.0	17.8
NR Band n41 SRS 3 (PC2)	E	AG1	14.0		14.0	14.0	14.0	14.0	19.8
NR Band n41 SRS 4 (PC3)	B	AG0	18.0		18.0	18.0	18.0	18.0	20.0
NR Band n41 SRS 4 (PC2)	B	AG0	18.0		18.0	18.0	18.0	18.0	22.0
NR Band n77 DoD SRS 1 (PC3)	F	AG1	17.0		17.0	17.0	17.0	17.0	24.0
NR Band n77 DoD SRS 1 (PC2)	F	AG1	17.0		17.0	17.0	17.0	17.0	26.0
NR Band n77 DoD SRS 2 (PC3)	I	AG1	17.0		17.0	17.0	17.0	17.0	24.0
NR Band n77 DoD SRS 2 (PC2)	I	AG1	17.0		17.0	17.0	17.0	17.0	26.0
NR Band n77 DoD SRS 3 (PC3)	D	AG0	10.5		10.5	10.5	10.5	10.5	17.5
NR Band n77 DoD SRS 3 (PC2)	D	AG0	10.5		10.5	10.5	10.5	10.5	19.5
NR Band n77 DoD SRS 4 (PC3)	C	AG0	11.0		11.0	11.0	11.0	11.0	16.5
NR Band n77 DoD SRS 4 (PC2)	C	AG0	11.0		11.0	11.0	11.0	11.0	18.5
NR Band n77 SRS 1 (PC3)	F	AG1	17.0		17.0	17.0	17.0	17.0	24.0
NR Band n77 SRS 1 (PC2)	F	AG1	17.0		17.0	17.0	17.0	17.0	26.0
NR Band n77 SRS 2 (PC3)	I	AG1	17.0		17.0	17.0	17.0	17.0	24.0
NR Band n77 SRS 2 (PC2)	I	AG1	17.0		17.0	17.0	17.0	17.0	26.0
NR Band n77 SRS 3 (PC3)	D	AG0	10.5		10.5	10.5	10.5	10.5	17.5
NR Band n77 SRS 3 (PC2)	D	AG0	10.5		10.5	10.5	10.5	10.5	19.5
NR Band n77 SRS 4 (PC3)	C	AG0	11.0		11.0	11.0	11.0	11.0	16.5
NR Band n77 SRS 4 (PC2)	C	AG0	11.0		11.0	11.0	11.0	11.0	18.5

Maximum tune up target power, P_{max} , is configured in NV settings in DUT to limit maximum transmitting power. This power is converted into peak power in NV settings for TDD schemes. The DUT maximum allowed output power is equal to $P_{max} + 1$ dB device uncertainty.

FCC ID: A3LSMS908U	 PCTEST Proud to be part of 	PART 2 RF EXPOSURE EVALUATION REPORT		Approved by: Quality Manager
Document S/N: 1M2109090102-23.A3L (Rev1)	Test Dates: 10/11/2021 – 11/18/2021	DUT Type: Portable Handset	Page 32 of 64	

Based on selection criteria described in Section 4.2.1, the selected technologies/bands for testing time-varying test sequences are highlighted in yellow in Table 8-1. Per the manufacturer, the *Reserve_power_margin* (dB) is set to 3dB in EFS and is used in Part 2 test.

The radio configurations used in Part 2 test for selected technologies, bands, DSIs and antennas are listed in Table 8-2. The corresponding worst-case radio configuration 1gSAR values for selected technology/band/DSI are extracted from Part 1 report and are listed in the last column of Table 8-2.

Based on equations (1a), (2a), (3a) and (4a), it is clear that Part 2 testing outcome is normalized quantity, which implies that it can be applied to any radio configuration within a selected technology/band/DSI. Thus, as long as applying the worst-case SAR obtained from the worst radio configuration in Part 1 testing to calculate time-varying SAR exposure in equations (1a), (2a), (3a) and (4a), the accuracy in compliance demonstration remains the same. Therefore, there may be some differences between the radio configuration selected for Part 2 testing and the radio configuration associated with worst-case SAR obtained in the Part 1 evaluation.



Table 8-2
Radio configurations selected for Part 2 test

Test Case #	Test Scenario	Tech	Band	Antenna	DSI	Channel	Frequency [MHz]	RB/RB Offset/Bandwidth (MHz)	Mode	SAR Exposure Scenario	Part 1 Worst Case Measured SAR at Plimit (W/kg)
1	Test Sequence 1	GSM	1900	A	3	661	1880	-	GPRS 4 Tx Slots	Bottom Edge, 10mm	0.793
	Test Sequence 2					661	1880	-	GPRS 4 Tx Slots		
2	Test Sequence 1	WCDMA	4	A	3	1412	1732	-	RMC	Bottom Edge, 10mm	1.030
	Test Sequence 2					1412	1732	-	RMC		
3	Test Sequence 1	LTE	66	A	3	132322	1745	1/50/20 MHz BW	QPSK	Bottom Edge, 10mm	0.848
	Test Sequence 2					132322	1745	1/50/20 MHz BW	QPSK		
4	Test Sequence 1	NR	n25	A	3	376500	1882.5	1/1/40 MHz BW	DFT-S-OFDM, QPSK	Bottom Edge, 10mm	0.846
	Test Sequence 2					376500	1882.5	1/1/40 MHz BW	DFT-S-OFDM, QPSK		
5	Call Drop	LTE	48	F	3	56207	3646.7	1/50/20 MHz BW	QPSK	Left Edge, 10mm	0.485
6	Tech/Band Switch	LTE	30	A	1	27710	2310	1/25/10 MHz BW	QPSK	Back Side, 0mm	2.040*
		WCDMA	4	A	1	1412	1732	-	RMC	Bottom Edge, 0mm	2.680*
7	Time Window/Antenna Switch	NR	n41/SA	J	3	518598	2593	1/1/100 MHz BW	DFT-S-OFDM, QPSK	Top Edge, 10mm	0.338
			n77/SA	F	3	650000	3750	1/1/100 MHz BW	DFT-S-OFDM, QPSK	Left Edge, 10mm	0.387
8	DSI Switch	LTE	30	A	1	27710	2310	1/25/10 MHz BW	QPSK	Back Side, 0mm	2.040*
					3	27710	2310	1/25/10 MHz BW	QPSK	Bottom Edge, 10mm	0.810
9	SAR1 vs SAR2	LTE	5	A	3	20525	836.5	1/0/10 MHz BW	QPSK	Back Side, 10mm	0.634
		NR	n66/NSA	A	3	349000	1745	1/1/40 MHz BW	DFT-S-OFDM, QPSK	Bottom Edge, 10mm	0.829

*Indicates 10g SAR

Table 8-3
DSI and Corresponding Exposure Scenarios

Scenario	Description	SAR Test Cases
Head (DSI = 2)	<ul style="list-style-type: none"> Device positioned next to head Receiver Active 	Head SAR per KDB Publication 648474 D04
Hotspot mode (DSI = 3)	<ul style="list-style-type: none"> Device transmits in hotspot mode near body Hotspot Mode Active 	Hotspot SAR per KDB Publication 941225 D06
Phablet Grip (DSI=1 or 4)	<ul style="list-style-type: none"> Device is held with hand and grip sensor is triggered Grip sensor triggered or earjack is active 	Phablet SAR per KDB Publication 648474 D04 & KDB Publication 616217 D04
Phablet (DSI = 0)	<ul style="list-style-type: none"> Device is held with hand and grip sensor is not triggered Distance grip sensor not triggered 	Phablet SAR per KDB Publication 648474 D04 & KDB Publication 616217 D04
Body-worn (DSI = 0)	<ul style="list-style-type: none"> Device being used with a body-worn accessory 	Body-worn SAR per KDB Publication 648474 D04



FCC ID: A3LSMS908U	 PART 2 RF EXPOSURE EVALUATION REPORT 	Approved by: Quality Manager
Document S/N: 1M2109090102-23.A3L (Rev1)	Test Dates: 10/11/2021 – 11/18/2021	DUT Type: Portable Handset
		Page 33 of 64

Based on the selection criteria described in Section 4.2, the radio configurations for the Tx varying transmission test cases listed in Section 3 are:

1. Technologies and bands for time-varying Tx power transmission: The test case 1~4 listed in Table 8-2 are selected to test with the test sequences defined in Section 4.1 in both time-varying conducted power measurement and time-varying SAR measurement.
2. Technology and band for change in call test: LTE Band 48, having the lowest P_{limit} among all technologies and bands (test case 5 in Table 8-2), is selected for performing the call drop test in conducted power setup.
3. Technologies and bands for change in technology/band test: Following the guidelines in Section 4.2.3, test case 6 in Table 8-2 is selected for handover test from a technology/band within one technology group (LTE Band 30, DSI=1, antenna A), to a technology/band in the same DSI within another technology group (WCDMA Band 4, DSI=1, antenna A) in conducted power setup.
4. Technologies and bands for change in time-window/antenna: Based on selection criteria in Section 4.2.6, for a given DSI=3, test case 7 in Table 8-2 is selected for time window switch between 60s window (NR n41 SA, Antenna J) and 100s window (NR n77 SA, Antenna F) in conducted power setup.
5. Technologies and bands for change in DSI: Based on selection criteria in Section 4.2.5, for a given technology and band, test case 8 in Table 8-2 is selected for DSI switch test by establishing a call in LTE Band 30 in DSI=1, and then handing over to DSI= 3 exposure scenario in conducted power setup.
6. Technologies and bands for switch in SAR exposure: Based on selection criteria in Section 4.2.7 Scenario 1, test case 9 in Table 8-2 is selected for SAR exposure switching test in one of the supported simultaneous WWAN transmission scenario, i.e., LTE + Sub6 NR active in the same 100s time window, in conducted power setup. Since this device supports LTE+mmW NR, test for Section 4.2.7 Scenario 2 for RF exposure switch is covered in Sections 11.1 and 11.2 between LTE (100s window) and mmW NR (4s window).

Note: All switching and EN-DC test cases (#6 - #9) were done with modes/bands within the same antenna group.

Note: This device supports inter-band NR ULCA operations with component carriers from different antenna groups. None of the supported NR CA configurations operate within the same antenna group. Therefore, SAR exposure switch testing for inter-band ULCA is not needed to validate Smart Transmit operations.

FCC ID: A3LSMS908U	 PCTEST Proud to be part of 	PART 2 RF EXPOSURE EVALUATION REPORT		Approved by: Quality Manager
Document S/N: 1M2109090102-23.A3L (Rev1)	Test Dates: 10/11/2021 – 11/18/2021	DUT Type: Portable Handset	Page 34 of 64	

8.2 P_{limit} and P_{max} measurement results

The measured P_{limit} for all the selected radio configurations given in Table 8-2 are listed in below Table 8-4. P_{max} was also measured for radio configurations selected for testing time-varying Tx power transmission scenarios in order to generate test sequences following the test procedures in Section 4.1.

Table 8-4
Measured P_{limit} and P_{max} of selected radio configurations

Test Case #	Test Scenario	Tech	Band	Antenna	DSI	Channel	Frequency [MHz]	RB/RB Offset/Bandwidth (MHz)	Mode	SAR Exposure Scenario	EFS P _{limit} [dBm]	Tune-up P _{max} [dBm]	Measured P _{limit} [dBm]	Measured P _{max} [dBm]
1	Test Sequence 1	GSM	1900	A	3	661	1880	-	GPRS 4 Tx Slots	Hotspot	18.5	20.8	17.58	19.98
	661					1880	-	GPRS 4 Tx Slots	18.5		20.8	17.58	19.98	
2	Test Sequence 1	WCDMA	4	A	3	1412	1732	-	RMC	Hotspot	19.0	23.0	19.68	23.67
	1412					1732	-	RMC	19.0		23.0	19.68	23.67	
3	Test Sequence 1	LTE	66	A	3	132322	1745	1/50/20 MHz BW	QPSK	Hotspot	18.5	23.8	19.00	24.01
	132322					1745	1/50/20 MHz BW	QPSK	18.5		23.8	19.00	24.01	
4	Test Sequence 1	NR	n25	A	3	376500	1882.5	1/1/40 MHz BW	DFT-S-OFDM, QPSK	Hotspot	17.5	23.5	18.09	24.05
	376500					1882.5	1/1/40 MHz BW	DFT-S-OFDM, QPSK	17.5		23.5	18.09	24.05	
5	Call Drop	LTE	48	F	3	56207	3646.7	1/50/20 MHz BW	QPSK	Hotspot	17.0	21.0	16.51	20.59
	27710					2310	1/25/10 MHz BW	QPSK	21.5		22.5	22.07	23.15	
6	Tech/Band Switch	WCDMA	4	A	1	1412	1732	-	RMC	Grip	19.0	23.0	19.51	22.99
	518598					2593	1/1/100 MHz BW	DFT-S-OFDM, QPSK	19.0		24.0	19.71	22.31	
7	Time Window/Antenna Switch	NR	n41/SA	J	3	650000	3750	1/1/100 MHz BW	DFT-S-OFDM, QPSK	Hotspot	17.0	24.0	17.65	21.88
	n77/SA		F	3	27710	2310	1/25/10 MHz BW	QPSK	21.5		22.5	22.07	23.15	
8	DSI Switch	LTE	30	A	3	27710	2310	1/25/10 MHz BW	QPSK	Grip	21.5	22.5	22.07	23.15
	27710					2310	1/25/10 MHz BW	QPSK	18.5		22.5	19.01	23.15	
9	SAR1 vs SAR2	LTE	5	A	3	20525	836.5	1/0/10 MHz BW	QPSK	Hotspot	25.9	24.5	24.23	24.23
	n66/NSA	A	3	349000	1745	1/1/40 MHz BW	DFT-S-OFDM, QPSK	Hotspot	18.5	23.9	18.89	24.16		

Note: The device uncertainty of P_{max} is +/- 1 dB as provided by manufacturer



Note: NR TDD P_{max} and P_{lim} are measured at 72% duty cycle

Note: The above P_{max} value for GSM1900 is for 4 Tx Slots

8.3 EFS v17 Verification

Per Qualcomm's 80-w2112-5 document, embedded file system (EFS) version 17 products are required to be verified for Smart Tx generation for relevant MCC settings. It was confirmed that this DUT contains embedded file system (EFS) version 17 configured for Smart Tx second generation (GEN2) for Sub6 and mmWave with MCC settings with MCC settings for the US market.

EFS v17 Generation	MCC
GEN2_Sub6_mmWave	310

FCC ID: A3LSMS908U	 PCTEST Proud to be part of 	PART 2 RF EXPOSURE EVALUATION REPORT		Approved by: Quality Manager
Document S/N: 1M2109090102-23.A3L (Rev1)	Test Dates: 10/11/2021 – 11/18/2021	DUT Type: Portable Handset	Page 35 of 64	

9.1 Time-varying Tx Power Case

The measurement setup is shown in Figure 6-1. The purpose of the time-varying Tx power measurement is to demonstrate the effectiveness of power limiting enforcement and that the time-averaged Tx power when represented in time-averaged 1gSAR or 10gSAR values does not exceed FCC limit as shown in Eq. (1a) and (1b), rewritten below:

$$1g_or_10gSAR(t) = \frac{conducted_Tx_power(t)}{conducted_Tx_power_P_{limit}} * 1g_or_10gSAR_P_{limit} \quad (1a)$$



$$\frac{\frac{1}{T_{SAR}} \int_{t-T_{SAR}}^t 1g_or_10gSAR(t) dt}{FCC\ SAR\ limit} \leq 1 \quad (1b)$$

where, $conducted_Tx_power(t)$, $conducted_Tx_power_P_{limit}$, and $1g_or_10gSAR_P_{limit}$ correspond to the measured instantaneous conducted Tx power, measured conducted Tx power at P_{limit} , and measured 1gSAR and 10gSAR values at P_{limit} reported in Part 1 test (listed in Table 8-2 of this report as well).

Following the test procedure in Section 4.3, the conducted Tx power measurement for all selected configurations are reported in this section. In all the conducted Tx power plots, the green curve represents time-averaged power and red line represents the conducted power limit that corresponds to FCC limit of 1.6 W/kg for 1gSAR or 4.0 W/kg for 10gSAR.

Similarly, in all the 1g or 10gSAR plots (when converted using Eq. (1a)), the green curve represents the 100s/60s-time averaged 1gSAR or 10gSAR value calculated based on instantaneous 1gSAR or 10gSAR; and the red line limit represents the FCC limit of 1.6 W/kg for 1gSAR or 4.0 W/kg for 10gSAR.

Time-varying Tx power measurements were conducted on test cases #1 ~ #4 in Table 8-2, by generating test sequence 1 and test sequence 2 given in APPENDIX C: using measured P_{limit} and measured P_{max} (last two columns of Table 8-4) for each of these test cases. Measurement results for test cases #1 ~ #4 are given in Sections 9.1.1-9.1.4.

FCC ID: A3LSMS908U	 PCTEST Proud to be part of 	PART 2 RF EXPOSURE EVALUATION REPORT		Approved by: Quality Manager
Document S/N: 1M2109090102-23.A3L (Rev1)	Test Dates: 10/11/2021 – 11/18/2021	DUT Type: Portable Handset		Page 36 of 64

9.1.1

GSM/GPRS/EDGE 1900

Test result for test sequence 1:

Time-averaged conducted Tx power is converted/calculated into time-averaged 1gSAR using Equation (1a) and plotted below to demonstrate that the time-averaged 1gSAR versus time does not exceed the FCC limit of 1.6 W/kg for 1gSAR:

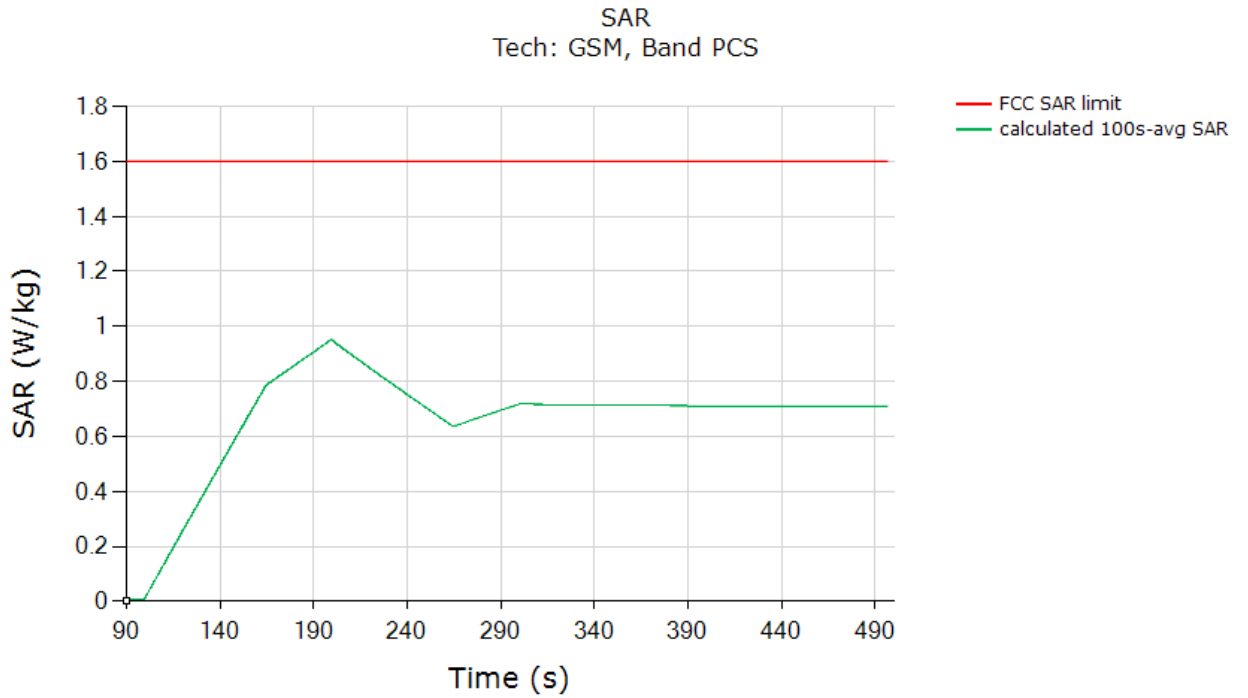

	(W/kg)
FCC 1gSAR limit	1.6
Max 100s-time averaged 1gSAR (green curve)	0.952
Validated: Max time averaged SAR (green curve) is within 1 dB device uncertainty of measured SAR at P_{limit} (last column in Table 8-2).	

FCC ID: A3LSMS908U	PCTEST Proud to be part of element	PART 2 RF EXPOSURE EVALUATION REPORT		Approved by: Quality Manager
Document S/N: 1M2109090102-23.A3L (Rev1)	Test Dates: 10/11/2021 – 11/18/2021	DUT Type: Portable Handset	Page 37 of 64	

Test result for test sequence 2:

Time-averaged conducted Tx power is converted/calculated into time-averaged 1gSAR using Equation (1a) and plotted below to demonstrate that the time-averaged 1gSAR versus time does not exceed the FCC limit of 1.6 W/kg for 1gSAR:

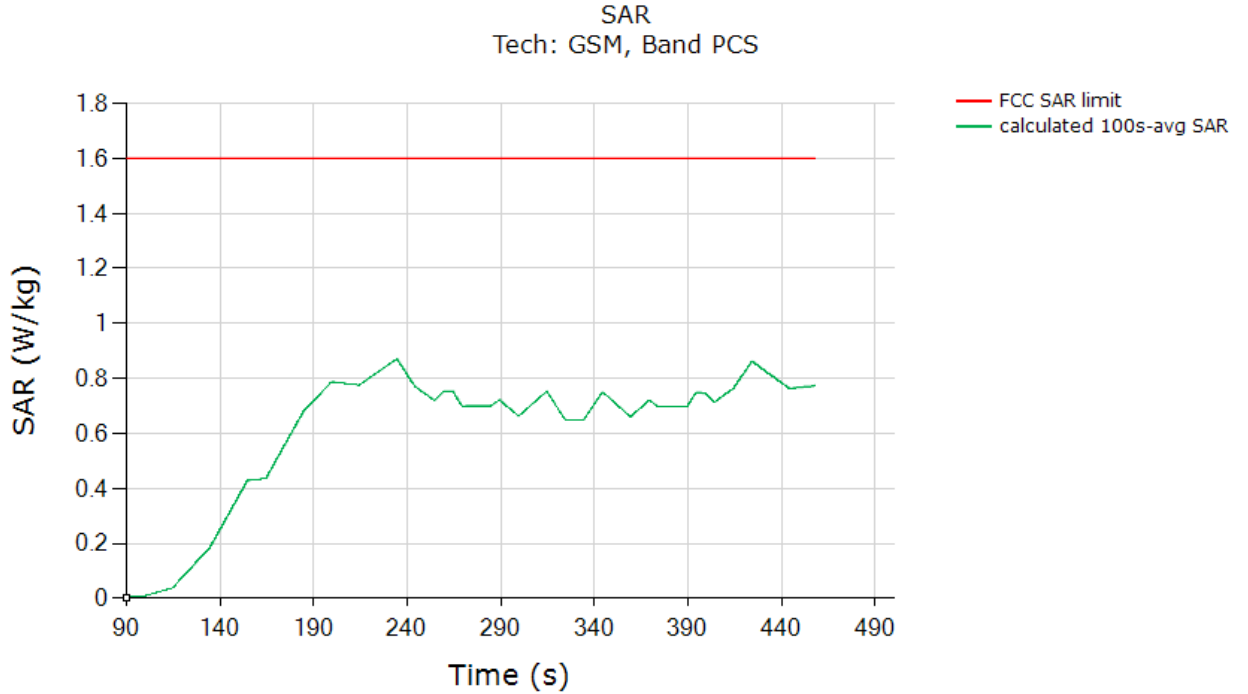

	(W/kg)
FCC 1gSAR limit	1.6
Max 100s-time averaged 1gSAR (green curve)	0.870
Validated: Max time averaged SAR (green curve) is within 1 dB device uncertainty of measured SAR at P_{limit} (last column in Table 8-2).	

FCC ID: A3LSMS908U	PCTEST Proud to be part of element	PART 2 RF EXPOSURE EVALUATION REPORT		Approved by: Quality Manager
Document S/N: 1M2109090102-23.A3L (Rev1)	Test Dates: 10/11/2021 – 11/18/2021	DUT Type: Portable Handset	Page 38 of 64	

9.1.2 WCDMA Band 4

Test result for test sequence 1:

Time-averaged conducted Tx power is converted/calculated into time-averaged 1gSAR using Equation (1a) and plotted below to demonstrate that the time-averaged 1gSAR versus time does not exceed the FCC limit of 1.6 W/kg for 1gSAR:

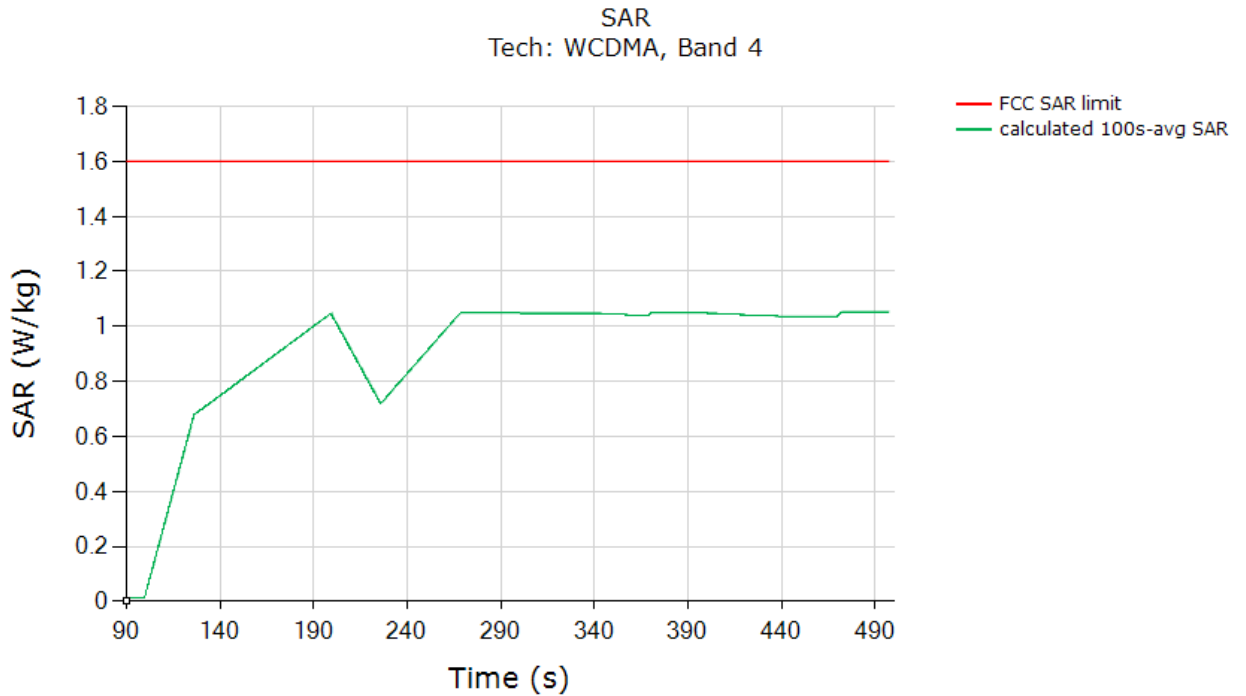

	(W/kg)
FCC 1gSAR limit	1.6
Max 100s-time averaged 1gSAR (green curve)	1.051
Validated: Max time averaged SAR (green curve) is within 1 dB device uncertainty of measured SAR at P_{limit} (last column in Table 8-2).	

FCC ID: A3LSMS908U	PCTEST Proud to be part of element	PART 2 RF EXPOSURE EVALUATION REPORT		Approved by: Quality Manager
Document S/N: 1M2109090102-23.A3L (Rev1)	Test Dates: 10/11/2021 – 11/18/2021	DUT Type: Portable Handset	Page 39 of 64	

Test result for test sequence 2:

Time-averaged conducted Tx power is converted/calculated into time-averaged 1gSAR using Equation (1a) and plotted below to demonstrate that the time-averaged 1gSAR versus time does not exceed the FCC limit of 1.6 W/kg for 1gSAR:

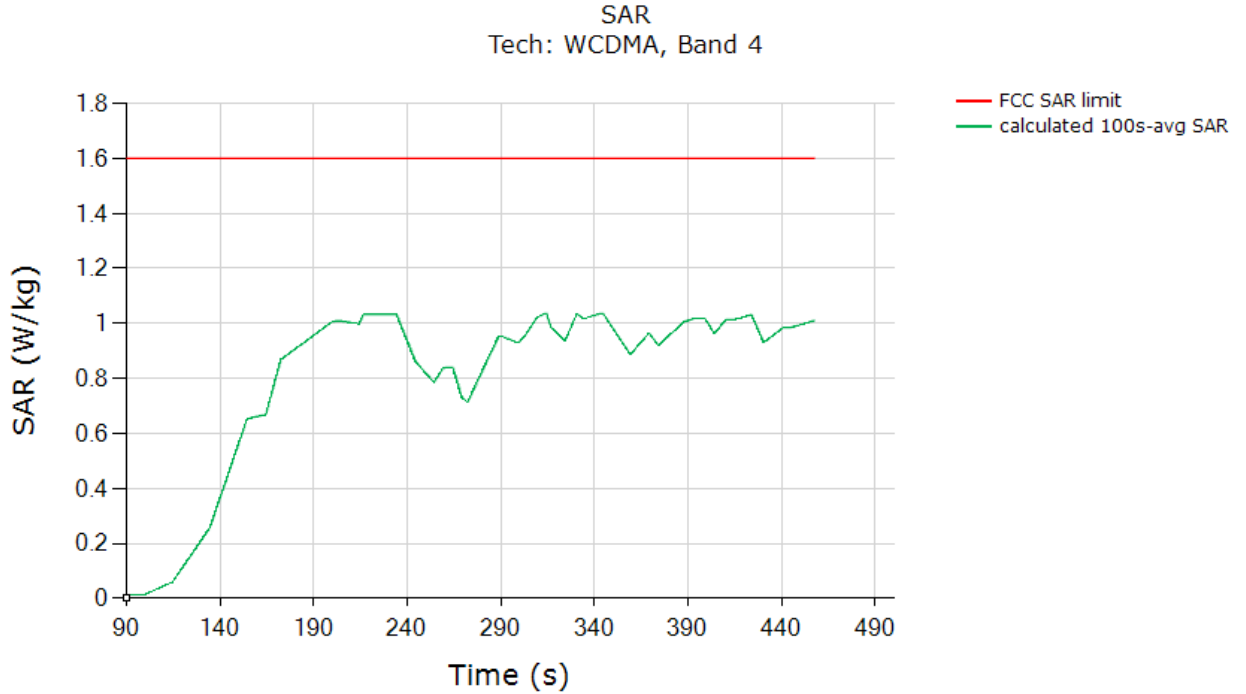

	(W/kg)
FCC 1gSAR limit	1.6
Max 100s-time averaged 1gSAR (green curve)	1.036
Validated: Max time averaged SAR (green curve) is within 1 dB device uncertainty of measured SAR at P_{limit} (last column in Table 8-2).	

FCC ID: A3LSMS908U	PCTEST Proud to be part of element	PART 2 RF EXPOSURE EVALUATION REPORT		Approved by: Quality Manager
Document S/N: 1M2109090102-23.A3L (Rev1)	Test Dates: 10/11/2021 – 11/18/2021	DUT Type: Portable Handset		Page 40 of 64

9.1.3 LTE Band 66

Test result for test sequence 1:

Time-averaged conducted Tx power is converted/calculated into time-averaged 1gSAR using Equation (1a) and plotted below to demonstrate that the time-averaged 1gSAR versus time does not exceed the FCC limit of 1.6 W/kg for 1gSAR:

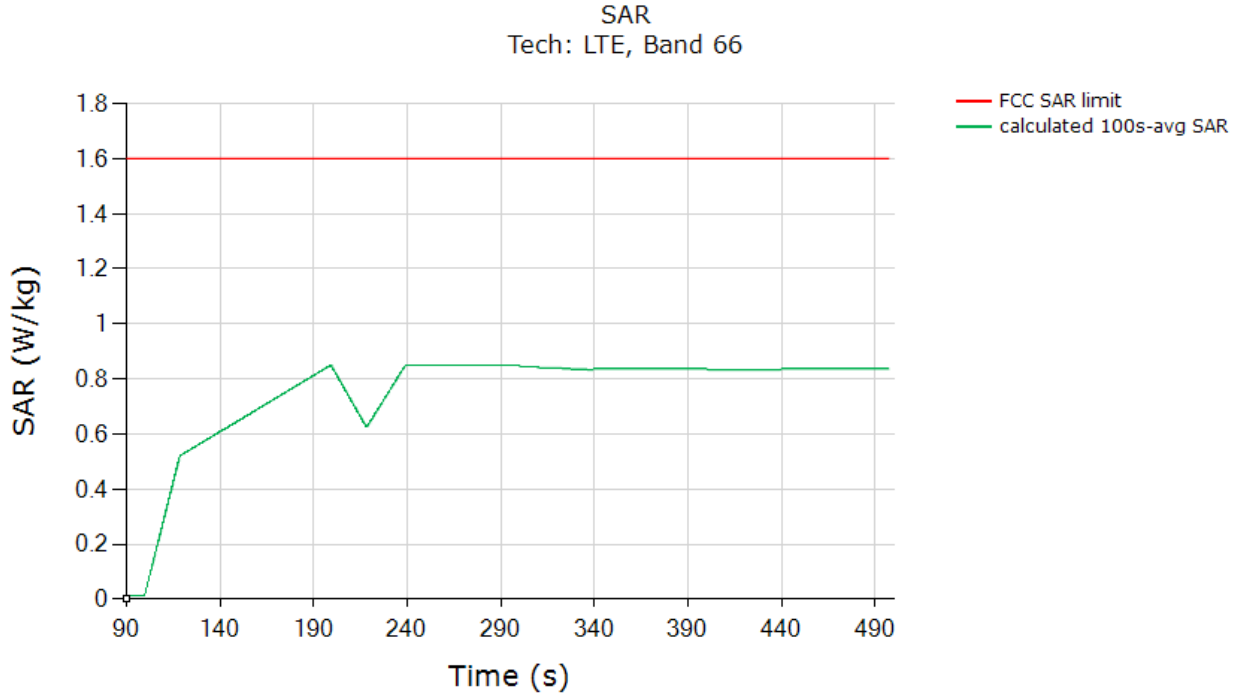

	(W/kg)
FCC 1gSAR limit	1.6
Max 100s-time averaged 1gSAR (green curve)	0.851
Validated: Max time averaged SAR (green curve) is within 1 dB device uncertainty of measured SAR at P_{limit} (last column in Table 8-2).	

FCC ID: A3LSMS908U	PCTEST Proud to be part of element	PART 2 RF EXPOSURE EVALUATION REPORT		Approved by: Quality Manager
Document S/N: 1M2109090102-23.A3L (Rev1)	Test Dates: 10/11/2021 – 11/18/2021	DUT Type: Portable Handset	Page 41 of 64	

Test result for test sequence 2:

Time-averaged conducted Tx power is converted/calculated into time-averaged 1gSAR using Equation (1a) and plotted below to demonstrate that the time-averaged 1gSAR versus time does not exceed the FCC limit of 1.6 W/kg for 1gSAR:

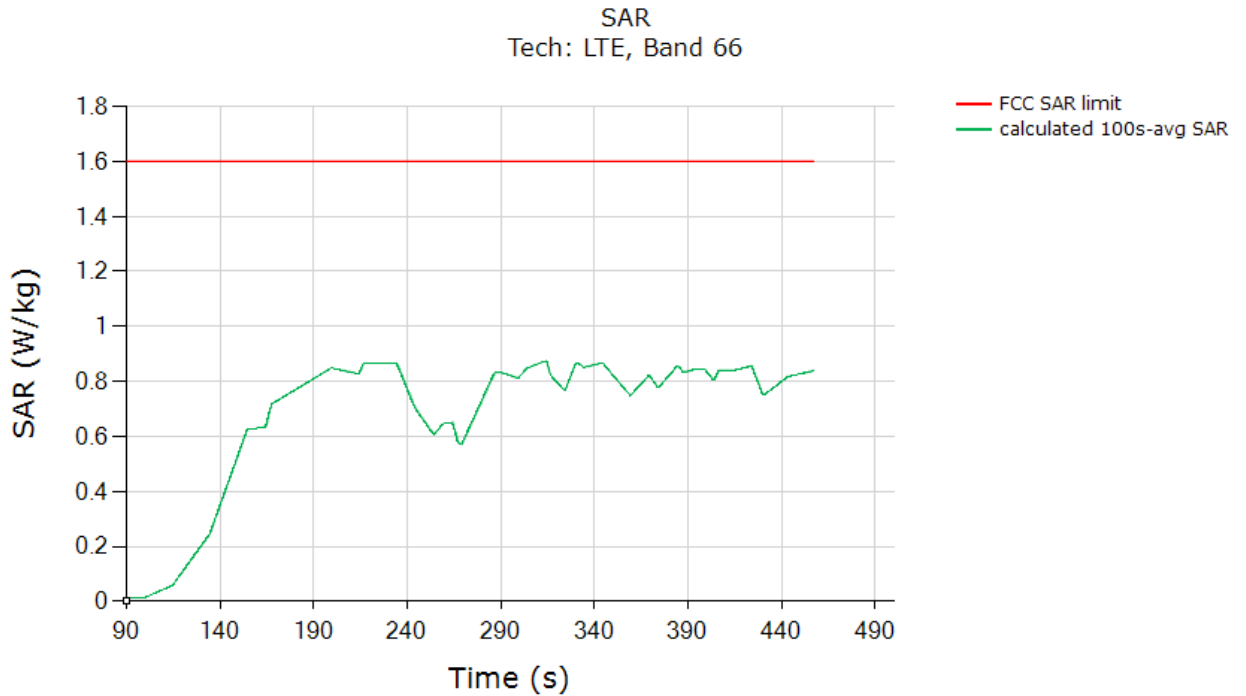

	(W/kg)
FCC 1gSAR limit	1.6
Max 100s-time averaged 1gSAR (green curve)	0.874
Validated: Max time averaged SAR (green curve) is within 1 dB device uncertainty of measured SAR at P_{limit} (last column in Table 8-2).	

FCC ID: A3LSMS908U	PCTEST Proud to be part of element	PART 2 RF EXPOSURE EVALUATION REPORT		Approved by: Quality Manager
Document S/N: 1M2109090102-23.A3L (Rev1)	Test Dates: 10/11/2021 – 11/18/2021	DUT Type: Portable Handset		Page 42 of 64

9.1.4

NR n25

Test result for test sequence 1:

Time-averaged conducted Tx power is converted/calculated into time-averaged 1gSAR using Equation (1a) and plotted below to demonstrate that the time-averaged 1gSAR versus time does not exceed the FCC limit of 1.6 W/kg for 1gSAR:

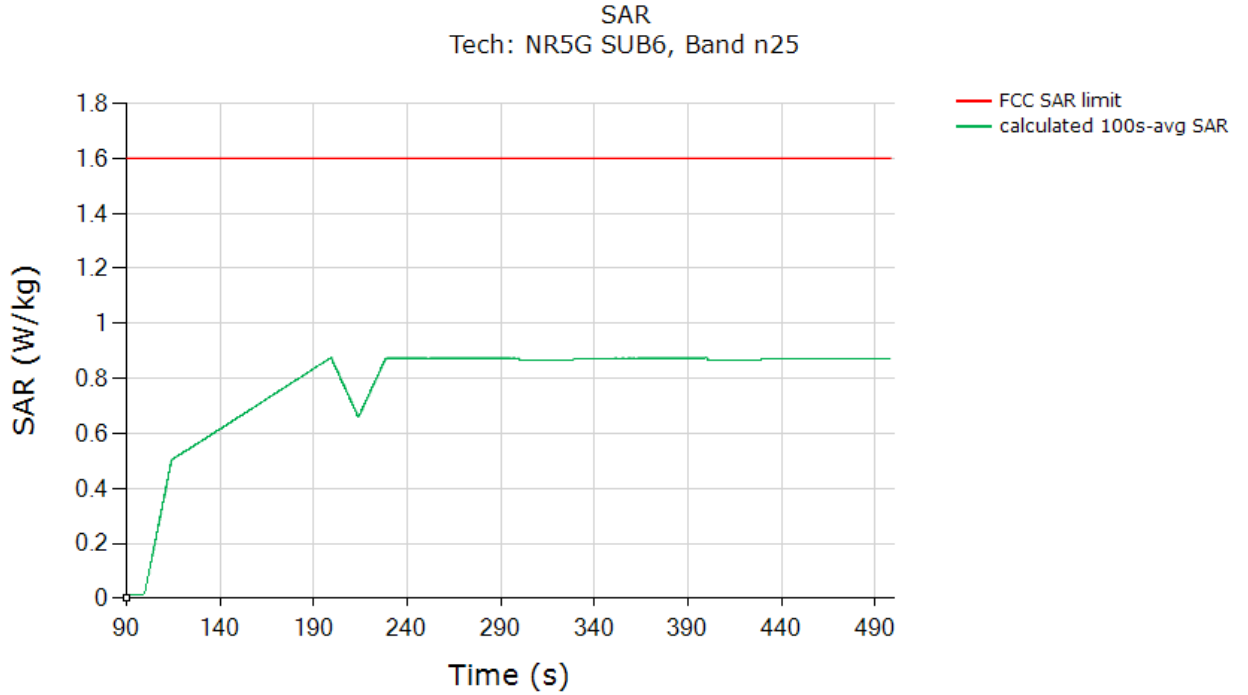

	(W/kg)
FCC 1gSAR limit	1.6
Max 100s-time averaged 1gSAR (green curve)	0.876
Validated: Max time averaged SAR (green curve) is within 1dB device uncertainty of the measured SAR at <i>Plimit</i> (last column in Table 8-2).	

FCC ID: A3LSMS908U	PCTEST Proud to be part of element	PART 2 RF EXPOSURE EVALUATION REPORT		Approved by: Quality Manager
Document S/N: 1M2109090102-23.A3L (Rev1)	Test Dates: 10/11/2021 – 11/18/2021	DUT Type: Portable Handset	Page 43 of 64	

Test result for test sequence 2:

Time-averaged conducted Tx power is converted/calculated into time-averaged 1gSAR using Equation (1a) and plotted below to demonstrate that the time-averaged 1gSAR versus time does not exceed the FCC limit of 1.6 W/kg for 1gSAR:

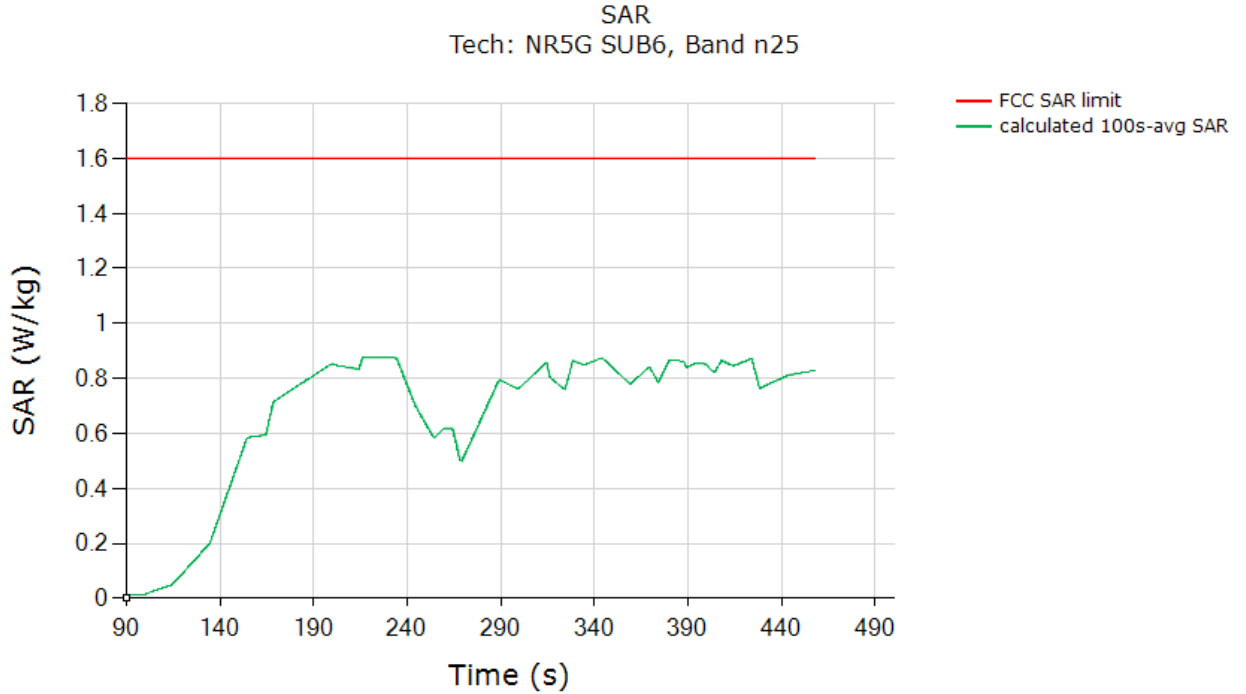

	(W/kg)
FCC 1gSAR limit	1.6
Max 100s-time averaged 1gSAR (green curve)	0.876
Validated: Max time averaged SAR (green curve) is within 1dB device uncertainty of the measured SAR at <i>P</i> _{limit} (last column in Table 8-2).	

FCC ID: A3LSMS908U	PART 2 RF EXPOSURE EVALUATION REPORT		Approved by: Quality Manager
Document S/N: 1M2109090102-23.A3L (Rev1)	Test Dates: 10/11/2021 – 11/18/2021	DUT Type: Portable Handset	Page 44 of 64

9.2 Call Drop Test Case

This test was measured LTE Band 48, Antenna F, DSI=3, and with callbox requesting maximum power. The call drop was manually performed when the DUT is transmitting at $P_{reserve}$ level as shown in the plot below. The measurement setup is shown in Figure 6-1. The detailed test procedure is described in Section 4.3.2.

Call drop test result:

Time-averaged conducted Tx power is converted/calculated into time-averaged 1gSAR using Equation (1a) and plotted below to demonstrate that the time-averaged 1gSAR versus time does not exceed the FCC limit of 1.6 W/kg for 1gSAR:

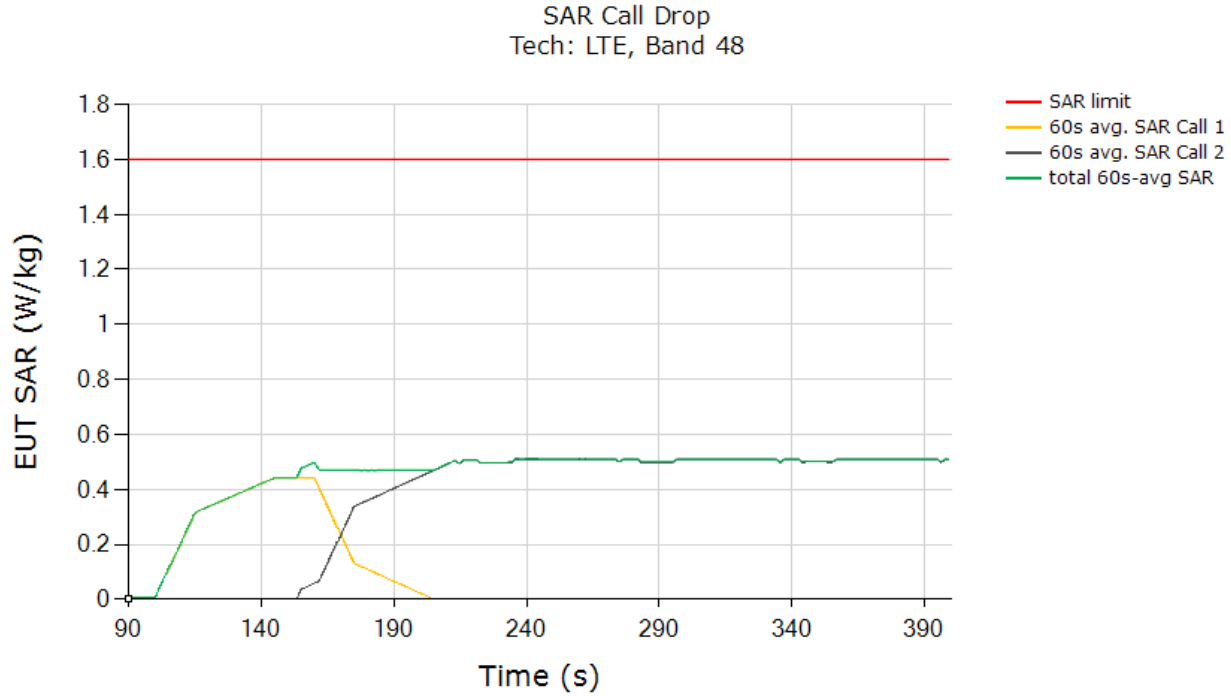

	(W/kg)
FCC 1gSAR limit	1.6
Max 60s-time averaged 1gSAR (green curve)	0.510
Validated	

The test result validated the continuity of power limiting in call change scenario.

FCC ID: A3LSMS908U	PCTEST Proud to be part of element	PART 2 RF EXPOSURE EVALUATION REPORT		Approved by: Quality Manager
Document S/N: 1M2109090102-23.A3L (Rev1)	Test Dates: 10/11/2021 – 11/18/2021	DUT Type: Portable Handset		Page 45 of 64

9.3 Change in Technology/Band Test Case

This test was conducted with callbox requesting maximum power, and with a technology switch from LTE Band 30, Antenna A, DSI = 1 to WCDMA Band 4, Antenna A, DSI = 1. Following procedure detailed in Section 4.3.3, and using the measurement setup shown in Figure 6-1, the technology/band switch was performed when the DUT is transmitting at $P_{reserve}$ level as shown in the plot below.

Test result for change in technology/band:

Time-averaged conducted Tx power measurement results were converted into time-averaged normalized SAR values using Equation (6a), (6b) and (6c), and plotted below to demonstrate that the time-averaged normalized SAR versus time does not exceed the normalized FCC limit of 1.0:

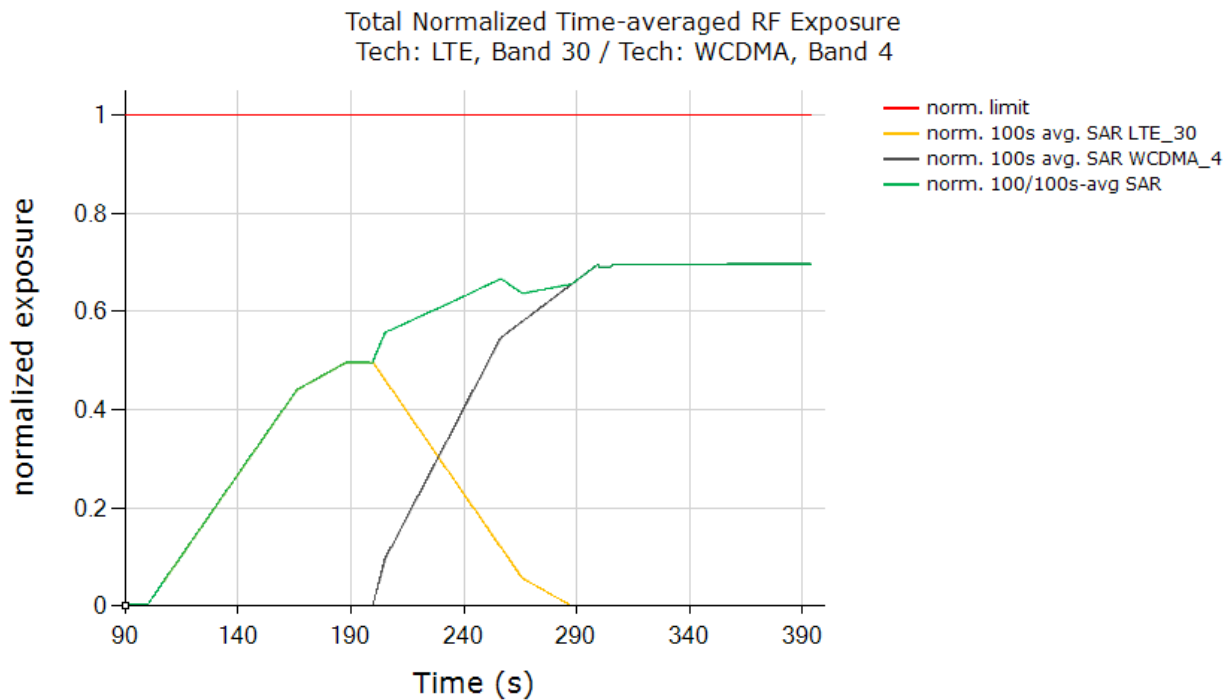

	(W/kg)
FCC normalized SAR limit	1.0
Max 100s-time averaged normalized SAR (green curve)	0.697
Validated	

The test result validated the continuity of power limiting in technology/band switch scenario.

FCC ID: A3LSMS908U	PCTEST Proud to be part of element	PART 2 RF EXPOSURE EVALUATION REPORT		Approved by: Quality Manager
Document S/N: 1M2109090102-23.A3L (Rev1)	Test Dates: 10/11/2021 – 11/18/2021	DUT Type: Portable Handset	Page 46 of 64	

9.4 Change in Time window / antenna switch test results

This test was conducted with callbox requesting maximum power, and with time-window/antenna switch between NR n41 PC3, Antenna J, DSI = 3 (100s window) and NR n77 PC3, Antenna F, DSI = 3 (60s window). Following procedure detailed in Section 4.3.6, and using the measurement setup shown in Figure 6-1(b), the time-window switch via tech/band/antenna switch was performed when the EUT is transmitting at $P_{reserve}$ level. Due to the limitation of the MT8000A callbox, this test was done at 72% duty cycle.

9.4.1 Test case 1: transition from NR n41 to NR n77 (i.e., 100s to 60s), then back to NR n41

Test result for change in time-window (from 100s to 60s to 100s):

All the conducted Tx power measurement results were converted into time-averaged normalized SAR values using Equation (7a), (7b) and (7c), and plotted below to demonstrate that the time-averaged normalized SAR versus time does not exceed the FCC limit of 1 unit. Equation (7a) is used to convert the Tx power of device to obtain 100s-averaged normalized SAR in NR n41 as shown in black curve. Similarly, equation (7b) is used to obtain 60s-averaged normalized SAR in NR n77 as shown in orange curve. Equation (7c) is used to obtain total time-averaged normalized SAR as shown in green curve (i.e., sum of black and orange curves).

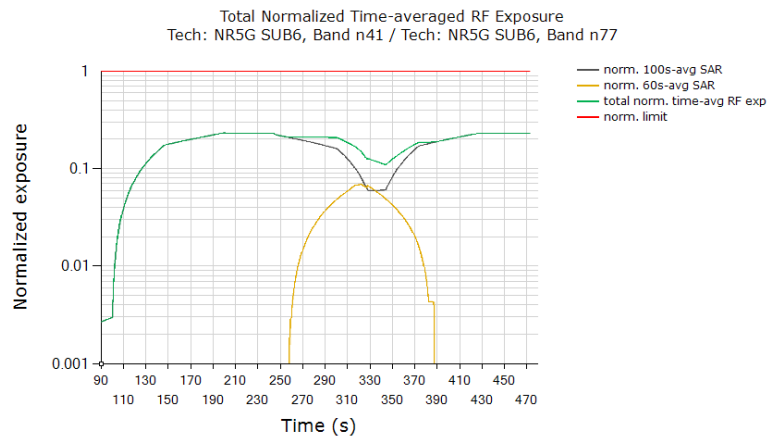

	(W/kg)
FCC normalized total exposure limit	1.0
Max time averaged normalized SAR (green curve)	0.233
Validated	

Plot Notes: Maximum power is requested by callbox for the entire duration of the test, with tech/band switches from 100s-to-60s window at ~250s time stamp, and from 60s-to-100s window at ~330s time stamp. Smart Transmit controls the Tx power during these time-window switches to ensure total time-averaged RF exposure, i.e., sum of black and orange curves given by equation (7c), is always compliant. In time-window switch test, at all times the total time-averaged normalized RF exposure (green curve) should not exceed normalized $SAR_{design_target} + 1\text{dB}$ device uncertainty. In this test, with a maximum normalized SAR of 0.233 being ≤ 0.79 ($= 1.0/1.6 + 1\text{dB}$ device uncertainty), the above test result validated the continuity of power limiting in time-window switch scenario.

FCC ID: A3LSMS908U	PCTEST Proud to be part of element	PART 2 RF EXPOSURE EVALUATION REPORT		Approved by: Quality Manager
Document S/N: 1M2109090102-23.A3L (Rev1)	Test Dates: 10/11/2021 – 11/18/2021	DUT Type: Portable Handset	Page 47 of 64	

9.4.2 Test case 2: transition from NR n77 to NR n41 (i.e., 60s to 100s), then back to NR n77

Test result for change in time-window (from 60s to 100s to 60s):

All the conducted Tx power measurement results were converted into time-averaged normalized SAR values using Equation (7a), (7b) and (7c), and plotted below to demonstrate that the time-averaged normalized SAR versus time does not exceed the FCC limit of 1 unit. Equation (7a) is used to convert the Tx power of device to obtain 60s-averaged normalized SAR in NR n77 as shown in black curve. Similarly, equation (7b) is used to obtain 100s-averaged normalized SAR in NR n41 as shown in orange curve. Equation (7c) is used to obtain total time-averaged normalized SAR as shown in green curve (i.e., sum of black and orange curves).

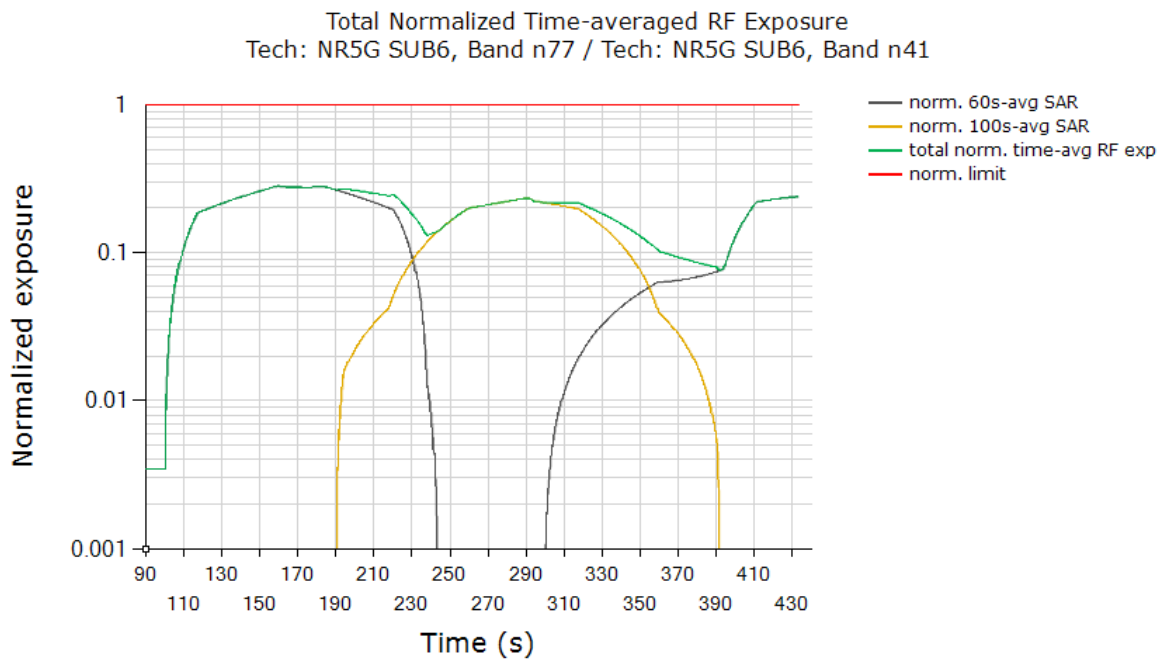

	(W/kg)
FCC normalized total exposure limit	1.0
Max time averaged normalized SAR (green curve)	0.283
Validated	

Plot Notes: Maximum power is requested by callbox for the entire duration of the test, with tech/band switches from 60s-to-100s window at ~190s time stamp, and from 100s-to-60s window at ~290s time stamp. Smart Transmit controls the Tx power during these time-window switches to ensure total time-averaged RF exposure, i.e., sum of black and orange curves given by equation (7c), is always compliant. In time-window switch test, at all times the total time-averaged normalized RF exposure (green curve) should not exceed normalized SAR_{design target} + 1dB device uncertainty. In this test, with a maximum normalized SAR of 0.283 being $\leq 0.79 (= 1.0/1.6 + 1\text{dB device uncertainty})$, the above test result validated the continuity of power limiting in time-window switch scenario.

FCC ID: A3LSMS908U	PCTEST Proud to be part of element	PART 2 RF EXPOSURE EVALUATION REPORT		Approved by: Quality Manager
Document S/N: 1M2109090102-23.A3L (Rev1)	Test Dates: 10/11/2021 – 11/18/2021	DUT Type: Portable Handset		Page 48 of 64

9.5 DSI Switch Test Case

This test was conducted with callbox requesting maximum power, and with DSI switch from LTE Band 30 DSI = 1 (grip) to DSI = 3 (hotspot). Following procedure detailed in Section 4.3.5 using the measurement setup shown in Figure 6-1, the DSI switch was performed when the DUT is transmitting at $P_{reserve}$ level as shown in the plot below.

Test result for change in DSI:

All the time-averaged conducted Tx power measurement results were converted into time-averaged normalized SAR values using Equation (6a), (6b) and (6c), and plotted below to demonstrate that the time-averaged normalized SAR versus time does not exceed the FCC limit of 1 unit.

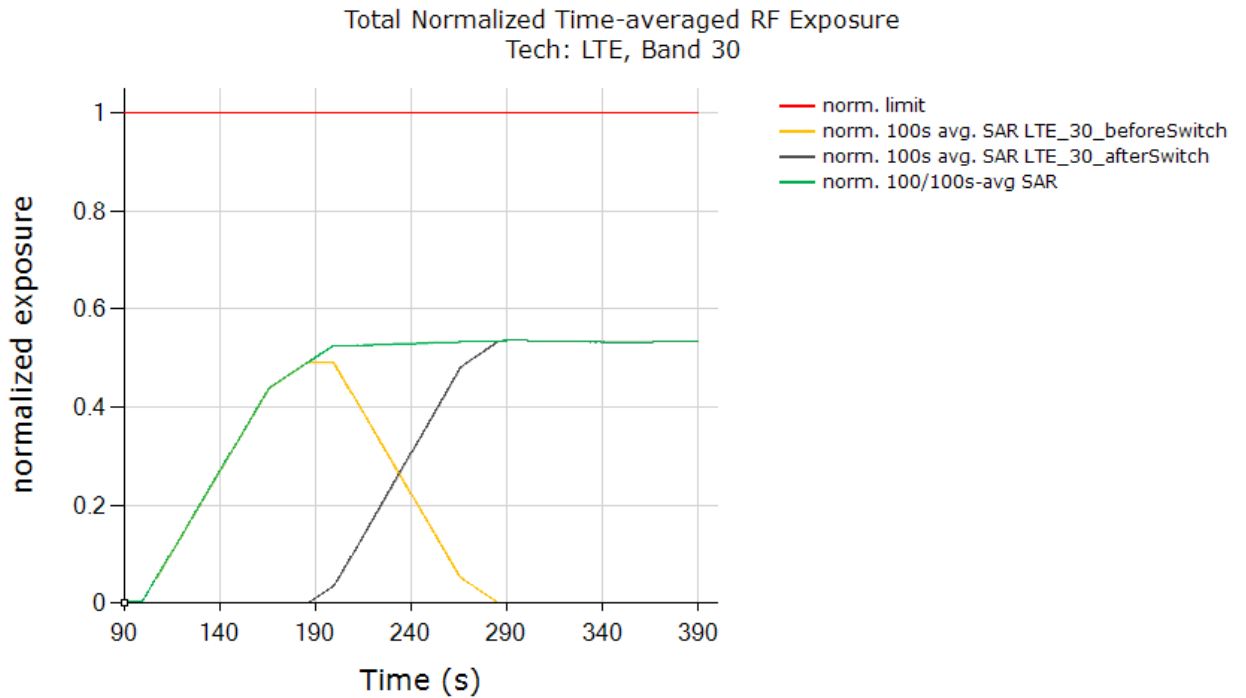

	(W/kg)
FCC normalized total exposure limit	1.0
Max 100s-time averaged normalized SAR (green curve)	0.537
Validated	

The test result validated the continuity of power limiting in DSI switch scenario.

FCC ID: A3LSMS908U	PCTEST Proud to be part of element	PART 2 RF EXPOSURE EVALUATION REPORT		Approved by: Quality Manager
Document S/N: 1M2109090102-23.A3L (Rev1)	Test Dates: 10/11/2021 – 11/18/2021	DUT Type: Portable Handset	Page 49 of 64	

9.6 Switch in SAR exposure test results

This test was conducted with callbox requesting maximum power, and with the EUT in LTE B5 + Sub6 NR Band n66 call. Following procedure detailed in Section 4.3.7 and Appendix D.2, and using the measurement setup shown in Figure 6-1(c) since LTE and Sub6 NR are sharing the same antenna, the SAR exposure switch measurement is performed with the EUT in various SAR exposure scenarios, i.e., in SAR_{sub6NR} only scenario (t = 0s ~ 120s), SAR_{su6NR} + SAR_{LTE} scenario (t = 120s ~ 210s) and SAR_{LTE} only scenario (t > 210s).

Plot Notes: All the conducted Tx power measurement results were converted into time-averaged normalized SAR values using Equation (7a), (7b) and (7c), and plotted below to demonstrate that the time-averaged normalized SAR versus time does not exceed the FCC limit of 1 unit. Equation (7a) is used to convert the LTE Tx power of device to obtain 100s-averaged normalized SAR in LTE Band 5 as shown in black curve. Similarly, equation (7b) is used to obtain 100s-averaged normalized SAR in Sub6 NR n66 as shown in orange curve. Equation (7c) is used to obtain total time-averaged normalized SAR as shown in green curve (i.e., sum of black and orange curves).

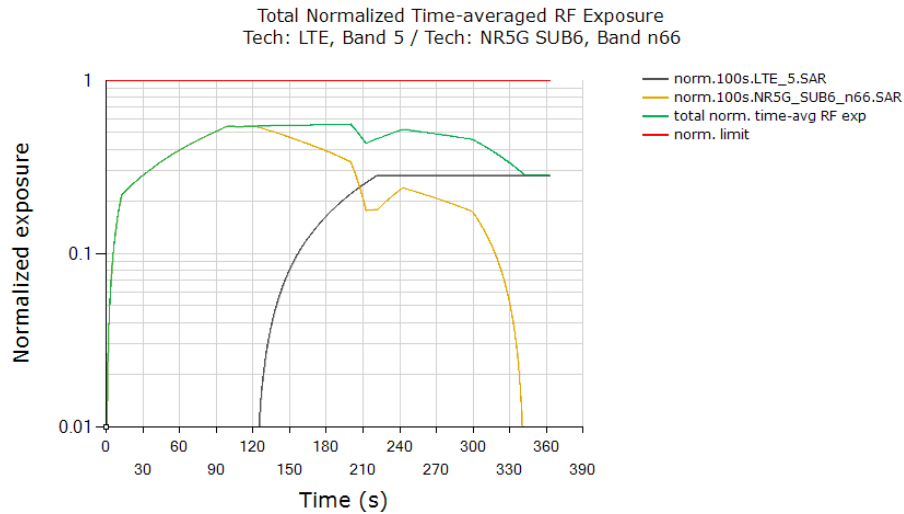

	(W/kg)
FCC normalized total exposure limit	1.0
Max time averaged normalized SAR (green curve)	0.561
Validated	

Plot Notes: Device starts predominantly in Sub6 NR SAR exposure scenario between 0s and 120s, and in LTE SAR + Sub6 NR SAR exposure scenario between 120s and 210s, and in predominantly in LTE SAR exposure scenario after t=210s. Here, Smart Transmit allocates a maximum of 100% of exposure margin (based on 3dB reserve margin setting) for Sub6 NR. This corresponds to a normalized 1gSAR exposure value = $100\% * 0.829 \text{ W/kg measured SAR at Sub6 NR } P_{limit} / 1.6\text{W/kg limit} = 0.518 \pm 1\text{dB}$ device related uncertainty (see orange curve between 0s~120s). For predominantly LTE SAR exposure scenario, maximum normalized 1gSAR exposure should correspond to 100% exposure margin = $0.634 \text{ W/kg measured SAR at LTE } P_{limit} / 1.6\text{W/kg limit} = 0.396 \pm 1\text{dB}$ device related uncertainty (see black curve after t = 210s). Additionally, in SAR exposure switch test, at all times the total time-averaged normalized RF exposure (green curve) should not exceed normalized SAR_{design target} + 1dB device uncertainty. In this test, with a maximum normalized SAR of 0.561 being $\leq 0.79 (= 1.0/1.6 + 1\text{dB device uncertainty})$, the above test result validated the continuity of power limiting in SAR exposure switch scenario.

FCC ID: A3LSMS908U	PCTEST Proud to be part of element	PART 2 RF EXPOSURE EVALUATION REPORT		Approved by: Quality Manager
Document S/N: 1M2109090102-23.A3L (Rev1)	Test Dates: 10/11/2021 – 11/18/2021	DUT Type: Portable Handset	Page 50 of 64	

10 TEST CONFIGURATIONS (FREQ > 6 GHz)

10.1 LTE + mmW NR transmission

Based on the selection criteria described in Section 4.2, the selections for LTE and mmW NR validation test are listed in Table 10-1. The radio configurations used in this test are listed in Table 10-2.

Table 10-1
Selections for LTE + mmW NR validation measurements

Transmission Scenario	Test	Technology and Band	mmWave Beam
Time-varying Tx power test	1. Cond. & Rad. Power meas.	LTE Band 2 and n261	Beam ID 25
Switch in SAR vs. PD	1. Cond. & Rad. Power meas.	LTE Band 2 and n261	Beam ID 25
Beam Switch Test	1. Cond. & Rad. Power meas.	LTE Band 2 and n261	Beam ID 25 to Beam ID 8
Favor Mode Switch	1. Cond. & Rad. Power meas.	LTE Band 2 and n77	-
		LTE Band 2 and n261	Beam ID 25

Table 10-2
Test configuration for LTE + mmW NR validation

Tech	Band	Antenna	DSI	Channel	Freq (MHz)	RB/RB Offset/Bandwidth (MHz)	Mode	UL Duty Cycle
LTE	2		3	18900	1880	1/0/20 MHz BW	QPSK	100%
mmW NR	n261	M	-	2071821	27559.32	66/0/100 MHz BW	DFT-S-OFDM, QPSK	86.5%*
	n260	0	-	2254147	38498.88	66/0/100 MHz BW	DFT-s-OFDM, QPSK	75.6%*

10.2 mmW NR radiated power test results

To demonstrate the compliance, the conducted Tx power of LTE Band 2 in DSI = 3 is converted to 1gSAR exposure by applying the corresponding worst-case 1g SAR value at P_{limit} as reported in Part 1 report and listed in Table 8-2 of this report.

Similarly, following Step 4 in Section 5.3.1, radiated Tx power of mmW Band n261 for the beams tested is converted by applying the corresponding measured worst-case 4cm²PD values, and listed in below Table 10-3. Qualcomm Smart Transmit feature operates based on time-averaged Tx power reported on a per symbol basis, which is independent of modulation, channel and bandwidth (RBs), therefore the worst-case 4cm²PD was conducted with the EUT in FTM mode, with CW modulation and 100% duty cycle. cDASY6 system verification for power density measurement is provided in Section 12, and the associated SPEAG certificates are attached in Appendix E.

Both the worst-case 1gSAR and 4cm²PD values used in this section are listed in Table 10-3. The measured EIRP at *input.power.limit* for the beams tested in this section are also listed in Table 10-3.



FCC ID: A3LSMS908U	 PCTEST Proud to be part of 	PART 2 RF EXPOSURE EVALUATION REPORT		Approved by: Quality Manager
Document S/N: 1M2109090102-23.A3L (Rev1)	Test Dates: 10/11/2021 – 11/18/2021	DUT Type: Portable Handset	Page 51 of 64	

Table 10-3
Worst-case 1gSAR, 4cm² avg. PD and EIRP measured at *input.power.limit* for the selected configurations

Tech	Band	Antenna	Beam ID	input.power.limit (dBm)	Measured psPD at input.power.limit		Measured EIRP at input.power.limit (dBm)
					4cm ² psPD (W/m ²)	Test Position	
mmW NR	n261	M	25	2.9	5.39	Back	17.01
		M	8	10.4	6.40	Back	12.00

Tech	Band	Antenna	DSI	Measured Plimit (dBm)	Measured 1g SAR at Plimit	
					1g SAR (W/kg)	Test Position
LTE	2	A	3	17.88	0.938	Bottom Edge, 10mm
NR	n77	F	3	16.67	0.387	Left Edge, 10mm

The 4cm² psPD distributions for the highest PD value per band, as listed in Table 10-3, are plotted below.

Figure 10-1
4cm² psPD distribution measured at *input.power.limit* of 10.4 dBm on the back side for n261 beam 8

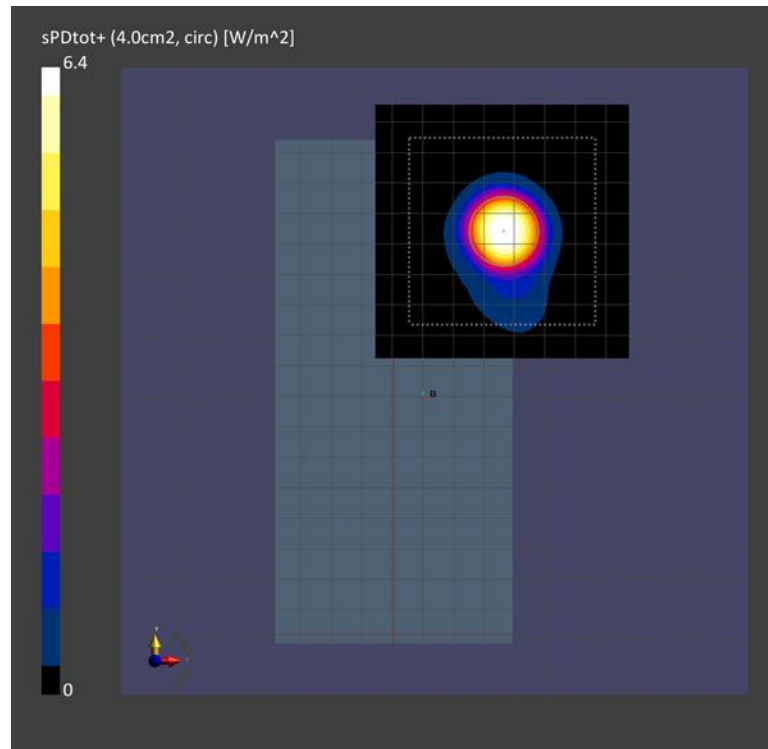

FCC ID: A3LSMS908U	PCTEST Proud to be part of element	PART 2 RF EXPOSURE EVALUATION REPORT		Approved by: Quality Manager
Document S/N: 1M2109090102-23.A3L (Rev1)	Test Dates: 10/11/2021 – 11/18/2021	DUT Type: Portable Handset		Page 52 of 64

11 RADIATED POWER TX CASES (FREQ > 6 GHZ)

11.1 Maximum Tx power test results for n261

This test was measured with LTE Band 2 and mmW Band n261 Beam ID 25, by following the detailed test procedure described in Section 5.3.1.

Time-averaged conducted Tx power for LTE Band 2 and radiated Tx power for mmW NR n261 beam 25 are converted into time-averaged 1gSAR and time-averaged 4cm²PD using Equation (2a) and (2b), which are divided by FCC 1gSAR limit of 1.6 W/kg and 4cm²PD limit of 10 W/m², respectively, to obtain normalized exposures versus time. Below plot shows (a) normalized time-averaged 1gSAR versus time, (b) normalized time-averaged 4cm²-avg.PD versus time, (c) sum of normalized time-averaged 1gSAR and normalized time-averaged 4cm²-avg.PD:

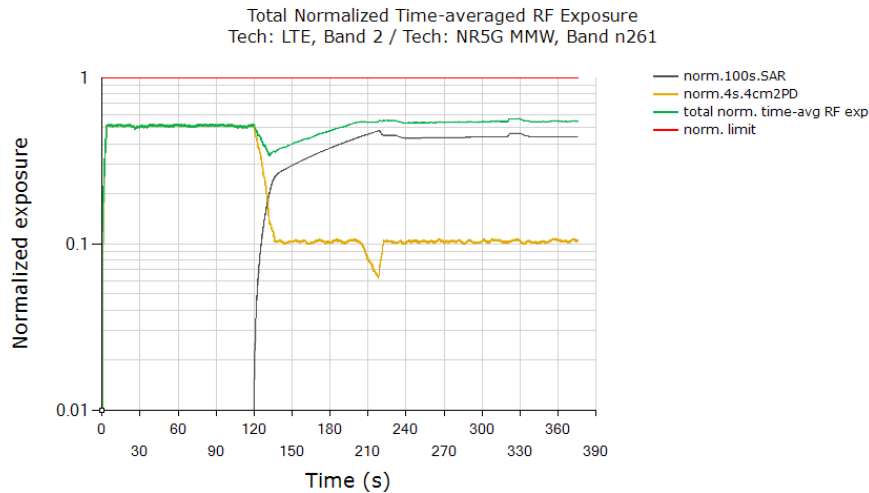

FCC requirement for total RF exposure (normalized)	1.0
Max total normalized time-averaged RF exposure (green curve)	0.568
Validated	

Plot notes: As soon as 5G mmW NR call was established, LTE was placed in all-down bits immediately. Between 0s~120s, mmW exposure is the dominant contributor. Here, Smart Transmit feature allocates a maximum of 100% for mmW (based on the 3dB reserve setting in Part 1 report). At ~120s time mark, LTE is set to all-up bits, taking away margin from mmW exposure gradually and towards the end of the test, LTE is the dominant contributor towards RF exposure. Table 11-1 shows the calculations for the normalized 4cm² PD exposure values and the normalized 1g SAR exposure value.

Table 11-1

	Static 4cm ² PD or 1g SAR [W/m ² or W/kg]	Normalized Exposure	Uncertainty [dB]
0s~120s: NR Green/Orange Curve	5.39	53.9%	2.0
After ~120s: LTE Black Curve	0.938	58.6%	1

As can be seen, the power limiting enforcement is effective and the total normalized time-averaged RF exposure does not exceed 1.0. Therefore, Qualcomm® Smart Transmit time averaging feature is validated.

FCC ID: A3LSMS908U	PCTEST Proud to be part of element	PART 2 RF EXPOSURE EVALUATION REPORT		Approved by: Quality Manager
Document S/N: 1M2109090102-23.A3L (Rev1)	Test Dates: 10/11/2021 – 11/18/2021	DUT Type: Portable Handset	Page 53 of 64	

11.2 Switch in SAR vs. PD exposure test results for n261

This test was measured with LTE Band 2 (DSI =3) and mmW Band n261 Beam ID 25, by following the detailed test procedure is described in Section 5.3.2.

Normalized time-averaged exposures for LTE (1gSAR) and mmW (4cm²PD), as well as total normalized time-averaged exposure versus time:

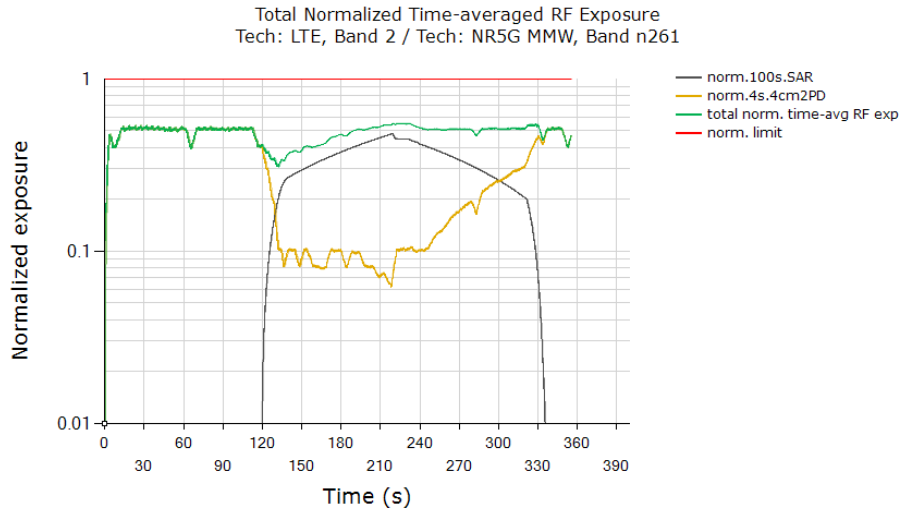

FCC requirement for total RF exposure (normalized)	1.0
Max total normalized time-averaged RF exposure (green curve)	0.553
Validated	

Plot notes: As soon as 5G mmW NR call was established, LTE was placed in all-down bits immediately. Between 0s~120s, mmW exposure is the dominant contributor. Here, Smart Transmit feature allocates a maximum of 100% for mmW). At ~120s time mark, LTE is set to all-up bits, taking away margin from mmW exposure gradually (orange curve for mmW exposure goes down while black curve for LTE exposure goes up). At ~240s time mark, LTE is set to all-down bits, which results in mmW getting back RF margin slowly as seen by gradual increase in mmW exposure (orange curve for mmW exposure goes up while black curve for LTE exposure goes down). Table 11-2 shows the calculations for the normalized 4cm² PD exposure value and the normalized 1g SAR exposure value.

Table 11-2

	Static 4cm ² PD or 1g SAR [W/m ² or W/kg]	Normalized Exposure	Uncert [dB]
0s~120s + After 240s: NR Green/Orange Curve	5.39	53.9%	2.0
120s - 240s: LTE Black Curve	0.938	58.6%	1

As can be seen, the power limiting enforcement is effective during transmission when SAR and PD exposures are switched, and the total normalized time-averaged RF exposure does not exceed 1.0. Therefore, Qualcomm® Smart Transmit time averaging feature is validated.

FCC ID: A3LSMS908U	PCTEST Proud to be part of element	PART 2 RF EXPOSURE EVALUATION REPORT		Approved by: Quality Manager
Document S/N: 1M2109090102-23.A3L (Rev1)	Test Dates: 10/11/2021 – 11/18/2021	DUT Type: Portable Handset	Page 54 of 64	

11.3 Change in Beam test results for n261

This test was measured with LTE Band 2 (DSI = 3) and mmW Band n261, with beam switch from Beam ID 25 to Beam ID 8, by following the test procedure is described in Section 5.3.3.

Normalized time-averaged exposures for LTE and mmW (4cm²PD), as well as total normalized time-averaged exposure versus time:

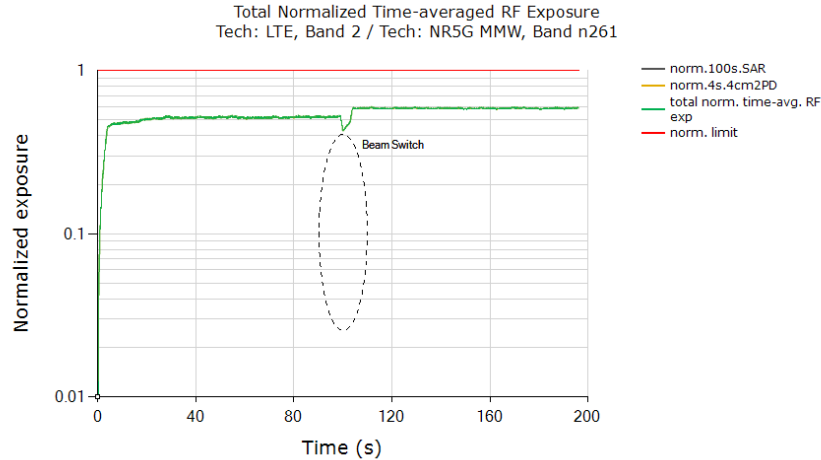

FCC requirement for total RF exposure (normalized)	1.0
Max total normalized time-averaged RF exposure (green curve)	0.597
Validated	

Plot notes: 5G mmW NR call was established at ~1s time mark and LTE was placed in all-down bits immediately after 5G mmW NR call was established. For the rest of this test, mmW exposure is the dominant contributor as LTE is left in all-down bits. Here, Smart Transmit feature allocates a maximum of 100% for mmW for the first beam (based on 3dB reserve setting in Part 1 report). At ~100s time mark (shown in black dotted ellipse), beam switch takes place and mmW starts transmission from the second beam. Second beam transmits at *input.power.limit* with active power limiting. During the switch, the ratio between the averaged radiated powers of the two beams (yellow curve) should correspond to the difference in EIRPs measured at each corresponding *input.power.limit* for these beams listed in Table 11-3. Table 11-3 shows the calculations for the normalized 4cm² PD exposure values and the difference in EIRPs between two beams.

Table 11-3

	Beam ID 25 (0 - 100 sec, before ellipse)	Beam ID 8 (100 - 200 sec, after ellipse)
Static psPD [W/m ²]	5.39	6.40
Input.power.limit [dBm]	2.9	10.4
Maximum Power [dBm]	13.5	
Normalized 4cm ² PD exposure value [% ± 2.0 dB uncertainty]	53.9%	64.0%
EIRP Difference [dB ± 2.0 dB uncertainty]	5.01 dB	

FCC ID: A3LSMS908U	PCTEST Proud to be part of element	PART 2 RF EXPOSURE EVALUATION REPORT		Approved by: Quality Manager
Document S/N: 1M2109090102-23.A3L (Rev1)	Test Dates: 10/11/2021 – 11/18/2021	DUT Type: Portable Handset	Page 55 of 64	

11.4 Switch between Sub6 and mmW Favor Modes

This test was measured with LTE Band 2 (DSI = 3), sub6 NR n77, and mmW Band n261 Beam ID 25, by following the detailed test procedure is described in Section 5.5. LTE B2 + Sub6 NR n77 + mmW NR n261 tested with below parameters. Due to the limitation of the Keysight UXM callbox, this test was done at 86.5% duty cycle for sub6 NR n77.

Tech/Band/Ant/DSI	Parameters	Values
LTE B2 Ant A DSI=3	meas P_{max}	22.63 dBm
	meas P_{limit}	17.88 dBm
	meas. 1gSAR at P_{limit}	0.938 W/kg
	Time Window applied for averaging	100s
LTE+FR2 call start time instant		220s
FR2 n261 Ant M	meas. Beam ID	25
	<i>input.power.limit</i>	2.9 dBm
	meas. EIRP @ <i>input.power.limit</i>	17.01 dBm
	meas. 4cm ² PD at <i>input.power.limit</i>	5.39 W/m ²
	Time Window applied for averaging	4s
LTE+FR2 to LTE+FR1 handover time instant		260s
FR1 n77 Ant F DSI=3	meas P_{max}	22.58 dBm
	meas P_{limit}	16.67 dBm
	meas. 1gSAR at P_{limit}	0.387 W/kg
	Time Window applied for averaging	60s
LTE+FR1 to LTE+FR2 handover time instant		360s

Normalized time-averaged exposures for LTE (1gSAR) and mmW (4cm²PD), as well as total normalized time-averaged exposure versus time:

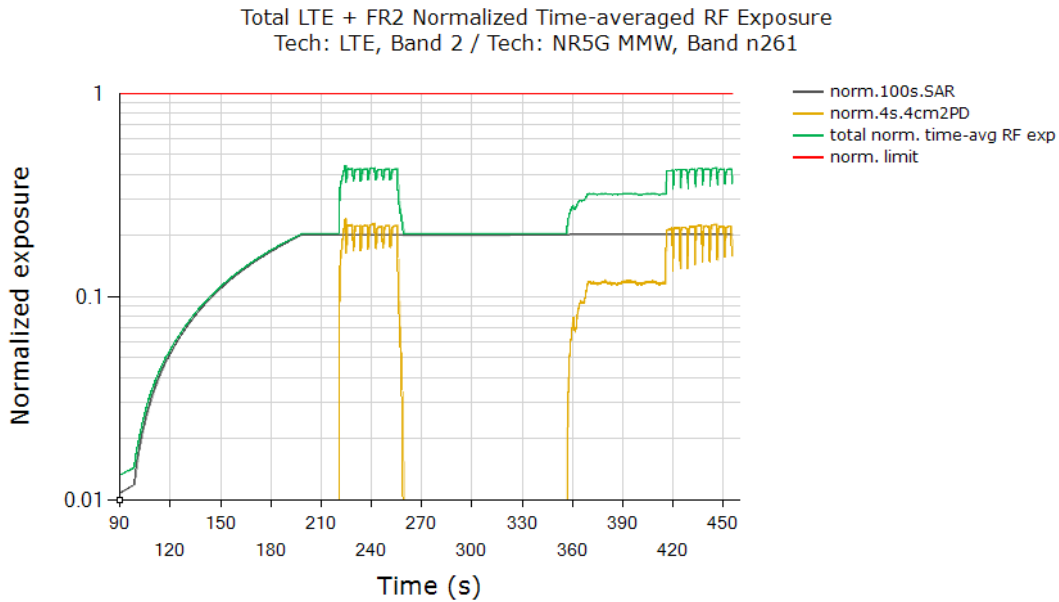

FCC ID: A3LSMS908U	PCTEST Proud to be part of element	PART 2 RF EXPOSURE EVALUATION REPORT		Approved by: Quality Manager
Document S/N: 1M2109090102-23.A3L (Rev1)	Test Dates: 10/11/2021 – 11/18/2021	DUT Type: Portable Handset		Page 56 of 64

Normalized time-averaged exposures for sub6NR n77 (1gSAR) and mmW (4cm²PD), as well as total normalized time-averaged exposure versus time:

Total FR1 + FR2 Normalized Time-averaged RF Exposure
 Tech: NR5G SUB6, Band n77 / Tech: NR5G MMW, Band n261

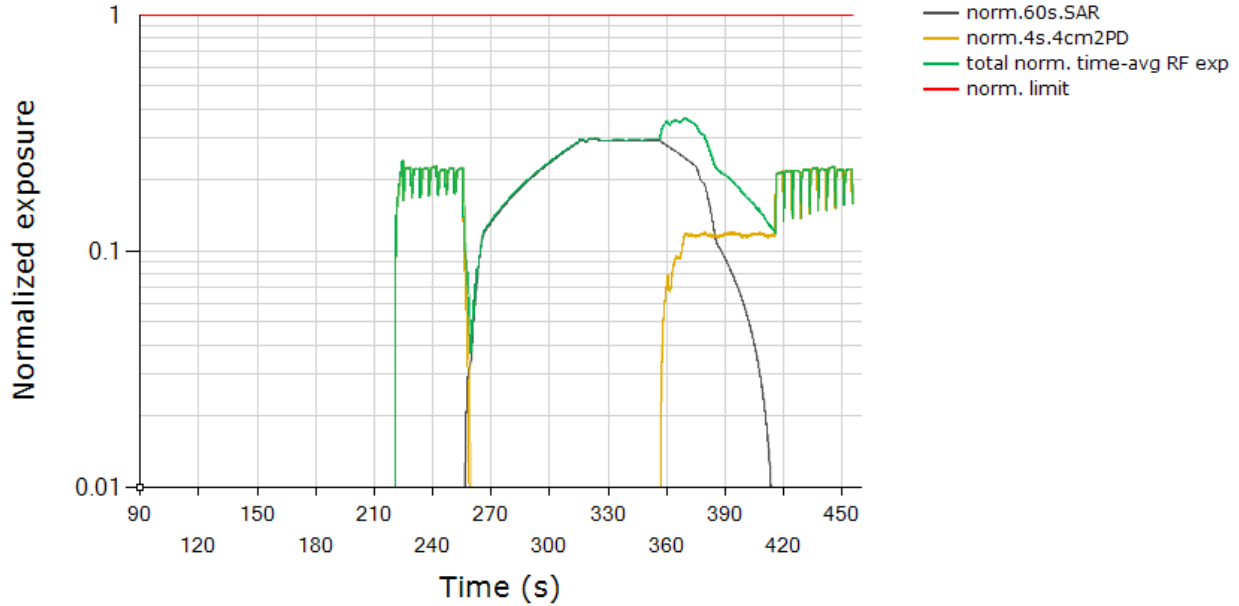

FCC requirement for total RF exposure (normalized)	1.0
Max norm.100s-avg.LTE.1gSAR + norm.4s-avg.FR2.4cm ² PD	0.444
Max norm.60s-avg.FR1.1gSAR + norm.4s-avg.FR2.4cm ² PD	0.367
Validated	

Plot Notes: Device starts in LTE B2 at 0dBm for ~100s, and then requested to transmit at (Plimit -4dB) for the rest of the test. At t~220s, LTE B2 + FR2 n261 call is initiated with FR2 n261 requested to transmit at maximum power. At t~260s, LTE B2 + FR2 n261 to LTE B2 + FR1 n77 handover is initiated with FR1 n77 requested to transmit at maximum power. At t~360s, LTE B2 + FR1 n77 to LTE B2 + FR2 n261 handover is initiated with FR2 n261 requested to transmit at maximum power. As the total normalized time-averaged RF exposure versus time didn't exceed the normalized limit of 1.0 for both the plots, the above test result validated the time-averaged RF exposure compliance continuity when switching between sub6 favor mode and mmW favor mode.

FCC ID: A3LSMS908U	PCTEST Proud to be part of element	PART 2 RF EXPOSURE EVALUATION REPORT		Approved by: Quality Manager
Document S/N: 1M2109090102-23.A3L (Rev1)	Test Dates: 10/11/2021 – 11/18/2021	DUT Type: Portable Handset	Page 57 of 64	

12 SYSTEM VERIFICATION (FREQ > 6 GHZ)

The system was verified to be within ± 0.66 dB of the power density targets on the calibration certificate according to the test system specification in the user's manual and calibration facility recommendation. The 0.66 dB deviation threshold represents the expanded uncertainty for system performance checks using SPEAG's mmWave verification sources. The same spatial resolution and measurement region used in the source calibration was applied during the system check.

The measured power density distribution of verification source was also confirmed through visual inspection to have no noticeable differences, both spatially (shape) and numerically (level) from the distribution provided by the manufacturer, per November 2017 TCBC Workshop Notes.



**Table 12-1
System Verification Results**

System Verification										
Syst.	Freq. (GHz)	Date	Source SN	Probe SN	Normal psPD (W/m ² over 4 cm ²)		Deviation (dB)	Total psPD (W/m ² over 4 cm ²)		Deviation (dB)
					measured	target		measured	target	
Q	30.00	11/3/2021	1035	9364	31.70	31.00	0.10	32.10	31.00	0.15

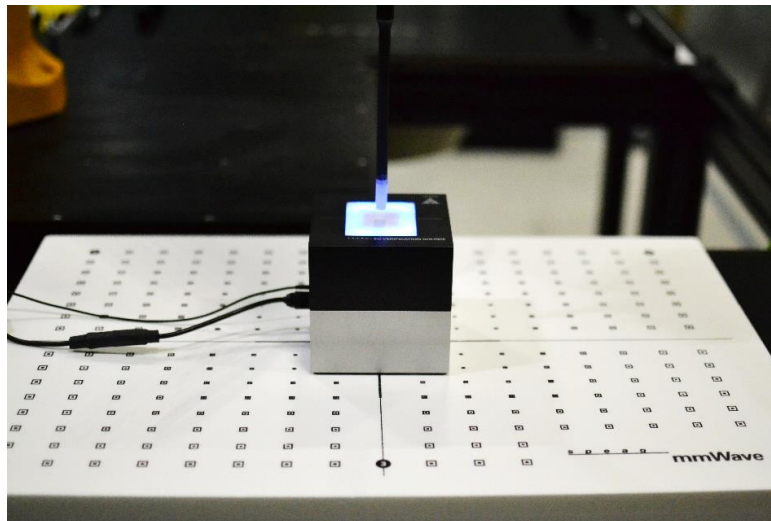
Note: A **10 mm distance spacing** was used from the reference horn antenna aperture to the probe element. This includes 4.45 mm from the reference antenna horn aperture to the surface of the verification source plus 5.55 mm from the surface to the probe. The SPEAG software requires a setting of "5.55 mm" for the correct set up.



**Figure 12-1
System Verification Setup Photo**



FCC ID: A3LSMS908U	 PCTEST Proud to be part of 	PART 2 RF EXPOSURE EVALUATION REPORT		Approved by: Quality Manager
Document S/N: 1M2109090102-23.A3L (Rev1)	Test Dates: 10/11/2021 – 11/18/2021	DUT Type: Portable Handset		Page 58 of 64

13 EQUIPMENT LIST

Manufacturer	Model	Description	Cal Date	Cal Interval	Cal Due	Serial Number
Anritsu	MT8000A	Radio Communication Test Station	2/6/2021	Annual	2/6/2022	6262036828
Anritsu	MT8821C	Radio Communication Test Station	4/14/2021	Annual	4/14/2022	6261895213
COMTECH	AR85729-5/5759B	Solid State Amplifier	CBT	N/A	CBT	M3W1A00-1002
COMTech	AR85729-5	Solid State Amplifier	CBT	N/A	CBT	M1S5A00-009
K & L	11SH10-1300/U4000	High Pass Filter	N/A	N/A	N/A	11SH10-1300/U4000 - 2
Keysight Technologies	772D	Dual Directional Coupler	CBT	N/A	CBT	MY52180215
Keysight Technologies	E7515B	UXM 5G Wireless Test Platform	NA	NA	NA	MY59150289
Keysight Technologies	M1740A	mmWave Transceiver	2/20/2020	Biennial	2/20/2022	MY59291989
Keysight Technologies	M1740A	mmWave Transceiver	2/20/2020	Biennial	2/20/2022	MY59291982
Keysight Technologies	E7770A	Common Interface Unit	N/A	N/A	N/A	MY58290483
Krytar	110067006	Directional Coupler, 10 - 67 GHz	N/A	N/A	N/A	200391
MCL	BW-N6W5+	6dB Attenuator	CBT	N/A	CBT	1139
Mini Circuits	ZA2PD2-63-S+	Power Splitter	CBT	N/A	CBT	SUU64901930
Mini Circuits	ZAPD-2-272-S+	Power Splitter	CBT	N/A	CBT	SF702001405
MiniCircuits	NLP-1200+	Low Pass Filter	N/A	N/A	N/A	VUU78201318
MiniCircuits	SLP-2400+	Low Pass Filter	CBT	N/A	CBT	R8979500903
MiniCircuits	VLF-6000+	Low Pass Filter	CBT	N/A	CBT	N/A
Mini-Circuits	BW-N20W5+	DC to 18 GHz Precision Fixed 20 dB Attenuator	CBT	N/A	CBT	N/A
Mini-Circuits	NLP-2950+	Low Pass Filter DC to 2700 MHz	CBT	N/A	CBT	N/A
Mini-Circuits	NLP-1200+	Low Pass Filter DC to 1000 MHz	CBT	N/A	CBT	N/A
Mini-Circuits	BW-N20W5	Power Attenuator	CBT	N/A	CBT	1226
Narda	4216-10	Directional Coupler, 0.5 to 8.0 GHz, 10 dB	CBT	N/A	CBT	01492
Narda	4216-10	Directional Coupler, 0.5 to 8.0 GHz, 10 dB	CBT	N/A	CBT	01493
Narda	4772-3	Attenuator	CBT	N/A	CBT	9406
Narda	BW-53W2	Attenuator	CBT	N/A	CBT	120
Narda	BW-510W2+	Attenuator	CBT	N/A	CBT	831
Narda	4014C-6	4 - 8 GHz SMA 6 dB Directional Coupler	CBT	N/A	CBT	N/A
Newmark System	NSC-G2	Motion Controller	CBT	N/A	CBT	1007-D
Pasternack	PE2208-6	Bidirectional Coupler	CBT	N/A	CBT	N/A
Pasternack	PE2209-10	Bidirectional Coupler	CBT	N/A	CBT	N/A
Rohde & Schwarz	CMW500	Radio Communication Tester	2/18/2021	Annual	2/18/2022	101767
Rohde & Schwarz	CMW500	Radio Communication Tester	1/19/2021	Annual	1/19/2022	111427
Rohde & Schwarz	NRP85	3 Path Dipole Power Sensor	3/24/2021	Annual	3/24/2022	108168
Rohde & Schwarz	NRP85	3-Path Dipole Power Sensor	5/13/2021	Annual	5/13/2022	109322
Rohde & Schwarz	NRP85	3-Path Dipole Power Sensor	5/13/2021	Annual	5/13/2022	109052
Rohde & Schwarz	NRP50S	3-Path Dipole Power Sensor	3/24/2021	Annual	3/24/2022	101164
SPEAG	5G Verification Source 30GHz	30GHz System Verification Antenna	2/10/2021	Annual	2/10/2022	1035
SPEAG	DAE4	Dasy Data Acquisition Electronics	4/7/2021	Annual	4/7/2022	1582
SPEAG	EUmmWV4	E-field Probes	6/21/2021	Annual	6/21/2022	9364
Zuhai Bojay Electronics	BJ8827	Shielded Test Enclosure	N/A	N/A	N/A	F229647

Notes:



1. CBT (Calibrated Before Testing). Prior to testing, the measurement paths containing a cable, amplifier, attenuator, coupler, or filter were connected to a calibrated source (i.e. a signal generator) to determine the losses of the measurement path. The power meter offset was then adjusted to compensate for the measurement system losses. This level offset is stored within the power meter before measurements are made. This calibration verification procedure applies to the system verification and output power measurements. The calibrated reading is then taken directly from the power meter after compensation of the losses for all final power measurements.
2. Each equipment item is used solely within its respective calibration period.

FCC ID: A3LSMS908U	 PCTEST Proud to be part of 	PART 2 RF EXPOSURE EVALUATION REPORT		Approved by: Quality Manager
Document S/N: 1M2109090102-23.A3L (Rev1)	Test Dates: 10/11/2021 – 11/18/2021	DUT Type: Portable Handset	Page 59 of 64	

14 MEASUREMENT UNCERTAINTIES



For SAR Measurements

a	c	d	e= f(d,k)	f	g	h = c x f/e	i = c x g/e	k
Uncertainty Component	Tol. (± %)	Prob. Dist.	Div.	c _i 1gm	c _i 10 gms	1gm u _i (± %)	10gms u _i (± %)	v _i
Measurement System								
Probe Calibration	6.55	N	1	1.0	1.0	6.6	6.6	∞
Axial Isotropy	0.25	N	1	0.7	0.7	0.2	0.2	∞
Hemishperical Isotropy	1.3	N	1	0.7	0.7	0.9	0.9	∞
Boundary Effect	2.0	R	1.73	1.0	1.0	1.2	1.2	∞
Linearity	0.3	N	1	1.0	1.0	0.3	0.3	∞
System Detection Limits	0.25	R	1.73	1.0	1.0	0.1	0.1	∞
Readout Electronics	0.3	N	1	1.0	1.0	0.3	0.3	∞
Response Time	0.8	R	1.73	1.0	1.0	0.5	0.5	∞
Integration Time	2.6	R	1.73	1.0	1.0	1.5	1.5	∞
RF Ambient Conditions - Noise	3.0	R	1.73	1.0	1.0	1.7	1.7	∞
RF Ambient Conditions - Reflections	3.0	R	1.73	1.0	1.0	1.7	1.7	∞
Probe Positioner Mechanical Tolerance	0.4	R	1.73	1.0	1.0	0.2	0.2	∞
Probe Positioning w/ respect to Phantom	6.7	R	1.73	1.0	1.0	3.9	3.9	∞
Extrapolation, Interpolation & Integration algorithms for Max. SAR Evaluation	4.0	R	1.73	1.0	1.0	2.3	2.3	∞
Test Sample Related								
Test Sample Positioning	2.7	N	1	1.0	1.0	2.7	2.7	35
Device Holder Uncertainty	1.67	N	1	1.0	1.0	1.7	1.7	5
Output Power Variation - SAR drift measurement	5.0	R	1.73	1.0	1.0	2.9	2.9	∞
SAR Scaling	0.0	R	1.73	1.0	1.0	0.0	0.0	∞
Phantom & Tissue Parameters								
Phantom Uncertainty (Shape & Thickness tolerances)	7.6	R	1.73	1.0	1.0	4.4	4.4	∞
Liquid Conductivity - measurement uncertainty	4.2	N	1	0.78	0.71	3.3	3.0	10
Liquid Permittivity - measurement uncertainty	4.1	N	1	0.23	0.26	1.0	1.1	10
Liquid Conductivity - Temperature Uncertainty	3.4	R	1.73	0.78	0.71	1.5	1.4	∞
Liquid Permittivity - Temperature Uncertainty	0.6	R	1.73	0.23	0.26	0.1	0.1	∞
Liquid Conductivity - deviation from target values	5.0	R	1.73	0.64	0.43	1.8	1.2	∞
Liquid Permittivity - deviation from target values	5.0	R	1.73	0.60	0.49	1.7	1.4	∞
Combined Standard Uncertainty (k=1)	RSS					11.5	11.3	60
Expanded Uncertainty (95% CONFIDENCE LEVEL)	k=2					23.0	22.6	

FCC ID: A3LSMS908U	 PCTEST Proud to be part of 	PART 2 RF EXPOSURE EVALUATION REPORT		Approved by: Quality Manager
Document S/N: 1M2109090102-23.A3L (Rev1)	Test Dates: 10/11/2021 – 11/18/2021	DUT Type: Portable Handset	Page 60 of 64	

For PD Measurements

a	b	c	d	e	f = c x f/e	g
Uncertainty Component	Unc. (± dB)	Prob. Dist.	Div.	c _i	u _i (± dB)	v _i
Measurement System						
Calibration	0.49	N	1	1	0.49	∞
Probe Correction	0.00	R	1.73	1	0.00	∞
Frequency Response	0.20	R	1.73	1	0.12	∞
Sensor Cross Coupling	0.00	R	1.73	1	0.00	∞
Isotropy	0.50	R	1.73	1	0.29	∞
Linearity	0.20	R	1.73	1	0.12	∞
Probe Scattering	0.00	R	1.73	1	0.00	∞
Probe Positioning offset	0.30	R	1.73	1	0.17	∞
Probe Positioning Repeatability	0.04	R	1.73	1	0.02	∞
Sensor Mechanical Offset	0.00	R	1.73	1	0.00	∞
Probe Spatial Resolution	0.00	R	1.73	1	0.00	∞
Field Impedance Dependence	0.00	R	1.73	1	0.00	∞
Amplitude and Phase Drift	0.00	R	1.73	1	0.00	∞
Amplitude and Phase Noise	0.04	R	1.73	1	0.02	∞
Measurement Area Truncation	0.00	R	1.73	1	0.00	∞
Data Acquisition	0.03	N	1	1	0.03	∞
Sampling	0.00	R	1.73	1	0.00	∞
Field Reconstruction	0.60	R	1.73	1	0.35	∞
Forward Transformation	0.00	R	1.73	1	0.00	∞
Power Density Scaling	0.00	R	1.73	1	0.00	∞
Spatial Averaging	0.10	R	1.73	1	0.06	∞
System Detection Limit	0.04	R	1.73	1	0.02	∞
Test Sample Related						
Probe Coupling with DUT	0.00	R	1.73	1	0.00	∞
Modulation Response	0.40	R	1.73	1	0.23	∞
Integration Time	0.00	R	1.73	1	0.00	∞
Response Time	0.00	R	1.73	1	0.00	∞
Device Holder Influence	0.10	R	1.73	1	0.06	∞
DUT alignment	0.00	R	1.73	1	0.00	∞
RF Ambient Conditions	0.04	R	1.73	1	0.02	∞
Ambient Reflections	0.04	R	1.73	1	0.02	∞
Immunity/Secondary Reception	0.00	R	1.73	1	0.00	∞
Drift of DUT	0.21	R	1.73	1	0.12	∞
Combined Standard Uncertainty (k=1)	RSS				0.76	∞
Expanded Uncertainty (95% CONFIDENCE LEVEL)	k=2				1.52	



FCC ID: A3LSMS908U	 PCTEST Proud to be part of 	PART 2 RF EXPOSURE EVALUATION REPORT		Approved by: Quality Manager
Document S/N: 1M2109090102-23.A3L (Rev1)	Test Dates: 10/11/2021 – 11/18/2021	DUT Type: Portable Handset	Page 61 of 64	

15 CONCLUSION

15.1 Measurement Conclusion



The SAR evaluation indicates that the DUT complies with the RF radiation exposure limits of the FCC and Innovation, Science, and Economic Development Canada, with respect to all parameters subject to this test. These measurements were taken to simulate the RF effects of RF exposure under worst-case conditions. Precise laboratory measures were taken to assure repeatability of the tests. The results and statements relate only to the item(s) tested.

Please note that the absorption and distribution of electromagnetic energy in the body are very complex phenomena that depend on the mass, shape, and size of the body, the orientation of the body with respect to the field vectors, and the electrical properties of both the body and the environment. Other variables that may play a substantial role in possible biological effects are those that characterize the environment (e.g. ambient temperature, air velocity, relative humidity, and body insulation) and those that characterize the individual (e.g. age, gender, activity level, debilitation, or disease). Because various factors may interact with one another to vary the specific biological outcome of an exposure to electromagnetic fields, any protection guide should consider maximal amplification of biological effects as a result of field-body interactions, environmental conditions, and physiological variables. [3]



FCC ID: A3LSMS908U	 PCTEST Proud to be part of 	PART 2 RF EXPOSURE EVALUATION REPORT		Approved by: Quality Manager
Document S/N: 1M2109090102-23.A3L (Rev1)	Test Dates: 10/11/2021 – 11/18/2021	DUT Type: Portable Handset	Page 62 of 64	

16 REFERENCES

- [1] Federal Communications Commission, ET Docket 93-62, Guidelines for Evaluating the Environmental Effects of Radiofrequency Radiation, Aug. 1996.
- [2] ANSI/IEEE C95.1-2005, American National Standard safety levels with respect to human exposure to radio frequency electromagnetic fields, 3kHz to 300GHz, New York: IEEE, 2006.
- [3] ANSI/IEEE C95.1-1992, American National Standard safety levels with respect to human exposure to radio frequency electromagnetic fields, 3kHz to 300GHz, New York: IEEE, Sept. 1992.
- [4] ANSI/IEEE C95.3-2002, IEEE Recommended Practice for the Measurement of Potentially Hazardous Electromagnetic Fields - RF and Microwave, New York: IEEE, December 2002.
- [5] IEEE Standards Coordinating Committee 39 –Standards Coordinating Committee 34 – IEEE Std. 1528-2013, IEEE Recommended Practice for Determining the Peak Spatial-Average Specific Absorption Rate (SAR) in the Human Head from Wireless Communications Devices: Measurement Techniques.
- [6] NCRP, National Council on Radiation Protection and Measurements, Biological Effects and Exposure Criteria for RadioFrequency Electromagnetic Fields, NCRP Report No. 86, 1986. Reprinted Feb. 1995.
- [7] T. Schmid, O. Egger, N. Kuster, Automated E-field scanning system for dosimetric assessments, IEEE Transaction on Microwave Theory and Techniques, vol. 44, Jan. 1996, pp. 105-113.
- [8] K. Pokovic, T. Schmid, N. Kuster, Robust setup for precise calibration of E-field probes in tissue simulating liquids at mobile communications frequencies, ICECOM97, Oct. 1997, pp. 1 -124.
- [9] K. Pokovic, T. Schmid, and N. Kuster, E-field Probe with improved isotropy in brain simulating liquids, Proceedings of the ELMAR, Zadar, Croatia, June 23-25, 1996, pp. 172-175.
- [10] Schmid & Partner Engineering AG, Application Note: Data Storage and Evaluation, June 1998, p2.
- [11] V. Hombach, K. Meier, M. Burkhardt, E. Kuhn, N. Kuster, The Dependence of EM Energy Absorption upon Human Modeling at 900 MHz, IEEE Transaction on Microwave Theory and Techniques, vol. 44 no. 10, Oct. 1996, pp. 1865-1873.
- [12] N. Kuster and Q. Balzano, Energy absorption mechanism by biological bodies in the near field of dipole antennas above 300MHz, IEEE Transaction on Vehicular Technology, vol. 41, no. 1, Feb. 1992, pp. 17-23.
- [13] G. Hartsgrove, A. Kraszewski, A. Surowiec, Simulated Biological Materials for Electromagnetic Radiation Absorption Studies, University of Ottawa, Bioelectromagnetics, Canada: 1987, pp. 29-36.
- [14] Q. Balzano, O. Garay, T. Manning Jr., Electromagnetic Energy Exposure of Simulated Users of Portable Cellular Telephones, IEEE Transactions on Vehicular Technology, vol. 44, no.3, Aug. 1995.
- [15] W. Gander, Computermathematik, Birkhaeuser, Basel, 1992.
- [16] W.H. Press, S.A. Teukolsky, W.T. Vetterling, and B.P. Flannery, Numerical Recipes in C, The Art of Scientific Computing, Second edition, Cambridge University Press, 1992.
- [17] N. Kuster, R. Kastle, T. Schmid, Dosimetric evaluation of mobile communications equipment with known precision, IEEE Transaction on Communications, vol. E80-B, no. 5, May 1997, pp. 645-652.

FCC ID: A3LSMS908U	 PCTEST Proud to be part of 	PART 2 RF EXPOSURE EVALUATION REPORT		Approved by: Quality Manager
Document S/N: 1M2109090102-23.A3L (Rev1)	Test Dates: 10/11/2021 – 11/18/2021	DUT Type: Portable Handset	Page 63 of 64	

- [18] CENELEC CLC/SC111B, European Prestandard (prENV 50166-2), Human Exposure to Electromagnetic Fields High-frequency: 10kHz-300GHz, Jan. 1995.
- [19] Prof. Dr. Niels Kuster, ETH, Eidgenössische Technische Hochschule Zürich, Dosimetric Evaluation of the Cellular Phone.
- [20] IEC 62209-1, Measurement procedure for the assessment of specific absorption rate of human exposure to radio frequency fields from hand-held and body-mounted wireless communication devices - Part 1: Devices used next to the ear (Frequency range of 300 MHz to 6 GHz), July 2016.
- [21] Innovation, Science, Economic Development Canada RSS-102 Radio Frequency Exposure Compliance of Radiocommunication Apparatus (All Frequency Bands) Issue 5, March 2015.
- [22] Health Canada Safety Code 6 Limits of Human Exposure to Radio Frequency Electromagnetic Fields in the Frequency Range from 3 kHz – 300 GHz, 2015
- [23] FCC SAR Test Procedures for 2G-3G Devices, Mobile Hotspot and UMPC Devices KDB Publications 941225, D01-D07
- [24] SAR Measurement Guidance for IEEE 802.11 Transmitters, KDB Publication 248227 D01
- [25] FCC SAR Considerations for Handsets with Multiple Transmitters and Antennas, KDB Publications 648474 D03-D04
- [26] FCC SAR Evaluation Considerations for Laptop, Notebook, Netbook and Tablet Computers, FCC KDB Publication 616217 D04
- [27] FCC SAR Measurement and Reporting Requirements for 100MHz – 6 GHz, KDB Publications 865664 D01-D02
- [28] FCC General RF Exposure Guidance and SAR Procedures for Dongles, KDB Publication 447498, D01-D02
- [29] Anexo à Resolução No. 533, de 10 de Setembro de 2009.
- [30] IEC 62209-2, Human exposure to radio frequency fields from hand-held and body-mounted wireless communication devices - Human models, instrumentation, and procedures - Part 2: Procedure to determine the specific absorption rate (SAR) for wireless communication devices used in close proximity to the human body (frequency range of 30 MHz to 6 GHz), Mar. 2010.

FCC ID: A3LSMS908U	 PART 2 RF EXPOSURE EVALUATION REPORT 		Approved by: Quality Manager
Document S/N: 1M2109090102-23.A3L (Rev1)	Test Dates: 10/11/2021 – 11/18/2021	DUT Type: Portable Handset	Page 64 of 64