



PART 2 RF EXPOSURE EVALUATION REPORT

Applicant Name:
Samsung Electronics Co., Ltd.
129, Samsung-ro, Maetan dong,
Yeongtong-gu, Suwon-si
Gyeonggi-do, 16677, Korea

Date of Testing:
02/16/2022 – 03/21/2022
Test Site/Location:
PCTEST Lab, Columbia, MD, USA
Document Serial No.:
1M2202030009-07.A3L

FCC ID: **A3LSMS906E**

APPLICANT: **SAMSUNG ELECTRONICS CO., LTD.**



DUT Type: Portable Handset
Application Type: Class II Permissive Change
FCC Rule Part(s): CFR §2.1093
Model: SM-S906E/DS
Additional Model: SM-S906E
Permissive Change(s): See FCC Change Document
Date of Original Certification: 01/10/2022
Device Serial Numbers: Pre-Production Samples [7864V]

I attest to the accuracy of data. All measurements reported herein were performed by me or were made under my supervision and are correct to the best of my knowledge and belief. I assume full responsibility for the completeness of these measurements and vouch for the qualifications of all persons taking them. Test results reported herein relate only to the item(s) tested.



RJ Ortanez
Executive Vice President





FCC ID: A3LSMS906E		 PART 2 RF EXPOSURE EVALUATION REPORT 		Approved by: Technical Manager
Document S/N: 1M2202030009-07.A3L	Test Dates: 02/16/2022 – 03/21/2022	DUT Type: Portable Handset		Page 1 of 26

T A B L E O F C O N T E N T S

1	DEVICE UNDER TEST	3
2	RF EXPOSURE LIMITS	5
3	TIME VARYING TRANSMISSION TEST CASES.....	7
4	FCC MEASUREMENT PROCEDURES (FREQ < 6 GHZ)	9
5	MEASUREMENT TEST SETUP (FREQ < 6 GHZ)	13
6	TEST CONFIGURATIONS (FREQ < 6 GHZ).....	15
7	CONDUCTED TX CASES (FREQ < 6 GHZ).....	18
8	EQUIPMENT LIST.....	21
9	CONCLUSION.....	24
10	REFERENCES	25

APPENDIX A: TEST SETUP PHOTOGRAPHS



APPENDIX B: TEST PROCEDURES FOR SUB6 NR + NR RADIO

FCC ID: A3LSMS906E	 <small>Proud to be part of element</small>	PART 2 RF EXPOSURE EVALUATION REPORT		Approved by: Technical Manager
Document S/N: 1M2202030009-07.A3L	Test Dates: 02/16/2022 – 03/21/2022	DUT Type: Portable Handset	Page 2 of 26	

1 DEVICE UNDER TEST

1.1 Device Overview

Band & Mode	Operating Modes	Tx Frequency
GSM/GPRS/EDGE 850	Voice/Data	824.20 - 848.80 MHz
GSM/GPRS/EDGE 1900	Voice/Data	1850.20 - 1909.80 MHz
UMTS 850	Voice/Data	826.40 - 846.60 MHz
UMTS 1750	Voice/Data	1712.4 - 1752.6 MHz
UMTS 1900	Voice/Data	1852.4 - 1907.6 MHz
LTE Band 12	Voice/Data	699.7 - 715.3 MHz
LTE Band 17	Voice/Data	706.5 - 713.5 MHz
LTE Band 13	Voice/Data	779.5 - 784.5 MHz
LTE Band 26 (Cell)	Voice/Data	814.7 - 848.3 MHz
LTE Band 5 (Cell)	Voice/Data	824.7 - 848.3 MHz
LTE Band 66 (AWS)	Voice/Data	1710.7 - 1779.3 MHz
LTE Band 4 (AWS)	Voice/Data	1710.7 - 1754.3 MHz
LTE Band 25 (PCS)	Voice/Data	1850.7 - 1914.3 MHz
LTE Band 2 (PCS)	Voice/Data	1850.7 - 1909.3 MHz
LTE Band 41	Voice/Data	2498.5 - 2687.5 MHz
NR Band n5 (Cell)	Voice/Data	826.5 - 846.5 MHz
NR Band n66 (AWS)	Voice/Data	1712.5 - 1777.5 MHz
NR Band n25 (PCS)	Voice/Data	1852.5 - 1912.5 MHz
NR Band n2 (PCS)	Voice/Data	1852.5 - 1907.5 MHz
NR Band n41	Voice/Data	2506.02 - 2679.99 MHz
NR Band n77 DoD	Voice/Data	3455.01 - 3544.98 MHz
NR Band n77	Voice/Data	3705 - 3975 MHz
2.4 GHz WLAN	Voice/Data	2412 - 2472 MHz
U-NII-1	Voice/Data	5180 - 5240 MHz
U-NII-2A	Voice/Data	5260 - 5320 MHz
U-NII-2C	Voice/Data	5500 - 5720 MHz
U-NII-3	Voice/Data	5745 - 5825 MHz
U-NII-4	Voice/Data	5845 - 5885 MHz
U-NII-5	Voice/Data	5935 - 6415 MHz
U-NII-6	Voice/Data	6435 - 6525 MHz
U-NII-7	Voice/Data	6535 - 6875 MHz
U-NII-8	Voice/Data	6895 - 7115 MHz
Bluetooth	Data	2402 - 2480 MHz
NFC Data	Data	13.56 MHz
UWB	Data	6489.6 - 7987.2 MHz

FCC ID: A3LSMS906E	 PCTEST Proud to be part of  element	PART 2 RF EXPOSURE EVALUATION REPORT		Approved by: Technical Manager
Document S/N: 1M2202030009-07.A3L	Test Dates: 02/16/2022 – 03/21/2022	DUT Type: Portable Handset	Page 3 of 26	

1.2 Time-Averaging Algorithm for RF Exposure Compliance

This device is enabled with Qualcomm® Smart Transmit feature. This feature performs time averaging algorithm in real time to control and manage transmitting power and ensure the time-averaged RF exposure is in compliance with FCC requirements all the time. DUT contains embedded file system (EFS) version 17 configured for the second generation (GEN2) for Sub6.

The Smart Transmit algorithm maintains the time-averaged transmit power, in turn, time-averaged RF exposure of SAR_design_target, below the predefined time-averaged power limit (i.e., P_{limit} for sub-6 radio), for each characterized technology and band.

The DUT utilizes Peak Exposure Mode, allowing the device to transmit at P_{limit} for frequencies < 6 GHz.

Note that the device uncertainty for sub-6GHz WWAN is 1.0 dB for this DUT.



This purpose of the Part 2 report is to demonstrate the DUT complies with FCC RF exposure requirement under Tx varying transmission scenarios, thereby validity of Qualcomm® Smart Transmit feature implementation in this device. It serves to compliment the Part 0 and Part 1 Test Reports to justify compliance per FCC and ISED.

1.3 Part 2 Test Case Reduction for Peak Exposure Mode

Per FCC and Qualcomm guidance, the number of test cases for Part 2 evaluation can be reduced in the case of peak exposure mode. Part 2 evaluation is needed for all simultaneous transmission cases, time window switch cases, and verification of WWAN backoff (not applicable for this model).

1.4 Bibliography

Report Type	Report Serial Number
RF Exposure Part 1 SAR Test Report – Original Grant	1M2110010116-01.A3L (Rev1)
RF Exposure Part 1 SAR Test Report – Class II	1M2202030009-05.A3L
RF Exposure Part 0 SAR Test Report	1M2202030009-06.A3L
RF Exposure Compliance Summary Report	1M2202030009-08.A3L

FCC ID: A3LSMS906E	 PCTEST Proud to be part of 	PART 2 RF EXPOSURE EVALUATION REPORT		Approved by: Technical Manager
Document S/N: 1M2202030009-07.A3L	Test Dates: 02/16/2022 – 03/21/2022	DUT Type: Portable Handset	Page 4 of 26	

2 RF EXPOSURE LIMITS

2.1 Uncontrolled Environment

UNCONTROLLED ENVIRONMENTS are defined as locations where there is the exposure of individuals who have no knowledge or control of their exposure. The general population/uncontrolled exposure limits are applicable to situations in which the general public may be exposed or in which persons who are exposed as a consequence of their employment may not be made fully aware of the potential for exposure or cannot exercise control over their exposure. Members of the general public would come under this category when exposure is not employment-related; for example, in the case of a wireless transmitter that exposes persons in its vicinity.

2.2 Controlled Environment



CONTROLLED ENVIRONMENTS are defined as locations where there is exposure that may be incurred by persons who are aware of the potential for exposure, (i.e. as a result of employment or occupation). In general, occupational/controlled exposure limits are applicable to situations in which persons are exposed as a consequence of their employment, who have been made fully aware of the potential for exposure and can exercise control over their exposure. This exposure category is also applicable when the exposure is of a transient nature due to incidental passage through a location where the exposure levels may be higher than the general population/uncontrolled limits, but the exposed person is fully aware of the potential for exposure and can exercise control over his or her exposure by leaving the area or by some other appropriate means.

2.3 RF Exposure Limits for Frequencies Below 6 GHz

Table 2-1
SAR Human Exposure Specified in ANSI/IEEE C95.1-1992 and Health Canada Safety Code 6

HUMAN EXPOSURE LIMITS		
	UNCONTROLLED ENVIRONMENT <i>General Population</i> (W/kg) or (mW/g)	CONTROLLED ENVIRONMENT <i>Occupational</i> (W/kg) or (mW/g)
Peak Spatial Average SAR Head	1.6	8.0
Whole Body SAR	0.08	0.4
Peak Spatial Average SAR Hands, Feet, Ankle, Wrists, etc.	4.0	20



1. The Spatial Peak value of the SAR averaged over any 1 gram of tissue (defined as a tissue volume in the shape of a cube) and over the appropriate averaging time.
2. The Spatial Average value of the SAR averaged over the whole body.
3. The Spatial Peak value of the SAR averaged over any 10 grams of tissue (defined as a tissue volume in the shape of a cube) and over the appropriate averaging time.

FCC ID: A3LSMS906E	 PCTEST Proud to be part of 	PART 2 RF EXPOSURE EVALUATION REPORT		Approved by: Technical Manager
Document S/N: 1M2202030009-07.A3L	Test Dates: 02/16/2022 – 03/21/2022	DUT Type: Portable Handset	Page 5 of 26	

2.4 Time Averaging Windows for FCC Compliance

Per October 2018 TCB Workshop Notes, the below time-averaging windows can be used for assessing time-averaged exposures for devices that are capable of actively monitoring and adjusting power output over time to comply with exposure limits.

Interim Guidance	Frequency (GHz)	Maximum Averaging Time (sec)
SAR	< 3	100
	3 – 6	60
MPE	6 - 10	30
	10 - 16	14
	16 – 24	8
	24 – 42	4
	42 – 95	2

FCC ID: A3LSMS906E	 PCTEST Proud to be part of 	PART 2 RF EXPOSURE EVALUATION REPORT		Approved by: Technical Manager
Document S/N: 1M2202030009-07.A3L	Test Dates: 02/16/2022 – 03/21/2022	DUT Type: Portable Handset	Page 6 of 26	

3 TIME VARYING TRANSMISSION TEST CASES

To validate the time averaging feature and demonstrate the compliance in Tx varying transmission conditions, the following transmission scenarios are covered in the Part 2 test:

1. During time window switch: To prove that the Smart Transmit feature correctly handles the transition from one time window to another specified by FCC, and maintains the normalized time-averaged RF exposure to be less than normalized FCC limit of 1.0 at all times.
2. SAR exposure switching between two active radios (radio1 and radio2): To prove that the Smart Transmit feature functions correctly and ensures total RF exposure compliance when exposure varies among SAR_radio1 only, SAR_radio1 + SAR_radio2, and SAR_radio2 only scenarios.

As described in Part 0 report, the RF exposure is proportional to the Tx power for a SAR-characterized wireless device. Thus, feature validation in Part 2 can be effectively performed through conducted (for $f < 6\text{GHz}$) power measurement. Therefore, the compliance demonstration under dynamic transmission conditions and feature validation are done in conducted/radiated power measurement setup for transmission scenario 1 through 2.

The strategy for testing in Tx varying transmission condition is outlined as follows:

- Demonstrate the total RF exposure averaged over FCC defined time windows does not exceed FCC's SAR limits, through time-averaged power measurements
 - Measure conducted Tx power (for $f < 6\text{GHz}$) versus time versus time.
 - Convert it into RF exposure and divide by respective FCC limits to get normalized exposure versus time.
 - Perform running time-averaging over FCC defined time windows.
 - Demonstrate that the total normalized time-averaged RF exposure is less than 1 for all transmission scenarios (i.e., transmission scenarios 1 and 2) at all times.

Mathematical expression:

For $< 6\text{ GHz}$ transmission only:



$$1g_or_10gSAR(t) = \frac{conducted_Tx_power(t)}{conducted_Tx_power_P_{limit}} * 1g_or_10gSAR_P_{limit} \quad (1a)$$

$$\frac{1}{T_{SAR}} \int_{t-T_{SAR}}^t 1g_or_10gSAR(t) dt \leq 1 \quad (1b)$$

FCC SAR limit

where, $conducted_Tx_power(t)$, $conducted_Tx_power_P_{limit}$, and $1g_or_10gSAR_P_{limit}$ correspond to the measured instantaneous conducted Tx power, measured conducted Tx power at P_{limit} , and measured $1gSAR$ or $10gSAR$ values at P_{limit} corresponding to sub-6 transmission. P_{limit} is the parameter pre-defined in Part 0 and loaded via Embedded File System (EFS) onto the EUT. T_{SAR} is the FCC defined time window for sub-6 radio.

- Demonstrate the total RF exposure averaged over FCC defined time windows does not exceed FCC's SAR and PD limits, through time-averaged SAR and PD measurements. Note as mentioned earlier, this measurement is performed for transmission scenario 1 only.
 - For sub-6 transmission only, measure instantaneous SAR versus time; for LTE+sub6 NR transmission, request low power (or all-down bits) on LTE so that measured SAR predominantly corresponds to sub6 NR.

FCC ID: A3LSMS906E	 PCTEST <small>Proud to be part of element</small>	PART 2 RF EXPOSURE EVALUATION REPORT		Approved by: Technical Manager
Document S/N: 1M2202030009-07.A3L	Test Dates: 02/16/2022 – 03/21/2022	DUT Type: Portable Handset	Page 7 of 26	

- Convert it into RF exposure and divide by respective FCC limits to obtain normalized exposure versus time.
- Perform time averaging over FCC defined time window.
- Demonstrate that the total normalized time-averaged RF exposure is less than 1 for transmission scenario 1 at all times.



Mathematical expression:

- For sub-6 transmission only:

$$1g_or_10gSAR(t) = \frac{pointSAR(t)}{pointSAR_P_{limit}} * 1g_or_10gSAR(t)_P_{limit} \quad (2a)$$

$$\frac{\frac{1}{T_{SAR}} \int_{t-T_{SAR}}^t 1g_or_10gSAR(t) dt}{FCC\ SAR\ limit} \leq 1 \quad (2b)$$

where, $pointSAR(t)$, $pointSAR_P_{limit}$, and $1g_or_10gSAR_P_{limit}$ correspond to the measured instantaneous point SAR, measured point SAR at P_{limit} , and measured $1gSAR$ or $10gSAR$ values at P_{limit} corresponding to sub-6 transmission.

FCC ID: A3LSMS906E	 PCTEST Proud to be part of 	PART 2 RF EXPOSURE EVALUATION REPORT		Approved by: Technical Manager
Document S/N: 1M2202030009-07.A3L	Test Dates: 02/16/2022 – 03/21/2022	DUT Type: Portable Handset	Page 8 of 26	

This chapter provides the test plan and test procedure for validating Qualcomm Smart Transmit feature for sub-6 transmission. The 100 seconds time window for operating $f < 3\text{GHz}$ is used as an example to detail the test procedures in this chapter. The same test plan and test procedures described in this chapter apply to 60 seconds time window for operating $f \geq 3\text{GHz}$.

4.1 Test configuration selection criteria for validating Smart Transmit feature

For validating the Smart Transmit feature, this section provides the general guidance to select test cases.

4.1.1 Test configuration selection for change in time window

FCC specifies different time window for time averaging based on operation frequency. The criteria to select a test configuration for validating Smart Transmit feature and demonstrating the compliance during the change in time window is

- Select any technology/band that has operation frequency classified in one time window defined by FCC (such as 100-seconds time window), and its corresponding P_{limit} is less than P_{max} if possible.
- Select the 2nd technology/band that has operation frequency classified in a different time window defined by FCC (such as 60-seconds time window), and its corresponding P_{limit} is less than P_{max} if possible.
- Note it is preferred both P_{limit} values of two selected technology/band less than corresponding P_{max} , but if not possible, at least one of technologies/bands has its P_{limit} less than P_{max} .

This test is performed with the EUT's Tx power requested to be at maximum power in selected technology/band. Test for one pair of time windows selected is sufficient as the feature operation is the same.

4.1.2 Test configuration selection for SAR exposure switching



If supported, the test configuration for SAR exposure switching should cover

1. SAR exposure switch when two active radios are in the same time window
2. SAR exposure switch when two active radios are in different time windows. One test with two active radios in any two different time windows is sufficient as Smart Transmit operation is the same for RF exposure switch in any combination of two different time windows. For device supporting LTE + mmW NR, this test is covered in SAR vs PD exposure switch validation.

The Smart Transmit time averaging operation is independent of the source of SAR exposure (for example, LTE vs. Sub6 NR) and ensures total time-averaged RF exposure compliance. Hence, validation of Smart Transmit in any one simultaneous SAR transmission scenario (i.e., one combination for LTE + Sub6 NR transmission) is sufficient, where the SAR exposure varies among $\text{SAR}_{\text{radio1}}$ only, $\text{SAR}_{\text{radio1}} + \text{SAR}_{\text{radio2}}$, and $\text{SAR}_{\text{radio2}}$ only scenarios.

The criteria to select a test configuration for validating Smart Transmit feature during SAR exposure switching scenarios is

- Select any two < 6GHz technologies/bands that the EUT supports simultaneous transmission (for example, LTE+Sub6 NR).
- Among all supported simultaneous transmission configurations, the selection order is
 1. select one configuration where both P_{limit} of radio1 and radio2 is less than their corresponding P_{max} , preferably, with different P_{limits} . If this configuration is not available, then,

FCC ID: A3LSMS906E	 PCTEST Proud to be part of 	PART 2 RF EXPOSURE EVALUATION REPORT		Approved by: Technical Manager
Document S/N: 1M2202030009-07.A3L	Test Dates: 02/16/2022 – 03/21/2022	DUT Type: Portable Handset	Page 9 of 26	

2. select one configuration that has P_{limit} less than its P_{max} for at least one radio. If this can not be found, then,
3. select one configuration that has P_{limit} of radio1 and radio2 greater than P_{max} but with least $(P_{limit} - P_{max})$ delta.

Test for one simultaneous transmission scenario is sufficient as the feature operation is the same.

4.2 Test procedures for conducted power measurements

This section provides general conducted power measurement procedures to perform compliance test under dynamic transmission scenarios described in Section 3. In practice, an adjustment can be made in these procedures. The justification/clarification may be provided.

4.2.1 Change in time window

This test is to demonstrate the correct power control by Smart Transmit during the change in averaging time window when a specific band handover occurs. FCC specifies time-averaging windows of 100s for Tx frequency < 3GHz, and 60s for Tx frequency between 3GHz and 6GHz.

To validate the continuity of RF exposure limiting during the transition, the band handover test needs to be performed when EUT handovers from operation band less than 3GHz to greater than 3GHz and vice versa. The equations (2a) and (2b) in Section 3 can be written as follows for transmission scenario having change in time window,

$$1gSAR_1(t) = \frac{\text{conducted_Tx_power_1}(t)}{\text{conducted_Tx_power_P}_{limit_1}} * 1g_or\ 10g_SAR_P_{limit_1} \quad (3a)$$

$$1gSAR_2(t) = \frac{\text{conducted_Tx_power_2}(t)}{\text{conducted_Tx_power_P}_{limit_2}} * 1g_or\ 10g_SAR_P_{limit_2} \quad (3b)$$

$$\frac{1}{T_{1SAR}} \left[\int_{t-T_{1SAR}}^{t_1} \frac{1g_or\ 10g_SAR_1(t)}{FCC\ SAR\ limit} dt \right] + \frac{1}{T_{2SAR}} \left[\int_{t-T_{2SAR}}^t \frac{1g_or\ 10g_SAR_2(t)}{FCC\ SAR\ limit} dt \right] \leq 1 \quad (3c)$$



where, $\text{conducted_Tx_power_1}(t)$, $\text{conducted_Tx_power_P}_{limit_1}(t)$, and $1g_or\ 10g_SAR_P_{limit_1}$ correspond to the instantaneous Tx power, conducted Tx power at P_{limit} , and compliance $1g_or\ 10g_SAR$ values at P_{limit_1} of band1 with time-averaging window ' T_{1SAR} '; $\text{conducted_Tx_power_2}(t)$, $\text{conducted_Tx_power_P}_{limit_2}(t)$, and $1g_or\ 10g_SAR_P_{limit_2}$ correspond to the instantaneous Tx power, conducted Tx power at P_{limit} , and compliance $1g_or\ 10g_SAR$ values at P_{limit_2} of band2 with time-averaging window ' T_{2SAR} '. One of the two bands is less than 3GHz, another is greater than 3GHz. Transition from first band with time-averaging window ' T_{1SAR} ' to the second band with time-averaging window ' T_{2SAR} ' happens at time-instant ' t_1 '.

Test procedure

1. Measure P_{limit} for both the technologies and bands selected in Section 4.1.1. Measure P_{limit} with Smart Transmit enabled and *Reserve_power_margin* set to 0 dB, callbox set to request maximum power.
2. Set *Reserve_power_margin* to actual (intended) value and enable Smart Transmit

Transition from 100s time window to 60s time window, and vice versa

3. Establish radio link with callbox in the technology/band having 100s time window selected in Section 4.1.1.
4. Request EUT's Tx power to be at 0 dBm for at least 100 seconds, followed by requesting EUT's Tx power to be at maximum power for about ~140 seconds, and then switch to second technology/band (having

FCC ID: A3LSMS906E	 PCTEST Proud to be part of  element	PART 2 RF EXPOSURE EVALUATION REPORT		Approved by: Technical Manager
Document S/N: 1M2202030009-07.A3L	Test Dates: 02/16/2022 – 03/21/2022	DUT Type: Portable Handset	Page 10 of 26	

60s time window) selected in Section 4.1.1. Continue with callbox requesting EUT's Tx power to be at maximum power for about ~60s in this second technology/band, and then switch back to the first technology/band. Continue with callbox requesting EUT's Tx power to be at maximum power for at least another 100s. Measure and record Tx power versus time for the entire duration of the test.

5. Once the measurement is done, extract instantaneous Tx power versus time, and convert the conducted Tx power into 1gSAR or 10gSAR value (see Eq. (7a) and (7b)) using corresponding technology/band Step 1 result, and then perform 100s running average to determine time-averaged 1gSAR or 10gSAR versus time. Note that in Eq.(7a) & (7b), instantaneous Tx power is converted into instantaneous 1gSAR or 10gSAR value by applying the worst-case 1gSAR or 10gSAR value tested in Part 1 for the selected technologies/bands at P_{limit} .
6. Make one plot containing: (a) instantaneous Tx power versus time measured in Step 4.
7. Make another plot containing: (a) instantaneous 1gSAR versus time determined in Step 5, (b) computed time-averaged 1gSAR versus time determined in Step 5, and (c) corresponding regulatory $1gSAR_{limit}$ of 1.6W/kg or $10gSAR_{limit}$ of 4.0W/kg.

Transition from 60s time window to 100s time window, and vice versa

8. Establish radio link with callbox in the technology/band having 60s time window selected in Section 4.1.1.
9. Request EUT's Tx power to be at 0 dBm for at least 60 seconds, followed by requesting EUT's Tx power to be at maximum power for about ~80 seconds, and then switch to second technology/band (having 100s time window) selected in Section 4.1.1. Continue with callbox requesting EUT's Tx power to be at maximum power for about ~100s in this second technology/band, and then switch back to the first technology/band. Continue with callbox requesting EUT's Tx power to be at maximum power for the remaining time for a total test time of 500 seconds. Measure and record Tx power versus time for the entire duration of the test.
10. Repeat above Step 5~7 to generate the plots



The validation criteria is, at all times, the time-averaged 1gSAR or 10gSAR versus time shall not exceed the regulatory $1gSAR_{limit}$ of 1.6W/kg or $10gSAR_{limit}$ of 4.0W/kg.

4.2.2 SAR exposure switching

This test is to demonstrate that Smart Transmit feature is accurately accounts for switching in exposures among SAR from radio1 only, SAR from both radio1 and radio2, and SAR from radio2 only scenarios, and ensures total time-averaged RF exposure complies with the FCC limit. Here, radio1 represents primary radio (for example, LTE anchor in a NR non-standalone mode call) and radio2 represents secondary radio (for example, sub6 NR or mmW NR). The detailed test procedure for SAR exposure switching in the case of LTE+Sub6 NR non-standalone mode transmission scenario is provided in APPENDIX B.

Test procedure:



1. Measure conducted Tx power corresponding to P_{limit} for radio1 and radio2 in selected band. Test condition to measure conducted P_{limit} is:
 - Establish device in call with the callbox for radio1 technology/band. Measure conducted Tx power corresponding to radio1 P_{limit} with Smart Transmit enabled and Reserve_power_margin set to 0 dB, callbox set to request maximum power.
 - Repeat above step to measure conducted Tx power corresponding to radio2 P_{limit} . If radio2 is dependent on radio1 (for example, non-standalone mode of Sub6 NR requiring radio1 LTE as anchor), then establish radio1 + radio2 call with callbox, and request all down bits for radio1 LTE.

FCC ID: A3LSMS906E	 PCTEST Proud to be part of  element	PART 2 RF EXPOSURE EVALUATION REPORT		Approved by: Technical Manager
Document S/N: 1M2202030009-07.A3L	Test Dates: 02/16/2022 – 03/21/2022	DUT Type: Portable Handset	Page 11 of 26	

In this scenario, with callbox requesting maximum power from radio2 Sub6 NR, measured conducted Tx power corresponds to radio2 P_{limit} (as radio1 LTE is at all-down bits)

2. Set *Reserve_power_margin* to actual (intended) value, with EUT setup for radio1 + radio2 call. In this description, it is assumed that radio2 has lower priority than radio1. Establish device in radio1+radio2 call, and request all-down bits or low power on radio1, with callbox requesting EUT's Tx power to be at maximum power in radio2 for at least one time window. After one time window, set callbox to request EUT's Tx power to be at maximum power on radio1, i.e., all-up bits. Continue radio1+radio2 call with both radios at maximum power for at least one time window, and drop (or request all-down bits on) radio2. Continue radio1 at maximum power for at least one time window. Record the conducted Tx power for both radio1 and radio2 for the entire duration of this test.
3. Once the measurement is done, extract instantaneous Tx power versus time for both radio1 and radio2 links. Convert the conducted Tx power for both these radios into 1gSAR or 10gSAR value (see Eq. (3a) and (3b)) using corresponding technology/band P_{limit} measured in Step 1, and then perform the running time average to determine time-averaged 1gSAR or 10gSAR versus time.
4. Make one plot containing: (a) instantaneous Tx power versus time measured in Step 2.
5. Make another plot containing: (a) instantaneous 1gSAR versus time determined in Step 3, (b) computed time-averaged 1gSAR versus time determined in Step 3, and (c) corresponding regulatory $1gSAR_{limit}$ of 1.6W/kg or $10gSAR_{limit}$ of 4.0W/kg.

The validation criteria is, at all times, the time-averaged 1gSAR or 10gSAR versus time shall not exceed the regulatory $1gSAR_{limit}$ of 1.6W/kg or $10gSAR_{limit}$ of 4.0W/kg.

FCC ID: A3LSMS906E	 PCTEST Proud to be part of 	PART 2 RF EXPOSURE EVALUATION REPORT		Approved by: Technical Manager
Document S/N: 1M2202030009-07.A3L	Test Dates: 02/16/2022 – 03/21/2022	DUT Type: Portable Handset	Page 12 of 26	

5.1 Conducted Measurement Test setup

Legacy Test Setup

The Rohde & Schwarz CMW500 callbox was used in this test. The test setup schematic is shown in Figure 5-1c (Appendix D – Test Setup Photo 3) for measurements involving Inter-band ULCA. For Inter-band ULCA measurements, two ports, (RF1 COM & RF3 COM) of the callbox used for signaling the PCC band and SCC band respectively are each connected to the PCC and SCC RF ports of the DUT using two directional couplers. In the setups, power meters are used to tap the directional couplers for measuring the conducted output power of the DUT.

All the path losses from RF port of DUT to the callbox RF COM port and to the power meter are calibrated and automatically entered as offsets in the callbox and the power meter via test scripts on the PC used to control callbox and power meter.

Sub6 NR test setup:



The Anritsu MT8000A callbox was used in this test. The test setup schematic is shown in Figure 5-1a (Appendix A – Test Setup Photo 1) for measurements involving antenna switch. For change in time window measurement, one port (RF1) of the callbox used for signaling two different bands is connected to a combiner, which is in turn connected to a directional coupler. The other end of the directional coupler is connected to a splitter to connect to two RF ports of the DUT corresponding to the two antennas of interest.

All the path losses from RF port of DUT to the callbox RF COM port and to the power meter are calibrated and automatically entered as offsets in the callbox and the power meter via test scripts on the PC used to control callbox and power meter.

LTE+Sub6 NR test setup:

LTE conducted port and Sub6 NR conducted port are the same on this EUT, therefore, the LTE and Sub6 NR signals for power meter measurement are performed on separate paths as shown below in Figure 5-1b (Appendix A – Test Setup Photo 2).

All the path losses from RF port of DUT to the callbox RF COM port and to the power meter are calibrated and automatically entered as offsets in the callbox and the power meter via test scripts on the PC used to control callbox and power meter.

FCC ID: A3LSMS906E	 PCTEST Proud to be part of 	PART 2 RF EXPOSURE EVALUATION REPORT		Approved by: Technical Manager
Document S/N: 1M2202030009-07.A3L	Test Dates: 02/16/2022 – 03/21/2022	DUT Type: Portable Handset	Page 13 of 26	

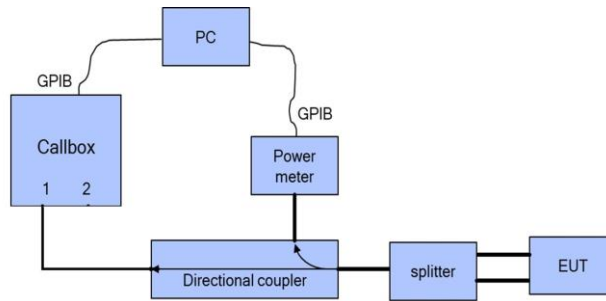

(a) Appendix A – Test Setup Photo 1

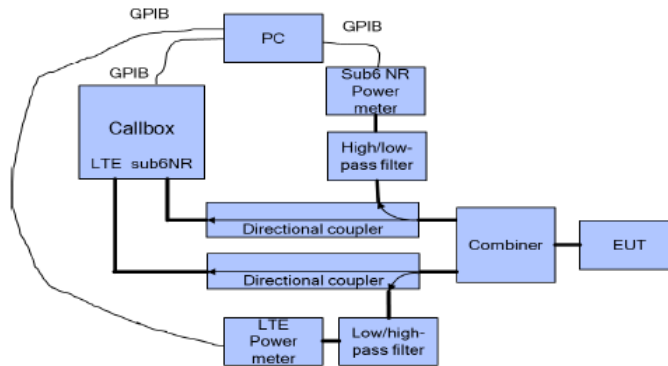

(b) Appendix A – Test Setup Photo 2

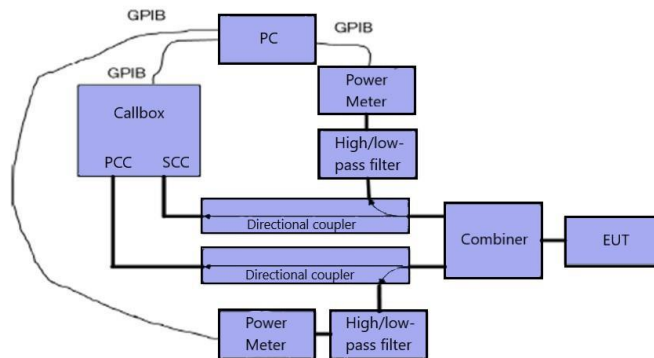



(c) Appendix A – Test Setup Photo 3

**Figure 5-1
Conducted power measurement setup**

Both the callbox and power meter are connected to the PC using GPIB cables.

Power meter readings are periodically recorded every 100ms. A running average of this measured Tx power over 100 seconds is performed in the post-data processing to determine the 100s-time averaged power.

FCC ID: A3LSMS906E	 PCTEST Proud to be part of 	PART 2 RF EXPOSURE EVALUATION REPORT		Approved by: Technical Manager
Document S/N: 1M2202030009-07.A3L	Test Dates: 02/16/2022 – 03/21/2022	DUT Type: Portable Handset		Page 14 of 26

6.1 WWAN (sub-6) transmission



The P_{limit} values, corresponding to 1.0 W/kg (1gSAR) and 2.5 W/kg (10gSAR) of SAR_{design_target} , for technologies and bands supported by DUT are derived in Part 0 report and summarized in Table 6-1. Note all P_{limit} power levels entered in Table 6-1 correspond to average power levels after accounting for duty cycle in the case of TDD modulation schemes.

Table 6-1
 P_{limit} for supported technologies and bands (P_{limit} in EFS file)

Exposure Scenario			Body-Worn	Phablet Max	Phablet Reduced	Head	Hotspot	Earjack	Maximum Tune-Up Output Power*
Averaging Volume			1g	10g	10g	1g	1g	10g	
Spacing			15 mm	11, 8, 6, 0 mm	0 mm	0 mm	10 mm	0 mm	
DSI			0	0	1	2	3	4	
Technology/Band	Antenna	Antenna Group							Pmax
GSM 850	A	AG0	30.0	28.1	30.0	27.8	28.1	25.3	
GSM 1900	A	AG0	26.6	17.8	32.5	17.8	17.8	22.1	
UMTS 850	A	AG0	29.9	26.6	30.7	26.6	26.6	24.0	
UMTS 1750	A	AG0	24.3	20.0	28.7	19.0	20.0	23.0	
UMTS 1900	A	AG0	24.8	19.5	31.2	17.5	19.5	23.0	
LTE Band 12/17	A	AG0	31.2	27.8	32.9	27.8	27.8	24.0	
LTE Band 13	A	AG0	29.7	27.6	29.9	26.9	27.6	24.0	
LTE Band 26/5 (Cell)	A	AG0	29.5	27.4	31.2	27.2	27.4	24.5	
LTE Band 66/4 (AWS)	A	AG0	26.0	18.5	30.5	17.0	18.5	22.5	
LTE Band 4 (AWS)	I	AG1	21.0	21.0	15.0	15.0	21.0	20.0	
LTE Band 25/2 (PCS)	A	AG0	24.1	18.5	29.6	16.5	18.5	22.0	
LTE Band 41 (PC3)	B	AG0	27.5	20.5	38.7	20.5	20.5	21.5	
LTE Band 41 (PC2)	B	AG0	27.5	20.5	38.7	20.5	20.5	21.9	
NR Band n5 (Cell)	A	AG0	30.6	26.5	30.9	26.5	26.5	24.0	
NR Band n66 (AWS)	A	AG0	26.1	20.0	30.5	18.5	20.0	23.5	
NR Band n66 (AWS)	I	AG1	22.0	22.0	18.0	22.0	22.0	22.0	
NR Band n25/n2 (PCS)	A	AG0	25.5	20.5	31.4	18.0	20.5	23.5	
NR Band n41 SRS 1	I	AG1	18.0	18.0	16.0	18.0	18.0	24.5	
NR Band n41 SRS 2	B	AG0	16.0	16.0	16.0	16.0	16.0	23.5	
NR Band n41 SRS 3	E	AG1	13.0	13.0	13.0	13.0	13.0	19.0	
NR Band n41 SRS 4	D	AG0	14.0	14.0	14.0	14.0	14.0	20.0	
NR Band n77 DoD SRS 1	F	AG1	18.0	18.0	12.5	18.0	18.0	24.5	
NR Band n77 DoD SRS 2	C	AG0	16.0	16.0	16.0	16.0	16.0	21.5	
NR Band n77 DoD SRS 3	H	AG1	17.5	17.5	15.0	17.5	17.5	24.5	
NR Band n77 DoD SRS 4	D	AG0	15.5	15.5	15.5	15.5	15.5	21.5	
NR Band n77 SRS 1	F	AG1	18.0	18.0	12.5	18.0	18.0	24.5	
NR Band n77 SRS 2	C	AG0	16.0	16.0	16.0	16.0	16.0	21.5	
NR Band n77 SRS 3	H	AG1	17.5	17.5	15.0	17.5	17.5	24.5	
NR Band n77 SRS 4	D	AG0	15.5	15.5	15.5	15.5	15.5	21.5	

* Maximum tune up target power, P_{max} , is configured in NV settings in DUT to limit maximum transmitting power. This power is converted into peak power in NV settings for TDD schemes. The DUT maximum allowed output power is equal to $P_{max} + 1$ dB device uncertainty.

Based on selection criteria described in Section 4.2.1, the selected technologies/bands for testing are highlighted in yellow in Table 6-1.

FCC ID: A3LSMS906E	 PCTEST Proud to be part of  element	PART 2 RF EXPOSURE EVALUATION REPORT		Approved by: Technical Manager
Document S/N: 1M2202030009-07.A3L	Test Dates: 02/16/2022 – 03/21/2022	DUT Type: Portable Handset		Page 15 of 26

The radio configurations used in Part 2 test for selected technologies, bands, DSIs and antennas are listed in Table 6-2. The corresponding worst-case radio configuration 1gSAR values for selected technology/band/DSI are extracted from Part 1 report and are listed in the last column of Table 6-2.

Based on equations (1a) and (2a), it is clear that Part 2 testing outcome is normalized quantity, which implies that it can be applied to any radio configuration within a selected technology/band/DSI. Thus, as long as applying the worst-case SAR obtained from the worst radio configuration in Part 1 testing to calculate time-varying SAR exposure in equations (1a) and (2a), the accuracy in compliance demonstration remains the same. Therefore, there may be some differences between the radio configuration selected for Part 2 testing and the radio configuration associated with worst-case SAR obtained in the Part 1 evaluation.

Table 6-2
Radio configurations selected for Part 2 test

Test Case #	Test Scenario	Tech	Band	Antenna	DSI	Channel	Frequency [MHz]	RB/RB Offset/Bandwidth (MHz)	Mode	SAR Exposure Scenario	Part 1 Worst Case Measured SAR at Plimit (W/kg)
1	Time Window/Antenna Switch	NR	n41/SA	I	2	518598	2593	1/1/100 MHz BW	DFT-S-OFDM, QPSK	Left, tilt	0.747
			n77/SA	F	2	650000	3750	1/1/100 MHz BW	DFT-S-OFDM, QPSK	Right, cheek	0.337
2	SAR1 vs SAR2	LTE	5	A	3	20525	836.5	1/0/10 MHz BW	QPSK	Back side, 10mm	0.449*
		Sub6 NR	n66/NSA	A	3	349000	1745	1/1/20 MHz BW	DFT-S-OFDM, QPSK	Bottom edge, 10mm	0.895*
3	Interband ULCA	LTE	4	A	3	20175	1732.5	1/50/20 MHz BW	QPSK	Bottom edge, 10mm	0.597*
		LTE	5	A	3	20525	836.5	1/0/10 MHz BW	QPSK	Back side, 10mm	0.449*



*Values from original certification

Table 6-3
DSI and Corresponding Exposure Scenarios

Scenario	Description	SAR Test Cases
Head (DSI = 2)	<ul style="list-style-type: none"> Device positioned next to head Receiver Active 	Head SAR per KDB Publication 648474 D04
Hotspot mode (DSI = 3)	<ul style="list-style-type: none"> Device transmits in hotspot mode near body Hotspot Mode Active 	Hotspot SAR per KDB Publication 941225 D06
Phablet Grip (DSI=1 or 4)	<ul style="list-style-type: none"> Device is held with hand and grip sensor is triggered Grip sensor triggered or earjack is active 	Phablet SAR per KDB Publication 648474 D04 & KDB Publication 616217 D04
Phablet (DSI = 0)	<ul style="list-style-type: none"> Device is held with hand and grip sensor is not triggered Distance grip sensor not triggered 	Phablet SAR per KDB Publication 648474 D04 & KDB Publication 616217 D04
Body-worn (DSI = 0)	<ul style="list-style-type: none"> Device being used with a body-worn accessory 	Body-worn SAR per KDB Publication 648474 D04

Based on the selection criteria described in Section 4.2, the radio configurations for the Tx varying transmission test cases listed in Section 3 are:

- Technologies and bands for change in time-window/antenna:** Based on selection criteria in Section 4.2.1, for a given DSI=2, test case 1 in Table 6-2 is selected for time window switch between 60s window (NR n77/SA, Antenna F) and 100s window (NR n41/SA, Antenna I) in conducted power setup.
- Technologies and bands for switch in SAR exposure (ENDC):** Based on selection criteria in Section 4.2.2 Scenario 1, test case 2 in Table 6-2 is selected for SAR exposure switching test in one of the supported simultaneous WWAN transmission scenario, i.e., LTE + Sub6 NR active in the same 100s time window, in conducted power setup.

FCC ID: A3LSMS906E	 PCTEST Proud to be part of 	PART 2 RF EXPOSURE EVALUATION REPORT		Approved by: Technical Manager
Document S/N: 1M2202030009-07.A3L	Test Dates: 02/16/2022 – 03/21/2022	DUT Type: Portable Handset	Page 16 of 26	

3. Technologies and bands for switch in SAR exposure (Interband ULCA): Based on selection criteria in Section 4.2.2 Scenario 1, test case 3 in Table 6 2 is selected for SAR exposure switching test in one of the supported simultaneous LTE transmission scenario, i.e., LTE interband ULCA, in conducted power setup.

Note: All test cases were done with modes/bands within the same antenna group. Thus, there is no technologies and bands for switch in SAR exposure with two active radios in any two different time windows.

6.2 P_{limit} and P_{max} measurement results

The measured P_{limit} for all the selected radio configurations given in Table 6-2 are listed in below Table 6-4. P_{max} was also measured for radio configurations selected for testing time-varying Tx power transmission scenarios in order to generate test sequences following the test procedures in Section 4.1.

Table 6-4
Measured P_{limit} and P_{max} of selected radio configurations

Test Case #	Test Scenario	Tech	Band	Antenna	DSI	Channel	Frequency [MHz]	RB/RB Offset/Bandwidth (MHz)	Mode	SAR Exposure Scenario	EFS P _{limit} [dBm]	Tune-up P _{max} [dBm]	Measured P _{limit} [dBm]	Measured P _{max} [dBm]
1	Time Window/Antenna Switch	NR	n41/SA	I	2	518598	2593	1/1/100 MHz BW	DFT-S-OFDM, QPSK	Head	16.0	24.5	16.32	22.92
			n77/SA	F	2	650000	3750	1/1/100 MHz BW	DFT-S-OFDM, QPSK	Head	12.5	24.5	13.45	22.94
2	SAR1 vs SAR2	LTE	5	A	3	20525	836.5	1/0/10 MHz BW	QPSK	Hotspot	27.2	24.5	24.62	24.62
			Sub6 NR	n66/NSA	A	3	349000	1745	1/1/20 MHz BW	DFT-S-OFDM, QPSK	Hotspot	18.5	23.5	19.14
3	Interband ULCA	LTE	4	A	3	20175	1732.5	1/50/20 MHz BW	QPSK	Hotspot	17.0	22.5	17.59	23.06
			5	A	3	20525	836.5	1/0/10 MHz BW	QPSK	Hotspot	27.2	24.5	24.62	24.62



Note: The device uncertainty of P_{max} is +/- 1 dB as provided by manufacturer.

Note: NR TDD P_{max} and P_{lim} are measured at 72% duty cycle.

6.3 EFS v17 Verification

Per Qualcomm's 80-w2112-5 document, embedded file system (EFS) version 17 products are required to be verified for Smart Tx generation for relevant MCC settings. It was confirmed that this DUT contains embedded file system (EFS) version 17 configured for Smart Tx second generation (GEN2) for Sub6 Peak Exposure Mode with MCC settings for the US market.

EFS v17 Generation	MCC
GEN2_SUB6	310

FCC ID: A3LSMS906E	 PCTEST Proud to be part of  element	PART 2 RF EXPOSURE EVALUATION REPORT		Approved by: Technical Manager
Document S/N: 1M2202030009-07.A3L	Test Dates: 02/16/2022 – 03/21/2022	DUT Type: Portable Handset	Page 17 of 26	

7 CONDUCTED TX CASES (FREQ < 6 GHZ)

7.1 Change in Time window / antenna switch test results

This test was conducted with callbox requesting maximum power, and with time-window/antenna switch between NR n41, Antenna I, DSI = 2 (100s window) and NR n77, Antenna F, DSI = 2 (60s window). Following procedure detailed in Section 4.2.1 and using the measurement setup shown in Figure 5-1(a), the time-window switch via tech/band/antenna switch was performed when the EUT is transmitting at $P_{reserve}$ level. Due to the limitation of the MT8000A callbox, this test was done at 72% duty cycle.

7.1.1 Test case 1: transition from NR n41 PC3 to NR n77 PC3 (i.e., 100s to 60s), then back to NR n41 PC3

Test result for change in time-window (from 100s to 60s to 100s):

All the conducted Tx power measurement results were converted into time-averaged normalized SAR values using Equation (3a), (3b) and (3c), and plotted below to demonstrate that the time-averaged normalized SAR versus time does not exceed the FCC limit of 1 unit. Equation (3a) is used to convert the Tx power of device to obtain 100s-averaged normalized SAR in NR n41 as shown in black curve. Similarly, equation (3b) is used to obtain 60s-averaged normalized SAR in NR n77 as shown in orange curve. Equation (3c) is used to obtain total time-averaged normalized SAR as shown in green curve (i.e., sum of black and orange curves).

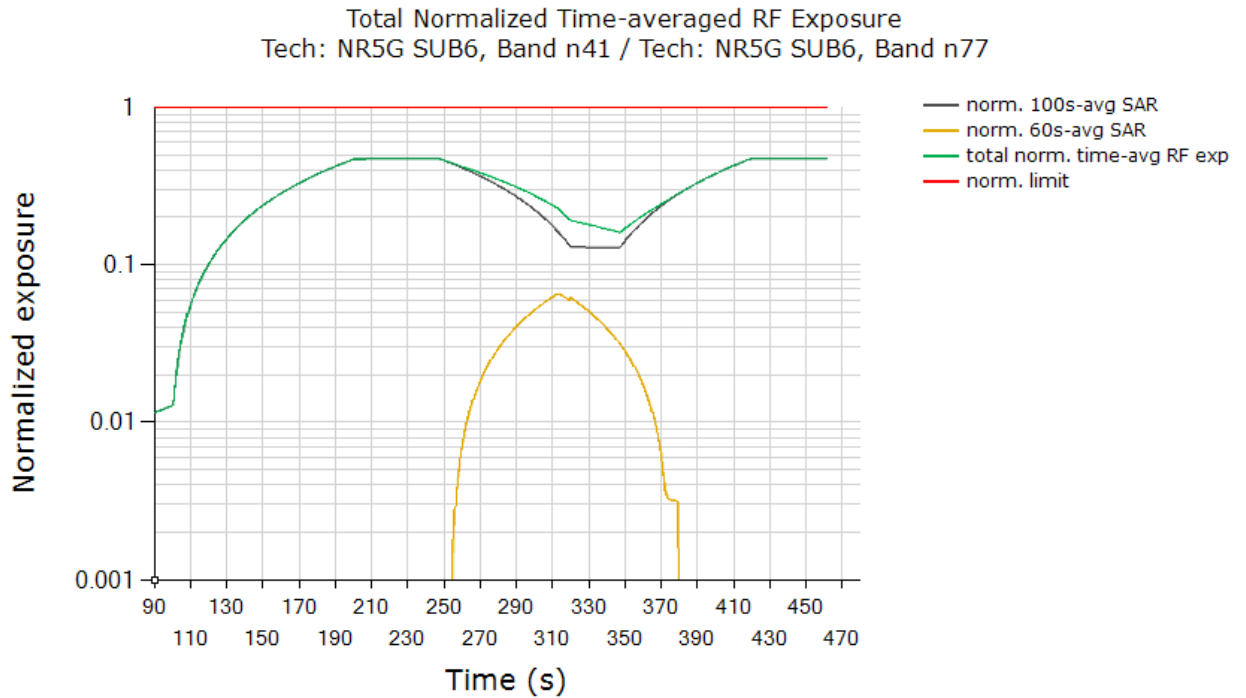

	(W/kg)
FCC normalized total exposure limit	1.0
Max time averaged normalized SAR (green curve)	0.473
Validated	

FCC ID: A3LSMS906E	 Proud to be part of	PART 2 RF EXPOSURE EVALUATION REPORT		Approved by: Technical Manager
Document S/N: 1M2202030009-07.A3L	Test Dates: 02/16/2022 – 03/21/2022	DUT Type: Portable Handset	Page 18 of 26	

Plot Notes: Maximum power is requested by callbox for the entire duration of the test, with tech/band switches from 100s-to-60s window at ~250s time stamp, and from 60s-to-100s window at ~320s time stamp. Smart Transmit controls the Tx power during these time-window switches to ensure total time-averaged RF exposure, i.e., sum of black and orange curves given by equation (3c), is always compliant. In time-window switch test, at all times the total time-averaged normalized RF exposure (green curve) should not exceed normalized $SAR_{design_target} + 1dB$ device uncertainty. In this test, with a maximum normalized SAR of 0.473 being ≤ 0.79 ($= 1.0/1.6 + 1dB$ device uncertainty), the above test result validated the continuity of power limiting in time-window switch scenario.

7.1.2 Test case 2: transition from NR n77 PC3 to NR n41 PC3(i.e., 60s to 100s), then back to NR n41 PC3

Test result for change in time-window (from 60s to 100s to 60s):

All the conducted Tx power measurement results were converted into time-averaged normalized SAR values using Equation (3a), (3b) and (3c), and plotted below to demonstrate that the time-averaged normalized SAR versus time does not exceed the FCC limit of 1 unit. Equation (3a) is used to convert the Tx power of device to obtain 60s-averaged normalized SAR in NR n77 as shown in black curve. Similarly, equation (3b) is used to obtain 100s-averaged normalized SAR in NR n41 as shown in orange curve. Equation (3c) is used to obtain total time-averaged normalized SAR as shown in green curve (i.e., sum of black and orange curves).

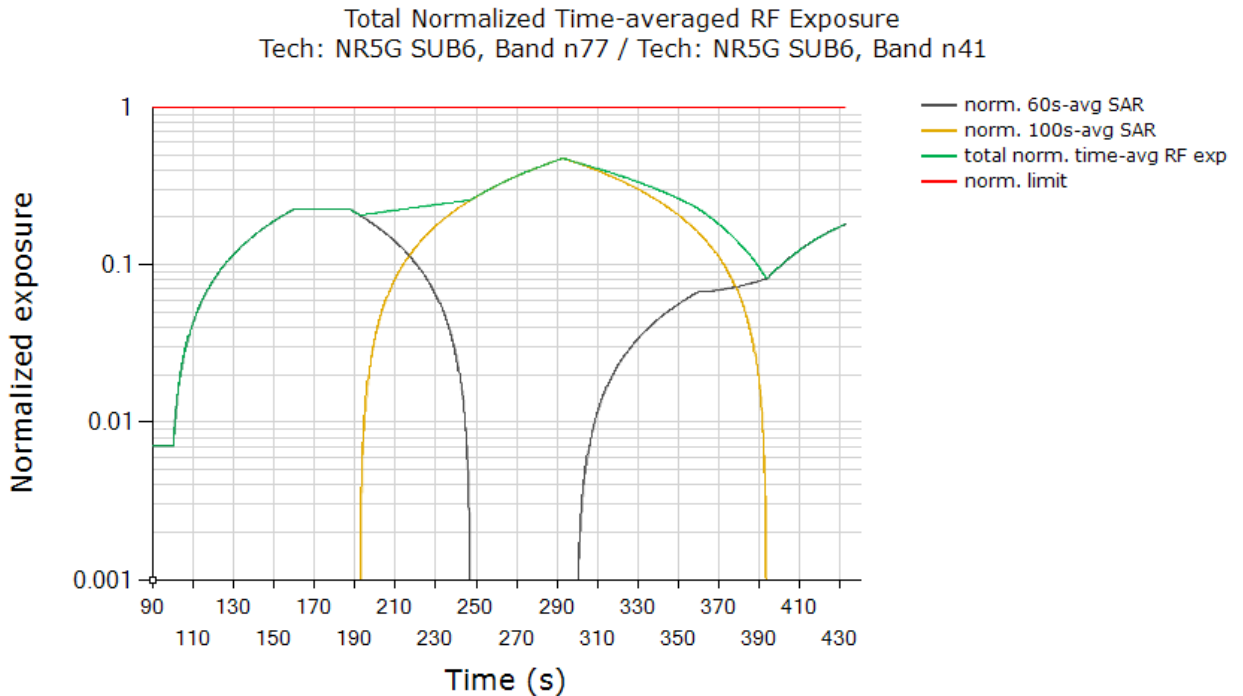

	(W/kg)
FCC normalized total exposure limit	1.0
Max time averaged normalized SAR (green curve)	0.471
Validated	

FCC ID: A3LSMS906E	PCTEST Proud to be part of element	PART 2 RF EXPOSURE EVALUATION REPORT		Approved by: Technical Manager
Document S/N: 1M2202030009-07.A3L	Test Dates: 02/16/2022 – 03/21/2022	DUT Type: Portable Handset	Page 19 of 26	

Plot Notes: Maximum power is requested by callbox for the entire duration of the test, with tech/band switches from 60s-to-100s window at ~190s time stamp, and from 100s-to-60s window at ~300s time stamp. Smart Transmit controls the Tx power during these time-window switches to ensure total time-averaged RF exposure, i.e., sum of black and orange curves given by equation (3c), is always compliant. In time-window switch test, at all times the total time-averaged normalized RF exposure (green curve) should not exceed normalized *SAR_design_target* + 1dB device uncertainty. In this test, with a maximum normalized SAR of 0.471 being ≤ 0.79 ($= 1.0/1.6 + 1\text{dB device uncertainty}$), the above test result validated the continuity of power limiting in time-window switch scenario.

7.2 Switch in SAR exposure test results (ENDC)

This test was conducted with callbox requesting maximum power, and with the EUT in LTE Band 5 + Sub6 NR Band n66 call. Following procedure detailed in Section 4.2.2 and Appendix B.1, and using the measurement setup shown in Figure 5-1(b) since LTE and Sub6 NR are sharing the same antenna port, the SAR exposure switch measurement is performed with the EUT in various SAR exposure scenarios, i.e., in SAR_{sub6NR} only scenario (t = 0s ~ 120s), SAR_{sub6NR} + SAR_{LTE} scenario (t = 120s ~ 240s) and SAR_{LTE} only scenario (t > 240s).

Plot Notes: All the conducted Tx power measurement results were converted into time-averaged normalized SAR values using Equation (3a), (3b) and (3c), and plotted below to demonstrate that the time-averaged normalized SAR versus time does not exceed the FCC limit of 1 unit. Equation (3a) is used to convert the LTE Tx power of device to obtain 100s-averaged normalized SAR in LTE Band 5 as shown in black curve. Similarly, equation (3b) is used to obtain 100s-averaged normalized SAR in Sub6 NR n66 as shown in orange curve. Equation (3c) is used to obtain total time-averaged normalized SAR as shown in green curve (i.e., sum of black and orange curves).

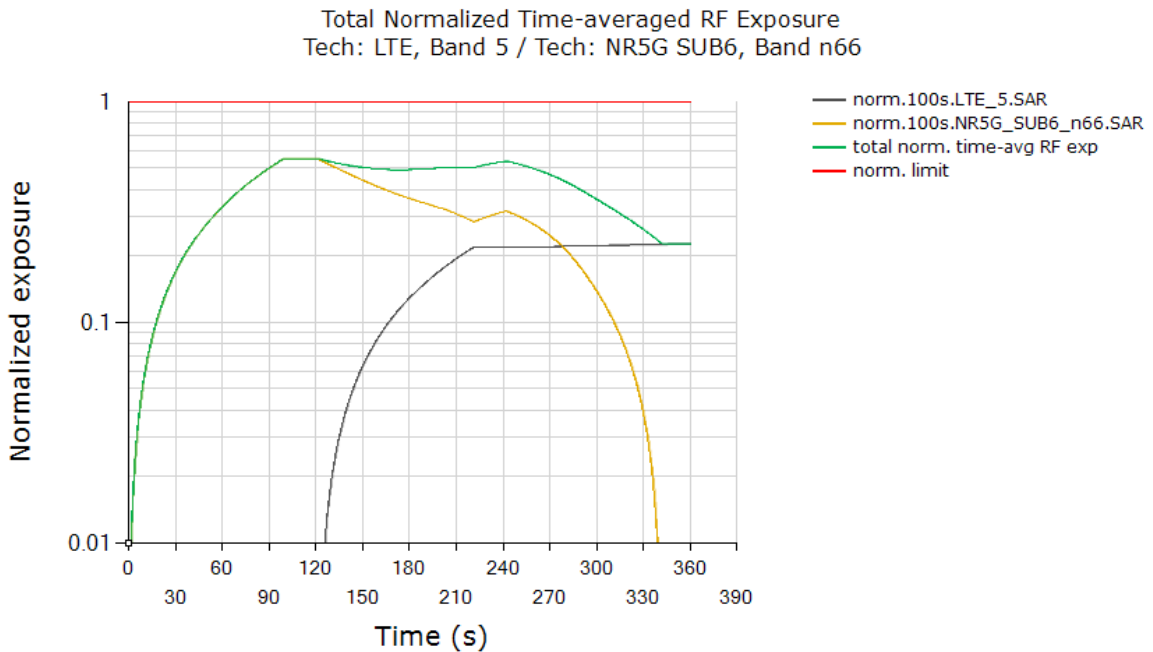

	(W/kg)
FCC normalized total exposure limit	1.0
Max time averaged normalized SAR (green curve)	0.552
Validated	

FCC ID: A3LSMS906E	PCTEST <small>Proud to be part of element</small>	PART 2 RF EXPOSURE EVALUATION REPORT		Approved by: Technical Manager
Document S/N: 1M2202030009-07.A3L	Test Dates: 02/16/2022 – 03/21/2022	DUT Type: Portable Handset	Page 20 of 26	

Plot Notes: Device starts predominantly in Sub6 NR SAR exposure scenario between 0s and 120s, and in LTE SAR + Sub6 NR SAR exposure scenario between 120s and 240s, and in predominantly in LTE SAR exposure scenario after t=240s. Here, Smart Transmit allocates a maximum of 100% of exposure margin (based on 3dB reserve margin setting) for Sub6 NR. This corresponds to a normalized 1gSAR exposure value = $100\% * 0.895 \text{ W/kg measured SAR at Sub6 NR } P_{limit} / 1.6\text{W/kg limit} = 0.559 \pm 1\text{dB device related uncertainty}$ (see orange curve between 120s). For predominantly LTE SAR exposure scenario, maximum normalized 1gSAR exposure should correspond to 100% exposure margin = $0.449 \text{ W/kg measured SAR at LTE } P_{limit} / 1.6\text{W/kg limit} = 0.281 \pm 1\text{dB device related uncertainty}$ (see black curve after t = 240s). Additionally, in SAR exposure switch test, at all times the total time-averaged normalized RF exposure (green curve) should not exceed normalized SAR_design_target + 1dB device uncertainty. In this test, with a maximum normalized SAR of 0.552 being $\leq 0.79 (= 1.0/1.6 + 1\text{dB device uncertainty})$, the above test result validated the continuity of power limiting in SAR exposure switch scenario.

7.3 Switch in SAR exposure test results (Inter-band ULCA)

This test was conducted with callbox requesting maximum power, and with the EUT in LTE Band 4 (PCC), Antenna A + LTE Band 5 (SCC), Antenna A call. The measurement setup shown in Figure 5-1(c) was used because each LTE shares the same antenna port. The SAR exposure switch measurement is performed with the EUT in various SAR exposure scenarios, i.e., in SAR_{SCC} max scenario (t =0s ~120s), SAR_{PCC} + SAR_{SCC} max scenario (t =120s ~ 240s) and SAR_{PCC} max scenario (t > 240s).

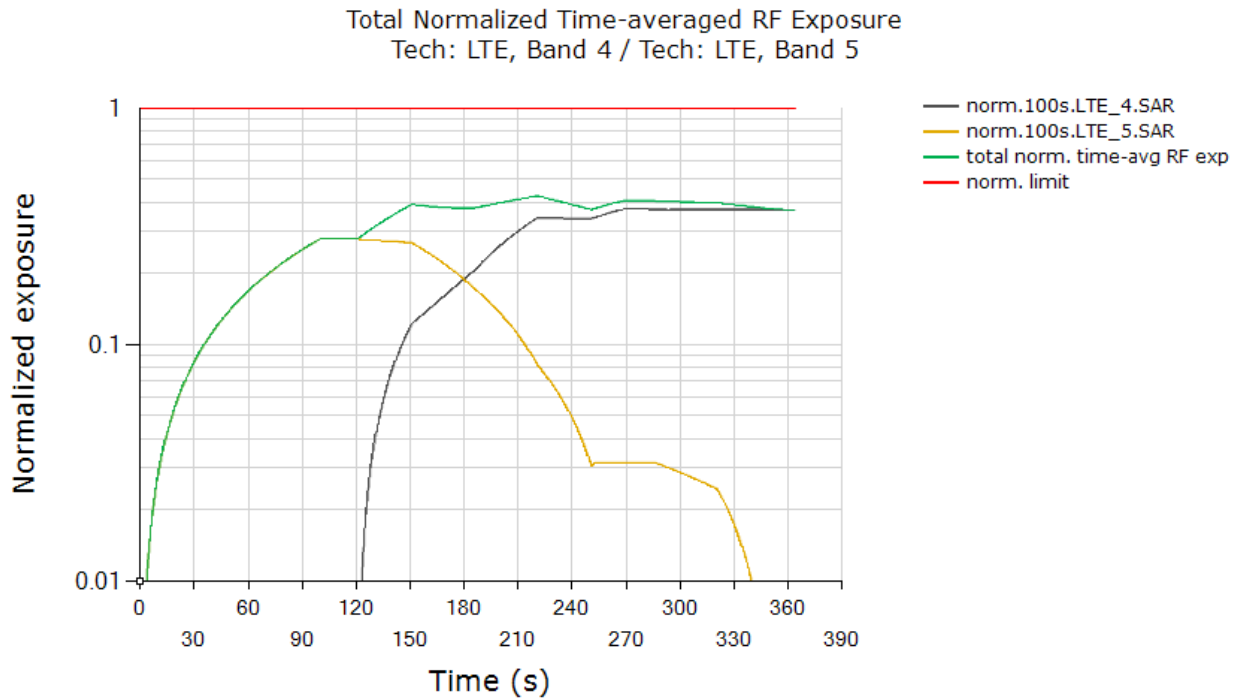

All the conducted Tx power measurement results were converted into time-averaged normalized SAR values using Equation (3a), (3b) and (3c), and plotted below to demonstrate that the time-averaged normalized SAR versus time does not exceed the FCC limit of 1 unit. Equation (3a) is used to convert the LTE Tx power of device to obtain 100s-averaged normalized SAR in LTE B4 (PCC) as shown in black curve. Similarly, equation (3b) is used to obtain 100s-averaged normalized SAR in LTE B5 (SCC) as shown in orange curve. Equation (3c) is used to obtain total time-averaged normalized SAR as shown in green curve (i.e., sum of black and orange curves).



FCC ID: A3LSMS906E	PCTEST Proud to be part of element	PART 2 RF EXPOSURE EVALUATION REPORT		Approved by: Technical Manager
Document S/N: 1M2202030009-07.A3L	Test Dates: 02/16/2022 – 03/21/2022	DUT Type: Portable Handset		Page 21 of 26

	(W/kg)
FCC normalized total exposure limit	1.0
Max time averaged normalized SAR (green curve)	0.425
Validated	

Plot Notes: Device starts predominantly in LTE B5 (SCC) SAR exposure scenario between 0s and 120s, and in LTE B4 (PCC) SAR + LTE B5 (SCC) SAR exposure scenario between 120s and 240s, and in predominantly in LTE B4 (PCC) SAR exposure scenario after t=240s. In SAR exposure switch test, at all times the total time-averaged normalized RF exposure (green curve) should not exceed normalized *SAR_design_target* + 1 dB device uncertainty. In this test, with a maximum normalized SAR of 0.425 being ≤ 0.79 ($= 1.0/1.6 + 1$ dB device uncertainty), the above test result validated the continuity of power limiting in SAR exposure switch scenario.

FCC ID: A3LSMS906E	 PCTEST Proud to be part of 	PART 2 RF EXPOSURE EVALUATION REPORT		Approved by: Technical Manager
Document S/N: 1M2202030009-07.A3L	Test Dates: 02/16/2022 – 03/21/2022	DUT Type: Portable Handset	Page 22 of 26	



8

EQUIPMENT LIST

Manufacturer	Model	Description	Cal Date	Cal Interval	Cal Due	Serial Number
Anritsu	MT8000A	Radio Communication Test Station	6/11/2021	Annual	6/11/2022	6261860125
Anritsu	MT8821C	Radio Communication Test Station	4/14/2021	Annual	4/14/2022	6261895213
K & L	11SH10-1300/U4000	High Pass Filter	N/A	N/A	N/A	11SH10-1300/U4000 - 2
Mini-Circuits	NLP-1200+	Low Pass Filter	N/A	N/A	N/A	VUU78201318
Mini-Circuits	BW-N20W5	Power Attenuator	CBT	N/A	CBT	1226
Narda	4216-10	Directional Coupler, 0.5 to 8.0 GHz, 10 dB	CBT	N/A	CBT	01492
Narda	4216-10	Directional Coupler, 0.5 to 8.0 GHz, 10 dB	CBT	N/A	CBT	01493
Narda	4772-3	Attenuator	CBT	N/A	CBT	9406
Narda	BW-S3W2	Attenuator	CBT	N/A	CBT	120
Narda	4014C-6	4 - 8 GHz SMA 6 dB Directional Coupler	CBT	N/A	CBT	N/A
Rohde & Schwarz	CMW500	Wideband Radio Communication Tester	10/27/2021	Annual	10/27/2022	108843
Rohde & Schwarz	NRP8S	3-Path Dipole Power Sensor	5/13/2021	Annual	5/13/2022	109322
Rohde & Schwarz	NRP8S	3-Path Dipole Power Sensor	5/13/2021	Annual	5/13/2022	109052
Rohde & Schwarz	NRP50S	3-Path Dipole Power Sensor	3/24/2021	Annual	3/24/2022	101164

Notes:



1. CBT (Calibrated Before Testing). Prior to testing, the measurement paths containing a cable, amplifier, attenuator, coupler, or filter were connected to a calibrated source (i.e. a signal generator) to determine the losses of the measurement path. The power meter offset was then adjusted to compensate for the measurement system losses. This level offset is stored within the power meter before measurements are made. This calibration verification procedure applies to the system verification and output power measurements. The calibrated reading is then taken directly from the power meter after compensation of the losses for all final power measurements.
2. Each equipment item is used solely within its respective calibration period.

FCC ID: A3LSMS906E	 PCTEST Proud to be part of 	PART 2 RF EXPOSURE EVALUATION REPORT		Approved by: Technical Manager
Document S/N: 1M2202030009-07.A3L	Test Dates: 02/16/2022 – 03/21/2022	DUT Type: Portable Handset	Page 23 of 26	

9.1 Measurement Conclusion



The SAR evaluation indicates that the DUT complies with the RF radiation exposure limits of the FCC and Innovation, Science, and Economic Development Canada, with respect to all parameters subject to this test. These measurements were taken to simulate the RF effects of RF exposure under worst-case conditions. Precise laboratory measures were taken to assure repeatability of the tests. The results and statements relate only to the item(s) tested.

Please note that the absorption and distribution of electromagnetic energy in the body are very complex phenomena that depend on the mass, shape, and size of the body, the orientation of the body with respect to the field vectors, and the electrical properties of both the body and the environment. Other variables that may play a substantial role in possible biological effects are those that characterize the environment (e.g. ambient temperature, air velocity, relative humidity, and body insulation) and those that characterize the individual (e.g. age, gender, activity level, debilitation, or disease). Because various factors may interact with one another to vary the specific biological outcome of an exposure to electromagnetic fields, any protection guide should consider maximal amplification of biological effects as a result of field-body interactions, environmental conditions, and physiological variables. [3]



FCC ID: A3LSMS906E	 PCTEST Proud to be part of 	PART 2 RF EXPOSURE EVALUATION REPORT		Approved by: Technical Manager
Document S/N: 1M2202030009-07.A3L	Test Dates: 02/16/2022 – 03/21/2022	DUT Type: Portable Handset	Page 24 of 26	

10 REFERENCES

- [1] Federal Communications Commission, ET Docket 93-62, Guidelines for Evaluating the Environmental Effects of Radiofrequency Radiation, Aug. 1996.
- [2] ANSI/IEEE C95.1-2005, American National Standard safety levels with respect to human exposure to radio frequency electromagnetic fields, 3kHz to 300GHz, New York: IEEE, 2006.
- [3] ANSI/IEEE C95.1-1992, American National Standard safety levels with respect to human exposure to radio frequency electromagnetic fields, 3kHz to 300GHz, New York: IEEE, Sept. 1992.
- [4] ANSI/IEEE C95.3-2002, IEEE Recommended Practice for the Measurement of Potentially Hazardous Electromagnetic Fields - RF and Microwave, New York: IEEE, December 2002.
- [5] IEEE Standards Coordinating Committee 39 –Standards Coordinating Committee 34 – IEEE Std. 1528-2013, IEEE Recommended Practice for Determining the Peak Spatial-Average Specific Absorption Rate (SAR) in the Human Head from Wireless Communications Devices: Measurement Techniques.
- [6] NCRP, National Council on Radiation Protection and Measurements, Biological Effects and Exposure Criteria for RadioFrequency Electromagnetic Fields, NCRP Report No. 86, 1986. Reprinted Feb. 1995.
- [7] T. Schmid, O. Egger, N. Kuster, Automated E-field scanning system for dosimetric assessments, IEEE Transaction on Microwave Theory and Techniques, vol. 44, Jan. 1996, pp. 105-113.
- [8] K. Pokovic, T. Schmid, N. Kuster, Robust setup for precise calibration of E-field probes in tissue simulating liquids at mobile communications frequencies, ICECOM97, Oct. 1997, pp. 1 -124.
- [9] K. Pokovic, T. Schmid, and N. Kuster, E-field Probe with improved isotropy in brain simulating liquids, Proceedings of the ELMAR, Zadar, Croatia, June 23-25, 1996, pp. 172-175.
- [10] Schmid & Partner Engineering AG, Application Note: Data Storage and Evaluation, June 1998, p2.
- [11] V. Hombach, K. Meier, M. Burkhardt, E. Kuhn, N. Kuster, The Dependence of EM Energy Absorption upon Human Modeling at 900 MHz, IEEE Transaction on Microwave Theory and Techniques, vol. 44 no. 10, Oct. 1996, pp. 1865-1873.
- [12] N. Kuster and Q. Balzano, Energy absorption mechanism by biological bodies in the near field of dipole antennas above 300MHz, IEEE Transaction on Vehicular Technology, vol. 41, no. 1, Feb. 1992, pp. 17-23.
- [13] G. Hartsgrove, A. Kraszewski, A. Surowiec, Simulated Biological Materials for Electromagnetic Radiation Absorption Studies, University of Ottawa, Bioelectromagnetics, Canada: 1987, pp. 29-36.
- [14] Q. Balzano, O. Garay, T. Manning Jr., Electromagnetic Energy Exposure of Simulated Users of Portable Cellular Telephones, IEEE Transactions on Vehicular Technology, vol. 44, no.3, Aug. 1995.
- [15] W. Gander, Computermathematik, Birkhaeuser, Basel, 1992.
- [16] W.H. Press, S.A. Teukolsky, W.T. Vetterling, and B.P. Flannery, Numerical Recipes in C, The Art of Scientific Computing, Second edition, Cambridge University Press, 1992.
- [17] N. Kuster, R. Kastle, T. Schmid, Dosimetric evaluation of mobile communications equipment with known precision, IEEE Transaction on Communications, vol. E80-B, no. 5, May 1997, pp. 645-652.

FCC ID: A3LSMS906E	 PCTEST Proud to be part of 	PART 2 RF EXPOSURE EVALUATION REPORT		Approved by: Technical Manager
Document S/N: 1M2202030009-07.A3L	Test Dates: 02/16/2022 – 03/21/2022	DUT Type: Portable Handset	Page 25 of 26	

- [18] CENELEC CLC/SC111B, European Prestandard (prENV 50166-2), Human Exposure to Electromagnetic Fields High-frequency: 10kHz-300GHz, Jan. 1995.
- [19] Prof. Dr. Niels Kuster, ETH, Eidgenössische Technische Hochschule Zürich, Dosimetric Evaluation of the Cellular Phone.
- [20] IEC 62209-1, Measurement procedure for the assessment of specific absorption rate of human exposure to radio frequency fields from hand-held and body-mounted wireless communication devices - Part 1: Devices used next to the ear (Frequency range of 300 MHz to 6 GHz), July 2016.
- [21] Innovation, Science, Economic Development Canada RSS-102 Radio Frequency Exposure Compliance of Radiocommunication Apparatus (All Frequency Bands) Issue 5, March 2015.
- [22] Health Canada Safety Code 6 Limits of Human Exposure to Radio Frequency Electromagnetic Fields in the Frequency Range from 3 kHz – 300 GHz, 2015
- [23] FCC SAR Test Procedures for 2G-3G Devices, Mobile Hotspot and UMPC Devices KDB Publications 941225, D01-D07
- [24] SAR Measurement Guidance for IEEE 802.11 Transmitters, KDB Publication 248227 D01
- [25] FCC SAR Considerations for Handsets with Multiple Transmitters and Antennas, KDB Publications 648474 D03-D04
- [26] FCC SAR Evaluation Considerations for Laptop, Notebook, Netbook and Tablet Computers, FCC KDB Publication 616217 D04
- [27] FCC SAR Measurement and Reporting Requirements for 100MHz – 6 GHz, KDB Publications 865664 D01-D02
- [28] FCC General RF Exposure Guidance and SAR Procedures for Dongles, KDB Publication 447498, D01-D02
- [29] Anexo à Resolução No. 533, de 10 de Setembro de 2009.
- [30] IEC 62209-2, Human exposure to radio frequency fields from hand-held and body-mounted wireless communication devices - Human models, instrumentation, and procedures - Part 2: Procedure to determine the specific absorption rate (SAR) for wireless communication devices used in close proximity to the human body (frequency range of 30 MHz to 6 GHz), Mar. 2010.

FCC ID: A3LSMS906E	 PCTEST Proud to be part of 	PART 2 RF EXPOSURE EVALUATION REPORT		Approved by: Technical Manager
Document S/N: 1M2202030009-07.A3L	Test Dates: 02/16/2022 – 03/21/2022	DUT Type: Portable Handset	Page 26 of 26	