

# APPENDIX I: LTE DOWNLINK ONLY CARRIER AGGREGATION TEST REDUCTION METHODOLOGY

SAR test exclusion for LTE downlink Carrier Aggregation is determined by power measurements according to the number of component carriers (CCs) supported by the product implementation. Per April 2018 TCBC Workshop Notes, the following test reduction methodology was applied to determine the combinations required for conducted power measurements.

## LTE DLCA Test Reduction Methodology:

- The supported combinations were arranged by the number of component carriers in columns.
- Any limitations on the PCC or SCC for each combination were identified alongside the combination (e.g. CA\_2A-2A-4A-12A, but B12 can only be configured as a SCC).
- Power measurements were performed for "supersets" (LTE CA combinations with multiple components carriers) and any "subsets" (LTE CA combinations with fewer component carriers) that were not completely covered by the supersets.
- Only subsets that have the exact same components as a superset were excluded for measurement.
- When there were certain restrictions on component carriers that existed in the superset that were not applied for the subset, the subset configuration was additionally evaluated.
- Both inter-band and intra-band downlink carrier aggregation scenarios were considered.
- Downlink CA combinations for SISO and 4x4 Downlink MIMO operations were measured independently, per May 2017 TCBC Workshop notes.

**Table I-1 – Example of Exclusion Table for SISO Configurations**

Index	CC	Supported Channel Bandwidth [MHz]	PCC/SCC	Restriction	Completely Covered by Measurement Superset
SISO	CA [2A]	5, 10, 15, 20	CC1		Yes
	CA [2A, 5A]	5, 10, 15, 20	CC1, CC2		Yes
	CA [2A, 7A]	5, 10, 15, 20	CC1, CC3		Yes
	CA [2A, 12A]	5, 10, 15, 20	CC1, CC4		Yes
	CA [2A, 5A, 7A]	5, 10, 15, 20	CC1, CC2, CC3		Yes
	CA [2A, 5A, 12A]	5, 10, 15, 20	CC1, CC2, CC4		Yes
	CA [2A, 7A, 12A]	5, 10, 15, 20	CC1, CC3, CC4		Yes
	CA [2A, 5A, 7A, 12A]	5, 10, 15, 20	CC1, CC2, CC3, CC4		Yes
	CA [2A, 5A]	5, 10, 15, 20	CC1	B12	No
	CA [2A, 5A]	5, 10, 15, 20	CC1	B12	No



**Table I-2 – Example of Exclusion Table for 4x4 Downlink MIMO Configurations**

Index	CC	Supported Channel Bandwidth [MHz]	PCC/SCC	Restriction	Completely Covered by Measurement Superset
4x4 DL MIMO	CA [2A]	5, 10, 15, 20	CC1		Yes
	CA [2A, 5A]	5, 10, 15, 20	CC1, CC2		Yes
	CA [2A, 7A]	5, 10, 15, 20	CC1, CC3		Yes
	CA [2A, 12A]	5, 10, 15, 20	CC1, CC4		Yes
	CA [2A, 5A, 7A]	5, 10, 15, 20	CC1, CC2, CC3		Yes
	CA [2A, 5A, 12A]	5, 10, 15, 20	CC1, CC2, CC4		Yes
	CA [2A, 7A, 12A]	5, 10, 15, 20	CC1, CC3, CC4		Yes
	CA [2A, 5A, 7A, 12A]	5, 10, 15, 20	CC1, CC2, CC3, CC4		Yes
	CA [2A, 5A]	5, 10, 15, 20	CC1	B12	No
	CA [2A, 5A]	5, 10, 15, 20	CC1	B12	No

Note: [CC] indicates component carrier with 4x4 DL MIMO antenna configuration

### 1.1 LTE Downlink Only Carrier Aggregation Test Selection and Setup

SAR test exclusion for LTE downlink Carrier Aggregation is determined by power measurements according to the number component carriers (CCs) supported by the product implementation. For those configurations required by April 2018 TCBC Workshop Notes, conducted power measurements with LTE Carrier Aggregation (CA) (downlink

<b>FCC ID</b> A3LSMS901E		<b>SAR EVALUATION REPORT</b>		<b>Approved by:</b> Quality Manager
<b>Test Dates:</b> 10/08/21 – 12/14/21	<b>DUT Type:</b> Portable Handset			<b>APPENDIX I:</b> Page 1 of 5

only) active are made in accordance to KDB Publication 941225 D05Av01r02. The RRC connection is only handled by one cell, the primary component carrier (PCC) for downlink and uplink communications. After making a data connection to the PCC, the UE device adds secondary component carrier(s) (SCC) on the downlink only. All uplink communications and acknowledgements remain identical to specifications when downlink carrier aggregation is inactive on the PCC. Additional conducted output powers are measured with the downlink carrier aggregation active for the configuration with highest measured maximum conducted power with downlink carrier aggregation active measured among the channel bandwidth, modulation, and RB combinations in each frequency band.

Per FCC KDB Publication 941225 D05Av01r02, no SAR measurements are required for carrier aggregation configurations when the maximum average output power with downlink only carrier aggregation active is not more than 0.25 dB higher than the average output power with downlink only carrier aggregation inactive. All bands required for SAR testing per FCC KDB procedures were considered. Based on the measured maximum powers below, no additional SAR tests were required for DLCA SAR configurations.

General PCC and SCC configuration selection procedure

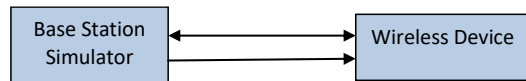

- PCC uplink channel, channel bandwidth, modulation and RB configurations were selected based on section C)3)b)ii) of KDB 941225 D05 V01r02. All LTE bandwidth conducted powers needed for PCC uplink configuration selection can be found in Section 9 and appendix H. The downlink PCC channel was paired with the selected PCC uplink channel according to normal configurations without carrier aggregation.
- To maximize aggregated bandwidth, highest channel bandwidth available for that CA combination was selected for SCC. For inter-band CA, the SCC downlink channels were selected near the middle of their transmission bands. For contiguous intra-band CA, the downlink channel spacing between the component carriers was set to multiple of 300 kHz less than the nominal channel spacing defined in section 5.4.1A of 3GPP TS 36.521. For non-contiguous intra-band CA, the downlink channel spacing between the component carriers was set to be larger than the nominal channel spacing and provided maximum separation between the component carriers.
- All selected PCC and SCC(s) remained fully within the uplink/downlink transmission band of the respective component carrier.

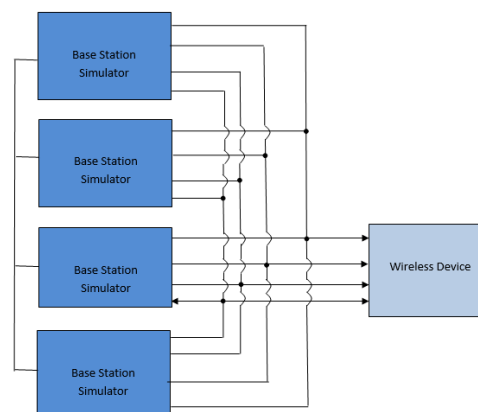

**Figure I-1**  
**DL CA Power Measurement Setup**



**Figure I-2**  
**DL CA with DL 4x4 MIMO Power Measurement Setup**

FCC ID A3LSMS901E	 Proud to be part of  element	SAR EVALUATION REPORT		Approved by: Quality Manager
Test Dates: 10/08/21 – 12/14/21	DUT Type: Portable Handset			APPENDIX I: Page 2 of 5

## I.2 Downlink Carrier Aggregation RF Conducted Powers

### I.2.1 LTE Band 12 as PCC

Table I-3  
Maximum Output Powers

Combination	PCC									SCC 1			SCC 2			Power			
	PCC Band	PCC BW [MHz]	PCC (UL) Ch.	PCC (UL) Freq. [MHz]	Mod.	PCC UL# RB	PCC UL RB Offset	PCC (DL) Channel	PCC (DL) Freq. [MHz]	SCC Band	SCC BW [MHz]	SCC (DL) Channel	SCC (DL) Freq. [MHz]	SCC Band	SCC BW [MHz]	SCC (DL) Channel	SCC (DL) Freq. [MHz]	LTE Tx.Power with DL CA Enabled (dBm)	LTE Single Carrier Tx Power (dBm)
CA_2A-12A (1)	LTE B12	10	23095	707.5	QPSK	1	0	5095	737.5	LTE B2	20	900	1960	-	-	-	-	24.44	24.38
CA_4A-12A (1)	LTE B12	10	23095	707.5	QPSK	1	0	5095	737.5	LTE B4	20	2175	2132.5	-	-	-	-	24.48	24.38
CA_4A-12A (2)	LTE B12	10	23095	707.5	QPSK	1	0	5095	737.5	LTE B4	20	2175	2132.5	-	-	-	-	24.48	24.38
CA_12A-66A (1)	LTE B12	10	23095	707.5	QPSK	1	0	5095	737.5	LTE B66	20	66786	2145	-	-	-	-	24.46	24.38
CA_12A-66A (2)	LTE B12	10	23095	707.5	QPSK	1	0	5095	737.5	LTE B66	20	66786	2145	-	-	-	-	24.46	24.38
CA_4A-4A-12A	LTE B12	10	23095	707.5	QPSK	1	0	5095	737.5	LTE B4	20	2175	2132.5	LTE B4	10	2350	2150	24.20	24.38
CA_12A-66A-66A	LTE B12	10	23095	707.5	QPSK	1	0	5095	737.5	LTE B66	20	66786	2145	LTE B66	20	67236	2190	24.24	24.38

### I.2.2 LTE Band 13 as PCC

Table I-4  
Maximum Output Powers

Combination	PCC									SCC 1			SCC 2			Power			
	PCC Band	PCC BW [MHz]	PCC (UL) Ch.	PCC (UL) Freq. [MHz]	Mod.	PCC UL# RB	PCC UL RB Offset	PCC (DL) Channel	PCC (DL) Freq. [MHz]	SCC Band	SCC BW [MHz]	SCC (DL) Channel	SCC (DL) Freq. [MHz]	SCC Band	SCC BW [MHz]	SCC (DL) Channel	SCC (DL) Freq. [MHz]	LTE Tx.Power with DL CA Enabled (dBm)	LTE Single Carrier Tx Power (dBm)
CA_2A-13A (2)	LTE B13	10	23230	782	QPSK	1	25	5230	751	LTE B2	20	900	1960	-	-	-	-	24.37	24.42
CA_2A-4A-13A	LTE B13	10	23230	782	QPSK	1	25	5230	751	LTE B2	20	900	1960	LTE B4	20	2175	2132.5	24.38	24.42

### I.2.3 LTE Band 26 as PCC



Table I-5  
Maximum Output Powers

Combination	PCC									SCC 1			SCC 2			Power			
	PCC Band	PCC BW [MHz]	PCC (UL) Ch.	PCC (UL) Freq. [MHz]	Mod.	PCC UL# RB	PCC UL RB Offset	PCC (DL) Channel	PCC (DL) Freq. [MHz]	SCC Band	SCC BW [MHz]	SCC (DL) Channel	SCC (DL) Freq. [MHz]	SCC Band	SCC BW [MHz]	SCC (DL) Channel	SCC (DL) Freq. [MHz]	LTE Tx.Power with DL CA Enabled (dBm)	LTE Single Carrier Tx Power (dBm)
CA_26A-41A	LTE B26	15	26865	831.5	QPSK	1	36	8865	876.5	LTE B41	20	40620	2593	-	-	-	-	23.91	23.75
CA_26A-41C	LTE B26	15	26865	831.5	QPSK	1	36	8865	876.5	LTE B41	20	40620	2593	LTE B41	20	40422	2573.2	23.95	23.75

### I.2.4 LTE Band 66 as PCC

Table I-6  
Maximum Output Powers

Combination	PCC									SCC 1			SCC 2			Power			
	PCC Band	PCC BW [MHz]	PCC (UL) Ch.	PCC (UL) Freq. [MHz]	Mod.	PCC UL# RB	PCC UL RB Offset	PCC (DL) Channel	PCC (DL) Freq. [MHz]	SCC Band	SCC BW [MHz]	SCC (DL) Channel	SCC (DL) Freq. [MHz]	SCC Band	SCC BW [MHz]	SCC (DL) Channel	SCC (DL) Freq. [MHz]	LTE Tx.Power with DL CA Enabled (dBm)	LTE Single Carrier Tx Power (dBm)
CA_2A-66A	LTE B66	20	132572	1770	QPSK	1	0	67036	2170	LTE B2	20	900	1960	-	-	-	-	23.77	23.80
CA_12A-66A (1)	LTE B66	20	132572	1770	QPSK	1	0	67036	2170	LTE B12	10	5095	737.5	-	-	-	-	23.78	23.80
CA_12A-66A (2)	LTE B66	20	132572	1770	QPSK	1	0	67036	2170	LTE B12	10	5095	737.5	-	-	-	-	23.78	23.80
CA_66B	LTE B66	10	132322	1745	QPSK	1	25	66786	2145	LTE B66	10	66687	2135.1	-	-	-	-	23.73	23.79
CA_66C	LTE B66	20	132572	1770	QPSK	1	0	67036	2170	LTE B66	20	66838	2150.2	-	-	-	-	23.75	23.80
CA_5A-66A-66A	LTE B66	20	132572	1770	QPSK	1	0	67036	2170	LTE B66	20	66536	2120	LTE B5	10	2525	881.5	23.74	23.80
CA_12A-66A-66A	LTE B66	20	132572	1770	QPSK	1	0	67036	2170	LTE B66	20	66536	2120	LTE B12	10	5095	737.5	23.72	23.80

FCC ID A3LSMS901E		SAR EVALUATION REPORT		Approved by: Quality Manager
Test Dates: 10/08/21 – 12/14/21	DUT Type: Portable Handset	APPENDIX I: Page 3 of 5		

## I.2.1 LTE Band 41 as PCC

**Table I-7**  
Maximum Output Powers

Combination	PCC								SCC 1				SCC 2				SCC 3				Power		
	PCC Band	PCC BW [MHz]	PCC (UL) Ch.	PCC (UL) Freq. [MHz]	Mod.	PCC UL# RB	PCC UL RB Offset	PCC (DL) Channel	PCC (DL) Freq. [MHz]	SCC Band	SCC BW [MHz]	SCC (DL) Channel	SCC (DL) Freq. [MHz]	SCC Band	SCC BW [MHz]	SCC (DL) Channel	SCC (DL) Freq. [MHz]	SCC Band	SCC BW [MHz]	SCC (DL) Channel	SCC (DL) Freq. [MHz]	LTE Tx.Power with DL CA Enabled (dBm)	LTE Single Carrier Tx Power (dBm)
CA 41A-41A (1)	LTE B41	20	40185	2549.5	QPSK	1	0	40185	2549.5	LTE B41	20	41490	2680	-	-	-	-	-	-	-	-	24.77	24.72
CA 41A-41C	LTE B41	20	40185	2549.5	QPSK	1	0	40185	2549.5	LTE B41	20	41292	2660.2	LTE B41	20	41490	2680	-	-	-	-	24.73	24.72
CA 41C-41A	LTE B41	20	40185	2549.5	QPSK	1	0	40185	2549.5	LTE B41	20	40383	2569.3	LTE B41	20	41490	2680	-	-	-	-	24.82	24.72
CA 41A-41D	LTE B41	20	40185	2549.5	QPSK	1	0	40185	2549.5	LTE B41	20	41084	2640.4	LTE B41	20	41292	2660.2	LTE B41	20	41490	2680	24.72	24.72
CA 41D-41A	LTE B41	20	40185	2549.5	QPSK	1	0	40185	2549.5	LTE B41	20	40383	2569.3	LTE B41	20	40581	2589.1	LTE B41	20	41490	2680	24.76	24.72
CA 41C-41C	LTE B41	20	40185	2549.5	QPSK	1	0	40185	2549.5	LTE B41	20	40383	2569.3	LTE B41	20	41292	2660.2	LTE B41	20	41490	2680	24.74	24.72
CA 41E	LTE B41	20	40185	2549.5	QPSK	1	0	40185	2549.5	LTE B41	20	40383	2569.3	LTE B41	20	40581	2589.1	LTE B41	20	40779	2608.9	24.69	24.72

## I.3 DL CA with DL 4x4 MIMO RF Conduction Powers

This device supports downlink 4x4 MIMO operations for some LTE bands. Uplink transmission is limited to a single output stream. When carrier aggregation was applicable, the general test selection and setup procedures described in Section I.1 were applied.

Per May 2017 TCB Workshop Notes, SAR for 4x4 DL MIMO was not needed since the maximum average output power in 4x4 DL MIMO mode was not more than 0.25 dB higher than the maximum output power with 4x4 DL MIMO inactive. Additionally, SAR for 4x4 MIMO Downlink Carrier Aggregation was not needed since the maximum average output power in 4x4 MIMO Downlink Carrier Aggregation mode was not more than 0.25 dB higher than the maximum output power with 4x4 MIMO Downlink and downlink carrier aggregation inactive.

### I.3.1 LTE 4x4 MIMO DL Standalone Powers



**Table I-8**  
Maximum Output Powers

LTE Band	Bandwidth [MHz]	Channel	Frequency [MHz]	Modulation	RB Size	RB Offset	4x4 DL MIMO Tx. Power [dBm]	Single Antenna Tx. Power [dBm]
66	20	132572	1770	QPSK	1	0	23.77	23.80
41	20	40185	2549.5	QPSK	1	0	24.77	24.72

### I.3.2 LTE Band 12 as PCC

**Table I-9**  
Maximum Output Powers

Combination	PCC								SCC 1				SCC 2				Power						
	PCC Band	PCC BW [MHz]	PCC (UL) Ch.	PCC (UL) Freq. [MHz]	Mod.	PCC UL# RB	PCC UL RB Offset	PCC (DL) Ch.	PCC (DL) Freq. [MHz]	DL Ant. Config.	SCC Band	SCC BW [MHz]	SCC (DL) Ch.	SCC (DL) Freq. [MHz]	DL Ant. Config.	SCC Band	SCC BW [MHz]	SCC (DL) Ch.	SCC (DL) Freq. [MHz]	DL Ant. Config.	LTE Tx.Power with DL CA Enabled (dBm)	LTE Single Carrier Tx Power (dBm)	
CA [4A]-12A (1)	LTE B12	10	23095	707.5	QPSK	1	0	5095	737.5	2x2	LTE B4	20	2175	2132.5	4x4	-	-	-	-	-	-	24.43	24.38
CA [4A]-12A (2)	LTE B12	10	23095	707.5	QPSK	1	0	5095	737.5	2x2	LTE B4	20	2175	2132.5	4x4	-	-	-	-	-	-	24.43	24.38
CA 12A-[66A] (1)	LTE B12	10	23095	707.5	QPSK	1	0	5095	737.5	2x2	LTE B66	20	66786	2145	4x4	-	-	-	-	-	-	24.45	24.38
CA 12A-[66A] (2)	LTE B12	10	23095	707.5	QPSK	1	0	5095	737.5	2x2	LTE B66	20	66786	2145	4x4	-	-	-	-	-	-	24.45	24.38
CA [4A]-4A-12A	LTE B12	10	23095	707.5	QPSK	1	0	5095	737.5	2x2	LTE B4	20	2175	2132.5	4x4	LTE B4	10	2350	2150	2x2	-	24.45	24.38
CA [4A]-[4A]-12A	LTE B12	10	23095	707.5	QPSK	1	0	5095	737.5	2x2	LTE B4	20	2175	2132.5	4x4	LTE B4	10	2350	2150	4x4	-	24.43	24.38
CA 12A-[66A]-66A	LTE B12	10	23095	707.5	QPSK	1	0	5095	737.5	2x2	LTE B66	20	66786	2145	4x4	LTE B66	20	67236	2190	2x2	-	24.50	24.38
CA 12A-[66A]-[66A]	LTE B12	10	23095	707.5	QPSK	1	0	5095	737.5	2x2	LTE B66	20	66786	2145	4x4	LTE B66	20	67236	2190	4x4	-	24.48	24.38

FCC ID A3LSMS901E		SAR EVALUATION REPORT		Approved by: Quality Manager
Test Dates: 10/08/21 – 12/14/21	DUT Type: Portable Handset	APPENDIX I: Page 4 of 5		

### I.3.3 LTE Band 13 as PCC

**Table I-10**  
Maximum Output Powers

Combination	PCC Band	PCC										SCC 1				SCC 2				Power		
		PCC BW [MHz]	PCC (UL) Ch.	PCC (UL) Freq. [MHz]	Mod.	PCC UL# RB	PCC UL RB Offset	PCC (DL) Ch.	PCC (DL) Freq. [MHz]	DL Ant. Config.	SCC Band	SCC BW [MHz]	SCC (DL) Ch.	SCC (DL) Freq. [MHz]	DL Ant. Config.	SCC Band	SCC BW [MHz]	SCC (DL) Ch.	SCC (DL) Freq. [MHz]	DL Ant. Config.	LTE Tx Power with DL CA Enabled (dBm)	LTE Single Carrier Tx Power (dBm)
CA_2A-[4A]-13A	LTE B13	10	23230	782	QPSK	1	25	5230	751	2x2	LTE B2	20	900	1960	2x2	LTE B4	20	2175	2132.5	4x4	24.41	24.42

### I.3.4 LTE Band 26 as PCC

**Table I-11**  
Maximum Output Powers

Combination	PCC Band	PCC										SCC 1				SCC 2				Power			
		PCC BW [MHz]	PCC (UL) Ch.	PCC (UL) Freq. [MHz]	Mod.	PCC UL# RB	PCC UL RB Offset	PCC (DL) Ch.	PCC (DL) Freq. [MHz]	DL Ant. Config.	SCC Band	SCC BW [MHz]	SCC (DL) Ch.	SCC (DL) Freq. [MHz]	DL Ant. Config.	SCC Band	SCC BW [MHz]	SCC (DL) Ch.	SCC (DL) Freq. [MHz]	DL Ant. Config.	LTE Tx Power with DL CA Enabled (dBm)	LTE Single Carrier Tx Power (dBm)	
CA_26A-[41A]	LTE B26	15	26865	831.5	QPSK	1	36	8865	876.5	2x2	LTE B41	20	40620	2593	4x4	-	-	-	-	-	-	23.78	23.75
CA_26A-[41C]	LTE B26	15	26865	831.5	QPSK	1	36	8865	876.5	2x2	LTE B41	20	40620	2593	4x4	LTE B41	20	40422	2573.2	4x4	-	23.57	23.75

### I.3.5 LTE Band 66 as PCC



**Table I-12**  
Maximum Output Powers

Combination	PCC Band	PCC										SCC 1				SCC 2				Power			
		PCC BW [MHz]	PCC (UL) Ch.	PCC (UL) Freq. [MHz]	Mod.	PCC UL# RB	PCC UL RB Offset	PCC (DL) Ch.	PCC (DL) Freq. [MHz]	DL Ant. Config.	SCC Band	SCC BW [MHz]	SCC (DL) Ch.	SCC (DL) Freq. [MHz]	DL Ant. Config.	SCC Band	SCC BW [MHz]	SCC (DL) Ch.	SCC (DL) Freq. [MHz]	DL Ant. Config.	LTE Tx Power with DL CA Enabled (dBm)	LTE Single Carrier Tx Power (dBm)	
CA_2A-[66A]	LTE B66	20	132572	1770	QPSK	1	0	67036	2170	4x4	LTE B2	20	900	1960	2x2	-	-	-	-	-	-	23.66	23.80
CA_12A-[66A] (1)	LTE B66	20	132572	1770	QPSK	1	0	67036	2170	4x4	LTE B12	10	5095	737.5	2x2	-	-	-	-	-	-	23.62	23.80
CA_12A-[66A] (2)	LTE B66	20	132572	1770	QPSK	1	0	67036	2170	4x4	LTE B12	10	5095	737.5	2x2	-	-	-	-	-	-	23.62	23.80
CA_5A-[66A]-66A	LTE B66	20	132572	1770	QPSK	1	0	67036	2170	4x4	LTE B66	20	66536	2120	2x2	LTE B5	10	2525	881.5	2x2	-	23.66	23.80
CA_5A-66A-[66A]	LTE B66	20	132572	1770	QPSK	1	0	67036	2170	2x2	LTE B66	20	66536	2120	4x4	LTE B5	10	2525	881.5	2x2	-	23.65	23.80
CA_5A-[66A]-[66A]	LTE B66	20	132572	1770	QPSK	1	0	67036	2170	4x4	LTE B66	20	66536	2120	4x4	LTE B5	10	2525	881.5	2x2	-	23.63	23.80
CA_12A-[66A]-[66A]	LTE B66	20	132572	1770	QPSK	1	0	67036	2170	4x4	LTE B66	20	66536	2120	2x2	LTE B12	10	5095	737.5	2x2	-	23.64	23.80
CA_12A-66A-[66A]	LTE B66	20	132572	1770	QPSK	1	0	67036	2170	2x2	LTE B66	20	66536	2120	4x4	LTE B12	10	5095	737.5	2x2	-	23.62	23.80
CA_12A-[66A]-[66A]	LTE B66	20	132572	1770	QPSK	1	0	67036	2170	4x4	LTE B66	20	66536	2120	4x4	LTE B12	10	5095	737.5	2x2	-	23.72	23.80

### I.3.6 LTE Band 41 as PCC

**Table I-13**  
Maximum Output Powers

Combination	PCC Band	PCC										SCC 1				SCC 2				SCC 3				Power						
		PCC BW [MHz]	PCC (UL) Ch.	PCC (UL) Freq. [MHz]	Mod.	PCC UL# RB	PCC UL RB Offset	PCC (DL) Ch.	PCC (DL) Freq. [MHz]	DL Ant. Config.	SCC Band	SCC BW [MHz]	SCC (DL) Ch.	SCC (DL) Freq. [MHz]	DL Ant. Config.	SCC Band	SCC BW [MHz]	SCC (DL) Ch.	SCC (DL) Freq. [MHz]	DL Ant. Config.	SCC Band	SCC BW [MHz]	SCC (DL) Ch.	SCC (DL) Freq. [MHz]	DL Ant. Config.	LTE Tx Power with DL CA Enabled (dBm)	LTE Single Carrier Tx Power (dBm)			
CA_41A-[41A] (1)	LTE B41	20	40185	2549.5	QPSK	1	0	40185	2549.5	4x4	LTE B41	20	41490	2680	2x2	-	-	-	-	-	-	-	-	-	-	-	24.76	24.72		
CA_41A-[41A] (1)	LTE B41	20	40185	2549.5	QPSK	1	0	40185	2549.5	2x2	LTE B41	20	41490	2680	4x4	-	-	-	-	-	-	-	-	-	-	-	-	24.77	24.72	
CA_41A-[41A] (1)	LTE B41	20	40185	2549.5	QPSK	1	0	40185	2549.5	4x4	LTE B41	20	41490	2680	4x4	-	-	-	-	-	-	-	-	-	-	-	-	24.74	24.72	
CA_41A-[41C]	LTE B41	20	40185	2549.5	QPSK	1	0	40185	2549.5	4x4	LTE B41	20	41292	2660.2	2x2	LTE B41	20	41490	2680	2x2	-	-	-	-	-	-	-	-	24.71	24.72
CA_41C-[41A]	LTE B41	20	40185	2549.5	QPSK	1	0	40185	2549.5	2x2	LTE B41	20	40383	2569.3	2x2	LTE B41	20	41490	2680	4x4	-	-	-	-	-	-	-	-	24.79	24.72
CA_41A-[41C]	LTE B41	20	40185	2549.5	QPSK	1	0	40185	2549.5	2x2	LTE B41	20	41292	2660.2	4x4	LTE B41	20	41490	2680	4x4	-	-	-	-	-	-	-	-	24.85	24.72
CA_41C-[41A]	LTE B41	20	40185	2549.5	QPSK	1	0	40185	2549.5	4x4	LTE B41	20	40383	2569.3	4x4	LTE B41	20	41490	2680	2x2	-	-	-	-	-	-	-	-	24.63	24.72
CA_41A-[41C]	LTE B41	20	40185	2549.5	QPSK	1	0	40185	2549.5	4x4	LTE B41	20	41292	2660.2	4x4	LTE B41	20	41490	2680	4x4	-	-	-	-	-	-	-	-	24.62	24.72
CA_41C-[41A]	LTE B41	20	40185	2549.5	QPSK	1	0	40185	2549.5	4x4	LTE B41	20	40383	2569.3	4x4	LTE B41	20	41490	2680	4x4	-	-	-	-	-	-	-	-	24.65	24.72
CA_41A-[41D]	LTE B41	20	40185	2549.5	QPSK	1	0	40185	2549.5	4x4	LTE B41	20	41094	2640.4	2x2	LTE B41	20	41292	2660.2	2x2	LTE B41	20	41490	2680	2x2	-	-	-	24.73	24.72
CA_41D-[41A]	LTE B41	20	40185	2549.5	QPSK	1	0	40185	2549.5	2x2	LTE B41	20	40383	2569.3	2x2	LTE B41	20	40581	2589.1	2x2	LTE B41	20	41490	2680	4x4	-	-	-	24.62	24.72
CA_41A-[41D]	LTE B41	20	40185	2549.5	QPSK	1	0	40185	2549.5	2x2	LTE B41	20	41094	2640.4	4x4	LTE B41	20	41292	2660.2	4x4	LTE B41	20	41490	2680	4x4	-	-	-	24.59	24.72
CA_41D-[41A]	LTE B41	20	40185	2549.5	QPSK	1	0	40185	2549.5	4x4	LTE B41	20	40383	2569.3	4x4	LTE B41	20	40581	2589.1	4x4	LTE B41	20	41490	2680	2x2	-	-	-	24.63	24.72
CA_41A-[41D]	LTE B41	20	40185	2549.5	QPSK	1	0	40185	2549.5	4x4	LTE B41	20	41094	2640.4	4x4	LTE B41	20	41292	2660.2	4x4	LTE B41	20	41490	2680	4x4	-	-	-	24.62	24.72
CA_41D-[41A]	LTE B41	20	40185	2549.5	QPSK	1	0	40185	2549.5	4x4	LTE B41	20	40383	2569.3	4x4	LTE B41	20	40581	2589.1	4x4	LTE B41	20	41490	2680	4x4	-	-	-	24.67	24.72
CA_41C-[41C]	LTE B41	20	40185	2549.5	QPSK	1	0	40185	2549.5	4x4	LTE B41	20	40383	2569.3	4x4	LTE B41	20	41292	2660.2	2x2	LTE B41	20	41490	2680	2x2	-	-	-	24.65	24.72
CA_41C-[41C]	LTE B41	20	40185	2549.5	QPSK	1	0	40185	2549.5	2x2	LTE B41	20	40383	2569.3	2x2	LTE B41	20	41292	2660.2	4x4	LTE B41	20	41490	2680	4x4	-	-	-	24.63	24.72
CA_41C-[41C]	LTE B41	20	40185	2549.5	QPSK	1	0	40185	2549.5	4x4	LTE B41	20	40383	2569.3	4x4	LTE B41	20	41292	2660.2	4x4	LTE B41	20	41490	2680	4x4	-	-	-	24.64	24.72
CA_41E	LTE B41	20	40185	2549.5	QPSK	1	0	40185	2549.5	4x4	LTE B41	20	40383	2569.3	4x4	LTE B41	20	40581	2589.1	4x4	LTE B41	20	40779	2608.9	4x4	-	-	-	24.66	24.72

FCC ID A3LSMS901E		SAR EVALUATION REPORT		Approved by: Quality Manager
Test Dates: 10/08/21 – 12/14/21	DUT Type: Portable Handset			APPENDIX I: Page 5 of 5