

HEARING AID COMPATIBILITY

Applicant Name:

Samsung Electronics Co., Ltd.
129, Samsung-ro, Maetan dong,
Yeongtong-gu, Suwon-si
Gyeonggi-do 443-742, Korea

Date of Testing:

02/09/2015

Test Site/Location:

PCTEST Lab, Columbia, MD, USA

Test Report Serial No.:

OY1502050385.A3L

FCC ID:

A3LSMS777C

APPLICANT:

SAMSUNG ELECTRONICS CO., LTD.

Scope of Test:

Audio Band Magnetic Testing (T-Coil)

Application Type:

Certification

FCC Rule Part(s):

CFR §20.19(b)

HAC Standard:

ANSI C63.19-2011

EUT Type:

Portable Handset

Model(s):

SM-S777C

Test Device Serial No.:

Pre-Production Sample [S/N: A0000048C57DF2]

C63.19-2011 HAC Category:

T3 (SIGNAL TO NOISE CATEGORY)

This wireless portable device has been shown to be hearing-aid compatible under the above rated category, specified in ANSI/IEEE Std. C63.19-2011 and has been tested in accordance with the specified measurement procedures. Test results reported herein relate only to the item(s) tested. Hearing-Aid Compatibility is based on the assumption that all production units will be designed electrically identical to the device tested in this report. North American Bands only.

I attest to the accuracy of data. All measurements reported herein were performed by me or were made under my supervision and are correct to the best of my knowledge and belief. I assume full responsibility for the completeness of these measurements and vouch for the qualifications of all persons taking them.



Randy Ortanez
President







| | | | | |
|-------------------------------|---|-------------------------------|---|---------------------------------|
| FCC ID: A3LSMS777C |  | HAC (T-COIL) TEST REPORT |  | Reviewed by: Quality Manager |
| Filename: OY1502050385.A3L | Test Dates: 02/09/2015 | EUT Type: Portable Handset | Page 1 of 36 | |

TABLE OF CONTENTS

| | | |
|-----|---|----|
| 1. | INTRODUCTION | 3 |
| 2. | EUT DESCRIPTION | 4 |
| 3. | ANSI C63.19-2011 PERFORMANCE CATEGORIES | 5 |
| 4. | METHOD OF MEASUREMENT | 7 |
| 5. | FCC 3G MEASUREMENTS | 17 |
| 6. | TEST SUMMARY | 18 |
| 7. | MEASUREMENT UNCERTAINTY | 22 |
| 8. | EQUIPMENT LIST | 23 |
| 9. | CALIBRATION CERTIFICATES | 24 |
| 10. | CONCLUSION | 31 |
| 11. | REFERENCES | 32 |
| 12. | TEST SETUP PHOTOGRAPHS | 34 |

| | | | | |
|--------------------------------------|--|--------------------------------------|---|--|
| FCC ID: A3LSMS777C |  <small>ENGINEERING LABORATORY, INC.</small> | HAC (T-COIL) TEST REPORT |  | Reviewed by: Quality Manager |
| Filename: 0Y1502050385.A3L | Test Dates: 02/09/2015 | EUT Type: Portable Handset | | Page 2 of 36 |

1. INTRODUCTION

On July 10, 2003, the Federal Communications Commission (FCC) adopted new rules requiring wireless manufacturers and service providers to provide digital wireless phones that are compatible with hearing aids. The FCC has modified the exemption for wireless phones under the Hearing Aid Compatibility Act of 1998 (HAC Act) in WT Docket 01-309 RM-8658¹ to extend the benefits of wireless telecommunications to individuals with hearing disabilities. These benefits encompass business, social and emergency communications, which increase the value of the wireless network for everyone. An estimated more than 10% of the population in the United States show signs of hearing impairment and of that fraction, almost 80% use hearing aids. Approximately 500 million people worldwide and 30 million people in the United States suffer from hearing loss.

Compatibility Tests Involved:

The standard calls for wireless communications devices to be measured for:

- RF Electric-field emissions
- T-coil mode, magnetic-signal strength in the audio band
- T-coil mode, magnetic-signal frequency response through the audio band
- T-coil mode, magnetic-signal and noise articulation index

The hearing aid must be measured for:

- RF immunity in microphone mode
- RF immunity in T-coil mode

In the following tests and results, this report includes the evaluation for a wireless communications device.

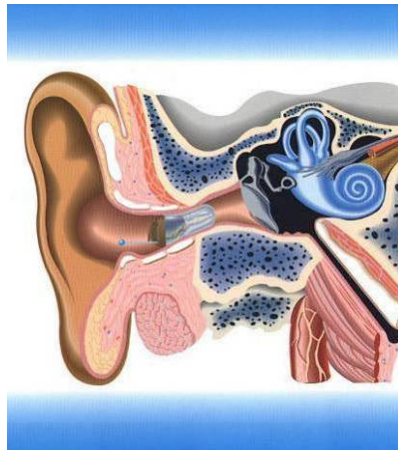



Figure 1-1 Hearing Aid *in-vitu*

¹ FCC Rule & Order, WT Docket 01-309 RM-8658

| | | | | |
|-------------------------------|---|-------------------------------|---|---------------------------------|
| FCC ID: A3LSMS777C |  | HAC (T-COIL) TEST REPORT |  | Reviewed by: Quality Manager |
| Filename: 0Y1502050385.A3L | Test Dates: 02/09/2015 | EUT Type: Portable Handset | | Page 3 of 36 |

2. EUT DESCRIPTION



FCC ID: A3LSMS777C
 Applicant: Samsung Electronics Co., Ltd.
 129, Samsung-ro, Maetan dong,
 Yeongtong-gu, Suwon-si
 Gyeonggi-do 443-742, Korea
 Model(s): SM-S777C
 Serial Number: A0000048C57DF2
 HW Version: N/A
 SW Version: S777CUDU0AOB1
 Antenna: Internal Antenna
 HAC Test Configurations: Cell. CDMA, 1013, 384, 777, BT Off, WLAN Off
 PCS CDMA, 25, 600, 1175, BT Off, WLAN Off
 EUT Type: Portable Handset

| Air-Interface | Band (MHz) | Type Transport | HAC Tested | Simultaneous But Not Tested | Voice over Digital Transport OTT Capability | WIFI Low Power | Additional GSM Power Reduction |
|--|------------|----------------|------------|-----------------------------|---|----------------|--------------------------------|
| CDMA | 835 | VO | Yes | Yes: WIFI or BT | N/A | N/A | N/A |
| | 1900 | | | | | | |
| | EVDO | DT | No | Yes: WIFI or BT | Yes | N/A | N/A |
| WIFI | 2450 | DT | No | Yes: CDMA | Yes | N/A | N/A |
| BT | 2450 | DT | No | Yes: CDMA | N/A | N/A | N/A |
| Type Transport VO = Voice Only DT = Digital Data - Not intended for CMRS Service | | | | | | | |

Table 2-1: A3LSMS777C HAC Air Interfaces

| | | | | |
|-------------------------------|---------------------------|-------------------------------|--------------|---------------------------------|
| FCC ID: A3LSMS777C | | HAC (T-COIL) TEST REPORT | | Reviewed by: Quality Manager |
| Filename: 0Y1502050385.A3L | Test Dates: 02/09/2015 | EUT Type: Portable Handset | Page 4 of 36 | |

3. ANSI C63.19-2011 PERFORMANCE CATEGORIES

I. MAGNETIC COUPLING

Axial and Radial Field Intensity

All orientations of the magnetic field, in the axial and radial position along the measurement plane shall be ≥ -18 dB(A/m) at 1 kHz in a 1/3 octave band filter per §8.3.1.

Frequency Response

The frequency response of the axial component of the magnetic field shall follow the response curve specified in EIA RS-504-1983, over the frequency range 300 Hz – 3000 Hz per §8.3.2.

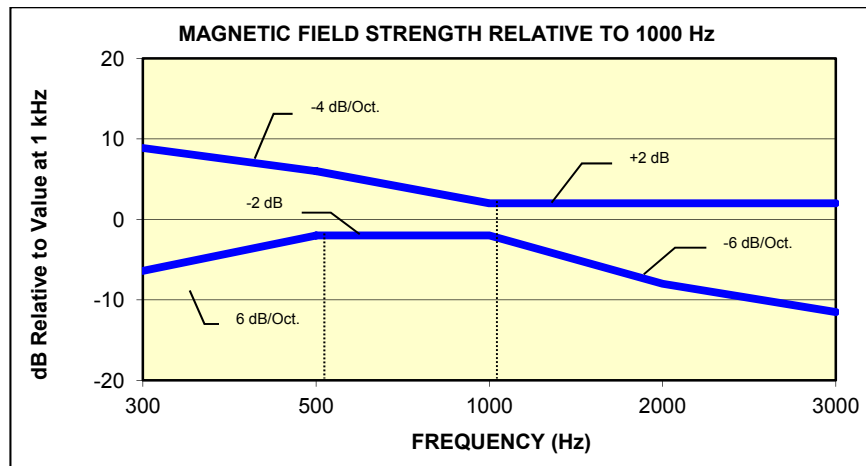

Figure 3-1
Magnetic field frequency response for Wireless Devices with an axial field ≤ -15 dB (A/m) at 1 kHz

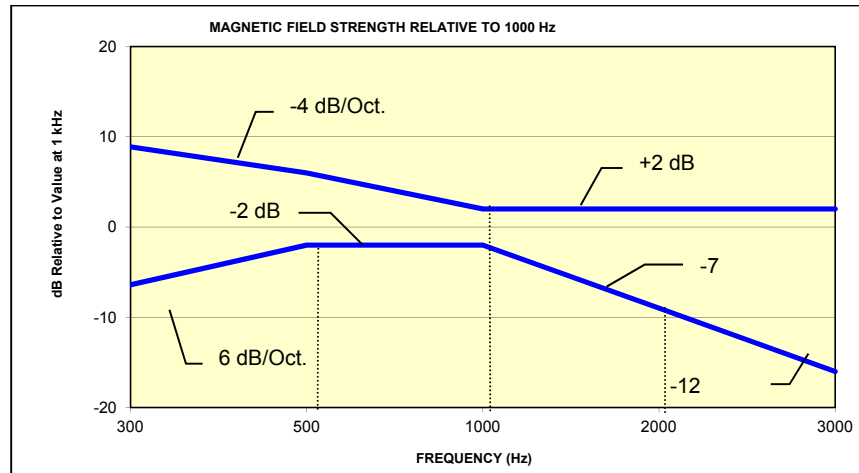



Figure 3-2
Magnetic Field frequency response for wireless devices with an axial field that exceeds -15 dB(A/m) at 1 kHz

| | | | | |
|-------------------------------|---|-------------------------------|---|---------------------------------|
| FCC ID: A3LSMS777C |  | HAC (T-COIL) TEST REPORT |  | Reviewed by: Quality Manager |
| Filename: 0Y1502050385.A3L | Test Dates: 02/09/2015 | EUT Type: Portable Handset | | Page 5 of 36 |



Signal Quality

The table below provides the signal quality requirement for the intended audio magnetic signal from a wireless device. Only the RF immunity of the hearing aid is measured in T-coil mode. It is assumed that a hearing aid can have no immunity to an interference signal in the audio band, which is the intended reception band for this mode. The only criterion that can be measured is the RF immunity in T-coil mode. This is measured using the same procedure as the audio coupling mode at the same levels.

The signal quality of the axial and radial components of the magnetic field was used to determine the T-coil mode category.

| Category | Telephone RF Parameters |
|----------|---|
| | Wireless Device Signal Quality [(Signal + Noise)-to-noise ratio in dB] |
| T1 | 0 to 10 dB |
| T2 | 10 to 20 dB |
| T3 | 20 to 30 dB |
| T4 | > 30 dB |

Table 3-1
Magnetic Coupling Parameters

| | | | | |
|-------------------------------|---|-------------------------------|---|---------------------------------|
| FCC ID: A3LSMS777C |  | HAC (T-COIL) TEST REPORT |  | Reviewed by: Quality Manager |
| Filename: 0Y1502050385.A3L | Test Dates: 02/09/2015 | EUT Type: Portable Handset | Page 6 of 36 | |

4. METHOD OF MEASUREMENT

I. Test Setup

The equipment was connected as shown in an acoustic/RF hemi-anechoic chamber:

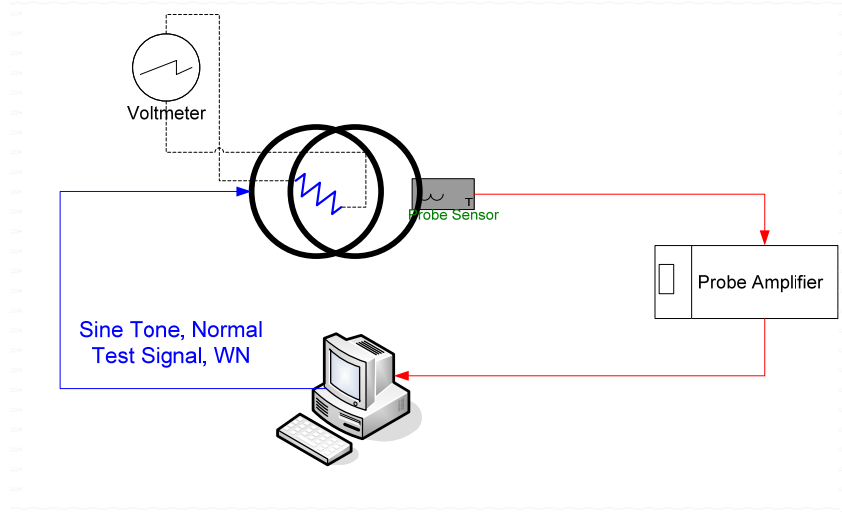

Figure 4-1
Validation Setup with Helmholtz Coil

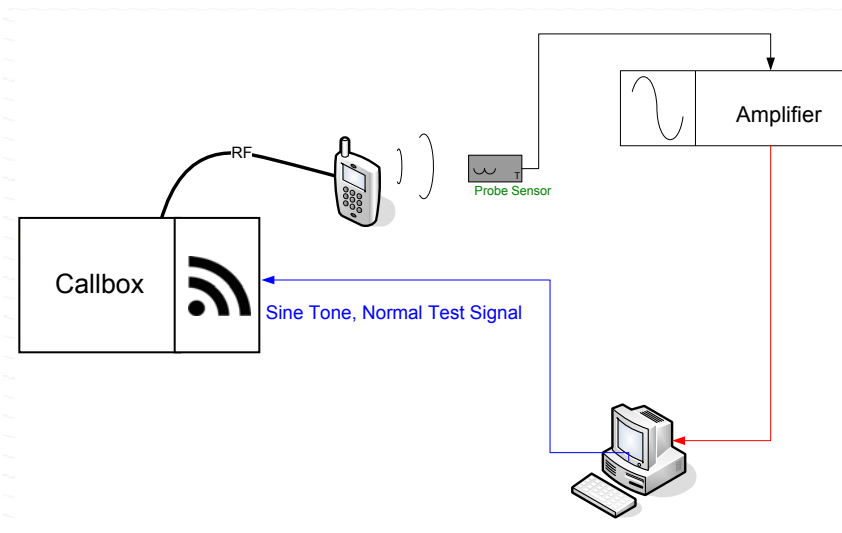



Figure 4-2
T-Coil Test Setup

| | | | | |
|-------------------------------|---|-------------------------------|---|---------------------------------|
| FCC ID: A3LSMS777C |  | HAC (T-COIL) TEST REPORT |  | Reviewed by: Quality Manager |
| Filename: 0Y1502050385.A3L | Test Dates: 02/09/2015 | EUT Type: Portable Handset | | Page 7 of 36 |

II. Scanning Mechanism

Manufacturer: TEM
 Accuracy: ± 0.83 cm/meter
 Minimum Step Size: 0.1 mm
 Maximum speed: 6.1 cm/sec
 Line Voltage: 115 VAC
 Line Frequency: 60 Hz
 Material Composite: Delrin (Acetal)
 Data Control: Parallel Port
 Dynamic Range (X-Y-Z): 45 x 31.75 x 47 cm
 Dimensions: 36" x 25" x 38"
 Operating Area: 36" x 49" x 55"
 Reflections: < -20 dB (in anechoic chamber)

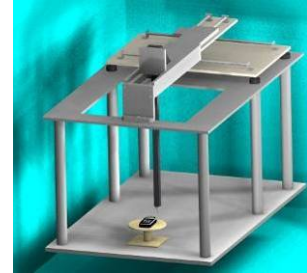

Figure 4-3
RF Near-Field Scanner

III. 3GPP2 Normal Test Signal (Speech)

Manufacturer: 3GPP2 (TIA 1042 §3.3.1)
 Modified-IRS weighted, multi-talker speech signal, 4 Male and 4
 Stimulus Type: Female speakers (alternating)
 Single Sample Duration: 51.62 seconds
 Activity Level: 77.4%

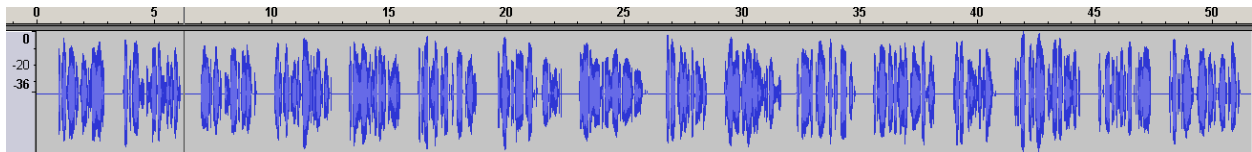

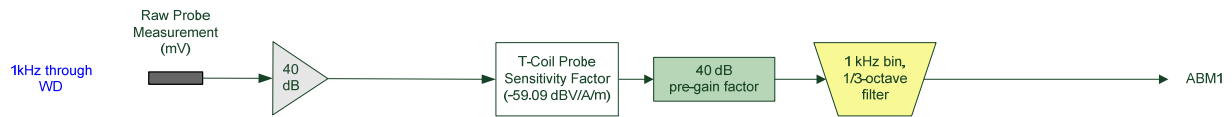

Figure 4-4
Temporal Characteristic of Normal Test Signal

| | | | | |
|-------------------------------|---|-------------------------------|---|---------------------------------|
| FCC ID: A3LSMS777C |  | HAC (T-COIL) TEST REPORT |  | Reviewed by: Quality Manager |
| Filename: 0Y1502050385.A3L | Test Dates: 02/09/2015 | EUT Type: Portable Handset | | Page 8 of 36 |

ABM1 Measurement Block Diagram:



ABM2 Measurement Block Diagram:

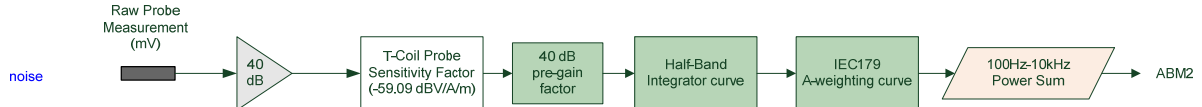

Figure 4-5 Magnetic Measurement Processing Steps

IV. Test Procedure

1. Ambient Noise Check per C63.19 §7.3.1
 - a. Ambient interference was monitored using a Real-Time Analyzer between 100-10,000 Hz with 1/3 octave filtering.
 - b. “A-weighting” and Half-Band Integration was applied to the measurements.
 - c. Since this measurement was measured in the same method as ABM2 measurements, this level was verified to be more than 10 dB below the lowest measurement signal (which is the highest ABM2 measurement for a T4 WD). Therefore the maximum noise level for a T4 WD with an ABM1 = -18 dBA/m is:

$$-18 - 30 - 10 = -58 \text{ dBA/m}$$
2. Measurement System Validation(See Figure 4-1)
 - a. The measurement system including the probe, pre-amplifier and acquisition system were validated as an entire system to ensure the reliability of test measurements.
 - b. ABM1 Validation
 The magnetic field at the center of the Helmholtz coil is given by the equation (per C63.19 Annex D.10.1):



$$H_c = \frac{NI}{r\sqrt{1.25^3}} = \frac{N\left(\frac{V}{R}\right)}{r\sqrt{1.25^3}}$$

Where H_c = magnetic field strength in amperes per meter
 N = number of turns per coil

For the Helmholtz Coil, $N=20$; $r=0.13\text{m}$; $R=10.193\Omega$ and using $V=29\text{mV}$:

$$H_c = \frac{20 \cdot \left(\frac{0.029}{10.193}\right)}{0.13 \cdot \sqrt{1.25^3}} = 0.31623 \text{ A/m} \approx -10 \text{ dB(A/m)}$$

Therefore a pure tone of 1kHz was applied into the coils such that 29 mV was observed across the 10 Ω resistor. The voltmeter used for measurement was verified to be capable of measurements in the audio band range. This theoretically generates an expected field of -10 dB(A/m) in the center of the Helmholtz coil which was used to validate the probe measurement at -10dB(A/m). This was verified to be within ± 0.5 dB of the -10dB(A/m) value (see Page 21).

| | | | | |
|-------------------------------|---|-------------------------------|---|---------------------------------|
| FCC ID: A3LSMS777C |  | HAC (T-COIL) TEST REPORT |  | Reviewed by: Quality Manager |
| Filename: 0Y1502050385.A3L | Test Dates: 02/09/2015 | EUT Type: Portable Handset | | Page 9 of 36 |

c. Frequency Response Validation

The frequency response through the Helmholtz Coil was verified to be within 0.5 dB relative to 1kHz, between 300 – 3000 Hz using the Normal speech signal as shown below:

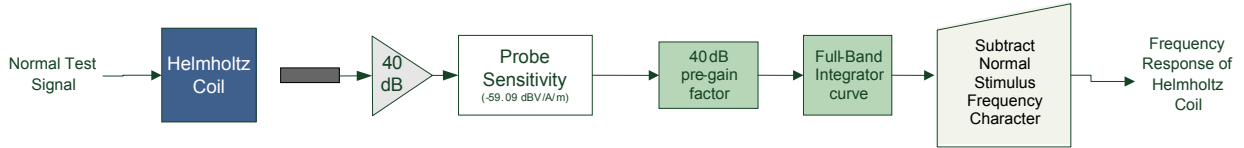



Figure 4-6 Frequency Response Validation

d. ABM2 Measurement Validation

WD noise measurements are filtered with A-weighting and Half-Band Integration over a frequency range of 100Hz – 10kHz to process ABM2 measurements. Below is the verification of the system processing A-weighting and Half-Band integration between system input to output within 0.5 dB of the theoretical result:

**Table 4-1
ABM2 Frequency Response Validation**

| f (Hz) | HBI, A - Measured (dB re 1kHz) | HBI, A - Theoretical (dB re 1kHz) | dB Var. |
|--------|--------------------------------|-----------------------------------|---------|
| 100 | -16.180 | -16.170 | -0.010 |
| 125 | -13.257 | -13.250 | -0.007 |
| 160 | -10.347 | -10.340 | -0.007 |
| 200 | -8.017 | -8.010 | -0.007 |
| 250 | -5.925 | -5.920 | -0.005 |
| 315 | -4.045 | -4.040 | -0.005 |
| 400 | -2.405 | -2.400 | -0.005 |
| 500 | -1.212 | -1.210 | -0.002 |
| 630 | -0.349 | -0.350 | 0.001 |
| 800 | 0.071 | 0.070 | 0.001 |
| 1000 | 0.000 | 0.000 | 0.000 |
| 1250 | -0.503 | -0.500 | -0.003 |
| 1600 | -1.513 | -1.510 | -0.003 |
| 2000 | -2.778 | -2.780 | 0.002 |
| 2500 | -4.316 | -4.320 | 0.004 |
| 3150 | -6.166 | -6.170 | 0.004 |
| 4000 | -8.322 | -8.330 | 0.008 |
| 5000 | -10.573 | -10.590 | 0.017 |
| 6300 | -13.178 | -13.200 | 0.022 |
| 8000 | -16.241 | -16.270 | 0.029 |
| 10000 | -19.495 | -19.520 | 0.025 |

| | | | | |
|-------------------------------|---|-------------------------------|---|---------------------------------|
| FCC ID: A3LSMS777C |  | HAC (T-COIL) TEST REPORT |  | Reviewed by: Quality Manager |
| Filename: 0Y1502050385.A3L | Test Dates: 02/09/2015 | EUT Type: Portable Handset | | Page 10 of 36 |

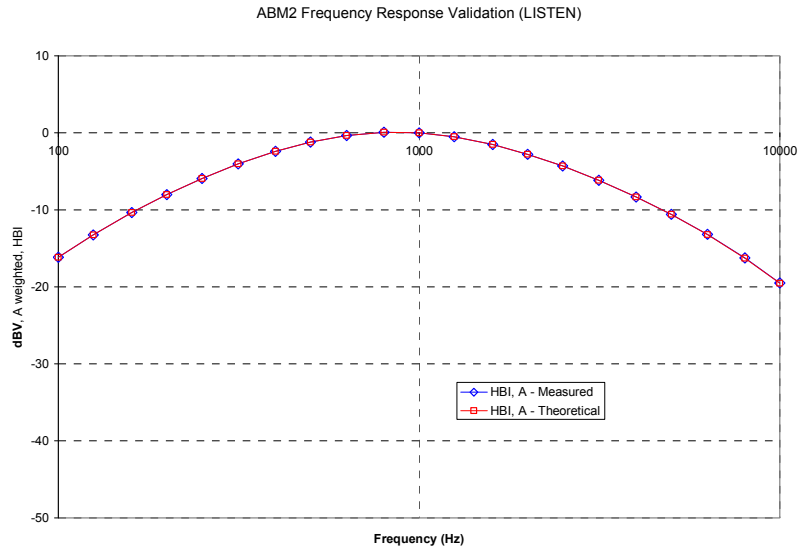

Figure 4-7
ABM2 Frequency Response Validation

The ABM2 result is a power sum from 100Hz to 10kHz with half-band integration and A-weighting. To verify the power sum measurement, a power sum over the full band was measured and verified to track with the source level (See Figure 4-9). Therefore the setup in this step was used to verify the power sum post-processing for ABM2 measurements. See below block diagram:

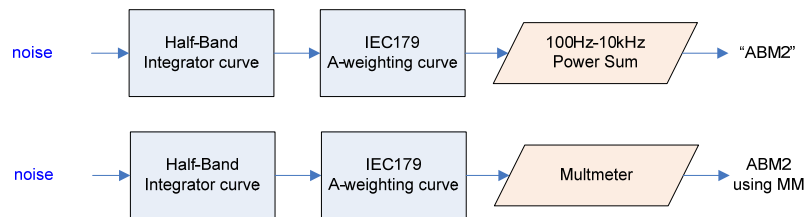

Figure 4-8
ABM2 Validation Block Diagram

The power summed output results for a known input were compared to the multi-meter results to verify any deviation in the post-processing implemented with the power-sum.

Table 4-2
ABM2 Power Sum Validation

| WN Input (dBV) | Power Sum (dBV) | Multimeter-Full (dBV) | Dev (dB) |
|----------------|-----------------|-----------------------|----------|
| -60 | -60.36 | -60.2 | 0.16 |
| -50 | -50.19 | -50.13 | 0.06 |
| -40 | -40.14 | -40.03 | 0.11 |
| -30 | -30.13 | -30.01 | 0.12 |
| -20 | -20.12 | -20 | 0.12 |
| -10 | -10.14 | -10 | 0.14 |

| | | | | |
|-------------------------------|---------------------------|-------------------------------|--|---------------------------------|
| FCC ID: A3LSMS777C | | HAC (T-COIL) TEST REPORT | | Reviewed by: Quality Manager |
| Filename: 0Y1502050385.A3L | Test Dates: 02/09/2015 | EUT Type: Portable Handset | | Page 11 of 36 |

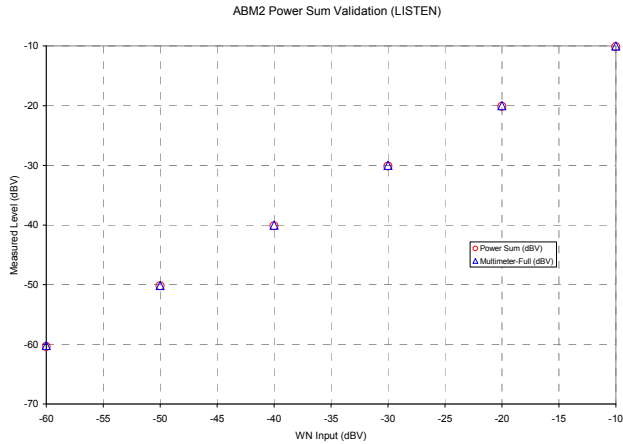

Figure 4-9
ABM2 Power Sum Validation

3. Measurement Test Setup

a. Fine scan above the WD (TEM)

- i. A multitone signal was applied to the handset such that the phone acoustic output was stable within 1dB over the probe settling time and with the acoustic output level at the C63.19 specified levels (below). The measurement step size was in 2 mm increments at a distance of 10 mm between the surface of the wireless device as shown below:

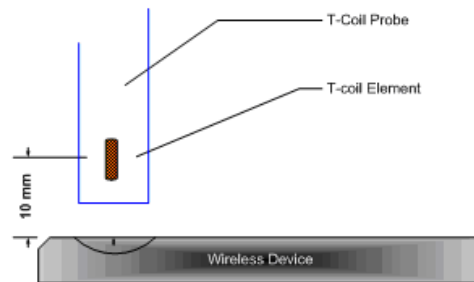



Figure 4-10
Measurement Distance

- ii. After scanning, the planar field maximum point was determined. The position of the probe was moved to this location to setup the test using the SoundCheck system.
- iii. These steps were repeated for all T-coil orientations (axial and radial) per Figure 4-14 after a T-coil orientation was fully measured with the SoundCheck system.

b. Speech Signal Setup to Base Station Simulator

- i. C63.19 Table 7-1 states audio reference input levels for various technologies:

| Standard | Technology | Input Level (dBm0) |
|-----------------|---------------------|--------------------|
| TIA/EIA/IS-2000 | CDMA | -18 |
| J-STD-007 | GSM (217) | -16 |
| T1/T1P1/3GPP | UMTS (WCDMA) | -16 |
| iDEN™ | TDMA (22 and 11 Hz) | -18 |

| | | | | |
|-------------------------------|---|-------------------------------|---|---------------------------------|
| FCC ID: A3LSMS777C |  | HAC (T-COIL) TEST REPORT |  | Reviewed by: Quality Manager |
| Filename: 0Y1502050385.A3L | Test Dates: 02/09/2015 | EUT Type: Portable Handset | Page 12 of 36 | |

The CMU200 audio levels were determined using base station simulator manufacturer calibration procedures resulting in the below corresponding voltages relative to handset test point level (in dBm0):

**Table 4-3
CMU200 Voltage Input Levels for Audio**

| dBm0 Ref. | Input Voltage | | Notes |
|-----------|---------------|-----------|---|
| 3.14 dBm0 | 1052.0 mV | 0.4 dBV | From CDMA2K "DECODER CAL". (What is needed through Encoder for FS) |
| -18 dBm0 | 92.260 mV | -20.7 dBV | For 8k Enhanced (Low) |

- c. Real-Time Analyzer (RTA)
 - i. The Real-Time Analyzer was configured to analyze measurements using 1/3 Octave band weighted filtering.
 - d. WD Radio Configuration Selection
 - i. The device was chosen to be tested in the worst-case ABM2 condition under RC1/SO3 (CDMA - EVRC) (See Section 5 for more information regarding worst-case configurations for CDMA.)
4. Signal Quality Data Analysis
- a. Narrow-band Magnetic Intensity
 - i. The standard specifies a 1kHz 1/3 octave band minimum field intensity for a sine tone. The ABM1 measurements were evaluated at 1kHz with 1/3 octave band filtering over an averaged period of 10 seconds.
 - b. Frequency Response
 - i. The appropriate frequency response curve was measured to curves in Figure 3-1 or Figure 3-2 between 300 – 3000 Hz using digital linear averaging (limit lines chosen according to measurement found in step 4a). A linear average over 3x the length of the artificial voice signal (3x sampling) was performed. A 10 second delay was configured in the measurement process of the stimulus to ensure handset vocoder latency effects and echo cancellation devices (if any) were appropriately stabilized during measurements.
 - ii. The appropriate post-processing was applied according to the system processing chain illustrated in Figure 4-12. All R10 frequencies were plotted with respect to 0dB at 1kHz value and aligned with respect to the EIA-504 mask.

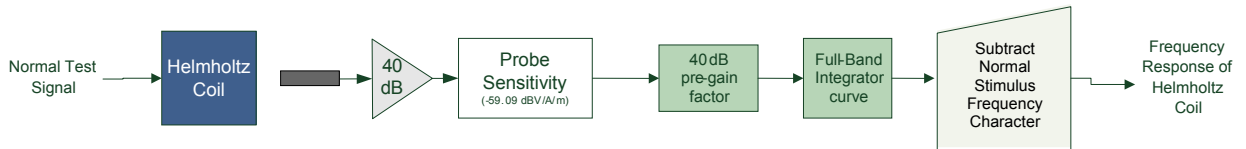

Figure 4-11 Frequency Response Block Diagram

- iii. The margin is represented by the closest measured data point on the curve to the EIA-504 limit lines, in dB.

| | | | | |
|-------------------------------|---------------------------|-------------------------------|--|---------------------------------|
| FCC ID: A3LSMS777C | | HAC (T-COIL) TEST REPORT | | Reviewed by: Quality Manager |
| Filename: 0Y1502050385.A3L | Test Dates: 02/09/2015 | EUT Type: Portable Handset | | Page 13 of 36 |

- c. Signal Quality Index
 - i. Ensuring the WD was at maximum RF power, maximum volume, backlight on, display on, maximum contrast setting, keypad lights on (when possible) with no audio signal through the vocoder, the WD was measured over at least 100 Hz – 10,000 Hz, maximized over 5 seconds with a 50ms sample time for the ABM2 measurement (5 second time period is used in noise measurements under standards such as IEEE 269, etc.).
 - ii. After applying half-band integration and A-weighting to the result, a power sum was applied over each 1/3 octave bandwidth frequency for an ABM2 value
 - iii. This result was subtracted from the ABM1 result in step a, to obtain the Signal Quality.

V. Test Setup

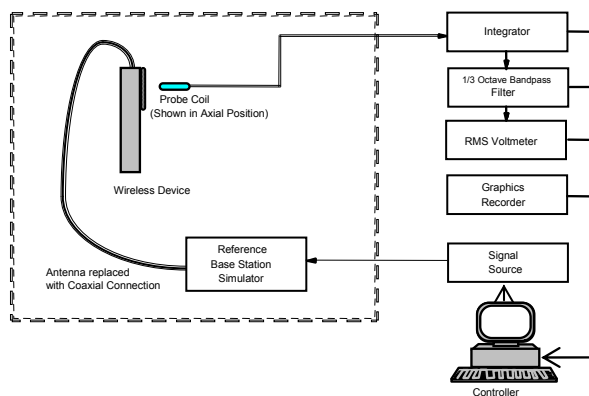



Figure 4-12
Audio Magnetic Field Test Setup

VI. Deviation from C63.19 Test Procedure

Non-conducted RF connection due to metallic shielding in battery cover.

| | | | | |
|--------------------------------------|---|--------------------------------------|---|--|
| FCC ID: A3LSMS777C |  | HAC (T-COIL) TEST REPORT |  | Reviewed by: Quality Manager |
| Filename: 0Y1502050385.A3L | Test Dates: 02/09/2015 | EUT Type: Portable Handset | | Page 14 of 36 |

VII. Air Interface Technologies Tested

According to the April 2013 TCB workshop slides, WIFI and other OTT data services are outside the current definition of a managed CMRS service and are currently not required to be evaluated.

VIII. Wireless Device Channels and Frequencies

The frequencies listed in the table below are those that lie in the center of the bands used for cellular telephony. Low, middle and high channels were tested in each band for FCC compliance evaluation to ensure the maximum emission is captured across the entire band.

To facilitate setting of a base station simulator for ABM measurements, specific band plan channel numbers are listed that may be used in lieu of the band center frequencies.

**Table 4-4
Center Channels and Frequencies**

| Test frequencies & associated channels | |
|--|-----------------|
| Channel | Frequency (MHz) |
| Cellular 850 | |
| 384 (CDMA) | 836.52 |
| PCS 1900 | |
| 600 (CDMA) | 1880 |

IX. RF Emission Effect on T-coil Measurements

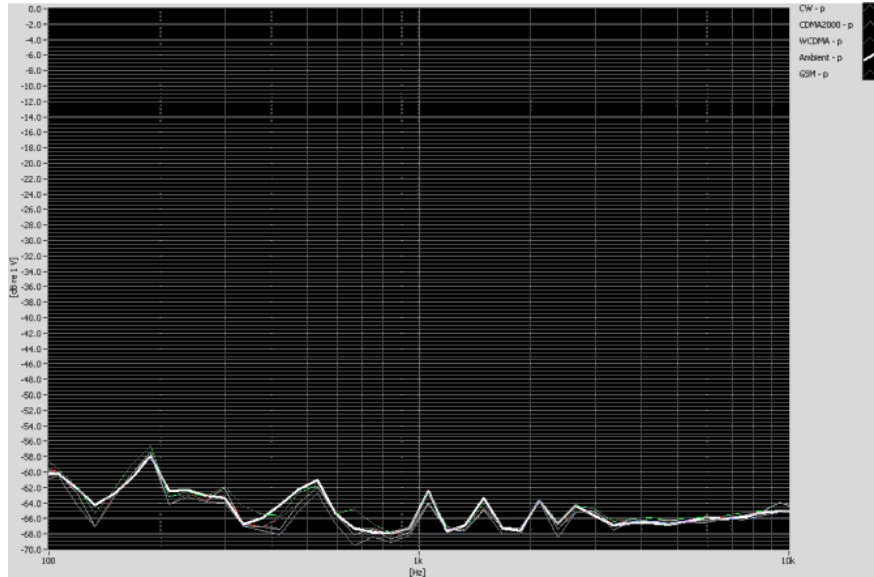



Figure 4-13

High power RF Emissions Effect with HAC Dipole on the T-coil Probe System 10mm between dipole maximum and magnetic probe

| | | | | |
|-------------------------------|---|-------------------------------|---|---------------------------------|
| FCC ID: A3LSMS777C |  | HAC (T-COIL) TEST REPORT |  | Reviewed by: Quality Manager |
| Filename: 0Y1502050385.A3L | Test Dates: 02/09/2015 | EUT Type: Portable Handset | | Page 15 of 36 |

X. Test Flow

The flow diagram below was followed (From C63.19):

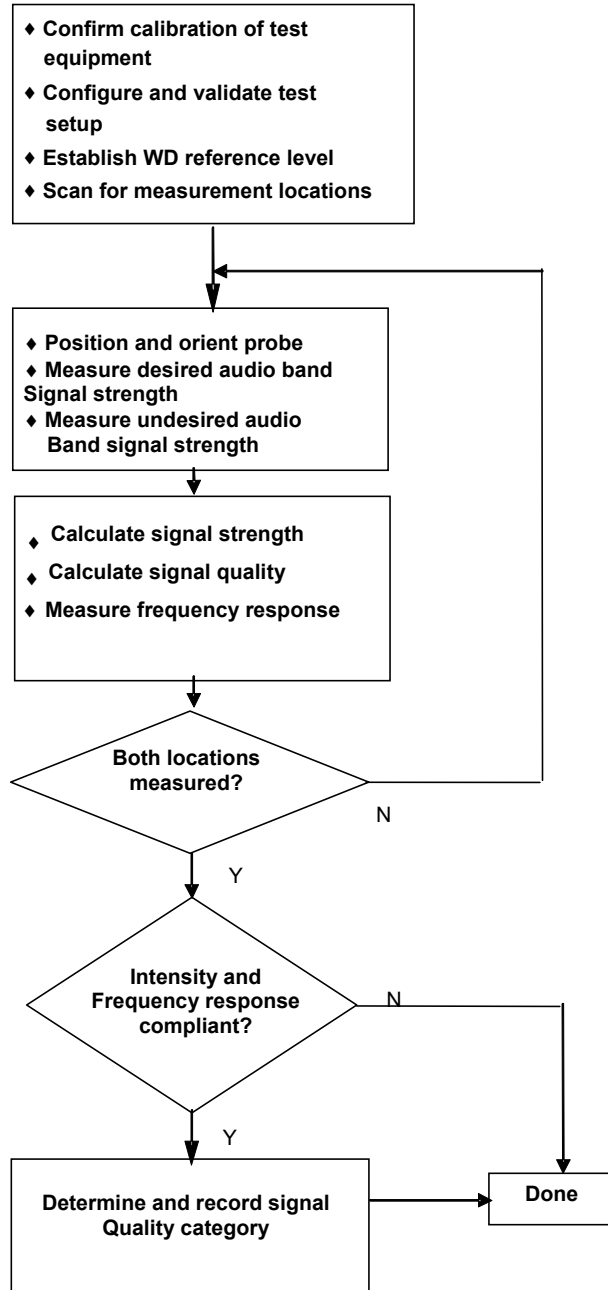



Figure 4-14
C63.19 T-Coil Signal Test Process

| | | | | |
|-------------------------------|---|-------------------------------|---|---------------------------------|
| FCC ID: A3LSMS777C |  | HAC (T-COIL) TEST REPORT |  | Reviewed by: Quality Manager |
| Filename: 0Y1502050385.A3L | Test Dates: 02/09/2015 | EUT Type: Portable Handset | | Page 16 of 36 |

5. FCC 3G MEASUREMENTS

I. CDMA Test Configurations

Radio Configuration 1, Service Option 3 (thick, green data curve) was used for the testing as the worst-case configuration for the handset due to vocoder gating from the EVRC logic. See below plot for ABM noise comparison between operational field service options and radio configurations for a CDMA2000 handset:

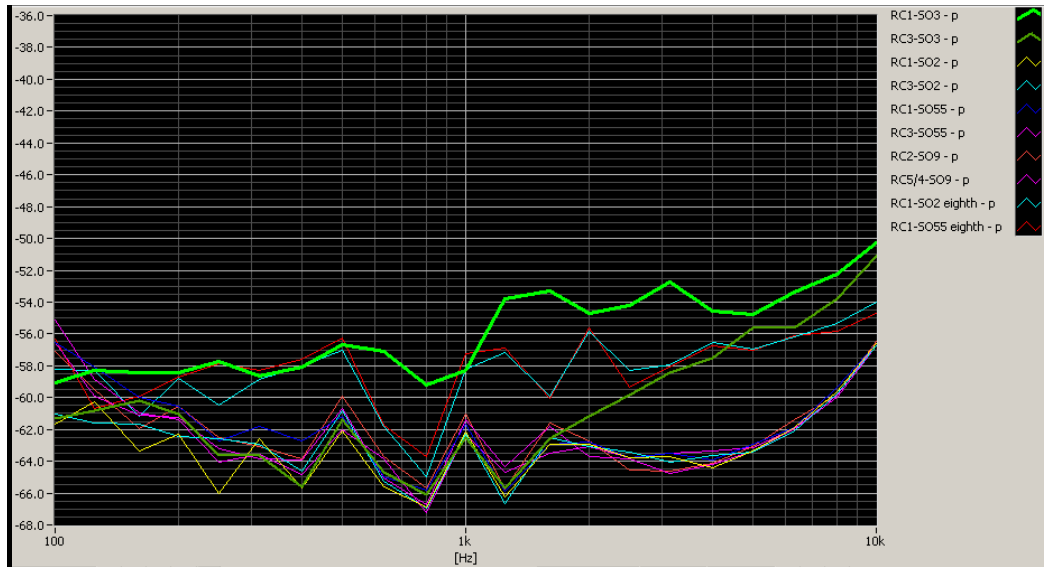

Figure 5-1
CDMA Audio Band Magnetic Noise

II. ABM Measurements

Table 5-1
FCC 3G ABM Measurements for A3LSMS777C (CDMA)

| Codec Setting: | RC1/SO3 | RC3/SO3 | RC4/SO3 | Orientation | Channel |
|---|---------|---------|---------|-------------|---------|
| ABM1 Pre-test (dBA/m) | -8.160 | -8.050 | -7.980 | Axial | 1175 |
| ABM2 Pre-test (dBA/m) (A-weight, Half-Band Int.) | -37.13 | -42.13 | -42.11 | | |
| S+N/N (dB) | 28.97 | 34.08 | 34.13 | | |

- Mute on; Backlight on; Max Volume, Max Contrast
- Power Control Bits = "All Up"



Figure 5-2
Audio Band Magnetic Curve Measurement Block Diagram

| | | | | |
|-------------------------------|---------------------------|-------------------------------|--|---------------------------------|
| FCC ID: A3LSMS777C | | HAC (T-COIL) TEST REPORT | | Reviewed by: Quality Manager |
| Filename: 0Y1502050385.A3L | Test Dates: 02/09/2015 | EUT Type: Portable Handset | | Page 17 of 36 |

6. TEST SUMMARY

I. T-Coil Test Summary

Table 6-1
Table of Results for CDMA



| C63.19 Sec. | Mode | Band | Test Description | Minimum Limit* | Measured | Verdict |
|-------------|------|----------|-------------------------------|----------------|--------------|------------------|
| | | | | <i>dBa/m</i> | <i>dBa/m</i> | <i>PASS/FAIL</i> |
| 8.3.1 | CDMA | Cellular | Intensity, Axial | -18 | -8.3 | PASS |
| 8.3.1 | | | Intensity, Radial | -18 | -16.3 | PASS |
| 8.3.4 | | | Signal-to-Noise/Noise, Axial | 20 | 29.3 | PASS |
| 8.3.4 | | | Signal-to-Noise/Noise, Radial | 20 | 30.9 | PASS |
| 8.3.2 | | | Frequency Response, Axial | 0 | 1.0 | PASS |
| 8.3.1 | CDMA | PCS | Intensity, Axial | -18 | -8.6 | PASS |
| 8.3.1 | | | Intensity, Radial | -18 | -16.6 | PASS |
| 8.3.4 | | | Signal-to-Noise/Noise, Axial | 20 | 28.8 | PASS |
| 8.3.4 | | | Signal-to-Noise/Noise, Radial | 20 | 30.0 | PASS |
| 8.3.2 | | | Frequency Response, Axial | 0 | 0.9 | PASS |

Note: The above summary table represents the worst-case numerical values according to configurations in Table 6-3.

Table 6-2
Consolidated Tabled Results

| | Volume Setting | Cellular | | PCS | |
|----------------------------|----------------|----------|--------|-------|--------|
| | | Axial | Radial | Axial | Radial |
| Freq. Response Margin | Maximum | PASS | N/A | PASS | N/A |
| Magnetic Intensity Verdict | | PASS | PASS | PASS | PASS |
| FCC SNR Verdict | | PASS | PASS | PASS | PASS |

Note: Result shown is for T-coil category only.

| | | | | |
|-------------------------------|---|-------------------------------|---|---------------------------------|
| FCC ID: A3LSMS777C |  | HAC (T-COIL) TEST REPORT |  | Reviewed by: Quality Manager |
| Filename: 0Y1502050385.A3L | Test Dates: 02/09/2015 | EUT Type: Portable Handset | | Page 18 of 36 |



II. Raw Handset Data

**Table 6-3
Raw Data Results for CDMA**

| | Volume | Cellular Band | | | | | |
|------------------------------------|------------------------|---------------|--------|--------|-----------|--------|--------|
| | | Axial | | | Radial | | |
| | | 1013 | 384 | 777 | 1013 | 384 | 777 |
| ABM1, dBA/m | Maximum | -8.25 | -8.12 | -8.08 | -15.89 | -16.27 | -15.93 |
| ABM2, dBA/m | | -38.67 | -38.08 | -37.37 | -47.94 | -47.88 | -46.86 |
| Ambient Noise, dBA/m | | -61.12 | -61.12 | -61.12 | -63.16 | -63.16 | -63.16 |
| Freq. Response Margin (dB) | | 1.09 | 1.15 | 1.00 | N/A | N/A | N/A |
| S+N/N (dB) | | 30.42 | 29.96 | 29.29 | 32.05 | 31.61 | 30.93 |
| S+N/N per orientation (dB) | | 29.29 | | | 30.93 | | |
| C63.19-2011 Rating per orientation | | T3 | | | T4 | | |
| | Volume | PCS Band | | | | | |
| | | Axial | | | Radial | | |
| | | 25 | 600 | 1175 | 25 | 600 | 1175 |
| ABM1, dBA/m | Maximum | -8.50 | -8.16 | -8.58 | -16.56 | -16.43 | -16.29 |
| ABM2, dBA/m | | -37.47 | -38.66 | -37.37 | -46.56 | -47.64 | -47.34 |
| Ambient Noise, dBA/m | | -61.12 | -61.12 | -61.12 | -63.16 | -63.16 | -63.16 |
| Freq. Response Margin (dB) | | 0.93 | 0.96 | 1.14 | N/A | N/A | N/A |
| S+N/N (dB) | | 28.97 | 30.50 | 28.79 | 30.00 | 31.21 | 31.05 |
| S+N/N per orientation (dB) | | 28.79 | | | 30.00 | | |
| C63.19-2011 Rating per orientation | | T3 | | | T3 | | |
| T-coil Coordinates (cm) | [x,y] from bottom left | 2.6, 2.6 | | | 2.6, 2.0 | | |

Notes:

1. Power Configuration: CDMA: Power Control Bits = "All Up"
2. Phone Condition: Mute on; Backlight on; Max Volume, Max Contrast
3. Vocoder Configuration: RC1/SO3 (CDMA - EVRC)
4. 'Radial' orientation refers to radial transverse.
5. Speech Signal: 3GPP2 Normal Test Signal.

| | | | | |
|-------------------------------|--|-------------------------------|---|---------------------------------|
| FCC ID: A3LSMS777C |  PCTEST ENGINEERING LABORATORY, INC. | HAC (T-COIL) TEST REPORT |  | Reviewed by: Quality Manager |
| Filename: 0Y1502050385.A3L | Test Dates: 02/09/2015 | EUT Type: Portable Handset | Page 19 of 36 | |

III. Frequency Response Graph

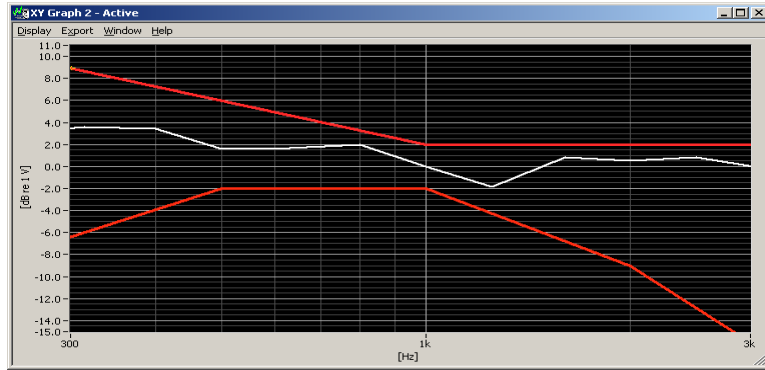
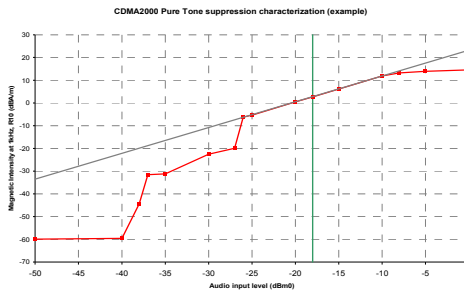

Figure 6-1
Axial Frequency Response

Note: User T-coil Mode (**Settings**→**Call**→**Additional Settings**→**Hearing aids**) was set to OFF for Frequency Response compliance. This frequency response represents the worst-case ABM2 test configuration according to Table 6-3.

IV. 1 kHz Vocoder Application Check



This model was verified to be within the linear region for ABM1 measurements at -18 dBm0 for CDMA. This measurement was taken in the axial configuration above the maximum location.

V. Undesirable Audio Magnetic Band Plot (ABM2)

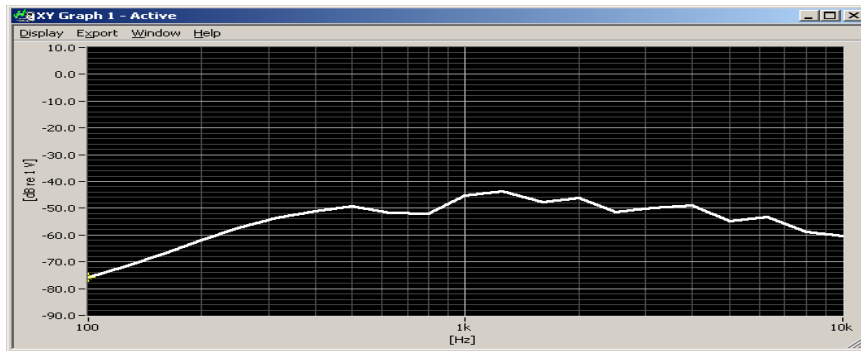



Figure 6-2
Worst-case ABM2 Plot for CDMA

Note: This plot represents the data from the location/configuration resulting in the highest ABM2 result shown in Table 6-3.

| | | | | |
|-------------------------------|---|-------------------------------|---|---------------------------------|
| FCC ID: A3LSMS777C |  | HAC (T-COIL) TEST REPORT |  | Reviewed by: Quality Manager |
| Filename: 0Y1502050385.A3L | Test Dates: 02/09/2015 | EUT Type: Portable Handset | | Page 20 of 36 |

VI. T-Coil Validation Test Results

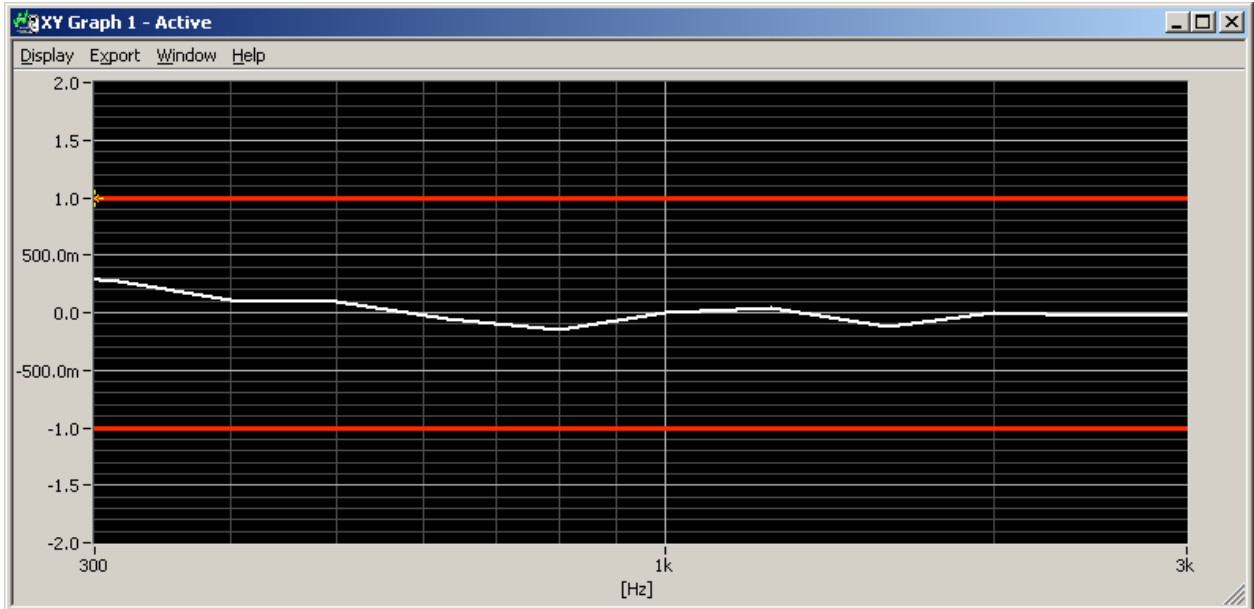



Figure 6-3
Helmholtz Coil Validation for Frequency Response

Table 6-4
Helmholtz Coil Validation Table of Results

| Item | Target | Result | Verdict |
|---------------------------------|--------------|--------|---------|
| Signal Validation | | | |
| Frequency Response, from limits | > 0 dB | 0.71 | PASS |
| Magnetic Intensity, -10 dBA/m | -10 ± 0.5 dB | -9.655 | PASS |
| Noise Validation | | | |
| Axial Environmental Noise | < - 58 dBA/m | -61.12 | PASS |
| Radial Environmental Noise | < - 58 dBA/m | -63.16 | PASS |

| | | | | |
|-------------------------------|---|-------------------------------|---|---------------------------------|
| FCC ID: A3LSMS777C |  | HAC (T-COIL) TEST REPORT |  | Reviewed by: Quality Manager |
| Filename: 0Y1502050385.A3L | Test Dates: 02/09/2015 | EUT Type: Portable Handset | | Page 21 of 36 |

7. MEASUREMENT UNCERTAINTY



**Table 7-1
Uncertainty Estimation Table**

| Contribution | Data +/- % | Data +/- dB | Data Type | Probability distribution | Divisor | Standard uncertainty | Standard Uncertainty (dB) |
|--|------------|-------------|---------------|--------------------------|---------|----------------------|---------------------------|
| ABM Noise | 7.0% | 0.29 | Std. Dev. | Normal k=1 | 1.00 | 7.0% | |
| RF Reflections | 4.7% | 0.20 | Specification | Rectangular | 1.73 | 2.7% | |
| Reference Signal Level | 12.2% | 0.50 | Specification | Rectangular | 1.73 | 7.0% | |
| Positioning Accuracy | 10.0% | 0.41 | Uncertainty | Rectangular | 1.73 | 5.8% | |
| Probe Coil Sensitivity | 12.2% | 0.50 | Specification | Rectangular | 1.73 | 7.0% | |
| Probe Linearity | 2.4% | 0.10 | Std. Dev. | Normal k=1 | 1.00 | 2.4% | |
| Cable Loss | 2.8% | 0.12 | Specification | Rectangular | 1.73 | 1.6% | |
| Frequency Analyzer | 5.0% | 0.21 | Specification | Rectangular | 1.73 | 2.9% | |
| System Repeatability | 5.0% | 0.21 | Std. Dev. | Normal k=1 | 1.00 | 5.0% | |
| WD Repeatability | 9.0% | 0.37 | Std. Dev. | Normal k=1 | 1.00 | 9.0% | |
| Positioner Accuracy | 1.0% | 0.04 | Specification | Rectangular | 1.73 | 0.6% | |
| Combined standard uncertainty, u_c (k=1) | | | | | | 17.7% | 0.71 |
| Expanded uncertainty (k=2), 95% confidence level | | | | | | 35.3% | 1.31 |

Notes:

1. Test equipments are calibrated according to techniques outlined in NIS81, NIS3003 and NIST Tech Note 1297.
2. All equipments have traceability according to NIST. Measurement Uncertainties are defined in further detail in NIS 81 and NIST Tech Note 1297 and UKAS M3003.



Measurement uncertainty reflects the quality and accuracy of a measured result as compared to the true value. Such statements are generally required when stating results of measurements so that it is clear to the intended audience that the results may differ when reproduced by different facilities. Measurement results vary due to the measurement uncertainty of the instrumentation, measurement technique, and test engineer. Most uncertainties are calculated using the tolerances of the instrumentation used in the measurement, the measurement setup variability, and the technique used in performing the test. While not generally included, the variability of the equipment under test also figures into the overall measurement uncertainty. Another component of the overall uncertainty is based on the variability of repeated measurements (so-called Type A uncertainty). This may mean that the Hearing Aid compatibility tests may have to be repeated by taking down the test setup and resetting it up so that there are a statistically significant number of repeat measurements to identify the measurement uncertainty. By combining the repeat measurement results with that of the instrumentation chain using the technique contained in NIS 81 and NIS 3003, the overall measurement uncertainty was estimated.

| | | | | |
|-------------------------------|---|-------------------------------|---|---------------------------------|
| FCC ID: A3LSMS777C |  | HAC (T-COIL) TEST REPORT |  | Reviewed by: Quality Manager |
| Filename: 0Y1502050385.A3L | Test Dates: 02/09/2015 | EUT Type: Portable Handset | Page 22 of 36 | |



8. EQUIPMENT LIST

**Table 8-1
Equipment List**

| Manufacturer | Model | Description | Cal Date | Cal Interval | Cal Due | Serial Number |
|-----------------|---------------------|-------------------------------------|------------|--------------|------------|---------------|
| Control Company | 36934-158 | Wall-Mounted Thermometer | 4/29/2014 | Biennial | 4/29/2016 | 122014488 |
| Listen | SoundConnect | Microphone Power Supply | 3/14/2014 | Annual | 3/14/2015 | PS2612 |
| Listen | SoundCheck | Acoustic Analyzer System | 10/17/2014 | Annual | 10/17/2015 | 01-20-03368 |
| NI | 4474 | Data Acquisition Card | N/A | | N/A | N/A |
| Rohde & Schwarz | CMU200 | Base Station Simulator | 4/24/2014 | Annual | 4/24/2015 | 836371/0079 |
| Seekonk | NC-100 | Torque Wrench (8" lb) | 3/18/2014 | Triennial | 3/18/2016 | N/A |
| TEM | Axial T-Coil Probe | Axial T-Coil Probe | 9/16/2014 | Annual | 9/16/2015 | TEM-1124 |
| TEM | Radial T-Coil Probe | Radial T-Coil Probe | 9/16/2014 | Annual | 9/16/2015 | TEM-1130 |
| TEM | Helmholtz Coil | Helmholtz Coil | 4/8/2014 | Annual | 4/8/2015 | 925 |
| TEM | | HAC System Controller with Software | N/A | | N/A | N/A |
| TEM | | HAC Positioner | N/A | | N/A | N/A |

| | | | | |
|--------------------------------------|---|--------------------------------------|---|--|
| FCC ID: A3LSMS777C |  PCTEST ENGINEERING LABORATORY, INC. | HAC (T-COIL) TEST REPORT |  | Reviewed by: Quality Manager |
| Filename: 0Y1502050385.A3L | Test Dates: 02/09/2015 | EUT Type: Portable Handset | Page 23 of 36 | |

9. CALIBRATION CERTIFICATES

| | | | | |
|--------------------------------------|---|--------------------------------------|---|--|
| FCC ID: A3LSMS777C |  PCTEST ENGINEERING LABORATORY, INC. | HAC (T-COIL) TEST REPORT |  | Reviewed by: Quality Manager |
| Filename: 0Y1502050385.A3L | Test Dates: 02/09/2015 | EUT Type: Portable Handset | | Page 24 of 36 |

West Caldwell Calibration Laboratories Inc.

Certificate of Calibration

for

AXIAL T COIL PROBE

Manufactured by: TEM CONSULTING
 Model No: AXIAL T COIL PROBE
 Serial No: TEM-1124
 Calibration Recall No: 24538

Submitted By:

Customer: JUSTIN CHAO
 Company: PCTEST ENGINEERING LAB
 Address: 6660-B DOBBIN ROAD
 COLUMBIA MD 21045

The subject instrument was calibrated to the indicated specification using standards traceable to the National Institute of Standards and Technology or to accepted values of natural physical constants. This document certifies that the instrument met the following specification upon its return to the submitter.

West Caldwell Calibration Laboratories Procedure No. AXIAL T C TEM

Upon receipt for Calibration, the instrument was found to be:

Within (X) see attached Report of Calibration.

the tolerance of the indicated specification.

QA
9/19/2014

West Caldwell Calibration Laboratories' calibration control system meets the requirements, ISO 10012-1 MIL-STD-45662A, ANSI/NCSL Z540-1, IEC Guide 25, ISO 9001:2008 and ISO 17025.

Note: With this Certificate, Report of Calibration is included.

Approved by:

Calibration Date: 16-Sep-14

FC

Certificate No: 24538 - 1

Felix Christopher (QA Mgr.)
 ISO/IEC 17025:2005



QA Doc. #1051 Rev. 2.0 10/1/01

Certificate Page 1 of 1

West Caldwell Calibration Laboratories, Inc.
 uncompromised calibration
 1575 State Route 96, Victor, NY 14564, U.S.A.



Calibration Lab. Cert. # 1533.01

| | | | | |
|-------------------------------|---|-------------------------------|---|---------------------------------|
| FCC ID: A3LSMS777C |  | HAC (T-COIL) TEST REPORT |  | Reviewed by: Quality Manager |
| Filename: 0Y1502050385.A3L | Test Dates: 02/09/2015 | EUT Type: Portable Handset | Page 25 of 36 | |



1575 State Route 96, Victor NY 14564

ISO/IEC 17025: 2005



Calibration Lab. Cert. # 1533.01

REPORT OF CALIBRATION

TEM Consulting LP Axial T Coil Probe

for
Model No.: Axial T Coil Probe

Serial No.: TEM-1124

Company : PCTEST Engineering Lab.

I. D. No: 80578

| Calibration results: | | Before data: | After data: |
|---|--------|--------------------|-------------------------------------|
| Probe Sensitivity measured with Helmholtz Coil | | | |
| <i>Helmholtz Coil;</i> | | | |
| the number of turns on each coil; | 10 | No. | |
| the radius of each coil, in meters; | 0.204 | m | |
| the current in the coils, in amperes.; | 0.09 | A | |
| <i>Helmholtz Coil Constant;</i> | 7.09 | A/m/V | |
| <i>Helmholtz Coil magnetic field;</i> | 5.97 | A/m | |
| Probe Sensitivity at | 1000 | Hz. | |
| was | -60.22 | dBV/A/m | |
| | 0.975 | mV/A/m | |
| Probe resistance | 901 | Ohms | |
| | | | Before & after data same: ...X..... |
| | | | Laboratory Environment: |
| | | | Ambient Temperature: 22.2 °C |
| | | | Ambient Humidity: 45.9 % RH |
| | | | Ambient Pressure: 99.5 kPa |
| | | | Calibration Date: 16-Sep-14 |
| | | | Re-calibration Due: 16-Sep-15 |
| | | | Report Number: 24538 -1 |
| | | | Control Number: 24538 |

The above listed instrument meets or exceeds the tested manufacturer's specifications.

This Calibration is traceable through NIST test numbers: ,287708

The expanded uncertainty of calibration: 0.30dB at 95% confidence level with a coverage factor of k=2.

Graph represents Probes Frequency Response.

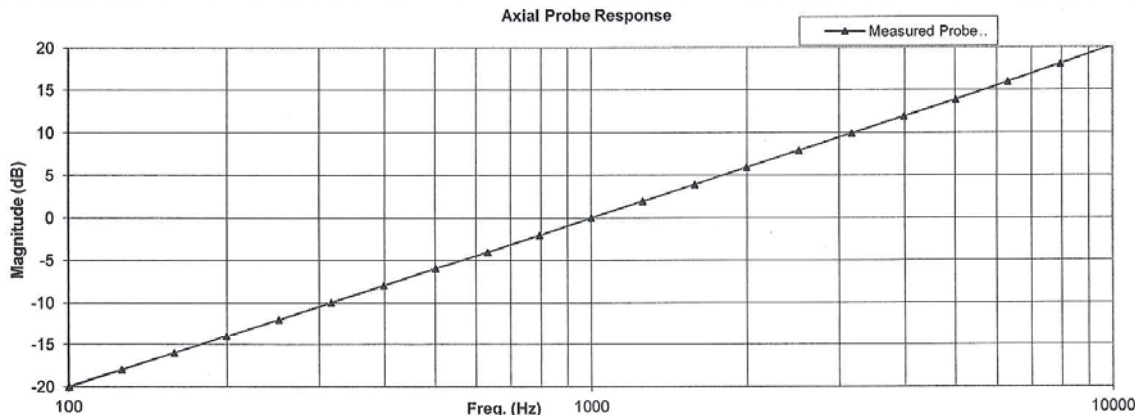

The above listed instrument was checked using calibration procedure documented in West Caldwell Calibration Laboratories Inc. procedure : **Rev. 7.0 Jan. 24, 2014 Doc. # 1038 HCATEMC**
 Calibration was performed by West Caldwell Calibration Laboratories Inc. under Operating Procedures intended to implement the requirements of ISO10012-1, IEC Guide 25, ANSI/NCCL Z540-1, (MIL-STD-45662A) and ISO 9001:2008, ISO 17025

Cal. Date: 16-Sep-2014

Measurements performed by: *[Signature]*

Calibrated on WCCL system type 9700

Felix Christopher

This document shall not be reproduced, except in full, without the written approval from West Caldwell Cal. Labs. Inc.

Rev. 7.0 Jan. 24, 2014 Doc. # 1038 HCATEMC

| | | | | |
|-------------------------------|---------------------------|-------------------------------|--|---------------------------------|
| FCC ID: A3LSMS777C | | HAC (T-COIL) TEST REPORT | | Reviewed by: Quality Manager |
| Filename: OY1502050385.A3L | Test Dates: 02/09/2015 | EUT Type: Portable Handset | | Page 26 of 36 |

HCATEMC_TEM-1124_Sep-16-2014

West Caldwell Calibration Laboratories Inc.

1575 State Route 96, Victor NY 14564
Tel. (585) 586-3900 FAX (585) 586-4327

Calibration Data Record

for
TEM Consulting LP Axial T Coil Probe Model No.: Axial T Coil Probe Serial No.: TEM-1124
Company : PCTEST Engineering Lab.

| Test | Function | Tolerance | Measured values | | | |
|------|--------------------------|-----------------------|-----------------|-------|---------|--|
| | | | Before | Out | Remarks | |
| 1.0 | Probe Sensitivity at | 1000 Hz. dBV/A/m | -60.22 | | | |
| 2.0 | Probe Level Linearity | | | | | |
| | | | dB | | | |
| | | | 6 | 6.00 | | |
| | | Ref. (0 dB) | 0 | 0.00 | | |
| | | | -6 | -6.00 | | |
| | | -12 | -12.10 | | | |
| 3.0 | Probe Frequency Response | | Hz | | | |
| | | | 100 | -20.0 | | |
| | | | 126 | -18.0 | | |
| | | | 158 | -16.0 | | |
| | | | 200 | -14.0 | | |
| | | | 251 | -12.0 | | |
| | | | 316 | -10.0 | | |
| | | | 398 | -8.0 | | |
| | | | 501 | -6.0 | | |
| | | | 631 | -4.1 | | |
| | | | 794 | -2.0 | | |
| | | | Ref. (0 dB) | 1000 | 0.0 | |
| | | | | 1259 | 1.9 | |
| | | | | 1585 | 3.9 | |
| | | | | 1995 | 5.9 | |
| | | | | 2512 | 7.9 | |
| | | | | 3162 | 9.9 | |
| | | 3981 | 11.9 | | | |
| | | 5012 | 13.9 | | | |
| | | 6310 | 15.9 | | | |
| | | 7943 | 18.0 | | | |
| | | 10000 | 20.2 | | | |



| Instruments used for calibration: | | | Date of Cal. | Traceability No. | Due Date |
|-----------------------------------|--------|--------------|--------------|------------------|------------|
| HP | 34401A | S/N 36064102 | 8-Oct-2013 | ,287708 | 8-Oct-2014 |
| HP | 34401A | S/N 36102471 | 8-Oct-2013 | ,287708 | 8-Oct-2014 |
| HP | 33120A | S/N 36043716 | 8-Oct-2013 | ,287708 | 8-Oct-2014 |
| B&K | 2133 | S/N 1583254 | 6-Jan-2014 | 683/284413-14 | 7-Jan-2015 |

Cal. Date: 16-Sep-2014
Calibrated on WCCL system type 9700

Tested by: Felix Christopher

This document shall not be reproduced, except in full, without the written approval from West Caldwell Cal. Labs. Inc.

Rev. 7.0 Jan. 24, 2014 Doc. # 1038 HCATEMC

| | | | | |
|-------------------------------|---|-------------------------------|---|---------------------------------|
| FCC ID: A3LSMS777C |  | HAC (T-COIL) TEST REPORT |  | Reviewed by: Quality Manager |
| Filename: 0Y1502050385.A3L | Test Dates: 02/09/2015 | EUT Type: Portable Handset | | Page 27 of 36 |

West Caldwell Calibration Laboratories Inc.

Certificate of Calibration

for

RADIAL T COIL PROBE

Manufactured by: TEM CONSULTING
Model No: RADIAL T COIL PROBE
Serial No: TEM-1130
Calibration Recall No: 24538

Submitted By:

Customer: JUSTIN CHAO
Company: PCTEST ENGINEERING LAB
Address: 6660-B DOBBIN ROAD
COLUMBIA MD 21045

The subject instrument was calibrated to the indicated specification using standards traceable to the National Institute of Standards and Technology or to accepted values of natural physical constants. This document certifies that the instrument met the following specification upon its return to the submitter.

West Caldwell Calibration Laboratories Procedure No. RADIAL T TEM

Upon receipt for Calibration, the instrument was found to be:

Within (X) see attached Report of Calibration.

the tolerance of the indicated specification.

West Caldwell Calibration Laboratories' calibration control system meets the requirements, ISO 10012-1 MIL-STD-45662A, ANSI/NCSL Z540-1, IEC Guide 25, ISO 9001:2008 and ISO 17025.

Note: With this Certificate, Report of Calibration is included.

Approved by:

Calibration Date: 16-Sep-14

Certificate No: 24538 - 2

QA Doc. #1051 Rev. 2.0 10/1/01

Certificate Page 1 of 1

FC
Felix Christopher (QA Mgr.)
ISO/IEC 17025:2005

West Caldwell Calibration Laboratories, Inc.
uncompromised calibration
1575 State Route 96, Victor, NY 14564, U.S.A.



Calibration Lab. Cert. # 1533.01

| | | | | |
|-------------------------------|--|-------------------------------|---------|---------------------------------|
| FCC ID: A3LSMS777C | PCTEST ENGINEERING LABORATORY, INC. | HAC (T-COIL) TEST REPORT | SAMSUNG | Reviewed by: Quality Manager |
| Filename: 0Y1502050385.A3L | Test Dates: 02/09/2015 | EUT Type: Portable Handset | | Page 28 of 36 |

West Caldwell Calibration Laboratories, Inc.
 uncompromised calibration
 1575 State Route 96, Victor NY 14564

ISO/IEC 17025: 2005



Calibration Lab. Cert. # 1533.01

REPORT OF CALIBRATION

TEM Consulting LP Radial T Coil Probe

Model No.: Radial T Coil Probe

Serial No.: TEM-1130

Company : PCTEST Engineering Lab.

I. D. No: 80579

| | | | |
|--|--------|-------------------------------------|-------------------|
| Calibration results: | | Before data: | After data: |
| Probe Sensitivity measured with Helmholtz Coil | | Before & after data same: ...X..... | |
| <i>Helmholtz Coil;</i> | | | |
| the number of turns on each coil; | 10 | No. | |
| the radius of each coil, in meters; | 0.204 | m | |
| the current in the coils, in amperes.; | 0.09 | A | |
| <i>Helmholtz Coil Constant;</i> | 7.09 | A/m/V | |
| <i>Helmholtz Coil magnetic field;</i> | 5.97 | A/m | |
| Probe Sensitivity at | 1000 | Hz. | |
| was | -60.58 | dBV/A/m | |
| | 0.936 | mV/A/m | |
| Probe resistance | 907 | Ohms | |
| | | Laboratory Environment: | |
| | | Ambient Temperature: | 22.2 °C |
| | | Ambient Humidity: | 45.9 % RH |
| | | Ambient Pressure: | 99.5 kPa |
| | | Calibration Date: | 16-Sep-14 |
| | | Re-calibration Due: | 16-Sep-15 |
| | | Report Number: | 24538 -2 |
| | | Control Number: | 24538 |
| The above listed instrument meets or exceeds the tested manufacturer's specifications. | | | |
| This Calibration is traceable through NIST test numbers: ,287708 | | | |
| The expanded uncertainty of calibration: 0.30dB at 95% confidence level with a coverage factor of k=2. | | | |
| Graph represents Probes Frequency Response. | | | |

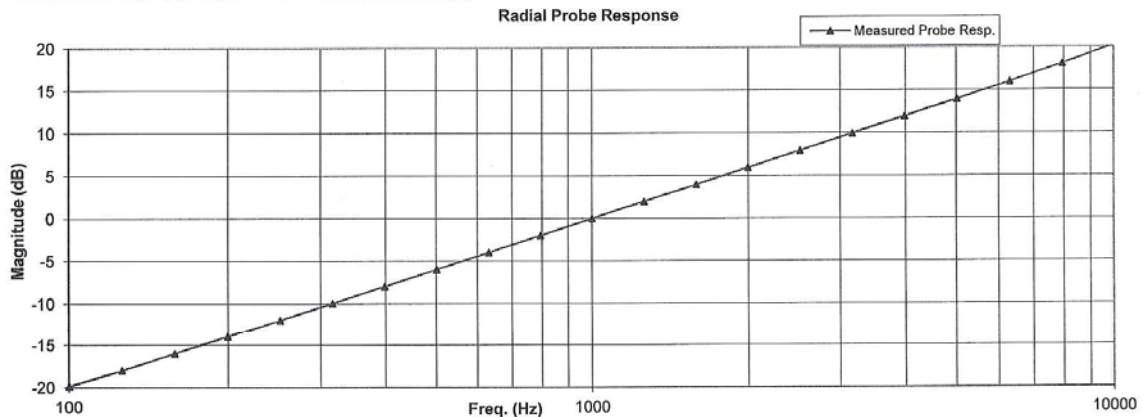

The above listed instrument was checked using calibration procedure documented in West Caldwell Calibration Laboratories Inc. procedure : **Rev. 7.0 Jan. 24, 2014 Doc. # 1038 HCRTEMC**
 Calibration was performed by West Caldwell Calibration Laboratories Inc. under Operating Procedures intended to implement the requirements of ISO10012-1, IEC Guide 25, ANSI/NCSL Z540-1, (MIL-STD-45662A) and ISO 9001:2008, ISO 17025

Cal. Date: 16-Sep-2014

Measurements performed by: *[Signature]*

Calibrated on WCCL system type 9700

Felix Christopher

This document shall not be reproduced, except in full, without the written approval from West Caldwell Cal. Labs. Inc.

Rev. 7.0 Jan. 24, 2014 Doc. # 1038 HCRTEMC

| | | | | |
|-------------------------------|---------------------------|-------------------------------|--|---------------------------------|
| FCC ID: A3LSMS777C | | HAC (T-COIL) TEST REPORT | | Reviewed by: Quality Manager |
| Filename: 0Y1502050385.A3L | Test Dates: 02/09/2015 | EUT Type: Portable Handset | | Page 29 of 36 |

HCRTEMC_TEM-1130_Sep-16-2014

West Caldwell Calibration Laboratories Inc.

1575 State Route 96, Victor NY 14564
Tel. (585) 586-3900 FAX (585) 586-4327

Calibration Data Record

for
TEM Consulting LP Radial T Coil Probe Model No.: Radial T Coil Probe Serial No.: TEM-1130
Company : PCTEST Engineering Lab.

| Test | Function | Tolerance | Measured values | | |
|-------|--------------------------|-----------------------|-----------------|--------|---------|
| | | | Before | Out | Remarks |
| 1.0 | Probe Sensitivity at | 1000 Hz. dBV/A/m | -60.58 | | |
| 2.0 | Probe Level Linearity | Ref. (0 dB) | dB | | |
| | | | 6 | 6.03 | |
| | | | 0 | 0.00 | |
| | | | -6 | -6.03 | |
| | | | -12 | -12.05 | |
| 3.0 | Probe Frequency Response | Ref. (0 dB) | Hz | | |
| | | | 100 | -19.8 | |
| | | | 126 | -18.0 | |
| | | | 158 | -16.0 | |
| | | | 200 | -13.9 | |
| | | | 251 | -12.0 | |
| | | | 316 | -10.0 | |
| | | | 398 | -8.0 | |
| | | | 501 | -6.0 | |
| | | | 631 | -4.0 | |
| | | | 794 | -2.0 | |
| | | | 1000 | 0.0 | |
| | | | 1259 | 2.0 | |
| | | | 1585 | 4.0 | |
| | | | 1995 | 6.0 | |
| | | | 2512 | 7.9 | |
| | | | 3162 | 9.9 | |
| | | | 3981 | 11.9 | |
| 5012 | 13.9 | | | | |
| 6310 | 16.0 | | | | |
| 7943 | 18.0 | | | | |
| 10000 | 20.2 | | | | |



| Instruments used for calibration: | | | Date of Cal. | Traceability No. | Due Date |
|-----------------------------------|--------|--------------|--------------|------------------|------------|
| HP | 34401A | S/N 36064102 | 8-Oct-2013 | ,287708 | 8-Oct-2014 |
| HP | 34401A | S/N 36102471 | 8-Oct-2013 | ,287708 | 8-Oct-2014 |
| HP | 33120A | S/N 36043716 | 8-Oct-2013 | ,287708 | 8-Oct-2014 |
| B&K | 2133 | S/N 1583254 | 6-Jan-2014 | 683/284413-14 | 7-Jan-2015 |

Cal. Date: 16-Sep-2014
Calibrated on WCCL system type 9700

Tested by: Felix Christopher

This document shall not be reproduced, except in full, without the written approval from West Caldwell Cal. Labs. Inc.



Rev. 7.0 Jan. 24, 2014 Doc. # 1038 HCRTEMC

| | | | | |
|-------------------------------|---|-------------------------------|---|---------------------------------|
| FCC ID: A3LSMS777C |  | HAC (T-COIL) TEST REPORT |  | Reviewed by: Quality Manager |
| Filename: 0Y1502050385.A3L | Test Dates: 02/09/2015 | EUT Type: Portable Handset | Page 30 of 36 | |

10. CONCLUSION



The measurements indicate that the wireless communications device complies with the HAC limits specified in accordance with the ANSI C63.19 Standard and FCC WT Docket No. 01-309 RM-8658. Precise laboratory measures were taken to assure repeatability of the tests. The tested device complies with the requirements in respect to all parameters specific to the test. The test results and statements relate only to the item(s) tested.

The measurement system and techniques presented in this evaluation are proposed in the ANSI standard as a means of best approximating wireless device compatibility with a hearing-aid. The literature is under continual re-construction.



| | | | | |
|--------------------------------------|---|--------------------------------------|---|--|
| FCC ID: A3LSMS777C |  | HAC (T-COIL) TEST REPORT |  | Reviewed by: Quality Manager |
| Filename: 0Y1502050385.A3L | Test Dates: 02/09/2015 | EUT Type: Portable Handset | | Page 31 of 36 |

11. REFERENCES

1. ANSI C63.19-2011, American National Standard for Methods of Measurement of Compatibility between Wireless communication devices and Hearing Aids.", New York, NY, IEEE, May 2011
2. FCC Office of Engineering and Technology KDB, "285076 D01 HAC Guidance v04," October 31, 2013
3. FCC Office of Engineering and Technology KDB, "285076 D02 T-Coil Testing for CMRS IP v01r01," October 31, 2013
4. FCC Public Notice DA 06-1215, *Wireless Telecommunications Bureau and Office of Engineering and Technology Clarify Use of Revised Wireless Phone Hearing Aid Compatibility Standard*, June 6, 2006
5. FCC 3G Review Guidance, Laboratory Division OET FCC, May/June 2006
6. Berger, H. S., "Compatibility Between Hearing Aids and Wireless Devices," Electronic Industries Forum, Boston, MA, May, 1997
7. Berger, H. S., "Hearing Aid and Cellular Phone Compatibility: Working Toward Solutions," *Wireless Telephones and Hearing Aids: New Challenges for Audiology*, Gallaudet University, Washington, D.C., May, 1997 (To be reprinted in the American Journal of Audiology).
8. Berger, H. S., "Hearing Aid Compatibility with Wireless Communications Devices," IEEE International Symposium on Electromagnetic Compatibility, Austin, TX, August, 1997.
9. Bronaugh, E. L., "Simplifying EMI Immunity (Susceptibility) Tests in TEM Cells," in the 1990 IEEE International Symposium on Electromagnetic Compatibility Symposium Record, Washington, D.C., August 1990, pp. 488-491
10. Byrne, D. and Dillon, H., The National Acoustics Laboratory (NAL) New Procedure for Selecting the Gain and Frequency Response of a Hearing Aid, *Ear and Hearing* 7:257-265, 1986.
11. Crawford, M. L., "Measurement of Electromagnetic Radiation from Electronic Equipment using TEM Transmission Cells," U.S. Department of Commerce, National Bureau of Standards, NBSIR 73-306, Feb. 1973.
12. Crawford, M. L., and Workman, J. L., "Using a TEM Cell for EMC Measurements of Electronic Equipment," U.S. Department of Commerce, National Bureau of Standards. Technical Note 1013, July 1981.
13. EHIMA GSM Project, Development phase, Project Report (1st part) Revision A. Technical-Audiological Laboratory and Telecom Denmark, October 1993.
14. EHIMA GSM Project, Development phase, Part II Project Report. Technical-Audiological Laboratory and Telecom Denmark, June 1994.
15. EHIMA GSM Project Final Report, Hearing Aids and GSM Mobile Telephones: Interference Problems, Methods of Measurement and Levels of Immunity. Technical-Audiological Laboratory and Telecom Denmark, 1995.

| | | | | |
|-------------------------------|---|-------------------------------|---|---------------------------------|
| FCC ID: A3LSMS777C |  | HAC (T-COIL) TEST REPORT |  | Reviewed by: Quality Manager |
| Filename: 0Y1502050385.A3L | Test Dates: 02/09/2015 | EUT Type: Portable Handset | | Page 32 of 36 |

16. HAMPIS Report, Comparison of Mobile phone electromagnetic near field with an upscaled electromagnetic far field, using hearing aid as reference, 21 October 1999.
17. Hearing Aids/GSM, Report from OTWIDAM, Technical-Audiological Laboratory and Telecom Denmark, April 1993.
18. IEEE 100, The Authoritative Dictionary of IEEE Standards Terms, Seventh Edition.
19. Joyner, K. H., et. al., Interference to Hearing Aids by the New Digital Mobile Telephone System, Global System for Mobile (GSM) Communication Standard, National Acoustic Laboratory, Australian Hearing Series, Sydney 1993.
20. Joyner, K. H., et. al., Interference to Hearing Aids by the Digital Mobile Telephone System, Global System for Mobile Communications (GSM), NAL Report #131, National Acoustic Laboratory, Australian Hearing Series, Sydney, 1995.
21. Kecker, W. T., Crawford, M. L., and Wilson, W. A., "Construction of a Transverse Electromagnetic Cell", U.S. Department of Commerce, National Bureau of Standards, Technical Note 1011, Nov. 1978.
22. Konigstein, D., and Hansen, D., "A New Family of TEM Cells with enlarged bandwidth and Optimized working Volume," in the Proceedings of the 7th International Symposium on EMC, Zurich, Switzerland, March 1987; 50:9, pp. 127-132.
23. Kuk, F., and Hjorstgaard, N. K., "Factors affecting interference from digital cellular telephones," Hearing Journal, 1997; 50:9, pp 32-34.
24. Ma, M. A., and Kanda, M., "Electromagnetic Compatibility and Interference Metrology," U.S. Department of Commerce, National Bureau of Standards, Technical Note 1099, July 1986, pp. 17-43.
25. Ma, M. A., Sreenivashiah, I. , and Chang, D. C., "A Method of Determining the Emission and Susceptibility Levels of Electrically Small Objects Using a TEM Cell," U.S. Department of Commerce, National Bureau of Standards, Technial Note 1040, July 1981.
26. McCandless, G. A., and Lyregaard, P. E., Prescription of Gain/Output (POGO) for Hearing Aids, Hearing Instruments 1:16-21, 1983
27. Skopec, M., "Hearing Aid Electromagnetic Interference from Digital Wireless Telephones, "IEEE Transactions on Rehabilitation Engineering, vol. 6, no. 2, pp. 235-239, June 1998.
28. Technical Report, GSM 05.90, GSM EMC Considerations, European Telecommunications Standards Institute, January 1993.
29. Victorian, T. A., "Digital Cellular Telephone Interference and Hearing Aid Compatibility—an Update," Hearing Journal 1998; 51:10, pp. 53-60
30. Wong, G. S. K., and Embleton, T. F. W., eds., AIP Handbook of Condenser Microphones: Theory, Calibration and Measurements, AIP Press.

| | | | | |
|--------------------------------------|---|--------------------------------------|---|--|
| FCC ID: A3LSMS777C |  | HAC (T-COIL) TEST REPORT |  | Reviewed by: Quality Manager |
| Filename: 0Y1502050385.A3L | Test Dates: 02/09/2015 | EUT Type: Portable Handset | Page 33 of 36 | |