



PART 2 RF EXPOSURE EVALUATION REPORT

Applicant Name:
 Samsung Electronics Co., Ltd.
 129, Samsung-ro, Maetan dong,
 Yeongtong-gu, Suwon-si
 Gyeonggi-do, 16677, Korea

Date of Testing:
 07/12/2023 – 07/28/2023
Test Site/Location:
 Element, Columbia, MD, USA
Document Serial No.:
 1M2304260060-25.A3L

FCC ID: A3LSMS711U

APPLICANT: SAMSUNG ELECTRONICS CO., LTD.

DUT Type: Portable Handset
Application Type: Certification
FCC Rule Part(s): CFR §2.1093
Model(s): SM-S711U, SM-S711U1
Device Serial Numbers: Pre-Production Samples [09016, 09511, 37447]

I attest to the accuracy of data. All measurements reported herein were performed by me or were made under my supervision and are correct to the best of my knowledge and belief. I assume full responsibility for the completeness of these measurements and vouch for the qualifications of all persons taking them. Test results reported herein relate only to the item(s) tested.



Rj Ortanez
 Executive Vice President



FCC ID: A3LSMS711U	PART 2 RF EXPOSURE EVALUATION REPORT	Approved by: Technical Manager
Document S/N: 1M2304260060-25.A3L	DUT Type: Portable Handset	Page 1 of 90

T A B L E O F C O N T E N T S

1	DEVICE UNDER TEST.....	3
2	RF EXPOSURE LIMITS.....	5
3	TIME VARYING TRANSMISSION TEST CASES.....	7
4	FCC MEASUREMENT PROCEDURES (FREQ < 6 GHZ).....	10
5	FCC MEASUREMENT PROCEDURES (FREQ > 6 GHZ).....	22
6	MEASUREMENT TEST SETUP (FREQ < 6 GHZ).....	30
7	MEASUREMENT TEST SETUP (FREQ > 6 GHZ).....	33
8	TEST CONFIGURATIONS (FREQ < 6 GHZ).....	35
9	CONDUCTED TX CASES (FREQ < 6 GHZ).....	39
10	SYSTEM VERIFICATION (FREQ < 6 GHZ).....	62
11	SAR TEST RESULTS (FREQ < 6 GHZ).....	64
12	TEST CONFIGURATIONS (FREQ > 6 GHZ).....	72
13	RADIATED POWER TX CASES (FREQ > 6 GHZ).....	75
14	SYSTEM VERIFICATION (FREQ > 6 GHZ).....	81
15	POWER DENSITY TEST RESULTS (FREQ > 6 GHZ).....	82
16	EQUIPMENT LIST.....	85
17	MEASUREMENT UNCERTAINTIES.....	86
18	CONCLUSION.....	88
19	REFERENCES.....	89
APPENDIX A: VERIFICATION PLOTS		
APPENDIX B: SAR TISSUE SPECIFICATIONS		
APPENDIX C: SAR SYSTEM VALIDATION		
APPENDIX D: TEST SETUP PHOTOGRAPHS		
APPENDIX E: TEST SEQUENCES		
APPENDIX F: TEST PROCEDURES FOR SUB6 NR + NR RADIO		
APPENDIX G: CALIBRATION CERTIFICATES		

FCC ID: A3LSMS711U	PART 2 RF EXPOSURE EVALUATION REPORT	Approved by: Technical Manager
Document S/N: 1M2304260060-25.A3L	DUT Type: Portable Handset	Page 2 of 90

1 DEVICE UNDER TEST

1.1 Device Overview

Band & Mode	Operating Modes	Tx Frequency
GSM/GPRS/EDGE 850	Voice/Data	824.20 - 848.80 MHz
GSM/GPRS/EDGE 1900	Voice/Data	1850.20 - 1909.80 MHz
UMTS 850	Voice/Data	826.40 - 846.60 MHz
UMTS 1750	Voice/Data	1712.4 - 1752.6 MHz
UMTS 1900	Voice/Data	1852.4 - 1907.6 MHz
LTE Band 71	Voice/Data	665.5 - 695.5 MHz
LTE Band 12	Voice/Data	699.7 - 715.3 MHz
LTE Band 13	Voice/Data	779.5 - 784.5 MHz
LTE Band 14	Voice/Data	790.5 - 795.5 MHz
LTE Band 26 (Cell)	Voice/Data	814.7 - 848.3 MHz
LTE Band 5 (Cell)	Voice/Data	824.7 - 848.3 MHz
LTE Band 66 (AWS)	Voice/Data	1710.7 - 1779.3 MHz
LTE Band 4 (AWS)	Voice/Data	1710.7 - 1754.3 MHz
LTE Band 25 (PCS)	Voice/Data	1850.7 - 1914.3 MHz
LTE Band 2 (PCS)	Voice/Data	1850.7 - 1909.3 MHz
LTE Band 30	Voice/Data	2307.5 - 2312.5 MHz
LTE Band 7	Voice/Data	2502.5 - 2567.5 MHz
LTE Band 41	Voice/Data	2498.5 - 2687.5 MHz
LTE Band 38	Voice/Data	2572.5 - 2617.5 MHz
LTE Band 48	Voice/Data	3552.5 - 3697.5 MHz
NR Band n71	Voice/Data	665.5 - 695.5 MHz
NR Band n12	Voice/Data	701.5 - 713.5 MHz
NR Band n26	Voice/Data	816.5 - 846.5 MHz
NR Band n66	Voice/Data	1712.5 - 1777.5 MHz
NR Band n25	Voice/Data	1852.5 - 1912.5 MHz
NR Band n30	Voice/Data	2307.5 - 2312.5 MHz
NR Band n41	Voice/Data	2506.02 - 2679.99 MHz
NR Band n48	Voice/Data	3555 - 3694.98 MHz
NR Band n77	Voice/Data	3455.01 - 3544.98 MHz 3705 - 3975 MHz
2.4 WLAN	Voice/Data	2412 - 2462 MHz
U-NII-1	Voice/Data	5180 - 5240 MHz
U-NII-2A	Voice/Data	5260 - 5320 MHz
U-NII-2C	Voice/Data	5500 - 5720 MHz
U-NII-3	Voice/Data	5745 - 5825 MHz
U-NII-4	Voice/Data	5845 - 5885 MHz
U-NII-5	Voice/Data	5935 - 6415 MHz
U-NII-6	Voice/Data	6435 - 6515 MHz
U-NII-7	Voice/Data	6535 - 6875 MHz
U-NII-8	Voice/Data	6895 - 7115 MHz
Bluetooth	Data	2402 - 2480 MHz
NFC	Data	13.56 MHz
NR Band n258	Data	24250 - 24450 MHz; 24750 - 25250 MHz
NR Band n260	Data	37000 - 40000 MHz
NR Band n261	Data	27500 - 28350 MHz

FCC ID: A3LSMS711U	PART 2 RF EXPOSURE EVALUATION REPORT	Approved by: Technical Manager
Document S/N: 1M2304260060-25.A3L	DUT Type: Portable Handset	Page 3 of 90

1.2 Time-Averaging Algorithm for RF Exposure Compliance

This device is enabled with Qualcomm® Smart Transmit feature. This feature performs time averaging algorithm in real time to control and manage transmitting power and ensure the time-averaged RF exposure is in compliance with FCC requirements all the time. DUT contains embedded file system (EFS) version 17 configured for the second generation (GEN2) for Sub6 and first generation (GEN1) for mmWave.

The Smart Transmit algorithm maintains the time-averaged transmit power, in turn, time-averaged RF exposure of SAR_design_target or PD_design_target, below the predefined time-averaged power limit (i.e., P_{limit} for sub-6 radio, and *input.power.limit* for 5G mmW NR), for each characterized technology and band.

Smart Transmit allows the device to transmit at higher power instantaneously, as high as P_{max} , when needed, but enforces power limiting to maintain time-averaged transmit power to P_{limit} for frequencies < 6 GHz and *input.power.limit* for frequencies > 6 GHz.

Note that the device uncertainty for sub-6GHz WWAN is 1.0 dB for this DUT, the device uncertainty for mmW is 2.0 dB, and the reserve power margin is 3 dB.

This purpose of the Part 2 report is to demonstrate the DUT complies with FCC RF exposure requirement under Tx varying transmission scenarios, thereby validity of Qualcomm® Smart Transmit feature implementation in this device. It serves to compliment the Part 0 and Part 1 Test Reports to justify compliance per FCC.

Note: WLAN operations are not enabled with Smart Transmit

1.3 Bibliography

Report Type	Report Serial Number
RF Exposure Part 0 Test Report	1M2304260060-02.A3L
RF Exposure Part 1 Test Report	1M2304260060-01.A3L
Part 0 Power Density Test Report	
Near Field PD Report (Part 1)	1M2304260060-27.A3L
RF Exposure Compliance Summary	1M2304260060-28.A3L

FCC ID: A3LSMS711U	PART 2 RF EXPOSURE EVALUATION REPORT	Approved by: Technical Manager
Document S/N: 1M2304260060-25.A3L	DUT Type: Portable Handset	Page 4 of 90

2 RF EXPOSURE LIMITS

2.1 Uncontrolled Environment

UNCONTROLLED ENVIRONMENTS are defined as locations where there is the exposure of individuals who have no knowledge or control of their exposure. The general population/uncontrolled exposure limits are applicable to situations in which the general public may be exposed or in which persons who are exposed as a consequence of their employment may not be made fully aware of the potential for exposure or cannot exercise control over their exposure. Members of the general public would come under this category when exposure is not employment-related; for example, in the case of a wireless transmitter that exposes persons in its vicinity.

2.2 Controlled Environment

CONTROLLED ENVIRONMENTS are defined as locations where there is exposure that may be incurred by persons who are aware of the potential for exposure, (i.e. as a result of employment or occupation). In general, occupational/controlled exposure limits are applicable to situations in which persons are exposed as a consequence of their employment, who have been made fully aware of the potential for exposure and can exercise control over their exposure. This exposure category is also applicable when the exposure is of a transient nature due to incidental passage through a location where the exposure levels may be higher than the general population/uncontrolled limits, but the exposed person is fully aware of the potential for exposure and can exercise control over his or her exposure by leaving the area or by some other appropriate means.

2.3 RF Exposure Limits for Frequencies Below 6 GHz

Table 2-1
SAR Human Exposure Specified in ANSI/IEEE C95.1-1992 and Health Canada Safety Code 6

HUMAN EXPOSURE LIMITS		
	UNCONTROLLED ENVIRONMENT <i>General Population</i> (W/kg) or (mW/g)	CONTROLLED ENVIRONMENT <i>Occupational</i> (W/kg) or (mW/g)
Peak Spatial Average SAR Head	1.6	8.0
Whole Body SAR	0.08	0.4
Peak Spatial Average SAR Hands, Feet, Ankle, Wrists, etc.	4.0	20

1. The Spatial Peak value of the SAR averaged over any 1 gram of tissue (defined as a tissue volume in the shape of a cube) and over the appropriate averaging time.
2. The Spatial Average value of the SAR averaged over the whole body.
3. The Spatial Peak value of the SAR averaged over any 10 grams of tissue (defined as a tissue volume in the shape of a cube) and over the appropriate averaging time.

FCC ID: A3LSMS711U	PART 2 RF EXPOSURE EVALUATION REPORT	Approved by: Technical Manager
Document S/N: 1M2304260060-25.A3L	DUT Type: Portable Handset	Page 5 of 90

2.4 RF Exposure Limits for Frequencies Above 6 GHz

Per §1.1310 (d)(3), the MPE limits are applied for frequencies above 6 GHz. Power Density is expressed in units of W/m² or mW/cm².

Peak Spatially Averaged Power Density was evaluated over a circular area of 4 cm² per interim FCC Guidance for near-field power density evaluations per October 2018 TCB Workshop notes.

**Table 2-2
Human Exposure Limits Specified in FCC 47 CFR §1.1310**

Human Exposure to Radiofrequency (RF) Radiation Limits		
Frequency Range [MHz]	Power Density [mW/cm ²]	Averaging Time [Minutes]
(A) Limits for Occupational / Controlled Environments		
1,500 – 100,000	5.0	6
(B) Limits for General Population / Uncontrolled Environments		
1,500 – 100,000	1.0	30

Note: 1.0 mW/cm² is 10 W/m²

2.5 Time Averaging Windows for FCC Compliance

Per October 2018 TCB Workshop Notes, the below time-averaging windows can be used for assessing time-averaged exposures for devices that are capable of actively monitoring and adjusting power output over time to comply with exposure limits.

Interim Guidance	Frequency (GHz)	Maximum Averaging Time (sec)
SAR	< 3	100
	3 – 6	60
MPE	6 - 10	30
	10 - 16	14
	16 – 24	8
	24 – 42	4
	42 – 95	2

FCC ID: A3LSMS711U	PART 2 RF EXPOSURE EVALUATION REPORT	Approved by: Technical Manager
Document S/N: 1M2304260060-25.A3L	DUT Type: Portable Handset	Page 6 of 90

3 TIME VARYING TRANSMISSION TEST CASES

To validate the time averaging feature and demonstrate the compliance in Tx varying transmission conditions, the following transmission scenarios are covered in the Part 2 test:

1. During a time-varying Tx power transmission: To prove that the Smart Transmit feature accounts for Tx power variations in time accurately.
2. During a call disconnect and re-establish scenario: To prove that the Smart Transmit feature accounts for history of past Tx power transmissions accurately.
3. During a technology/band handover: To prove that the Smart Transmit feature functions correctly during transitions in technology/band.
4. During a DSI (Device State Index) change: To prove that the Smart Transmit feature functions correctly during transition from one device state (DSI) to another.
5. During an antenna (or beam) switch: To prove that the Smart Transmit feature functions correctly during transitions in antenna (such as AsDiv scenario) or beams (different antenna array configurations) or beams (different antenna array configurations).
6. SAR vs. PD exposure switching during sub-6+mmW transmission: To prove that the Smart Transmit feature functions correctly and ensures total RF exposure compliance during transitions in SAR dominant exposure, SAR+PD exposure, and PD dominant exposure scenarios.
7. During time window switch: To prove that the Smart Transmit feature correctly handles the transition from one time window to another specified by FCC, and maintains the normalized time-averaged RF exposure to be less than normalized FCC limit of 1.0 at all times.
8. SAR exposure switching between two active radios (radio1 and radio2): To prove that the Smart Transmit feature functions correctly and ensures total RF exposure compliance when exposure varies among SAR_radio1 only, SAR_radio1 + SAR_radio2, and SAR_radio2 only scenarios.

As described in Part 0 report, the RF exposure is proportional to the Tx power for a SAR- and PD-characterized wireless device. Thus, feature validation in Part 2 can be effectively performed through conducted (for $f < 6\text{GHz}$) and radiated (for $f \geq 6\text{GHz}$) power measurement. Therefore, the compliance demonstration under dynamic transmission conditions and feature validation are done in conducted/radiated power measurement setup for transmission scenario 1 through 8.

To add confidence in the feature validation, the time-averaged SAR and PD measurements are also performed but only performed for transmission scenario 1 to avoid the complexity in SAR and PD measurement (such as, for scenario 3 requiring change in SAR probe calibration file to accommodate different bands and/or tissue simulating liquid).

The strategy for testing in Tx varying transmission condition is outlined as follows:

- Demonstrate the total RF exposure averaged over FCC defined time windows does not exceed FCC's SAR and PD limits, through time-averaged power measurements
 - Measure conducted Tx power (for $f < 6\text{GHz}$) versus time, and radiated Tx power (EIRP for $f > 10\text{GHz}$) versus time.
 - Convert it into RF exposure and divide by respective FCC limits to get normalized exposure versus time.

FCC ID: A3LSMS711U	PART 2 RF EXPOSURE EVALUATION REPORT	Approved by: Technical Manager
Document S/N: 1M2304260060-25.A3L	DUT Type: Portable Handset	Page 7 of 90

- Perform running time-averaging over FCC defined time windows.
- Demonstrate that the total normalized time-averaged RF exposure is less than 1 for all transmission scenarios (i.e., transmission scenarios 1, 2, 3, 4, 5, 6, 7, and 8) at all times.

Mathematical expression:

For < 6 GHz transmission only:

$$1g_or_10gSAR(t) = \frac{conducted_Tx_power(t)}{conducted_Tx_power_P_{limit}} * 1g_or_10gSAR_P_{limit} \quad (1a)$$

$$\frac{\frac{1}{T_{SAR}} \int_{t-T_{SAR}}^t 1g_or_10gSAR(t) dt}{FCC\ SAR\ limit} \leq 1 \quad (1b)$$

For sub-6+mmW transmission:

$$1g_or_10gSAR(t) = \frac{conducted_Tx_power(t)}{conducted_Tx_power_P_{limit}} * 1g_or_10gSAR_P_{limit} \quad (2a)$$

$$4cm^2PD(t) = \frac{radiated_Tx_power(t)}{radiated_Tx_power_input_power_limit} * 4cm^2PD_input_power_limit \quad (2b)$$

$$\frac{\frac{1}{T_{SAR}} \int_{t-T_{SAR}}^t 1g_or_10gSAR(t) dt}{FCC\ SAR\ limit} + \frac{\frac{1}{T_{PD}} \int_{t-T_{PD}}^t 4cm^2PD(t) dt}{FCC\ 4cm^2\ PD\ limit} \leq 1 \quad (2c)$$

where, *conducted_Tx_power(t)*, *conducted_Tx_power_P_{limit}*, and *1g_or_10gSAR_P_{limit}* correspond to the measured instantaneous conducted Tx power, measured conducted Tx power at *P_{limit}*, and measured 1gSAR or 10gSAR values at *P_{limit}* corresponding to sub-6 transmission. Similarly, *radiated_Tx_power(t)*, *radiated_Tx_power_input_power_limit*, and *4cm²PD_input_power_limit* correspond to the measured instantaneous radiated Tx power, radiated Tx power at *input.power.limit* (i.e., radiated power limit), and 4cm²PD value at *input.power.limit* corresponding to mmW transmission. Both *P_{limit}* and *input.power.limit* are the parameters pre-defined in Part 0 and loaded via Embedded File System (EFS) onto the EUT. *T_{SAR}* is the FCC defined time window for sub-6 radio; *T_{PD}* is the FCC defined time window for mmW radio.

- Demonstrate the total RF exposure averaged over FCC defined time windows does not exceed FCC's SAR and PD limits, through time-averaged SAR and PD measurements. Note as mentioned earlier, this measurement is performed for transmission scenario 1 only.
 - For sub-6 transmission only, measure instantaneous SAR versus time; for LTE+sub6 NR transmission, request low power (or all-down bits) on LTE so that measured SAR predominantly corresponds to sub6 NR.
 - For LTE + mmW transmission, measure instantaneous E-field versus time for mmW radio and instantaneous conducted power versus time for LTE radio.

FCC ID: A3LSMS711U	PART 2 RF EXPOSURE EVALUATION REPORT	Approved by: Technical Manager
Document S/N: 1M2304260060-25.A3L	DUT Type: Portable Handset	Page 8 of 90

- Convert it into RF exposure and divide by respective FCC limits to obtain normalized exposure versus time.
- Perform time averaging over FCC defined time window.
- Demonstrate that the total normalized time-averaged RF exposure is less than 1 for transmission scenario 1 at all times.

Mathematical expression:

- For sub-6 transmission only:

$$1g_or_10gSAR(t) = \frac{pointSAR(t)}{pointSAR_P_{limit}} * 1g_or_10gSAR(t)_P_{limit} \quad (3a)$$

$$\frac{\frac{1}{T_{SAR}} \int_{t-T_{SAR}}^t 1g_or_10gSAR(t) dt}{FCC\ SAR\ limit} \leq 1 \quad (3b)$$

- For LTE+mmW transmission:

$$1g_or_10gSAR(t) = \frac{conducted_Tx_power(t)}{conducted_Tx_power_P_{limit}} * 1g_or_10gSAR_P_{limit} \quad (4a)$$

$$4cm^2PD(t) = \frac{[pointE(t)]^2}{[pointE_input.power.limit]^2} * 4cm^2PD_input.power.limit \quad (4b)$$

$$\frac{\frac{1}{T_{SAR}} \int_{t-T_{SAR}}^t 1g_or_10gSAR(t) dt}{FCC\ SAR\ limit} + \frac{\frac{1}{T_{PD}} \int_{t-T_{PD}}^t 4cm^2PD(t) dt}{FCC\ 4cm^2PD\ limit} \leq 1 \quad (4c)$$

where, $pointSAR(t)$, $pointSAR_P_{limit}$, and $1g_or_10gSAR_P_{limit}$ correspond to the measured instantaneous point SAR, measured point SAR at P_{limit} , and measured $1gSAR$ or $10gSAR$ values at P_{limit} corresponding to sub-6 transmission. Similarly, $pointE(t)$, $pointE_input.power.limit$, and $4cm^2PD_input.power.limit$ correspond to the measured instantaneous E-field, E-field at $input.power.limit$, and $4cm^2PD$ value at $input.power.limit$ corresponding to mmW transmission.

Note: cDASY6 measurement system by Schmid & Partner Engineering AG (SPEAG) of Zurich, Switzerland measures relative E-field, and provides ratio of $\frac{[pointE(t)]^2}{[pointE_input.power.limit]^2}$ versus time.

FCC ID: A3LSMS711U	PART 2 RF EXPOSURE EVALUATION REPORT	Approved by: Technical Manager
Document S/N: 1M2304260060-25.A3L	DUT Type: Portable Handset	Page 9 of 90

4 FCC MEASUREMENT PROCEDURES (FREQ < 6 GHZ)

This chapter provides the test plan and test procedure for validating Qualcomm Smart Transmit feature for sub-6 transmission. The 100 seconds time window for operating $f < 3\text{GHz}$ is used as an example to detail the test procedures in this chapter. The same test plan and test procedures described in this chapter apply to 60 seconds time window for operating $f \geq 3\text{GHz}$.

4.1 Test sequence determination for validation

Following the FCC recommendation, two test sequences having time-variation in Tx power are predefined for sub-6 ($f < 6\text{GHz}$) validation:

- Test sequence 1: request DUT's Tx power to be at maximum power, measured P_{max}^\dagger , for 80s, then requesting for half of the maximum power, i.e., measured $P_{max}/2$, for the rest of the time.
- Test sequence 2: request DUT's Tx power to vary with time. This sequence is generated relative to measured P_{max} , measured P_{limit} and calculated $P_{reserve}$ (= measured P_{limit} in dBm - *Reserve_power_margin* in dB) of DUT based on measured P_{limit} .

The details for generating these two test sequences is described and listed in Appendix E.

NOTE: For test sequence generation, "measured P_{limit} " and "measured P_{max} " are used instead of the " P_{limit} " specified in EFS entry and " P_{max} " specified for the device, because the Smart Transmit feature operates against the actual power level of the " P_{limit} " that was calibrated for the DUT. The "measured P_{limit} " accurately reflects what the feature is referencing to, therefore, it should be used during feature validation testing. The RF tune up and device-to-device variation are already considered in Part 0 report prior to determining P_{limit} .

4.2 Test configuration selection criteria for validating Smart Transmit feature

For validating the Smart Transmit feature, this section provides the general guidance to select test cases.

4.2.1 Test configuration selection for time-varying Tx power transmission

The Smart Transmit time averaging feature operation is independent of bands, modes, and channels for a given technology. Hence, validation of Smart Transmit in one band/mode/channel per technology is sufficient. Two bands per technology are proposed and selected for this testing to provide high confidence in this validation.

Note this test is designed for single radio transmission scenario. If UE supports sub6 NR in both non-standalone (NSA) and standalone (SA) modes, then validation in time-varying Tx power transmission scenario described in this section needs to be performed in SA mode. Otherwise, it needs to be performed in NSA mode with LTE anchor set to low power. The choice between SA and NSA mode needs to also take into account the selection criteria described below. In general, one mode out of the two modes (NSA or SA) is sufficient for this test.

The criteria for the selection are based on the P_{limit} values determined in Part 0 report. Select two bands* in each supported technology that correspond to least** and highest*** P_{limit} values that are less than P_{max} for validating Smart Transmit. Note:

1. P_{max} refers to maximum Tx power configured for this device in this technology/band (not rated P_{max}). This P_{max} definition applies throughout this Part 2 report.

FCC ID: A3LSMS711U	PART 2 RF EXPOSURE EVALUATION REPORT	Approved by: Technical Manager
Document S/N: 1M2304260060-25.A3L	DUT Type: Portable Handset	Page 10 of 90

2. If $P_{limit} > P_{max}$, the validation test with time-varying test sequences is not needed as no power enforcement will be required in this condition.

* If one P_{limit} level applies to all the bands within a technology, then only one band needs to be tested. In this case, within the bands having the same P_{limit} , the radio configuration (e.g., # of RBs, channel#) and device position that correspond to the highest *measured* 1gSAR at P_{limit} shown in Part 1 report is selected.

** In case of multiple bands having the same least P_{limit} within the technology, then select the band having the highest *measured* 1gSAR at P_{limit} .

*** The band having a higher P_{limit} needs to be properly selected so that the power limiting enforced by Smart Transmit can be validated using the pre-defined test sequences. If the highest P_{limit} in a technology is too high where the power limiting enforcement is not needed when testing with the pre-defined test sequences, then the next highest level is checked. This process is continued within the technology until the second band for validation testing is determined.

4.2.2 Test configuration selection for change in call

The criteria to select a test configuration for call-drop measurement is:

- Select technology/band with least P_{limit} among all supported technologies/bands, and select the radio configuration (e.g., # of RBs, channel#) in this technology/band that corresponds to the highest *measured* 1gSAR at P_{limit} listed in Part 1 report.
- In case of multiple bands having same least P_{limit} , then select the band having the highest *measured* 1gSAR at P_{limit} in Part 1 report.

This test is performed with the DUT's Tx power requested to be at maximum power, the above band selection will result in Tx power enforcement (i.e., DUT forced to have Tx power at $P_{reserve}$) for longest duration in one FCC defined time window. The call change (call drop/reestablish) is performed during the Tx power enforcement duration (i.e., during the time when DUT is forced to have Tx power at $P_{reserve}$). One test is sufficient as the feature operation is independent of technology and band.

4.2.3 Test configuration selection for change in technology/band

The selection criteria for this measurement is, for a given antenna, to have DUT switch from a technology/band with lowest P_{limit} within the technology group (in case of multiple bands having the same P_{limit} , then select the band with highest *measured* 1gSAR at P_{limit}) to a technology/band with highest P_{limit} within the technology group, in case of multiple bands having the same P_{limit} , then select the band with lowest *measured* 1gSAR at P_{limit} in Part 1 report, or vice versa.

This test is performed with the DUT's Tx power requested to be at maximum power, the technology/band switch is performed during Tx power enforcement duration (i.e., during the time when DUT is forced to have Tx power at $P_{reserve}$).

4.2.4 Test configuration selection for change in antenna

The criteria to select a test configuration for antenna switch measurement is:

- Whenever possible and supported by the DUT, first select antenna switch configuration within the same technology/band (i.e., same technology and band combination).

FCC ID: A3LSMS711U	PART 2 RF EXPOSURE EVALUATION REPORT	Approved by: Technical Manager
Document S/N: 1M2304260060-25.A3L	DUT Type: Portable Handset	Page 11 of 90

- Then, select any technology/band that supports multiple Tx antennas, and has the highest difference in P_{limit} among all supported antennas.
- In case of multiple bands having same difference in P_{limit} among supported antennas, then select the band having the highest *measured* 1gSAR at P_{limit} in Part 1 report.

This test is performed with the DUT's Tx power requested to be at maximum power in selected technology/band, and antenna change is conducted during Tx power enforcement duration (i.e., during the time when DUT is forced to have Tx power at $P_{reserve}$).

4.2.5 Test configuration selection for change in DSI

The criteria to select a test configuration for DSI change test is

- Select a technology/band having the $P_{limit} < P_{max}$ within any technology and DSI group, and for the same technology/band having a different P_{limit} in any other DSI group. Note that the selected DSI transition need to be supported by the device.

This test is performed with the DUT's Tx power requested to be at maximum power in selected technology/band, and DSI change is conducted during Tx power enforcement duration (i.e., during the time when DUT is forced to have Tx power at $P_{reserve}$).

4.2.6 Test configuration selection for change in time window

FCC specifies different time window for time averaging based on operation frequency. The criteria to select a test configuration for validating Smart Transmit feature and demonstrating the compliance during the change in time window is

- Select any technology/band that has operation frequency classified in one time window defined by FCC (such as 100-seconds time window), and its corresponding P_{limit} is less than P_{max} if possible.
- Select the 2nd technology/band that has operation frequency classified in a different time window defined by FCC (such as 60-seconds time window), and its corresponding P_{limit} is less than P_{max} if possible.
- Note it is preferred both P_{limit} values of two selected technology/band less than corresponding P_{max} , but if not possible, at least one of technologies/bands has its P_{limit} less than P_{max} .

This test is performed with the EUT's Tx power requested to be at maximum power in selected technology/band. Test for one pair of time windows selected is sufficient as the feature operation is the same.

4.2.7 Test configuration selection for SAR exposure switching

If supported, the test configuration for SAR exposure switching should cover

1. SAR exposure switch when two active radios are in the same time window
2. SAR exposure switch when two active radios are in different time windows. One test with two active radios in any two different time windows is sufficient as Smart Transmit operation is the same for RF exposure switch in any combination of two different time windows. For device supporting LTE + mmW NR, this test is covered in SAR vs PD exposure switch validation.

The Smart Transmit time averaging operation is independent of the source of SAR exposure (for example, LTE vs. Sub6 NR) and ensures total time-averaged RF exposure compliance. Hence, validation of Smart Transmit in any one simultaneous SAR transmission scenario (i.e., one combination for LTE + Sub6 NR transmission) is sufficient, where the SAR exposure varies among SAR_{radio1} only, $SAR_{radio1} + SAR_{radio2}$, and SAR_{radio2} only scenarios.

FCC ID: A3LSMS711U	PART 2 RF EXPOSURE EVALUATION REPORT	Approved by: Technical Manager
Document S/N: 1M2304260060-25.A3L	DUT Type: Portable Handset	Page 12 of 90

The criteria to select a test configuration for validating Smart Transmit feature during SAR exposure switching scenarios is

- Select any two < 6GHz technologies/bands that the EUT supports simultaneous transmission (for example, LTE+Sub6 NR).
- Among all supported simultaneous transmission configurations, the selection order is
 1. select one configuration where both P_{limit} of radio1 and radio2 is less than their corresponding P_{max} , preferably, with different P_{limits} . If this configuration is not available, then,
 2. select one configuration that has P_{limit} less than its P_{max} for at least one radio. If this can not be found, then,
 3. select one configuration that has P_{limit} of radio1 and radio2 greater than P_{max} but with least $(P_{limit} - P_{max})$ delta.

Test for one simultaneous transmission scenario is sufficient as the feature operation is the same.

4.3 Test procedures for conducted power measurements

This section provides general conducted power measurement procedures to perform compliance test under dynamic transmission scenarios described in Section 3. In practice, an adjustment can be made in these procedures. The justification/clarification may be provided.

4.3.1 Time-varying Tx power transmission scenario

This test is performed with the two pre-defined test sequences described in Section 4.1 for all the technologies and bands selected in Section 4.2.1. The purpose of the test is to demonstrate the effectiveness of power limiting enforcement and that the time-averaged SAR (corresponding time-averaged Tx power) does not exceed the FCC limit at all times (see Eq. (1a) and (1b)).

Test procedure

1. Measure P_{max} , measure P_{limit} and calculate $P_{reserve}$ (measured P_{limit} in dBm – $Reserve_power_margin$ in dB) and follow Section 4.1 to generate the test sequences for all the technologies and bands selected in Section 4.2.1. Both test sequence 1 and test sequence 2 are created based on measured P_{max} and measured P_{limit} of the DUT. Test condition to measure P_{max} and P_{limit} is:
 - a. Measure P_{max} with Smart Transmit disabled and callbox set to request maximum power.
 - b. Measure P_{limit} with Smart Transmit enabled and $Reserve_power_margin$ set to 0 dB, callbox set to request maximum power.
2. Set $Reserve_power_margin$ to actual (intended) value (3dB for this DUT based on Part 1 report) and reset power on DUT to enable Smart Transmit, establish radio link in desired radio configuration, with callbox requesting the DUT's Tx power to be at pre-defined test sequence 1, measure and record Tx power versus time, and then convert the conducted Tx power into 1gSAR or 10gSAR value (see Eq. (1a)) using measured P_{limit} from above Step 1. Perform running time average to determine time-averaged power and 1gSAR or 10gSAR versus time as illustrated in Figure 4-1 where using 100-seconds time window as an example.

FCC ID: A3LSMS711U	PART 2 RF EXPOSURE EVALUATION REPORT	Approved by: Technical Manager
Document S/N: 1M2304260060-25.A3L	DUT Type: Portable Handset	Page 13 of 90

Note: In Eq.(1a), instantaneous Tx power is converted into instantaneous 1gSAR or 10gSAR value by applying the measured worst-case 1gSAR or 10gSAR value at P_{limit} for the corresponding technology/band/antenna/DSI reported in Part 1 report.

Note: For an easier computation of the running time average, 0 dBm can be added at the beginning of the test sequences the length of the responding time window, for example, add 0dBm for 100-seconds so the running time average can be directly performed starting with the first 100-seconds data using excel spreadsheet. This technique applies to all tests performed in this Part 2 report for easier time-averaged computation using excel spreadsheet.

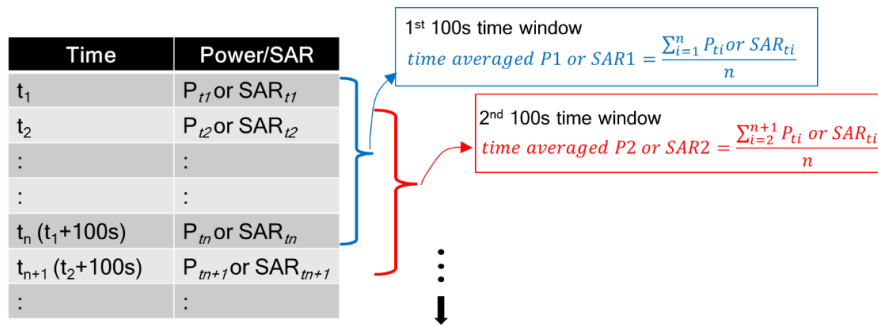

Figure 4-1
Running Average Illustration

3. Make one plot containing:
 - a. Instantaneous Tx power versus time measured in Step 2,
 - b. Requested Tx power used in Step 2 (test sequence 1),
 - c. Computed time-averaged power versus time determined in Step 2,
 - d. Time-averaged power limit (corresponding to FCC SAR limit of 1.6 W/kg for 1gSAR or 4.0W/kg for 10gSAR) given by

$$Time\ averaged\ power\ limit = meas.P_{limit} + 10 \times \log\left(\frac{FCC\ SAR\ limit}{meas.SAR_Plimit}\right) \quad (5a)$$

where $meas.P_{limit}$ and $meas.SAR_Plimit$ correspond to measured power at P_{limit} and measured SAR at P_{limit} .

4. Make another plot containing:
 - a. Computed time-averaged 1gSAR or 10gSAR versus time determined in Step 2
 - b. FCC $1gSAR_{limit}$ of 1.6W/kg or FCC $10gSAR_{limit}$ of 4.0W/kg.
5. Repeat Steps 2 ~ 4 for pre-defined test sequence 2 and replace the requested Tx power (test sequence 1) in Step 2 with test sequence 2.
6. Repeat Steps 2 ~ 5 for all the selected technologies and bands.
7. The validation criteria are, at all times, the time-averaged power versus time shown in Step 3 plot shall not exceed the time-averaged power limit (defined in Eq. (5a)), in turn, the time-averaged 1gSAR or

FCC ID: A3LSMS711U	PART 2 RF EXPOSURE EVALUATION REPORT	Approved by: Technical Manager
Document S/N: 1M2304260060-25.A3L	DUT Type: Portable Handset	Page 14 of 90

10gSAR versus time shown in Step 4 plot shall not exceed the FCC limit of 1.6 W/kg for 1gSAR or 4.0 W/kg for 10gSAR (i.e., Eq. (1b)).

4.3.2 Change in call scenario

This test is to demonstrate that Smart Transmit feature accurately accounts for the past Tx powers during time-averaging when a new call is established.

The call disconnect and re-establishment needs to be performed during power limit enforcement, i.e., when the DUT's Tx power is at $P_{reserve}$ level, to demonstrate the continuity of RF exposure management and limiting in call change scenario. In other words, the RF exposure averaged over any FCC defined time window (including the time windows containing the call change) doesn't exceed FCC limit of 1.6 W/kg for 1gSAR or 4.0 W/kg for 10gSAR.

Test procedure

1. Measure P_{limit} for the technology/band selected in Section 4.2.2. Measure P_{limit} with Smart Transmit enabled and *Reserve_power_margin* set to 0 dB, callbox set to request maximum power.
2. Set *Reserve_power_margin* to actual (intended) value and reset power on DUT to enable Smart Transmit.
3. Establish radio link with callbox in the selected technology/band.
4. Request DUT's Tx power at 0 dBm for at least one time window specified for the selected technology/band, followed by requesting DUT's Tx power to be at maximum power for about ~60 seconds, and then drop the call for ~10 seconds. Afterwards, re-establish another call in the same radio configuration (i.e., same technology/band/channel) and continue callbox requesting DUT's Tx power to be at maximum power for the remaining time of at least another full duration of the specified time window. Measure and record Tx power versus time. Once the measurement is done, extract instantaneous Tx power versus time, convert the measured conducted Tx power into 1gSAR or 10gSAR value using Eq. (1a), and then perform the running time average to determine time-averaged power and 1gSAR or 10gSAR versus time.

NOTE: In Eq.(1a), instantaneous Tx power is converted into instantaneous 1gSAR or 10gSAR value by applying the measured worst-case 1gSAR or 10gSAR value at P_{limit} for the corresponding technology/band/antenna/DSI reported in Part 1 report.

5. Make one plot containing: (a) instantaneous Tx power versus time, (b) requested power, (c) computed time-averaged power, (d) time-averaged power limit calculated using Eq.(5a).
6. Make another plot containing: (a) computed time-averaged 1gSAR or 10gSAR versus time, and (b) FCC limit of 1.6 W/kg for 1gSAR or 4.0 W/kg for 10gSAR.

The validation criteria are, at all times, the time-averaged power versus time shall not exceed the time-averaged power limit (defined in Eq.(5a)), in turn, the time-averaged 1gSAR or 10gSAR versus time shall not exceed the FCC limit of 1.6 W/kg for 1gSAR or 4.0 W/kg for 10gSAR (i.e., Eq. (1b)).

4.3.3 Change in technology and band

This test is to demonstrate the correct power control by Smart Transmit during technology switches and/or band handovers.

FCC ID: A3LSMS711U	PART 2 RF EXPOSURE EVALUATION REPORT	Approved by: Technical Manager
Document S/N: 1M2304260060-25.A3L	DUT Type: Portable Handset	Page 15 of 90

Similar to the change in call test in Section 4.3.2, to validate the continuity of RF exposure limiting during the transition, the technology and band handover needs to be performed when DUT's Tx power is at $P_{reserve}$ level (i.e., during Tx power enforcement) to make sure that the DUT's Tx power from previous $P_{reserve}$ level to the new $P_{reserve}$ level (corresponding to new technology/band). Since the P_{limit} could vary with technology and band, Eq. (1a) can be written as follows to convert the instantaneous Tx power in 1gSAR or 10gSAR exposure for the two given radios, respectively:

$$1g_or_10gSAR_1(t) = \frac{conducted_Tx_power_1(t)}{conducted_Tx_power_P_{limit_1}} * 1g_or_10gSAR_P_{limit_1} \quad (6a)$$

$$1g_or_10gSAR_2(t) = \frac{conducted_Tx_power_2(t)}{conducted_Tx_power_P_{limit_2}} * 1g_or_10gSAR_P_{limit_2} \quad (6b)$$

$$\frac{1}{T_{SAR}} \left[\int_{t-T_{SAR}}^{t_1} \frac{1g_or_10gSAR_1(t)}{FCC\ SAR\ limit} dt + \int_{t-T_{SAR}}^t \frac{1g_or_10gSAR_2(t)}{FCC\ SAR\ limit} dt \right] \leq 1 \quad (6c)$$

where, $conducted_Tx_power_1(t)$, $conducted_Tx_power_P_{limit_1}$, and $1g_or_10gSAR_P_{limit_1}$ correspond to the measured instantaneous conducted Tx power, measured conducted Tx power at P_{limit} , and measured 1gSAR or 10gSAR value at P_{limit} of technology1/band1; $conducted_Tx_power_2(t)$, $conducted_Tx_power_P_{limit_2}(t)$, and $1g_or_10gSAR_P_{limit_2}$ correspond to the measured instantaneous conducted Tx power, measured conducted Tx power at P_{limit} , and measured 1gSAR or 10gSAR value at P_{limit} of technology2/band2. Transition from technology1/band1 to the technology2/band2 happens at time-instant ' t_1 '.

Test procedure

1. Measure P_{limit} for both the technologies and bands selected in Section 4.2.3. Measure P_{limit} with Smart Transmit enabled and *Reserve_power_margin* set to 0 dB, callbox set to request maximum power.
2. Set *Reserve_power_margin* to actual (intended) value and reset power on DUT to enable Smart Transmit.
3. Establish radio link with callbox in first technology/band selected.
4. Request DUT's Tx power at 0 dBm for at least one time window specified for the selected technology/band, followed by requesting DUT's Tx power to be at maximum power for about ~60 seconds, and then switch to second technology/band selected. Continue with callbox requesting DUT's Tx power to be at maximum power for the remaining time of at least another full duration of the specified time window. Measure and record Tx power versus time for the full duration of the test.
5. Once the measurement is done, extract instantaneous Tx power versus time, and convert the conducted Tx power into 1gSAR or 10gSAR value using Eq. (6a) and (6b) and corresponding measured P_{limit} values from Step 1 of this section. Perform the running time average to determine time-averaged power and 1gSAR or 10gSAR versus time.

NOTE: In Eq.(6a) & (6b), instantaneous Tx power is converted into instantaneous 1gSAR or 10gSAR value by applying the measured worst-case 1gSAR or 10gSAR value at P_{limit} for the corresponding technology/band/antenna/DSI reported in Part 1 report.

6. Make one plot containing: (a) instantaneous Tx power versus time, (b) requested power, (c) computed time-averaged power, (d) time-averaged power limit calculated using Eq.(5a).
7. Make another plot containing: (a) computed time-averaged 1gSAR or 10gSAR versus time, and (b) FCC limit of 1.6 W/kg for 1gSAR or 4.0 W/kg for 10gSAR.

FCC ID: A3LSMS711U	PART 2 RF EXPOSURE EVALUATION REPORT	Approved by: Technical Manager
Document S/N: 1M2304260060-25.A3L	DUT Type: Portable Handset	Page 16 of 90

The validation criteria are, at all times, the time-averaged 1gSAR or 10gSAR versus time shall not exceed the FCC limit of 1.6 W/kg for 1gSAR or 4.0 W/kg for 10gSAR (i.e., Eq. (6c)).

4.3.4 Change in antenna

This test is to demonstrate the correct power control by Smart Transmit during antenna switches from one antenna to another. The test procedure is identical to Section 4.3.3, by replacing technology/band switch operation with antenna switch. The validation criteria are, at all times, the time-averaged 1gSAR or 10gSAR versus time shall not exceed FCC limit of 1.6 W/kg for 1gSAR or 4.0 W/kg for 10gSAR.

NOTE: If the DUT does not support antenna switch within the same technology/band, but has multiple antennas to support different frequency bands, then the antenna switch test is included as part of change in technology and band (Section 4.3.3) test.

4.3.5 Change in DSI

This test is to demonstrate the correct power control by Smart Transmit during DSI switches from one DSI to another. The test procedure is identical to Section 4.3.3, by replacing technology/band switch operation with DSI switch. The validation criteria are, at all times, the time-averaged 1gSAR or 10gSAR versus time shall not exceed FCC limit of 1.6 W/kg for 1gSAR or 4.0 W/kg for 10gSAR.

4.3.6 Change in time window

This test is to demonstrate the correct power control by Smart Transmit during the change in averaging time window when a specific band handover occurs. FCC specifies time-averaging windows of 100s for Tx frequency < 3GHz, and 60s for Tx frequency between 3GHz and 6GHz.

To validate the continuity of RF exposure limiting during the transition, the band handover test needs to be performed when EUT handovers from operation band less than 3GHz to greater than 3GHz and vice versa. The equations (3a) and (3b) in Section 2 can be written as follows for transmission scenario having change in time window,

$$1gSAR_1(t) = \frac{\text{conducted_Tx_power_1}(t)}{\text{conducted_Tx_power_P}_{limit_1}} * 1g_or\ 10g_SAR_P_{limit_1} \quad (7a)$$

$$1gSAR_2(t) = \frac{\text{conducted_Tx_power_2}(t)}{\text{conducted_Tx_power_P}_{limit_2}} * 1g_or\ 10g_SAR_P_{limit_2} \quad (7b)$$

$$\frac{1}{T1_{SAR}} \left[\int_{t-T1_{SAR}}^{t_1} \frac{1g_or\ 10g_SAR_1(t)}{FCC\ SAR\ limit} dt \right] + \frac{1}{T2_{SAR}} \left[\int_{t-T2_{SAR}}^t \frac{1g_or\ 10g_SAR_2(t)}{FCC\ SAR\ limit} dt \right] \leq 1 \quad (7c)$$

where, *conducted_Tx_power_1(t)*, *conducted_Tx_power_P_{limit_1}(t)*, and *1g_or_10g_SAR_P_{limit_1}* correspond to the instantaneous Tx power, conducted Tx power at *P_{limit}*, and compliance *1g_or_10g_SAR* values at *P_{limit_1}* of band1 with time-averaging window 'T1_{SAR}'; *conducted_Tx_power_2(t)*, *conducted_Tx_power_P_{limit_2}(t)*, and *1g_or_10g_SAR_P_{limit_2}* correspond to the instantaneous Tx power, conducted Tx power at *P_{limit}*, and compliance *1g_or_10g_SAR* values at *P_{limit_2}* of band2 with time-averaging window 'T2_{SAR}'. One of the two bands is less than 3GHz, another is greater than 3GHz. Transition from first band with time-averaging window 'T1_{SAR}' to the second band with time-averaging window 'T2_{SAR}' happens at time-instant 't₁'.

Test procedure

1. Measure *P_{limit}* for both the technologies and bands selected in Section 4.2.6. Measure *P_{limit}* with Smart Transmit enabled and *Reserve_power_margin* set to 0 dB, callbox set to request maximum power.

FCC ID: A3LSMS711U	PART 2 RF EXPOSURE EVALUATION REPORT	Approved by: Technical Manager
Document S/N: 1M2304260060-25.A3L	DUT Type: Portable Handset	Page 17 of 90

2. Set *Reserve_power_margin* to actual (intended) value and enable Smart Transmit.

Transition from 100s time window to 60s time window, and vice versa

3. Establish radio link with callbox in the technology/band having 100s time window selected in Section 4.2.6.
4. Request EUT's Tx power to be at 0 dBm for at least 100 seconds, followed by requesting EUT's Tx power to be at maximum power for about ~140 seconds, and then switch to second technology/band (having 60s time window) selected in Section 4.2.6. Continue with callbox requesting EUT's Tx power to be at maximum power for about ~60s in this second technology/band, and then switch back to the first technology/band. Continue with callbox requesting EUT's Tx power to be at maximum power for at least another 100s. Measure and record Tx power versus time for the entire duration of the test.
5. Once the measurement is done, extract instantaneous Tx power versus time, and convert the conducted Tx power into 1gSAR or 10gSAR value (see Eq. (7a) and (7b)) using corresponding technology/band Step 1 result, and then perform 100s running average to determine time-averaged 1gSAR or 10gSAR versus time. Note that in Eq.(7a) & (7b), instantaneous Tx power is converted into instantaneous 1gSAR or 10gSAR value by applying the worst-case 1gSAR or 10gSAR value tested in Part 1 for the selected technologies/bands at P_{limit} .
6. Make one plot containing: (a) instantaneous Tx power versus time measured in Step 4.
7. Make another plot containing: (a) instantaneous 1gSAR versus time determined in Step 5, (b) computed time-averaged 1gSAR versus time determined in Step 5, and (c) corresponding regulatory $1gSAR_{limit}$ of 1.6W/kg or $10gSAR_{limit}$ of 4.0W/kg.

Transition from 60s time window to 100s time window, and vice versa

8. Establish radio link with callbox in the technology/band having 60s time window selected in Section 4.2.6.
9. Request EUT's Tx power to be at 0 dBm for at least 60 seconds, followed by requesting EUT's Tx power to be at maximum power for about ~80 seconds, and then switch to second technology/band (having 100s time window) selected in Section 4.2.6. Continue with callbox requesting EUT's Tx power to be at maximum power for about ~100s in this second technology/band, and then switch back to the first technology/band. Continue with callbox requesting EUT's Tx power to be at maximum power for the remaining time for a total test time of 500 seconds. Measure and record Tx power versus time for the entire duration of the test.
10. Repeat above Step 5~7 to generate the plots

The validation criteria is, at all times, the time-averaged 1gSAR or 10gSAR versus time shall not exceed the regulatory $1gSAR_{limit}$ of 1.6W/kg or $10gSAR_{limit}$ of 4.0W/kg.

4.3.7 SAR exposure switching

This test is to demonstrate that Smart Transmit feature is accurately accounts for switching in exposures among SAR from radio1 only, SAR from both radio1 and radio2, and SAR from radio2 only scenarios, and ensures total time-averaged RF exposure complies with the FCC limit. Here, radio1 represents primary radio (for example, LTE anchor in a NR non-standalone mode call) and radio2 represents secondary radio (for example, sub6 NR or mmW NR). The detailed test procedure for SAR exposure switching in the case of LTE+Sub6 NR non-standalone mode transmission scenario is provided in APPENDIX F.

FCC ID: A3LSMS711U	PART 2 RF EXPOSURE EVALUATION REPORT	Approved by: Technical Manager
Document S/N: 1M2304260060-25.A3L	DUT Type: Portable Handset	Page 18 of 90

Test procedure:

1. Measure conducted Tx power corresponding to P_{limit} for radio1 and radio2 in selected band. Test condition to measure conducted P_{limit} is:
 - Establish device in call with the callbox for radio1 technology/band. Measure conducted Tx power corresponding to radio1 P_{limit} with Smart Transmit enabled and *Reserve_power_margin* set to 0 dB, callbox set to request maximum power.
 - Repeat above step to measure conducted Tx power corresponding to radio2 P_{limit} . If radio2 is dependent on radio1 (for example, non-standalone mode of Sub6 NR requiring radio1 LTE as anchor), then establish radio1 + radio2 call with callbox, and request all down bits for radio1 LTE. In this scenario, with callbox requesting maximum power from radio2 Sub6 NR, measured conducted Tx power corresponds to radio2 P_{limit} (as radio1 LTE is at all-down bits)
2. Set *Reserve_power_margin* to actual (intended) value, with EUT setup for radio1 + radio2 call. In this description, it is assumed that radio2 has lower priority than radio1. Establish device in radio1+radio2 call, and request all-down bits or low power on radio1, with callbox requesting EUT's Tx power to be at maximum power in radio2 for at least one time window. After one time window, set callbox to request EUT's Tx power to be at maximum power on radio1, i.e., all-up bits. Continue radio1+radio2 call with both radios at maximum power for at least one time window, and drop (or request all-down bits on) radio2. Continue radio1 at maximum power for at least one time window. Record the conducted Tx power for both radio1 and radio2 for the entire duration of this test.
3. Once the measurement is done, extract instantaneous Tx power versus time for both radio1 and radio2 links. Convert the conducted Tx power for both these radios into 1gSAR or 10gSAR value (see Eq. (6a) and (6b)) using corresponding technology/band P_{limit} measured in Step 1, and then perform the running time average to determine time-averaged 1gSAR or 10gSAR versus time.
4. Make one plot containing: (a) instantaneous Tx power versus time measured in Step 2.
5. Make another plot containing: (a) instantaneous 1gSAR versus time determined in Step 3, (b) computed time-averaged 1gSAR versus time determined in Step 3, and (c) corresponding regulatory $1gSAR_{limit}$ of 1.6W/kg or $10gSAR_{limit}$ of 4.0W/kg.

The validation criteria is, at all times, the time-averaged 1gSAR or 10gSAR versus time shall not exceed the regulatory $1gSAR_{limit}$ of 1.6W/kg or $10gSAR_{limit}$ of 4.0W/kg.

FCC ID: A3LSMS711U	PART 2 RF EXPOSURE EVALUATION REPORT	Approved by: Technical Manager
Document S/N: 1M2304260060-25.A3L	DUT Type: Portable Handset	Page 19 of 90

4.4 Test procedure for time-varying SAR measurements

This section provides general time-varying SAR measurement procedures to perform compliance test under dynamic transmission scenarios described in Section 3. In practice, an adjustment can be made in these procedures. The justification/clarification may be provided.

To perform the validation through SAR measurement for transmission scenario 1 described in Section 3, the “path loss” between callbox antenna and DUT needs to be calibrated to ensure that the DUT Tx power reacts to the requested power from callbox in a radiated call. It should be noted that when signaling in closed loop mode, protocol-level power control is in play, resulting in DUT not solely following callbox TPC (Tx power control) commands. In other words, DUT response has many dependencies (RSSI, quality of signal, path loss variation, fading, etc.) other than just TPC commands. These dependencies have less impact in conducted setup (as it is a controlled environment and the path loss can be very well calibrated) but have significant impact on radiated testing in an uncontrolled environment, such as SAR test setup. Therefore, the deviation in DUT Tx power from callbox requested power is expected, however the time-averaged SAR should not exceed FCC SAR requirement at all times as Smart Transmit controls Tx power at DUT.

The following steps are for time averaging feature validation through SAR measurement:

1. “Path Loss” calibration: Place the DUT against the phantom in the worst-case position determined based on Section 4.2.1. For each band selected, prior to SAR measurement, perform “path loss” calibration between callbox antenna and DUT. Since the SAR test environment is not controlled and well calibrated for OTA (Over the Air) test, extreme care needs to be taken to avoid the influence from reflections. The test setup is described in Section 6.2.
2. Time averaging feature validation:
 - i For a given radio configuration (technology/band) selected in Section 4.2.1, enable Smart Transmit and set *Reserve_power_margin* to 0 dB, with callbox to request maximum power, perform area scan, conduct pointSAR measurement at peak location of the area scan. This point SAR value, *pointSAR_Plimit*, corresponds to point SAR at the measured P_{limit} (i.e., measured P_{limit} from the DUT in Step 1 of Section 4.3.1).
 - ii Set *Reserve_power_margin* to actual (intended) value and reset power on DUT to enable Smart Transmit. Note, if *Reserve_power_margin* cannot be set wirelessly, care must be taken to re-position the DUT in the exact same position relative to the SAM phantom as in above Step 2.i. Establish radio link in desired radio configuration, with callbox requesting the DUT’s Tx power at power levels described by test sequence 1 generated in Step 1 of Section 4.3.1, conduct point SAR measurement versus time at peak location of the area scan determined in Step 2.i of this section. Once the measurement is done, extract instantaneous point SAR vs time data, *pointSAR(t)*, and convert it into instantaneous 1gSAR or 10gSAR vs. time using Eq. (3a), re-written below:

$$1g_or_10gSAR(t) = \frac{pointSAR(t)}{pointSAR_P_{limit}} * 1g_or_10gSAR_P_{limit}$$
 where, *pointSAR_Plimit* is the value determined in Step 2.i, and *pointSAR(t)* is the instantaneous point SAR measured in Step 2.ii, *1g_or_10gSAR_Plimit* is the measured 1gSAR or 10gSAR value listed in Part 1 report.
 - iii Perform 100s running average to determine time-averaged 1gSAR or 10gSAR versus time.
 - iv Make one plot containing: (a) time-averaged 1gSAR or 10gSAR versus time determined in Step 2.iii of this section, (b) FCC limit of 1.6 W/kg for 1gSAR or 4.0 W/kg for 10gSAR.

FCC ID: A3LSMS711U	PART 2 RF EXPOSURE EVALUATION REPORT	Approved by: Technical Manager
Document S/N: 1M2304260060-25.A3L	DUT Type: Portable Handset	Page 20 of 90

- v Repeat 2.ii ~ 2.iv for test sequence 2 generated in Step 1 of Section 4.3.1.
- vi Repeat 2.i ~ 2.v for all the technologies and bands selected in Section 4.2.1.

The time-averaging validation criteria for SAR measurement is that, at all times, the time-averaged 1gSAR or 10gSAR versus time shall not exceed FCC limit of 1.6 W/kg for 1gSAR or 4.0 W/kg for 10gSAR (i.e., Eq. (3b)).

FCC ID: A3LSMS711U	PART 2 RF EXPOSURE EVALUATION REPORT	Approved by: Technical Manager
Document S/N: 1M2304260060-25.A3L	DUT Type: Portable Handset	Page 21 of 90

5 FCC MEASUREMENT PROCEDURES (FREQ > 6 GHZ)

This section provides the test plan and test procedures for validating Qualcomm Smart Transmit feature for mmW transmission. For this EUT, millimeter wave (mmW) transmission is only in non-standalone mode, i.e., it requires an LTE link as anchor.

5.1 Test sequence for validation in mmW NR transmission

In 5G mmW NR transmission, the test sequence for validation is with the callbox requesting EUT's Tx power in 5G mmW NR at maximum power all the time.

5.2 Test configuration selection criteria for validating Smart Transmit feature

5.2.1 Test configuration selection for time-varying Tx power transmission

The Smart Transmit time averaging operation is independent of bands, modes, channels, and antenna configurations (beams) for a given technology. Hence, validation of Smart Transmit in any one band/mode/channel per technology is sufficient. Two mmW bands are proposed and selected for this testing to provide high confidence in this validation (Note, the EUT used in this report is only supported in one mmW band).

The selection criteria for this measurement is to test EUT transmit in a beam containing highest number of elements (as it has lower *input.power.limit*).

5.2.2 Test configuration selection for change in antenna configuration (beam)

The Smart Transmit time averaging feature operation is independent of bands, modes, channels, and antenna configurations (beams) for a given technology. Hence, validation of Smart Transmit with beam switch between any two beams is sufficient.

NOTE: The selected two beams should be in the same module group if EUT is configured with GEN2_MMW or GEN2_SUB6_MMW.

5.2.3 Test configuration selection for SAR vs. PD exposure switch during transmission

The Smart Transmit time averaging feature operation is independent of the nature of exposure (SAR vs. PD) and ensures total time-averaged RF exposure compliance. Hence, validation of Smart Transmit in any one band/mode/channel/beam for mmW + sub-6 (LTE) transmission is sufficient, where the exposure varies among SAR dominant scenario, SAR+PD scenario, and PD only scenarios.

The selection criteria for this measurement is to test EUT transmit in a beam containing highest number of elements (as it has lower *input.power.limit*).

FCC ID: A3LSMS711U	PART 2 RF EXPOSURE EVALUATION REPORT	Approved by: Technical Manager
Document S/N: 1M2304260060-25.A3L	DUT Type: Portable Handset	Page 22 of 90

5.3 Test procedures for mmW radiated power measurements

Perform conducted power measurement (for $f < 6\text{GHz}$) and radiated power measurement (for $f > 6\text{GHz}$) for LTE + mmW transmission to validate Smart Transmit time averaging feature in the various transmission scenarios described in Section 3.

This section provides general conducted power measurement procedures to perform compliance test under dynamic transmission scenarios described in Section 3. In practice, an adjustment can be made in these procedures. The justification/clarification may be provided.

5.3.1 Time-varying Tx power scenario

The purpose of the test is to demonstrate the effectiveness of power limiting enforcement and that the time-averaged Tx power when converted into RF exposure values does not exceed the FCC limit at all times (see Eq. (2a), (2b) & (2c) in Section 3).

Test procedure:

1. Measure conducted Tx power corresponding to P_{limit} for LTE in selected band, and measure radiated Tx power corresponding to *input.power.limit* in desired mmW band/channel/beam by following below steps:
 - a. Measure radiated power corresponding to mmW *input.power.limit* by setting up the EUT's Tx power in desired band/channel/beam at *input.power.limit* in Factory Test Mode (FTM). This test is performed in a calibrated anechoic chamber. Rotate the EUT to obtain maximum radiated Tx power, keep the EUT in this position and do not disturb the position of the EUT inside the anechoic chamber for the rest of this test.
 - b. Reset EUT to place in online mode and establish radio link in LTE, measure conducted Tx power corresponding to LTE P_{limit} with Smart Transmit enabled and *Reserve_power_margin* set to 0 dB, and callbox set to request maximum power.
2. Set *Reserve_power_margin* to actual (intended) value and reset power on EUT to enable Smart Transmit. With DUT setup for a mmW NR call in the desired/selected LTE band and mmW NR band, perform the following steps:
 - a. Establish LTE and mmW NR connection in desired band/channel/beam used in Step 1. As soon as the mmW connection is established, immediately request all-down bits on LTE link. With callbox requesting EUT's Tx power to be at maximum mmW power to test predominantly PD exposure scenario (as SAR exposure is less when LTE's Tx power is at low power).
 - b. After 120s, request LTE to go all-up bits for at least 100s. SAR exposure is dominant. There are two scenarios:
 - i. If $P_{limit} < P_{max}$ for LTE, then the RF exposure margin (provided to mmW NR) gradually runs out (due to high SAR exposure). This results in gradual reduction in the 5G mmW NR transmission power and eventually seized 5G mmW NR transmission when LTE goes to $P_{reserve}$ level.
 - ii. If $P_{limit} \geq P_{max}$ for LTE, then the 5G mmW NR transmission's averaged power should gradually reduce but the mmW NR connection can sustain all the time (assuming TxAGC uncertainty = 0dB).

FCC ID: A3LSMS711U	PART 2 RF EXPOSURE EVALUATION REPORT	Approved by: Technical Manager
Document S/N: 1M2304260060-25.A3L	DUT Type: Portable Handset	Page 23 of 90

- c. Record the conducted Tx power of LTE and radiated Tx power of mmW for the full duration of this test of at least 300s.
3. Once the measurement is done, extract instantaneous Tx power versus time for both LTE and mmW links. Convert the conducted Tx power for LTE into 1gSAR or 10gSAR value using Eq. (2a) and P_{limit} measured in Step 1.b, and then divide by FCC limit of 1.6 W/kg for 1gSAR or 4.0 W/kg for 10gSAR to obtain instantaneous normalized 1gSAR or 10gSAR versus time. Perform 100s running average to determine normalized 100s-averaged 1gSAR or 10gSAR versus time.

NOTE: In Eq.(2a), instantaneous Tx power is converted into instantaneous 1gSAR or 10gSAR value by applying the measured worst-case 1gSAR or 10gSAR value at P_{limit} for the corresponding technology/band/antenna/DSI reported in Part 1 report.

4. Similarly, convert the radiated Tx power for mmW into 4cm²PD value using Eq. (2b) and the radiated Tx power limit (i.e., radiated Tx power at *input.power.limit*) measured in Step 1.a, then divide by FCC 4cm²PD limit of 10W/m² to obtain instantaneous normalized 4cm²PD versus time. Perform 4s running average to determine normalized 4s-averaged 4cm²PD versus time.

NOTE: In Eq.(2b), instantaneous radiated Tx power is converted into instantaneous 4cm²PD by applying the worst-case 4cm²PD value measured at *input.power.limit* for the selected band/beam in Part 1 report.

5. Make one plot containing: (a) instantaneous conducted Tx power for LTE versus time, (b) computed 100s-averaged conducted Tx power for LTE versus time, (c) instantaneous radiated Tx power for mmW versus time, as measured in Step 2, (d) computed 4s-averaged radiated Tx power for mmW versus time, and (e) time-averaged conducted and radiated power limits for LTE and mmW radio using Eq. (5a) & (5b), respectively:

$$Time\ averaged\ LTE\ power\ limit = meas.P_{limit} + 10 \times \log\left(\frac{FCC\ SAR\ limit}{meas.SAR_P_{limit}}\right) \quad (5a)$$

$$Time\ averaged\ mmW\ NR\ power\ limit = meas.EIRP_{input.power.limit} + 10 \times \log\left(\frac{FCC\ PD\ limit}{meas.PD_input.power.limit}\right) \quad (5b)$$

where $meas.EIRP_{input.power.limit}$ and $meas.PD_input.power.limit$ correspond to measured EIRP at *input.power.limit* and measured power density at *input.power.limit*.

6. Make another plot containing: (a) computed normalized 100s-averaged 1gSAR or 10gSAR versus time determined in Step 3, (b) computed normalized 4s-averaged 4cm²PD versus time determined in Step 4, and (c) corresponding total normalized time-averaged RF exposure (sum of steps (6.a) and (6.b)) versus time.

The validation criteria are, at all times, the total normalized time-averaged RF exposure versus time determined in Step 6.c shall not exceed the normalized limit of 1.0 of FCC requirement (i.e., Eq. (2c)).

5.3.2 Switch in SAR vs. PD exposure during transmission

This test is to demonstrate that Smart Transmit feature is independent of the nature of exposure (SAR vs. PD), accurately accounts for switching in exposures among SAR dominant, SAR+PD, and PD dominant scenarios, and ensures total time-averaged RF exposure compliance.

FCC ID: A3LSMS711U	PART 2 RF EXPOSURE EVALUATION REPORT	Approved by: Technical Manager
Document S/N: 1M2304260060-25.A3L	DUT Type: Portable Handset	Page 24 of 90

Test procedure:

1. Measure conducted Tx power corresponding to P_{limit} for LTE in selected band, and measure radiated Tx power corresponding to *input.power.limit* in desired mmW band/channel/beam by following below steps:
 - a. Measure radiated power corresponding to *input.power.limit* by setting up the EUT's Tx power in desired band/channel/beam at *input.power.limit* in FTM. This test is performed in a calibrated anechoic chamber. Rotate the EUT to obtain maximum radiated Tx power, keep the EUT in this position and do not disturb the position of the EUT inside the anechoic chamber for the rest of this test.
 - b. Reset EUT to place in online mode and establish radio link in LTE, measure conducted Tx power corresponding to LTE P_{limit} Smart Transmit enabled and *Reserve_power_margin* set to 0 dB, and callbox set to request maximum power.
2. Set *Reserve_power_margin* to actual (intended) value and reset power in EUT. With DUT setup for LTE + mmW call, perform the following steps:
 - a. Establish LTE (sub-6) and mmW NR connection with callbox.
 - b. As soon as the mmW connection is established, immediately request all-down bits on LTE link. Continue LTE (all-down bits) + mmW transmission for more than 100s duration to test predominantly PD exposure scenario (as SAR exposure is negligible from all-down bits in LTE).
 - c. After 120s, request LTE to go all-up bits, mmW transmission should gradually run out of RF exposure margin if LTE's $P_{limit} < P_{max}$ and seize mmW transmission (SAR only scenario); or mmW transmission should gradually reduce in Tx power and will sustain the connection if LTE's $P_{limit} > P_{max}$.
 - d. After 75s, request LTE to go all-down bits, mmW transmission should start getting back RF exposure margin and resume transmission again.
 - e. Record the conducted Tx power of LTE and radiated Tx power of mmW for the entire duration of this test of at least 300s.
3. Once the measurement is done, extract instantaneous Tx power versus time for both LTE and mmW links. Convert the conducted Tx power for LTE into 1gSAR or 10gSAR value using Eq. (2a) and P_{limit} measured in Step 1.b, and then divide by FCC limit of 1.6 W/kg for 1gSAR or 4.0 W/kg for 10gSAR to obtain instantaneous normalized 1gSAR or 10gSAR versus time. Perform 100s running average to determine normalized 100s-averaged 1gSAR or 10gSAR versus time.

NOTE: In Eq.(2a), instantaneous Tx power is converted into instantaneous 1gSAR or 10gSAR value by applying the measured worst-case 1gSAR or 10gSAR value at P_{limit} for the corresponding technology/band/antenna/DSI reported in Part 1 report.

4. Similarly, convert the radiated Tx power for mmW into 4cm²PD value using Eq. (2b) and the radiated Tx power limit (i.e., radiated Tx power at *input.power.limit*) measured in Step 1.a, then divide this by FCC 4cm²PD limit of 10W/m² to obtain instantaneous normalized 4cm²PD versus time. Perform 4s running average to determine normalized 4s-averaged 4cm²PD versus time.

FCC ID: A3LSMS711U	PART 2 RF EXPOSURE EVALUATION REPORT	Approved by: Technical Manager
Document S/N: 1M2304260060-25.A3L	DUT Type: Portable Handset	Page 25 of 90

NOTE: In Eq.(2b), instantaneous radiated Tx power is converted into instantaneous $4\text{cm}^2\text{PD}$ by applying the worst-case $4\text{cm}^2\text{PD}$ value measured at *input.power.limit* for the selected band/beam in Part 1 report.

5. Make one plot containing: (a) instantaneous conducted Tx power for LTE versus time, (b) computed 100s-averaged conducted Tx power for LTE versus time, (c) instantaneous radiated Tx power for mmW versus time, as measured in Step 2, (d) computed 4s-averaged radiated Tx power for mmW versus time, and (e) time-averaged conducted and radiated power limits for LTE and mmW radio using Eq. (5a) & (5b), respectively.
6. Make another plot containing: (a) computed normalized 100s-averaged 1gSAR or 10gSAR versus time determined in Step 3, (b) computed normalized 4s-averaged $4\text{cm}^2\text{PD}$ versus time determined in Step 4, and (c) corresponding total normalized time-averaged RF exposure (sum of steps (6.a) and (6.b)) versus time.

The validation criteria are, at all times, the total normalized time-averaged RF exposure versus time determined in Step 6.c shall not exceed the normalized limit of 1.0 of FCC requirement (i.e., Eq. (2c)).

5.3.3 Change in antenna configuration (beam)

This test is to demonstrate the correct power control by Smart Transmit during changes in antenna configuration (beam). Since the *input.power.limit* varies with beam, the Eq. (2a), (2b) and (2c) in Section 3 are written as below for transmission scenario having change in beam,

$$1g_or_10gSAR(t) = \frac{conducted_Tx_power(t)}{conducted_Tx_power_P_{limit}} * 1g_or_10gSAR_P_{limit} \quad (8a)$$

$$4cm^2PD_1(t) = \frac{radiated_Tx_power_1(t)}{radiated_Tx_power_input.power.limit_1} * 4cm^2PD_input.power.limit_1 \quad (8b)$$

$$4cm^2PD_2(t) = \frac{radiated_Tx_power_2(t)}{radiated_Tx_power_input.power.limit_2} * 4cm^2PD_input.power.limit_2 \quad (8c)$$

$$\frac{\frac{1}{T_{SAR}} \int_{t-T_{SAR}}^t 1g_or_10gSAR(t) dt}{FCC\ SAR\ limit} + \frac{\frac{1}{T_{PD}} \left[\int_{t-T_{PD}}^{t_1} 4cm^2PD_1(t) dt + \int_{t_1}^t 4cm^2PD_2(t) dt \right]}{FCC\ 4cm^2\ PD\ limit} \leq 1 \quad (8d)$$

where, *conducted_Tx_power(t)*, *conducted_Tx_power_P_{limit}*, and *1g_or_10gSAR_P_{limit}* correspond to the measured instantaneous conducted Tx power, measured conducted Tx power at *P_{limit}*, and measured 1gSAR or 10gSAR values at *P_{limit}* corresponding to LTE transmission. Similarly, *radiated_Tx_power_1(t)*, *radiated_Tx_power_input.power.limit_1*, and *4cm²PD_input.power.limit_1* correspond to the measured instantaneous radiated Tx power, radiated Tx power at *input.power.limit*, and *4cm²PD* value at *input.power.limit* of beam 1; *radiated_Tx_power_2(t)*, *radiated_Tx_power_input.power.limit_2*, and *4cm²PD_input.power.limit_2* correspond to the measured instantaneous radiated Tx power, radiated Tx power at *input.power.limit*, and *4cm²PD* value at *input.power.limit* of beam 2 corresponding to mmW transmission.

FCC ID: A3LSMS711U	PART 2 RF EXPOSURE EVALUATION REPORT	Approved by: Technical Manager
Document S/N: 1M2304260060-25.A3L	DUT Type: Portable Handset	Page 26 of 90

Test procedure:

1. Measure conducted Tx power corresponding to P_{limit} for LTE in selected band, and measure radiated Tx power corresponding to *input.power.limit* in desired mmW band/channel/beam by following below steps:
 - a. Measure radiated power corresponding to mmW *input.power.limit* by setting up the EUT's Tx power in desired band/channel at *input.power.limit* of beam 1 in FTM. Do not disturb the position of the EUT inside the anechoic chamber for the rest of this test. Repeat this Step 1.a for beam 2.
 - b. Reset EUT to place in online mode and establish radio link in LTE, measure conducted Tx power corresponding to LTE P_{limit} with Smart Transmit enabled and *Reserve_power_margin* set to 0 dB, and callbox set to request maximum power.
2. Set *Reserve_power_margin* to actual (intended) value and reset power in EUT. With DUT setup for LTE + mmW connection, perform the following steps:
 - a. Establish LTE (sub-6) and mmW NR connection in beam 1. As soon as the mmW connection is established, immediately request all-down bits on LTE link with the callbox requesting EUT's Tx power to be at maximum mmW power.
 - b. After beam 1 continues transmission for at least 20s, request the EUT to change from beam 1 to beam 2, and continue transmitting with beam 2 for at least 20s.
 - c. Record the conducted Tx power of LTE and radiated Tx power of mmW for the entire duration of this test.
3. Once the measurement is done, extract instantaneous Tx power versus time for both LTE and mmW links. Convert the conducted Tx power for LTE into 1gSAR or 10gSAR value using the similar approach described in Step 3 of Section 5.3.2. Perform 100s running average to determine normalized 100s-averaged 1gSAR versus time.
4. Similarly, convert the radiated Tx power for mmW NR into 4cm²PD value using Eq. (8b), (8c) and the radiated Tx power limits (i.e., radiated Tx power at *input.power.limit*) measured in Step 1.a for beam 1 and beam 2, respectively, and then divide the resulted PD values by FCC 4cm²PD limit of 10W/m² to obtain instantaneous normalized 4cm²PD versus time for beam 1 and beam 2. Perform 4s running average to determine normalized 4s-averaged 4cm²PD versus time.

NOTE: In Eq.(8b) and (8c), instantaneous radiated Tx power of beam 1 and beam 2 is converted into instantaneous 4cm²PD by applying the worst-case 4cm²PD value measured at the *input.power.limit* of beam 1 and beam 2 in Part 1 report, respectively.

5. Since the measured radiated powers for beam 1 and beam 2 in Step 1.a were performed at an arbitrary rotation of EUT in anechoic chamber, repeat Step 1.a of this procedure by rotating the EUT to determine maximum radiated power at *input.power.limit* in FTM mode for both beams separately. Re-scale the measured instantaneous radiated power in Step 2.c by the delta in radiated power measured in Step 5 and the radiated power measured in Step 1.a for plotting purposes in next Step. In other words, this step essentially converts measured instantaneous radiated power during the measurement in Step 2 into maximum instantaneous radiated power for both beams. Perform 4s running average to compute 4s-averaged radiated Tx power. Additionally, use these EIRP values measured at *input.power.limit* at respective peak locations to determine the EIRP limits (using Eq. (5b)) for both these beams.

FCC ID: A3LSMS711U	PART 2 RF EXPOSURE EVALUATION REPORT	Approved by: Technical Manager
Document S/N: 1M2304260060-25.A3L	DUT Type: Portable Handset	Page 27 of 90

6. Make one plot containing: (a) instantaneous conducted Tx power for LTE versus time, (b) computed 100s-averaged conducted Tx power for LTE versus time, (c) instantaneous radiated Tx power for mmW versus time, as obtained in Step 5, (d) computed 4s-averaged radiated Tx power for mmW versus time, as obtained in Step 5, and (e) time-averaged conducted and radiated power limits for LTE and mmW radio, respectively.
7. Make another plot containing: (a) computed normalized 100s-averaged 1gSAR versus time determined in Step 3, (b) computed normalized 4s-averaged 4cm²PD versus time determined in Step 4, and (c) corresponding total normalized time-averaged RF exposure (sum of steps (6.a) and (6.b)) versus time.

The validation criteria are, at all times, the total normalized time-averaged RF exposure versus time determined in Step 6.c shall not exceed the normalized limit of 1.0 of FCC requirement (i.e., (8d)).

5.4 Test procedure for time-varying PD measurements

The following steps are used to perform the validation through PD measurement for transmission scenario 1 described in Section 3:

1. Place the EUT on the cDASY6 platform to perform PD measurement in the worst-case position/surface for the selected mmW band/beam. In PD measurement, the callbox is set to request maximum Tx power from EUT all the time. Hence, “path loss” calibration between callbox antenna and EUT is not needed in this test.
2. Time averaging feature validation:
 - a. Measure conducted Tx power corresponding to P_{limit} for LTE in selected band, and measure point E-field corresponding to *input.power.limit* in desired mmW band/channel/beam by following the below steps:
 - i. Measure conducted Tx power corresponding to LTE P_{limit} with Smart Transmit enabled and *Reserve_power_margin* set to 0 dB, with callbox set to request maximum power.
 - ii. Measure point E-field at peak location of fast area scan corresponding to *input.power.limit* by setting up the EUT’s Tx power in desired mmW band/channel/beam at *input.power.limit* in FTM. Do not disturb the position of EUT and mmW cDASY6 probe.
 - b. Set *Reserve_power_margin* to actual value (i.e., intended value) and reset power on EUT, place EUT in online mode. With EUT setup for LTE (sub-6) + mmW NR call, as soon as the mmW NR connection is established, request all-down bits on LTE link. Continue LTE (all-down bits) + mmW transmission for more than 100s duration to test predominantly PD exposure scenario. After 120s, request LTE to go all-up bits, mmW transmission should gradually reduce. Simultaneously, record the conducted Tx power of LTE transmission using power meter and point E-field (in terms of ratio of $\frac{[pointE(t)]^2}{[pointE_input.power.limit]^2}$) of mmW transmission using cDASY6 E-field probe at peak location identified in Step 2.a.ii for the entire duration of this test of at least 300s.
 - c. Once the measurement is done, extract instantaneous conducted Tx power versus time for LTE transmission and $\frac{[pointE(t)]^2}{[pointE_input.power.limit]^2}$ ratio versus time from cDASY6 system for mmW transmission. Convert the conducted Tx power for LTE into 1gSAR or 10gSAR value using Eq. (4a) and P_{limit} measured in Step 2.a.i, and then divide this by FCC limit of 1.6 W/kg for 1gSAR or 4.0 W/kg for 10gSAR to obtain instantaneous normalized 1gSAR or 10gSAR versus time.

FCC ID: A3LSMS711U	PART 2 RF EXPOSURE EVALUATION REPORT	Approved by: Technical Manager
Document S/N: 1M2304260060-25.A3L	DUT Type: Portable Handset	Page 28 of 90

Perform 100s running average to determine normalized 100s-averaged 1gSAR or 10gSAR versus time

NOTE: In Eq.(4a), instantaneous Tx power is converted into instantaneous 1gSAR or 10gSAR value by applying the measured worst-case 1gSAR or 10gSAR value at P_{limit} for the corresponding technology/band reported in Part 1 report.

- d. Similarly, convert the point E-field for mmW transmission into $4\text{cm}^2\text{PD}$ value using Eq. (4b) and radiated power limit measured in Step 2.a.ii, and then divide this by FCC $4\text{cm}^2\text{PD}$ limit of $10\text{W}/\text{m}^2$ to obtain instantaneous normalized $4\text{cm}^2\text{PD}$ versus time. Perform 4s running average to determine normalized 4s-averaged $4\text{cm}^2\text{PD}$ versus time.
- e. Make one plot containing: (i) computed normalized 100s-averaged 1gSAR or 10gSAR versus time determined in Step 2.c, (ii) computed normalized 4s-averaged $4\text{cm}^2\text{PD}$ versus time determined in Step 2.d, and (iii) corresponding total normalized time-averaged RF exposure (sum of steps (2.e.i) and (2.e.ii)) versus time.

The validation criteria are, at all times, the total normalized time-averaged RF exposure versus time determined in Step 2.e.iii shall not exceed the normalized limit of 1.0 of FCC requirement (i.e., Eq. (4c)).

FCC ID: A3LSMS711U	PART 2 RF EXPOSURE EVALUATION REPORT	Approved by: Technical Manager
Document S/N: 1M2304260060-25.A3L	DUT Type: Portable Handset	Page 29 of 90

6 MEASUREMENT TEST SETUP (FREQ < 6 GHZ)

6.1 Conducted Measurement Test setup

Legacy Test Setup

The Rohde & Schwarz CMW500 callbox was used in this test. The test setup schematic is shown in Figure 6-1a (Appendix D – Test Setup Photo 1 and 2) for measurements with a single antenna of DUT, and in Figure 6-1b (Appendix D – Test Setup Photo 3) for measurements involving antenna switch. For single antenna measurement, one port (RF1 COM) of the callbox is connected to the RF port of the DUT using a directional coupler. For technology/band switch measurement, one port (RF1 COM) of the callbox used for signaling two different technologies is connected to a combiner, which is in turn connected to a directional coupler. The other end of the directional coupler is connected to a splitter to connect to two RF ports of the DUT corresponding to the two antennas of interest. In the setups, power meter is used to tap the directional coupler for measuring the conducted output power of the DUT. For all legacy conducted tests, only RF1 COM port of the callbox is used to communicate with the DUT.

All the path losses from RF port of DUT to the callbox RF COM port and to the power meter are calibrated and automatically entered as offsets in the callbox and the power meter via test scripts on the PC used to control callbox and power meter.

Sub6 NR test setup:

The Anritsu MT8000A callbox was used in this test. The test setup schematic is the same as the Legacy Test Setup shown in Figure 6-1a (Appendix D – Test Setup Photo 4 and 5). One port of the callbox is connected to the RF port of the DUT using a directional coupler. In the setup, the power meter is used to tap the directional coupler for measuring the conducted output power of the DUT.

All the path losses from RF port of DUT to the callbox RF COM port and to the power meter are calibrated and automatically entered as offsets in the callbox and the power meter via test scripts on the PC used to control callbox and power meter.

LTE+Sub6 NR test setup:

LTE conducted port and Sub6 NR conducted ports are the same on this EUT, therefore, the LTE and Sub6 NR signals for power meter measurement are performed on separate paths as shown below in Figure 6-1c (Appendix D – Test Setup Photo 6).

All the path losses from RF port of DUT to the callbox RF COM port and to the power meter are calibrated and automatically entered as offsets in the callbox and the power meter via test scripts on the PC used to control callbox and power meter.

FCC ID: A3LSMS711U	PART 2 RF EXPOSURE EVALUATION REPORT	Approved by: Technical Manager
Document S/N: 1M2304260060-25.A3L	DUT Type: Portable Handset	Page 30 of 90

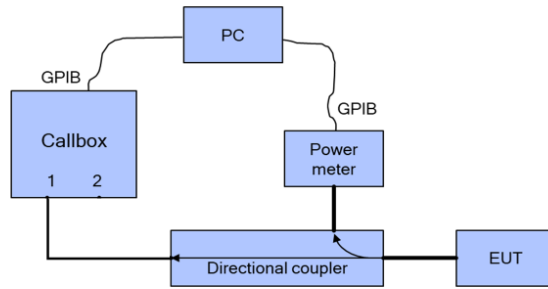

(a) Appendix D – Test Setup Photo 1, 2, 4 and 5

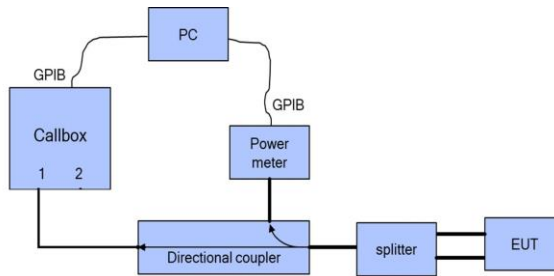

(b) Appendix D – Test Setup Photo 3

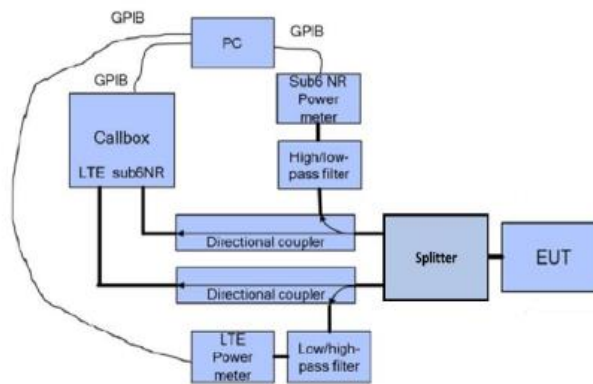

(c) Appendix D – Test Setup Photo 6

Figure 6-1
Conducted power measurement setup

FCC ID: A3LSMS711U	PART 2 RF EXPOSURE EVALUATION REPORT	Approved by: Technical Manager
Document S/N: 1M2304260060-25.A3L	DUT Type: Portable Handset	Page 31 of 90

Both the callbox and power meter are connected to the PC using GPIB cables. Two test scripts are custom made for automation, and the test duration set in the test scripts is 500 seconds.

For time-varying Tx power measurement, the PC runs the 1st test script to send GPIB commands to control the callbox’s requested power versus time, while at the same time to record the conducted power measured at DUT RF port using the power meter. The commands sent to the callbox to request power are:

- 0dBm for 100 seconds
- test sequence 1 or test sequence 2 (defined in Section 4.1 and generated in Section 4.2.1), for 360 seconds.
- stay at the last power level of test sequence 1 or test sequence 2 for the remaining time.

Power meter readings are periodically recorded every 100ms. A running average of this measured Tx power over 100 seconds is performed in the post-data processing to determine the 100s-time averaged power.

For call drop, technology/band/antenna switch, and DSI switch tests, after the call is established, the callbox is set to request the DUT’s Tx power at 0dBm for 100 seconds while simultaneously starting the 2nd test script runs at the same time to start recording the Tx power measured at DUT RF port using the power meter. After the initial 100 seconds since starting the Tx power recording, the callbox is set to request maximum power from the DUT for the rest of the test. Note that the call drop/re-establish, or technology/band/antenna switch or DSI switch is manually performed when the Tx power of DUT is at $P_{reserve}$ level. See Section 4.3 for detailed test procedure of call drop test, technology/band/antenna switch test and DSI switch test.

6.2 SAR Measurement setup

The measurement setup is similar to normal SAR measurements as described in the Part 1 Test Report. The difference in SAR measurement setup for time averaging feature validation is that the callbox is signaling in close loop power control mode (instead of requesting maximum power in open loop control mode) and callbox is connected to the PC using GPIB so that the test script executed on PC can send GPIB commands to control the callbox’s requested power over time (test sequence). The same test script used in conducted setup for time-varying Tx power measurements is also used in this section for running the test sequences during SAR measurements, and the recorded values from the disconnected power meter by the test script were discarded.

As mentioned in Section 4.4, for DUT to follow TPC command sent from the callbox wirelessly, the “path loss” between callbox antenna and the DUT needs to be very well calibrated. Since the SAR chamber is in uncontrolled environment, precautions must be taken to minimize the environmental influences on “path loss”. Similarly, in the case of time-varying SAR measurements in Sub6 NR (with LTE as anchor), “path loss” between callbox antenna and the EUT needs to be carefully calibrated for both LTE link as well as for Sub6 NR link.

The DUT is placed in worst-case position according to Table 8-2.

FCC ID: A3LSMS711U	PART 2 RF EXPOSURE EVALUATION REPORT	Approved by: Technical Manager
Document S/N: 1M2304260060-25.A3L	DUT Type: Portable Handset	Page 32 of 90

7 MEASUREMENT TEST SETUP (FREQ > 6 GHZ)

7.1 Radiated Power Measurement Test setup

The Keysight Technologies E7515B UXM callbox is used in this test. The schematic of the setup is shown in Figure 7-1. The UXM callbox has two RF radio heads to up/down convert IF to mmW frequencies, which in turn are connected to two horn antennas for V- and H-polarizations for downlink communication. In the uplink, a directional coupler is used in the path of one of the horn antennas to measure and record radiated power using a Rohde & Schwarz NRP50S power sensor. Note here that the isolation of the directional coupler may not be sufficient to attenuate the downlink signal from the callbox, which will result in high noise floor masking the recording of radiated power from EUT. In that case, either lower the downlink signal strength emanating from the RF radio heads of callbox or add an attenuator between callbox radio heads and directional coupler. Additionally, note that since the measurements performed in this validation are all relative, measurement of EUT's radiated power in one polarization is sufficient. The EUT is placed inside an anechoic chamber with V- and H-pol horn antennas to establish the radio link as shown in Figure 7-1. The callbox's LTE port is directly connected to the EUT's RF port via a directional coupler to measure the EUT's conducted Tx power using a Rohde & Schwarz NRP8S power sensor. Additionally, EUT is connected to the PC via USB connection for sending beam switch command. Care is taken to route the USB cable and RF cable (for LTE connection) away from the EUT's mmW antenna modules.

Setup in Figure 7-1 is used for the test scenario 1, 5 and 6 described in Section 3. The test procedures described in Section 5 are followed. The path losses from the EUT to both the power meters are calibrated and used as offset in the power meter.

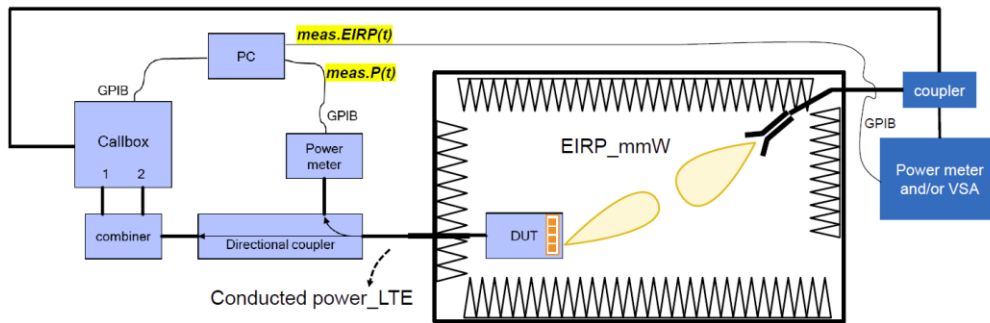

Figure 7-1
mmW NR radiated power measurement setup – Test Setup Photo 10

Both the callbox and power meters are connected to the PC using USB cables. Test scripts are custom made for automation of establishing LTE + mmW call, LTE + sub6 NR call, and sub6 NR + mmW call conducted Tx powers recording for LTE, sub6 NR and radiated Tx power recording for mmW. These tests are manually stopped after desired time duration. Test script is programmed to set LTE Tx power to all-down bits on the callbox immediately after the mmW link is established and programmed to set toggle between all-up and all-down bits depending on the transmission scenario being evaluated. Similarly, test

FCC ID: A3LSMS711U	PART 2 RF EXPOSURE EVALUATION REPORT	Approved by: Technical Manager
Document S/N: 1M2304260060-25.A3L	DUT Type: Portable Handset	Page 33 of 90

script is also programmed to send beam switch command manually to the EUT via USB connection. For all the tests, the callbox is set to request maximum Tx power in mmW NR radio from EUT all the time.

Test configurations for this validation are detailed in Section 5.2. Test procedures are listed in Section 5.3.

7.2 Power Density Measurement Test setup

The measurement setup is similar to normal PD measurements, the EUT is positioned on cDASY6 platform, and is connected with the callbox (conducted for LTE and wirelessly for mmW). Keysight UXM callbox is set to request maximum mmW Tx power from EUT all the time. Hence, “path loss” calibration between callbox antenna and EUT is not needed in this test. The callbox’s LTE port is directly connected to the EUT’s RF port via a directional coupler to measure the EUT’s conducted Tx power using a Rohde & Schwarz NRP8S power sensor. Additionally, EUT is connected to the PC via USB connection for toggling between FTM and online mode with Smart Transmit enabled following the test procedures described Section 5.4.

Worst-surface of EUT (for the mmW beam being tested) is positioned facing up for PD measurement with cDASY6 mmW probe. Figure 7-3 shows the schematic of this measurement setup.

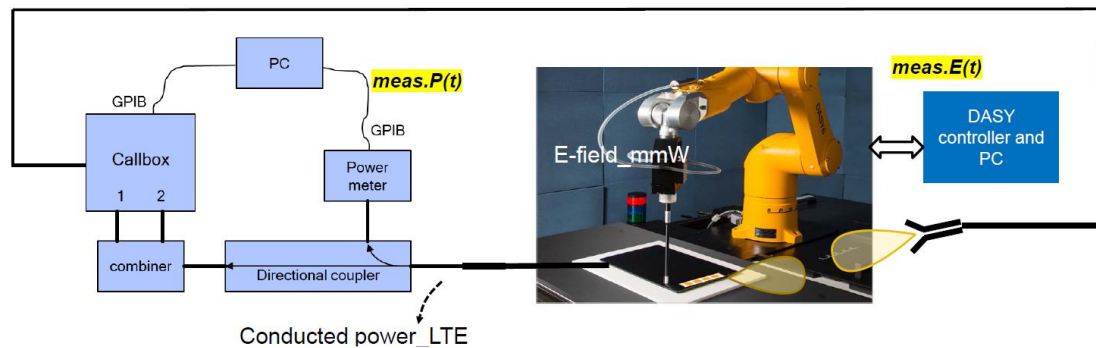

Figure 7-2
Power Density Measurement Setup – Test Setup Photo 11

Both callbox and power meters are connected to the PC using USB cables. Test scripts are custom made for automation of establishing LTE + mmW call, and for conducted Tx power recording of LTE transmission. These tests are manually stopped after desired time duration. Once the mmW link is established, LTE Tx power is programmed to toggle between all-up and all-down bits on the callbox. For all the tests, the callbox is set to request maximum Tx power in mmW NR radio from EUT all the time. Therefore, the calibration for the pathloss between the EUT and the horn antenna connected to the remote radio head of the callbox is not required.

Power meter readings are periodically recorded every 10ms on NR8S power sensor for LTE conducted Tx power. Time-averaged E-field measurements are performed using EUmmWV4 mmW probe at peak location of fast area scan. The distance between EUmmWV4 mmW probe tip to EUT surface is ~0.5 mm, and the distance between EUmmWV4 mmW probe sensor to probe tip is 1.5 mm. cDASY6 records relative point E-field (i.e., ratio $\frac{[pointE(t)]^2}{[pointE_input.power.limit]^2}$) versus time for mmW NR transmission.

FCC ID: A3LSMS711U	PART 2 RF EXPOSURE EVALUATION REPORT	Approved by: Technical Manager
Document S/N: 1M2304260060-25.A3L	DUT Type: Portable Handset	Page 34 of 90

8 TEST CONFIGURATIONS (FREQ < 6 GHZ)

8.1 WWAN (sub-6) transmission

The P_{limit} values, corresponding to 1.0 W/kg (1gSAR) and 2.5 W/kg (10gSAR) of SAR_{design_target} , for technologies and bands supported by DUT are derived in Part 0 report and summarized in Table 8-1. Note all P_{limit} power levels entered in Table 8-1 correspond to average power levels after accounting for duty cycle in the case of TDD modulation schemes.

Table 8-1
 P_{limit} for supported technologies and bands (P_{limit} in EFS file)

Exposure Scenario			Maximum Tune-Up Output Power*	Body-Worn	Phablet	Head	Hotspot
Averaging Volume				1g	10g	1g	1g
Spacing			Pmax	10 mm	0 mm	0 mm	10 mm
DSI				0	0	1	2
Technology/Band	Antenna	Antenna Group					
GSM 850	A	AG0	25.3	28.2		30.4	28.0
GSM 1900	A	AG0	22.1	20.0		30.6	20.0
UMTS 850	A	AG0	24.0	27.0		30.4	27.0
UMTS 1750	A	AG0	23.0	19.0		31.5	19.0
UMTS 1900	A	AG0	23.0	19.0		30.4	19.0
LTE Band 71	A	AG0	24.5	28.6		31.9	28.6
LTE Band 12	A	AG0	24.5	27.4		31.4	27.4
LTE Band 13	A	AG0	24.5	26.7		30.0	26.7
LTE Band 14	A	AG0	24.5	26.5		29.7	26.5
LTE Band 26 (Cell)	A	AG0	24.5	26.6		31.0	26.6
LTE Band 5 (Cell)	A	AG0	24.5	26.3		31.3	26.3
LTE Band 66/4 (AWS)	A	AG0	23.5	20.0		29.0	20.0
LTE Band 66/4 (AWS)	F	AG1	22.5	20.0		16.0	20.0
LTE Band 25/2 (PCS)	A	AG0	23.5	19.0		29.8	19.0
LTE Band 25/2 (PCS)	F	AG1	22.5	19.5		17.0	19.5
LTE Band 30	A	AG0	22.0	17.0		34.8	17.0
LTE Band 30	F	AG1	21.5	20.0		15.5	20.0
LTE Band 7	B	AG0	23.0	19.0		32.7	19.0
LTE Band 7	F	AG1	21.0	18.5		14.0	18.5
LTE Band 41/38 (PC3)	B	AG0	22.0	19.0		33.5	19.0
LTE Band 41 (PC2)	B	AG0	22.0	19.0		33.5	19.0
LTE Band 41/38 (PC3)	F	AG1	20.0	19.0		14.5	19.0
LTE Band 41 (PC2)	F	AG1	19.0	19.0		14.5	19.0
LTE Band 48	F	AG1	20.3	18.0		16.0	18.0
NR Band n71	A	AG0	24.5	28.8		32.6	28.8
NR Band n12	A	AG0	24.5	28.4		31.9	28.4
NR Band n26/n5	A	AG0	24.5	27.1		32.4	27.1
NR Band n66	A	AG0	23.5	20.0		30.0	20.0
NR Band n66	F	AG1	22.5	20.0		17.0	20.0
NR Band n25/n2 (PCS)	A	AG0	23.5	19.0		29.7	19.0
NR Band n25/n2 (PCS)	F	AG1	22.5	19.5		16.0	19.5
NR Band n30	A	AG0	22.5	17.0		34.5	17.0
NR Band n30	F	AG1	21.5	20.0		15.5	20.0
NR Band n41 (PC2)	B	AG0	26.0	19.0		19.0	19.0
NR Band n41 (PC2)	F	AG1	22.0	15.5		15.5	15.5
NR Band n41 (PC2)	E	AG1	19.5	16.5		16.5	16.5
NR Band n41 (PC2)	D	AG0	19.0	17.5		17.5	17.5
NR Band n48	F	AG1	22.3	18.0		16.0	18.0
NR Band n77 (PC2)	F	AG1	26.0	18.0		14.5	18.0
NR Band n77 (PC2)	C	AG0	22.0	14.5		13.5	14.5
NR Band n77 (PC2)	I	AG1	24.0	17.5		16.5	17.5
NR Band n77 (PC2)	D	AG0	21.5	13.0		12.0	13.0

* Maximum tune up target power, P_{max} , is configured in NV settings in DUT to limit maximum transmitting power. This power is converted into peak power in NV settings for TDD schemes. The DUT maximum allowed output power is equal to $P_{max} + 1$ dB device uncertainty.

FCC ID: A3LSMS711U	PART 2 RF EXPOSURE EVALUATION REPORT	Approved by: Technical Manager
Document S/N: 1M2304260060-25.A3L	DUT Type: Portable Handset	Page 35 of 90

Based on selection criteria described in Section 4.2.1, the selected technologies/bands for testing time-varying test sequences are highlighted in yellow in Table 8-1. Per the manufacturer, the *Reserve_power_margin* (dB) is set to 3dB in EFS and is used in Part 2 test.

The radio configurations used in Part 2 test for selected technologies, bands, DSIs and antennas are listed in Table 8-2. The corresponding worst-case radio configuration 1gSAR values for selected technology/band/DSI are extracted from Part 1 report and are listed in the last column of Table 8-2.

Based on equations (1a), (2a), (3a) and (4a), it is clear that Part 2 testing outcome is normalized quantity, which implies that it can be applied to any radio configuration within a selected technology/band/DSI. Thus, as long as applying the worst-case SAR obtained from the worst radio configuration in Part 1 testing to calculate time-varying SAR exposure in equations (1a), (2a), (3a) and (4a), the accuracy in compliance demonstration remains the same. Therefore, there may be some differences between the radio configuration selected for Part 2 testing and the radio configuration associated with worst-case SAR obtained in the Part 1 evaluation.

The measured P_{limit} for all the selected radio configurations are listed in below Table 8-2. P_{max} was also measured for radio configurations selected for testing time-varying Tx power transmission scenarios in order to generate test sequences following the test procedures in Section 4.1.

Table 8-2
Radio configurations selected for Part 2 test

Test Case #	Test Scenario	Tech	Band	Antenna	DSI	Channel	Frequency [MHz]	Test Configurations	SAR Exposure Scenario	Part 1 Worst Case Measured SAR at P _{limit} (W/kg)	EFS P _{limit} [dBm]	Tune-up P _{max} [dBm]	Measured P _{limit} [dBm]	Measured P _{max} [dBm]
1	Test Sequence A	GSM	1900	A	2	661	1880	4Tx Slot	Bottom Edge, 10mm	0.296	20.0	21.3	19.98	21.56
	Test Sequence B													
2	Test Sequence A	WCDMA	4	A	2	1413	1745	RMC	Bottom Edge, 10mm	0.850	19.0	23.0	19.69	23.32
	Test Sequence B													
3	Test Sequence A	WCDMA	2	A	2	9400	1880	RMC	Bottom Edge, 10mm	0.428	19.0	23.0	19.89	23.52
	Test Sequence B													
4	Test Sequence A	LTE	66	A	2	132322	1745	QPSK 1/50/20 MHz BW	Bottom Edge, 10mm	0.949	20.0	23.5	20.77	24.31
	Test Sequence B													
5	Test Sequence A	LTE	7	F	1	21100	2535	QPSK 1/50/20 MHz BW	Right, Cheek	0.554	14.0	21.0	14.29	21.44
	Test Sequence B													
6	Test Sequence A	NR	n66	A	2	349000	1745	DFT-s-OFDM, QPSK 1/1/40 MHz BW	Bottom Edge, 10mm	1.120	20.0	23.5	20.55	23.60
	Test Sequence B													
7	Test Sequence A	NR	n25	F	1	376500	1882.5	DFT-s-OFDM, QPSK 1/1/40 MHz BW	Right, Tilt	0.585	16.0	22.5	16.90	23.44
	Test Sequence B													
8	Change in Call	LTE	7	F	1	21100	2535	QPSK 1/50/20 MHz BW	Right, Cheek	0.554	14.0	21.0	14.29	21.44
9	Tech/Band Switch	LTE	66	A	2	132322	1745	QPSK 1/50/20 MHz BW	Bottom Edge, 10mm	0.949	20.0	23.5	20.77	24.31
		WCDMA	2	A	2	9400	1880	RMC	Bottom Edge, 10mm	0.428	19.0	23.0	19.89	23.52
10	Antenna Switch	LTE	7	B	2	21100	2535	QPSK 1/50/20 MHz BW	Bottom Edge, 10mm	0.438	19.0	23.0	19.54	23.55
			30	A	2	27710	2310	QPSK 1/25/10 MHz BW	Bottom Edge, 10mm	0.639	17.0	22.0	17.60	22.69
11	Time Window Switch	LTE	66	F	2	132322	1745	QPSK 1/50/20 MHz BW	Top Edge, 10mm	0.603	20.0	22.5	20.65	23.19
			48	F	2	56207	3646.7	DFT-s-OFDM, QPSK 1/136/100 MHz BW	Top Edge, 10mm	0.175	18.0	20.3	18.82	20.75
12	DSI Switch	LTE	48	F	2	56207	3646.7	QPSK 1/50/20 MHz BW	Top Edge, 10mm	0.175	18.0	20.3	18.82	20.75
					1	56207	3646.7	RMC	Right, Tilt	0.418	16.0	20.3	16.80	20.75
13	SAR1 vs SAR2 (same time window)	LTE	5	A	2	20525	836.5	QPSK 1/25/20 MHz BW	Back Side, 10mm	0.541	24.5	24.5	25.09	25.09
		NR	n66	A	2	349000	1745	DFT-s-OFDM, QPSK 1/1/40 MHz BW	Bottom Edge, 10mm	1.120	20.0	23.5	20.56	23.59

FCC ID: A3LSMS711U	PART 2 RF EXPOSURE EVALUATION REPORT	Approved by: Technical Manager
Document S/N: 1M2304260060-25.A3L	DUT Type: Portable Handset	Page 36 of 90

Note: The device uncertainty of P_{max} is +/- 1 dB as provided by manufacturer.

Note: The above P_{max} value for GPRS1900 is for 4 Tx Slots

**Table 8-3
DSI and Corresponding Exposure Scenarios**

Scenario	Description	SAR Test Cases
Head (DSI = 1)	Device positioned next to head Receiver Active	Head SAR per KDB Publication 648474 D04
Hotspot mode (DSI = 2)	Device transmits in hotspot mode near body Hotspot Mode Active	Hotspot SAR per KDB Publication 941225 D06
Phablet (DSI = 0)	Device is held with hand and grip sensor is triggered Distance grip sensor not triggered	Phablet SAR per KDB Publication 648474 D04 & KDB Publication 616217 D04
Body-worn (DSI = 0)	Device being used with a body-worn accessory	Body-worn SAR per KDB Publication 648474 D04

Based on the selection criteria described in Section 4.2, the radio configurations for the Tx varying transmission test cases listed in Section 3 are:

- Technologies and bands for time-varying Tx power transmission: The test case 1~7 listed in Table 8-2 are selected to test with the test sequences defined in Section 4.1 in both time-varying conducted power measurement and time-varying SAR measurement.
- Technology and band for change in call test: LTE Band 7, having the lowest P_{limit} among all technologies and bands (test case 8 in Table 8-2), is selected for performing the call drop test in conducted power setup.
- Technologies and bands for change in technology/band test: Following the guidelines in Section 4.2.3, test case 9 in Table 8-2 is selected for handover test from a technology/band within one technology group (LTE Band 66, DSI=2, antenna A), to a technology/band in the same DSI within another technology group (WCDMA Band 2, DSI=2, antenna A) in conducted power setup.
- Technologies and bands for change in antenna: Based on selection criteria in Section 4.2.4, for a given DSI=2, test case 10 in Table 8-2 is selected for antenna switch between LTE Band 7, Antenna B and LTE Band 30, Antenna A in conducted power setup.
- Technologies and bands for change in time-window: Based on selection criteria in Section 4.2.6, for a given DSI=2, test case 11 in Table 8-2 is selected for time window switch between 60s window (LTE Band 48 Antenna F) and 100s window (LTE Band 66, Antenna F) in conducted power setup.
- Technologies and bands for change in DSI: Based on selection criteria in Section 4.2.5, for a given technology and band, test case 12 in Table 8-2 is selected for DSI switch test by establishing a call in LTE Band 48 in DSI=2, and then handing over to DSI=1 exposure scenario in conducted power setup.
- Technologies and bands for switch in SAR exposure: Based on selection criteria in Section 4.2.7 Scenario 1, test case 13 in Table 8-2 is selected for SAR exposure switching test in one of the supported simultaneous WWAN transmission scenario, i.e., LTE + Sub6 NR active in the same 100s time window, in conducted power setup. Since this device supports LTE+mmW NR, test for Section 4.2.7 Scenario 2 for RF exposure switch is covered in Sections 13.1 and 13.2 between LTE (100s window) and mmW NR (4s window).

FCC ID: A3LSMS711U	PART 2 RF EXPOSURE EVALUATION REPORT	Approved by: Technical Manager
Document S/N: 1M2304260060-25.A3L	DUT Type: Portable Handset	Page 37 of 90

Note: All switching and EN-DC test cases (9 - 13) were done with modes/bands within the same antenna group.

Note: This device supports inter-band NR ULCA operations with component carriers from different antenna groups. None of the supported NR CA configurations operate within the same antenna group. Therefore, SAR exposure switch testing for inter-band ULCA is not needed to validate Smart Transmit operations.

8.2 EFS v17 Verification

Per Qualcomm's 80-w2112-5 document, embedded file system (EFS) version 17 products are required to be verified for Smart Tx generation for relevant MCC settings. It was confirmed that this DUT contains embedded file system (EFS) version 17 configured for Smart Tx second generation (GEN2) for Sub6 and first generation (GEN1) for mmWave with MCC settings for the US market.

EFS v17 Generation	MCC
GEN2_Sub6_GEN1_mmWave	310

FCC ID: A3LSMS711U	PART 2 RF EXPOSURE EVALUATION REPORT	Approved by: Technical Manager
Document S/N: 1M2304260060-25.A3L	DUT Type: Portable Handset	Page 38 of 90

9 CONDUCTED TX CASES (FREQ < 6 GHZ)

9.1 Time-varying Tx Power Case

The measurement setup is shown in Figure 6-1. The purpose of the time-varying Tx power measurement is to demonstrate the effectiveness of power limiting enforcement and that the time-averaged Tx power when represented in time-averaged 1gSAR or 10gSAR values does not exceed FCC limit as shown in Eq. (1a) and (1b), rewritten below:

$$1g_or_10gSAR(t) = \frac{conducted_Tx_power(t)}{conducted_Tx_power_P_{limit}} * 1g_or_10gSAR_P_{limit} \quad (1a)$$

$$\frac{\frac{1}{T_{SAR}} \int_{t-T_{SAR}}^t 1g_or_10gSAR(t) dt}{FCC\ SAR\ limit} \leq 1 \quad (1b)$$

where, $conducted_Tx_power(t)$, $conducted_Tx_power_P_{limit}$, and $1g_or_10gSAR_P_{limit}$ correspond to the measured instantaneous conducted Tx power, measured conducted Tx power at P_{limit} , and measured 1gSAR and 10gSAR values at P_{limit} reported in Part 1 test (listed in Table 8-2 of this report as well).

Following the test procedure in Section 4.3, the conducted Tx power measurement for all selected configurations are reported in this section. In all the conducted Tx power plots, the green curve represents time-averaged power and red line represents the conducted power limit that corresponds to FCC limit of 1.6 W/kg for 1gSAR or 4.0 W/kg for 10gSAR.

Similarly, in all the 1g or 10gSAR plots (when converted using Eq. (1a)), the green curve represents the 100s/60s-time averaged 1gSAR or 10gSAR value calculated based on instantaneous 1gSAR or 10gSAR; and the red line limit represents the FCC limit of 1.6 W/kg for 1gSAR or 4.0 W/kg for 10gSAR.

Time-varying Tx power measurements were conducted on test cases #1 ~ #7 in Table 8-2, by generating test sequence 1 and test sequence 2 given in APPENDIX E: using measured P_{limit} and measured P_{max} (last two columns of Table 8-2) for each of these test cases. Measurement results for test cases #1 ~ #7 are given in Sections 9.1.1-9.1.7.

Note: All test cases involving multiple antennas (switches/simult tx, etc) were performed with antennas within the same group.

FCC ID: A3LSMS711U	PART 2 RF EXPOSURE EVALUATION REPORT	Approved by: Technical Manager
Document S/N: 1M2304260060-25.A3L	DUT Type: Portable Handset	Page 39 of 90

9.1.1 GSM/GPRS/EDGE 1900

Test result for test sequence 1:

Time-averaged conducted Tx power is converted/calculated into time-averaged 1gSAR using Equation (1a) and plotted below to demonstrate that the time-averaged 1gSAR versus time does not exceed the FCC limit of 1.6 W/kg for 1gSAR:

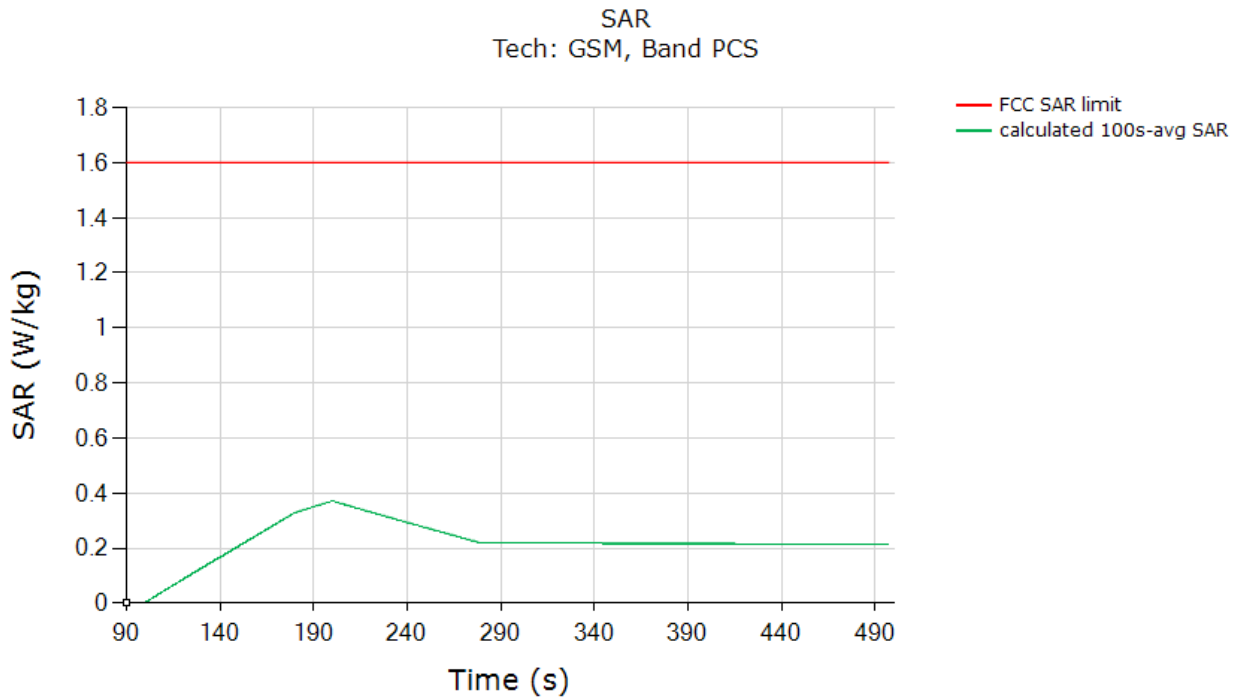

	(W/kg)
FCC 1gSAR limit	1.6
Max 100s-time averaged 1gSAR (green curve)	0.371
Validated: Max time averaged SAR (green curve) is within 1 dB device uncertainty of measured SAR at P_{limit} (last column in Table 8-2).	

FCC ID: A3LSMS711U	PART 2 RF EXPOSURE EVALUATION REPORT	Approved by: Technical Manager
Document S/N: 1M2304260060-25.A3L	DUT Type: Portable Handset	Page 40 of 90

Test result for test sequence 2:

Time-averaged conducted Tx power is converted/calculated into time-averaged 1gSAR using Equation (1a) and plotted below to demonstrate that the time-averaged 1gSAR versus time does not exceed the FCC limit of 1.6 W/kg for 1gSAR:

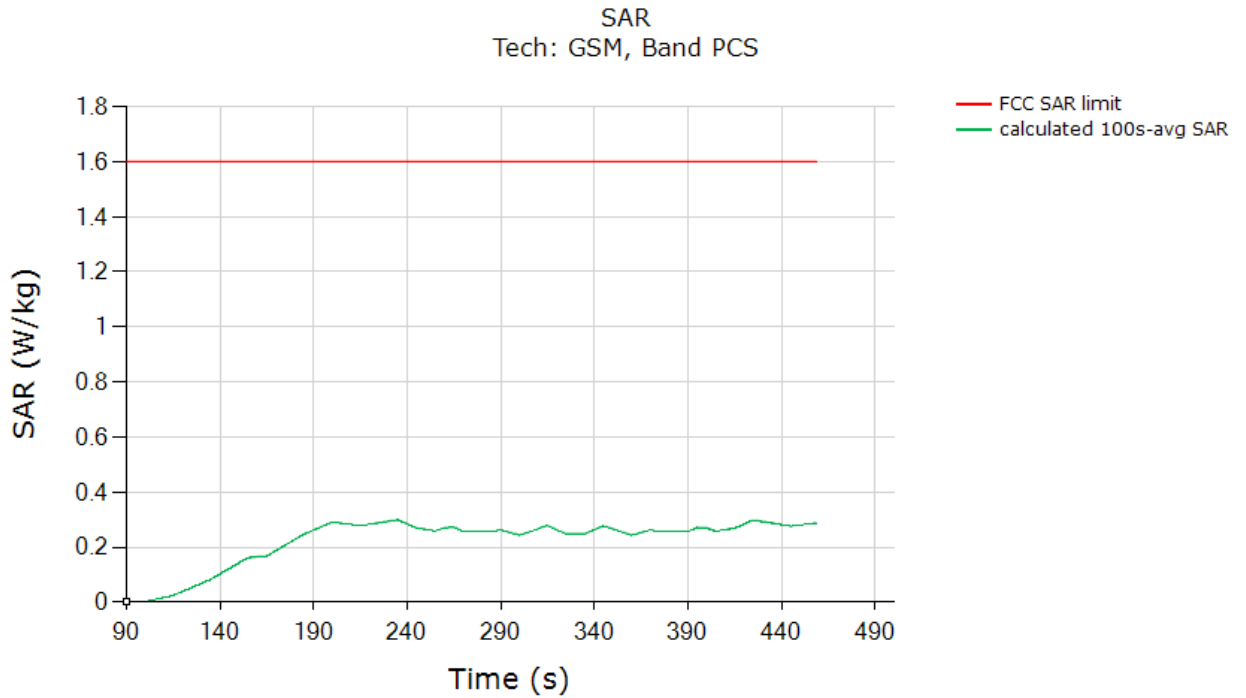

	(W/kg)
FCC 1gSAR limit	1.6
Max 100s-time averaged 1gSAR (green curve)	0.298
Validated: Max time averaged SAR (green curve) is within 1 dB device uncertainty of measured SAR at P_{limit} (last column in Table 8-2).	

FCC ID: A3LSMS711U	PART 2 RF EXPOSURE EVALUATION REPORT	Approved by: Technical Manager
Document S/N: 1M2304260060-25.A3L	DUT Type: Portable Handset	Page 41 of 90

9.1.2 WCDMA Band 4

Test result for test sequence 1:

Time-averaged conducted Tx power is converted/calculated into time-averaged 1gSAR using Equation (1a) and plotted below to demonstrate that the time-averaged 1gSAR versus time does not exceed the FCC limit of 1.6 W/kg for 1gSAR:

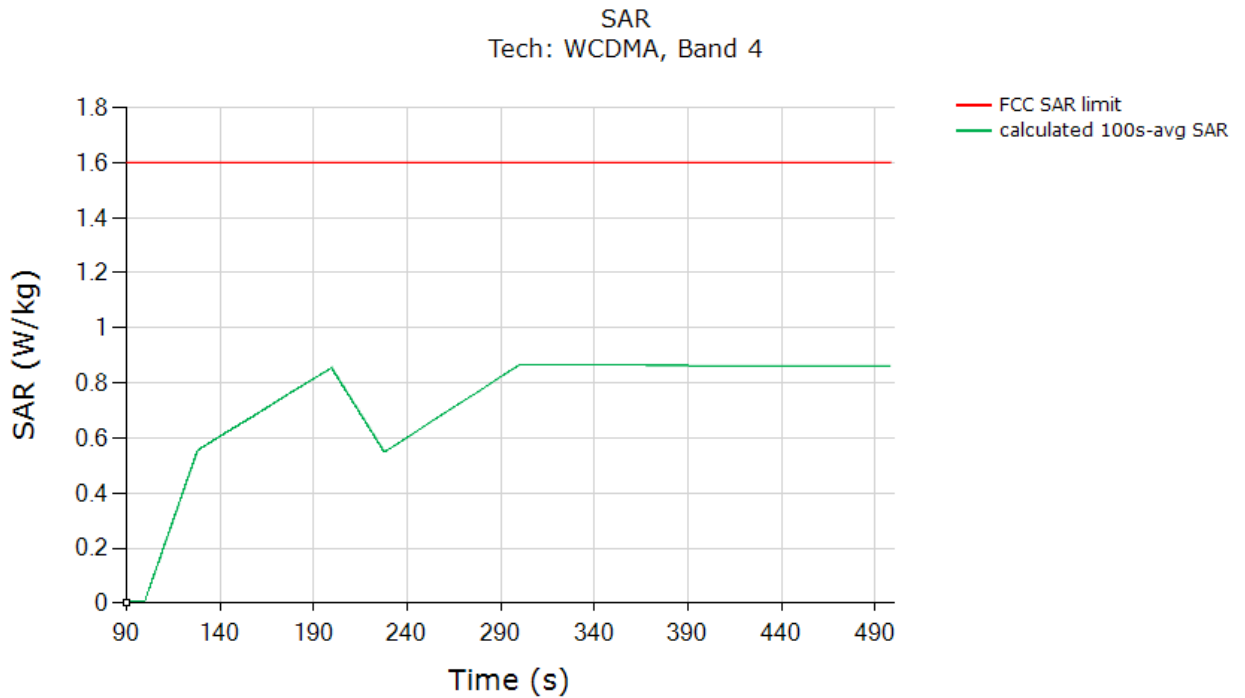

	(W/kg)
FCC 1gSAR limit	1.6
Max 100s-time averaged 1gSAR (green curve)	0.865
Validated: Max time averaged SAR (green curve) is within 1 dB device uncertainty of measured SAR at P_{limit} (last column in Table 8-2).	

FCC ID: A3LSMS711U	PART 2 RF EXPOSURE EVALUATION REPORT	Approved by: Technical Manager
Document S/N: 1M2304260060-25.A3L	DUT Type: Portable Handset	Page 42 of 90

Test result for test sequence 2:

Time-averaged conducted Tx power is converted/calculated into time-averaged 1gSAR using Equation (1a) and plotted below to demonstrate that the time-averaged 1gSAR versus time does not exceed the FCC limit of 1.6 W/kg for 1gSAR:

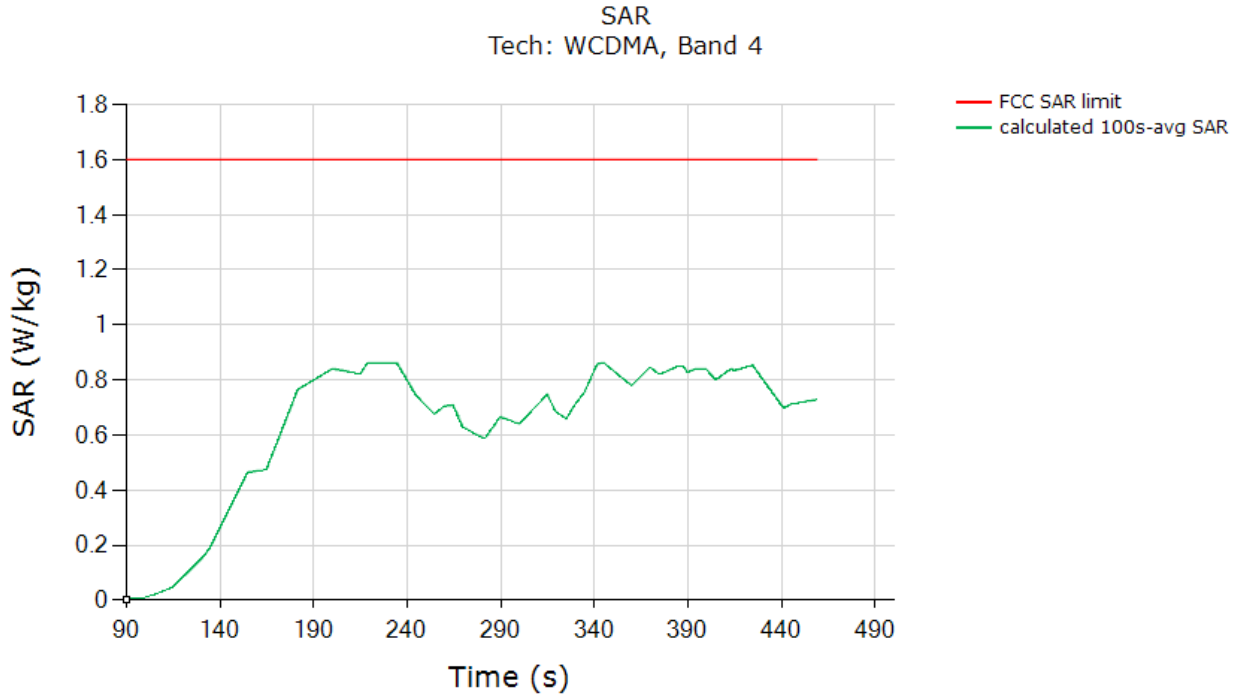

	(W/kg)
FCC 1gSAR limit	1.6
Max 100s-time averaged 1gSAR (green curve)	0.862
Validated: Max time averaged SAR (green curve) is within 1 dB device uncertainty of measured SAR at P_{limit} (last column in Table 8-2).	

FCC ID: A3LSMS711U	PART 2 RF EXPOSURE EVALUATION REPORT	Approved by: Technical Manager
Document S/N: 1M2304260060-25.A3L	DUT Type: Portable Handset	Page 43 of 90

9.1.3 WCDMA Band 2

Test result for test sequence 1:

Time-averaged conducted Tx power is converted/calculated into time-averaged 1gSAR using Equation (1a) and plotted below to demonstrate that the time-averaged 1gSAR versus time does not exceed the FCC limit of 1.6 W/kg for 1gSAR:

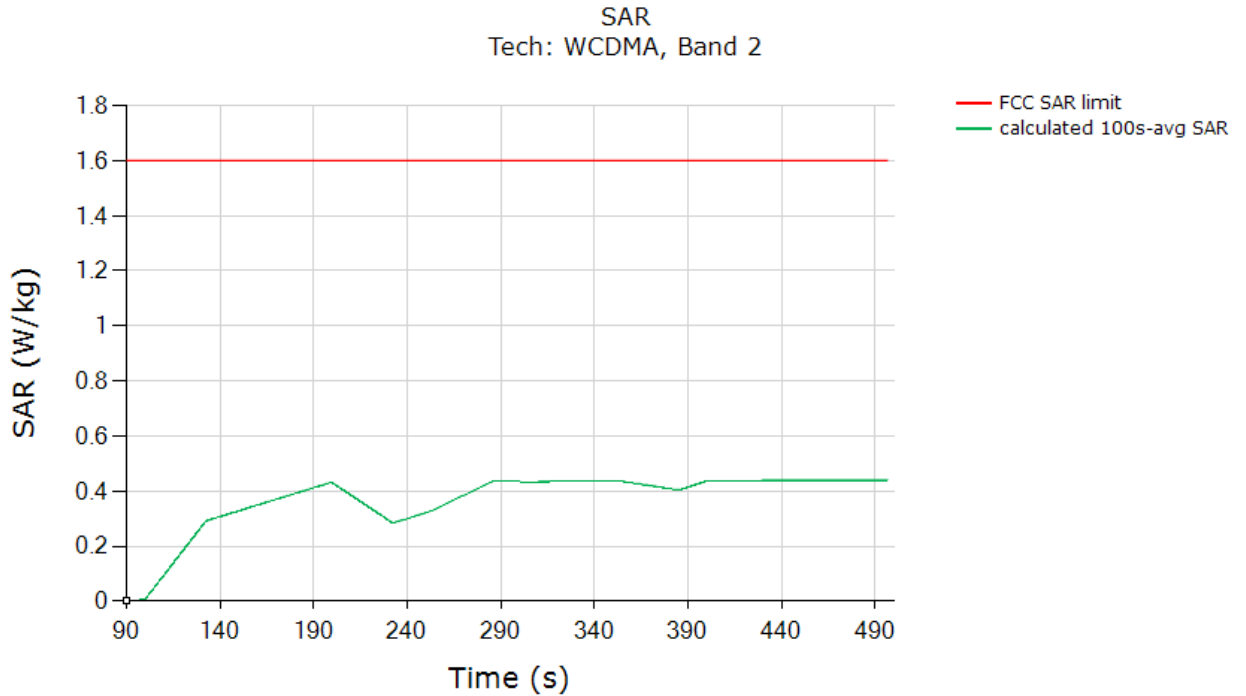

	(W/kg)
FCC 1gSAR limit	1.6
Max 100s-time averaged 1gSAR (green curve)	0.438
Validated: Max time averaged SAR (green curve) is within 1 dB device uncertainty of measured SAR at P_{limit} (last column in Table 8-2).	

FCC ID: A3LSMS711U	PART 2 RF EXPOSURE EVALUATION REPORT	Approved by: Technical Manager
Document S/N: 1M2304260060-25.A3L	DUT Type: Portable Handset	Page 44 of 90

Test result for test sequence 2:

Time-averaged conducted Tx power is converted/calculated into time-averaged 1gSAR using Equation (1a) and plotted below to demonstrate that the time-averaged 1gSAR versus time does not exceed the FCC limit of 1.6 W/kg for 1gSAR:

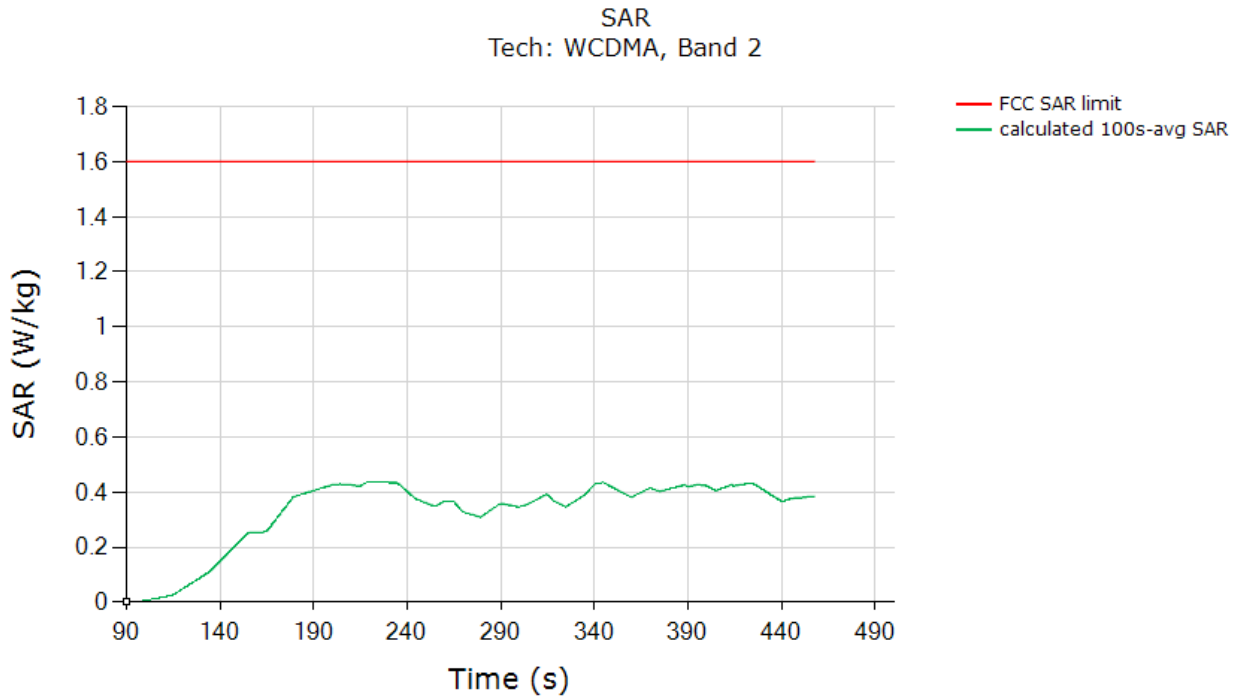

	(W/kg)
FCC 1gSAR limit	1.6
Max 100s-time averaged 1gSAR (green curve)	0.435
Validated: Max time averaged SAR (green curve) is within 1 dB device uncertainty of measured SAR at P_{limit} (last column in Table 8-2).	

FCC ID: A3LSMS711U	PART 2 RF EXPOSURE EVALUATION REPORT	Approved by: Technical Manager
Document S/N: 1M2304260060-25.A3L	DUT Type: Portable Handset	Page 45 of 90

9.1.4 LTE Band 66

Test result for test sequence 1:

Time-averaged conducted Tx power is converted/calculated into time-averaged 1gSAR using Equation (1a) and plotted below to demonstrate that the time-averaged 1gSAR versus time does not exceed the FCC limit of 1.6 W/kg for 1gSAR:

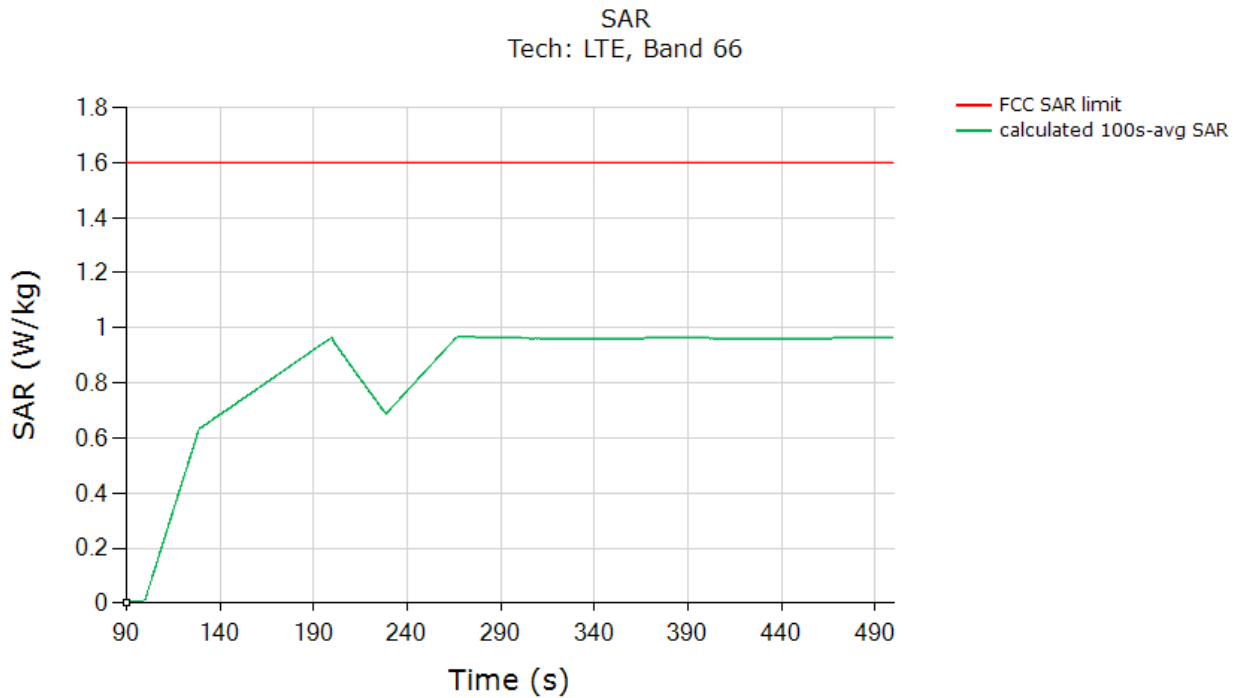

	(W/kg)
FCC 1gSAR limit	1.6
Max 100s-time averaged 1gSAR (green curve)	0.966
Validated: Max time averaged SAR (green curve) is within 1 dB device uncertainty of measured SAR at P_{limit} (last column in Table 8-2).	

FCC ID: A3LSMS711U	PART 2 RF EXPOSURE EVALUATION REPORT	Approved by: Technical Manager
Document S/N: 1M2304260060-25.A3L	DUT Type: Portable Handset	Page 46 of 90

Test result for test sequence 2:

Time-averaged conducted Tx power is converted/calculated into time-averaged 1gSAR using Equation (1a) and plotted below to demonstrate that the time-averaged 1gSAR versus time does not exceed the FCC limit of 1.6 W/kg for 1gSAR:

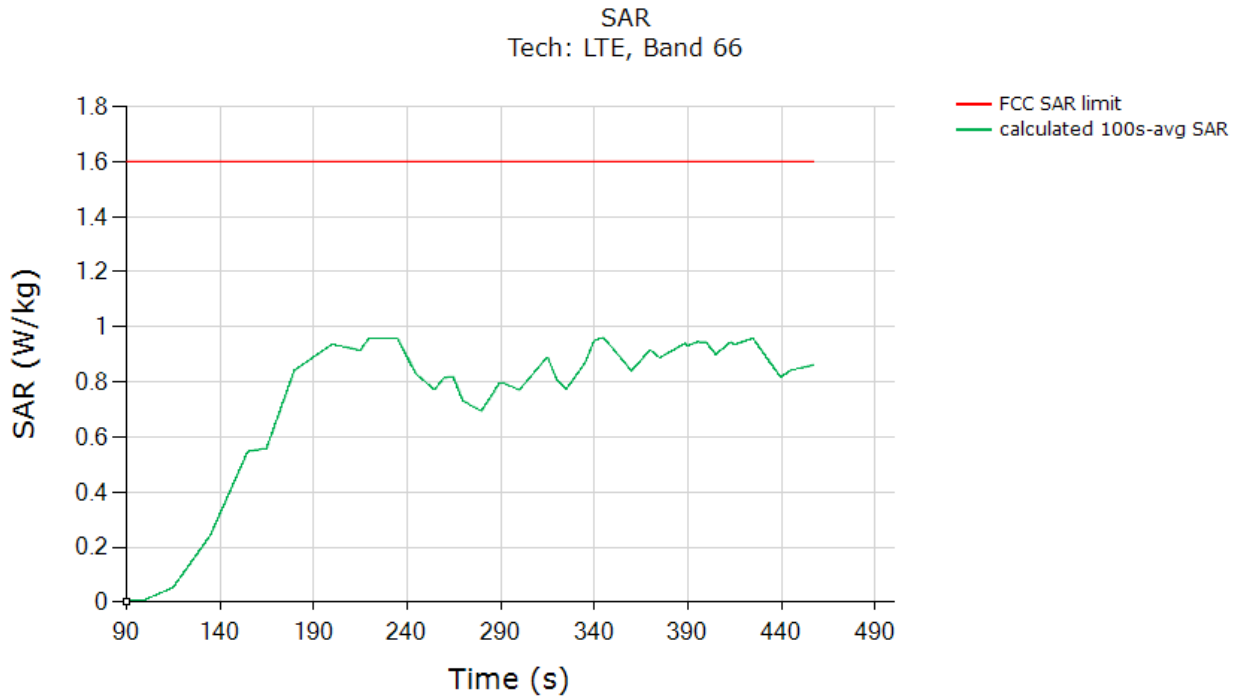

	(W/kg)
FCC 1gSAR limit	1.6
Max 100s-time averaged 1gSAR (green curve)	0.960
Validated: Max time averaged SAR (green curve) is within 1 dB device uncertainty of measured SAR at P_{limit} (last column in Table 8-2).	

FCC ID: A3LSMS711U	PART 2 RF EXPOSURE EVALUATION REPORT	Approved by: Technical Manager
Document S/N: 1M2304260060-25.A3L	DUT Type: Portable Handset	Page 47 of 90

9.1.5 LTE Band 7

Test result for test sequence 1:

Time-averaged conducted Tx power is converted/calculated into time-averaged 1gSAR using Equation (1a) and plotted below to demonstrate that the time-averaged 1gSAR versus time does not exceed the FCC limit of 1.6 W/kg for 1gSAR:

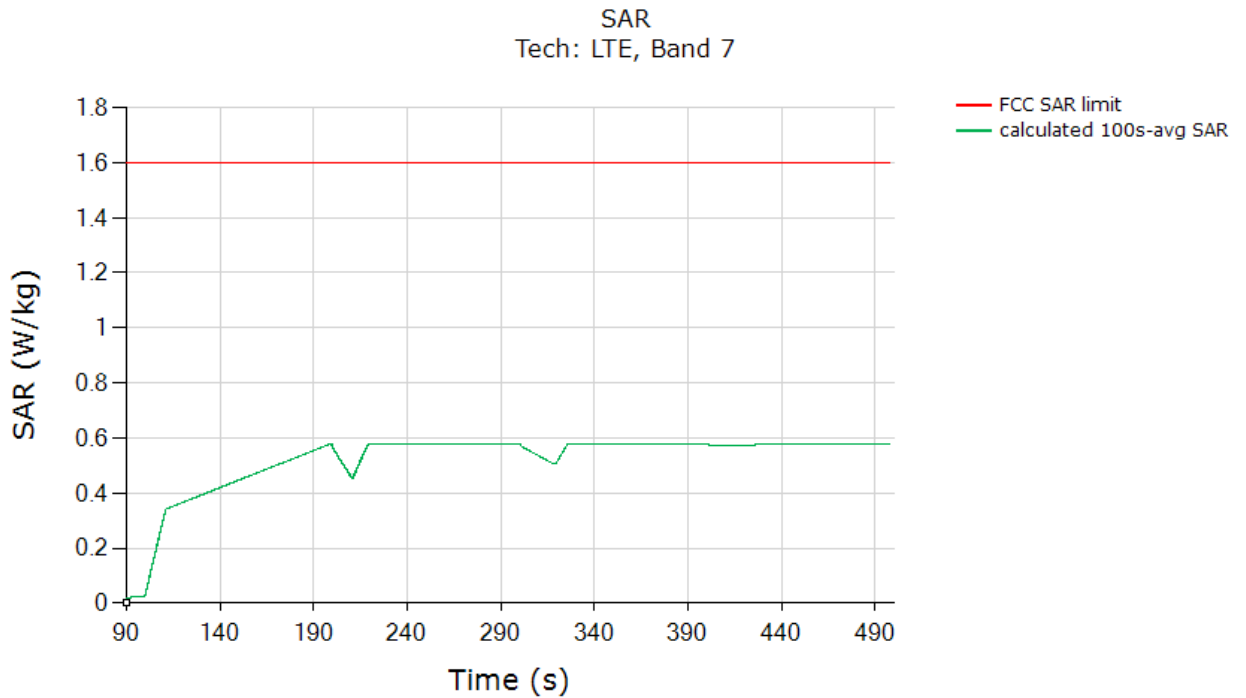

	(W/kg)
FCC 1gSAR limit	1.6
Max 100s-time averaged 1gSAR (green curve)	0.580
Validated: Max time averaged SAR (green curve) is within 1 dB device uncertainty of measured SAR at P_{limit} (last column in Table 8-2).	

FCC ID: A3LSMS711U	PART 2 RF EXPOSURE EVALUATION REPORT	Approved by: Technical Manager
Document S/N: 1M2304260060-25.A3L	DUT Type: Portable Handset	Page 48 of 90

Test result for test sequence 2:

Time-averaged conducted Tx power is converted/calculated into time-averaged 1gSAR using Equation (1a) and plotted below to demonstrate that the time-averaged 1gSAR versus time does not exceed the FCC limit of 1.6 W/kg for 1gSAR:

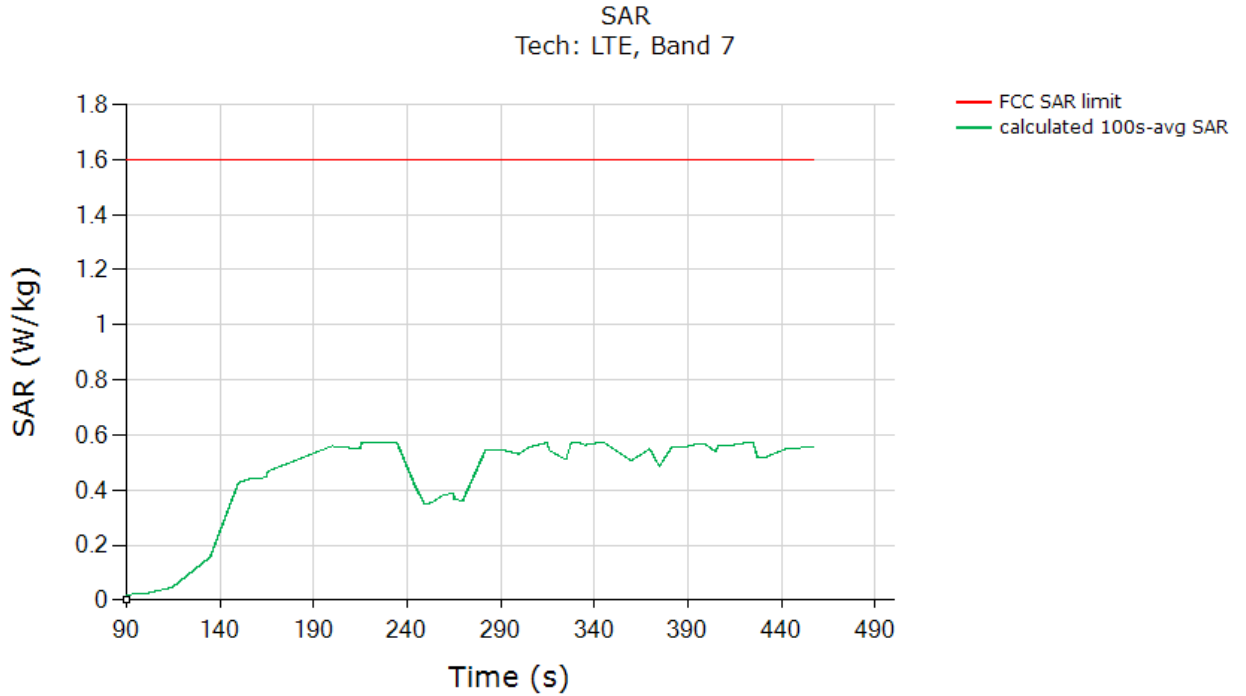

	(W/kg)
FCC 1gSAR limit	1.6
Max 100s-time averaged 1gSAR (green curve)	0.575
Validated: Max time averaged SAR (green curve) is within 1 dB device uncertainty of measured SAR at P_{limit} (last column in Table 8-2).	

FCC ID: A3LSMS711U	PART 2 RF EXPOSURE EVALUATION REPORT	Approved by: Technical Manager
Document S/N: 1M2304260060-25.A3L	DUT Type: Portable Handset	Page 49 of 90

9.1.6 NR n66 SA

Test result for test sequence 1:

Time-averaged conducted Tx power is converted/calculated into time-averaged 1gSAR using Equation (1a) and plotted below to demonstrate that the time-averaged 1gSAR versus time does not exceed the FCC limit of 1.6 W/kg for 1gSAR:

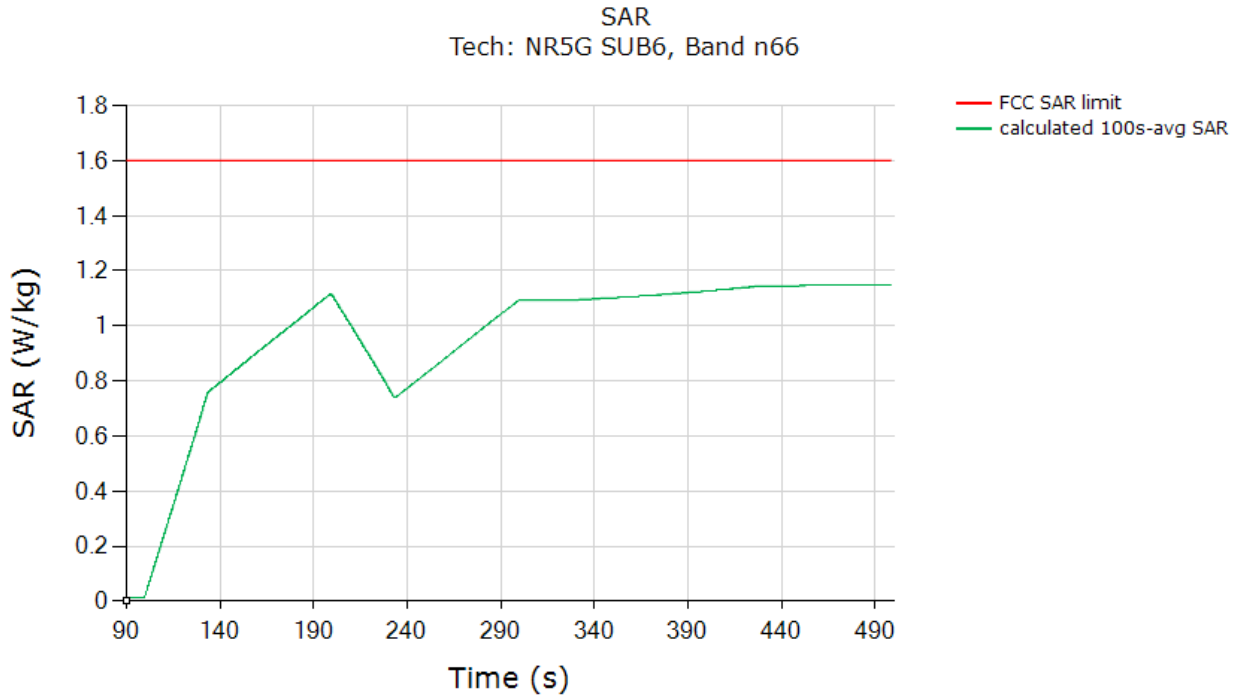

	(W/kg)
FCC 1gSAR limit	1.6
Max 100s-time averaged 1gSAR (green curve)	1.150
Validated: Max time averaged SAR (green curve) is within 1 dB device uncertainty of measured SAR at P_{limit} (last column in Table 8-2).	

FCC ID: A3LSMS711U	PART 2 RF EXPOSURE EVALUATION REPORT	Approved by: Technical Manager
Document S/N: 1M2304260060-25.A3L	DUT Type: Portable Handset	Page 50 of 90

Test result for test sequence 2:

Time-averaged conducted Tx power is converted/calculated into time-averaged 1gSAR using Equation (1a) and plotted below to demonstrate that the time-averaged 1gSAR versus time does not exceed the FCC limit of 1.6 W/kg for 1gSAR:

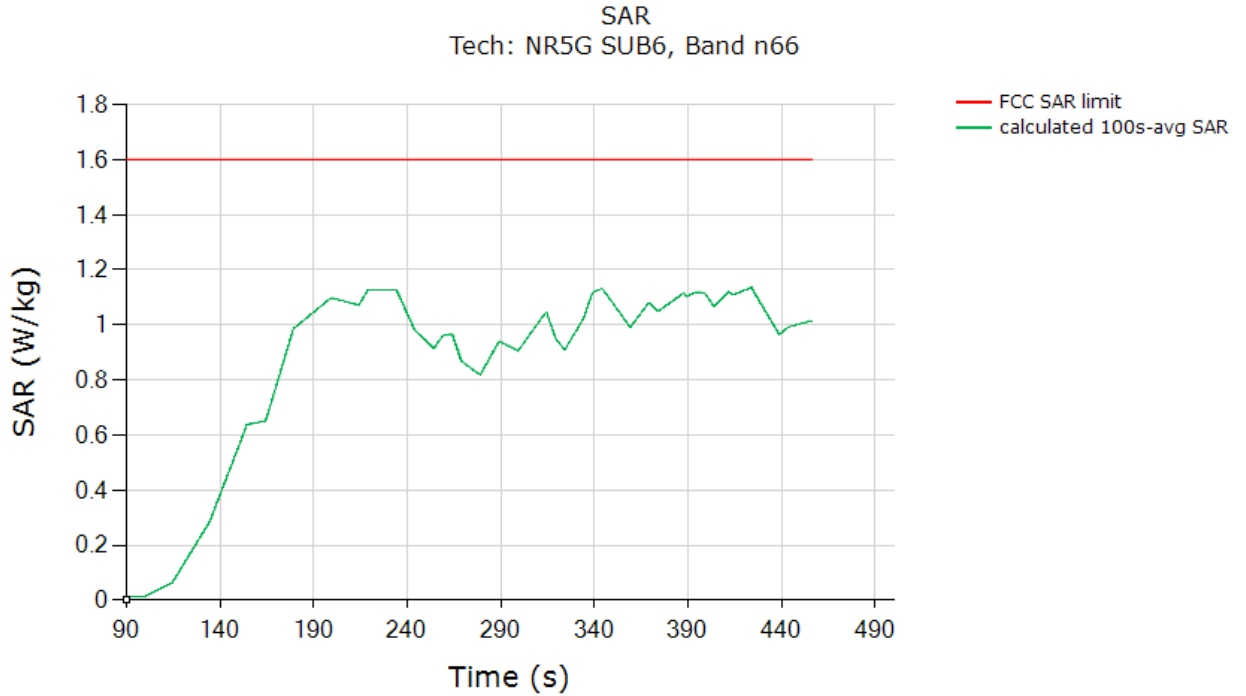

	(W/kg)
FCC 1gSAR limit	1.6
Max 100s-time averaged 1gSAR (green curve)	1.135
Validated: Max time averaged SAR (green curve) is within 1 dB device uncertainty of measured SAR at P_{limit} (last column in Table 8-2).	

FCC ID: A3LSMS711U	PART 2 RF EXPOSURE EVALUATION REPORT	Approved by: Technical Manager
Document S/N: 1M2304260060-25.A3L	DUT Type: Portable Handset	Page 51 of 90

9.1.7 NR n25 SA

Test result for test sequence 1:

Time-averaged conducted Tx power is converted/calculated into time-averaged 1gSAR using Equation (1a) and plotted below to demonstrate that the time-averaged 1gSAR versus time does not exceed the FCC limit of 1.6 W/kg for 1gSAR:

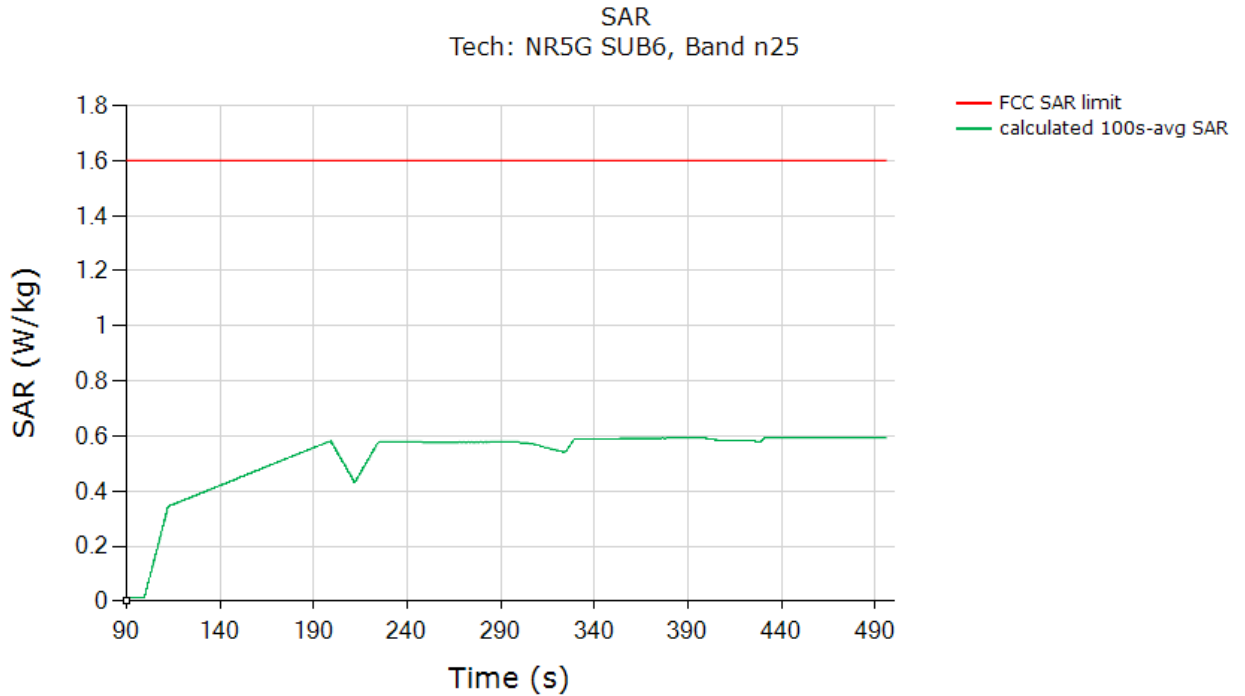

	(W/kg)
FCC 1gSAR limit	1.6
Max 100s-time averaged 1gSAR (green curve)	0.593
Validated: Max time averaged SAR (green curve) is within 1 dB device uncertainty of measured SAR at P_{limit} (last column in Table 8-2).	

FCC ID: A3LSMS711U	PART 2 RF EXPOSURE EVALUATION REPORT	Approved by: Technical Manager
Document S/N: 1M2304260060-25.A3L	DUT Type: Portable Handset	Page 52 of 90

Test result for test sequence 2:

Time-averaged conducted Tx power is converted/calculated into time-averaged 1gSAR using Equation (1a) and plotted below to demonstrate that the time-averaged 1gSAR versus time does not exceed the FCC limit of 1.6 W/kg for 1gSAR:

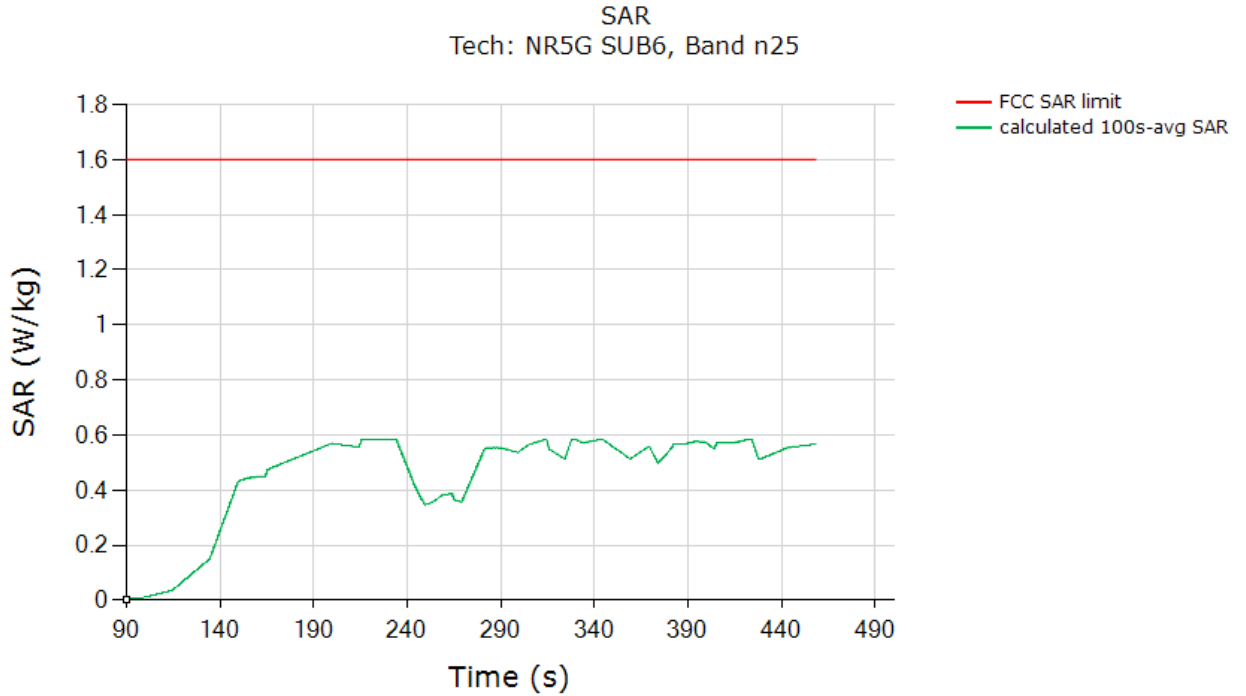

	(W/kg)
FCC 1gSAR limit	1.6
Max 100s-time averaged 1gSAR (green curve)	0.585
Validated: Max time averaged SAR (green curve) is within 1 dB device uncertainty of measured SAR at P_{limit} (last column in Table 8-2).	

FCC ID: A3LSMS711U	PART 2 RF EXPOSURE EVALUATION REPORT	Approved by: Technical Manager
Document S/N: 1M2304260060-25.A3L	DUT Type: Portable Handset	Page 53 of 90

9.2 Call Drop Test Case

This test was measured LTE Band 7, Antenna F, DSI = 1, and with callbox requesting maximum power. The call drop was manually performed when the DUT is transmitting at $P_{reserve}$ level as shown in the plot below. The measurement setup is shown in Figure 6-1. The detailed test procedure is described in Section 4.3.2.

Call drop test result:

Time-averaged conducted Tx power is converted/calculated into time-averaged 1gSAR using Equation (1a) and plotted below to demonstrate that the time-averaged 1gSAR versus time does not exceed the FCC limit of 1.6 W/kg for 1gSAR:

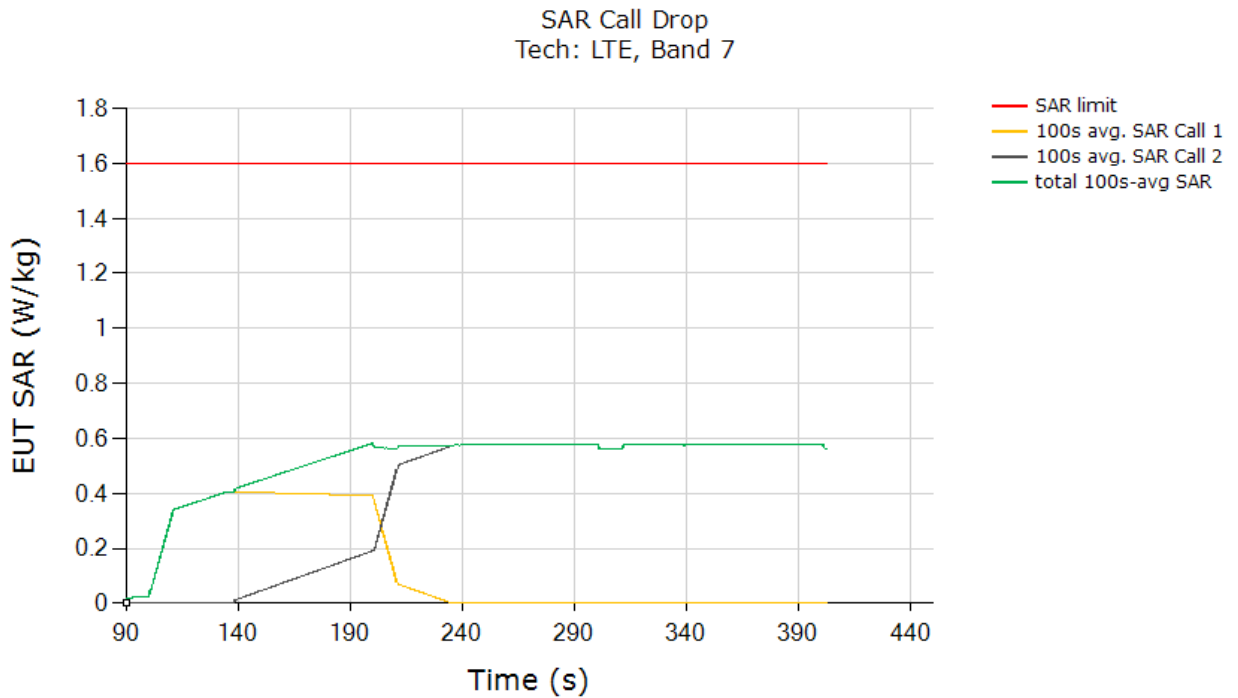

	(W/kg)
FCC 1gSAR limit	1.6
Max 100s-time averaged 1gSAR (green curve)	0.582
Validated	

The test result validated the continuity of power limiting in call change scenario.

FCC ID: A3LSMS711U	PART 2 RF EXPOSURE EVALUATION REPORT	Approved by: Technical Manager
Document S/N: 1M2304260060-25.A3L	DUT Type: Portable Handset	Page 54 of 90

9.3 Change in Technology/Band Test Case

This test was conducted with callbox requesting maximum power, and with a technology switch from LTE Band 66, Antenna A, DSI = 2 to WCDMA Band 2, Antenna A, DSI = 2. Following procedure detailed in Section 4.3.3, and using the measurement setup shown in Figure 6-1, the technology/band switch was performed when the DUT is transmitting at $P_{reserve}$ level as shown in the plot below.

Test result for change in technology/band:

Time-averaged conducted Tx power measurement results were converted into time-averaged normalized SAR values using Equation (6a), (6b) and (6c), and plotted below to demonstrate that the time-averaged normalized SAR versus time does not exceed the normalized FCC limit of 1.0:

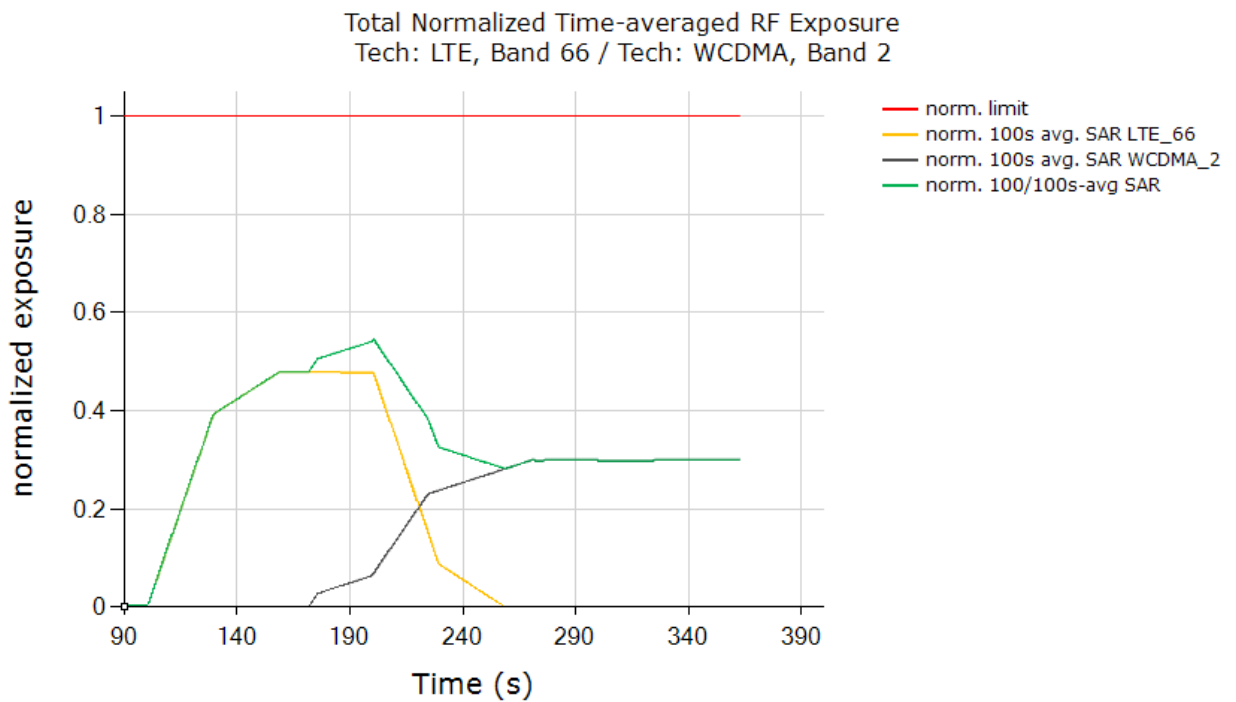

	(W/kg)
FCC normalized SAR limit	1.0
Max 100s-time averaged normalized SAR (green curve)	0.546
Validated	

The test result validated the continuity of power limiting in technology/band switch scenario.

FCC ID: A3LSMS711U	PART 2 RF EXPOSURE EVALUATION REPORT	Approved by: Technical Manager
Document S/N: 1M2304260060-25.A3L	DUT Type: Portable Handset	Page 55 of 90

9.4 Change in Antenna

This test was conducted with callbox requesting maximum power, and with an antenna switch from LTE Band 7, Antenna B, DSI = 2 to LTE Band 30, Antenna A, DSI = 2. Following procedure detailed in Section 4.3.4, and using the measurement setup shown in Figure 6-1, the antenna switch was performed when the DUT is transmitting at $P_{reserve}$ level as shown in the plot below.

Test result for change in technology/band:

Time-averaged conducted Tx power measurement results were converted into time-averaged normalized SAR values using Equation (6a), (6b) and (6c), and plotted below to demonstrate that the time-averaged normalized SAR versus time does not exceed the normalized FCC limit of 1.0:

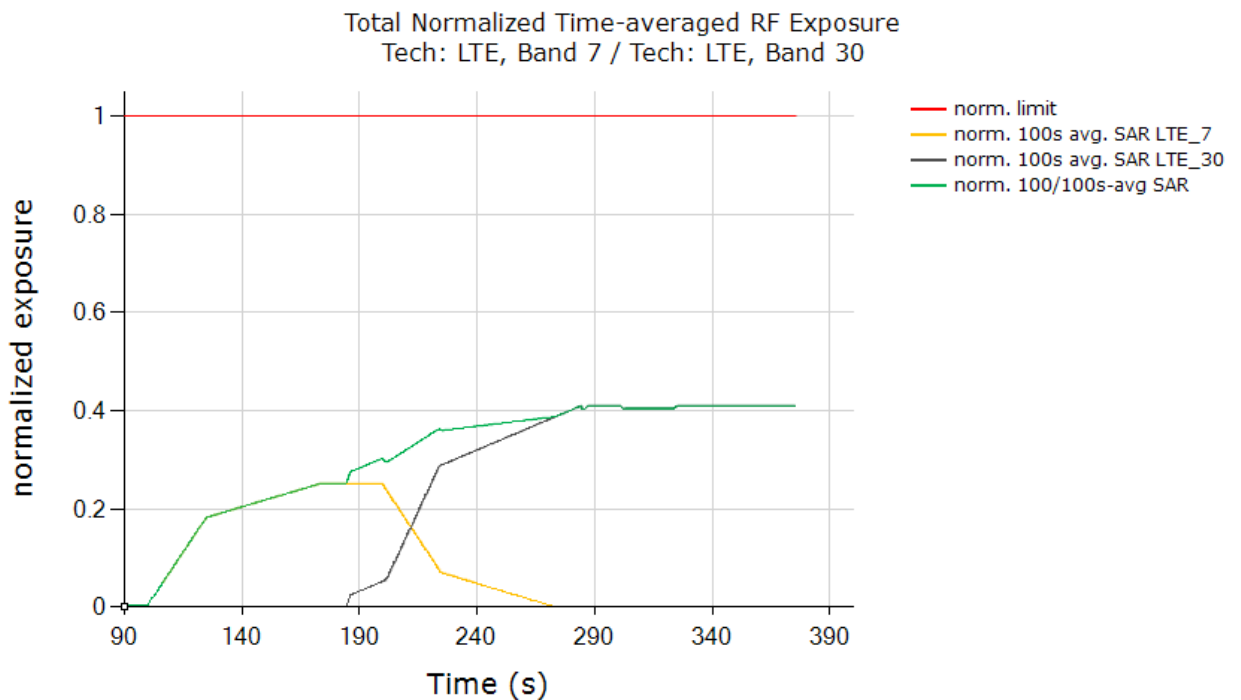

	(W/kg)
FCC normalized SAR limit	1.0
Max 100s-time averaged normalized SAR (green curve)	0.410
Validated	

The test result validated the continuity of power limiting in antenna switch scenario

FCC ID: A3LSMS711U	PART 2 RF EXPOSURE EVALUATION REPORT	Approved by: Technical Manager
Document S/N: 1M2304260060-25.A3L	DUT Type: Portable Handset	Page 56 of 90

9.5 Change in Time window

This test was conducted with callbox requesting maximum power, and with time-window between LTE Band 66, Antenna F, DSI = 2 (100s window) and LTE Band 48, Antenna F, DSI = 2 (60s window). Following procedure detailed in Section 4.3.6, and using the measurement setup shown in Figure 6-1(a), the time-window switch via tech/band/antenna switch was performed when the EUT is transmitting at $P_{reserve}$ level.

9.5.1 Test case 1: transition from LTE Band 66 to LTE Band 48 (i.e., 100s to 60s), then back to LTE Band 66

Test result for change in time-window (from 100s to 60s to 100s):

All the conducted Tx power measurement results were converted into time-averaged normalized SAR values using Equation (7a), (7b) and (7c), and plotted below to demonstrate that the time-averaged normalized SAR versus time does not exceed the FCC limit of 1 unit. Equation (7a) is used to convert the Tx power of device to obtain 100s-averaged normalized SAR in LTE Band 66 as shown in black curve. Similarly, equation (7b) is used to obtain 60s-averaged normalized SAR in LTE Band 48 as shown in orange curve. Equation (7c) is used to obtain total time-averaged normalized SAR as shown in green curve (i.e., sum of black and orange curves).

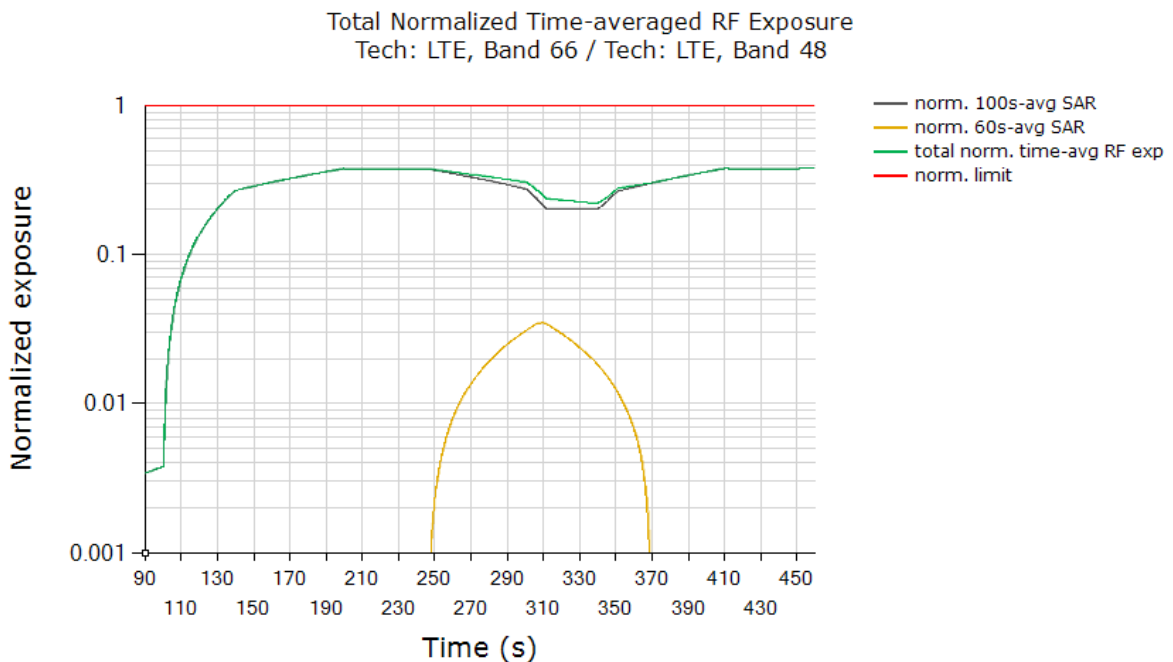

	(W/kg)
FCC normalized total exposure limit	1.0
Max time averaged normalized SAR (green curve)	0.379
Validated	

FCC ID: A3LSMS711U	PART 2 RF EXPOSURE EVALUATION REPORT	Approved by: Technical Manager
Document S/N: 1M2304260060-25.A3L	DUT Type: Portable Handset	Page 57 of 90

Plot Notes: Maximum power is requested by callbox for the entire duration of the test, with tech/band switches from 100s-to-60s window at ~245s time stamp, and from 60s-to-100s window at ~310s time stamp. Smart Transmit controls the Tx power during these time-window switches to ensure total time-averaged RF exposure, i.e., sum of black and orange curves given by equation (7c), is always compliant. In time-window switch test, at all times the total time-averaged normalized RF exposure (green curve) should not exceed normalized $SAR_design_target + 1dB$ device uncertainty. In this test, with a maximum normalized SAR of 0.379 being $\leq 0.79 (= 1.0/1.6 + 1dB$ device uncertainty), the above test result validated the continuity of power limiting in time-window switch scenario.

9.5.2 Test case 2: transition from LTE Band 48 to LTE Band 66 (i.e., 60s to 100s), then back to LTE Band 48

Test result for change in time-window (from 60s to 100s to 60s):

All the conducted Tx power measurement results were converted into time-averaged normalized SAR values using Equation (7a), (7b) and (7c), and plotted below to demonstrate that the time-averaged normalized SAR versus time does not exceed the FCC limit of 1 unit. Equation (7a) is used to convert the Tx power of device to obtain 60s-averaged normalized SAR in LTE Band 48 as shown in black curve. Similarly, equation (7b) is used to obtain 100s-averaged normalized SAR in LTE Band 66 as shown in orange curve. Equation (7c) is used to obtain total time-averaged normalized SAR as shown in green curve (i.e., sum of black and orange curves).

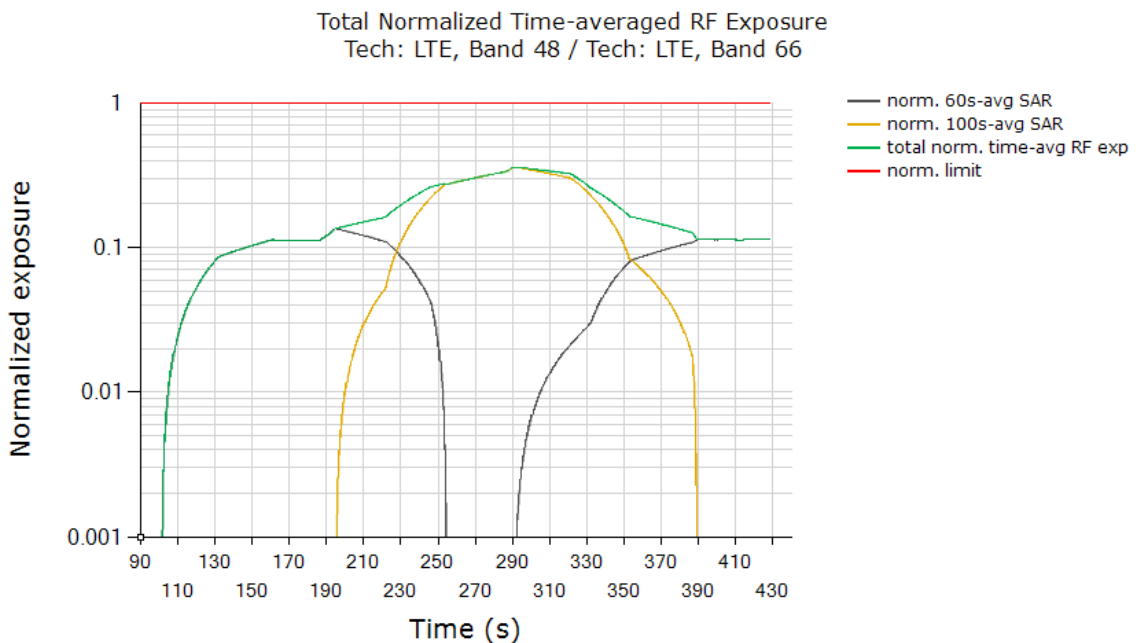

	(W/kg)
FCC normalized total exposure limit	1.0
Max time averaged normalized SAR (green curve)	0.356
Validated	

FCC ID: A3LSMS711U	PART 2 RF EXPOSURE EVALUATION REPORT	Approved by: Technical Manager
Document S/N: 1M2304260060-25.A3L	DUT Type: Portable Handset	Page 58 of 90

Plot Notes: Maximum power is requested by callbox for the entire duration of the test, with tech/band switches from 60s-to-100s window at ~190s time stamp, and from 100s-to-60s window at ~290s time stamp. Smart Transmit controls the Tx power during these time-window switches to ensure total time-averaged RF exposure, i.e., sum of black and orange curves given by equation (7c), is always compliant. In time-window switch test, at all times the total time-averaged normalized RF exposure (green curve) should not exceed normalized $SAR_{design_target} + 1dB$ device uncertainty. In this test, with a maximum normalized SAR of 0.356 being ≤ 0.79 ($= 1.0/1.6 + 1dB$ device uncertainty), the above test result validated the continuity of power limiting in time-window switch scenario.

9.6 DSI Switch Test Case

This test was conducted with callbox requesting maximum power, and with DSI switch from LTE Band 48 DSI = 2 (Hotspot) to DSI = 1 (Head). Following procedure detailed in Section 4.3.5 using the measurement setup shown in Figure 6-1, the DSI switch was performed when the DUT is transmitting at $P_{reserve}$ level as shown in the plot below.

Test result for change in DSI:

All the time-averaged conducted Tx power measurement results were converted into time-averaged normalized SAR values using Equation (6a), (6b) and (6c), and plotted below to demonstrate that the time-averaged normalized SAR versus time does not exceed the FCC limit of 1 unit.

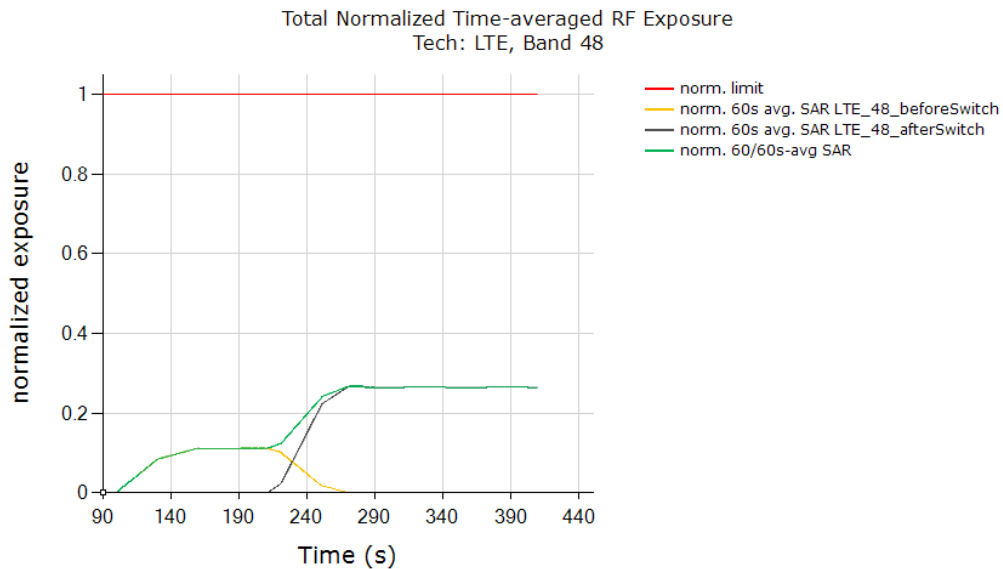

	(W/kg)
FCC normalized total exposure limit	1.0
Max 60s-time averaged normalized SAR (green curve)	0.268
Validated	

The test result validated the continuity of power limiting in DSI switch scenario.

FCC ID: A3LSMS711U	PART 2 RF EXPOSURE EVALUATION REPORT	Approved by: Technical Manager
Document S/N: 1M2304260060-25.A3L	DUT Type: Portable Handset	Page 59 of 90

9.7 Switch in SAR exposure test results

This test was conducted with callbox requesting maximum power, and with the EUT in LTE Band 5 + Sub6 NR Band n66 call. Following procedure detailed in Section 4.3.7 and Appendix F.2, and using the measurement setup shown in Figure 6-1(c) since LTE and Sub6 NR are on the same antenna port, the SAR exposure switch measurement is performed with the EUT in various SAR exposure scenarios, i.e., in SAR_{sub6NR} only scenario (t = 0s ~ 120s), SAR_{sub6NR} + SAR_{LTE} scenario (t = 120s ~ 240s) and SAR_{LTE} only scenario (t > 240s).

Plot Notes: All the conducted Tx power measurement results were converted into time-averaged normalized SAR values using Equation (7a), (7b) and (7c), and plotted below to demonstrate that the time-averaged normalized SAR versus time does not exceed the FCC limit of 1 unit. Equation (7a) is used to convert the LTE Tx power of device to obtain 100s-averaged normalized SAR in LTE Band 5 as shown in black curve. Similarly, equation (7b) is used to obtain 100s-averaged normalized SAR in Sub6 NR n66 as shown in orange curve. Equation (7c) is used to obtain total time-averaged normalized SAR as shown in green curve (i.e., sum of black and orange curves).

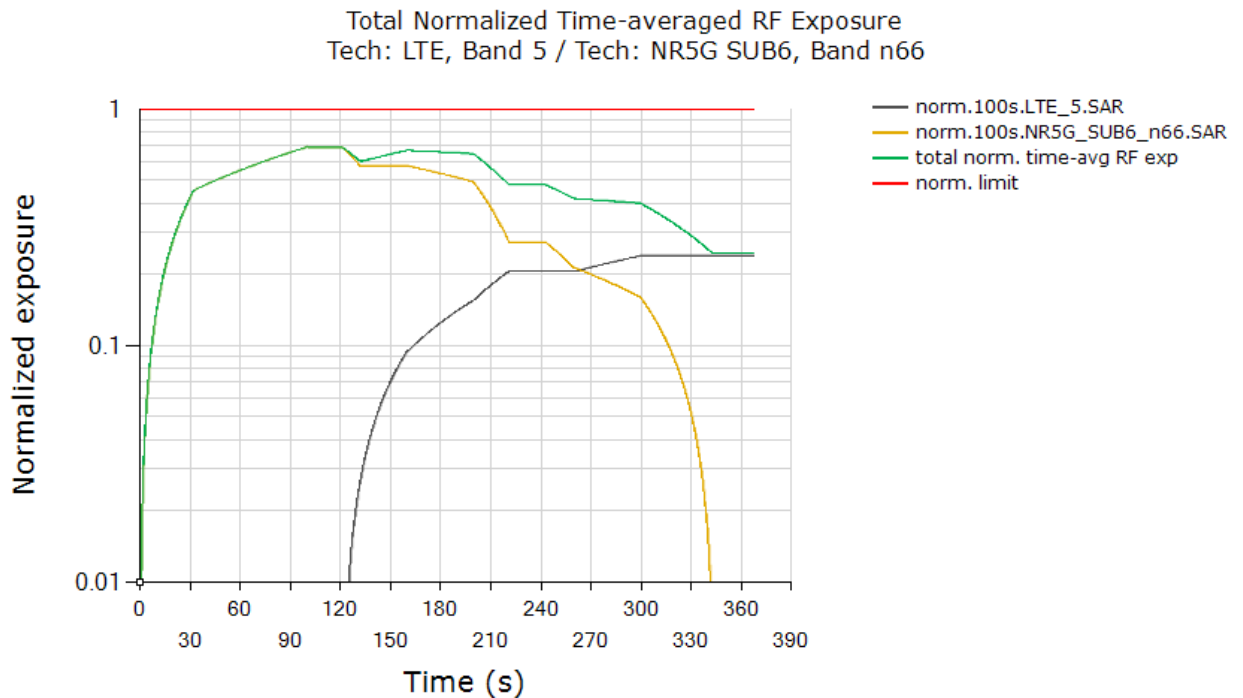

	(W/kg)
FCC normalized total exposure limit	1.0
Max time averaged normalized SAR (green curve)	0.693
Validated	

Plot Notes: Device starts predominantly in Sub6 NR SAR exposure scenario between 0s and 120s, and in LTE SAR + Sub6 NR SAR exposure scenario between 120s and 240s, and in predominantly in LTE SAR exposure scenario after t=240s. Here, Smart Transmit allocates a maximum of 100% of exposure margin

FCC ID: A3LSMS711U	PART 2 RF EXPOSURE EVALUATION REPORT	Approved by: Technical Manager
Document S/N: 1M2304260060-25.A3L	DUT Type: Portable Handset	Page 60 of 90

(based on 3dB reserve margin setting) for Sub6 NR. This corresponds to a normalized 1gSAR exposure value = $100\% * 1.120\text{W/kg measured SAR at Sub6 NR } P_{limit} / 1.6\text{W/kg limit} = 0.700 \pm 1\text{dB device related uncertainty}$ (see orange curve between 120s). For predominantly LTE SAR exposure scenario, maximum normalized 1gSAR exposure should correspond to 100% exposure margin = $0.541\text{ W/kg measured SAR at LTE } P_{limit} / 1.6\text{W/kg limit} = 0.338 \pm 1\text{dB device related uncertainty}$ (see black curve after $t = 240\text{s}$). Additionally, in SAR exposure switch test, at all times the total time-averaged normalized RF exposure (green curve) should not exceed normalized $SAR_{design_target} + 1\text{dB device uncertainty}$. In this test, with a maximum normalized SAR of 0.693 being $\leq 0.79 (= 1.0/1.6 + 1\text{dB device uncertainty})$, the above test result validated the continuity of power limiting in SAR exposure switch scenario.

FCC ID: A3LSMS711U	PART 2 RF EXPOSURE EVALUATION REPORT	Approved by: Technical Manager
Document S/N: 1M2304260060-25.A3L	DUT Type: Portable Handset	Page 61 of 90

10 SYSTEM VERIFICATION (FREQ < 6 GHZ)

10.1 Tissue Verification

**Table 10-1
Measured Tissue Properties**

Calibrated for Tests Performed on:	Tissue Type	Tissue Temp During Calibration (°C)	Measured Frequency (MHz)	Measured Conductivity, σ (S/m)	Measured Dielectric Constant, ϵ	TARGET Conductivity, σ (S/m)	TARGET Dielectric Constant, ϵ	% dev σ	% dev ϵ
7/20/2023	1750 Head	22.5	1710	1.322	40.196	1.348	40.142	-1.93%	0.13%
			1720	1.327	40.176	1.354	40.126	-1.99%	0.12%
			1745	1.341	40.115	1.368	40.087	-1.97%	0.07%
			1750	1.345	40.104	1.371	40.079	-1.90%	0.06%
			1770	1.358	40.076	1.383	40.047	-1.81%	0.07%
			1790	1.370	40.065	1.394	40.016	-1.72%	0.12%
7/20/2023	1900 Head	22.5	1850	1.400	39.983	1.400	40.000	0.00%	-0.04%
			1860	1.406	39.963	1.400	40.000	0.43%	-0.09%
			1880	1.421	39.933	1.400	40.000	1.50%	-0.17%
			1900	1.435	39.921	1.400	40.000	2.50%	-0.20%
			1905	1.439	39.920	1.400	40.000	2.79%	-0.20%
			1910	1.442	39.918	1.400	40.000	3.00%	-0.21%
7/28/2023	1900 Head	20.9	1850	1.400	39.023	1.400	40.000	0.00%	-2.44%
			1860	1.406	39.008	1.400	40.000	0.43%	-2.48%
			1880	1.419	38.976	1.400	40.000	1.36%	-2.56%
			1900	1.432	38.950	1.400	40.000	2.29%	-2.62%
			1905	1.435	38.943	1.400	40.000	2.50%	-2.64%
			1910	1.438	38.937	1.400	40.000	2.71%	-2.66%
7/28/2023	2600 Head	20.9	2500	1.861	38.035	1.855	39.136	0.32%	-2.81%
			2510	1.869	38.018	1.866	39.123	0.16%	-2.82%
			2535	1.889	37.969	1.893	39.092	-0.21%	-2.87%
			2550	1.901	37.937	1.909	39.073	-0.42%	-2.91%
			2560	1.910	37.916	1.920	39.060	-0.52%	-2.93%
			2600	1.942	37.857	1.964	39.009	-1.12%	-2.95%
			2650	1.981	37.748	2.018	38.945	-1.83%	-3.07%
			2680	2.007	37.699	2.051	38.907	-2.15%	-3.10%
			2700	2.022	37.686	2.073	38.882	-2.46%	-3.08%

The above measured tissue parameters were used in the DASY software. The DASY software was used to perform interpolation to determine the dielectric parameters at the SAR test device frequencies (per KDB Publication 865664 D01v01r04 and IEEE 1528-2013 6.6.1.2). The tissue parameters listed in the SAR test plots may slightly differ from the table above due to significant digit rounding in the software.

FCC ID: A3LSMS711U	PART 2 RF EXPOSURE EVALUATION REPORT	Approved by: Technical Manager
Document S/N: 1M2304260060-25.A3L	DUT Type: Portable Handset	Page 62 of 90

10.2 Test System Verification

Prior to SAR assessment, the system is verified to $\pm 10\%$ of the SAR measurement on the reference dipole at the time of calibration by the calibration facility. Full system validation status and result summary can be found in Appendix C.

**Table 10-2
System Verification Results – 1g**

System Verification TARGET & MEASURED													
SAR System #	Tissue Frequency (MHz)	Tissue Type	Date	Amb. Temp (°C)	Liquid Temp (°C)	Input Power (W)	Source SN	Probe SN	DAE	Measured SAR _{1g} (W/kg)	1 W Target SAR _{1g} (W/kg)	1 W Normalized SAR _{1g} (W/kg)	Deviation _{1g} (%)
M	1750	HEAD	7/20/2023	22.5	22.5	0.1	1150	7670	1681	3.54	36.9	35.4	-4.07%
M	1900	HEAD	7/20/2023	22.5	22.5	0.1	5d149	7670	1681	4.24	40.5	42.4	4.69%
M	1900	HEAD	7/28/2023	21.4	20.9	0.1	5d149	7670	1681	4.19	40.5	41.9	3.46%
M	2600	HEAD	7/28/2023	21.4	20.9	0.1	1071	7670	1681	5.81	56.5	58.1	2.83%

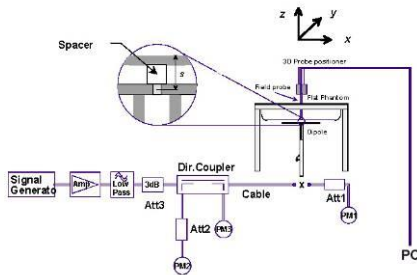

**Figure 10-1
System Verification Setup Diagram**



**Figure 10-2
System Verification Setup Photo**

FCC ID: A3LSMS711U	PART 2 RF EXPOSURE EVALUATION REPORT	Approved by: Technical Manager
Document S/N: 1M2304260060-25.A3L	DUT Type: Portable Handset	Page 63 of 90

11 SAR TEST RESULTS (FREQ < 6 GHZ)

11.1 Time-varying Tx Power Case

Following Section 4.4 procedure, time-averaged SAR measurements are conducted using a SAR probe at peak location of area scan over 500 seconds. cDASY6 system verification for SAR measurement is provided in Section 10, and the associated SPEAG certificates are attached in Appendix G.

SAR probe integration times depend on the communication signal being tested as defined in the probe calibration parameters.

Since the sampling rate used by cDASY6 for pointSAR measurements is not in user control, the number of points in 100s interval is determined from the scan duration setting in cDASY6 time-average pointSAR measurement by (100s cDASY6_scan_duration * total number of pointSAR values recorded). Running average is performed over these number of points in excel spreadsheet to obtain 100s averaged point SAR.

Following Section 4.4, for each of selected technology/band (listed in Table 8-2):

8. With *Reserve_power_margin* set to 0 dB, area scan is performed at P_{limit} , and time-averaged pointSAR measurements are conducted to determine the pointSAR at P_{limit} at peak location, denoted as $pointSAR_{P_{limit}}$.
9. With *Reserve_power_margin* set to actual (intended) value, two more time-averaged pointSAR measurements are performed at the same peak location for test sequences 1 and 2.

To demonstrate compliance, all the pointSAR measurement results were converted into 1gSAR or 10gSAR values by using Equation (3a), rewritten below:

$$1g_or_10gSAR(t) = \frac{pointSAR(t)}{pointSAR_{P_{limit}}} * 1g_or_10gSAR_{P_{limit}} \quad (3a)$$

where, $pointSAR(t)$, $pointSAR_{P_{limit}}$, and $1g_or_10gSAR_{P_{limit}}$ correspond to the measured instantaneous point SAR, measured point SAR at P_{limit} from above step 1 and 2, and measured 1gSAR or 10gSAR values at P_{limit} obtained from Part 1 report and listed in Table 8-2 of this report.

FCC ID: A3LSMS711U	PART 2 RF EXPOSURE EVALUATION REPORT	Approved by: Technical Manager
Document S/N: 1M2304260060-25.A3L	DUT Type: Portable Handset	Page 64 of 90

11.1.1 GSM/GPRS/EDGE 1900

SAR test results for test sequence 1:

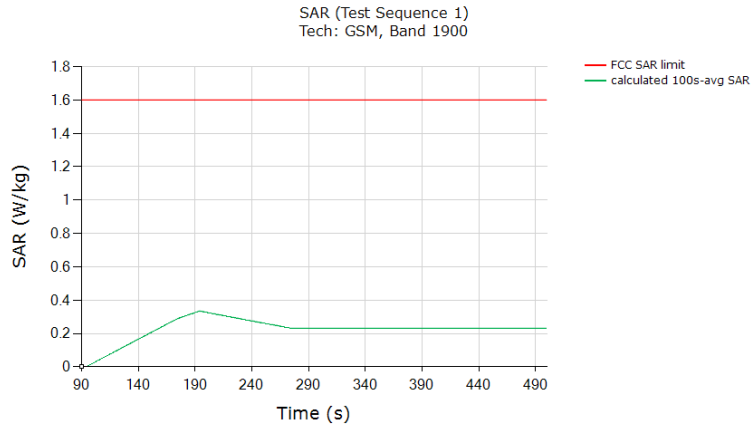

	(W/kg)
FCC 1gSAR limit	1.6
Max 100s-time averaged point 1gSAR (green curve)	0.333
Validated: Max time averaged SAR (green curve) is within 1 dB device uncertainty of measured SAR at P_{limit} (last column in Table 8-2).	

SAR test results for test sequence 2:

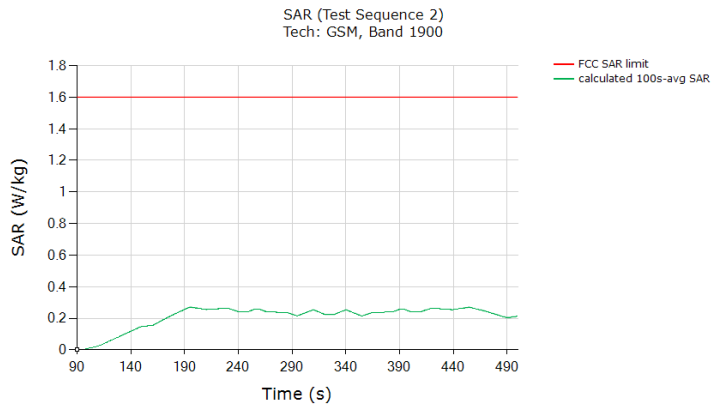

	(W/kg)
FCC 1gSAR limit	1.6
Max 100s-time averaged point 1gSAR (green curve)	0.270
Validated: Max time averaged SAR (green curve) is within 1 dB device uncertainty of measured SAR at P_{limit} (last column in Table 8-2).	

FCC ID: A3LSMS711U	PART 2 RF EXPOSURE EVALUATION REPORT	Approved by: Technical Manager
Document S/N: 1M2304260060-25.A3L	DUT Type: Portable Handset	Page 65 of 90

11.1.2 WCDMA Band 4

SAR test results for test sequence 1:

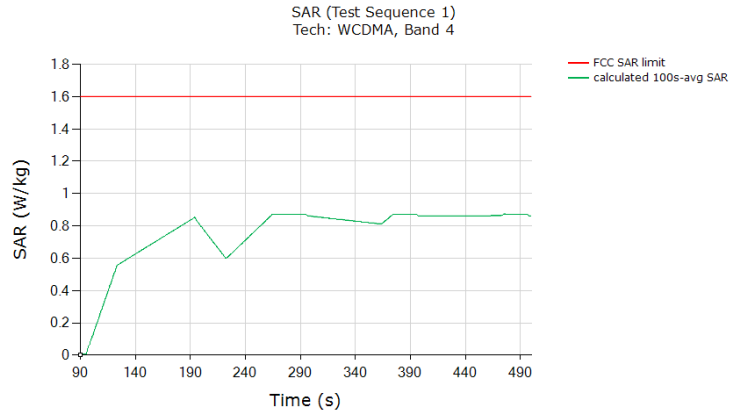

	(W/kg)
FCC 1gSAR limit	1.6
Max 100s-time averaged point 1gSAR (green curve)	0.872
Validated: Max time averaged SAR (green curve) is within 1 dB device uncertainty of measured SAR at P_{limit} (last column in Table 8-2).	

SAR test results for test sequence 2:

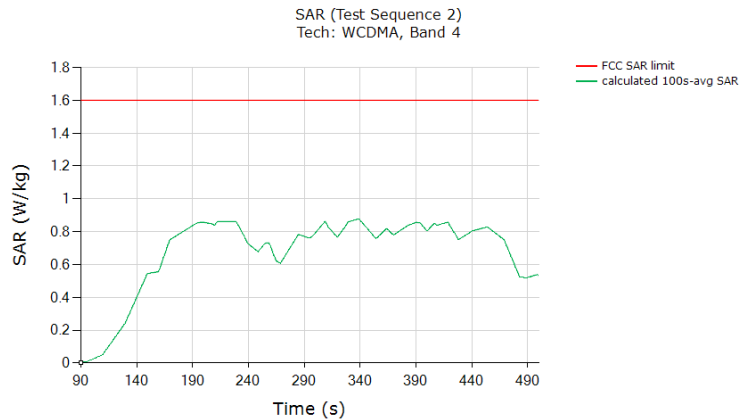

	(W/kg)
FCC 1gSAR limit	1.6
Max 100s-time averaged point 1gSAR (green curve)	0.876
Validated: Max time averaged SAR (green curve) is within 1 dB device uncertainty of measured SAR at P_{limit} (last column in Table 8-2).	

FCC ID: A3LSMS711U	PART 2 RF EXPOSURE EVALUATION REPORT	Approved by: Technical Manager
Document S/N: 1M2304260060-25.A3L	DUT Type: Portable Handset	Page 66 of 90

11.1.3 WCDMA Band 2

SAR test results for test sequence 1:

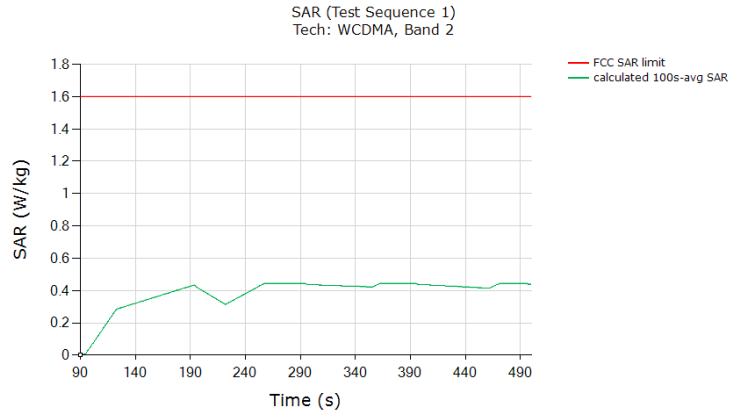

	(W/kg)
FCC 1gSAR limit	1.6
Max 100s-time averaged point 1gSAR (green curve)	0.452
Validated: Max time averaged SAR (green curve) is within 1 dB device uncertainty of measured SAR at P_{limit} (last column in Table 8-2).	

SAR test results for test sequence 2:

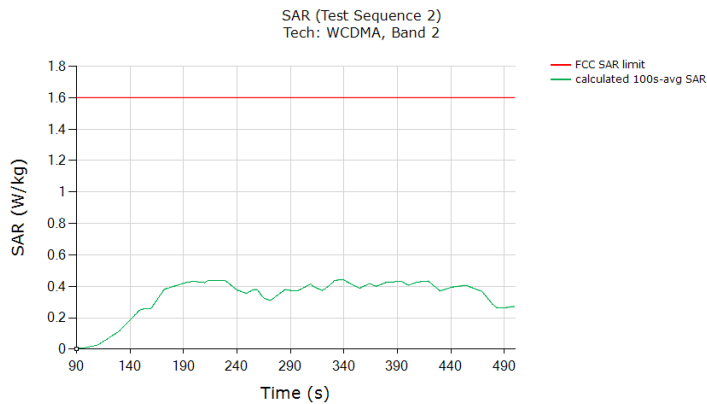

	(W/kg)
FCC 1gSAR limit	1.6
Max 100s-time averaged point 1gSAR (green curve)	0.442
Validated: Max time averaged SAR (green curve) is within 1 dB device uncertainty of measured SAR at P_{limit} (last column in Table 8-2).	

FCC ID: A3LSMS711U	PART 2 RF EXPOSURE EVALUATION REPORT	Approved by: Technical Manager
Document S/N: 1M2304260060-25.A3L		DUT Type: Portable Handset
		Page 67 of 90

11.1.4 LTE Band 66

SAR test results for test sequence 1:

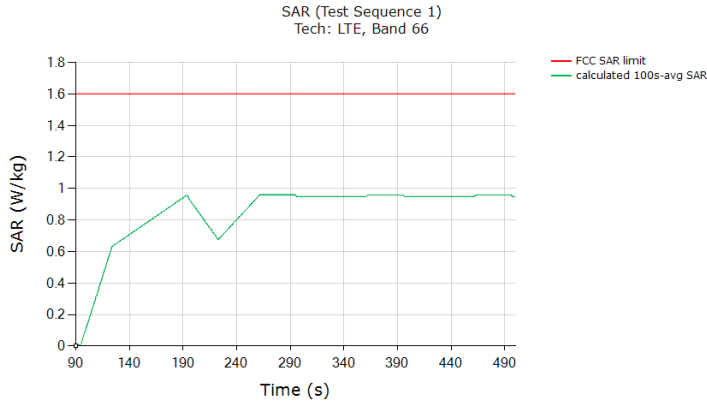

	(W/kg)
FCC 1gSAR limit	1.6
Max 100s-time averaged point 1gSAR (green curve)	0.960
Validated: Max time averaged SAR (green curve) is within 1 dB device uncertainty of measured SAR at P_{limit} (last column in Table 8-2).	

SAR test results for test sequence 2:

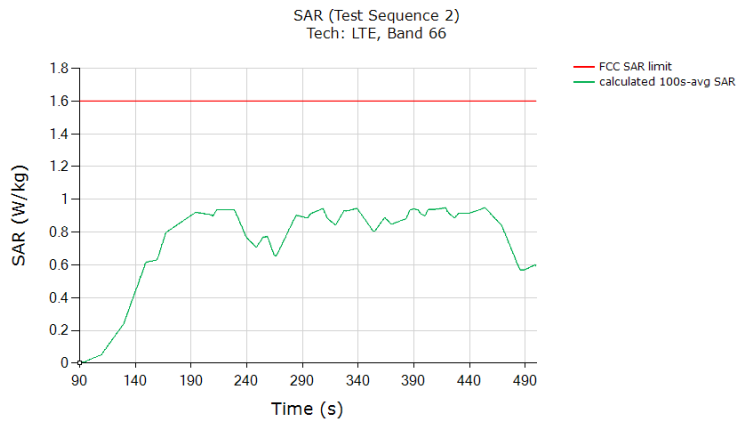

	(W/kg)
FCC 1gSAR limit	1.6
Max 100s-time averaged point 1gSAR (green curve)	0.947
Validated: Max time averaged SAR (green curve) is within 1 dB device uncertainty of measured SAR at P_{limit} (last column in Table 8-2).	

FCC ID: A3LSMS711U	PART 2 RF EXPOSURE EVALUATION REPORT	Approved by: Technical Manager
Document S/N: 1M2304260060-25.A3L	DUT Type: Portable Handset	Page 68 of 90

11.1.5 LTE Band 7

SAR test results for test sequence 1:

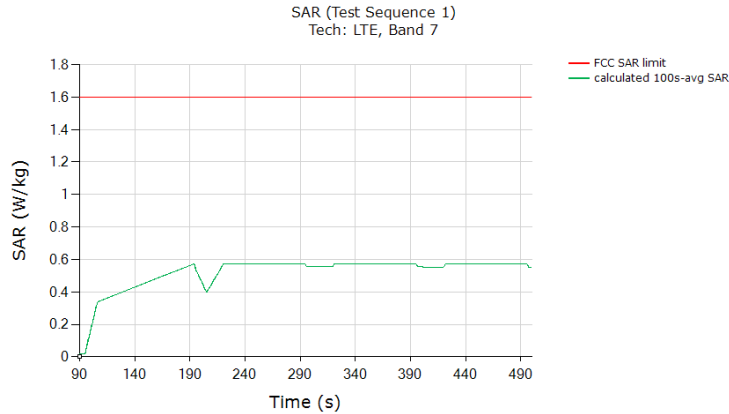

	(W/kg)
FCC 1gSAR limit	1.6
Max 100s-time averaged point 1gSAR (green curve)	0.572
Validated: Max time averaged SAR (green curve) is within 1 dB device uncertainty of measured SAR at P_{limit} (last column in Table 8-2).	

SAR test results for test sequence 2:

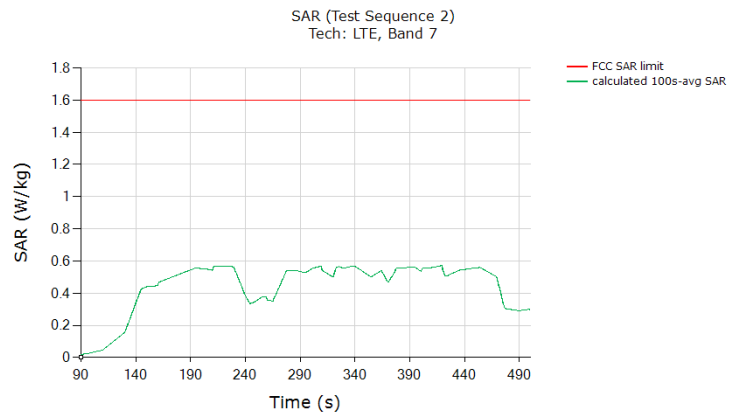

	(W/kg)
FCC 1gSAR limit	1.6
Max 100s-time averaged point 1gSAR (green curve)	0.571
Validated: Max time averaged SAR (green curve) is within 1 dB device uncertainty of measured SAR at P_{limit} (last column in Table 8-2).	

FCC ID: A3LSMS711U	PART 2 RF EXPOSURE EVALUATION REPORT	Approved by: Technical Manager
Document S/N: 1M2304260060-25.A3L	DUT Type: Portable Handset	Page 69 of 90

11.1.6 NR n66 SA

SAR test results for test sequence 1:

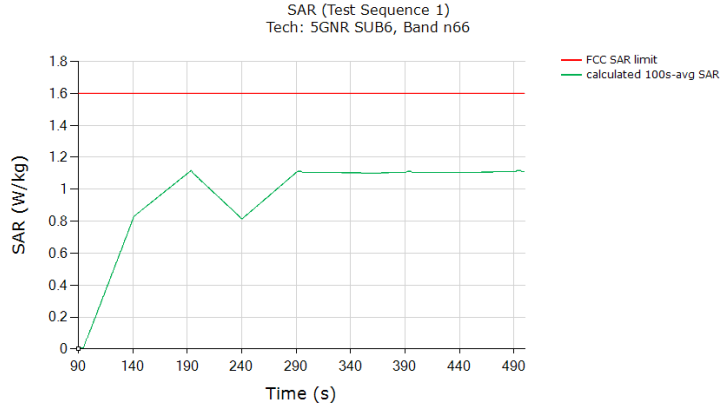

	(W/kg)
FCC 1gSAR limit	1.6
Max 100s-time averaged point 1gSAR (green curve)	1.119
Validated: Max time averaged SAR (green curve) is within 1 dB device uncertainty of measured SAR at P_{limit} (last column in Table 8-2).	

SAR test results for test sequence 2:

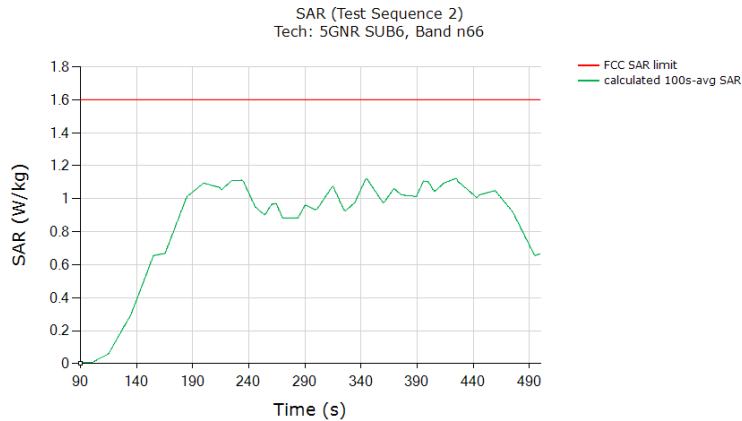

	(W/kg)
FCC 1gSAR limit	1.6
Max 100s-time averaged point 1gSAR (green curve)	1.123
Validated: Max time averaged SAR (green curve) is within 1 dB device uncertainty of measured SAR at P_{limit} (last column in Table 8-2).	

FCC ID: A3LSMS711U	PART 2 RF EXPOSURE EVALUATION REPORT	Approved by: Technical Manager
Document S/N: 1M2304260060-25.A3L		Page 70 of 90

11.1.7 NR n25 SA

SAR test results for test sequence 1:

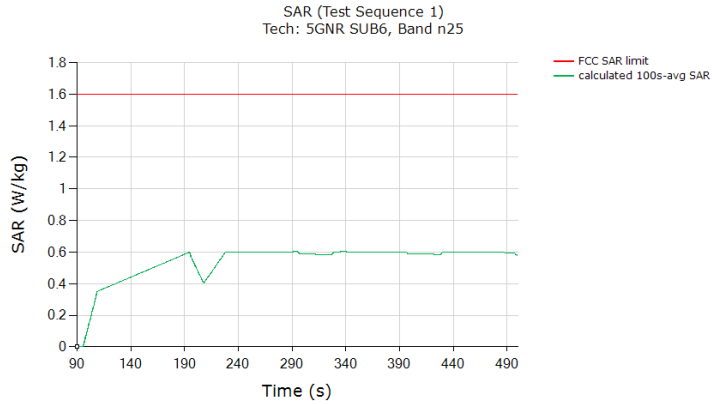

	(W/kg)
FCC 1gSAR limit	1.6
Max 100s-time averaged point 1gSAR (green curve)	0.602
Validated: Max time averaged SAR (green curve) is within 1 dB device uncertainty of measured SAR at P_{limit} (last column in Table 8-2).	

SAR test results for test sequence 2:

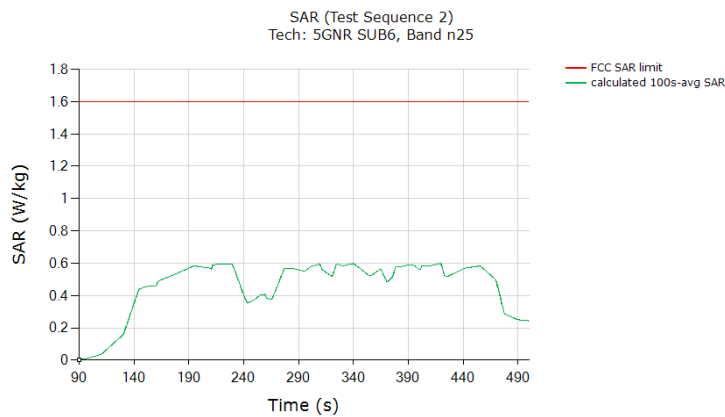

	(W/kg)
FCC 1gSAR limit	1.6
Max 100s-time averaged point 1gSAR (green curve)	0.598
Validated: Max time averaged SAR (green curve) is within 1 dB device uncertainty of measured SAR at P_{limit} (last column in Table 8-2).	

FCC ID: A3LSMS711U	PART 2 RF EXPOSURE EVALUATION REPORT	Approved by: Technical Manager
Document S/N: 1M2304260060-25.A3L	DUT Type: Portable Handset	Page 71 of 90

12 TEST CONFIGURATIONS (FREQ > 6 GHZ)

12.1 LTE + su6NR and LTE + mmW NR transmission

Based on the selection criteria described in Section 5.2, the selections for LTE and mmW NR validation test are listed in Table 12-1. The radio configurations used in this test are listed in Table 12-2.

Table 12-1
Selections for LTE + mmW NR validation measurements

Transmission Scenario	Test	Technology and Band	mmWave Beam
Time-varying Tx power test	1. Cond. & Rad. Power meas. 2. PD meas.	LTE Band 2 and n261	Beam ID 19
		LTE Band 2 and n260	Beam ID 14
Switch in SAR vs. PD	1. Cond. & Rad. Power meas.	LTE Band 2 and n261	Beam ID 19
		LTE Band 2 and n260	Beam ID 14
Beam switch test	1. Cond. & Rad. Power meas.	LTE Band 2 and n261	Beam ID 19 to Beam ID 2
		LTE Band 2 and n260	Beam ID 14 to Beam ID 0

Table 12-2
Test configuration for LTE + su6NR and LTE + mmW NR validation

Tech	Band	Antenna	DSI	Channel	Freq (MHz)	RB/RB Offset/Bandwidth (MHz)	Mode	UL Duty Cycle
LTE	2	A	2	18900	1880	1/0/20 MHz BW	QPSK	100%
mmW NR	n261	M	-	2077915	27924.96	20/22/100 MHz BW	DFT-s-OFDM, QPSK	75.6%*
	n260	M	-	2254165	38499.96	20/22/100 MHz BW	DFT-s-OFDM, QPSK	75.6%*

12.2 mmW NR and sub6 NR radiated power test results

To demonstrate the compliance, the conducted Tx power of LTE Band 2 in DSI =2, is converted to 1gSAR exposure by applying the corresponding worst-case 1g SAR value at P_{limit} as reported in Part 1 report and listed in Table 8-2 of this report.

Similarly, following Step 4 in Section 5.3.1, radiated Tx power of mmW Band n261 and n260 for the beams tested is converted by applying the corresponding measured worst-case $4\text{cm}^2\text{PD}$ values, and listed in below Table 12-3. Qualcomm Smart Transmit feature operates based on time-averaged Tx power reported on a per symbol basis, which is independent of modulation, channel and bandwidth (RBs), therefore the worst-case $4\text{cm}^2\text{PD}$ was conducted with the EUT in FTM mode, with CW modulation and 100% duty cycle. cDASY6 system verification for power density measurement is provided in Section 14, and the associated SPEAG certificates are attached in Appendix G.

Both the worst-case 1gSAR and $4\text{cm}^2\text{PD}$ values used in this section are listed in Table 12-3. The measured EIRP at *input.power.limit* for the beams tested in this section are also listed in Table 12-3.

FCC ID: A3LSMS711U	PART 2 RF EXPOSURE EVALUATION REPORT	Approved by: Technical Manager
Document S/N: 1M2304260060-25.A3L	DUT Type: Portable Handset	Page 72 of 90

Table 12-3
Worst-case 1gSAR, 4cm² avg. PD and EIRP measured at *input.power.limit* for the selected configurations

Tech	Band	Antenna	Beam ID	input.power.limit (dBm)	Measured psPD at input.power.limit		Measured EIRP at input.power.limit (dBm)
					4cm ² psPD (W/m ²)	Test Position	
mmW NR	n261	M	19	3.9	5.23	Left Edge	16.83
		M	2	10.6	5.18	Left Edge	10.99
mmW NR	n260	M	14	2.1	2.99	Left Edge	14.43
		M	0	8.4	2.08	Left Edge	9.62

Tech	Band	Antenna	DSI	Measured Plimit (dBm)	Measured 1g SAR at Plimit	
					1g SAR (W/kg)	Test Position
LTE	2	A	2	18.71	0.702	Bottom Edge, 10mm

The 4cm² psPD distributions for the highest PD value per band, as listed in Table 12-3, are plotted below.

FCC ID: A3LSMS711U	PART 2 RF EXPOSURE EVALUATION REPORT	Approved by: Technical Manager
Document S/N: 1M2304260060-25.A3L	DUT Type: Portable Handset	Page 73 of 90

Figure 12-1
4cm² psPD distribution measured at *input.power.limit* of 3.9 dBm on the left edge for n261 beam 19

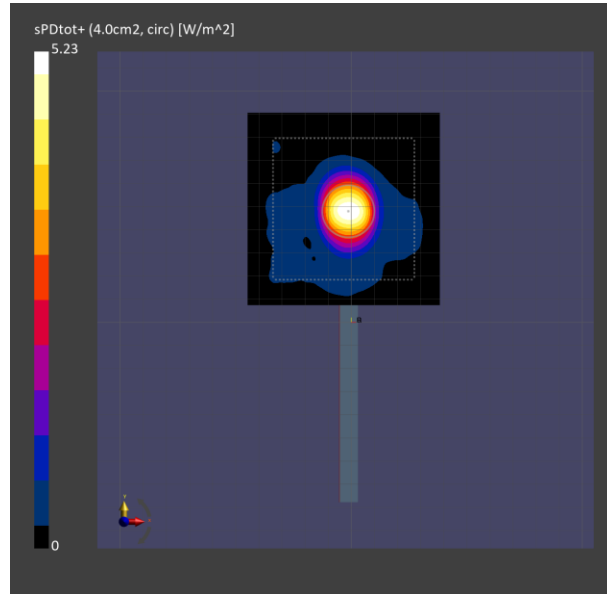
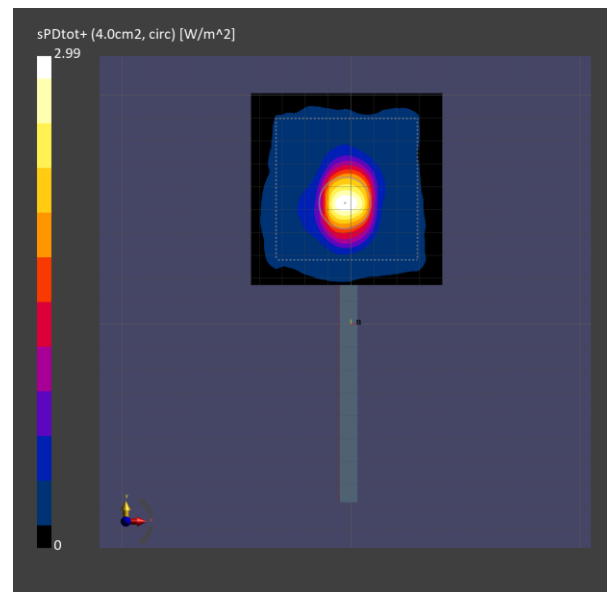

Figure 12-2
4cm² psPD distribution measured at *input.power.limit* of 2.1 dBm on the left edge for n260 beam 14



FCC ID: A3LSMS711U	PART 2 RF EXPOSURE EVALUATION REPORT	Approved by: Technical Manager
Document S/N: 1M2304260060-25.A3L	DUT Type: Portable Handset	Page 74 of 90

13 RADIATED POWER TX CASES (FREQ > 6 GHZ)

13.1 Maximum Tx power test results for n261

This test was measured with LTE Band 2 and mmW Band n261 Beam ID 19, by following the detailed test procedure described in Section 5.3.1.

Time-averaged conducted Tx power for LTE Band 2 and radiated Tx power for mmW NR n261 beam 19 are converted into time-averaged 1gSAR and time-averaged 4cm²PD using Equation (2a) and (2b), which are divided by FCC 1gSAR limit of 1.6 W/kg and 4cm²PD limit of 10 W/m², respectively, to obtain normalized exposures versus time. Below plot shows (a) normalized time-averaged 1gSAR versus time, (b) normalized time-averaged 4cm²-avg.PD versus time, (c) sum of normalized time-averaged 1gSAR and normalized time-averaged 4cm²-avg.PD:

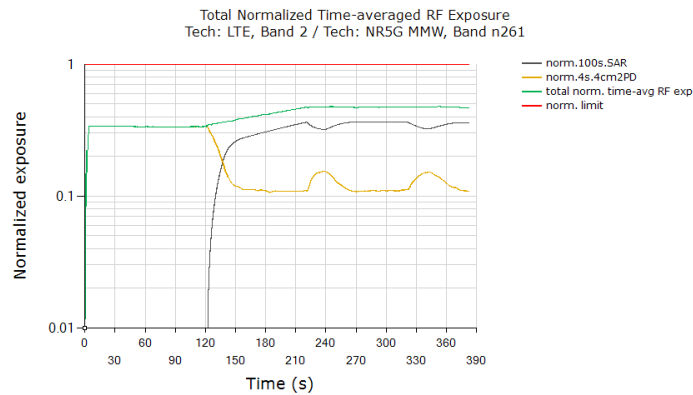

FCC requirement for total RF exposure (normalized)	1.0
Max total normalized time-averaged RF exposure (green curve)	0.479
Validated	

Plot notes: As soon as 5G mmW NR call was established, LTE was placed in all-down bits immediately. Between 0s~120s, mmW exposure is the dominant contributor. Here, Smart Transmit feature allocates a maximum of 1.0 for mmW (based on the 3dB reserve setting in Part 1 report). At ~120s time mark, LTE is set to all-up bits, taking away margin from mmW exposure gradually and towards the end of the test, LTE is the dominant contributor towards RF exposure. Table 13-1 shows the calculations for the normalized 4cm² PD exposure values and the normalized 1g SAR exposure value.

Table 13-1

	Static 4cm ² PD or 1g SAR [W/m ² or W/kg]	Normalized Exposure	Uncertainty [dB]
0s~120s: NR Green/Orange Curve	5.23	52.3%	2.0
After ~120s: LTE Black Curve	0.702	43.9%	1.0

As can be seen, the power limiting enforcement is effective and the total normalized time-averaged RF exposure does not exceed 1.0. Therefore, Qualcomm® Smart Transmit time averaging feature is validated.

FCC ID: A3LSMS711U	PART 2 RF EXPOSURE EVALUATION REPORT	Approved by: Technical Manager
Document S/N: 1M2304260060-25.A3L	DUT Type: Portable Handset	Page 75 of 90

13.2 Maximum Tx power test results for n260

This test was measured with LTE Band 2 and mmW Band n260 Beam ID 14, by following the detailed test procedure described in Section 5.3.1.

Time-averaged conducted Tx power for LTE Band 2 and radiated Tx power for mmW NR n260 beam 14 are converted into time-averaged 1gSAR and time-averaged 4cm²PD using Equation (2a) and (2b), which are divided by FCC 1gSAR limit of 1.6 W/kg and 4cm²PD limit of 10 W/m², respectively, to obtain normalized exposures versus time. Below plot shows (a) normalized time-averaged 10gSAR versus time, (b) normalized time-averaged 4cm²-avg.PD versus time, (c) sum of normalized time-averaged 1gSAR and normalized time-averaged 4cm²-avg.PD:

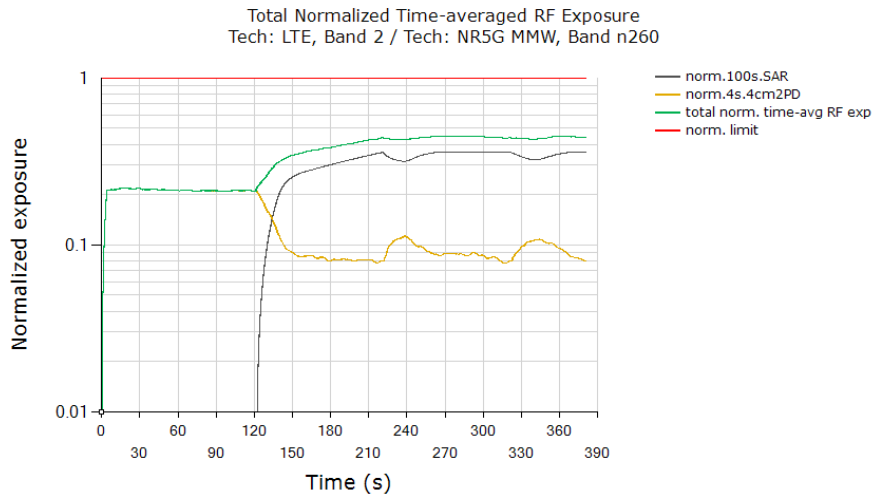

FCC requirement for total RF exposure (normalized)	1.0
Max total normalized time-averaged RF exposure (green curve)	0.449
Validated	

Plot notes: As soon as 5G mmW NR call was established, LTE was placed in all-down bits immediately. Between 0s~120s, mmW exposure is the dominant contributor. Here, Smart Transmit feature allocates a maximum of 1.0 for mmW (based on the 3dB reserve setting in Part 1 report). At ~120s time mark, LTE is set to all-up bits, taking away margin from mmW exposure gradually and towards the end of the test, LTE is the dominant contributor towards RF exposure. Table 13-2 shows the calculations for the normalized 4cm² PD exposure values and the normalized 1g SAR exposure value.

Table 13-2

	Static 4cm ² PD or 1g SAR [W/m ² or W/kg]	Normalized Exposure	Uncertainty [dB]
0s~120s: NR Green/Orange Curve	2.99	29.9%	2.0
After ~120s: LTE Black Curve	0.702	43.9%	1.0

As can be seen, the power limiting enforcement is effective and the total normalized time-averaged RF exposure does not exceed 1.0. Therefore, Qualcomm® Smart Transmit time averaging feature is validated.

FCC ID: A3LSMS711U	PART 2 RF EXPOSURE EVALUATION REPORT	Approved by: Technical Manager
Document S/N: 1M2304260060-25.A3L	DUT Type: Portable Handset	Page 76 of 90

13.3 Switch in SAR vs. PD exposure test results for n261

This test was measured with LTE Band 2 (DSI = 2) and mmW Band n261 Beam ID 19, by following the detailed test procedure is described in Section 5.3.2.

Normalized time-averaged exposures for LTE (1gSAR) and mmW (4cm²PD), as well as total normalized time-averaged exposure versus time:

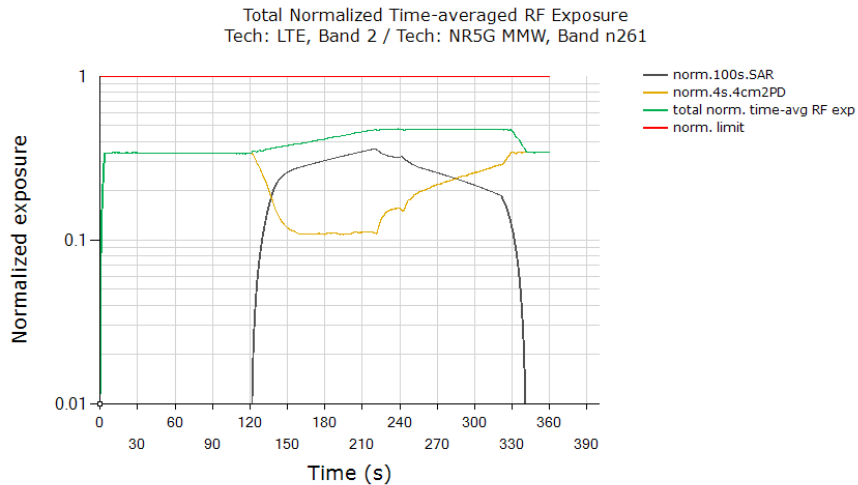

FCC requirement for total RF exposure (normalized)	1.0
Max total normalized time-averaged RF exposure (green curve)	0.478
Validated	

Plot notes: As soon as 5G mmW NR call was established, LTE was placed in all-down bits immediately. Between 0s~120s, mmW exposure is the dominant contributor. Here, Smart Transmit feature allocates a maximum of 1.0 for mmW). At ~120s time mark, LTE is set to all-up bits, taking away margin from mmW exposure gradually (orange curve for mmW exposure goes down while black curve for LTE exposure goes up). At ~240s time mark, LTE is set to all-down bits, which results in mmW getting back RF margin slowly as seen by gradual increase in mmW exposure (orange curve for mmW exposure goes up while black curve for LTE exposure goes down). Table 13-3 shows the calculations for the normalized 4cm² PD exposure value and the normalized 1g SAR exposure value.

Table 13-3

	Static 4cm ² PD or 1g SAR [W/m ² or W/kg]	Normalized Exposure	Uncert [dB]
0s~120s + After 240s: NR Green/Orange Curve	5.23	52.3%	2.0
120s - 240s: LTE Black Curve	0.702	43.9%	1.0

As can be seen, the power limiting enforcement is effective during transmission when SAR and PD exposures are switched, and the total normalized time-averaged RF exposure does not exceed 1.0. Therefore, Qualcomm[®] Smart Transmit time averaging feature is validated.

FCC ID: A3LSMS711U	PART 2 RF EXPOSURE EVALUATION REPORT	Approved by: Technical Manager
Document S/N: 1M2304260060-25.A3L	DUT Type: Portable Handset	Page 77 of 90

13.4 Switch in SAR vs. PD exposure test results for n260

This test was measured with LTE Band 2 (DSI =2) and mmW Band n260 Beam ID 14, by following the detailed test procedure is described in Section 5.3.2.

Normalized time-averaged exposures for LTE (1gSAR) and mmW (4cm²PD), as well as total normalized time-averaged exposure versus time:

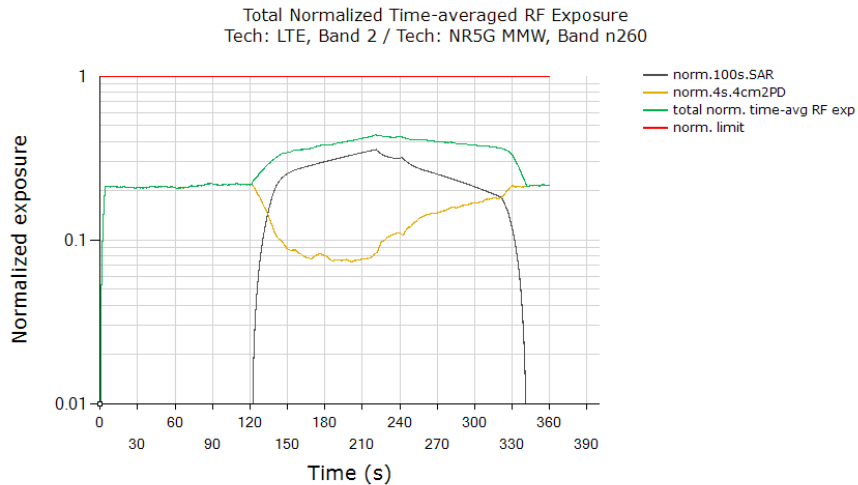

FCC requirement for total RF exposure (normalized)	1.0
Max total normalized time-averaged RF exposure (green curve)	0.441
Validated	

Plot notes: As soon as 5G mmW NR call was established, LTE was placed in all-down bits immediately. Between 0s~120s, mmW exposure is the dominant contributor. Here, Smart Transmit feature allocates a maximum of 1.0 for mmW). At ~120s time mark, LTE is set to all-up bits, taking away margin from mmW exposure gradually (orange curve for mmW exposure goes down while black curve for LTE exposure goes up). At ~240s time mark, LTE is set to all-down bits, which results in mmW getting back RF margin slowly as seen by gradual increase in mmW exposure (orange curve for mmW exposure goes up while black curve for LTE exposure goes down). Table 13-4 shows the calculations for the normalized 4cm² PD exposure value and the normalized 1g SAR exposure value.

Table 13-4

	Static 4cm ² PD or 1g SAR [W/m ² or W/kg]	Normalized Exposure	Uncert [dB]
0s~120s + After 240s: NR Green/Orange Curve	2.99	29.9%	2.0
120s - 240s: LTE Black Curve	0.702	43.9%	1.0

As can be seen, the power limiting enforcement is effective during transmission when SAR and PD exposures are switched, and the total normalized time-averaged RF exposure does not exceed 1.0. Therefore, Qualcomm® Smart Transmit time averaging feature is validated.

FCC ID: A3LSMS711U	PART 2 RF EXPOSURE EVALUATION REPORT	Approved by: Technical Manager
Document S/N: 1M2304260060-25.A3L	DUT Type: Portable Handset	Page 78 of 90

13.5 Change in Beam test results for n261

This test was measured with LTE Band 2 (DSI = 2) and mmW Band n261, with beam switch from Beam ID 19 to Beam ID 2, by following the test procedure is described in Section 5.3.3.

Normalized time-averaged exposures for LTE and mmW (4cm²PD), as well as total normalized time-averaged exposure versus time:

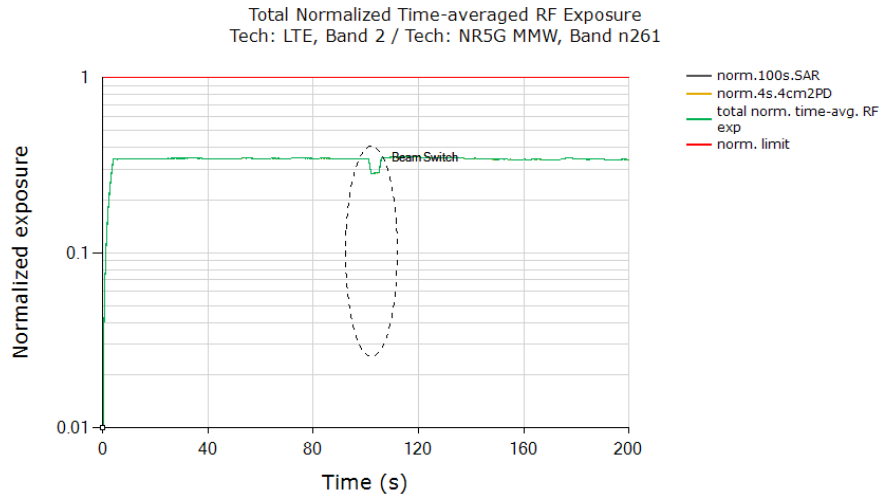

FCC requirement for total RF exposure (normalized)	1.0
Max total normalized time-averaged RF exposure (green curve)	0.354
Validated	

Plot notes: 5G mmW NR call was established at ~1s time mark and LTE was placed in all-down bits immediately after 5G mmW NR call was established. For the rest of this test, mmW exposure is the dominant contributor as LTE is left in all-down bits. Here, Smart Transmit feature allocates a maximum of 1.0 for mmW for the first beam (based on 3dB reserve setting in Part 1 report). At ~100s time mark (shown in black dotted ellipse), beam switch takes place and mmW starts transmission from the second beam. Second beam transmits at *input.power.limit* with active power limiting. Table 13-5 shows the calculations for the normalized 4cm² PD exposure values and the difference in EIRPs between two beams.

Table 13-5

	Beam ID 19 (0 - 100 sec, before ellipse)	Beam ID 2 (100 - 200 sec, after ellipse)
Static psPD [W/m ²]	5.23	5.18
Input.power.limit [dBm]	3.9	10.6
Maximum Power [dBm]	13.5	
Normalized 4cm ² PD exposure value [% ± 2.0 dB uncertainty]	52.3%	51.8%
EIRP Difference [dB ± 2.0 dB uncertainty]	5.84	

FCC ID: A3LSMS711U	PART 2 RF EXPOSURE EVALUATION REPORT	Approved by: Technical Manager
Document S/N: 1M2304260060-25.A3L	DUT Type: Portable Handset	Page 79 of 90

13.6 Change in Beam test results for n260

This test was measured with LTE Band 2 (DSI = 2) and mmW Band n260, with beam switch from Beam ID 14 to Beam ID 0, by following the test procedure is described in Section 5.3.3.

Normalized time-averaged exposures for LTE and mmW (4cm²PD), as well as total normalized time-averaged exposure versus time:

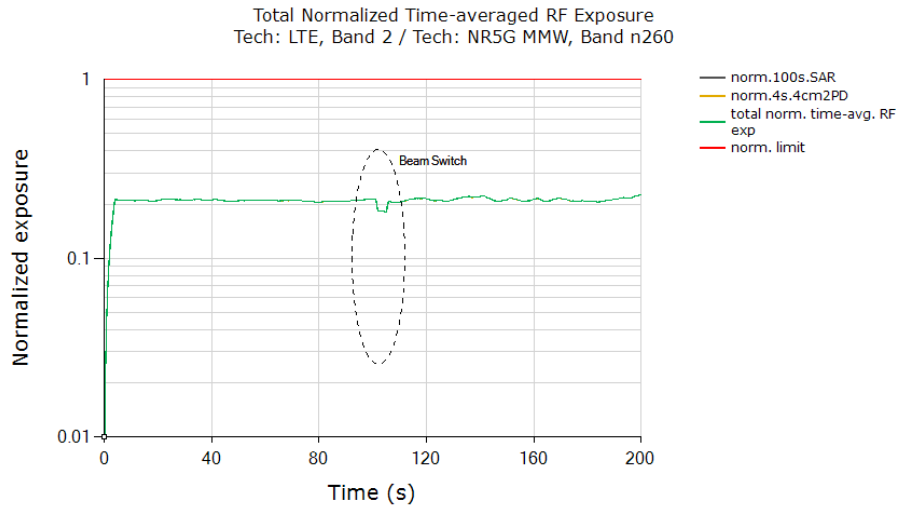

FCC requirement for total RF exposure (normalized)	1.0
Max total normalized time-averaged RF exposure (green curve)	0.227
Validated	

Plot notes: 5G mmW NR call was established at ~1s time mark and LTE was placed in all-down bits immediately after 5G mmW NR call was established. For the rest of this test, mmW exposure is the dominant contributor as LTE is left in all-down bits. Here, Smart Transmit feature allocates a maximum of 1.0 for mmW for the first beam (based on 3dB reserve setting in Part 1 report). At ~100s time mark (shown in black dotted ellipse), beam switch takes place and mmW starts transmission from the second beam. Second beam transmits at *input.power.limit* with active power limiting. Table 13-6 shows the calculations for the normalized 4cm² PD exposure values and the difference in EIRPs between two beams.

Table 13-6

	Beam ID 14 (0 - 100 sec. before ellipse)	Beam ID 0 (100 - 200 sec. after ellipse)
Static psPD [W/m ²]	2.99	2.08
Input.power.limit [dBm]	2.1	8.4
MTPL [dBm]	12.5	
Normalized 4cm ² PD exposure value [% ± 2.0 dB uncertainty]	29.9%	20.8%
EIRP Difference [dB ± 2.0 dB uncertainty]	4.81 dB	

FCC ID: A3LSMS711U	PART 2 RF EXPOSURE EVALUATION REPORT	Approved by: Technical Manager
Document S/N: 1M2304260060-25.A3L	DUT Type: Portable Handset	Page 80 of 90

14 SYSTEM VERIFICATION (FREQ > 6 GHZ)

The system was verified to be within ± 0.66 dB of the power density targets on the calibration certificate according to the test system specification in the user’s manual and calibration facility recommendation. The 0.66 dB deviation threshold represents the expanded uncertainty for system performance checks using SPEAG’s mmWave verification sources. The same spatial resolution and measurement region used in the source calibration was applied during the system check.

The measured power density distribution of verification source was also confirmed through visual inspection to have no noticeable differences, both spatially (shape) and numerically (level) from the distribution provided by the manufacturer, per November 2017 TCBC Workshop Notes.

**Table 14-1
System Verification Results**

System Verification										
Syst.	Freq. (GHz)	Date	Source SN	Probe SN	Normal psPD (W/m ² over 4 cm ²)		Deviation (dB)	Total psPD (W/m ² over 4 cm ²)		Deviation (dB)
					measured	target		measured	target	
√	30.00	7/27/2023	1043	9389	25.40	26.70	-0.22	25.70	26.70	-0.17

Note: A **10 mm distance spacing** was used from the reference horn antenna aperture to the probe element. This includes 4.45 mm from the reference antenna horn aperture to the surface of the verification source plus 5.55 mm from the surface to the probe. The SPEAG software requires a setting of “5.55 mm” for the correct setup.

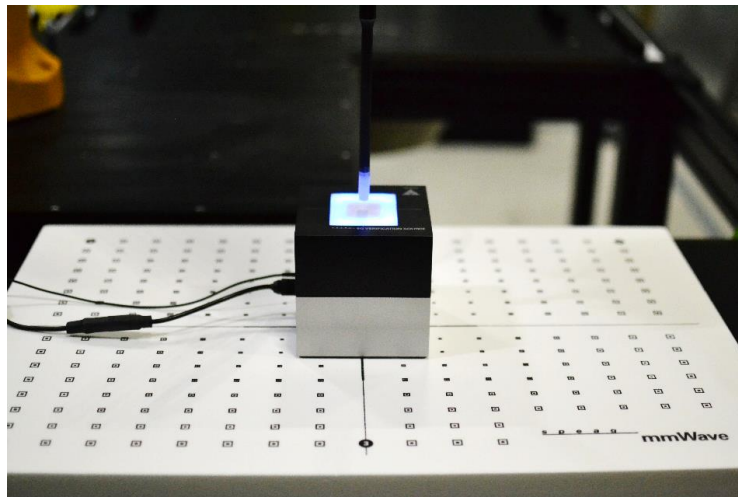

**Figure 14-1
System Verification Setup Photo**

FCC ID: A3LSMS711U	PART 2 RF EXPOSURE EVALUATION REPORT	Approved by: Technical Manager
Document S/N: 1M2304260060-25.A3L	DUT Type: Portable Handset	Page 81 of 90

15 POWER DENSITY TEST RESULTS (FREQ > 6 GHZ)

15.1 PD measurement results for maximum power transmission scenario

The following configurations were measured by following the detailed test procedure is described in Section 5.4:

1. LTE Band 2 (DSI = 2) and mmW Band n261 Beam ID 19
2. LTE Band 2 (DSI = 2) and mmW Band n260 Beam ID 14

The measured conducted Tx power of LTE and ratio of $\frac{[pointE(t)]^2}{[pointE_input.power.limit]^2}$ of mmW is converted into 1gSAR and 4cm²PD value, respectively, using Eq. (4a) and (4b), rewritten below:

$$1g_or_10gSAR(t) = \frac{conducted_Tx_power(t)}{conducted_Tx_power_P_limit} * 1g_or_10gSAR_P_limit \quad (4a)$$

$$4cm^2PD(t) = \frac{[pointE(t)]^2}{[pointE_input.power.limit]^2} * 4cm^2PD_input.power.limit \quad (4b)$$

$$\frac{\frac{1}{T_{SAR}} \int_{t-T_{SAR}}^t 1g_or_10gSAR(t) dt}{FCC\ SAR\ limit} + \frac{\frac{1}{T_{PD}} \int_{t-T_{PD}}^t 4cm^2PD(t) dt}{FCC\ 4cm^2PD\ limit} \leq 1 \quad (4c)$$

where, $conducted_Tx_power(t)$, $conducted_Tx_power_P_limit$, and $1g_or_10gSAR_P_limit$ correspond to the measured instantaneous conducted Tx power, measured conducted Tx power at P_{limit} , and measured 1gSAR or 10gSAR values at P_{limit} corresponding to LTE transmission. Similarly, $pointE(t)$, $pointE_input.power.limit$, and $4cm^2PD@input.power.limit$ correspond to the measured instantaneous E-field, E-field at $input.power.limit$, and 4cm²PD value at $input.power.limit$ corresponding to mmW transmission.

NOTE: cDASY6 system measures relative E-field, and provides ratio of $\frac{[pointE(t)]^2}{[pointE_input.power.limit]^2}$ versus time.

The radio configurations tested are described in Table 12-1 and Table 12-2. The 1gSAR at P_{limit} for LTE Band 2 DSI = 2, the measured 4cm²PD at $input.power.limit$ of mmW n261 beam 19 and n260 beam 14, are all listed in Table 12-3.

FCC ID: A3LSMS711U	PART 2 RF EXPOSURE EVALUATION REPORT	Approved by: Technical Manager
Document S/N: 1M2304260060-25.A3L	DUT Type: Portable Handset	Page 82 of 90

15.1.1 PD test results for n261

Step 2.e plot (in Section 5.4) for normalized instantaneous and time-averaged exposures for LTE and mmW n261 beam 19.

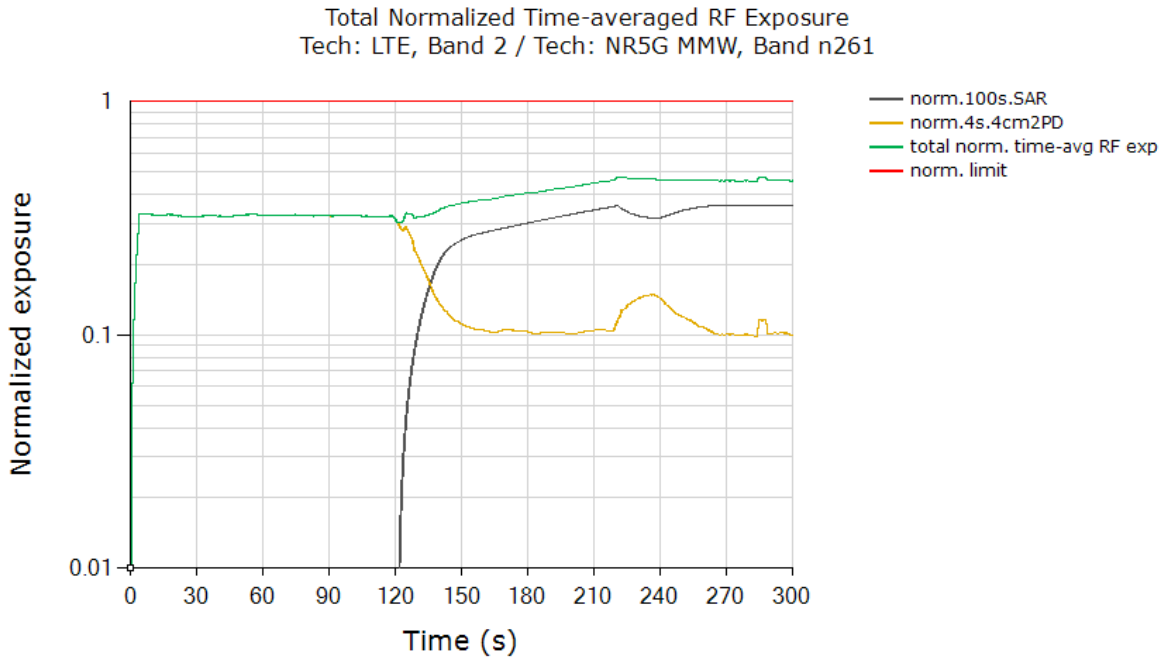

FCC limit for total RF exposure (normalized)	1.0
Max total normalized time-averaged RF exposure (green curve)	0.481
Validated	

Plot notes: LTE was placed in all-down bits immediately after 5G mmW NR call was established. Between 0s~120s, mmW exposure is the dominant contributor. Here, Smart Transmit feature allocates a maximum of 100% for mmW (based on the 3dB reserve setting in Part 1 report). Around the 120s time mark, LTE is set to all-up bits, taking away margin from mmW exposure gradually. Towards the end of the test, LTE is the dominant contributor towards RF exposure. Table 15-1 shows the calculations for the normalized 4cm² PD exposure values and the normalized 1g SAR exposure value.

Table 15-1

	Static 4cm ² PD or 1g SAR [W/m ² or W/kg]	Normalized Exposure	Uncertainty [dB]
0s~120s: NR Green/Orange Curve	5.23	52.3%	2.0
After ~120s: LTE Black Curve	0.702	43.9%	1.0

As can be seen, the power limiting enforcement is effective and the total normalized time-averaged RF exposure does not exceed 1.0. Therefore, Qualcomm® Smart Transmit time averaging feature is validated.

FCC ID: A3LSMS711U	PART 2 RF EXPOSURE EVALUATION REPORT	Approved by: Technical Manager
Document S/N: 1M2304260060-25.A3L	DUT Type: Portable Handset	Page 83 of 90

15.1.2 PD test results for n260

Step 2.e plot (in Section 5.4) for normalized instantaneous and time-averaged exposures for LTE and mmW n260 beam 14.

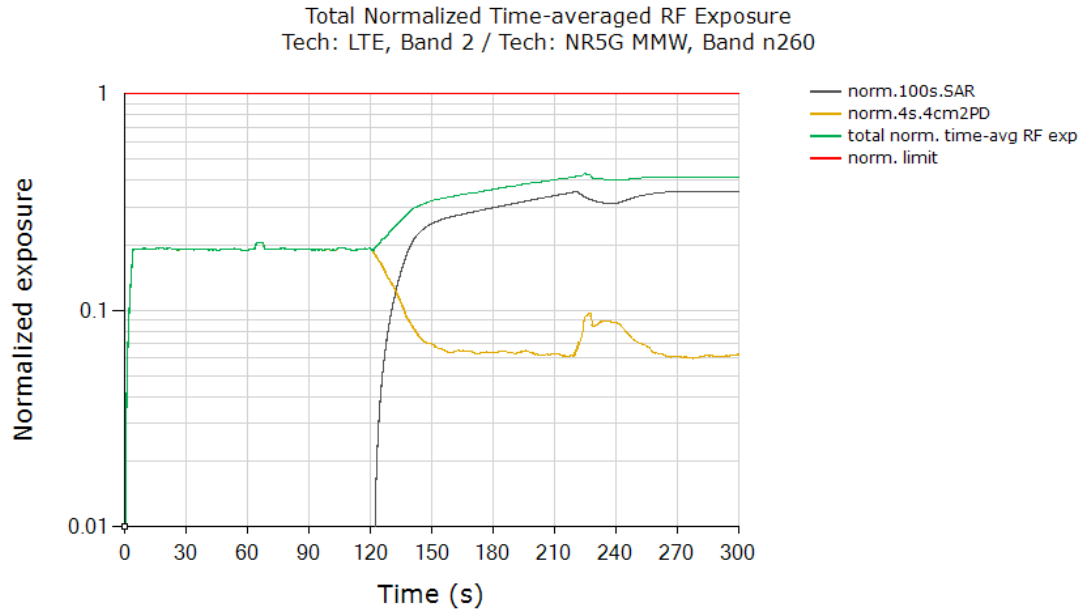

FCC limit for total RF exposure	1.0
Max total normalized time-averaged RF exposure (green curve)	0.428
Validated	

Plot notes: LTE was placed in all-down bits immediately after 5G mmW NR call was established. Between 0s~120s, mmW exposure is the dominant contributor. Here, Smart Transmit feature allocates a maximum of 100% for mmW (based on the 3dB reserve setting in Part 1 report). Around the 120s time mark, LTE is set to all-up bits, taking away margin from mmW exposure gradually. Towards the end of the test, LTE is the dominant contributor towards RF exposure. Table 15-2 shows the calculations for the normalized 4cm² PD exposure values and the normalized 1g SAR exposure value.

Table 15-2

	Static 4cm ² PD or 1g SAR [W/m ² or W/kg]	Normalized Exposure	Uncertainty [dB]
0s~120s: NR Green/Orange Curve	2.99	29.9%	2.0
After ~120s: LTE Black Curve	0.702	43.9%	1.0

As can be seen, the power limiting enforcement is effective and the total normalized time-averaged RF exposure does not exceed 1.0. Therefore, Qualcomm® Smart Transmit time averaging feature is validated.

FCC ID: A3LSMS711U	PART 2 RF EXPOSURE EVALUATION REPORT	Approved by: Technical Manager
Document S/N: 1M2304260060-25.A3L	DUT Type: Portable Handset	Page 84 of 90

16 EQUIPMENT LIST

Manufacturer	Model	Description	Cal Date	Cal Interval	Cal Due	Serial Number
Agilent	8594A	(9kHz-2.9GHz) Spectrum Analyzer	N/A	N/A	N/A	3051A00187
Agilent	E4438C	ESG Vector Signal Generator	1/18/2023	Annual	1/18/2024	MY47270002
Agilent	N9020A	MXA Signal Analyzer	3/15/2023	Annual	3/15/2024	US46470561
Agilent	N5182A	MXG Vector Signal Generator	11/30/2022	Annual	11/30/2023	MY47420603
Amplifier Research	1551G6	Amplifier	CBT	N/A	CBT	433972
Amplifier Research	1551G6	Amplifier	CBT	N/A	CBT	433974
Anritsu	MT8000A	Radio Communication Test Station	2/9/2023	Annual	2/9/2024	6272337408
Anritsu	MT8821C	Radio Communication Test Station	1/10/2023	Annual	1/10/2024	6201524637
Anritsu	MA24106A	USB Power Sensor	1/20/2023	Annual	1/20/2024	2018534
Anritsu	MA24106A	USB Power Sensor	2/9/2023	Annual	2/9/2024	1520505
Anritsu	ML2496A	Power Meter	8/16/2022	Annual	8/16/2023	1351001
Anritsu	MA2411B	Pulse Power Sensor	1/10/2023	Annual	1/10/2024	1315051
Anritsu	MA2411B	Pulse Power Sensor	10/21/2022	Annual	10/21/2023	1207364
COMTECH	AR85729-5/5759B	Solid State Amplifier	CBT	N/A	CBT	M3W1A00-1002
COMTECH	AR85729-5	Solid State Amplifier	CBT	N/A	CBT	M155A00-009
Control Company	4352	Long Stem Thermometer	9/10/2022	Biennial	9/10/2023	210774678
Control Company	4040	Therm./ Clock/ Humidity Monitor	1/17/2023	Annual	1/17/2024	160574418
Control Company	4352	Long Stem Thermometer	9/10/2022	Biennial	9/10/2023	210774685
K & L	11SH10-1300/U4000	High Pass Filter	CBT	N/A	CBT	11SH10-1300/U4000 - 2
Keysight Technologies	772D	Dual Directional Coupler	CBT	N/A	CBT	MY52180215
Keysight Technologies	E7515B	UXM 5G Wireless Test Platform	CBT	N/A	CBT	MY59150289
Keysight Technologies	M1740A	mmWave Transceiver	CBT	N/A	CBT	MY59291989
Keysight Technologies	M1740A	mmWave Transceiver	CBT	N/A	CBT	MY59291982
Keysight Technologies	E7770A	Common Interface Unit	CBT	N/A	CBT	MY58290483
Krytar	110067006	Directional Coupler, 10 - 67 GHz	CBT	N/A	CBT	200391
MCL	BW-N6W5+	6dB Attenuator	CBT	N/A	CBT	1139
Mini Circuits	ZA2PD2-63-5+	Power Splitter	CBT	N/A	CBT	SUU64901930
Mini Circuits	ZAPD-2-272-5+	Power Splitter	CBT	N/A	CBT	SF702001405
MiniCircuits	NLP-1200+	Low Pass Filter	CBT	N/A	CBT	VUU78201318
MiniCircuits	SLP-2400+	Low Pass Filter	CBT	N/A	CBT	R8979500903
MiniCircuits	VLF-6000+	Low Pass Filter	CBT	N/A	CBT	N/A
Mini-Circuits	BW-N20W5+	DC to 18 GHz Precision Fixed 20 dB Attenuator	CBT	N/A	CBT	N/A
Mini-Circuits	NLP-2950+	Low Pass Filter DC to 2700 MHz	CBT	N/A	CBT	N/A
Mini-Circuits	NLP-1200+	Low Pass Filter DC to 1000 MHz	CBT	N/A	CBT	N/A
Mini-Circuits	BW-N20W5	Power Attenuator	CBT	N/A	CBT	1226
Narda	4216-10	Directional Coupler, 0.5 to 8.0 GHz, 10 dB	CBT	N/A	CBT	01492
Narda	4216-10	Directional Coupler, 0.5 to 8.0 GHz, 10 dB	CBT	N/A	CBT	01493
Narda	4772-3	Attenuator	CBT	N/A	CBT	9406
Narda	BW-53W2	Attenuator	CBT	N/A	CBT	120
Narda	BW-510W2+	Attenuator	CBT	N/A	CBT	831
Narda	4014C-6	4 - 8 GHz SMA 6 dB Directional Coupler	CBT	N/A	CBT	N/A
Newmark System	NSC-G2	Motion Controller	CBT	N/A	CBT	1007-D
Pasternack	PE2208-6	Bidirectional Coupler	CBT	N/A	CBT	N/A
Pasternack	PE2209-10	Bidirectional Coupler	CBT	N/A	CBT	N/A
Rohde & Schwarz	CMW500	Radio Communication Tester	9/1/2022	Annual	9/1/2023	128636
Rohde & Schwarz	CMW500	Radio Communication Tester	8/25/2022	Annual	8/25/2023	140144
Rohde & Schwarz	NRP8S	3-Path Dipole Power Sensor	8/10/2022	Annual	8/10/2023	109322
Rohde & Schwarz	NRP8S	3-Path Dipole Power Sensor	8/10/2022	Annual	8/10/2023	109052
Rohde & Schwarz	NRP50S	3-Path Dipole Power Sensor	8/10/2022	Annual	8/10/2023	101339
SPEAG	5G Verification Source 30GHz	30GHz System Verification Antenna	6/23/2023	Annual	6/23/2024	1043
SPEAG	DAK-3.5	Dielectric Assessment Kit	10/17/2022	Annual	10/17/2023	1091
SPEAG	D1750V2	1750 MHz SAR Dipole	10/21/2021	Biennial	10/21/2023	1150
SPEAG	D1900V2	1900 MHz SAR Dipole	9/21/2021	Biennial	9/21/2023	56149
SPEAG	D2600V2	2600 MHz SAR Dipole	11/15/2022	Annual	11/15/2023	1071
SPEAG	DAE4	Dasy Data Acquisition Electronics	1/18/2023	Annual	1/18/2024	1530
SPEAG	DAE4	Dasy Data Acquisition Electronics	8/15/2022	Annual	8/15/2023	1681
SPEAG	EUmmWV3	E-field Probes	12/13/2022	Annual	12/13/2023	9389
SPEAG	EX3DV4	SAR Probe	8/22/2022	Annual	8/22/2023	7670
Zhuhai Bojay Electronics	BJ8827	Shielded Test Enclosure	N/A	N/A	N/A	F229647

Notes:

1. CBT (Calibrated Before Testing). Prior to testing, the measurement paths containing a cable, amplifier, attenuator, coupler, or filter were connected to a calibrated source (i.e. a signal generator) to determine the losses of the measurement path. The power meter offset was then adjusted to compensate for the measurement system losses. This level offset is stored within the power meter before measurements are made. This calibration verification procedure applies to the system verification and output power measurements. The calibrated reading is then taken directly from the power meter after compensation of the losses for all final power measurements.
2. Each equipment item is used solely within its respective calibration period.

FCC ID: A3LSMS711U	PART 2 RF EXPOSURE EVALUATION REPORT	Approved by: Technical Manager
Document S/N: 1M2304260060-25.A3L	DUT Type: Portable Handset	Page 85 of 90

17 MEASUREMENT UNCERTAINTIES

For SAR Measurements

a	c	d	e= f(d,k)	f	g	h = c x f/e	i = c x g/e	k
Uncertainty Component	Tol. (± %)	Prob. Dist.	Div.	c _i 1gm	c _i 10 gms	1gm u _i (± %)	10gms u _i (± %)	v _i
Measurement System								
Probe Calibration	6.55	N	1	1.0	1.0	6.6	6.6	∞
Axial Isotropy	0.25	N	1	0.7	0.7	0.2	0.2	∞
Hemishperical Isotropy	1.3	N	1	0.7	0.7	0.9	0.9	∞
Boundary Effect	2.0	R	1.73	1.0	1.0	1.2	1.2	∞
Linearity	0.3	N	1	1.0	1.0	0.3	0.3	∞
System Detection Limits	0.25	R	1.73	1.0	1.0	0.1	0.1	∞
Readout Electronics	0.3	N	1	1.0	1.0	0.3	0.3	∞
Response Time	0.8	R	1.73	1.0	1.0	0.5	0.5	∞
Integration Time	2.6	R	1.73	1.0	1.0	1.5	1.5	∞
RF Ambient Conditions - Noise	3.0	R	1.73	1.0	1.0	1.7	1.7	∞
RF Ambient Conditions - Reflections	3.0	R	1.73	1.0	1.0	1.7	1.7	∞
Probe Positioner Mechanical Tolerance	0.4	R	1.73	1.0	1.0	0.2	0.2	∞
Probe Positioning w/ respect to Phantom	6.7	R	1.73	1.0	1.0	3.9	3.9	∞
Extrapolation, Interpolation & Integration algorithms for Max. SAR Evaluation	4.0	R	1.73	1.0	1.0	2.3	2.3	∞
Test Sample Related								
Test Sample Positioning	2.7	N	1	1.0	1.0	2.7	2.7	35
Device Holder Uncertainty	1.67	N	1	1.0	1.0	1.7	1.7	5
Output Power Variation - SAR drift measurement	5.0	R	1.73	1.0	1.0	2.9	2.9	∞
SAR Scaling	0.0	R	1.73	1.0	1.0	0.0	0.0	∞
Phantom & Tissue Parameters								
Phantom Uncertainty (Shape & Thickness tolerances)	7.6	R	1.73	1.0	1.0	4.4	4.4	∞
Liquid Conductivity - measurement uncertainty	4.2	N	1	0.78	0.71	3.3	3.0	10
Liquid Permittivity - measurement uncertainty	4.1	N	1	0.23	0.26	1.0	1.1	10
Liquid Conductivity - Temperature Uncertainty	3.4	R	1.73	0.78	0.71	1.5	1.4	∞
Liquid Permittivity - Temperature Uncertainty	0.6	R	1.73	0.23	0.26	0.1	0.1	∞
Liquid Conductivity - deviation from target values	5.0	R	1.73	0.64	0.43	1.8	1.2	∞
Liquid Permittivity - deviation from target values	5.0	R	1.73	0.60	0.49	1.7	1.4	∞
Combined Standard Uncertainty (k=1)	RSS					11.5	11.3	60
Expanded Uncertainty (95% CONFIDENCE LEVEL)	k=2					23.0	22.6	

FCC ID: A3LSMS711U	PART 2 RF EXPOSURE EVALUATION REPORT	Approved by: Technical Manager
Document S/N: 1M2304260060-25.A3L	DUT Type: Portable Handset	Page 86 of 90

For PD Measurements

a	b	c	d	e	f = c x f/e	g
Uncertainty Component	Unc. (± dB)	Prob. Dist.	Div.	c _i	u _i (± dB)	v _i
Measurement System						
Calibration	0.49	N	1	1	0.49	∞
Probe Correction	0.00	R	1.73	1	0.00	∞
Frequency Response	0.20	R	1.73	1	0.12	∞
Sensor Cross Coupling	0.00	R	1.73	1	0.00	∞
Isotropy	0.50	R	1.73	1	0.29	∞
Linearity	0.20	R	1.73	1	0.12	∞
Probe Scattering	0.00	R	1.73	1	0.00	∞
Probe Positioning offset	0.30	R	1.73	1	0.17	∞
Probe Positioning Repeatability	0.04	R	1.73	1	0.02	∞
Sensor Mechanical Offset	0.00	R	1.73	1	0.00	∞
Probe Spatial Resolution	0.00	R	1.73	1	0.00	∞
Field Impedance Dependence	0.00	R	1.73	1	0.00	∞
Amplitude and Phase Drift	0.00	R	1.73	1	0.00	∞
Amplitude and Phase Noise	0.04	R	1.73	1	0.02	∞
Measurement Area Truncation	0.00	R	1.73	1	0.00	∞
Data Acquisition	0.03	N	1	1	0.03	∞
Sampling	0.00	R	1.73	1	0.00	∞
Field Reconstruction	0.60	R	1.73	1	0.35	∞
Forward Transformation	0.00	R	1.73	1	0.00	∞
Power Density Scaling	0.00	R	1.73	1	0.00	∞
Spatial Averaging	0.10	R	1.73	1	0.06	∞
System Detection Limit	0.04	R	1.73	1	0.02	∞
Test Sample Related						
Probe Coupling with DUT	0.00	R	1.73	1	0.00	∞
Modulation Response	0.40	R	1.73	1	0.23	∞
Integration Time	0.00	R	1.73	1	0.00	∞
Response Time	0.00	R	1.73	1	0.00	∞
Device Holder Influence	0.10	R	1.73	1	0.06	∞
DUT alignment	0.00	R	1.73	1	0.00	∞
RF Ambient Conditions	0.04	R	1.73	1	0.02	∞
Ambient Reflections	0.04	R	1.73	1	0.02	∞
Immunity/Secondary Reception	0.00	R	1.73	1	0.00	∞
Drift of DUT	0.21	R	1.73	1	0.12	∞
Combined Standard Uncertainty (k=1)	RSS				0.76	∞
Expanded Uncertainty (95% CONFIDENCE LEVEL)	k=2				1.52	

FCC ID: A3LSMS711U	PART 2 RF EXPOSURE EVALUATION REPORT	Approved by: Technical Manager
Document S/N: 1M2304260060-25.A3L	DUT Type: Portable Handset	Page 87 of 90

18 CONCLUSION

18.1 Measurement Conclusion

The SAR evaluation indicates that the DUT complies with the RF radiation exposure limits of the FCC and Innovation, Science, and Economic Development Canada, with respect to all parameters subject to this test. These measurements were taken to simulate the RF effects of RF exposure under worst-case conditions. Precise laboratory measures were taken to assure repeatability of the tests. The results and statements relate only to the item(s) tested.

Please note that the absorption and distribution of electromagnetic energy in the body are very complex phenomena that depend on the mass, shape, and size of the body, the orientation of the body with respect to the field vectors, and the electrical properties of both the body and the environment. Other variables that may play a substantial role in possible biological effects are those that characterize the environment (e.g. ambient temperature, air velocity, relative humidity, and body insulation) and those that characterize the individual (e.g. age, gender, activity level, debilitation, or disease). Because various factors may interact with one another to vary the specific biological outcome of an exposure to electromagnetic fields, any protection guide should consider maximal amplification of biological effects as a result of field-body interactions, environmental conditions, and physiological variables. [3]

FCC ID: A3LSMS711U	PART 2 RF EXPOSURE EVALUATION REPORT	Approved by: Technical Manager
Document S/N: 1M2304260060-25.A3L	DUT Type: Portable Handset	Page 88 of 90

19 REFERENCES

- [1] Federal Communications Commission, ET Docket 93-62, Guidelines for Evaluating the Environmental Effects of Radiofrequency Radiation, Aug. 1996.
- [2] ANSI/IEEE C95.1-2005, American National Standard safety levels with respect to human exposure to radio frequency electromagnetic fields, 3kHz to 300GHz, New York: IEEE, 2006.
- [3] ANSI/IEEE C95.1-1992, American National Standard safety levels with respect to human exposure to radio frequency electromagnetic fields, 3kHz to 300GHz, New York: IEEE, Sept. 1992.
- [4] ANSI/IEEE C95.3-2002, IEEE Recommended Practice for the Measurement of Potentially Hazardous Electromagnetic Fields - RF and Microwave, New York: IEEE, December 2002.
- [5] IEEE Standards Coordinating Committee 39 –Standards Coordinating Committee 34 – IEEE Std. 1528-2013, IEEE Recommended Practice for Determining the Peak Spatial-Average Specific Absorption Rate (SAR) in the Human Head from Wireless Communications Devices: Measurement Techniques.
- [6] NCRP, National Council on Radiation Protection and Measurements, Biological Effects and Exposure Criteria for RadioFrequency Electromagnetic Fields, NCRP Report No. 86, 1986. Reprinted Feb. 1995.
- [7] T. Schmid, O. Egger, N. Kuster, Automated E-field scanning system for dosimetric assessments, IEEE Transaction on Microwave Theory and Techniques, vol. 44, Jan. 1996, pp. 105-113.
- [8] K. Pokovic, T. Schmid, N. Kuster, Robust setup for precise calibration of E-field probes in tissue simulating liquids at mobile communications frequencies, ICECOM97, Oct. 1997, pp. 1 -124.
- [9] K. Pokovic, T. Schmid, and N. Kuster, E-field Probe with improved isotropy in brain simulating liquids, Proceedings of the ELMAR, Zadar, Croatia, June 23-25, 1996, pp. 172-175.
- [10] Schmid & Partner Engineering AG, Application Note: Data Storage and Evaluation, June 1998, p2.
- [11] V. Hombach, K. Meier, M. Burkhardt, E. Kuhn, N. Kuster, The Dependence of EM Energy Absorption upon Human Modeling at 900 MHz, IEEE Transaction on Microwave Theory and Techniques, vol. 44 no. 10, Oct. 1996, pp. 1865-1873.
- [12] N. Kuster and Q. Balzano, Energy absorption mechanism by biological bodies in the near field of dipole antennas above 300MHz, IEEE Transaction on Vehicular Technology, vol. 41, no. 1, Feb. 1992, pp. 17-23.
- [13] G. Hartsgrove, A. Kraszewski, A. Surowiec, Simulated Biological Materials for Electromagnetic Radiation Absorption Studies, University of Ottawa, Bioelectromagnetics, Canada: 1987, pp. 29-36.
- [14] Q. Balzano, O. Garay, T. Manning Jr., Electromagnetic Energy Exposure of Simulated Users of Portable Cellular Telephones, IEEE Transactions on Vehicular Technology, vol. 44, no.3, Aug. 1995.
- [15] W. Gander, Computermathematick, Birkhaeuser, Basel, 1992.
- [16] W.H. Press, S.A. Teukolsky, W.T. Vetterling, and B.P. Flannery, Numerical Recipes in C, The Art of Scientific Computing, Second edition, Cambridge University Press, 1992.

FCC ID: A3LSMS711U	PART 2 RF EXPOSURE EVALUATION REPORT	Approved by: Technical Manager
Document S/N: 1M2304260060-25.A3L	DUT Type: Portable Handset	Page 89 of 90

- [17] N. Kuster, R. Kastle, T. Schmid, Dosimetric evaluation of mobile communications equipment with known precision, IEEE Transaction on Communications, vol. E80-B, no. 5, May 1997, pp. 645-652.
- [18] CENELEC CLC/SC111B, European Prestandard (prENV 50166-2), Human Exposure to Electromagnetic Fields High-frequency: 10kHz-300GHz, Jan. 1995.
- [19] Prof. Dr. Niels Kuster, ETH, Eidgenössische Technische Hochschule Zürich, Dosimetric Evaluation of the Cellular Phone.
- [20] IEC 62209-1, Measurement procedure for the assessment of specific absorption rate of human exposure to radio frequency fields from hand-held and body-mounted wireless communication devices - Part 1: Devices used next to the ear (Frequency range of 300 MHz to 6 GHz), July 2016.
- [21] Innovation, Science, Economic Development Canada RSS-102 Radio Frequency Exposure Compliance of Radiocommunication Apparatus (All Frequency Bands) Issue 5, March 2015.
- [22] Health Canada Safety Code 6 Limits of Human Exposure to Radio Frequency Electromagnetic Fields in the Frequency Range from 3 kHz – 300 GHz, 2015
- [23] FCC SAR Test Procedures for 2G-3G Devices, Mobile Hotspot and UMPC Devices KDB Publications 941225, D01-D07
- [24] SAR Measurement Guidance for IEEE 802.11 Transmitters, KDB Publication 248227 D01
- [25] FCC SAR Considerations for Handsets with Multiple Transmitters and Antennas, KDB Publications 648474 D03-D04
- [26] FCC SAR Evaluation Considerations for Laptop, Notebook, Netbook and Tablet Computers, FCC KDB Publication 616217 D04
- [27] FCC SAR Measurement and Reporting Requirements for 100MHz – 6 GHz, KDB Publications 865664 D01-D02
- [28] FCC General RF Exposure Guidance and SAR Procedures for Dongles, KDB Publication 447498, D01-D02
- [29] Anexo à Resolução No. 533, de 10 de Setembro de 2009.
- [30] IEC 62209-2, Human exposure to radio frequency fields from hand-held and body-mounted wireless communication devices - Human models, instrumentation, and procedures - Part 2: Procedure to determine the specific absorption rate (SAR) for wireless communication devices used in close proximity to the human body (frequency range of 30 MHz to 6 GHz), Mar. 2010.

FCC ID: A3LSMS711U	PART 2 RF EXPOSURE EVALUATION REPORT	Approved by: Technical Manager
Document S/N: 1M2304260060-25.A3L	DUT Type: Portable Handset	Page 90 of 90