

**Test mode: LTE Band 26**

**1.4M BW QPSK Mid ch.**

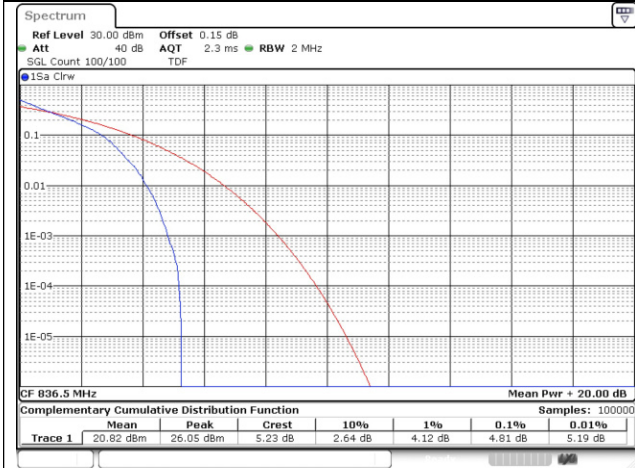

**1.4M BW 16QAM Mid ch.**

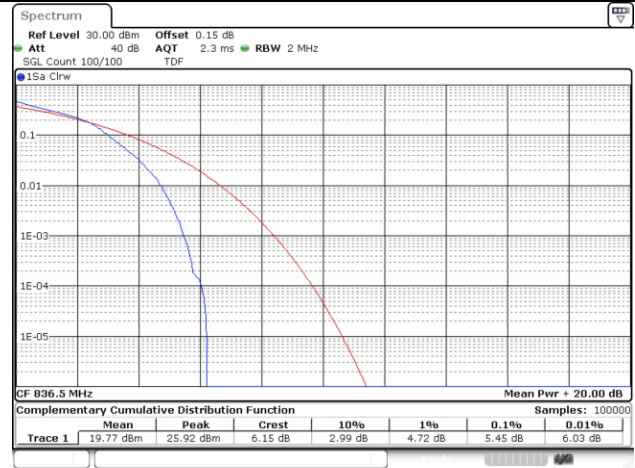

**3M BW QPSK Mid ch.**

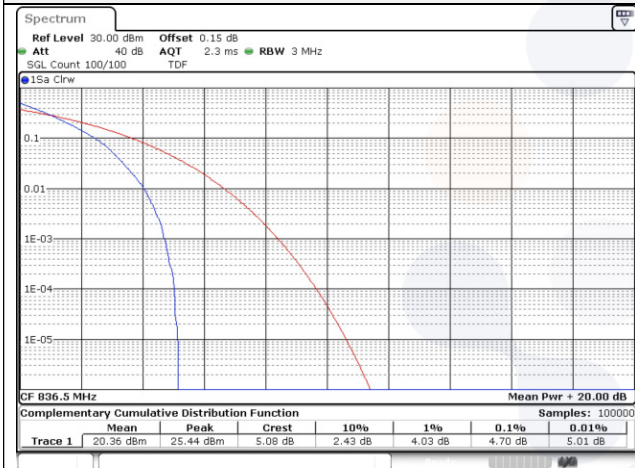

**3M BW 16QAM Mid ch.**

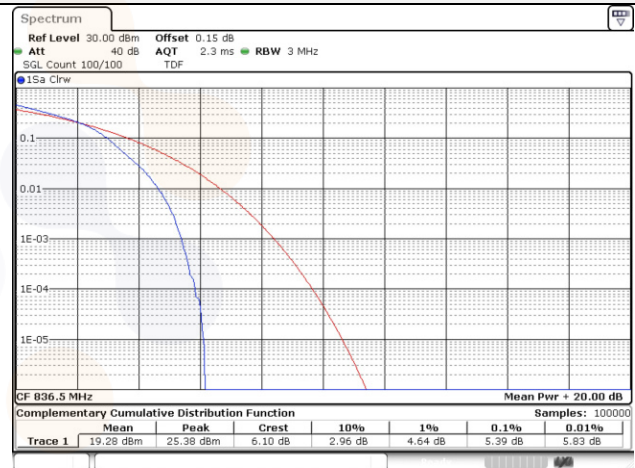

**5M BW QPSK Mid ch.**

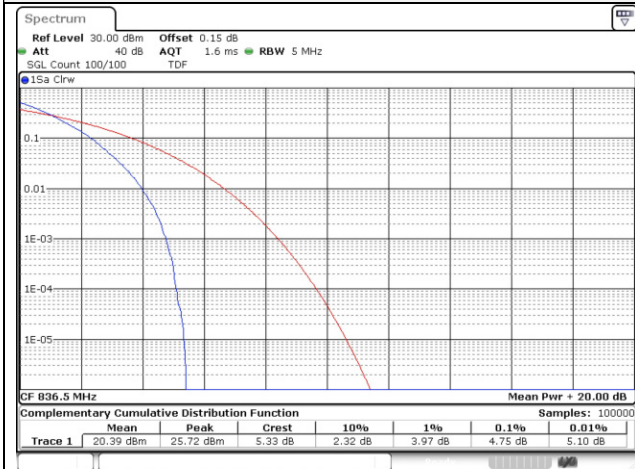

**5M BW 16QAM Mid ch.**

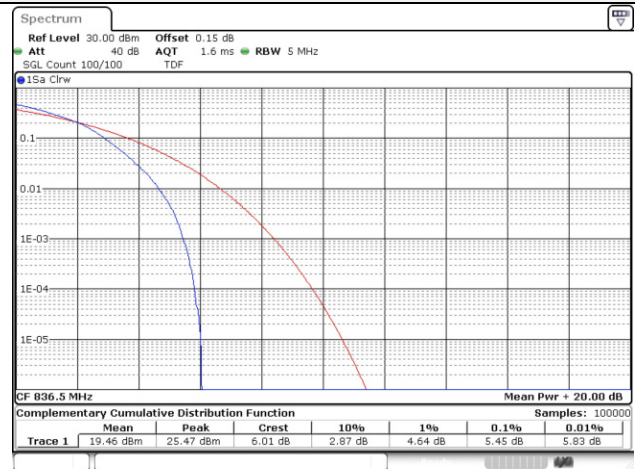

**10M BW QPSK Mid ch.**

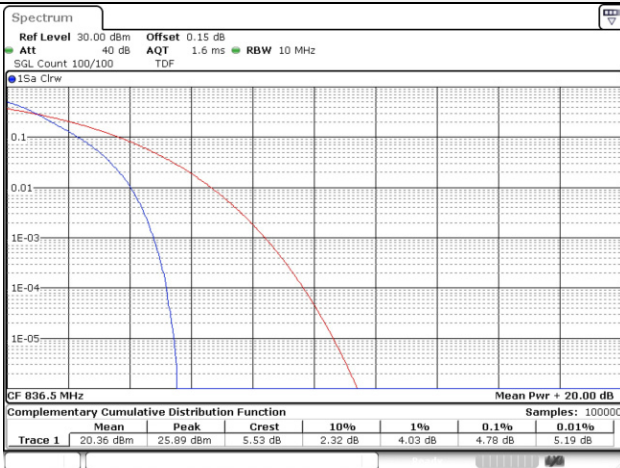

**10M BW 16QAM Mid ch.**

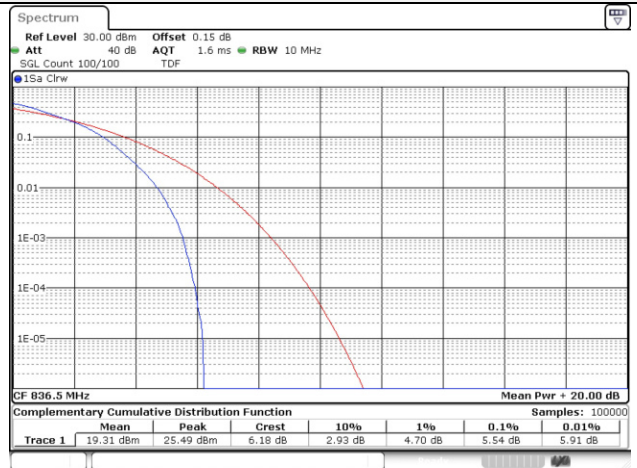

**15M BW QPSK Mid ch.**

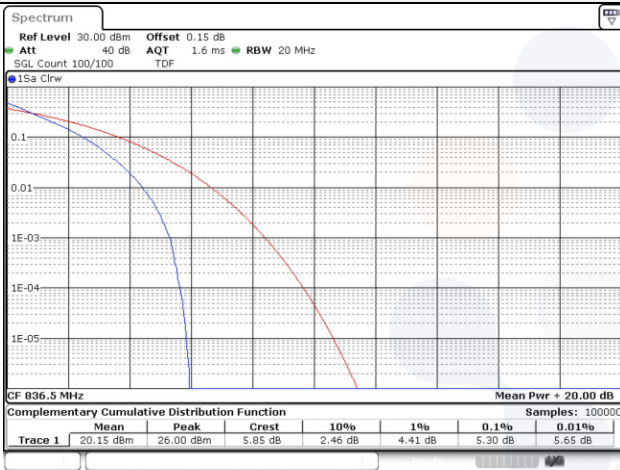

**15M BW 16QAM Mid ch.**

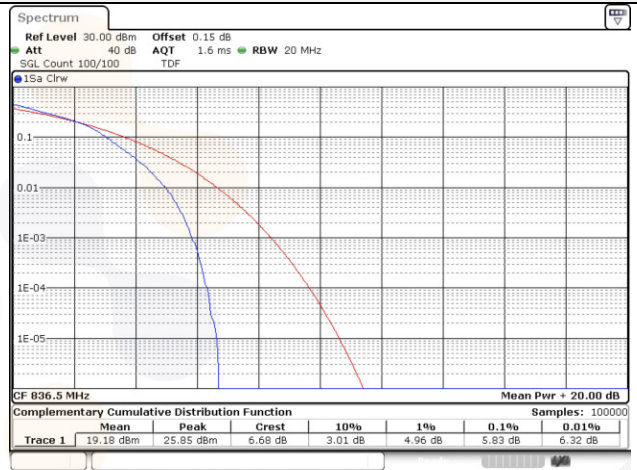

**Test mode: LTE Band 66/4**

**1.4M BW QPSK Mid ch.**

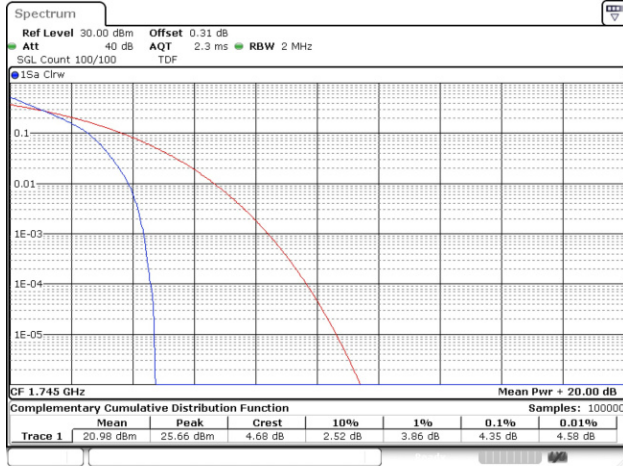

**1.4M BW 16QAM Mid ch.**

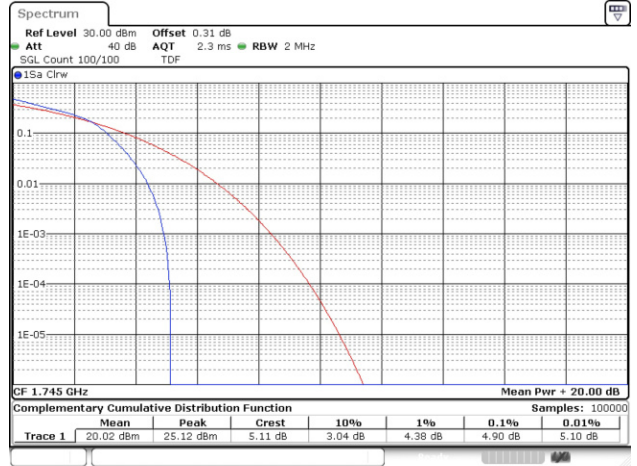

**3M BW QPSK Mid ch.**

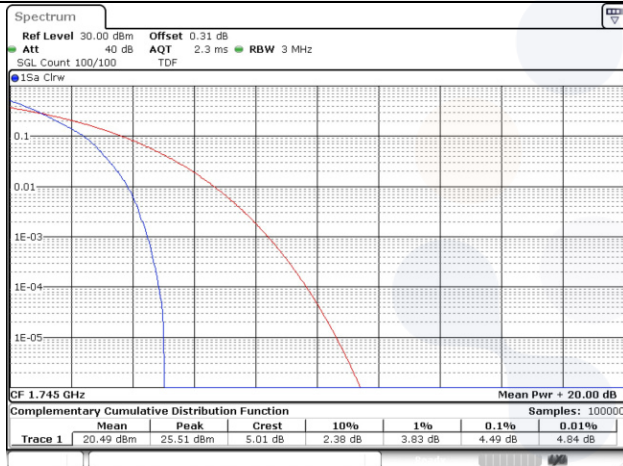

**3M BW 16QAM Mid ch.**

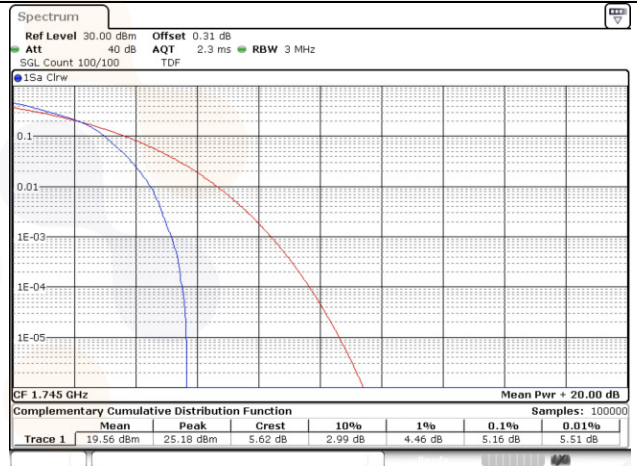

**5M BW QPSK Mid ch.**

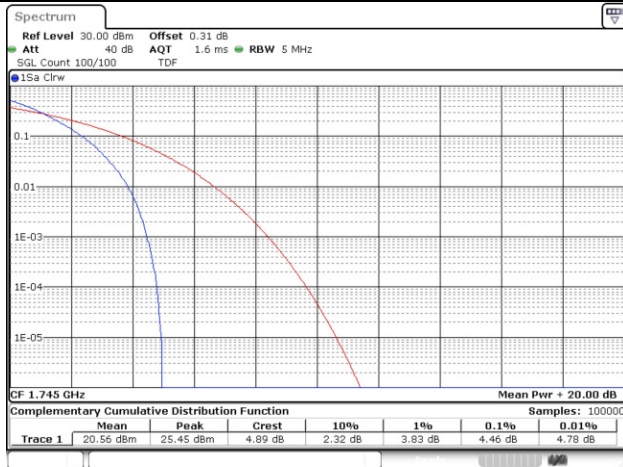

**5M BW 16QAM Mid ch.**

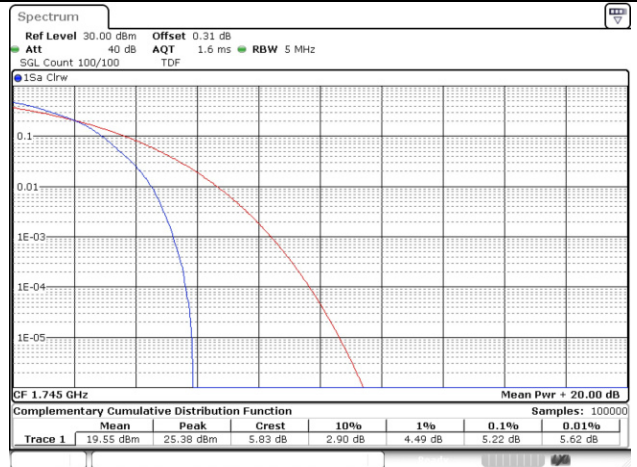

**10M BW QPSK Mid ch.**

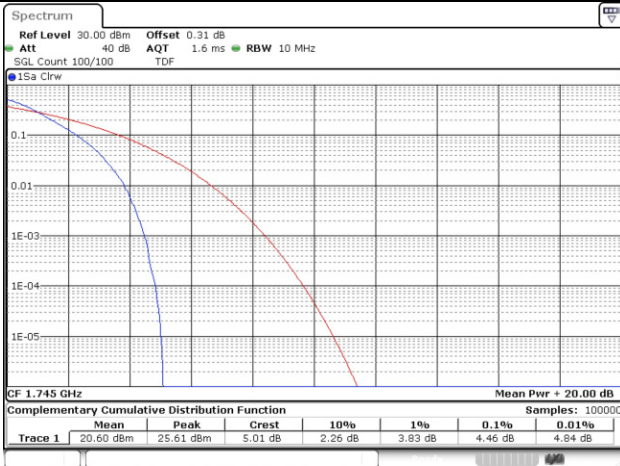

**10M BW 16QAM Mid ch.**

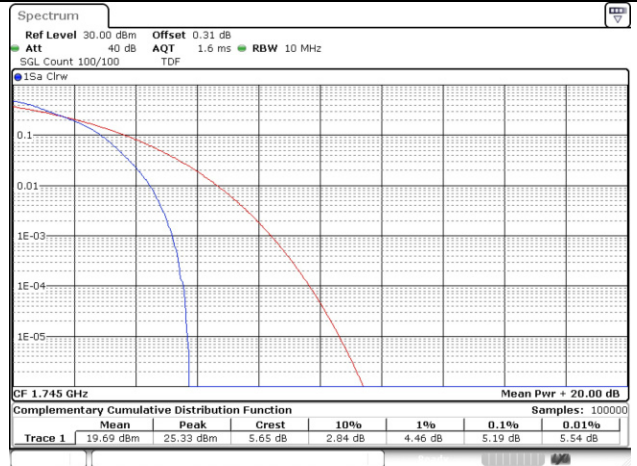

**15M BW QPSK Mid ch.**

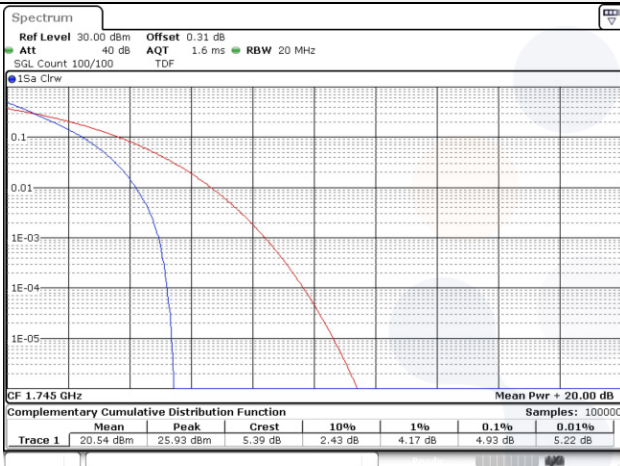

**15M BW 16QAM Mid ch.**

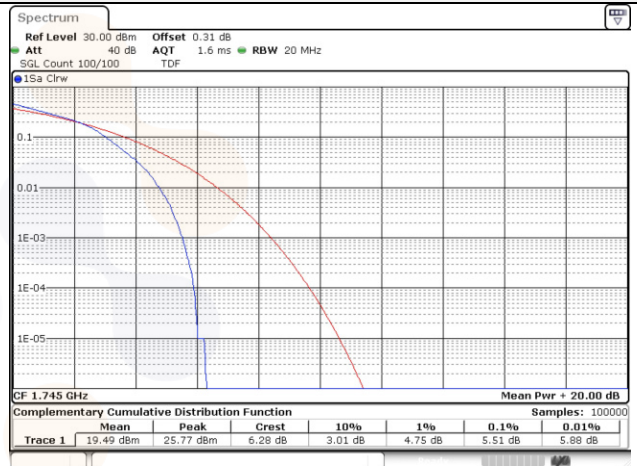

**20M BW QPSK Mid ch.**

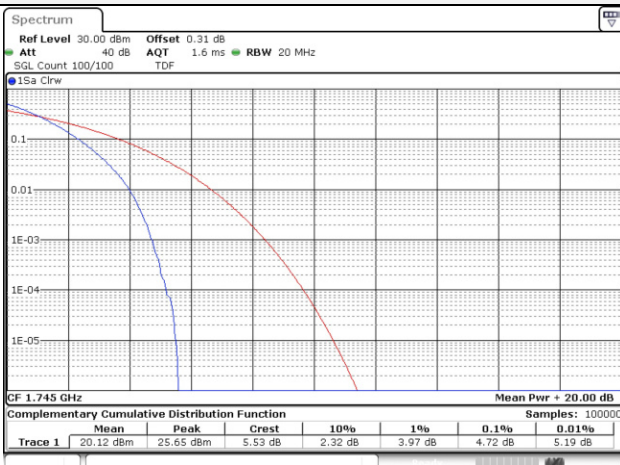

**20M BW 16QAM Mid ch.**

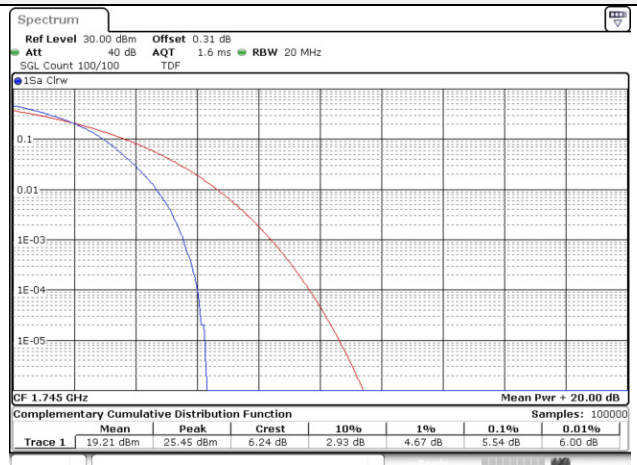

## 7.6. Frequency stability

### Test setup

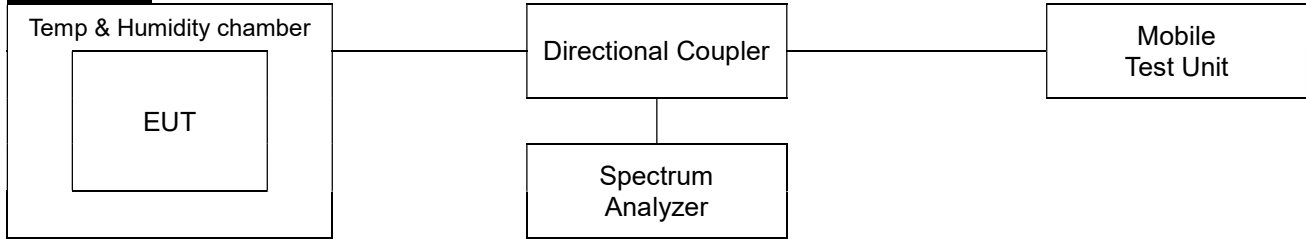

### Limit

#### According to §2.1055(a),

The frequency stability shall be measured with variation of ambient temperature as follows:

- 1) From  $-30^{\circ}$  to  $+50^{\circ}$  centigrade for all equipment except that specified in paragraphs (a) (2) and (3) of this section.
- 2) From  $-20^{\circ}$  to  $+50^{\circ}$  centigrade for equipment to be licensed for use in the maritime services under part 80 of this chapter, except for class A, B, and S emergency position indicating radio beacons (EPIRBS), and equipment to be licensed for use above 952 MHz at operational fixed stations in all services, stations in the local television transmission service and point-to-point microwave radio service under part 21 of this chapter, equipment licensed for use aboard aircraft in the aviation services under part 87 of this chapter, and equipment authorized for use in the family radio service under part 95 of this chapter.
- 3) From  $0^{\circ}$  to  $+50^{\circ}$  centigrade for equipment to be licensed for use in the radio broadcast Services under part 73 of this chapter.

#### According to §2.1055(d),



The frequency stability shall be measured with variation of primary supply Voltage as follows:

- 1) Vary primary supply voltage from 85 to 115 percent of the nominal value for other than hand carried battery equipment.
- 2) For hand carried, battery powered equipment, reduce primary supply voltage to the battery operating and point which shall be specified by the manufacturer.
- 3) The supply voltage shall be measured at the input to the cable normally provided with the equipment, or at the power supply terminals if cables are not normally provided. Effects on frequency of transmitter keying (except for broadcast transmitters) and any heating element cycling at the nominal supply voltage and at each extreme also shall be shown.

#### According to §22.355 and RSS-132(5.3)

For FCC, the carrier frequency of each transmitter in the public mobile services must be maintained within the tolerances given in Table of this section. For mobile devices operating in the 824 to 849 MHz band at a power level than or equal to 3 Watts, the limit specified in Table C-1 is  $\pm 2.5$  ppm.

For ISED, the frequency stability shall be sufficient to ensure that the occupied bandwidth stays within each of the sub-bands when tested at the temperature and supply voltage variations specified in RSS-Gen

<p><b>Eurofins KCTL Co.,Ltd.</b>  65, Sinwon-ro, Yeongtong-gu,  Suwon-si, Gyeonggi-do, 16677, Korea  TEL: 82-70-5008-1021 FAX: 82-505-299-8311  <a href="http://www.kctl.co.kr">www.kctl.co.kr</a></p>	<p>Report No.:  KR23-SRF0135  Page (137) of (167)</p>	   
--	---	---

**According to §24.235 and RSS-133(6.3),**

For FCC, the frequency stability shall be sufficient to ensure that the fundamental emission stays within the authorized frequency block.

For ISED, the carrier frequency shall not depart from the reference frequency, in excess of  $\pm 2.5$  ppm for mobile stations and  $\pm 1.0$  ppm for base stations.

**According to §27.54 and RSS-130(4.5), RSS-199(4.3)**

For FCC&ISED, the frequency stability shall be sufficient to ensure that the fundamental emissions stay within the authorized bands of operation.

**According to §27.54 and RSS-139(5.4),**

For FCC, the frequency stability shall be sufficient to ensure that the fundamental emissions stay within the authorized bands of operation.

For ISED, the frequency stability shall be sufficient to ensure that the occupied bandwidth stay within the operating frequency block or frequency block group when tested to the temperature and supply voltage variations specified in RSS-Gen.

**Test procedure**

ANSI 63.26-2015 – Section 5.6

**Test settings**

- 1) The carrier frequency of the transmitter is measured at room temperature.  
(20°C to provide a reference)
- 2) The equipment is turned on in a “standby” condition for one minute before applying power to the transmitter. Measurement of the carrier frequency of the transmitter is made within one minute after applying power to the transmitter.
- 3) Frequency measurements are made at 10°C intervals ranging from -30°C to +50°C.  
A period of at least one half-hour is provided to allow stabilization of the equipment at each Temperature level.

**Test results**

Test mode : LTE Band 5  
 Frequency (Hz) : 836 500 000  
 Channel : 20525  
 Deviation limit(FCC) : ±0.00025% or 2.5ppm  
 Deviation limit(IC) : The frequency stability shall be sufficient to ensure that the occupied bandwidth stays within each of the sub-bands when tested at the temperature and supply voltage

Voltage (%)	Power (V)	Temp. (°C)	Frequency (Hz)	Frequency error (Hz)	Deviation	
					(ppm)	(%)
100%	3.88	+21.5(Ref)	836,499,997	2.96	0.0	0.000000
		-30	836,500,011	-11.34	0.0	0.000001
		-20	836,500,010	-10.11	0.0	0.000001
		-10	836,500,005	-5.31	0.0	0.000001
		0	836,500,003	-2.85	0.0	0.000000
		+10	836,499,996	4.16	0.0	0.000000
		+20	836,499,999	1.34	0.0	0.000000
		+30	836,499,997	3.48	0.0	0.000000
		+40	836,499,995	4.56	0.0	-0.000001
		+50	836,499,991	9.07	0.0	-0.000001
115%	4.46	+21.5(Ref)	836,499,998	2.07	0.0	0.000000
End point	3.40	+21.5(Ref)	836,499,997	2.96	0.0	0.000000

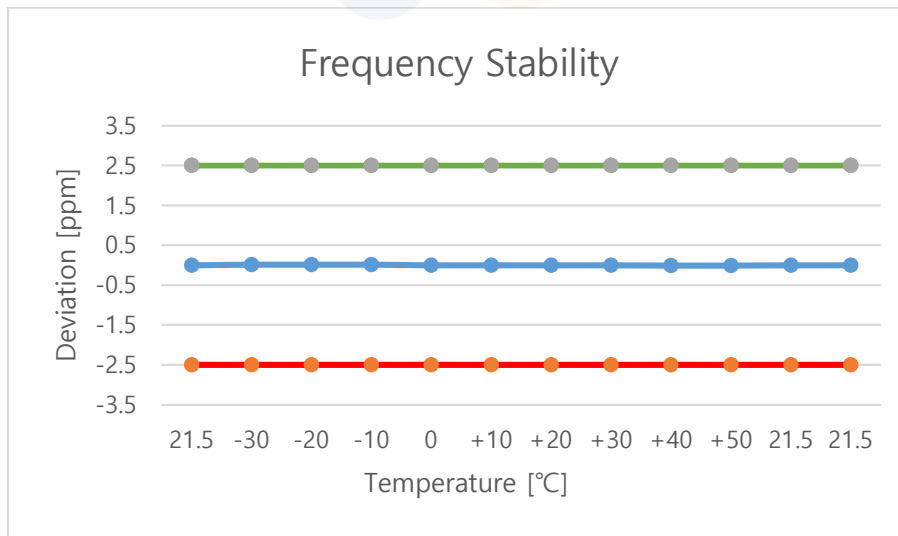

Test mode : LTE Band 7  
 Frequency (Hz) : 2 535 000 000  
 Channel : 21100  
 Deviation limit(FCC&IC) : The frequency stability shall be sufficient to ensure that the fundamental emission stay within the authorized bands of operation

Voltage (%)	Power (V)	Temp. (°C)	Frequency (Hz)	Frequency error (Hz)	Deviation	
					(ppm)	(%)
100%	3.88	+21.5(Ref)	2,535,000,002	-2.01	0.0	0.000000
		-30	2,534,999,993	7.34	0.0	0.000000
		-20	2,534,999,990	10.06	0.0	0.000000
		-10	2,534,999,989	11.38	0.0	0.000000
		0	2,534,999,992	8.11	0.0	0.000000
		+10	2,534,999,997	3.08	0.0	0.000000
		+20	2,535,000,003	-3.11	0.0	0.000000
		+30	2,535,000,005	-5.07	0.0	0.000000
		+40	2,535,000,004	-4.38	0.0	0.000000
115%	4.46	+21.5(Ref)	2,535,000,001	-1.38	0.0	0.000000
End point	3.40	+21.5(Ref)	2,535,000,003	-2.68	0.0	0.000000

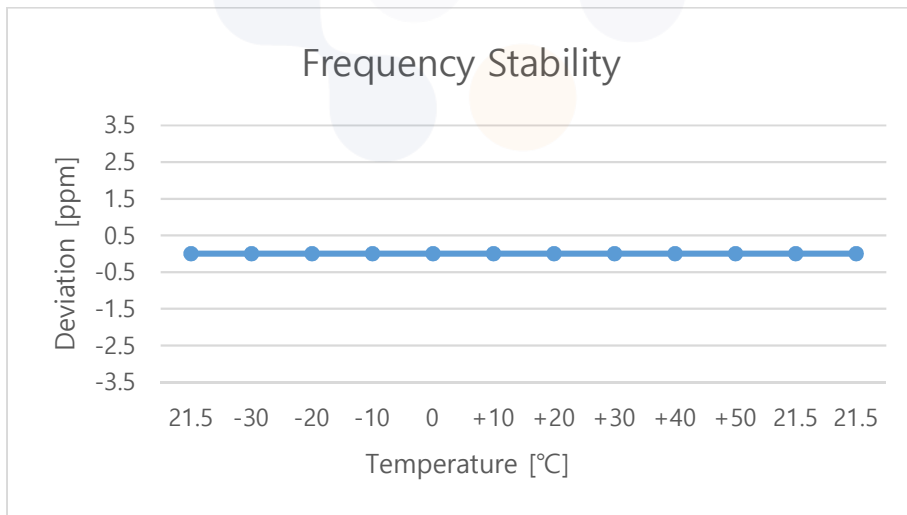



Test mode : LTE Band 12  
 Frequency (Hz) : 707 500 000  
 Channel : 23095  
 Deviation limit(FCC&IC) : The frequency stability shall be sufficient to ensure that the fundamental emission stay within the authorized bands of operation

Voltage (%)	Power (V)	Temp. (°C)	Frequency (Hz)	Frequency error (Hz)	Deviation	
					(ppm)	(%)
100%	3.88	+21.5(Ref)	707,499,999	-1.13	0.0	0.000000
		-30	707,500,008	7.66	0.0	0.000001
		-20	707,500,005	5.41	0.0	0.000001
		-10	707,500,013	13.09	0.0	0.000002
		0	707,500,008	8.11	0.0	0.000001
		+10	707,500,006	6.28	0.0	0.000001
		+20	707,499,998	-1.98	0.0	0.000000
		+30	707,499,996	-3.54	0.0	-0.000001
		+40	707,499,999	-1.05	0.0	0.000000
		+50	707,500,005	4.65	0.0	0.000001
115%	4.46	+21.5(Ref)	707,499,999	-1.16	0.0	0.000000
End point	3.40	+21.5(Ref)	707,499,997	-2.76	0.0	0.000000

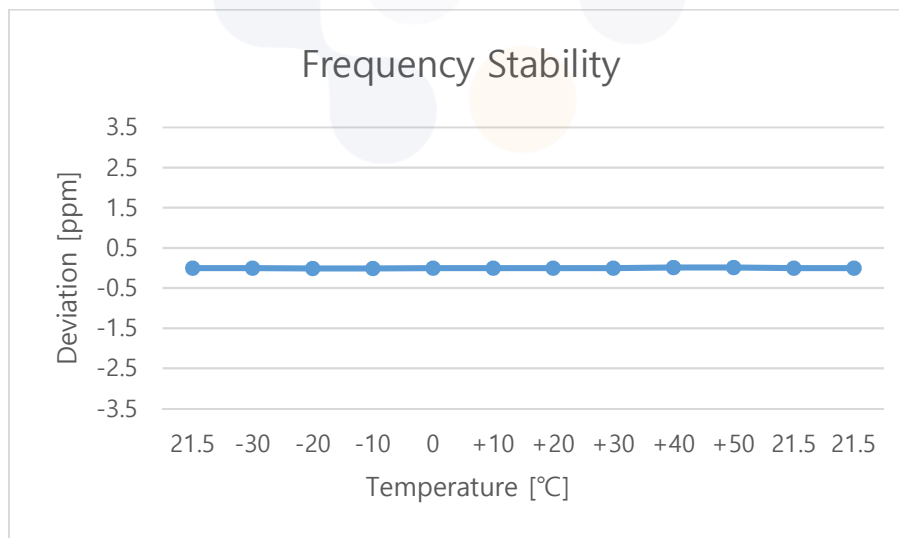

Test mode : LTE Band 13  
 Frequency (Hz) : 782 000 000  
 Channel : 23230  
 Deviation limit(FCC&IC) : The frequency stability shall be sufficient to ensure that the fundamental emission stay within the authorized bands of operation

Voltage (%)	Power (V)	Temp. (°C)	Frequency (Hz)	Frequency error (Hz)	Deviation	
					(ppm)	(%)
100%	3.88	+21.5(Ref)	781,999,999	-1.24	0.0	0.000000
		-30	781,999,997	-2.67	0.0	0.000000
		-20	781,999,995	-5.10	0.0	-0.000001
		-10	781,999,991	-9.46	0.0	-0.000001
		0	781,999,996	-3.78	0.0	0.000000
		+10	781,999,998	-1.98	0.0	0.000000
		+20	782,000,001	1.19	0.0	0.000000
		+30	782,000,004	3.50	0.0	0.000000
		+40	782,000,004	4.18	0.0	0.000001
		+50	782,000,006	5.55	0.0	0.000001
115%	4.46	+21.5(Ref)	781,999,999	-0.82	0.0	0.000000
End point	3.40	+21.5(Ref)	781,999,999	-0.64	0.0	0.000000

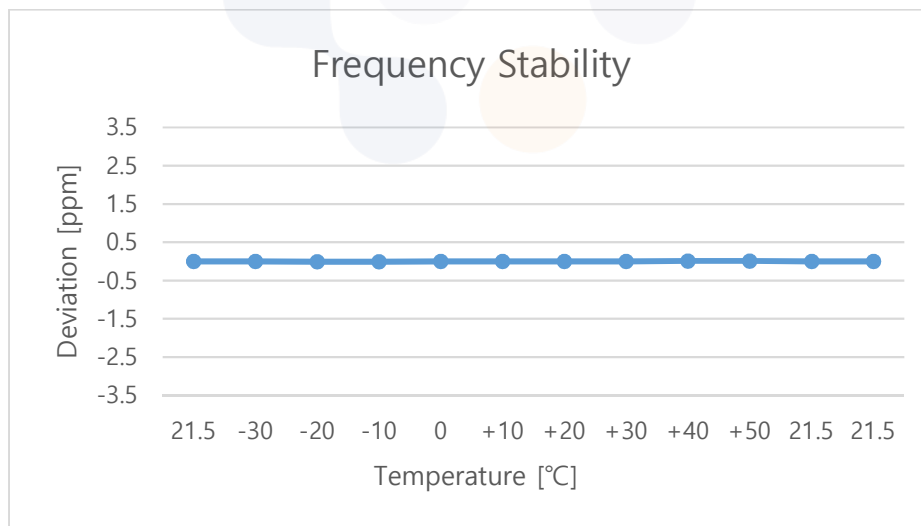

Test mode : LTE Band 25/2  
 Frequency (Hz) : 1 882 500 000  
 Channel : 26365  
 Deviation limit(FCC) : The frequency stability shall be sufficient to ensure that the fundamental emission stays within the authorized frequency block.  
 Deviation limit(IC) : ±0.00025% or 2.5ppm

Voltage (%)	Power (V)	Temp. (°C)	Frequency (Hz)	Frequency error (Hz)	Deviation	
					(ppm)	(%)
100%	3.88	+21.5(Ref)	1,882,500,002	1.54	0.0	0.000000
		-30	1,882,500,004	4.13	0.0	0.000000
		-20	1,882,500,009	9.03	0.0	0.000000
		-10	1,882,500,006	5.88	0.0	0.000000
		0	1,882,500,005	4.65	0.0	0.000000
		+10	1,882,500,003	3.04	0.0	0.000000
		+20	1,882,500,002	1.54	0.0	0.000000
		+30	1,882,499,997	-3.07	0.0	0.000000
		+40	1,882,499,996	-4.19	0.0	0.000000
		+50	1,882,499,993	-6.64	0.0	0.000000
115%	4.46	+21.5(Ref)	1,882,500,002	1.53	0.0	0.000000
End point	3.40	+21.5(Ref)	1,882,500,002	1.69	0.0	0.000000

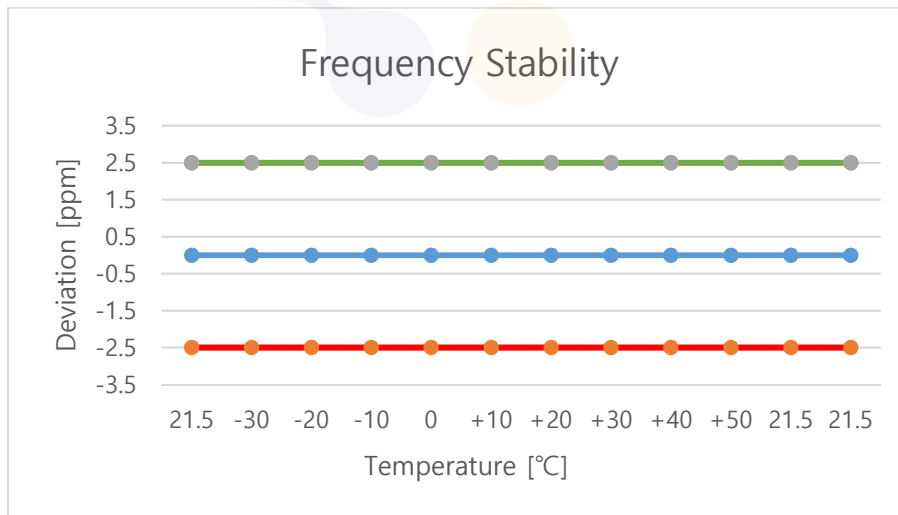

Test mode : LTE Band 26  
 Frequency (Hz) : 836 500 000  
 Channel : 26915  
 Deviation limit(FCC) : ±0.00025% or 2.5ppm  
 Deviation limit(IC) : The frequency stability shall be sufficient to ensure that the occupied bandwidth stays within each of the sub-bands when tested at the temperature and supply voltage

Voltage (%)	Power (V)	Temp. (°C)	Frequency (Hz)	Frequency error (Hz)	Deviation	
					(ppm)	(%)
100%	3.88	+21.5(Ref)	836,500,001	1.10	0.0	0.000000
		-30	836,500,008	7.85	0.0	0.000001
		-20	836,500,010	10.34	0.0	0.000001
		-10	836,500,004	4.08	0.0	0.000000
		0	836,500,003	3.33	0.0	0.000000
		+10	836,500,006	6.04	0.0	0.000001
		+20	836,500,002	1.86	0.0	0.000000
		+30	836,500,001	0.64	0.0	0.000000
		+40	836,499,994	-5.78	0.0	-0.000001
		+50	836,499,991	-9.06	0.0	-0.000001
115%	4.46	+21.5(Ref)	836,500,003	2.50	0.0	0.000000
End point	3.40	+21.5(Ref)	836,500,001	1.22	0.0	0.000000

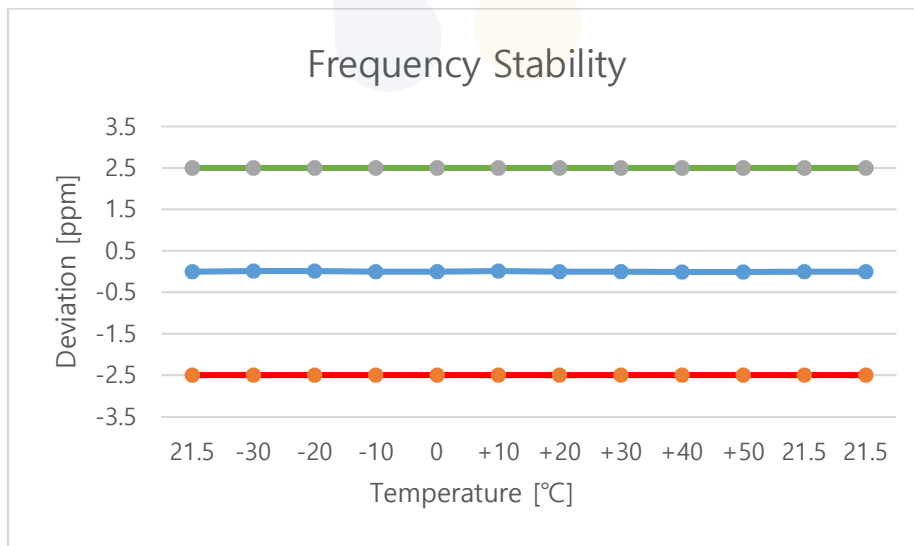

Test mode : LTE Band 66/4  
 Frequency (Hz) : 1 745 000 000  
 Channel : 132322  
 Deviation limit(FCC) : The frequency stability shall be sufficient to ensure that the fundamental emission stay within the authorized bands of operation.  
 Deviation limit(IC) : The frequency stability shall be sufficient to ensure that the occupied bandwidth stays within each of the sub-bands when tested at the temperature and supply voltage

Voltage (%)	Power (V)	Temp. (°C)	Frequency (Hz)	Frequency error (Hz)	Deviation	
					(ppm)	(%)
100%	3.88	+21.5(Ref)	1,745,000,003	3.15	0.0	0.000000
		-30	1,744,999,992	-8.06	0.0	0.000000
		-20	1,744,999,997	-3.46	0.0	0.000000
		-10	1,744,999,994	-5.57	0.0	0.000000
		0	1,744,999,997	-3.08	0.0	0.000000
		+10	1,744,999,997	-2.64	0.0	0.000000
		+20	1,745,000,004	4.38	0.0	0.000000
		+30	1,745,000,001	1.35	0.0	0.000000
		+40	1,745,000,003	3.06	0.0	0.000000
		+50	1,745,000,004	4.27	0.0	0.000000
115%	4.46	+21.5(Ref)	1,745,000,003	3.33	0.0	0.000000
End point	3.40	+21.5(Ref)	1,745,000,005	5.09	0.0	0.000000

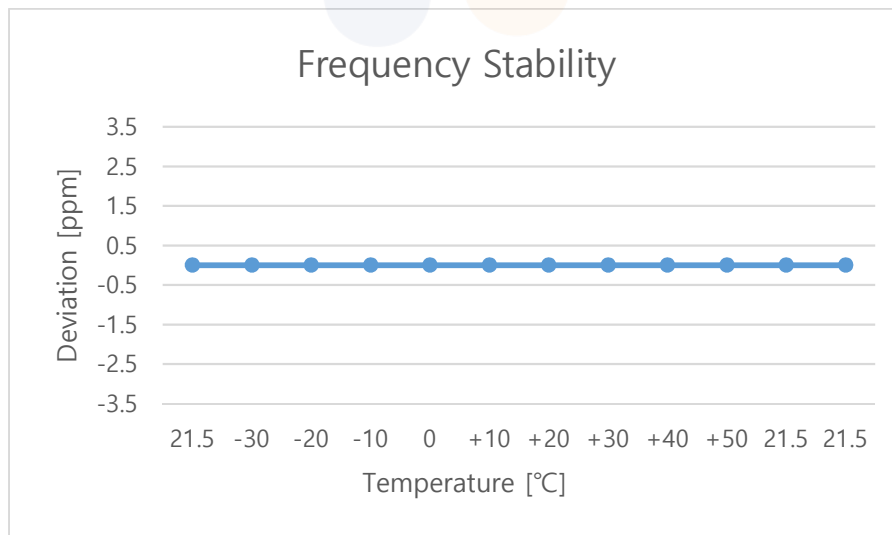

Test mode : LTE Band 71  
 Frequency (Hz) : 680 500 000  
 Channel : 133297  
 Deviation limit(FCC) : The frequency stability shall be sufficient to ensure that the fundamental emission stay within the authorized bands of operation.

Voltage (%)	Power (V)	Temp. (°C)	Frequency (Hz)	Frequency error (Hz)	Deviation	
					(ppm)	(%)
100%	3.88	+21.5(Ref)	680,500,001	0.64	0.0	0.000000
		-30	680,499,996	-4.38	0.0	-0.000001
		-20	680,500,004	3.54	0.0	0.000001
		-10	680,500,008	8.02	0.0	0.000001
		0	680,500,005	4.65	0.0	0.000001
		+10	680,500,003	2.89	0.0	0.000000
		+20	680,500,001	1.30	0.0	0.000000
		+30	680,500,002	2.22	0.0	0.000000
		+40	680,500,005	5.02	0.0	0.000001
		+50	680,500,004	4.18	0.0	0.000001
115%	4.46	+21.5(Ref)	680,500,001	0.86	0.0	0.000000
End point	3.40	+21.5(Ref)	680,500,001	0.92	0.0	0.000000

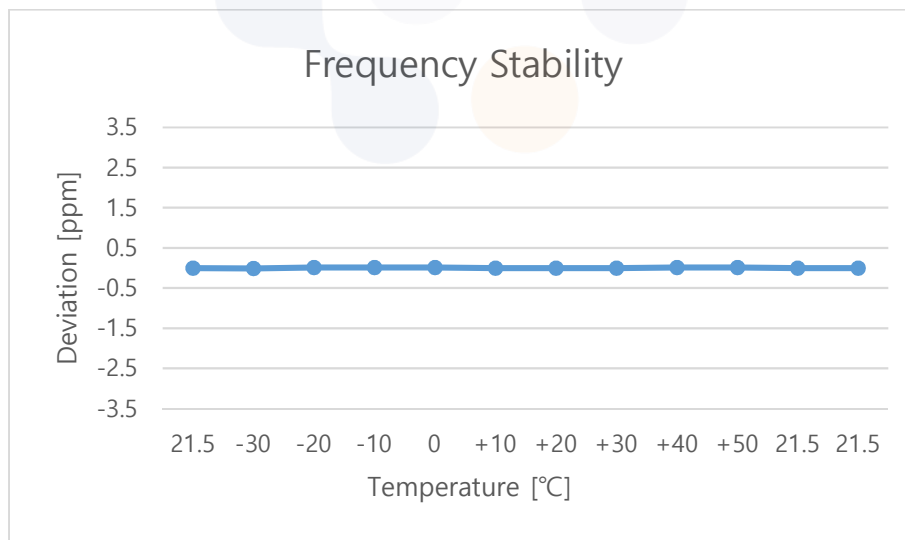

## 7.7. Radiated Power (ERP/EIRP)

### Test setup

The diagram below shows the test setup that is utilized to make the measurements for emission from 30 MHz to 1 GHz emissions.

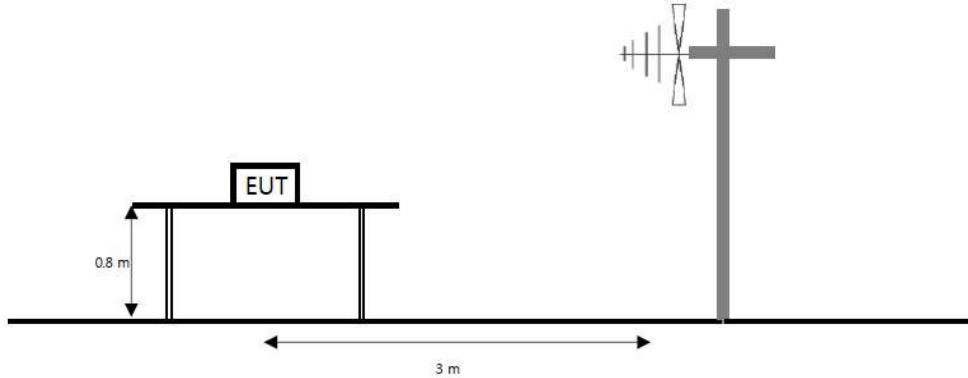

The diagram below shows the test setup that is utilized to make the measurements for emission from 1 GHz to the tenth harmonic of the highest fundamental frequency or to 40 GHz emissions, whichever is lower.

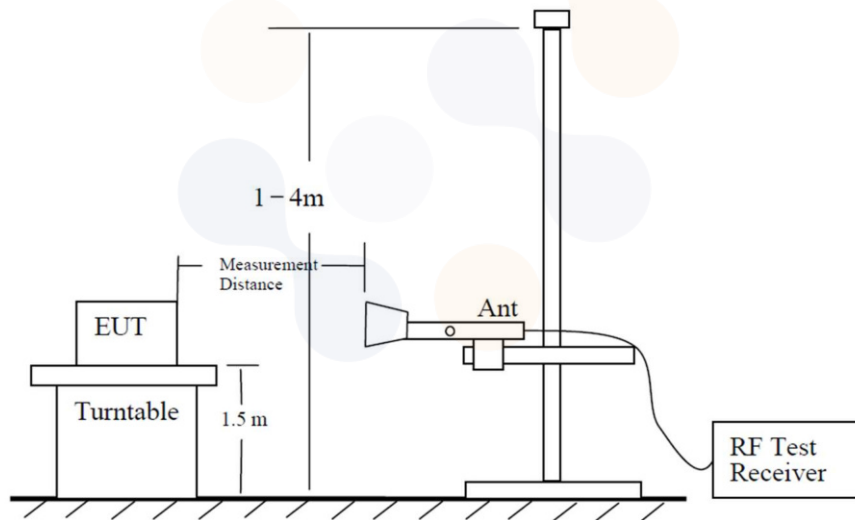

The diagram below shows the test setup for substituted method.

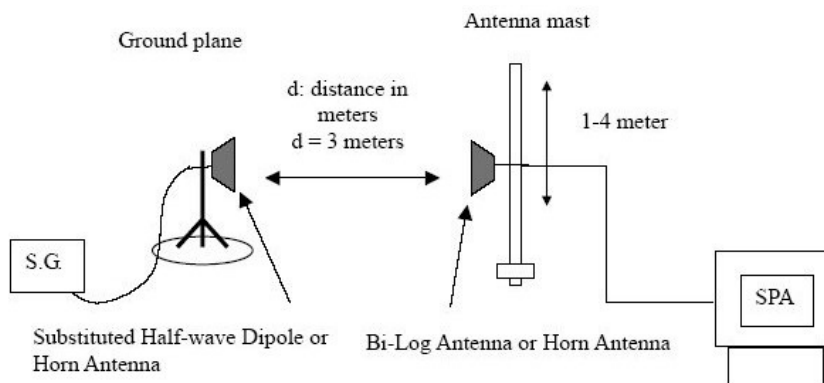

### **Limit**

According to §22.913(a)(5), the ERP of transmitters in the cellular radiotelephone service must not exceed the limits in this section. The ERP of mobile transmitters and auxiliary test transmitters must not exceed 7 watts.

According to RSS-132(5.4), the equivalent radiated power (e.r.p.) shall not exceed 7 watts for mobile equipment and 3 watts for portable equipment.

According to §24.232(c) and RSS-133(6.4), Mobile and portable stations are limited to 2 watts EIRP and the equipment must employ a means for limiting power to the minimum necessary for successful communications.

According to §27.50(b)(10), 27.50(c)(10) and RSS-130(4.6), Portable stations (hand-held devices) in the 698 -746 MHz, 746-757 MHz, 776-788 MHz, and 805-806 MHz bands are limited 3 watts ERP.

According to §27.50(d)(4), Fixed, mobile and portable (hand-held) stations operating in the 1710-1755 MHz and 1755-1780 MHz bands are limited to 1 watt EIRP.

According to RSS-139(5.5), the equivalent isotropically radiated power (e.i.r.p.) for mobile and portable transmitters shall not exceed one watt. The e.i.r.p. for fixed and base stations in the band 1710-1780 MHz shall not exceed one watt(30 dBm e.i.r.p./channel bandwidth).

According to §27.57(h), mobile stations are limited to 2.0 watts EIRP. All user stations are limited to 2.0 watts transmitter output power.

According to RSS-199(4.4), for mobile subscriber equipment, the e.i.r.p. shall not exceed 2 W.



### **Test procedure**

971168 D01 v03r01 - Section 5.2 and 5.8, 412172 D01 v01r01  
ANSI 63.26-2015 – Section 5.2  
ANSI/TIA-603-E-2016 - Section 2.2.17

### **Test settings**

- 1) RBW = 1 % to 5 % of the OBW.
- 2) VBW  $\geq 3 \times$  RBW.
- 3) SPAN = 2  $\times$  to 3  $\times$  the OBW.
- 4) Number of measurement points in sweep  $\geq 2 \times$  span / RBW.
- 5) Sweep time :
  - 1) Auto couple, or
  - 2)  $\geq [10 \times (\text{number of points in sweep}) \times (\text{transmission period})]$  for single sweep (automation-compatible) measurement. Transmission period is the on and off time of the transmitter.
- 6) Detector = RMS
- 7) If the EUT can be configured to transmit continuously, then set the trigger to free run.
- 8) If the EUT cannot be configured to transmit continuously, then use a sweep trigger with the level set to enable triggering only on full power bursts and configure the EUT to transmit at full power for the entire duration of each sweep. Verify that the sweep time is less than or equal to the transmission burst duration. Time gating can also be used under similar constraints (i.e., configured such that measurement data is collected only during active full-power transmissions).
- 9) Trace mode = trace averaging (RMS) over 100 sweeps.
- 10) Compute the power by integrating the spectrum across the OBW of the signal using the instrument's band or channel power measurement function, with the band/channel limits



<p><b>Eurofins KCTL Co.,Ltd.</b>  65, Sinwon-ro, Yeongtong-gu,  Suwon-si, Gyeonggi-do, 16677, Korea  TEL: 82-70-5008-1021 FAX: 82-505-299-8311  <a href="http://www.kctl.co.kr">www.kctl.co.kr</a></p>	<p>Report No.:  KR23-SRF0135  Page (148) of (167)</p>	 
--	---	---

set equal to the OBW band edges. If the instrument does not have a band or channel power function, then sum the spectrum levels (in linear power units) at intervals equal to the RBW extending across the entire OBW of the spectrum.

11) Allow trace to fully stabilize.

**Notes:**

1. On a test site, the EUT shall be placed at 80 cm or 1.5 m height on a turn table, and in the position close to normal use as declared by the applicant.
2. The test antenna shall be oriented initially for vertical polarization located 3 m from EUT to correspond to the fundamental frequency of the transmitter.
3. The turntable is rotated through 360°, and the receiving antenna scans in order to determine the Level of the maximized emission.
4. The test antenna shall be raised and lowered again through the specified range of height until the maximum signal level is detected by the measuring receiver.
5. The maximum signal level detected by the measuring receiver shall be noted.
6. The EUT was replaced by half-wave dipole (1 GHz below) or horn antenna (1 GHz above) connected to a signal generator.  
The power is calculated by the following formula;  

$$P_d(\text{dBm}) = P_g(\text{dBm}) - \text{Cable loss (dB)} + \text{Antenna gain (dB)}$$
Note.  $P_d$  is the dipole equivalent power and  $P_g$  is the generator output power into the substitution antenna.
7. The test antenna shall be raised and lowered through the specified range of height to ensure that The maximum signal is received.
8. The input signal to the substitution antenna shall be adjusted to the level that produces a level Detected by the measuring corrected for the change of input attenuator setting of the measuring Receiver.
9. The input level to the substitution antenna shall be recorded as power level in dBm, corrected for Any change of input attenuator setting of the measuring receiver.
10. The measurement shall be repeated with the test antenna and the substitution antenna Orientated for horizontal polarization.

## Test results

### Test mode: LTE Band 5

Bandwidth	Modulation	Frequency	Pol.	Antenna Gain	C.L	Substitute Level	ERP	
		[MHz]	[V/H]	[dBd]	[dB]	[dBm]	[dBm]	[W]
1.4 M	QPSK	824.70	H	5.24	2.66	12.03	14.61	0.029
		836.50	H	5.40	2.58	12.64	15.46	0.035
		848.30	H	5.48	2.39	13.59	16.68	0.047
	16QAM	824.70	H	5.24	2.66	10.72	13.30	0.021
		836.50	H	5.40	2.58	11.30	14.12	0.026
		848.30	H	5.48	2.39	12.10	15.19	0.033
3 M	QPSK	825.50	H	5.27	2.67	12.13	14.72	0.030
		836.50	H	5.40	2.58	12.70	15.52	0.036
		847.50	H	5.48	2.58	13.31	16.20	0.042
	16QAM	825.50	H	5.27	2.67	10.67	13.26	0.021
		836.50	H	5.40	2.58	11.46	14.28	0.027
		847.50	H	5.48	2.58	11.91	14.80	0.030
5 M	QPSK	826.50	H	5.30	2.78	12.21	14.72	0.030
		836.50	H	5.40	2.58	12.69	15.51	0.036
		846.50	H	5.47	2.16	13.18	16.48	0.044
	16QAM	826.50	H	5.30	2.78	10.79	13.30	0.021
		836.50	H	5.40	2.58	11.35	14.17	0.026
		846.50	H	5.47	2.16	11.58	14.88	0.031
10 M	QPSK	829.00	H	5.37	2.57	12.17	14.97	0.031
		836.50	H	5.40	2.58	12.42	15.24	0.033
		844.00	H	5.44	2.78	12.74	15.40	0.035
	16QAM	829.00	H	5.37	2.57	10.68	13.48	0.022
		836.50	H	5.40	2.58	11.10	13.92	0.025
		844.00	H	5.44	2.78	11.21	13.87	0.024

Note.

1. E.R.P & E.I.R.P(dBm) = Substitute Level(dB) + Antenna gain(dBi&dBd) - C.L(Cable loss) (dB)

**Test mode: LTE Band 7**

Bandwidth	Modulation	Frequency	Pol.	Antenna Gain	C.L	Substitute Level	EIRP	
		[MHz]	[V/H]	[dBi]	[dB]	[dBm]	[dBm]	[W]
5 M	QPSK	2 502.50	V	6.20	5.91	12.70	12.99	0.020
		2 535.00	V	6.24	5.98	10.45	10.70	0.012
		2 567.50	V	6.27	6.20	10.80	10.87	0.012
	16QAM	2 502.50	V	6.20	5.91	11.58	11.87	0.015
		2 535.00	V	6.24	5.98	9.55	9.80	0.010
		2 567.50	V	6.27	6.20	9.72	9.79	0.010
10 M	QPSK	2 505.00	V	6.21	5.95	13.23	13.48	0.022
		2 535.00	V	6.24	5.98	10.45	10.70	0.012
		2 565.00	V	6.27	6.19	10.63	10.70	0.012
	16QAM	2 505.00	V	6.21	5.95	12.30	12.55	0.018
		2 535.00	V	6.24	5.98	9.21	9.46	0.009
		2 565.00	V	6.27	6.19	9.62	9.69	0.009
15 M	QPSK	2 507.50	V	6.21	5.97	12.51	12.75	0.019
		2 535.00	V	6.24	5.98	10.35	10.60	0.011
		2 562.50	V	6.26	6.19	10.58	10.65	0.012
	16QAM	2 507.50	V	6.21	5.97	11.03	11.27	0.013
		2 535.00	V	6.24	5.98	9.59	9.84	0.010
		2 562.50	V	6.26	6.19	9.58	9.65	0.009
20 M	QPSK	2 510.00	V	6.21	5.98	11.62	11.85	0.015
		2 535.00	V	6.24	5.98	10.56	10.81	0.012
		2 560.00	V	6.26	6.19	11.11	11.18	0.013
	16QAM	2 510.00	V	6.21	5.98	10.28	10.51	0.011
		2 535.00	V	6.24	5.98	9.27	9.52	0.009
		2 560.00	V	6.26	6.19	9.94	10.01	0.010

Note.

1. E.R.P & E.I.R.P(dBm) = Substitute Level(dB) + Antenna gain(dBi&dBd) - C.L(Cable loss) (dB)

**Test mode: LTE Band 12**

Bandwidth	Modulation	Frequency	Pol.	Antenna Gain	C.L	Substitute Level	ERP	
		[MHz]	[V/H]	[dBd]	[dB]	[dBm]	[dBm]	[W]
1.4 M	QPSK	699.70	H	4.50	2.45	11.48	13.53	0.023
		707.50	H	4.65	2.29	11.37	13.73	0.024
		715.30	H	4.65	2.37	10.93	13.21	0.021
	16QAM	699.70	H	4.50	2.45	10.19	12.24	0.017
		707.50	H	4.65	2.29	10.14	12.50	0.018
		715.30	H	4.65	2.37	9.54	11.82	0.015
3 M	QPSK	700.50	H	4.51	2.69	11.45	13.27	0.021
		707.50	H	4.65	2.29	11.33	13.69	0.023
		714.50	H	4.66	2.42	10.99	13.22	0.021
	16QAM	700.50	H	4.51	2.69	9.86	11.68	0.015
		707.50	H	4.65	2.29	9.99	12.35	0.017
		714.50	H	4.66	2.42	10.02	12.25	0.017
5 M	QPSK	701.50	H	4.53	2.50	11.44	13.47	0.022
		707.50	H	4.65	2.29	11.30	13.66	0.023
		713.50	H	4.67	2.15	11.10	13.61	0.023
	16QAM	701.50	H	4.53	2.50	10.04	12.07	0.016
		707.50	H	4.65	2.29	9.93	12.29	0.017
		713.50	H	4.67	2.15	9.76	12.27	0.017
10 M	QPSK	704.00	H	4.58	2.73	11.63	13.48	0.022
		707.50	H	4.65	2.29	11.50	13.86	0.024
		711.00	H	4.69	2.46	11.18	13.41	0.022
	16QAM	704.00	H	4.58	2.73	10.03	11.88	0.015
		707.50	H	4.65	2.29	9.95	12.31	0.017
		711.00	H	4.69	2.46	9.85	12.08	0.016

**Test mode: LTE Band 13**

Bandwidth	Modulation	Frequency	Pol.	Antenna Gain	C.L	Substitute Level	ERP	
		[MHz]	[V/H]	[dBd]	[dB]	[dBm]	[dBm]	[W]
5 M	QPSK	779.50	H	5.30	2.78	13.14	15.66	0.037
		782.00	H	5.30	2.64	13.05	15.71	0.037
		784.50	H	5.30	2.63	12.81	15.48	0.035
	16QAM	779.50	H	5.30	2.78	11.72	14.24	0.027
		782.00	H	5.30	2.64	12.11	14.77	0.030
		784.50	H	5.30	2.63	11.54	14.21	0.026
10 M	QPSK	782.00	H	5.30	2.64	13.07	15.73	0.037
	16QAM	782.00	H	5.30	2.64	11.35	14.01	0.025

Note.

1. E.R.P & E.I.R.P(dBm) = Substitute Level(dB) + Antenna gain(dBi&dBd) - C.L(Cable loss) (dB)

**Test mode: LTE Band 25/2**

Bandwidth	Modulation	Frequency	Pol.	Antenna Gain	C.L	Substitute Level	EIRP	
		[MHz]	[V/H]	[dBi]	[dB]	[dBm]	[dBm]	[W]
1.4 M	QPSK	1 850.70	H	5.60	5.17	17.09	17.52	0.056
		1 882.50	H	5.54	5.08	18.63	19.08	0.081
		1 914.30	H	5.47	5.29	16.99	17.17	0.052
	16QAM	1 850.70	H	5.60	5.17	15.76	16.19	0.042
		1 882.50	H	5.54	5.08	17.28	17.73	0.059
		1 914.30	H	5.47	5.29	15.98	16.16	0.041
3 M	QPSK	1 851.50	H	5.60	5.18	17.51	17.93	0.062
		1 882.50	H	5.54	5.08	18.73	19.18	0.083
		1 913.50	H	5.47	5.29	17.45	17.63	0.058
	16QAM	1 851.50	H	5.60	5.18	15.79	16.21	0.042
		1 882.50	H	5.54	5.08	17.18	17.63	0.058
		1 913.50	H	5.47	5.29	16.20	16.38	0.043
5 M	QPSK	1 852.50	H	5.60	5.18	17.18	17.59	0.057
		1 882.50	H	5.54	5.08	18.44	18.89	0.077
		1 912.50	H	5.48	5.21	18.06	18.32	0.068
	16QAM	1 852.50	H	5.60	5.18	16.66	17.07	0.051
		1 882.50	H	5.54	5.08	16.98	17.43	0.055
		1 912.50	H	5.48	5.21	16.83	17.09	0.051
10 M	QPSK	1 855.00	H	5.59	5.19	17.26	17.66	0.058
		1 882.50	H	5.54	5.08	18.34	18.79	0.076
		1 910.00	H	5.48	5.24	18.33	18.57	0.072
	16QAM	1 855.00	H	5.59	5.19	15.73	16.13	0.041
		1 882.50	H	5.54	5.08	16.99	17.44	0.055
		1 910.00	H	5.48	5.24	16.79	17.03	0.050
15 M	QPSK	1 857.50	H	5.59	5.21	16.98	17.35	0.054
		1 882.50	H	5.54	5.08	18.10	18.55	0.072
		1 907.50	H	5.49	5.31	17.29	17.46	0.056
	16QAM	1 857.50	H	5.59	5.21	15.52	15.89	0.039
		1 882.50	H	5.54	5.08	16.94	17.39	0.055
		1 907.50	H	5.49	5.31	16.15	16.32	0.043
20 M	QPSK	1 860.00	H	5.58	5.17	17.21	17.62	0.058
		1 882.50	H	5.54	5.08	18.12	18.57	0.072
		1 905.00	H	5.49	5.26	17.29	17.52	0.056
	16QAM	1 860.00	H	5.58	5.17	15.90	16.31	0.043
		1 882.50	H	5.54	5.08	16.76	17.21	0.053
		1 905.00	H	5.49	5.26	16.01	16.24	0.042

Note.

1. E.R.P & E.I.R.P(dBm) = Substitute Level(dB) + Antenna gain(dBi&dBd) - C.L(Cable loss) (dB)

**Test mode: LTE Band 26**

Bandwidth	Modulation	Frequency	Pol.	Antenna Gain	C.L	Substitute Level	ERP	
		[MHz]	[V/H]	[dBd]	[dB]	[dBm]	[dBm]	[W]
1.4 M	QPSK	824.70	H	5.24	2.66	12.47	15.05	0.032
		836.50	H	5.40	2.58	12.29	15.11	0.032
		848.30	H	5.48	2.39	12.90	15.99	0.040
	16QAM	824.70	H	5.24	2.66	11.02	13.60	0.023
		836.50	H	5.40	2.58	10.92	13.74	0.024
		848.30	H	5.48	2.39	11.70	14.79	0.030
3 M	QPSK	825.50	H	5.27	2.67	12.43	15.02	0.032
		836.50	H	5.40	2.58	12.55	15.37	0.034
		847.50	H	5.48	2.58	12.52	15.41	0.035
	16QAM	825.50	H	5.27	2.67	10.73	13.32	0.021
		836.50	H	5.40	2.58	10.93	13.75	0.024
		847.50	H	5.48	2.58	11.46	14.35	0.027
5 M	QPSK	826.50	H	5.30	2.78	12.51	15.02	0.032
		836.50	H	5.40	2.58	12.31	15.13	0.033
		846.50	H	5.47	2.16	12.74	16.04	0.040
	16QAM	826.50	H	5.30	2.78	11.22	13.73	0.024
		836.50	H	5.40	2.58	11.00	13.82	0.024
		846.50	H	5.47	2.16	11.50	14.80	0.030
10 M	QPSK	829.00	H	5.37	2.57	12.72	15.52	0.036
		836.50	H	5.40	2.58	12.30	15.12	0.033
		844.00	H	5.44	2.78	12.79	15.45	0.035
	16QAM	829.00	H	5.37	2.57	11.00	13.80	0.024
		836.50	H	5.40	2.58	10.87	13.69	0.023
		844.00	H	5.44	2.78	11.45	14.11	0.026
15 M	QPSK	831.50	H	5.40	2.52	12.42	15.30	0.034
		836.50	H	5.40	2.58	12.34	15.16	0.033
		841.50	H	5.42	2.75	12.24	14.90	0.031
	16QAM	831.50	H	5.40	2.52	10.93	13.81	0.024
		836.50	H	5.40	2.58	11.28	14.10	0.026
		841.50	H	5.42	2.75	10.87	13.53	0.023

Note.

1. E.R.P & E.I.R.P(dBm) = Substitute Level(dB) + Antenna gain(dBi&dBd) - C.L(Cable loss) (dB)

**Test mode: LTE Band 66/4**

Bandwidth	Modulation	Frequency	Pol.	Antenna Gain	C.L	Substitute Level	EIRP	
		[MHz]	[V/H]	[dBi]	[dB]	[dBm]	[dBm]	[W]
1.4 M	QPSK	1 710.70	H	5.88	5.20	15.11	15.79	0.038
		1 745.00	H	5.81	5.21	16.60	17.20	0.052
		1 779.30	H	5.74	5.26	16.96	17.44	0.055
	16QAM	1 710.70	H	5.88	5.20	13.59	14.27	0.027
		1 745.00	H	5.81	5.21	15.05	15.65	0.037
		1 779.30	H	5.74	5.26	15.55	16.03	0.040
3 M	QPSK	1 711.50	H	5.88	5.19	15.32	16.01	0.040
		1 745.00	H	5.81	5.21	16.65	17.25	0.053
		1 778.50	H	5.74	5.26	16.98	17.46	0.056
	16QAM	1 711.50	H	5.88	5.19	13.72	14.41	0.028
		1 745.00	H	5.81	5.21	15.26	15.86	0.039
		1 778.50	H	5.74	5.26	15.30	15.78	0.038
5 M	QPSK	1 712.50	H	5.88	5.16	15.54	16.25	0.042
		1 745.00	H	5.81	5.21	16.86	17.46	0.056
		1 777.50	H	5.75	5.28	17.29	17.75	0.060
	16QAM	1 712.50	H	5.88	5.16	14.10	14.81	0.030
		1 745.00	H	5.81	5.21	15.44	16.04	0.040
		1 777.50	H	5.75	5.28	16.01	16.47	0.044
10 M	QPSK	1 715.00	H	5.87	5.08	16.33	17.12	0.052
		1 745.00	H	5.81	5.21	16.79	17.39	0.055
		1 775.00	H	5.75	5.23	17.41	17.93	0.062
	16QAM	1 715.00	H	5.87	5.08	14.85	15.64	0.037
		1 745.00	H	5.81	5.21	15.34	15.94	0.039
		1 775.00	H	5.75	5.23	15.97	16.49	0.045
15 M	QPSK	1 717.50	H	5.87	5.17	15.69	16.38	0.043
		1 745.00	H	5.81	5.21	16.51	17.11	0.051
		1 772.50	H	5.76	5.26	17.20	17.69	0.059
	16QAM	1 717.50	H	5.87	5.17	14.73	15.42	0.035
		1 745.00	H	5.81	5.21	15.04	15.64	0.037
		1 772.50	H	5.76	5.26	15.68	16.17	0.041
20 M	QPSK	1 720.00	H	5.86	5.19	16.10	16.77	0.048
		1 745.00	H	5.81	5.21	16.24	16.84	0.048
		1 770.00	H	5.76	5.29	16.96	17.43	0.055
	16QAM	1 720.00	H	5.86	5.19	15.17	15.84	0.038
		1 745.00	H	5.81	5.21	14.90	15.50	0.035
		1 770.00	H	5.76	5.29	15.54	16.01	0.040

Note.

1. E.R.P & E.I.R.P(dBm) = Substitute Level(dB) + Antenna gain(dBi&dBd) - C.L(Cable loss) (dB)

**Test mode: LTE Band 71**

Bandwidth	Modulation	Frequency	Pol.	Antenna Gain	C.L	Substitute Level	ERP	
		[MHz]	[V/H]	[dBd]	[dB]	[dBm]	[dBm]	[W]
5 M	QPSK	665.50	H	4.84	2.48	11.66	14.01	0.025
		680.50	H	4.51	2.43	12.81	14.88	0.031
		695.50	H	4.55	2.67	12.75	14.62	0.029
	16QAM	665.50	H	4.84	2.48	10.07	12.42	0.017
		680.50	H	4.51	2.43	11.26	13.33	0.022
		695.50	H	4.55	2.67	11.45	13.32	0.021
10 M	QPSK	668.00	H	4.76	2.52	12.46	14.70	0.030
		680.50	H	4.51	2.43	13.03	15.10	0.032
		693.00	H	4.57	2.51	12.91	14.97	0.031
	16QAM	668.00	H	4.76	2.52	11.11	13.35	0.022
		680.50	H	4.51	2.43	11.55	13.62	0.023
		693.00	H	4.57	2.51	11.58	13.64	0.023
15 M	QPSK	670.50	H	4.69	2.42	12.15	14.42	0.028
		680.50	H	4.51	2.43	12.49	14.56	0.029
		690.50	H	4.60	2.58	12.43	14.44	0.028
	16QAM	670.50	H	4.69	2.42	10.61	12.88	0.019
		680.50	H	4.51	2.43	11.10	13.17	0.021
		690.50	H	4.60	2.58	11.19	13.20	0.021
20 M	QPSK	673.00	H	4.64	2.58	12.51	14.57	0.029
		680.50	H	4.51	2.43	12.65	14.72	0.030
		688.00	H	4.58	2.58	12.70	14.70	0.030
	16QAM	673.00	H	4.64	2.58	10.98	13.04	0.020
		680.50	H	4.51	2.43	11.42	13.49	0.022
		688.00	H	4.58	2.58	11.30	13.30	0.021

Note.

1. E.R.P & E.I.R.P(dBm) = Substitute Level(dB) + Antenna gain(dBi&dBd) - C.L(Cable loss) (dB)



## 7.8. Radiated Spurious Emissions

### Test setup

The diagram below shows the test setup that is utilized to make the measurements for emission from 30 MHz to 1 GHz emissions.

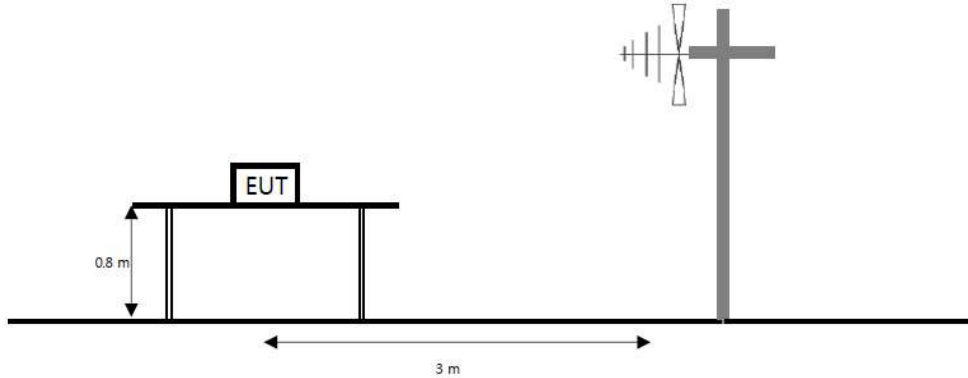

The diagram below shows the test setup that is utilized to make the measurements for emission from 1 GHz to the tenth harmonic of the highest fundamental frequency or to 40 GHz emissions, whichever is lower.

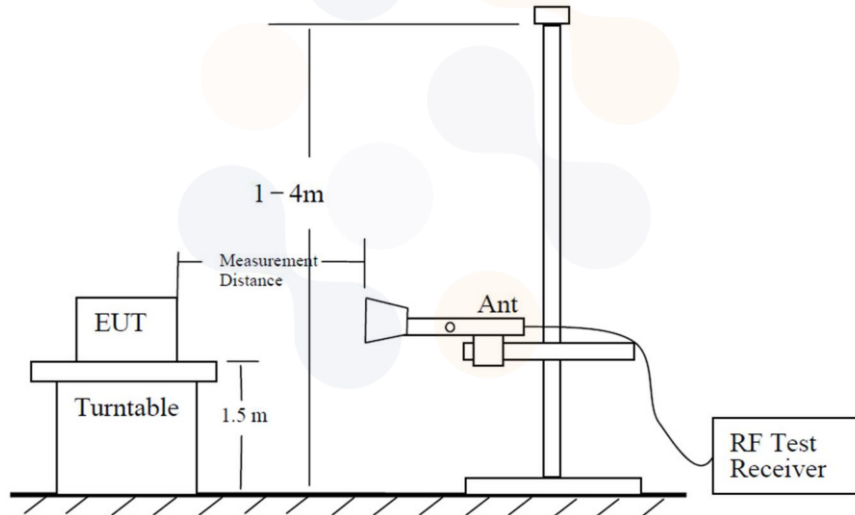

The diagram below shows the test setup for substituted method.

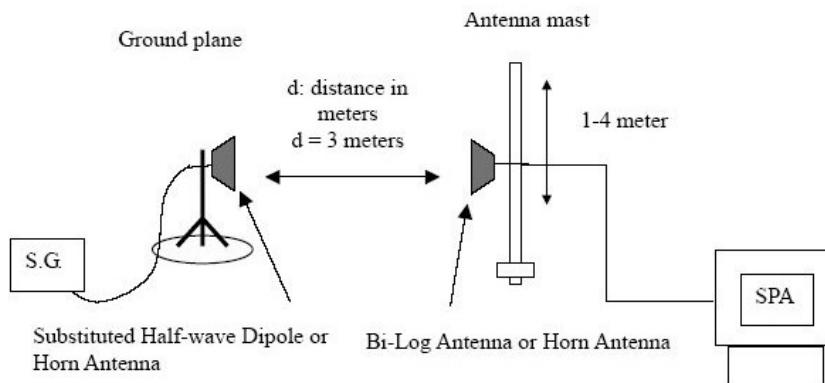

### **Limit**

According to §22.917(a), §24.238(a) and RSS-132(5.5), RSS-133(6.5), the power of any emission outside of the authorized operating frequency ranges must be attenuated below the transmitting power (P) by a factor of at least  $43 + 10\log(P_{\text{[Watts]}})$  dB.

According to §27.53(c)(2) and RSS-130(4.7), on any frequency outside the 776-788 MHz band, the power of any emission shall be attenuated outside the band below the transmitter power (P) by at least  $43 + 10\log(P_{\text{[Watts]}})$  dB.

According to §27.53(f) and RSS-130(4.7), for operations in the 746-758 MHz, 775-788 MHz, and 805-806 MHz bands, emissions in the band 1559-1610 MHz shall be limited to -70 dBW/MHz equivalent isotropically radiated power (EIRP) for wideband signals, and -80 dBW EIRP for discrete emissions of less than 700 Hz bandwidth. For the purpose of equipment authorization, a transmitter shall be tested with an antenna that is representative of the type that will be used with the equipment in normal operation.

According to §27.53(g) and RSS-130(4.7), for operations in the 600 MHz band and the 698-746 MHz band, the power of any emission outside a licensee's frequency band(s) of operation shall be attenuated below the transmitter power (P) within the licensed band(s) of operation, measured in watts, by at least  $43 + 10\log(P_{\text{[Watts]}})$  dB.

According to §27.53(h) and RSS-139(5.6), the power of any emission outside a licensee's frequency block shall be attenuated below the transmitter power (P) in watts by at least  $43 + 10\log(P_{\text{[Watts]}})$  dB.



According to §27.53(m) and RSS-199(4.5), the minimum permissible attenuation level of any spurious emission is  $55 + 10\log(P_{\text{[Watts]}})$  dB.

### **Test procedure**

971168 D01 v03r01 - Section 6.2  
ANSI 63.26-2015 – Section 5.5  
ANSI/TIA-603-E-2016 - Section 2.2.12

### **Test settings**

- 1) RBW = 100 kHz for below 1 GHz and 1 MHz for above 1 GHz.
- 2) VBW  $\geq 3 \times$  RBW.
- 3) Detector = RMS
- 4) Trace mode = Max hold
- 5) Sweep time = Auto couple
- 6) Number of sweep points  $\geq 2 \times$  span / RBW
- 7) Allow trace to fully stabilize.

<p><b>Eurofins KCTL Co.,Ltd.</b> 65, Sinwon-ro, Yeongtong-gu, Suwon-si, Gyeonggi-do, 16677, Korea TEL: 82-70-5008-1021 FAX: 82-505-299-8311 <a href="http://www.kctl.co.kr">www.kctl.co.kr</a></p>	<p>Report No.: KR23-SRF0135 Page (158) of (167)</p>	<p>   </p>
--	---	--

**Notes:**

1. On a test site, the EUT shall be placed at 80 cm or 1.5 m height on a turn table, and in the position close to normal use as declared by the applicant.
2. The test antenna shall be oriented initially for vertical polarization located 3 m from EUT to correspond to the fundamental frequency of the transmitter.
3. The turntable is rotated through 360°, and the receiving antenna scans in order to determine the level of the maximized emission.
4. The test antenna shall be raised and lowered again through the specified range of height until the maximum signal level is detected by the measuring receiver.
5. The maximum signal level detected by the measuring receiver shall be noted.
6. The EUT was replaced by half-wave dipole (1 GHz below) or horn antenna (1 GHz above) connected to a signal generator.
7. The test antenna shall be raised and lowered through the specified range of height to ensure that the maximum signal is received.
8. The input signal to the substitution antenna shall be adjusted to the level that produces a level detected by the measuring corrected for the change of input attenuator setting of the measuring receiver.
9. The input level to the substitution antenna shall be recorded as power level in dBm, corrected for any change of input attenuator setting of the measuring receiver.
10. The measurement shall be repeated with the test antenna and the substitution antenna orientated for horizontal polarization.

**Test results (Above 1 000 MHz)**

Test mode : LTE Band 5

Frequency(MHz) : 824.7

Channel : 20407

Bandwidth(MHz) : 1.4

Mode	Frequency	Pol.	Antenna Gain	Cable loss	Substitute Level	Level	Limit	Margin
	[MHz]	[V/H]	[dBi]	[dB]	[dBm]	[dBm]	[dBm]	[dB]
QPSK	1 649.60	H	6.00	5.02	-58.68	-57.70	-13.00	44.70
	2 471.20	H	6.15	6.00	-56.45	-56.30	-13.00	43.30
	3 301.60	H	7.67	6.76	-55.81	-54.90	-13.00	41.90
	4 126.40	H	9.00	7.39	-55.11	-53.50	-13.00	40.50

Test mode : LTE Band 5

Frequency(MHz) : 836.5

Channel : 20525

Bandwidth(MHz) : 1.4

Mode	Frequency	Pol.	Antenna Gain	Cable loss	Substitute Level	Level	Limit	Margin
	[MHz]	[V/H]	[dBi]	[dB]	[dBm]	[dBm]	[dBm]	[dB]
QPSK	1 674.00	V	5.95	5.13	-61.12	-60.30	-13.00	47.30
	2 510.40	H	6.21	5.98	-57.03	-56.80	-13.00	43.80
	3 346.80	H	7.81	6.80	-57.61	-56.60	-13.00	43.60
	4 186.00	H	9.05	7.31	-57.24	-55.50	-13.00	42.50

Test mode : LTE Band 5

Frequency(MHz) : 848.3

Channel : 20643

Bandwidth(MHz) : 1.4

Mode	Frequency	Pol.	Antenna Gain	Cable loss	Substitute Level	Level	Limit	Margin
	[MHz]	[V/H]	[dBi]	[dB]	[dBm]	[dBm]	[dBm]	[dB]
QPSK	1 697.60	H	5.90	5.18	-59.52	-58.80	-13.00	45.80
	2 546.40	V	6.25	5.99	-52.16	-51.90	-13.00	38.90
	3 400.80	H	7.98	6.85	-56.43	-55.30	-13.00	42.30
	4 244.80	V	9.10	7.29	-57.41	-55.60	-13.00	42.60

Note.

1. E.R.P & E.I.R.P(dB m) = Substitute Level(dB) + Antenna gain(dB i&dB d) - C.L(Cable loss) (dB)

Test mode : LTE Band 7

Frequency(MHz) : 2 505.0

Channel : 20800

Bandwidth(MHz) : 10

Mode	Frequency	Pol.	Antenna Gain	Cable loss	Substitute Level	Level	Limit	Margin
	[MHz]	[V/H]	[dBi]	[dB]	[dBm]	[dBm]	[dBm]	[dB]
QPSK	5 009.25	V	10.21	8.33	-54.38	-52.50	-25.00	27.50
	7 514.25	H	12.11	9.45	-52.16	-49.50	-25.00	24.50
	10 020.00	V	13.10	10.57	-49.43	-46.90	-25.00	21.90
	12 523.50	V	13.21	11.37	-49.14	-47.30	-25.00	22.30

Test mode : LTE Band 7

Frequency(MHz) : 2 535.0

Channel : 21100

Bandwidth(MHz) : 10

Mode	Frequency	Pol.	Antenna Gain	Cable loss	Substitute Level	Level	Limit	Margin
	[MHz]	[V/H]	[dBi]	[dB]	[dBm]	[dBm]	[dBm]	[dB]
QPSK	5 078.25	V	10.25	8.39	-48.06	-46.20	-25.00	21.20
	7 617.75	V	12.19	9.64	-54.75	-52.20	-25.00	27.20
	10 158.00	V	13.13	10.48	-48.25	-45.60	-25.00	20.60
	12 699.00	H	13.32	10.84	-49.08	-46.60	-25.00	21.60

Test mode : LTE Band 7

Frequency(MHz) : 2 565.0

Channel : 21400

Bandwidth(MHz) : 10

Mode	Frequency	Pol.	Antenna Gain	Cable loss	Substitute Level	Level	Limit	Margin
	[MHz]	[V/H]	[dBi]	[dB]	[dBm]	[dBm]	[dBm]	[dB]
QPSK	5 121.00	V	10.27	8.38	-48.79	-46.90	-25.00	21.90
	7 680.75	H	12.24	9.64	-53.70	-51.10	-25.00	26.10
	10 237.50	V	13.15	10.47	-50.08	-47.40	-25.00	22.40
	12 801.00	H	13.38	11.84	-45.94	-44.40	-25.00	19.40

Note.

1. E.R.P & E.I.R.P(dB m) = Substitute Level(dB) + Antenna gain(dB i&dB d) - C.L(Cable loss) (dB)

Test mode : LTE Band 12

Frequency(MHz) : 704

Channel : 23060

Bandwidth(MHz) : 10

Mode	Frequency	Pol.	Antenna Gain	Cable loss	Substitute Level	Level	Limit	Margin
	[MHz]	[V/H]	[dBi]	[dB]	[dBm]	[dBm]	[dBm]	[dB]
QPSK	1 395.60	H	5.53	4.50	-64.03	-63.00	-13.00	50.00
	2 095.60	V	5.47	5.34	-58.53	-58.40	-13.00	45.40
	2 797.20	V	6.50	6.30	-57.40	-57.20	-13.00	44.20
	3 495.60	H	8.29	6.93	-56.86	-55.50	-13.00	42.50

Test mode : LTE Band 12

Frequency(MHz) : 707.5

Channel : 23095

Bandwidth(MHz) : 10

Mode	Frequency	Pol.	Antenna Gain	Cable loss	Substitute Level	Level	Limit	Margin
	[MHz]	[V/H]	[dBi]	[dB]	[dBm]	[dBm]	[dBm]	[dB]
QPSK	1 406.00	H	5.60	4.44	-64.06	-62.90	-13.00	49.90
	2 109.60	H	5.50	5.36	-58.24	-58.10	-13.00	45.10
	2 810.40	H	6.51	6.31	-58.30	-58.10	-13.00	45.10
	3 512.80	H	8.32	6.95	-56.87	-55.50	-13.00	42.50

Test mode : LTE Band 12

Frequency(MHz) : 711

Channel : 23130

Bandwidth(MHz) : 10

Mode	Frequency	Pol.	Antenna Gain	Cable loss	Substitute Level	Level	Limit	Margin
	[MHz]	[V/H]	[dBi]	[dB]	[dBm]	[dBm]	[dBm]	[dB]
QPSK	1 412.80	V	5.65	4.46	-62.89	-61.70	-13.00	48.70
	2 118.40	V	5.51	5.37	-58.74	-58.60	-13.00	45.60
	2 823.20	H	6.52	6.32	-56.90	-56.70	-13.00	43.70
	3 529.20	H	8.34	6.96	-57.78	-56.40	-13.00	43.40

Note.

1. E.R.P & E.I.R.P(dB m) = Substitute Level(dB) + Antenna gain(dB i&dB d) - C.L(Cable loss) (dB)

**Test mode** : LTE Band 13

**Frequency(MHz)** : 782.0

**Channel** : 23230

**Bandwidth(MHz)** : 10

Mode	Frequency	Pol.	Antenna Gain	Cable loss	Substitute Level	Level	Limit	Margin
	[MHz]	[V/H]	[dBi]	[dB]	[dBm]	[dBm]	[dBm]	[dB]
QPSK	1 554.80	V	6.19	4.88	-61.61	-60.30	-13.00	47.30
	2 332.80	V	5.90	5.71	-53.69	-53.50	-13.00	40.50
	3 109.60	V	7.05	6.58	-55.17	-54.70	-13.00	41.70
	3 886.80	H	8.76	7.26	-55.30	-53.80	-13.00	40.80

**Test mode** : LTE Band 13

**Frequency(MHz)** : 782.0 (1 559 – 1 610 MHz)

**Channel** : 23230

**Bandwidth(MHz)** : 10

Mode	Frequency	Pol.	Antenna Gain	Cable loss	Substitute Level	Level	Limit	Margin
	[MHz]	[V/H]	[dBi]	[dB]	[dBm]	[dBm]	[dBm]	[dB]
QPSK	1 562.74	H	6.17	4.89	-57.88	-56.60	-40.00	16.60

**Note.**

1. Limit Calculation(dBm)= 43 + 10log(P<sub>[Watts]</sub>)

Limit Calculation of wide-band (dBm/MHz) = -70dBW/MHz (-40 dBm/MHz)

Limit Calculation of narrow-band (dBm) = -80dBW (-50dBm)

2. E.R.P & E.I.R.P(dB m) = Substitute Level(dB) + Antenna gain(dB i&dB d) - C.L(Cable loss) (dB)

Test mode : LTE Band 25/2

Frequency(MHz) : 1 851.5

Channel : 26055

Bandwidth(MHz) : 3

Mode	Frequency	Pol.	Antenna Gain	Cable loss	Substitute Level	Level	Limit	Margin
	[MHz]	[V/H]	[dBi]	[dB]	[dBm]	[dBm]	[dBm]	[dB]
QPSK	3 699.75	H	8.54	7.06	-56.18	-54.70	-13.00	41.70
	5 547.75	H	10.52	8.62	-55.70	-53.80	-13.00	40.80
	7 402.50	H	11.98	9.28	-54.00	-51.30	-13.00	38.30
	9 249.00	H	13.30	9.82	-52.68	-49.20	-13.00	36.20

Test mode : LTE Band 25/2

Frequency(MHz) : 1 882.5

Channel : 26365

Bandwidth(MHz) : 3

Mode	Frequency	Pol.	Antenna Gain	Cable loss	Substitute Level	Level	Limit	Margin
	[MHz]	[V/H]	[dBi]	[dB]	[dBm]	[dBm]	[dBm]	[dB]
QPSK	3 767.25	H	8.62	6.97	-56.45	-54.80	-13.00	41.80
	5 650.50	V	10.56	8.67	-55.39	-53.50	-13.00	40.50
	7 536.00	V	12.13	9.45	-53.48	-50.80	-13.00	37.80
	9 423.75	H	13.30	10.26	-51.34	-48.30	-13.00	35.30

Test mode : LTE Band 25/2

Frequency(MHz) : 1 913.5

Channel : 26675

Bandwidth(MHz) : 3

Mode	Frequency	Pol.	Antenna Gain	Cable loss	Substitute Level	Level	Limit	Margin
	[MHz]	[V/H]	[dBi]	[dB]	[dBm]	[dBm]	[dBm]	[dB]
QPSK	3 828.75	H	8.69	7.03	-58.56	-56.90	-13.00	43.90
	5 745.75	V	10.60	8.68	-55.92	-54.00	-13.00	41.00
	7 656.75	V	12.23	9.64	-52.59	-50.00	-13.00	37.00
	9 576.00	H	13.27	10.69	-50.98	-48.40	-13.00	35.40

Note.

1. E.R.P & E.I.R.P(dB m) = Substitute Level(dB) + Antenna gain(dB i&dB d) - C.L(Cable loss) (dB)



Test mode : LTE Band 26

Frequency(MHz) : 826.5

Channel : 26815

Bandwidth(MHz) : 5

Mode	Frequency	Pol.	Antenna Gain	Cable loss	Substitute Level	Level	Limit	Margin
	[MHz]	[V/H]	[dBi]	[dB]	[dBm]	[dBm]	[dBm]	[dB]
QPSK	1 653.20	H	5.99	5.09	-60.60	-59.70	-13.00	46.70
	2 478.80	H	6.16	6.02	-57.54	-57.40	-13.00	44.40
	3 307.60	H	7.68	6.76	-56.82	-55.90	-13.00	42.90
	4 131.20	V	9.00	7.39	-55.61	-54.00	-13.00	41.00

Test mode : LTE Band 26

Frequency(MHz) : 836.5

Channel : 26915

Bandwidth(MHz) : 5

Mode	Frequency	Pol.	Antenna Gain	Cable loss	Substitute Level	Level	Limit	Margin
	[MHz]	[V/H]	[dBi]	[dB]	[dBm]	[dBm]	[dBm]	[dB]
QPSK	1 673.60	V	5.95	5.13	-60.12	-59.30	-13.00	46.30
	2 509.20	V	6.21	5.97	-56.44	-56.20	-13.00	43.20
	3 346.40	V	7.81	6.80	-57.21	-56.20	-13.00	43.20
	4 180.80	H	9.04	7.30	-54.74	-53.00	-13.00	40.00

Test mode : LTE Band 26

Frequency(MHz) : 846.5

Channel : 27015

Bandwidth(MHz) : 5

Mode	Frequency	Pol.	Antenna Gain	Cable loss	Substitute Level	Level	Limit	Margin
	[MHz]	[V/H]	[dBi]	[dB]	[dBm]	[dBm]	[dBm]	[dB]
QPSK	1 688.80	H	5.92	5.16	-60.86	-60.10	-13.00	47.10
	2 533.20	H	6.23	6.01	-56.62	-56.40	-13.00	43.40
	3 376.40	H	7.90	6.83	-56.47	-55.40	-13.00	42.40
	4 220.40	H	9.08	7.25	-56.63	-54.80	-13.00	41.80

Note.

1. E.R.P & E.I.R.P(dB m) = Substitute Level(dB) + Antenna gain(dB i&dB d) - C.L(Cable loss) (dB)

**Test mode** : LTE Band 66/4

**Frequency(MHz)** : 1 715.0

**Channel** : 132022

**Bandwidth(MHz)** : 10

Mode	Frequency	Pol.	Antenna Gain	Cable loss	Substitute Level	Level	Limit	Margin
	[MHz]	[V/H]	[dBi]	[dB]	[dBm]	[dBm]	[dBm]	[dB]
QPSK	3 438.00	H	8.10	6.88	-59.12	-57.90	-13.00	44.90
	5 160.75	V	10.30	8.42	-56.98	-55.10	-13.00	42.10
	6 879.75	V	11.36	10.34	-52.82	-51.80	-13.00	38.80
	8 603.25	H	13.14	9.62	-51.72	-48.20	-13.00	35.20

**Test mode** : LTE Band 66/4

**Frequency(MHz)** : 1 745.0

**Channel** : 132322

**Bandwidth(MHz)** : 10

Mode	Frequency	Pol.	Antenna Gain	Cable loss	Substitute Level	Level	Limit	Margin
	[MHz]	[V/H]	[dBi]	[dB]	[dBm]	[dBm]	[dBm]	[dB]
QPSK	3 481.50	V	8.24	6.92	-59.52	-58.20	-13.00	45.20
	5 218.50	H	10.33	8.50	-55.83	-54.00	-13.00	41.00
	6 960.00	V	11.45	10.12	-52.63	-51.30	-13.00	38.30
	8 698.50	V	13.18	9.68	-54.00	-50.50	-13.00	37.50

**Test mode** : LTE Band 66/4

**Frequency(MHz)** : 1 775.0

**Channel** : 132622

**Bandwidth(MHz)** : 10

Mode	Frequency	Pol.	Antenna Gain	Cable loss	Substitute Level	Level	Limit	Margin
	[MHz]	[V/H]	[dBi]	[dB]	[dBm]	[dBm]	[dBm]	[dB]
QPSK	3 549.75	V	8.36	6.98	-57.58	-56.20	-13.00	43.20
	5 321.25	H	10.39	8.53	-55.26	-53.40	-13.00	40.40
	7 106.25	V	11.63	9.72	-52.61	-50.70	-13.00	37.70
	8 874.00	V	13.25	10.04	-50.71	-47.50	-13.00	34.50

Note.

1. E.R.P & E.I.R.P(dB m) = Substitute Level(dB) + Antenna gain(dB i&dB d) - C.L(Cable loss) (dB)

Test mode : LTE Band 71

Frequency(MHz) : 668.0

Channel : 133172

Bandwidth(MHz) : 10

Mode	Frequency	Pol.	Antenna Gain	Cable loss	Substitute Level	Level	Limit	Margin
	[MHz]	[V/H]	[dBi]	[dB]	[dBm]	[dBm]	[dBm]	[dB]
QPSK	1 345.60	H	5.16	4.46	-60.90	-60.20	-13.00	47.20
	2 017.60	H	5.33	5.24	-54.89	-54.80	-13.00	41.80
	2 694.00	H	6.39	6.21	-56.68	-56.50	-13.00	43.50
	3 365.20	H	7.87	6.82	-57.25	-56.20	-13.00	43.20

Test mode : LTE Band 71

Frequency(MHz) : 680.5

Channel : 133297

Bandwidth(MHz) : 10

Mode	Frequency	Pol.	Antenna Gain	Cable loss	Substitute Level	Level	Limit	Margin
	[MHz]	[V/H]	[dBi]	[dB]	[dBm]	[dBm]	[dBm]	[dB]
QPSK	1 372.00	V	5.35	4.45	-60.90	-60.00	-13.00	47.00
	2 054.80	H	5.40	5.27	-52.13	-52.00	-13.00	39.00
	2 742.40	H	6.44	6.25	-56.39	-56.20	-13.00	43.20
	3 426.80	H	8.07	6.87	-56.10	-54.90	-13.00	41.90

Test mode : LTE Band 71

Frequency(MHz) : 693.0

Channel : 133422

Bandwidth(MHz) : 10

Mode	Frequency	Pol.	Antenna Gain	Cable loss	Substitute Level	Level	Limit	Margin
	[MHz]	[V/H]	[dBi]	[dB]	[dBm]	[dBm]	[dBm]	[dB]
QPSK	1 376.40	V	5.39	4.46	-60.43	-59.50	-13.00	46.50
	2 065.60	H	5.42	5.29	-52.73	-52.60	-13.00	39.60
	2 751.20	V	6.45	6.26	-56.99	-56.80	-13.00	43.80
	3 441.60	V	8.11	6.89	-57.22	-56.00	-13.00	43.00

Note.

1. E.R.P & E.I.R.P(dB m) = Substitute Level(dB) + Antenna gain(dB i&dB d) - C.L(Cable loss) (dB)

## 8. Measurement equipment

Equipment Name	Manufacturer	Model No.	Serial No.	Next Cal. Date
Spectrum Analyzer	R&S	FSV30	100810	23.07.12
Spectrum Analyzer	AGILENT	N9040B	MY57010132	23.10.14
Signal Generator	R&S	SMB100A	176206	24.01.19
DC Power Supply	AGILENT	E3632A	KR73001026	24.01.19
Directional Coupler	AAMCS	AAMCS-UDC-0.5G-18G-10dB-SF	399	24.01.19
Directional Coupler	Marki Microwave, Inc.	CBR17-0026	0001	23.08.10
Wideband Radio Communication Tester	R&S	CMW500	106840	24.01.19
Wideband Radio Communication Tester	R&S	CMW500	168683	24.02.09
Wideband Radio Communication Tester	R&S	CMW500	141780	24.01.19
Temp & Humid Chamber	Daejin Engineering	DJ-THR11000	10041	24.01.19
Bi-log Antenna	Teseq GmbH	CBL 6112D	62027	24.11.17
Bi-log Antenna	ETS.LINDGREN	3143B	228420	23.09.28
Horn Antenna	ETS-LINDGREN	3117	251528	24.02.02
Horn Antenna	ETS.LINDGREN	3117	227509	23.09.20
Horn Antenna	ETS-Lindgren	3116	00086632	24.01.25
Horn Antenna	ETS-LINDGREN	3116C	251516	24.02.02
Amplifier	SONOMA INSTRUMENT	310N	421822	23.12.14
Amplifier	C&K Technologies, Inc.	BZRT-00504000-481055-382525	26299-27735	23.09.19
Amplifier	C&K Technologies, Inc.	BZR-00504000-551028-252525	27736	23.09.19
High Pass Filter	Wainwright Instruments GmbH	WHKX10-900-1000-15000-40SS	11	23.08.10
High Pass Filter	Wainwright Instruments GmbH	WHKX12-2805-3000-18000-40SS	32	23.08.10
Antenna Mast	innco systems GmbH	MA4640-XP-ET	N/A	-
Controller	Innco Systems	CO3000	1175/458503 19/P	-

**End of test report**