





TEST REPORT

<p>Eurofins KCTL Co.,Ltd. 65, Sinwon-ro, Yeongtong-gu, Suwon-si, Gyeonggi-do, 16677, Korea TEL: 82-70-5008-1021 FAX: 82-505-299-8311 www.kctl.co.kr</p>	<p>Report No.: KR23-SRF0134 Page (1) of (40)</p>	 KCTL
<p>1. Client</p> <ul style="list-style-type: none"> ◦ Name : Samsung Electronics Co., Ltd. ◦ Address : 129, Samsung-ro, Yeongtong-gu, Suwon-si, Gyeonggi-do, 16677, Rep. of Korea ◦ Date of Receipt : 2023-03-23 <p>2. Use of Report : Certification</p> <p>3. Name of Product / Model : Smart wearable / SM-R945U (FCC), SM-R945F (ISED)</p> <p>4. Manufacturer / Country of Origin : Samsung Electronics Co., Ltd. / Vietnam</p> <p>5. FCC ID : A3LSMR945 (SM-R945U, SM-R945F)</p> <p>6. IC Certificate No. : 649E-SMR945 (SM-R945F)</p> <p>7. Date of Test : 2023-03-28 to 2023-05-17</p> <p>8. Location of Test : <input checked="" type="checkbox"/> Permanent Testing Lab <input type="checkbox"/> On Site Testing (Address:65, Sinwon-ro, Yeongtong-gu, Suwon-si, Gyeonggi-do, 16677, Korea)</p> <p>9. Test method used : FCC Part 2 / RSS-Gen Issue 5 FCC Part 22 Subpart H / RSS-132 Issue 4 FCC Part 24 Subpart E / RSS-133 Issue 6 FCC Part 27 Subpart L / RSS-139 Issue 4</p> <p>10. Test Result : Refer to the test result in the test report</p>		
<p>Affirmation</p>	<p>Tested by</p> <p>Name : Kwonse Kim (Signature)</p>	<p>Technical Manager</p> <p>Name : Harim Lee (Signature)</p>
<p style="text-align: right;">2023-05-19</p> <p style="text-align: center;">Eurofins KCTL Co.,Ltd.</p> <p>As a test result of the sample which was submitted from the client, this report does not guarantee the whole product quality. This test report should not be used and copied without a written agreement by Eurofins KCTL Co.,Ltd.</p>		

<p>Eurofins KCTL Co.,Ltd. 65, Sinwon-ro, Yeongtong-gu, Suwon-si, Gyeonggi-do, 16677, Korea TEL: 82-70-5008-1021 FAX: 82-505-299-8311 www.kctl.co.kr</p>	<p>Report No.: KR23-SRF0134 Page (2) of (40)</p>	
--	--	---

REPORT REVISION HISTORY

Date	Revision	Page No
2023-05-19	Originally issued	-

This report shall not be reproduced except in full, without the written approval of Eurofins KCTL Co.,Ltd. This document may be altered or revised by Eurofins KCTL Co.,Ltd. personnel only, and shall be noted in the revision section of the document. Any alteration of this document not carried out by Eurofins KCTL Co.,Ltd. will constitute fraud and shall nullify the document. This test report is a general report that does not use the KOLAS accreditation mark and is not related to KS Q ISO/IEC 17025 and KOLAS accreditation.

General remarks for test reports

Statement concerning the uncertainty of the measurement systems used for the tests

(may be required by the product standard or client)

Internal procedure used for type testing through which traceability of the measuring uncertainty has been established:

Procedure number, issue date and title:

Calculations leading to the reported values are on file with the testing laboratory that conducted the testing.

Statement not required by the standard or client used for type testing

CONTENTS

1.	General information	4
2.	Device information	4
2.1.	Accessory information	5
2.2.	Frequency/channel operations.....	5
3.	Maximum ERP/EIRP power	6
4.	Summary of tests.....	7
4.1.	Worst case orientation	8
5.	Measurement uncertainty	9
6.	Measurement results explanation example	10
7.	Test results	11
7.1.	Conducted output power.....	11
7.2.	99% Occupied Bandwidth & 26dB Bandwidth	13
7.3.	Band Edge Emissions at Antenna Terminal	18
7.4.	Spurious Emissions at Antenna Terminal.....	21
7.5.	Peak to Average Power Ratio (PAPR)	24
7.6.	Frequency stability	26
7.7.	Radiated Power (ERP/EIRP)	31
7.8.	Radiated Spurious Emissions.....	35
8.	Measurement equipment.....	40

<p align="center">Eurofins KCTL Co.,Ltd. 65, Sinwon-ro, Yeongtong-gu, Suwon-si, Gyeonggi-do, 16677, Korea TEL: 82-70-5008-1021 FAX: 82-505-299-8311 www.kctl.co.kr</p>	<p align="center">Report No.: KR23-SRF0134 Page (4) of (40)</p>	
---	--	---

1. General information

Client : Samsung Electronics Co., Ltd.
Address : 129, Samsung-ro, Yeongtong-gu, Suwon-si, Gyeonggi-do, 16677, Rep. of Korea

Manufacturer : Samsung Electronics Co., Ltd.
Address : 129, Samsung-ro, Yeongtong-gu, Suwon-si, Gyeonggi-do, 16677, Rep. of Korea

Factory 1 : AG TECH CO.,LTD
Address : Lot G3, Que Vo Industrial Park(Expanded Area), Nam son Ward, Bac Ninh Province, Vietnam

Factory 2 : ALMUS VINA
Address : Lot CN07A, Phu Ha Industrial Park, Ha Thach Commune, Phu Tho Town, Phu Tho Province, Vietnam

Laboratory : Eurofins KCTL Co.,Ltd.
Address : 65, Sinwon-ro, Yeongtong-gu, Suwon-si, Gyeonggi-do, 16677, Korea

Accreditations : FCC Site Designation No: KR0040, FCC Site Registration No: 687132
VCCI Registration No. : R-20080, G-20078, C-20059, T-20056
CAB Identifier: KR0040
ISED Number: 8035A
KOLAS No.: KT231

2. Device information

Equipment under test : Smart wearable
Model : SM-R945U(FCC), SM-R945F(ISED)
Derivative model : SM-R945F(FCC)
Modulation technique : QPSK
Power source : DC 3.88 V
Antenna specification : Metal Antenna
Frequency range : WCDMA 850 : 826.4 MHz ~ 846.6 MHz
WCDMA 1700 : 1 712.4 MHz ~ 1 752.6 MHz
WCDMA 1900 : 1 852.4 MHz ~ 1 907.6 MHz

Software version : SM-R945U_R945U.001, SM-R945F_R945F.001
Hardware version : REV1.0

Test device serial No. : Conducted : R3AW2008FWL, R3AW400RKAJ, R3AW400RKK9N
Radiated : R3AW400R4DD, R3AW400R56J

Operation temperature : -20 °C ~ 50 °C

Note.

1. Due to marketing purpose, the model SM-R945F will be filed for ISED approval and the test reports remain valid for Model SM-R945F ISED submission.
2. The product equality letter includes detailed information about the differences between SM-R945U and SM-R945F model.

2.1. Accessory information

Equipment	Manufacturer	Model	Serial No.	Power source	FCC ID & IC
Wireless charger	Samsung Electronics Co., Ltd.	EP-OR900	-	5.0 V, 2.0 A	FCC ID : A3LEPOR900 IC : 649E-EPOR900

2.2. Frequency/channel operations

This device contains the following capabilities:

WLAN (11a/b/g/n), Bluetooth (BDR/EDR/BLE), LTE B2/4/5/7/12/13/25/26/66/71,
WCDMA 850/1700/1900

WCDMA 850

Ch.	Frequency (MHz)
4132	826.4
4183	836.6
4233	846.6

Table 2.2.1.
RMC/HSDPA/HSUPA/
DC-HSDPA

WCDMA 1700

Ch.	Frequency (MHz)
1312	1 712.4
1412	1 732.4
1513	1 752.6

Table 2.2.2.
RMC/HSDPA/HSUPA/
DC-HSDPA

WCDMA 1900

Ch.	Frequency (MHz)
9262	1 852.4
9400	1 880.0
9538	1 907.6

Table 2.2.3.
RMC/HSDPA/HSUPA/
DC-HSDPA

3. Maximum ERP/EIRP power

WCDMA 850

Mode	Tx frequency (MHz)	Emission designator	ERP	
			Max. power (dBm)	Max. power (W)
WCDMA 850	826.4 ~ 846.6	4M15F9W	15.86	0.039

WCDMA 1700 / WCDMA 1900

Mode	Tx frequency (MHz)	Emission designator	EIRP	
			Max. power (dBm)	Max. power (W)
WCDMA 1700	1 712.4 ~ 1 752.6	4M15F9W	18.98	0.079
WCDMA 1900	1 852.4 ~ 1 907.6	4M17F9W	17.36	0.054



4. Summary of tests

FCC Part Section(s)	RSS Section(s)	Parameter	Test Limit	Test Condition	Test results	
2.1046	RSS-132(5.4) RSS-133(4.1) RSS-139(5.5)	Conducted Output Power	N/A	Conducted	Pass	
2.1049	RSS-Gen(6.7)	Occupied Bandwidth & 26 dB Bandwidth	N/A		Pass	
2.1051 22.917(a) 24.238(a) 27.53(h)	RSS-132(5.5) RSS-133(6.5) RSS-139(5.6)	Band Edge Emissions at Antenna Terminal	<43 + 10Log ₁₀ (P) dB		Pass	
		Spurious Emissions at Antenna Terminal			Pass	
24.232(d) 27.50(d)(5)	RSS-132(5.4) RSS-133(6.4) RSS-139(5.5)	Peak to Average Power Ratio	< 13 dB		Pass	
2.1055 22.355	RSS-132(5.3)	Frequency stability	< 2.5 ppm (FCC), Emission must remain in band (IC)		Pass	
24.235	RSS-133(6.3)		Emission must remain in band (FCC), < 2.5 ppm (IC)			
27.54	RSS-139(5.4)		Emission must remain in band			
22.913(a)(5)	RSS-132(5.4)	Effective Radiated Power	< 7 Watts max. ERP (FCC) < 3 Watts max. ERP (IC)		Radiated	Pass
24.232(c)	RSS-133(6.4)	Equivalent Isotropic Radiated Power	< 2 Watts max. EIRP			Pass
27.50(d)(4)	RSS-139(5.5)		< 1 Watts max. EIRP	Pass		
2.1053 22.917(a) 24.238(a) 27.53(h)	RSS-132(5.5) RSS-133(6.5) RSS-139(5.6)	Radiated Spurious Emissions	<43 + 10Log ₁₀ (P) dB	Pass		

Notes:

- The test procedure(s) in this report were performed in accordance as following.
 - ◆ ANSI C63.26-2015
 - ◆ ANSI/TIA-603-E-2016
 - ◆ KDB 971168 D01 v03r01
 - ◆ KDB 971168 D02 v02r02

4.1. Worst case orientation

- All modes of operation were investigated and the worst case emissions are reported with the EUT positioning, modulations, RB sizes and offsets, and channel bandwidth configurations in the test data.
- The fundamental of the EUT was investigated in three orthogonal orientations X, Y and Z and all of the radiated tests have been performed with the accessories as below. It was determined that below orientation was worst case orientation for each band.

Band	Strap	With charger	Without charger		
		X-axis	X-axis	Y-axis	Z-axis
WCDMA850	With strap	-	-	-	-
	Without strap	O	-	-	-
WCDMA1700	With strap	-	-	-	O
	Without strap	-	-	-	-
WCDMA1900	With strap	-	-	-	O
	Without strap	-	-	-	-

3. Test Condition

- The measurement was performed with various configurations then worst results are reported.

1) Radiated measurement

Test Description	Mode	Modulation	Test Channel
Effective Radiated Power	WCDMA 850	RMC (12.2 kbps)	Low, Mid, High
Equivalent Isotropic Radiated Power	WCDMA 1700/1900	RMC (12.2 kbps)	Low, Mid, High
Radiated Spurious Emissions	WCDMA 850/1700/1900	RMC (12.2 kbps)	Low, Mid, High

2) Conducted measurement

Conducted Test			
Test Description	Mode	Modulation	Test Channel
Output Power	WCDMA 850/1700/1900	WCDMA : RMC/HSDPA/HSUPA/DC-HSUPA	Low, Mid, High
OBW & 26 dB BW		WCDMA : RMC (12.2 kbps)	Low, Mid, High
PAPR			Mid
Band Edge		WCDMA : RMC (12.2 kbps)	Low, High
Spurious Emissions			Low, Mid, High

5. Measurement uncertainty

The measurement uncertainties shown below were calculated in accordance with the requirements of ANSI C63.4-2014.

All measurement uncertainty values are shown with a coverage factor of $k=2$ to indicated a 95 % level of confidence. The measurement data shown herein meets or exceeds the U_{CISPR} measurement uncertainty values specified in CISPR 16-4-2 and thus, can be compared directly to specified limits to determine compliance.

Parameter	Expanded uncertainty (\pm)	
Conducted RF power	0.9 dB	
Conducted spurious emissions	1.3 dB	
Radiated spurious emissions	Below 1 000 MHz	2.5 dB
	1 000 MHz ~ 18 000 MHz	4.7 dB
	Above 1 8000 MHz	4.8 dB



6. Measurement results explanation example

Frequency (MHz)	Factor(dB)	Frequency (MHz)	Factor(dB)
30	10.06	11 000	13.44
50	10.79	12 000	13.17
100	10.97	13 000	13.07
200	10.43	14 000	13.10
300	10.57	15 000	13.42
400	10.88	16 000	12.87
500	10.92	17 000	13.21
600	10.40	18 000	12.92
700	10.28	19 000	12.56
800	10.39	20 000	12.60
900	10.63	21 000	12.84
1 000	10.85	22 000	12.08
2 000	11.25	23 000	12.56
3 000	11.46	24 000	12.19
4 000	11.85	25 000	13.66
5 000	11.86	26 000	13.07
6 000	12.10	26 500	13.95
7 000	12.04	27 000	13.59
8 000	12.88	28 000	13.54
9 000	12.73	29 000	14.32
10 000	13.05	30 000	14.48

Note.

Offset(dB) = RF cable loss(dB) + Directional Coupler (dB)

7. Test results

7.1. Conducted output power

Test setup

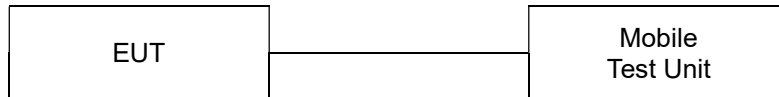

Test procedure

971168 D01 v03r01 – Section 5.2

ANSI C63.26-2015 – Section 5.2.4.2

CFR 47, - Section §2.1046

Radio Standards Specifications – Section 132, 133, 139

Test settings

When an average power meter is used to perform RF output power measurements, the fundamental condition that measurement be performed only over durations of active transmissions at maximum output power level applies. Thus, an average power meter can always be used to perform the measurement when the EUT can be configured to transmit continuously.

If the EUT cannot be configured to transmit continuously (i.e., burst duty cycle < 98%), then the following options can be implemented to facilitate measurement of the average power with an average power meter:

- a) A gated average power meter can be used to perform the measurement if the gating parameters can be adjusted such that the power is measured only during active transmission bursts at maximum output power levels.
- b) A conventional average power meter with no signal gating capability can also be used if the measured burst duty cycle is constant (i.e., duty cycle variations are less than or equal to $\pm 2\%$) by performing the measurement over the on/off burst cycles and then correcting (increasing) the measured level by a factor equal to $[10\log (1/\text{duty cycle})]$. See 5.2.4.3.4 for guidance with respect to measuring the transmitter duty cycle.

See item r) of 4.1 for more information regarding power meter functional requirements and limitations, and consult the instrumentation-specific application literature for proper set-up and use.

Notes:

1. Offset(dB) = RF cable loss(dB)

Test results

Test Band	Test mode	Average Conducted Power (dBm)			MPR (dB)
		Frequency (MHz)			
		Low	Middle	High	
WCDMA 850	RMC	22.47	22.46	22.52	-
	HSDPA-Subtest 1	22.39	22.44	22.36	0
	HSDPA-Subtest 2	22.11	22.08	21.86	0
	HSDPA-Subtest 3	22.26	22.26	21.86	0.5
	HSDPA-Subtest 4	21.15	21.37	21.18	0.5
	HSUPA-Subtest 1	21.05	21.04	21.04	0
	HSUPA-Subtest 2	19.00	18.97	18.77	2
	HSUPA-Subtest 3	21.63	21.64	21.57	1
	HSUPA-Subtest 4	19.00	18.88	18.78	2
	HSUPA-Subtest 5	22.34	22.21	22.18	0
	DC-HSDPA-Subtest 1	22.40	22.41	22.48	0
	DC-HSDPA-Subtest 2	22.28	22.31	22.36	0
	DC-HSDPA-Subtest 3	21.41	21.42	21.43	0.5
DC-HSDPA-Subtest 4	21.41	21.41	21.43	0.5	
WCDMA 1700	RMC	22.49	22.55	22.50	-
	HSDPA-Subtest 1	22.34	22.45	22.36	0
	HSDPA-Subtest 2	21.14	21.23	21.35	0
	HSDPA-Subtest 3	21.55	21.59	21.69	0.5
	HSDPA-Subtest 4	20.54	20.59	20.71	0.5
	HSUPA-Subtest 1	20.38	20.42	20.39	0
	HSUPA-Subtest 2	18.51	18.53	18.58	2
	HSUPA-Subtest 3	21.46	21.39	21.40	1
	HSUPA-Subtest 4	18.56	18.62	18.65	2
	HSUPA-Subtest 5	21.90	21.98	22.06	0
	DC-HSDPA-Subtest 1	22.36	22.49	22.27	0
	DC-HSDPA-Subtest 2	21.63	21.63	21.59	0
	DC-HSDPA-Subtest 3	20.61	20.65	20.62	0.5
DC-HSDPA-Subtest 4	20.64	20.62	20.62	0.5	
WCDMA 1900	RMC	22.65	22.70	22.42	-
	HSDPA-Subtest 1	22.47	22.65	22.40	0
	HSDPA-Subtest 2	21.20	21.01	21.02	0
	HSDPA-Subtest 3	21.44	21.29	21.23	0.5
	HSDPA-Subtest 4	20.61	20.53	20.54	0.5
	HSUPA-Subtest 1	20.21	20.08	20.18	0
	HSUPA-Subtest 2	18.18	18.08	18.04	2
	HSUPA-Subtest 3	21.23	21.10	21.02	1
	HSUPA-Subtest 4	18.20	18.07	18.06	2
	HSUPA-Subtest 5	22.09	22.07	21.98	0
	DC-HSDPA-Subtest 1	22.54	22.55	22.39	0
	DC-HSDPA-Subtest 2	21.94	21.61	21.60	0
	DC-HSDPA-Subtest 3	20.98	20.64	20.68	0.5
DC-HSDPA-Subtest 4	20.97	20.63	20.68	0.5	

7.2. 99% Occupied Bandwidth & 26dB Bandwidth

Test setup

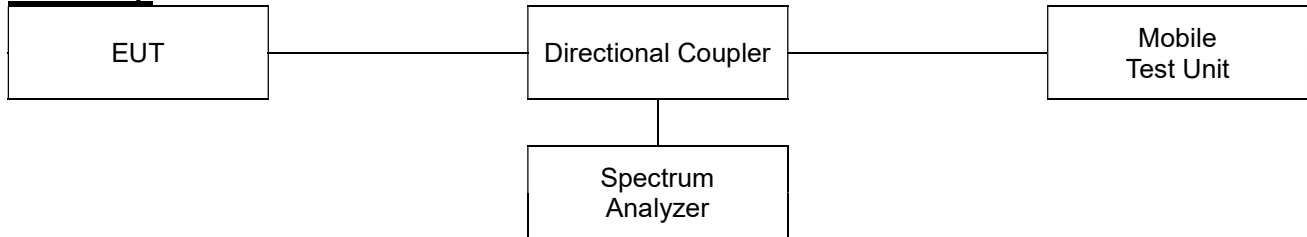

Limit

According to §2.1049 and RSS-Gen 6.7, the occupied bandwidth, that is the frequency bandwidth such that, below its lower and above its upper frequency limits, the mean powers radiated are each equal to 0.5 percent of the total mean power radiated by a given emission shall be measured.



Test procedure

971168 D01 v03r01 – Section 4.2 and 4.3
ANSI C63.26-2015 – Section 5.4.3 and 5.4.4

Test settings

◆ 26dB Bandwidth

- a) The spectrum analyzer center frequency is set to the nominal EUT channel center frequency. The span range for the spectrum analyzer shall be wide enough to see sufficient roll off of the signal to make the measurement.
- b) The nominal RBW shall be in the range of 1% to 5% of the anticipated OBW, and the VBW shall be set $\geq 3 \times$ RBW.
- c) Set the reference level of the instrument as required to prevent the signal amplitude from exceeding the maximum spectrum analyzer input mixer level for linear operation. See guidance provided in 4.2.3.
- d) The dynamic range of the spectrum analyzer at the selected RBW shall be more than 10 dB below the target “-X dB” requirement, i.e., if the requirement calls for measuring the -26 dB OBW, the spectrum analyzer noise floor at the selected RBW shall be at least 36 dB below the reference level.
- e) Set spectrum analyzer detection mode to peak, and the trace mode to max hold.
- f) Determine the reference value by either of the following:
 - 1) Set the EUT to transmit a modulated signal. Allow the trace to stabilize. Set the spectrum analyzer marker to the highest level of the displayed trace (this is the reference value).
 - 2) Set the EUT to transmit an unmodulated carrier. Set the spectrum analyzer marker to the level of the carrier.
- g) Determine the “-X dB amplitude” as equal to (Reference Value - X). Alternatively, this calculation can be performed on the spectrum analyzer using the delta-marker measurement function.
- h) If the reference value was determined using an unmodulated carrier, turn the EUT modulation on, then either clear the existing trace or start a new trace on the spectrum analyzer and allow the new trace to stabilize. Otherwise the trace from step f) shall be used for step i).

<p>Eurofins KCTL Co.,Ltd. 65, Sinwon-ro, Yeongtong-gu, Suwon-si, Gyeonggi-do, 16677, Korea TEL: 82-70-5008-1021 FAX: 82-505-299-8311 www.kctl.co.kr</p>	<p>Report No.: KR23-SRF0134 Page (14) of (40)</p>	 
--	---	---

- i) Place two markers, one at the lowest and the other at the highest frequency of the envelope of the spectral display such that each marker is at or slightly below the “-X dB amplitude” determined in step f). If a marker is below this “-X dB amplitude” value it should be as close as possible to this value. The OBW is the positive frequency difference between the two markers.
- j) The spectral envelope can cross the “-X dB amplitude” at multiple points. The lowest or highest frequency shall be selected as the frequencies that are the farthest away from the center frequency at which the spectral envelope crosses the “-X dB amplitude.”
- k) The OBW shall be reported by providing plot(s) of the measuring instrument display, to include markers depicting the relevant frequency and amplitude information (e.g., marker table). The frequency and amplitude axis and scale shall be clearly labeled. Tabular data may be reported in addition to the plot(s).

◆ 99% Occupied Bandwidth

- a) The spectrum analyzer center frequency is set to the nominal EUT channel center frequency. The frequency span for the spectrum analyzer shall be set wide enough to capture all modulation products including the emission skirts (typically a span of $1.5 \times \text{OBW}$ is sufficient).
- b) The nominal IF filter 3 dB bandwidth (RBW) shall be in the range of 1% to 5% of the anticipated OBW, and the VBW shall be set $\geq 3 \times \text{RBW}$.
- c) Set the reference level of the instrument as required to prevent the signal amplitude from exceeding the maximum spectrum analyzer input mixer level for linear operation. See guidance provided in 4.2.3.
- d) Set the detection mode to peak, and the trace mode to max-hold.
- e) If the instrument does not have a 99% OBW function, recover the trace data points and sum directly in linear power terms. Place the recovered amplitude data points, beginning at the lowest frequency, in a running sum until 0.5% of the total is reached. Record that frequency as the lower OBW frequency. Repeat the process until 99.5% of the total is reached and record that frequency as the upper OBW frequency. The 99% power OBW can be determined by computing the difference these two frequencies.
- f) The OBW shall be reported and plot(s) of the measuring instrument display shall be provided with the test report. The frequency and amplitude axis and scale shall be clearly labeled. Tabular data can be reported in addition to the plot(s).

Test results

Test mode		Frequency (MHz)	26 dB bandwidth (MHz)	99 % bandwidth (MHz)
WCDMA 850	RMC	826.4	4.74	4.15
		836.6	4.74	4.14
		846.6	4.78	4.14
WCDMA 1700	RMC	1 712.4	4.71	4.15
		1 732.4	4.74	4.15
		1 752.6	4.74	4.14
WCDMA 1900	RMC	1 852.4	4.71	4.15
		1 880.0	4.72	4.14
		1 907.6	4.75	4.17



26dB Bandwidth

Test mode: WCDMA 850

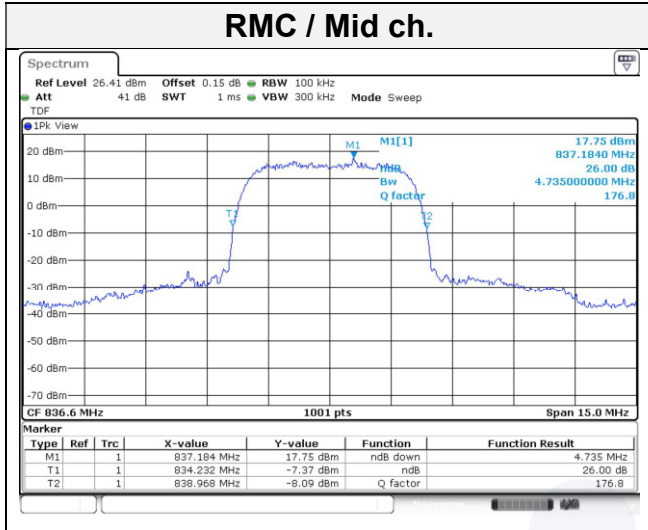

Test mode: WCDMA 1700

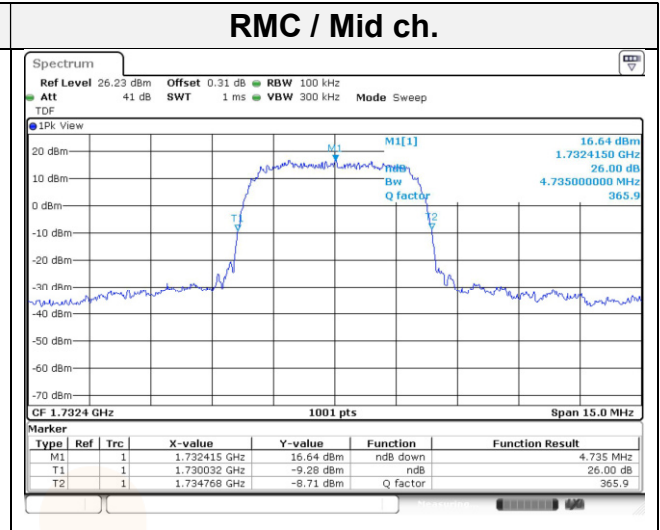

Test mode: WCDMA 1900

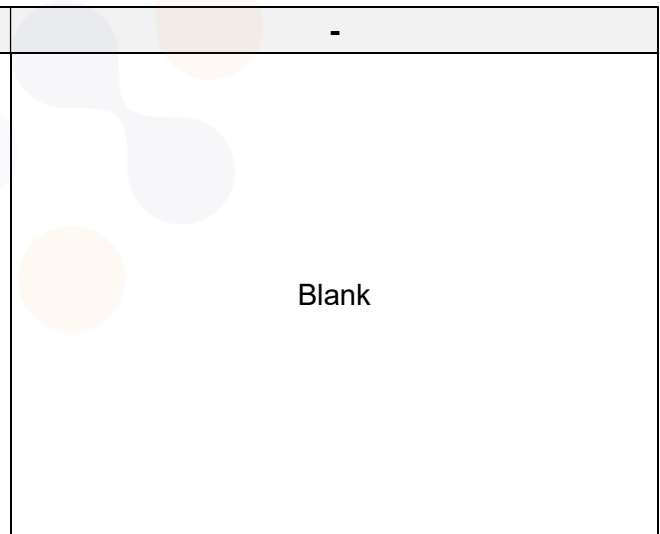
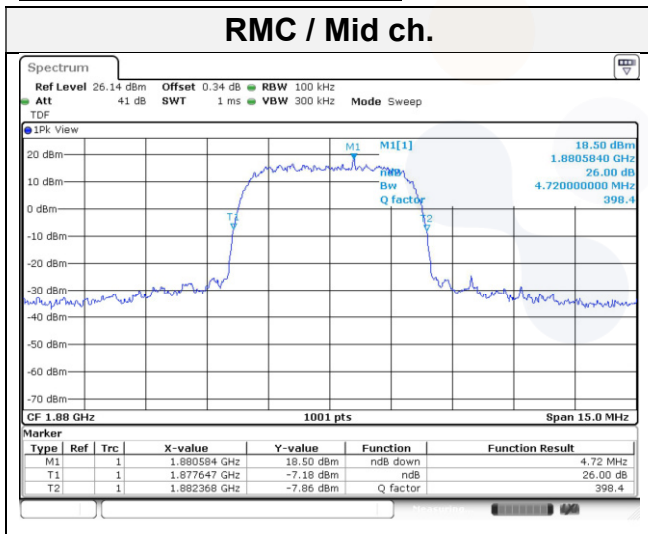

99% Occupied Bandwidth

Test mode: WCDMA 850

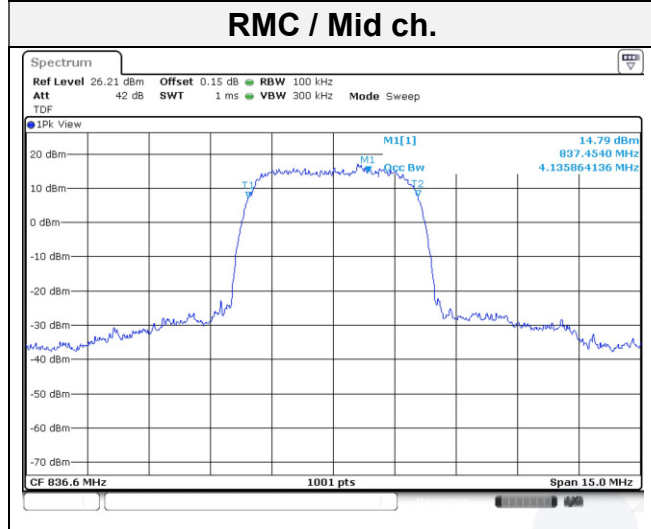

Test mode: WCDMA 1700

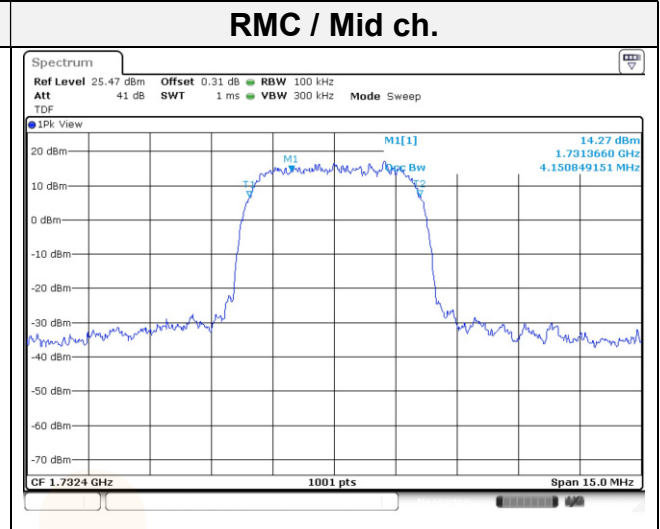

Test mode: WCDMA 1900

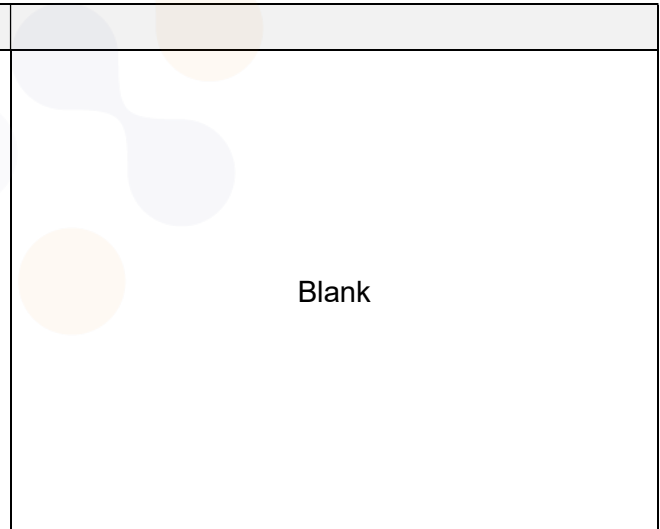
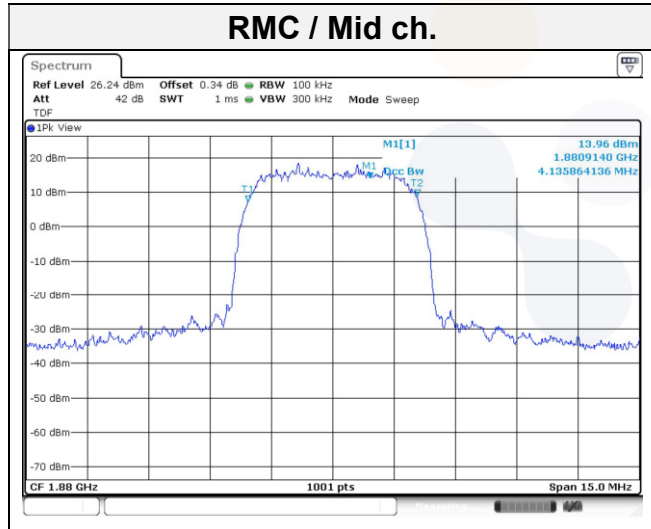

7.3. Band Edge Emissions at Antenna Terminal

Test setup

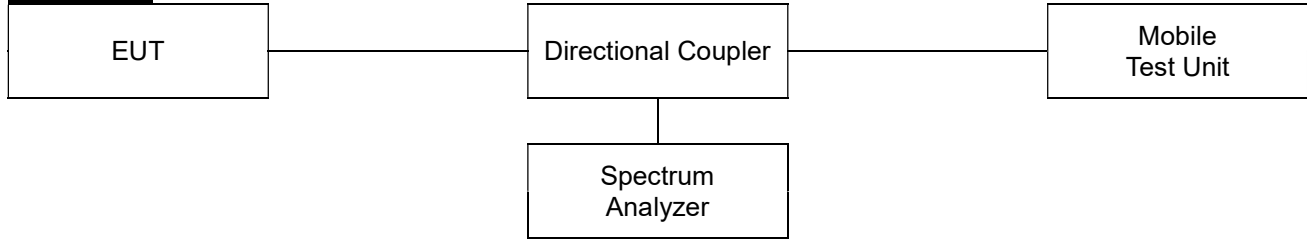

Limit

According to §22.917(a), §24.238(a) and RSS-132(5.5), RSS-133(6.5), the power of any emission outside of the authorized operating frequency ranges must be attenuated below the transmitting power (P) by a factor of at least $43 + 10\log(P)$ dB.

According to §27.53(h) and RSS-139(5.5), the power of any emission outside a licensee's frequency block shall be attenuated below the transmitter power (P) in watts by at least $43 + 10\log(P_{\text{[Watts]}})$ dB.

Test procedure

971168 D01 v03r01 - Section 6
ANSI C63.26-2015 – Section 5.7

Test settings

- 1) Start frequency was set to 30 MHz and stop frequency was set to at least 10th the fundamental frequency.
- 2) Span was set large enough so as to capture all out of band emissions near the band edge.
- 3) Set the RBW > 1% of the emission bandwidth.
- 4) Set the VBW $\geq 3 \times$ RBW.
- 5) Set the number of sweep points $\geq 2 \times$ Span/RBW
- 6) Detector = RMS
- 7) Trace mode = trace average
- 8) Sweep time should be auto for peak detection. For RMS detection the sweep time should be set as follows:
 - a) If the device can be configured to transmit continuously (duty cycle $\geq 98\%$), set the (sweep time) > (number of points in sweep) \times (symbol period) (e.g., by a factor of 10 \times symbol period \times number of points) Increasing the sweep time (i.e., slowing the sweep speed) will allow for averaging over multiple symbols.
 - b) If the device cannot transmit continuously (duty cycle < 98%), a gated sweep shall be used when possible (i.e., gate triggered such that the analyzer only sweeps when the device is transmitting at full power), set the sweep time > (number of points in sweep) \times (symbol period) but the sweep time shall always be maintained at a value that is less than or equal to the minimum transmission time
 - c) If the device cannot be configured to transmit continuously (duty cycle > 98%), and a free-running sweep must be used, set the sweep time so that the averaging is performed over multiple on/off cycles by setting the sweep time > (number of points in sweep) \times (transmitter period) (i.e., the transmit on-time + the off-time). The spectrum analyzer readings shall subsequently be corrected by

[10 log (1/duty cycle)]. This assumes that the transmission period and duty cycle is relatively constant (duty cycle variation $\leq \pm 2\%$).

- d) If the device cannot be configured to transmit continuously and a free-running sweep must be used, and if the transmissions exhibit a non-constant duty cycle (duty cycle variations $> \pm 2\%$), set the sweep time so that the averaging is performed over the on-period by setting the sweep time $>$ (symbol period) \times (number of points), while also maintaining the sweep time $<$ (transmitter on-time). The trace mode shall be set to max hold, since not every display point will be averaged only over just the on-time. Thus, multiple sweeps (e.g., 100) in maximum hold are necessary to ensure that the maximum power is measured.
- 9) Allow trace to fully stabilize.

Notes:

1. Per 22.917(b), 24.238(b), 24.53(h)(3) and RSS-132(5.5), RSS-133(6.5), RSS-139(5.6), compliance with these rules is based on the use of measurement instrumentation employing a resolution bandwidth of 1 MHz or greater. However in the 1 MHz bands immediately outside and adjacent to the frequency block a resolution bandwidth of at least one percent of the emission bandwidth of the fundamental emission of the transmitter may be employed. The emission bandwidth is defined as the width of the signal between two points, one below the carrier center frequency and one above the carrier center frequency, outside of which all emissions are attenuated at least 26 dB below the transmitter power.

Test results

Test mode: WCDMA 850

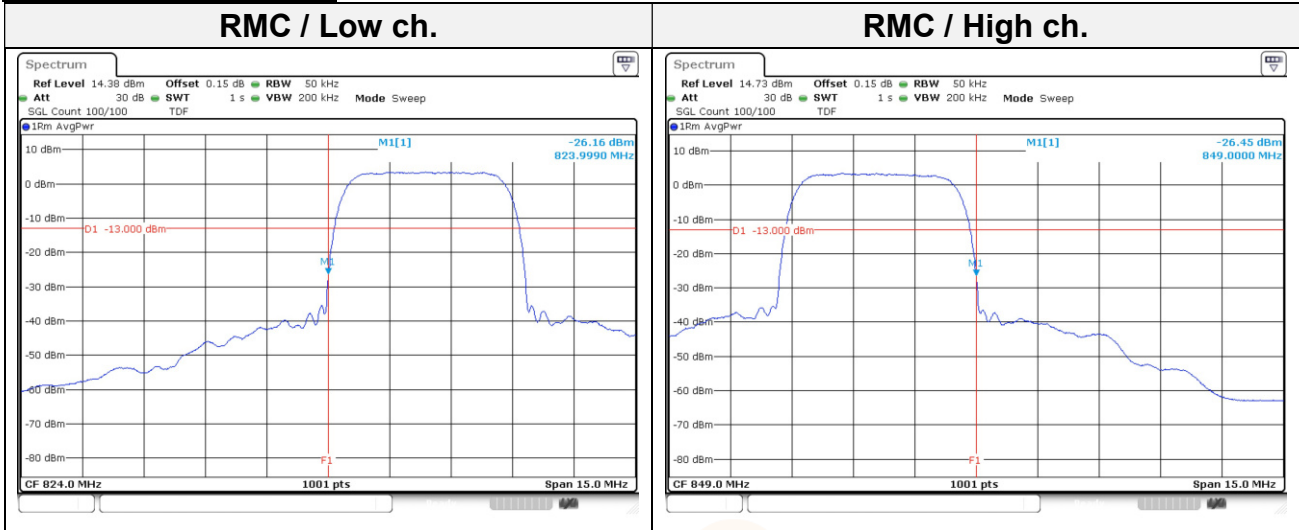

Test mode: WCDMA 1700

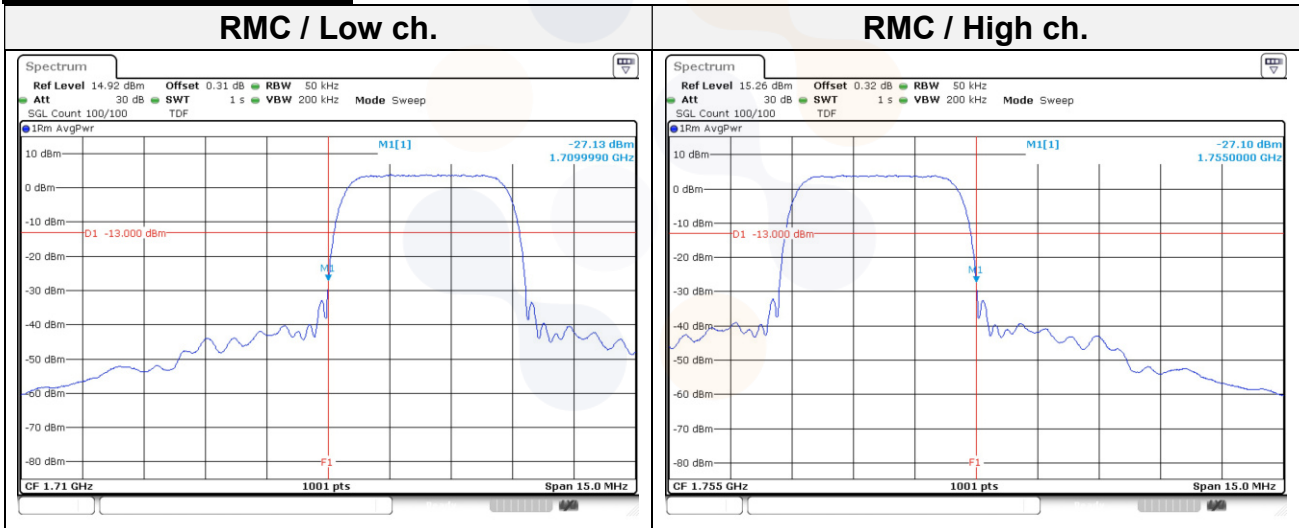

Test mode: WCDMA 1900

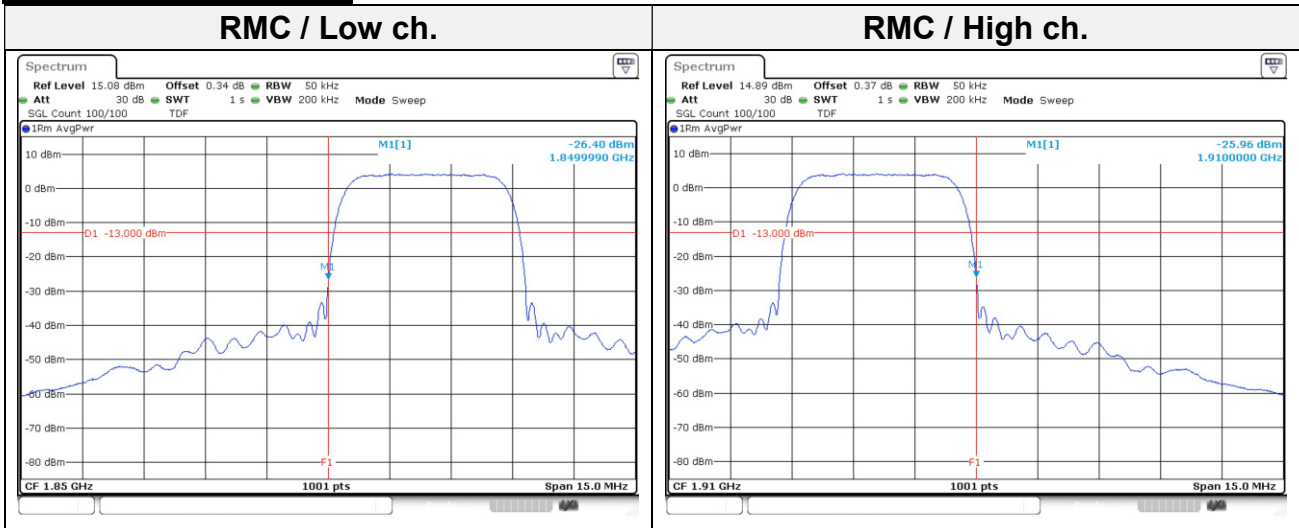

7.4. Spurious Emissions at Antenna Terminal

Test setup

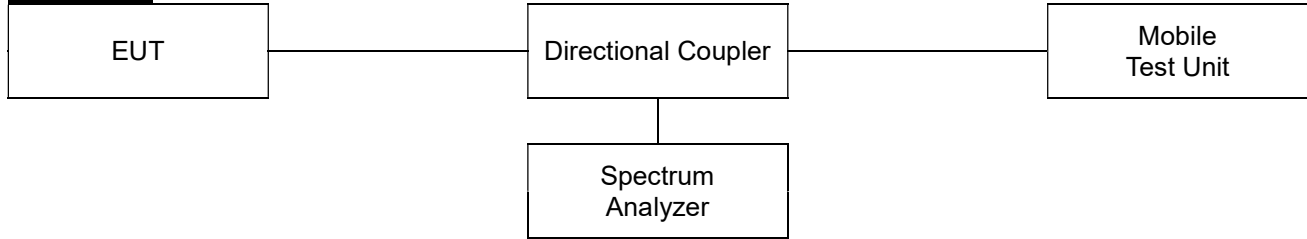

Limit

According to §22.917(a), §24.238(a) and RSS-132(5.5), RSS-133(6.5), the power of any emission outside of the authorized operating frequency ranges must be attenuated below the transmitting power (P) by a factor of at least $43 + 10\log(P)$ dB.

According to §27.53(h) and RSS-139(5.6), the power of any emission outside a licensee's frequency block shall be attenuated below the transmitter power (P) in watts by at least $43 + 10\log(P_{\text{Watts}})$ dB.

Test procedure

971168 D01 v03r01 - Section 6
ANSI 63.26-2015 – Section 5.7

Test settings

- 1) Start frequency was set to 30 MHz and stop frequency was set to at least 10th the fundamental frequency.
- 2) Detector = RMS
- 3) Sweep time = auto couple.
- 4) Trace mode = trace average
- 5) Allow trace to fully stabilize.
- 6) Please see test notes below RBW and VBW settings.

Notes:

1. Per 22.917(b), 24.238(b), 27.53(h) and RSS-132(5.5), RSS-133(6.5), RSS-139(5.6), compliance with these provisions is based on the use of measurement instrumentation employing a resolution bandwidth of 100 kHz or greater for frequencies less than 1 GHz and 1 MHz or greater for frequencies greater than 1 GHz.

The emission bandwidth is defined as the width of the signal between two points, one below the carrier center frequency and one above the carrier center frequency, outside of which all emissions are attenuated at least 26 dB below the transmitter power.

Test results

Test mode: WCDMA 850

Test mode: WCDMA 1700

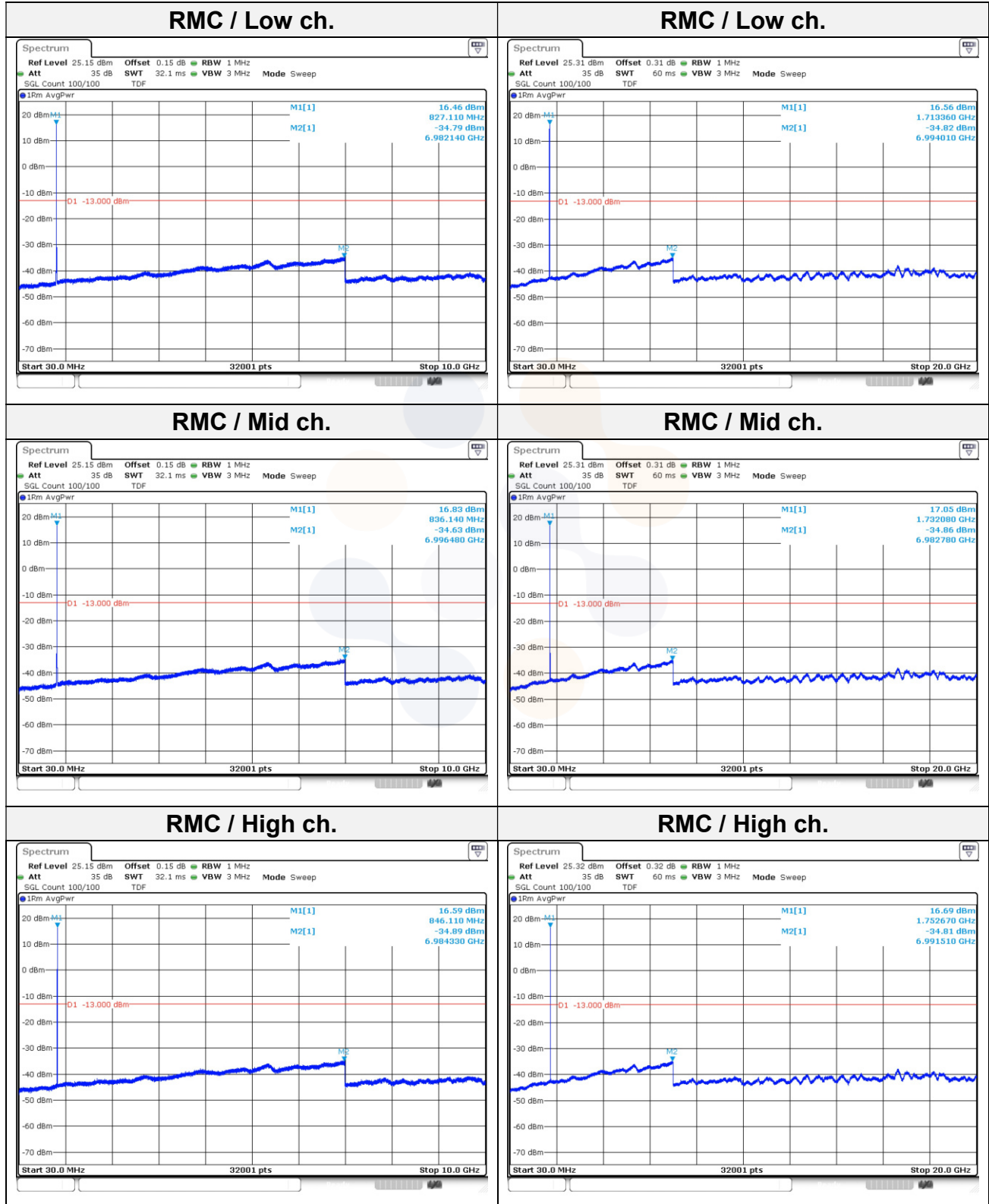

Test mode: WCDMA 1900

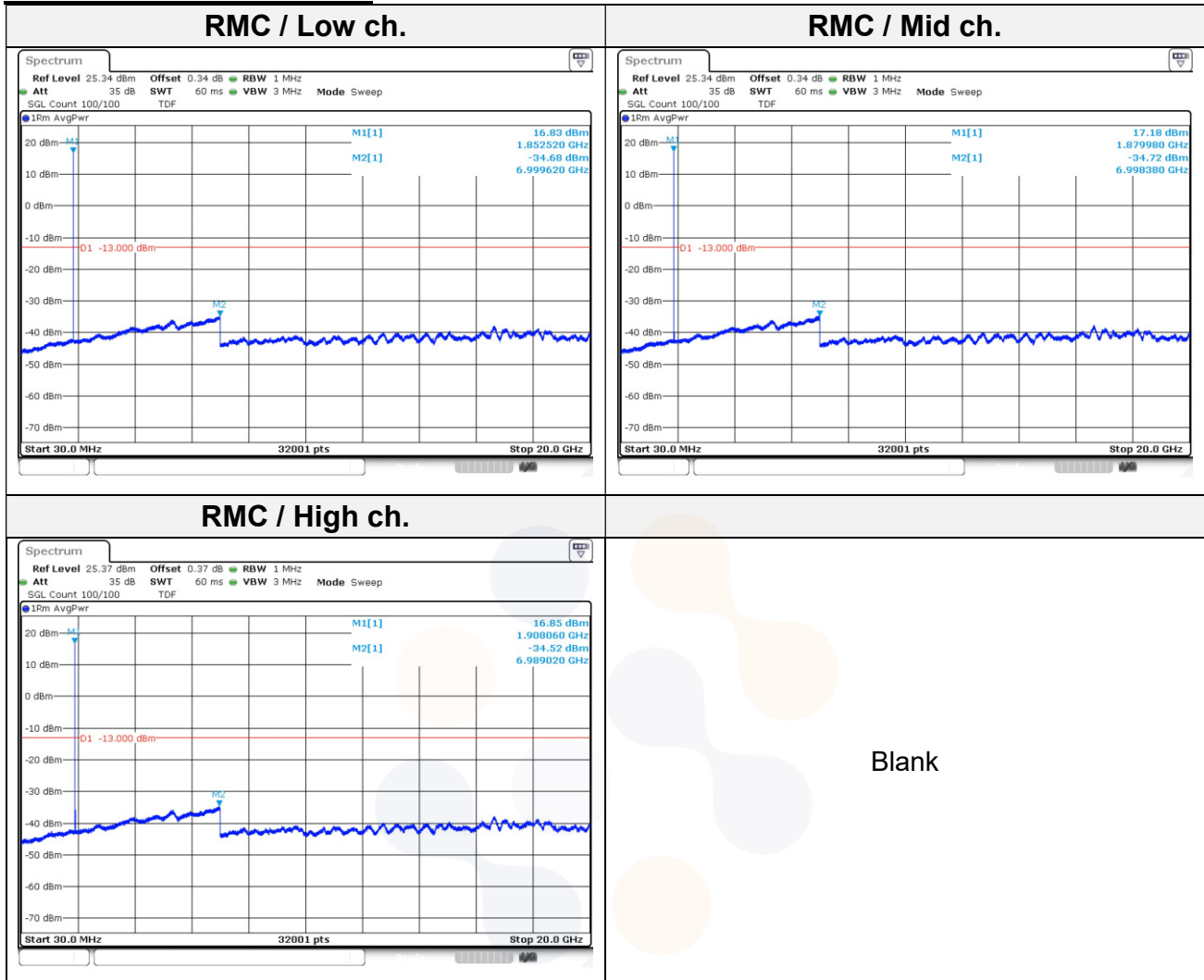

7.5. Peak to Average Power Ratio (PAPR)

Test setup

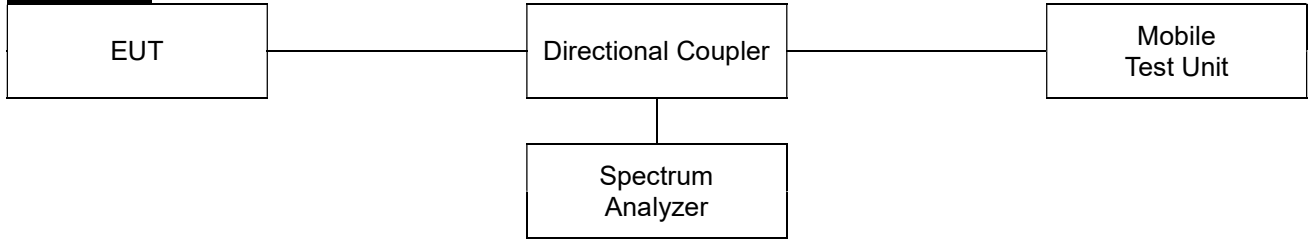

Limit

According to §24.232(d), §27.50(d)(5) and RSS-132(5.4), RSS-133(6.4), RSS-139(5.5), the peak-to-average ratio(PAR) of the transmission must not exceed 13 dB.

Test procedure

971168 D01 v03r01 - Section 5.7.2 or 5.7.3
971168 D02 v02r01 – Section VII
ANSI 63.26-2015 – Section 5.2.3.4 or 5.2.6

Test settings

5.2.3.4 Measurement of peak power in a broadband noise-like signal using CCDF

- 1) Set resolution/measurement bandwidth \geq OBW or specified reference bandwidth
- 2) Set the number of counts to a value that stabilizes the measured CCDF curve.
- 3) Set the measurement interval as follows:
 - a) For continuous transmissions, set to the greater of [10 x (number of points in sweep) x (transmission symbol period)] or 1 ms .
 - b) For burst transmissions, employ an external trigger that is synchronized with the EUT burst timing sequence, or use the internal burst trigger with a trigger level that allows the burst to stabilize. Set the measurement interval to a time that is less than or equal to the burst duration.
 - c) If there are several carriers in a single antenna port, the peak power shall be determined for each individual carrier (by disabling the other carriers while measuring the required carrier) and the total peak power calculated from the sum of the individual carrier peak powers.
- 4) Record the maximum PAPR level associated with a probability of 0.1%

5.2.6 Peak-to-average power ratio

Use one of the procedures presented in 5.2(ANSI C63.26-2015) to measure the total peak power and record as P_{PK} .

Use one of the applicable procedure presented 5.2(ANSI C63.26-2015) to measure the total average power and record as P_{AG} . Determine the P.A.P.R from:

$$PAPR(\text{dB}) = P_{PK}(\text{dBm or dBW}) - P_{AG}(\text{dBm or dBW})$$

Test results

WCDMA 850

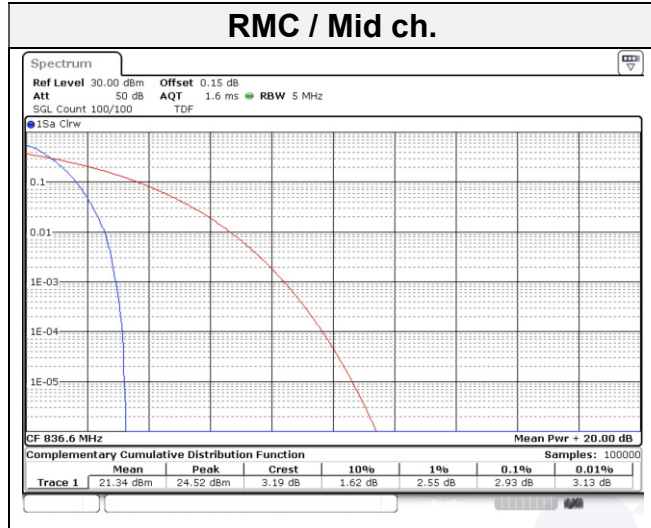

WCDMA 1700

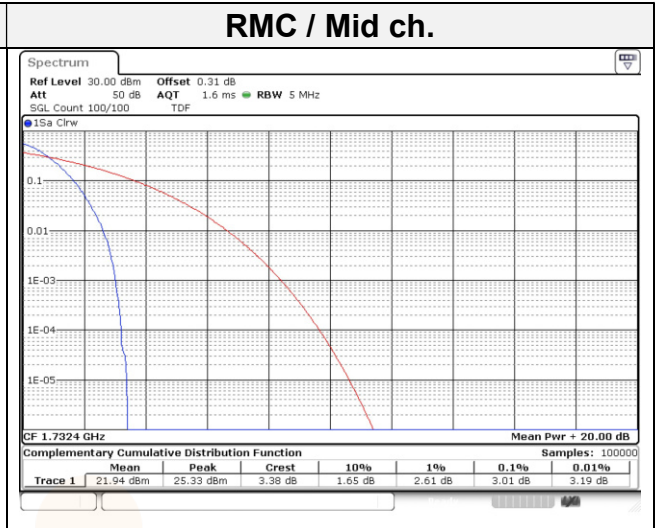

WCDMA 1900

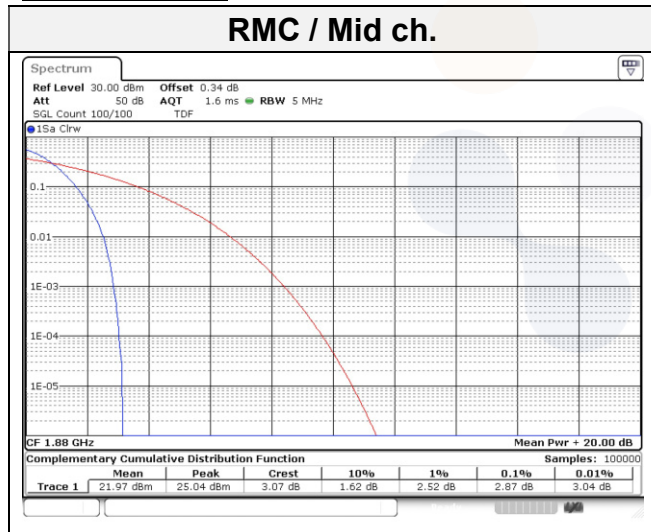

Blank

7.6. Frequency stability

Test setup

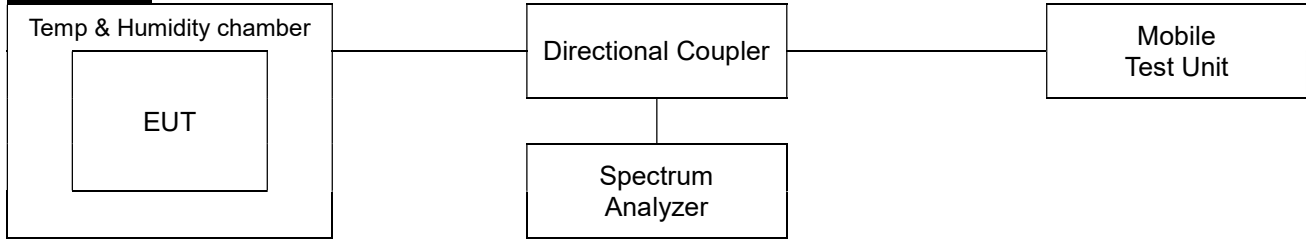

Limit

According to §2.1055(a),

The frequency stability shall be measured with variation of ambient temperature as follows:

- 1) From -30° to $+50^{\circ}$ centigrade for all equipment except that specified in paragraphs (a) (2) and (3) of this section.
- 2) From -20° to $+50^{\circ}$ centigrade for equipment to be licensed for use in the maritime services under part 80 of this chapter, except for class A, B, and S emergency position indicating Radiobeacons (EPIRBS), and equipment to be licensed for use above 952 MHz at operational fixed stations in all services, stations in the local television transmission service and point-to-point microwave radio service under part 21 of this chapter, equipment licensed for use aboard aircraft in the aviation services under part 87 of this chapter, and equipment authorized for use in the family radio service under part 95 of this chapter.
- 3) From 0° to $+50^{\circ}$ centigrade for equipment to be licensed for use in the radio broadcast Services under part 73 of this chapter.

According to §2.1055(d),

The frequency stability shall be measured with variation of primary supply Voltage as follows:

- 1) Vary primary supply voltage from 85 to 115 percent of the nominal value for other than hand carried battery equipment.
- 2) For hand carried, battery powered equipment, reduce primary supply voltage to the battery operating and point which shall be specified by the manufacturer.
- 3) The supply voltage shall be measured at the input to the cable normally provided with the equipment, or at the power supply terminals if cables are not normally provided. Effects on frequency of transmitter keying (except for broadcast transmitters) and any heating element cycling at the nominal supply voltage and at each extreme also shall be shown.

According to §22.355 and RSS-132(5.3),

For FCC, the carrier frequency of each transmitter in the public mobile services must be maintained within the tolerances given in Table of this section. For mobile devices operating in the 824 to 849 MHz band at a power level than or equal to 3 Watts, the limit specified in Table C-1 is ± 2.5 ppm.

For ISED, the frequency stability shall be sufficient to ensure that the occupied bandwidth stays within each of the sub-bands when tested at the temperature and supply voltage variations specified in RSS-Gen

According to §24.235 and RSS-133(6.3),

For FCC, the frequency stability shall be sufficient to ensure that the fundamental emission stays within the authorized frequency block.

For ISED, the carrier frequency shall not depart from the reference frequency, in excess of ± 2.5 ppm for mobile stations and ± 1.0 ppm for base stations.

According to §27.54 and RSS-139(5.4),

For FCC, the frequency stability shall be sufficient to ensure that the fundamental emissions stay within the authorized bands of operation.

For ISED, the frequency stability shall be sufficient to ensure that the occupied bandwidth stay within the operating frequency block or frequency block group when tested to the temperature and supply voltage variations specified in RSS-Gen.

Test procedure

ANSI 63.26-2015 – Section 5.6

Test settings

- 1) The carrier frequency of the transmitter is measured at room temperature.
(20°C to provide a reference)
- 2) The equipment is turned on in a “standby” condition for one minute before applying power to the transmitter. Measurement of the carrier frequency of the transmitter is made within one minute after applying power to the transmitter.
- 3) Frequency measurements are made at 10°C intervals ranging from -30°C to +50°C.
A period of at least one half-hour is provided to allow stabilization of the equipment at each Temperature level.

Test results

Test mode : WCDMA 850
 Frequency (Hz) : 836 600 000
 Channel : 4183
 Deviation limit(FCC) : ±0.00025% or 2.5 ppm
 Deviation limit(IC) : The frequency stability shall be sufficient to ensure that the occupied bandwidth stays within each of the sub-bands when tested at the temperature and supply voltage

Voltage (%)	Power (V)	Temp. (°C)	Frequency (Hz)	Frequency error (Hz)	Deviation	
					(ppm)	(%)
100%	3.88	+21.5(Ref)	836,600,001	1.17	0.0	0.000000
		-30	836,600,006	5.62	0.0	0.000001
		-20	836,600,007	7.11	0.0	0.000001
		-10	836,600,008	8.16	0.0	0.000001
		0	836,600,004	3.78	0.0	0.000000
		+10	836,600,002	2.14	0.0	0.000000
		+20	836,600,002	1.55	0.0	0.000000
		+30	836,600,002	2.31	0.0	0.000000
		+40	836,600,004	4.08	0.0	0.000000
		+50	836,600,004	3.78	0.0	0.000000
115%	4.46	+21.5(Ref)	836,600,001	0.99	0.0	0.000000
End point	3.40	+21.5(Ref)	836,600,001	0.69	0.0	0.000000

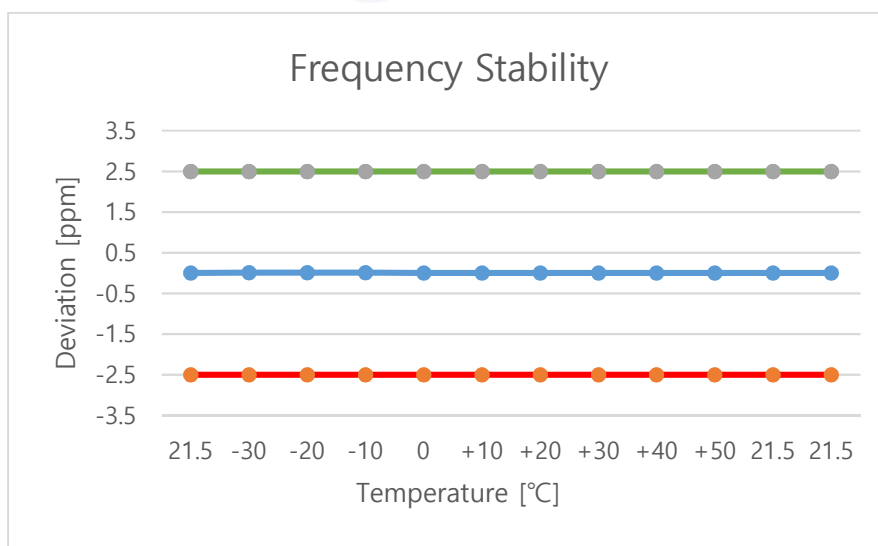

Test mode : WCDMA 1700
 Frequency (Hz) : 1 732 400 000
 Channel : 1412
 Deviation limit(FCC) : The frequency stability shall be sufficient to ensure that the fundamental emission stays within the authorized frequency block.
 Deviation limit(IC) : The frequency stability shall be sufficient to ensure that the occupied bandwidth stays within each of the sub-bands when tested at the temperature and supply voltage

Voltage (%)	Power (V)	Temp. (°C)	Frequency (Hz)	Frequency error (Hz)	Deviation	
					(ppm)	(%)
100%	3.88	+21.5(Ref)	1,732,399,999	-1.42	0.0	0.000000
		-30	1,732,400,006	6.31	0.0	0.000000
		-20	1,732,400,004	4.30	0.0	0.000000
		-10	1,732,400,004	4.09	0.0	0.000000
		0	1,732,400,002	1.75	0.0	0.000000
		+10	1,732,399,997	-2.85	0.0	0.000000
		+20	1,732,399,998	-2.34	0.0	0.000000
		+30	1,732,399,996	-4.01	0.0	0.000000
		+40	1,732,400,003	2.67	0.0	0.000000
		+50	1,732,400,008	7.60	0.0	0.000000
115%	4.46	+21.5(Ref)	1,732,399,999	-1.15	0.0	0.000000
End point	3.40	+21.5(Ref)	1,732,399,998	-1.82	0.0	0.000000

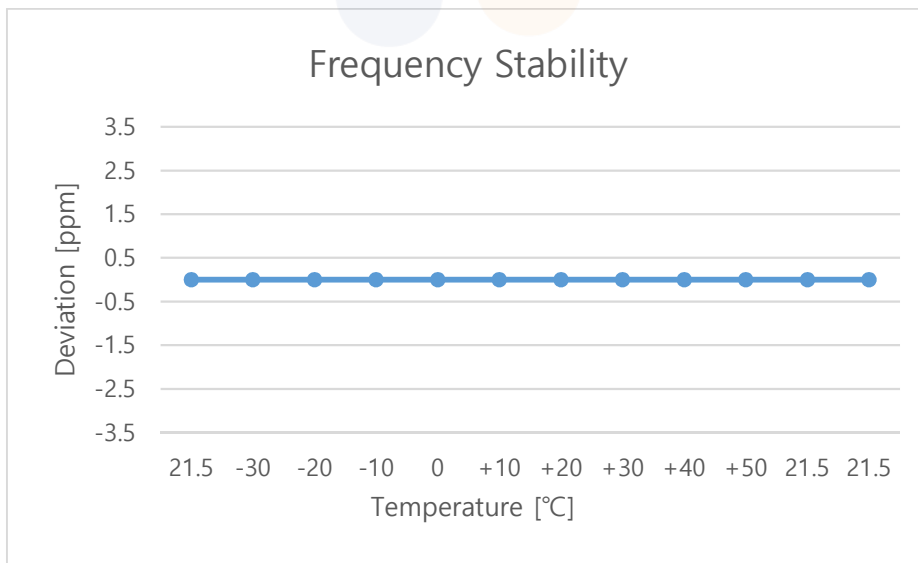

Test mode : WCDMA 1900
 Frequency (Hz) : 1 880 000 000
 Channel : 9400
 Deviation limit(FCC) : The frequency stability shall be sufficient to ensure that the fundamental emission stays within the authorized frequency block.
 Deviation limit(IC) : ±0.00025% or 2.5ppm

Voltage (%)	Power (V)	Temp. (°C)	Frequency (Hz)	Frequency error (Hz)	Deviation	
					(ppm)	(%)
100%	3.88	+21.5(Ref)	1,879,999,998	-1.76	0.0	0.000000
		-30	1,880,000,007	7.28	0.0	0.000000
		-20	1,880,000,008	8.31	0.0	0.000000
		-10	1,880,000,004	4.45	0.0	0.000000
		0	1,880,000,003	3.05	0.0	0.000000
		+10	1,880,000,001	1.32	0.0	0.000000
		+20	1,879,999,997	-3.06	0.0	0.000000
		+30	1,879,999,995	-5.12	0.0	0.000000
		+40	1,879,999,990	-10.04	0.0	-0.000001
		+50	1,879,999,991	-9.47	0.0	-0.000001
115%	4.46	+21.5(Ref)	1,879,999,999	-0.92	0.0	0.000000
End point	3.40	+21.5(Ref)	1,879,999,998	-1.91	0.0	0.000000

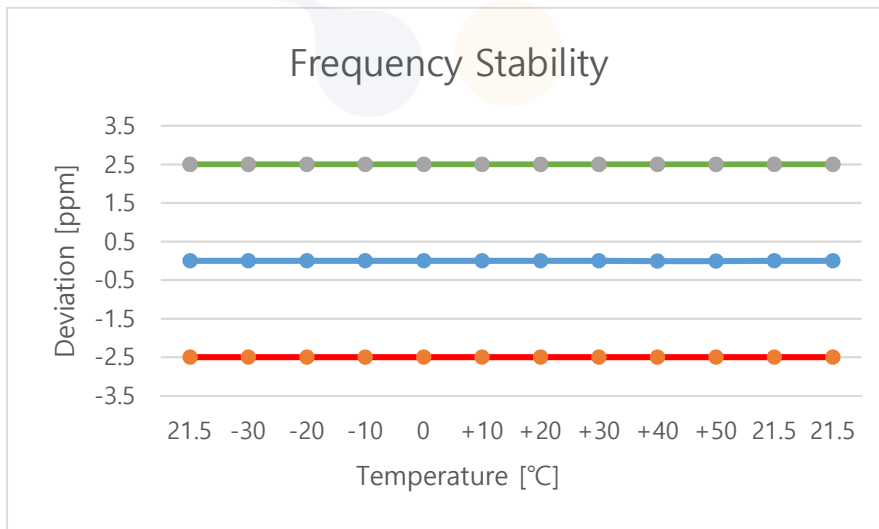

7.7. Radiated Power (ERP/EIRP)

Test setup

The diagram below shows the test setup that is utilized to make the measurements for emission from 30 MHz to 1 GHz emissions.

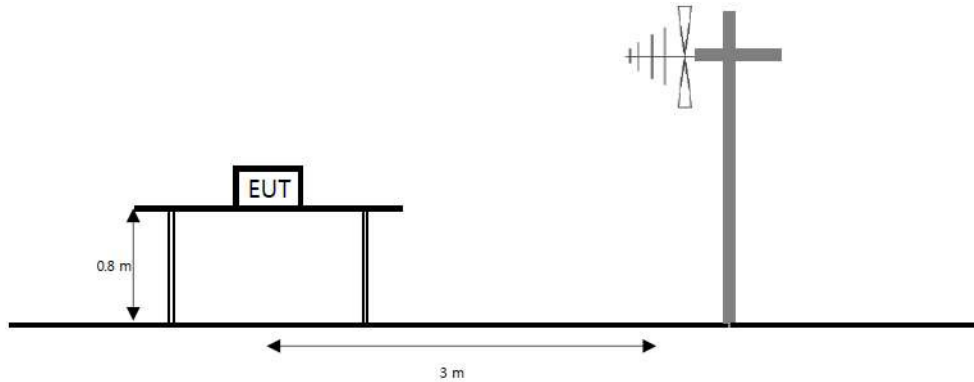

The diagram below shows the test setup that is utilized to make the measurements for emission from 1 GHz to the tenth harmonic of the highest fundamental frequency or to 40 GHz emissions, whichever is lower.

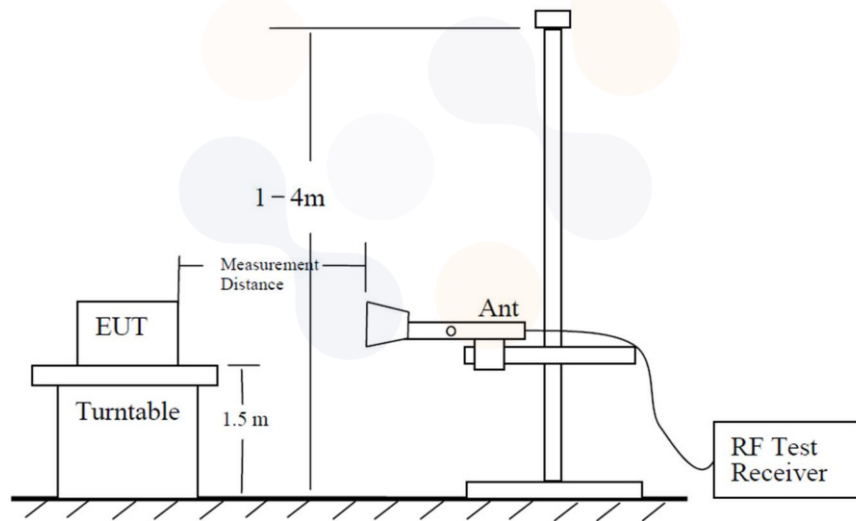

The diagram below shows the test setup for substituted method.

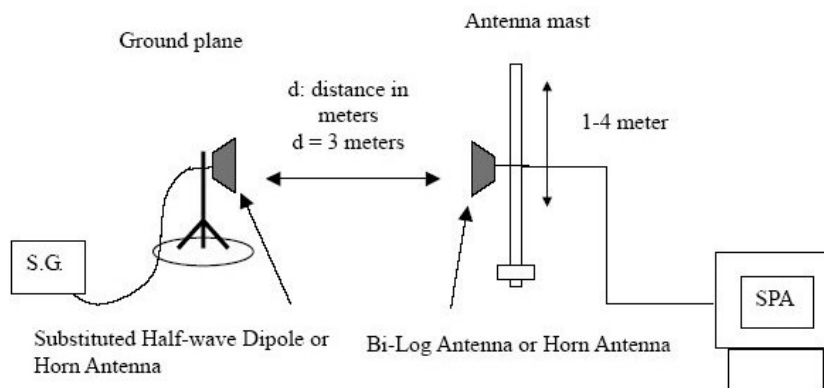

Limit

According to §22.913(a)(5), the ERP of transmitters in the cellular radiotelephone service must not exceed the limits in this section. The ERP of mobile transmitters and auxiliary test transmitters must not exceed 7 watts. And according to RSS-132(5.4), the equivalent radiated power (e.r.p.) shall not exceed 7 watts for mobile equipment and 3 watts for portable equipment.

According to §24.232(c), mobile and portable stations are limited to 2 watts EIRP and the equipment must employ a means for limiting power to the minimum necessary for successful communications. And according to RSS-133(6.4), the equivalent isotropically radiated power (e.i.r.p.) for transmitters shall not exceed the limits given in SRSP-510.

For SRSP-510, mobile stations and hand-held portables are limited to 2 watts maximum e.i.r.p.



According to §27.50(d)(4), fixed, mobile, and portable (hand-held) stations operating in the 1710~1755 MHz band and mobile and portable stations operating in the 1695~1710 MHz and 1755~1780 MHz bands are 1 watt EIRP. And according to RSS-139(5.6), the equivalent isotropically radiated power (e.i.r.p.) for mobile and portable transmitters shall not exceed one watt. The e.i.r.p. for fixed and base stations in the band 1710-1780 MHz shall not exceed one watt(30 dBm e.i.r.p./channel bandwidth).

Test procedure

971168 D01 v03r01 - Section 5.2.2
ANSI 63.26-2015 – Section 5.2.4.4.1
ANSI/TIA-603-E-2016 - Section 2.2.17

Test settings

- 1) RBW = 1 % to 5 % of the OBW.
- 2) VBW $\geq 3 \times$ RBW.
- 3) SPAN = 2 \times to 3 \times the OBW.
- 4) Number of measurement points in sweep $\geq 2 \times$ span / RBW.
- 5) Sweep time :
 - 1) Auto couple, or
 - 2) $\geq [10 \times (\text{number of points in sweep}) \times (\text{transmission period})]$ for single sweep (automation-compatible) measurement. Transmission period is the on and off time of the transmitter.
- 6) Detector = RMS
- 7) If the EUT can be configured to transmit continuously, then set the trigger to free run.
- 8) If the EUT cannot be configured to transmit continuously, then use a sweep trigger with the level set to enable triggering only on full power bursts and configure the EUT to transmit at full power for the entire duration of each sweep. Verify that the sweep time is less than or equal to the transmission burst duration. Time gating can also be used under similar constraints (i.e., configured such that measurement data is collected only during active full-power transmissions).
- 9) Trace mode = trace averaging (RMS) over 100 sweeps.
- 10) Compute the power by integrating the spectrum across the OBW of the signal using the instrument's band or channel power measurement function, with the band/channel limits set equal to the OBW band edges. If the instrument does not have a band or channel power function, then sum the spectrum levels (in linear power units) at intervals equal to the RBW extending across the entire OBW of the spectrum.
- 11) Allow trace to fully stabilize.

<p>Eurofins KCTL Co.,Ltd. 65, Sinwon-ro, Yeongtong-gu, Suwon-si, Gyeonggi-do, 16677, Korea TEL: 82-70-5008-1021 FAX: 82-505-299-8311 www.kctl.co.kr</p>	<p>Report No.: KR23-SRF0134 Page (33) of (40)</p>	 
--	---	---

Notes:

1. On a test site, the EUT shall be placed at 80 cm or 1.5 m height on a turn table, and in the position close to normal use as declared by the applicant.
2. The test antenna shall be oriented initially for vertical polarization located 3 m from EUT to correspond to the fundamental frequency of the transmitter.
3. The turntable is rotated through 360°, and the receiving antenna scans in order to determine the Level of the maximized emission.
4. The test antenna shall be raised and lowered again through the specified range of height until the maximum signal level is detected by the measuring receiver.
5. The maximum signal level detected by the measuring receiver shall be noted.
6. The EUT was replaced by half-wave dipole (1 GHz below) or horn antenna (1 GHz above) connected to a signal generator.
The power is calculated by the following formula;

$$Pd(\text{dBm}) = Pg(\text{dBm}) - \text{Cable loss (dB)} + \text{Antenna gain (dB)}$$
Note. Pd is the dipole equivalent power and Pg is the generator output power into the substitution antenna.
7. The test antenna shall be raised and lowered through the specified range of height to ensure that The maximum signal is received.
8. The input signal to the substitution antenna shall be adjusted to the level that produces a level Detected by the measuring corrected for the change of input attenuator setting of the measuring Receiver.
9. The input level to the substitution antenna shall be recorded as power level in dBm, corrected for Any change of input attenuator setting of the measuring receiver.
10. The measurement shall be repeated with the test antenna and the substitution antenna Orientated for horizontal polarization.

Test results

Test mode: WCDMA 850

Mode	Channel	Frequency	Pol.	Antenna Gain	C.L	Substitute Level	ERP	
		[MHz]	[V/H]	[dBd]	[dB]	[dB m]	[dB m]	[W]
RMC	1312	826.40	H	5.29	2.80	13.09	15.58	0.036
	1412	836.60	H	5.40	2.84	13.09	15.65	0.037
	1513	846.60	H	5.47	2.49	12.88	15.86	0.039

Test mode: WCDMA 1700

Mode	Channel	Frequency	Pol.	Antenna Gain	C.L	Substitute Level	EIRP	
		[MHz]	[V/H]	[dBi]	[dB]	[dB m]	[dB m]	[W]
RMC	1312	1 712.40	H	5.88	5.19	15.64	16.32	0.043
	1412	1 732.40	H	5.84	5.21	15.90	16.52	0.045
	1513	1 752.60	H	5.79	5.26	18.45	18.98	0.079

Test mode: WCDMA 1900

Mode	Channel	Frequency	Pol.	Antenna Gain	C.L	Substitute Level	EIRP	
		[MHz]	[V/H]	[dBi]	[dB]	[dB m]	[dB m]	[W]
RMC	9262	1 852.40	H	5.60	5.18	16.49	16.90	0.049
	9400	1 880.00	H	5.54	5.19	15.67	16.02	0.040
	9538	1 907.60	H	5.48	5.30	17.18	17.36	0.054

Note.

1. E.R.P & E.I.R.P(dBm) = Substitute Level(dB) + Antenna gain(dBi&dBd) - C.L(Cable loss) (dB)

7.8. Radiated Spurious Emissions

Test setup

The diagram below shows the test setup that is utilized to make the measurements for emission from 30 MHz to 1 GHz emissions.

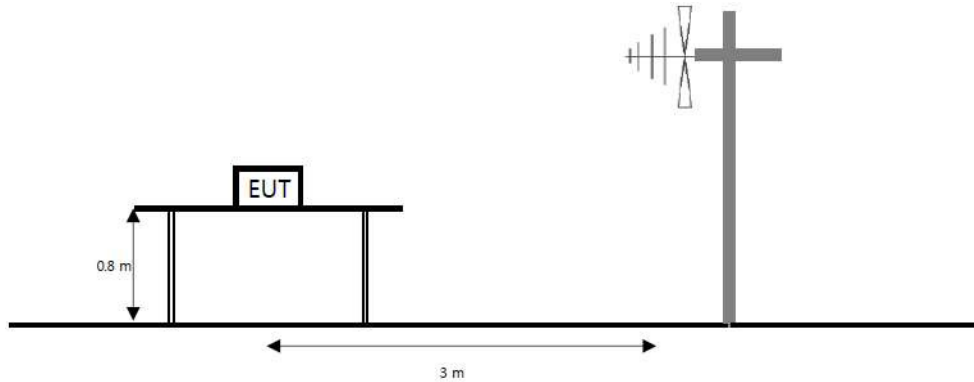

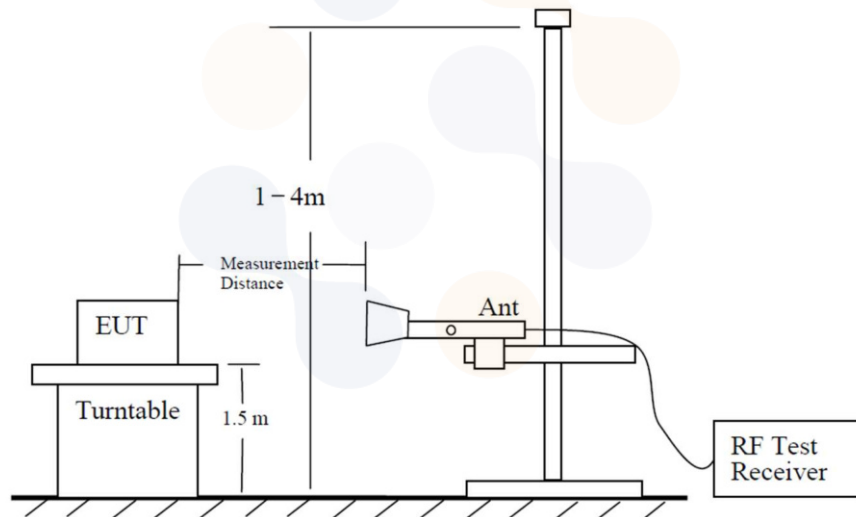

The diagram below shows the test setup that is utilized to make the measurements for emission from 1 GHz to the tenth harmonic of the highest fundamental frequency or to 40 GHz emissions, whichever is lower.

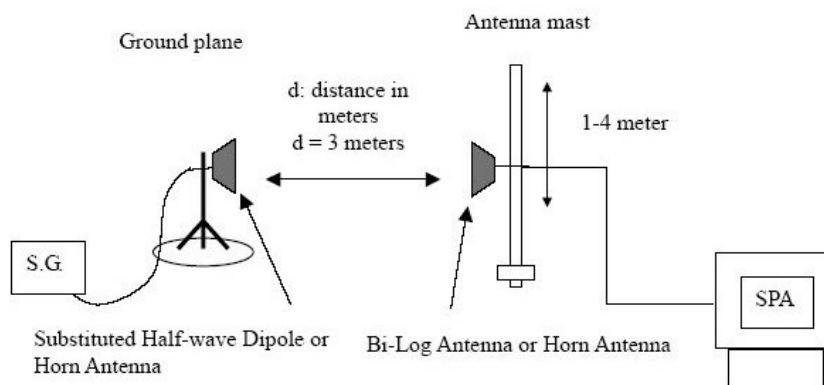

The diagram below shows the test setup for substituted method.



<p style="text-align: center;">Eurofins KCTL Co.,Ltd. 65, Sinwon-ro, Yeongtong-gu, Suwon-si, Gyeonggi-do, 16677, Korea TEL: 82-70-5008-1021 FAX: 82-505-299-8311 www.kctl.co.kr</p>	<p style="text-align: center;">Report No.: KR23-SRF0134 Page (36) of (40)</p>	 
--	---	---

Limit

According to §22.917(a), §24.238(a) and RSS-132(5.5), RSS-133(6.5), the power of any emission outside of the authorized operating frequency ranges must be attenuated below the transmitting power (P) by a factor of at least $43 + 10\log(P)$ dB.

According to §27.53(h) and RSS-139(5.6), the power of any emission outside a licensee's frequency block shall be attenuated below the transmitter power (P) in watts by at least $43 + 10\log(P_{\text{Watts}})$ dB.

Test procedure

971168 D01 v03r01 - Section 5.8

ANSI 63.26-2015 – Section 5.5

ANSI/TIA-603-E-2016 - Section 2.2.12

Test settings

- 1) RBW = 1 kHz for below 1 GHz and 1 MHz for above 1 GHz.
- 2) VBW $\geq 3 \times$ RBW.
- 3) Detector = RMS
- 4) Trace mode = Max hold
- 5) Sweep time = Auto couple
- 6) Number of sweep points $\geq 2 \times$ span / RBW
- 7) Allow trace to fully stabilize.

Notes:

1. On a test site, the EUT shall be placed at 80 cm or 1.5 m height on a turn table, and in the position close to normal use as declared by the applicant.
2. The test antenna shall be oriented initially for vertical polarization located 3 m from EUT to correspond to the fundamental frequency of the transmitter.
3. The turntable is rotated through 360°, and the receiving antenna scans in order to determine the Level of the maximized emission.
4. The test antenna shall be raised and lowered again through the specified range of height until the maximum signal level is detected by the measuring receiver.
5. The maximum signal level detected by the measuring receiver shall be noted.
6. The EUT was replaced by half-wave dipole (1 GHz below) or horn antenna (1 GHz above) connected to a signal generator.
7. The test antenna shall be raised and lowered through the specified range of height to ensure that The maximum signal is received.
8. The input signal to the substitution antenna shall be adjusted to the level that produces a level Detected by the measuring corrected for the change of input attenuator setting of the measuring Receiver.
9. The input level to the substitution antenna shall be recorded as power level in dBm, corrected for Any change of input attenuator setting of the measuring receiver.
10. The measurement shall be repeated with the test antenna and the substitution antenna Orientated for horizontal polarization.

Test results (Above 1 000 MHz)

Test mode : WCDMA 850

Frequency(MHz) : 826.4

Channel : 4132

Mode	Frequency	Pol.	Antenna Gain	Cable loss	Substitute Level	Level	Limit	Margin
	[MHz]	[V/H]	[dBi]	[dB]	[dBm]	[dBm]	[dBm]	[dB]
RMC	1 648.80	V	6.00	5.02	-60.18	-59.20	-13.00	46.20
	2 482.80	H	6.17	6.03	-53.84	-53.70	-13.00	40.70
	3 304.40	H	7.67	6.76	-56.81	-55.90	-13.00	42.90
	4 131.20	H	9.00	7.39	-54.91	-53.30	-13.00	40.30

Test mode : WCDMA 850

Frequency(MHz) : 836.6

Channel : 4183

Mode	Frequency	Pol.	Antenna Gain	Cable loss	Substitute Level	Level	Limit	Margin
	[MHz]	[V/H]	[dBi]	[dB]	[dBm]	[dBm]	[dBm]	[dB]
RMC	1 673.60	H	5.95	5.13	-63.32	-62.50	-13.00	49.50
	2 507.20	H	6.21	5.98	-54.43	-54.20	-13.00	41.20
	3 347.60	V	7.81	6.80	-58.01	-57.00	-13.00	44.00
	4 181.60	H	9.05	7.30	-54.75	-53.00	-13.00	40.00

Test mode : WCDMA 850

Frequency(MHz) : 846.6

Channel : 4233

Mode	Frequency	Pol.	Antenna Gain	Cable loss	Substitute Level	Level	Limit	Margin
	[MHz]	[V/H]	[dBi]	[dB]	[dBm]	[dBm]	[dBm]	[dB]
RMC	1 694.00	H	5.91	5.17	-61.74	-61.00	-13.00	48.00
	2 537.60	H	6.24	5.98	-55.76	-55.50	-13.00	42.50
	3 387.60	H	7.94	6.84	-57.30	-56.20	-13.00	43.20
	4 231.60	H	9.09	7.27	-57.52	-55.70	-13.00	42.70

Note.

1. Limit Calculation(dBm)= 43 + 10log(P_{Watts})

2. E.R.P & E.I.R.P(dB m) = Substitute Level(dB) + Antenna gain(dB d&dB i) - C.L(Cable loss) (dB)

Test mode : WCDMA 1700

Frequency(MHz) : 1 712.4

Channel : 1312

Mode	Frequency	Pol.	Antenna Gain	Cable loss	Substitute Level	Level	Limit	Margin
	[MHz]	[V/H]	[dBi]	[dB]	[dBm]	[dBm]	[dBm]	[dB]
RMC	3 424.50	H	8.06	6.87	-57.99	-56.80	-13.00	43.80
	5 138.25	H	10.28	8.40	-55.88	-54.00	-13.00	41.00
	6 845.25	H	11.31	10.37	-52.04	-51.10	-13.00	38.10
	8 565.75	V	13.13	9.41	-51.42	-47.70	-13.00	34.70

Test mode : WCDMA 1700

Frequency(MHz) : 1 732.4

Channel : 1412

Mode	Frequency	Pol.	Antenna Gain	Cable loss	Substitute Level	Level	Limit	Margin
	[MHz]	[V/H]	[dBi]	[dB]	[dBm]	[dBm]	[dBm]	[dB]
RMC	3 465.75	H	8.19	6.91	-58.08	-56.80	-13.00	43.80
	5 195.25	V	10.32	8.45	-54.27	-52.40	-13.00	39.40
	6 928.50	V	11.41	10.14	-53.17	-51.90	-13.00	38.90
	8 661.00	V	13.16	9.66	-51.20	-47.70	-13.00	34.70

Test mode : WCDMA 1700

Frequency(MHz) : 1 752.6

Channel : 1513

Mode	Frequency	Pol.	Antenna Gain	Cable loss	Substitute Level	Level	Limit	Margin
	[MHz]	[V/H]	[dBi]	[dB]	[dBm]	[dBm]	[dBm]	[dB]
RMC	3 504.00	H	8.30	6.94	-57.16	-55.80	-13.00	42.80
	5 259.75	V	10.36	8.55	-55.51	-53.70	-13.00	40.70
	7 010.25	V	11.51	9.36	-53.25	-51.10	-13.00	38.10
	8 767.50	V	13.21	10.12	-50.29	-47.20	-13.00	34.20

Note.

1. Limit Calculation(dBm)= 43 + 10log(P_{Watts})

2. E.R.P & E.I.R.P(dB m) = Substitute Level(dB) + Antenna gain(dB d&dB i) - C.L.(Cable loss) (dB)

Test mode : WCDMA 1900

Frequency(MHz) : 1 852.4

Channel : 9262

Mode	Frequency	Pol.	Antenna Gain	Cable loss	Substitute Level	Level	Limit	Margin
	[MHz]	[V/H]	[dBi]	[dB]	[dBm]	[dBm]	[dBm]	[dB]
RMC	3 705.75	V	8.55	7.12	-55.63	-54.20	-13.00	41.20
	5 559.00	V	10.52	8.63	-51.39	-49.50	-13.00	36.50
	7 410.00	H	11.99	9.29	-52.60	-49.90	-13.00	36.90
	9 263.25	H	13.30	9.83	-51.67	-48.20	-13.00	35.20

Test mode : WCDMA 1900

Frequency(MHz) : 1 880.0

Channel : 9400

Mode	Frequency	Pol.	Antenna Gain	Cable loss	Substitute Level	Level	Limit	Margin
	[MHz]	[V/H]	[dBi]	[dB]	[dBm]	[dBm]	[dBm]	[dB]
RMC	3 760.50	V	8.61	6.96	-57.05	-55.40	-13.00	42.40
	5 636.25	V	10.55	8.66	-50.59	-48.70	-13.00	35.70
	7 518.00	V	12.11	9.45	-50.16	-47.50	-13.00	34.50
	9 399.00	V	13.30	10.18	-50.02	-46.90	-13.00	33.90

Test mode : WCDMA 1900

Frequency(MHz) : 1 907.6

Channel : 9538

Mode	Frequency	Pol.	Antenna Gain	Cable loss	Substitute Level	Level	Limit	Margin
	[MHz]	[V/H]	[dBi]	[dB]	[dBm]	[dBm]	[dBm]	[dB]
RMC	3 816.00	H	8.68	7.02	-57.16	-55.50	-13.00	42.50
	5 727.00	V	10.59	8.66	-51.33	-49.40	-13.00	36.40
	7 626.00	V	12.20	9.64	-52.16	-49.60	-13.00	36.60
	9 539.25	H	13.28	10.69	-49.19	-46.60	-13.00	33.60

Note.

1. Limit Calculation(dBm)= 43 + 10log(P_{Watts})

2. E.R.P & E.I.R.P(dBm) = Substitute Level(dB) + Antenna gain(dB&dBi) - C.L(Cable loss) (dB)

8. Measurement equipment

Equipment Name	Manufacturer	Model No.	Serial No.	Next Cal. Date
Spectrum Analyzer	R&S	FSV30	100810	23.07.12
Spectrum Analyzer	AGILENT	N9040B	MY57010132	23.10.14
Signal Generator	R&S	SMB100A	176206	24.01.19
DC Power Supply	AGILENT	E3632A	KR73001026	24.01.19
Directional Coupler	AAMCS	AAMCS-UDC-0.5G-18G-10dB-SF	399	24.01.19
Directional Coupler	Marki Microwave, Inc.	CBR17-0026	0001	23.08.10
Wideband Radio Communication Tester	R&S	CMW500	106840	24.01.19
Wideband Radio Communication Tester	R&S	CMW500	168683	24.02.09
Wideband Radio Communication Tester	R&S	CMW500	141780	24.01.19
Temp & Humid Chamber	Daejin Engineering	DJ-THR11000	10041	24.01.19
Bi-log Antenna	Teseq GmbH	CBL 6112D	62027	24.11.17
Bi-log Antenna	ETS.LINDGREN	3143B	228420	23.09.28
Horn Antenna	ETS-LINDGREN	3117	251528	24.02.02
Horn Antenna	ETS.LINDGREN	3117	227509	23.09.20
Horn Antenna	ETS-Lindgren	3116	00086632	24.01.25
Horn Antenna	ETS-LINDGREN	3116C	251516	24.02.02
Amplifier	SONOMA INSTRUMENT	310N	421822	23.12.14
Amplifier	C&K Technologies, Inc.	BZRT-00504000-481055-382525	26299-27735	23.09.19
Amplifier	C&K Technologies, Inc.	BZR-00504000-551028-252525	27736	23.09.19
High Pass Filter	Wainwright Instruments GmbH	WHKX10-900-1000-15000-40SS	11	23.08.10
High Pass Filter	Wainwright Instruments GmbH	WHKX12-2805-3000-18000-40SS	32	23.08.10
Antenna Mast	innco systems GmbH	MA4640-XP-ET	N/A	-
Controller	Innco Systems	CO3000	1175/458503 19/P	-

End of test report