





TEST REPORT

<p>Eurofins KCTL Co.,Ltd. 65, Sinwon-ro, Yeongtong-gu, Suwon-si, Gyeonggi-do, 16677, Korea TEL: 82-70-5008-1021 FAX: 82-505-299-8311 www.kctl.co.kr</p>	<p>Report No.: KR23-SPF0011 Page (1) of (200)</p>	 
------------------------------------------------------------------------------------------------------------------------------------------------------------------------------------------------------------------------------------------------------------------------	---------------------------------------------------------------------------------------------	-------------------------------------------------------------------------------------------------------------------------------------------------------------------------

1. Client

- Name : Samsung Electronics Co., Ltd.
- Address : 129, Samsung-ro, Yeongtong-gu, Suwon-si, Gyeonggi-do, 16677, Rep. of Korea
- Date of Receipt : 2023-03-23

2. Use of Report : Certification

3. Name of Product and Model : Smart Wearable
 ◦ Model Number : SM-R935U
 ◦ Manufacturer and Country of Origin: Samsung Electronics Co., Ltd. / VIETNAM



4. FCC ID : A3LSMR935

5. Date of Test : 2023-04-12 ~ 2023-05-08

6. Location of Test : Permanent Testing Lab On Site Testing
 (Address: 65, Sinwon-ro, Yeongtong-gu, Suwon-si, Gyeonggi-do, 16677, Korea)

7. Test Standards : IEEE 1528-2013, ANSI/IEEE C95.1, KDB Publication

8. Test Results : Refer to the test result in the test report

	Tested by	Technical Manager
Affirmation	Name : Bosaeng Shim (Signature) 	Name : Jongwon Ma (Signature) 

2023-05-19

Eurofins KCTL Co.,Ltd.

As a test result of the sample which was submitted from the client, this report does not guarantee the whole product quality. This test report should not be used and copied without a written agreement by Eurofins KCTL Co.,Ltd.

REPORT REVISION HISTORY

Date	Revision	Page No
2023-05-19	Originally issued	-

This report shall not be reproduced except in full, without the written approval of Eurofins KCTL Co.,Ltd. This document may be altered or revised by Eurofins KCTL Co.,Ltd. personnel only, and shall be noted in the revision section of the document. Any alteration of this document not carried out by Eurofins KCTL Co.,Ltd. will constitute fraud and shall nullify the document. This test report is a general report that does not use the KOLAS accreditation mark and is not related to KS Q ISO/IEC 17025 and KOLAS accreditation.

General remarks for test reports

Statement concerning the uncertainty of the measurement systems used for the tests

(may be required by the product standard or client)

Internal procedure used for type testing through which traceability of the measuring uncertainty has been established:

Procedure number, issue date and title:

Calculations leading to the reported values are on file with the testing laboratory that conducted the testing.

Statement not required by the standard or client used for type testing

1. Identification when information is provided by the customer: Information marked " # " is provided by the customer. - Disclaimer: This information is provided by the customer and can affect the validity of results.

CONTENTS

1.	General information.....	4
2.	Device information.....	5
3.	#LTE Information.....	10
4.	Specific Absorption Rate.....	12
5.	SAR Measurement Procedures.....	13
6.	SAR Measurement Configurations.....	14
7.	RF Exposure Limits.....	15
8.	FCC SAR General Measurement Procedures.....	16
9.	RF Average Conducted Output Power.....	22
10.	System Verification.....	45
11.	SAR Test Results.....	49
12.	Simultaneous Transmission.....	59
13.	SAR Measurement Variability.....	60
14.	Measurement Uncertainty.....	61
15.	Test Equipment Information.....	62
16.	Test System Verification Results.....	63
17.	Test Results.....	73
	Appendixes List.....	105
	Appendix A. Calibration certificate.....	106
	Appendix B. SAR Tissue Specification.....	194
	Appendix C. #Antenna Location & Distance.....	195
	Appendix D. EUT Photo.....	197
	Appendix E. Test Setup Photo.....	200
	End of test report.....	200

<p>Eurofins KCTL Co.,Ltd. 65, Sinwon-ro, Yeongtong-gu, Suwon-si, Gyeonggi-do, 16677, Korea TEL: 82-70-5008-1021 FAX: 82-505-299-8311 www.kctl.co.kr</p>	<p>Report No.: KR23-SPF0011 Page (4) of (200)</p>	
------------------------------------------------------------------------------------------------------------------------------------------------------------------------------------------------------------------------	--------------------------------------------------------------------	-------------------------------------------------------------------------------------

1. General information

Client	: Samsung Electronics Co., Ltd.
Address	: 129, Samsung-ro, Yeongtong-gu, Suwon-si, Gyeonggi-do, 16677, Rep. of Korea
Manufacturer	: Samsung Electronics Co., Ltd.
Address	: 129, Samsung-ro, Yeongtong-gu, Suwon-si, Gyeonggi-do, 16677, Rep. of Korea
Factory	: Samsung Electronics Vietnam Thai Nguyen Co., Ltd
Address	: Yen Binh Industrial Park, Dong Tien Ward, Pho Yen Town, Thai Nguyen Province, Vietnam
Factory	: AG TECH CO.,LTD
Address	: Lot G3, Que Vo Industrial Park(Expanded Area), Nam son Ward, Bac Ninh Province, Vietnam
Laboratory	: Eurofins KCTL Co.,Ltd.
Address	: 65, Sinwon-ro, Yeongtong-gu, Suwon-si, Gyeonggi-do, 16677, Korea
Accreditations	: FCC Site Designation No: KR0040, FCC Site Registration No: 687132 VCCI Registration No. : R-3327, G-198, C-3706, T-1849 CAB Identifier: KR0040, ISED Number: 8035A KOLAS No.: KT231

1.1 Report Overview

This report details the results of testing carried out on the samples listed in section 2, the results contained in this test report do not relate to other samples of the same product. The manufacturer should ensure that all products in series production are in conformity with the product sample detailed in this report.

This report may only be reproduced and distributed in full. If the product in this test report is used in any configuration other than that detailed in the test report, the manufacturer must ensure the new configuration complies with all relevant standards and certification requirements. Any mention of Eurofins KCTL Co.,Ltd. Wireless lab or testing done by Eurofins KCTL Co.,Ltd. Wireless lab made in connection with the distribution or use of the tested product must be approved in writing by Eurofins KCTL Co.,Ltd. Wireless lab.

2. Device information

2.1 Basic description

Product Name		Smart Wearable	
Product Model Number		SM-R935U	
Derivative Model		SM-R935F	
Product Manufacturer		Samsung Electronics Co., Ltd	
Product Serial Number	Radiation	R3AW3004TER, R3AW3004RXN	
		R3AW3004QGB, R3AW3004RML	
		R3AW3004X8X, R3AW400NBGT	
		R3AW400N96L	
	WWAN Conduction	R3AW30040XE	
	WLAN Conduction	R3AW200GZHT	
Mode of Operation		WCDMA II/ IV/ V, LTE Band 2/4/5/7/12/13/25/26/66/71 WLAN 2.4/5 GHz, Bluetooth, NFC(Only RX)	
Tx Freq. Range	Band & Mode	Operating Modes	Tx Frequency(MHz)
	WCDMA II	Voice/Data	1 852.4 ~ 1 907.6
	WCDMA IV	Voice/Data	1 712.4 ~ 1 752.6
	WCDMA V	Voice/Data	826.4 ~ 846.6
	LTE Band 2	Voice/Data	1 850.7 ~ 1 909.3
	LTE Band 4	Voice/Data	1 710.7 ~ 1 754.3
	LTE Band 5	Voice/Data	824.7 ~ 848.3
	LTE Band 7	Voice/Data	2 502.5 ~ 2 567.5
	LTE Band 12	Voice/Data	699.7 ~ 715.3
	LTE Band 13	Voice/Data	779.5 ~ 784.5
	LTE Band 25	Voice/Data	1 850.7 ~ 1 914.3
	LTE Band 26	Voice/Data	814.7 ~ 848.3
	LTE Band 66	Voice/Data	1 710.7 ~ 1 779.3
	LTE Band 71	Voice/Data	665.5 ~ 695.5
	WLAN 2.4 GHz	Voice/Data	2 412.0 ~ 2 472.0
	U-NII-1	Voice/Data	5 180.0 ~ 5 240.0
	U-NII-2A	Voice/Data	5 260.0 ~ 5 320.0
	U-NII-2C	Voice/Data	5 500.0 ~ 5 720.0
	U-NII-3	Voice/Data	5 745.0 ~ 5 825.0
Bluetooth	Data	2 402.0 ~ 2 480.0	
TDWR Information		5.60 GHz~ 5.65 GHz band (TDWR) is supported by the device.	

2.2 Summary of SAR Test Results

Band	Equipment Class	Highest Reported	
		1g SAR (W/kg)	10g SAR (W/kg)
		Next to Mouth	Extremity
WCDMA II	PCT	1.03	1.38
WCDMA IV	PCT	0.76	2.30
WCDMA V	PCT	< 0.10	0.32
LTE Band 2	PCT	N/A	N/A
LTE Band 4	PCT	N/A	N/A
LTE Band 5	PCT	< 0.10	0.30
LTE Band 7	PCT	0.18	0.99
LTE Band 12	PCT	< 0.10	0.38
LTE Band 13	PCT	< 0.10	0.26
LTE Band 25	PCT	1.08	1.41
LTE Band 26	PCT	< 0.10	0.33
LTE Band 66	PCT	0.98	2.85
LTE Band 71	PCT	< 0.10	0.29
WLAN 2.4 GHz	DTS	< 0.10	0.20
U-NII-2A	NII	< 0.10	< 0.10
U-NII-2C	NII	< 0.10	< 0.10
U-NII-3	NII	< 0.10	< 0.10
Bluetooth	DSS	< 0.10	0.22
Simultaneous SAR per KDB 690783 D01v01r03		1.15	3.17

2.3 #Antenna information

Antenna Type	Metal												
Band	WCDMA			LTE									
	II	IV	V	2	4	5	7	12	13	25	26	66	71
Peak gain (dBi)	-9.4	-8.1	-13.4	-9.4	-8.1	-13.4	-12.2	-14.0	-14.0	-9.4	-13.4	-8.1	-17.8

Antenna Type	LDS			
Band	WLAN 2.4 GHz / Bluetooth	UNII-2A	UNII-2C	UNII-3
Peak gain (dBi)	-7.6	-4.1	-3.6	-3.6

2.4 #Maximum Tune-up power

This device operates using the following maximum output power specifications. SAR values were scaled to the maximum allowed power to determine compliance per KDB Publication 447498 D04v01.

When the specified maximum output power is the same for both UNII Band1 and UNII Band 2A, begins SAR measurement in UNII band 2A; and if the highest reported SAR for U NII band 2A is $\leq 1.2W/kg$, SAR is not required for U-NII-1 band for that configuration; otherwise, each band is tested independently for SAR.

2.4.1 #Maximum 3G/4G Output Power

Band	Mode	Output Power (dBm)		
		Target	Max. Allowed	
WCDMA II, WCDMA IV, WCDMA V	RMC	23.00	24.00	
	AMR	23.00	24.00	
	HSDPA	Subtest 1	23.00	24.00
		Subtest 2	23.00	24.00
		Subtest 3	22.50	23.50
		Subtest 4	22.50	23.50
	HSUPA	Subtest 1	21.00	22.00
		Subtest 2	20.00	21.00
		Subtest 3	22.00	23.00
		Subtest 4	20.00	21.00
		Subtest 5	23.00	24.00
	DC-HSDPA	Subtest 1	23.00	24.00
		Subtest 2	23.00	24.00
		Subtest 3	22.50	23.50
		Subtest 4	22.50	23.50
	*LTE Band 2		23.50	24.50
*LTE Band 4		23.50	24.50	
LTE Band 5		23.50	24.50	
LTE Band 7		22.50	23.50	
LTE Band 12		23.00	24.00	
LTE Band 13		23.00	24.00	
LTE Band 25		23.50	24.50	
LTE Band 26		23.50	24.50	
LTE Band 66		23.50	24.50	
LTE Band 71		23.00	24.00	

Notes:

*LTE Band 2 Measured Results

SAR for LTE Band 2 (Frequency range: 1 850.7 ~ 1 909.3 MHz) is covered by LTE Band 25 (Frequency range: 1 850.7 ~ 1 914.3 MHz) due to overlapping frequency range, same maximum tune-up limit and same channel bandwidth.

*LTE Band 4 Measured Results

SAR for LTE Band 4 (Frequency range: 1 710.7 ~ 1 754.3 MHz) is covered by LTE Band 66 (Frequency range: 1 710.7 ~ 1 779.3 MHz) due to overlapping frequency range, same maximum tune-up limit and same channel bandwidth.

2.4.2 #Maximum WLAN and Bluetooth Output Power

Band	Mode	Channel	Output Power (dB m)	
			Target	Max. Allowed
WLAN 2.4 GHz	802.11b	1~11	17.00	18.00
		12, 13	8.00	9.00
	802.11g	1~11	16.00	17.00
		12, 13	8.00	9.00
	802.11n(HT20)	1~11	16.00	17.00
		12, 13	8.00	9.00
NII	802.11a	All Channel	16.00	17.00
	802.11n(HT20)	All Channel	16.00	17.00
Bluetooth	BDR(GFSK)	All Channel	17.00	18.00
	EDR ($\pi/4$ DQPSK)	All Channel	11.00	12.00
	EDR(8DPSK)	All Channel	11.00	12.00
	LE(GFSK)	All Channel	8.00	9.00

2.5 #DUT Antenna Locations

A diagram showing the location of the device antennas can be found in Appendix C

Band	Device Edge for SAR Testing (Front View)		
	Next to Mouth	Extremity	Edge
	Front (10mm)	Rear (0mm)	
WCDMA II/IV/ V	Yes	Yes	N/A
LTE Band 5/7/12/13/25/26/66/71	Yes	Yes	N/A
WLAN 2.4 GHz / NII	Yes	Yes	N/A
Bluetooth	Yes	Yes	N/A

2.6 #Simultaneous Transmission Configurations

According to FCC KDB 447498 D04v01, transmitters are considered to be transmitting simultaneously when there is overlapping transmission, with the exception of transmissions during network hand-offs with maximum hand-off duration less than 30 seconds.

This device contains multiple transmitters that may operate simultaneously, and therefore requires a simultaneous transmission analysis according to FCC KDB Publication 447498 D04v01 4.3.2 procedures.

No.	Scenario	RF Exposure Condition	
		Next to Mouth	Extremity
1.	WCDMA / LTE + WLAN 2.4 GHz	Yes	
2.	WCDMA / LTE + WLAN 5 GHz	Yes	
3.	WCDMA / LTE + 2.4 GHz Bluetooth	Yes	
4.	WCDMA / LTE + 2.4 GHz Bluetooth + WLAN 5 GHz	Yes	
5.	WLAN 2.4 GHz + 2.4 GHz Bluetooth	No	
6.	WLAN 2.4 GHz + WLAN 5 GHz (RSDB Scenario)	No	

Notes:

- It does not transmit simultaneously the Bluetooth and 2.4 GHz WLAN.
- It is to use the Bluetooth and 2.4 GHz WLAN same antenna path.

2.7 SAR Test Methods and Procedures

The tests documented in this report were performed in accordance with IEEE 1528-2013 and the following published KDB procedures:

- IEEE 1528-2013
- 248227 D01 802.11 Wi-Fi SAR v02r02
- 447498 D04 General RF Exposure Guidance v01
- 865664 D01 SAR measurement 100 MHz to 6 GHz v01r04
- 865664 D02 RF Exposure Reporting v01r02
- 941225 D01 3G SAR Procedures v03r01
- 941225 D05 SAR for LTE Devices v02r05
- 941225 D05A LTE Rel.10 KDB Inquiry Sheet v01r02
- October 2016 TCB Workshop Notes (Bluetooth Duty Factor)
- April 2019 TCB Workshop Notes (Tissue Simulating Liquids)

3. #LTE Information

LTE Information				
Form Factor		Smart Wearable		
Frequency Range of each LTE transmission band		LTE Band 2 (1 850.7 MHz ~ 1 909.3 MHz) LTE Band 4 (1 710.7 MHz ~ 1 754.3 MHz) LTE Band 5 (824.7 MHz ~ 848.3 MHz) LTE Band 7 (2 502.5 MHz ~ 2 567.5 MHz) LTE Band 12 (699.7 MHz ~ 715.3 MHz) LTE Band 13 (779.5 MHz ~ 784.5 MHz) LTE Band 25 (1 850.7 MHz ~ 1 914.3 MHz) LTE Band 26 (814.7 MHz ~ 848.3 MHz) LTE Band 66 (1 710.7 MHz ~ 1 779.3 MHz) LTE Band 71 (665.5 MHz ~ 695.5 MHz)		
Channel Bandwidths		LTE Band 2: 1.4 MHz, 3 MHz, 5 MHz, 10 MHz, 15 MHz, 20 MHz LTE Band 4: 1.4 MHz, 3 MHz, 5 MHz, 10 MHz, 15 MHz, 20 MHz LTE Band 5: 1.4 MHz, 3 MHz, 5 MHz, 10 MHz LTE Band 7: 5 MHz, 10 MHz, 15 MHz, 20 MHz LTE Band 12: 1.4 MHz, 3 MHz, 5 MHz, 10 MHz LTE Band 13: 5 MHz, 10 MHz LTE Band 25: 1.4 MHz, 3 MHz, 5 MHz, 10 MHz, 15 MHz, 20 MHz LTE Band 26: 1.4 MHz, 3 MHz, 5 MHz, 10 MHz, 15 MHz LTE Band 66: 1.4 MHz, 3 MHz, 5 MHz, 10 MHz, 15 MHz, 20 MHz LTE Band 71: 5 MHz, 10 MHz, 15 MHz, 20 MHz		
Channel Numbers and Frequencies(MHz)		Low	Mid	High
LTE Band 2	1.4 MHz	1 850.7 (18 607)	1 880.0 (18 900)	1 909.3 (19 193)
	3 MHz	1 851.5 (18 615)	1 880.0 (18 900)	1 908.5 (19 185)
	5 MHz	1 852.5 (18 625)	1 880.0 (18 900)	1 907.5 (19 175)
	10 MHz	1 855.0 (18 650)	1 880.0 (18 900)	1 905.0 (19 150)
	15 MHz	1 857.5 (18 675)	1 880.0 (18 900)	1 902.5 (19 125)
	20 MHz	1 860.0 (18 700)	1 880.0 (18 900)	1 900.0 (19 100)
LTE Band 4	1.4 MHz	1 710.7 (19 957)	1 732.5 (20 175)	1 754.3 (20 393)
	3 MHz	1 711.5 (19 965)	1 732.5 (20 175)	1 753.5 (20 385)
	5 MHz	1 712.5 (19 975)	1 732.5 (20 175)	1 752.5 (20 375)
	10 MHz	1 715.0 (20 000)	1 732.5 (20 175)	1 750.0 (20 350)
	15 MHz	1 717.5 (20 025)	1 732.5 (20 175)	1 747.5 (20 325)
	20 MHz	1 720.0 (20 050)	1 732.5 (20 175)	1 745.0 (20 300)
LTE Band 5	1.4 MHz	824.7 (20 407)	836.5 (20 525)	848.3 (20 643)
	3 MHz	825.5 (20 415)	836.5 (20 525)	847.5 (20 635)
	5 MHz	826.5 (20 425)	836.5 (20 525)	846.5 (20 625)
	10 MHz	829.0 (20 450)	836.5 (20 525)	844.0 (20 600)
LTE Band 7	5 MHz	2 502.5 (20 775)	2 535.0 (21 100)	2 567.5 (21 425)
	10 MHz	2 505.0 (20 800)	2 535.0 (21 100)	2 565.0 (21 400)
	15 MHz	2 507.5 (20 825)	2 535.0 (21 100)	2 562.5 (21 375)
	20 MHz	2 510.0 (20 850)	2 535.0 (21 100)	2 560.0 (21 350)

Channel Numbers and Frequencies(MHz)		Low	Mid	High
LTE Band 12	1.4 MHz	699.7 (23 017)	707.5 (23 095)	715.3 (23 173)
	3 MHz	700.5 (23 025)	707.5 (23 095)	714.5 (23 165)
	5 MHz	701.5 (23 035)	707.5 (23 095)	713.5 (23 155)
	10 MHz	704.0 (23 060)	707.5 (23 095)	711.0 (23 130)
LTE Band 13	5 MHz	779.5 (23 205)	782.0 (23 230)	784.5 (23 255)
	10 MHz	-	782.0 (23 230)	-
LTE Band 25	1.4 MHz	1 850.7 (26 047)	1 882.5 (26 365)	1 914.3 (26 683)
	3 MHz	1 851.5 (26 055)	1 882.5 (26 365)	1 913.5 (26 675)
	5 MHz	1 852.5 (26 065)	1 882.5 (26 365)	1 912.5 (26 665)
	10 MHz	1 855.0 (26 090)	1 882.5 (26 365)	1 910.0 (26 640)
	15 MHz	1 857.5 (26 115)	1 882.5 (26 365)	1 907.5 (26 615)
	20 MHz	1 860.0 (26 140)	1 882.5 (26 365)	1 905.0 (26 590)
LTE Band 26	1.4 MHz	814.7 (26 697)	831.5 (26 865)	848.3 (27 033)
	3 MHz	815.5 (26 705)	831.5 (26 865)	847.5 (27 025)
	5 MHz	816.5 (26 715)	831.5 (26 865)	846.5 (27 015)
	10 MHz	819.0 (26 740)	831.5 (26 865)	844.0 (26 990)
	15 MHz	821.5 (26 765)	831.5 (26 865)	841.5 (26 965)
LTE Band 66	1.4 MHz	1 710.7 (131 979)	1 745.0 (132 322)	1 779.3 (132 665)
	3 MHz	1 711.5 (131 987)	1 745.0 (132 322)	1 778.5 (132 657)
	5 MHz	1 712.5 (131 997)	1 745.0 (132 322)	1 777.5 (132 647)
	10 MHz	1 715.0 (132 022)	1 745.0 (132 322)	1 775.0 (132 622)
	15 MHz	1 717.5 (132 047)	1 745.0 (132 322)	1 772.5 (132 597)
	20 MHz	1 720.0 (132 072)	1 745.0 (132 322)	1 770.0 (132 572)
LTE Band 71:	5 MHz	665.5 (133 147)	680.5 (133 297)	695.5 (133 447)
	10 MHz	668.0 (133 172)	680.5 (133 297)	693.0 (133 422)
	15 MHz	670.5 (133 197)	680.5 (133 297)	690.5 (133 397)
	20 MHz	673.0 (133 222)	680.5 (133 297)	688.0 (133 372)
UE Category	1			
Modulations Supported in UL	QPSK, 16QAM			
LTE MPR Permanently implemented per 3GPP TS 36.101 section 6.2.3 ~ 6.2.5?(manufacturer attestation to be provided)	YES			
A-MPR(Additional MPR) disabled for SAR Testing?	YES			
LTE Carrier Aggregation Possible Combinations	This device not supports LTE CA.			
LTE Additional Information	This device does not support full CA features on 3GPP Release 10. Uplink communications are done on the PCC. The following LTE Release 10 Features are not supported: Relay, HetNet, Enhanced MIMO, eICIC, WIFI Offloading, MDH, eMBMS, Cross-Carrier Scheduling, Enhanced SC-FDMA.			

4. Specific Absorption Rate

4.1 Introduction

The SAR is related to the rate at which energy is absorbed per unit mass in an object exposed to a radio field. The SAR distribution in a biological body is complicated and is usually carried out by experimental techniques or numerical modeling. The standard recommends limits for two tiers of groups, occupational / controlled and general population/uncontrolled, based on a person's awareness and ability to exercise control over his or her exposure. In general, occupational/controlled exposure limits are higher than the limits for general population/uncontrolled.

4.2 SAR Definition

The SAR definition is the time derivative (rate) of the incremental energy (dW) absorbed by (dissipated in) an incremental mass (dm) contained in a volume element (dv) of a given density (ρ). The equation description is as below:

$$SAR = \frac{d}{dt} \left(\frac{dW}{dm} \right) = \frac{d}{dt} \left(\frac{dW}{\rho dv} \right)$$

SAR is expressed in units of Watts per kilogram (W/kg)

SAR measurement can be either related to the temperature elevation in tissue by

$$SAR = C \left(\frac{\delta T}{\delta t} \right)$$

Where: C is the specific heat capacity, δT is the temperature rise and δt is the exposure duration, or related to the electrical field in the tissue by

$$SAR = \frac{\sigma |E|^2}{\rho}$$

Where: σ is the conductivity of the tissue, ρ is the mass density of the tissue and E is the RMS electrical field strength. However for evaluating SAR of low power transmitter, electrical field measurement is typically applied.

5. SAR Measurement Procedures

5.1 SAR Scan Procedures

Step 1: Power Reference Measurement

The Power Reference Measurement and Power Drift Measurements are for monitoring the power drift of the device under test in the batch process. The Minimum distance of probe sensors to surface determines the closest measurement point to phantom surface. The minimum distance of probe sensors to surface is 1.4 mm. This distance cannot be smaller than the Distance of sensor calibration points to probe tip as defined in the probe properties.

Step 2: Area Scan & Zoom Scan

The Area Scan is used as a fast scan in two dimensions to find the area of high field values, before doing a fine measurement around the hot spot and Zoom Scans are used to assess the peak spatial SAR values within a cubic averaging volume containing 1 g and 10 g of simulated tissue. If only one Zoom Scan follows the Area Scan, then only the absolute maximum will be taken as reference. For cases where multiple maximums are detected, the number of Zoom Scans has to be increased accordingly. Area Scan & Zoom Scan Parameters extracted from KDB 865664 D01 SAR Measurement 100 MHz to 6 GHz v01r04.

		≤ 3 GHz	> 3 GHz
Maximum distance from closest measurement point (geometric center of probe sensors) to phantom surface		5 mm ± 1 mm	$\frac{1}{2} \cdot \delta \cdot \ln(2)$ mm 0.5 mm
Maximum probe angle from probe axis to phantom surface normal at the measurement location		$30^\circ \pm 1^\circ$	$20^\circ \pm 1^\circ$
Maximum area scan spatial resolution: Δx_{Area} , Δy_{Area}		≤ 2 GHz: ≤ 15 mm 2 – 3 GHz: ≤ 12 mm	3 – 4 GHz: ≤ 12 mm 4 – 6 GHz: ≤ 10 mm
		When the x or y dimension of the test device, in the measurement plane orientation, is smaller than the above, the measurement resolution must be ≤ the corresponding x or y dimension of the test device with at least one measurement point on the test device.	
Maximum zoom scan spatial resolution: Δx_{Zoom} , Δy_{Zoom}		≤ 2 GHz: ≤ 8 mm 2 – 3 GHz: ≤ 5 mm*	3 – 4 GHz: ≤ 5 mm* 4 – 6 GHz: ≤ 4 mm*
Maximum zoom scan spatial resolution, normal to phantom surface	uniform grid: $\Delta z_{Zoom}(n)$	≤ 5 mm	3 – 4 GHz: ≤ 4 mm 4 – 5 GHz: ≤ 3 mm 5 – 6 GHz: ≤ 2 mm
	graded grid	≤ 4 mm	3 – 4 GHz: ≤ 3 mm 4 – 5 GHz: ≤ 2.5 mm 5 – 6 GHz: ≤ 2 mm
	$\Delta z_{Zoom}(n>1)$: between subsequent points	≤ 1.5 · $\Delta z_{Zoom}(n-1)$ mm	
Minimum zoom scan volume	x, y, z	≥ 30 mm	3 – 4 GHz: ≥ 28 mm 4 – 5 GHz: ≥ 25 mm 5 – 6 GHz: ≥ 22 mm
Note: δ is the penetration depth of a plane-wave at normal incidence to the tissue medium; see IEEE Std 1528-2013 for details. * When zoom scan is required and the reported SAR from the area scan based 1-g SAR estimation procedures of KDB Publication 447498 is ≤ 1.4 W/kg, ≤ 8 mm, ≤ 7 mm and ≤ 5 mm zoom scan resolution may be applied, respectively, for 2 GHz to 3 GHz, 3 GHz to 4 GHz and 4 GHz to 6 GHz.			

Step 3: Power drift measurement

The Power Drift Measurement measures the field at the same location as the most recent power reference measurement within the same procedure, and with the same settings. The Power Drift Measurement gives the field difference in dB from the reading conducted within the last Power Reference Measurement. This allows a user to monitor the power drift of the device under test within a batch process. The measurement procedure is the same as Step 1.

6. SAR Measurement Configurations

6.1 Watch device

Transmitters that are built-in within a wrist watch or similar wrist-worn devices typically operate in speaker mode for voice communication, with the device worn on the wrist and positioned next to mouth. Next to the mouth exposure requires 1g SAR, and the wrist-worn condition requires 10g extremity SAR. Next to the mouth use is evaluated with the front of the device positioned at 10 mm from a flat phantom filled with head tissue-equivalent medium. SAR for wrist exposure is evaluated with the back of the devices positioned in direct contact against a flat phantom fill with head tissue-equivalent medium.



Figure 1
Test position for extremity

6.2 Device Holder

The device holder is made out of low-loss POM material having the following dielectric parameters: relative permittivity $\epsilon = 3$ and loss tangent $\delta = 0.02$.

7. RF Exposure Limits

UNCONTROLLED ENVIRONMENTS are defined as locations where there is the exposure of individuals who have no knowledge or control of their exposure. The general population/uncontrolled exposure limits are applicable to situations in which the general public may be exposed or in which persons who are exposed as a consequence of their employment may not be made fully aware of the potential for exposure or cannot exercise control over their exposure. Members of the general public would come under this category when exposure is not employment-related; for example, in the case of a wireless transmitter that exposes persons in its vicinity.

CONTROLLED ENVIRONMENTS are defined as locations where there is exposure that may be incurred by persons who are aware of the potential for exposure, (i.e. as a result of employment or occupation). In general, occupational/controlled exposure limits are applicable to situations in which persons are exposed as a consequence of their employment, who have been made fully aware of the potential for exposure and can exercise control over their exposure. This exposure category is also applicable when the exposure is of a transient nature due to incidental passage through a location where the exposure levels may be higher than the general population/uncontrolled limits, but the exposed person is fully aware of the potential for exposure and can exercise control over his or her exposure by leaving the area or by some other appropriate means.

Human Exposure	Uncontrolled Environment General Population	Controlled Environment Occupational
Partial Peak SAR ¹⁾ (Partial)	1.60 mW/g	8.00 mW/g
Partial Average SAR ²⁾ (Whole Body)	0.08 mW/g	0.40 mW/g
Partial Peak SAR ³⁾ (Hands/Feet/Ankle/Wrist)	4.00 mW/g	20.00 mW/g

- 1) The spatial Peak value of the SAR averaged over any 1g gram of tissue (defined as a tissue volume in the shape of a cube) and over the appropriate averaging time.
- 2) The spatial Average value of the SAR averaged over the whole body.
- 3) The Spatial Peak value of the SAR averaged over any 10 grams of tissue (defined as a tissue volume in the shape of a cube) and over the appropriate averaging time.

<p>Eurofins KCTL Co.,Ltd. 65, Sinwon-ro, Yeongtong-gu, Suwon-si, Gyeonggi-do, 16677, Korea TEL: 82-70-5008-1021 FAX: 82-505-299-8311 www.kctl.co.kr</p>	<p>Report No.: KR23-SPF0011 Page (16) of (200)</p>	
------------------------------------------------------------------------------------------------------------------------------------------------------------------------------------------------------------------------	--------------------------------------------------------------	-------------------------------------------------------------------------------------

8. FCC SAR General Measurement Procedures

8.1 Measured and Reported SAR

Per FCC KDB Publication 447498 D04v01, When SAR is not measured at the maximum power level allowed for production units, the results must be scaled to the maximum tune-up tolerance limit according to the power applied to the individual channels tested to determine compliance. For simultaneous transmission, the measured aggregate SAR must be scaled according to the sum of the differences between the maximum tune-up tolerance and actual power used to test each transmitter. When SAR is measured at or scaled to the maximum tune-up tolerance limit, the results are referred to as reported SAR. Test highest reported SAR results are identified on the grant of equipment authorization according to procedures in KDB 690783 D01v01r03.

8.2 3G SAR Test Reduction Procedure

In FCC KDB Publication 941225 D01v03r01, certain transmission modes within a frequency band and wireless mode evaluated for SAR are defined as primary modes. The equivalent modes considered for SAR test reduction are denoted as secondary modes. When the maximum output power including tune-up tolerance specified for production units in a secondary mode is ≤ 0.25 dB higher than the primary mode or when the highest reported SAR of the primary mode, scaled by the ratio of specified maximum output power and tune-up tolerance of secondary to primary mode, is ≤ 1.2 W/kg, SAR measurements are not required for the secondary mode. These criteria are referred to as the 3G SAR test reduction procedure. When the 3G SAR test reduction procedure is not satisfied, SAR measurements are additionally required for the secondary mode.

8.3 Procedures Used to Establish RF Signal for SAR

The following procedures are according to FCC KDB Publication 941225 D01v03r01 "3G SAR Measurement Procedures."

The device is placed into a simulated call using a base station simulator in a RF shielded chamber. Establishing connections in this manner ensure a consistent means for testing SAR and are recommended for evaluating SAR [4]. Devices under test are evaluated prior to testing, with a fully charged battery and were configured to operate at maximum output power. In order to verify that the device is tested throughout the SAR test at maximum output power, the SAR measurement system measures a "point SAR" at an arbitrary reference point at the start and end of the 1 gram SAR evaluation, to assess for any power drifts during the evaluation. If the power drift deviates by more than 5%, the SAR test and drift measurements are repeated.

8.4 SAR Measurement Conditions for UMTS

8.4.1 Output Power Verification

Maximum output power is verified on the High, Middle and Low channels according to the general descriptions in sec. 5.2 of 3GPP TS 34.121, using the appropriate RMC with TPC (transmit power control) set to all "1s" or applying the required inner loop power control procedures to maintain maximum output power while HSUPA is active. Results for all applicable physical channel configurations (DPCCH, DPDCHn and spreading codes, HS-DPCCH etc) are tabulated in this test report. All configurations that are not supported by the DUT or cannot be measured due to technical or equipment limitations are identified.

8.4.2 Head SAR Measurements

SAR for next to the ear head exposure is measured using a 12.2 kbps RMC with TPC bits configured to all "1's". The 3G SAR test reduction procedure is applied to AMR configurations with 12.2 kbps RMC as the primary mode. Otherwise, SAR is measured for 12.2 kbps AMR in 3.4 kbps SRB (signaling radio bearer) using the highest reported SAR configuration in 12.2 kbps RMC for head exposure.

8.4.3 Body SAR measurements

SAR for body exposure configurations is measured using the 12.2kbps RMC with the TPC bits all "1s". the 3G SAR test reduction procedure is applied to other spreading codes and multiple DPDCHn configurations supported by the handset with 12.2 kbps RMC as the primary mode. Otherwise, SAR is measured using and applicable RMC configuration with the corresponding spreading code or DPDCHn, for the highest reported SAR configuration in 12.2kbps RMC.

8.4.4 SAR Measurements with Rel. 5 HSDPA

The 3G SAR test reduction procedure is applied to HSDPA body configurations with 12.2 kbps RMC as the primary mode. Otherwise, Body SAR for HSDPA is measured using and FRC with H-SET 1 in Sub-test and a 12.2 kbps RMC without HSDPA. Handsets with both HSDPA and HSUPA are tested according to release 6 HSPA test procedures. 8.4.5 SAR Measurement with Rel.6 HSUPA The 3G SAR test Reduction Procedure is applied to HSPA (HSUPA/HSDPA with RMC) body configurations with 12.2 kbps RMC as the primary mode. Otherwise, Body SAR for HSPA is measured with E-DCH Sub-test 5, Using H-Set 1 and QPSK for FRC and a 12.2kbps RMC configured in Test Loop Mode 1 and Power Control algorithm 2, according to the highest reported body SAR configuration in 12.2 kbps RMC without HSPA. When VOIP applies to head exposure, the 3G SAR test reduction procedure is applied with 12.2 kbps RMC as the primary mode; otherwise, the same HSPA configuration used for body SAR measurements are applied to head exposure testing.

8.4.5 SAR Measurements with Rel. 6 HSUPA

The 3G SAR test reduction procedure is applied to HSPA (HSUPA/HSDPA with RMC) body configurations with 12.2 kbps RMC as the primary mode. Otherwise, Body SAR for HSPA is measured with E-DCH Sub-test 5, using H-Set1 and QPSK for FRC and a 12.2 kbps RMC configured in Test Loop Mode 1 and power control algorithm 2, according to the highest reported body SAR configuration in 12.2 kbps RMC without HSPA.

8.4.6 SAR Measurements with Rel. 8 DC-HSDPA

SAR is required for Rel. 8 DC-HSDPA when SAR is required for Rel. 5 HSDPA; otherwise, the 3G SAR test reduction procedure is applied to DC-HSDPA with 12.2 kbps RMC as the primary mode. Power is measured for DC-HSDPA according to the H-Set 12, FRC configuration in Table C.8.1.12 of 3GPP TS 34.121-1 to determine SAR test reduction. A primary and a secondary serving HS-DSCH Cell are required to perform the power measurement and for the results to be acceptable

8.5 SAR Measurement Conditions for LTE

LTE modes are tested according to FCC KDB 941225 D05v02r05 publication. Establishing connections with base station simulators ensure a consistent means for testing SAR and are recommended for evaluation SAR [4]. The R&S CMW500 or Anritsu MT8820C simulators are used for LTE output power measurements and SAR testing. Closed loop power control was used so the UE transmits with maximum output power during SAR testing. SAR tests were performed with the same number of RB and RB offsets transmitting on all TTI frames (maximum TTI).

8.5.1 Spectrum Plots for RB Configurations

A properly configured base station simulator was used for SAR tests and power measurements. Therefore, spectrum plots for RB configurations were not required to be included in this report.

8.5.2 MPR

MPR is permanently implemented for this device by the manufacturer. The specific manufacturer target MPR is indicated alongside the SAR results. MPR is enabled for this device, according to 3GPP TS36. 101 Section 6.2.3 – 6.2.5 under Table 6.2.3-1.

8.5.3 A-MPR

A-MPR (Additional MPR) has been disabled for all SAR tests by setting NS=01 on the base station simulator

8.5.4 Required RB Size and RB offsets for SAR testing

According to FCC KDB 941225 D05v02r05

1. Per sec 4.2.1, SAR is required for QPSK 1 RB Allocation for the largest bandwidth
 - a. The required channel and offset combination with the highest maximum output power is required for SAR.
 - b. When the reported SAR is ≤ 0.8 W/Kg, testing of the remaining RB offset configurations and required test channels is not required. Otherwise, SAR is required for the remaining required test channels using the RB offset configuration with highest output power for that channel.
 - c. When the reported SAR for a required test channel is > 1.45 W/kg, SAR is required for all RB offset configurations for that channel
2. Per Sec 4.2.2, SAR is required for 50% RB allocation using the largest bandwidth following the same procedures outlined in Sec 4.2.1.
3. Per Sec. 4.2.3, QPSK SAR is not required for the 100% allocation when the highest maximum output power for the 100% allocation is less than the highest maximum output power of the 1 RB and 50% RB allocations and the reported SAR for the 1 RB and 50% RB allocations is < 0.8 W/kg.
4. Per Sec. 4.2.4 and 4.3, SAR test for higher order modulations and lower bandwidths configurations are not required when the conducted power of the required test configurations determined by Sec. 4.2.1 through 4.2.3 is less than or equal to 1/2 dB higher than the equivalent configuration using QPSK modulation and when the QPSK SAR for those configurations is < 1.45 W/Kg.

8.6 SAR Testing with 802.11 Transmitters

The normal network operating configurations are not suitable for measuring the SAR of 802.11 a/b/g transmitters. Unpredictable fluctuations in network traffic and antenna diversity conditions can introduce undesirable variations in SAR results. The SAR for these devices should be measured using chipset based test mode software to ensure the results are consistent and reliable.

8.6.1 General Device Setup

Chipset based test mode software is hardware dependent and generally varies among manufacturers. The device operating parameters established in test mode for SAR measurements must be identical to those programmed in production units, including output power levels, amplifier gain settings and other RF performance tuning parameters. A periodic duty factor is required for current generation SAR systems to measure SAR. When 802.11 frame gaps are accounted for in the transmission, a maximum transmission duty factor of 92 – 96% is typically achievable in most test mode configurations. A minimum transmission duty factor of 85% is required to avoid certain hardware and device implementation issues related to wide range SAR scaling. The reported SAR is scaled to 100% transmission duty factor to determine compliance at the maximum tune-up tolerance limit.

8.6.2 U-NII-1 and U-NII-2A

For devices that operate in both U-NII-1 and U-NII-2A bands, when the same maximum output power is specified for both bands, SAR measurement using OFDM SAR test procedures is not required for U-NII-1 unless the highest reported SAR for U-NII-2A is > 1.2 W/kg. When different maximum output powers is not required unless the highest reported SAR for the U-NII band with the higher maximum output power, adjusted by the ratio of lower to higher specified maximum output power for the two bands, is > 1.2 W/kg. When 10g SAR measurement is considered, a factor of 2.5 is applied to the thresholds above.

8.6.3 U-NII-2C and U-NII-3

The frequency range covered by U-NII-2C and U-NII-3 is 380 MHz (5.47 – 5.85 GHz), which requires a minimum of at least two SAR probe calibration frequency points to support SAR measurements. When Terminal Doppler Weather Radar (TDWR) restriction applies, the channels at 5.60 – 5.65 GHz in U-NII-2C band must be disabled with acceptable mechanisms and documented in the equipment certification. Unless band gap channels are permanently disabled, SAR must be considered for these channels. When band gap channels are disabled, each band is tested independently according to the normally required OFDM SAR measurement and probe calibration frequency point requirements.

8.6.4 Initial Test Position Procedure

For exposure conditions with multiple test positions, such as handset operating next to the ear, devices with hotspot mode or UMPC mini-tablet, procedures for initial test position can be applied. Using the transmission mode determined by the DSSS procedure or initial test configuration, area scans are measured for all positions in an exposure condition. The test position with the highest extrapolated (peak) SAR is used as the initial test position. When reported SAR for the initial test position is ≤ 0.4 W/kg, no additional testing for the remaining test positions is required. Otherwise, SAR is evaluated at the subsequent highest peak SAR positions until the reported SAR result is ≤ 0.8 W/kg or all test positions are measured.

<p>Eurofins KCTL Co.,Ltd. 65, Sinwon-ro, Yeongtong-gu, Suwon-si, Gyeonggi-do, 16677, Korea TEL: 82-70-5008-1021 FAX: 82-505-299-8311 www.kctl.co.kr</p>	<p>Report No.: KR23-SPF0011 Page (20) of (200)</p>	
------------------------------------------------------------------------------------------------------------------------------------------------------------------------------------------------------------------------	---------------------------------------------------------------------	-------------------------------------------------------------------------------------

8.6.5 2.4 GHz SAR Test Requirement

SAR is measured for 2.4 GHz 802.11b DSSS using either the fixed test position or, when applicable, the initial test position procedure. SAR test reduction is determined according to the following.

- 1) When the reported SAR of the highest measured maximum output power channel for the exposure configuration is ≤ 0.8 W/kg, no further SAR testing is required for 802.11b DSSS in that exposure configuration.
- 2) When the reported SAR is > 0.8 W/kg, SAR is required for that position using the next highest measured output power channel; i.e., all channels require testing.

2.4 GHz 802.11g/n OFDM are additionally evaluated for SAR if highest reported SAR for 802.11b, adjusted by the ratio of the OFDM to DSSS specified maximum output power, is > 1.2 W/kg. When SAR is required for OFDM modes in 2.4 GHz band, the Initial Test Configuration Procedures should be followed.

8.6.6 OFDM Transmission Mode and SAR Test Channel Selection

For the 2.4 GHz and 5 GHz band, when the same maximum output power was specified for multiple OFDM transmission mode configurations in a frequency band or aggregated band, SAR is measured using the configuration with the largest channel bandwidth, lowest order modulation and lowest data rate. When the maximum output power of a channel is the same for equivalent OFDM configurations; for example, 802.11a, 802.11n and 802.11ac or 802.11g and 802.11n with the same channel band width, modulation and data rate etc., the lower order 802.11 mode i.e., 802.11a, then 802.11n and 802.11ac or 802.11g then 802.11n, is used for SAR measurement. When maximum output power are the same for multiple test channels, either according to the default or additional power measurement requirements, SAR is measured using the channel closest to the middle of the frequency band or aggregated band. When there are multiple channels with the same maximum output power, SAR is measured using the higher number channel.

8.6.7 Initial Test Configuration Procedure

For OFDM, in both 2.4 and 5 GHz bands, an initial test configuration is determined for each frequency band and aggregated band, according to the transmission mode with the highest maximum output power specified for SAR measurements. When the same maximum output power is specified for multiple OFDM transmission mode configurations in a frequency band or aggregated band, SAR is measured using the configuration(s) with the largest channel bandwidth, lowest order modulation, and lowest data rate. If the average RF output powers of the highest identical transmission modes are within 0.25 dB of each other, mid channel of the transmission mode with highest average RF output power is the initial test channel. Otherwise, the channel of the transmission mode with the highest average RF output conducted power will be the initial test configuration.

When the reported SAR is ≤ 0.8 W/kg, no additional measurements on other test channels are required. Otherwise, SAR is evaluated using the subsequent highest average RF output channel until the reported SAR result is ≤ 1.2 W/kg or all channels are measured. When there are multiple untested channels having the same subsequent highest average RF output power, the channel with higher frequency from the lowest 802.11 mode is considered for SAR measurements.

8.6.8 Subsequent Test Configuration Procedures

For OFDM configurations in each frequency band and aggregated band, SAR is evaluated for initial test configuration using the fixed test position or the initial test position procedure. When the highest reported SAR (for the initial test configuration), adjusted by the ratio of the specified maximum output power of the subsequent test configuration to initial test configuration, is ≤ 1.2 W/kg, no additional SAR tests for the subsequent test configurations are required. When 10g SAR measurement is considered, a factor of 2.5 is applied to the thresholds above.



9. RF Average Conducted Output Power

9.1 WCDMA Average Conducted Output Power

Band	Mode	Average Conducted Power (dBm)			MPR [dB]
		Channel			
		9 262	9 400	9 538	
		1 852.4 MHz	1 880.0 MHz	1 907.6 MHz	
WCDMA II	RMC	23.31	23.21	23.45	-
	AMR	23.30	23.15	23.41	-
	HSDPA-Subtest 1	22.26	22.20	22.44	0
	HSDPA-Subtest 2	21.60	21.55	21.53	0
	HSDPA-Subtest 3	21.45	21.39	21.56	0.5
	HSDPA-Subtest 4	21.06	21.06	21.07	0.5
	HSUPA-Subtest 1	20.45	20.37	20.58	2
	HSUPA-Subtest 2	18.79	18.64	18.85	3
	HSUPA-Subtest 3	21.43	21.31	21.50	1
	HSUPA-Subtest 4	18.76	18.66	18.85	3
	HSUPA-Subtest 5	22.17	22.19	22.49	0
	DC-HSDPA-Subtest 1	22.21	22.31	22.46	0
	DC-HSDPA-Subtest 2	21.53	21.55	21.53	0
	DC-HSDPA-Subtest 3	21.09	21.04	21.10	0.5
DC-HSDPA-Subtest 4	21.07	21.03	21.21	0.5	

Band	Mode	Average Conducted Power (dBm)			MPR [dB]
		Channel			
		1 312	1 412	1 513	
		1 712.4 MHz	1 732.4 MHz	1 752.6 MHz	
WCDMA IV	RMC	23.49	23.46	23.44	-
	AMR	23.44	23.44	23.42	-
	HSDPA-Subtest 1	22.40	22.30	22.31	0
	HSDPA-Subtest 2	21.56	21.52	21.57	0
	HSDPA-Subtest 3	21.53	21.67	21.53	0.5
	HSDPA-Subtest 4	21.05	21.05	21.02	0.5
	HSUPA-Subtest 1	20.48	20.49	20.40	2
	HSUPA-Subtest 2	18.76	18.75	18.58	3
	HSUPA-Subtest 3	21.45	21.49	21.38	1
	HSUPA-Subtest 4	18.74	18.72	18.72	3
	HSUPA-Subtest 5	21.99	21.83	21.87	0
	DC-HSDPA-Subtest 1	22.40	22.42	22.33	0
	DC-HSDPA-Subtest 2	21.57	21.54	21.52	0
	DC-HSDPA-Subtest 3	21.05	21.00	21.01	0.5
DC-HSDPA-Subtest 4	21.09	21.02	21.03	0.5	

Band	Mode	Average Conducted Power (dBm)			MPR [dB]
		Channel			
		4 132	4 183	4 233	
		826.4 MHz	836.6 MHz	846.6 MHz	
WCDMA V	RMC	23.39	23.41	23.25	-
	AMR	23.31	23.36	23.15	-
	HSDPA-Subtest 1	22.55	22.55	22.41	0
	HSDPA-Subtest 2	21.89	21.87	21.84	0
	HSDPA-Subtest 3	21.80	21.82	21.56	0.5
	HSDPA-Subtest 4	21.00	21.01	21.08	0.5
	HSUPA-Subtest 1	20.75	20.74	20.71	2
	HSUPA-Subtest 2	18.79	18.81	18.71	3
	HSUPA-Subtest 3	21.74	21.78	21.69	1
	HSUPA-Subtest 4	18.75	18.77	18.76	3
	HSUPA-Subtest 5	22.09	22.15	22.04	0
	DC-HSDPA-Subtest 1	22.57	22.39	22.52	0
	DC-HSDPA-Subtest 2	22.00	21.98	22.09	0
	DC-HSDPA-Subtest 3	21.00	21.07	21.20	0.5
	DC-HSDPA-Subtest 4	21.09	21.09	21.15	0.5

9.2 LTE Average Conducted Output Power

9.2.1 LTE Band 5

Band width	Modulation	RB Size	RB offset	Maximum Average Power		MPR
				20 525		
				836.5 MHz		
10 MHz	QPSK	1	0	23.84		0
		1	25	23.48		0
		1	49	23.36		0
		25	0	22.80		1
		25	12	23.02		1
		25	25	22.70		1
		50	0	22.92		1
	16QAM	1	0	22.66		1
		1	25	22.65		1
		1	49	22.70		1
		25	0	21.73		2
		25	12	21.76		2
		25	25	21.74		2
		50	0	21.73		2

10 MHz Bandwidths does not support at least three non-overlapping channels in certain channel bandwidths. When a device supports overlapping channel assignment in a channel bandwidth configuration, the middle channel of the group of overlapping channels should be selected for testing per KDB 941225 D05 SAR for LTE Devices.

Band width	Modulation	RB Size	RB offset	Maximum Average Power			MPR
				20 425	20 525	20 625	
				826.5 MHz	836.5 MHz	846.5 MHz	
5 MHz	QPSK	1	0	23.45	23.34	23.30	0
		1	12	23.42	23.22	23.34	0
		1	24	23.41	23.14	23.41	0
		12	0	22.82	22.70	22.76	1
		12	7	22.84	22.70	22.73	1
		12	13	22.80	22.66	22.72	1
		25	0	22.80	22.71	22.74	1
	16QAM	1	0	22.73	23.03	22.60	1
		1	12	22.73	22.75	22.56	1
		1	24	22.70	23.01	22.62	1
		12	0	21.79	21.83	21.64	2
		12	7	21.74	21.81	21.56	2
		12	13	21.72	21.79	21.67	2
		25	0	21.79	21.79	21.63	2

Band width	Modulation	RB Size	RB offset	Maximum Average Power			MPR
				20 415	20 525	20 635	
				825.5 MHz	836.5 MHz	847.5 MHz	
3 MHz	QPSK	1	0	23.26	23.27	23.24	0
		1	8	23.68	23.18	23.15	0
		1	14	23.24	23.61	23.12	0
		8	0	22.88	22.88	22.79	1
		8	4	22.87	22.82	22.80	1
		8	7	22.86	22.83	22.81	1
		15	0	22.79	22.73	22.74	1
	16QAM	1	0	23.00	22.79	22.91	1
		1	8	22.87	22.74	22.63	1
		1	14	22.97	22.71	22.68	1
		8	0	22.03	21.81	21.77	2
		8	4	21.96	21.73	21.77	2
		8	7	22.03	21.83	21.77	2
		15	0	21.82	21.81	21.72	2

Band width	Modulation	RB Size	RB offset	Maximum Average Power			MPR
				20 407	20 525	20 643	
				824.7 MHz	836.5 MHz	848.3 MHz	
1.4 MHz	QPSK	1	0	23.53	23.32	23.32	0
		1	3	23.42	23.53	23.03	0
		1	5	23.48	23.33	23.23	0
		3	0	23.93	23.75	23.57	0
		3	1	23.88	23.77	23.67	0
		3	3	23.90	23.67	23.68	0
		6	0	22.97	22.75	22.76	1
	16QAM	1	0	22.89	22.83	22.67	1
		1	3	22.87	22.82	22.76	1
		1	5	22.90	22.72	22.81	1
		3	0	22.81	22.73	22.59	1
		3	1	22.91	22.67	22.74	1
		3	3	22.81	22.43	22.66	1
		6	0	21.95	21.87	21.84	2

9.2.2 LTE Band 7

Band width	Modulation	RB Size	RB offset	Maximum Average Power			MPR
				20 850	21 100	21 350	
				2 510.0 MHz	2 535.0 MHz	2 560.0 MHz	
20 MHz	QPSK	1	0	22.49	22.97	22.53	0
		1	49	22.75	22.49	22.81	0
		1	99	22.79	22.49	22.66	0
		50	0	22.30	22.38	22.22	1
		50	24	22.33	22.06	22.19	1
		50	50	22.29	21.65	22.12	1
		100	0	22.30	22.31	22.15	1
	16QAM	1	0	22.23	22.45	22.30	1
		1	49	22.44	22.14	22.36	1
		1	99	22.49	21.25	22.27	1
		50	0	21.31	21.38	21.19	2
		50	24	21.32	21.19	21.16	2
		50	50	21.31	20.83	21.13	2
		100	0	21.35	21.22	21.20	2

Band width	Modulation	RB Size	RB offset	Maximum Average Power			MPR
				20 825	21 100	21 375	
				2 507.5 MHz	2 535.0 MHz	2 562.5 MHz	
15 MHz	QPSK	1	0	22.83	22.71	22.95	0
		1	36	22.70	22.21	22.86	0
		1	74	22.82	22.61	22.78	0
		36	0	22.45	22.15	22.33	1
		36	18	22.38	21.90	22.36	1
		36	37	22.37	21.65	22.32	1
		75	0	22.36	21.88	22.36	1
	16QAM	1	0	22.39	22.42	22.48	1
		1	36	22.36	21.97	22.50	1
		1	74	22.45	21.36	22.43	1
		36	0	21.47	21.34	21.33	2
		36	18	21.32	21.14	21.33	2
		36	37	21.39	20.90	21.30	2
		75	0	21.43	21.13	21.31	2

Band width	Modulation	RB Size	RB offset	Maximum Average Power			MPR
				20 800	21 100	21 400	
				2 505.0 MHz	2 535.0 MHz	2 565.0 MHz	
10 MHz	QPSK	1	0	22.65	22.46	22.78	0
		1	25	22.89	22.45	22.75	0
		1	49	22.35	22.27	22.74	0
		25	0	22.16	22.17	22.22	1
		25	12	22.26	22.06	22.23	1
		25	25	22.27	21.80	22.21	1
		50	0	22.28	21.96	22.15	1
	16QAM	1	0	22.32	22.06	22.45	1
		1	25	22.48	22.06	22.23	1
		1	49	22.07	21.38	22.06	1
		25	0	21.35	21.30	21.27	2
		25	12	21.33	21.27	21.30	2
		25	25	21.31	21.02	21.25	2
		50	0	21.35	21.16	21.25	2

Band width	Modulation	RB Size	RB offset	Maximum Average Power			MPR
				20 775	21 100	21 425	
				2 502.5 MHz	2 535.0 MHz	2 567.5 MHz	
5 MHz	QPSK	1	0	23.25	22.34	22.91	0
		1	12	22.84	22.21	22.88	0
		1	24	22.88	22.01	22.84	0
		12	0	22.23	22.01	22.22	1
		12	7	22.20	21.90	22.24	1
		12	13	22.12	21.83	22.24	1
		25	0	22.22	21.93	22.20	1
	16QAM	1	0	22.41	22.03	22.47	1
		1	12	22.30	22.05	22.43	1
		1	24	22.32	21.76	22.43	1
		12	0	21.23	21.17	21.27	2
		12	7	21.24	21.11	21.30	2
		12	13	21.22	21.04	21.26	2
		25	0	21.26	21.11	21.31	2

9.2.3 LTE Band 12

Band width	Modulation	RB Size	RB offset	Maximum Average Power		MPR
				23 095		
				707.5 MHz		
10 MHz	QPSK	1	0	23.75		0
		1	25	23.38		0
		1	49	23.57		0
		25	0	22.76		1
		25	12	22.63		1
		25	25	22.69		1
		50	0	22.75		1
	16QAM	1	0	22.67		1
		1	25	22.69		1
		1	49	22.72		1
		25	0	21.67		2
		25	12	21.69		2
		25	25	21.70		2
		50	0	21.67		2

10 MHz Bandwidths does not support at least three non-overlapping channels in certain channel bandwidths. When a device supports overlapping channel assignment in a channel bandwidth configuration, the middle channel of the group of overlapping channels should be selected for testing per KDB 941225 D05 SAR for LTE Devices.

Band width	Modulation	RB Size	RB offset	Maximum Average Power			MPR
				23 035	23 095	23 155	
				701.5 MHz	707.5 MHz	713.5 MHz	
5 MHz	QPSK	1	0	23.48	23.42	23.26	0
		1	12	23.52	23.38	23.30	0
		1	24	23.71	23.39	23.25	0
		12	0	22.73	22.63	22.58	1
		12	7	22.70	22.65	22.56	1
		12	13	22.72	22.67	22.58	1
		25	0	22.70	22.64	22.58	1
	16QAM	1	0	22.73	22.83	22.52	1
		1	12	22.52	22.52	22.40	1
		1	24	22.76	22.54	22.41	1
		12	0	21.69	21.64	21.59	2
		12	7	21.68	21.64	21.62	2
		12	13	21.65	21.61	21.61	2
		25	0	21.71	21.62	21.56	2

Band width	Modulation	RB Size	RB offset	Maximum Average Power			MPR
				23 025	23 095	23 165	
				700.5 MHz	707.5 MHz	714.5 MHz	
3 MHz	QPSK	1	0	23.34	23.67	23.33	0
		1	8	23.34	23.27	23.18	0
		1	14	23.35	23.41	23.33	0
		8	0	22.79	22.69	22.60	1
		8	4	22.81	22.66	22.65	1
		8	7	22.80	22.67	22.61	1
		15	0	22.73	22.63	22.60	1
	16QAM	1	0	22.67	22.81	22.68	1
		1	8	22.72	22.77	22.49	1
		1	14	22.62	22.77	22.53	1
		8	0	21.74	21.62	21.55	2
		8	4	21.89	21.61	21.51	2
		8	7	21.91	21.65	21.49	2
		15	0	21.65	21.46	21.59	2

Band width	Modulation	RB Size	RB offset	Maximum Average Power			MPR
				23 017	23 095	23 173	
				699.7 MHz	707.5 MHz	715.3 MHz	
1.4 MHz	QPSK	1	0	23.59	23.44	23.29	0
		1	3	23.56	23.40	23.21	0
		1	5	23.59	23.46	23.30	0
		3	0	23.72	23.68	23.57	0
		3	1	23.82	23.67	23.55	0
		3	3	23.75	23.64	23.57	0
		6	0	22.87	22.67	22.58	1
	16QAM	1	0	22.93	22.62	22.62	1
		1	3	22.88	22.42	22.93	1
		1	5	22.98	22.68	22.62	1
		3	0	22.81	22.64	22.58	1
		3	1	22.61	22.67	22.44	1
		3	3	22.62	22.66	22.52	1
		6	0	21.93	21.63	21.73	2

9.2.4 LTE Band 13

Band width	Modulation	RB Size	RB offset	Maximum Average Power		MPR
				23 230		
				782.0 MHz		
10 MHz	QPSK	1	0	23.61		0
		1	25	23.31		0
		1	49	23.22		0
		25	0	22.62		1
		25	12	22.55		1
		25	25	22.54		1
		50	0	22.58		1
	16QAM	1	0	22.85		1
		1	25	22.58		1
		1	49	22.68		1
		25	0	21.57		2
		25	12	21.58		2
		25	25	21.55		2
		50	0	21.64		2

Band width	Modulation	RB Size	RB offset	Maximum Average Power		MPR
				23 230		
				782.0 MHz		
5 MHz	QPSK	1	0	23.44		0
		1	12	23.30		0
		1	24	23.32		0
		12	0	22.60		1
		12	7	22.61		1
		12	13	22.59		1
		25	0	22.62		1
	16QAM	1	0	22.83		1
		1	12	22.57		1
		1	24	22.75		1
		12	0	21.60		2
		12	7	21.60		2
		12	13	21.60		2
		25	0	21.59		2

5 MHz Bandwidths does not support at least three non-overlapping channels in certain channel bandwidths. When a device supports overlapping channel assignment in a channel bandwidth configuration, the middle channel of the group of overlapping channels should be selected for testing per KDB 941225 D05 SAR for LTE Devices.

9.2.5 LTE Band 25

Band width	Modulation	RB Size	RB offset	Maximum Average Power			MPR
				26 140	26 365	26 590	
				1 860.0 MHz	1 882.5 MHz	1 905.0 MHz	
20 MHz	QPSK	1	0	23.53	23.88	23.69	0
		1	49	23.41	23.43	23.69	0
		1	99	23.47	23.29	23.57	0
		50	0	22.93	22.98	22.97	1
		50	24	22.93	22.84	22.93	1
		50	50	22.90	22.83	22.88	1
		100	0	22.91	22.92	22.89	1
	16QAM	1	0	22.84	22.99	22.99	1
		1	49	22.85	23.00	23.00	1
		1	99	22.99	22.91	22.93	1
		50	0	21.90	21.87	21.94	2
		50	24	21.91	21.85	21.88	2
		50	50	21.86	21.82	21.85	2
		100	0	21.93	21.85	21.95	2

Band width	Modulation	RB Size	RB offset	Maximum Average Power			MPR
				26 115	26 365	26 615	
				1 857.5 MHz	1 882.5 MHz	1 907.5 MHz	
15 MHz	QPSK	1	0	23.40	23.86	23.61	0
		1	36	23.52	23.37	23.61	0
		1	74	23.85	23.34	23.54	0
		36	0	22.97	22.97	22.89	1
		36	18	22.95	22.97	22.86	1
		36	37	22.92	22.92	22.81	1
		75	0	22.98	22.92	22.87	1
	16QAM	1	0	22.82	22.90	22.93	1
		1	36	22.81	22.85	22.94	1
		1	74	22.97	22.78	23.00	1
		36	0	21.95	22.00	21.99	2
		36	18	21.95	21.98	22.00	2
		36	37	21.95	21.95	21.94	2
		75	0	21.87	21.94	21.81	2

Band width	Modulation	RB Size	RB offset	Maximum Average Power			MPR
				26 090	26 365	26 640	
				1 855.0 MHz	1 882.5 MHz	1 910.0 MHz	
10 MHz	QPSK	1	0	23.43	23.41	23.55	0
		1	25	23.41	23.34	23.52	0
		1	49	23.34	23.34	23.60	0
		25	0	22.89	22.86	22.83	1
		25	12	22.90	22.91	22.99	1
		25	25	22.85	22.85	22.96	1
		50	0	22.84	22.85	22.82	1
	16QAM	1	0	22.86	22.92	22.93	1
		1	25	22.86	22.84	22.90	1
		1	49	22.83	22.79	22.91	1
		25	0	21.88	21.89	21.84	2
		25	12	21.89	21.89	21.81	2
		25	25	21.73	21.93	21.99	2
		50	0	21.89	21.86	22.00	2

Band width	Modulation	RB Size	RB offset	Maximum Average Power			MPR
				26 065	26 365	26 665	
				1 852.5 MHz	1 882.5 MHz	1 912.5 MHz	
5 MHz	QPSK	1	0	23.33	23.36	23.72	0
		1	12	23.40	23.32	23.84	0
		1	24	23.17	23.33	23.77	0
		12	0	22.78	22.86	22.90	1
		12	7	22.74	22.86	22.91	1
		12	13	22.76	22.86	22.94	1
		25	0	22.79	22.88	22.89	1
	16QAM	1	0	22.57	22.78	22.95	1
		1	12	22.49	22.75	22.93	1
		1	24	22.51	22.76	22.94	1
		12	0	21.79	21.89	21.87	2
		12	7	21.77	21.74	21.87	2
		12	13	21.75	21.82	21.86	2
		25	0	21.82	21.83	21.85	2

Band width	Modulation	RB Size	RB offset	Maximum Average Power			MPR
				26 055	26 365	26 675	
				1 851.5 MHz	1 882.5 MHz	1 913.5 MHz	
3 MHz	QPSK	1	0	23.37	23.34	23.73	0
		1	8	23.16	23.35	23.93	0
		1	14	23.19	23.29	23.71	0
		8	0	22.78	22.93	22.89	1
		8	4	22.80	22.92	22.90	1
		8	7	22.76	22.93	22.91	1
		15	0	22.70	22.85	22.87	1
	16QAM	1	0	22.28	22.91	22.96	1
		1	8	22.67	22.85	22.90	1
		1	14	22.28	22.84	22.99	1
		8	0	21.85	21.99	21.91	2
		8	4	21.82	21.93	21.92	2
		8	7	21.85	21.93	21.92	2
		15	0	21.74	21.85	21.86	2

Band width	Modulation	RB Size	RB offset	Maximum Average Power			MPR
				26 047	26 365	26 683	
				1 850.7 MHz	1 882.5 MHz	1 914.3 MHz	
1.4 MHz	QPSK	1	0	23.41	23.35	23.52	0
		1	3	23.67	23.36	23.50	0
		1	5	23.46	23.35	23.54	0
		3	0	23.65	23.83	23.82	0
		3	1	23.65	23.87	23.99	0
		3	3	23.66	23.82	23.99	0
		6	0	22.75	22.94	22.91	1
	16QAM	1	0	22.94	22.80	22.93	1
		1	3	22.93	22.80	22.99	1
		1	5	22.83	22.85	22.93	1
		3	0	22.73	22.86	22.93	1
		3	1	22.77	22.90	22.81	1
		3	3	22.74	22.99	22.90	1
		6	0	21.91	21.86	21.97	2

9.2.6 LTE Band 26

Band width	Modulation	RB Size	RB offset	Maximum Average Power		MPR
				26 865		
				831.5 MHz		
15 MHz	QPSK	1	0	23.65		0
		1	36	23.40		0
		1	74	23.32		0
		36	0	23.31		1
		36	18	22.83		1
		36	37	22.81		1
		75	0	23.10		1
	16QAM	1	0	23.02		1
		1	36	22.84		1
		1	74	22.87		1
		36	0	21.98		2
		36	18	21.92		2
		36	37	21.88		2
		75	0	21.92		2

15 MHz Bandwidths does not support at least three non-overlapping channels in certain channel bandwidths. When a device supports overlapping channel assignment in a channel bandwidth configuration, the middle channel of the group of overlapping channels should be selected for testing per KDB 941225 D05 SAR for LTE Devices.

Band width	Modulation	RB Size	RB offset	Maximum Average Power			MPR
				26 740	26 865	26 990	
				819.0 MHz	831.5 MHz	844.0 MHz	
10 MHz	QPSK	1	0	23.26	23.45	23.47	0
		1	25	23.22	23.40	23.23	0
		1	49	23.20	23.46	23.15	0
		25	0	22.82	22.90	22.60	1
		25	12	22.76	22.86	22.58	1
		25	25	22.76	22.75	22.68	1
		50	0	22.70	22.72	22.67	1
	16QAM	1	0	23.00	22.94	22.78	1
		1	25	22.98	22.86	22.77	1
		1	49	22.95	22.79	22.73	1
		25	0	21.79	21.90	21.69	2
		25	12	21.71	21.78	21.63	2
		25	25	21.79	21.82	21.65	2
		50	0	21.71	21.79	21.71	2

Band width	Modulation	RB Size	RB offset	Maximum Average Power			MPR
				26 715	26 865	27 015	
				816.5 MHz	831.5 MHz	846.5 MHz	
5 MHz	QPSK	1	0	23.28	23.20	23.50	0
		1	12	23.26	23.18	23.03	0
		1	24	23.21	23.66	23.69	0
		12	0	22.84	22.87	22.61	1
		12	7	22.79	22.87	22.57	1
		12	13	22.78	22.84	22.53	1
		25	0	22.75	22.86	22.58	1
	16QAM	1	0	22.45	22.71	22.87	1
		1	12	22.57	23.18	22.48	1
		1	24	22.40	22.68	22.74	1
		12	0	21.61	21.92	21.73	2
		12	7	21.59	21.88	21.74	2
		12	13	21.61	21.79	21.69	2
		25	0	21.61	21.82	21.74	2

Band width	Modulation	RB Size	RB offset	Maximum Average Power			MPR
				26 705	26 865	27 025	
				815.5 MHz	831.5 MHz	847.5 MHz	
3 MHz	QPSK	1	0	23.31	23.55	23.65	0
		1	8	23.38	23.41	23.13	0
		1	14	23.30	23.38	23.63	0
		8	0	22.87	22.91	22.72	1
		8	4	22.86	22.87	22.75	1
		8	7	22.74	22.90	22.72	1
		15	0	22.67	22.82	22.66	1
	16QAM	1	0	22.95	23.03	22.81	1
		1	8	22.83	23.00	22.77	1
		1	14	22.79	22.79	22.64	1
		8	0	21.99	21.96	21.78	2
		8	4	22.01	21.93	21.75	2
		8	7	22.02	21.91	21.69	2
		15	0	21.79	21.84	21.70	2

Band width	Modulation	RB Size	RB offset	Maximum Average Power			MPR
				26 697	26 865	27 033	
				814.7 MHz	831.5 MHz	848.3 MHz	
1.4 MHz	QPSK	1	0	23.30	23.36	23.22	0
		1	3	23.60	23.24	23.19	0
		1	5	23.34	23.46	23.22	0
		3	0	23.75	23.84	23.66	0
		3	1	23.85	23.85	23.63	0
		3	3	23.78	23.86	23.60	0
		6	0	22.94	22.90	22.57	1
	16QAM	1	0	22.82	22.88	22.73	1
		1	3	22.73	22.78	22.53	1
		1	5	22.90	22.82	22.42	1
		3	0	22.63	22.83	22.62	1
		3	1	22.77	22.82	22.28	1
		3	3	22.71	23.03	22.62	1
		6	0	21.95	21.88	21.59	2



9.2.7 LTE Band 66

Band width	Modulation	RB Size	RB offset	Maximum Average Power			MPR
				132 072	132 322	132 572	
				1 720.0 MHz	1 745.0 MHz	1 770.0 MHz	
20 MHz	QPSK	1	0	23.87	23.88	23.68	0
		1	49	23.73	23.70	23.55	0
		1	99	23.67	23.52	23.73	0
		50	0	22.87	22.93	22.85	1
		50	24	22.82	22.97	22.80	1
		50	50	22.96	22.84	22.72	1
		100	0	22.82	22.89	22.80	1
	16QAM	1	0	22.98	22.97	22.87	1
		1	49	22.92	22.92	22.92	1
		1	99	22.84	22.86	22.82	1
		50	0	21.86	21.87	21.81	2
		50	24	21.99	21.89	21.76	2
		50	50	21.93	21.80	21.56	2
		100	0	21.83	21.89	21.76	2

Band width	Modulation	RB Size	RB offset	Maximum Average Power			MPR
				132 047	132 322	132 597	
				1 717.5 MHz	1 745.0 MHz	1 772.5 MHz	
15 MHz	QPSK	1	0	23.75	23.81	23.63	0
		1	36	23.60	23.69	23.48	0
		1	74	23.63	23.63	23.43	0
		36	0	22.98	22.83	22.84	1
		36	18	22.95	22.95	22.82	1
		36	37	22.91	22.96	22.81	1
		75	0	22.94	22.98	22.85	1
	16QAM	1	0	22.90	22.95	22.97	1
		1	36	22.89	22.84	22.90	1
		1	74	22.99	22.79	22.91	1
		36	0	21.90	21.86	21.78	2
		36	18	21.97	21.84	21.78	2
		36	37	21.93	21.81	21.73	2
		75	0	21.97	21.99	21.76	2

Band width	Modulation	RB Size	RB offset	Maximum Average Power			MPR
				132 022	132 322	132 622	
				1 715.0 MHz	1 745.0 MHz	1 775.0 MHz	
10 MHz	QPSK	1	0	23.68	23.92	23.57	0
		1	25	23.60	23.91	23.54	0
		1	49	23.58	23.89	23.68	0
		25	0	22.94	22.99	22.79	1
		25	12	22.95	22.92	22.81	1
		25	25	22.91	22.95	22.79	1
		50	0	22.92	22.92	22.76	1
	16QAM	1	0	22.82	22.93	22.97	1
		1	25	22.88	22.94	22.85	1
		1	49	22.83	22.81	22.80	1
		25	0	21.94	21.98	21.82	2
		25	12	21.93	21.95	21.78	2
		25	25	21.92	21.92	21.76	2
		50	0	21.97	21.94	21.75	2

Band width	Modulation	RB Size	RB offset	Maximum Average Power			MPR
				131 997	132 322	132 647	
				1 712.5 MHz	1 745.0 MHz	1 777.5 MHz	
5 MHz	QPSK	1	0	23.55	23.97	23.74	0
		1	12	23.62	23.81	23.74	0
		1	24	23.42	23.92	23.56	0
		12	0	22.90	22.95	22.76	1
		12	7	22.84	22.92	22.71	1
		12	13	22.73	22.96	22.72	1
		25	0	22.88	22.92	22.76	1
	16QAM	1	0	22.79	22.92	22.66	1
		1	12	22.58	22.89	22.83	1
		1	24	22.52	22.79	22.99	1
		12	0	21.84	21.96	21.77	2
		12	7	21.84	21.98	21.75	2
		12	13	21.82	21.95	21.75	2
		25	0	21.85	21.86	21.76	2

Band width	Modulation	RB Size	RB offset	Maximum Average Power			MPR
				131 987	132 322	132 657	
				1711.5 MHz	1745.0 MHz	1778.5 MHz	
3 MHz	QPSK	1	0	23.44	23.64	23.39	0
		1	8	23.79	23.61	23.38	0
		1	14	23.75	23.62	23.46	0
		8	0	22.87	22.93	22.81	1
		8	4	22.86	22.83	22.79	1
		8	7	22.82	22.98	22.76	1
		15	0	22.76	22.86	22.72	1
	16QAM	1	0	22.93	22.84	22.68	1
		1	8	22.88	22.87	22.88	1
		1	14	22.93	22.79	22.53	1
		8	0	21.93	22.00	21.78	2
		8	4	21.97	21.95	21.67	2
		8	7	21.92	21.71	21.82	2
		15	0	21.79	21.91	21.72	2

Band width	Modulation	RB Size	RB offset	Maximum Average Power			MPR
				131 979	132 322	132 665	
				1710.7 MHz	1745.0 MHz	1779.3 MHz	
1.4 MHz	QPSK	1	0	23.54	23.67	23.51	0
		1	3	23.53	23.62	23.48	0
		1	5	23.63	23.67	23.53	0
		3	0	23.75	23.97	23.76	0
		3	1	23.75	23.96	23.74	0
		3	3	23.76	23.95	23.72	0
		6	0	22.77	22.98	22.79	1
	16QAM	1	0	22.94	22.95	22.84	1
		1	3	22.88	22.96	22.69	1
		1	5	22.88	22.93	22.87	1
		3	0	22.67	22.82	22.63	1
		3	1	22.64	22.99	22.61	1
		3	3	22.65	22.89	22.57	1
		6	0	21.69	21.80	21.76	2

9.2.8 LTE Band 71

Band width	Modulation	RB Size	RB offset	Maximum Average Power		MPR
				133 297		
				680.5 MHz		
20 MHz	QPSK	1	0	23.59	0	
		1	49	23.21	0	
		1	99	23.09	0	
		50	0	22.55	1	
		50	24	22.43	1	
		50	50	22.38	1	
		100	0	22.51	1	
	16QAM	1	0	22.52	1	
		1	49	22.52	1	
		1	99	22.38	1	
		50	0	21.46	2	
		50	24	21.46	2	
		50	50	21.34	2	
		100	0	21.44	2	

Band width	Modulation	RB Size	RB offset	Maximum Average Power		MPR
				133 297		
				680.5 MHz		
15 MHz	QPSK	1	0	23.30	0	
		1	36	23.18	0	
		1	74	23.16	0	
		36	0	22.51	1	
		36	18	22.49	1	
		36	37	22.46	1	
		75	0	22.49	1	
	16QAM	1	0	22.37	1	
		1	36	22.31	1	
		1	74	22.23	1	
		36	0	21.58	2	
		36	18	21.55	2	
		36	37	21.53	2	
		75	0	21.50	2	

20 MHz ,15 MHz Bandwidths does not support at least three non-overlapping channels in certain channel bandwidths. When a device supports overlapping channel assignment in a channel bandwidth configuration, the middle channel of the group of overlapping channels should be selected for testing per KDB 941225 D05 SAR for LTE Devices.

Band width	Modulation	RB Size	RB offset	Maximum Average Power			MPR
				133 172	133 297	133 422	
				668.0 MHz	680.5 MHz	693.0 MHz	
10 MHz	QPSK	1	0	23.28	23.29	23.21	0
		1	25	23.30	23.36	23.17	0
		1	49	23.13	23.32	23.26	0
		25	0	22.48	22.38	22.37	1
		25	12	22.48	22.42	22.34	1
		25	25	22.46	22.42	22.40	1
		50	0	22.47	22.45	22.37	1
	16QAM	1	0	22.56	22.58	22.36	1
		1	25	22.58	22.54	22.22	1
		1	49	22.49	22.44	22.16	1
		25	0	21.52	21.45	21.44	2
		25	12	21.52	21.47	21.44	2
		25	25	21.48	21.43	21.41	2
		50	0	21.53	21.48	21.36	2

Band width	Modulation	RB Size	RB offset	Maximum Average Power			MPR
				133 147	133 297	133 447	
				665.5 MHz	680.5 MHz	695.5 MHz	
5 MHz	QPSK	1	0	23.08	23.20	23.10	0
		1	12	23.52	23.19	23.13	0
		1	24	23.12	23.15	23.16	0
		12	0	22.27	22.46	22.48	1
		12	7	22.42	22.47	22.45	1
		12	13	22.40	22.41	22.47	1
		25	0	22.35	22.45	22.44	1
	16QAM	1	0	22.24	22.46	22.44	1
		1	12	22.56	22.32	22.34	1
		1	24	22.31	22.48	22.41	1
		12	0	21.50	21.45	21.52	2
		12	7	21.50	21.47	21.48	2
		12	13	21.45	21.46	21.46	2
		25	0	21.47	21.41	21.51	2

9.3 WLAN Average Conducted Output Power

Band	Freq. [MHz]	Channel	Mode		
			802.11b	802.11g	802.11n(HT20)
WLAN 2.4 GHz	2 412.0	1	17.67	16.34	16.29
	2 437.0	6	17.51	16.41	16.25
	2 462.0	11	17.34	16.37	16.40
	2 467.0	12	8.20	8.37	8.22
	2 472.0	13	8.31	8.49	8.32
Band	Freq. [MHz]	Channel	Mode		
			802.11a	802.11n(HT20)	
NII	5 180.0	36	15.77	16.00	
	5 200.0	40	15.93	15.94	
	5 220.0	44	16.14	16.15	
	5 240.0	48	16.25	16.30	
	5 260.0	52	16.16	16.34	
	5 280.0	56	16.69	16.84	
	5 300.0	60	15.19	15.39	
	5 320.0	64	15.13	15.29	
	5 500.0	100	15.77	16.00	
	5 600.0	120	15.51	15.56	
	5 620.0	124	16.05	15.89	
	5 720.0	144	16.01	15.85	
	5 745.0	149	16.58	16.69	
	5 785.0	157	16.33	16.36	
5 825.0	165	16.33	16.42		

Justification for test configurations for WLAN per KDB Publication 248227 D01v02r02:

- Power measurements were performed for the transmission mode configuration with the highest maximum output power specified for production units.
- For transmission modes with the same maximum output power specification, powers were measured for the largest channel bandwidth, lowest order modulation and lowest data rate.
- For transmission modes with identical maximum specified output power, channel bandwidth, modulation and data rates, power measurements were required for all identical configurations.
- For each transmission mode configuration, powers were measured for the highest and lowest channels; and at the mid-band channel(s) when there were at least 3 channels supported. For configurations with multiple mid-band channels, due to an even number of channels, both channels were measured.

Power Measurement Setup

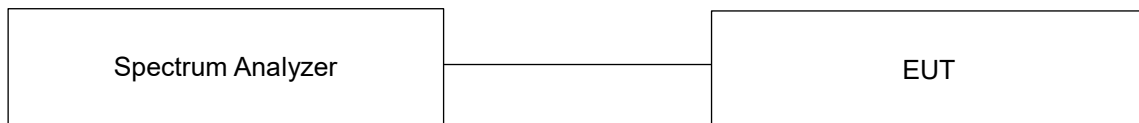

9.4 Bluetooth Average Conducted Output Power

Mode	Freq. [MHz]	Channel	Conducted Powers (dBm)
BDR_DH5 (1 Mbps)	2 402.0	0	17.01
	2 441.0	39	17.13
	2 480.0	78	16.39
BDR_2-DH5 (2 Mbps)	2 402.0	0	10.88
	2 441.0	39	10.97
	2 480.0	78	10.61
EDR_3-DH5 (3 Mbps)	2 402.0	0	10.99
	2 441.0	39	11.05
	2 480.0	78	10.70
LE (1 Mbps 37)	2 402.0	0	8.64
	2 440.0	19	8.45
	2 480.0	39	8.42
LE (1 Mbps 255)	2 402.0	0	8.58
	2 440.0	19	8.36
	2 480.0	39	8.29
LE (2 Mbps 37)	2 402.0	0	8.81
	2 440.0	19	8.63
	2 480.0	39	8.61
LE (2 Mbps 255)	2 402.0	0	8.66
	2 440.0	19	8.46
	2 480.0	39	8.40

9.5 Wireless Band Duty Cycle

Wireless Bands	Frequency Bands		Mode		Duty Cycle (%)	
WCDMA	Band II/IV/ V		RMC, AMR, HSDPA, HSUPA, DC-HSDPA		100	
LTE	FDD Band 5/7/12/13/25/26/66/71		QPSK, 16QAM		100	
WLAN	2.4 GHz		802.11b		98.49	
	NII		802.11a		92.37	
Bluetooth	Mode	Packet	On Time (ms)	On-Off Time (ms)	Duty Cycle (%)	Duty Cycle Compensate Factor
	BDR(GFSK)	DH5	2.88	3.75	76.80	1.302

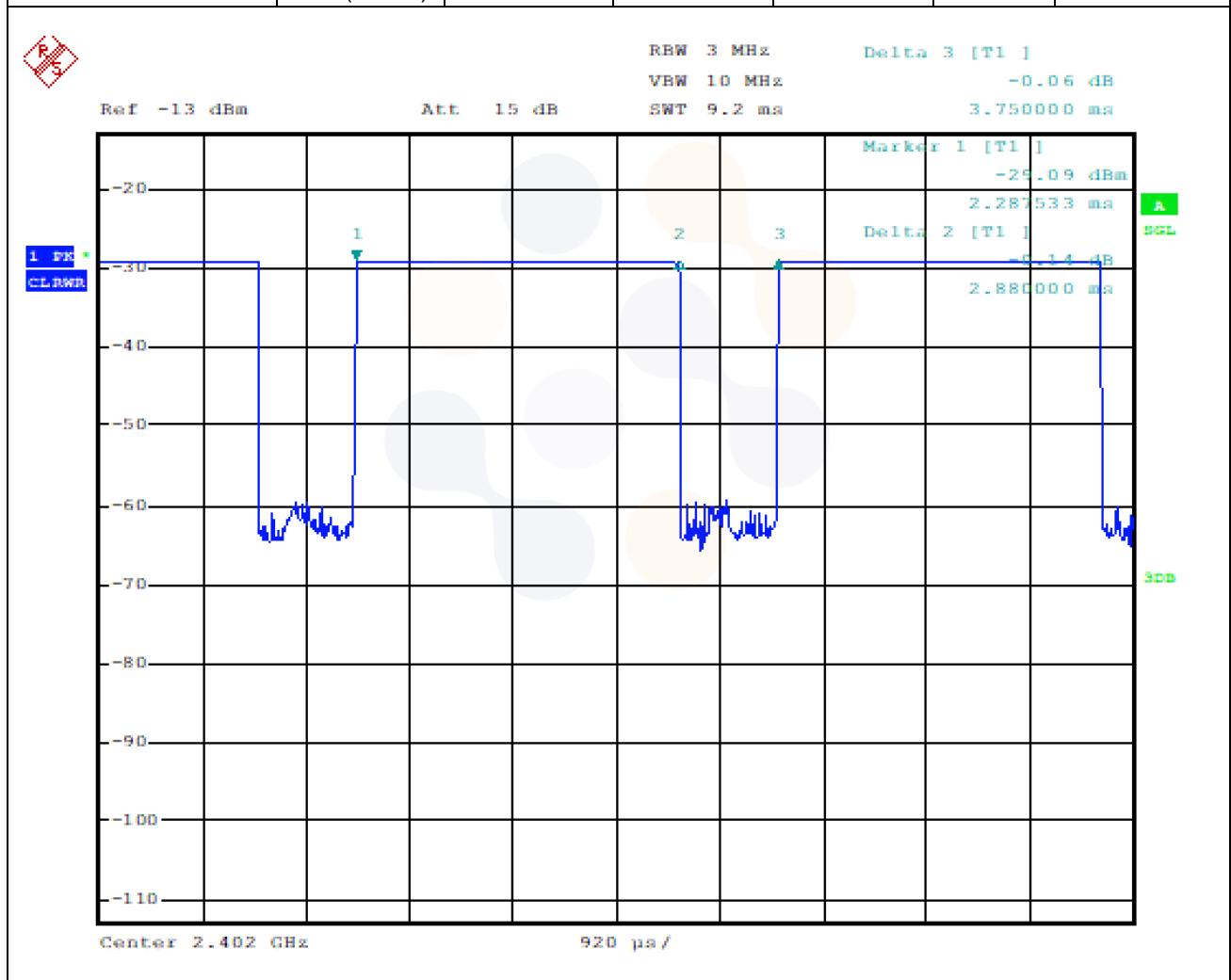

10. System Verification

10.1 Measurement date and environment

Shield room	Date	Environment	
		Temperature (°C)	Humidity (%)
8F - 1	2023-04-13	21.2 ~ 21.5	49.1
	2023-04-14	20.7 ~ 20.8	49.5
	2023-04-17	21.0 ~ 21.3	47.8
	2023-04-18	20.8 ~ 21.0	48.9
	2023-04-20	20.9 ~ 21.2	48.8
8F - 2	2023-04-12	20.3 ~ 20.5	44.1
	2023-04-15	20.6 ~ 20.8	45.1
	2023-05-08	21.3 ~ 21.4	48.3



10.2 Tissue Verification

The dielectric properties for this Tissue Simulant Liquids were measured by using the SPEAG Model DAK3.5 Dielectric Probe in conjunction with Agilent E5071B Network Analyzer (300 kHz – 8 500 MHz). The Conductivity (σ) and Permittivity (ρ) are listed in Table 1. For the SAR measurement given in this report. The temperature variation of the Tissue Simulant Liquids was $(22 \pm 2) ^\circ\text{C}$.

Freq. (MHz)	Limit/Measured		Permittivity (ρ)	Conductivity (σ)	Temp. ($^\circ\text{C}$)
750.0	Recommended Limit		$41.90 \pm 5 \%$ (39.81~44.00)	$0.89 \pm 5 \%$ (0.85~0.93)	22 ± 2
	Measured	2023-04-14	43.12	0.89	20.82
850.0	Recommended Limit		$41.50 \pm 5 \%$ (39.43~43.58)	$0.92 \pm 5 \%$ (0.87~0.97)	22 ± 2
	Measured	2023-04-18	40.71	0.92	21.03
1 750.0	Recommended Limit		$40.07 \pm 5 \%$ (38.07~42.07)	$1.37 \pm 5 \%$ (1.30~1.44)	22 ± 2
	Measured	2023-04-17	40.59	1.36	20.91
1 900.0	Recommended Limit		$40.00 \pm 5 \%$ (38.00~42.00)	$1.40 \pm 5 \%$ (1.33~1.47)	22 ± 2
	Measured	2023-04-13	38.53	1.41	20.88
2 450.0	Recommended Limit		$39.20 \pm 5 \%$ (37.24~41.16)	$1.80 \pm 5 \%$ (1.71~1.89)	22 ± 2
	Measured	2023-04-12	38.77	1.83	20.75
	Measured	2023-05-08	39.14	1.85	20.89
2 600.0	Recommended Limit		$39.00 \pm 5 \%$ (37.05~40.95)	$1.96 \pm 5 \%$ (1.86~2.06)	22 ± 2
	Measured	2023-04-20	38.16	2.01	20.89
5 250.0	Recommended Limit		$35.90 \pm 5 \%$ (34.11~37.70)	$4.76 \pm 5 \%$ (4.52~5.00)	22 ± 2
	Measured	2023-04-15	36.13	4.73	20.77
5 600.0	Recommended Limit		$35.50 \pm 5 \%$ (33.73~37.28)	$5.07 \pm 5 \%$ (4.82~5.32)	22 ± 2
	Measured	2023-04-15	35.36	5.14	20.77
5 800.0	Recommended Limit		$35.30 \pm 5 \%$ (33.54~37.07)	$5.27 \pm 5 \%$ (5.01~5.53)	22 ± 2
	Measured	2023-04-15	34.96	5.36	20.77

<Table 1.Measurement result of Tissue electric parameters>

10.3 Test System Verification

The microwave circuit arrangement for system verification is sketched below picture. The daily system accuracy verification occurs within the flat section of the SAM phantom. A SAR measurement was performed to see if the measured SAR was within $\pm 10\%$ from the target SAR values. The tests were conducted on the same days as the measurement of the EUT. The obtained results from the system accuracy verification are displayed in the Table 2. During the tests, the ambient temperature of the laboratory was in the range $(22 \pm 2) ^\circ\text{C}$, the relative humidity was in the range $(50 \pm 20)\%$ and the liquid depth Above the ear/grid reference points was above 15 cm in all the cases. It is seen that the system is operating within its specification, as the results are within acceptable tolerance of the reference values.

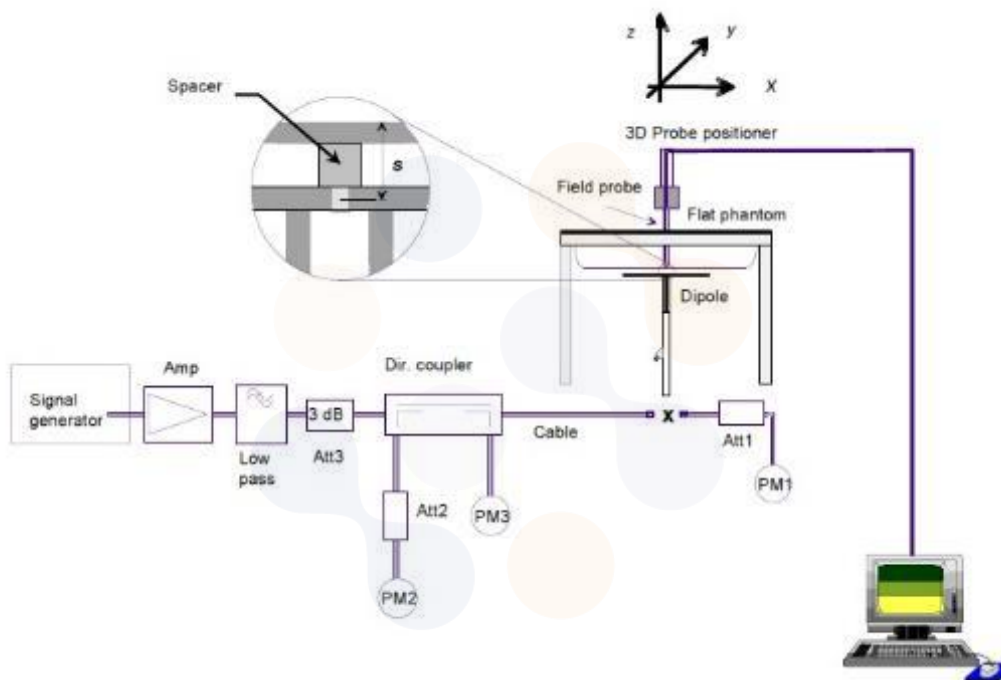

Verification Kit	Probe S/N	Frequency (Mhz)	Tissue Type	Date	Limit/Measured (Normalized to 1 W)	
					Recommended Limit 1g (Normalized)	Recommended Limit 10g (Normalized)
D750V3 SN: 1183	EX3DV4 SN:3865	750.0	HSL	Measured	8.44 ± 10 % (7.60~9.28)	5.53 ± 10 % (4.98~6.08)
				2023-04-14	8.28	5.44
D850V2 SN: 1006	EX3DV4 SN: 3865	850.0	HSL	Measured	10.10 ± 10 % (9.09~11.11)	6.54 ± 10 % (5.89~7.19)
				2023-04-18	10.36	6.76
D1750V2 SN: 1072	EX3DV4 SN:3865	1 750.0	HSL	Measured	36.50 ± 10 % (32.85~40.15)	19.30 ± 10 % (17.37~21.23)
				2023-04-17	36.52	19.52
D1900V2 SN: 5d160	EX3DV4 SN: 3865	1 900.0	HSL	Measured	39.60 ± 10 % (35.64~43.56)	20.80 ± 10 % (18.72~22.88)
				2023-04-13	38.36	20.00
D2450V2 SN: 895	EX3DV4 SN: 7753	2 450.0	HSL	Measured	52.30 ± 10 % (47.07~57.53)	24.60 ± 10 % (22.14~27.06)
				2023-04-12	52.70	24.40
				2023-05-08	51.70	23.90
D2600V2 SN: 1050	EX3DV4 SN: 3865	2 600.0	HSL	Measured	56.70 ± 10 % (51.03~62.37)	25.40 ± 10 % (22.86~27.94)
				2023-04-20	55.40	24.90
D5GHzV2 SN: 1293	EX3DV4 SN: 7753	5 250.0	HSL	Measured	80.50 ± 10 % (72.45~88.55)	22.90 ± 10 % (20.61~25.19)
				2023-04-15	79.00	23.10
D5GHzV2 SN: 1293	EX3DV4 SN: 7753	5 600.0	HSL	Measured	82.60 ± 10 % (74.34~90.86)	23.40 ± 10 % (21.06~25.74)
				2023-04-15	81.40	23.90
D5GHzV2 SN: 1293	EX3DV4 SN: 7753	5 800.0	HSL	Measured	80.10 ± 10 % (72.09~88.11)	22.50 ± 10 % (20.25~24.75)
				2023-04-15	76.00	22.20

<Table 2. System Verification>

11. SAR Test Results

WCDMA II									
Next to Mouth									
EUT Position	Mode	Distance (mm)	Frequency (MHz)	Measured Conducted Power (dB m)	Max. Tune-up Power (dB m)	Power Scaling Factor	Measured 1 g SAR (W/kg)	Reported 1 g SAR (W/kg)	Plot No.
Front	RMC	10	1 880.0	23.21	24.00	1.199	0.809	0.970	
		10	1 852.4	23.31	24.00	1.172	0.878	1.029	1
		10	1 907.6	23.45	24.00	1.135	0.799	0.907	
Repeated SAR Test									
Front	RMC	10	1 852.4	23.31	24.00	1.172	0.765	0.897	
Extremity									
EUT Position	Mode	Distance (mm)	Frequency (MHz)	Measured Conducted Power (dB m)	Max. Tune-up Power (dB m)	Power Scaling Factor	Measured 10 g SAR (W/kg)	Reported 10 g SAR (W/kg)	Plot No.
Rear	RMC	0	1 880.0	23.21	24.00	1.199	1.150	1.379	2

WCDMA IV									
Next to Mouth									
EUT Position	Mode	Distance (mm)	Frequency (MHz)	Measured Conducted Power (dB m)	Max. Tune-up Power (dB m)	Power Scaling Factor	Measured 1 g SAR (W/kg)	Reported 1 g SAR (W/kg)	Plot No.
Front	RMC	10	1 732.4	23.46	24.00	1.132	0.673	0.762	3
Extremity									
EUT Position	Mode	Distance (mm)	Frequency (MHz)	Measured Conducted Power (dB m)	Max. Tune-up Power (dB m)	Power Scaling Factor	Measured 10 g SAR (W/kg)	Reported 10 g SAR (W/kg)	Plot No.
Rear	RMC	0	1 732.4	23.46	24.00	1.132	1.980	2.241	
		0	1 712.4	23.49	24.00	1.125	1.880	2.115	
		0	1 752.6	23.44	24.00	1.138	2.020	2.299	4
Repeated SAR Test									
Rear	RMC	0	1 752.6	23.44	24.00	1.138	1.990	2.265	

WCDMA V									
Next to Mouth									
EUT Position	Mode	Distance (mm)	Frequency (MHz)	Measured Conducted Power (dB m)	Max. Tune-up Power (dB m)	Power Scaling Factor	Measured 1 g SAR (W/kg)	Reported 1 g SAR (W/kg)	Plot No.
Front	RMC	10	836.6	23.41	24.00	1.146	0.022	0.025	5
Extremity									
EUT Position	Mode	Distance (mm)	Frequency (MHz)	Measured Conducted Power (dB m)	Max. Tune-up Power (dB m)	Power Scaling Factor	Measured 10 g SAR (W/kg)	Reported 10 g SAR (W/kg)	Plot No.
Rear	RMC	0	836.6	23.41	24.00	1.146	0.278	0.319	6

LTE Band 5									
Next to Mouth									
EUT Position	Mode	Distance (mm)	Frequency (MHz)	Measured Conducted Power (dB m)	Max. Tune-up Power (dB m)	Power Scaling Factor	Measured 1 g SAR (W/kg)	Reported 1 g SAR (W/kg)	Plot No.
Front	QPSK 10 MHz 1RB 0offset	10	836.5	23.84	24.50	1.164	0.022	0.026	7
	QPSK 10 MHz 25RB 12offset	10	836.5	23.02	23.50	1.117	0.018	0.020	
Extremity									
EUT Position	Mode	Distance (mm)	Frequency (MHz)	Measured Conducted Power (dB m)	Max. Tune-up Power (dB m)	Power Scaling Factor	Measured 10 g SAR (W/kg)	Reported 10 g SAR (W/kg)	Plot No.
Rear	QPSK 10 MHz 1RB 0offset	0	836.5	23.84	24.50	1.164	0.260	0.303	8
	QPSK 10 MHz 25RB 12offset	0	836.5	23.02	23.50	1.117	0.172	0.192	

LTE Band 7

Next to Mouth

EUT Position	Mode	Distance (mm)	Frequency (MHz)	Measured Conducted Power (dB m)	Max. Tune-up Power (dB m)	Power Scaling Factor	Measured 1 g SAR (W/kg)	Reported 1 g SAR (W/kg)	Plot No.
Front	QPSK 20 MHz 1RB 0offset	10	2 535.0	22.97	23.50	1.130	0.161	0.182	9
	QPSK 20 MHz 50RB 0offset	10	2 535.0	22.38	22.50	1.028	0.118	0.121	

Extremity

EUT Position	Mode	Distance (mm)	Frequency (MHz)	Measured Conducted Power (dB m)	Max. Tune-up Power (dB m)	Power Scaling Factor	Measured 10 g SAR (W/kg)	Reported 10 g SAR (W/kg)	Plot No.
Rear	QPSK 20 MHz 1RB 0offset	0	2 535.0	22.97	23.50	1.130	0.872	0.985	10
	QPSK 20 MHz 50RB 0offset	0	2 535.0	22.38	22.50	1.028	0.704	0.724	

LTE Band 12

Next to Mouth

EUT Position	Mode	Distance (mm)	Frequency (MHz)	Measured Conducted Power (dB m)	Max. Tune-up Power (dB m)	Power Scaling Factor	Measured 1 g SAR (W/kg)	Reported 1 g SAR (W/kg)	Plot No.
Front	QPSK 10 MHz 1RB 0offset	10	707.5	23.75	24.00	1.059	0.006	0.006	
	QPSK 10 MHz 25RB 0offset	10	707.5	22.76	23.00	1.057	0.007	0.007	11

Extremity

EUT Position	Mode	Distance (mm)	Frequency (MHz)	Measured Conducted Power (dB m)	Max. Tune-up Power (dB m)	Power Scaling Factor	Measured 10 g SAR (W/kg)	Reported 10 g SAR (W/kg)	Plot No.
Rear	QPSK 10 MHz 1RB 0offset	0	707.5	23.75	24.00	1.059	0.358	0.379	12
	QPSK 10 MHz 25RB 0offset	0	707.5	22.76	23.00	1.057	0.259	0.274	

LTE Band 13

Next to Mouth

EUT Position	Mode	Distance (mm)	Frequency (MHz)	Measured Conducted Power (dB m)	Max. Tune-up Power (dB m)	Power Scaling Factor	Measured 1 g SAR (W/kg)	Reported 1 g SAR (W/kg)	Plot No.
Front	QPSK 10 MHz 1RB 0offset	10	782.0	23.61	24.00	1.094	0.013	0.014	13
	QPSK 10 MHz 25RB 0offset	10	782.0	22.62	23.00	1.091	0.011	0.012	

Extremity

EUT Position	Mode	Distance (mm)	Frequency (MHz)	Measured Conducted Power (dB m)	Max. Tune-up Power (dB m)	Power Scaling Factor	Measured 10 g SAR (W/kg)	Reported 10 g SAR (W/kg)	Plot No.
Rear	QPSK 10 MHz 1RB 0offset	0	782.0	23.61	24.00	1.094	0.234	0.256	14
	QPSK 10 MHz 25RB 0offset	0	782.0	22.62	23.00	1.091	0.183	0.200	

LTE Band 25

Next to Mouth

EUT Position	Mode	Distance (mm)	Frequency (MHz)	Measured Conducted Power (dB m)	Max. Tune-up Power (dB m)	Power Scaling Factor	Measured 1 g SAR (W/kg)	Reported 1 g SAR (W/kg)	Plot No.
Front	QPSK 20 MHz 1RB 0offset	10	1 882.5	23.88	24.50	1.153	0.873	1.007	
		10	1 860.0	23.53	24.50	1.250	0.864	1.080	15
		10	1 905.0	23.69	24.50	1.205	0.833	1.004	
	QPSK 20 MHz 50RB 0offset	10	1 882.5	22.98	23.50	1.127	0.649	0.731	
	QPSK 20 MHz 100RB 0offset	10	1 882.5	22.92	23.50	1.143	0.623	0.712	

Repeated SAR Test

Front	QPSK 20 MHz 1RB 0offset	10	1 882.5	23.88	24.50	1.153	0.808	0.932	
-------	----------------------------	----	---------	-------	-------	-------	-------	-------	--

Extremity

EUT Position	Mode	Distance (mm)	Frequency (MHz)	Measured Conducted Power (dB m)	Max. Tune-up Power (dB m)	Power Scaling Factor	Measured 10 g SAR (W/kg)	Reported 10 g SAR (W/kg)	Plot No.
Rear	QPSK 20 MHz 1RB 0offset	0	1 882.5	23.88	24.50	1.153	1.220	1.407	16
	QPSK 20 MHz 50RB 0offset	0	1 882.5	22.98	23.50	1.127	0.962	1.084	

LTE Band 26									
Next to Mouth									
EUT Position	Mode	Distance (mm)	Frequency (MHz)	Measured Conducted Power (dB m)	Max. Tune-up Power (dB m)	Power Scaling Factor	Measured 1 g SAR (W/kg)	Reported 1 g SAR (W/kg)	Plot No.
Front	QPSK 15 MHz 1RB 0offset	10	831.5	23.65	24.50	1.216	0.019	0.023	17
	QPSK 15 MHz 36RB 0offset	10	831.5	23.31	23.50	1.045	0.018	0.019	
Extremity									
EUT Position	Mode	Distance (mm)	Frequency (MHz)	Measured Conducted Power (dB m)	Max. Tune-up Power (dB m)	Power Scaling Factor	Measured 10 g SAR (W/kg)	Reported 10 g SAR (W/kg)	Plot No.
Rear	QPSK 15 MHz 1RB 0offset	0	831.5	23.65	24.50	1.216	0.273	0.332	18
	QPSK 15 MHz 36RB 0offset	0	831.5	23.31	23.50	1.045	0.264	0.276	

LTE Band 66

Next to Mouth

EUT Position	Mode	Distance (mm)	Frequency (MHz)	Measured Conducted Power (dB m)	Max. Tune-up Power (dB m)	Power Scaling Factor	Measured 1 g SAR (W/kg)	Reported 1 g SAR (W/kg)	Plot No.
Front	QPSK 20 MHz 1RB 0offset	10	1 745.0	23.88	24.50	1.153	0.781	0.900	
		10	1 720.0	23.87	24.50	1.156	0.699	0.808	
		10	1 770.0	23.68	24.50	1.208	0.811	0.980	19
	QPSK 20 MHz 50RB 24offset	10	1 745.0	22.97	23.50	1.130	0.575	0.650	
	QPSK 20 MHz 100RB 0offset	10	1 745.0	22.89	23.50	1.151	0.580	0.668	

Repeated SAR Test

Front	QPSK 20 MHz 1RB 0offset	10	1 770.0	23.68	24.50	1.208	0.800	0.966	
-------	----------------------------	----	---------	-------	-------	-------	-------	-------	--

Extremity

EUT Position	Mode	Distance (mm)	Frequency (MHz)	Measured Conducted Power (dB m)	Max. Tune-up Power (dB m)	Power Scaling Factor	Measured 10 g SAR (W/kg)	Reported 10 g SAR (W/kg)	Plot No.
Rear	QPSK 20 MHz 1RB 0offset	0	1 745.0	23.88	24.50	1.153	1.980	2.283	
		0	1 720.0	23.87	24.50	1.156	1.860	2.150	
		0	1 770.0	23.68	24.50	1.208	2.360	2.851	20
	QPSK 20 MHz 50RB 24offset	0	1 745.0	22.97	23.50	1.130	1.680	1.898	
	QPSK 20 MHz 100RB 0offset	0	1 745.0	22.89	23.50	1.151	1.740	2.003	

Repeated SAR Test

Rear	QPSK 20 MHz 1RB 0offset	0	1 770.0	23.68	24.50	1.208	2.180	2.633	
------	----------------------------	---	---------	-------	-------	-------	-------	-------	--

LTE Band 71

Next to Mouth

EUT Position	Mode	Distance (mm)	Frequency (MHz)	Measured Conducted Power (dB m)	Max. Tune-up Power (dB m)	Power Scaling Factor	Measured 1 g SAR (W/kg)	Reported 1 g SAR (W/kg)	Plot No.
Front	QPSK 20 MHz 1RB 0offset	10	680.5	23.59	24.00	1.099	0.003	0.003	
	QPSK 20 MHz 50RB 0offset	10	680.5	22.55	23.00	1.109	0.004	0.004	21

Extremity

EUT Position	Mode	Distance (mm)	Frequency (MHz)	Measured Conducted Power (dB m)	Max. Tune-up Power (dB m)	Power Scaling Factor	Measured 10 g SAR (W/kg)	Reported 10 g SAR (W/kg)	Plot No.
Rear	QPSK 20 MHz 1RB 0offset	0	680.5	23.59	24.00	1.099	0.266	0.292	22
	QPSK 20 MHz 50RB 0offset	0	680.5	22.55	23.00	1.109	0.216	0.240	

WLAN 2.4 GHz

Next to Mouth

EUT Position	Mode	Distance (mm)	Frequency (MHz)	Measured Conducted Power (dB m)	Max. Tune-up Power (dB m)	Power Scaling Factor	Duty Cycle Compensate Factor	Measured 1 g SAR (W/kg)	Reported 1g SAR (W/kg)	Plot No.
Front	802.11b	10	2 412.0	17.67	18.00	1.079	1.015	0.021	0.023	23

Extremity

EUT Position	Mode	Distance (mm)	Frequency (MHz)	Measured Conducted Power (dB m)	Max. Tune-up Power (dB m)	Power Scaling Factor	Duty Cycle Compensate Factor	Measured 10 g SAR (W/kg)	Reported 10 g SAR (W/kg)	Plot No.
Rear	802.11b	0	2 412.0	17.67	18.00	1.079	1.015	0.186	0.204	24

U-NII-2A

Next to Mouth

EUT Position	Mode	Distance (mm)	Frequency (MHz)	Measured Conducted Power (dB m)	Max. Tune-up Power (dB m)	Power Scaling Factor	Duty Cycle Compensate Factor	Measured 1 g SAR (W/kg)	Reported 1g SAR (W/kg)	Plot No.
Front	802.11a	10	5 280.0	16.69	17.00	1.074	1.083	0.000	0.000	25

Extremity

EUT Position	Mode	Distance (mm)	Frequency (MHz)	Measured Conducted Power (dB m)	Max. Tune-up Power (dB m)	Power Scaling Factor	Duty Cycle Compensate Factor	Measured 10 g SAR (W/kg)	Reported 10 g SAR (W/kg)	Plot No.
Rear	802.11a	0	5 280.0	16.69	17.00	1.074	1.083	0.085	0.099	26

U-NII-2C

Next to Mouth										
EUT Position	Mode	Distance (mm)	Frequency (MHz)	Measured Conducted Power (dB m)	Max. Tune-up Power (dB m)	Power Scaling Factor	Duty Cycle Compensate Factor	Measured 1 g SAR (W/kg)	Reported 1g SAR (W/kg)	Plot No.
Front	802.11a	10	5 620.0	16.05	17.00	1.245	1.083	0.000	0.000	27
Extremity										
EUT Position	Mode	Distance (mm)	Frequency (MHz)	Measured Conducted Power (dB m)	Max. Tune-up Power (dB m)	Power Scaling Factor	Duty Cycle Compensate Factor	Measured 10 g SAR (W/kg)	Reported 10 g SAR (W/kg)	Plot No.
Rear	802.11a	0	5 620.0	16.05	17.00	1.245	1.083	0.046	0.062	28

U-NII-3

Next to Mouth										
EUT Position	Mode	Distance (mm)	Frequency (MHz)	Measured Conducted Power (dB m)	Max. Tune-up Power (dB m)	Power Scaling Factor	Duty Cycle Compensate Factor	Measured 1 g SAR (W/kg)	Reported 1g SAR (W/kg)	Plot No.
Front	802.11a	10	5 745.0	16.58	17.00	1.102	1.083	0.000	0.000	29
Extremity										
EUT Position	Mode	Distance (mm)	Frequency (MHz)	Measured Conducted Power (dB m)	Max. Tune-up Power (dB m)	Power Scaling Factor	Duty Cycle Compensate Factor	Measured 10 g SAR (W/kg)	Reported 10 g SAR (W/kg)	Plot No.
Rear	802.11a	0	5 745.0	16.58	17.00	1.102	1.083	0.044	0.053	30

Bluetooth

Next to Mouth										
EUT Position	Mode	Distance (mm)	Frequency (MHz)	Measured Conducted Power (dB m)	Max. Tune-up Power (dB m)	Power Scaling Factor	Duty Cycle Compensate Factor	Measured 1 g SAR (W/kg)	Reported 1g SAR (W/kg)	Plot No.
Front	DH5	10	2 441.0	17.13	18.00	1.222	1.302	0.042	0.067	31
Extremity										
EUT Position	Mode	Distance (mm)	Frequency (MHz)	Measured Conducted Power (dB m)	Max. Tune-up Power (dB m)	Power Scaling Factor	Duty Cycle Compensate Factor	Measured 10 g SAR (W/kg)	Reported 10 g SAR (W/kg)	Plot No.
Rear	DH5	0	2 441.0	17.13	18.00	1.222	1.302	0.140	0.223	32

<p align="center">Eurofins KCTL Co.,Ltd. 65, Sinwon-ro, Yeongtong-gu, Suwon-si, Gyeonggi-do, 16677, Korea TEL: 82-70-5008-1021 FAX: 82-505-299-8311 www.kctl.co.kr</p>	<p align="center">Report No.: KR23-SPF0011 Page (57) of (200)</p>	
---------------------------------------------------------------------------------------------------------------------------------------------------------------------------------------------------------------------------------------	------------------------------------------------------------------------------------	-------------------------------------------------------------------------------------

General Notes:

1. According to test procedures specified in IEEE1528-2013 and FCC KDB publication 447498 D04v01, the DUT was tested in all operating configurations, but only worst-case SAR values were reported
2. Only standard batteries were used for all tests and fully charged.
3. The depth of tissue-equivalent liquids in the phantom was at least 15cm.
4. The manufacturer guarantees that the tested devices have same physical, mechanical and thermal characteristics and meet the requirements for expected operational tolerances.
5. Measured SAR values were scaled up by applying the power scaling factor to comply FCC KDB publication 447498 D04v01
6. The EUT is tested 2nd hot-spot peak, if it is less than 2 dB below the highest peak.
7. According to the KDB guidance, a factor of 2.5 was considered for the 10g-Extremity SAR.

WCDMA & LTE Notes:



KDB 941225 D01 SAR test for 3G devices:

When the maximum output power and tune-up tolerance specified for production units in a secondary mode is $\leq \frac{1}{4}$ dB higher than the primary mode or when the highest reported SAR of the primary mode is scaled by the ratio of specified maximum output power and tune-up tolerance of secondary to primary mode and the adjusted SAR is ≤ 1.2 W/kg, SAR measurement is not required for the secondary mode.

KDB 941225 D05 SAR for LTE Devices:

SAR test reduction is applied using the following criteria:

1. Justification Start with the largest channel bandwidth and measure SAR for QPSK with 1 RB, and 50% RB allocation, using the RB offset and required test channel combination with the highest maximum output power among RB offsets at the upper edge, middle and lower edge of each required test channel.
2. When the reported SAR is > 0.8 W/kg, testing for other Channels is performed at the highest output power level for 1RB, and 50% RB configuration for that channel.
3. Testing for 100% RB configuration is performed at the highest output power level for 100% RB configuration across the Low, Mid and High Channel when the highest reported SAR for 1 RB and 50% RB are > 0.8 W/kg. Testing for the remaining required channels is not needed because the reported SAR for 100% RB Allocation < 1.45 W/kg.
4. Testing for 16-QAM modulation is not required because the reported SAR for QPSK is < 1.45 W/Kg and its output power is not more than 0.5 dB higher than that of QPSK.
5. Testing for the other channel bandwidths is not required because the reported SAR for the highest channel bandwidth is < 1.45 W/Kg and its output power is not more than 0.5 dB higher than that of the highest channel bandwidth.
6. For LTE bands that do not support at least three non-overlapping channels in certain channel bandwidths, test the available non-overlapping channels instead. When a device supports overlapping channel assignment in a channel bandwidth configuration, the middle channel of the group of overlapping channels should be selected for testing; therefore, the requirement for H, M and L channels may not fully apply.

<p>Eurofins KCTL Co.,Ltd. 65, Sinwon-ro, Yeongtong-gu, Suwon-si, Gyeonggi-do, 16677, Korea TEL: 82-70-5008-1021 FAX: 82-505-299-8311 www.kctl.co.kr</p>	<p>Report No.: KR23-SPF0011 Page (58) of (200)</p>	<p> </p>
--------------------------------------------------------------------------------------------------------------------------------------------------------------------------------------------------------------------	------------------------------------------------------------	----------------------------------------------------------------------------------------------------------------------------------------------------------------------------------

WLAN & Bluetooth Notes:

1. Justification for test configurations for WLAN per KDB Publication 248227 D01v02r02 for 2.4GHz WIFI operations, the highest measured maximum output power channel for DSSS was selected for SAR measurement. SAR for OFDM modes (2.4GHz 802.11g/n) was not required due to the maximum allowed powers and the highest reported DSSS SAR.
2. The device was configured to transmit continuously at the required data rate, channel bandwidth and signal modulation, using the highest transmission duty factor supported by the test mode tools. The reported SAR was scaled to the 100% transmission duty factor to determine compliance.
3. When the same transmission mode configurations have the same maximum output power on the same channel for the 802.11 a/g/n/ac modes, the channel in the lower order/sequence 802.11 mode (i.e. a, g, n then ac) is selected.
4. When the highest reported SAR for the initial test configuration (when applicable, include subsequent highest output channels), according to the initial test position or fixed exposure requirements, is adjusted by the ratio of the subsequent test configuration to the initial test configuration specified maximum output power and the adjusted SAR is ≤ 1.2 W/Kg, SAR is not required for that subsequent test configuration.
5. During the test, the WLAN transmission was monitored through the spectrum analyzer.



12. Simultaneous Transmission

The following procedures adopted from FCC KDB Publication 447498 D04v01 are applicable to devices with built in unlicensed transmitters such as 802.11 and Bluetooth devices which may simultaneously transmit with the licensed transmitter.

This device contains transmitters that may operate simultaneously. Therefore, simultaneous transmission analysis is required. Per FCC KDB Publication 447498 D04v01 4.3.2 and IEEE 1528-2013 Section 6.3.4.1.2, simultaneous transmission SAR test exclusion may be applied when the sum of the 1g or 10g SAR for all the simultaneous transmitting antennas in a specific a physical test configuration is within SAR limits. The different test positions in an exposure condition may be considered collectively to determine SAR test exclusion according to the sum of 1g or 10g SAR.

Band	Exposure Condition /Position		licensed	WLAN		Bluetooth	Summation			
				2.4 GHz	5 GHz		[①+②]	[①+③]	[①+④]	[①+③+④]
			[①]	[②]	[③]	[④]				
WCDMA II	Next to Mouth (1 g)	Front	1.029	0.023	0.000	0.067	1.052	1.029	1.096	1.096
	Extremity (10 g)	Rear	1.379	0.204	0.099	0.223	1.583	1.478	1.602	1.701
WCDMA IV	Next to Mouth (1 g)	Front	0.762	0.023	0.000	0.067	0.785	0.762	0.829	0.829
	Extremity (10 g)	Rear	2.299	0.204	0.099	0.223	2.503	2.398	2.522	2.621
WCDMA V	Next to Mouth (1 g)	Front	0.025	0.023	0.000	0.067	0.048	0.025	0.092	0.092
	Extremity (10 g)	Rear	0.319	0.204	0.099	0.223	0.523	0.418	0.542	0.641
LTE Band 5	Next to Mouth (1 g)	Front	0.026	0.023	0.000	0.067	0.049	0.026	0.093	0.093
	Extremity (10 g)	Rear	0.303	0.204	0.099	0.223	0.507	0.402	0.526	0.625
LTE Band 7	Next to Mouth (1 g)	Front	0.182	0.023	0.000	0.067	0.205	0.182	0.249	0.249
	Extremity (10 g)	Rear	0.985	0.204	0.099	0.223	1.189	1.084	1.208	1.307
LTE Band 12	Next to Mouth (1 g)	Front	0.007	0.023	0.000	0.067	0.030	0.007	0.074	0.074
	Extremity (10 g)	Rear	0.379	0.204	0.099	0.223	0.583	0.478	0.602	0.701
LTE Band 13	Next to Mouth (1 g)	Front	0.014	0.023	0.000	0.067	0.037	0.014	0.081	0.081
	Extremity (10 g)	Rear	0.256	0.204	0.099	0.223	0.460	0.355	0.479	0.578
LTE Band 25	Next to Mouth (1 g)	Front	1.080	0.023	0.000	0.067	1.103	1.080	1.147	1.147
	Extremity (10 g)	Rear	1.407	0.204	0.099	0.223	1.611	1.506	1.630	1.729
LTE Band 26	Next to Mouth (1 g)	Front	0.023	0.023	0.000	0.067	0.046	0.023	0.090	0.090
	Extremity (10 g)	Rear	0.332	0.204	0.099	0.223	0.536	0.431	0.555	0.654
LTE Band 66	Next to Mouth (1 g)	Front	0.980	0.023	0.000	0.067	1.003	0.980	1.047	1.047
	Extremity (10 g)	Rear	2.851	0.204	0.099	0.223	3.055	2.950	3.074	3.173
LTE Band 71	Next to Mouth (1 g)	Front	0.004	0.023	0.000	0.067	0.027	0.004	0.071	0.071
	Extremity (10 g)	Rear	0.292	0.204	0.099	0.223	0.496	0.391	0.515	0.614

Notes

- Simultaneous transmission SAR test exclusion considerations
Simultaneous transmission SAR test exclusion is determined for each operating configuration and exposure condition according to the reported standalone SAR of each applicable simultaneously transmitting antenna. When the sum of 1-g or 10-g SAR of all simultaneously transmitting antennas in an operating mode and exposure condition combination is within the SAR limit, SAR test exclusion applies to that simultaneous transmission configuration. Per KDB Publication 447498 D04v01.
- When the sum of SAR1g or SAR10g of all simultaneously transmitting antennas in an operating mode and exposure condition combination is within the SAR limit (SAR1g 1.6 W/kg / SAR10g 4.0 W/kg), the SPLSR procedures is not required. When the sum of SAR1g or SAR10g is greater than the SAR limit (SAR1g 1.6 W/kg / SAR10g 4.0 W/kg), SAR test exclusion is determined by the SPLSR.

13. SAR Measurement Variability

Per FCC KDB Publication 865664 D01v01r04, SAR measurement variability was assessed for each frequency band, which was determined by the SAR probe calibration point and tissue-equivalent medium used for the device measurements. When both head and body tissue-equivalent media were required for SAR measurements in a frequency band, the variability measurement procedures were applied to the tissue medium with the highest measured SAR, using the highest measured SAR configuration for that tissue-equivalent medium. These additional measurements were repeated after the completion of all measurements requiring the same head or body tissue equivalent medium in a frequency band. The test device was returned to ambient conditions (normal room temperature) with the battery fully charged before it was re-mounted on the device holder for the repeated measurement(s) to minimize any unexpected variations in the repeated results.

SAR Measurement Variability was assessed using the following procedures for each frequency band:

- 1) Repeated measurements are not required when the original highest measured SAR is < 0.80 W/kg.
- 2) **When the original highest measured SAR is ≥ 0.80 W/kg, the measurement was repeated once.**
- 3) A second repeated measurement was performed only if the ratio of largest to smallest SAR for the original and first repeated measurements was > 1.20 or when the original or repeated measurement was ≥ 1.45 W/kg (~ 10% from the 1-g SAR limit).
- 4) A third repeated measurement was performed only if the original, first or second repeated measurement was ≥ 1.5 W/kg and the ratio of largest to smallest SAR for the original, first and second repeated measurements is > 1.20.

Exposure Condition	Band	Mode	Frequency (MHz)	EUT Position	Separation Distance (mm)	Measured 1 g SAR (W/kg)	Repeated Measured 1 g SAR (W/kg)	Ratio
Next to Mouth	WCDMA II	RMC	1 852.4	Front	10	0.878	0.765	1.15
	LTE Band 25	QPSK 20 MHz 1RB 0offset	1 882.5	Front	10	0.873	0.808	1.08
	LTE Band 66	QPSK 20 MHz 1RB 0offset	1 770.0	Front	10	0.811	0.800	1.01

Exposure Condition	Band	Mode	Frequency (MHz)	EUT Position	Separation Distance (mm)	Measured 10 g SAR (W/kg)	Repeated Measured 10 g SAR (W/kg)	Ratio
Extremity	WCDMA IV	RMC	1 752.6	Rear	0	2.020	1.990	1.02
	LTE Band 66	QPSK 20 MHz 1RB 0offset	1 770.0	Rear	0	2.360	2.180	1.08

14. Measurement Uncertainty

Per KDB 865664 D01 SAR measurement 100MHz to 6GHz, when the highest measured 1-g SAR within a frequency band is < 1.5 W/kg and the measured 10-g SAR within a frequency band is < 3.75 W/kg. The expanded SAR measurement uncertainty must be $\leq 30\%$, for a confidence interval of $k = 2$. If these conditions are met, extensive SAR measurement uncertainty analysis described in IEEE Standard 1528-2013 is not required in SAR reports submitted for equipment approval. For this device, the highest measured 1-g SAR is less 1.5W/kg and highest measured 10-g SAR is less 3.75W/kg. Therefore, the measurement uncertainty table is not required in this report.



15. Test Equipment Information

Test Platform	SPEAG DASY5 System			
Version	DASY52: 52.10.4.1535 / SEMCAD: 14.6.14 (7501)			
Location	Eurofins KCTL Co.,Ltd. 65, Sinwon-ro, Yeongtong-gu, Suwon-si, Gyeonggi-do, Korea			
Manufacture	SPEAG			
Hardware Reference				
Equipment	Model	Serial Number	Date of Calibration	Due date of next Calibration
Shield Room	-	8F - 1	-	-
	-	8F - 2	-	-
DASY5 Robot	TX90XL speag	F07/554JA1/A/01	-	-
	TX90XL speag	F12/5L7FA1/A/01	-	-
Phantom	Twin SAM Phantom	1724	-	-
	Twin SAM Phantom	1728	-	-
Mounting Device	Mounting Device	-	-	-
DAE	DAE4	1567	2023-03-22	2024-03-22
	DAE4	1586	2022-04-29	2023-04-29
	DAE4	1587	2022-07-20	2023-07-20
Probe	EX3DV4	3865	2023-01-22	2024-01-22
	EX3DV4	7753	2022-11-01	2023-11-01
ESG Vector Signal Generator	E4438C	MY42080845	2023-02-09	2024-02-09
Dual Power Meter	E4419B	GB40202503	2022-11-21	2023-11-21
Power Sensor	E9301A	US39210857	2022-11-21	2023-11-21
	E9301A	US39212236	2022-11-21	2023-11-21
Attenuator	PE7005-10	2228-1	2022-12-15	2023-12-15
	PE7005-10	2228-2	2022-12-15	2023-12-15
	PE7005-10	2228-3	2022-12-15	2023-12-15
Dual Directional Coupler	778D	16059	2023-02-09	2024-02-09
	772D	2839A00719	2023-02-09	2024-02-09
Power Amplifier	GRF5039	1062	2023-02-09	2024-02-09
	2055-BBS3Q7E9I	1005D/C0521	2023-02-09	2024-02-09
	5190FE	1012	2023-02-09	2024-02-09
Low Pass Filter	NLP-1000+	VUU86701432	2023-02-09	2024-02-09
	LA-15N	36543	2023-02-09	2024-02-09
	LA-30N	40058	2023-02-09	2024-02-09
	Low Pass Filter	LA-60N	2023-02-09	2024-02-09
Dipole Validation Kits	D750V3	1183	2022-09-21	2024-09-21
	D850V2	1006	2022-04-26	2024-04-26
	D1750V2	1072	2022-04-27	2024-04-27
	D1900V2	5d160	2022-04-29	2024-04-29
	D2450V2	895	2022-07-15	2024-07-15
	D2600V2	1050	2022-07-15	2024-07-15
	D5GHzV2	1293	2023-01-25	2025-01-25
Network Analyzer	E5071B	MY42403524	2023-02-09	2024-02-09
Dielectric Assessment Kit	DAK-3.5	1078	2022-05-30	2023-05-30
Humidity/Temp	MHB-382SD	25737	2022-05-04	2023-05-04
	MHB-382SD	46301	2023-02-14	2024-02-14
	MHB-382SD	73871	2022-05-04	2023-05-04
Wideband Radio Communication Tester	CMW500	168683	2023-02-09	2024-02-09
Spectrum Analyzer	FSP7	100289	2022-12-08	2023-12-08

16. Test System Verification Results

Date: 2023-04-14

Test Laboratory: Eurofins KCTL Co.,Ltd.

File Name: [750 MHz Verification Input Power 250 mW 2023-04-14.da52:0](#)

DUT: Dipole 750 MHz D750V3, Type: D750V3, Serial: D750V3 - SN:1183

Communication System: UID 0, CW (0); Frequency: 750 MHz; Duty Cycle: 1:1
 Medium parameters used: $f = 750$ MHz; $\sigma = 0.89$ S/m; $\epsilon_r = 43.124$; $\rho = 1000$ kg/m³
 Phantom section: Flat Section

DASY5 Configuration:

- Probe: EX3DV4 - SN3865;ConvF(9.39, 10.15, 9.66) @ 750 MHz; Calibrated: 2023-01-22
- Sensor-Surface: 1.4mm (Mechanical Surface Detection)
- Electronics: DAE4 Sn1587; Calibrated: 2022-07-20
- Phantom: Twin-SAM V5.0; Type: QD 000 P40 CD; Serial: 1724
- Measurement SW: DASY52, Version 52.10 (4);

Configuration/750 MHz Verification Input Power 250 mW 2023-04-14/Area Scan (7x13x1):

Measurement grid: dx=15mm, dy=15mm
 Maximum value of SAR (measured) = 2.75 W/kg

Configuration/750 MHz Verification Input Power 250 mW 2023-04-14/Zoom Scan (5x5x7)/Cube 0:

Measurement grid: dx=8mm, dy=8mm, dz=5mm
 Reference Value = 58.23 V/m; Power Drift = 0.02 dB
 Peak SAR (extrapolated) = 3.12 W/kg
SAR(1 g) = 2.07 W/kg; SAR(10 g) = 1.36 W/kg

Maximum value of SAR (measured) = 2.77 W/kg

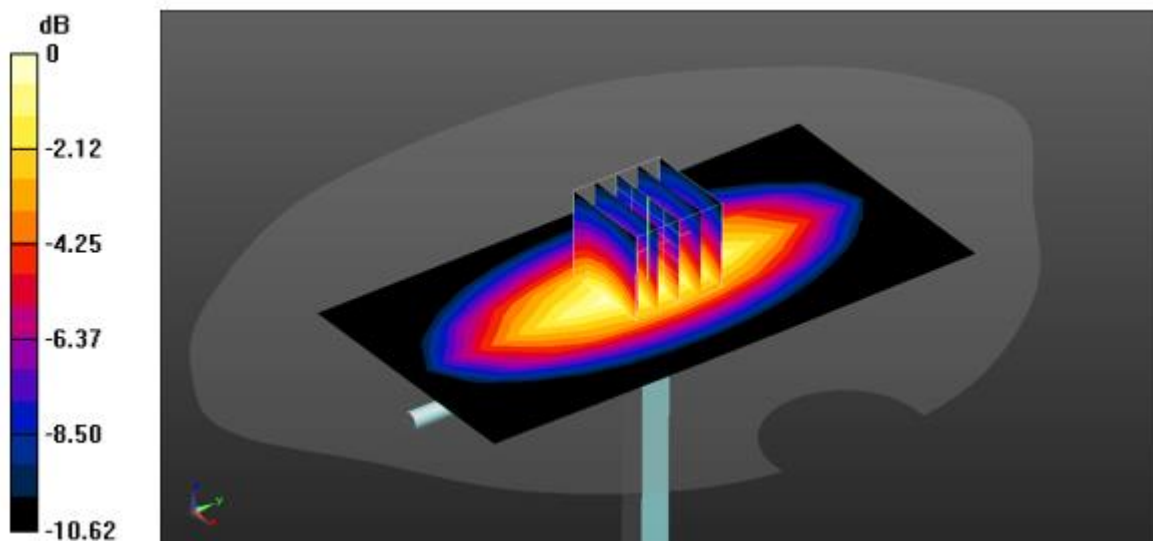

0 dB = 2.77 W/kg = 4.42 dBW/kg

Date: 2023-04-18

Test Laboratory: Eurofins KCTL Co.,Ltd.

File Name: [850 MHz Verification Input Power 250 mW 2023-04-18.da52:0](#)

DUT: Dipole 850 MHz D850V2, Type: D850V2, Serial: D850V2 - SN:1006

Communication System: UID 0, CW (0); Frequency: 850 MHz; Duty Cycle: 1:1
 Medium parameters used: $f = 850$ MHz; $\sigma = 0.917$ S/m; $\epsilon_r = 40.706$; $\rho = 1000$ kg/m³
 Phantom section: Flat Section

DASY5 Configuration:

- Probe: EX3DV4 - SN3865;ConvF(9.24, 9.5, 9.66) @ 850 MHz; Calibrated: 2023-01-22
- Sensor-Surface: 1.4mm (Mechanical Surface Detection)
- Electronics: DAE4 Sn1587; Calibrated: 2022-07-20
- Phantom: Twin-SAM V5.0; Type: QD 000 P40 CD; Serial: 1724
- Measurement SW: DASY52, Version 52.10 (4);

Configuration/850 MHz Verification Input Power 250 mW 2023-04-18/Area Scan (7x13x1):

Measurement grid: dx=15mm, dy=15mm
 Maximum value of SAR (measured) = 3.47 W/kg

Configuration/850 MHz Verification Input Power 250 mW 2023-04-18/Zoom Scan (5x5x7)/Cube 0:

Measurement grid: dx=8mm, dy=8mm, dz=5mm
 Reference Value = 64.95 V/m; Power Drift = -0.02 dB
 Peak SAR (extrapolated) = 3.97 W/kg
SAR(1 g) = 2.59 W/kg; SAR(10 g) = 1.69 W/kg

Maximum value of SAR (measured) = 3.48 W/kg

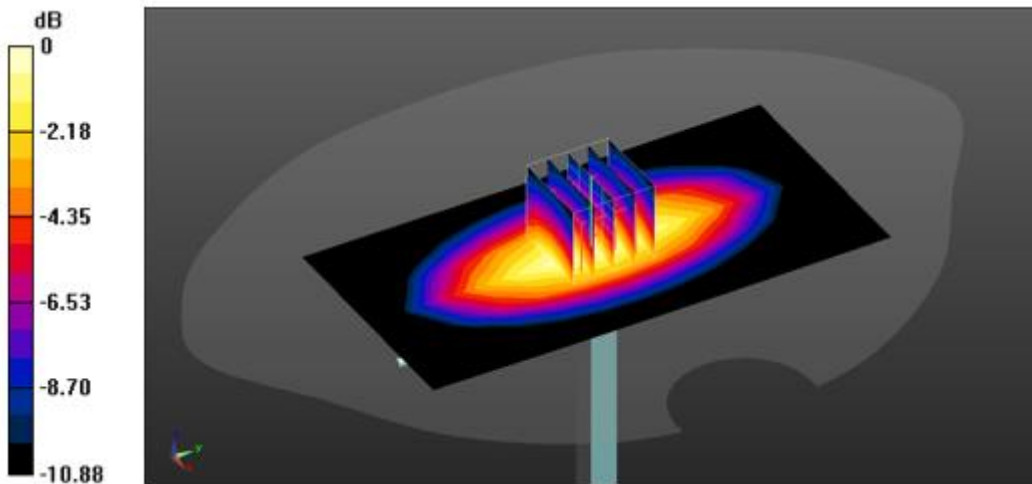

0 dB = 3.48 W/kg = 5.42 dBW/kg

Date: 2023-04-17

Test Laboratory: Eurofins KCTL Co.,Ltd.

File Name: [1750 MHz Verification Input Power 250 mW 2023-04-17.da52:0](#)

DUT: Dipole 1750 MHz D1750V2, Type: D1750V2, Serial: D1750V2 - SN:1072

Communication System: UID 0, CW (0); Frequency: 1750 MHz; Duty Cycle: 1:1
 Medium parameters used: $f = 1750$ MHz; $\sigma = 1.362$ S/m; $\epsilon_r = 40.586$; $\rho = 1000$ kg/m³
 Phantom section: Flat Section

DASY5 Configuration:

- Probe: EX3DV4 - SN3865;ConvF(8.38, 8.84, 8.67) @ 1750 MHz; Calibrated: 2023-01-22
- Sensor-Surface: 1.4mm (Mechanical Surface Detection)
- Electronics: DAE4 Sn1587; Calibrated: 2022-07-20
- Phantom: Twin-SAM V5.0; Type: QD 000 P40 CD; Serial: 1724
- Measurement SW: DASY52, Version 52.10 (4);

Configuration/1750 MHz Verification Input Power 250 mW 2023-04-17/Area Scan (8x10x1):

Measurement grid: dx=15mm, dy=15mm
 Maximum value of SAR (measured) = 13.6 W/kg

Configuration/1750 MHz Verification Input Power 250 mW 2023-04-17/Zoom Scan (5x5x7)/Cube 0:

Measurement grid: dx=8mm, dy=8mm, dz=5mm
 Reference Value = 92.25 V/m; Power Drift = 0.19 dB
 Peak SAR (extrapolated) = 16.5 W/kg
SAR(1 g) = 9.13 W/kg; SAR(10 g) = 4.88 W/kg

Maximum value of SAR (measured) = 13.9 W/kg

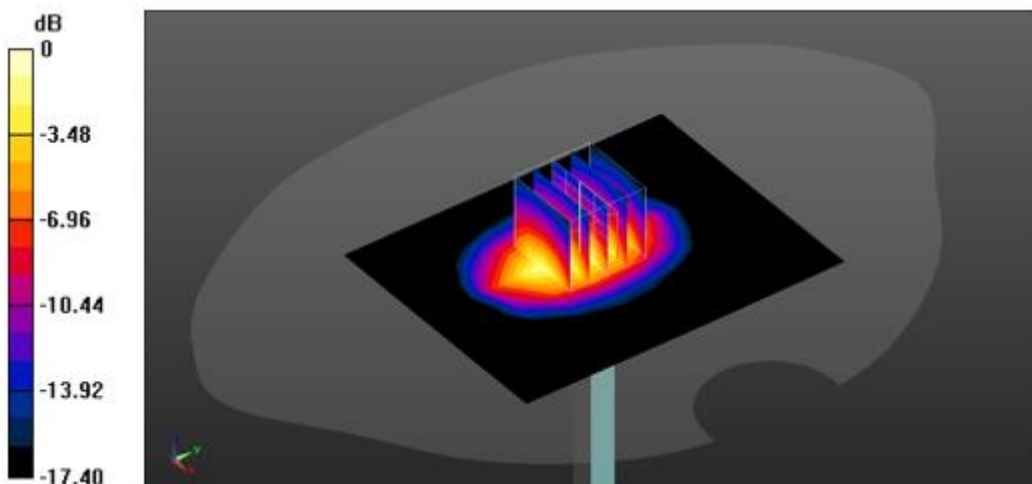

0 dB = 13.9 W/kg = 11.43 dBW/kg

Date: 2023-04-13

Test Laboratory: Eurofins KCTL Co.,Ltd.

File Name: [1900 MHz Verification Input Power 250 mW 2023-04-13.da52:0](#)

DUT: Dipole 1900 MHz D1900V2, Type: D1900V2, Serial: D1900V2 - SN:5d160

Communication System: UID 0, CW (0); Frequency: 1900 MHz; Duty Cycle: 1:1
 Medium parameters used: $f = 1900$ MHz; $\sigma = 1.412$ S/m; $\epsilon_r = 38.526$; $\rho = 1000$ kg/m³
 Phantom section: Flat Section

DASY5 Configuration:

- Probe: EX3DV4 - SN3865;ConvF(8.28, 8.79, 8.53) @ 1900 MHz; Calibrated: 2023-01-22
- Sensor-Surface: 1.4mm (Mechanical Surface Detection)
- Electronics: DAE4 Sn1587; Calibrated: 2022-07-20
- Phantom: Twin-SAM V5.0; Type: QD 000 P40 CD; Serial: 1724
- Measurement SW: DASY52, Version 52.10 (4);

Configuration/1900 MHz Verification Input Power 250 mW 2023-04-13/Area Scan (8x11x1):

Measurement grid: dx=15mm, dy=15mm
 Maximum value of SAR (measured) = 14.4 W/kg

Configuration/1900 MHz Verification Input Power 250 mW 2023-04-13/Zoom Scan (5x5x7)/Cube 0:

Measurement grid: dx=8mm, dy=8mm, dz=5mm
 Reference Value = 90.61 V/m; Power Drift = -0.10 dB
 Peak SAR (extrapolated) = 17.6 W/kg
SAR(1 g) = 9.59 W/kg; SAR(10 g) = 5 W/kg

Maximum value of SAR (measured) = 14.7 W/kg

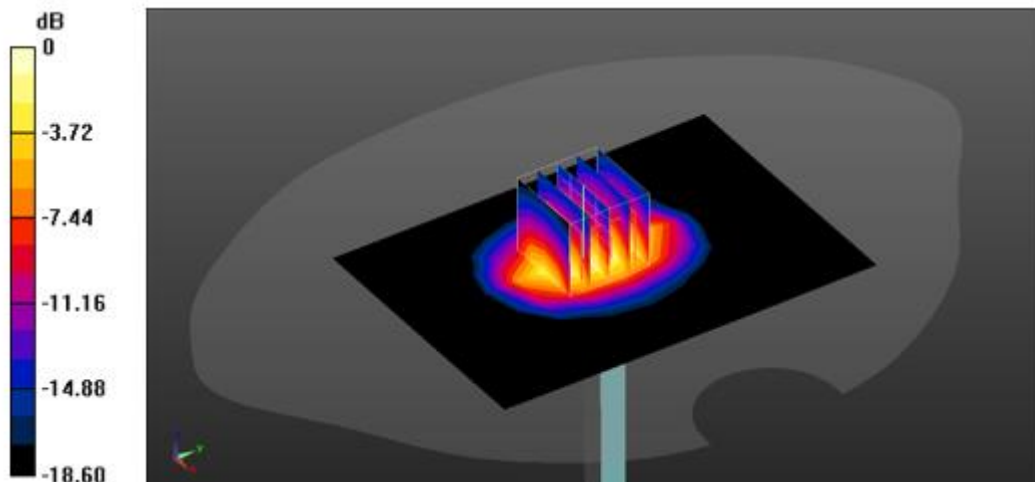

0 dB = 14.7 W/kg = 11.67 dBW/kg

Date: 2023-04-12

Test Laboratory: Eurofins KCTL Co.,Ltd.

File Name: [2450 MHz Verification Input Power 100 mW 2023-04-12.da5.da53:0](#)

DUT: Dipole 2450 MHz D2450V2, Type: D2450V2, Serial: D2450V2 - SN:895

Communication System: UID 0, CW (0); Frequency: 2450 MHz; Duty Cycle: 1:1
 Medium parameters used (interpolated): $f = 2450$ MHz; $\sigma = 1.83$ S/m; $\epsilon_r = 38.768$; $\rho = 1000$ kg/m³
 Phantom section: Flat Section

DASY5 Configuration:

- Probe: EX3DV4 - SN7753;ConvF(7.02, 7.02, 7.02) @ 2450 MHz; Calibrated: 2022-11-01
- Sensor-Surface: 1.4mm (Mechanical Surface Detection)
- Electronics: DAE4 Sn1586; Calibrated: 2022-04-29
- Phantom: Twin-SAM V4.0; Type: QD 000 P40 CC; Serial: 1728
- Measurement SW: DASY52, Version 52.10 (4);

Configuration/2450 MHz Verification Input Power 100 mW 2023-04-12/Area Scan (11x11x1):

Measurement grid: dx=12mm, dy=12mm

[Info: Interpolated medium parameters used for SAR evaluation.](#)

Maximum value of SAR (measured) = 8.76 W/kg

Configuration/2450 MHz Verification Input Power 100 mW 2023-04-12/Zoom Scan (7x7x7)/Cube 0:

Measurement grid: dx=5mm, dy=5mm, dz=5mm

Reference Value = 71.25 V/m; Power Drift = -0.07 dB

Peak SAR (extrapolated) = 11.0 W/kg

SAR(1 g) = 5.27 W/kg; SAR(10 g) = 2.44 W/kg

[Info: Interpolated medium parameters used for SAR evaluation.](#)

Maximum value of SAR (measured) = 8.85 W/kg

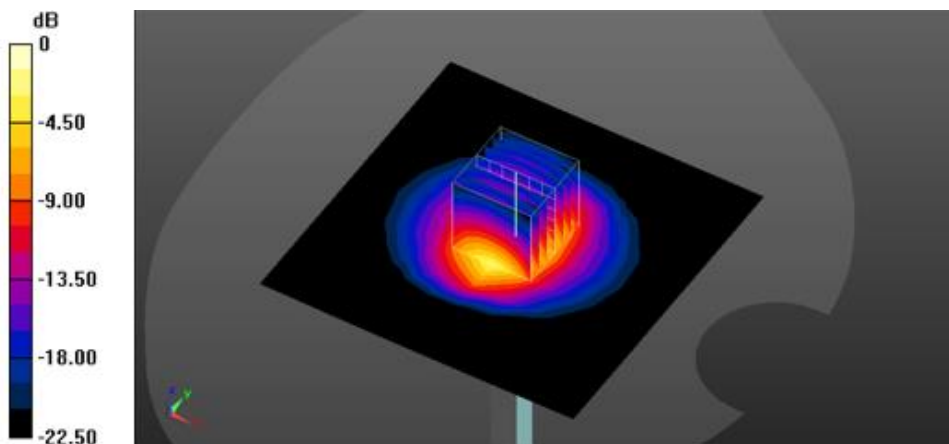

0 dB = 8.85 W/kg = 9.47 dBW/kg

Date: 2023-05-08

Test Laboratory: Eurofins KCTL Co.,Ltd.

File Name: [2450 MHz Verification Input Power 100 mW 2023-05-08.da5.da53:0](#)

DUT: Dipole 2450 MHz D2450V2, Type: D2450V2, Serial: D2450V2 - SN:895

Communication System: UID 0, CW (0); Frequency: 2450 MHz; Duty Cycle: 1:1
 Medium parameters used (interpolated): $f = 2450$ MHz; $\sigma = 1.848$ S/m; $\epsilon_r = 39.144$; $\rho = 1000$ kg/m³
 Phantom section: Flat Section

DASY5 Configuration:

- Probe: EX3DV4 - SN7753;ConvF(7.02, 7.02, 7.02) @ 2450 MHz; Calibrated: 2022-11-01
- Sensor-Surface: 1.4mm (Mechanical Surface Detection)
- Electronics: DAE4 Sn1567; Calibrated: 2023-03-22
- Phantom: Twin-SAM V4.0; Type: QD 000 P40 CC; Serial: 1728
- Measurement SW: DASY52, Version 52.10 (4);

Configuration/2450 MHz Verification Input Power 100 mW 2023-05-08/Area Scan (11x11x1):

Measurement grid: dx=12mm, dy=12mm

[Info: Interpolated medium parameters used for SAR evaluation.](#)

Maximum value of SAR (measured) = 8.40 W/kg

Configuration/2450 MHz Verification Input Power 100 mW 2023-05-08/Zoom Scan (7x7x7)/Cube 0:

Measurement grid: dx=5mm, dy=5mm, dz=5mm

Reference Value = 69.38 V/m; Power Drift = 0.09 dB

Peak SAR (extrapolated) = 10.8 W/kg

SAR(1 g) = 5.17 W/kg; SAR(10 g) = 2.39 W/kg

[Info: Interpolated medium parameters used for SAR evaluation.](#)

Maximum value of SAR (measured) = 8.69 W/kg

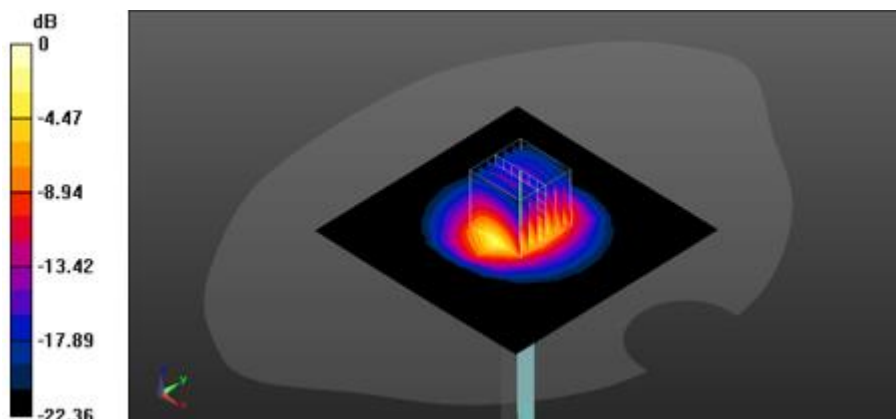

0 dB = 8.69 W/kg = 9.39 dBW/kg

Date: 2023-04-20

Test Laboratory: Eurofins KCTL Co.,Ltd.

File Name: [2600 MHz Verification Input Power 100 mW 2023-04-20.da52:0](#)

DUT: Dipole 2600 MHz D2600V2, Type: D2600V2, Serial: D2600V2 - SN:1050

Communication System: UID 0, CW (0); Frequency: 2600 MHz; Duty Cycle: 1:1
 Medium parameters used: $f = 2600$ MHz; $\sigma = 2.014$ S/m; $\epsilon_r = 38.157$; $\rho = 1000$ kg/m³
 Phantom section: Flat Section

DASY5 Configuration:

- Probe: EX3DV4 - SN3865;ConvF(7.22, 7.64, 7.61) @ 2600 MHz; Calibrated: 2023-01-22
- Sensor-Surface: 1.4mm (Mechanical Surface Detection)
- Electronics: DAE4 Sn1587; Calibrated: 2022-07-20
- Phantom: Twin-SAM V5.0; Type: QD 000 P40 CD; Serial: 1724
- Measurement SW: DASY52, Version 52.10 (4);

Configuration/2600 MHz Verification Input Power 100 mW 2023-04-20/Area Scan (11x16x1):

Measurement grid: dx=12mm, dy=12mm
 Maximum value of SAR (measured) = 8.02 W/kg

Configuration/2600 MHz Verification Input Power 100 mW 2023-04-20/Zoom Scan (7x7x7)/Cube 0:

Measurement grid: dx=5mm, dy=5mm, dz=5mm
 Reference Value = 71.43 V/m; Power Drift = 0.07 dB
 Peak SAR (extrapolated) = 11.7 W/kg
SAR(1 g) = 5.54 W/kg; SAR(10 g) = 2.49 W/kg

Maximum value of SAR (measured) = 9.45 W/kg

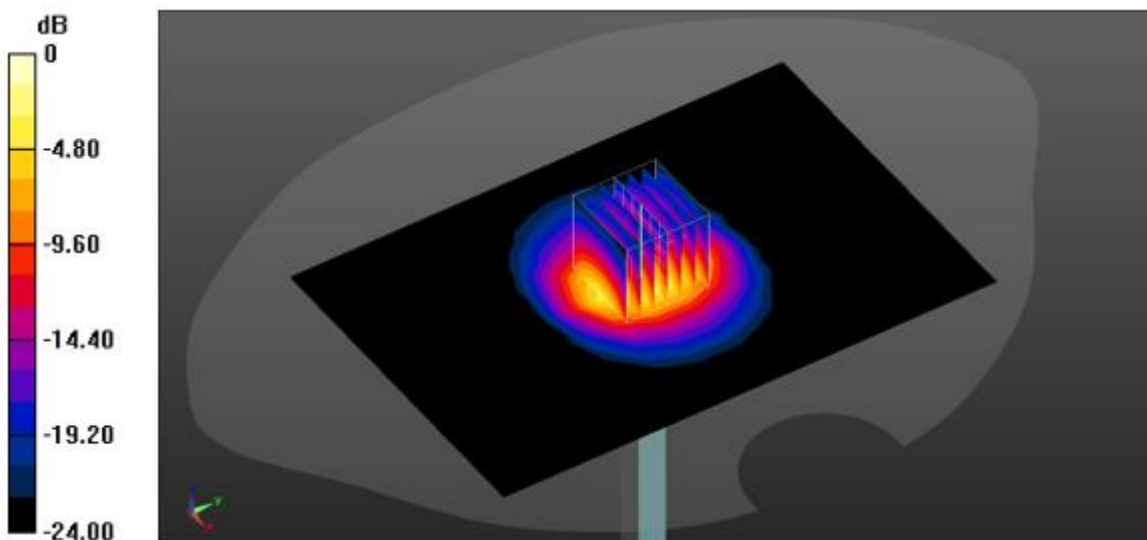

0 dB = 9.45 W/kg = 9.75 dBW/kg

Date: 2023-04-15

Test Laboratory: Eurofins KCTL Co.,Ltd.

File Name: [5250 MHz Verification Input Power 100 mW 2023-04-15.da5:0](#)

DUT: Dipole D5GHzV2, Type: D5GHzV2, Serial: D5GHzV2 - SN:1293

Communication System: UID 0, CW (0); Frequency: 5250 MHz; Duty Cycle: 1:1
 Medium parameters used (interpolated): $f = 5250$ MHz; $\sigma = 4.727$ S/m; $\epsilon_r = 36.129$; $\rho = 1000$ kg/m³
 Phantom section: Flat Section

DASY5 Configuration:

- Probe: EX3DV4 - SN7753;ConvF(4.92, 4.92, 4.92) @ 5250 MHz; Calibrated: 2022-11-01
- Sensor-Surface: 1.4mm (Mechanical Surface Detection)
- Electronics: DAE4 Sn1586; Calibrated: 2022-04-29
- Phantom: Twin-SAM V4.0; Type: QD 000 P40 CC; Serial: 1728
- Measurement SW: DASY52, Version 52.10 (4);

Configuration/5250 MHz Verification Input Power 100 mW 2023-04-15/Area Scan (11x11x1):

Measurement grid: dx=10mm, dy=10mm

[Info: Interpolated medium parameters used for SAR evaluation.](#)

Maximum value of SAR (measured) = 15.9 W/kg

Configuration/5250 MHz Verification Input Power 100 mW 2023-04-15/Zoom Scan (8x8x7)/Cube 0:

Measurement grid: dx=4mm, dy=4mm, dz=1.4mm

Reference Value = 63.69 V/m; Power Drift = 0.13 dB

Peak SAR (extrapolated) = 30.4 W/kg

SAR(1 g) = 7.9 W/kg; SAR(10 g) = 2.31 W/kg

[Info: Interpolated medium parameters used for SAR evaluation.](#)

Maximum value of SAR (measured) = 19.6 W/kg

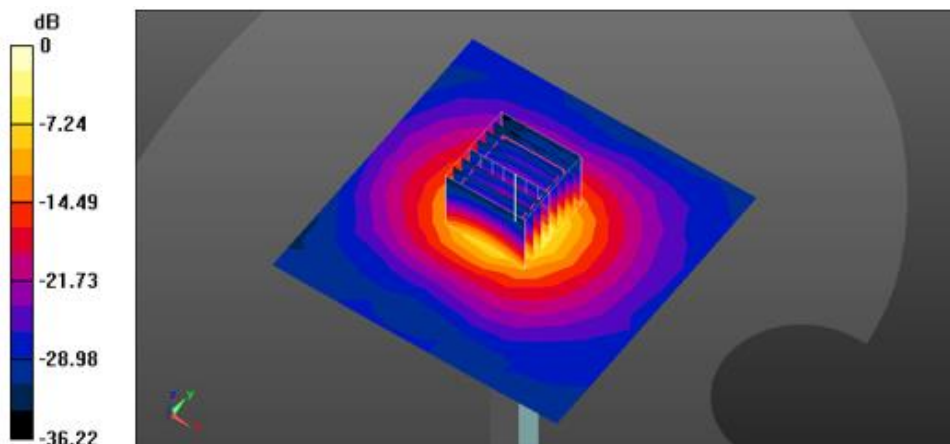

0 dB = 19.6 W/kg = 12.92 dBW/kg

Date: 2023-04-15

Test Laboratory: Eurofins KCTL Co.,Ltd.

File Name: [5600 MHz Verification Input Power 100 mW 2023-04-15.da5:0](#)

DUT: Dipole D5GHzV2, Type: D5GHzV2, Serial: D5GHzV2 - SN:1293

Communication System: UID 0, CW (0); Frequency: 5600 MHz; Duty Cycle: 1:1
Medium parameters used: $f = 5600$ MHz; $\sigma = 5.139$ S/m; $\epsilon_r = 35.357$; $\rho = 1000$ kg/m³
Phantom section: Flat Section

DASY5 Configuration:

- Probe: EX3DV4 - SN7753;ConvF(4.36, 4.36, 4.36) @ 5600 MHz; Calibrated: 2022-11-01
- Sensor-Surface: 1.4mm (Mechanical Surface Detection)
- Electronics: DAE4 Sn1586; Calibrated: 2022-04-29
- Phantom: Twin-SAM V4.0; Type: QD 000 P40 CC; Serial: 1728
- Measurement SW: DASY52, Version 52.10 (4);

Configuration/5600 MHz Verification Input Power 100 mW 2023-04-15/Area Scan (11x11x1):

Measurement grid: dx=10mm, dy=10mm
Maximum value of SAR (measured) = 18.6 W/kg

Configuration/5600 MHz Verification Input Power 100 mW 2023-04-15/Zoom Scan (8x8x7)/Cube 0:

Measurement grid: dx=4mm, dy=4mm, dz=1.4mm
Reference Value = 65.58 V/m; Power Drift = 0.05 dB
Peak SAR (extrapolated) = 31.3 W/kg
SAR(1 g) = 8.14 W/kg; SAR(10 g) = 2.39 W/kg

Maximum value of SAR (measured) = 20.2 W/kg

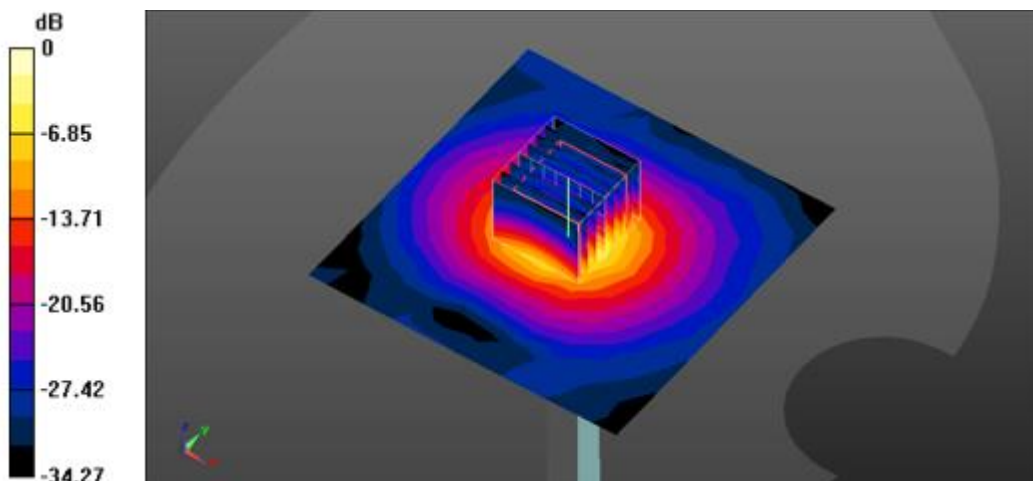

0 dB = 20.2 W/kg = 13.05 dBW/kg

Date: 2023-04-15

Test Laboratory: Eurofins KCTL Co.,Ltd.

File Name: [5800 MHz Verification Input Power 100 mW 2023-04-15.da5:0](#)

DUT: Dipole D5GHzV2, Type: D5GHzV2, Serial: D5GHzV2 - SN:1293

Communication System: UID 0, CW (0); Frequency: 5800 MHz; Duty Cycle: 1:1
 Medium parameters used: $f = 5800$ MHz; $\sigma = 5.363$ S/m; $\epsilon_r = 34.959$; $\rho = 1000$ kg/m³
 Phantom section: Flat Section

DASY5 Configuration:

- Probe: EX3DV4 - SN7753;ConvF(4.4, 4.4, 4.4) @ 5800 MHz; Calibrated: 2022-11-01
- Sensor-Surface: 1.4mm (Mechanical Surface Detection)
- Electronics: DAE4 Sn1586; Calibrated: 2022-04-29
- Phantom: Twin-SAM V4.0; Type: QD 000 P40 CC; Serial: 1728
- Measurement SW: DASY52, Version 52.10 (4);

Configuration/5800 MHz Verification Input Power 100 mW 2023-04-15/Area Scan (11x11x1):

Measurement grid: dx=10mm, dy=10mm
 Maximum value of SAR (measured) = 17.1 W/kg

Configuration/5800 MHz Verification Input Power 100 mW 2023-04-15/Zoom Scan (8x8x7)/Cube 0:

Measurement grid: dx=4mm, dy=4mm, dz=1.4mm
 Reference Value = 62.92 V/m; Power Drift = 0.03 dB
 Peak SAR (extrapolated) = 29.7 W/kg
SAR(1 g) = 7.6 W/kg; SAR(10 g) = 2.22 W/kg

Maximum value of SAR (measured) = 19.0 W/kg

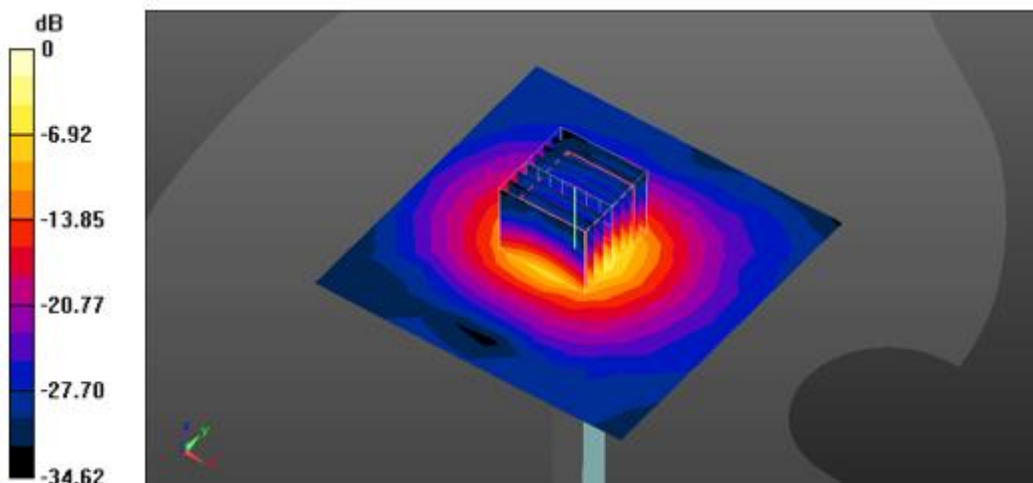

0 dB = 19.0 W/kg = 12.79 dBW/kg

17. Test Results

1)

Date: 2023-04-13

Test Laboratory: Eurofins KCTL Co.,Ltd.

File Name: [1. WCDMA Band II.da53:0](#)

DUT: SM-R935U, Type: Smart Wearable, Serial: R3AW3004RML

Communication System: UID 0, W-CDMA 1900 (Band 2) (0); Frequency: 1852.4 MHz; Duty Cycle: 1:1
 Medium parameters used: $f = 1852.4$ MHz; $\sigma = 1.379$ S/m; $\epsilon_r = 38.635$; $\rho = 1000$ kg/m³
 Phantom section: Flat Section

DASY5 Configuration:

- Probe: EX3DV4 - SN3865;ConvF(8.28, 8.79, 8.53) @ 1852.4 MHz; Calibrated: 2023-01-22
- Sensor-Surface: 1.4mm (Mechanical Surface Detection)
- Electronics: DAE4 Sn1587; Calibrated: 2022-07-20
- Phantom: Twin-SAM V5.0; Type: QD 000 P40 CD; Serial: 1724
- Measurement SW: DASY52, Version 52.10 (4);

Next to Mouth/WCDMA II _CH9262_Front_10 mm/Area Scan (6x7x1): Measurement grid: dx=15mm, dy=15mm

Maximum value of SAR (measured) = 1.05 W/kg

Next to Mouth/WCDMA II _CH9262_Front_10 mm/Zoom Scan (5x5x7)/Cube 0: Measurement grid: dx=8mm, dy=8mm, dz=5mm

Reference Value = 30.44 V/m; Power Drift = -0.02 dB

Peak SAR (extrapolated) = 1.33 W/kg

SAR(1 g) = 0.878 W/kg; SAR(10 g) = 0.475 W/kg

Maximum value of SAR (measured) = 1.18 W/kg

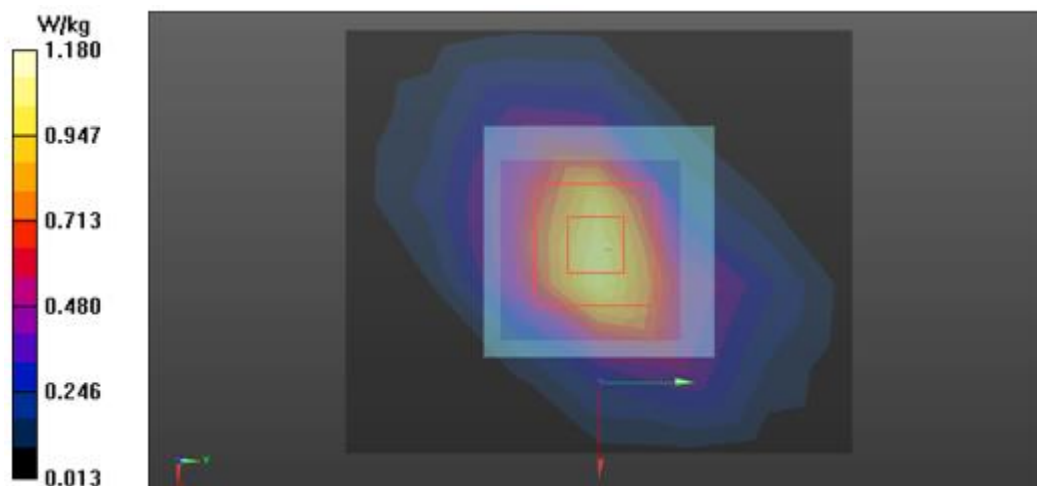

2)

Date: 2023-04-13

Test Laboratory: Eurofins KCTL Co.,Ltd.

File Name: [1. WCDMA Band II.da53:1](#)

DUT: SM-R935U, Type: Smart Wearable, Serial: R3AW3004TER

Communication System: UID 0, W-CDMA 1900 (Band 2) (0); Frequency: 1880 MHz; Duty Cycle: 1:1
 Medium parameters used: $f = 1880$ MHz; $\sigma = 1.398$ S/m; $\epsilon_r = 38.565$; $\rho = 1000$ kg/m³
 Phantom section: Flat Section

DASY5 Configuration:

- Probe: EX3DV4 - SN3865;ConvF(8.28, 8.79, 8.53) @ 1880 MHz; Calibrated: 2023-01-22
- Sensor-Surface: 1.4mm (Mechanical Surface Detection)
- Electronics: DAE4 Sn1587; Calibrated: 2022-07-20
- Phantom: Twin-SAM V5.0; Type: QD 000 P40 CD; Serial: 1724
- Measurement SW: DASY52, Version 52.10 (4);

Extremity/WCDMA II _CH9400_Rear_0mm/Area Scan (6x7x1): Measurement grid: dx=15mm, dy=15mm
 Maximum value of SAR (measured) = 2.76 W/kg

Extremity/WCDMA II _CH9400_Rear_0mm/Zoom Scan (6x6x7)/Cube 0: Measurement grid: dx=8mm, dy=8mm, dz=5mm
 Reference Value = 38.65 V/m; Power Drift = 0.00 dB
 Peak SAR (extrapolated) = 3.99 W/kg
SAR(1 g) = 2.32 W/kg; SAR(10 g) = 1.15 W/kg

Maximum value of SAR (measured) = 3.22 W/kg

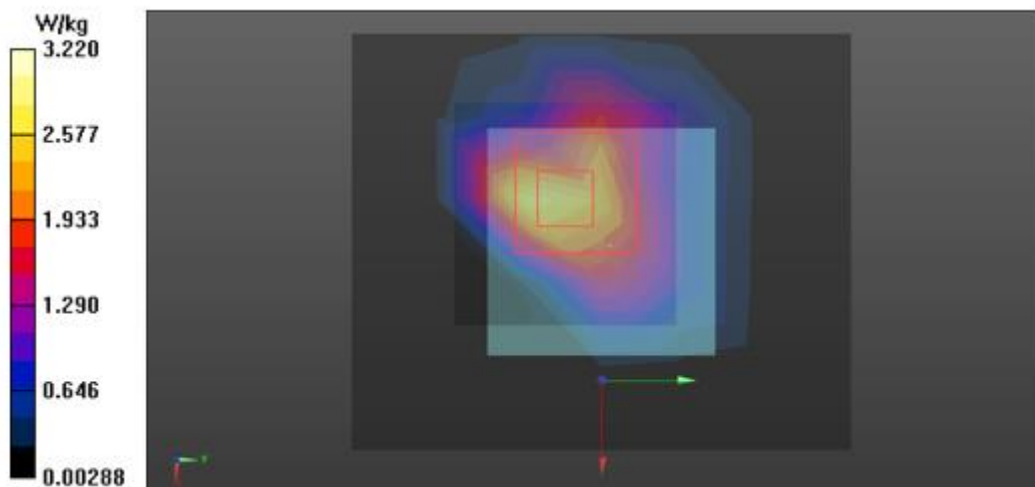

3)

Date: 2023-04-17

Test Laboratory: Eurofins KCTL Co.,Ltd.

File Name: [1. WCDMA Band IV.da53:0](#)

DUT: SM-R935U, Type: Smart Wearable, Serial: R3AW3004X8X

Communication System: UID 0, W-CDMA 1700 (Band4) (0); Frequency: 1732.4 MHz; Duty Cycle: 1:1
Medium parameters used: $f = 1732.4$ MHz; $\sigma = 1.353$ S/m; $\epsilon_r = 40.629$; $\rho = 1000$ kg/m³
Phantom section: Flat Section

DASY5 Configuration:

- Probe: EX3DV4 - SN3865;ConvF(8.38, 8.84, 8.67) @ 1732.4 MHz; Calibrated: 2023-01-22
- Sensor-Surface: 1.4mm (Mechanical Surface Detection)
- Electronics: DAE4 Sn1587; Calibrated: 2022-07-20
- Phantom: Twin-SAM V5.0; Type: QD 000 P40 CD; Serial: 1724
- Measurement SW: DASY52, Version 52.10 (4);

Next to Mouth/WCDMA IV _CH1412_Front_10 mm/Area Scan (6x7x1): Measurement grid: dx=15mm, dy=15mm

Maximum value of SAR (measured) = 0.762 W/kg

Next to Mouth/WCDMA IV _CH1412_Front_10 mm/Zoom Scan (5x5x7)/Cube 0: Measurement grid: dx=8mm, dy=8mm, dz=5mm

Reference Value = 24.42 V/m; Power Drift = 0.16 dB

Peak SAR (extrapolated) = 0.988 W/kg

SAR(1 g) = 0.673 W/kg; SAR(10 g) = 0.411 W/kg

Maximum value of SAR (measured) = 0.858 W/kg

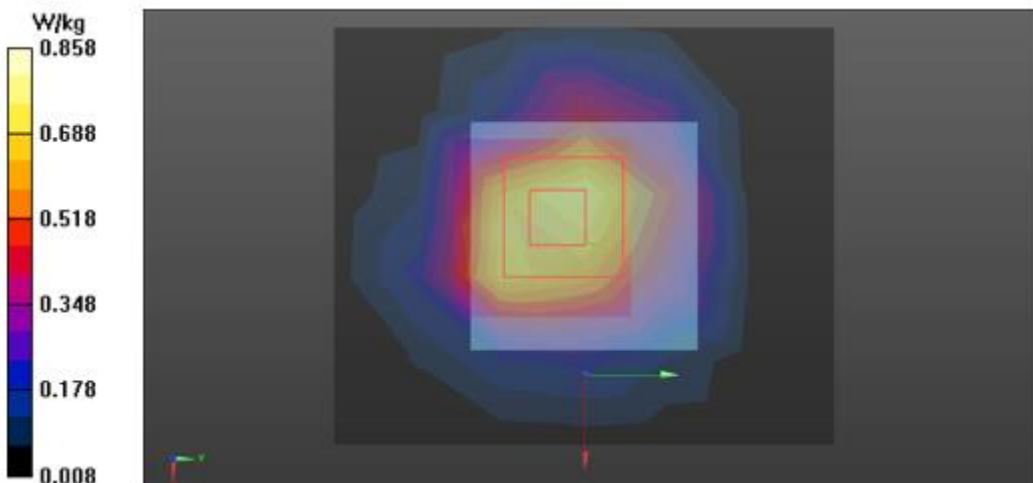

4)

Date: 2023-04-17

Test Laboratory: Eurofins KCTL Co.,Ltd.

File Name: [1. WCDMA Band IV.da53:1](#)

DUT: SM-R935U, Type: Smart Wearable, Serial: R3AW3004RML

Communication System: UID 0, W-CDMA 1700 (Band4) (0); Frequency: 1752.6 MHz; Duty Cycle: 1:1
Medium parameters used: $f = 1752.6$ MHz; $\sigma = 1.362$ S/m; $\epsilon_r = 40.58$; $\rho = 1000$ kg/m³
Phantom section: Flat Section

DASY5 Configuration:

- Probe: EX3DV4 - SN3865;ConvF(8.38, 8.84, 8.67) @ 1752.6 MHz; Calibrated: 2023-01-22
- Sensor-Surface: 1.4mm (Mechanical Surface Detection)
- Electronics: DAE4 Sn1587; Calibrated: 2022-07-20
- Phantom: Twin-SAM V5.0; Type: QD 000 P40 CD; Serial: 1724
- Measurement SW: DASY52, Version 52.10 (4);

Extremity/WCDMA IV _CH1513_Rear_0mm/Area Scan (6x7x1): Measurement grid: dx=15mm, dy=15mm
Maximum value of SAR (measured) = 4.84 W/kg

Extremity/WCDMA IV _CH1513_Rear_0mm/Zoom Scan (5x5x7)/Cube 0: Measurement grid: dx=8mm, dy=8mm, dz=5mm
Reference Value = 52.86 V/m; Power Drift = 0.18 dB
Peak SAR (extrapolated) = 6.81 W/kg
SAR(1 g) = 4.18 W/kg; SAR(10 g) = 2.02 W/kg

Maximum value of SAR (measured) = 5.60 W/kg

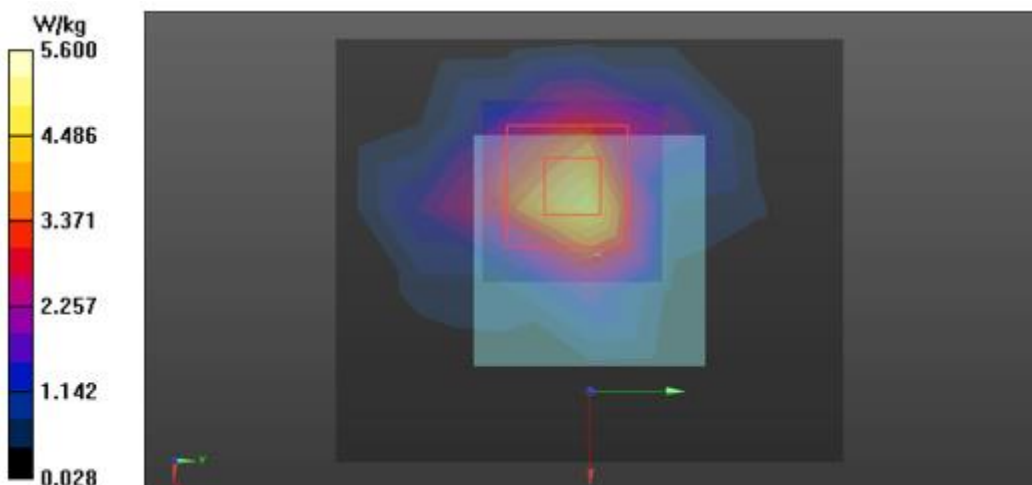

5)

Date: 2023-04-18

Test Laboratory: Eurofins KCTL Co.,Ltd.

File Name: [1. WCDMA Band V.da53:0](#)

DUT: SM-R935U, Type: Smart Wearable, Serial: R3AW3004RXN

Communication System: UID 0, W-CDMA 850 (Band 5) (0); Frequency: 836.6 MHz; Duty Cycle: 1:1
Medium parameters used: $f = 836.6$ MHz; $\sigma = 0.914$ S/m; $\epsilon_r = 40.732$; $\rho = 1000$ kg/m³
Phantom section: Flat Section

DASY5 Configuration:

- Probe: EX3DV4 - SN3865;ConvF(9.24, 9.5, 9.66) @ 836.6 MHz; Calibrated: 2023-01-22
- Sensor-Surface: 1.4mm (Mechanical Surface Detection)
- Electronics: DAE4 Sn1587; Calibrated: 2022-07-20
- Phantom: Twin-SAM V5.0; Type: QD 000 P40 CD; Serial: 1724
- Measurement SW: DASY52, Version 52.10 (4);

Next to Mouth/WCDMA V _CH4183_Front_10 mm/Area Scan (6x7x1): Measurement grid: dx=15mm, dy=15mm

Maximum value of SAR (measured) = 0.0320 W/kg

Next to Mouth/WCDMA V _CH4183_Front_10 mm/Zoom Scan (5x5x7)/Cube 0: Measurement grid: dx=8mm, dy=8mm, dz=5mm

Reference Value = 5.621 V/m; Power Drift = -0.11 dB

Peak SAR (extrapolated) = 0.0530 W/kg

SAR(1 g) = 0.022 W/kg; SAR(10 g) = 0.0085 W/kg

Maximum value of SAR (measured) = 0.0326 W/kg

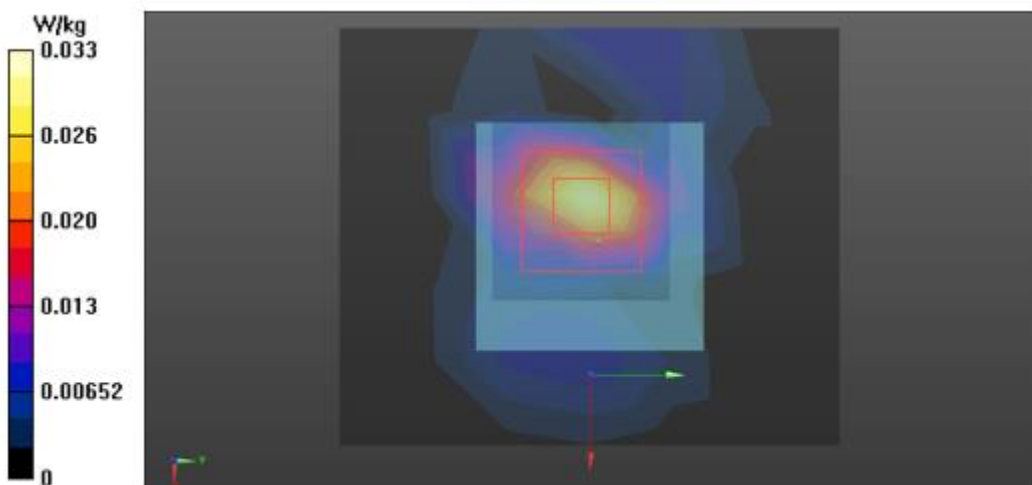

6)

Date: 2023-04-18

Test Laboratory: Eurofins KCTL Co.,Ltd.

File Name: [1. WCDMA Band V.da53:1](#)

DUT: SM-R935U, Type: Smart Wearable, Serial: R3AW3004QGB

Communication System: UID 0, W-CDMA 850 (Band 5) (0); Frequency: 836.6 MHz; Duty Cycle: 1:1
Medium parameters used: $f = 836.6$ MHz; $\sigma = 0.914$ S/m; $\epsilon_r = 40.732$; $\rho = 1000$ kg/m³
Phantom section: Flat Section

DASY5 Configuration:

- Probe: EX3DV4 - SN3865;ConvF(9.24, 9.5, 9.66) @ 836.6 MHz; Calibrated: 2023-01-22
- Sensor-Surface: 1.4mm (Mechanical Surface Detection)
- Electronics: DAE4 Sn1587; Calibrated: 2022-07-20
- Phantom: Twin-SAM V5.0; Type: QD 000 P40 CD; Serial: 1724
- Measurement SW: DASY52, Version 52.10 (4);

Extremity/WCDMA V _CH4183_Rear_0mm/Area Scan (7x8x1): Measurement grid: dx=15mm, dy=15mm
Maximum value of SAR (measured) = 1.05 W/kg

Extremity/WCDMA V _CH4183_Rear_0mm/Zoom Scan (5x5x7)/Cube 0: Measurement grid: dx=8mm, dy=8mm, dz=5mm
Reference Value = 35.73 V/m; Power Drift = 0.05 dB
Peak SAR (extrapolated) = 1.94 W/kg
SAR(1 g) = 0.685 W/kg; SAR(10 g) = 0.278 W/kg

Maximum value of SAR (measured) = 1.21 W/kg

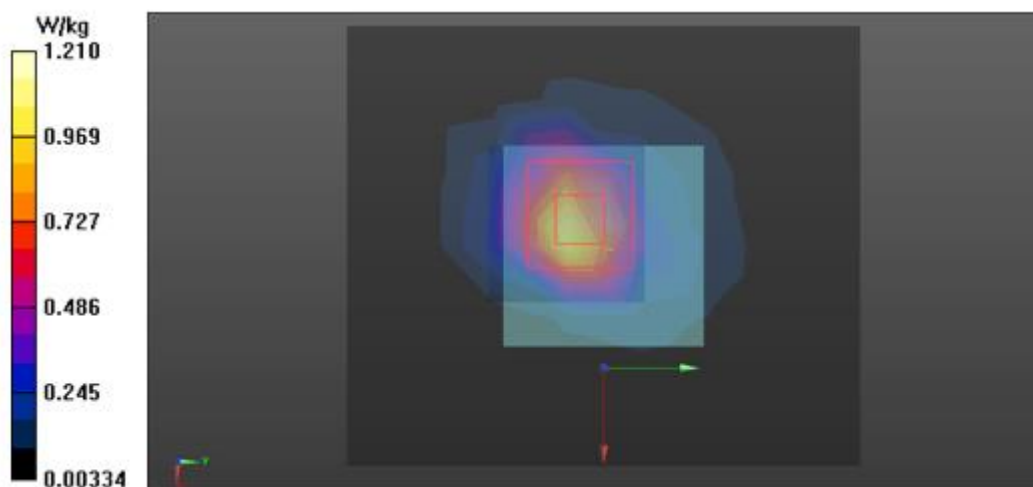

7)

Date: 2023-04-18

Test Laboratory: Eurofins KCTL Co.,Ltd.

File Name: [1. LTE Band 5 QPSK 10 MHz..da53:0](#)

DUT: SM-R935U, Type: Smart Wearable, Serial: R3AW3004QGB

Communication System: UID 0, LTE Band 5 (0); Frequency: 836.5 MHz; Duty Cycle: 1:1
Medium parameters used (interpolated): $f = 836.5$ MHz; $\sigma = 0.914$ S/m; $\epsilon_r = 40.727$; $\rho = 1000$ kg/m³
Phantom section: Flat Section

DASY5 Configuration:

- Probe: EX3DV4 - SN3865;ConvF(9.24, 9.5, 9.66) @ 836.5 MHz; Calibrated: 2023-01-22
- Sensor-Surface: 1.4mm (Mechanical Surface Detection)
- Electronics: DAE4 Sn1587; Calibrated: 2022-07-20
- Phantom: Twin-SAM V5.0; Type: QD 000 P40 CD; Serial: 1724
- Measurement SW: DASY52, Version 52.10 (4);

Next to Mouth/LTE Band 5_QPSK_10 MHz_1RB_0offset_CH20525_Front_10 mm/Area Scan (6x7x1):

Measurement grid: dx=15mm, dy=15mm

[Info: Interpolated medium parameters used for SAR evaluation.](#)

Maximum value of SAR (measured) = 0.0240 W/kg

Next to Mouth/LTE Band 5_QPSK_10 MHz_1RB_0offset_CH20525_Front_10 mm/Zoom Scan

(5x6x7)/Cube 0: Measurement grid: dx=8mm, dy=8mm, dz=5mm

Reference Value = 6.515 V/m; Power Drift = -0.17 dB

Peak SAR (extrapolated) = 0.0500 W/kg

SAR(1 g) = 0.022 W/kg; SAR(10 g) = 0.0089 W/kg

[Info: Interpolated medium parameters used for SAR evaluation.](#)

Maximum value of SAR (measured) = 0.0330 W/kg

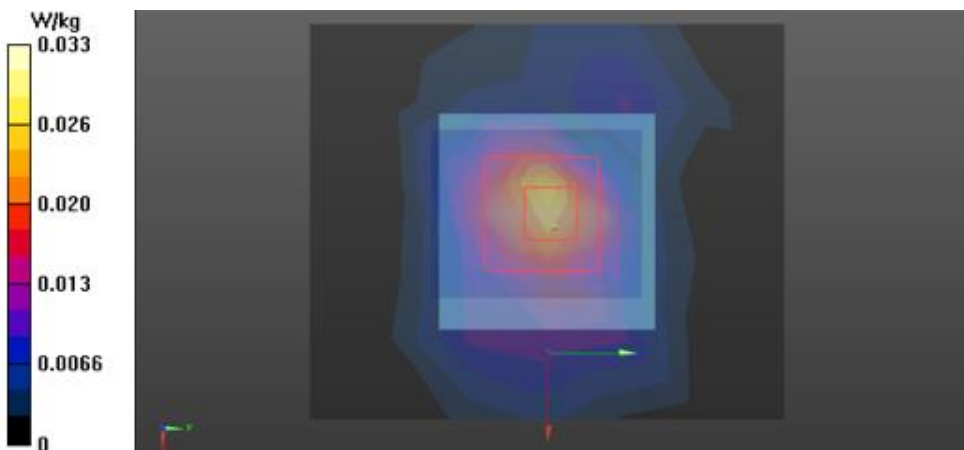

8)

Date: 2023-04-18

Test Laboratory: Eurofins KCTL Co.,Ltd.

File Name: [1. LTE Band 5 QPSK 10 MHz..da53:1](#)

DUT: SM-R935U, Type: Smart Wearable, Serial: R3AW3004TER

Communication System: UID 0, LTE Band 5 (0); Frequency: 836.5 MHz; Duty Cycle: 1:1
 Medium parameters used (interpolated): $f = 836.5$ MHz; $\sigma = 0.914$ S/m; $\epsilon_r = 40.727$; $\rho = 1000$ kg/m³
 Phantom section: Flat Section

DASY5 Configuration:

- Probe: EX3DV4 - SN3865;ConvF(9.24, 9.5, 9.66) @ 836.5 MHz; Calibrated: 2023-01-22
- Sensor-Surface: 1.4mm (Mechanical Surface Detection)
- Electronics: DAE4 Sn1587; Calibrated: 2022-07-20
- Phantom: Twin-SAM V5.0; Type: QD 000 P40 CD; Serial: 1724
- Measurement SW: DASY52, Version 52.10 (4);

Extremity/LTE Band 5_QPSK_10 MHz_1RB_0offset_CH20525_Rear_0 mm/Area Scan (6x7x1):

Measurement grid: dx=15mm, dy=15mm

[Info: Interpolated medium parameters used for SAR evaluation.](#)

Maximum value of SAR (measured) = 0.757 W/kg

Extremity/LTE Band 5_QPSK_10 MHz_1RB_0offset_CH20525_Rear_0 mm/Zoom Scan (5x5x7)/Cube

0: Measurement grid: dx=8mm, dy=8mm, dz=5mm

Reference Value = 26.86 V/m; Power Drift = 0.00 dB

Peak SAR (extrapolated) = 1.63 W/kg

SAR(1 g) = 0.620 W/kg; SAR(10 g) = 0.260 W/kg

[Info: Interpolated medium parameters used for SAR evaluation.](#)

Maximum value of SAR (measured) = 1.12 W/kg

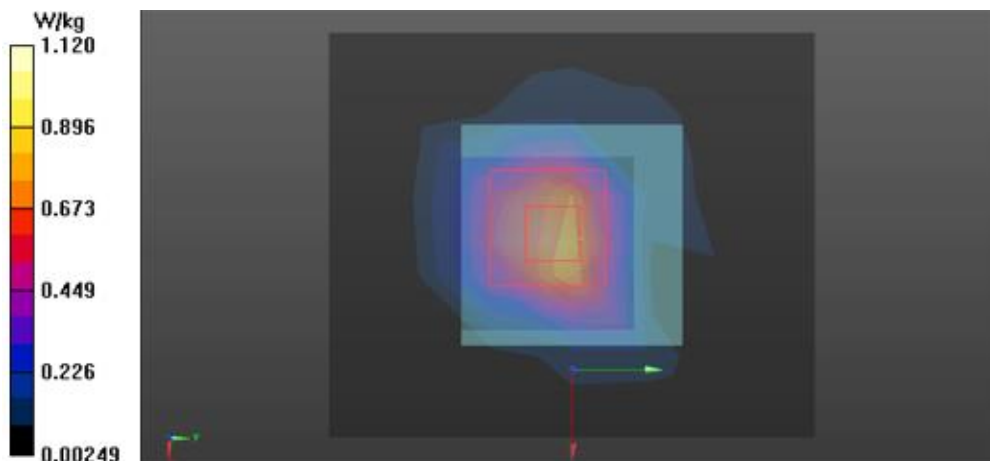

9)

Date: 2023-04-20

Test Laboratory: Eurofins KCTL Co.,Ltd.

File Name: [1. LTE Band 7 QPSK 20 MHz.da53:0](#)

DUT: SM-R935U, Type: Smart Wearable, Serial: R3AW3004QGB

Communication System: UID 0, LTE band 7 (0); Frequency: 2535 MHz; Duty Cycle: 1:1

Medium parameters used: $f = 2535 \text{ MHz}$; $\sigma = 1.95 \text{ S/m}$; $\epsilon_r = 38.218$; $\rho = 1000 \text{ kg/m}^3$

Phantom section: Flat Section

DASY5 Configuration:

- Probe: EX3DV4 - SN3865;ConvF(7.22, 7.64, 7.61) @ 2535 MHz; Calibrated: 2023-01-22
- Sensor-Surface: 1.4mm (Mechanical Surface Detection)
- Electronics: DAE4 Sn1587; Calibrated: 2022-07-20
- Phantom: Twin-SAM V5.0; Type: QD 000 P40 CD; Serial: 1724
- Measurement SW: DASY52, Version 52.10 (4);

Next to Mouth/LTE Band 7_QPSK_20 MHz_1RB_0offset_CH21100_Front_10 mm/Area Scan (7x8x1):

Measurement grid: $dx=12\text{mm}$, $dy=12\text{mm}$

Maximum value of SAR (measured) = 0.229 W/kg

Next to Mouth/LTE Band 7_QPSK_20 MHz_1RB_0offset_CH21100_Front_10 mm/Zoom Scan

(7x7x7)/Cube 0: Measurement grid: $dx=5\text{mm}$, $dy=5\text{mm}$, $dz=5\text{mm}$

Reference Value = 11.57 V/m; Power Drift = 0.12 dB

Peak SAR (extrapolated) = 0.307 W/kg

SAR(1 g) = 0.161 W/kg; SAR(10 g) = 0.075 W/kg

Maximum value of SAR (measured) = 0.250 W/kg

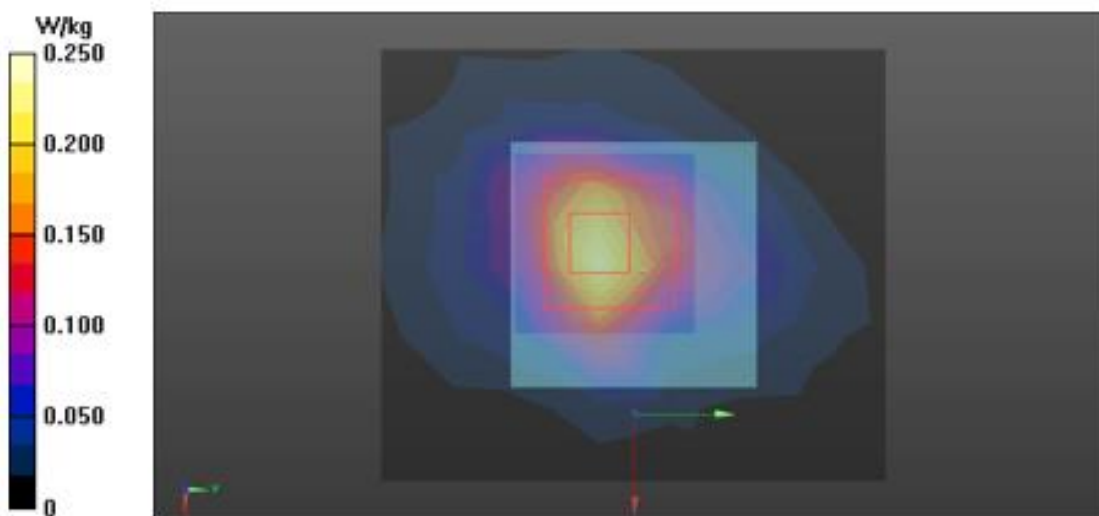

10)

Date: 2023-04-20

Test Laboratory: Eurofins KCTL Co.,Ltd.

File Name: [1. LTE Band 7 QPSKT 20 MHz.da53:1](#)

DUT: SM-R935U, Type: Smart Wearable, Serial: R3AW3004TER

Communication System: UID 0, LTE band 7 (0); Frequency: 2535 MHz; Duty Cycle: 1:1

Medium parameters used: $f = 2535 \text{ MHz}$; $\sigma = 1.95 \text{ S/m}$; $\epsilon_r = 38.218$; $\rho = 1000 \text{ kg/m}^3$

Phantom section: Flat Section

DASY5 Configuration:

- Probe: EX3DV4 - SN3865;ConvF(7.22, 7.64, 7.61) @ 2535 MHz; Calibrated: 2023-01-22
- Sensor-Surface: 1.4mm (Mechanical Surface Detection)
- Electronics: DAE4 Sn1587; Calibrated: 2022-07-20
- Phantom: Twin-SAM V5.0; Type: QD 000 P40 CD; Serial: 1724
- Measurement SW: DASY52, Version 52.10 (4);

Extremity/LTE Band 7_QPSK_20 MHz_1RB_0offset_CH21100_Rear_0 mm/Area Scan (7x8x1):

Measurement grid: $dx=12\text{mm}$, $dy=12\text{mm}$

Maximum value of SAR (measured) = 2.78 W/kg

Extremity/LTE Band 7_QPSK_20 MHz_1RB_0offset_CH21100_Rear_0 mm/Zoom Scan (7x7x7)/Cube

0: Measurement grid: $dx=5\text{mm}$, $dy=5\text{mm}$, $dz=5\text{mm}$

Reference Value = 27.98 V/m; Power Drift = -0.03 dB

Peak SAR (extrapolated) = 6.32 W/kg

SAR(1 g) = 2.4 W/kg; SAR(10 g) = 0.872 W/kg

Maximum value of SAR (measured) = 4.32 W/kg

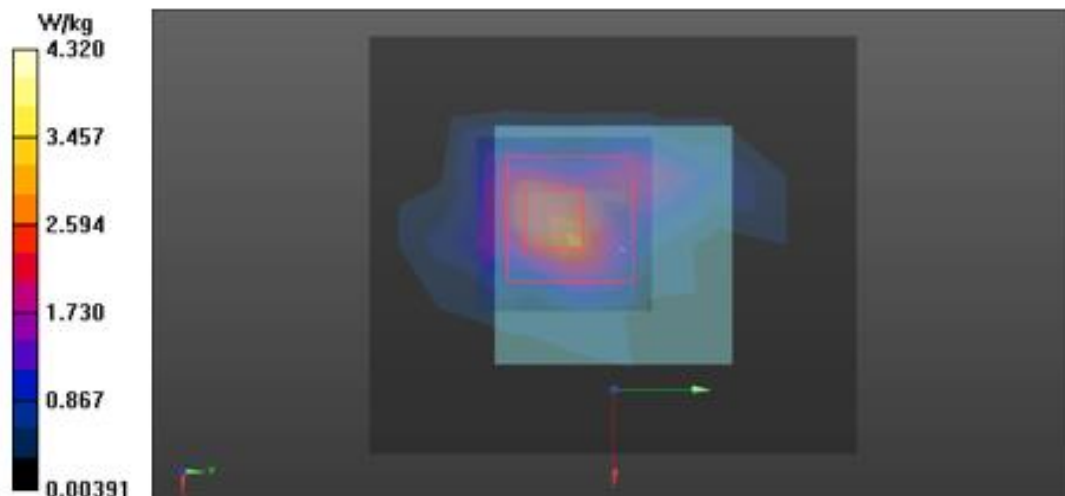

11)

Date: 2023-04-14

Test Laboratory: Eurofins KCTL Co.,Ltd.

File Name: [1. LTE Band 12 QPSK 10 MHz.da53:0](#)

DUT: SM-R935U, Type: Smart Wearable, Serial: R3AW3004X8X

Communication System: UID 0, LTE Band 12 (0); Frequency: 707.5 MHz; Duty Cycle: 1:1
 Medium parameters used: $f = 707.5$ MHz; $\sigma = 0.872$ S/m; $\epsilon_r = 43.394$; $\rho = 1000$ kg/m³
 Phantom section: Flat Section

DASY5 Configuration:

- Probe: EX3DV4 - SN3865;ConvF(9.39, 10.15, 9.66) @ 707.5 MHz; Calibrated: 2023-01-22
- Sensor-Surface: 1.4mm (Mechanical Surface Detection)
- Electronics: DAE4 Sn1587; Calibrated: 2022-07-20
- Phantom: Twin-SAM V5.0; Type: QD 000 P40 CD; Serial: 1724
- Measurement SW: DASY52, Version 52.10 (4);

Next to Mouth/LTE Band 12_QPSK_10 MHz_25RB_0offset_CH23095_Front_10 mm/Area Scan (6x7x1): Measurement grid: dx=15mm, dy=15mm
 Maximum value of SAR (measured) = 0.00788 W/kg

Next to Mouth/LTE Band 12_QPSK_10 MHz_25RB_0offset_CH23095_Front_10 mm/Zoom Scan (5x5x7)/Cube 0: Measurement grid: dx=8mm, dy=8mm, dz=5mm
 Reference Value = 2.462 V/m; Power Drift = 0.18 dB
 Peak SAR (extrapolated) = 0.0220 W/kg
SAR(1 g) = 0.00661 W/kg; SAR(10 g) = 0.00186 W/kg

Maximum value of SAR (measured) = 0.00825 W/kg

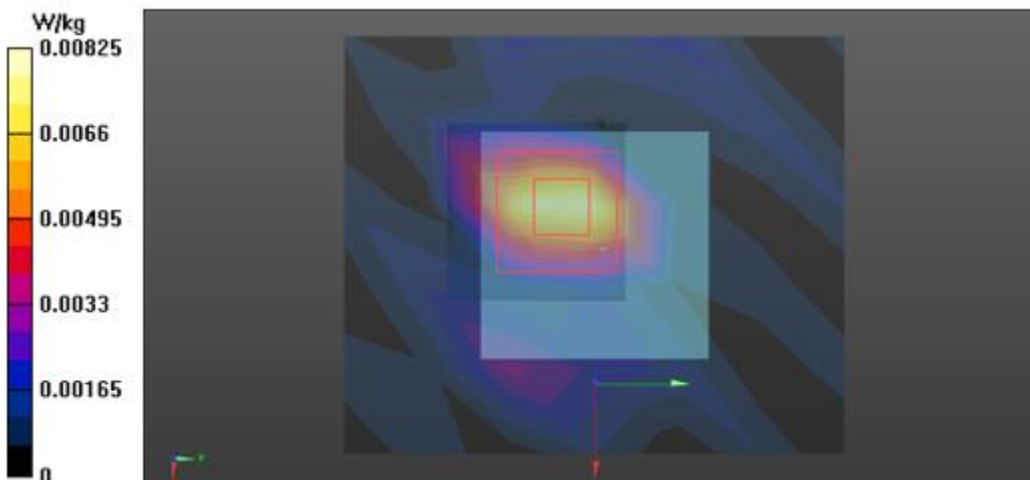

12)

Date: 2023-04-14

Test Laboratory: Eurofins KCTL Co.,Ltd.

File Name: [1. LTE Band 12 QPSK 10 MHz.da53:1](#)

DUT: SM-R935U, Type: Smart Wearable, Serial: R3AW3004QGB

Communication System: UID 0, LTE Band 12 (0); Frequency: 707.5 MHz; Duty Cycle: 1:1

Medium parameters used: $f = 707.5$ MHz; $\sigma = 0.872$ S/m; $\epsilon_r = 43.394$; $\rho = 1000$ kg/m³

Phantom section: Flat Section

DASY5 Configuration:

- Probe: EX3DV4 - SN3865;ConvF(9.39, 10.15, 9.66) @ 707.5 MHz; Calibrated: 2023-01-22
- Sensor-Surface: 1.4mm (Mechanical Surface Detection)
- Electronics: DAE4 Sn1587; Calibrated: 2022-07-20
- Phantom: Twin-SAM V5.0; Type: QD 000 P40 CD; Serial: 1724
- Measurement SW: DASY52, Version 52.10 (4);

Extremity/LTE Band 12_QPSK_10 MHz_1RB_0offset_CH23095_Rear_0 mm/Area Scan (6x7x1):

Measurement grid: dx=15mm, dy=15mm

Maximum value of SAR (measured) = 1.41 W/kg

Extremity/LTE Band 12_QPSK_10 MHz_1RB_0offset_CH23095_Rear_0 mm/Zoom Scan (5x5x7)/Cube

0: Measurement grid: dx=8mm, dy=8mm, dz=5mm

Reference Value = 40.12 V/m; Power Drift = -0.19 dB

Peak SAR (extrapolated) = 2.57 W/kg

SAR(1 g) = 0.870 W/kg; SAR(10 g) = 0.358 W/kg

Maximum value of SAR (measured) = 1.54 W/kg

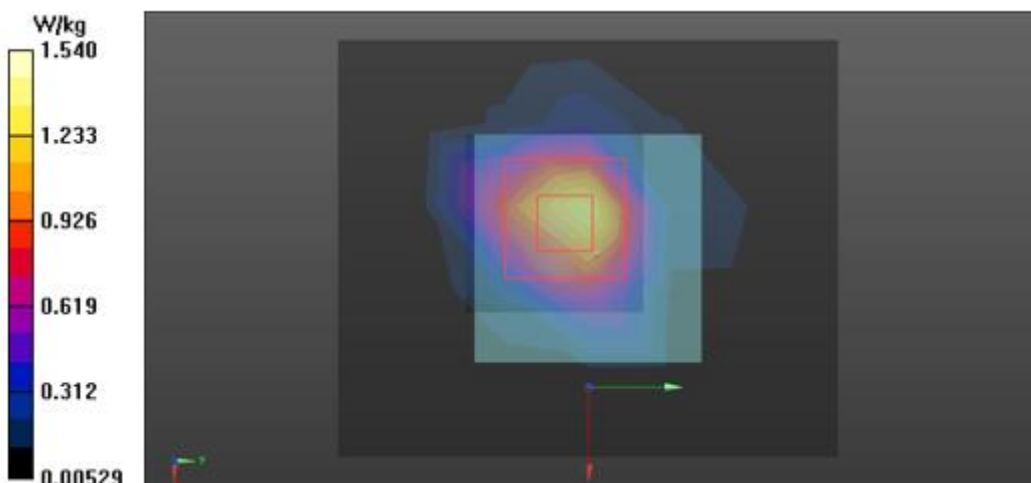

13)

Date: 2023-04-14

Test Laboratory: Eurofins KCTL Co.,Ltd.

File Name: [1. LTE Band 13 QPSK 10 MHz.da53:0](#)

DUT: SM-R935U, **Type:** Smart Wearable, **Serial:** R3AW3004RML

Communication System: UID 0, LTE Band 13 (0); Frequency: 782 MHz; Duty Cycle: 1:1

Medium parameters used: $f = 782 \text{ MHz}$; $\sigma = 0.907 \text{ S/m}$; $\epsilon_r = 43.07$; $\rho = 1000 \text{ kg/m}^3$

Phantom section: Flat Section

DASY5 Configuration:

- Probe: EX3DV4 - SN3865;ConvF(9.39, 10.15, 9.66) @ 782 MHz; Calibrated: 2023-01-22
- Sensor-Surface: 1.4mm (Mechanical Surface Detection)
- Electronics: DAE4 Sn1587; Calibrated: 2022-07-20
- Phantom: Twin-SAM V5.0; Type: QD 000 P40 CD; Serial: 1724
- Measurement SW: DASY52, Version 52.10 (4);

Next to Mouth/LTE Band 13_QPSK_10 MHz_1RB_0offset_CH23230_Front_10 mm/Area Scan

(6x7x1): Measurement grid: $dx=15\text{mm}$, $dy=15\text{mm}$

Maximum value of SAR (measured) = 0.0199 W/kg

Next to Mouth/LTE Band 13_QPSK_10 MHz_1RB_0offset_CH23230_Front_10 mm/Zoom Scan

(5x5x7)/Cube 0: Measurement grid: $dx=8\text{mm}$, $dy=8\text{mm}$, $dz=5\text{mm}$

Reference Value = 3.279 V/m; Power Drift = 0.17 dB

Peak SAR (extrapolated) = 0.0370 W/kg

SAR(1 g) = 0.013 W/kg; SAR(10 g) = 0.00489 W/kg

Maximum value of SAR (measured) = 0.0184 W/kg

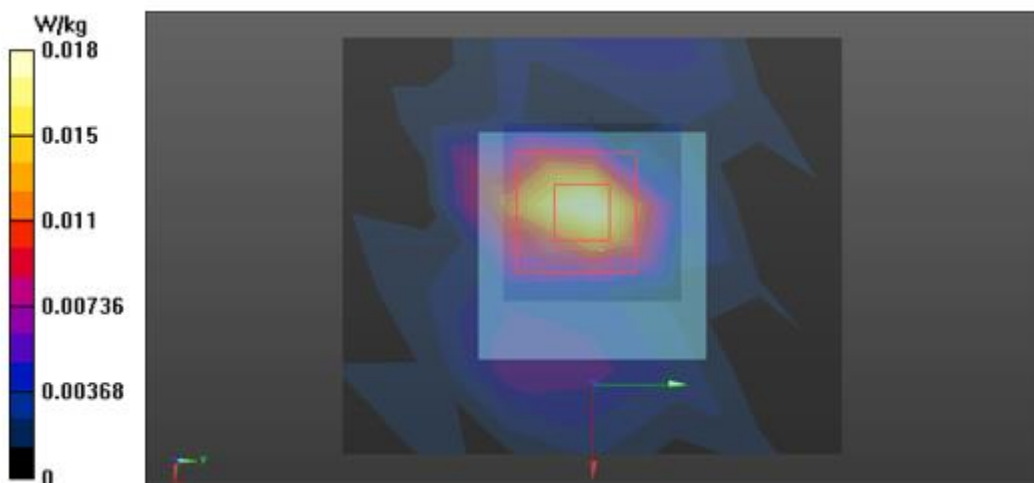

14)

Date: 2023-04-14

Test Laboratory: Eurofins KCTL Co.,Ltd.

File Name: [1. LTE Band 13 QPSK 10 MHz.da53:1](#)

DUT: SM-R935U, Type: Smart Wearable, Serial: R3AW3004RXN

Communication System: UID 0, LTE Band 13 (0); Frequency: 782 MHz; Duty Cycle: 1:1

Medium parameters used: $f = 782 \text{ MHz}$; $\sigma = 0.907 \text{ S/m}$; $\epsilon_r = 43.07$; $\rho = 1000 \text{ kg/m}^3$

Phantom section: Flat Section

DASY5 Configuration:

- Probe: EX3DV4 - SN3865;ConvF(9.39, 10.15, 9.66) @ 782 MHz; Calibrated: 2023-01-22
- Sensor-Surface: 1.4mm (Mechanical Surface Detection)
- Electronics: DAE4 Sn1587; Calibrated: 2022-07-20
- Phantom: Twin-SAM V5.0; Type: QD 000 P40 CD; Serial: 1724
- Measurement SW: DASY52, Version 52.10 (4);

Extremity/LTE Band 13_QPSK_10 MHz_1RB_0offset_CH23230_Rear_0 mm/Area Scan (6x7x1):

Measurement grid: $dx=15\text{mm}$, $dy=15\text{mm}$

Maximum value of SAR (measured) = 0.906 W/kg

Extremity/LTE Band 13_QPSK_10 MHz_1RB_0offset_CH23230_Rear_0 mm/Zoom Scan

(5x5x7)/Cube 0: Measurement grid: $dx=8\text{mm}$, $dy=8\text{mm}$, $dz=5\text{mm}$

Reference Value = 32.49 V/m; Power Drift = 0.05 dB

Peak SAR (extrapolated) = 1.73 W/kg

SAR(1 g) = 0.580 W/kg; SAR(10 g) = 0.234 W/kg

Maximum value of SAR (measured) = 1.08 W/kg

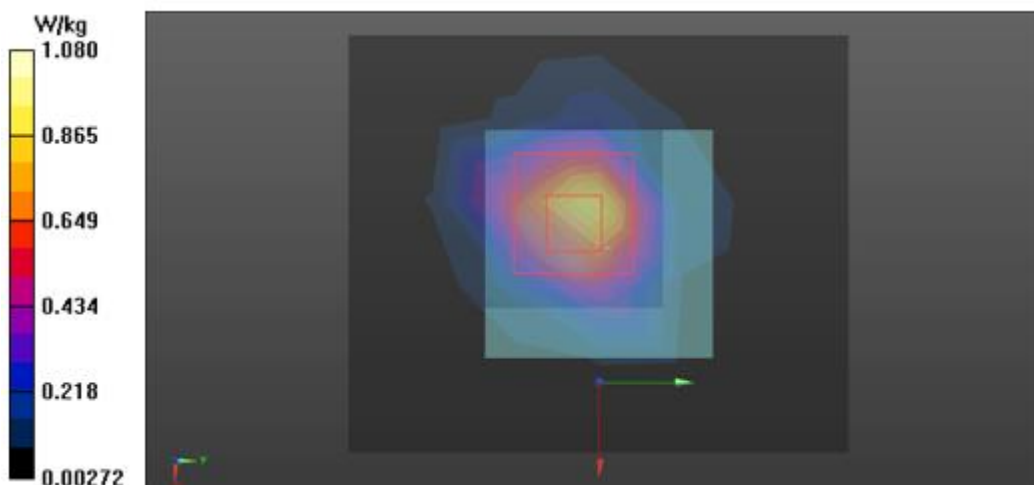

15)

Date: 2023-04-13

Test Laboratory: Eurofins KCTL Co.,Ltd.

File Name: [1. LTE Band 25 QPSK 20 MHz.da53:0](#)

DUT: SM-R935U, Type: Smart Wearable, Serial: R3AW3004RML

Communication System: UID 0, LTE Band 25 (0); Frequency: 1860 MHz; Duty Cycle: 1:1

Medium parameters used: $f = 1860$ MHz; $\sigma = 1.384$ S/m; $\epsilon_r = 38.615$; $\rho = 1000$ kg/m³

Phantom section: Flat Section

DASY5 Configuration:

- Probe: EX3DV4 - SN3865;ConvF(8.28, 8.79, 8.53) @ 1860 MHz; Calibrated: 2023-01-22
- Sensor-Surface: 1.4mm (Mechanical Surface Detection)
- Electronics: DAE4 Sn1587; Calibrated: 2022-07-20
- Phantom: Twin-SAM V5.0; Type: QD 000 P40 CD; Serial: 1724
- Measurement SW: DASY52, Version 52.10 (4);

Next to Mouth/LTE Band 25_QPSK_20 MHz_1RB_0offset_CH26140_Front_10 mm/Area Scan

(6x7x1): Measurement grid: dx=15mm, dy=15mm

Maximum value of SAR (measured) = 1.12 W/kg

Next to Mouth/LTE Band 25_QPSK_20 MHz_1RB_0offset_CH26140_Front_10 mm/Zoom Scan

(5x5x7)/Cube 0: Measurement grid: dx=8mm, dy=8mm, dz=5mm

Reference Value = 30.21 V/m; Power Drift = -0.17 dB

Peak SAR (extrapolated) = 1.31 W/kg

SAR(1 g) = 0.864 W/kg; SAR(10 g) = 0.467 W/kg

Maximum value of SAR (measured) = 1.17 W/kg

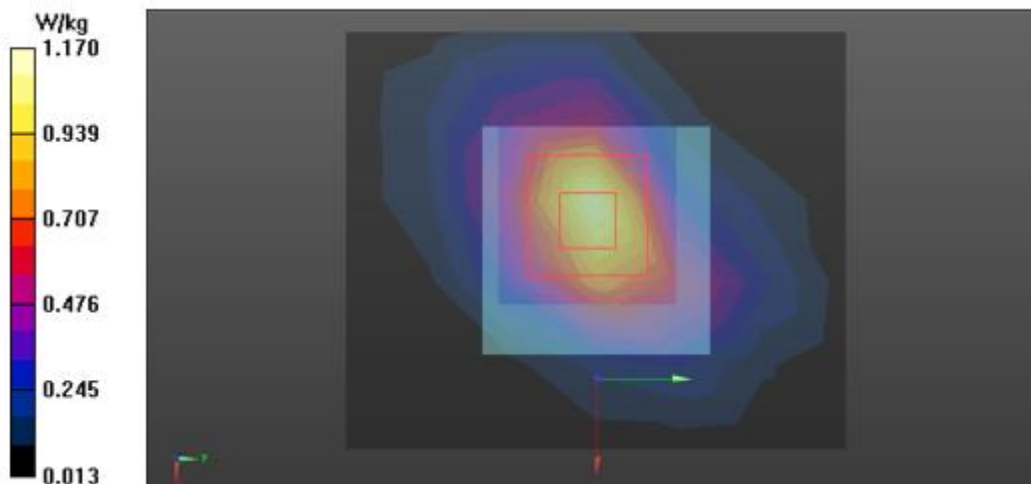

16)

Date: 2023-04-13

Test Laboratory: Eurofins KCTL Co.,Ltd.

File Name: [1. LTE Band 25 QPSK 20 MHz.da53:1](#)

DUT: SM-R935U, Type: Smart Wearable, Serial: R3AW3004TER

Communication System: UID 0, LTE Band 25 (0); Frequency: 1882.5 MHz; Duty Cycle: 1:1
 Medium parameters used (interpolated): $f = 1882.5$ MHz; $\sigma = 1.4$ S/m; $\epsilon_r = 38.559$; $\rho = 1000$ kg/m³
 Phantom section: Flat Section

DASY5 Configuration:

- Probe: EX3DV4 - SN3865;ConvF(8.28, 8.79, 8.53) @ 1882.5 MHz; Calibrated: 2023-01-22
- Sensor-Surface: 1.4mm (Mechanical Surface Detection)
- Electronics: DAE4 Sn1587; Calibrated: 2022-07-20
- Phantom: Twin-SAM V5.0; Type: QD 000 P40 CD; Serial: 1724
- Measurement SW: DASY52, Version 52.10 (4);

Extremity/LTE Band 25_QPSK_20 MHz_1RB_0offset_CH26140_Rear_0 mm/Area Scan (6x7x1):
 Measurement grid: dx=15mm, dy=15mm

[Info: Interpolated medium parameters used for SAR evaluation.](#)

Maximum value of SAR (measured) = 3.09 W/kg

Extremity/LTE Band 25_QPSK_20 MHz_1RB_0offset_CH26140_Rear_0 mm/Zoom Scan (5x5x7)/Cube 0: Measurement grid: dx=8mm, dy=8mm, dz=5mm

Reference Value = 39.04 V/m; Power Drift = -0.04 dB

Peak SAR (extrapolated) = 4.14 W/kg

SAR(1 g) = 2.43 W/kg; SAR(10 g) = 1.22 W/kg

[Info: Interpolated medium parameters used for SAR evaluation.](#)

Maximum value of SAR (measured) = 3.42 W/kg

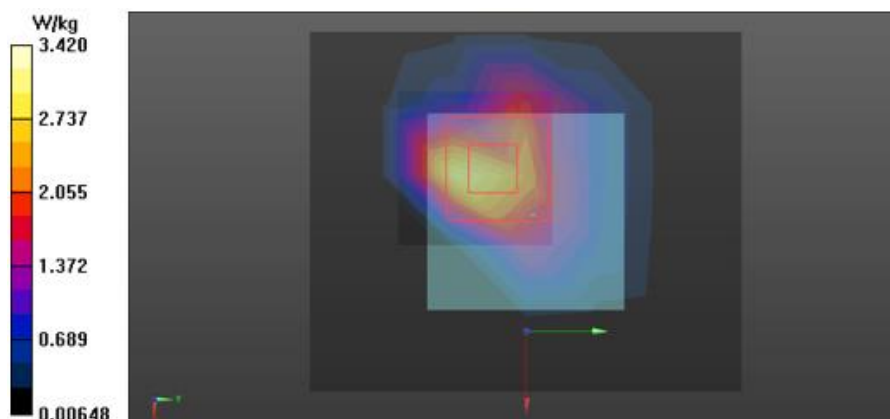

17)

Date: 2023-04-18

Test Laboratory: Eurofins KCTL Co.,Ltd.

File Name: [1. LTE Band 26 QPSK 15 MHz..da53:0](#)

DUT: SM-R935U, Type: Smart Wearable, Serial: R3AW3004TER

Communication System: UID 0, LTE Band 26 (0); Frequency: 831.5 MHz; Duty Cycle: 1:1
Medium parameters used: $f = 831.5$ MHz; $\sigma = 0.913$ S/m; $\epsilon_r = 40.75$; $\rho = 1000$ kg/m³
Phantom section: Flat Section

DASY5 Configuration:

- Probe: EX3DV4 - SN3865;ConvF(9.24, 9.5, 9.66) @ 831.5 MHz; Calibrated: 2023-01-22
- Sensor-Surface: 1.4mm (Mechanical Surface Detection)
- Electronics: DAE4 Sn1587; Calibrated: 2022-07-20
- Phantom: Twin-SAM V5.0; Type: QD 000 P40 CD; Serial: 1724
- Measurement SW: DASY52, Version 52.10 (4);

Next to Mouth/LTE Band 26_QPSK_15 MHz_1RB_0offset_CH26865_Front_10 mm/Area Scan (6x7x1): Measurement grid: dx=15mm, dy=15mm
Maximum value of SAR (measured) = 0.0198 W/kg

Next to Mouth/LTE Band 26_QPSK_15 MHz_1RB_0offset_CH26865_Front_10 mm/Zoom Scan (5x5x7)/Cube 0: Measurement grid: dx=8mm, dy=8mm, dz=5mm
Reference Value = 5.950 V/m; Power Drift = 0.02 dB
Peak SAR (extrapolated) = 0.0450 W/kg
SAR(1 g) = 0.019 W/kg; SAR(10 g) = 0.00761 W/kg

Maximum value of SAR (measured) = 0.0303 W/kg

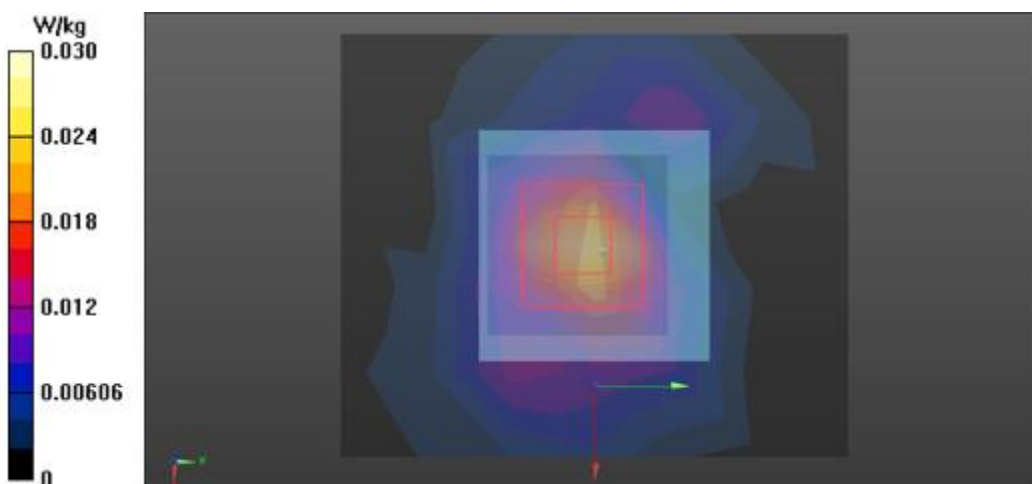

18)

Date: 2023-04-18

Test Laboratory: Eurofins KCTL Co.,Ltd.

File Name: [1. LTE Band 26 QPSK 15 MHz..da53:1](#)

DUT: SM-R935U, Type: Smart Wearable, Serial: R3AW3004QGB

Communication System: UID 0, LTE Band 26 (0); Frequency: 831.5 MHz; Duty Cycle: 1:1
Medium parameters used: $f = 831.5$ MHz; $\sigma = 0.913$ S/m; $\epsilon_r = 40.75$; $\rho = 1000$ kg/m³
Phantom section: Flat Section

DASY5 Configuration:

- Probe: EX3DV4 - SN3865;ConvF(9.24, 9.5, 9.66) @ 831.5 MHz; Calibrated: 2023-01-22
- Sensor-Surface: 1.4mm (Mechanical Surface Detection)
- Electronics: DAE4 Sn1587; Calibrated: 2022-07-20
- Phantom: Twin-SAM V5.0; Type: QD 000 P40 CD; Serial: 1724
- Measurement SW: DASY52, Version 52.10 (4);

Extremity/LTE Band 26_QPSK_15 MHz_1RB_0offset_CH26865_Rear_0 mm/Area Scan (6x7x1):

Measurement grid: dx=15mm, dy=15mm

Maximum value of SAR (measured) = 0.908 W/kg

Extremity/LTE Band 26_QPSK_15 MHz_1RB_0offset_CH26865_Rear_0 mm/Zoom Scan

(5x5x7)/Cube 0: Measurement grid: dx=8mm, dy=8mm, dz=5mm

Reference Value = 39.67 V/m; Power Drift = -0.06 dB

Peak SAR (extrapolated) = 1.79 W/kg

SAR(1 g) = 0.663 W/kg; SAR(10 g) = 0.273 W/kg

Maximum value of SAR (measured) = 1.21 W/kg

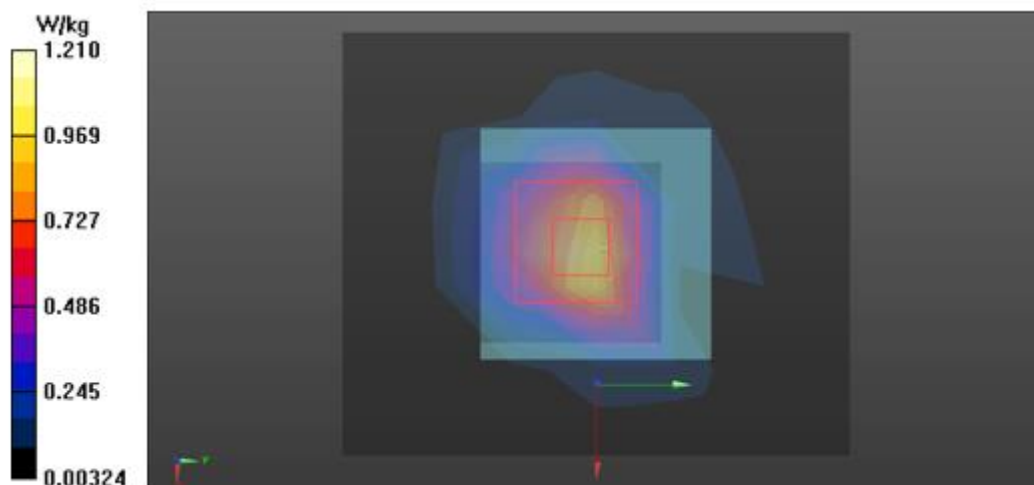

19)

Date: 2023-04-17

Test Laboratory: Eurofins KCTL Co.,Ltd.

File Name: [1. LTE Band 66 QPSK 20 MHz.da53:0](#)

DUT: SM-R935U, Type: Smart Wearable, Serial: R3AW3004RML

Communication System: UID 0, LTE Band 66 (0); Frequency: 1770 MHz; Duty Cycle: 1:1
Medium parameters used: $f = 1770$ MHz; $\sigma = 1.372$ S/m; $\epsilon_r = 40.569$; $\rho = 1000$ kg/m³
Phantom section: Flat Section

DASY5 Configuration:

- Probe: EX3DV4 - SN3865;ConvF(8.38, 8.84, 8.67) @ 1770 MHz; Calibrated: 2023-01-22
- Sensor-Surface: 1.4mm (Mechanical Surface Detection)
- Electronics: DAE4 Sn1587; Calibrated: 2022-07-20
- Phantom: Twin-SAM V5.0; Type: QD 000 P40 CD; Serial: 1724
- Measurement SW: DASY52, Version 52.10 (4);

Next to Mouth/LTE Band 66_QPSK_20 MHz_1RB_0offset_CH132572_Front_10 mm/Area Scan (6x7x1): Measurement grid: dx=15mm, dy=15mm
Maximum value of SAR (measured) = 0.957 W/kg

Next to Mouth/LTE Band 66_QPSK_20 MHz_1RB_0offset_CH132572_Front_10 mm/Zoom Scan (5x5x7)/Cube 0: Measurement grid: dx=8mm, dy=8mm, dz=5mm
Reference Value = 28.87 V/m; Power Drift = -0.11 dB
Peak SAR (extrapolated) = 1.20 W/kg
SAR(1 g) = 0.811 W/kg; SAR(10 g) = 0.470 W/kg

Maximum value of SAR (measured) = 1.06 W/kg

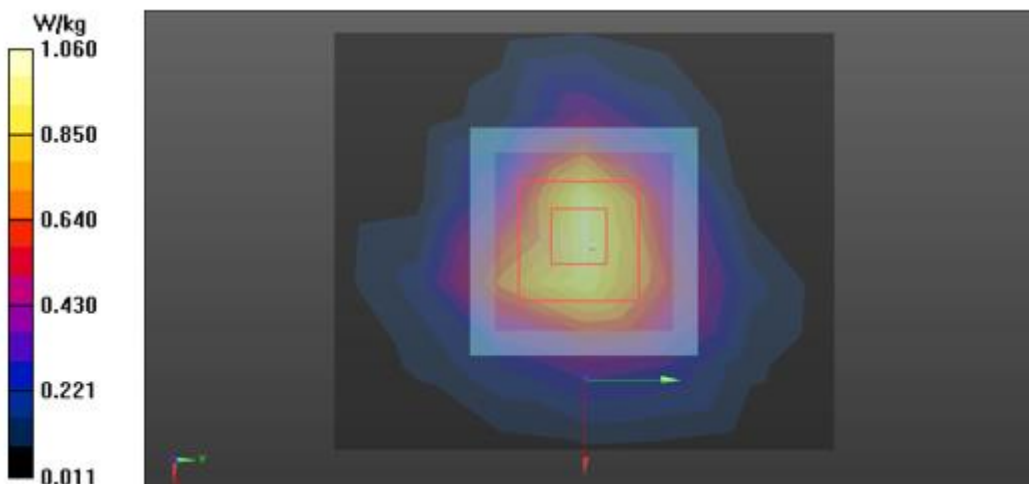

20)

Date: 2023-04-17

Test Laboratory: Eurofins KCTL Co.,Ltd.

File Name: [1. LTE Band 66 QPSK 20 MHz.da53:1](#)

DUT: SM-R935U, Type: Smart Wearable, Serial: R3AW3004QGB

Communication System: UID 0, LTE Band 66 (0); Frequency: 1770 MHz; Duty Cycle: 1:1
Medium parameters used: $f = 1770$ MHz; $\sigma = 1.372$ S/m; $\epsilon_r = 40.569$; $\rho = 1000$ kg/m³
Phantom section: Flat Section

DASY5 Configuration:

- Probe: EX3DV4 - SN3865;ConvF(8.38, 8.84, 8.67) @ 1770 MHz; Calibrated: 2023-01-22
- Sensor-Surface: 1.4mm (Mechanical Surface Detection)
- Electronics: DAE4 Sn1587; Calibrated: 2022-07-20
- Phantom: Twin-SAM V5.0; Type: QD 000 P40 CD; Serial: 1724
- Measurement SW: DASY52, Version 52.10 (4);

Extremity/LTE Band 66_QPSK_20 MHz_1RB_0offset_CH132572_Rear_0 mm/Area Scan (6x7x1):

Measurement grid: dx=15mm, dy=15mm

Maximum value of SAR (measured) = 5.76 W/kg

Extremity/LTE Band 66_QPSK_20 MHz_1RB_0offset_CH132572_Rear_0 mm/Zoom Scan

(5x5x7)/Cube 0: Measurement grid: dx=8mm, dy=8mm, dz=5mm

Reference Value = 57.41 V/m; Power Drift = -0.08 dB

Peak SAR (extrapolated) = 8.02 W/kg

SAR(1 g) = 4.68 W/kg; SAR(10 g) = 2.36 W/kg

Maximum value of SAR (measured) = 6.25 W/kg

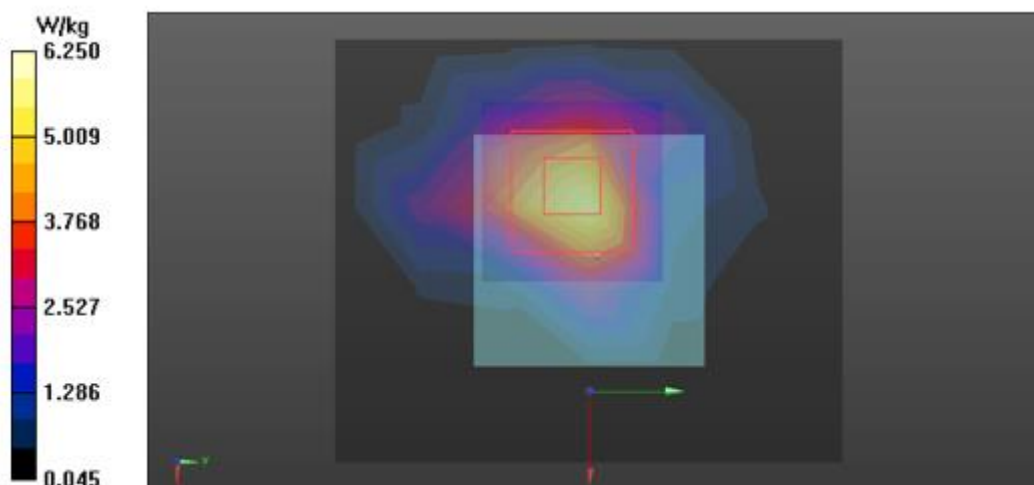

21)

Date: 2023-04-14

Test Laboratory: Eurofins KCTL Co.,Ltd.

File Name: [1. LTE Band 71 QPSK 20 MHz.da53:0](#)

DUT: SM-R935U, **Type:** Smart Wearable, **Serial:** R3AW3004QGB

Communication System: UID 0, LTE Band 71 (0); Frequency: 680.5 MHz; Duty Cycle: 1:1
 Medium parameters used (interpolated): $f = 680.5$ MHz; $\sigma = 0.866$ S/m; $\epsilon_r = 43.499$; $\rho = 1000$ kg/m³
 Phantom section: Flat Section

DASY5 Configuration:

- Probe: EX3DV4 - SN3865;ConvF(9.39, 10.15, 9.66) @ 680.5 MHz; Calibrated: 2023-01-22
- Sensor-Surface: 1.4mm (Mechanical Surface Detection)
- Electronics: DAE4 Sn1587; Calibrated: 2022-07-20
- Phantom: Twin-SAM V5.0; Type: QD 000 P40 CD; Serial: 1724
- Measurement SW: DASY52, Version 52.10 (4);

Next to Mouth/LTE Band 71_QPSK_20 MHz_50RB_0offset_CH133297_Front_10 mm/Area Scan (6x7x1): Measurement grid: dx=15mm, dy=15mm

[Info: Interpolated medium parameters used for SAR evaluation.](#)

Maximum value of SAR (measured) = 0.00336 W/kg

Next to Mouth/LTE Band 71_QPSK_20 MHz_50RB_0offset_CH133297_Front_10 mm/Zoom Scan (5x5x7)/Cube 0: Measurement grid: dx=8mm, dy=8mm, dz=5mm

Reference Value = 2.440 V/m; Power Drift = 0.10 dB

Peak SAR (extrapolated) = 0.0110 W/kg

SAR(1 g) = 0.00355 W/kg; SAR(10 g) = 0.00164 W/kg

[Info: Interpolated medium parameters used for SAR evaluation.](#)

Maximum value of SAR (measured) = 0.00538 W/kg

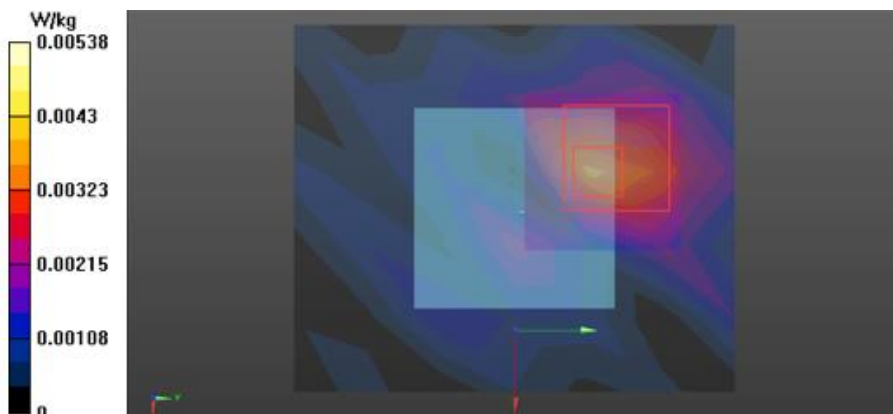

22)

Date: 2023-04-14

Test Laboratory: Eurofins KCTL Co.,Ltd.

File Name: [1. LTE Band 71 QPSK 20 MHz.da53:1](#)

DUT: SM-R935U, Type: Smart Wearable, Serial: R3AW3004RML

Communication System: UID 0, LTE Band 71 (0); Frequency: 680.5 MHz; Duty Cycle: 1:1
Medium parameters used (interpolated): $f = 680.5$ MHz; $\sigma = 0.866$ S/m; $\epsilon_r = 43.499$; $\rho = 1000$ kg/m³
Phantom section: Flat Section

DASY5 Configuration:

- Probe: EX3DV4 - SN3865;ConvF(9.39, 10.15, 9.66) @ 680.5 MHz; Calibrated: 2023-01-22
- Sensor-Surface: 1.4mm (Mechanical Surface Detection)
- Electronics: DAE4 Sn1587; Calibrated: 2022-07-20
- Phantom: Twin-SAM V5.0; Type: QD 000 P40 CD; Serial: 1724
- Measurement SW: DASY52, Version 52.10 (4);

Extremity/LTE Band 71_QPSK_20 MHz_1RB_0offset_CH133297_Rear_0 mm 2 2/Area Scan (6x7x1):
Measurement grid: dx=15mm, dy=15mm

[Info: Interpolated medium parameters used for SAR evaluation.](#)

Maximum value of SAR (measured) = 0.974 W/kg

Extremity/LTE Band 71_QPSK_20 MHz_1RB_0offset_CH133297_Rear_0 mm 2 2/Zoom Scan (5x5x7)/Cube 0: Measurement grid: dx=8mm, dy=8mm, dz=5mm

Reference Value = 39.09 V/m; Power Drift = 0.16 dB

Peak SAR (extrapolated) = 1.95 W/kg

SAR(1 g) = 0.656 W/kg; SAR(10 g) = 0.266 W/kg

[Info: Interpolated medium parameters used for SAR evaluation.](#)

Maximum value of SAR (measured) = 1.20 W/kg

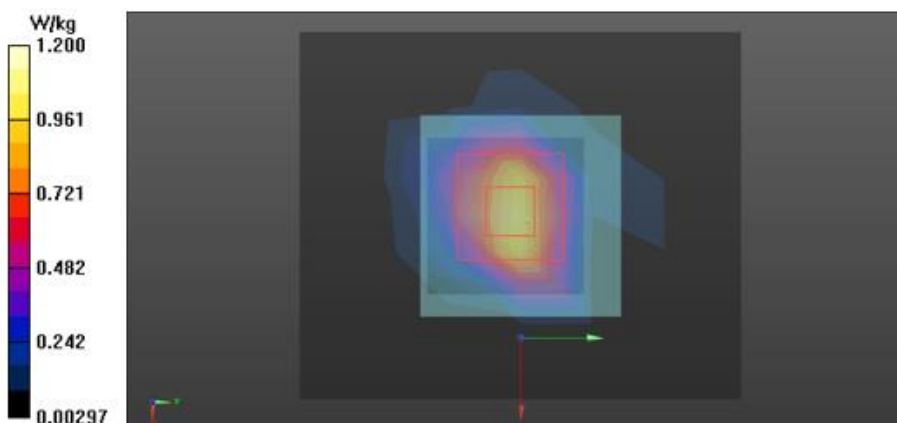

23)

Date: 2023-04-12

Test Laboratory: Eurofins KCTL Co.,Ltd.

File Name: [1. WLAN 2.4 GHz.da53:0](#)

DUT: SM-R935U, Type: Smart Wearable, Serial: R3AW3004TER

Communication System: UID 0, 2.4G WLAN (0); Frequency: 2412 MHz; Duty Cycle: 1:1

Medium parameters used: $f = 2412$ MHz; $\sigma = 1.79$ S/m; $\epsilon_r = 38.754$; $\rho = 1000$ kg/m³

Phantom section: Flat Section

DASY5 Configuration:

- Probe: EX3DV4 - SN7753;ConvF(7.02, 7.02, 7.02) @ 2412 MHz; Calibrated: 2022-11-01
- Sensor-Surface: 1.4mm (Mechanical Surface Detection)
- Electronics: DAE4 Sn1586; Calibrated: 2022-04-29
- Phantom: Twin-SAM V4.0; Type: QD 000 P40 CC; Serial: 1728
- Measurement SW: DASY52, Version 52.10 (4);

Next to Mouth/802.11_b_CH1_Front_10 mm/Area Scan (10x8x1): Measurement grid: dx=12mm, dy=12mm

Maximum value of SAR (measured) = 0.0295 W/kg

Next to Mouth/802.11_b_CH1_Front_10 mm/Zoom Scan (7x7x7)/Cube 0: Measurement grid: dx=5mm, dy=5mm, dz=5mm

Reference Value = 25.95 V/m; Power Drift = 0.09 dB

Peak SAR (extrapolated) = 0.0390 W/kg

SAR(1 g) = 0.021 W/kg; SAR(10 g) = 0.00694 W/kg

Maximum value of SAR (measured) = 0.0330 W/kg

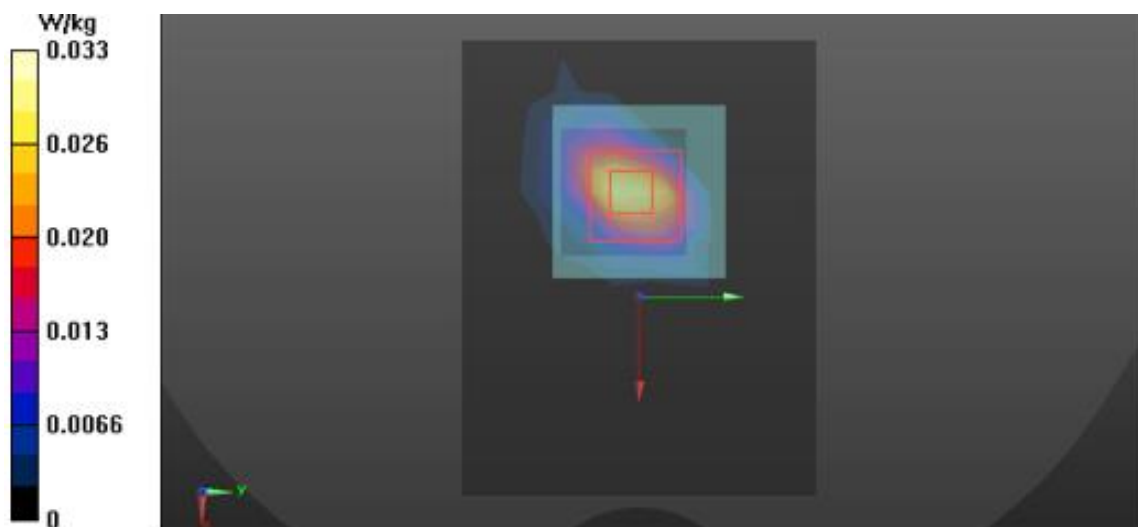

24)

Date: 2023-04-12

Test Laboratory: Eurofins KCTL Co.,Ltd.

File Name: [1. WLAN 2.4 GHz.da53:1](#)

DUT: SM-R935U, Type: Smart Wearable, Serial: R3AW3004QGB

Communication System: UID 0, 2.4GWLAN (0); Frequency: 2412 MHz; Duty Cycle: 1:1

Medium parameters used: $f = 2412 \text{ MHz}$; $\sigma = 1.79 \text{ S/m}$; $\epsilon_r = 38.754$; $\rho = 1000 \text{ kg/m}^3$

Phantom section: Flat Section

DASY5 Configuration:

- Probe: EX3DV4 - SN7753;ConvF(7.02, 7.02, 7.02) @ 2412 MHz; Calibrated: 2022-11-01
- Sensor-Surface: 1.4mm (Mechanical Surface Detection)
- Electronics: DAE4 Sn1586; Calibrated: 2022-04-29
- Phantom: Twin-SAM V4.0; Type: QD 000 P40 CC; Serial: 1728
- Measurement SW: DASY52, Version 52.10 (4);

Extremity/802.11_b_CH1_Rear_0 mm/Area Scan (7x8x1): Measurement grid: $dx=12\text{mm}$, $dy=12\text{mm}$

Maximum value of SAR (measured) = 0.729 W/kg

Extremity/802.11_b_CH1_Rear_0 mm/Zoom Scan (7x7x7)/Cube 0: Measurement grid: $dx=5\text{mm}$, $dy=5\text{mm}$, $dz=5\text{mm}$

Reference Value = 23.77 V/m; Power Drift = -0.08 dB

Peak SAR (extrapolated) = 1.43 W/kg

SAR(1 g) = 0.526 W/kg; SAR(10 g) = 0.186 W/kg

Maximum value of SAR (measured) = 0.994 W/kg

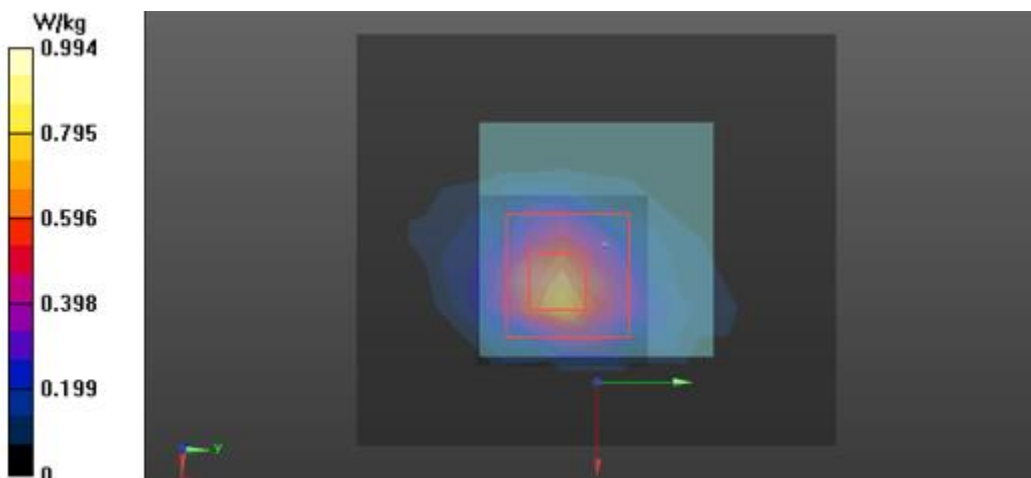

25)

Date: 2023-04-15

Test Laboratory: Eurofins KCTL Co.,Ltd.

File Name: [1. WLAN 5.3GHz.da53:0](#)

DUT: SM-R935U, Type: Smart Wearable, Serial: R3AW3004TER

Communication System: UID 0, 5G WLAN (0); Frequency: 5280 MHz; Duty Cycle: 1:1

Medium parameters used: $f = 5280$ MHz; $\sigma = 4.761$ S/m; $\epsilon_r = 36.041$; $\rho = 1000$ kg/m³

Phantom section: Flat Section

DASY5 Configuration:

- Probe: EX3DV4 - SN7753;ConvF(4.92, 4.92, 4.92) @ 5280 MHz; Calibrated: 2022-11-01
- Sensor-Surface: 1.4mm (Mechanical Surface Detection)
- Electronics: DAE4 Sn1586; Calibrated: 2022-04-29
- Phantom: Twin-SAM V4.0; Type: QD 000 P40 CC; Serial: 1728
- Measurement SW: DASY52, Version 52.10 (4);

Next to Mouth/802.11_a_CH56_Front_10 mm/Area Scan (12x12x1): Measurement grid: dx=10mm, dy=10mm

Maximum value of SAR (measured) = 0.0165 W/kg

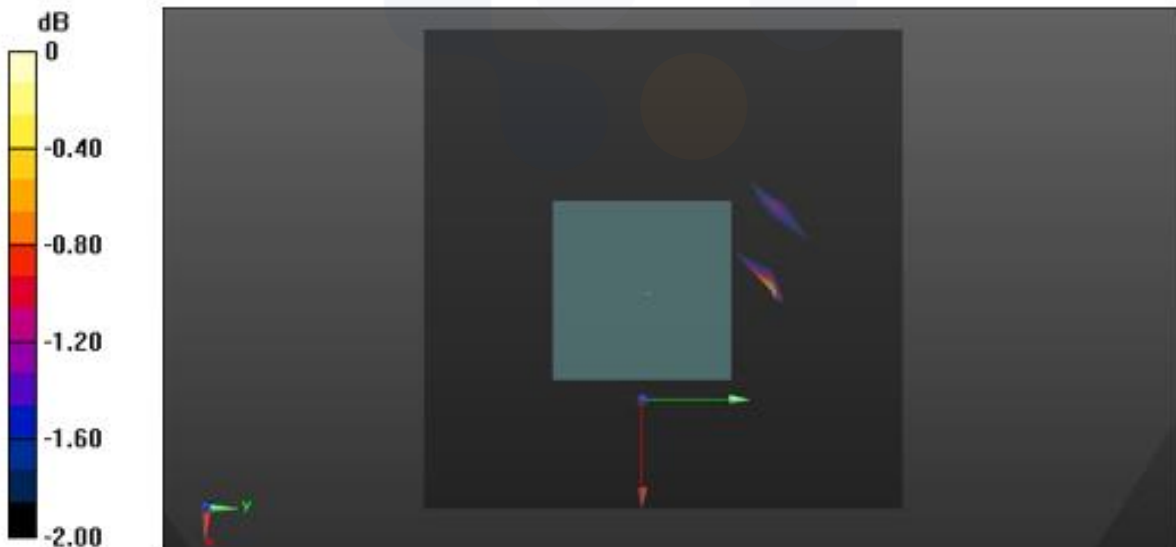

26)

Date: 2023-04-15

Test Laboratory: Eurofins KCTL Co.,Ltd.

File Name: [1. WLAN 5.3GHz.da53:1](#)

DUT: SM-R935U, Type: Smart Wearable, Serial: R3AW3004RXN

Communication System: UID 0, 5GWLAN (0); Frequency: 5280 MHz; Duty Cycle: 1:1

Medium parameters used: $f = 5280$ MHz; $\sigma = 4.761$ S/m; $\epsilon_r = 36.041$; $\rho = 1000$ kg/m³

Phantom section: Flat Section

DASY5 Configuration:

- Probe: EX3DV4 - SN7753;ConvF(4.92, 4.92, 4.92) @ 5280 MHz; Calibrated: 2022-11-01
- Sensor-Surface: 1.4mm (Mechanical Surface Detection)
- Electronics: DAE4 Sn1586; Calibrated: 2022-04-29
- Phantom: Twin-SAM V4.0; Type: QD 000 P40 CC; Serial: 1728
- Measurement SW: DASY52, Version 52.10 (4);

Extremity/802.11_a_CH56_Rear_0 mm/Area Scan (12x12x1): Measurement grid: dx=10mm, dy=10mm

Maximum value of SAR (measured) = 0.929 W/kg

Extremity/802.11_a_CH56_Rear_0 mm/Zoom Scan (9x9x7)/Cube 0: Measurement grid: dx=4mm, dy=4mm, dz=1.4mm

Reference Value = 7.933 V/m; Power Drift = 0.04 dB

Peak SAR (extrapolated) = 1.61 W/kg

SAR(1 g) = 0.342 W/kg; SAR(10 g) = 0.085 W/kg

Maximum value of SAR (measured) = 1.09 W/kg

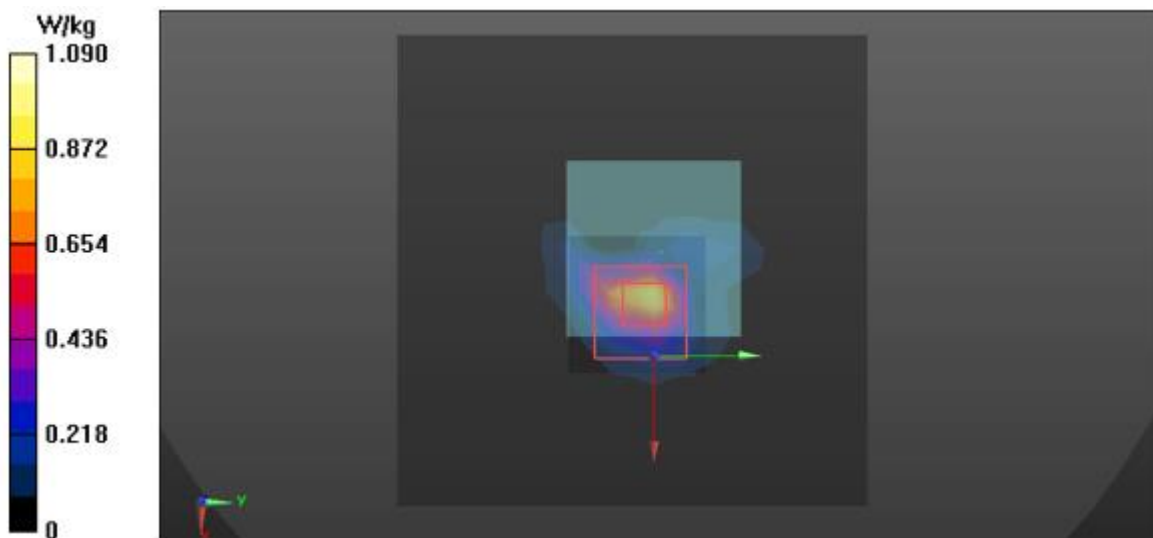

27)

Date: 2023-04-15

Test Laboratory: Eurofins KCTL Co.,Ltd.

File Name: [1. WLAN 5.6GHz.da53:0](#)

DUT: SM-R935U, Type: Smart Wearable, Serial: R3AW3004TER

Communication System: UID 0, 5GWLAN (0); Frequency: 5620 MHz; Duty Cycle: 1:1
 Medium parameters used (interpolated): $f = 5620$ MHz; $\sigma = 5.16$ S/m; $\epsilon_r = 35.327$; $\rho = 1000$ kg/m³
 Phantom section: Flat Section

DASY5 Configuration:

- Probe: EX3DV4 - SN7753;ConvF(4.36, 4.36, 4.36) @ 5620 MHz; Calibrated: 2022-11-01
- Sensor-Surface: 1.4mm (Mechanical Surface Detection)
- Electronics: DAE4 Sn1586; Calibrated: 2022-04-29
- Phantom: Twin-SAM V4.0; Type: QD 000 P40 CC; Serial: 1728
- Measurement SW: DASY52, Version 52.10 (4);

Next to Mouth/802.11_a_CH140_Front_10 mm/Area Scan (11x11x1): Measurement grid: dx=10mm, dy=10mm

Info: Interpolated medium parameters used for SAR evaluation.

Maximum value of SAR (measured) = 0.0216 W/kg

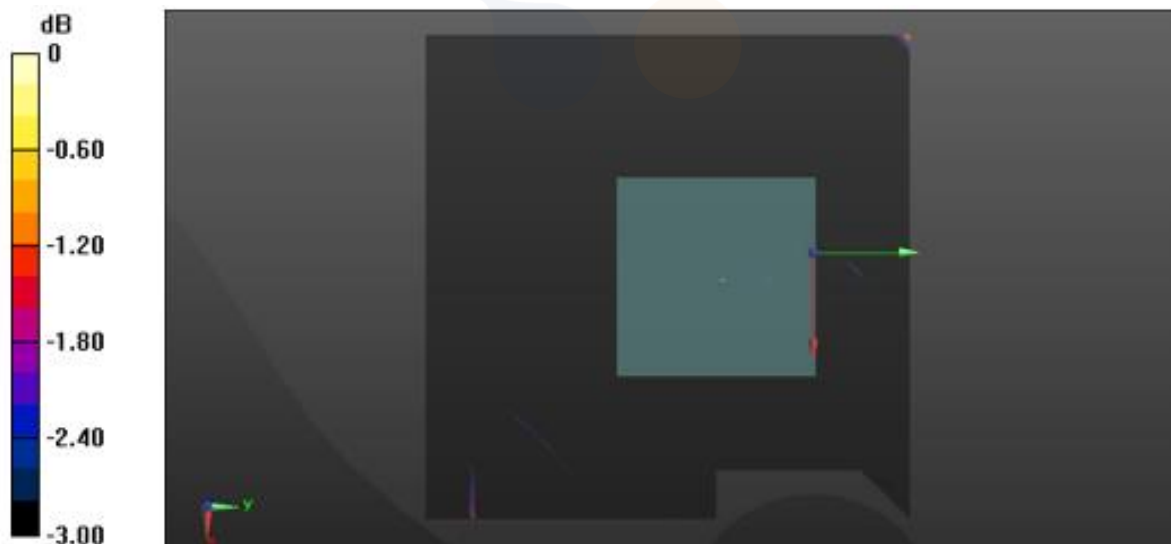

28)

Date: 2023-04-15

Test Laboratory: Eurofins KCTL Co.,Ltd.

File Name: [1. WLAN 5.6GHz.da53:1](#)

DUT: SM-R935U, Type: Smart Wearable, Serial: R3AW3004QGB

Communication System: UID 0, 5GWLAN (0); Frequency: 5620 MHz; Duty Cycle: 1:1
 Medium parameters used (interpolated): $f = 5620$ MHz; $\sigma = 5.16$ S/m; $\epsilon_r = 35.327$; $\rho = 1000$ kg/m³
 Phantom section: Flat Section

DASY5 Configuration:

- Probe: EX3DV4 - SN7753;ConvF(4.36, 4.36, 4.36) @ 5620 MHz; Calibrated: 2022-11-01
- Sensor-Surface: 1.4mm (Mechanical Surface Detection)
- Electronics: DAE4 Sn1586; Calibrated: 2022-04-29
- Phantom: Twin-SAM V4.0; Type: QD 000 P40 CC; Serial: 1728
- Measurement SW: DASY52, Version 52.10 (4);

Extremity/802.11_a_CH124_Rear_0 mm/Area Scan (11x11x1): Measurement grid: dx=10mm, dy=10mm

[Info: Interpolated medium parameters used for SAR evaluation.](#)

Maximum value of SAR (measured) = 0.754 W/kg

Extremity/802.11_a_CH124_Rear_0 mm/Zoom Scan (9x9x7)/Cube 0: Measurement grid: dx=4mm, dy=4mm, dz=1.4mm

Reference Value = 8.208 V/m; Power Drift = -0.07 dB

Peak SAR (extrapolated) = 1.46 W/kg

SAR(1 g) = 0.217 W/kg; SAR(10 g) = 0.046 W/kg

[Info: Interpolated medium parameters used for SAR evaluation.](#)

Maximum value of SAR (measured) = 0.952 W/kg

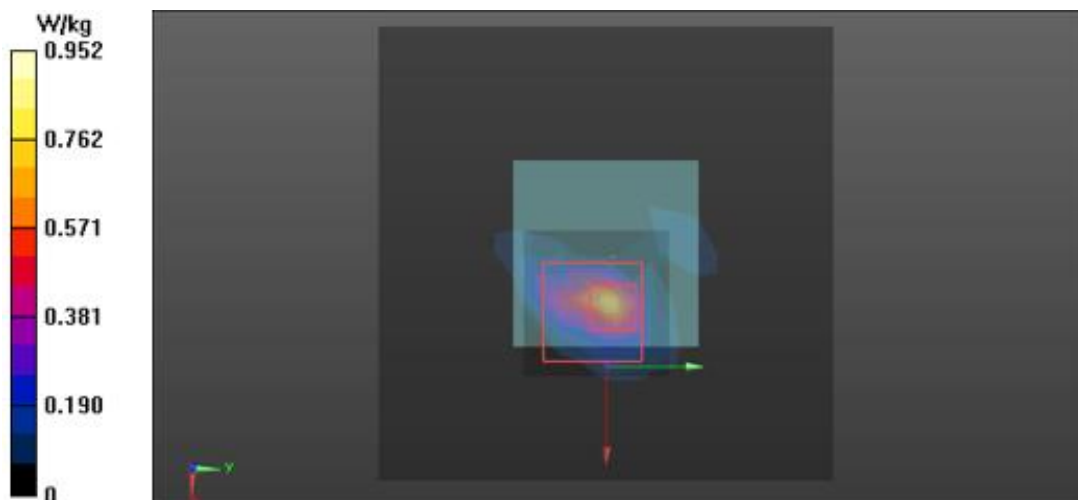

29)

Date: 2023-04-15

Test Laboratory: Eurofins KCTL Co.,Ltd.

File Name: [1. WLAN 5.8GHz.da53:0](#)

DUT: SM-R935U, Type: Smart Wearable, Serial: R3AW3004TER

Communication System: UID 0, 5GWLAN (0); Frequency: 5745 MHz; Duty Cycle: 1:1
 Medium parameters used (interpolated): $f = 5745$ MHz; $\sigma = 5.334$ S/m; $\epsilon_r = 35.149$; $\rho = 1000$ kg/m³
 Phantom section: Flat Section

DASY5 Configuration:

- Probe: EX3DV4 - SN7753;ConvF(4.4, 4.4, 4.4) @ 5745 MHz; Calibrated: 2022-11-01
- Sensor-Surface: 1.4mm (Mechanical Surface Detection)
- Electronics: DAE4 Sn1586; Calibrated: 2022-04-29
- Phantom: Twin-SAM V4.0; Type: QD 000 P40 CC; Serial: 1728
- Measurement SW: DASY52, Version 52.10 (4);

Next to Mouth/802.11_a_CH149_Front_10 mm/Area Scan (15x13x1): Measurement grid: dx=10mm, dy=10mm

Info: [Interpolated medium parameters used for SAR evaluation.](#)

Maximum value of SAR (measured) = 0.0194 W/kg

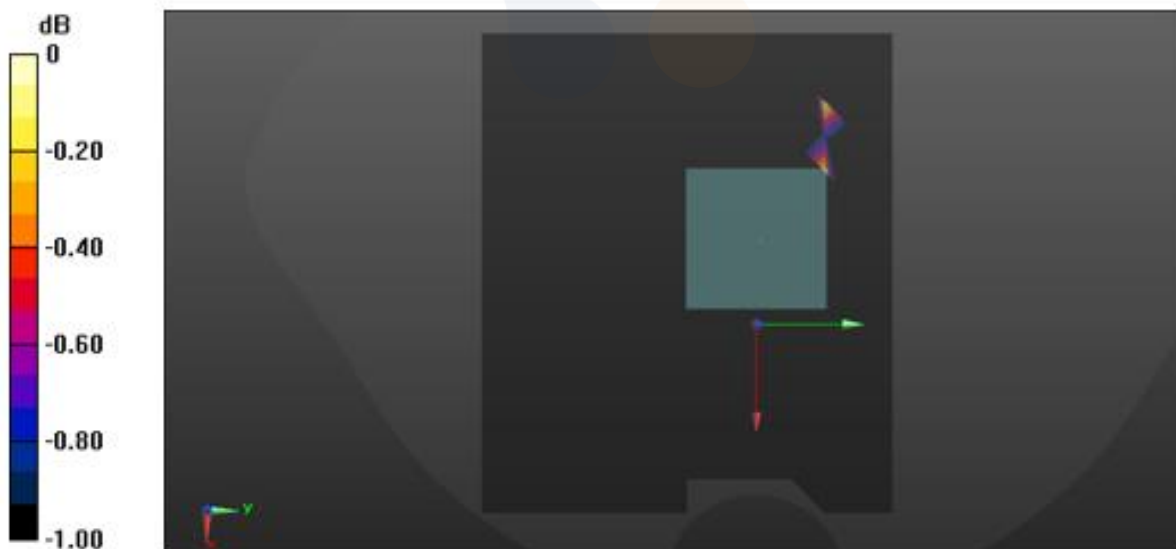

30)

Date: 2023-04-15

Test Laboratory: Eurofins KCTL Co.,Ltd.

File Name: [1. WLAN 5.8GHz.da53:1](#)

DUT: SM-R935U, Type: Smart Wearable, Serial: R3AW3004QGB

Communication System: UID 0, 5GWLAN (0); Frequency: 5745 MHz; Duty Cycle: 1:1
 Medium parameters used (interpolated): $f = 5745$ MHz; $\sigma = 5.334$ S/m; $\epsilon_r = 35.149$; $\rho = 1000$ kg/m³
 Phantom section: Flat Section

DASY5 Configuration:

- Probe: EX3DV4 - SN7753;ConvF(4.4, 4.4, 4.4) @ 5745 MHz; Calibrated: 2022-11-01
- Sensor-Surface: 1.4mm (Mechanical Surface Detection)
- Electronics: DAE4 Sn1586; Calibrated: 2022-04-29
- Phantom: Twin-SAM V4.0; Type: QD 000 P40 CC; Serial: 1728
- Measurement SW: DASY52, Version 52.10 (4);

Extremity/802.11_a_CH149_Rear_0 mm/Area Scan (11x11x1): Measurement grid: dx=10mm, dy=10mm

Info: [Interpolated medium parameters used for SAR evaluation.](#)

Maximum value of SAR (measured) = 0.543 W/kg

Extremity/802.11_a_CH149_Rear_0 mm/Zoom Scan (9x10x7)/Cube 0: Measurement grid: dx=4mm, dy=4mm, dz=1.4mm

Reference Value = 7.135 V/m; Power Drift = 0.08 dB

Peak SAR (extrapolated) = 1.87 W/kg

SAR(1 g) = 0.234 W/kg; SAR(10 g) = 0.044 W/kg

Info: [Interpolated medium parameters used for SAR evaluation.](#)

Maximum value of SAR (measured) = 0.953 W/kg

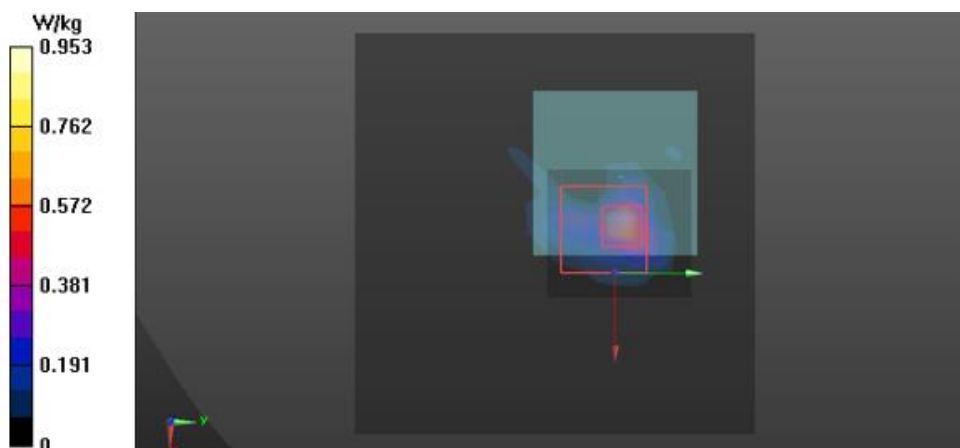

31)

Date: 2023-05-08

Test Laboratory: Eurofins KCTL Co.,Ltd.

File Name: [1. Bluetooth.da53:0](#)

DUT: SM-R935U, Type: Smart Wearable, Serial: R3AW400NBGT

Communication System: UID 0, Bluetooth (0); Frequency: 2441 MHz; Duty Cycle: 1:1.30167
 Medium parameters used (interpolated): $f = 2441$ MHz; $\sigma = 1.84$ S/m; $\epsilon_r = 39.168$; $\rho = 1000$ kg/m³
 Phantom section: Flat Section

DASY5 Configuration:

- Probe: EX3DV4 - SN7753;ConvF(7.02, 7.02, 7.02) @ 2441 MHz; Calibrated: 2022-11-01
- Sensor-Surface: 1.4mm (Mechanical Surface Detection)
- Electronics: DAE4 Sn1567; Calibrated: 2023-03-22
- Phantom: Twin-SAM V4.0; Type: QD 000 P40 CC; Serial: 1728
- Measurement SW: DASY52, Version 52.10 (4);

Next to Mouth/Bluetooth_DH5_BDR_CH39_Front_10 mm/Area Scan (9x9x1): Measurement grid:
 dx=12mm, dy=12mm

Info: [Interpolated medium parameters used for SAR evaluation.](#)

Maximum value of SAR (measured) = 0.0586 W/kg

Next to Mouth/Bluetooth_DH5_BDR_CH39_Front_10 mm/Zoom Scan (7x7x7)/Cube 0: Measurement
 grid: dx=5mm, dy=5mm, dz=5mm

Reference Value = 5.358 V/m; Power Drift = 0.07 dB

Peak SAR (extrapolated) = 0.0790 W/kg

SAR(1 g) = 0.042 W/kg; SAR(10 g) = 0.021 W/kg

Info: [Interpolated medium parameters used for SAR evaluation.](#)

Maximum value of SAR (measured) = 0.0644 W/kg

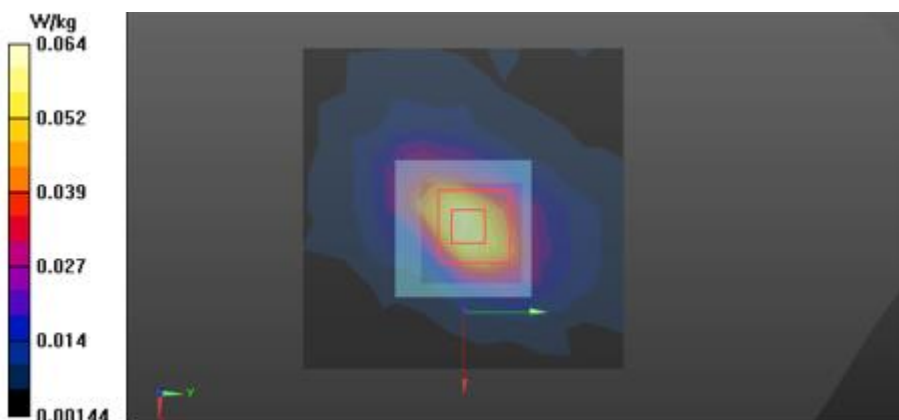

32)

Date: 2023-05-08

Test Laboratory: Eurofins KCTL Co.,Ltd.

File Name: [1. Bluetooth.da53:1](#)

DUT: SM-R935U, Type: Smart Wearable, Serial: R3AW400N96L

Communication System: UID 0, Bluetooth (0); Frequency: 2441 MHz; Duty Cycle: 1:1.30167
 Medium parameters used (interpolated): $f = 2441$ MHz; $\sigma = 1.84$ S/m; $\epsilon_r = 39.168$; $\rho = 1000$ kg/m³
 Phantom section: Flat Section

DASY5 Configuration:

- Probe: EX3DV4 - SN7753;ConvF(7.02, 7.02, 7.02) @ 2441 MHz; Calibrated: 2022-11-01
- Sensor-Surface: 1.4mm (Mechanical Surface Detection)
- Electronics: DAE4 Sn1567; Calibrated: 2023-03-22
- Phantom: Twin-SAM V4.0; Type: QD 000 P40 CC; Serial: 1728
- Measurement SW: DASY52, Version 52.10 (4);

Extremity/Bluetooth_DH5_BDR_CH39_Rear_0 mm/Area Scan (8x8x1): Measurement grid: dx=12mm, dy=12mm

[Info: Interpolated medium parameters used for SAR evaluation.](#)

Maximum value of SAR (measured) = 0.744 W/kg

Extremity/Bluetooth_DH5_BDR_CH39_Rear_0 mm/Zoom Scan (7x7x7)/Cube 0: Measurement grid: dx=5mm, dy=5mm, dz=5mm

Reference Value = 19.51 V/m; Power Drift = 0.03 dB

Peak SAR (extrapolated) = 1.03 W/kg

SAR(1 g) = 0.376 W/kg; SAR(10 g) = 0.140 W/kg

[Info: Interpolated medium parameters used for SAR evaluation.](#)

Maximum value of SAR (measured) = 0.685 W/kg

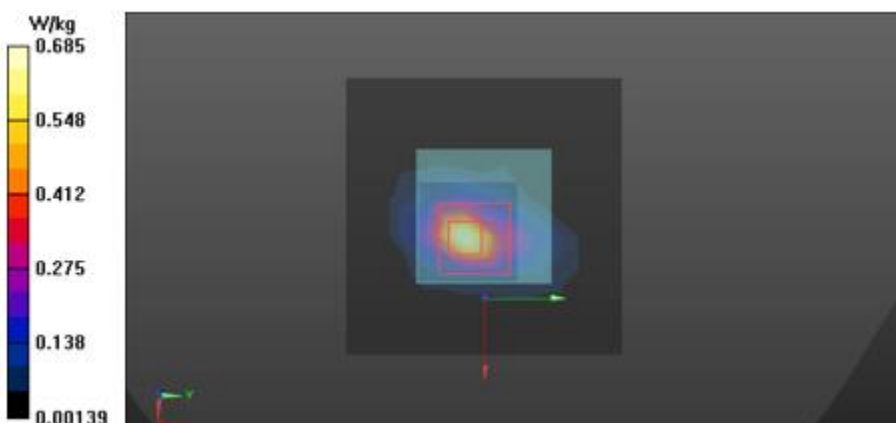

Appendixes List

<p>Appendix A</p>	<p>A.1 Probe Calibration certificate (EX3DV4_3865) A.2 Probe Calibration certificate (EX3DV4_7753) A.3 Dipole Calibration certificate (D750V3_1183) A.4 Dipole Calibration certificate (D850V2_1006) A.5 Dipole Calibration certificate (D1750V2_1072) A.6 Dipole Calibration certificate (D1900V2_5d160) A.7 Dipole Calibration certificate (D2450V2_895) A.8 Dipole Calibration certificate (D2600V2_1050) A.9 Dipole Calibration certificate (D5GHzV2_1293)</p>
<p>Appendix B</p>	<p>SAR Tissue Specification</p>
<p>Appendix C</p>	<p>#Antenna Location & Distance</p>
<p>Appendix D</p>	<p>EUT Photo</p>
<p>Appendix E</p>	<p>Test Setup Photo</p>