

Test mode: LTE B66/4

1.4M BW QPSK

Low channel 1RB



High channel 1RB

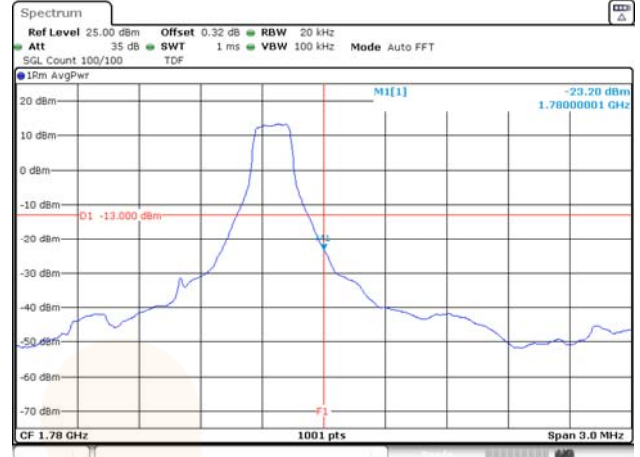

Low channel FRB



High channel FRB

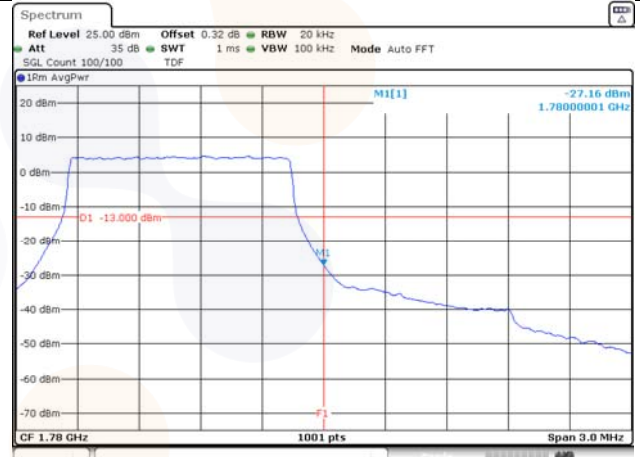

3M BW QPSK

Low channel 1RB

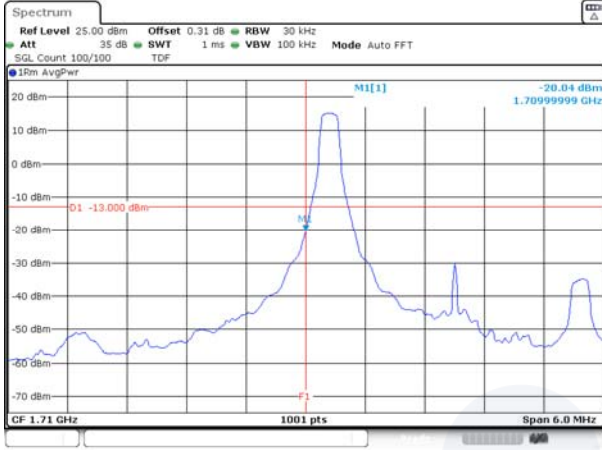

High channel 1RB

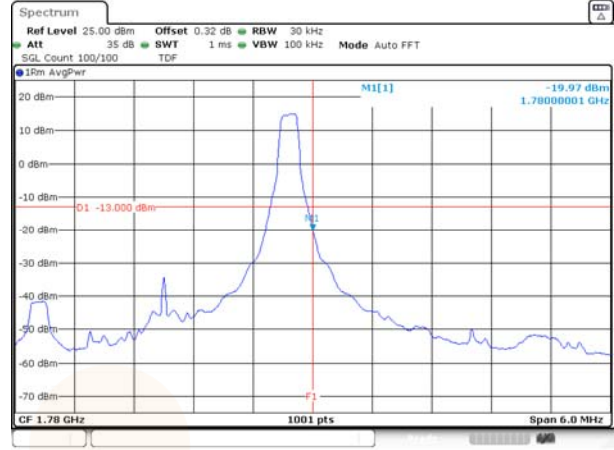

Low channel FRB



High channel FRB

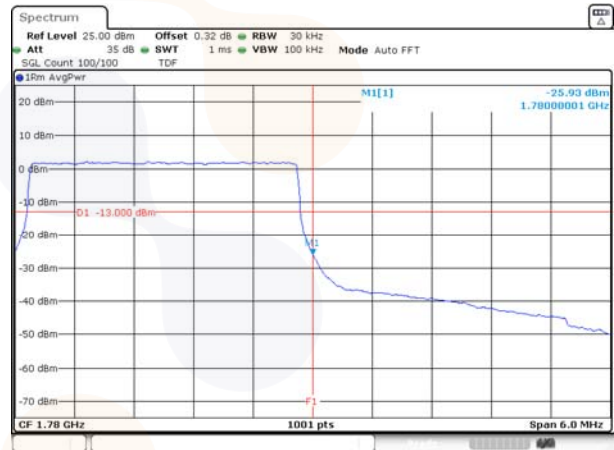

5M BW QPSK

Low channel 1RB

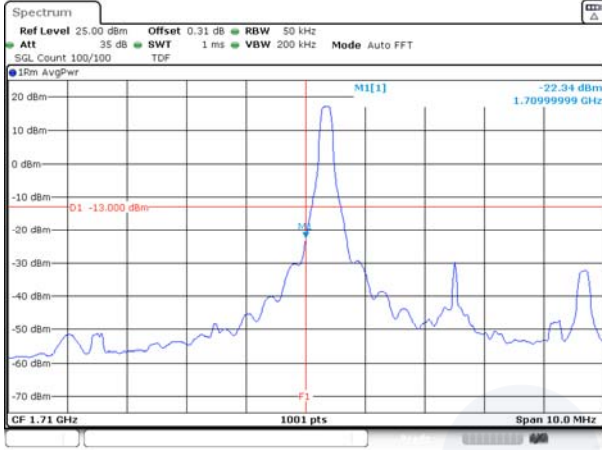

High channel 1RB

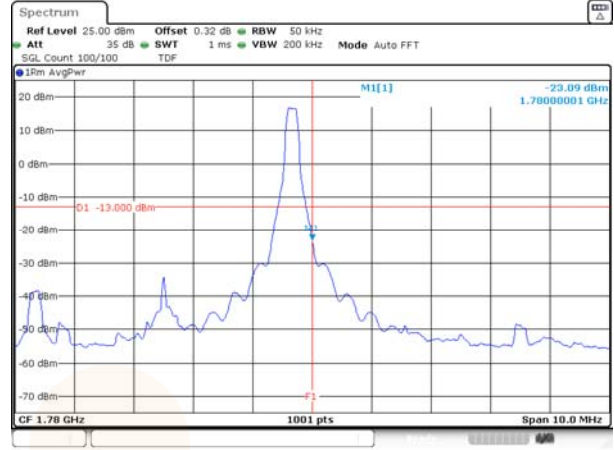

Low channel FRB

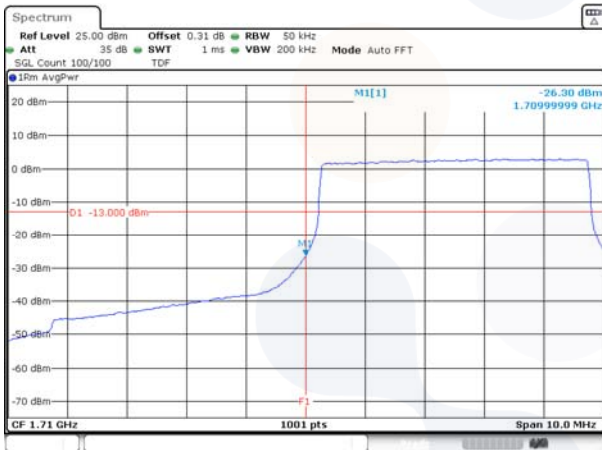

High channel FRB

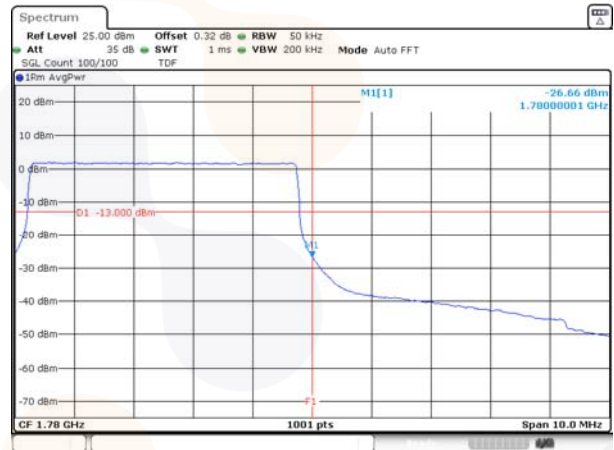

10M BW QPSK

Low channel 1RB

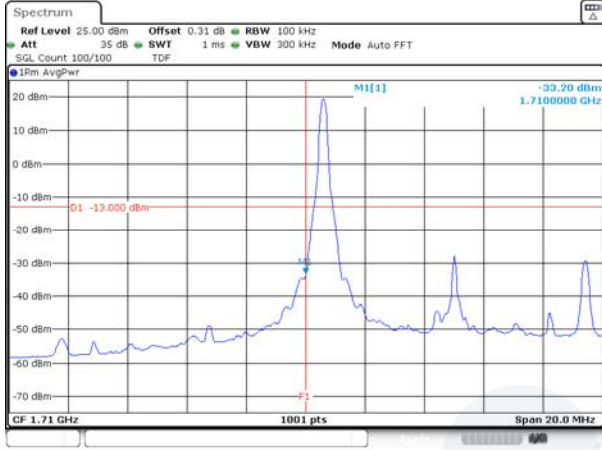

High channel 1RB

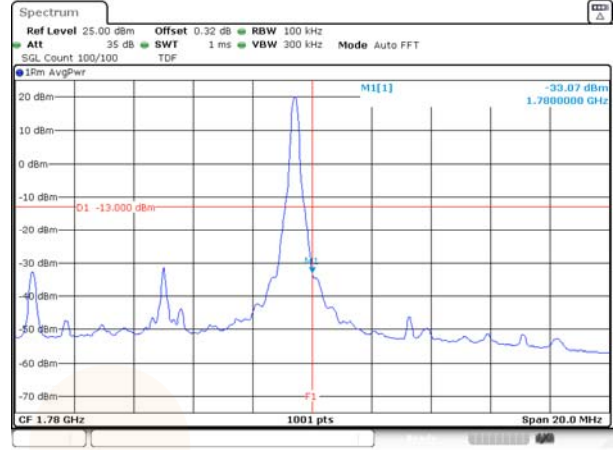

Low channel FRB



High channel FRB

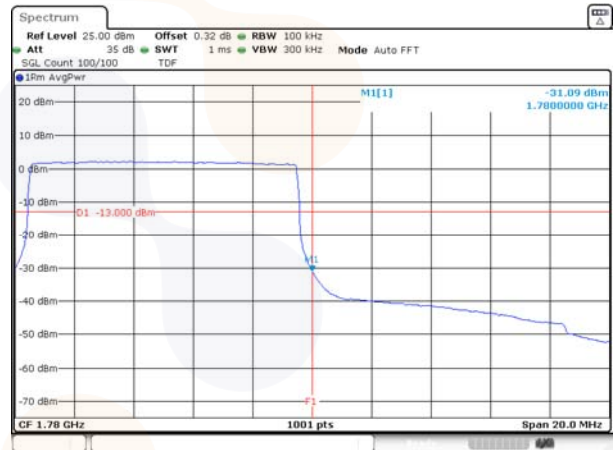

15M BW QPSK

Low channel 1RB

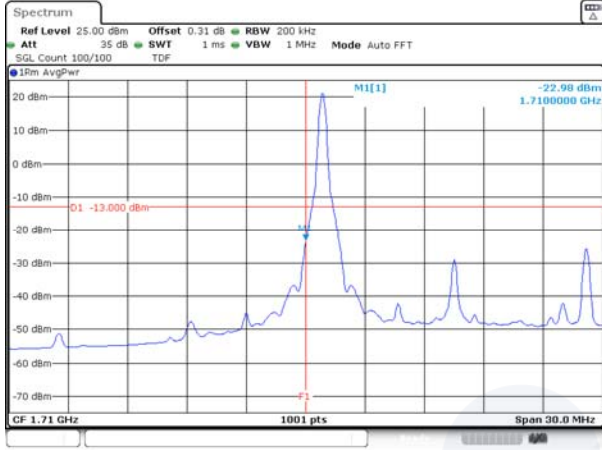

High channel 1RB

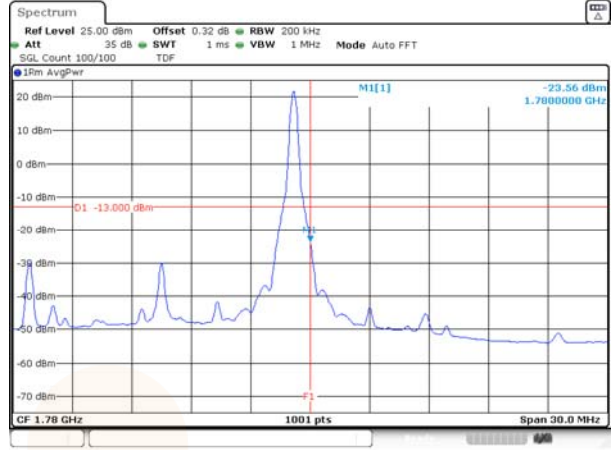

Low channel FRB



High channel FRB

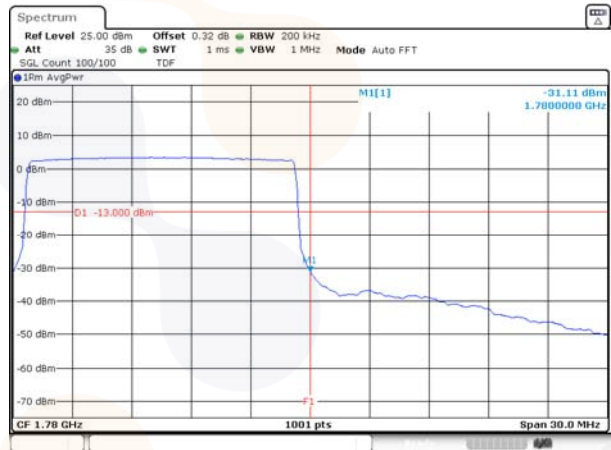

20M BW QPSK

Low channel 1RB

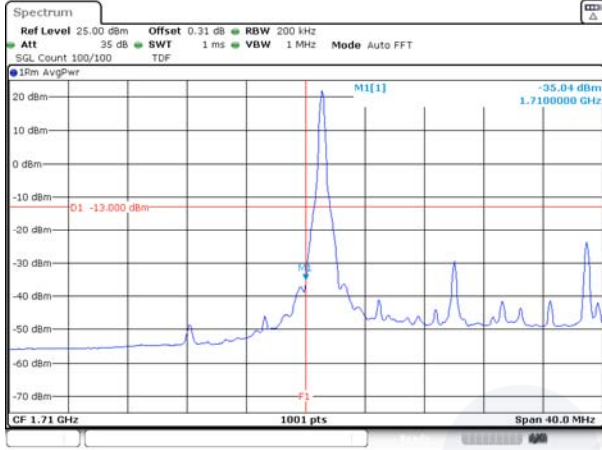

High channel 1RB

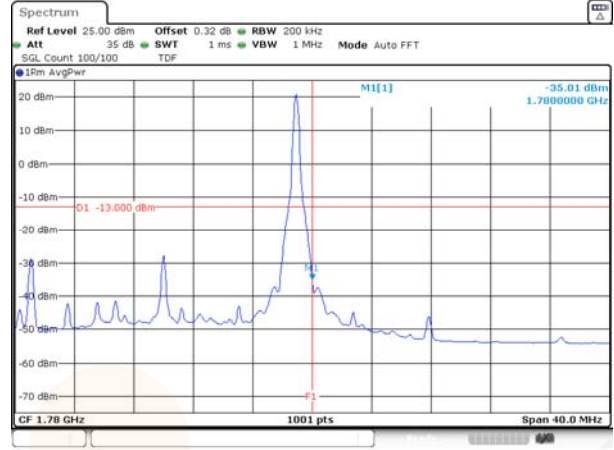

Low channel FRB

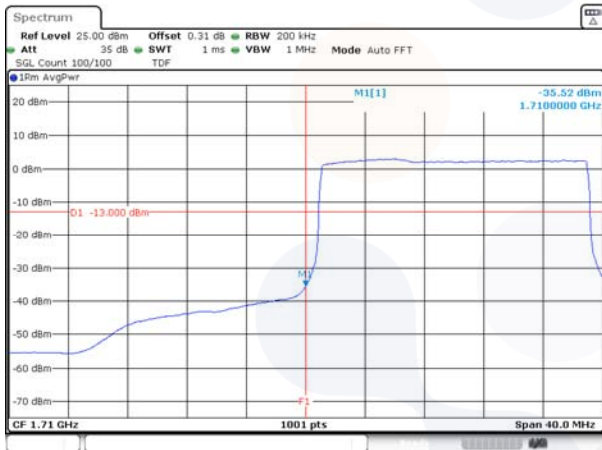

High channel FRB

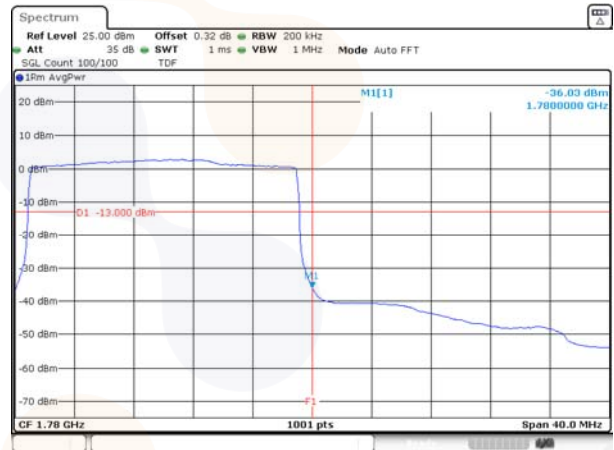

Test mode: LTE B71

5M BW QPSK

Low channel 1RB



High channel 1RB



Low channel FRB



High channel FRB



5M BW QPSK

Lower extended 1RB



Upper extended 1RB



Lower extended FRB

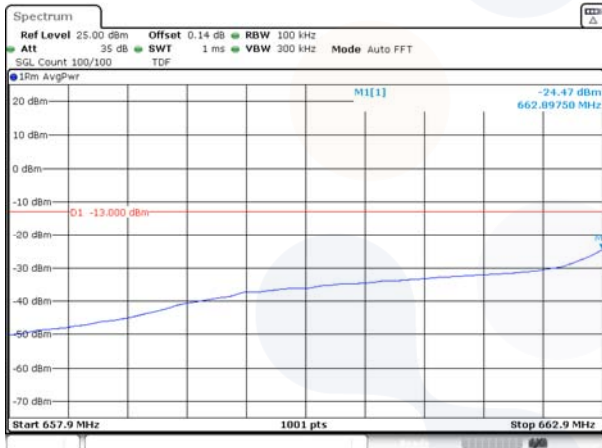

Upper extended FRB

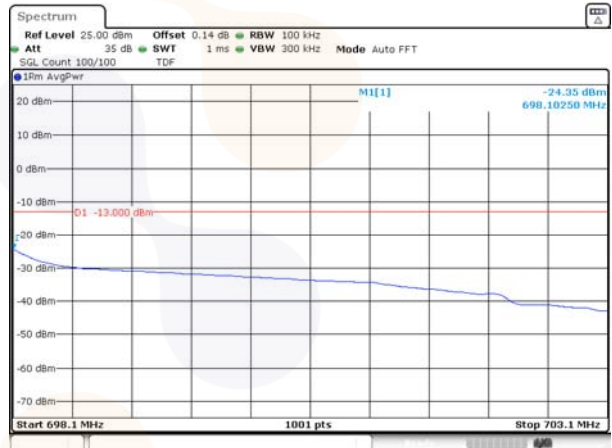

10M BW QPSK

Low channel 1RB

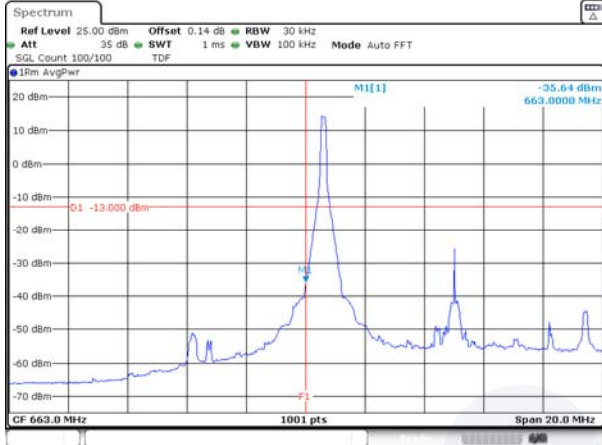

High channel 1RB

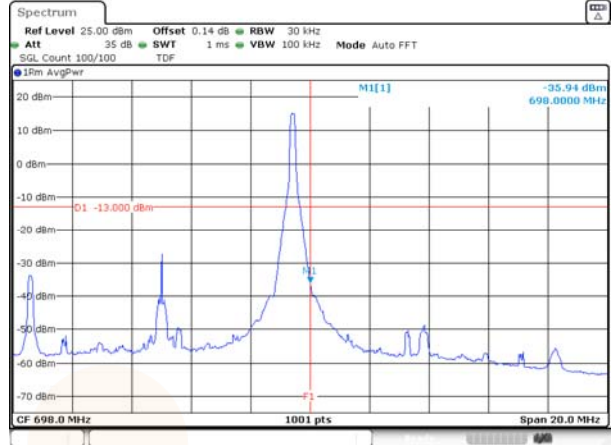

Low channel FRB



High channel FRB



10M BW QPSK

Lower extended 1RB



Upper extended 1RB

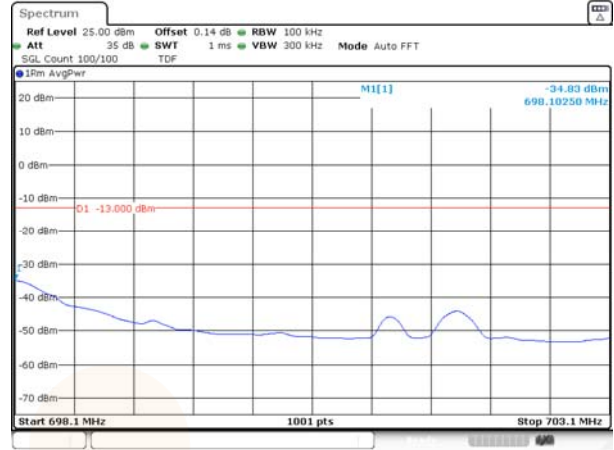

Lower extended FRB

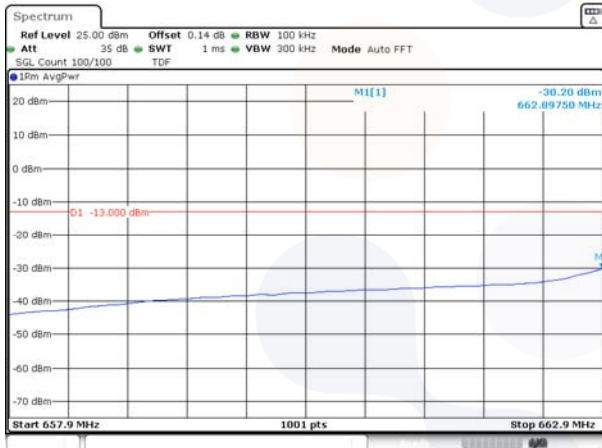

Upper extended FRB

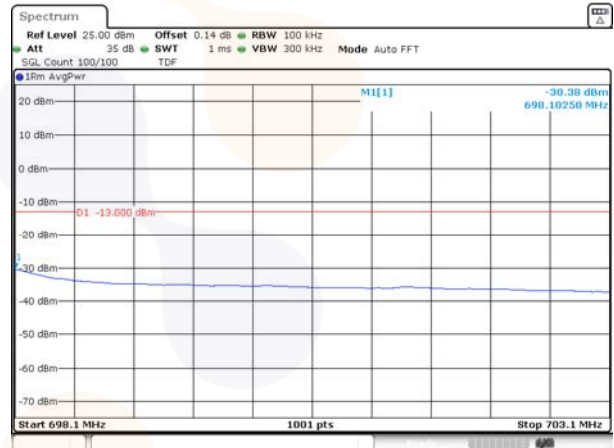

15M BW QPSK

Low channel 1RB

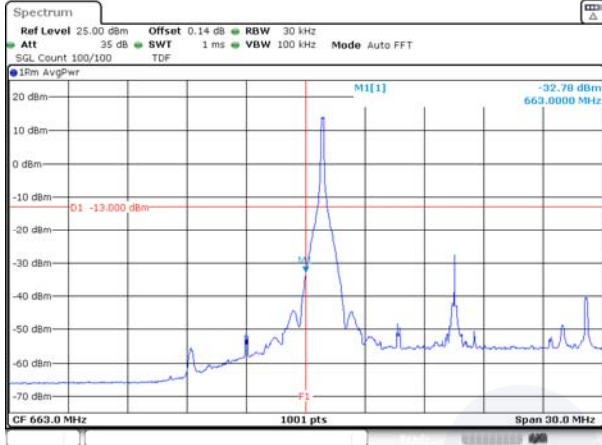

High channel 1RB

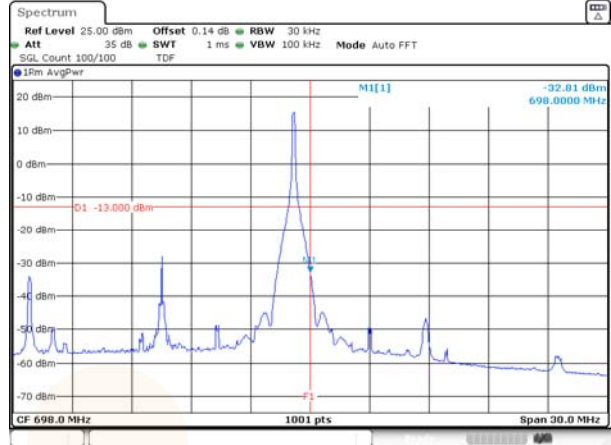

Low channel FRB



High channel FRB



15M BW QPSK

Lower extended 1RB



Upper extended 1RB



Lower extended FRB

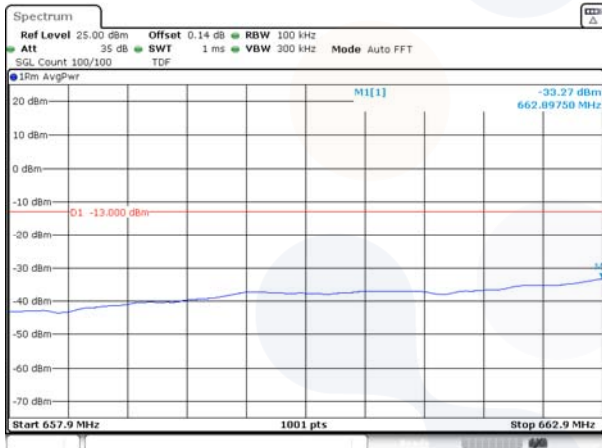

Upper extended FRB

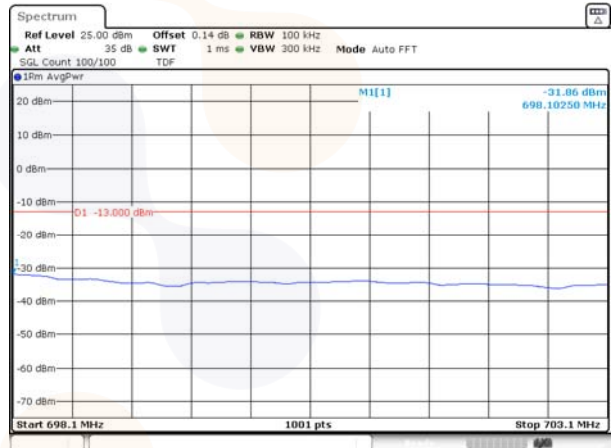

20M BW QPSK

Low channel 1RB

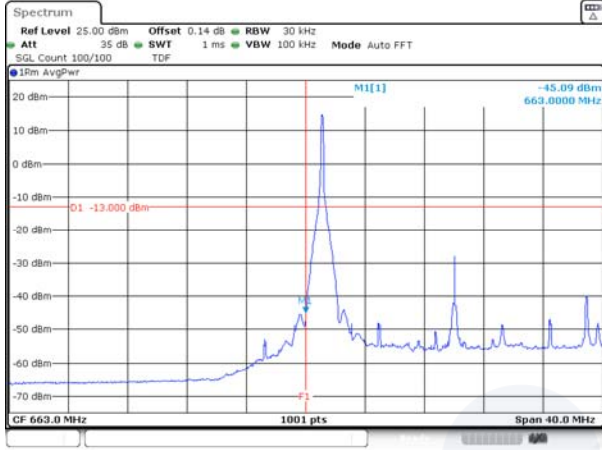

High channel 1RB

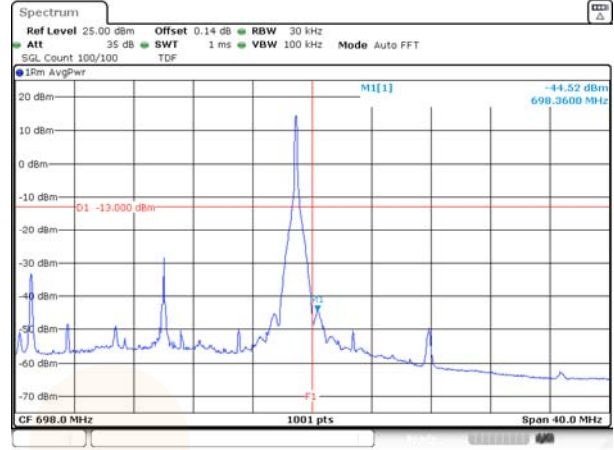

Low channel FRB

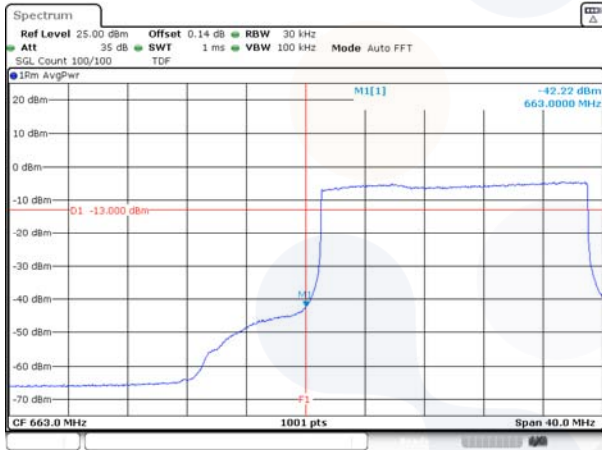

High channel FRB



20M BW QPSK

Lower extended 1RB



Upper extended 1RB



Lower extended FRB

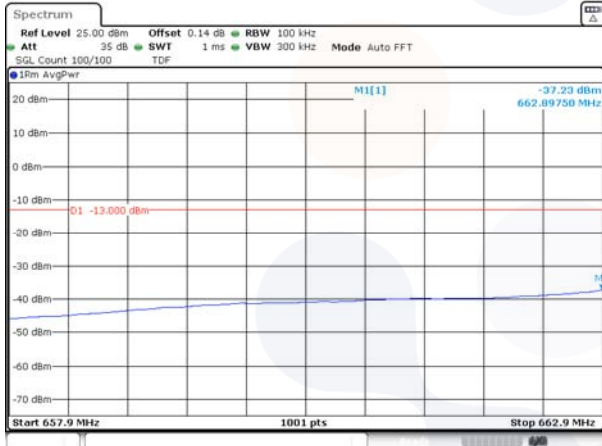

Upper extended FRB

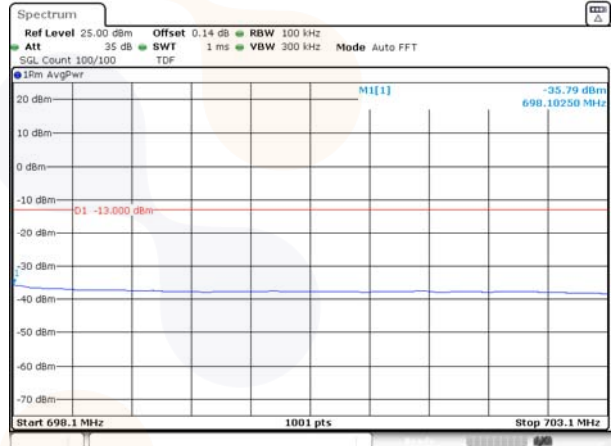

7.4. Spurious Emissions at Antenna Terminal

Test setup

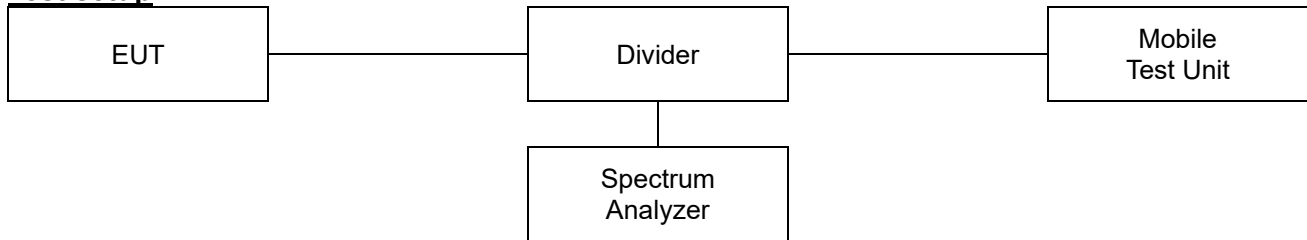

Limit

According to §27.53(c)(2),

For operations in the 746–758 MHz band and the 776–788 MHz band, the power of any emission outside the licensee's frequency band(s) of operation shall be attenuated below the transmitter power (P) within the licensed band(s) of operation, measured in watts, in accordance with the following:

- (1) On any frequency outside the 746–758 MHz band, the power of any emission shall be attenuated outside the band below the transmitter power (P) by at least $43 + 10 \log (P)$ dB;
- (2) On any frequency outside the 776–788 MHz band, the power of any emission shall be attenuated outside the band below the transmitter power (P) by at least $43 + 10 \log (P)$ dB;
- (3) On all frequencies between 763–775 MHz and 793–805 MHz, by a factor not less than $76 + 10 \log (P)$ dB in a 6.25 kHz band segment, for base and fixed stations;
- (4) On all frequencies between 763–775 MHz and 793–805 MHz, by a factor not less than $65 + 10 \log (P)$ dB in a 6.25 kHz band segment, for mobile and portable stations;
- (5) Compliance with the provisions of paragraphs (c)(1) and (c)(2) of this section is based on the use of measurement instrumentation employing a resolution bandwidth of 100 kHz or greater. However, in the 100 kHz bands immediately outside and adjacent to the frequency block, a resolution bandwidth of at least 30 kHz may be employed;
- (6) Compliance with the provisions of paragraphs (c)(3) and (c)(4) of this section is based on the use of measurement instrumentation such that the reading taken with any resolution bandwidth setting should be adjusted to indicate spectral energy in a 6.25 kHz segment

According to §27.53(g),

For operations in the 600 MHz band and the 698-746 MHz band, the power of any emission outside a licensee's frequency band(s) of operation shall be attenuated below the transmitter power (P) within the licensed band(s) of operation, measured in watts, by at least $43 + 10 \log (P_{\text{Watts}})$ dB.

According to §27.53(h),

The power of any emission outside a licensee's frequency block shall be attenuated below the transmitter power (P) in watts by at least $43 + 10 \log (P_{\text{Watts}})$ dB.

Test procedure

971168 D01 v03r01 - Section 6
ANSI 63.26-2015 – Section 5.7

Test settings

- 1) Start frequency was set to 30 MHz and stop frequency was set to at least 10th the fundamental frequency.
- 2) Detector = RMS
- 3) Sweep time = auto couple.
- 4) Trace mode = trace average
- 5) Allow trace to fully stabilize.
- 6) Please see test notes below RBW and VBW settings.

Notes:

1. Per 27.53(c), 27.53(g), 27.53(h)(3), compliance with these provisions is based on the use of measurement instrumentation employing a resolution bandwidth of 100 kHz or greater for frequencies less than 1 GHz and 1 MHz or greater for frequencies greater than 1 GHz.
The emission bandwidth is defined as the width of the signal between two points, one below the carrier center frequency and one above the carrier center frequency, outside of which all emissions are attenuated at least 26 dB below the transmitter power.
2. All modes of operation were investigated and the worst-case configuration results are reported.

Test results

Test mode: WCDMA 1700

RMC

Low channel (30 MHz ~ 10 GHz)

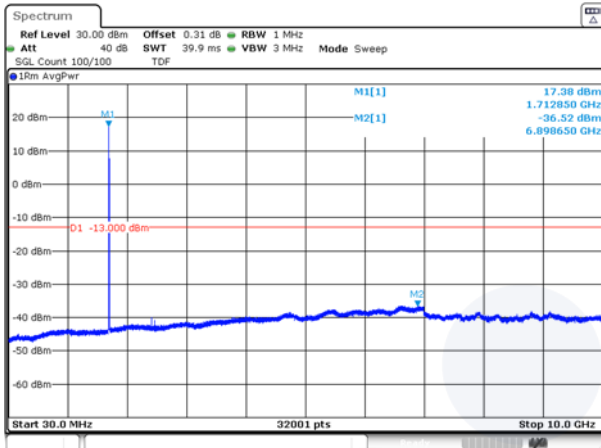

Low channel (10 GHz ~ 20 GHz)

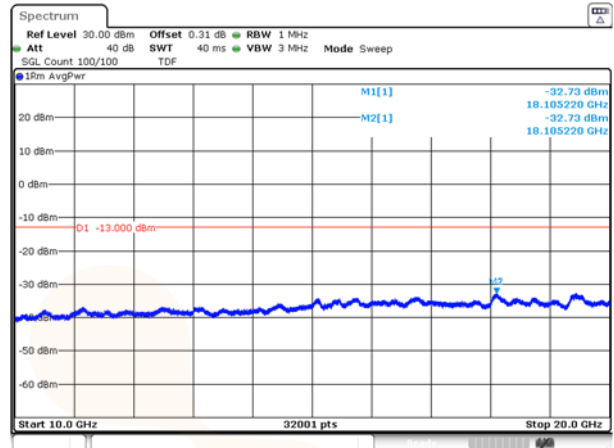

Middle channel (30 MHz ~ 10 GHz)

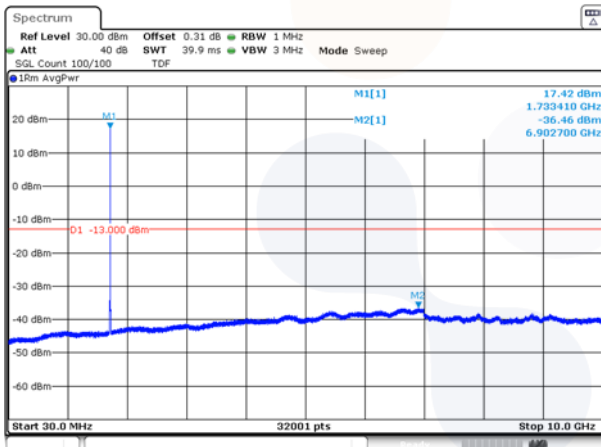

Middle channel (10 GHz ~ 20 GHz)

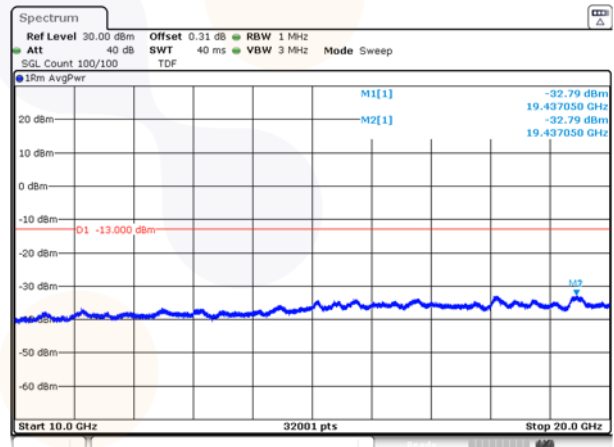

High channel (30 MHz ~ 10 GHz)

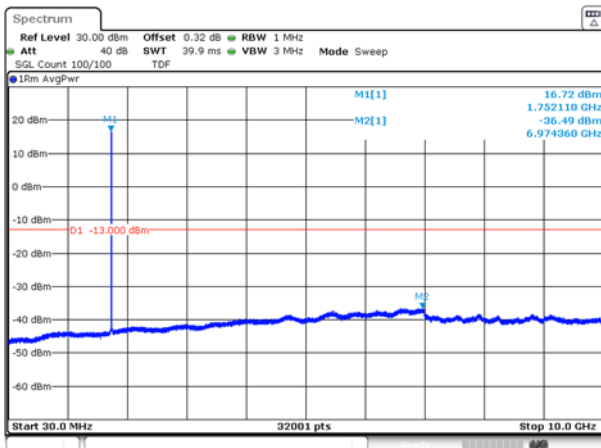

High channel (10 GHz ~ 20 GHz)

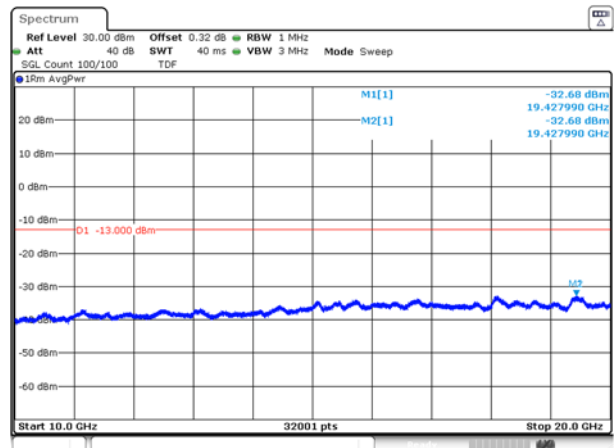

Test mode: LTE B12

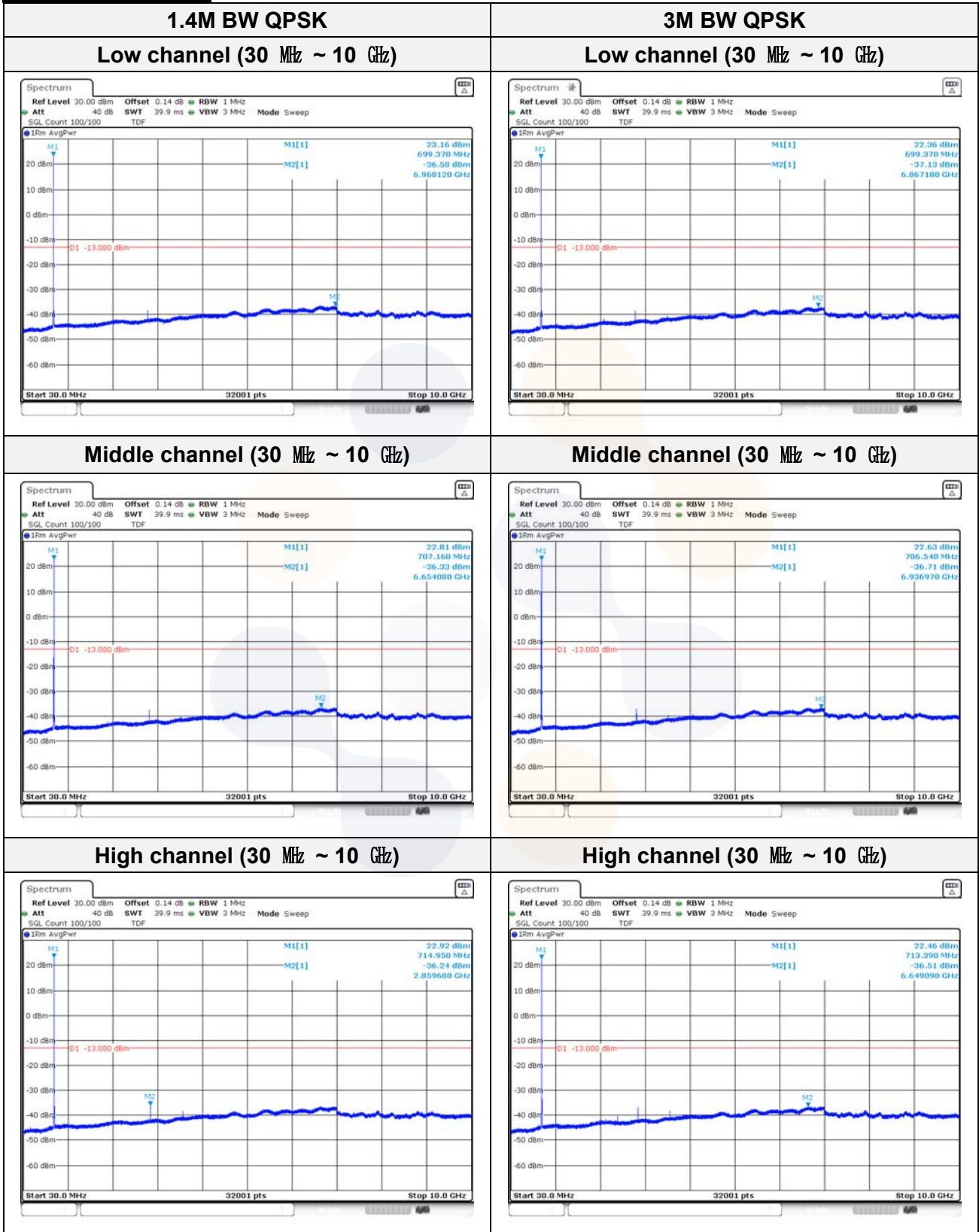

5M BW QPSK

Low channel (30 MHz ~ 10 GHz)

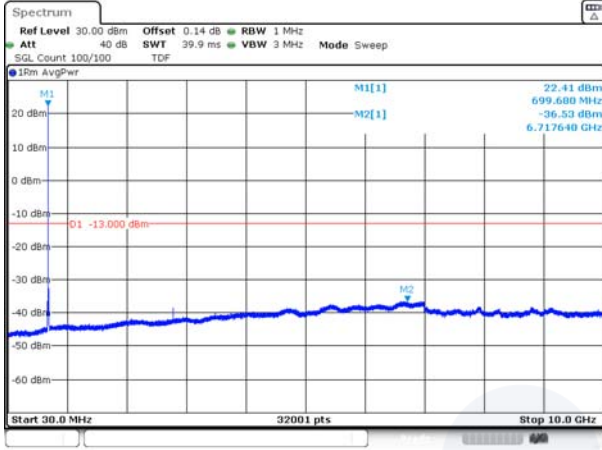

10M BW QPSK

Low channel (30 MHz ~ 10 GHz)

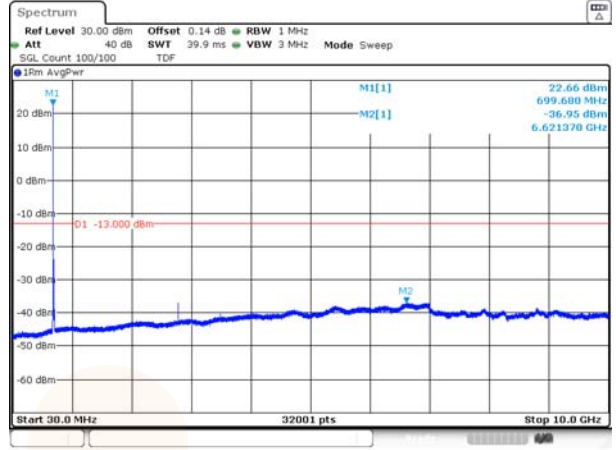

Middle channel (30 MHz ~ 10 GHz)

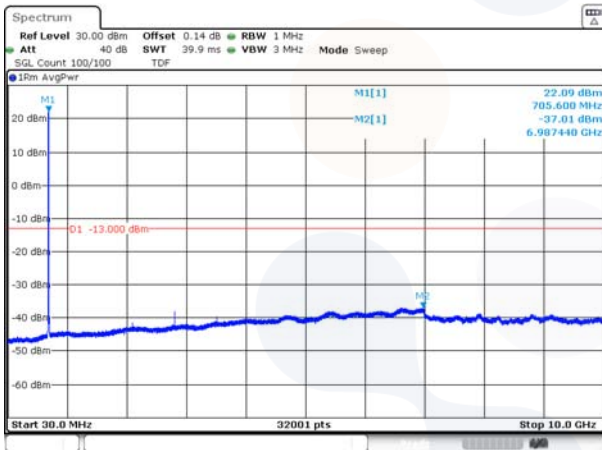

Middle channel (30 MHz ~ 10 GHz)

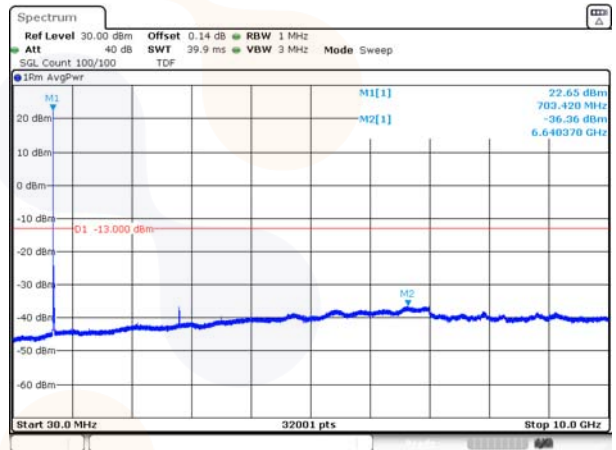

High channel (30 MHz ~ 10 GHz)

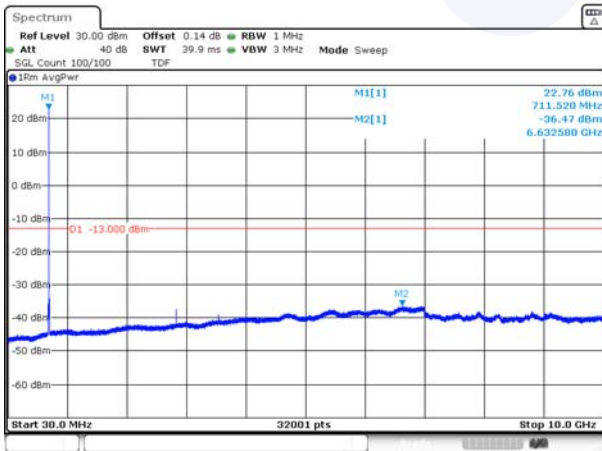

High channel (30 MHz ~ 10 GHz)

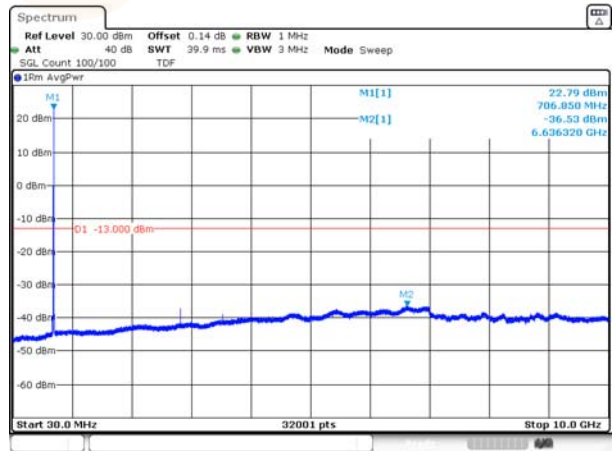

Test mode: LTE B13

5M BW QPSK	10M BW QPSK
<p align="center">Low channel (30 MHz ~ 10 GHz)</p>	<p align="center">Middle channel (30 MHz ~ 10 GHz)</p>
<p align="center">Middle channel (30 MHz ~ 10 GHz)</p>	<p align="center">-</p>
	<p align="center">Blank</p>
<p align="center">High channel (30 MHz ~ 10 GHz)</p>	<p align="center">-</p>
	<p align="center">Blank</p>

Test mode: LTE B66/4

1.4M BW QPSK

Low channel (30 MHz ~ 10 GHz)

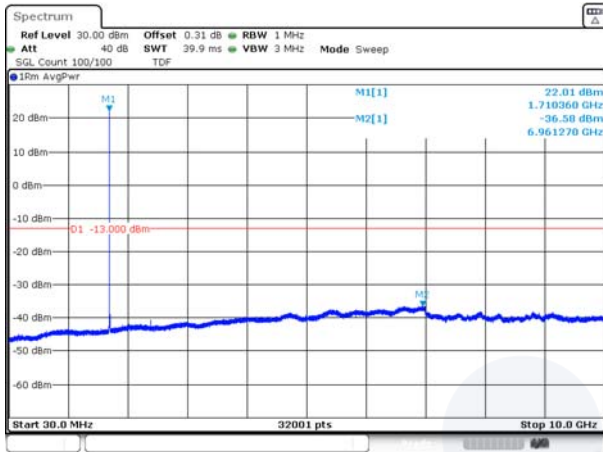

Low channel (10 GHz ~ 20 GHz)

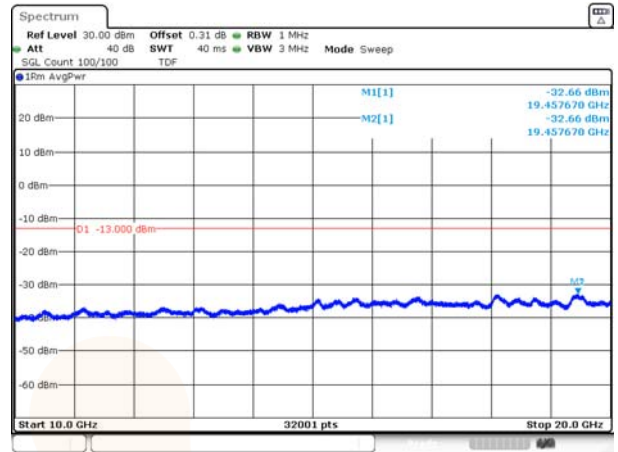

Middle channel (30 MHz ~ 10 GHz)

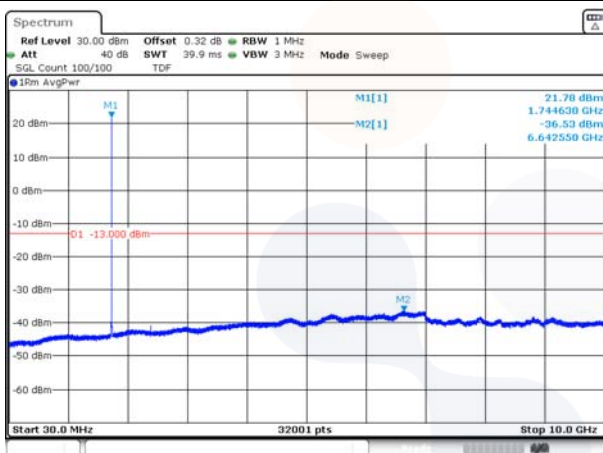

Middle channel (10 GHz ~ 20 GHz)

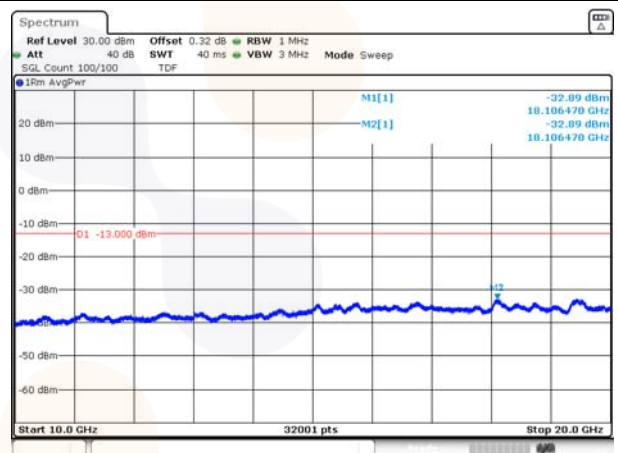

High channel (30 MHz ~ 10 GHz)

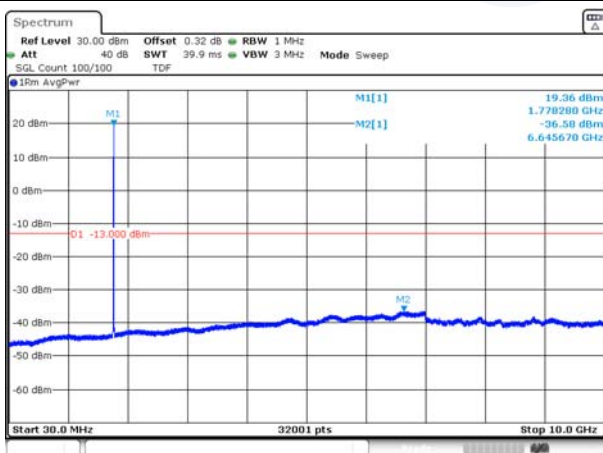

High channel (10 GHz ~ 20 GHz)

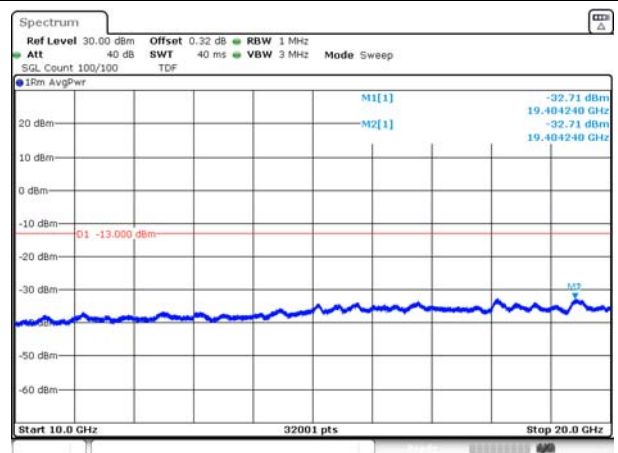

3M BW QPSK

Low channel (30 MHz ~ 10 GHz)

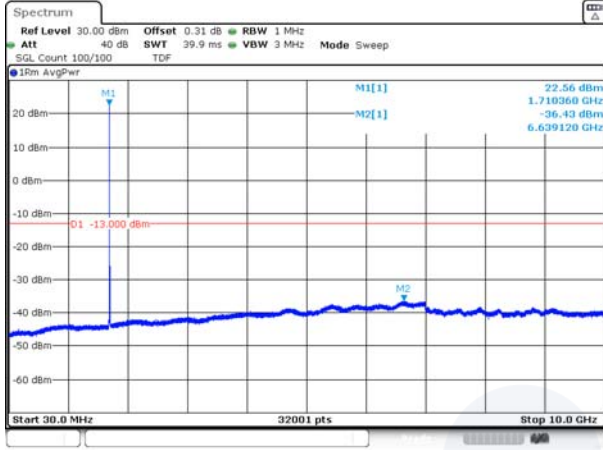

Low channel (10 GHz ~ 20 GHz)

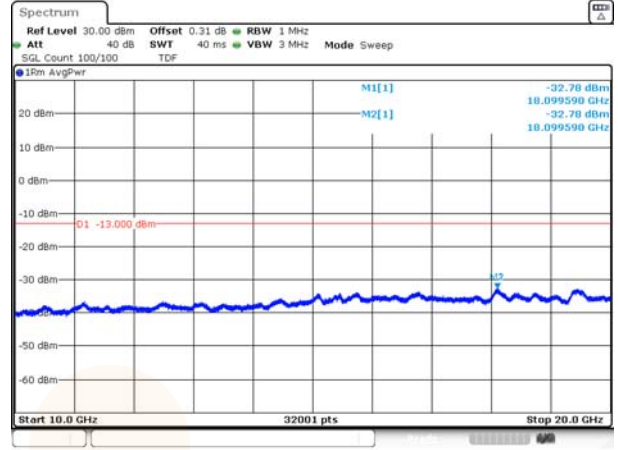

Middle channel (30 MHz ~ 10 GHz)

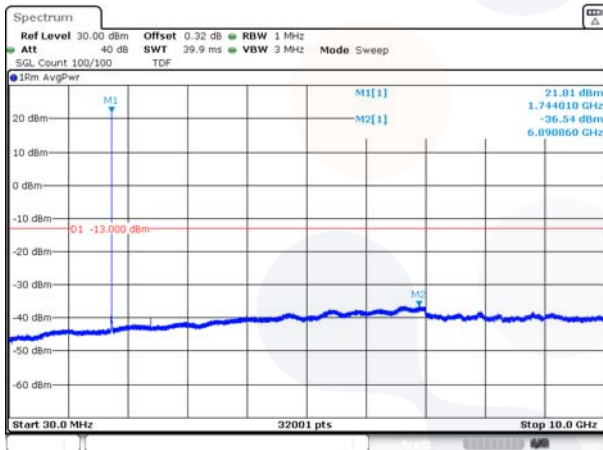

Middle channel (10 GHz ~ 20 GHz)

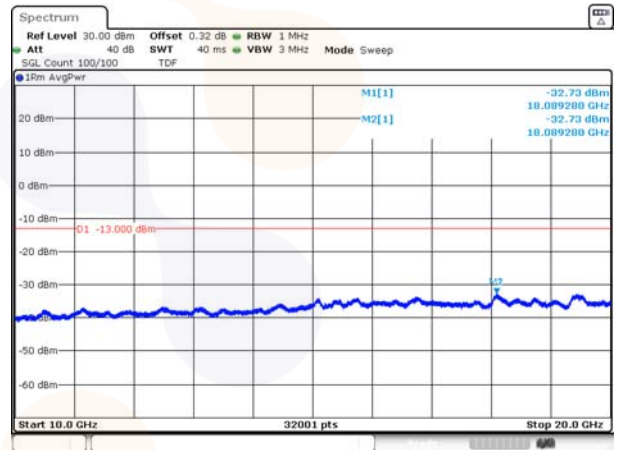

High channel (30 MHz ~ 10 GHz)

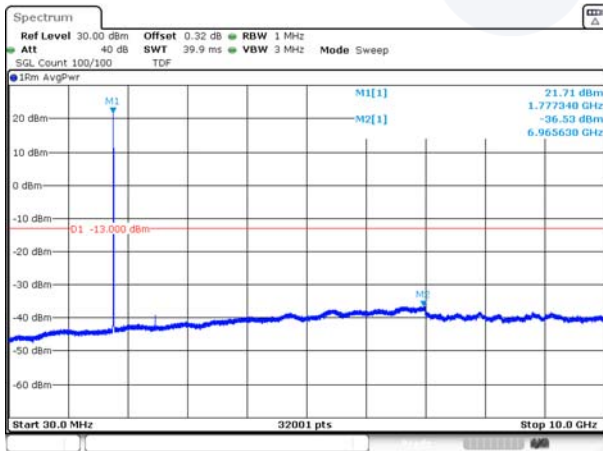

High channel (10 GHz ~ 20 GHz)

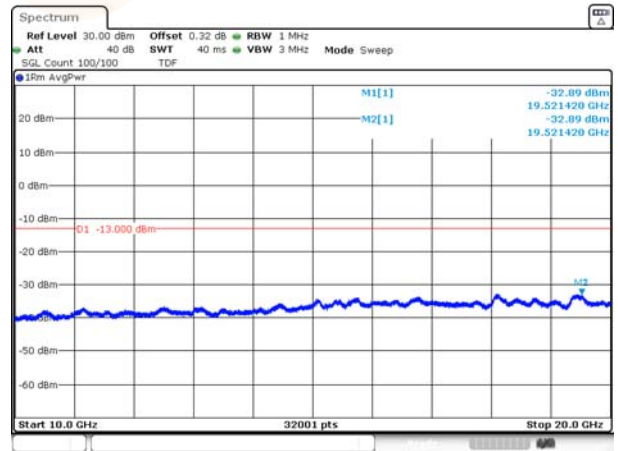

5M BW QPSK

Low channel (30 MHz ~ 10 GHz)

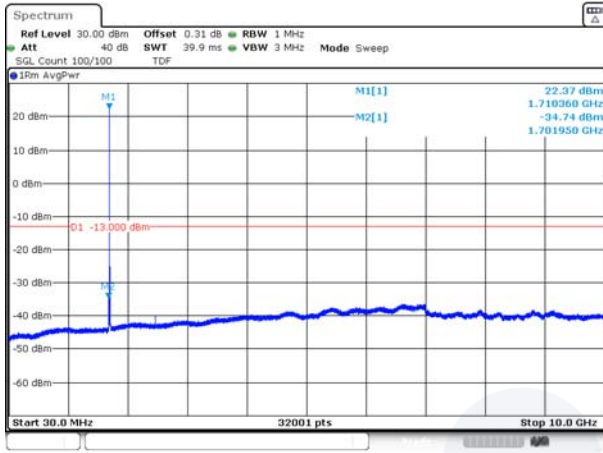

Low channel (10 GHz ~ 20 GHz)

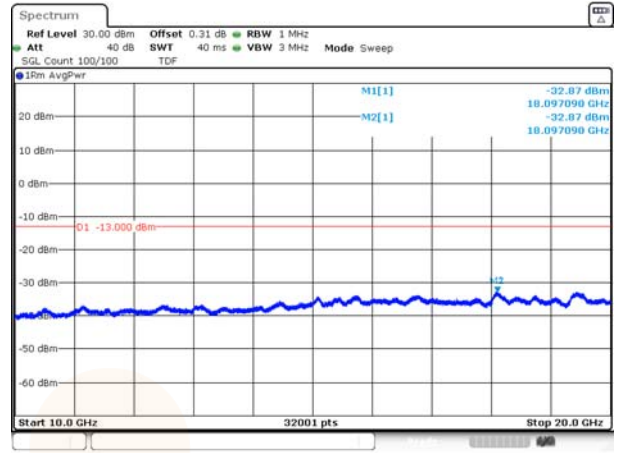

Middle channel (30 MHz ~ 10 GHz)

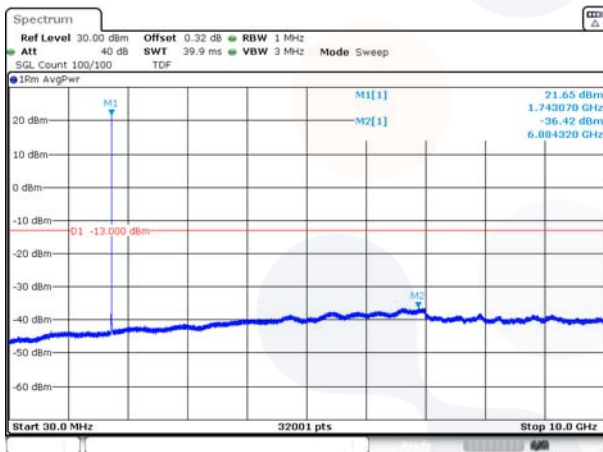

Middle channel (10 GHz ~ 20 GHz)

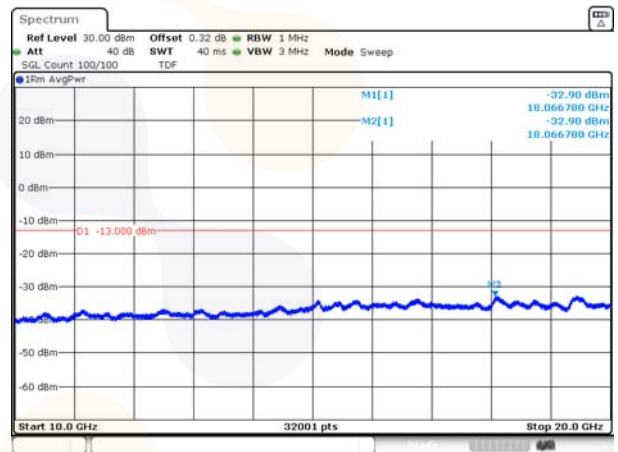

High channel (30 MHz ~ 10 GHz)

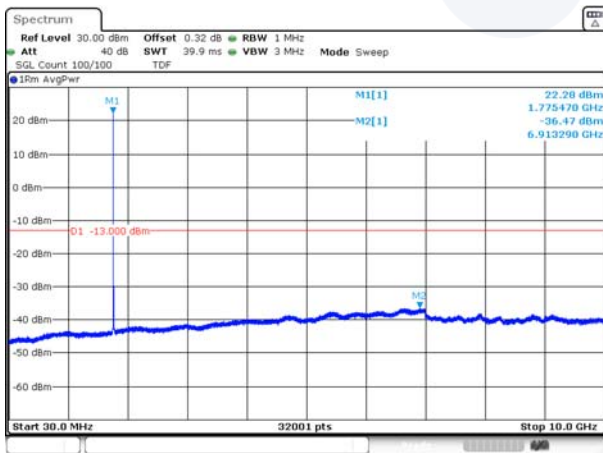

High channel (10 GHz ~ 20 GHz)

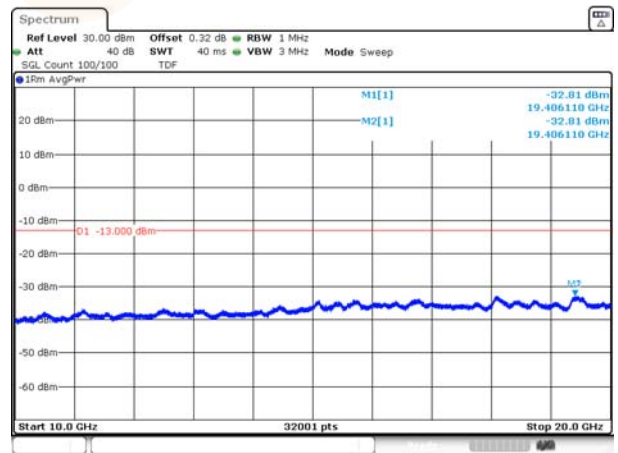

10M BW QPSK

Low channel (30 MHz ~ 10 GHz)

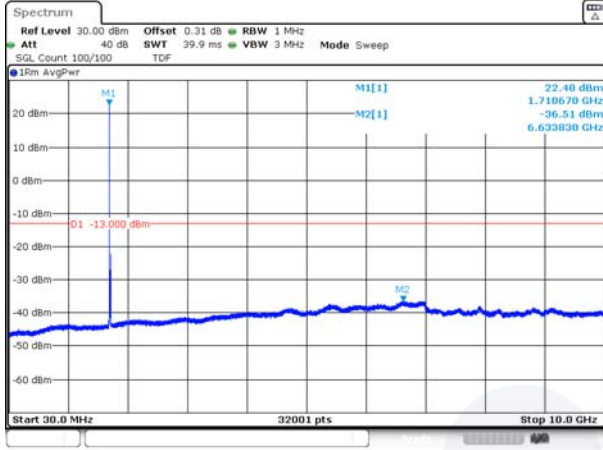

Low channel (10 GHz ~ 20 GHz)

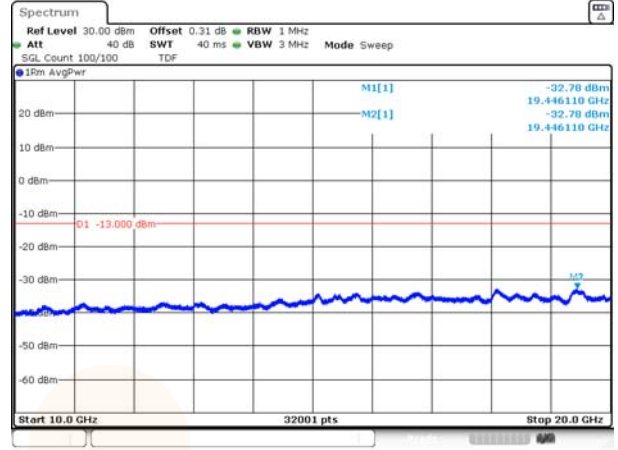

Middle channel (30 MHz ~ 10 GHz)

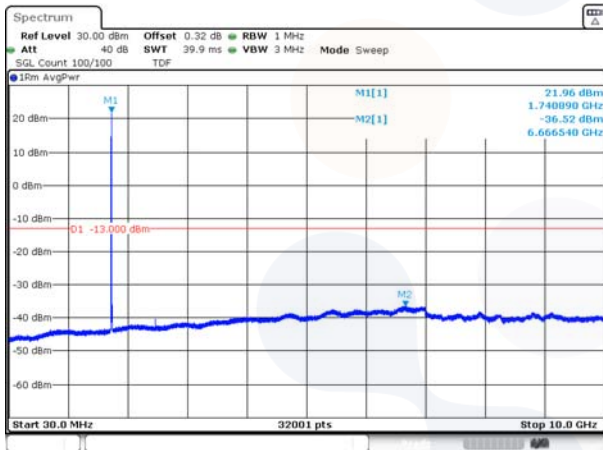

Middle channel (10 GHz ~ 20 GHz)

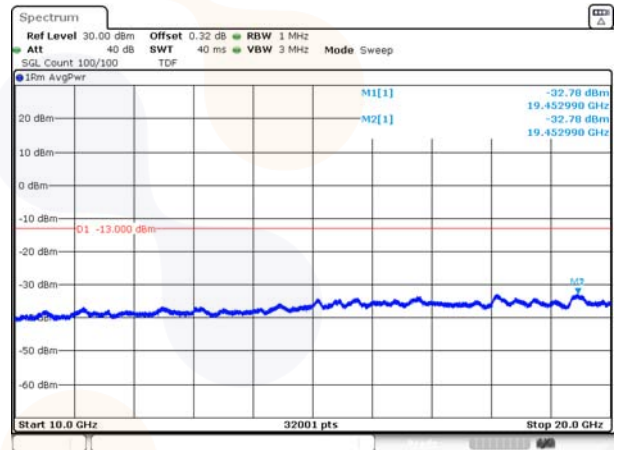

High channel (30 MHz ~ 10 GHz)

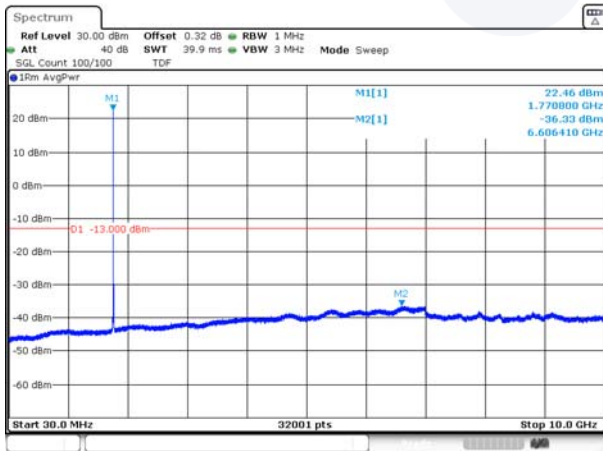

High channel (10 GHz ~ 20 GHz)

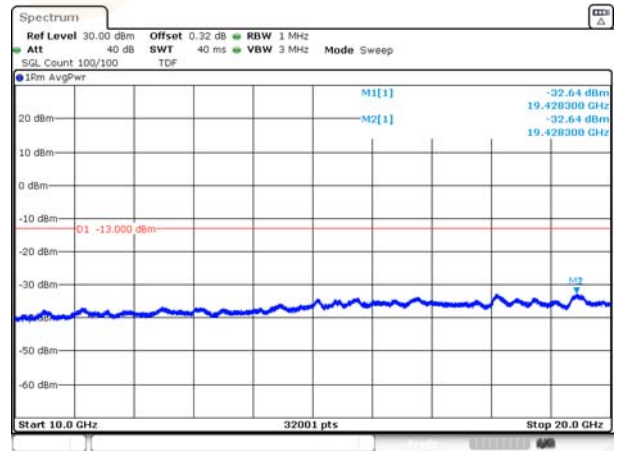

15M BW QPSK

Low channel (30 MHz ~ 10 GHz)

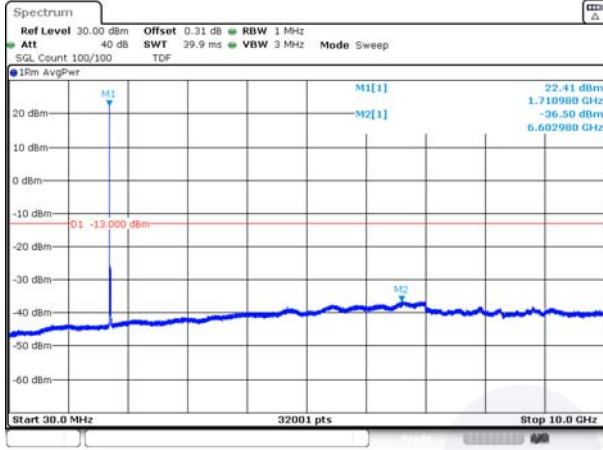

Low channel (10 GHz ~ 20 GHz)

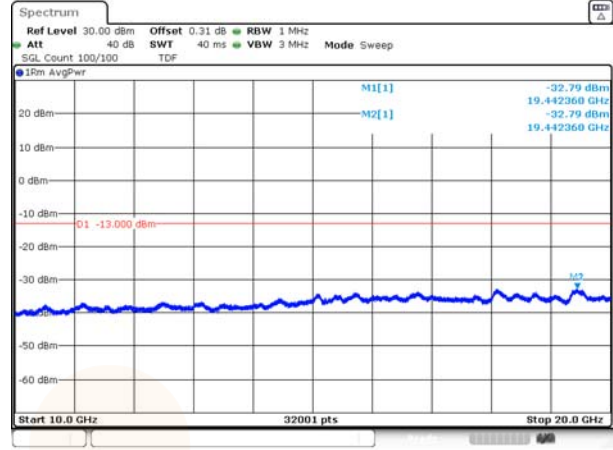

Middle channel (30 MHz ~ 10 GHz)

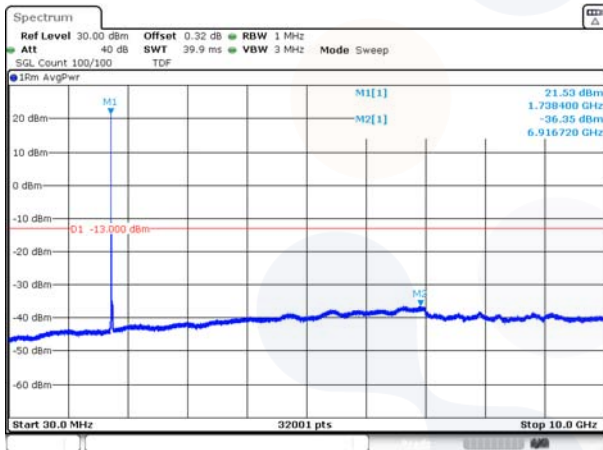

Middle channel (10 GHz ~ 20 GHz)

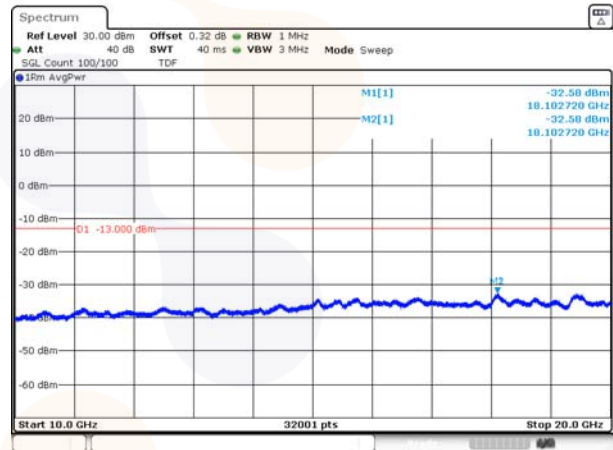

High channel (30 MHz ~ 10 GHz)

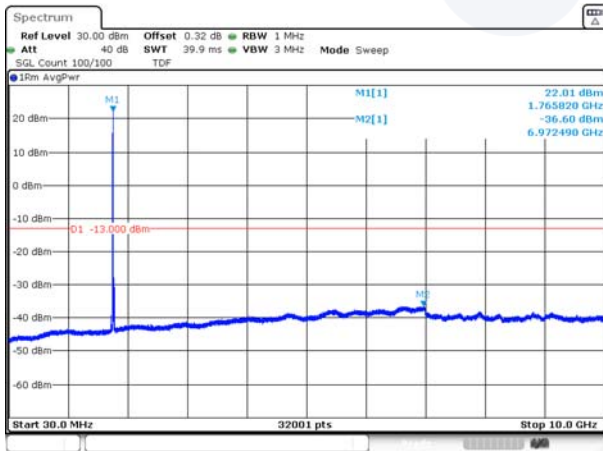

High channel (10 GHz ~ 20 GHz)

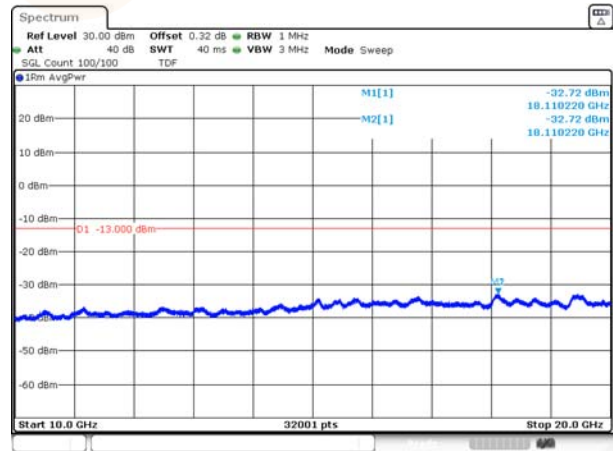

20M BW QPSK

Low channel (30 MHz ~ 10 GHz)

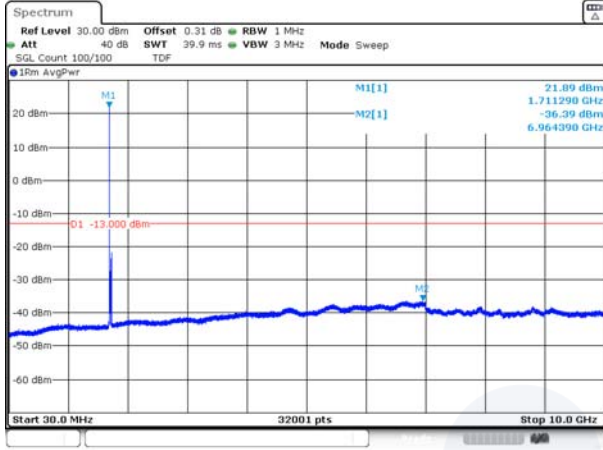

Low channel (10 GHz ~ 20 GHz)

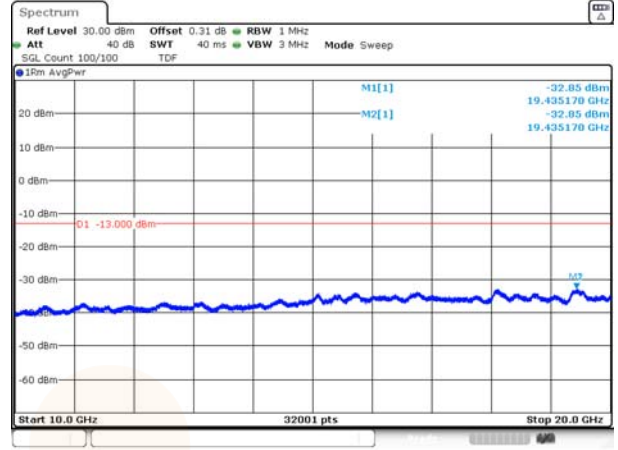

Middle channel (30 MHz ~ 10 GHz)

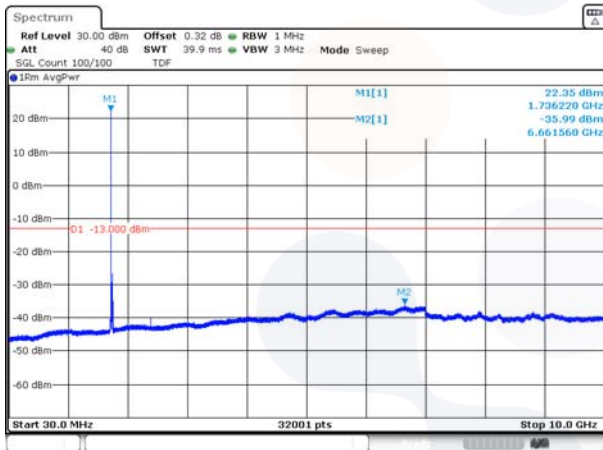

Middle channel (10 GHz ~ 20 GHz)

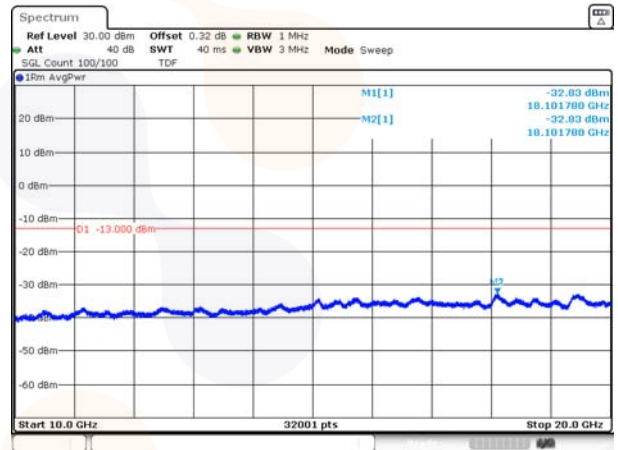

High channel (30 MHz ~ 10 GHz)

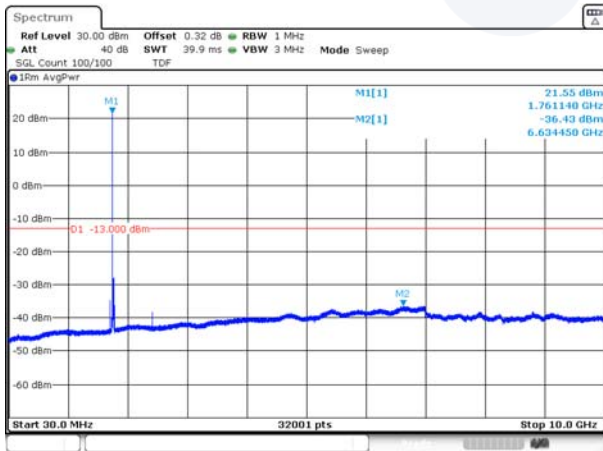

High channel (10 GHz ~ 20 GHz)

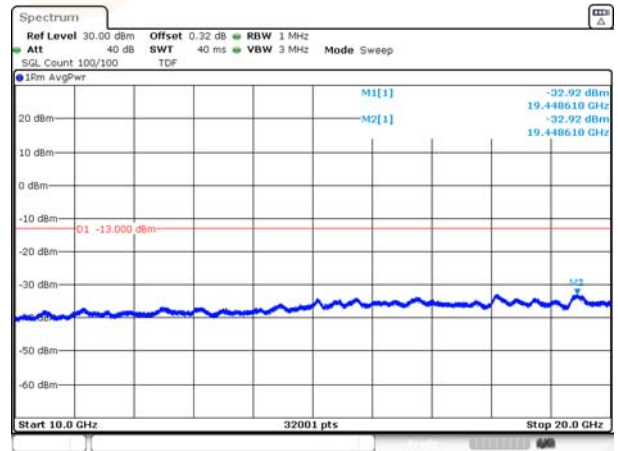

Test mode: LTE B71

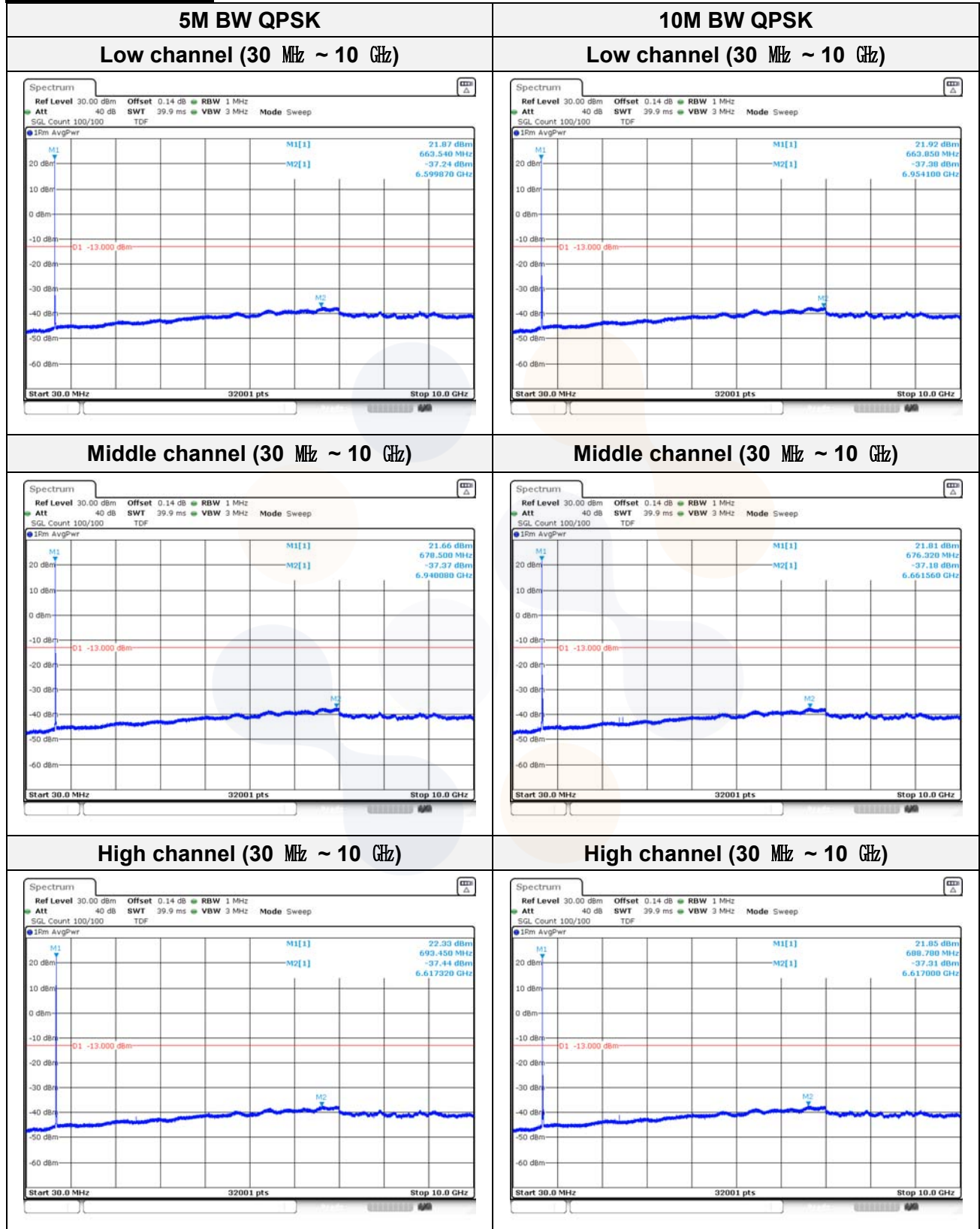

15M BW QPSK

Low channel (30 MHz ~ 10 GHz)

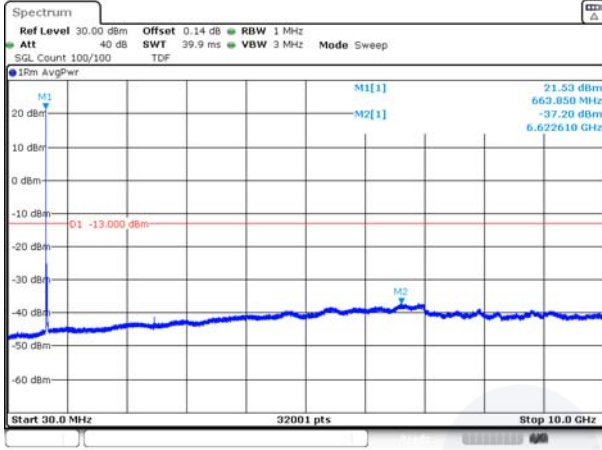

20M BW QPSK

Low channel (30 MHz ~ 10 GHz)

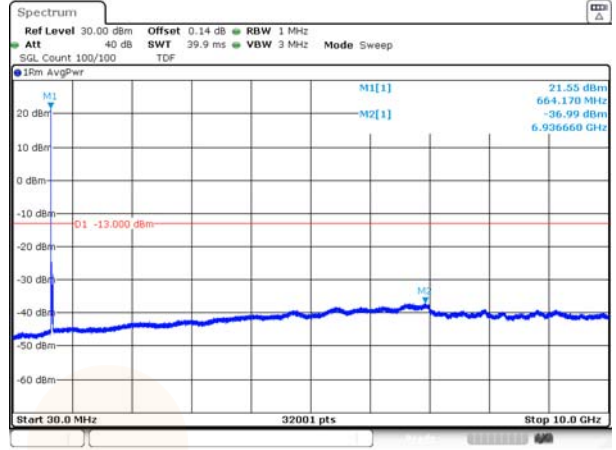

Middle channel (30 MHz ~ 10 GHz)

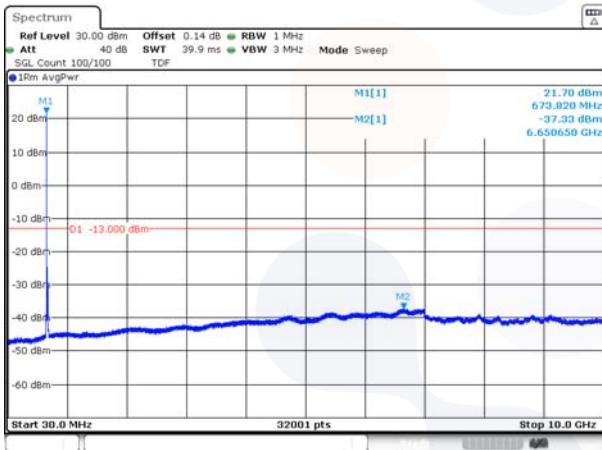

Middle channel (30 MHz ~ 10 GHz)

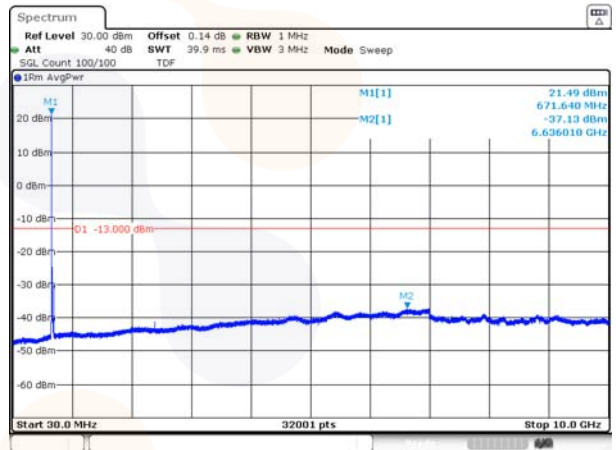

High channel (30 MHz ~ 10 GHz)

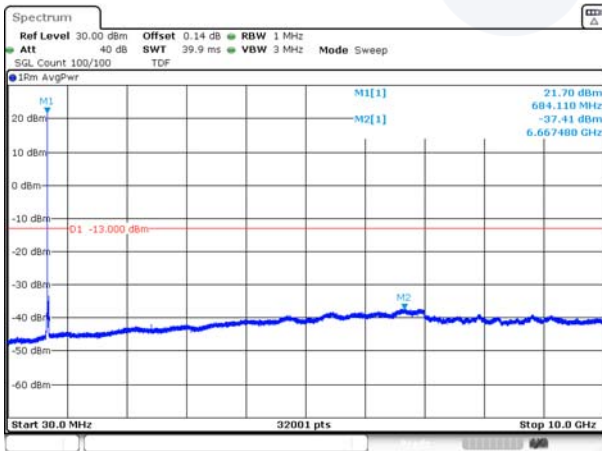

High channel (30 MHz ~ 10 GHz)

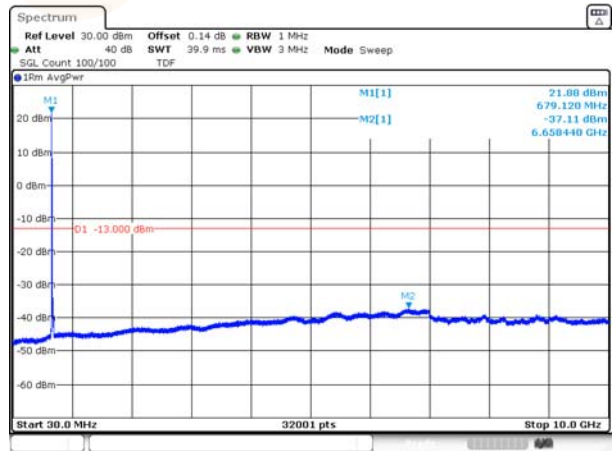

7.5. Peak to Average Power Ratio (PAPR)

Test setup

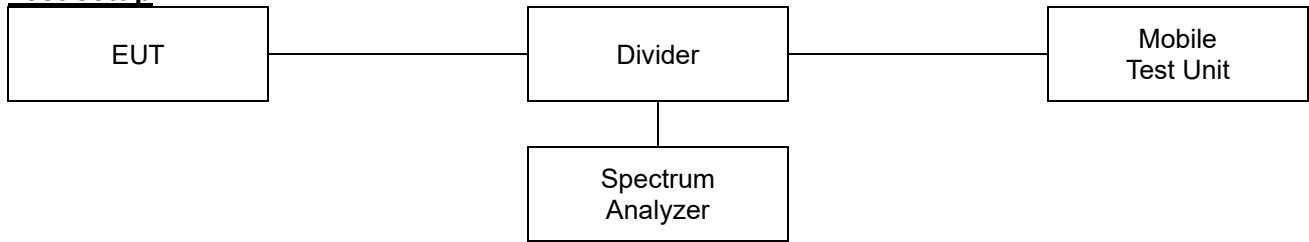

Limit

According to §27.50(d),

The peak-to-average ratio(PAR) of the transmission must not exceed 13 dB.

Test procedure

971168 D01 v03r01 - Section 5.7.2 or 5.7.3
ANSI 63.26-2015 – Section 5.2.3.4 or 5.2.6

Test settings

5.2.3.4 Measurement of peak power in a broadband noise-like signal using CCDF

- 1) Set resolution/measurement bandwidth \geq OBW or specified reference bandwidth
- 2) Set the number of counts to a value that stabilizes the measured CCDF curve.
- 3) Set the measurement interval as follows:
 - a) For continuous transmissions, set to the greater of $[10 \times (\text{number of points in sweep}) \times (\text{transmission symbol period})]$ or 1 ms .
 - b) For burst transmissions, employ an external trigger that is synchronized with the EUT burst timing sequence, or use the internal burst trigger with a trigger level that allows the burst to stabilize. Set the measurement interval to a time that is less than or equal to the burst duration.
 - c) If there are several carriers in a single antenna port, the peak power shall be determined for each individual carrier (by disabling the other carriers while measuring the required carrier) and the total peak power calculated from the sum of the individual carrier peak powers.
- 4) Record the maximum PAPR level associated with a probability of 0.1%

5.2.6 Peak-to-average power ratio

Use one of the procedures presented in 5.2(ANSI C63.26-2015) to measure the total peak power and record as P_{PK} .

Use one of the applicable procedure presented 5.2(ANSI C63.26-2015) to measure the total average power and record as P_{AG} . Determine the P.A.P.R from:

$$PAPR(\text{dB}) = P_{PK}(\text{dBm or dBW}) - P_{AG}(\text{dBm or dBW})$$

Test results

WCDMA 1700

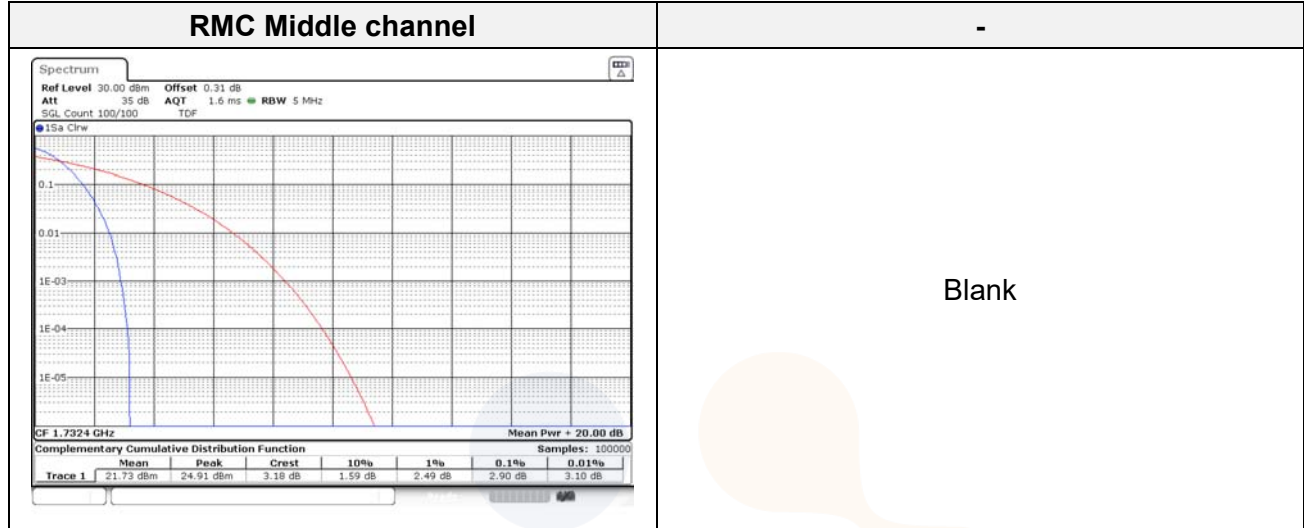

Test mode: LTE B12

1.4M BW QPSK Middle channel

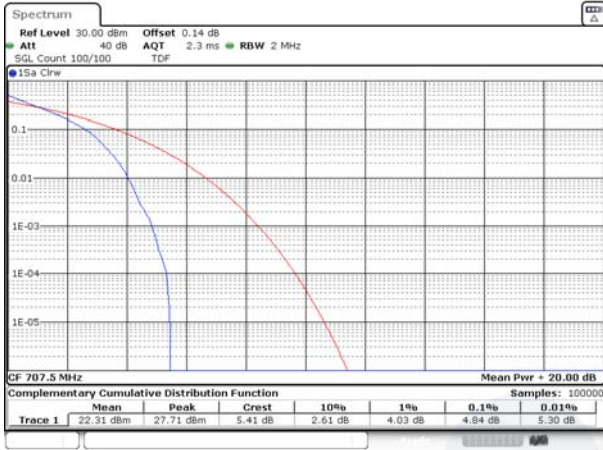

1.4M BW 16QAM Middle channel

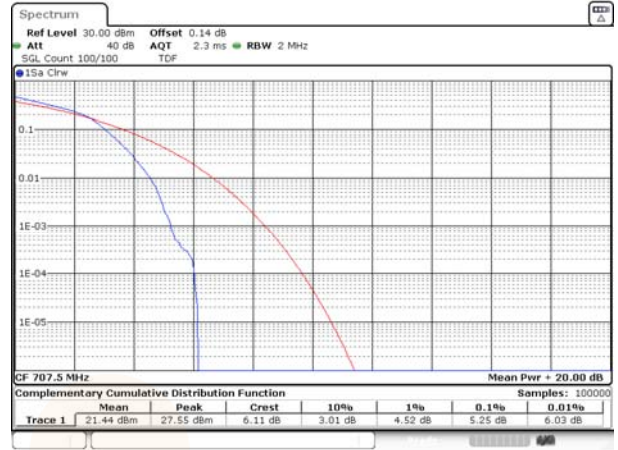

3M BW QPSK Middle channel



3M BW 16QAM Middle channel

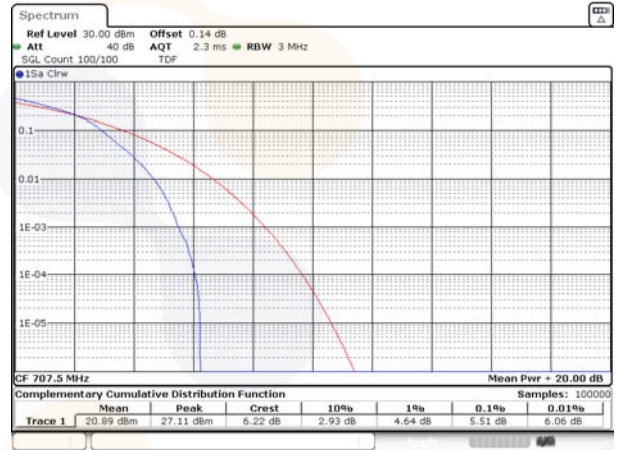

5M BW QPSK Middle channel

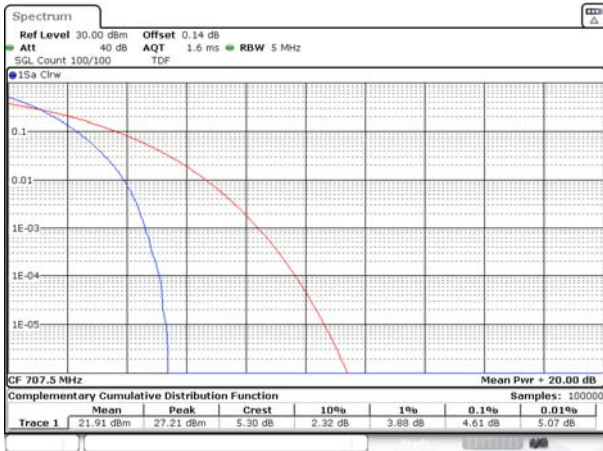

5M BW 16QAM Middle channel

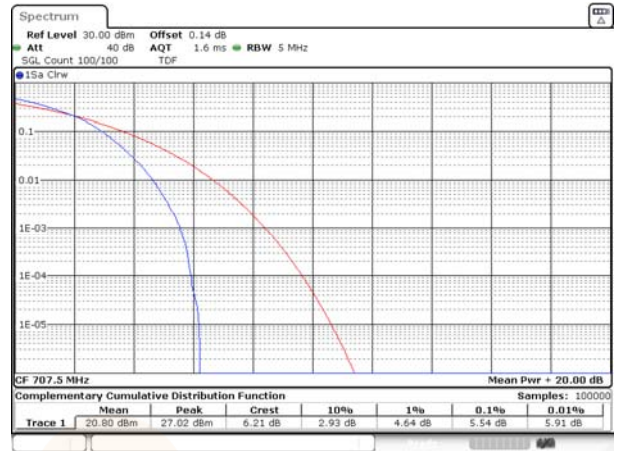

10M BW QPSK Middle channel

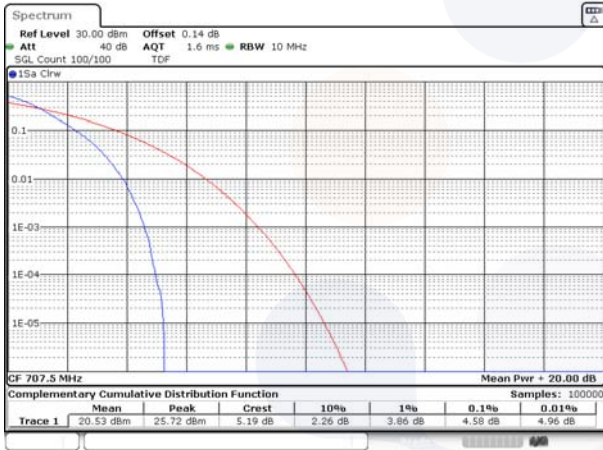

10M BW 16QAM Middle channel

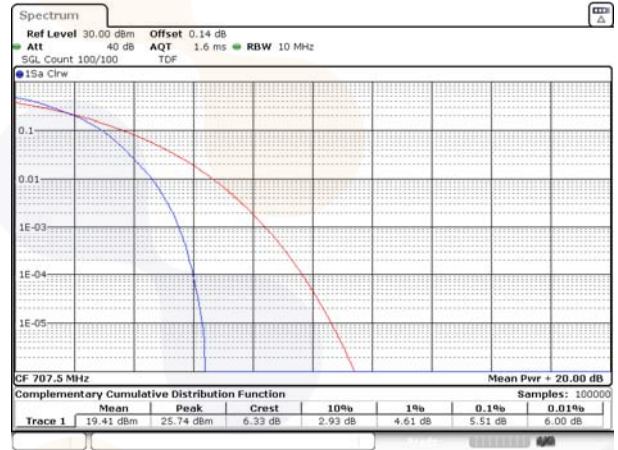

Test mode: LTE B13

5M BW QPSK Middle channel

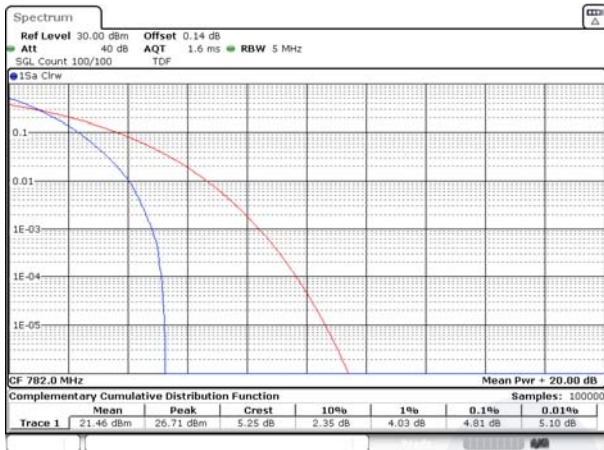

5M BW 16QAM Middle channel

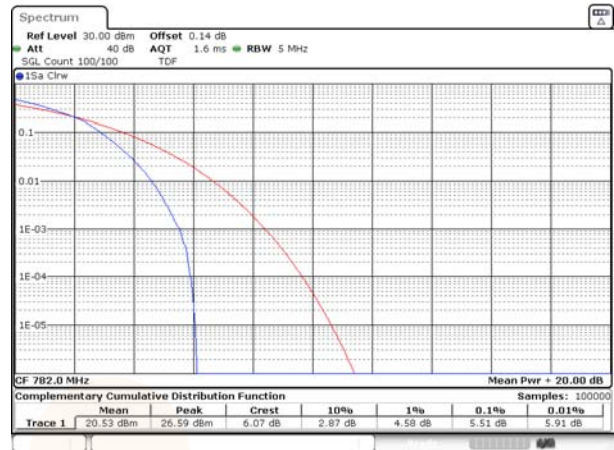

10M BW QPSK Middle channel

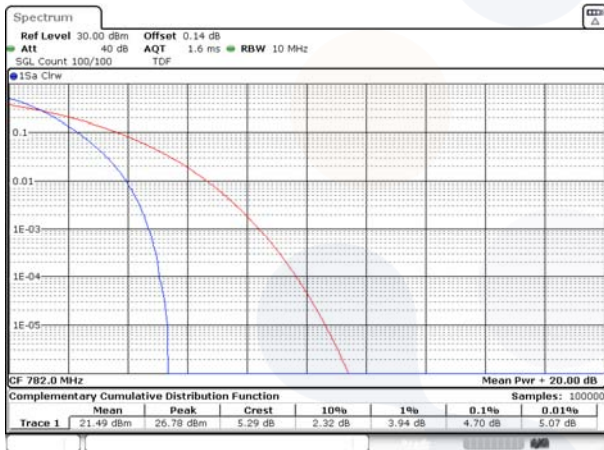

10M BW 16QAM Middle channel

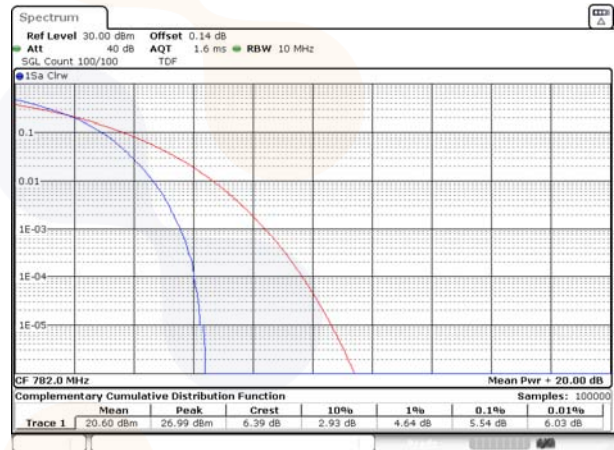

Test mode: LTE B66/4

1.4M BW QPSK Middle channel

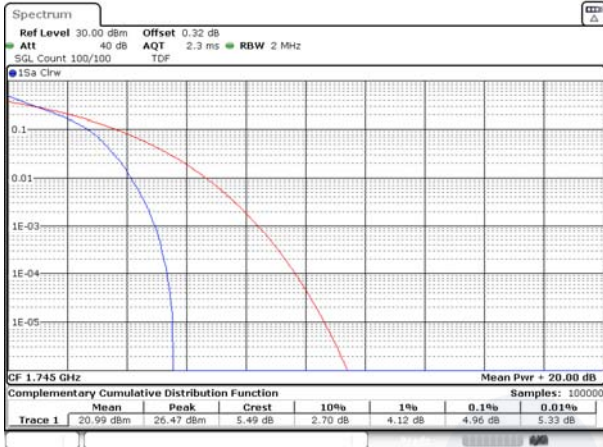

1.4M BW 16QAM Middle channel

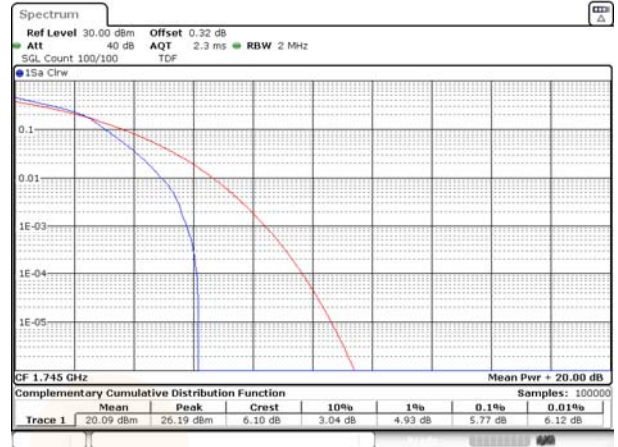

3M BW QPSK Middle channel

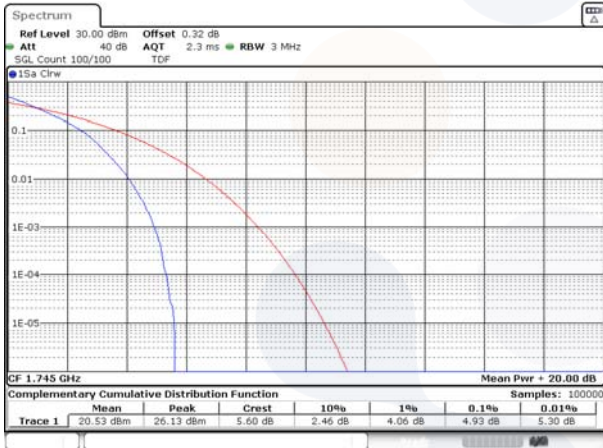

3M BW 16QAM Middle channel

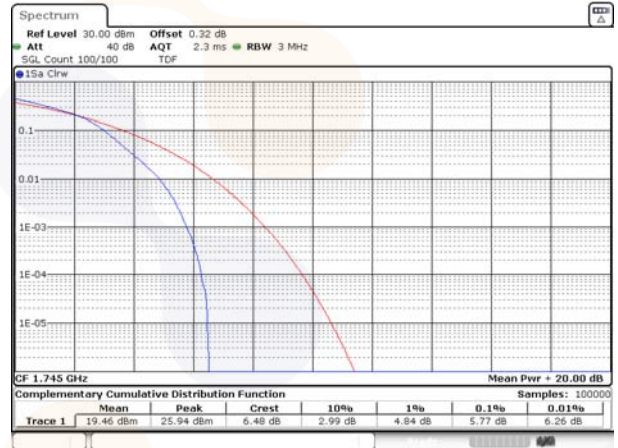

5M BW QPSK Middle channel

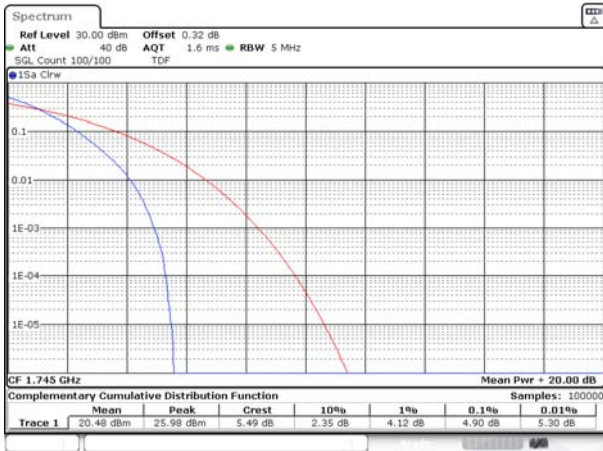

5M BW 16QAM Middle channel

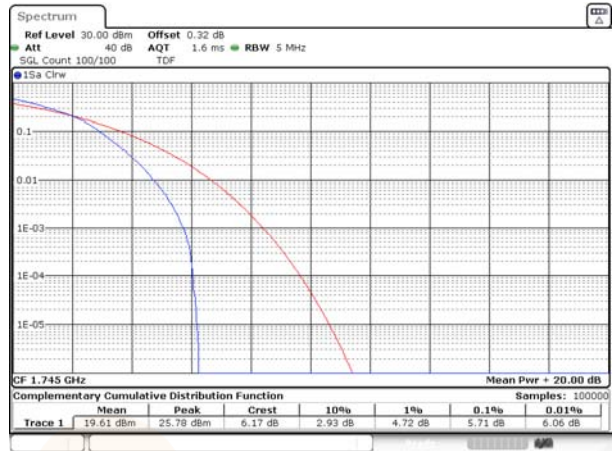

10M BW QPSK Middle channel

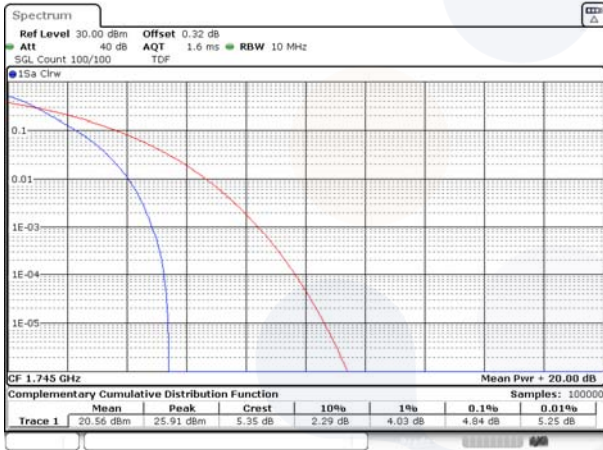

10M BW 16QAM Middle channel

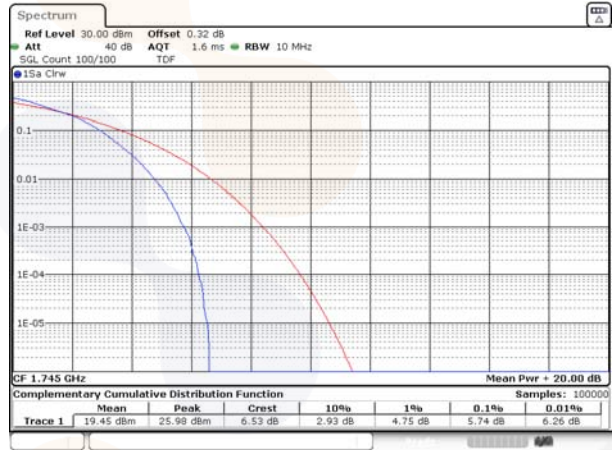

15M BW QPSK Middle channel

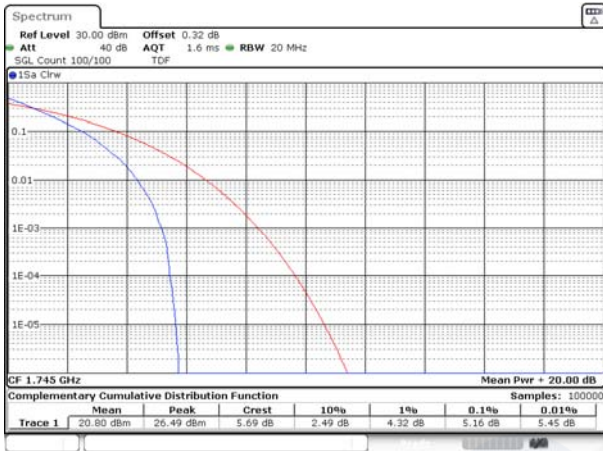

15M BW 16QAM Middle channel

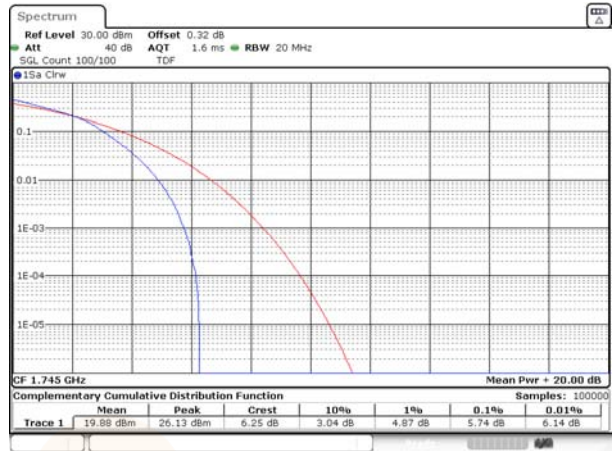

20M BW QPSK Middle channel

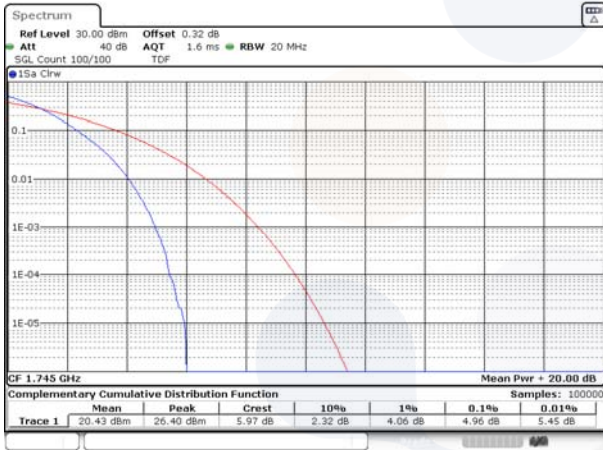

20M BW 16QAM Middle channel

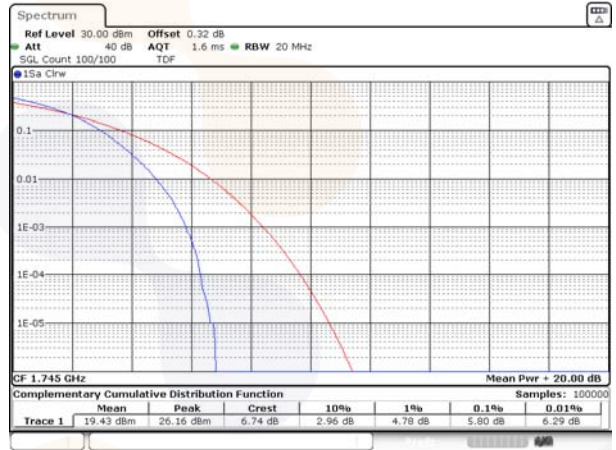

Test mode: LTE B71

5M BW QPSK Middle channel

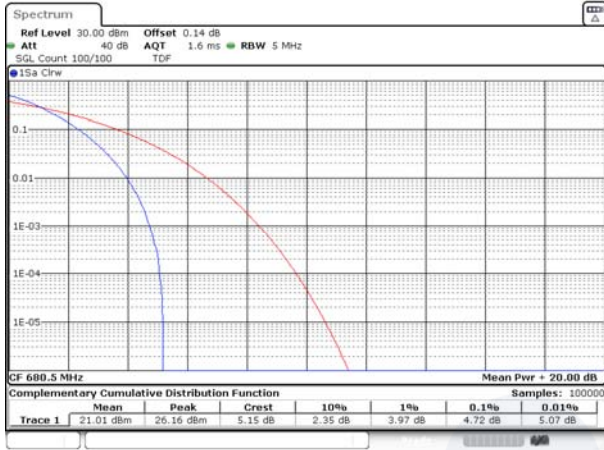

5M BW 16QAM Middle channel

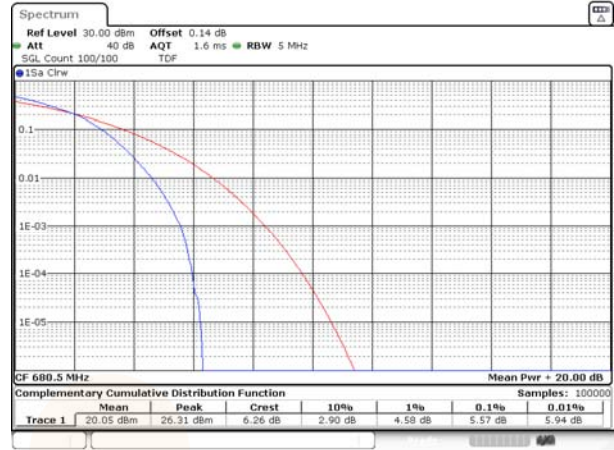

10M BW QPSK Middle channel

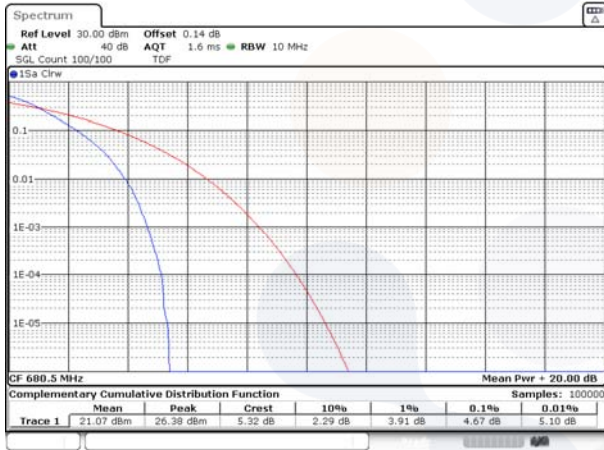

10M BW 16QAM Middle channel

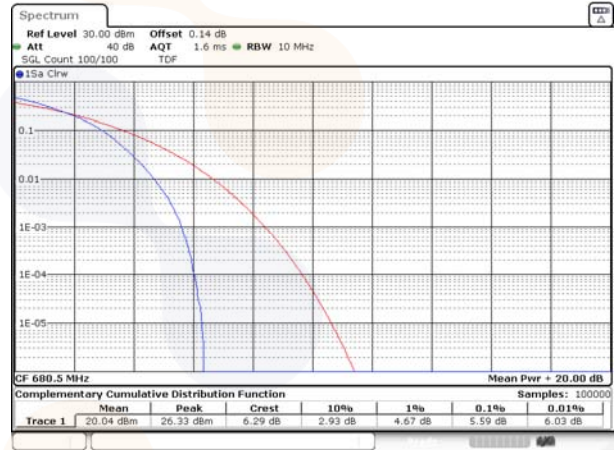

15M BW QPSK Middle channel

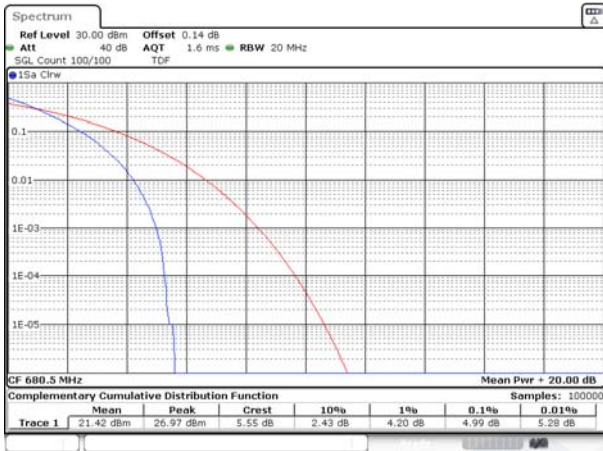

15M BW 16QAM Middle channel

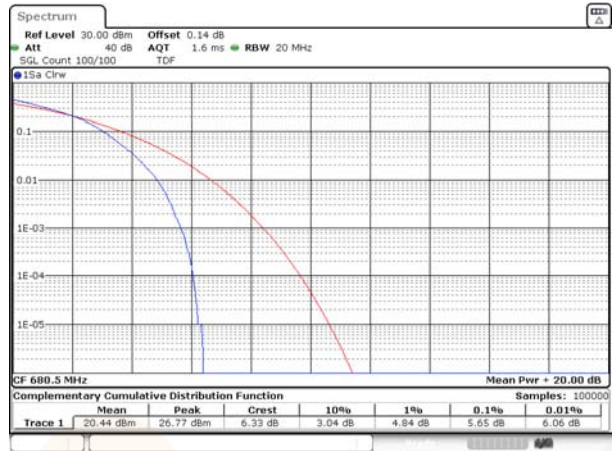

20M BW QPSK Middle channel

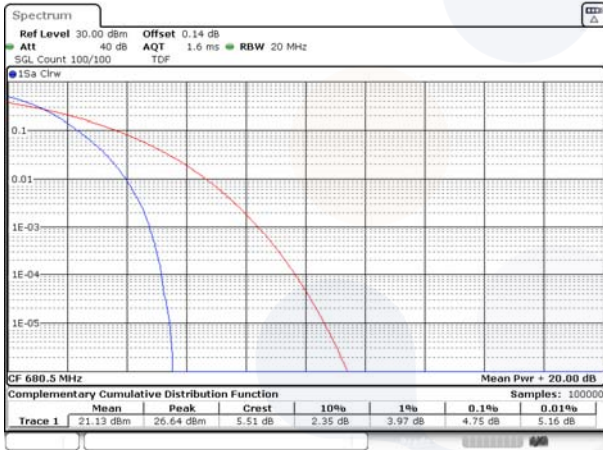

20M BW 16QAM Middle channel

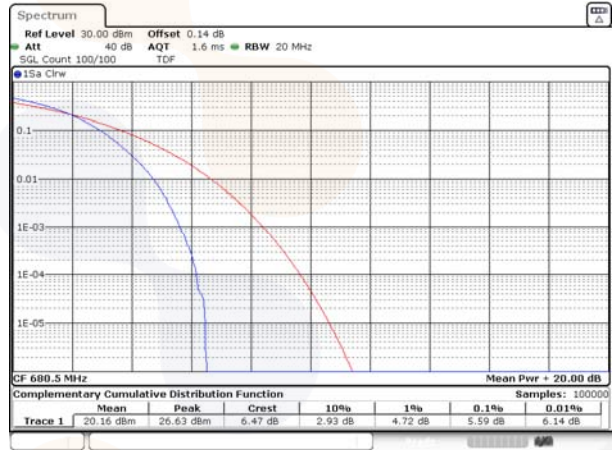

7.6. Frequency stability

Test setup

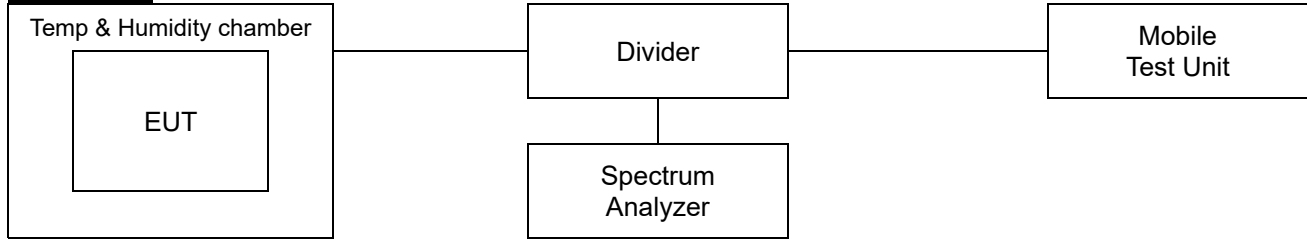

Limit

According to §2.1055(a),

The frequency stability shall be measured with variation of ambient temperature as follows:

- 1) From -30° to $+50^{\circ}$ centigrade for all equipment except that specified in paragraphs (a) (2) and (3) of this section.
- 2) From -20° to $+50^{\circ}$ centigrade for equipment to be licensed for use in the maritime services under part 80 of this chapter, except for class A, B, and S emergency position indicating radiobeacons (EPIRBS), and equipment to be licensed for use above 952 MHz at operational fixed stations in all services, stations in the local television transmission service and point-to-point microwave radio service under part 21 of this chapter, equipment licensed for use aboard aircraft in the aviation services under part 87 of this chapter, and equipment authorized for use in the family radio service under part 95 of this chapter.
- 3) From 0° to $+50^{\circ}$ centigrade for equipment to be licensed for use in the radio broadcast Services under part 73 of this chapter.

According to §2.1055(d),

The frequency stability shall be measured with variation of primary supply Voltage as follows:

- 1) Vary primary supply voltage from 85 to 115 percent of the nominal value for other than hand carried battery equipment.
- 2) For hand carried, battery powered equipment, reduce primary supply voltage to the battery operating and point which shall be specified by the manufacturer.
- 3) The supply voltage shall be measured at the input to the cable normally provided with the equipment, or at the power supply terminals if cables are not normally provided. Effects on frequency of transmitter keying (except for broadcast transmitters) and any heating element cycling at the nominal supply voltage and at each extreme also shall be shown.

According to §27.54,

The frequency stability shall be sufficient to ensure that the fundamental emission stays within the authorized bands of operation.

Test procedure

ANSI 63.26-2015 – Section 5.6

Test settings

- 1) The carrier frequency of the transmitter is measured at room temperature. (20°C to provide a reference)
- 2) The equipment is turned on in a “standby” condition for one minute before applying power to the transmitter. Measurement of the carrier frequency of the transmitter is made within one minute after applying power to the transmitter.
- 3) Frequency measurements are made at 10°C intervals ranging from -30°C to +50°C. A period of at least one half-hour is provided to allow stabilization of the equipment at each Temperature level.



Test results

Test mode : WCDMA 1700
 Frequency (Hz) : 1 732 400 000
 Channel : 1412
 Deviation limit : The frequency stability shall be sufficient to ensure that the fundamental emissions stay within the authorized bands of operation.

Voltage (%)	Power (V)	Temp. (°C)	Frequency (Hz)	Frequency error (Hz)	Deviation	
					(ppm)	(%)
100%	3.88	+21(Ref)	1,732,400,003	2.93	0.0	0.000 000
		-30	1,732,399,999	-1.49	0.0	0.000 000
		-20	1,732,399,997	-3.29	0.0	0.000 000
		-10	1,732,400,004	3.88	0.0	0.000 000
		0	1,732,399,999	-1.24	0.0	0.000 000
		+10	1,732,399,999	-0.72	0.0	0.000 000
		+20	1,732,399,999	-0.70	0.0	0.000 000
		+30	1,732,399,999	-0.74	0.0	0.000 000
		+40	1,732,400,001	0.69	0.0	0.000 000
		+50	1,732,400,004	4.13	0.0	0.000 000
115%	4.46	+21(Ref)	1,732,399,996	-3.52	0.0	0.000 000
End point	3.40	+21(Ref)	1,732,399,997	-2.62	0.0	0.000 000

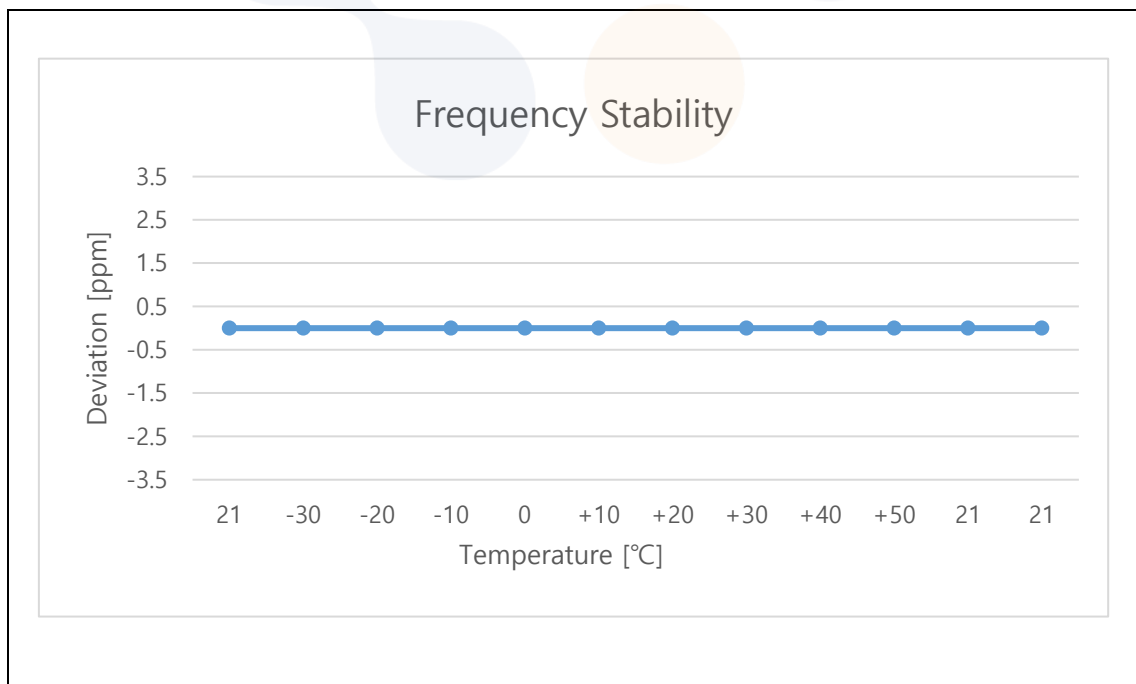

Test mode : LTE B12
 Frequency (Hz) : 707 500 000
 Channel : 23095
 Deviation limit : The frequency stability shall be sufficient to ensure that the fundamental emissions stay within the authorized bands of operation.

Voltage (%)	Power (V)	Temp. (°C)	Frequency (Hz)	Frequency error (Hz)	Deviation	
					(ppm)	(%)
100%	3.88	+21(Ref)	707,499,997	-2.85	0.0	0.000 000
		-30	707,500,006	5.71	0.0	0.000 001
		-20	707,499,998	-2.13	0.0	0.000 000
		-10	707,499,999	-1.12	0.0	0.000 000
		0	707,499,999	-1.17	0.0	0.000 000
		+10	707,500,003	3.08	0.0	0.000 000
		+20	707,499,999	-1.37	0.0	0.000 000
		+30	707,500,003	3.03	0.0	0.000 000
		+40	707,499,997	-3.39	0.0	0.000 000
		+50	707,500,000	-0.07	0.0	0.000 000
115%	4.46	+21(Ref)	707,499,999	-1.26	0.0	0.000 000
End point	3.40	+21(Ref)	707,500,000	0.13	0.0	0.000 000

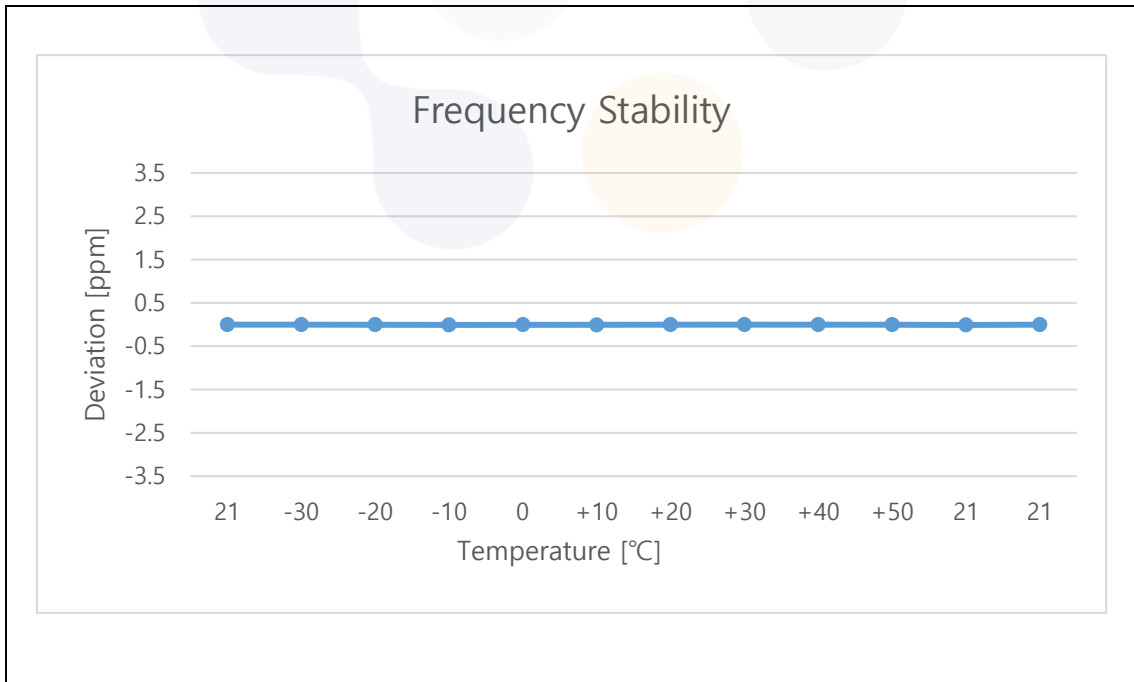

Test mode : LTE B13
 Frequency (Hz) : 782 000 000
 Channel : 23230
 Deviation limit : The frequency stability shall be sufficient to ensure that the fundamental emissions stay within the authorized bands of operation.

Voltage (%)	Power (V)	Temp. (°C)	Frequency (Hz)	Frequency error (Hz)	Deviation	
					(ppm)	(%)
100%	3.88	+21(Ref)	781,999,998	-2.39	0.0	0.000 000
		-30	781,999,999	-0.53	0.0	0.000 000
		-20	782,000,000	-0.24	0.0	0.000 000
		-10	781,999,995	-4.94	0.0	-0.000 001
		0	781,999,999	-1.14	0.0	0.000 000
		+10	781,999,995	-4.71	0.0	-0.000 001
		+20	781,999,996	-3.75	0.0	0.000 000
		+30	781,999,998	-2.37	0.0	0.000 000
		+40	782,000,001	1.12	0.0	0.000 000
		+50	781,999,999	-1.29	0.0	0.000 000
115%	4.46	+21(Ref)	781,999,995	-4.96	0.0	-0.000 001
End point	3.40	+21(Ref)	781,999,997	-3.18	0.0	0.000 000

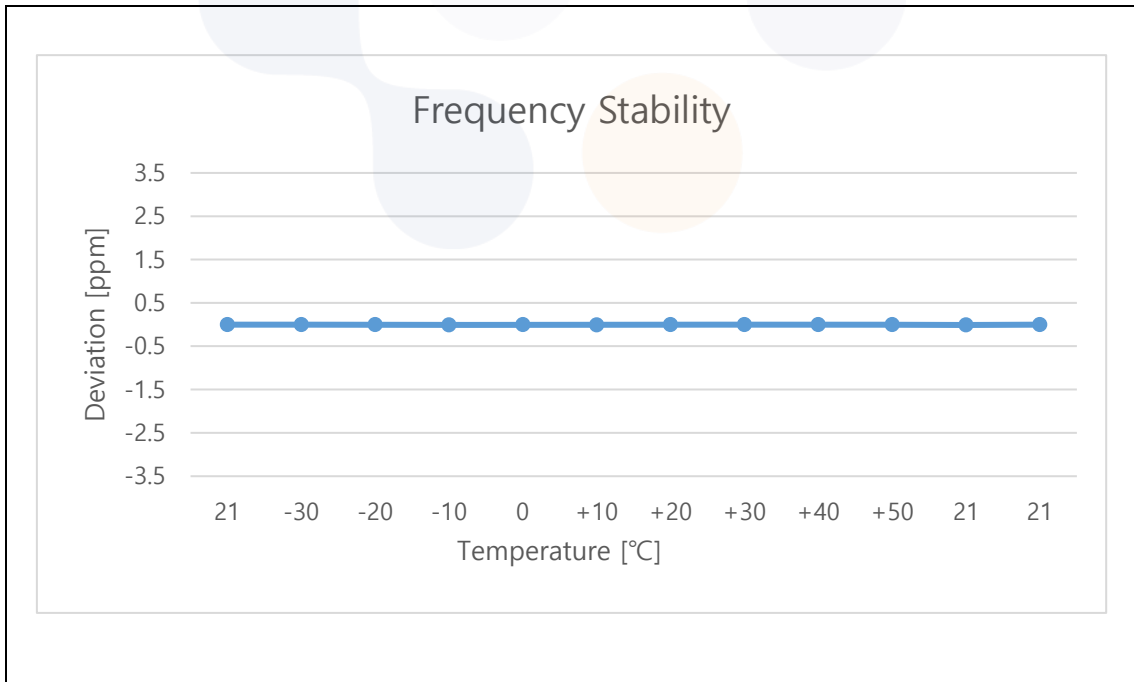

Test mode : LTE B66/4
 Frequency (Hz) : 1 745 000 000
 Channel : 132322
 Deviation limit : The frequency stability shall be sufficient to ensure that the fundamental emissions stay within the authorized bands of operation.

Voltage (%)	Power (V)	Temp. (°C)	Frequency (Hz)	Frequency error (Hz)	Deviation	
					(ppm)	(%)
100%	3.88	+21(Ref)	1,745,000,001	1.49	0.0	0.000 000
		-30	1,745,000,000	-0.39	0.0	0.000 000
		-20	1,745,000,001	0.57	0.0	0.000 000
		-10	1,744,999,995	-5.04	0.0	0.000 000
		0	1,744,999,993	-7.17	0.0	0.000 000
		+10	1,744,999,997	-2.93	0.0	0.000 000
		+20	1,745,000,001	0.66	0.0	0.000 000
		+30	1,745,000,003	3.28	0.0	0.000 000
		+40	1,745,000,000	0.17	0.0	0.000 000
		+50	1,745,000,001	0.54	0.0	0.000 000
115%	4.46	+21(Ref)	1,744,999,996	-4.32	0.0	0.000 000
End point	3.40	+21(Ref)	1,744,999,998	-1.60	0.0	0.000 000

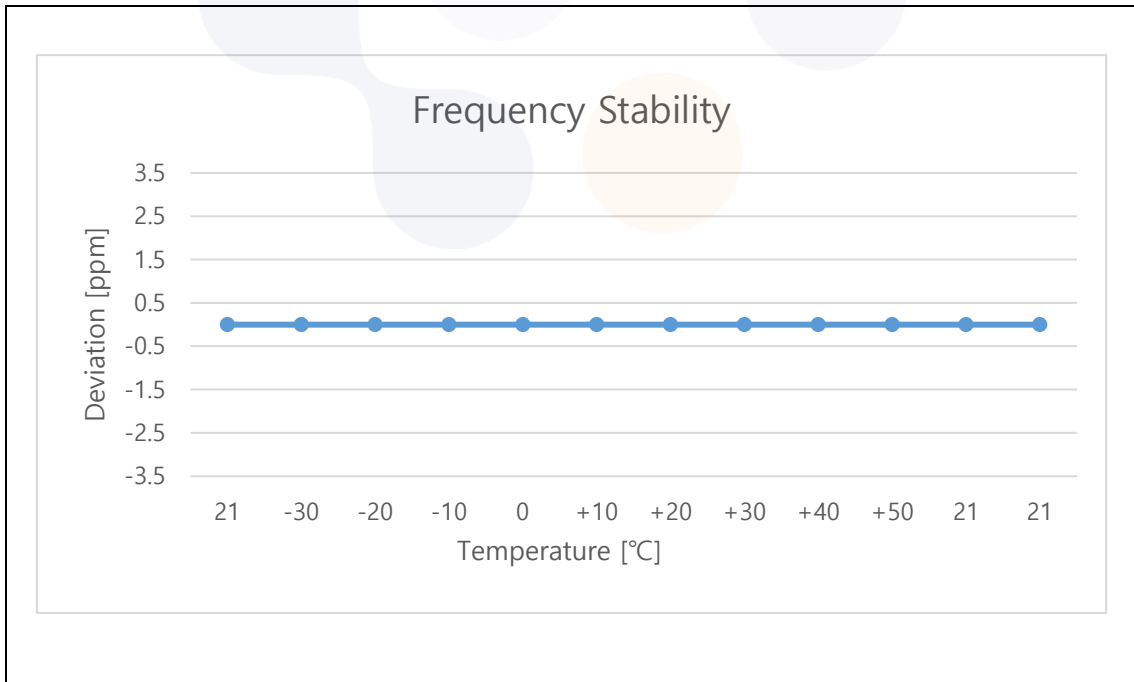

Test mode : LTE B71
 Frequency (Hz) : 680 500 000
 Channel : 133297
 Deviation limit : The frequency stability shall be sufficient to ensure that the fundamental emissions stay within the authorized bands of operation.

Voltage (%)	Power (V)	Temp. (°C)	Frequency (Hz)	Frequency error (Hz)	Deviation	
					(ppm)	(%)
100%	3.88	+21(Ref)	680,500,000	0.49	0.0	0.000 000
		-30	680,500,001	0.82	0.0	0.000 000
		-20	680,500,001	0.99	0.0	0.000 000
		-10	680,500,001	0.73	0.0	0.000 000
		0	680,500,001	0.72	0.0	0.000 000
		+10	680,500,000	0.03	0.0	0.000 000
		+20	680,499,997	-2.65	0.0	0.000 000
		+30	680,499,999	-0.60	0.0	0.000 000
		+40	680,499,998	-2.09	0.0	0.000 000
		+50	680,500,000	-0.34	0.0	0.000 000
115%	4.46	+21(Ref)	680,500,000	0.09	0.0	0.000 000
End point	3.40	+21(Ref)	680,500,000	-0.47	0.0	0.000 000

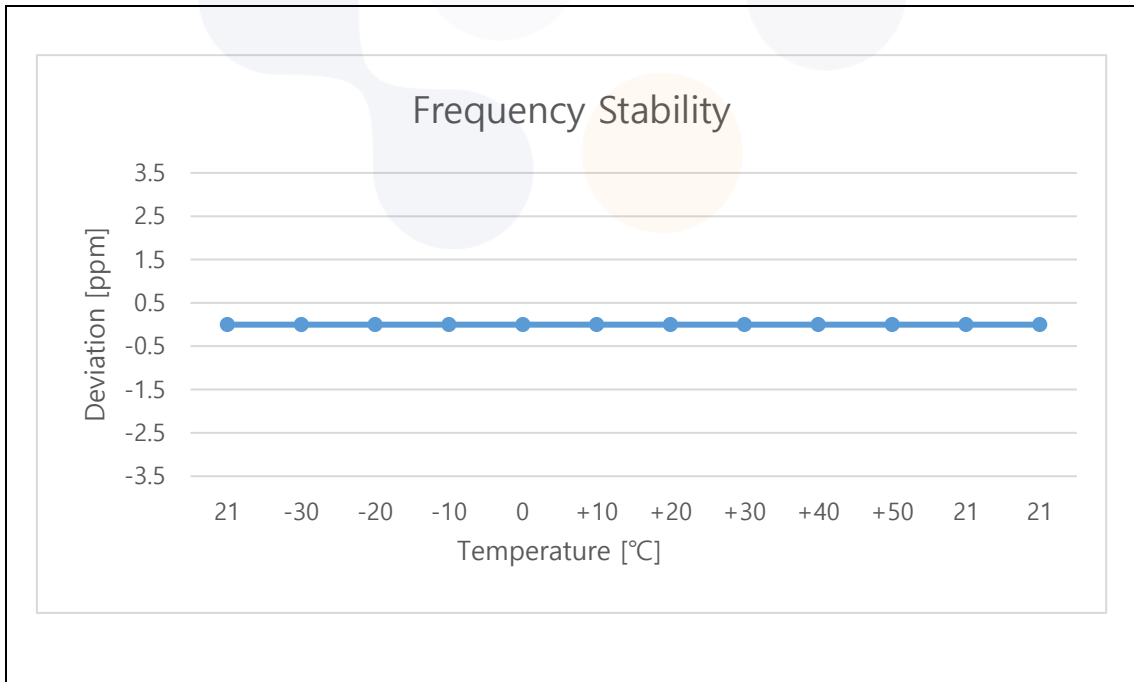

7.7. Radiated Power (ERP/EIRP)

Test setup

The diagram below shows the test setup that is utilized to make the measurements for emission from 30 MHz to 1 GHz emissions.

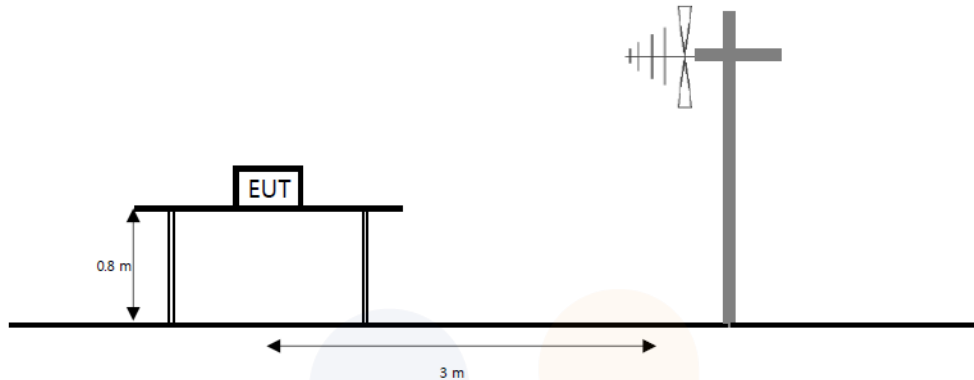

The diagram below shows the test setup that is utilized to make the measurements for emission from 1 GHz to the tenth harmonic of the highest fundamental frequency or to 40 GHz emissions, whichever is lower.

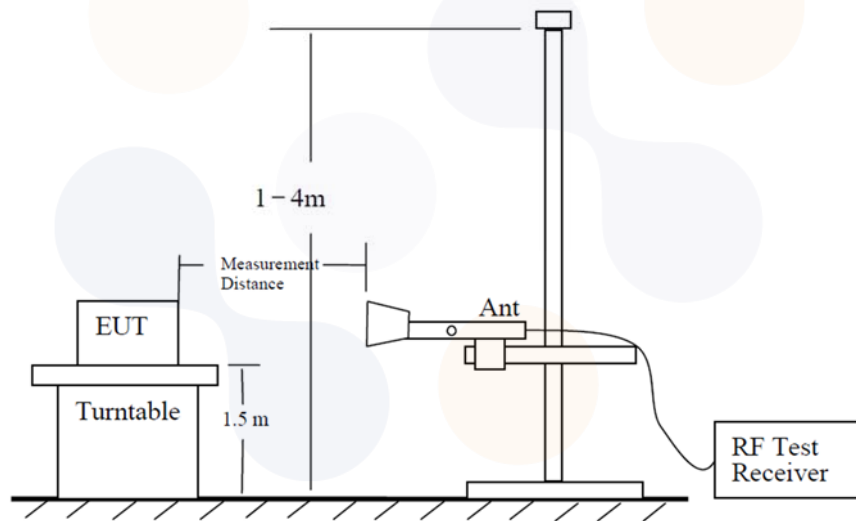

The diagram below shows the test setup for substituted method.

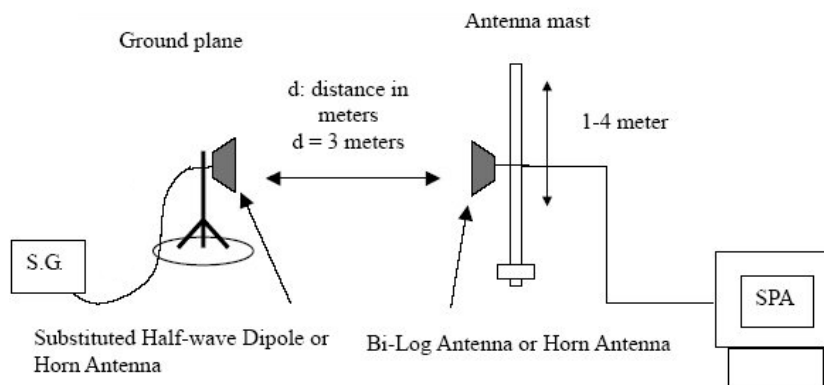

Limit

According to §27.50(b)(10),

Portable stations (hand-held devices) in the 746-757 MHz, 776-788 MHz, and 805-806 MHz bands are limited to 3 watts ERP.

According to §27.50(c)(10),

Portable stations (hand-held devices) in the 600 MHz uplink band and the 698-746 MHz band, and fixed and mobile stations in the 600 MHz uplink band are limited to 3 watts ERP.

According to §27.50(d)(4),

Fixed, mobile and portable (hand-held) stations operating in the 1710-1755 MHz band and mobile and portable stations operating in the 1695-1710 MHz and 1755-1780 MHz bands are limited to 1 watt EIRP.

Test procedure

412172 D01 v01r01
971168 D01 v03r01 - Section 5.2 and 5.8
ANSI 63.26-2015 – Section 5.2
ANSI/TIA-603-E-2016 - Section 2.2.17

Test settings

- 1) RBW = 1 % to 5 % of the OBW.
- 2) VBW $\geq 3 \times$ RBW.
- 3) SPAN = 2 \times to 3 \times the OBW.
- 4) Number of measurement points in sweep $\geq 2 \times$ span / RBW.
- 5) Sweep time :
 - 1) Auto couple, or
 - 2) $\geq [10 \times (\text{number of points in sweep}) \times (\text{transmission period})]$ for single sweep (automation-compatible) measurement. Transmission period is the on and off time of the transmitter.
- 6) Detector = RMS
- 7) If the EUT can be configured to transmit continuously, then set the trigger to free run.
- 8) If the EUT cannot be configured to transmit continuously, then use a sweep trigger with the level set to enable triggering only on full power bursts and configure the EUT to transmit at full power for the entire duration of each sweep. Verify that the sweep time is less than or equal to the transmission burst duration. Time gating can also be used under similar constraints (i.e., configured such that measurement data is collected only during active full-power transmissions).
- 9) Trace mode = trace averaging (RMS) over 100 sweeps.
- 10) Compute the power by integrating the spectrum across the OBW of the signal using the instrument's band or channel power measurement function, with the band/channel limits set equal to the OBW band edges. If the instrument does not have a band or channel power function, then sum the spectrum levels (in linear power units) at intervals equal to the RBW extending across the entire OBW of the spectrum.
- 11) Allow trace to fully stabilize.

<p>Eurofins KCTL Co.,Ltd. 65, Sinwon-ro, Yeongtong-gu, Suwon-si, Gyeonggi-do, 16677, Korea TEL: 82-70-5008-1021 FAX: 82-505-299-8311 www.kctl.co.kr</p>	<p>Report No.: KR24-SRF0086 Page (110) of (124)</p>	
--	---	---

Notes:

1. On a test site, the EUT shall be placed at 80 cm or 1.5 m height on a turn table, and in the position close to normal use as declared by the applicant.
2. The test antenna shall be oriented initially for vertical polarization located 3 m from EUT to correspond to the fundamental frequency of the transmitter.
3. The turntable is rotated through 360°, and the receiving antenna scans in order to determine the Level of the maximized emission.
4. The test antenna shall be raised and lowered again through the specified range of height until the maximum signal level is detected by the measuring receiver.
5. The maximum signal level detected by the measuring receiver shall be noted.
6. The EUT was replaced by half-wave dipole (1 GHz below) or horn antenna (1 GHz above) connected to a signal generator.
The power is calculated by the following formula;

$$Pd(\text{dBm}) = Pg(\text{dBm}) - \text{Cable loss (dB)} + \text{Antenna gain (dB)}$$
Note. Pd is the dipole equivalent power and Pg is the generator output power into the substitution antenna.
The test antenna shall be raised and lowered through the specified range of height to ensure that
7. The maximum signal is received.
The input signal to the substitution antenna shall be adjusted to the level that produces a level
8. Detected by the measuring corrected for the change of input attenuator setting of the measuring Receiver.
9. The input level to the substitution antenna shall be recorded as power level in dBm, corrected for Any change of input attenuator setting of the measuring receiver.
10. The measurement shall be repeated with the test antenna and the substitution antenna Orientated for horizontal polarization.

Test results

Test mode: WCDMA 1700

Mode	Channel	Pol.	Antenna Gain	C.L	Substitute Level	EIRP	
		[V/H]	[dBi]	[dB]	[dBm]	[dBm]	[W]
RMC	Low	V	5.56	8.81	20.29	17.04	0.051
	Middle	V	5.50	8.83	19.85	16.52	0.045
	High	V	5.44	8.93	21.83	18.34	0.068

Note.

1. $E.I.R.P(dBm) = Substitute\ Level(dB) + Antenna\ gain(dBi) - C.L(Cable\ loss)\ (dB)$



Test mode: LTE B12

Bandwidth [MHz]	Modulation	Channel [MHz]	Pol.	Antenna Gain	C.L	Substitute Level	ERP	
			[V/H]	[dBd]	[dB]	[dBm]	[dBm]	[W]
1.4	QPSK	Low	H	2.55	5.61	15.32	12.26	0.017
		Middle	H	2.63	5.60	16.21	13.23	0.021
		High	H	2.60	5.63	17.95	14.91	0.031
	16QAM	Low	H	2.55	5.61	14.09	11.03	0.013
		Middle	H	2.63	5.60	14.77	11.80	0.015
		High	H	2.60	5.63	16.62	13.59	0.023
3	QPSK	Low	H	2.56	5.62	15.44	12.37	0.017
		Middle	H	2.63	5.60	16.32	13.34	0.022
		High	H	2.61	5.63	17.63	14.60	0.029
	16QAM	Low	H	2.56	5.62	13.82	10.76	0.012
		Middle	H	2.63	5.60	14.71	11.73	0.015
		High	H	2.61	5.63	16.14	13.11	0.020
5	QPSK	Low	H	2.57	5.62	15.30	12.25	0.017
		Middle	H	2.63	5.60	16.18	13.20	0.021
		High	H	2.62	5.63	17.21	14.19	0.026
	16QAM	Low	H	2.57	5.62	13.77	10.71	0.012
		Middle	H	2.63	5.60	14.47	11.50	0.014
		High	H	2.62	5.63	15.63	12.62	0.018
10	QPSK	Low	H	2.59	5.59	15.02	12.02	0.016
		Middle	H	2.63	5.60	15.33	12.36	0.017
		High	H	2.64	5.63	16.16	13.17	0.021
	16QAM	Low	H	2.59	5.59	14.05	11.05	0.013
		Middle	H	2.63	5.60	14.24	11.27	0.013
		High	H	2.64	5.63	14.90	11.91	0.016

Note.

1. $E.R.P(dBm) = \text{Substitute Level}(dB) + \text{Antenna gain}(dBd) - C.L(\text{Cable loss})(dB)$

Test mode: LTE B13

Bandwidth [MHz]	Modulation	Channel	Pol.	Antenna Gain	C.L	Substitute Level	ERP	
			[V/H]	[dBd]	[dB]	[dBm]	[dBm]	[W]
5	QPSK	Low	H	3.35	5.85	15.47	12.97	0.020
		Middle	H	3.31	5.87	15.24	12.68	0.019
		High	H	3.26	5.87	14.82	12.21	0.017
	16QAM	Low	H	3.35	5.85	14.54	12.04	0.016
		Middle	H	3.31	5.87	14.09	11.53	0.014
		High	H	3.26	5.87	13.78	11.17	0.013
10	QPSK	Middle	H	3.31	5.87	15.63	13.07	0.020
	16QAM	Middle	H	3.31	5.87	14.61	12.05	0.016

Note.

1. $E.R.P(dBm) = \text{Substitute Level}(dB) + \text{Antenna gain}(dBd) - C.L(\text{Cable loss})(dB)$

Test mode: LTE B66/4

Bandwidth [MHz]	Modulation	Channel	Pol.	Antenna Gain	C.L	Substitute Level	EIRP	
			[V/H]	[dBi]	[dB]	[dBm]	[dBm]	[W]
1.4	QPSK	Low	V	5.57	8.80	21.78	18.55	0.072
		Middle	V	5.47	8.89	22.40	18.98	0.079
		High	V	5.36	9.01	21.45	17.80	0.060
	16QAM	Low	V	5.57	8.80	20.83	17.60	0.058
		Middle	V	5.47	8.89	21.31	17.89	0.061
		High	V	5.36	9.01	20.57	16.92	0.049
3	QPSK	Low	V	5.57	8.81	21.64	18.40	0.069
		Middle	V	5.47	8.89	22.41	18.99	0.079
		High	V	5.36	9.02	22.08	18.42	0.070
	16QAM	Low	V	5.57	8.81	20.78	17.53	0.057
		Middle	V	5.47	8.89	21.24	17.81	0.060
		High	V	5.36	9.02	21.20	17.54	0.057
5	QPSK	Low	V	5.56	8.81	21.79	18.55	0.072
		Middle	V	5.47	8.89	22.18	18.76	0.075
		High	V	5.37	9.00	21.97	18.34	0.068
	16QAM	Low	V	5.56	8.81	20.86	17.61	0.058
		Middle	V	5.47	8.89	21.14	17.72	0.059
		High	V	5.37	9.00	20.92	17.29	0.054
10	QPSK	Low	V	5.56	8.80	21.95	18.71	0.074
		Middle	V	5.47	8.89	20.56	17.13	0.052
		High	V	5.38	9.02	20.43	16.79	0.048
	16QAM	Low	V	5.56	8.80	21.03	17.79	0.060
		Middle	V	5.47	8.89	19.48	16.06	0.040
		High	V	5.38	9.02	19.56	15.91	0.039
15	QPSK	Low	V	5.55	8.81	22.31	19.05	0.080
		Middle	V	5.47	8.89	20.65	17.22	0.053
		High	V	5.38	9.02	21.57	17.93	0.062
	16QAM	Low	V	5.55	8.81	21.41	18.15	0.065
		Middle	V	5.47	8.89	19.62	16.20	0.042
		High	V	5.38	9.02	20.54	16.90	0.049
20	QPSK	Low	V	5.54	8.82	21.70	18.42	0.070
		Middle	V	5.47	8.89	22.88	19.46	0.088
		High	V	5.39	9.01	22.21	18.59	0.072
	16QAM	Low	V	5.54	8.82	20.78	17.50	0.056
		Middle	V	5.47	8.89	21.81	18.38	0.069
		High	V	5.39	9.01	21.23	17.61	0.058

Note.

1. E.I.R.P(dBm) = Substitute Level(dB) + Antenna gain(dBi) - C.L(Cable loss) (dB)

Test mode: LTE B71

Bandwidth [MHz]	Modulation	Channel	Pol.	Antenna Gain	C.L	Substitute Level	ERP	
			[V/H]	[dBd]	[dB]	[dBm]	[dBm]	[W]
5	QPSK	Low	H	3.14	5.45	14.98	12.67	0.019
		Middle	H	2.84	5.49	12.82	10.16	0.010
		High	H	2.55	5.54	12.88	9.89	0.010
	16QAM	Low	H	3.14	5.45	13.98	11.67	0.015
		Middle	H	2.84	5.49	11.75	9.09	0.008
		High	H	2.55	5.54	11.63	8.64	0.007
10	QPSK	Low	H	3.09	5.49	14.44	12.04	0.016
		Middle	H	2.84	5.49	13.03	10.37	0.011
		High	H	2.55	5.54	12.94	9.95	0.010
	16QAM	Low	H	3.09	5.49	13.37	10.97	0.013
		Middle	H	2.84	5.49	12.20	9.55	0.009
		High	H	2.55	5.54	11.85	8.86	0.008
15	QPSK	Low	H	3.04	5.50	13.77	11.31	0.014
		Middle	H	2.84	5.49	12.62	9.96	0.010
		High	H	2.55	5.54	12.77	9.78	0.009
	16QAM	Low	H	3.04	5.50	12.64	10.18	0.010
		Middle	H	2.84	5.49	11.45	8.79	0.008
		High	H	2.55	5.54	11.52	8.53	0.007
20	QPSK	Low	H	2.99	5.47	14.49	12.01	0.016
		Middle	H	2.84	5.49	12.72	10.06	0.010
		High	H	2.61	5.55	12.25	9.31	0.009
	16QAM	Low	H	2.99	5.47	13.53	11.05	0.013
		Middle	H	2.84	5.49	11.82	9.16	0.008
		High	H	2.61	5.55	11.21	8.27	0.007

Note.

1. $E.R.P(dBm) = \text{Substitute Level}(dB) + \text{Antenna gain}(dBd) - C.L(\text{Cable loss})(dB)$

7.8. Radiated Spurious Emissions

Test setup

The diagram below shows the test setup that is utilized to make the measurements for emission from 30 MHz to 1 GHz emissions.

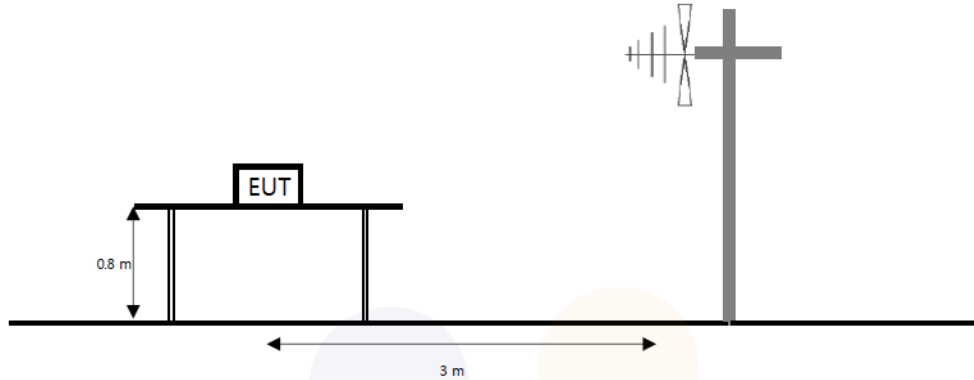

The diagram below shows the test setup that is utilized to make the measurements for emission from 1 GHz to the tenth harmonic of the highest fundamental frequency or to 40 GHz emissions, whichever is lower.

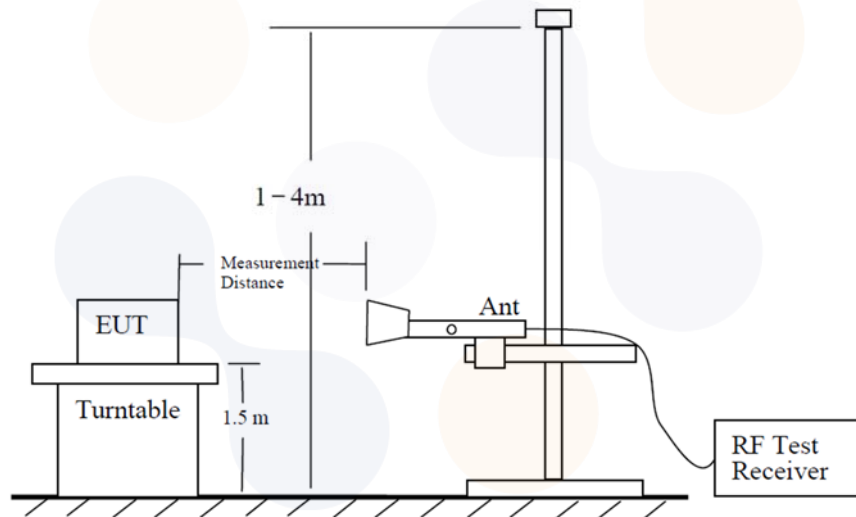

The diagram below shows the test setup for substituted method.

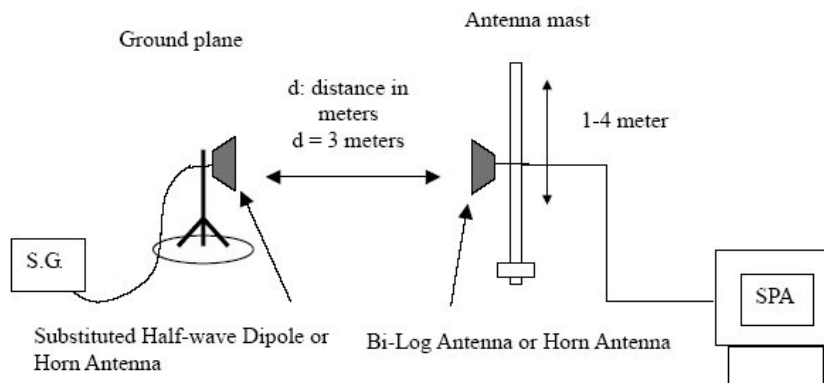

Limit

According to §27.53(c)(2),

On any frequency outside the 776-788 MHz band, the power of any emission shall be attenuated outside the band below the transmitter power (P) by at least $43 + 10\log(P)$ dB.

According to §27.53(f),

For operations in the 746-758 MHz, 775-788 MHz, and 805-806 MHz bands, emissions in the band 1559-1610 MHz shall be limited to -70 dBW/MHz equivalent isotropically radiated power (EIRP) for wideband signals, and -80 dBW EIRP for discrete emissions of less than 700 Hz bandwidth. For the purpose of equipment authorization, a transmitter shall be tested with an antenna that is representative of the type that will be used with the equipment in normal operation.

According to §27.53(g),

For operations in the 600 MHz band and the 698-746 MHz band, the power of any emission outside a licensee's frequency band(s) of operation shall be attenuated below the transmitter power (P) within the licensed band(s) of operation, measured in watts, by at least $43 + 10\log(P)$ dB.

According to §27.53(h),

The power of any emission outside a licensee's frequency block shall be attenuated below the transmitter power (P) in watts by at least $43 + 10\log(P)$ dB.

Test procedure



971168 D01 v03r01 - Section 6.2

ANSI 63.26-2015 – Section 5.5

ANSI/TIA-603-E-2016 - Section 2.2.12

Test settings

- 1) RBW = 100 kHz for below 1 GHz and 1 MHz for above 1 GHz.
- 2) VBW $\geq 3 \times$ RBW.
- 3) Detector = RMS
- 4) Trace mode = Max hold
- 5) Sweep time = Auto couple
- 6) Number of sweep points $\geq 2 \times$ span / RBW
- 7) Allow trace to fully stabilize.

<p>Eurofins KCTL Co.,Ltd. 65, Sinwon-ro, Yeongtong-gu, Suwon-si, Gyeonggi-do, 16677, Korea TEL: 82-70-5008-1021 FAX: 82-505-299-8311 www.kctl.co.kr</p>	<p>Report No.: KR24-SRF0086 Page (118) of (124)</p>	<p> </p>
--	---	--

Notes:

1. On a test site, the EUT shall be placed at 80 cm or 1.5 m height on a turn table, and in the position close to normal use as declared by the applicant.
2. The test antenna shall be oriented initially for vertical polarization located 3 m from EUT to correspond to the fundamental frequency of the transmitter.
3. The turntable is rotated through 360°, and the receiving antenna scans in order to determine the Level of the maximized emission.
4. The test antenna shall be raised and lowered again through the specified range of height until the maximum signal level is detected by the measuring receiver.
5. The maximum signal level detected by the measuring receiver shall be noted.
6. The EUT was replaced by half-wave dipole (1 GHz below) or horn antenna (1 GHz above) connected to a signal generator.
7. The test antenna shall be raised and lowered through the specified range of height to ensure that The maximum signal is received.
8. The input signal to the substitution antenna shall be adjusted to the level that produces a level Detected by the measuring corrected for the change of input attenuator setting of the measuring Receiver.
9. The input level to the substitution antenna shall be recorded as power level in dBm, corrected for Any change of input attenuator setting of the measuring receiver.
10. The measurement shall be repeated with the test antenna and the substitution antenna Orientated for horizontal polarization.

Test results (Above 1 000 MHz)

Test mode : WCDMA 1700

Frequency(MHz) : 1 712.4

Channel : 1312

Mode	Frequency	Pol.	Antenna Gain	Cable loss	Substitute Level	Level	Limit	Margin
	[MHz]	[V/H]	[dBi]	[dB]	[dBm]	[dBm]	[dBm]	[dB]
RMC	3 425.76	H	8.15	12.75	-49.30	-53.90	-13.00	40.90
	5 137.75	H	10.38	16.71	-41.37	-47.70	-13.00	34.70
	6 851.02	V	11.28	18.53	-37.85	-45.10	-13.00	32.10
	8 564.92	V	13.03	20.69	-37.54	-45.20	-13.00	32.20

Test mode : WCDMA 1700

Frequency(MHz) : 1 732.4

Channel : 1412

Mode	Frequency	Pol.	Antenna Gain	Cable loss	Substitute Level	Level	Limit	Margin
	[MHz]	[V/H]	[dBi]	[dB]	[dBm]	[dBm]	[dBm]	[dB]
RMC	3 465.34	H	8.23	12.84	-49.29	-53.90	-13.00	40.90
	5 197.75	V	10.42	16.77	-41.95	-48.30	-13.00	35.30
	6 929.53	V	11.34	18.57	-39.57	-46.80	-13.00	33.80
	8 663.22	V	13.07	20.58	-36.19	-43.70	-13.00	30.70

Test mode : WCDMA 1700

Frequency(MHz) : 1 752.6

Channel : 1513

Mode	Frequency	Pol.	Antenna Gain	Cable loss	Substitute Level	Level	Limit	Margin
	[MHz]	[V/H]	[dBi]	[dB]	[dBm]	[dBm]	[dBm]	[dB]
RMC	3 505.55	V	8.31	12.93	-48.58	-53.20	-13.00	40.20
	5 255.84	V	10.45	16.02	-43.13	-48.70	-13.00	35.70
	7 008.68	V	11.41	18.71	-38.50	-45.80	-13.00	32.80
	8 765.99	H	13.11	20.64	-36.47	-44.00	-13.00	31.00

Note.

- E.I.R.P(dBm) = Substitute Level(dB) + Antenna gain(dBi) - C.L(Cable loss) (dB)

Test mode : LTE B12

Frequency(MHz) : 669.7

Channel : 23017

Bandwidth(MHz) : 1.4

Mode	Frequency	Pol.	Antenna Gain	Cable loss	Substitute Level	Level	Limit	Margin
	[MHz]	[V/H]	[dBi]	[dB]	[dBm]	[dBm]	[dBm]	[dB]
QPSK	1 399.61	H	5.50	7.96	-47.74	-50.20	-13.00	37.20
	2 101.60	V	4.96	9.77	-43.39	-48.20	-13.00	35.20
	2 799.07	H	6.78	11.38	-37.30	-41.90	-13.00	28.90
	3 499.00	H	8.30	12.91	-40.29	-44.90	-13.00	31.90

Test mode : LTE B12

Frequency(MHz) : 707.5

Channel : 23095

Bandwidth(MHz) : 1.4

Mode	Frequency	Pol.	Antenna Gain	Cable loss	Substitute Level	Level	Limit	Margin
	[MHz]	[V/H]	[dBi]	[dB]	[dBm]	[dBm]	[dBm]	[dB]
QPSK	1 415.61	H	5.61	8.01	-50.50	-52.90	-13.00	39.90
	2 122.11	V	5.02	9.82	-44.00	-48.80	-13.00	35.80
	2 831.89	H	6.86	11.46	-42.10	-46.70	-13.00	33.70
	3 539.21	H	8.37	13.00	-39.27	-43.90	-13.00	30.90

Test mode : LTE B12

Frequency(MHz) : 715.3

Channel : 23173

Bandwidth(MHz) : 1.4

Mode	Frequency	Pol.	Antenna Gain	Cable loss	Substitute Level	Level	Limit	Margin
	[MHz]	[V/H]	[dBi]	[dB]	[dBm]	[dBm]	[dBm]	[dB]
QPSK	1 432.02	H	5.72	8.06	-52.46	-54.80	-13.00	41.80
	2 147.96	H	5.08	9.88	-44.50	-49.30	-13.00	36.30
	2 863.07	V	6.94	11.52	-42.92	-47.50	-13.00	34.50
	3 580.24	V	8.44	12.79	-39.45	-43.80	-13.00	30.80

Note.

1. E.I.R.P(dBm) = Substitute Level(dB) + Antenna gain(dBi) - C.L(Cable loss) (dB)

Test mode : LTE B13

Frequency(MHz) : 782

Channel : 23230

Bandwidth(MHz) : 10

Mode	Frequency	Pol.	Antenna Gain	Cable loss	Substitute Level	Level	Limit	Margin
	[MHz]	[V/H]	[dBi]	[dB]	[dBm]	[dBm]	[dBm]	[dB]
QPSK	1 555.52	V	6.03	8.37	-50.16	-52.50	-13.00	39.50
	1 563.53	V	6.01	8.39	-53.42	-55.80	-40.00	15.80
	2 332.17	H	5.56	10.40	-42.96	-47.80	-13.00	34.80
	3 110.88	H	7.52	12.06	-38.56	-43.10	-13.00	30.10
	3 885.89	V	8.99	13.60	-35.29	-39.90	-13.00	26.90

Note.

- For the range 1 559 ~ 1 610 MHz,
 Limit Calculation(dBm)= 43 + 10log(P_[Watts])
 Limit Calculation of wide-band (dBm/MHz) = -70 dBW/MHz (-40 dBm/MHz)
 Limit Calculation of narrow-band (dBm) = -80 dBW (-50 dBm)
- E.I.R.P(dBm) = Substitute Level(dB) + Antenna gain(dBi) - C.L(Cable loss) (dB)

Test mode : LTE B66/4

Frequency(MHz) : 1720

Channel : 132072

Bandwidth(MHz) : 20

Mode	Frequency	Pol.	Antenna Gain	Cable loss	Substitute Level	Level	Limit	Margin
	[MHz]	[V/H]	[dBi]	[dB]	[dBm]	[dBm]	[dBm]	[dB]
QPSK	3 441.72	V	8.18	12.79	-48.49	-53.10	-13.00	40.10
	5 160.09	V	10.40	16.73	-45.17	-51.50	-13.00	38.50
	6 878.46	H	11.30	18.56	-39.64	-46.90	-13.00	33.90
	8 600.66	V	13.04	20.48	-35.86	-43.30	-13.00	30.30

Test mode : LTE B66/4

Frequency(MHz) : 1745

Channel : 132322

Bandwidth(MHz) : 20

Mode	Frequency	Pol.	Antenna Gain	Cable loss	Substitute Level	Level	Limit	Margin
	[MHz]	[V/H]	[dBi]	[dB]	[dBm]	[dBm]	[dBm]	[dB]
QPSK	3 489.60	H	8.28	12.89	-47.49	-52.10	-13.00	39.10
	5 236.05	H	10.44	15.99	-42.55	-48.10	-13.00	35.10
	6 978.04	H	11.38	18.64	-39.04	-46.30	-13.00	33.30
	8 723.86	V	13.09	20.58	-37.51	-45.00	-13.00	32.00

Test mode : LTE B66/4

Frequency(MHz) : 1770

Channel : 132572

Bandwidth(MHz) : 20

Mode	Frequency	Pol.	Antenna Gain	Cable loss	Substitute Level	Level	Limit	Margin
	[MHz]	[V/H]	[dBi]	[dB]	[dBm]	[dBm]	[dBm]	[dB]
QPSK	3 518.32	H	8.33	12.95	-46.98	-51.60	-13.00	38.60
	5 281.37	H	10.47	16.06	-43.91	-49.50	-13.00	36.50
	7 041.87	V	11.46	18.75	-38.31	-45.60	-13.00	32.60
	8 800.46	H	13.12	20.69	-35.83	-43.40	-13.00	30.40

Note.

1. E.I.R.P(dBm) = Substitute Level(dB) + Antenna gain(dBi) - C.L(Cable loss) (dB)

Test mode : LTE B71
Frequency(MHz) : 665.5
Channel : 133147
Bandwidth(MHz) : 5

Mode	Frequency	Pol.	Antenna Gain	Cable loss	Substitute Level	Level	Limit	Margin
	[MHz]	[V/H]	[dBi]	[dB]	[dBm]	[dBm]	[dBm]	[dB]
QPSK	1 336.43	H	5.05	7.80	-52.65	-55.40	-13.00	42.40
	2 003.95	H	4.71	9.61	-45.30	-50.20	-13.00	37.20
	2 673.93	H	6.45	11.16	-40.39	-45.10	-13.00	32.10
	3 342.27	V	7.98	12.57	-39.41	-44.00	-13.00	31.00

Test mode : LTE B71
Frequency(MHz) : 680.5
Channel : 133297
Bandwidth(MHz) : 5

Mode	Frequency	Pol.	Antenna Gain	Cable loss	Substitute Level	Level	Limit	Margin
	[MHz]	[V/H]	[dBi]	[dB]	[dBm]	[dBm]	[dBm]	[dB]
QPSK	1 366.38	V	5.26	7.86	-50.90	-53.50	-13.00	40.50
	2 050.31	H	4.83	9.64	-43.69	-48.50	-13.00	35.50
	2 734.65	H	6.61	11.24	-40.77	-45.40	-13.00	32.40
	3 414.89	H	8.13	12.73	-39.80	-44.40	-13.00	31.40

Test mode : LTE B71
Frequency(MHz) : 695.5
Channel : 133447
Bandwidth(MHz) : 5

Mode	Frequency	Pol.	Antenna Gain	Cable loss	Substitute Level	Level	Limit	Margin
	[MHz]	[V/H]	[dBi]	[dB]	[dBm]	[dBm]	[dBm]	[dB]
QPSK	1 385.25	V	5.40	7.92	-52.38	-54.90	-13.00	41.90
	2 076.98	H	4.90	9.71	-43.69	-48.50	-13.00	35.50
	2 774.86	V	6.71	11.33	-40.88	-45.50	-13.00	32.50
	3 467.41	H	8.23	12.84	-38.09	-42.70	-13.00	29.70

Note.

1. E.I.R.P(dBm) = Substitute Level(dB) + Antenna gain(dBi) - C.L(Cable loss) (dB)

8. Measurement equipment

Equipment Name	Manufacturer	Model No.	Serial No.	Next Cal. Date
Spectrum Analyzer	R&S	FSV40-N	101462	24.10.12
Spectrum Analyzer	Agilent	N9040B	US55230151	24.07.03
Divider	Marki Microwave, Inc.	PD-0040	D0006	24.07.04
DC Power Supply	AGILENT	E3632A	MY40001543	25.04.24
Wideband Radio Communication Tester	R&S	CMW500	106840	25.01.18
Wideband Radio Communication Tester	R&S	CMW500	141780	25.01.18
Signal Generator	R&S	SMB100A	176206	25.01.18
Temp & Humid Chamber	Myeongseong R&P	CTHC-50P-DT	20150824-2	25.01.18
Bi-log Antenna	Teseq GmbH	CBL 6112D	62027	24.11.17
Bi-log Antenna	ETS-LINDGREN	3143B	00228420	25.07.20
Horn Antenna	ETS-LINDGREN	3117	00251528	25.01.26
Horn Antenna	ETS-LINDGREN	3117	00227509	24.07.12
Horn Antenna	ETS-LINDGREN	3116C	00251516	25.02.01
Horn Antenna	ETS-LINDGREN	3116	421822	24.10.12
Amplifier	SONOMA INSTRUMENT	310N	421822	24.10.12
Amplifier	B&Z Technologies	BZR-0050400-551028-252525	27736	24.07.04
Amplifier	B&Z Technologies	BZRT-00504000-481055-382525	26299-27735	24.07.04
High pass Filter	Wainwright Instruments GmbH	WHKX10-900-1000-15000-40SS	11	24.07.04
High pass Filter	Wainwright Instruments GmbH	WHKX12-2805-3000-18000-40SS	32	24.07.04

End of test report