





# TEST REPORT

<p><b>Eurofins KCTL Co.,Ltd.</b>                  65, Sinwon-ro, Yeongtong-gu,                  Suwon-si, Gyeonggi-do, 16677, Korea                  TEL: 82-70-5008-1021 FAX: 82-505-299-8311  <a href="http://www.kctl.co.kr">www.kctl.co.kr</a></p>	<p>Report No.:                  KR24-SRF0085                  Page(1) of (65)</p>	 
--	---	---

**1. Client**

- Name : Samsung Electronics Co., Ltd.
- Address : 129, Samsung-ro, Yeongtong-gu, Suwon-si, Gyeonggi-do, 16677, Rep. of Korea
- Date of Receipt : 2024-05-02

**2. Use of Report** : Certification

**3. Name of Product / Model** : Smart Wearable / SM-R866U

**4. Manufacturer / Country of Origin** : Samsung Electronics Co., Ltd. / Vietnam

**5. FCC ID** : A3LSMR866

**6. Date of Test** : 2024-05-03 to 2024-05-14

**7. Location of Test** :  Permanent Testing Lab  On Site Testing  
 (Address:65, Sinwon-ro, Yeongtong-gu, Suwon-si, Gyeonggi-do, 16677, Korea)

**8. Test method used** : FCC Part 2  
 FCC Part 24 Subpart E

**9. Test Result** : Refer to the test result in the test report

Affirmation	Tested by	Technical Manager
	Name : Kwonse Kim (Signature)	Name : Seungyong Kim (Signature)

2024-05-17

**Eurofins KCTL Co.,Ltd.**

As a test result of the sample which was submitted from the client, this report does not guarantee the whole product quality. This test report should not be used and copied without a written agreement by Eurofins KCTL Co.,Ltd.

**REPORT REVISION HISTORY**

Date	Revision	Page No
2024-05-17	Originally issued	-

*This report shall not be reproduced except in full, without the written approval of Eurofins KCTL Co.,Ltd. This document may be altered or revised by Eurofins KCTL Co.,Ltd. personnel only, and shall be noted in the revision section of the document. Any alteration of this document not carried out by Eurofins KCTL Co.,Ltd. will constitute fraud and shall nullify the document. This test report is a general report that does not use the KOLAS accreditation mark and is not related to KS Q ISO/IEC 17025 and KOLAS accreditation.*

**General remarks for test reports**

**Statement concerning the uncertainty of the measurement systems used for the tests**

(may be required by the product standard or client)

Internal procedure used for type testing through which traceability of the measuring uncertainty has been established:

**Procedure number, issue date and title:**

Calculations leading to the reported values are on file with the testing laboratory that conducted the testing.

Statement not required by the standard or client used for type testing

## CONTENTS

1.	General information .....	4
2.	Device information .....	4
2.1.	Accessory information .....	4
2.2.	Frequency/channel operations.....	5
3.	Maximum ERP/EIRP power.....	6
4.	Summary of tests.....	7
4.1.	Worst case orientation .....	8
5.	Measurement uncertainty .....	10
6.	Measurement results explanation example .....	11
7.	Test results .....	12
7.1.	Conducted output power.....	12
7.2.	99% Occupied Bandwidth & 26dB Bandwidth .....	18
7.3.	Band Edge Emissions at Antenna Terminal .....	30
7.4.	Spurious Emissions at Antenna Terminal.....	39
7.5.	Peak to Average Power Ratio (PAPR) .....	47
7.6.	Frequency stability .....	52
7.7.	Radiated Power (EIRP) .....	56
7.8.	Radiated Spurious Emissions.....	61
8.	Measurement equipment.....	65

## 1. General information

Client : Samsung Electronics Co., Ltd.  
 Address : 129, Samsung-ro, Yeongtong-gu, Suwon-si, Gyeonggi-do, 16677, Rep. of Korea  
 Manufacturer : Samsung Electronics Co., Ltd.  
 Address : 129, Samsung-ro, Yeongtong-gu, Suwon-si, Gyeonggi-do, 16677, Rep. of Korea  
 Factory 1 : AG TECH CO.,LTD  
 Address 1 : Lot G3, Que Vo Industrial Park(Expanded Area), Nam son Ward, Bac Ninh Province, Vietnam  
 Factory 2 : ALMUS VINA  
 Address 2 : Lot CN07A, Phu Ha Industrial Park, Ha Thach Commune, Phu Tho Town, Phu Tho Province, Vietnam  
 Laboratory : Eurofins KCTL Co.,Ltd.  
 Address : 65, Sinwon-ro, Yeongtong-gu, Suwon-si, Gyeonggi-do, 16677, Korea  
 Accreditations : FCC Site Designation No: KR0040, FCC Site Registration No: 687132  
 VCCI Registration No. : R-20080, G-20078, C-20059, T-20056  
 CAB Identifier: KR0040  
 ISED Number: 8035A  
 KOLAS No.: KT231

## 2. Device information

Equipment under test : Smart Wearable  
 Model : SM-R866U  
 Modulation technique : WCDMA : QPSK  
 LTE : QPSK, 16QAM  
 Power source : DC 3.88 V  
 Antenna specification : PIFA (Housing metal) Antenna  
 Antenna gain : -10.9 dBi  
 Frequency range : WCDMA 1900 : 1 852.4 MHz ~ 1 907.6 MHz  
 LTE B2 : 1 850.7 MHz ~ 1 909.3 MHz  
 LTE B25 : 1 850.7 MHz ~ 1 914.3 MHz  
 Bandwidth : LTE B2 : 1.4/3/5/10/15/20 MHz  
 LTE B25 : 1.4/3/5/10/15/20 MHz  
 Software version : R866U.001  
 Hardware version : REV1.0  
 Test device serial No. : Conducted : R3AX400LVCR  
 Radiated : R3AX400M6VX, R3AX400M3RT, R3AX400M10T, R3AX400LWTM  
 Operation Temperature : -30 °C ~ 50 °C

### 2.1. Accessory information

Equipment	Manufacturer	Model	Serial No.	Power source	FCC ID
Wireless charger	SAMSUNG	EP-OR825	-	5.0 V, 1.0 A	A3LEPOR825

## 2.2. Frequency/channel operations

This device contains the following capabilities:  
 WCDMA 1900, LTE B2/25

### WCDMA 1900

Ch.	Frequency (MHz)
9262	1 852.4
9400	1 880.0
9538	1 907.6

Table 2.2-1. RMC/HSDPA/HSUPA/DC-HSDPA

### LTE B2

Ch.	Frequency (MHz)
18607	1 850.7
18900	1 880.0
19193	1 909.3

Table 2.2-2. 1.4M BW

Ch.	Frequency (MHz)
18615	1 851.5
18900	1 880.0
19185	1 908.5

Table 2.2-3. 3M BW

Ch.	Frequency (MHz)
18625	1 852.5
18900	1 880.0
19175	1 907.5

Table 2.2-4. 5M BW

Ch.	Frequency (MHz)
18650	1 855.0
18900	1 880.0
19150	1 905.0

Table 2.2-5. 10M BW

Ch.	Frequency (MHz)
18675	1 857.5
18900	1 880.0
19125	1 902.5

Table 2.2-6. 15M BW

Ch.	Frequency (MHz)
18700	1 860.0
18900	1 880.0
19100	1 900.0

Table 2.2-7. 20M BW

### LTE B25

Ch.	Frequency (MHz)
26047	1 850.7
26365	1 882.5
26683	1 914.3

Table 2.2-8. 1.4M BW

Ch.	Frequency (MHz)
26055	1 851.5
26365	1 882.5
26675	1 913.5

Table 2.2-9. 3M BW

Ch.	Frequency (MHz)
26065	1 852.5
26365	1 882.5
26665	1 912.5

Table 2.2-10. 5M BW

Ch.	Frequency (MHz)
26090	1 855.0
26365	1 882.5
26640	1 910.0

Table 2.2-11. 10M BW

Ch.	Frequency (MHz)
26115	1 857.5
26365	1 882.5
26615	1 907.5

Table 2.2-12. 15M BW

Ch.	Frequency (MHz)
26140	1 860.0
26365	1 882.5
26590	1 905.0

Table 2.2-13. 20M BW

#### Notes:

1. LTE B2(1 850 – 1 910 MHz) overlaps the entire frequency range of LTE B25(1 850 – 1 915 MHz) and they have same maximum tune-up power. Therefore, B25 was tested as a representative and the test data provided in this report covers B25 as well as B2 subpart to Part24.

### 3. Maximum ERP/EIRP power

#### WCDMA 1900

Mode	Tx frequency (MHz)	Emission designator	EIRP	
			Max. power (dBm)	Max. power (W)
WCDMA 1900	1 852.4 ~ 1 907.6	4M14F9W	19.02	0.080

#### LTE B25/2

Mode	Tx frequency (MHz)	Emission designator	EIRP	
			Max. power (dBm)	Max. power (W)
LTE B25/2	1 850.7 ~ 1 914.3	1M10G7D	19.11	0.082
		1M10W7D	18.10	0.064
	1 851.5 ~ 1 913.5	2M72G7D	19.20	0.083
		2M70W7D	18.24	0.067
	1 852.5 ~ 1 912.5	4M53G7D	17.84	0.061
		4M55W7D	16.78	0.048
	1 855.0 ~ 1 910.0	8M99G7D	18.82	0.076
		9M02W7D	17.77	0.060
	1 857.5 ~ 1 907.5	13M5G7D	18.30	0.068
		13M5W7D	17.34	0.054
	1 860.0 ~ 1 905.0	18M0G7D	17.82	0.061
		18M0W7D	16.91	0.049

#### 4. Summary of tests

FCC Part section(s)	Parameter	Test Limit	Test Condition	Test results
2.1046	Conducted Output Power	N/A	Conducted	Pass
2.1049	Occupied Bandwidth & 26 dB Bandwidth	N/A		Pass
2.1051 24.238(a)	Band Edge Emissions at Antenna Terminal	<43 + 10Log <sub>10</sub> (P) dB at Band edge and for all out of band emissions		Pass
	Spurious Emissions at Antenna Terminal			Pass
24.232(d)	Peak to Average Power Ratio	<13 dB		Pass
2.1055 24.355	Frequency stability	< 2.5 ppm		Pass
24.232(c)	Equivalent Isotropic Radiated Power	< 2 Watts max. ERP	Radiated	Pass
2.1053 24.238(a)	Radiated Spurious Emissions	<43 + 10Log <sub>10</sub> (P) dB for all out of band emissions		Pass

**Notes:**

- The test procedure(s) in this report were performed in accordance as following.
  - ◆ ANSI C63.26-2015
  - ◆ ANSI/TIA-603-E-2016
  - ◆ KDB 971168 D01 v03r01

#### 4.1. Worst case orientation

- All modes of operation were investigated and the worst case emissions are reported with the EUT positioning, modulations, RB sizes and offsets, and channel bandwidth configurations in the test data.
- In the case of radiated spurious emissions, only the worst case bandwidth results were reported.
- Output power measurements were measured on all of modulation. All tests except output power was performed with below modulation with highest power.
  - WCDMA: RMC
  - LTE: QPSK, 16QAM
- However, the PAPR was evaluated for all wave forms and modulations during pre-test, then all bandwidth was performed for the modulations with the highest result.
  - LTE: QPSK, 16QAM
- All configurations have been performed (Stand-alone, Stand-alone with TA, with Strap).
- The fundamental of the EUT was investigated in three orthogonal orientations X, Y and Z and all of the radiated tests have been performed with the accessories as below. It was determined that below orientation was worst case orientation for each band.

Band	Strap	With charger	Without charger		
		X-axis	X-axis	Y-axis	Z-axis
WCDMA1900	With strap	-	-	O	-
	Without strap	-	-	-	-
LTE B25/2	With strap	-	-	O	-
	Without strap	-	-	-	-

#### 7. Test Condition

- The measurement was performed with various configurations then worst results are reported.
- Radiated measurement

Test Description	Mode	Condition		Test Channel
Effective Radiated Power	WCDMA	RMC (12.2 kbps)		Low, Middle, High
	LTE	QPSK, 16QAM	RB Size: 1	
Radiated Spurious Emissions	WCDMA	RMC (12.2 kbps)		Low, Middle, High
	LTE	QPSK	RB Size: 1	

Band	Bandwidth (MHz)	RB size	RB offset
LTE B25/2	1.4, 3, 5, 10, 15, 20	1	Low, Middle, High



2) Conducted measurement

Test Description	Mode	Condition		Test Channel
OBW & 26 dB BW	WCDMA	RMC (12.2 kbps)		Low, Middle, High
	LTE	QPSK, 16QAM	RB Size: Full	
PAPR	WCDMA	RMC (12.2 kbps)		Middle
	LTE	QPSK, 16QAM	RB Size: Full	
Band Edge	WCDMA	RMC (12.2 kbps)		Low, High
	LTE	QPSK	RB Size: 1, Full	
Spurious Emissions	WCDMA	RMC (12.2 kbps)		Low, Middle, High
	LTE	QPSK	RB Size: 1	

Band	Bandwidth (MHz)	RB size	RB offset
LTE B25/2	1.4, 3, 5, 10, 15, 20	1	0, 5, 14, 24, 49, 74, 99
		Full	0

## 5. Measurement uncertainty

The measurement uncertainties shown below were calculated in accordance with the requirements of ANSI C63.4-2014.

All measurement uncertainty values are shown with a coverage factor of  $k=2$  to indicated a 95 % level of confidence. The measurement data shown herein meets or exceeds the  $U_{CISPR}$  measurement uncertainty values specified in CISPR 16-4-2 and thus, can be compared directly to specified limits to determine compliance.

Parameter	Expanded uncertainty ( $\pm$ )	
Conducted RF power	0.9 dB	
Conducted spurious emissions	1.9 dB	
Radiated spurious emissions	Below 1 000 MHz	2.5 dB
	1 000 MHz ~ 18 000 MHz	2.5 dB
	Above 1 8000 MHz	2.6 dB

## 6. Measurement results explanation example

Frequency (MHz)	Factor(dB)	Frequency (MHz)	Factor(dB)
30	5.82	16 000	9.29
50	6.09	17 000	9.50
100	6.15	18 000	9.55
200	6.09	19 000	9.31
300	6.28	20 000	8.51
400	6.51	21 000	9.00
500	6.57	22 000	9.52
600	6.62	23 000	9.53
700	6.67	24 000	9.95
800	6.70	25 000	10.82
900	6.74	26 000	10.60
1 000	6.76	26 500	10.73
2 000	7.06	27 000	10.59
3 000	7.25	28 000	11.48
4 000	7.39	29 000	10.38
5 000	7.54	30 000	10.69
6 000	7.94	31 000	11.57
7 000	8.10	32 000	11.70
8 000	8.21	33 000	12.00
9 000	8.26	34 000	11.88
10 000	7.36	35 000	11.65
11 000	8.35	36 000	11.80
12 000	8.40	37 000	11.51
13 000	8.62	38 000	10.82
14 000	8.71	39 000	11.00
15 000	9.02	40 000	11.30

**Note.**

- Offset(dB) = RF cable loss(dB) + Divider (dB)

## 7. Test results

### 7.1. Conducted output power

#### Test setup

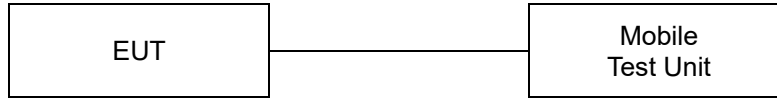

#### Test procedure

971168 D01 v03r01 – Section 5.2  
ANSI C63.26-2015 – Section 5.2.4.2  
CFR 47 - Section §2.1046

#### Test settings

When an average power meter is used to perform RF output power measurements, the fundamental condition that measurement be performed only over durations of active transmissions at maximum output power level applies. Thus, an average power meter can always be used to perform the measurement when the EUT can be configured to transmit continuously.

If the EUT cannot be configured to transmit continuously (i.e., burst duty cycle < 98%), then the following options can be implemented to facilitate measurement of the average power with an average power meter:

- a) A gated average power meter can be used to perform the measurement if the gating parameters can be adjusted such that the power is measured only during active transmission bursts at maximum output power levels.
- b) A conventional average power meter with no signal gating capability can also be used if the measured burst duty cycle is constant (i.e., duty cycle variations are less than or equal to  $\pm 2\%$ ) by performing the measurement over the on/off burst cycles and then correcting (increasing) the measured level by a factor equal to  $[10\log (1/\text{duty cycle})]$ . See 5.2.4.3.4 for guidance with respect to measuring the transmitter duty cycle.

See item r) of 4.1 for more information regarding power meter functional requirements and limitations, and consult the instrumentation-specific application literature for proper set-up and use.

#### Note:

1. Offset(dB) = RF cable loss(dB)

## Test results

Test Band	Test mode	Maximum Average Power (dBm)		
		Channel		
		Low	Middle	High
WCDMA 1900	RMC	21.49	22.00	22.35
	HSDPA-Subtest 1	21.41	21.89	22.31
	HSDPA-Subtest 2	21.45	20.98	21.37
	HSDPA-Subtest 3	20.88	19.96	20.34
	HSDPA-Subtest 4	20.88	19.97	20.59
	HSUPA-Subtest 1	19.76	18.82	19.31
	HSUPA-Subtest 2	17.79	17.01	17.28
	HSUPA-Subtest 3	20.27	20.00	20.40
	HSUPA-Subtest 4	17.86	17.07	17.29
	HSUPA-Subtest 5	21.12	20.85	21.24
	DC-HSDPA-Subtest 1	21.34	21.90	22.32
	DC-HSDPA-Subtest 2	21.42	21.26	22.00
	DC-HSDPA-Subtest 3	20.77	20.50	21.04
	DC-HSDPA-Subtest 4	20.81	20.47	21.05

Test Band	Bandwidth (MHz)	Test mode	RB size	RB offset	Maximum Average Power (dBm)			
					Channel			
					Low	Middle	High	
LTE B2	1.4	QPSK	1	0	22.97	22.37	23.10	
			1	3	22.99	22.39	23.15	
			1	5	22.90	22.35	23.13	
			3	0	23.05	22.48	23.15	
			3	1	23.13	22.44	23.11	
			3	3	23.07	22.45	23.06	
		16QAM	6	0	22.03	21.39	22.02	
			1	0	21.97	21.25	22.03	
			1	3	21.96	21.35	22.00	
			1	5	21.91	21.39	22.15	
			3	0	21.93	21.17	21.97	
			3	1	21.99	21.26	21.94	
		3	QPSK	3	3	21.69	21.29	21.88
				6	0	21.10	20.46	21.11
				1	0	23.18	22.51	23.21
				1	8	23.13	22.47	23.26
				1	14	23.20	22.50	23.23
				8	0	22.13	21.45	22.19
	16QAM		8	4	22.08	21.46	22.10	
			8	7	22.12	21.45	22.07	
			15	0	22.09	21.48	22.10	
			1	0	22.23	21.55	22.27	
			1	8	22.25	21.49	22.20	
			1	14	22.23	21.35	22.24	
	5		QPSK	8	0	21.08	20.46	21.12
				8	4	21.21	20.49	21.09
				8	7	21.16	20.47	21.16
				15	0	21.10	20.51	21.16
				1	0	23.07	22.65	23.22
				1	12	23.17	22.58	23.24
		16QAM	1	24	23.15	22.53	23.24	
			12	0	22.06	21.49	22.19	
			12	7	22.14	21.46	22.25	
			12	13	22.12	21.51	22.18	
			25	0	22.07	21.53	22.17	
			1	0	22.22	21.40	22.19	
		10	QPSK	1	12	22.03	21.52	22.46
				1	24	22.19	21.52	22.21
				12	0	21.24	20.57	21.24
				12	7	21.17	20.25	21.24
				12	13	21.29	20.49	21.21
				25	0	20.81	20.48	21.10
	16QAM		1	0	22.98	22.56	22.91	
			1	25	23.11	22.58	23.14	
			1	49	23.04	22.52	23.14	
			25	0	22.08	21.16	22.13	
			25	12	21.99	21.51	22.13	
			25	25	22.07	21.51	22.17	
	QPSK		50	0	22.03	21.55	22.14	
			1	0	22.20	21.45	22.33	
1			25	22.15	21.64	22.17		
1			49	22.23	21.57	22.20		
25			0	21.03	20.51	21.11		
25			12	21.11	20.50	21.14		
16QAM	25	25	21.12	20.53	21.13			
	50	0	21.11	20.51	21.19			

Test Band	Bandwidth (MHz)	Test mode	RB size	RB offset	Maximum Average Power (dBm)		
					Channel		
					Low	Middle	High
LTE B2	15	QPSK	1	0	22.86	22.50	23.22
			1	36	22.87	22.49	23.19
			1	74	22.95	22.49	23.09
			36	0	21.95	21.49	22.13
			36	18	21.95	21.47	22.09
			36	37	21.90	21.50	22.07
			75	0	22.01	21.53	22.07
		16QAM	1	0	21.99	21.37	22.14
			1	36	21.87	21.29	22.03
			1	74	21.97	21.41	21.98
			36	0	20.97	20.43	21.08
			36	18	21.04	20.47	21.11
			36	37	20.92	20.43	21.07
			75	0	20.97	20.50	21.00
	20	QPSK	1	0	22.91	22.58	23.05
			1	49	22.92	22.47	23.03
			1	99	22.99	22.56	22.96
			50	0	21.97	21.47	22.06
			50	24	21.93	21.51	22.03
			50	50	21.89	21.48	22.03
			100	0	21.90	21.51	22.03
		16QAM	1	0	21.98	21.53	21.99
			1	49	21.86	21.50	22.10
			1	99	21.96	21.55	21.95
		50	0	20.98	20.52	21.07	
		50	24	20.91	20.51	21.00	
		50	50	20.97	20.59	20.95	
		100	0	20.92	20.49	21.00	

Test Band	Bandwidth (MHz)	Test mode	RB size	RB offset	Maximum Average Power (dBm)			
					Channel			
					Low	Middle	High	
LTE B25	1.4	QPSK	1	0	23.08	22.56	23.06	
			1	3	23.08	22.58	23.11	
			1	5	23.04	22.50	23.07	
			3	0	23.10	22.50	23.09	
			3	1	23.07	22.50	23.11	
			3	3	23.06	22.52	23.07	
		16QAM	6	0	22.06	21.49	22.07	
			1	0	22.09	21.32	22.01	
			1	3	21.93	21.29	22.21	
			1	5	22.11	21.12	22.03	
			3	0	21.99	21.44	21.95	
			3	1	22.01	21.46	21.99	
		3	QPSK	3	3	22.01	21.47	21.90
				3	3	22.01	21.47	21.90
				6	0	21.23	20.56	21.11
				1	0	23.12	22.59	23.18
				1	8	23.19	22.56	23.11
				1	14	23.24	22.60	23.17
	16QAM		8	0	22.09	21.46	22.06	
			8	4	22.12	21.50	22.08	
			8	7	22.06	21.51	22.05	
			15	0	22.15	21.55	22.11	
			1	0	22.19	21.53	22.02	
			1	8	22.11	21.59	21.99	
	5		QPSK	1	14	22.21	21.61	22.12
				8	0	21.07	20.50	21.06
				8	4	21.09	20.49	21.01
				8	7	21.06	20.48	21.00
				15	0	21.11	20.45	21.11
				1	0	23.14	22.58	23.22
		16QAM	1	12	23.17	22.63	23.19	
			1	24	23.13	22.61	22.99	
			12	0	22.15	21.61	22.09	
			12	7	22.08	21.56	22.13	
			12	13	22.12	21.56	22.05	
			25	0	22.18	21.56	22.16	
		10	QPSK	1	0	22.21	21.52	22.16
				1	12	22.20	21.45	22.21
				1	24	22.24	21.49	22.14
				12	0	21.16	20.54	21.10
				12	7	21.14	20.54	21.09
				12	13	21.10	20.50	21.17
	16QAM		25	0	21.16	20.52	21.04	
			1	0	23.12	22.59	23.23	
			1	25	23.12	22.59	23.21	
			1	49	23.08	22.52	22.68	
			25	0	22.12	21.53	22.19	
			25	12	22.10	21.59	22.16	
16QAM	25		25	22.10	21.55	22.18		
	50		0	22.16	21.60	22.19		
	1		0	22.06	21.52	22.16		
	1		25	22.06	21.37	22.16		
	1		49	21.94	21.43	21.71		
	25		0	21.09	20.51	21.24		
	25	12	21.10	20.54	21.23			
	25	25	21.08	20.56	21.15			
	50	0	21.10	20.53	21.20			



Test Band	Bandwidth (MHz)	Test mode	RB size	RB offset	Maximum Average Power (dBm)		
					Channel		
					Low	Middle	High
LTE B25	15	QPSK	1	0	23.02	22.53	22.94
			1	36	23.04	22.55	23.21
			1	74	23.00	22.54	22.61
			36	0	22.05	21.57	22.21
			36	18	22.02	21.52	22.24
			36	37	21.98	21.53	22.15
			75	0	22.09	21.57	22.14
		16QAM	1	0	22.03	21.43	22.15
			1	36	22.14	21.55	22.18
			1	74	22.03	21.64	21.63
			36	0	20.97	20.53	21.19
			36	18	20.98	20.45	21.21
			36	37	20.99	20.58	21.09
			75	0	21.04	20.46	21.11
	20	QPSK	1	0	22.99	22.72	23.17
			1	49	22.81	22.58	23.04
			1	99	22.93	22.50	22.54
			50	0	21.98	21.57	22.20
			50	24	21.92	21.53	22.12
			50	50	21.96	21.53	22.19
			100	0	21.94	21.53	22.11
		16QAM	1	0	21.97	21.56	22.15
			1	49	21.89	21.69	22.10
			1	99	21.94	21.39	21.75
		50	0	20.99	20.51	21.21	
		50	24	20.94	20.50	21.10	
		50	50	20.98	20.51	21.14	
		100	0	20.94	20.54	21.14	

## 7.2. 99% Occupied Bandwidth & 26dB Bandwidth

### Test setup

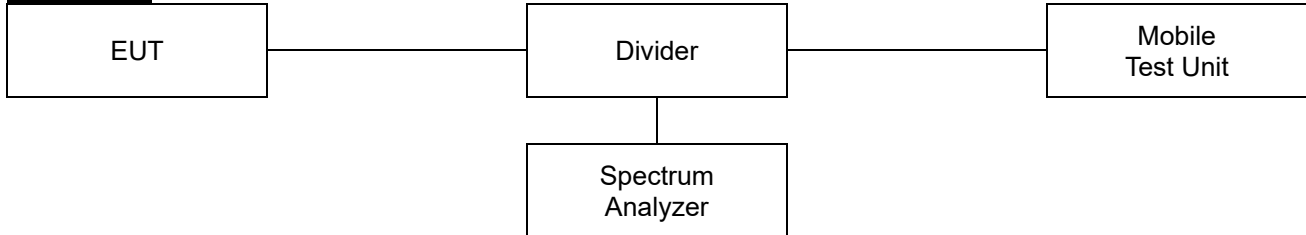

### Limit

#### According to §2.1049,

The occupied bandwidth, that is the frequency bandwidth such that, below its lower and above its upper frequency limits, the mean powers radiated are each equal to 0.5 percent of the total mean power radiated by a given emission shall be measured.

### Test procedure

971168 D01 v03r01 – Section 4.2 and 4.3  
ANSI C63.26-2015 – Section 5.4.3 and 5.4.4

### Test settings

#### ◆ 26dB Bandwidth

- a) The spectrum analyzer center frequency is set to the nominal EUT channel center frequency. The span range for the spectrum analyzer shall be wide enough to see sufficient roll off of the signal to make the measurement.
- b) The nominal RBW shall be in the range of 1% to 5% of the anticipated OBW, and the VBW shall be set  $\geq 3 \times$  RBW.
- c) Set the reference level of the instrument as required to prevent the signal amplitude from exceeding the maximum spectrum analyzer input mixer level for linear operation. See guidance provided in 4.2.3.
- d) The dynamic range of the spectrum analyzer at the selected RBW shall be more than 10 dB below the target “-X dB” requirement, i.e., if the requirement calls for measuring the -26 dB OBW, the spectrum analyzer noise floor at the selected RBW shall be at least 36 dB below the reference level.
- e) Set spectrum analyzer detection mode to peak, and the trace mode to max hold.
- f) Determine the reference value by either of the following:
  - 1) Set the EUT to transmit a modulated signal. Allow the trace to stabilize. Set the spectrum analyzer marker to the highest level of the displayed trace (this is the reference value).
  - 2) Set the EUT to transmit an unmodulated carrier. Set the spectrum analyzer marker to the level of the carrier.
- g) Determine the “-X dB amplitude” as equal to (Reference Value - X). Alternatively, this calculation can be performed on the spectrum analyzer using the delta-marker measurement function.
- h) If the reference value was determined using an unmodulated carrier, turn the EUT modulation on, then either clear the existing trace or start a new trace on the spectrum analyzer and allow the new trace to stabilize. Otherwise the trace from step f) shall be used for step i).

<p style="text-align: center;"><b>Eurofins KCTL Co.,Ltd.</b>  65, Sinwon-ro, Yeongtong-gu,  Suwon-si, Gyeonggi-do, 16677, Korea  TEL: 82-70-5008-1021 FAX: 82-505-299-8311  <a href="http://www.kctl.co.kr">www.kctl.co.kr</a></p>	<p style="text-align: center;">Report No.:  KR24-SRF0085  Page (19) of (65)</p>	
--	---	---

- i) Place two markers, one at the lowest and the other at the highest frequency of the envelope of the spectral display such that each marker is at or slightly below the “-X dB amplitude” determined in step f). If a marker is below this “-X dB amplitude” value it should be as close as possible to this value. The OBW is the positive frequency difference between the two markers.
- j) The spectral envelope can cross the “-X dB amplitude” at multiple points. The lowest or highest frequency shall be selected as the frequencies that are the farthest away from the center frequency at which the spectral envelope crosses the “-X dB amplitude.”
- k) The OBW shall be reported by providing plot(s) of the measuring instrument display, to include markers depicting the relevant frequency and amplitude information (e.g., marker table). The frequency and amplitude axis and scale shall be clearly labeled. Tabular data may be reported in addition to the plot(s).

### ◆ 99% Occupied Bandwidth

- a) The spectrum analyzer center frequency is set to the nominal EUT channel center frequency. The frequency span for the spectrum analyzer shall be set wide enough to capture all modulation products including the emission skirts (typically a span of  $1.5 \times \text{OBW}$  is sufficient).
- b) The nominal IF filter 3 dB bandwidth (RBW) shall be in the range of 1% to 5% of the anticipated OBW, and the VBW shall be set  $\geq 3 \times \text{RBW}$ .
- c) Set the reference level of the instrument as required to prevent the signal amplitude from exceeding the maximum spectrum analyzer input mixer level for linear operation. See guidance provided in 4.2.3.
- d) Set the detection mode to peak, and the trace mode to max-hold.
- e) If the instrument does not have a 99% OBW function, recover the trace data points and sum directly in linear power terms. Place the recovered amplitude data points, beginning at the lowest frequency, in a running sum until 0.5% of the total is reached. Record that frequency as the lower OBW frequency. Repeat the process until 99.5% of the total is reached and record that frequency as the upper OBW frequency. The 99% power OBW can be determined by computing the difference these two frequencies.
- f) The OBW shall be reported and plot(s) of the measuring instrument display shall be provided with the test report. The frequency and amplitude axis and scale shall be clearly labeled. Tabular data can be reported in addition to the plot(s).

### Notes:

1. The EUT was setup to maximum output power with all bandwidth and modulation.

**Test results**

Test mode		Channel	26 dB Bandwidth (MHz)	99 % Bandwidth (MHz)
WCDMA1900	RMC	Low	4.75	4.14
		Middle	4.72	4.14
		High	4.71	4.14



Test Band	Bandwidth (MHz)	Channel	Test mode	26dB Bandwidth (MHz)	99 % Bandwidth (MHz)
LTE B25/2	1.4	Low	QPSK	1.34	1.10
			16QAM	1.35	1.09
		Middle	QPSK	1.36	1.10
			16QAM	1.33	1.10
		High	QPSK	1.35	1.10
			16QAM	1.35	1.10
	3	Low	QPSK	3.10	2.72
			16QAM	3.13	2.70
		Middle	QPSK	3.11	2.70
			16QAM	3.09	2.70
		High	QPSK	3.10	2.70
			16QAM	3.11	2.70
	5	Low	QPSK	5.33	4.53
			16QAM	5.31	4.55
		Middle	QPSK	5.40	4.53
			16QAM	5.26	4.51
		High	QPSK	5.37	4.52
			16QAM	5.40	4.55
	10	Low	QPSK	10.29	8.99
			16QAM	10.09	9.02
		Middle	QPSK	10.42	8.97
			16QAM	10.27	9.02
		High	QPSK	10.04	8.97
			16QAM	10.22	8.99
15	Low	QPSK	14.91	13.45	
		16QAM	14.99	13.45	
	Middle	QPSK	14.99	13.49	
		16QAM	14.80	13.49	
	High	QPSK	14.69	13.37	
		16QAM	14.99	13.45	
20	Low	QPSK	19.63	17.88	
		16QAM	19.58	17.88	
	Middle	QPSK	19.88	17.98	
		16QAM	19.83	17.98	
	High	QPSK	20.13	17.98	
		16QAM	19.98	18.03	

**In order to simplify the report, only Middle channel test plots are attached**

**26dB Bandwidth**

**Test mode: WCDMA 1900**



**Test mode: LTE B25/2**

**1.4M BW QPSK Middle channel**

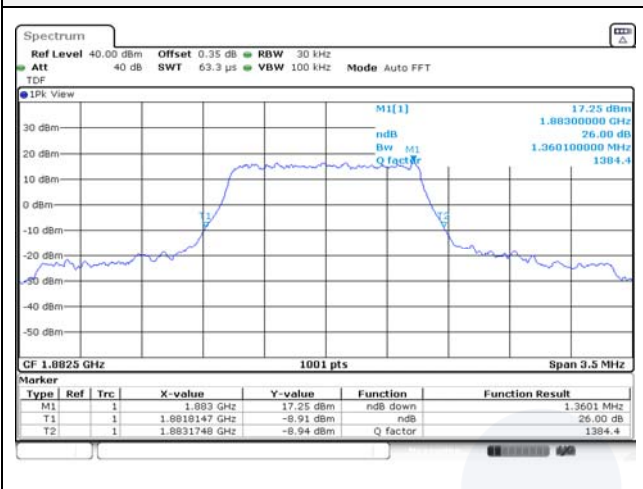

**1.4M BW 16QAM Middle channel**

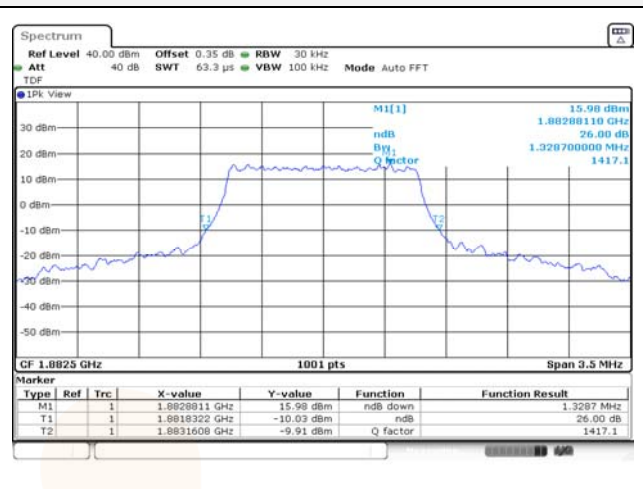

**3M BW QPSK Middle channel**

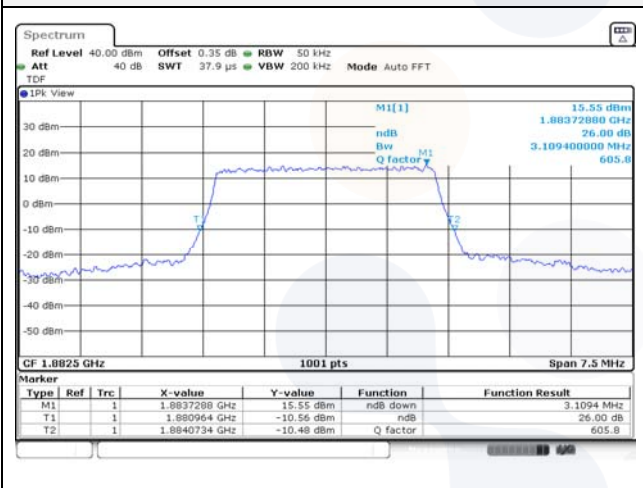

**3M BW 16QAM Middle channel**

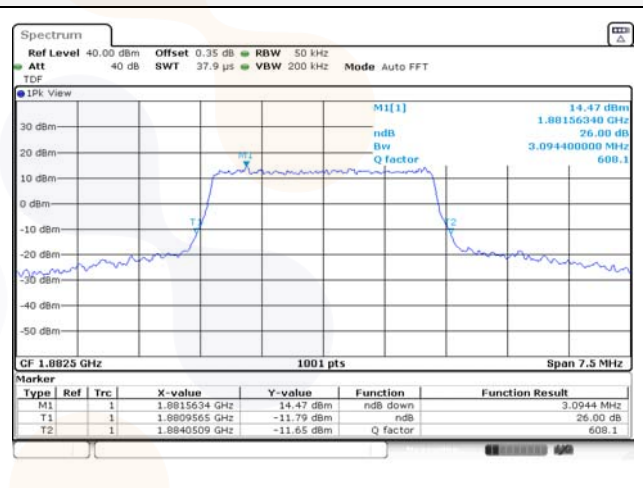

**5M BW QPSK Middle channel**

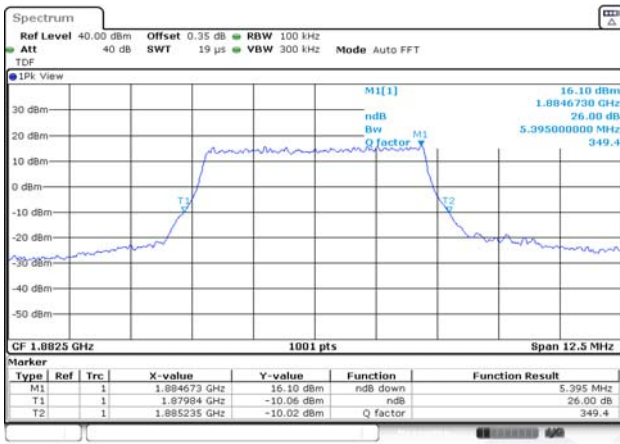

**5M BW 16QAM Middle channel**

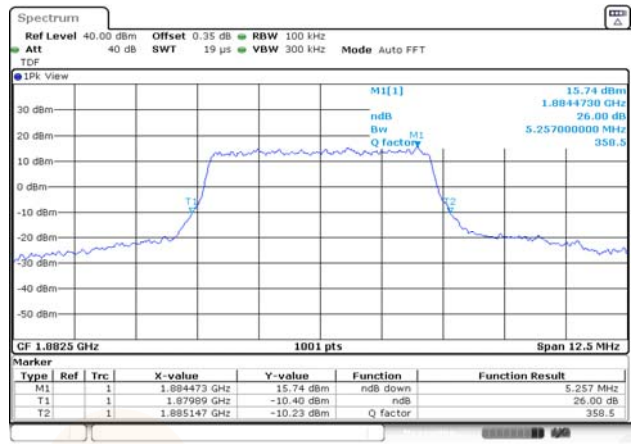

**10M BW QPSK Middle channel**

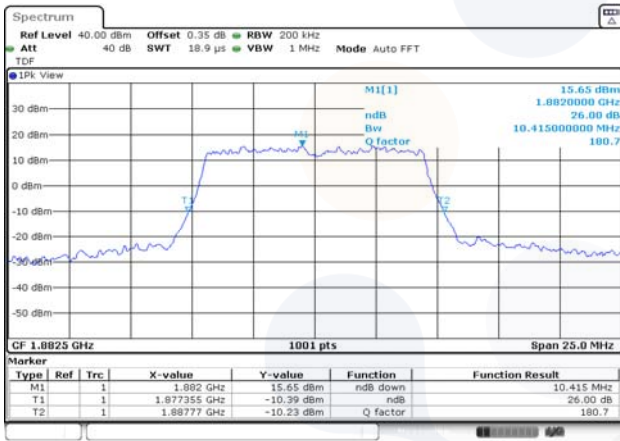

**10M BW 16QAM Middle channel**

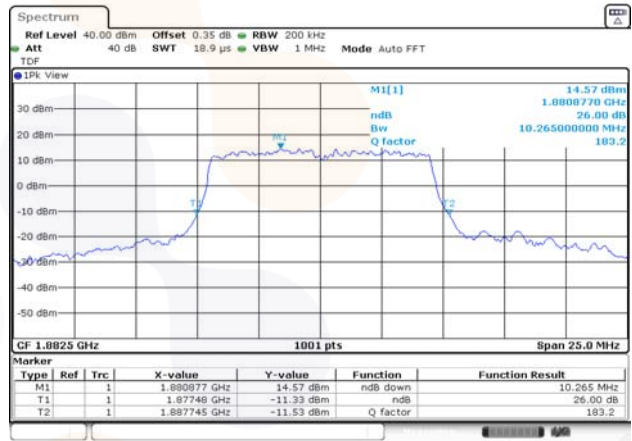



**15M BW QPSK Middle channel**

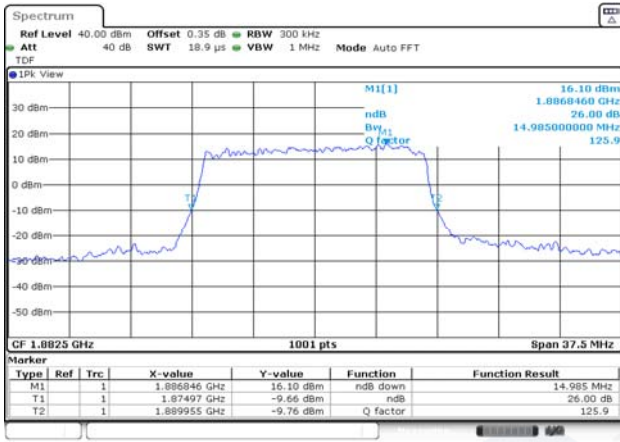

**15M BW 16QAM Middle channel**

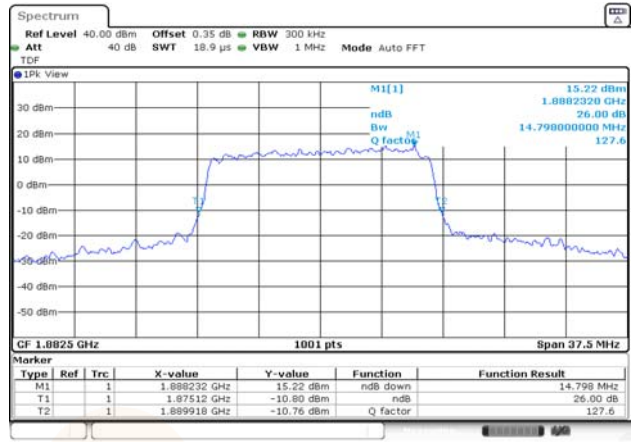

**20M BW QPSK Middle channel**

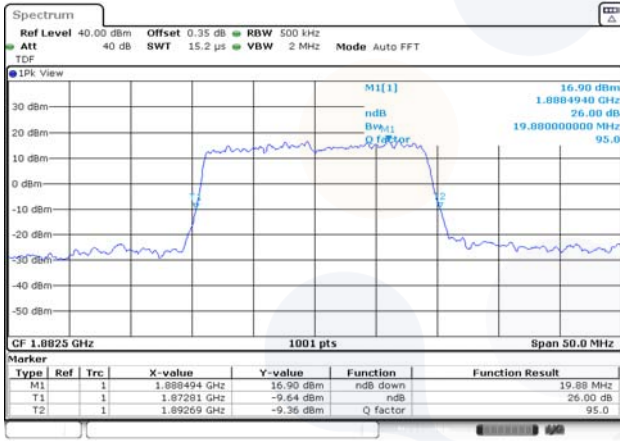

**20M BW 16QAM Middle channel**

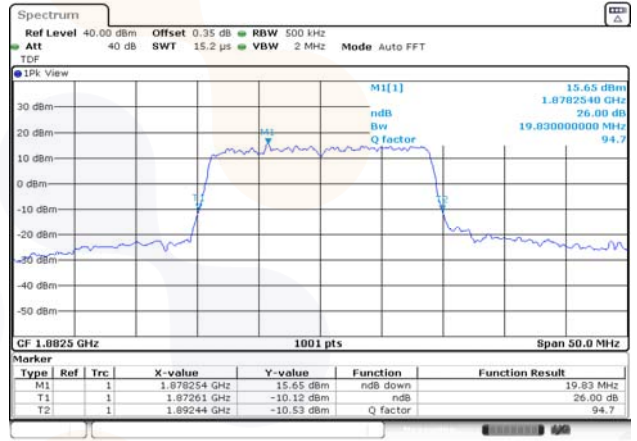

**99% Occupied Bandwidth**

**Test mode: WCDMA 1900**

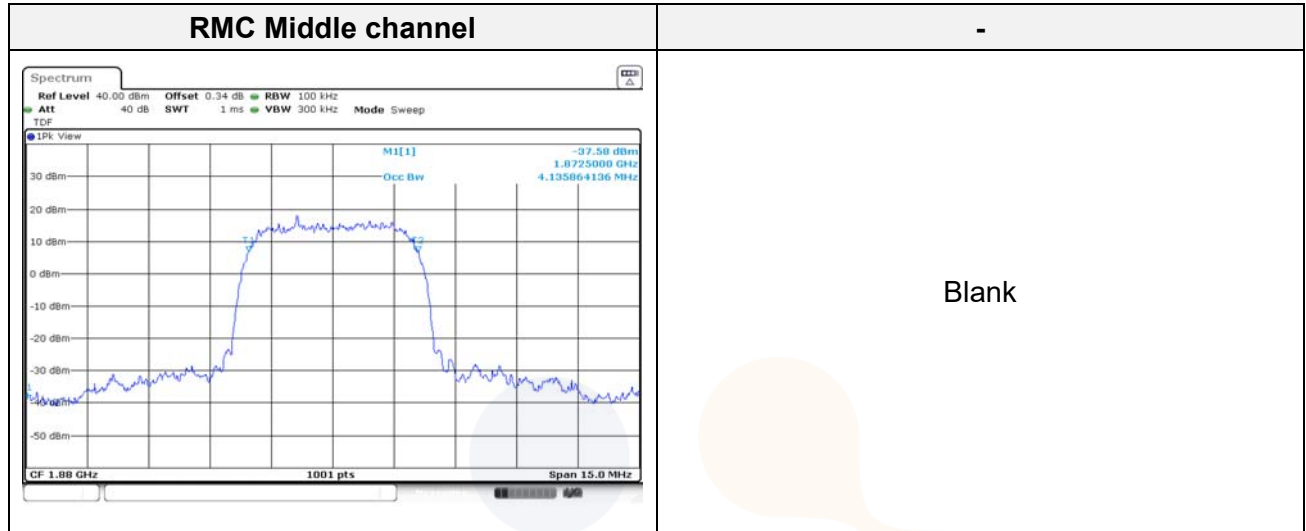

**Test mode: LTE B25/2**

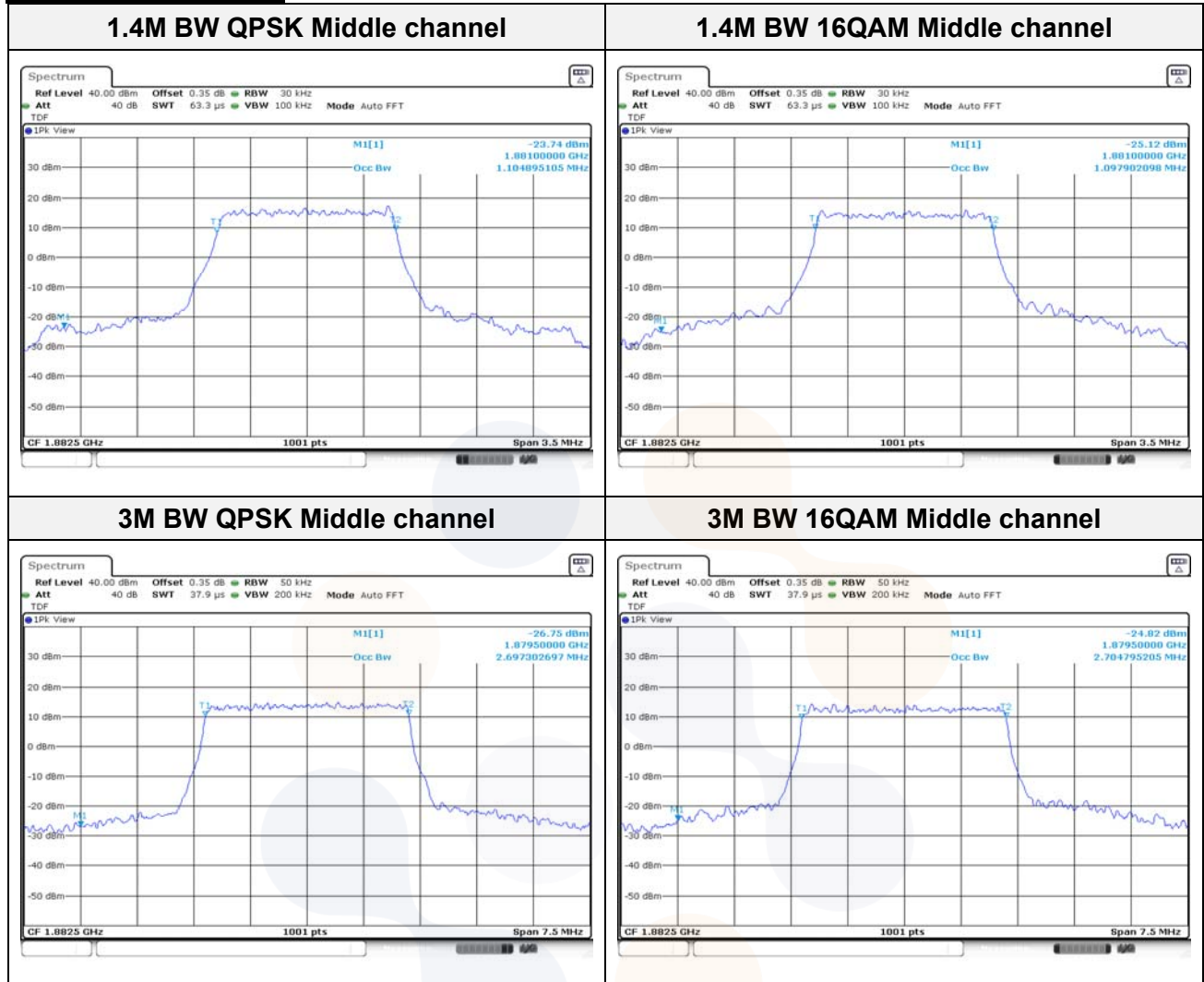

**5M BW QPSK Middle channel**

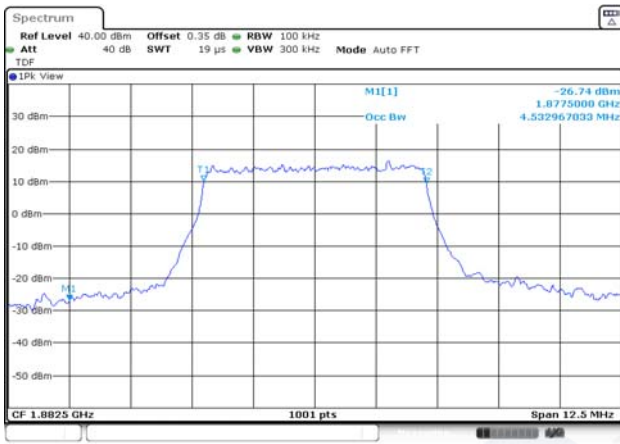

**5M BW 16QAM Middle channel**

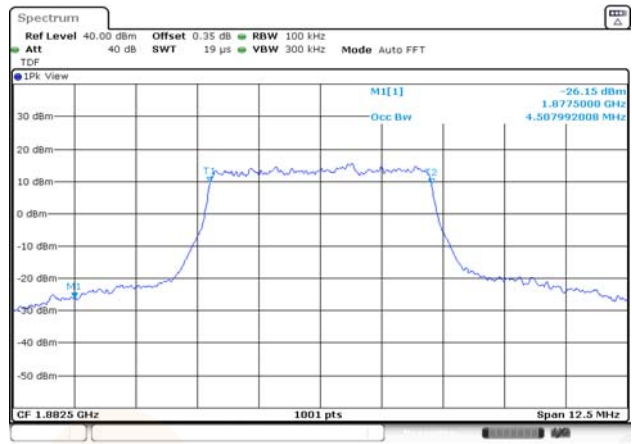

**10M BW QPSK Middle channel**



**10M BW 16QAM Middle channel**

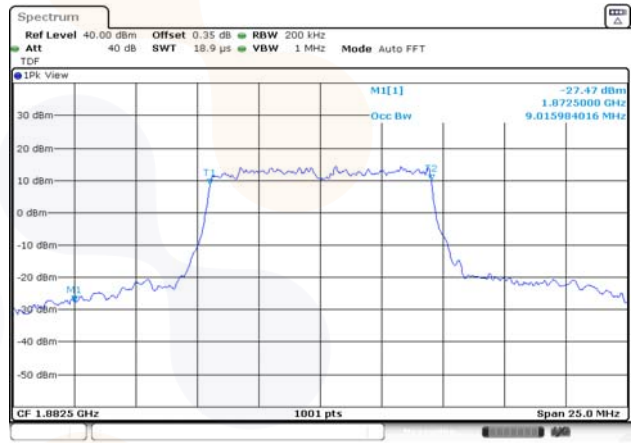

**15M BW QPSK Middle channel**

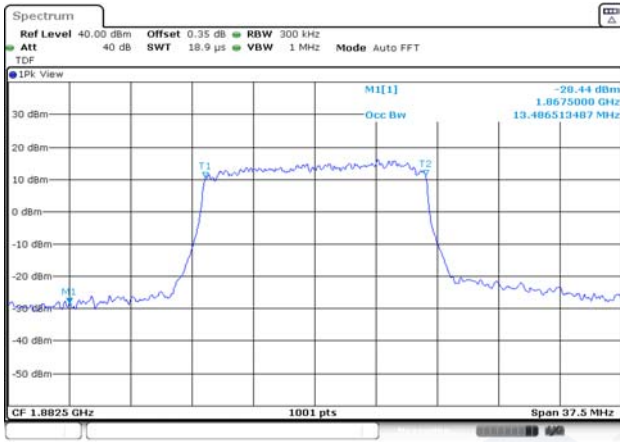

**15M BW 16QAM Middle channel**

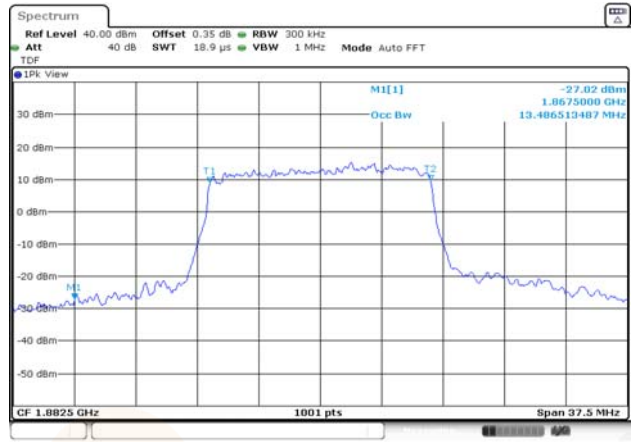

**20M BW QPSK Middle channel**



**20M BW 16QAM Middle channel**



### 7.3. Band Edge Emissions at Antenna Terminal

#### Test setup

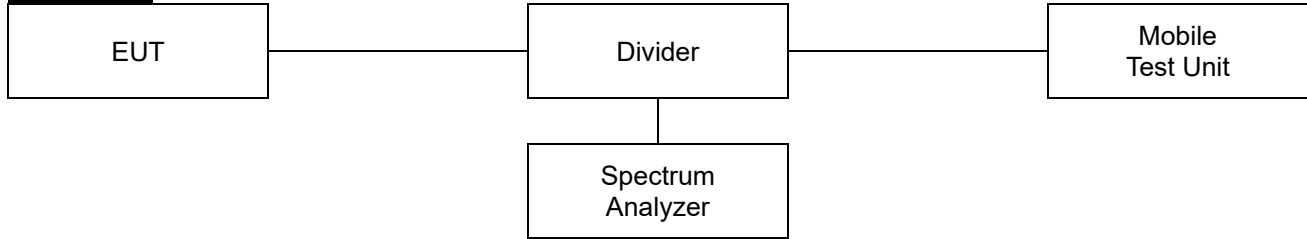

#### Limit

##### According to §24.238(a),

The power of any emission outside of the authorized operating frequency ranges must be attenuated below the transmitting power (P) by a factor of at least  $43 + 10\log(P)$  dB.



#### Test procedure

971168 D01 v03r01 - Section 6

ANSI C63.26-2015 – Section 5.7

#### Test settings

- 1) Start and stop frequency were set such that the band edge would be placed in the center of the plot
- 2) Span was set large enough so as to capture all out of band emissions near the band edge.
- 3) Set the RBW > 1% of the emission bandwidth.
- 4) Set the VBW  $\geq 3 \times$  RBW.
- 5) Set the number of sweep points  $\geq 2 \times$  Span/RBW
- 6) Detector = RMS
- 7) Trace mode = trace average
- 8) Sweep time should be auto for peak detection. For RMS detection the sweep time should be set as follows:
  - a) If the device can be configured to transmit continuously (duty cycle  $\geq 98\%$ ), set the (sweep time) > (number of points in sweep)  $\times$  (symbol period) (e.g., by a factor of  $10 \times$  symbol period  $\times$  number of points) Increasing the sweep time (i.e., slowing the sweep speed) will allow for averaging over multiple symbols.
  - b) If the device cannot transmit continuously (duty cycle <  $98\%$ ), a gated sweep shall be used when possible (i.e., gate triggered such that the analyzer only sweeps when the device is transmitting at full power), set the sweep time > (number of points in sweep)  $\times$  (symbol period) but the sweep time shall always be maintained at a value that is less than or equal to the minimum transmission time
  - c) If the device cannot be configured to transmit continuously (duty cycle >  $98\%$ ), and a free-running sweep must be used, set the sweep time so that the averaging is performed over multiple on/off cycles by setting the sweep time > (number of points in sweep)  $\times$  (transmitter period) (i.e., the transmit on-time + the off-time). The spectrum analyzer readings shall subsequently be corrected by  $[10 \log (1/\text{duty cycle})]$ . This assumes that the transmission period and duty cycle is relatively constant (duty cycle variation  $\leq \pm 2\%$ ).
  - d) If the device cannot be configured to transmit continuously and a free-running

<p><b>Eurofins KCTL Co.,Ltd.</b>  65, Sinwon-ro, Yeongtong-gu,  Suwon-si, Gyeonggi-do, 16677, Korea  TEL: 82-70-5008-1021 FAX: 82-505-299-8311  <a href="http://www.kctl.co.kr">www.kctl.co.kr</a></p>	<p>Report No.:  KR24-SRF0085  Page (31) of (65)</p>	   
--	---	---

sweep must be used, and if the transmissions exhibit a non-constant duty cycle (duty cycle variations  $> \pm 2\%$ ), set the sweep time so that the averaging is performed over the on-period by setting the sweep time  $> (\text{symbol period}) \times (\text{number of points})$ , while also maintaining the sweep time  $< (\text{transmitter on-time})$ . The trace mode shall be set to max hold, since not every display point will be averaged only over just the on-time. Thus, multiple sweeps (e.g., 100) in maximum hold are necessary to ensure that the maximum power is measured.

- 9) Allow trace to fully stabilize.

**Notes:**

1. Per 24.238(b), compliance with these rules is based on the use of measurement instrumentation employing a resolution bandwidth of 1 MHz or greater. However, in the 1 MHz bands immediately outside and adjacent to the frequency block a resolution bandwidth of at least one percent of the emission bandwidth of the fundamental emission of the transmitter may be employed. The emission bandwidth is defined as the width of the signal between two points, one below the carrier center frequency and one above the carrier center frequency, outside of which all emissions are attenuated at least 26 dB below the transmitter power.
2. The EUT was setup to maximum output power as its lowest and highest channel with all bandwidth, modulation and RB configurations.

## Test results

### Test mode: WCDMA 1900

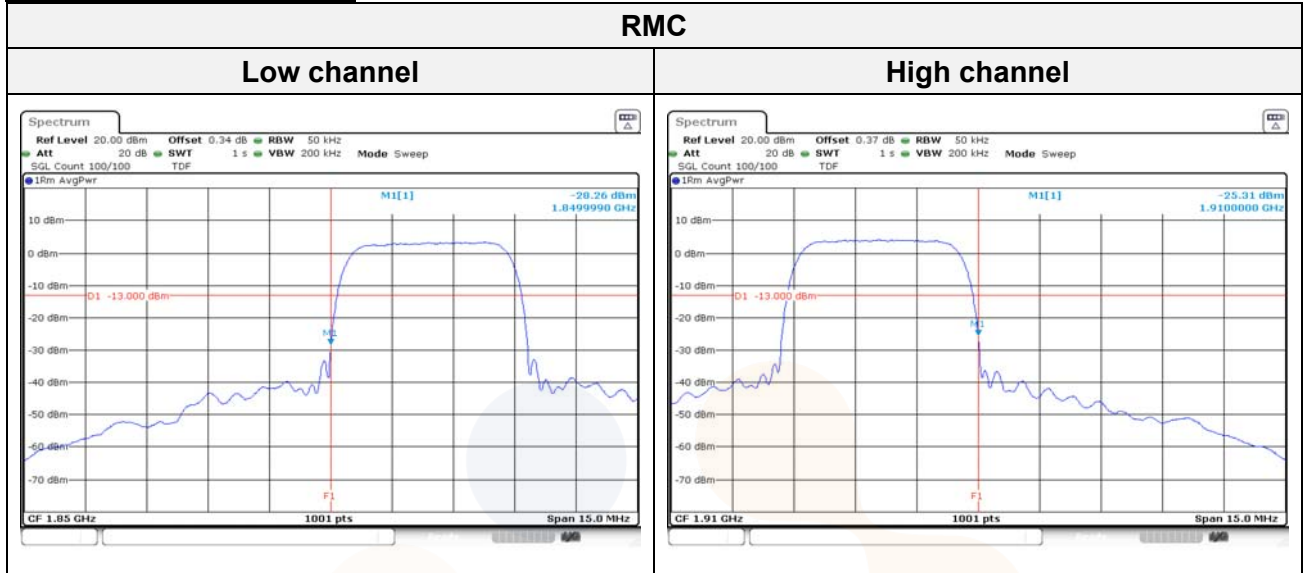



**Test mode: LTE B25/2**

**1.4M BW QPSK**

**Low channel 1RB**

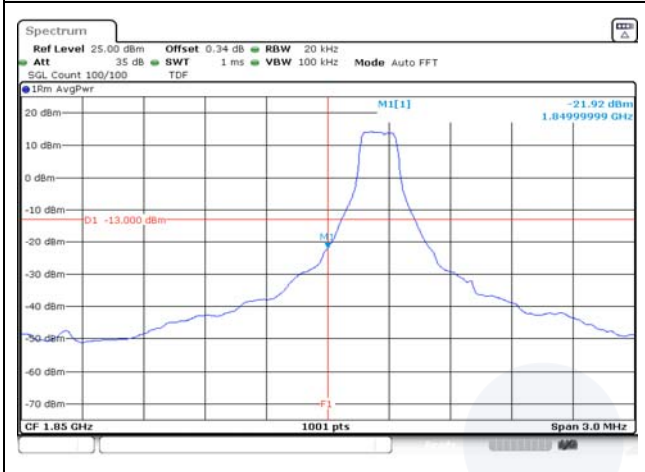

**High channel 1RB**

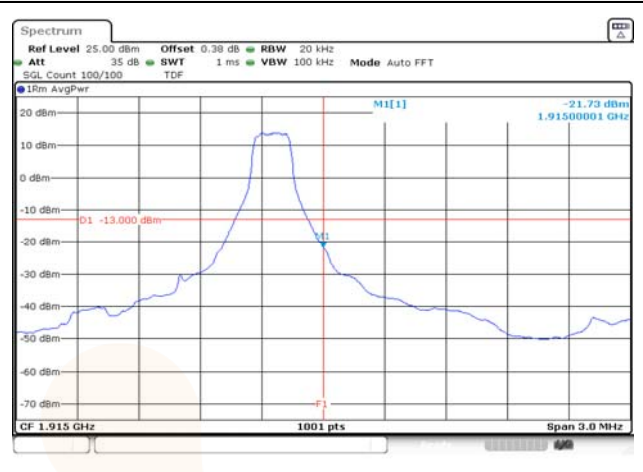

**Low channel FRB**

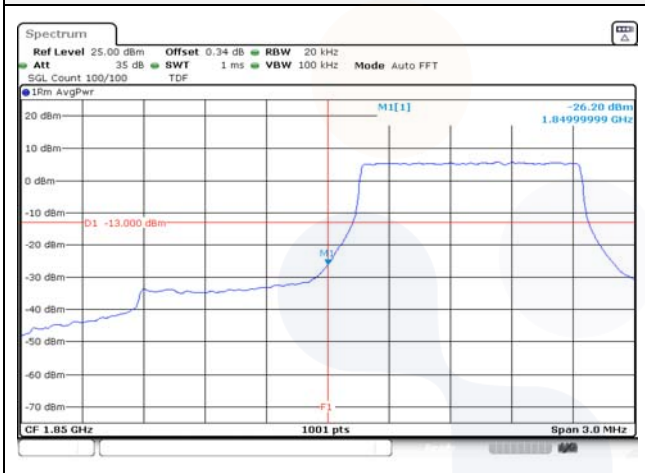

**High channel FRB**

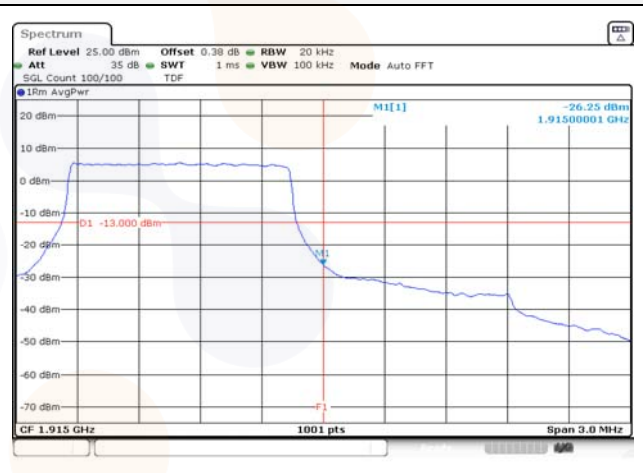

**3M BW QPSK**

**Low channel 1RB**

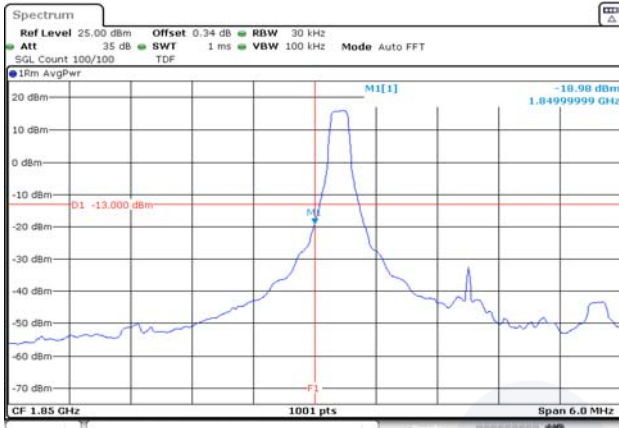

**High channel 1RB**

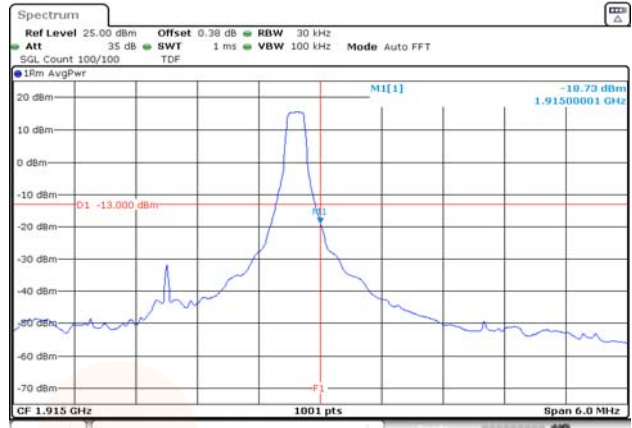

**Low channel FRB**

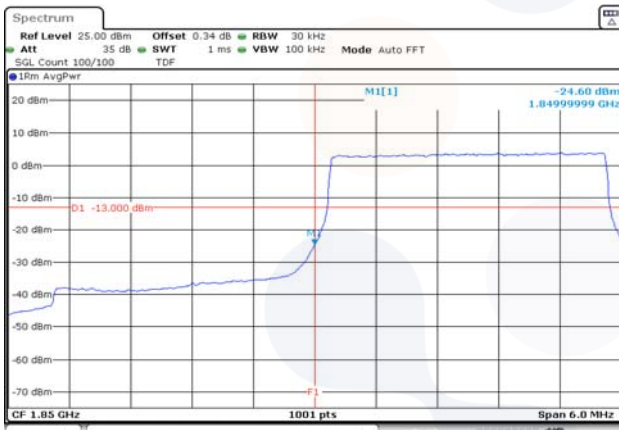

**High channel FRB**

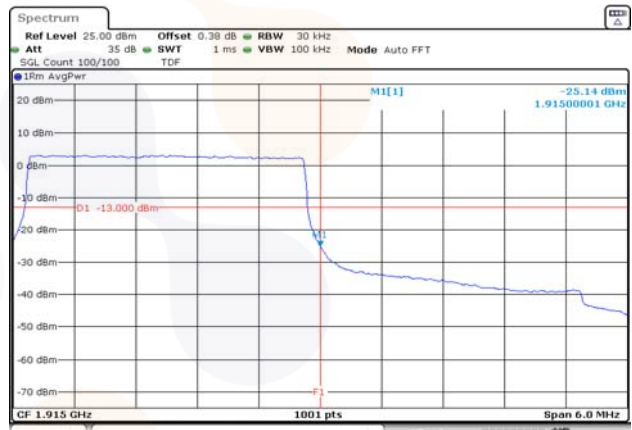

**5M BW QPSK**

**Low channel 1RB**

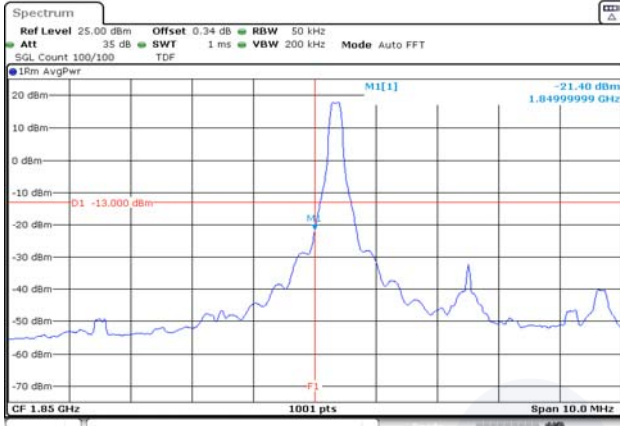

**High channel 1RB**

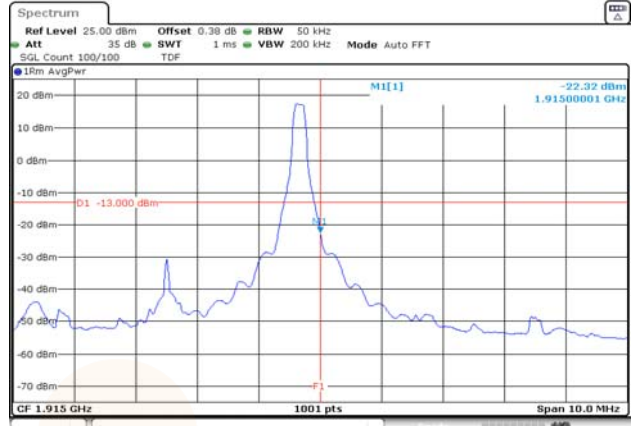

**Low channel FRB**

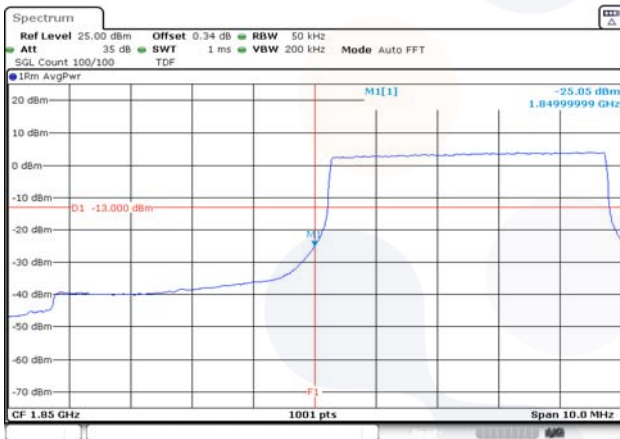

**High channel FRB**

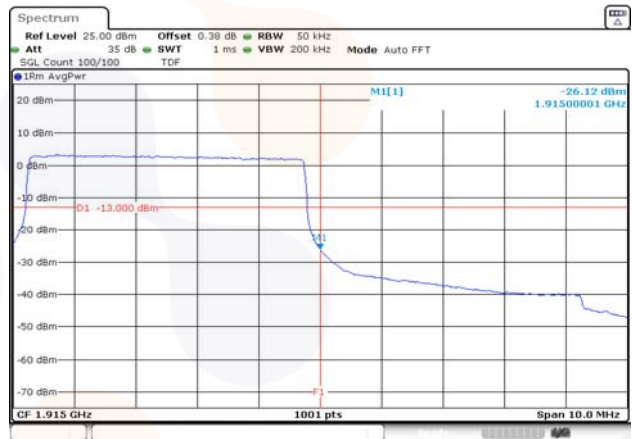

**10M BW QPSK**

**Low channel 1RB**

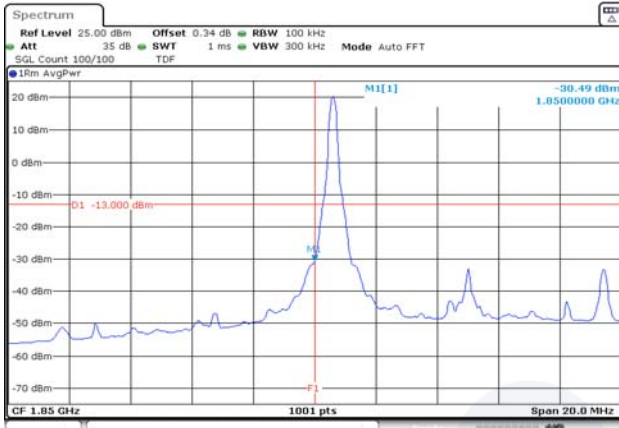

**High channel 1RB**

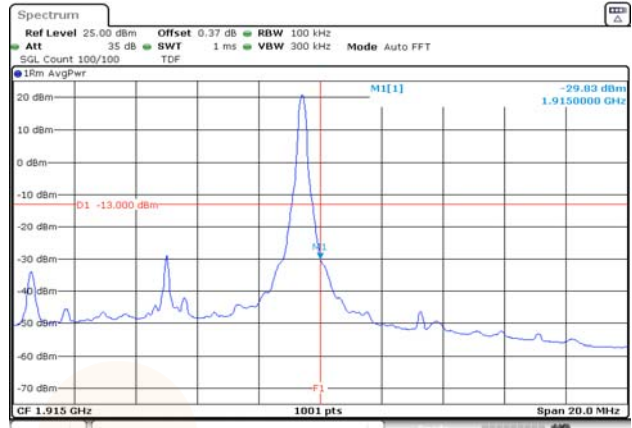

**Low channel FRB**

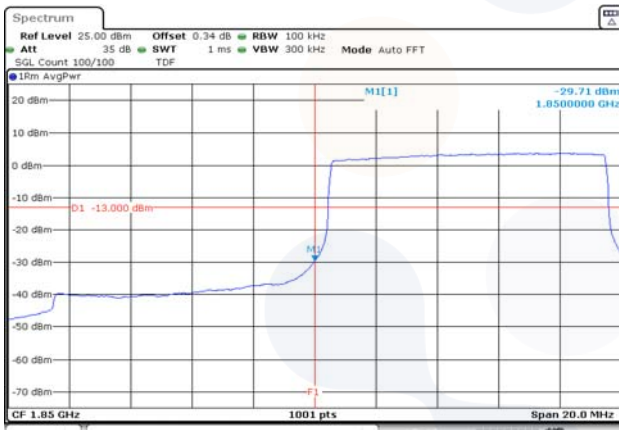

**High channel FRB**

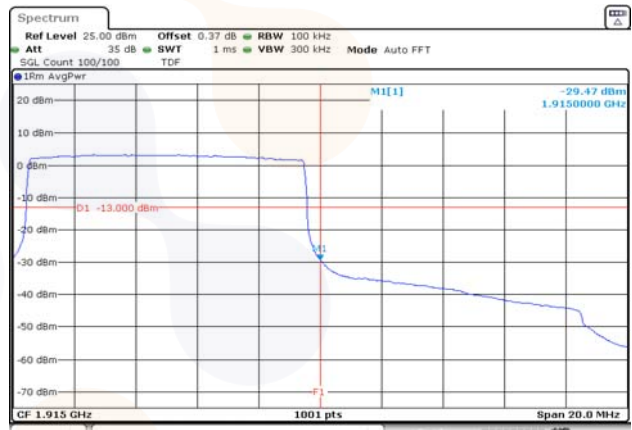

**15M BW QPSK**

**Low channel 1RB**

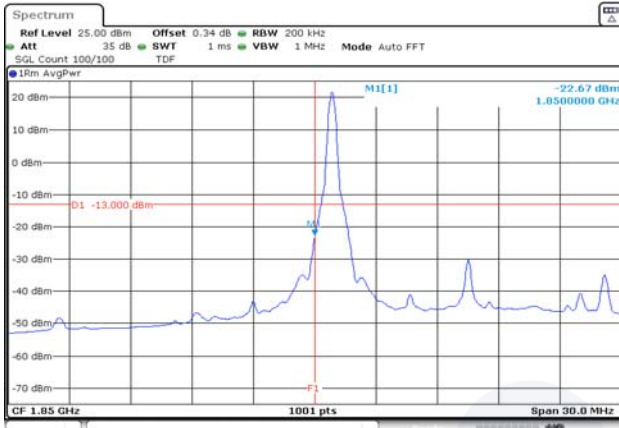

**High channel 1RB**

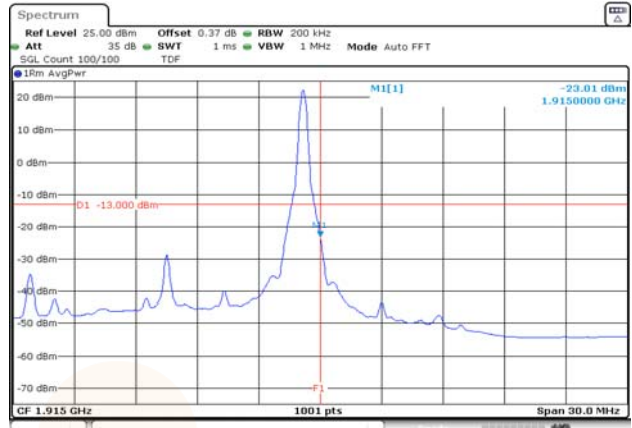

**Low channel FRB**

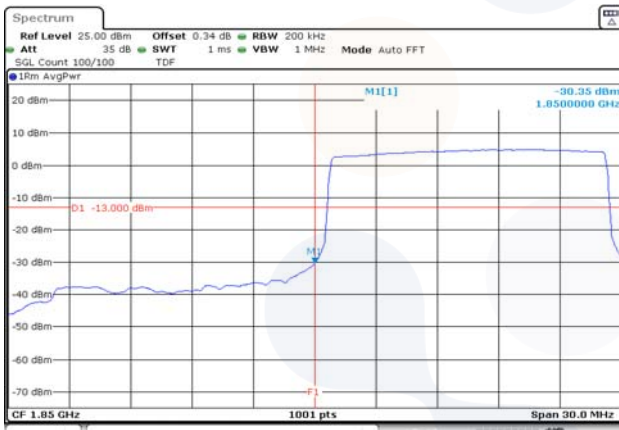

**High channel FRB**

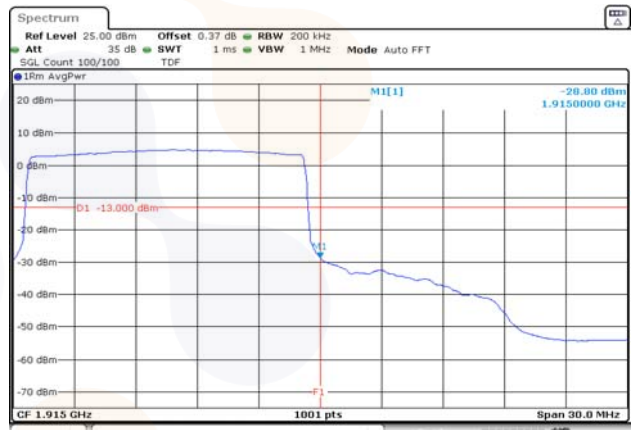

**20M BW QPSK**

**Low channel 1RB**

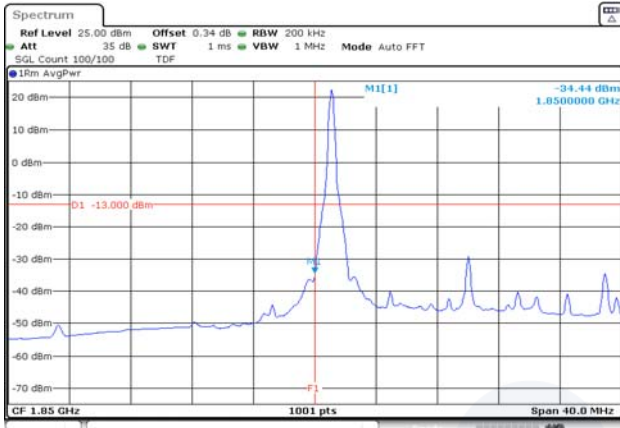

**High channel 1RB**

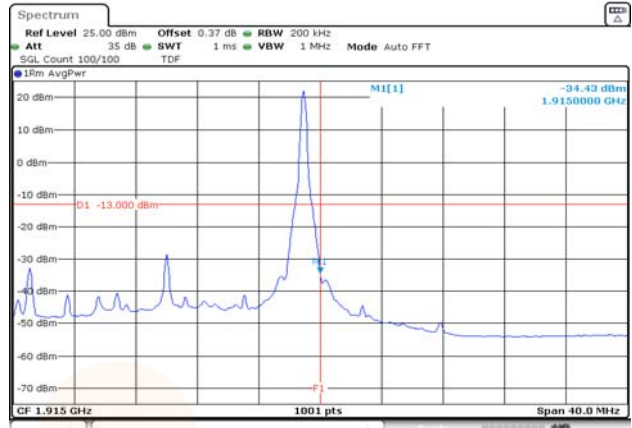

**Low channel FRB**

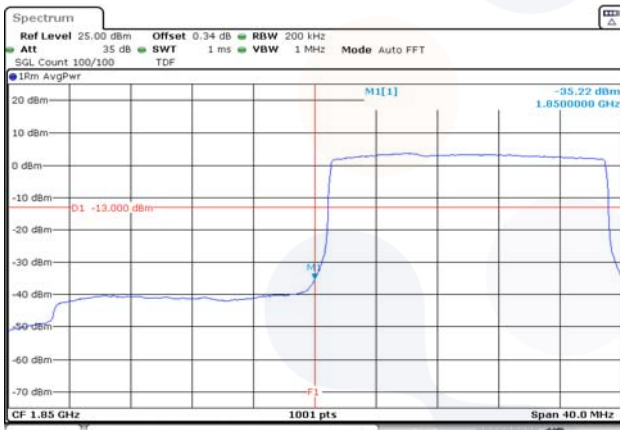

**High channel FRB**

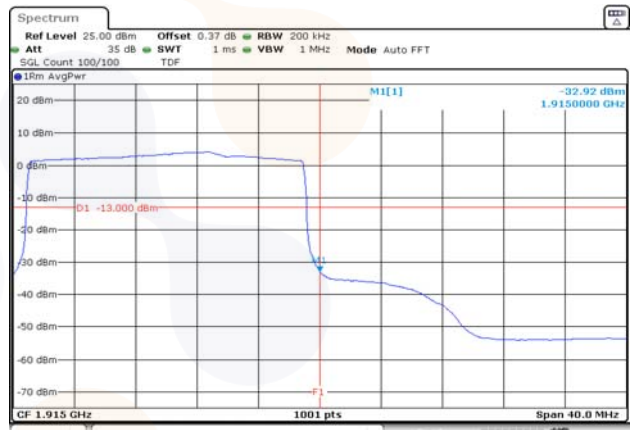

## 7.4. Spurious Emissions at Antenna Terminal

### Test setup

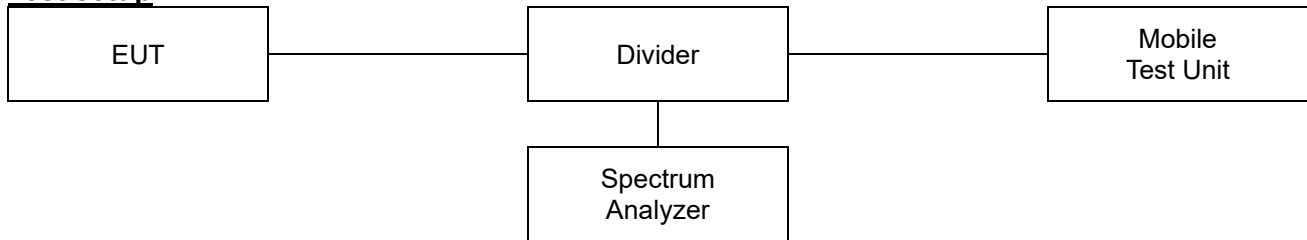

### Limit

#### According to §24.238(a),

The power of any emission outside of the authorized operating frequency ranges must be attenuated below the transmitting power (P) by a factor of at least  $43 + 10\log(P)$  dB.

### Test procedure

971168 D01 v03r01 - Section 6  
ANSI 63.26-2015 – Section 5.7

### Test settings

- 1) Start frequency was set to 30 MHz and stop frequency was set to at least 10<sup>th</sup> the fundamental frequency.
- 2) Detector = RMS
- 3) Sweep time = auto couple.
- 4) Trace mode = trace average
- 5) Allow trace to fully stabilize.
- 6) Please see test notes below RBW and VBW settings.

### Notes:

1. Per 24.238(b), compliance with these provisions is based on the use of measurement instrumentation employing a resolution bandwidth of 100 kHz or greater for frequencies less than 1 GHz and 1 MHz or greater for frequencies greater than 1 GHz. The emission bandwidth is defined as the width of the signal between two points, one below the carrier center frequency and one above the carrier center frequency, outside of which all emissions are attenuated at least 26 dB below the transmitter power.
2. All modes of operation were investigated and the worst-case configuration results are reported.

**Test results**

**Test mode: WCDMA 1900**

**RMC**

**Low channel (30 MHz ~ 10 GHz)**

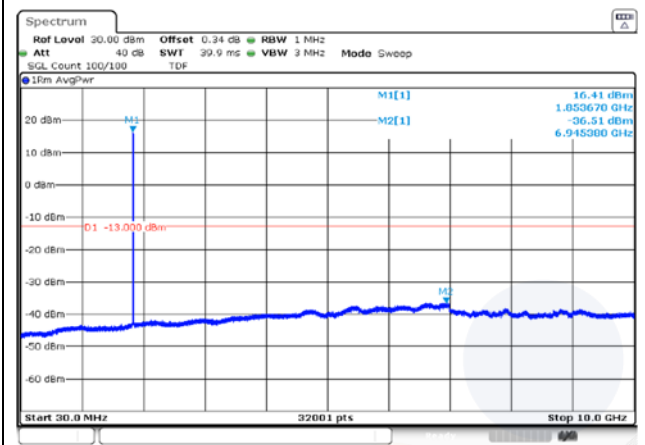

**Low channel (10 GHz ~ 20 GHz)**

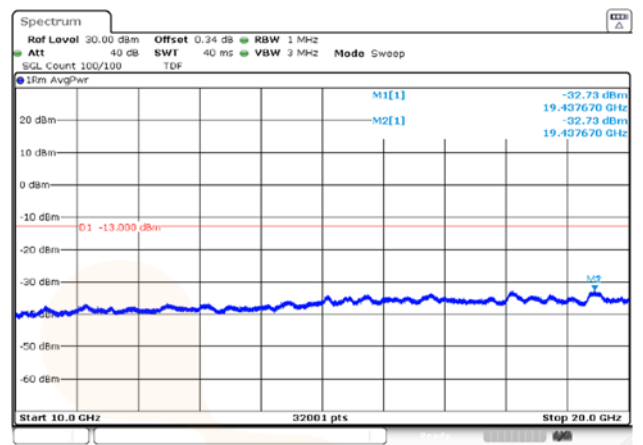

**Middle channel (30 MHz ~ 10 GHz)**

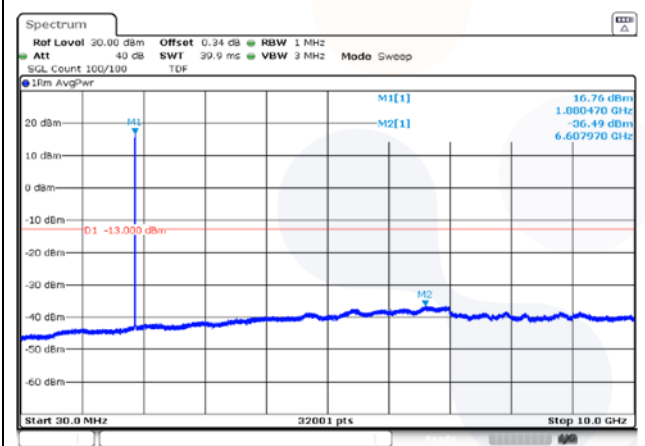

**Middle channel (10 GHz ~ 20 GHz)**

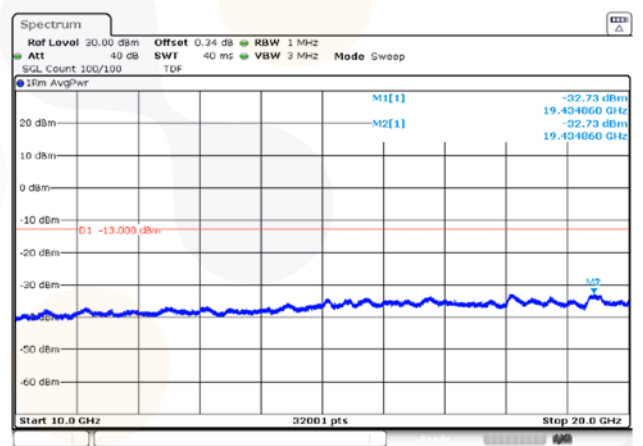

**High channel (30 MHz ~ 10 GHz)**

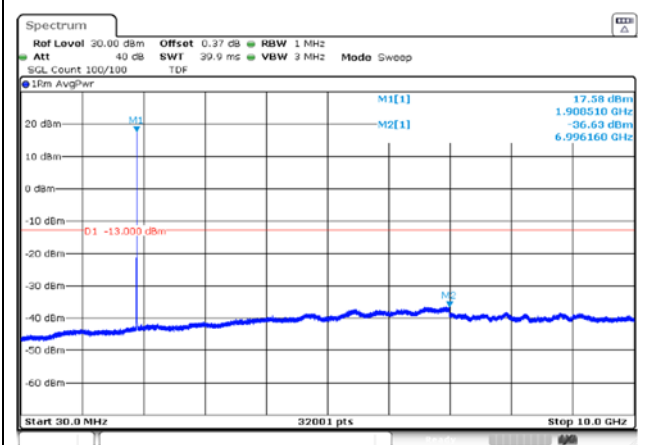

**High channel (10 GHz ~ 20 GHz)**

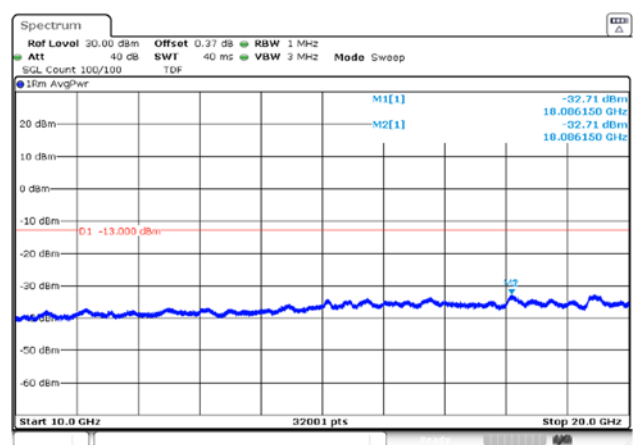



**Test mode: LTE B25/2**

**1.4M BW QPSK**

**Low channel (30 MHz ~ 10 GHz)**

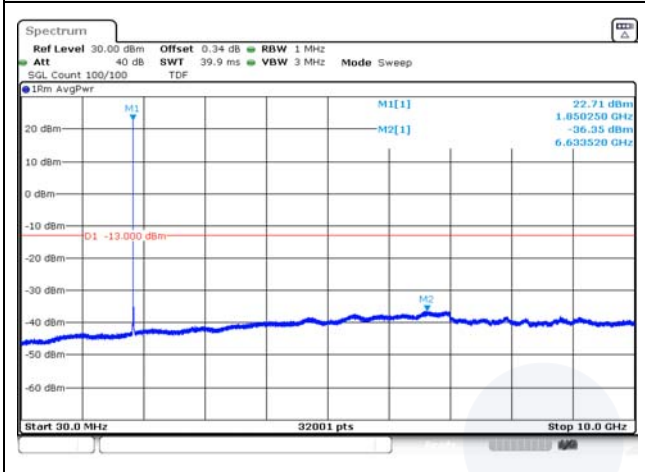

**Low channel (10 GHz ~ 20 GHz)**

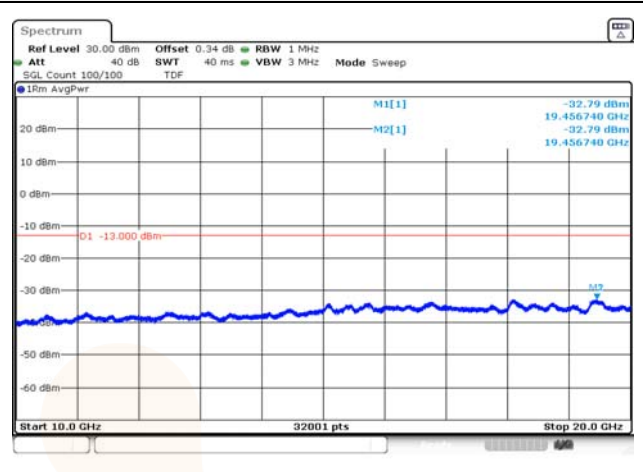

**Middle channel (30 MHz ~ 10 GHz)**

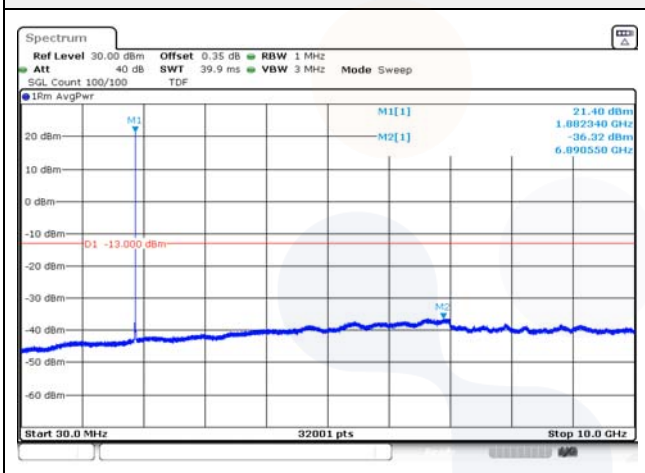

**Middle channel (10 GHz ~ 20 GHz)**

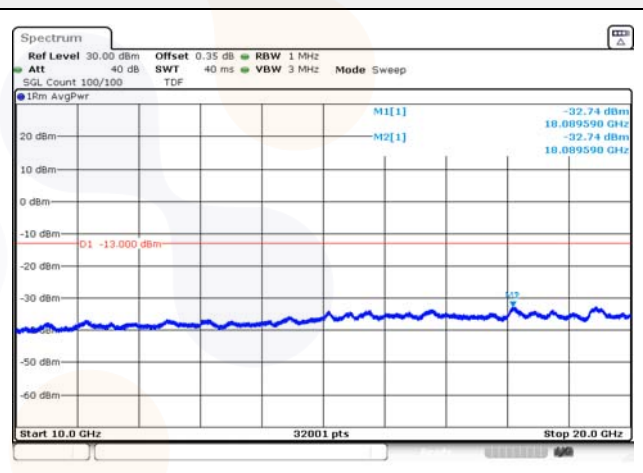

**High channel (30 MHz ~ 10 GHz)**

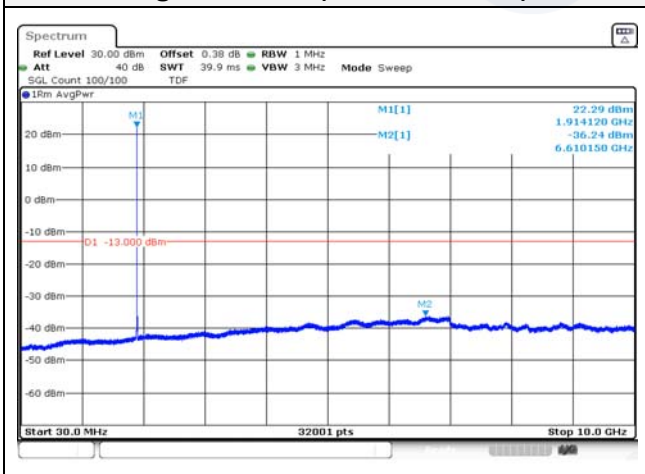

**High channel (10 GHz ~ 20 GHz)**

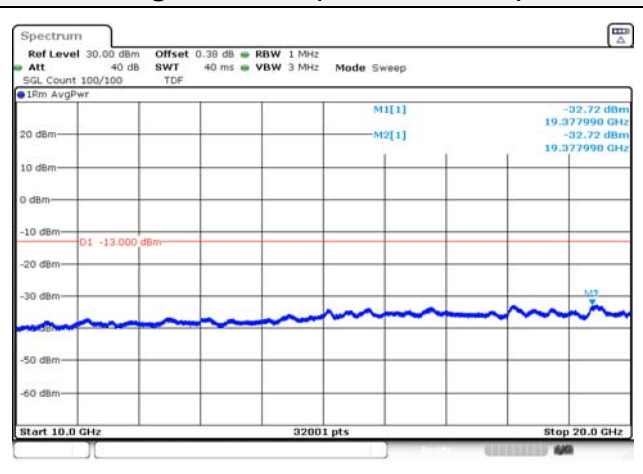

**3M BW QPSK**

**Low channel (30 MHz ~ 10 GHz)**

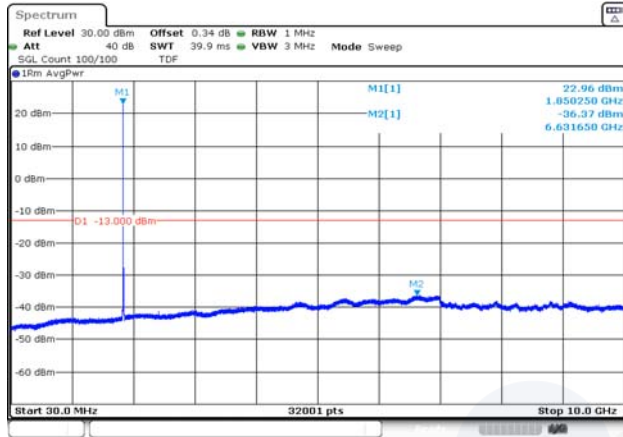

**Low channel (10 GHz ~ 20 GHz)**

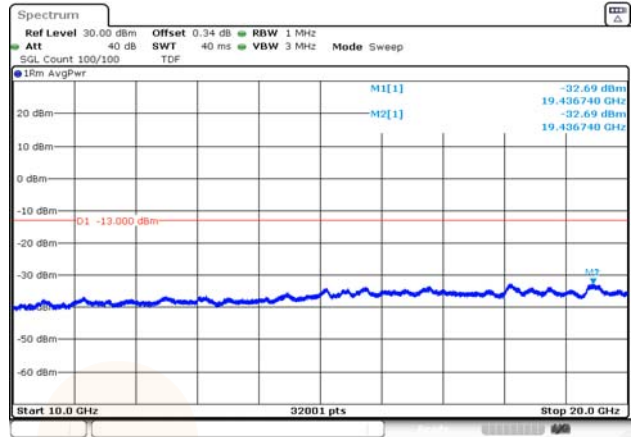

**Middle channel (30 MHz ~ 10 GHz)**

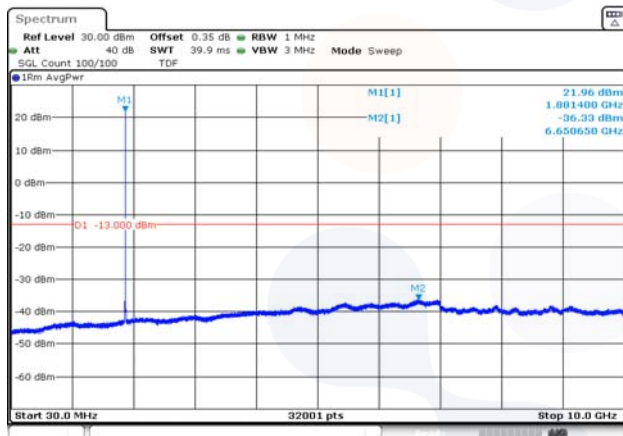

**Middle channel (10 GHz ~ 20 GHz)**

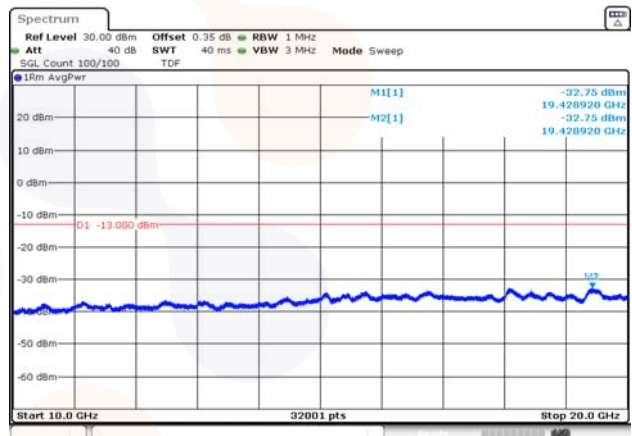

**High channel (30 MHz ~ 10 GHz)**

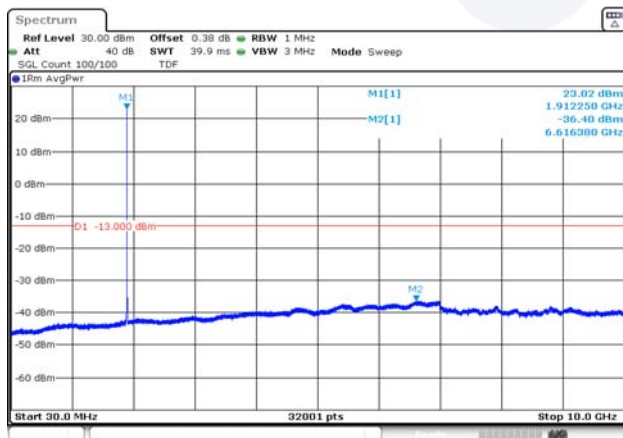

**High channel (10 GHz ~ 20 GHz)**

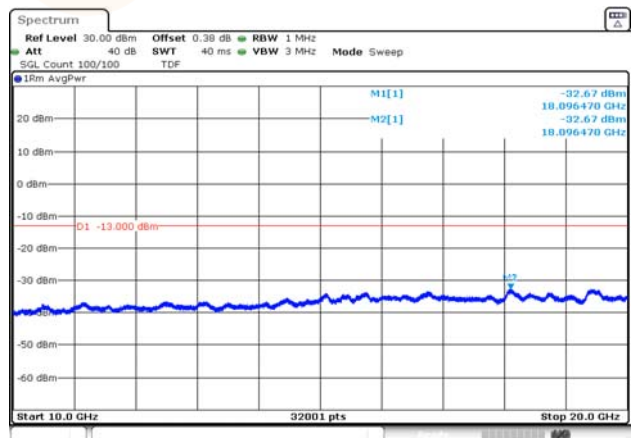

**5M BW QPSK**

**Low channel (30 MHz ~ 10 GHz)**

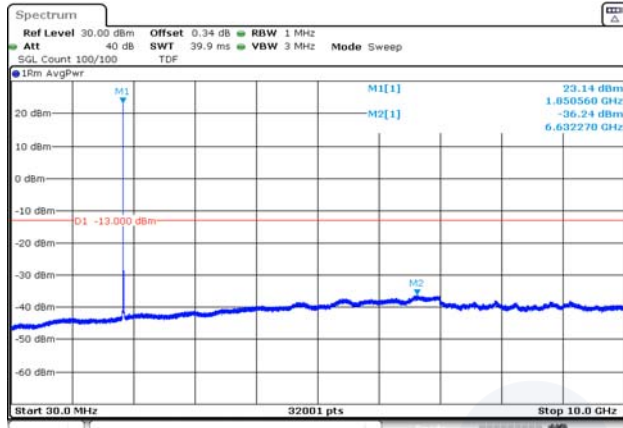

**Low channel (10 GHz ~ 20 GHz)**

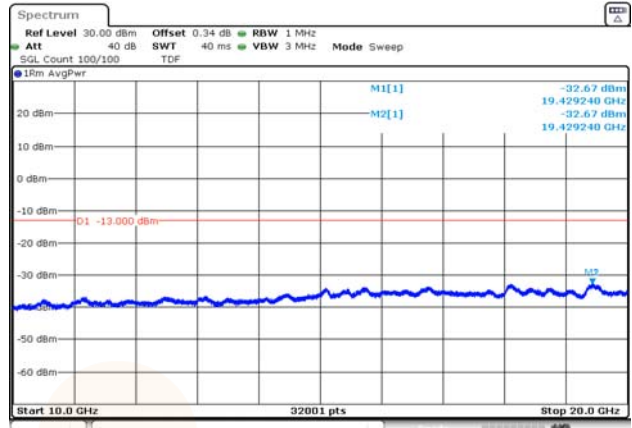

**Middle channel (30 MHz ~ 10 GHz)**

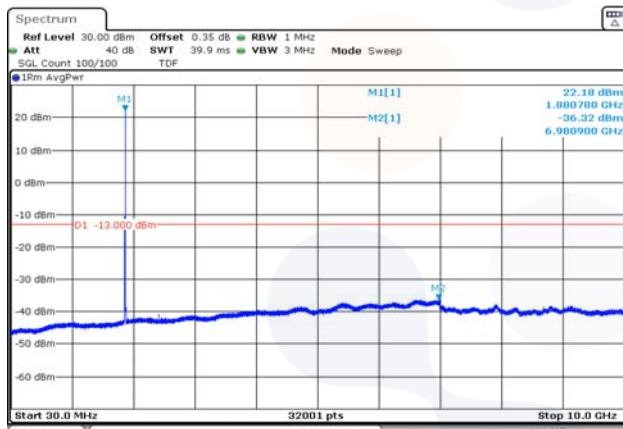

**Middle channel (10 GHz ~ 20 GHz)**

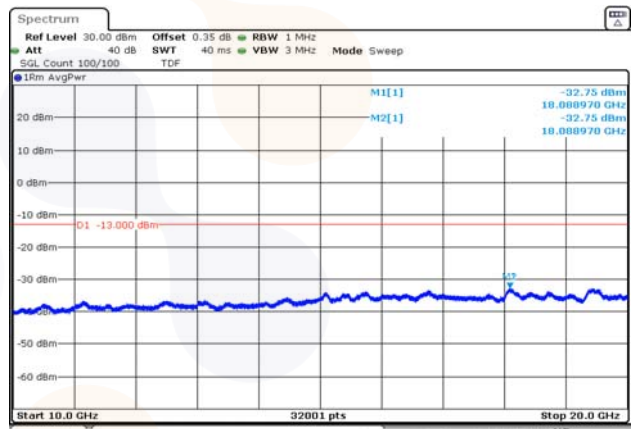

**High channel (30 MHz ~ 10 GHz)**

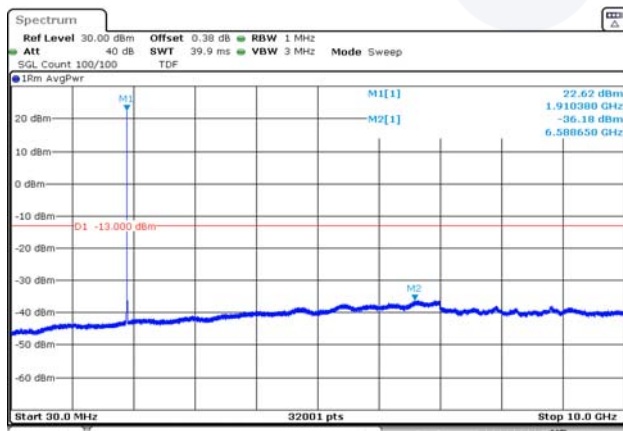

**High channel (10 GHz ~ 20 GHz)**

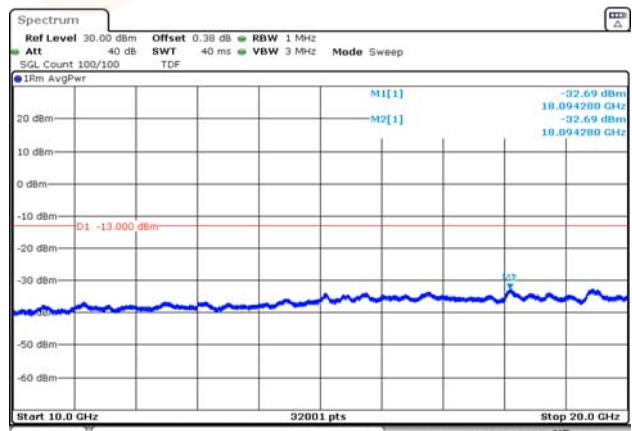

**10M BW QPSK**

**Low channel (30 MHz ~ 10 GHz)**

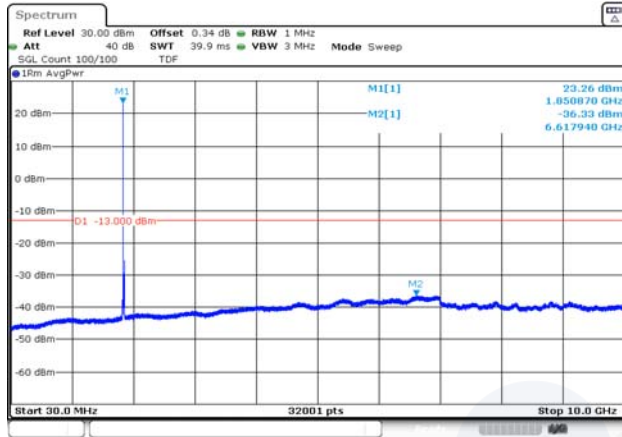

**Low channel (10 GHz ~ 20 GHz)**

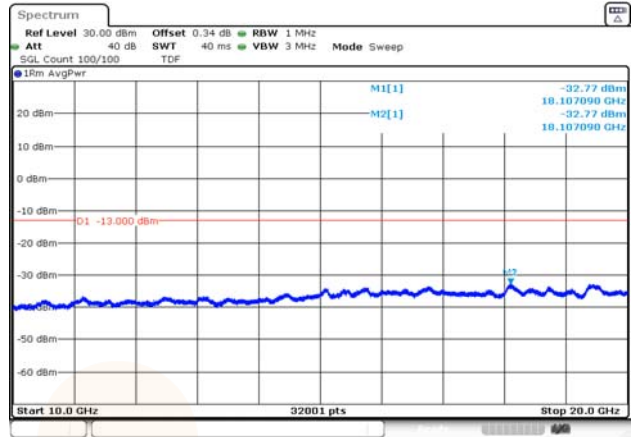

**Middle channel (30 MHz ~ 10 GHz)**

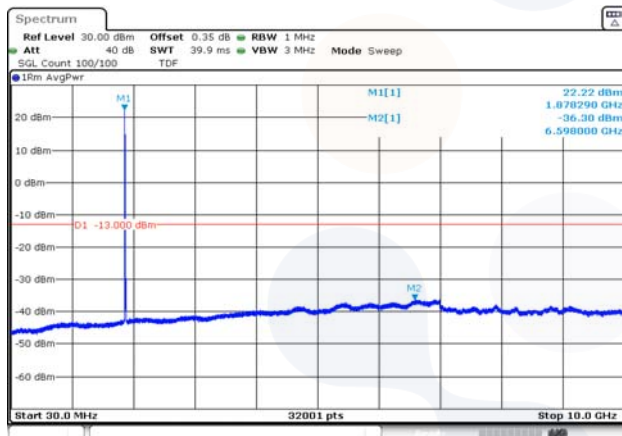

**Middle channel (10 GHz ~ 20 GHz)**

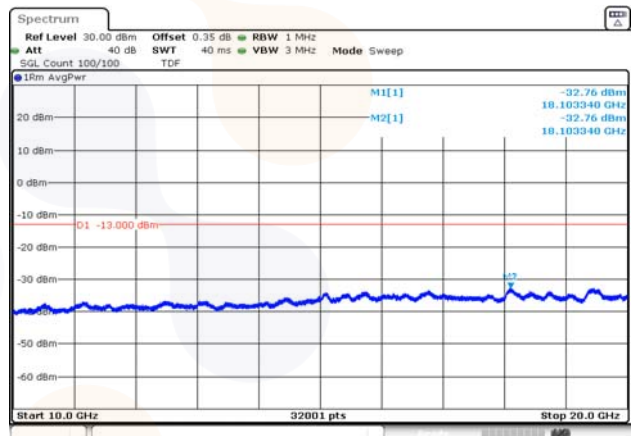

**High channel (30 MHz ~ 10 GHz)**

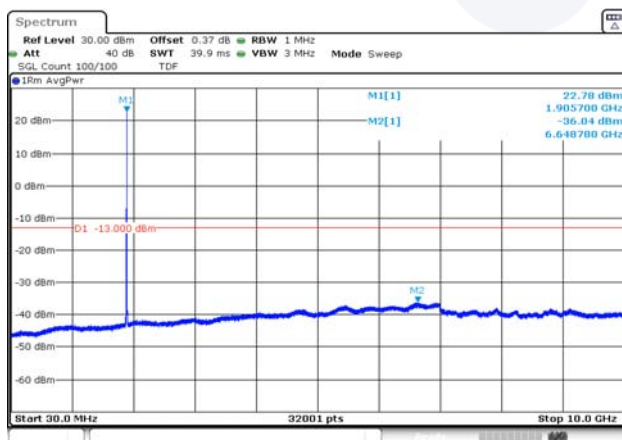

**High channel (10 GHz ~ 20 GHz)**

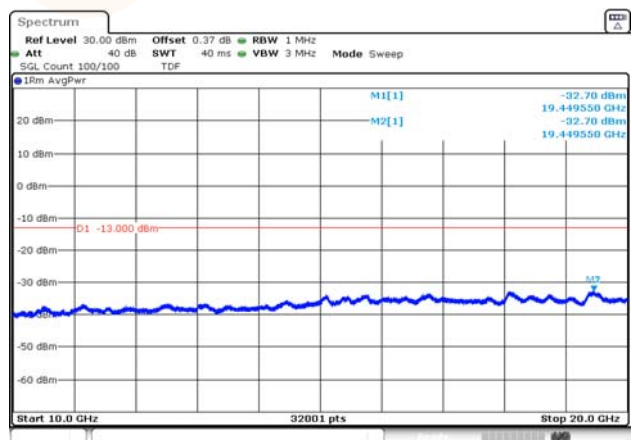

**15M BW QPSK**

**Low channel (30 MHz ~ 10 GHz)**

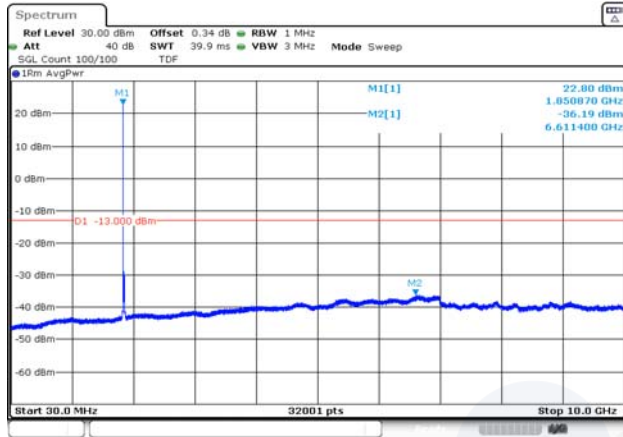

**Low channel (10 GHz ~ 20 GHz)**

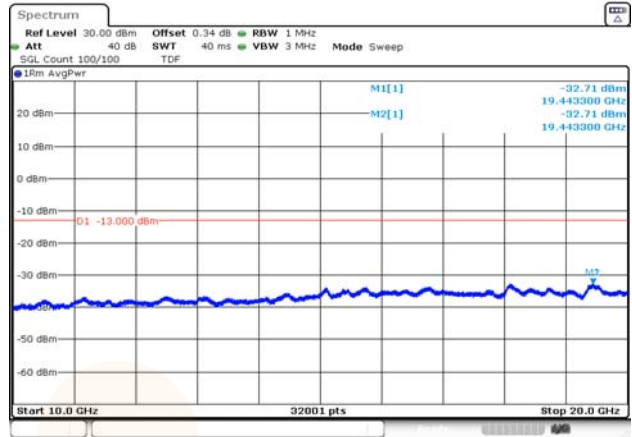

**Middle channel (30 MHz ~ 10 GHz)**

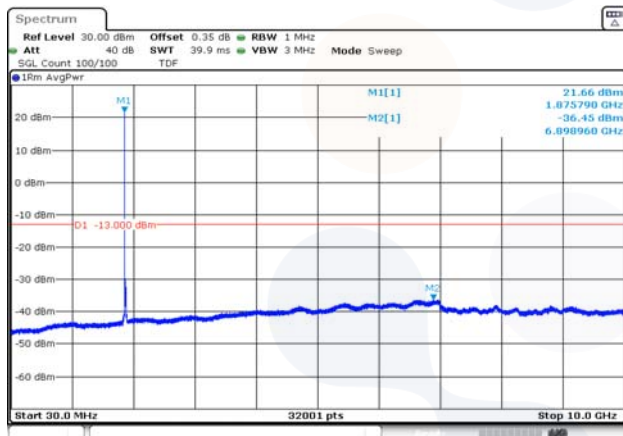

**Middle channel (10 GHz ~ 20 GHz)**

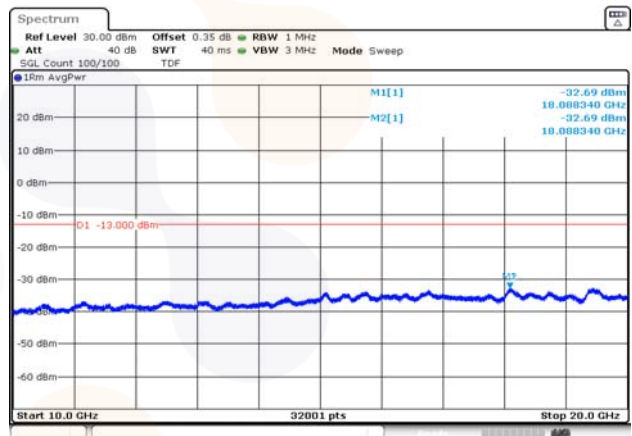

**High channel (30 MHz ~ 10 GHz)**

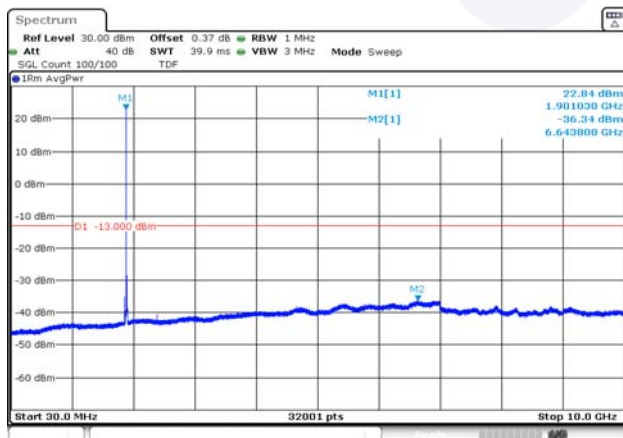

**High channel (10 GHz ~ 20 GHz)**

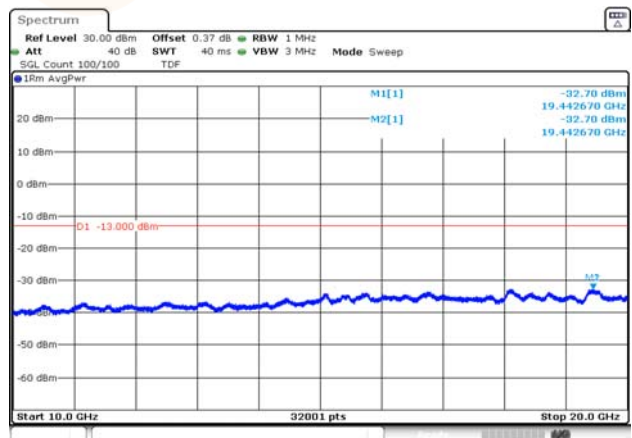

**20M BW QPSK**

**Low channel (30 MHz ~ 10 GHz)**

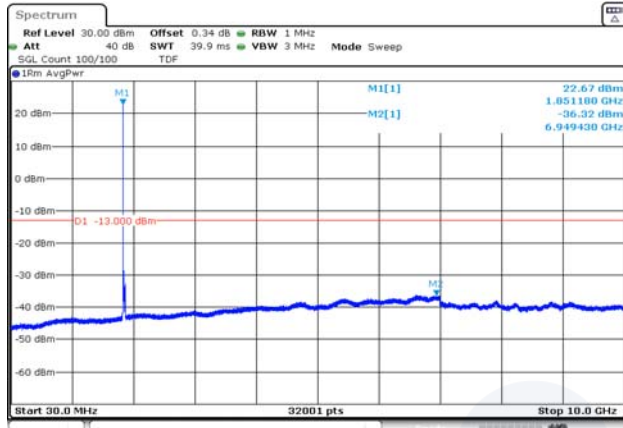

**Low channel (10 GHz ~ 20 GHz)**

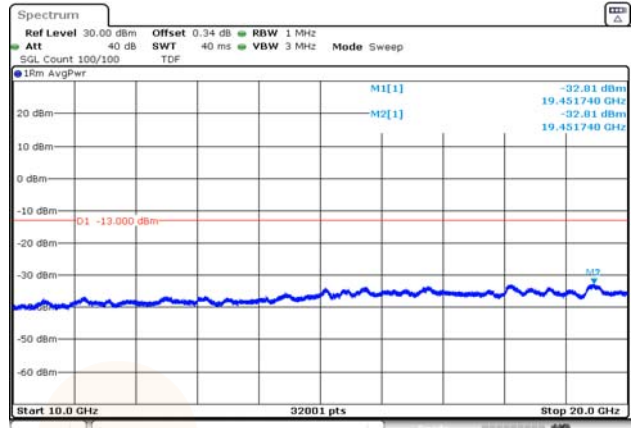

**Middle channel (30 MHz ~ 10 GHz)**

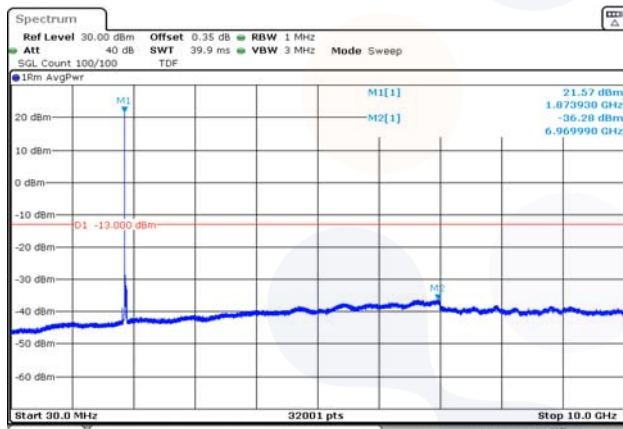

**Middle channel (10 GHz ~ 20 GHz)**

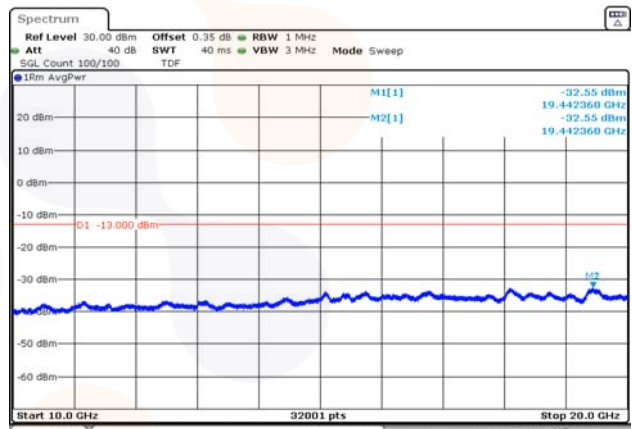

**High channel (30 MHz ~ 10 GHz)**

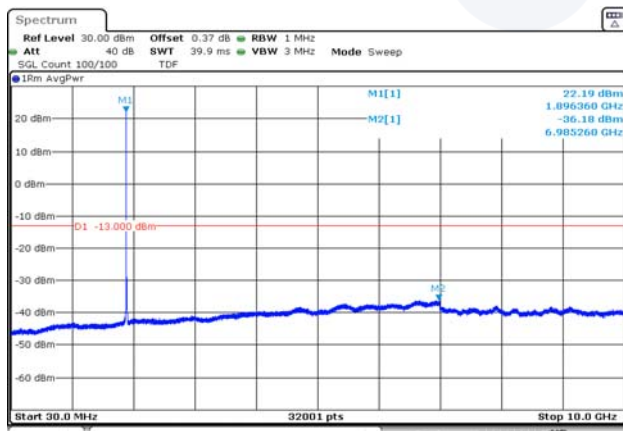

**High channel (10 GHz ~ 20 GHz)**

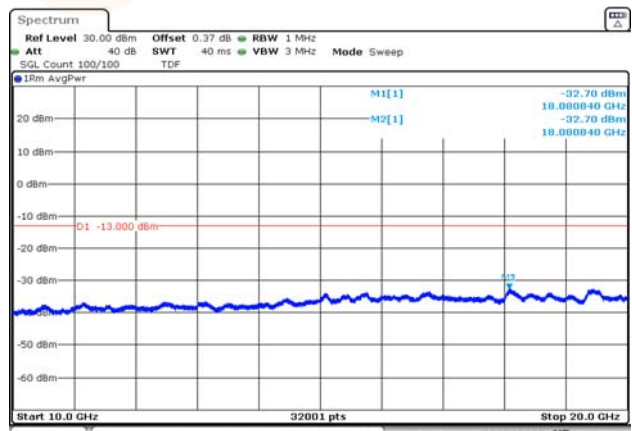

## 7.5. Peak to Average Power Ratio (PAPR)

### Test setup

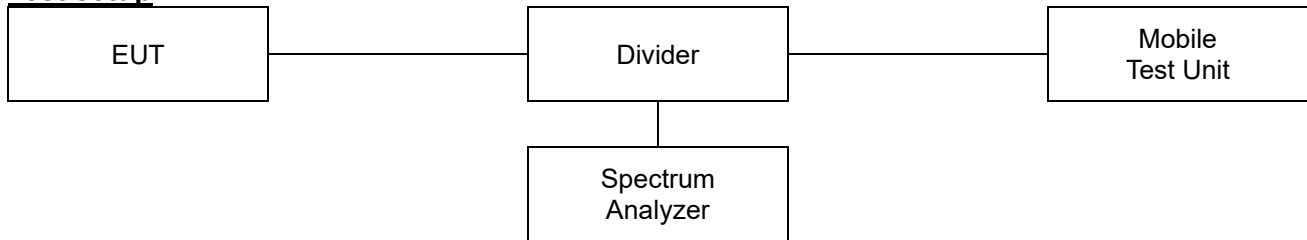

### Limit

#### According to §24.232(d),

The peak-to-average ratio(PAR) of the transmission must not exceed 13 dB.

### Test procedure

971168 D01 v03r01 - Section 5.7.2 or 5.7.3  
ANSI 63.26-2015 – Section 5.2.3.4 or 5.2.6

### Test settings

#### 5.2.3.4 Measurement of peak power in a broadband noise-like signal using CCDF

- 1) Set resolution/measurement bandwidth  $\geq$  OBW or specified reference bandwidth
- 2) Set the number of counts to a value that stabilizes the measured CCDF curve.
- 3) Set the measurement interval as follows:
  - a) For continuous transmissions, set to the greater of [10 x (number of points in sweep) x (transmission symbol period)] or 1 ms .
  - b) For burst transmissions, employ an external trigger that is synchronized with the EUT burst timing sequence, or use the internal burst trigger with a trigger level that allows the burst to stabilize. Set the measurement interval to a time that is less than or equal to the burst duration.
  - c) If there are several carriers in a single antenna port, the peak power shall be determined for each individual carrier (by disabling the other carriers while measuring the required carrier) and the total peak power calculated from the sum of the individual carrier peak powers.
- 4) Record the maximum PAPR level associated with a probability of 0.1%

#### 5.2.6 Peak-to-average power ratio

Use one of the procedures presented in 5.2(ANSI C63.26-2015) to measure the total peak power and record as  $P_{PK}$ .

Use one of the applicable procedure presented 5.2(ANSI C63.26-2015) to measure the total average power and record as  $P_{AG}$ . Determine the P.A.P.R from:

$$PAPR(\text{dB}) = P_{PK}(\text{dBm or dBW}) - P_{AG}(\text{dBm or dBW})$$

**Test results**

**Test mode: WCDMA 1900**

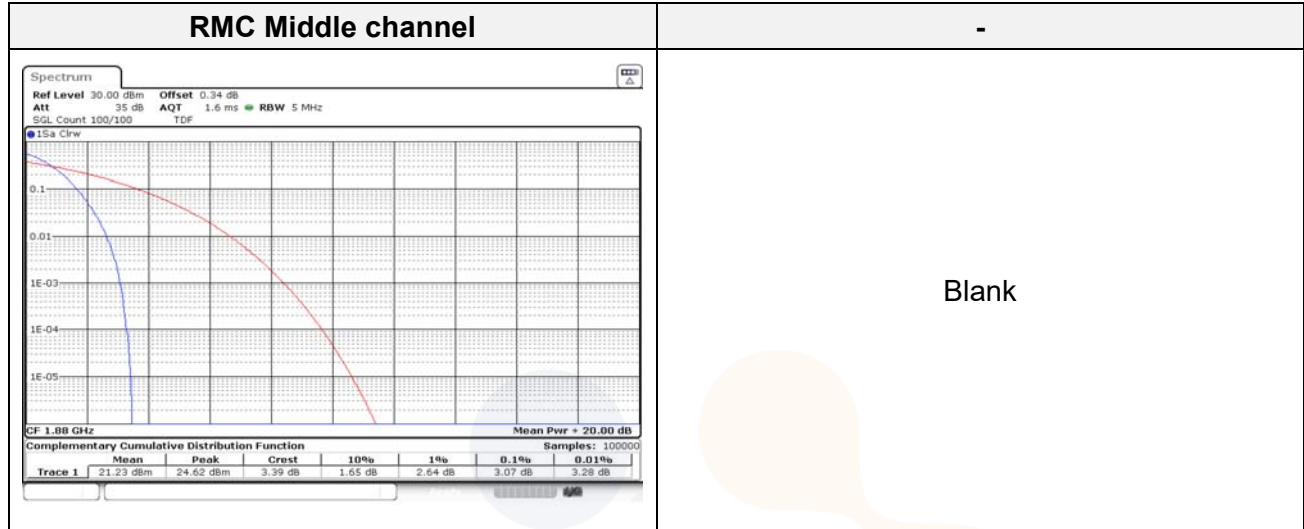



**Test mode: LTE B25/2**

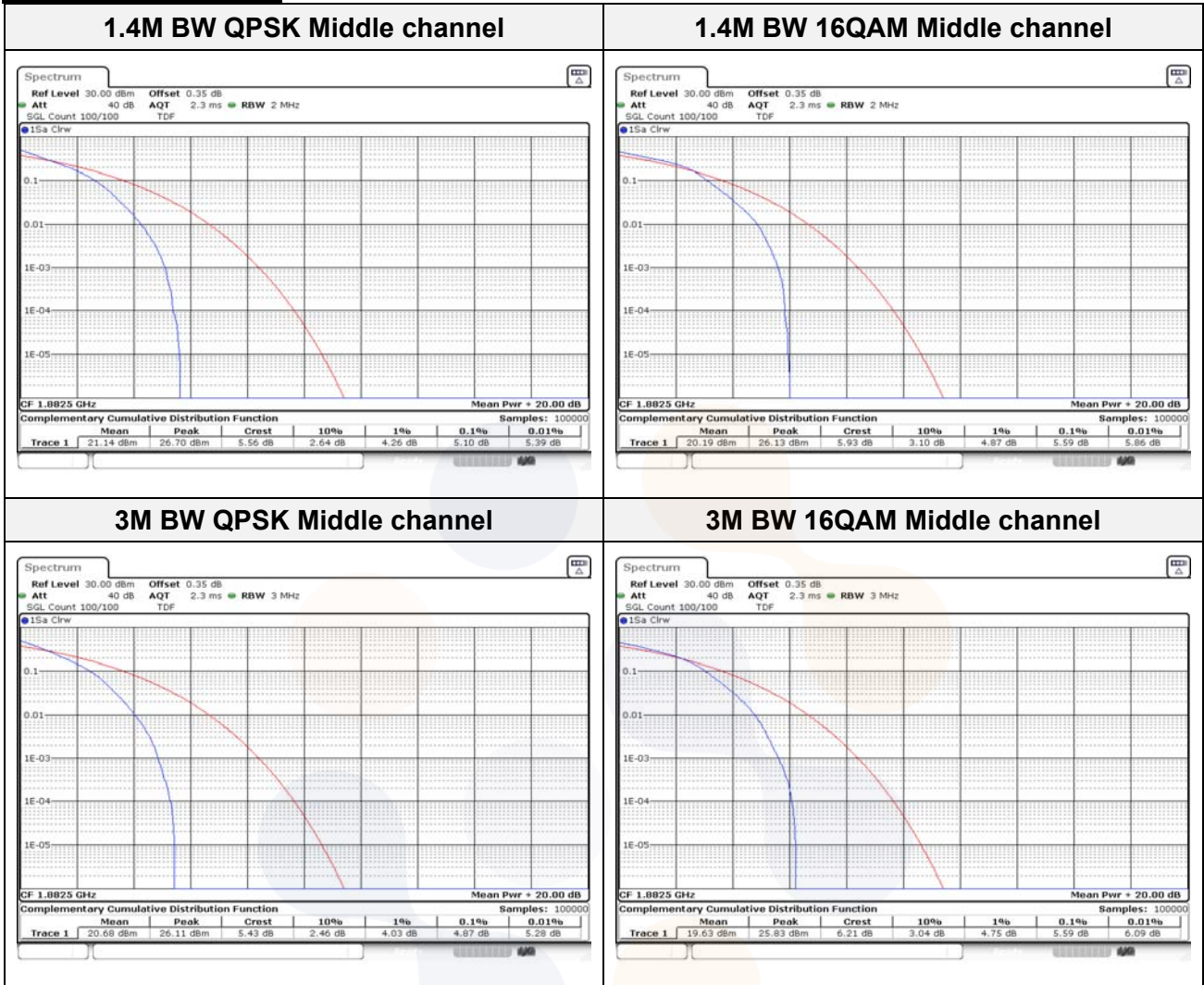

**5M BW QPSK Middle channel**

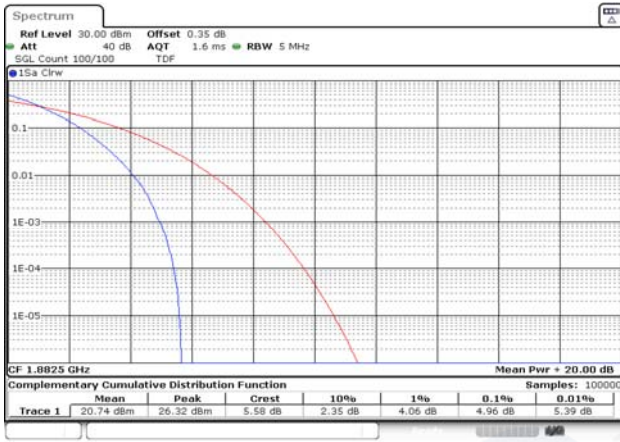

**5M BW 16QAM Middle channel**

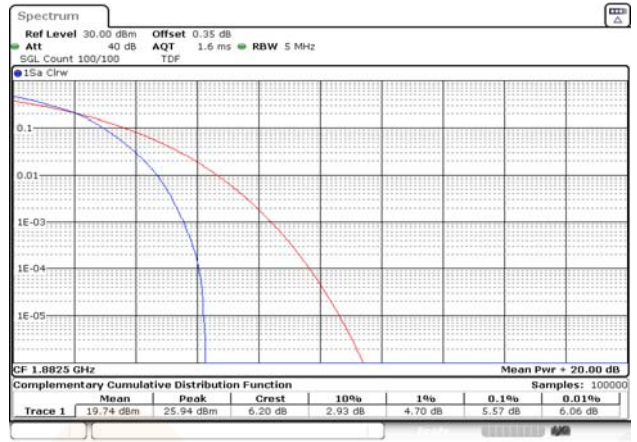

**10M BW QPSK Middle channel**

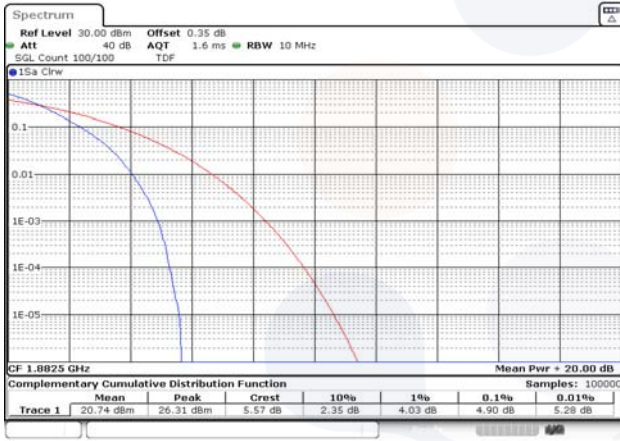

**10M BW 16QAM Middle channel**

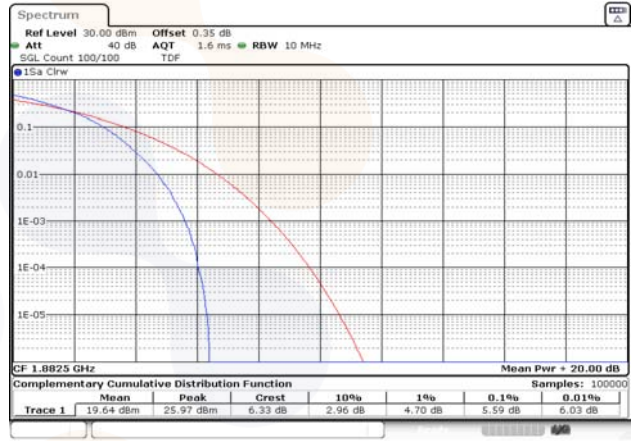

**15M BW QPSK Middle channel**

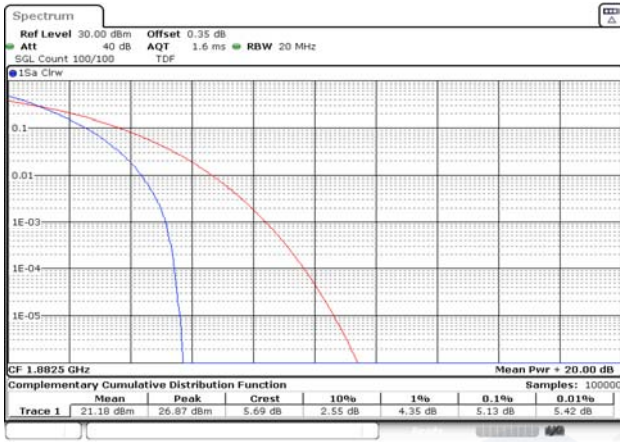

**15M BW 16QAM Middle channel**

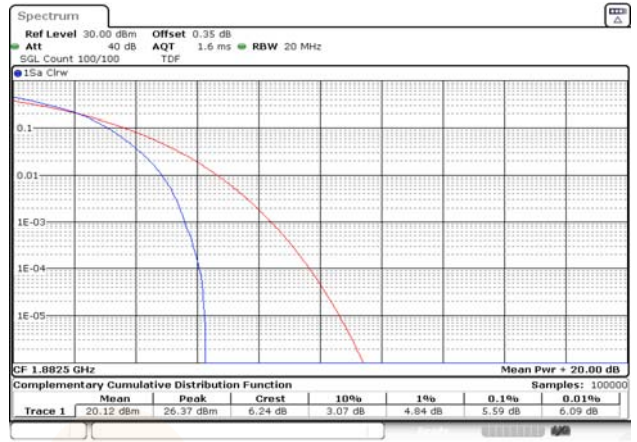

**20M BW QPSK Middle channel**

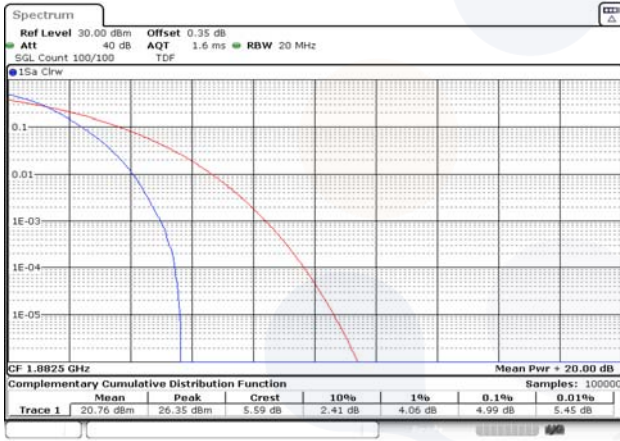

**20M BW 16QAM Middle channel**

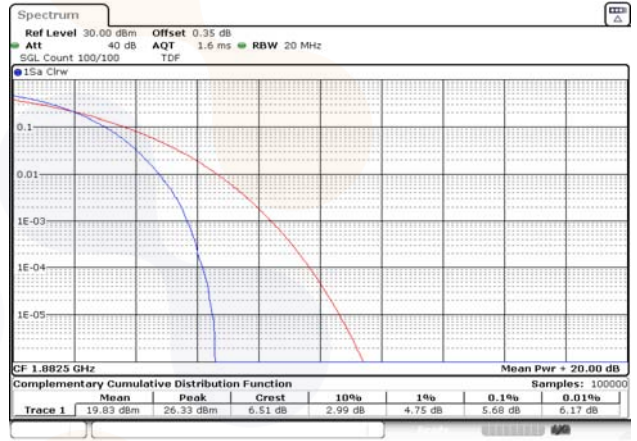

## 7.6. Frequency stability

### Test setup

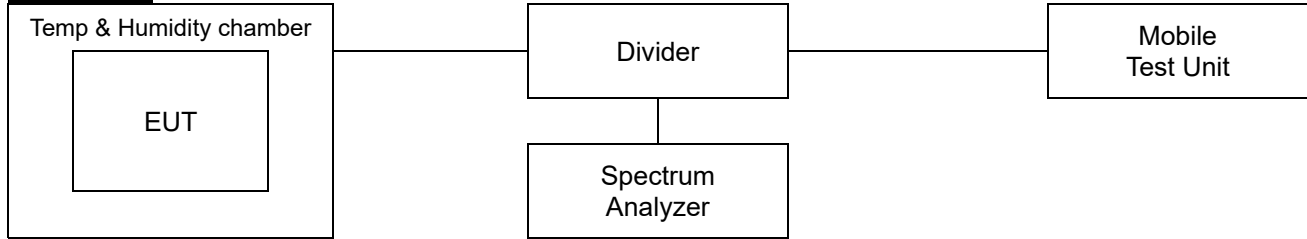

### Limit

#### According to §2.1055(a),

The frequency stability shall be measured with variation of ambient temperature as follows:

- 1) From  $-30^{\circ}$  to  $+50^{\circ}$  centigrade for all equipment except that specified in paragraphs (a) (2) and (3) of this section.
- 2) From  $-20^{\circ}$  to  $+50^{\circ}$  centigrade for equipment to be licensed for use in the maritime services under part 80 of this chapter, except for class A, B, and S emergency position indicating radiobeacons (EPIRBS), and equipment to be licensed for use above 952 MHz at operational fixed stations in all services, stations in the local television transmission service and point-to-point microwave radio service under part 21 of this chapter, equipment licensed for use aboard aircraft in the aviation services under part 87 of this chapter, and equipment authorized for use in the family radio service under part 95 of this chapter.
- 3) From  $0^{\circ}$  to  $+50^{\circ}$  centigrade for equipment to be licensed for use in the radio broadcast Services under part 73 of this chapter.

#### According to §2.1055(d),

The frequency stability shall be measured with variation of primary supply Voltage as follows:

- 1) Vary primary supply voltage from 85 to 115 percent of the nominal value for other than hand carried battery equipment.
- 2) For hand carried, battery powered equipment, reduce primary supply voltage to the battery operating and point which shall be specified by the manufacturer.
- 3) The supply voltage shall be measured at the input to the cable normally provided with the equipment, or at the power supply terminals if cables are not normally provided. Effects on frequency of transmitter keying (except for broadcast transmitters) and any heating element cycling at the nominal supply voltage and at each extreme also shall be shown.

#### According to §24.235,

The frequency stability shall be sufficient to ensure that the fundamental emission stays within the authorized frequency block.

### **Test procedure**

ANSI 63.26-2015 – Section 5.6

### **Test settings**

- 1) The carrier frequency of the transmitter is measured at room temperature. (20°C to provide a reference)
- 2) The equipment is turned on in a “standby” condition for one minute before applying power to the transmitter. Measurement of the carrier frequency of the transmitter is made within one minute after applying power to the transmitter.
- 3) Frequency measurements are made at 10°C intervals ranging from -30°C to +50°C. A period of at least one half-hour is provided to allow stabilization of the equipment at each Temperature level.



**Test results**

Test mode : WCDMA 1900  
 Frequency (Hz) : 1 880 000 000  
 Channel : 9400  
 Deviation limit : The frequency stability shall be sufficient to ensure that the fundamental emission stays within the authorized frequency block.

Voltage (%)	Power (V)	Temp. (°C)	Frequency (Hz)	Frequency error (Hz)	Deviation	
					(ppm)	(%)
100%	3.88	+21(Ref)	1,880,000,000	-0.22	0.0	0.000 000
		-30	1,880,000,002	1.52	0.0	0.000 000
		-20	1,880,000,000	-0.14	0.0	0.000 000
		-10	1,879,999,999	-0.85	0.0	0.000 000
		0	1,879,999,999	-1.06	0.0	0.000 000
		+10	1,880,000,000	-0.36	0.0	0.000 000
		+20	1,879,999,999	-1.46	0.0	0.000 000
		+30	1,879,999,999	-1.24	0.0	0.000 000
		+40	1,880,000,001	1.02	0.0	0.000 000
		+50	1,879,999,999	-1.42	0.0	0.000 000
115%	4.46	+21(Ref)	1,880,000,001	1.34	0.0	0.000 000
End point	3.40	+21(Ref)	1,880,000,000	-0.29	0.0	0.000 000

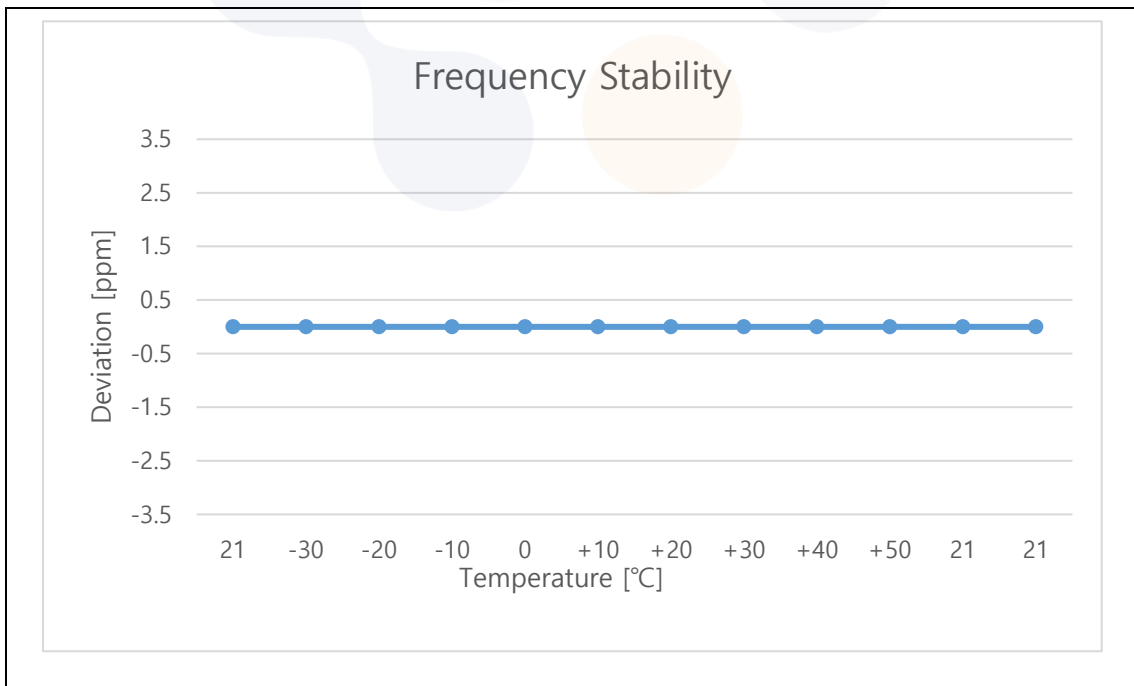

Test mode : LTE B25/2  
 Frequency (Hz) : 1 882 500 000  
 Channel : 26365  
 Deviation limit : The frequency stability shall be sufficient to ensure that the fundamental emission stays within the authorized frequency block.

Voltage (%)	Power (V)	Temp. (°C)	Frequency (Hz)	Frequency error (Hz)	Deviation	
					(ppm)	(%)
100%	3.88	+21(Ref)	1,882,500,000	0.20	0.0	0.000 000
		-30	1,882,499,995	-5.11	0.0	0.000 000
		-20	1,882,500,003	2.95	0.0	0.000 000
		-10	1,882,499,995	-4.53	0.0	0.000 000
		0	1,882,499,992	-8.31	0.0	0.000 000
		+10	1,882,500,001	0.96	0.0	0.000 000
		+20	1,882,499,992	-8.41	0.0	0.000 000
		+30	1,882,499,998	-2.45	0.0	0.000 000
		+40	1,882,499,993	-7.42	0.0	0.000 000
		+50	1,882,499,992	-8.35	0.0	0.000 000
115%	4.46	+21(Ref)	1,882,499,996	-4.25	0.0	0.000 000
End point	3.40	+21(Ref)	1,882,499,997	-2.70	0.0	0.000 000

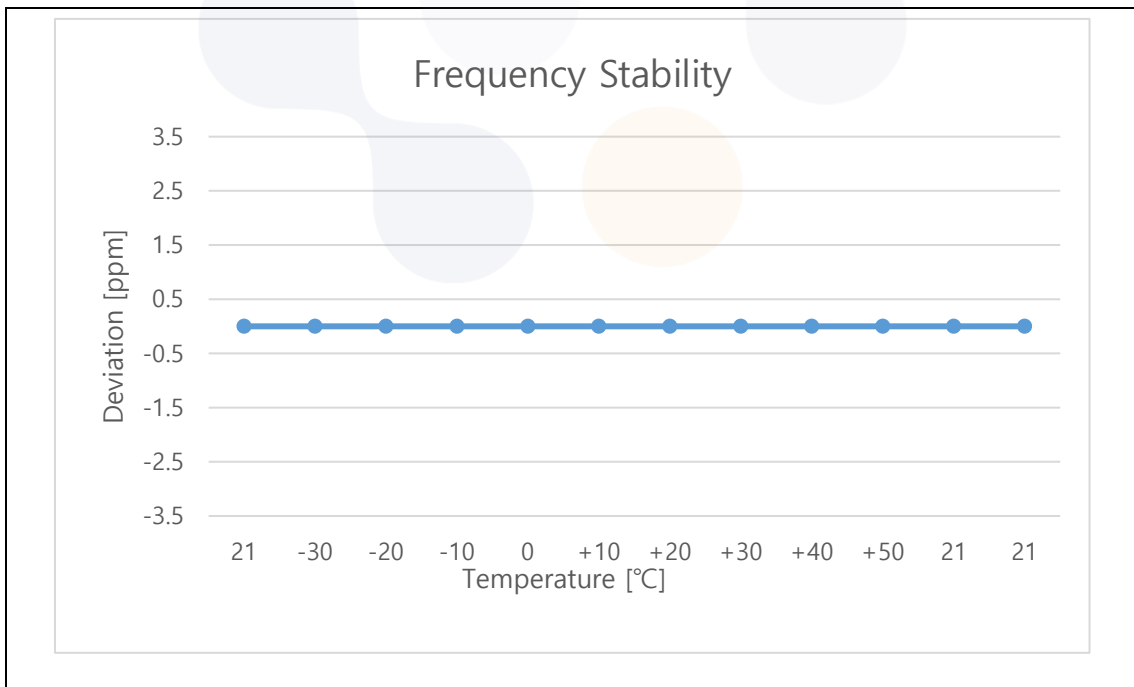

## 7.7. Radiated Power (EIRP)

### Test setup

The diagram below shows the test setup that is utilized to make the measurements for emission from 30 MHz to 1 GHz emissions.

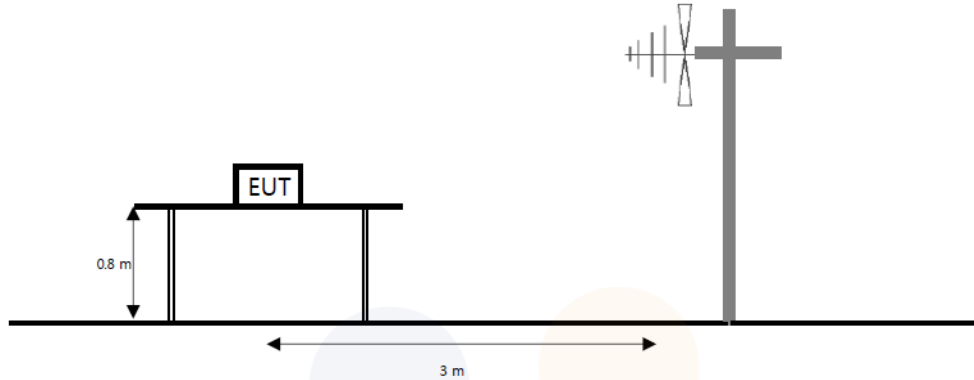

The diagram below shows the test setup that is utilized to make the measurements for emission from 1 GHz to the tenth harmonic of the highest fundamental frequency or to 40 GHz emissions, whichever is lower.

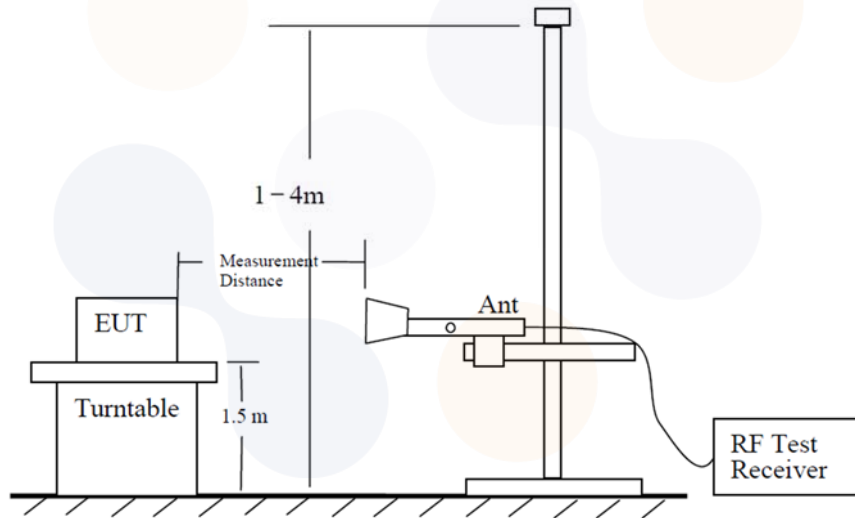

The diagram below shows the test setup for substituted method.

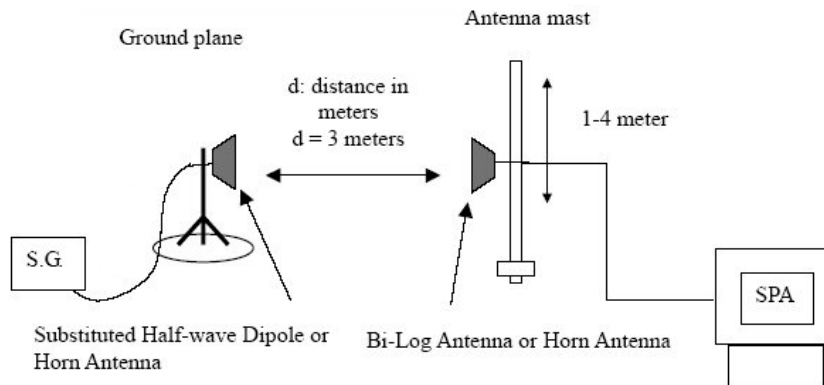



### **Limit**

#### **According to §24.232(c),**

Mobile and portable stations are limited to 2 watts EIRP and the equipment must employ a means for limiting power to the minimum necessary for successful communications.

### **Test procedure**

412172 D01 v01r01

971168 D01 v03r01 - Section 5.2 and 5.8

ANSI 63.26-2015 – Section 5.2

ANSI/TIA-603-E-2016 - Section 2.2.17

### **Test settings**

- 1) RBW = 1 % to 5 % of the OBW.
- 2) VBW  $\geq 3 \times$  RBW.
- 3) SPAN = 2  $\times$  to 3  $\times$  the OBW.
- 4) Number of measurement points in sweep  $\geq 2 \times$  span / RBW.
- 5) Sweep time :
  - 1) Auto couple, or
  - 2)  $\geq [10 \times (\text{number of points in sweep}) \times (\text{transmission period})]$  for single sweep (automation-compatible) measurement. Transmission period is the on and off time of the transmitter.
- 6) Detector = RMS
- 7) If the EUT can be configured to transmit continuously, then set the trigger to free run.
- 8) If the EUT cannot be configured to transmit continuously, then use a sweep trigger with the level set to enable triggering only on full power bursts and configure the EUT to transmit at full power for the entire duration of each sweep. Verify that the sweep time is less than or equal to the transmission burst duration. Time gating can also be used under similar constraints (i.e., configured such that measurement data is collected only during active full-power transmissions).
- 9) Trace mode = trace averaging (RMS) over 100 sweeps.
- 10) Compute the power by integrating the spectrum across the OBW of the signal using the instrument's band or channel power measurement function, with the band/channel limits set equal to the OBW band edges. If the instrument does not have a band or channel power function, then sum the spectrum levels (in linear power units) at intervals equal to the RBW extending across the entire OBW of the spectrum.
- 11) Allow trace to fully stabilize.

<p><b>Eurofins KCTL Co.,Ltd.</b>  65, Sinwon-ro, Yeongtong-gu,  Suwon-si, Gyeonggi-do, 16677, Korea  TEL: 82-70-5008-1021 FAX: 82-505-299-8311  <a href="http://www.kctl.co.kr">www.kctl.co.kr</a></p>	<p>Report No.:  KR24-SRF0085  Page (58) of (65)</p>	
--	---	---

**Notes:**

1. On a test site, the EUT shall be placed at 80 cm or 1.5 m height on a turn table, and in the position close to normal use as declared by the applicant.
2. The test antenna shall be oriented initially for vertical polarization located 3 m from EUT to correspond to the fundamental frequency of the transmitter.
3. The turntable is rotated through 360°, and the receiving antenna scans in order to determine the Level of the maximized emission.
4. The test antenna shall be raised and lowered again through the specified range of height until the maximum signal level is detected by the measuring receiver.
5. The maximum signal level detected by the measuring receiver shall be noted.
6. The EUT was replaced by half-wave dipole (1 GHz below) or horn antenna (1 GHz above) connected to a signal generator.  
The power is calculated by the following formula;  

$$Pd(\text{dBm}) = Pg(\text{dBm}) - \text{Cable loss (dB)} + \text{Antenna gain (dB)}$$
Note. Pd is the dipole equivalent power and Pg is the generator output power into the substitution antenna.  
The test antenna shall be raised and lowered through the specified range of height to ensure that
7. The maximum signal is received.  
The input signal to the substitution antenna shall be adjusted to the level that produces a level
8. Detected by the measuring corrected for the change of input attenuator setting of the measuring Receiver.
9. The input level to the substitution antenna shall be recorded as power level in dBm, corrected for Any change of input attenuator setting of the measuring receiver.
10. The measurement shall be repeated with the test antenna and the substitution antenna Orientated for horizontal polarization.

## Test results

### Test mode: WCDMA 1900

Mode	Channel	Pol.	Antenna Gain	C.L	Substitute Level	EIRP	
		[V/H]	[dBi]	[dB]	[dBm]	[dBm]	[W]
RMC	Low	V	5.14	9.13	21.89	17.90	0.062
	Middle	V	5.06	9.22	23.18	19.02	0.080
	High	V	4.98	9.29	22.90	18.59	0.072

**Note.**

1.  $E.I.R.P(dBm) = \text{Substitute Level}(dB) + \text{Antenna gain}(dBi) - C.L(\text{Cable loss})(dB)$



**Test mode: LTE B25/2**

Bandwidth [MHz]	Modulation	Channel	Pol.	Antenna Gain	C.L	Substitute Level	EIRP	
			[V/H]	[dBi]	[dB]	[dBm]	[dBm]	[W]
1.4	QPSK	Low	V	5.15	9.13	23.10	19.11	0.082
		Middle	V	5.05	9.24	21.56	17.37	0.055
		High	V	4.96	9.26	21.27	16.96	0.050
	16QAM	Low	V	5.15	9.13	22.08	18.10	0.064
		Middle	V	5.05	9.24	20.53	16.34	0.043
		High	V	4.96	9.26	20.30	16.00	0.040
3	QPSK	Low	V	5.15	9.12	23.17	19.20	0.083
		Middle	V	5.05	9.24	21.98	17.79	0.060
		High	V	4.96	9.25	20.76	16.47	0.044
	16QAM	Low	V	5.15	9.12	22.21	18.24	0.067
		Middle	V	5.05	9.24	20.83	16.65	0.046
		High	V	4.96	9.25	19.58	15.29	0.034
5	QPSK	Low	V	5.14	9.13	21.83	17.84	0.061
		Middle	V	5.05	9.24	20.85	16.66	0.046
		High	V	4.96	9.26	21.86	17.57	0.057
	16QAM	Low	V	5.14	9.13	20.77	16.78	0.048
		Middle	V	5.05	9.24	20.01	15.83	0.038
		High	V	4.96	9.26	20.87	16.57	0.045
10	QPSK	Low	V	5.14	9.16	21.46	17.43	0.055
		Middle	V	5.05	9.24	23.01	18.82	0.076
		High	V	4.97	9.28	21.27	16.96	0.050
	16QAM	Low	V	5.14	9.16	20.36	16.33	0.043
		Middle	V	5.05	9.24	21.95	17.77	0.060
		High	V	4.97	9.28	20.27	15.96	0.039
15	QPSK	Low	V	5.13	9.17	21.81	17.77	0.060
		Middle	V	5.05	9.24	22.49	18.30	0.068
		High	V	4.98	9.30	20.99	16.67	0.046
	16QAM	Low	V	5.13	9.17	20.56	16.52	0.045
		Middle	V	5.05	9.24	21.53	17.34	0.054
		High	V	4.98	9.30	20.02	15.69	0.037
20	QPSK	Low	V	5.12	9.18	21.38	17.32	0.054
		Middle	V	5.05	9.24	22.01	17.82	0.061
		High	V	4.99	9.27	21.29	17.01	0.050
	16QAM	Low	V	5.12	9.18	20.57	16.51	0.045
		Middle	V	5.05	9.24	21.10	16.91	0.049
		High	V	4.99	9.27	20.33	16.05	0.040

**Note.**

1. E.I.R.P(dBm) = Substitute Level(dB) + Antenna gain(dBi) - C.L(Cable loss) (dB)

## 7.8. Radiated Spurious Emissions

### Test setup

The diagram below shows the test setup that is utilized to make the measurements for emission from 30 MHz to 1 GHz emissions.

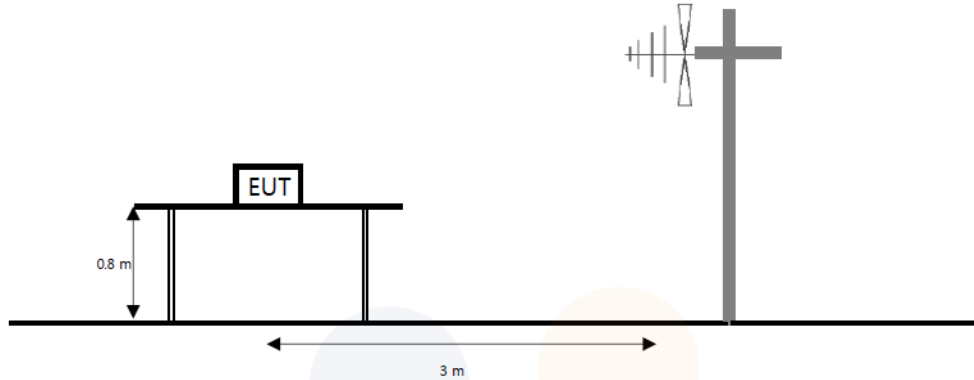

The diagram below shows the test setup that is utilized to make the measurements for emission from 1 GHz to the tenth harmonic of the highest fundamental frequency or to 40 GHz emissions, whichever is lower.

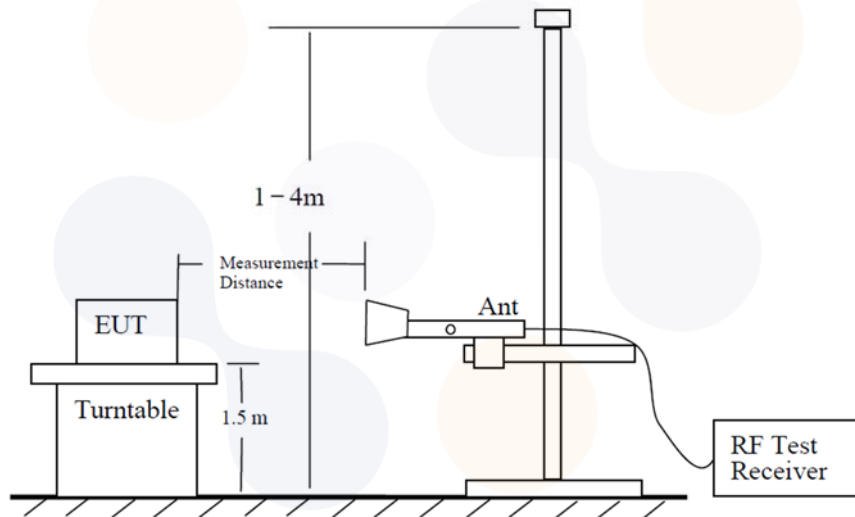

The diagram below shows the test setup for substituted method.

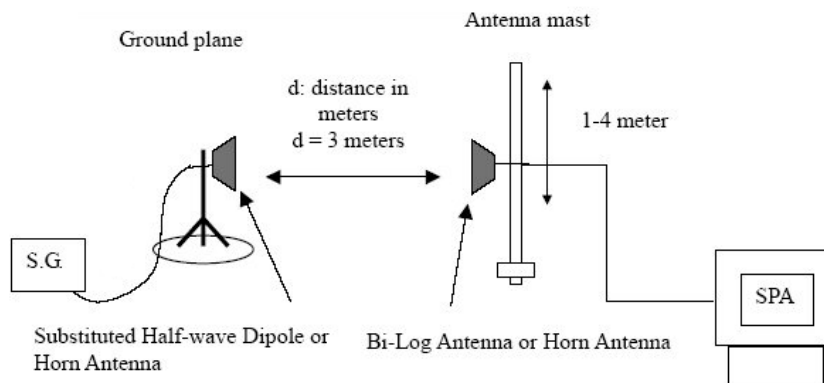

### **Limit**

#### **According to §24.238(a),**

The power of any emission outside of the authorized operating frequency ranges must be attenuated below the transmitting power (P) by a factor of at least  $43 + 10\log(P)$  dB.

### **Test procedure**

971168 D01 v03r01 - Section 6.2

ANSI 63.26-2015 – Section 5.5

ANSI/TIA-603-E-2016 - Section 2.2.12

### **Test settings**

- 1) RBW = 100 kHz for below 1 GHz and 1 MHz for above 1 GHz.
- 2) VBW  $\geq 3 \times$  RBW.
- 3) Detector = RMS
- 4) Trace mode = Max hold
- 5) Sweep time = Auto couple
- 6) Number of sweep points  $\geq 2 \times$  span / RBW
- 7) Allow trace to fully stabilize.

### **Notes:**

1. On a test site, the EUT shall be placed at 80 cm or 1.5 m height on a turn table, and in the position close to normal use as declared by the applicant.
2. The test antenna shall be oriented initially for vertical polarization located 3 m from EUT to correspond to the fundamental frequency of the transmitter.
3. The turntable is rotated through 360°, and the receiving antenna scans in order to determine the Level of the maximized emission.
4. The test antenna shall be raised and lowered again through the specified range of height until the maximum signal level is detected by the measuring receiver.
5. The maximum signal level detected by the measuring receiver shall be noted.
6. The EUT was replaced by half-wave dipole (1 GHz below) or horn antenna (1 GHz above) connected to a signal generator.
7. The test antenna shall be raised and lowered through the specified range of height to ensure that the maximum signal is received.
8. The input signal to the substitution antenna shall be adjusted to the level that produces a level detected by the measuring corrected for the change of input attenuator setting of the measuring Receiver.
9. The input level to the substitution antenna shall be recorded as power level in dBm, corrected for any change of input attenuator setting of the measuring receiver.
10. The measurement shall be repeated with the test antenna and the substitution antenna oriented for horizontal polarization.

**Test results (Above 1 000 MHz)**

Test mode : WCDMA 1900

Frequency(MHz) : 1 852.4

Channel : 9262

Mode	Frequency	Pol.	Antenna Gain	Cable loss	Substitute Level	Level	Limit	Margin
	[MHz]	[V/H]	[dBi]	[dB]	[dBm]	[dBm]	[dBm]	[dB]
RMC	3 702.16	H	8.66	13.35	-47.21	-51.90	-13.00	38.90
	5 557.13	H	10.61	16.58	-45.13	-51.10	-13.00	38.10
	7 410.19	H	11.97	19.53	-38.04	-45.60	-13.00	32.60
	9 263.88	H	13.20	21.60	-35.60	-44.00	-13.00	31.00

Test mode : WCDMA 1900

Frequency(MHz) : 1 880.0

Channel : 9400

Mode	Frequency	Pol.	Antenna Gain	Cable loss	Substitute Level	Level	Limit	Margin
	[MHz]	[V/H]	[dBi]	[dB]	[dBm]	[dBm]	[dBm]	[dB]
RMC	3 760.88	V	8.77	13.51	-46.76	-51.50	-13.00	38.50
	5 640.11	H	10.63	16.57	-43.66	-49.60	-13.00	36.60
	7 521.26	H	12.12	19.31	-38.61	-45.80	-13.00	32.80
	9 404.31	H	13.20	21.67	-35.23	-43.70	-13.00	30.70

Test mode : WCDMA 1900

Frequency(MHz) : 1 907.6

Channel : 9538

Mode	Frequency	Pol.	Antenna Gain	Cable loss	Substitute Level	Level	Limit	Margin
	[MHz]	[V/H]	[dBi]	[dB]	[dBm]	[dBm]	[dBm]	[dB]
RMC	3 816.42	V	8.87	13.43	-48.14	-52.70	-13.00	39.70
	5 723.09	H	10.64	16.71	-42.83	-48.90	-13.00	35.90
	7 630.41	V	12.20	19.56	-38.24	-45.60	-13.00	32.60
	9 539.00	V	13.19	21.84	-34.75	-43.40	-13.00	30.40

**Note.**

1. E.I.R.P(dBm) = Substitute Level(dB) + Antenna gain(dBi) - C.L(Cable loss) (dB)

Test mode : LTE B25/2

Frequency(MHz) : 1 851.5

Channel : 26055

Bandwidth(MHz) : 3

Mode	Frequency	Pol.	Antenna Gain	Cable loss	Substitute Level	Level	Limit	Margin
	[MHz]	[V/H]	[dBi]	[dB]	[dBm]	[dBm]	[dBm]	[dB]
QPSK	3 702.16	H	8.66	13.35	-46.61	-51.30	-13.00	38.30
	5 553.94	V	10.61	16.57	-43.04	-49.00	-13.00	36.00
	7 405.72	V	11.97	19.53	-39.24	-46.80	-13.00	33.80
	9 256.86	V	13.20	21.59	-35.41	-43.80	-13.00	30.80

Test mode : LTE B25/2

Frequency(MHz) : 1 882.5

Channel : 26365

Bandwidth(MHz) : 3

Mode	Frequency	Pol.	Antenna Gain	Cable loss	Substitute Level	Level	Limit	Margin
	[MHz]	[V/H]	[dBi]	[dB]	[dBm]	[dBm]	[dBm]	[dB]
QPSK	3 768.54	V	8.78	13.52	-46.76	-51.50	-13.00	38.50
	5 653.52	V	10.63	16.60	-43.53	-49.50	-13.00	36.50
	7 535.94	V	12.13	19.33	-38.70	-45.90	-13.00	32.90
	9 419.00	V	13.20	21.69	-34.51	-43.00	-13.00	30.00

Test mode : LTE B25/2

Frequency(MHz) : 1 913.5

Channel : 26675

Bandwidth(MHz) : 3

Mode	Frequency	Pol.	Antenna Gain	Cable loss	Substitute Level	Level	Limit	Margin
	[MHz]	[V/H]	[dBi]	[dB]	[dBm]	[dBm]	[dBm]	[dB]
QPSK	3 824.08	H	8.88	13.45	-47.23	-51.80	-13.00	38.80
	5 735.86	V	10.65	16.73	-44.02	-50.10	-13.00	37.10
	7 648.28	H	12.22	19.58	-38.84	-46.20	-13.00	33.20
	9 559.43	V	13.19	21.86	-33.63	-42.30	-13.00	29.30

**Note.**

1. E.I.R.P(dBm) = Substitute Level(dB) + Antenna gain(dBi) - C.L(Cable loss) (dB)



## 8. Measurement equipment

Equipment Name	Manufacturer	Model No.	Serial No.	Next Cal. Date
Spectrum Analyzer	R&S	FSV40-N	101462	24.10.12
Spectrum Analyzer	Agilent	N9040B	US55230151	24.07.03
Divider	Marki Microwave, Inc.	PD-0040	D0006	24.07.04
DC Power Supply	AGILENT	E3632A	MY40001543	25.04.24
Wideband Radio Communication Tester	R&S	CMW500	106840	25.01.18
Wideband Radio Communication Tester	R&S	CMW500	141780	25.01.18
Signal Generator	R&S	SMB100A	176206	25.01.18
Temp & Humid Chamber	Myeongseong R&P	CTHC-50P-DT	20150824-2	25.01.18
Bi-log Antenna	Teseq GmbH	CBL 6112D	62027	24.11.17
Bi-log Antenna	ETS-LINDGREN	3143B	00228420	25.07.20
Horn Antenna	ETS-LINDGREN	3117	00251528	25.01.26
Horn Antenna	ETS-LINDGREN	3117	00227509	24.07.12
Horn Antenna	ETS-LINDGREN	3116C	00251516	25.02.01
Horn Antenna	ETS-LINDGREN	3116	421822	24.10.12
Amplifier	SONOMA INSTRUMENT	310N	421822	24.10.12
Amplifier	B&Z Technologies	BZRT-00504000-481055-382525	26299-27735	24.07.04
Amplifier	B&Z Technologies	BZR-0050400-551028-252525	27736	24.07.04
High pass Filter	Wainwright Instruments GmbH	WHKX12-2805-3000-18000-40SS	32	24.07.04

**End of test report**