

Test results

Test mode: WCDMA 1700

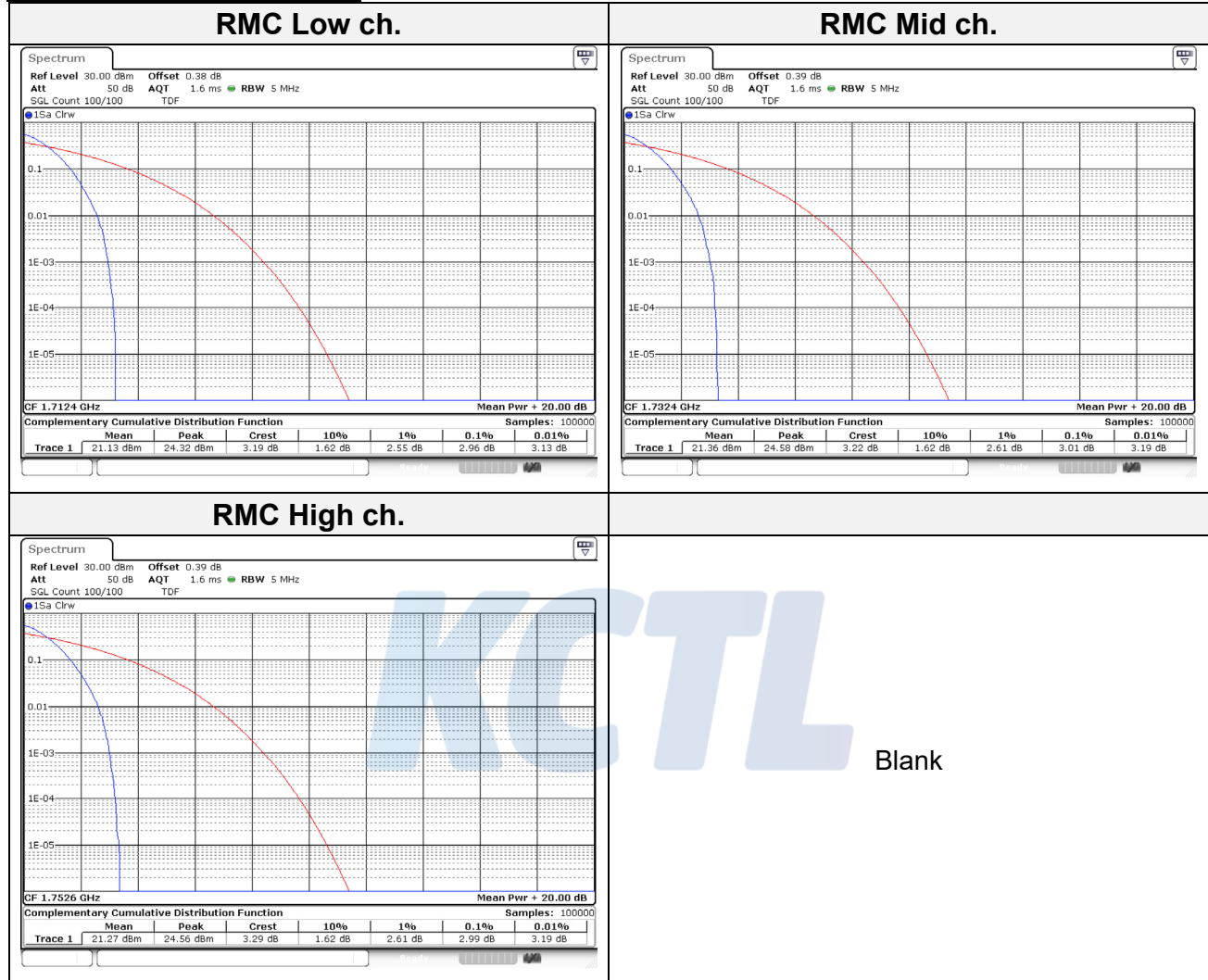

Test mode: WCDMA 1900

RMC Low ch.

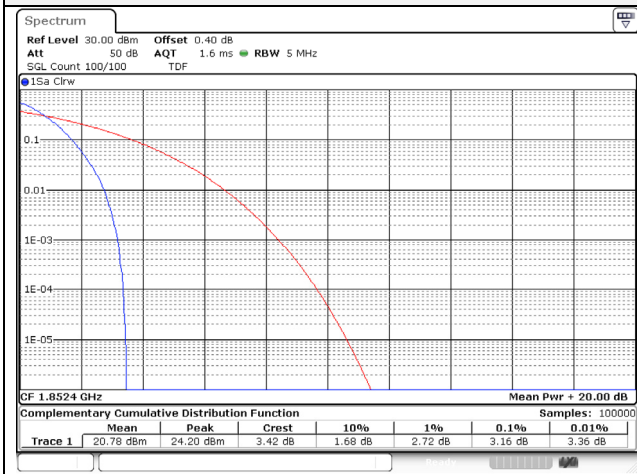

RMC Mid ch.

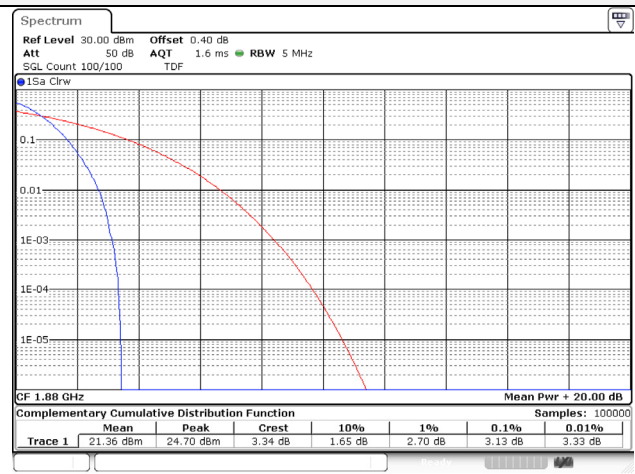

RMC High ch.

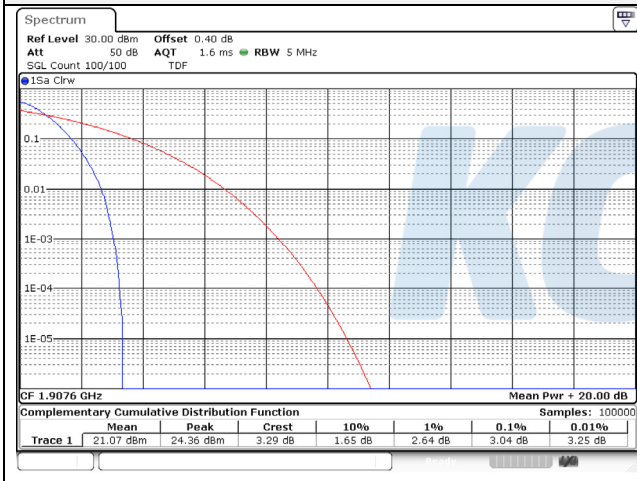

Blank

7.6. Frequency stability

Test setup

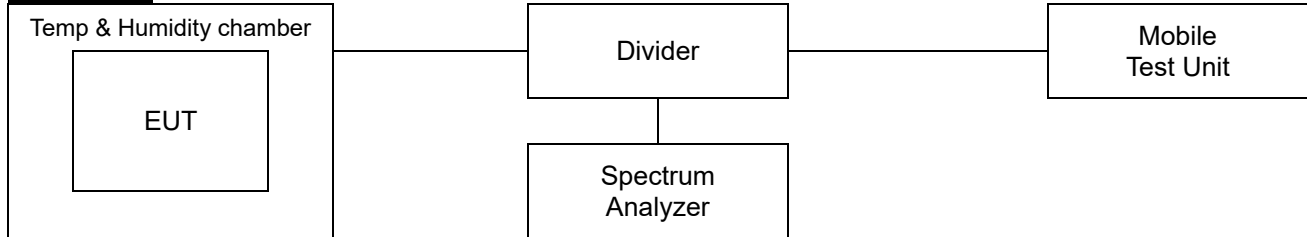

Limit

According to §2.1055(a),

The frequency stability shall be measured with variation of ambient temperature as follows:

- 1) From -30° to $+50^{\circ}$ centigrade for all equipment except that specified in paragraphs (a) (2) and (3) of this section.
- 2) From -20° to $+50^{\circ}$ centigrade for equipment to be licensed for use in the maritime services under part 80 of this chapter, except for class A, B, and S emergency position indicating radiobeacons (EPIRBS), and equipment to be licensed for use above 952 MHz at operational fixed stations in all services, stations in the local television transmission service and point-to-point microwave radio service under part 21 of this chapter, equipment licensed for use aboard aircraft in the aviation services under part 87 of this chapter, and equipment authorized for use in the family radio service under part 95 of this chapter.
- 3) From 0° to $+50^{\circ}$ centigrade for equipment to be licensed for use in the radio broadcast Services under part 73 of this chapter.

According to §2.1055(d),

The frequency stability shall be measured with variation of primary supply Voltage as follows:

- 1) Vary primary supply voltage from 85 to 115 percent of the nominal value for other than hand carried battery equipment.
- 2) For hand carried, battery powered equipment, reduce primary supply voltage to the battery operating and point which shall be specified by the manufacturer.
- 3) The supply voltage shall be measured at the input to the cable normally provided with the equipment, or at the power supply terminals if cables are not normally provided. Effects on frequency of transmitter keying (except for broadcast transmitters) and any heating element cycling at the nominal supply voltage and at each extreme also shall be shown.

According to §22.355 and RSS-132(5.3),

The carrier frequency of each transmitter in the public mobile services must be maintained within the tolerances given in Table of this section.

For mobile devices operating in the 824 to 849 MHz band at a power level than or equal to 3 Watts, the limit specified in Table C-1 is ± 2.5 ppm.

According to §24.235 and RSS-133(6.3),

The frequency stability shall be sufficient to ensure that the fundamental emission stays within the authorized frequency block.

The carrier frequency shall not depart from the reference frequency, in excess of ± 2.5 ppm for mobile stations and ± 1.0 ppm for base stations.

According to §27.54 and RSS-139(6.4),

The frequency stability shall be sufficient to ensure that the fundamental emissions stay within the Authorized bands of operation.

Test procedure

ANSI 63.26-2015 – Section 5.6

Test settings

- 1) The carrier frequency of the transmitter is measured at room temperature.
(20°C to provide a reference)
- 2) The equipment is turned on in a “standby” condition for one minute before applying power to the transmitter. Measurement of the carrier frequency of the transmitter is made within one minute after applying power to the transmitter.
- 3) Frequency measurements are made at 10°C intervals ranging from -30°C to +50°C.
A period of at least one half-hour is provided to allow stabilization of the equipment at each Temperature level.

Test results

Test mode : WCDMA 850
 Frequency (Hz) : 836 600 000
 Channel : 4183
 Deviation limit(FCC&IC) : ±0.00025% or 2.5 ppm

| Voltage (%) | Power (V) | Temp. (°C) | Frequency (Hz) | Frequency error (Hz) | Deviation | |
|-------------|-----------|------------|----------------|----------------------|-----------|----------|
| | | | | | (ppm) | (%) |
| 100% | 3.85 | +22(Ref) | 836,599,998 | -1.75 | 0.0 | 0.000000 |
| | | -30 | 836,600,002 | 2.10 | 0.0 | 0.000000 |
| | | -20 | 836,600,000 | 0.28 | 0.0 | 0.000000 |
| | | -10 | 836,599,998 | -1.99 | 0.0 | 0.000000 |
| | | 0 | 836,600,001 | 0.94 | 0.0 | 0.000000 |
| | | +10 | 836,600,001 | 1.07 | 0.0 | 0.000000 |
| | | +20 | 836,600,000 | 0.38 | 0.0 | 0.000000 |
| | | +30 | 836,600,000 | -0.31 | 0.0 | 0.000000 |
| | | +40 | 836,599,999 | -1.18 | 0.0 | 0.000000 |
| | | +50 | 836,599,998 | -1.89 | 0.0 | 0.000000 |
| 115% | 4.43 | +22(Ref) | 836,599,999 | -0.84 | 0.0 | 0.000000 |
| End point | 3.55 | +22(Ref) | 836,599,999 | -1.41 | 0.0 | 0.000000 |

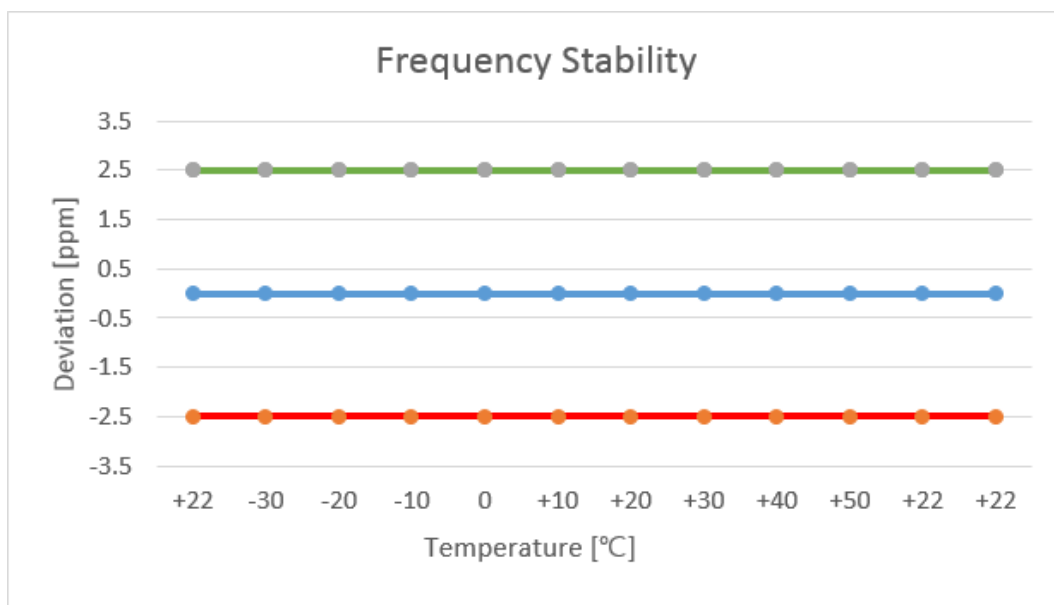

Test mode : WCDMA 1700
 Frequency (Hz) : 1 732 400 000
 Channel : 1412
 Deviation limit(FCC&IC) : The frequency stability shall be sufficient to ensure that the fundamental emission stays within the authorized bands of operation.

| Voltage (%) | Power (V) | Temp. (°C) | Frequency (Hz) | Frequency error (Hz) | Deviation | |
|-------------|-----------|------------|----------------|----------------------|-----------|----------|
| | | | | | (ppm) | (%) |
| 100% | 3.85 | +22(Ref) | 1,732,399,999 | -1.21 | 0.0 | 0.000000 |
| | | -30 | 1,732,400,004 | 3.50 | 0.0 | 0.000000 |
| | | -20 | 1,732,400,003 | 3.35 | 0.0 | 0.000000 |
| | | -10 | 1,732,400,003 | 3.26 | 0.0 | 0.000000 |
| | | 0 | 1,732,400,003 | 2.65 | 0.0 | 0.000000 |
| | | +10 | 1,732,400,002 | 1.95 | 0.0 | 0.000000 |
| | | +20 | 1,732,400,001 | 1.33 | 0.0 | 0.000000 |
| | | +30 | 1,732,400,001 | 0.99 | 0.0 | 0.000000 |
| | | +40 | 1,732,400,002 | 1.77 | 0.0 | 0.000000 |
| | | +50 | 1,732,400,003 | 2.98 | 0.0 | 0.000000 |
| 115% | 4.43 | +22(Ref) | 1,732,399,999 | -1.07 | 0.0 | 0.000000 |
| End point | 3.55 | +22(Ref) | 1,732,399,999 | -1.32 | 0.0 | 0.000000 |

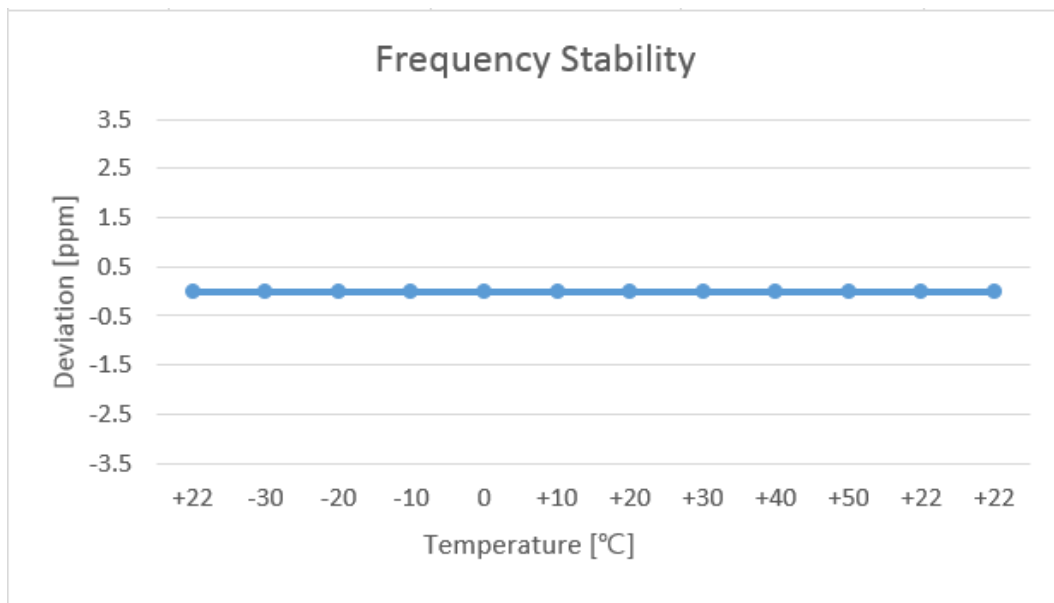

Test mode : WCDMA 1900
 Frequency (Hz) : 1 880 000 000
 Channel : 9400
 Deviation limit(FCC) : The frequency stability shall be sufficient to ensure that the Fundamental emission stays within the authorized frequency block.
 Deviation limit(IC) : ±0.00025% or 2.5ppm

| Voltage (%) | Power (V) | Temp. (°C) | Frequency (Hz) | Frequency error (Hz) | Deviation | |
|-------------|-----------|------------|----------------|----------------------|-----------|----------|
| | | | | | (ppm) | (%) |
| 100% | 3.85 | +22(Ref) | 1,880,000,002 | 1.85 | 0.0 | 0.000000 |
| | | -30 | 1,879,999,998 | -2.31 | 0.0 | 0.000000 |
| | | -20 | 1,879,999,998 | -2.45 | 0.0 | 0.000000 |
| | | -10 | 1,879,999,997 | -2.56 | 0.0 | 0.000000 |
| | | 0 | 1,879,999,998 | -1.64 | 0.0 | 0.000000 |
| | | +10 | 1,880,000,000 | 0.46 | 0.0 | 0.000000 |
| | | +20 | 1,880,000,000 | 0.16 | 0.0 | 0.000000 |
| | | +30 | 1,879,999,999 | -0.74 | 0.0 | 0.000000 |
| | | +40 | 1,879,999,998 | -1.88 | 0.0 | 0.000000 |
| | | +50 | 1,879,999,998 | -2.21 | 0.0 | 0.000000 |
| 115% | 4.43 | +22(Ref) | 1,880,000,002 | 1.69 | 0.0 | 0.000000 |
| End point | 3.55 | +22(Ref) | 1,880,000,001 | 0.96 | 0.0 | 0.000000 |

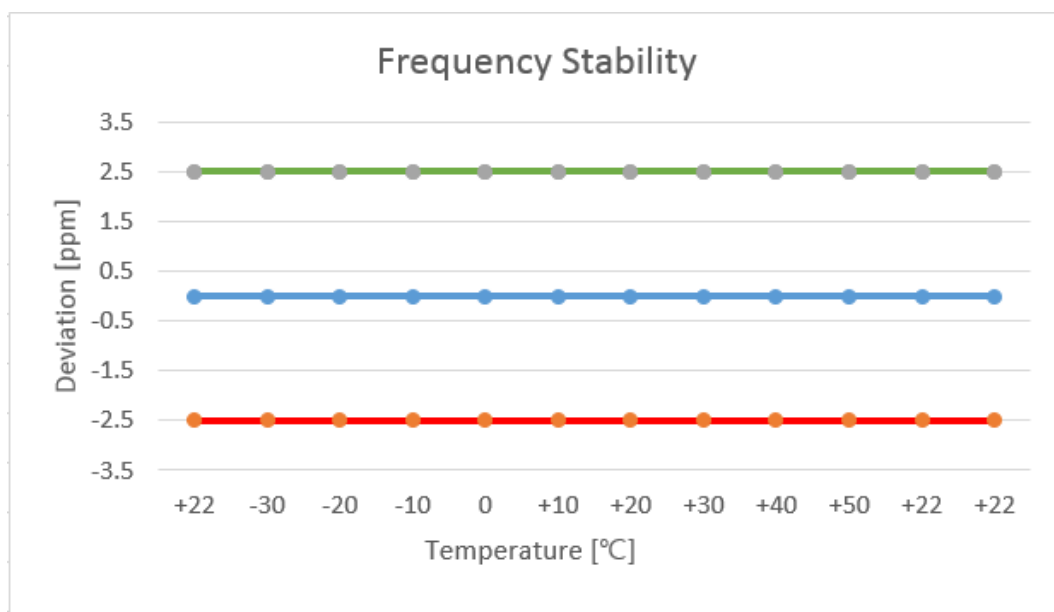

7.7. Radiated Power (ERP/EIRP)

Test setup

The diagram below shows the test setup that is utilized to make the measurements for emission from 30 MHz to 1 GHz emissions.

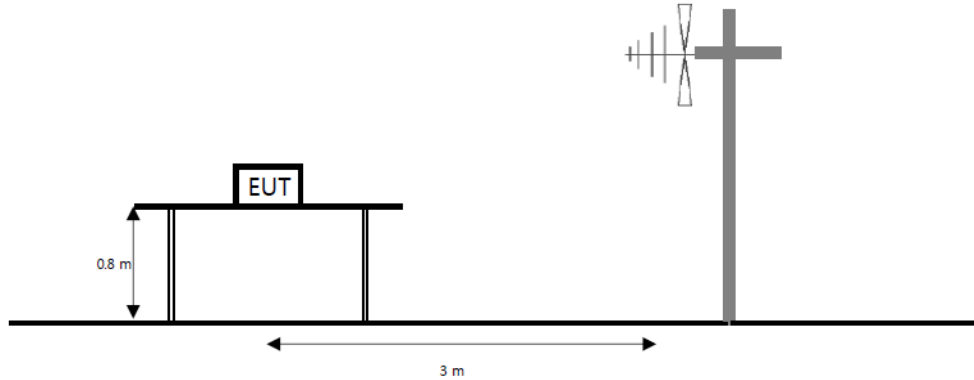

The diagram below shows the test setup that is utilized to make the measurements for emission from 1 GHz to the tenth harmonic of the highest fundamental frequency or to 40 GHz emissions, whichever is lower.

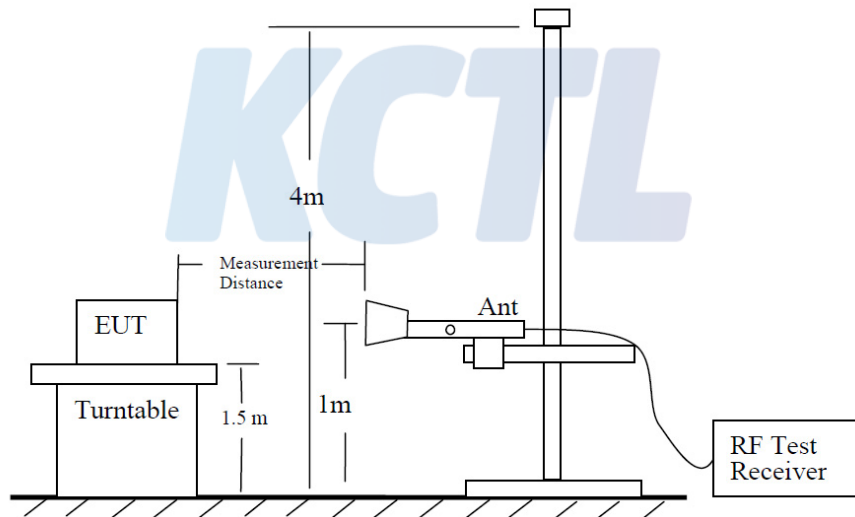

The diagram below shows the test setup for substituted method.

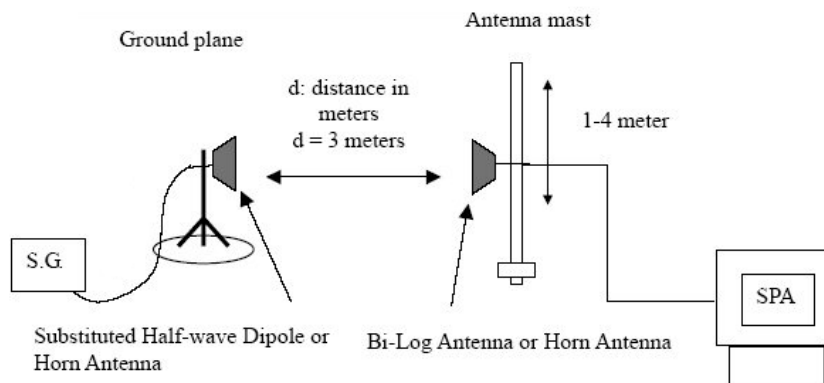

Limit

According to §22.913(a)(5), the ERP of transmitters in the cellular radiotelephone service must not exceed the limits in this section. The ERP of mobile transmitters and auxiliary test transmitters must not exceed 7 watts. And according to RSS-132(5.4), the equivalent isotropically radiated power (e.i.r.p) for mobile equipment shall not exceed 11.5 watts. Refer to SRSP-503 for base stations e.i.r.p limits.

According to §24.232(c) and RSS-133(6.4), mobile and portable stations are limited to 2 watts EIRP and the equipment must employ a means for limiting power to the minimum necessary for successful communications.

According to §27.50(d)(4) and RSS-139(6.5), fixed, mobile, and portable (hand-held) stations operating in the 1710~1755 MHz band and mobile and portable stations operating in the 1695~1710 MHz and 1755~1780 MHz bands are 1 watt EIRP.

Test procedure

971168 D01 v03r01 - Section 5.2.2

ANSI 63.26-2015 – Section 5.2.4.4.1

ANSI/TIA-603-E-2016 - Section 2.2.17

Test settings

- 1) RBW = 1 % to 5 % of the OBW.
- 2) VBW $\geq 3 \times$ RBW.
- 3) SPAN = 2 \times to 3 \times the OBW.
- 4) Number of measurement points in sweep $\geq 2 \times$ span / RBW.
- 5) Sweep time :
 - 1) Auto couple, or
 - 2) $\geq [10 \times (\text{number of points in sweep}) \times (\text{transmission period})]$ for single sweep (automation-compatible) measurement. Transmission period is the on and off time of the transmitter.
- 6) Detector = RMS
- 7) If the EUT can be configured to transmit continuously, then set the trigger to free run.
- 8) If the EUT cannot be configured to transmit continuously, then use a sweep trigger with the level set to enable triggering only on full power bursts and configure the EUT to transmit at full power for the entire duration of each sweep. Verify that the sweep time is less than or equal to the transmission burst duration. Time gating can also be used under similar constraints (i.e., configured such that measurement data is collected only during active full-power transmissions).
- 9) Trace mode = trace averaging (RMS) over 100 sweeps.
- 10) Compute the power by integrating the spectrum across the OBW of the signal using the instrument's band or channel power measurement function, with the band/channel limits set equal to the OBW band edges. If the instrument does not have a band or channel power function, then sum the spectrum levels (in linear power units) at intervals equal to the RBW extending across the entire OBW of the spectrum.
- 11) Allow trace to fully stabilize.

Notes:

1. On a test site, the EUT shall be placed at 80 cm height on a turn table, and in the position close To normal use as declared by the applicant.
2. The test antenna shall be oriented initially for vertical polarization located 3 m from EUT to Correspond to the fundamental frequency of the transmitter.
3. The turntable is rotated through 360°, and the receiving antenna scans in order to determine the Level of the maximized emission.
4. The test antenna shall be raised and lowered again through the specified range of height until the maximum signal level is detected by the measuring receiver.
5. The maximum signal level detected by the measuring receiver shall be noted.
6. The EUT was replaced by half-wave dipole (1 GHz below) or horn antenna (1 GHz above) connected to a signal generator.
The power is calculated by the following formula;
$$Pd(\text{dBm}) = Pg(\text{dBm}) - \text{Cable loss (dB)} + \text{Antenna gain (dB)}$$

Note. Pd is the dipole equivalent power and Pg is the generator output power into the substitution antenna.
7. The test antenna shall be raised and lowered through the specified range of height to ensure that The maximum signal is received.
8. The input signal to the substitution antenna shall be adjusted to the level that produces a level Detected by the measuring corrected for the change of input attenuator setting of the measuring Receiver.
9. The input level to the substitution antenna shall be recorded as power level in dBm, corrected for Any change of input attenuator setting of the measuring receiver.
10. The measurement shall be repeated with the test antenna and the substitution antenna Orientated for horizontal polarization.

Test results**Test mode: WCDMA 850**

| Mode | Channel | Frequency | Pol. | Antenna Gain | C.L | Substitute Level | ERP | | EIRP ^{Note.1} | |
|------|---------|-----------|------|--------------|------|------------------|--------------|--------------|------------------------|--------------|
| | | [MHz] | | | | | [V/H] | [dBi] | [dB] | [dB m] |
| RMC | 4132 | 826.40 | H | -0.20 | 5.07 | 17.54 | 12.27 | 0.017 | 14.42 | 0.028 |
| | 4183 | 836.60 | H | -0.20 | 5.11 | 18.15 | 12.84 | 0.019 | 14.99 | 0.032 |
| | 4233 | 846.60 | H | -0.50 | 5.16 | 18.00 | 12.34 | 0.017 | 14.49 | 0.028 |

Test mode: WCDMA 1700

| Mode | Channel | Frequency | Pol. | Antenna Gain | C.L | Substitute Level | EIRP | |
|------|---------|-----------|------|--------------|------|------------------|--------------|--------------|
| | | [MHz] | | | | | [V/H] | [dBi] |
| RMC | 1312 | 1 712.4 | H | 5.96 | 7.53 | 14.87 | 13.30 | 0.021 |
| | 1412 | 1 732.4 | H | 5.90 | 7.56 | 15.27 | 13.61 | 0.023 |
| | 1513 | 1 752.6 | H | 5.84 | 7.61 | 15.57 | 13.80 | 0.024 |

Test mode: WCDMA 1900

| Mode | Channel | Frequency | Pol. | Antenna Gain | C.L | Substitute Level | EIRP | |
|------|---------|-----------|------|--------------|------|------------------|--------------|--------------|
| | | [MHz] | | | | | [V/H] | [dBi] |
| RMC | 9262 | 1 852.4 | H | 5.54 | 7.79 | 20.32 | 18.07 | 0.064 |
| | 9400 | 1 880.0 | H | 5.46 | 7.86 | 20.42 | 18.02 | 0.063 |
| | 9538 | 1 907.6 | H | 5.38 | 7.88 | 21.11 | 18.61 | 0.073 |

Note.

1. The E.I.R.P conversion formula for IC :

$$\text{E.I.R.P result(dBm)} = \text{E.R.P result (dBm)} + 2.15 \text{ (dB)}$$

2. E.R.P & E.I.R.P(dBm) = Substitute Level(dB) + Antenna gain(dBi) - C.L(Cable loss) (dB)

7.8. Radiated Spurious Emissions

Test setup

The diagram below shows the test setup that is utilized to make the measurements for emission from 30 MHz to 1 GHz emissions.

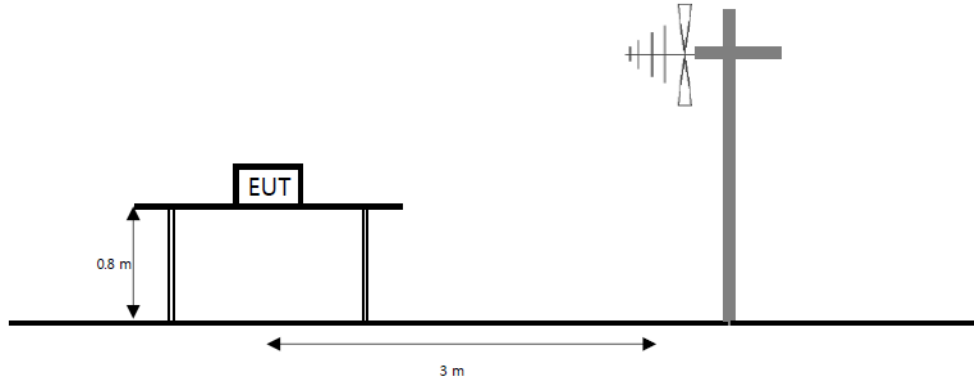

The diagram below shows the test setup that is utilized to make the measurements for emission from 1 GHz to the tenth harmonic of the highest fundamental frequency or to 40 GHz emissions, whichever is lower.

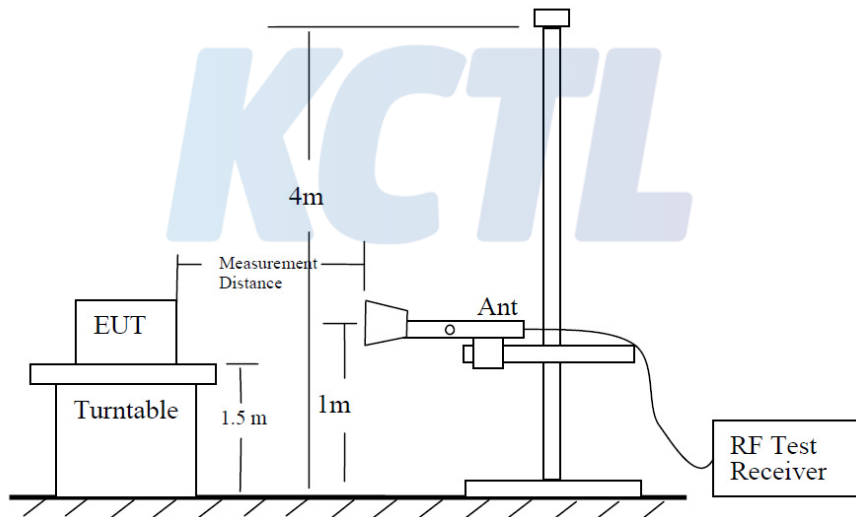

The diagram below shows the test setup for substituted method.

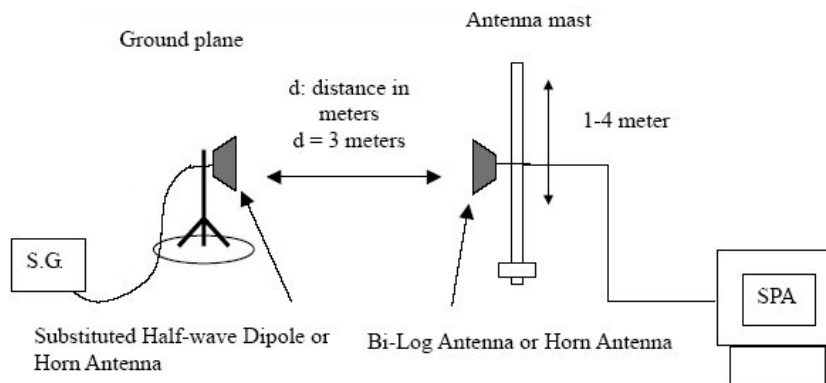

Limit

According to §22.917(a), §24.238(a) and RSS-132(5.5), RSS-133(6.5), the power of any emission outside of the authorized operating frequency ranges must be attenuated below the transmitting power (P) by a factor of at least $43 + 10\log(P)$ dB.

According to §27.53(h) and RSS-139(6.6), the power of any emission outside a licensee's frequency block shall be attenuated below the transmitter power (P) in watts by at least $43 + 10\log(P_{\text{Watts}})$ dB.

Test procedure

971168 D01 v03r01 - Section 5.8

ANSI 63.26-2015 – Section 5.5

ANSI/TIA-603-E-2016 - Section 2.2.12

Test settings

- 1) RBW = 1 kHz for below 1 GHz and 1 MHz for above 1 GHz.
- 2) VBW $\geq 3 \times$ RBW.
- 3) Detector = RMS
- 4) Trace mode = Max hold
- 5) Sweep time = Auto couple
- 6) Number of sweep points $\geq 2 \times$ span / RBW
- 7) Allow trace to fully stabilize.

Notes:

1. On a test site, the EUT shall be placed at 80 cm height on a turn table, and in the position close to normal use as declared by the applicant.
2. The test antenna shall be oriented initially for vertical polarization located 3 m from EUT to correspond to the fundamental frequency of the transmitter.
3. The turntable is rotated through 360° , and the receiving antenna scans in order to determine the level of the maximized emission.
4. The test antenna shall be raised and lowered again through the specified range of height until the maximum signal level is detected by the measuring receiver.
5. The maximum signal level detected by the measuring receiver shall be noted.
6. The EUT was replaced by half-wave dipole (1 GHz below) or horn antenna (1 GHz above) connected to a signal generator.
7. The test antenna shall be raised and lowered through the specified range of height to ensure that the maximum signal is received.
8. The input signal to the substitution antenna shall be adjusted to the level that produces a level detected by the measuring corrected for the change of input attenuator setting of the measuring receiver.
9. The input level to the substitution antenna shall be recorded as power level in dBm, corrected for any change of input attenuator setting of the measuring receiver.
10. The measurement shall be repeated with the test antenna and the substitution antenna orientated for horizontal polarization.

Test results (Above 1 000 MHz)Test mode : WCDMA 850Frequency(MHz) : 826.4Channel : 4132

| Mode | Frequency | Pol. | Antenna Gain | Cable loss | Substitute Level | Level | Limit | Margin |
|------|-----------|-------|--------------|------------|------------------|--------|--------|--------|
| | [MHz] | [V/H] | [dBi] | [dB] | [dBm] | [dBm] | [dBm] | [dB] |
| RMC | 1 653.60 | H | 6.14 | 5.34 | -61.70 | -60.90 | -13.00 | 47.90 |
| | 2 480.40 | H | 5.39 | 6.51 | -55.78 | -56.90 | -13.00 | 43.90 |
| | 3 305.20 | H | 8.17 | 7.63 | -59.24 | -58.70 | -13.00 | 45.70 |
| | 4 138.80 | H | 8.49 | 8.70 | -54.49 | -54.70 | -13.00 | 41.70 |

Test mode : WCDMA 850Frequency(MHz) : 836.6Channel : 4183

| Mode | Frequency | Pol. | Antenna Gain | Cable loss | Substitute Level | Level | Limit | Margin |
|------|-----------|-------|--------------|------------|------------------|--------|--------|--------|
| | [MHz] | [V/H] | [dBi] | [dB] | [dBm] | [dBm] | [dBm] | [dB] |
| RMC | 1 639.20 | H | 6.18 | 5.36 | -63.72 | -62.90 | -13.00 | 49.90 |
| | 2 512.80 | H | 5.46 | 6.55 | -52.51 | -53.60 | -13.00 | 40.60 |
| | 3 344.80 | V | 8.21 | 7.69 | -55.62 | -55.10 | -13.00 | 42.10 |
| | 4 198.80 | H | 8.44 | 8.82 | -53.72 | -54.10 | -13.00 | 41.10 |

Test mode : WCDMA 850Frequency(MHz) : 846.6Channel : 4233

| Mode | Frequency | Pol. | Antenna Gain | Cable loss | Substitute Level | Level | Limit | Margin |
|------|-----------|-------|--------------|------------|------------------|--------|--------|--------|
| | [MHz] | [V/H] | [dBi] | [dB] | [dBm] | [dBm] | [dBm] | [dB] |
| RMC | 1 694.40 | V | 6.02 | 5.37 | -61.85 | -61.20 | -13.00 | 48.20 |
| | 2 538.80 | H | 5.59 | 6.57 | -56.82 | -57.80 | -13.00 | 44.80 |
| | 3 390.00 | H | 8.27 | 7.75 | -57.42 | -56.90 | -13.00 | 43.90 |
| | 4 236.00 | H | 8.41 | 8.90 | -55.61 | -56.10 | -13.00 | 43.10 |

Note.

1. Limit Calculation(dBm)= 43 + 10log(P_{Watts})
2. Level(dB m) = Antenna gain(dB i) - Cable loss(dB) - Substitute level(dB m)

Test mode : WCDMA 1700Frequency(MHz) : 1 712.4Channel : 1312

| Mode | Frequency | Pol. | Antenna Gain | Cable loss | Substitute Level | Level | Limit | Margin |
|------|-----------|-------|--------------|------------|------------------|--------|--------|--------|
| | [MHz] | [V/H] | [dBi] | [dB] | [dBm] | [dBm] | [dBm] | [dB] |
| RMC | 3 424.00 | V | 8.31 | 7.80 | -59.61 | -59.10 | -13.00 | 46.10 |
| | 5 140.50 | V | 10.28 | 9.85 | -47.33 | -46.90 | -13.00 | 33.90 |
| | 6 850.00 | V | 11.15 | 11.47 | -52.08 | -52.40 | -13.00 | 39.40 |
| | 8 563.00 | V | 13.11 | 12.52 | -53.49 | -52.90 | -13.00 | 39.90 |

Test mode : WCDMA 1700Frequency(MHz) : 1 732.4Channel : 1412

| Mode | Frequency | Pol. | Antenna Gain | Cable loss | Substitute Level | Level | Limit | Margin |
|------|-----------|-------|--------------|------------|------------------|--------|--------|--------|
| | [MHz] | [V/H] | [dBi] | [dB] | [dBm] | [dBm] | [dBm] | [dB] |
| RMC | 3 464.00 | V | 8.36 | 7.86 | -59.10 | -58.60 | -13.00 | 45.60 |
| | 5 201.00 | V | 10.32 | 9.93 | -49.89 | -49.50 | -13.00 | 36.50 |
| | 6 929.50 | V | 11.23 | 11.46 | -54.37 | -54.60 | -13.00 | 41.60 |
| | 8 663.00 | H | 13.13 | 12.61 | -50.52 | -50.00 | -13.00 | 37.00 |

Test mode : WCDMA 1700Frequency(MHz) : 1 752.6Channel : 1513

| Mode | Frequency | Pol. | Antenna Gain | Cable loss | Substitute Level | Level | Limit | Margin |
|------|-----------|-------|--------------|------------|------------------|--------|--------|--------|
| | [MHz] | [V/H] | [dBi] | [dB] | [dBm] | [dBm] | [dBm] | [dB] |
| RMC | 3 505.00 | H | 8.40 | 7.92 | -56.58 | -56.10 | -13.00 | 43.10 |
| | 5 261.00 | V | 10.36 | 10.00 | -49.66 | -49.30 | -13.00 | 36.30 |
| | 7 010.50 | V | 11.32 | 11.45 | -55.47 | -55.60 | -13.00 | 42.60 |
| | 8 763.50 | V | 13.15 | 12.65 | -50.80 | -50.30 | -13.00 | 37.30 |

Note.

1. Limit Calculation(dBm)= 43 + 10log(P_[Watts])

2. Level(dB m) = Antenna gain(dB i) - Cable loss(dB) - Substitute level(dB m)

Test mode : WCDMA 1900Frequency(MHz) : 1 852.4Channel : 9262

| Mode | Frequency | Pol. | Antenna Gain | Cable loss | Substitute Level | Level | Limit | Margin |
|------|-----------|-------|--------------|------------|------------------|--------|--------|--------|
| | [MHz] | [V/H] | [dBi] | [dB] | [dBm] | [dBm] | [dBm] | [dB] |
| RMC | 3 726.00 | V | 8.49 | 8.23 | -56.26 | -56.00 | -13.00 | 43.00 |
| | 5 554.50 | V | 10.51 | 10.34 | -50.17 | -50.00 | -13.00 | 37.00 |
| | 7 402.00 | V | 11.94 | 11.72 | -53.32 | -53.10 | -13.00 | 40.10 |
| | 9 265.50 | V | 13.20 | 12.99 | -49.41 | -49.20 | -13.00 | 36.20 |

Test mode : WCDMA 1900Frequency(MHz) : 1 880.0Channel : 9400

| Mode | Frequency | Pol. | Antenna Gain | Cable loss | Substitute Level | Level | Limit | Margin |
|------|-----------|-------|--------------|------------|------------------|--------|--------|--------|
| | [MHz] | [V/H] | [dBi] | [dB] | [dBm] | [dBm] | [dBm] | [dB] |
| RMC | 3 762.50 | H | 8.51 | 8.29 | -49.32 | -49.10 | -13.00 | 36.10 |
| | 5 638.00 | V | 10.53 | 10.55 | -49.28 | -49.30 | -13.00 | 36.30 |
| | 7 519.50 | H | 12.12 | 11.79 | -53.53 | -53.20 | -13.00 | 40.20 |
| | 9 413.00 | H | 13.20 | 13.10 | -52.20 | -52.10 | -13.00 | 39.10 |

Test mode : WCDMA 1900Frequency(MHz) : 1 907.6Channel : 9538

| Mode | Frequency | Pol. | Antenna Gain | Cable loss | Substitute Level | Level | Limit | Margin |
|------|-----------|-------|--------------|------------|------------------|--------|--------|--------|
| | [MHz] | [V/H] | [dBi] | [dB] | [dBm] | [dBm] | [dBm] | [dB] |
| RMC | 3 816.00 | V | 8.53 | 8.38 | -50.15 | -50.00 | -13.00 | 37.00 |
| | 5 720.00 | V | 10.54 | 10.36 | -48.98 | -48.80 | -13.00 | 35.80 |
| | 7 635.00 | V | 12.23 | 11.88 | -51.85 | -51.50 | -13.00 | 38.50 |
| | 9 538.00 | V | 13.18 | 13.08 | -51.10 | -51.00 | -13.00 | 38.00 |

Note.

1. Limit Calculation(dBm)= 43 + 10log(P_[Watts])

2. Level(dBm) = Antenna gain(dBi) - Cable loss(dB) - Substitute level(dBm)

8. Measurement equipment

| Equipment Name | Manufacturer | Model No. | Serial No. | Next Cal. Date |
|-------------------------------------|-----------------------------|------------------------|-------------|----------------|
| Spectrum Analyzer | R&S | FSV30 | 100807 | 20.07.30 |
| Spectrum Analyzer | AGILENT | N9040B | MY57010132 | 20.07.31 |
| Vector Signal Generator | R&S | SMBV100A | 257566 | 20.07.16 |
| Signal Generator | R&S | SMR40 | 100007 | 21.04.08 |
| Signal Generator | R&S | SMB100A | 176206 | 21.01.21 |
| Wideband Radio Communication Tester | R&S | CMW500 | 141780 | 21.04.16* |
| Wideband Radio Communication Tester | R&S | CMW500 | 102572 | 20.09.19 |
| DC Power Supply | AGILENT | E3632A | KR73001026 | 21.04.09 |
| Power Divider | AGILENT | 11636B | 54456 | 21.01.06 |
| Temp & Humid Chamber | ESPEC CORP. | SH-661 | 92004048 | 21.01.03 |
| Biconical VHF-UHF Broadband Antenna | SCHWARZBECK | VUBA9117 | 275 | 22.04.09 |
| Bilog Antenna | Teseq GmbH | CBL 6143A | 35039 | 21.05.21 |
| Horn Antenna | ETS.lindgren | 3115 | 62589 | 20.08.01 |
| Horn Antenna | ETS.lindgren | 3117 | 161225 | 21.05.12* |
| Horn Antenna | ETS.lindgren | 3116 | 00086632 | 21.02.17 |
| Horn Antenna | ETS.lindgren | 3116 | 00086635 | 21.05.12* |
| High pass Filter | Wainwright Instruments GmbH | WHKX3.0/18G-12SS | 44 | 21.01.21 |
| High pass Filter | Wainwright Instruments GmbH | WHKX1.0/1.5S-10SS | 14 | 21.01.21 |
| Attenuator | Weinschel ENGINEERING | 10 | AJ1239 | 21.05.15* |
| Attenuator | API Inmet | 40AH2W-10 | 12 | 21.05.12* |
| Amplifier | SONOMA INSTRUMENT | 310N | 186280 | 21.01.21 |
| Amplifier | L-3 Narda-MITEQ | AMF-7D-01001800-22-10P | 2031196 | 21.02.12 |
| Amplifier | L-3 Narda-MITEQ | JS44-18004000-33-8P | 2000997 | 20.08.01 |
| Antenna Mast | MATURO | EAS 1.5 | 042/8941211 | N/A |
| Antenna Mast | MATURO | EAS 1.5 | 043/8941211 | N/A |
| Turn Table | MATURO | TT 0.8 PF | 041/8941211 | N/A |

*The equipment was used after finished calibration.

End of test report