

Straddle channel

1.4M BW QPSK Low ch. 1RB

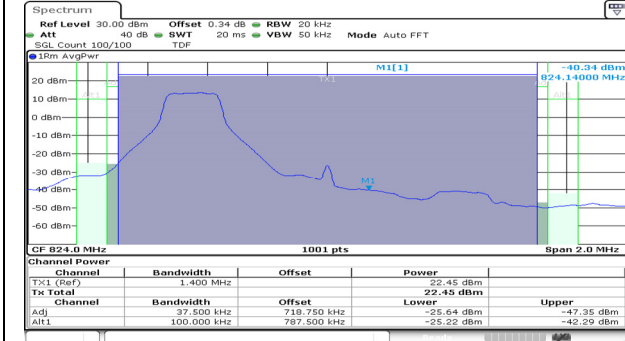

1.4M BW QPSK High ch. 1RB

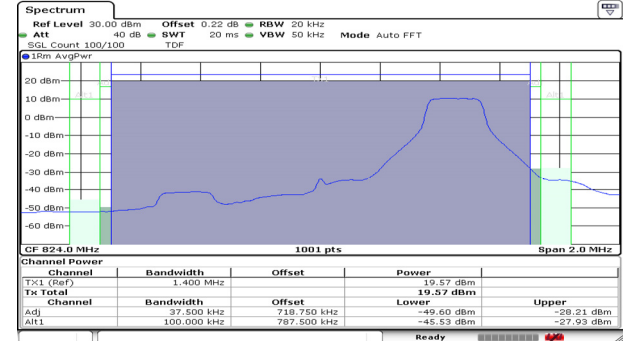

1.4M BW QPSK Low ch. FRB

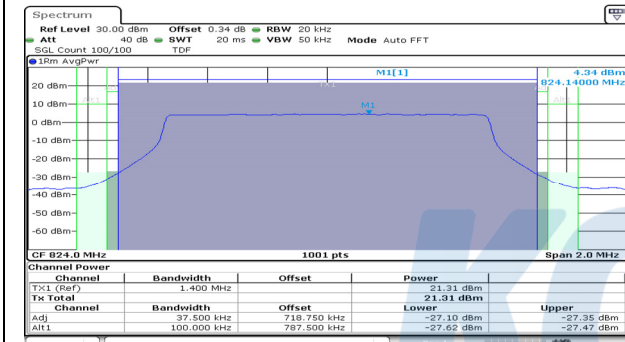

1.4M BW QPSK High ch. FRB

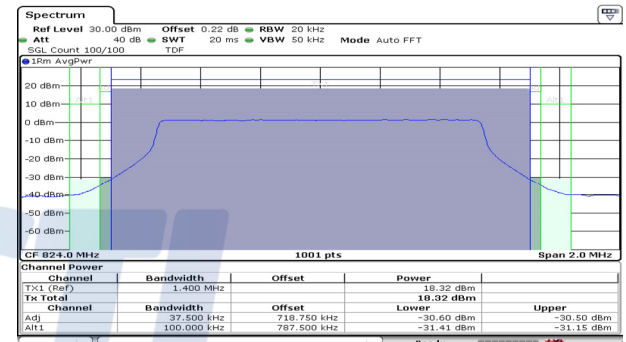

1.4M BW 16QAM Low ch. 1RB

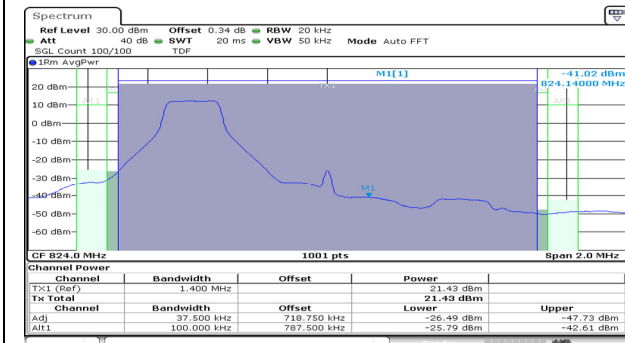

1.4M BW 16QAM High ch. 1RB

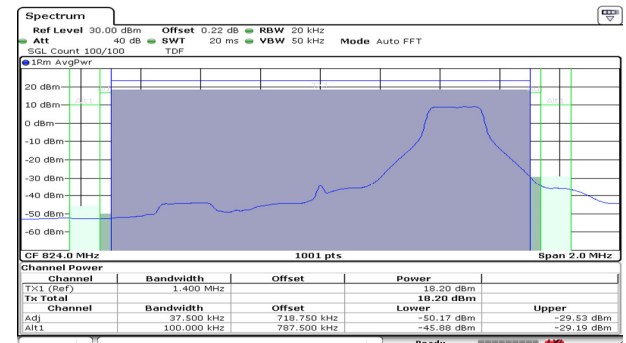

1.4M BW 16QAM Low ch. FRB

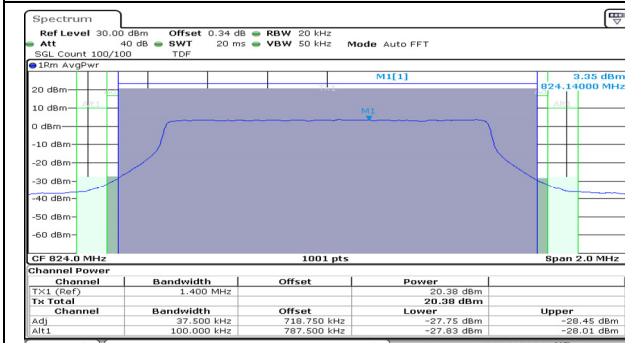

1.4M BW 16QAM High ch. FRB

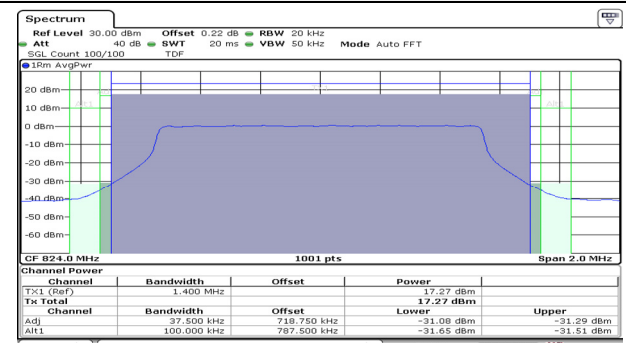

3M BW QPSK Low ch. 1RB

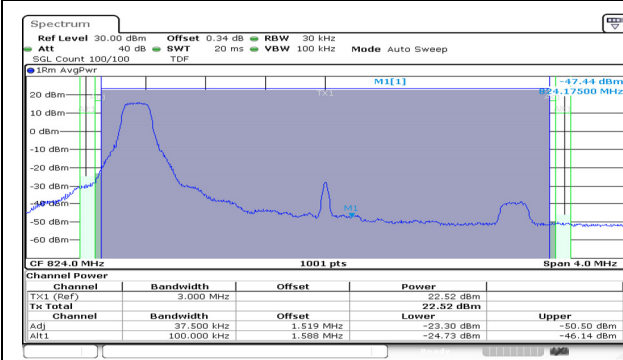

3M BW QPSK High ch. 1RB

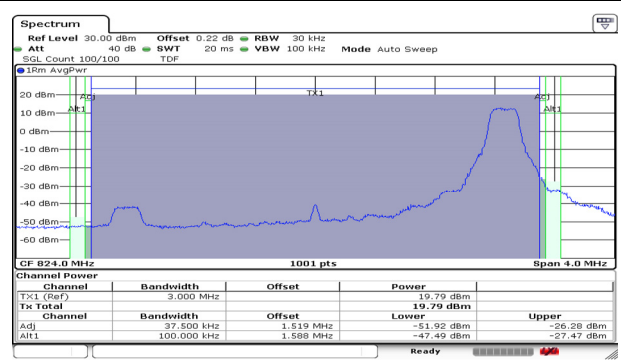

3M BW QPSK Low ch. FRB

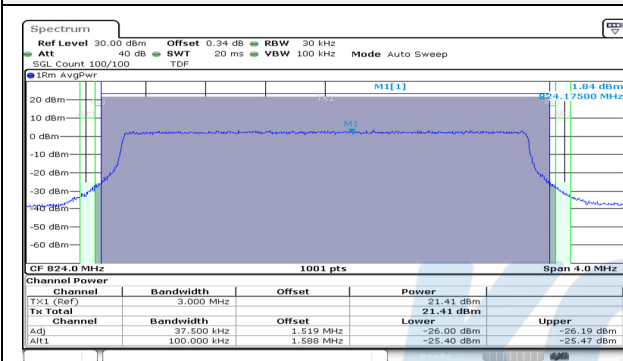

3M BW QPSK High ch. FRB

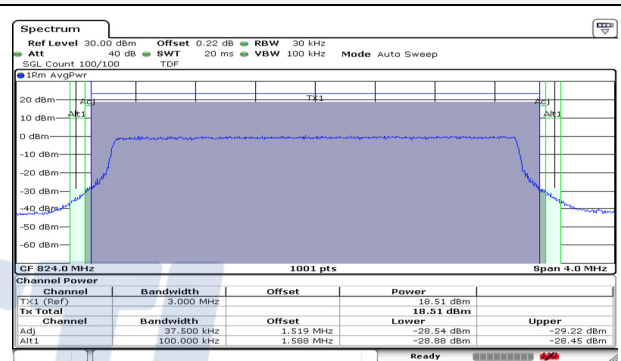

3M BW 16QAM Low ch. 1RB

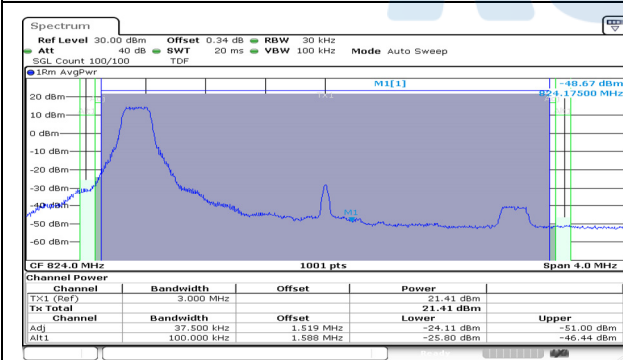

3M BW 16QAM High ch. 1RB

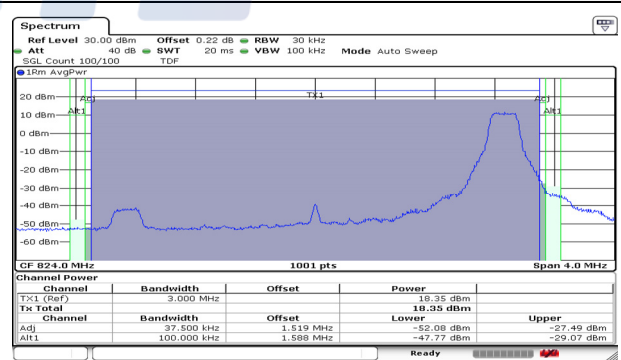

3M BW 16QAM Low ch. FRB

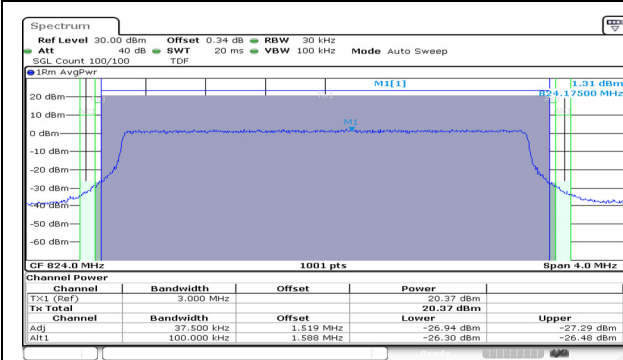

3M BW 16QAM High ch. FRB

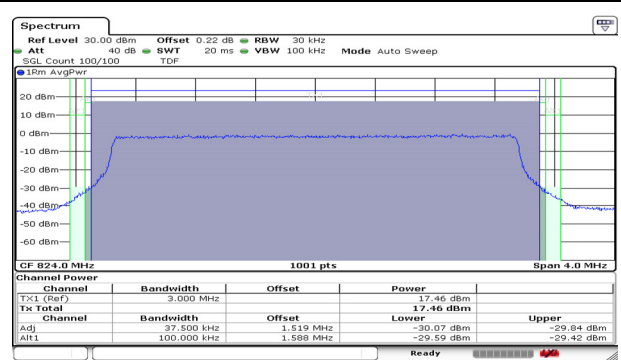

5M BW QPSK Low ch. 1RB

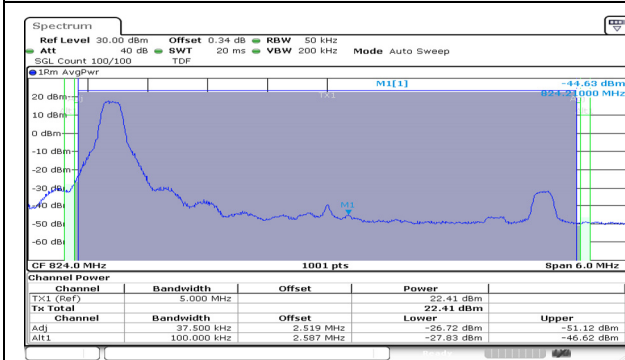

5M BW QPSK High ch. 1RB

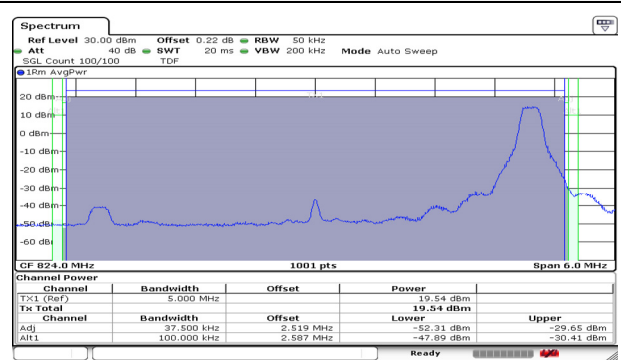

5M BW QPSK Low ch. FRB

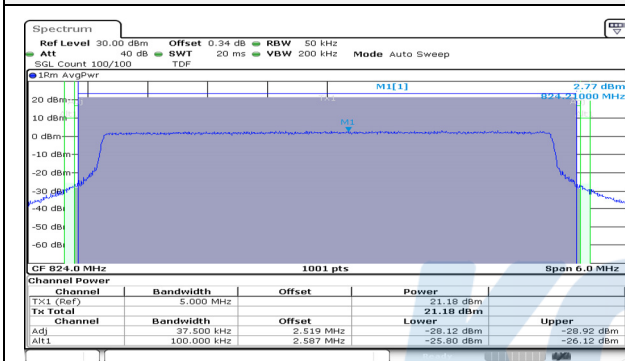

5M BW QPSK High ch. FRB

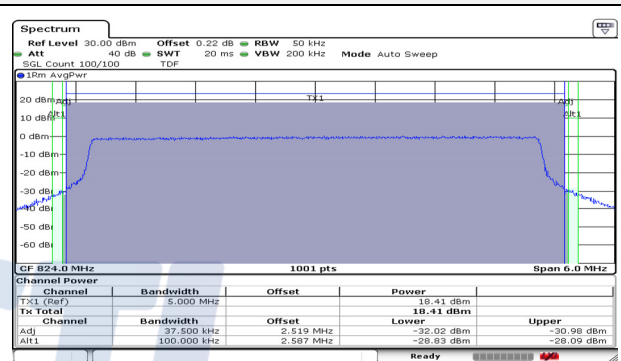

5M BW 16QAM Low ch. 1RB

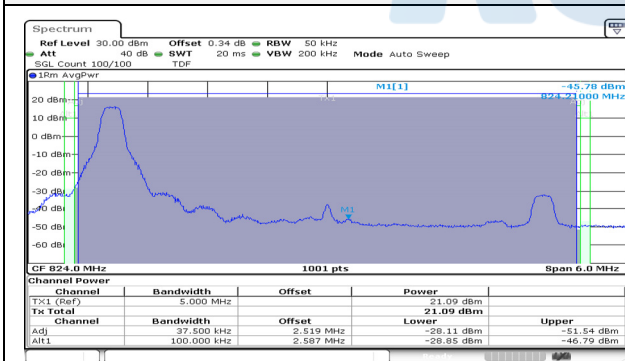

5M BW 16QAM High ch. 1RB

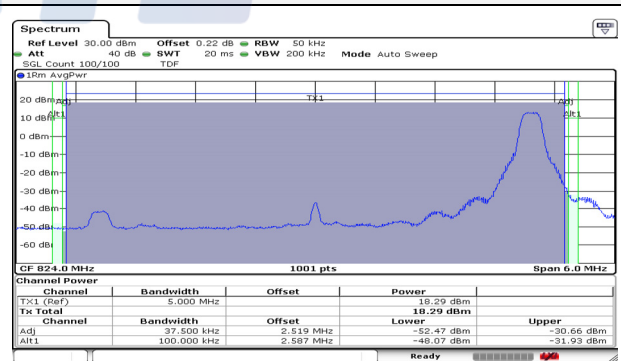

5M BW 16QAM Low ch. FRB

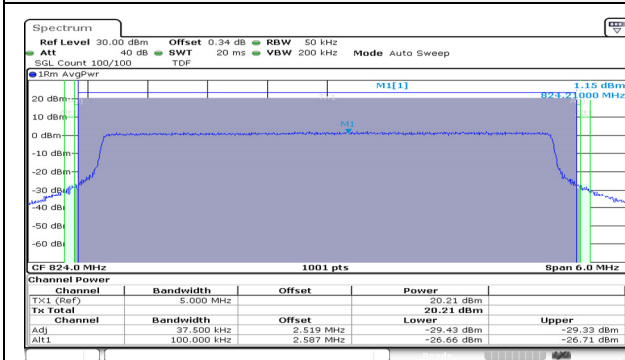

5M BW 16QAM High ch. FRB

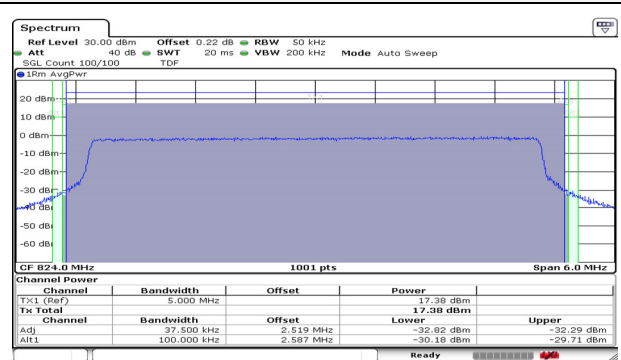

10M BW QPSK Mid ch. Lower 1RB

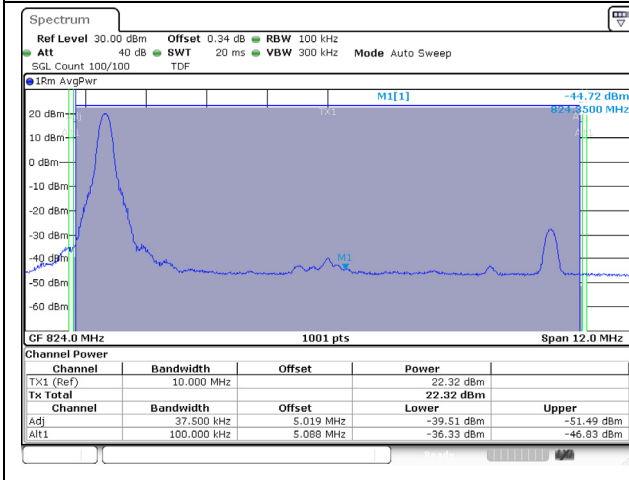

10M BW 16QAM Mid ch. Lower 1RB

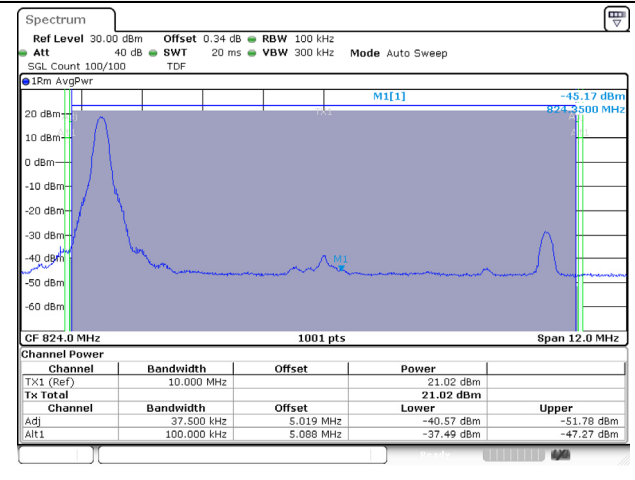

10M BW QPSK Mid ch. Upper 1RB

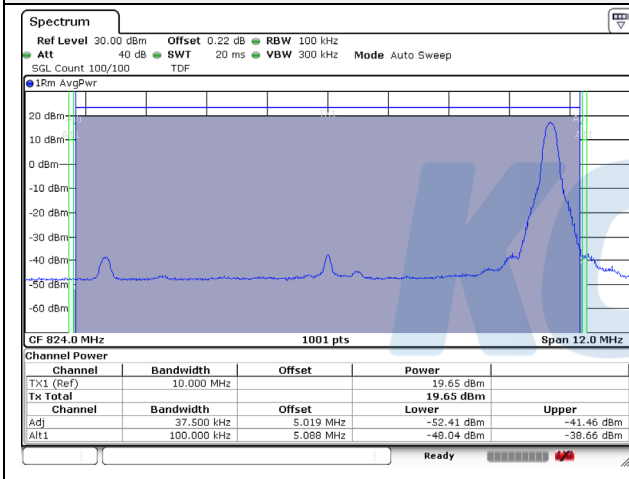

10M BW 16QAM Mid ch. Upper 1RB

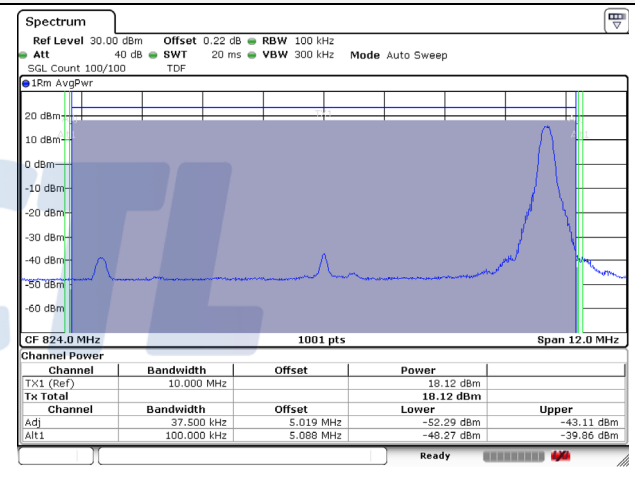

10M BW QPSK Mid ch. FRB

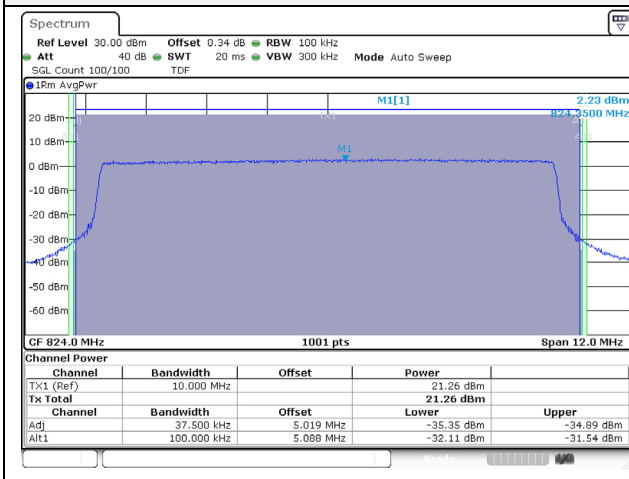

10M BW 16QAM Mid ch. FRB

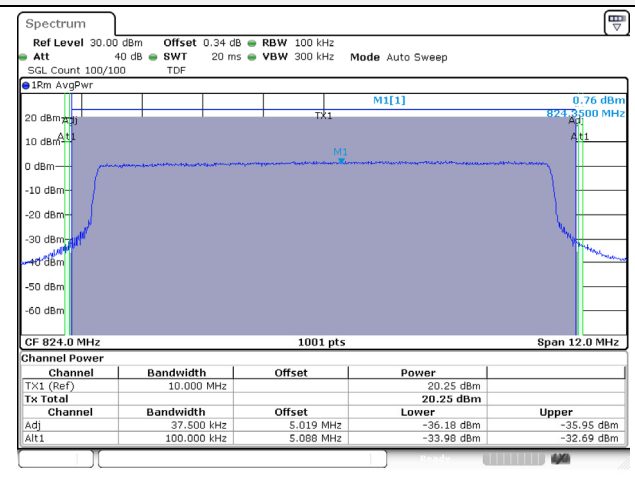

15M BW QPSK Mid ch. Lower 1RB

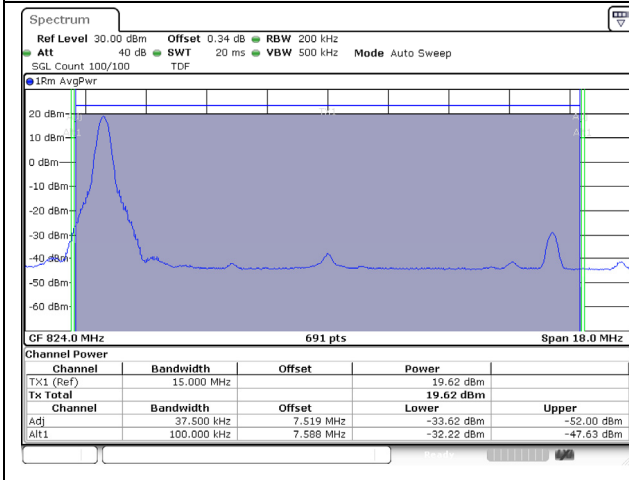

15M BW 16QAM Mid ch. Lower 1RB

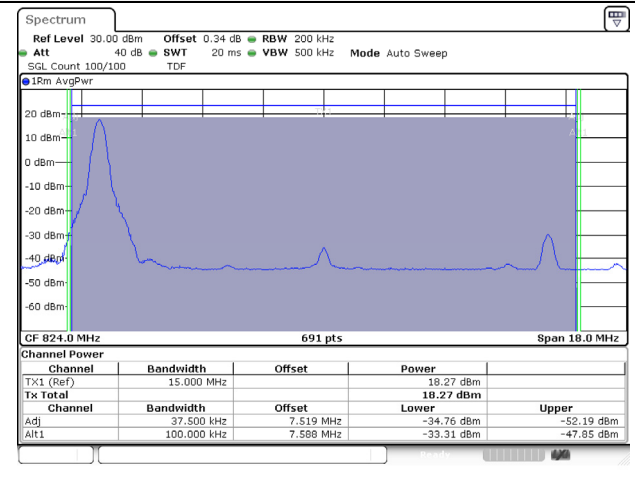

15M BW QPSK Mid ch. Upper 1RB

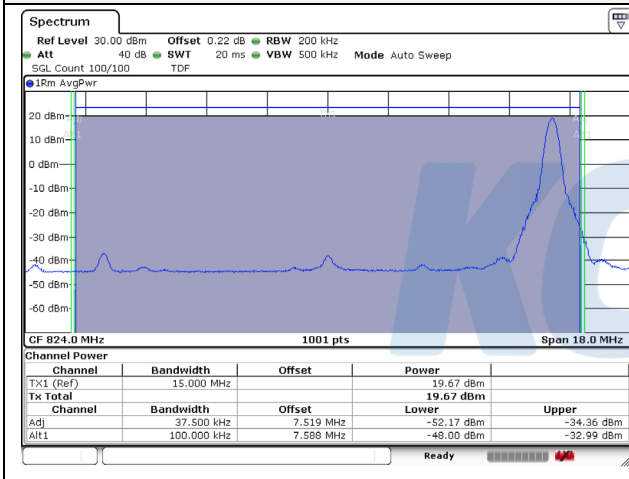

15M BW 16QAM Mid ch. Upper 1RB

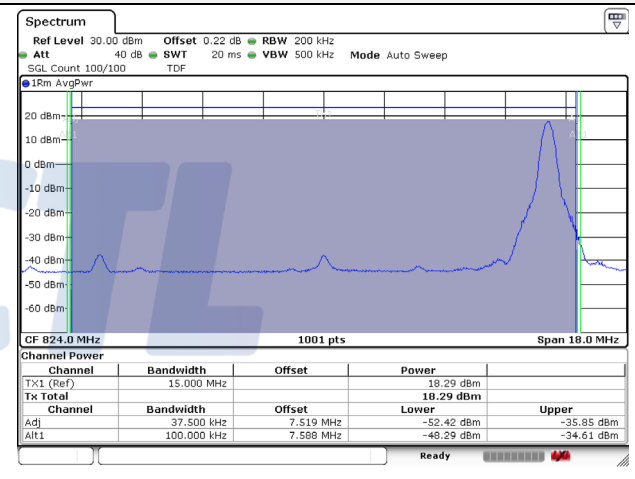

15M BW QPSK Mid ch. FRB

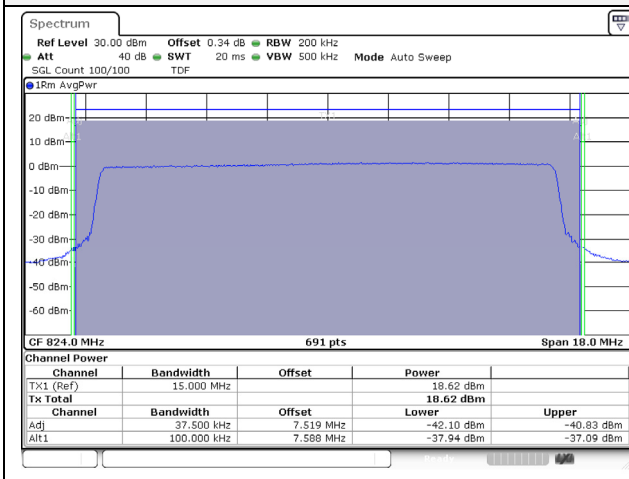

15M BW 16QAM Mid ch. FRB

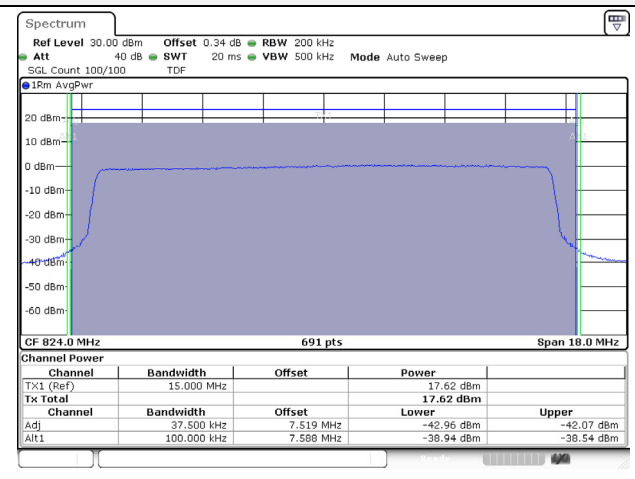

7.5. Frequency stability

Test setup

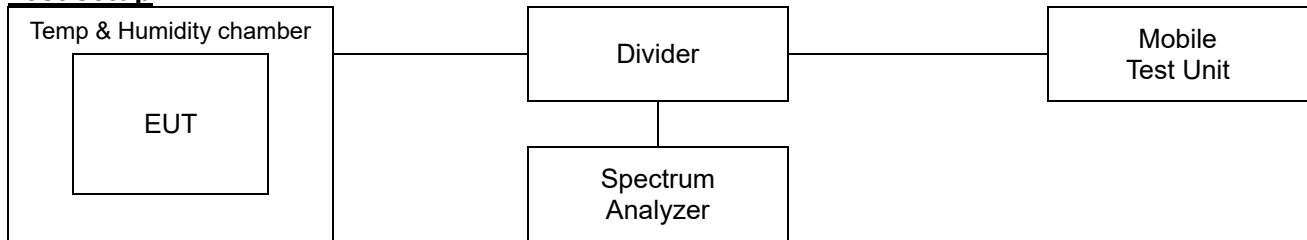

Limit

According to §2.1055(a),

The frequency stability shall be measured with variation of ambient temperature as follows:

- 1) From -30° to $+50^{\circ}$ centigrade for all equipment except that specified in paragraphs (a) (2) and (3) of this section.
- 2) From -20° to $+50^{\circ}$ centigrade for equipment to be licensed for use in the maritime services under part 80 of this chapter, except for class A, B, and S emergency position indicating radiobeacons (EPIRBS), and equipment to be licensed for use above 952 MHz at operational fixed stations in all services, stations in the local television transmission service and point-to-point microwave radio service under part 21 of this chapter, equipment licensed for use aboard aircraft in the aviation services under part 87 of this chapter, and equipment authorized for use in the family radio service under part 95 of this chapter.
- 3) From 0° to $+50^{\circ}$ centigrade for equipment to be licensed for use in the radio broadcast Services under part 73 of this chapter.

According to §2.1055(d),

The frequency stability shall be measured with variation of primary supply Voltage as follows:

- 1) Vary primary supply voltage from 85 to 115 percent of the nominal value for other than hand carried battery equipment.
- 2) For hand carried, battery powered equipment, reduce primary supply voltage to the battery operating and point which shall be specified by the manufacturer.
- 3) The supply voltage shall be measured at the input to the cable normally provided with the equipment, or at the power supply terminals if cables are not normally provided. Effects on frequency of transmitter keying (except for broadcast transmitters) and any heating element cycling at the nominal supply voltage and at each extreme also shall be shown.

According to §90.213

For mobile devices operating in the 809 to 824 MHz band at a power level 2 Watts or less, the limit specified in Table is ± 2.5 ppm.

Test procedure

ANSI 63.26-2015 – Section 5.6

Test settings

- 1) The carrier frequency of the transmitter is measured at room temperature. (20°C to provide a reference)
- 2) The equipment is turned on in a “standby” condition for one minute before applying power to the transmitter. Measurement of the carrier frequency of the transmitter is made within one minute after applying power to the transmitter.
- 3) Frequency measurements are made at 10°C intervals ranging from -30°C to +50°C. A period of at least one half-hour is provided to allow stabilization of the equipment at each Temperature level.

KCTL

Test results

Test mode : LTE Band 26
 Frequency (Hz) : 819 000 000
 Channel : 26740
 Deviation limit(FCC) : ±0.00025% or 2.5ppm

Voltage (%)	Power (V)	Temp. (°C)	Frequency (Hz)	Frequency error (Hz)	Deviation	
					(ppm)	(%)
100%	3.85	+22(Ref)	818,999,999	-0.70	0.0	0.000000
		-30	818,999,997	-3.15	0.0	0.000000
		-20	818,999,997	-2.98	0.0	0.000000
		-10	818,999,997	-2.70	0.0	0.000000
		0	818,999,998	-2.50	0.0	0.000000
		+10	818,999,998	-2.29	0.0	0.000000
		+20	818,999,998	-1.66	0.0	0.000000
		+30	819,000,000	-0.24	0.0	0.000000
		+40	818,999,998	-1.55	0.0	0.000000
		+50	818,999,998	-2.30	0.0	0.000000
115%	4.43	+22(Ref)	818,999,999	-0.87	0.0	0.000000
End point	3.55	+22(Ref)	818,999,999	-0.96	0.0	0.000000

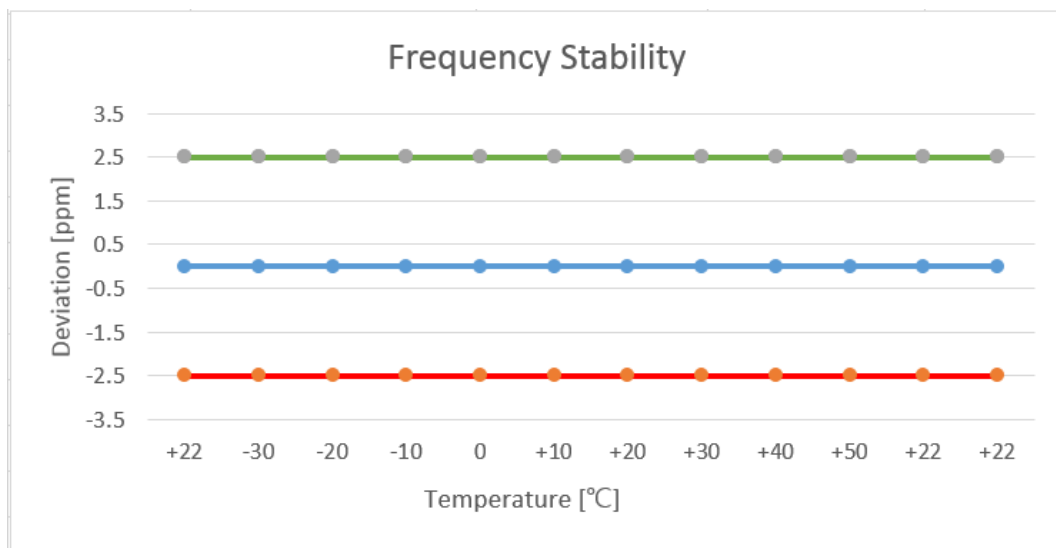

7.6. Radiated Power (ERP/EIRP)

Test setup

The diagram below shows the test setup that is utilized to make the measurements for emission from 30 MHz to 1 GHz emissions.

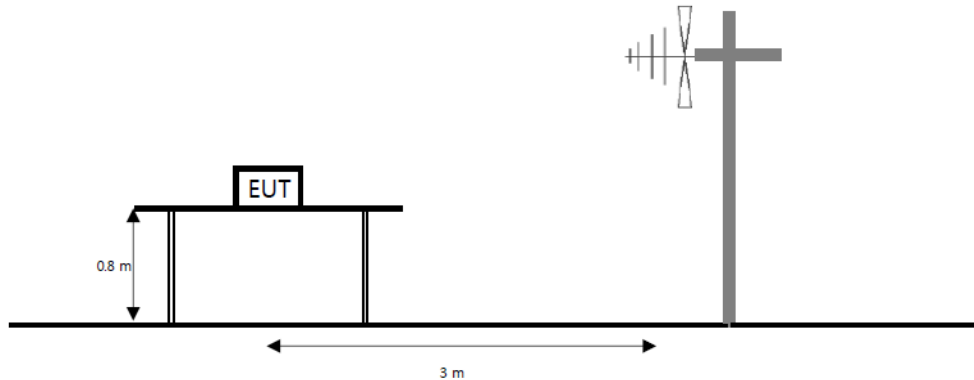

The diagram below shows the test setup that is utilized to make the measurements for emission from 1 GHz to the tenth harmonic of the highest fundamental frequency or to 40 GHz emissions, whichever is lower.

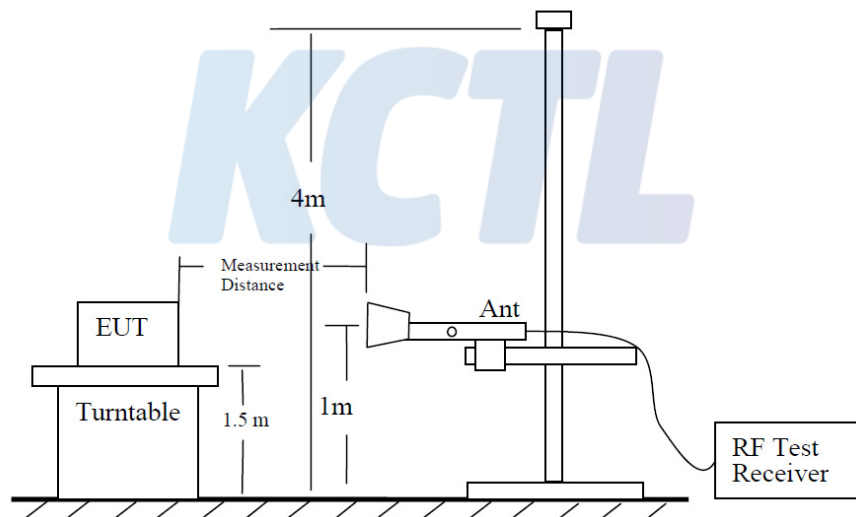

The diagram below shows the test setup for substituted method.

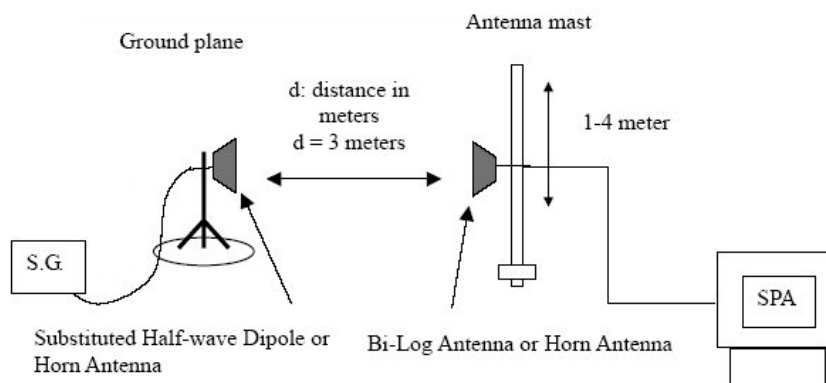

Limit

According to §90.635(b), the maximum output power of the transmitter for mobile stations is 100 watts(20 dBw).

Test procedure

971168 D01 v03r01 - Section 5.2 and 5.8

ANSI 63.26-2015 – Section 5.2

ANSI/TIA-603-E-2016 - Section 2.2.17

Test settings

- 1) RBW = 1 % to 5 % of the OBW.
- 2) VBW $\geq 3 \times$ RBW.
- 3) SPAN = 2 \times to 3 \times the OBW.
- 4) Number of measurement points in sweep $\geq 2 \times$ span / RBW.
- 5) Sweep time :
 - 1) Auto couple, or
 - 2) $\geq [10 \times (\text{number of points in sweep}) \times (\text{transmission period})]$ for single sweep (automation-compatible) measurement. Transmission period is the on and off time of the transmitter.
- 6) Detector = RMS
- 7) If the EUT can be configured to transmit continuously, then set the trigger to free run.
- 8) If the EUT cannot be configured to transmit continuously, then use a sweep trigger with the level set to enable triggering only on full power bursts and configure the EUT to transmit at full power for the entire duration of each sweep. Verify that the sweep time is less than or equal to the transmission burst duration. Time gating can also be used under similar constraints (i.e., configured such that measurement data is collected only during active full-power transmissions).
- 9) Trace mode = trace averaging (RMS) over 100 sweeps.
- 10) Compute the power by integrating the spectrum across the OBW of the signal using the instrument's band or channel power measurement function, with the band/channel limits set equal to the OBW band edges. If the instrument does not have a band or channel power function, then sum the spectrum levels (in linear power units) at intervals equal to the RBW extending across the entire OBW of the spectrum.
- 11) Allow trace to fully stabilize.

Notes:

1. On a test site, the EUT shall be placed at 80 cm height on a turn table, and in the position close To normal use as declared by the applicant.
2. The test antenna shall be oriented initially for vertical polarization located 3 m from EUT to Correspond to the fundamental frequency of the transmitter.
3. The turntable is rotated through 360°, and the receiving antenna scans in order to determine the Level of the maximized emission.
4. The test antenna shall be raised and lowered again through the specified range of height until the maximum signal level is detected by the measuring receiver.
5. The maximum signal level detected by the measuring receiver shall be noted.
6. The EUT was replaced by half-wave dipole (1 GHz below) or horn antenna (1 GHz above) connected to a signal generator.
The power is calculated by the following formula;
$$Pd(\text{dBm}) = Pg(\text{dBm}) - \text{Cable loss (dB)} + \text{Antenna gain (dB)}$$

Note. Pd is the dipole equivalent power and Pg is the generator output power into the substitution antenna.
7. The test antenna shall be raised and lowered through the specified range of height to ensure that The maximum signal is received.
8. The input signal to the substitution antenna shall be adjusted to the level that produces a level Detected by the measuring corrected for the change of input attenuator setting of the measuring Receiver.
9. The input level to the substitution antenna shall be recorded as power level in dBm, corrected for Any change of input attenuator setting of the measuring receiver.
10. The measurement shall be repeated with the test antenna and the substitution antenna Orientated for horizontal polarization.

Test results**Test mode: LTE Band 26**

Bandwidth	Modulation	Frequency	Pol.	Antenna Gain	C.L	Substitute Level	ERP	
		[MHz]	[V/H]	[dBi]	[dB]	[dBm]	[dBm]	[W]
1.4 M	QPSK	814.7	H	0.40	4.97	17.20	12.63	0.018
		823.3	H	-0.30	5.05	17.92	12.57	0.018
	16QAM	814.7	H	0.40	4.97	15.82	11.25	0.013
		823.3	H	-0.30	5.05	16.63	11.28	0.013
3 M	QPSK	815.5	H	0.40	4.99	17.30	12.71	0.019
		822.5	H	-0.30	5.03	17.84	12.51	0.018
	16QAM	815.5	H	0.40	4.99	16.18	11.59	0.014
		822.5	H	-0.30	5.03	16.52	11.19	0.013
5 M	QPSK	816.5	H	0.40	4.97	17.52	12.95	0.020
		821.5	H	-0.30	5.04	17.58	12.24	0.017
	16QAM	816.5	H	0.40	4.97	16.11	11.54	0.014
		821.5	H	-0.30	5.04	16.24	10.90	0.012
10 M	QPSK	819.0	H	-0.30	5.01	18.22	12.91	0.020
	16QAM	819.0	H	-0.30	5.01	16.92	11.61	0.014
15 M	QPSK	821.5	H	-0.30	5.04	18.36	13.02	0.020
	16QAM	821.5	H	-0.30	5.04	16.92	11.58	0.014

Straddle channel

Bandwidth	Modulation	Frequency	Pol.	Antenna Gain	C.L	Substitute Level	ERP	
		[MHz]	[V/H]	[dBi]	[dB]	[dBm]	[dBm]	[W]
1.4 M	QPSK	824	H	-0.30	5.06	18.06	12.70	0.019
	16QAM		H	-0.30	5.06	16.77	11.41	0.014
3 M	QPSK		H	-0.30	5.06	17.89	12.53	0.018
	16QAM		H	-0.30	5.06	16.27	10.91	0.012
5 M	QPSK		H	-0.30	5.06	18.11	12.75	0.019
	16QAM		H	-0.30	5.06	17.00	11.64	0.015
10 M	QPSK		H	-0.30	5.06	18.28	12.92	0.020
	16QAM		H	-0.30	5.06	17.18	11.82	0.015
15 M	QPSK		H	-0.30	5.06	19.13	13.77	0.024
	16QAM		H	-0.30	5.06	17.54	12.18	0.017

Note.

1. E.R.P & E.I.R.P(dBm) = Substitute Level(dB) + Antenna gain(dBi) - C.L(Cable loss) (dB)

7.7. Radiated Spurious Emissions

Test setup

The diagram below shows the test setup that is utilized to make the measurements for emission from 30 MHz to 1 GHz emissions.

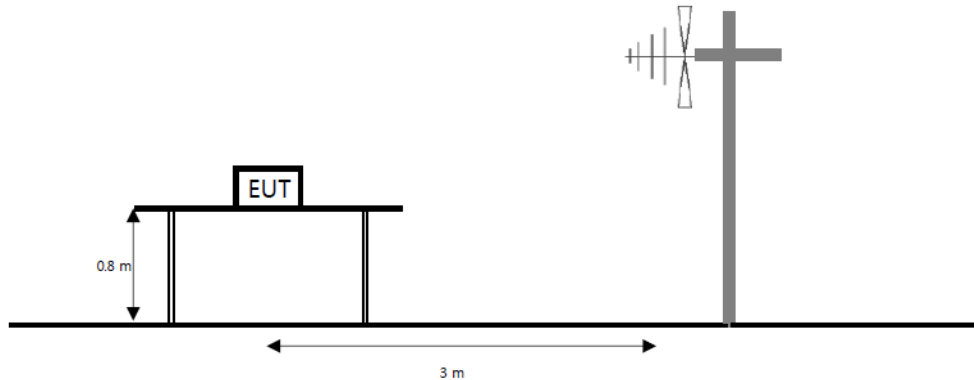

The diagram below shows the test setup that is utilized to make the measurements for emission from 1 GHz to the tenth harmonic of the highest fundamental frequency or to 40 GHz emissions, whichever is lower.

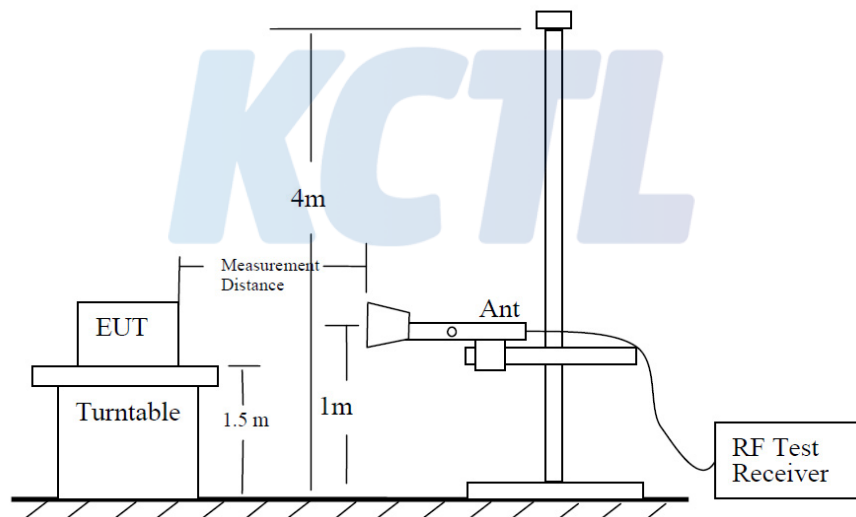

The diagram below shows the test setup for substituted method.

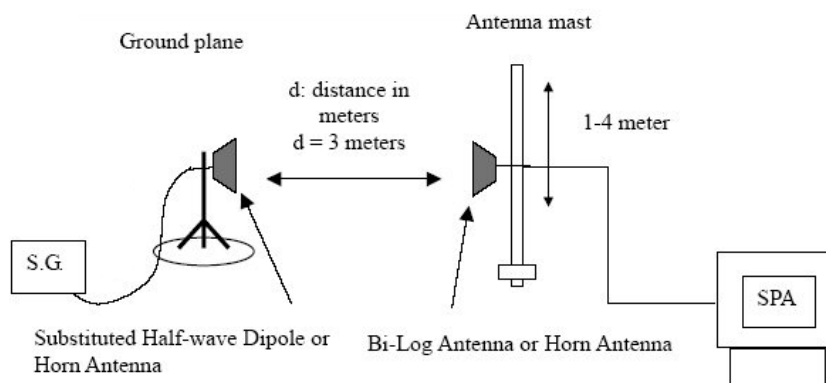

Limit

According to §90.691(a), Out-of-band emission requirement shall apply only to the “outer” channels included in an EA license and to spectrum adjacent to interior channels used by incumbent licensees. The emission limits are as follows:

(1) For any frequency removed from the EA licensee’s frequency block by up to and including 37.5 kHz, the power of any emission shall be attenuated below the transmitter power (P) in watts by at least $116 \log_{10}(f/6.1)$ decibels or $50 + 10\log_{10}(P)$ decibels or 80 decibels, whichever is the lesser attenuation, where f is the frequency removed from the center of the outer channel in the block in kilohertz where f is greater than 12.5 kHz.

(2) For any frequency removed from the EA licensee’s frequency block greater than 37.5 kHz, the power of any emission shall be attenuated below the transmitter power (P) in watts by at least $43 + 10\log_{10}(P)$ decibels or 80 decibels, whichever is the lesser attenuation, where f is the frequency removed from the center of the outer channel in the block in kilohertz and where f is greater than 37.5 kHz.

Test procedure

971168 D01 v03r01 - Section 6.2

ANSI 63.26-2015 – Section 5.5

ANSI/TIA-603-E-2016 - Section 2.2.12

Test settings

- 1) RBW = 1 kHz for below 1 GHz and 1 MHz for above 1 GHz.
- 2) VBW $\geq 3 \times$ RBW.
- 3) Detector = RMS
- 4) Trace mode = Max hold
- 5) Sweep time = Auto couple
- 6) Number of sweep points $\geq 2 \times$ span / RBW
- 7) Allow trace to fully stabilize.

Notes:

1. On a test site, the EUT shall be placed at 80 cm height on a turn table, and in the position close to normal use as declared by the applicant.
2. The test antenna shall be oriented initially for vertical polarization located 3 m from EUT to correspond to the fundamental frequency of the transmitter.
3. The turntable is rotated through 360°, and the receiving antenna scans in order to determine the level of the maximized emission.
4. The test antenna shall be raised and lowered again through the specified range of height until the maximum signal level is detected by the measuring receiver.
5. The maximum signal level detected by the measuring receiver shall be noted.
6. The EUT was replaced by half-wave dipole (1 GHz below) or horn antenna (1 GHz above) connected to a signal generator.
7. The test antenna shall be raised and lowered through the specified range of height to ensure that the maximum signal is received.
8. The input signal to the substitution antenna shall be adjusted to the level that produces a level detected by the measuring corrected for the change of input attenuator setting of the measuring receiver.
9. The input level to the substitution antenna shall be recorded as power level in dBm, corrected for any change of input attenuator setting of the measuring receiver.
10. The measurement shall be repeated with the test antenna and the substitution antenna orientated for horizontal polarization.

Test results (Above 1 000 MHz)Test mode : LTE Band 26Frequency(MHz) : 821.5Channel : 26765Bandwidth(MHz) : 115

Mode	Frequency	Pol.	Antenna Gain	Cable loss	Substitute Level	Level	Limit	Margin
	[MHz]	[V/H]	[dBi]	[dB]	[dBm]	[dBm]	[dBm]	[dB]
QPSK	1 656.27	H	6.13	5.34	-48.59	-47.80	-13.00	34.80
	2 484.27	H	5.39	6.52	-56.97	-58.10	-13.00	45.10
	3 515.20	V	8.41	7.93	-58.58	-58.10	-13.00	45.10
	4 140.80	V	8.49	8.70	-50.09	-50.30	-13.00	37.30

Test mode : LTE Band 26Frequency(MHz) : 824.0Channel : 26790Bandwidth(MHz) : 15

Mode	Frequency	Pol.	Antenna Gain	Cable loss	Substitute Level	Level	Limit	Margin
	[MHz]	[V/H]	[dBi]	[dB]	[dBm]	[dBm]	[dBm]	[dB]
QPSK	1 648.27	V	6.16	5.36	-53.20	-52.40	-13.00	39.40
	2 472.00	H	5.38	6.50	-55.88	-57.00	-13.00	44.00
	3 297.07	H	8.16	7.62	-58.84	-58.30	-13.00	45.30
	4 121.07	V	8.50	8.68	-47.02	-47.20	-13.00	34.20

Note.

1. Limit Calculation(dBm)= 43 + 10log(P_{Watts})

8. Measurement equipment

Equipment Name	Manufacturer	Model No.	Serial No.	Next Cal. Date
Spectrum Analyzer	R&S	FSV30	100807	20.07.30
Spectrum Analyzer	AGILENT	N9040B	MY57010132	20.07.31
Vector Signal Generator	R&S	SMBV100A	257566	20.07.16
Signal Generator	R&S	SMR40	100007	21.04.08
Signal Generator	R&S	SMB100A	176206	21.01.21
Wideband Radio Communication Tester	R&S	CMW500	141780	21.04.16*
Wideband Radio Communication Tester	R&S	CMW500	102572	20.09.19
DC Power Supply	AGILENT	E3632A	KR73001026	21.04.09
Power Divider	AGILENT	11636B	54456	21.01.06
Temp & Humid Chamber	ESPEC CORP.	SH-661	92004048	21.01.03
Biconical VHF-UHF Broadband Antenna	SCHWARZBECK	VUBA9117	275	22.04.09
Bilog Antenna	Teseq GmbH	CBL 6143A	35039	21.05.21
Horn Antenna	ETS.lindgren	3115	62589	20.08.01
Horn Antenna	ETS.lindgren	3117	161225	21.05.12*
Horn Antenna	ETS.lindgren	3116	00086632	21.02.17
Horn Antenna	ETS.lindgren	3116	00086635	21.05.12*
High pass Filter	Wainwright Instruments GmbH	WHKX3.0/18G-12SS	44	21.01.21
High pass Filter	Wainwright Instruments GmbH	WHKX1.0/1.5S-10SS	14	21.01.21
Attenuator	Weinschel ENGINEERING	10	AJ1239	21.05.15*
Attenuator	API Inmet	40AH2W-10	12	21.05.12*
Amplifier	SONOMA INSTRUMENT	310N	186280	21.01.21
Amplifier	L-3 Narda-MITEQ	AMF-7D-01001800-22-10P	2031196	21.02.12
Amplifier	L-3 Narda-MITEQ	JS44-18004000-33-8P	2000997	20.08.01
Antenna Mast	MATURO	EAS 1.5	042/8941211	N/A
Antenna Mast	MATURO	EAS 1.5	043/8941211	N/A
Turn Table	MATURO	TT 0.8 PF	041/8941211	N/A

*The equipment was used after finished calibration.

End of test report