

5M BW QPSK Low ch. 1RB

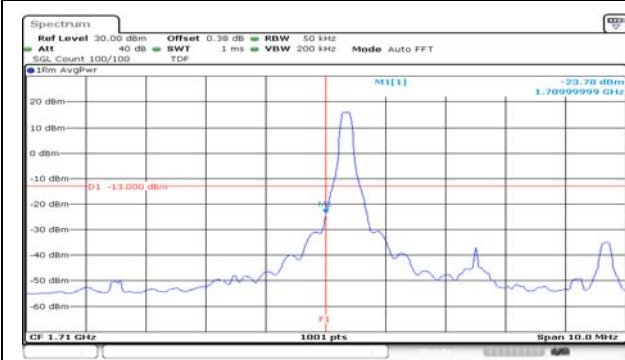

5M BW QPSK High ch. 1RB



5M BW QPSK Low ch. FRB



5M BW QPSK High ch. FRB



5M BW 16QAM Low ch. 1RB



5M BW 16QAM High ch. 1RB



5M BW 16QAM Low ch. FRB



5M BW 16QAM High ch. FRB



10M BW QPSK Low ch. 1RB

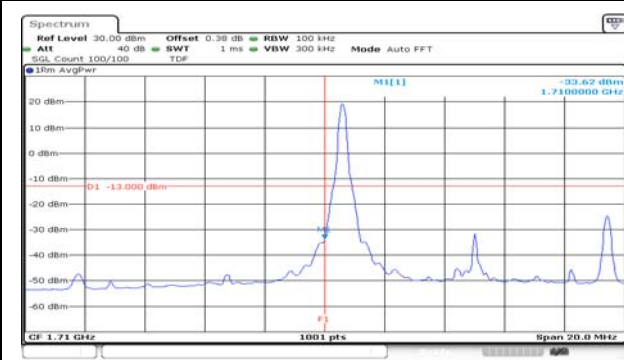

10M BW QPSK High ch. 1RB

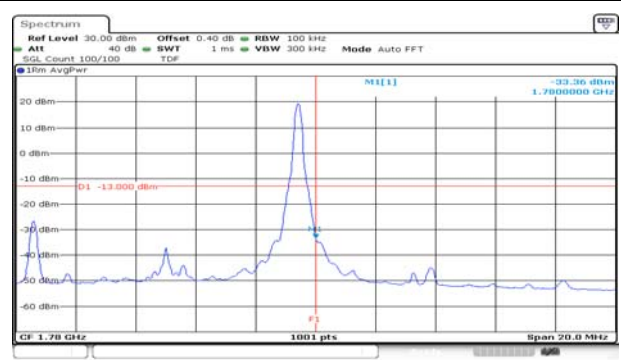

10M BW QPSK Low ch. FRB



10M BW QPSK High ch. FRB



10M BW 16QAM Low ch. 1RB

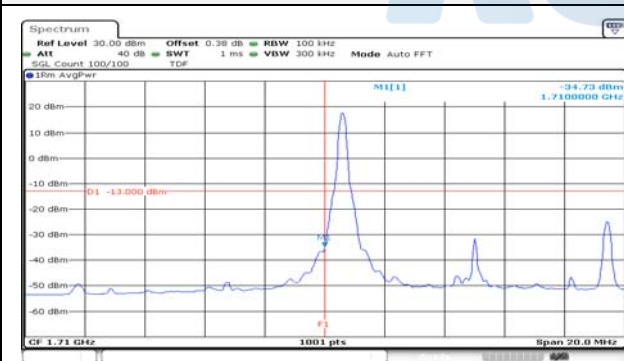

10M BW 16QAM High ch. 1RB

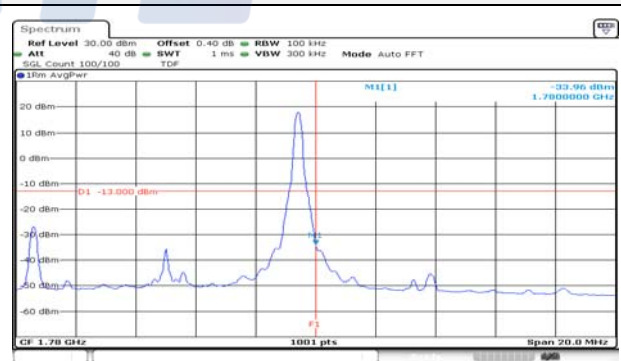

10M BW 16QAM Low ch. FRB

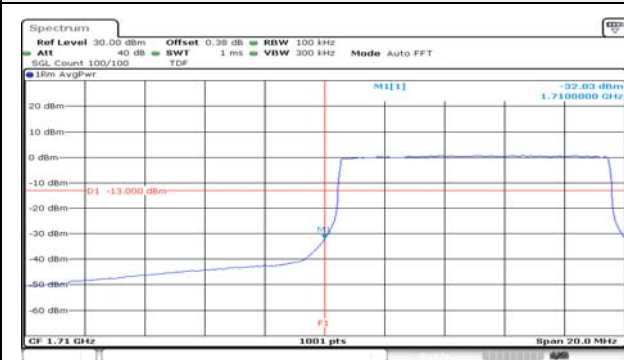

10M BW 16QAM High ch. FRB



15M BW QPSK Low ch. 1RB

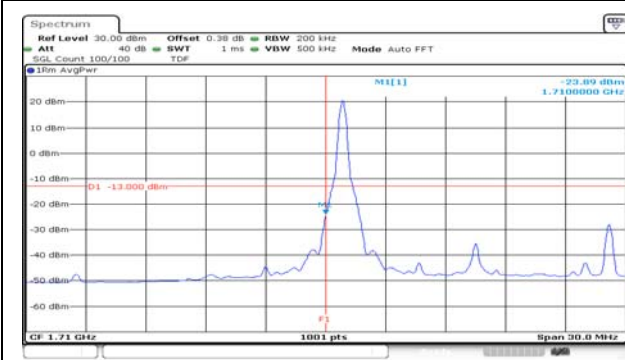

15M BW QPSK High ch. 1RB

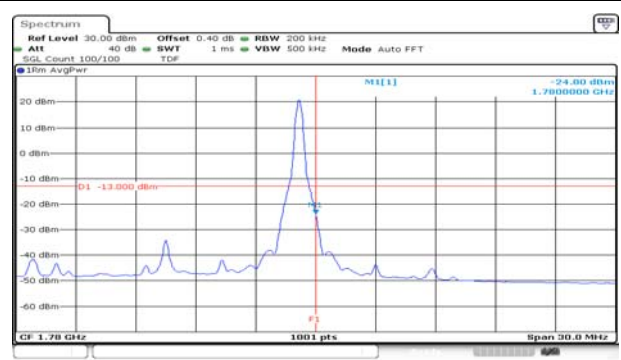

15M BW QPSK Low ch. FRB



15M BW QPSK High ch. FRB



15M BW 16QAM Low ch. 1RB

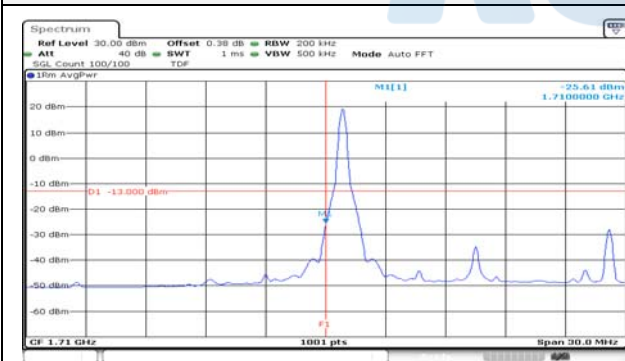

15M BW 16QAM High ch. 1RB

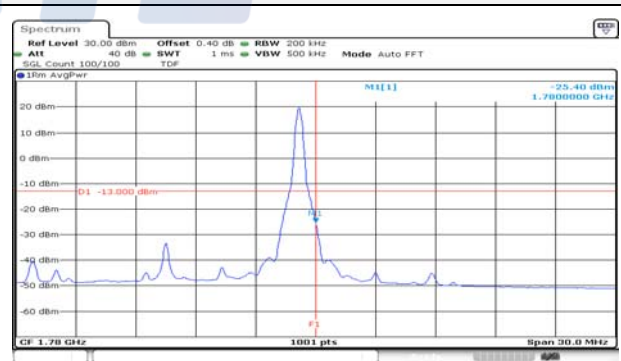

15M BW 16QAM Low ch. FRB

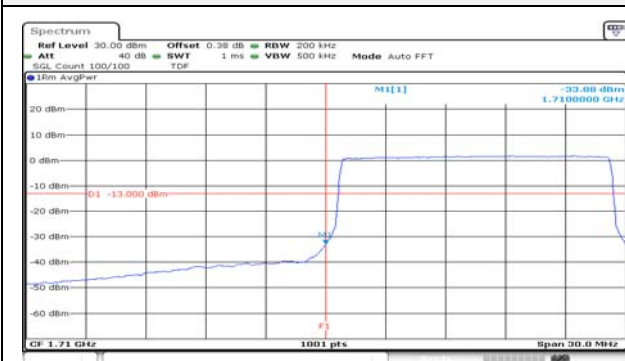

15M BW 16QAM High ch. FRB

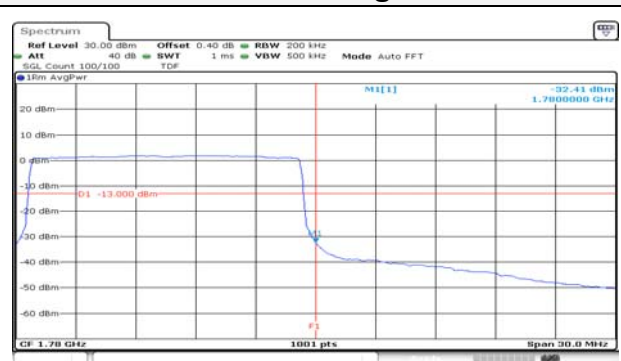

20M BW QPSK Low ch. 1RB

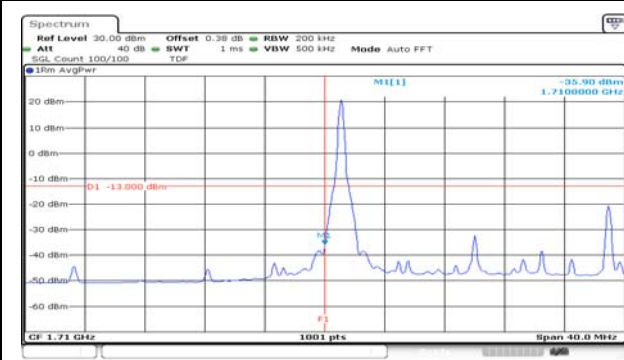

20M BW QPSK High ch. 1RB

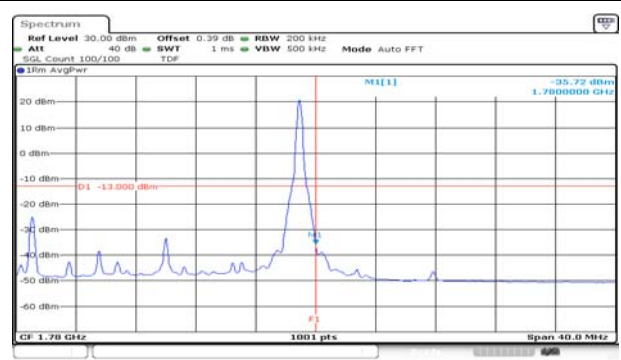

20M BW QPSK Low ch. FRB



20M BW QPSK High ch. FRB



20M BW 16QAM Low ch. 1RB

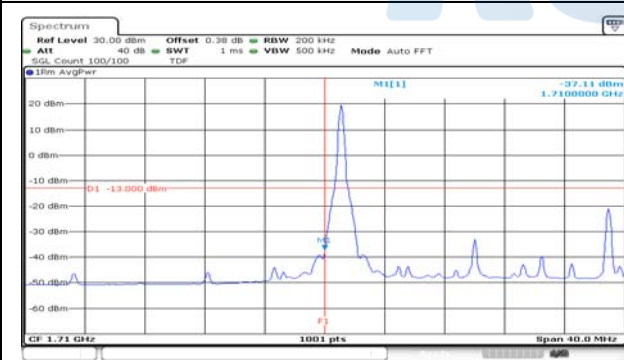

20M BW 16QAM High ch. 1RB

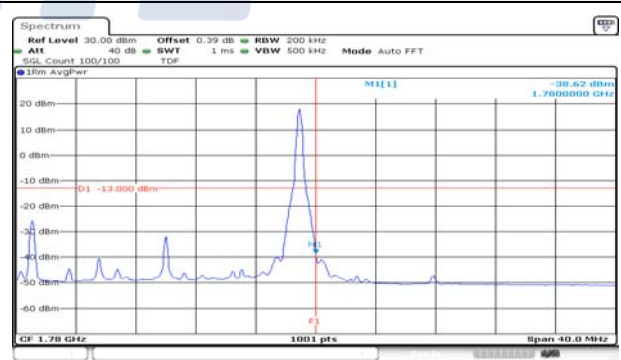

20M BW 16QAM Low ch. FRB



20M BW 16QAM High ch. FRB



Test mode: LTE Band 71

5M BW QPSK Low ch. 1RB

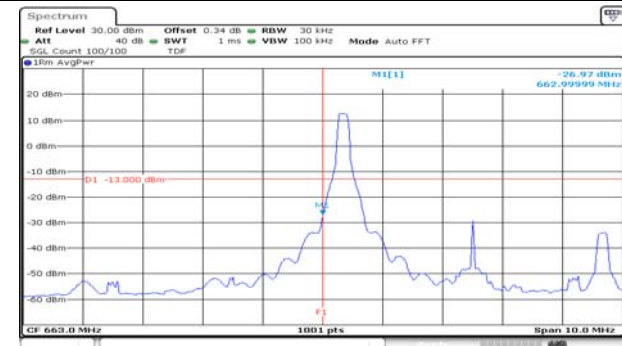

5M BW QPSK High ch. 1RB

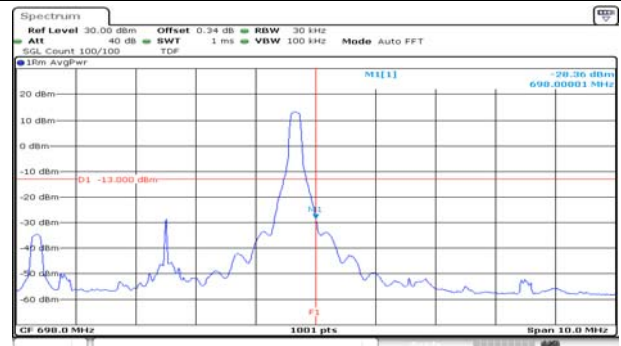

5M BW QPSK Low ch. FRB



5M BW QPSK High ch. FRB

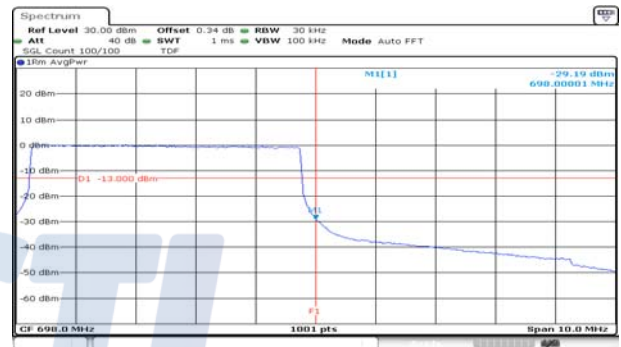

5M BW 16QAM Low ch. 1RB

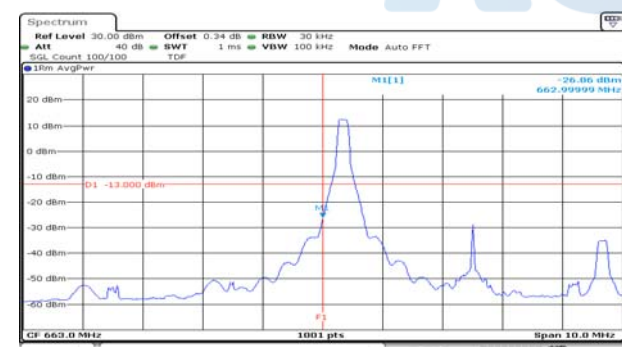

5M BW 16QAM High ch. 1RB

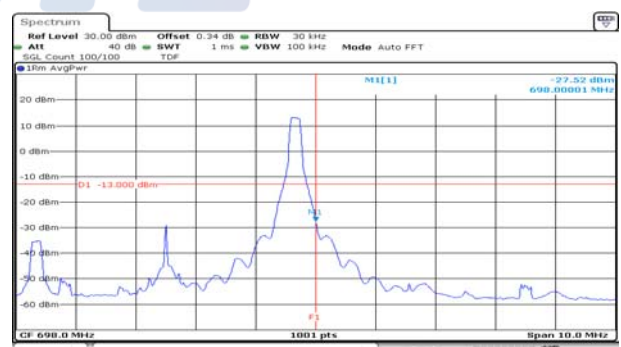

5M BW 16QAM Low ch. FRB



5M BW 16QAM High ch. FRB



5M BW QPSK Lower extended 1RB

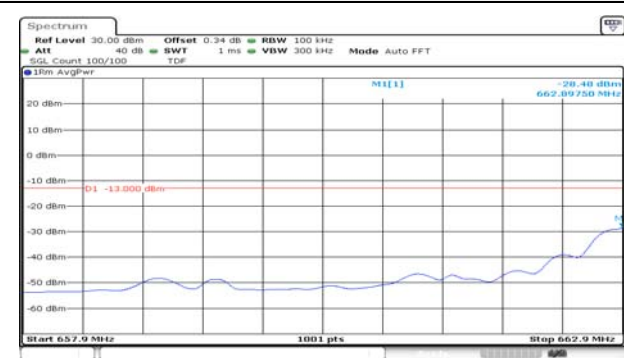

5M BW QPSK Upper extended 1RB



5M BW QPSK Lower extended FRB

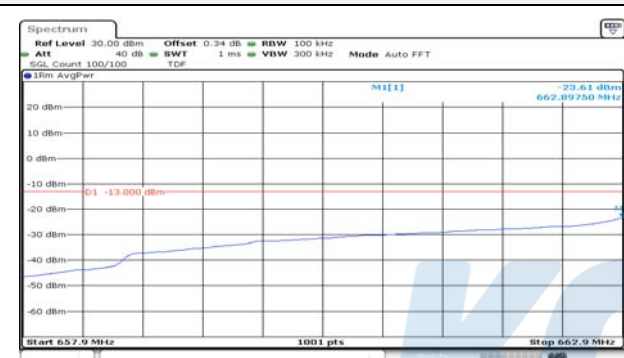

5M BW QPSK Upper extended FRB



5M BW 16QAM Lower extended 1RB

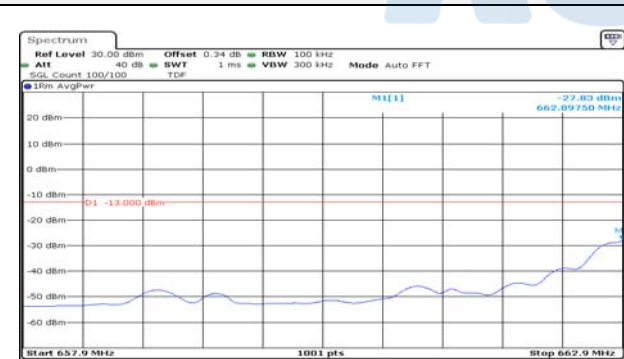

5M BW 16QAM Upper extended 1RB

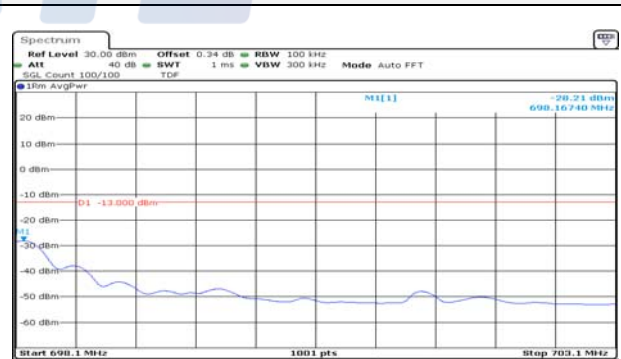

5M BW 16QAM Lower extended FRB

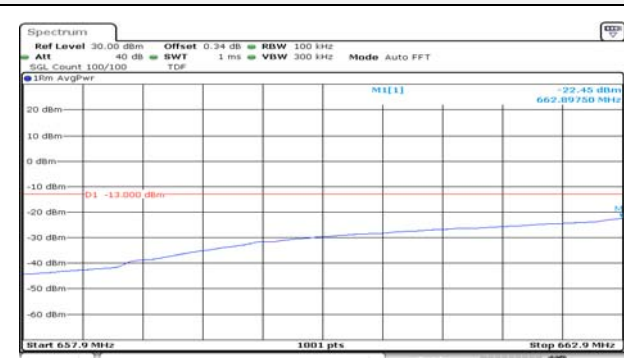

5M BW 16QAM Upper extended FRB

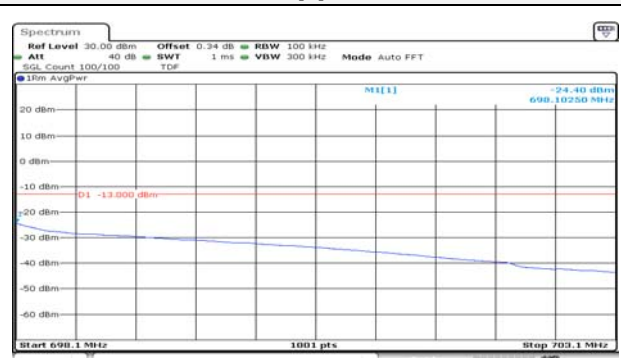

10M BW QPSK Low ch. 1RB

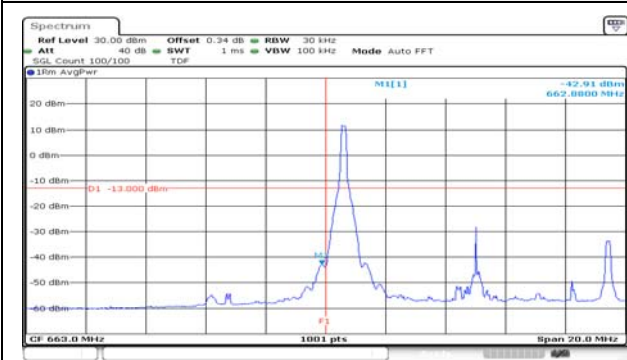

10M BW QPSK High ch. 1RB

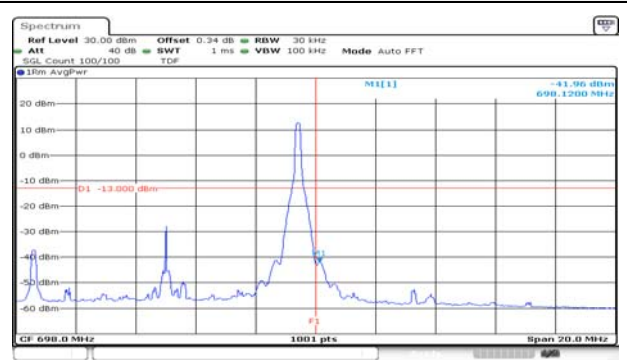

10M BW QPSK Low ch. FRB



10M BW QPSK High ch. FRB



10M BW 16QAM Low ch. 1RB

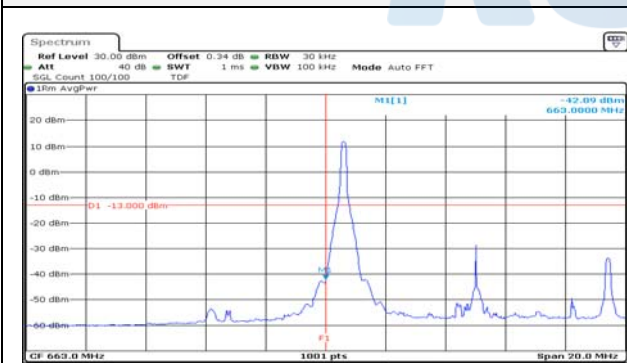

10M BW 16QAM High ch. 1RB

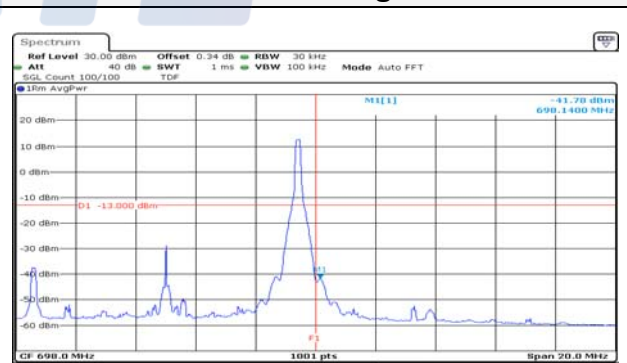

10M BW 16QAM Low ch. FRB



10M BW 16QAM High ch. FRB

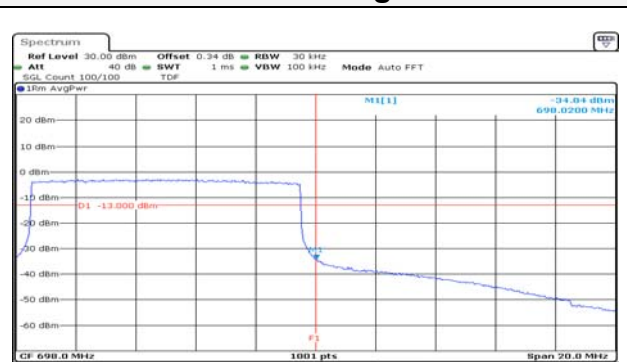

10M BW QPSK Lower extended 1RB

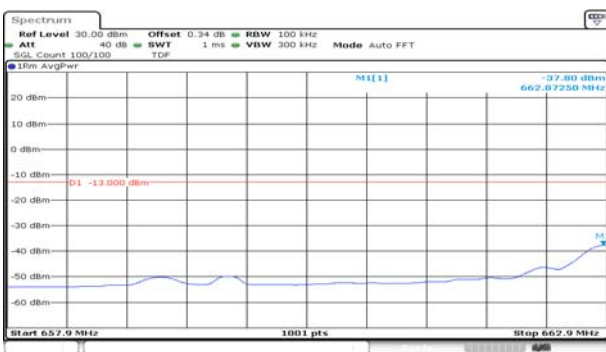

10M BW QPSK Upper extended 1RB

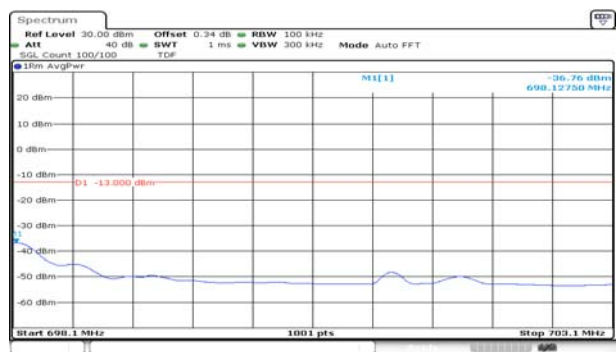

10M BW QPSK Lower extended FRB

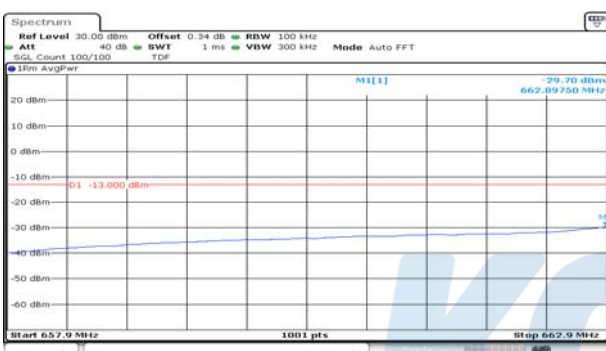

10M BW QPSK Upper extended FRB

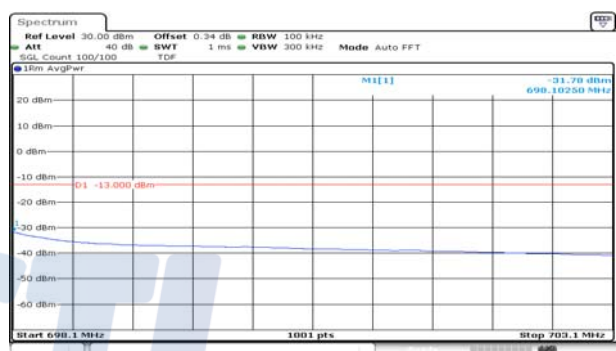

10M BW 16QAM Lower extended 1RB

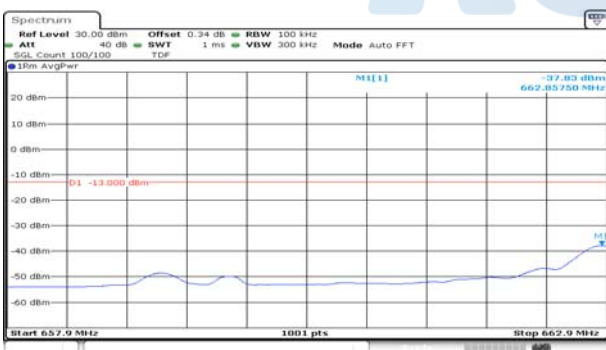

10M BW 16QAM Upper extended 1RB

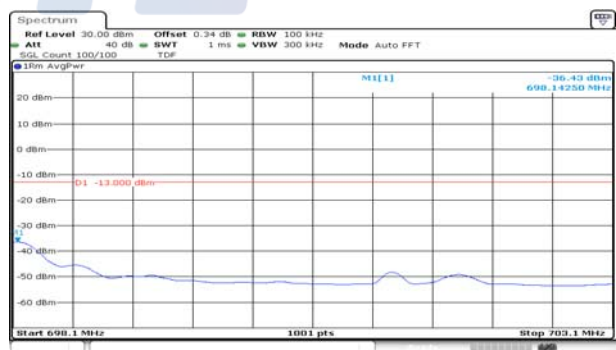

10M BW 16QAM Lower extended FRB

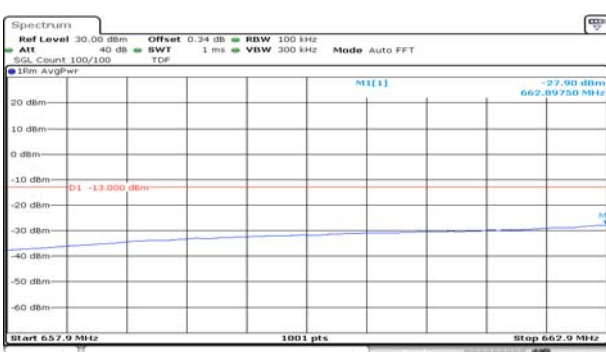

10M BW 16QAM Upper extended FRB



15M BW QPSK Low ch. 1RB

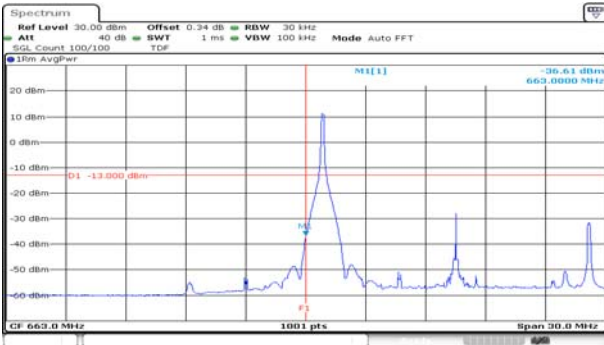

15M BW QPSK High ch. 1RB

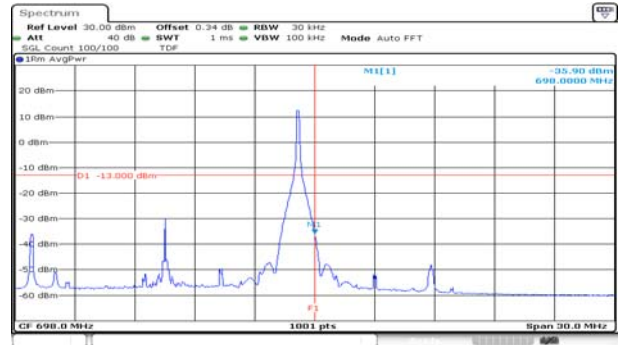

15M BW / QPSK / Low ch. / FRB

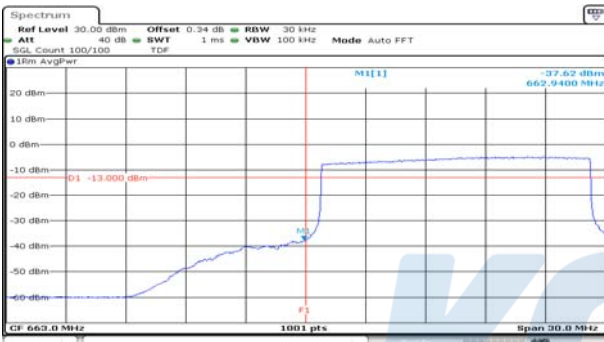

15M BW / QPSK / High ch. / FRB

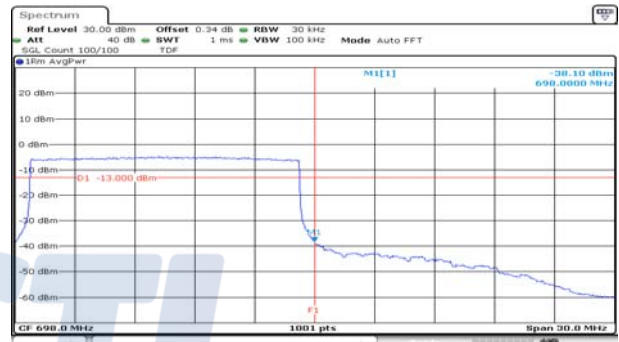

15M BW 16QAM Low ch. 1RB

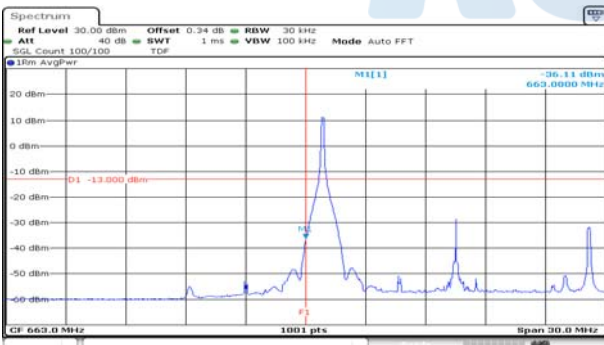

15M BW 16QAM High ch. 1RB

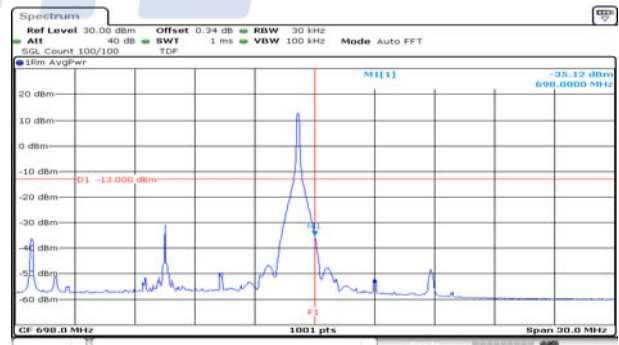

15M BW 16QAM Low ch. FRB

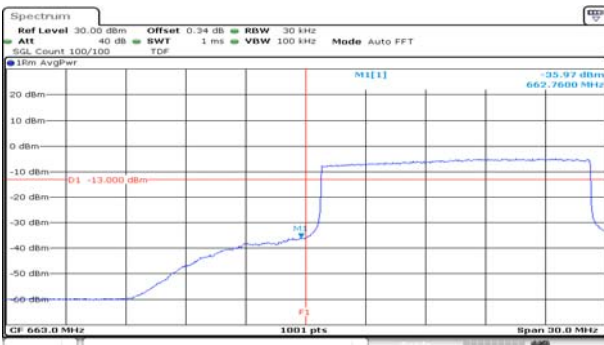

15M BW 16QAM High ch. FRB

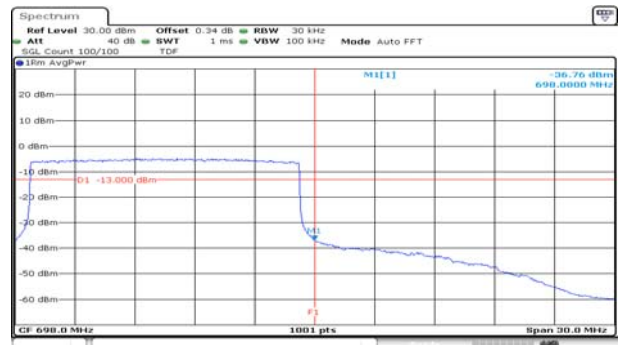

15M BW QPSK Lower extended 1RB

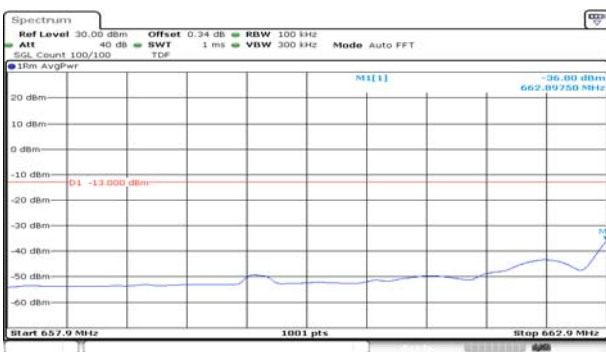

15M BW QPSK Upper extended 1RB

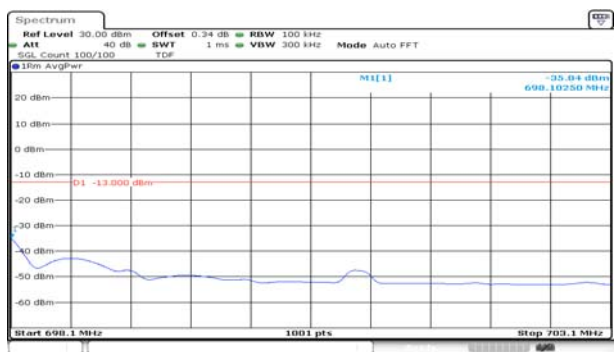

15M BW QPSK Lower extended FRB

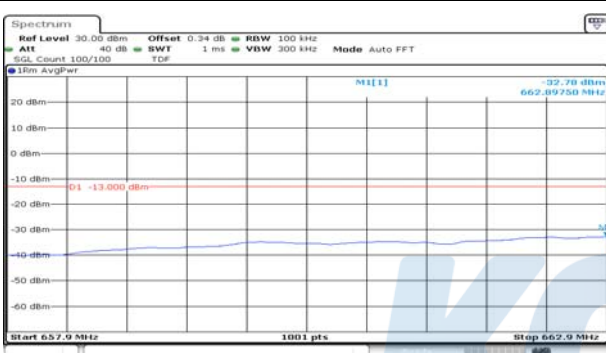

15M BW QPSK Upper extended FRB

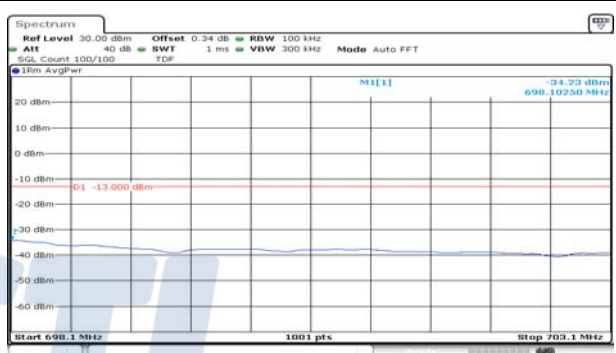

15M BW 16QAM Lower extended 1RB

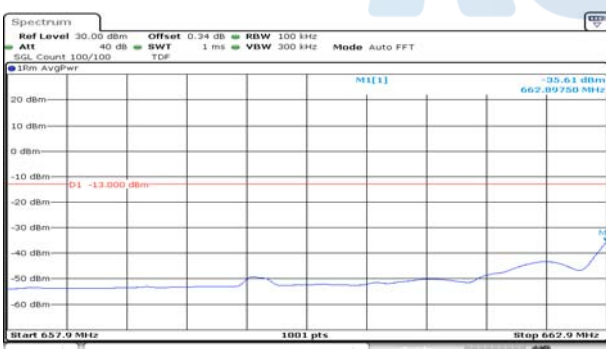

15M BW 16QAM Upper extended 1RB

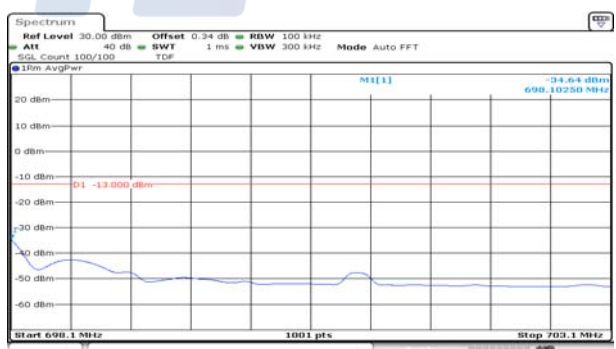

15M BW 16QAM Lower extended FRB

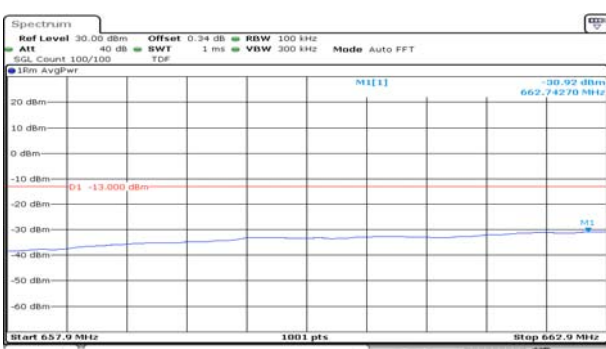

15M BW 16QAM Upper extended FRB

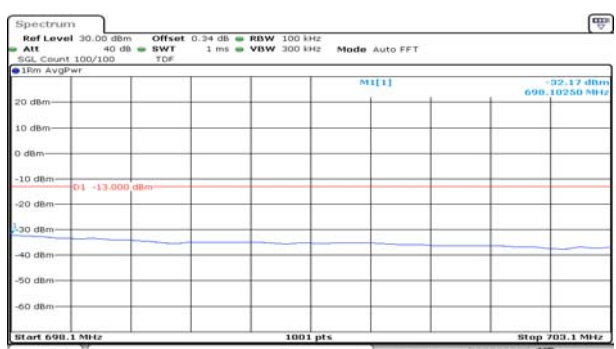

20M BW QPSK Low ch. 1RB

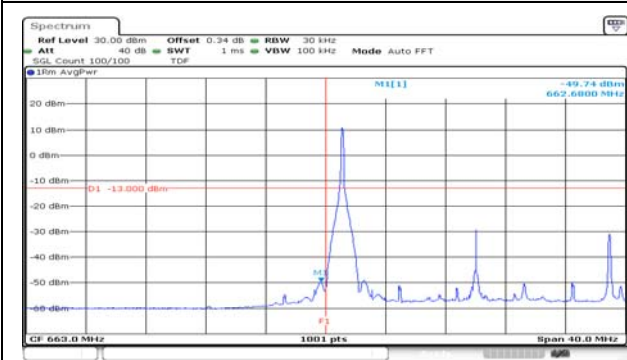

20M BW QPSK High ch. 1RB

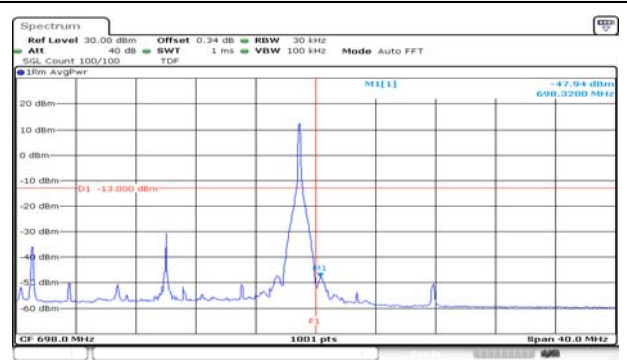

20M BW QPSK Low ch. FRB



20M BW QPSK High ch. FRB



20M BW 16QAM Low ch. 1RB

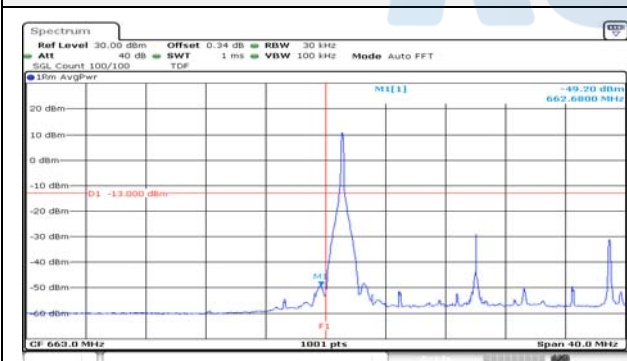

20M BW 16QAM High ch. 1RB

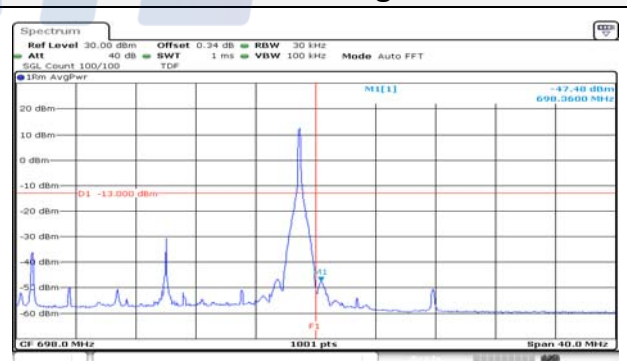

20M BW 16QAM Low ch. FRB

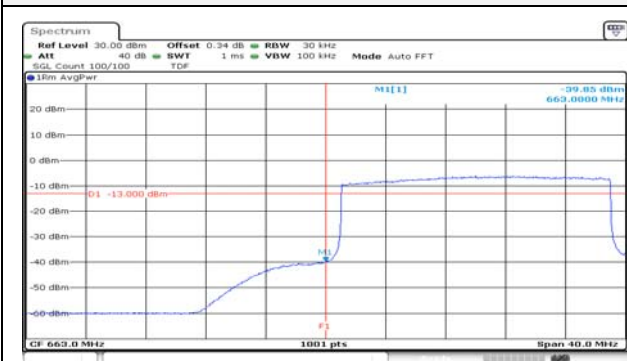

20M BW 16QAM High ch. FRB



20M BW QPSK Lower extended 1RB

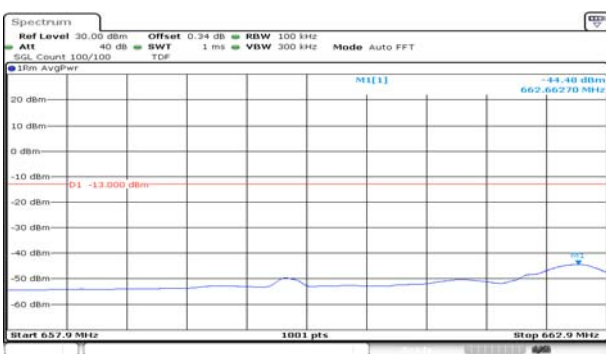

20M BW QPSK Upper extended 1RB

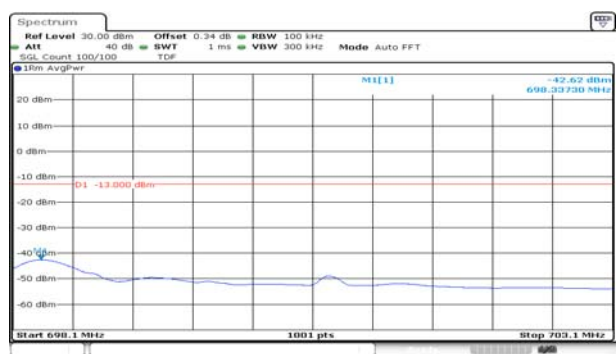

20M BW QPSK Lower extended FRB

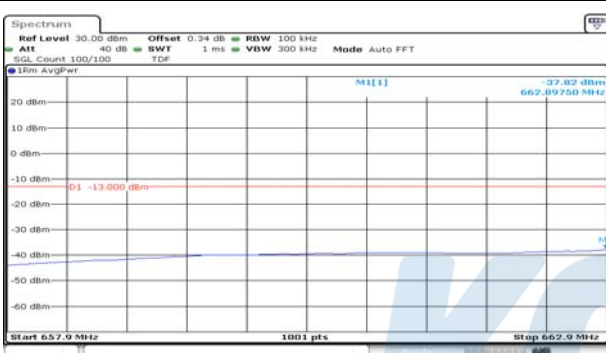

20M BW QPSK Upper extended FRB

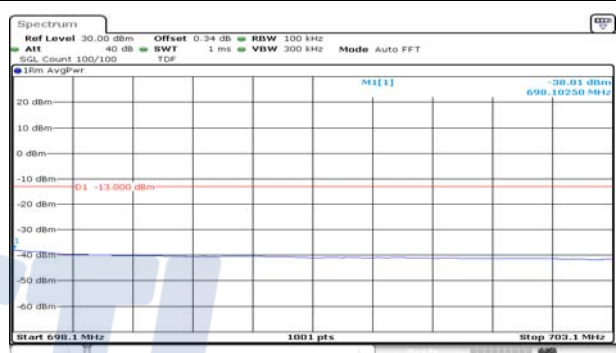

20M BW 16QAM Lower extended 1RB



20M BW 16QAM Upper extended 1RB

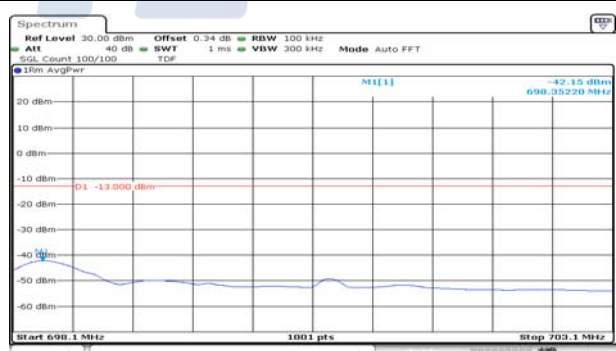

20M BW 16QAM Lower extended FRB



20M BW 16QAM Upper extended FRB

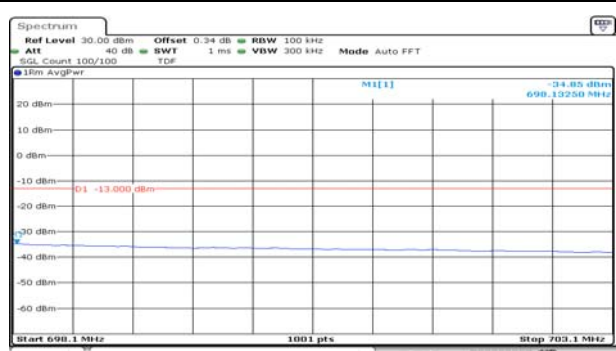

7.5. Peak to Average Power Ratio (PAPR)

Test setup

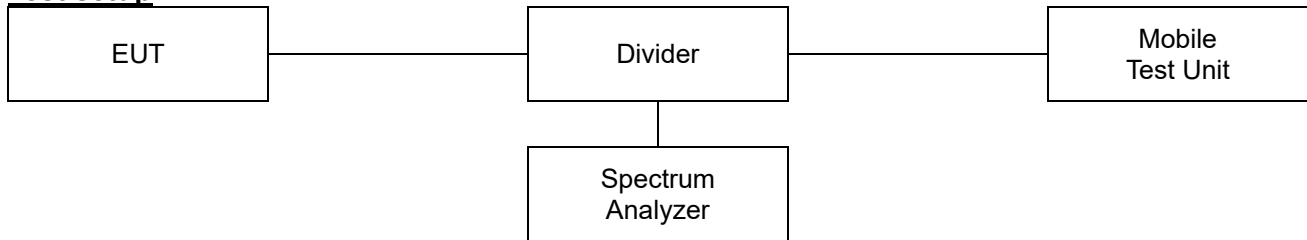

Limit

According to §24.232(d), §27.50(d)(5) and RSS-130(4.6), RSS-132(5.4), RSS-133(6.4), RSS-139(6.5), the peak-to-average ratio(PAR) of the transmission must not exceed 13 dB.

Test procedure

971168 D01 v03r01 - Section 5.7.2

ANSI 63.26-2015 – Section 5.2.3.4

Test settings

5.2.3.4 Measurement of peak power in a broadband noise-like signal using CCDF

- 1) Set resolution/measurement bandwidth \geq OBW or specified reference bandwidth
- 2) Set the number of counts to a value that stabilizes the measured CCDF curve.
- 3) Set the measurement interval as follows:
 - a) For continuous transmissions, set to the greater of [10 x (number of points in sweep) x (transmission symbol period)] or 1 ms.
 - b) For burst transmissions, employ an external trigger that is synchronized with the EUT burst timing sequence, or use the internal burst trigger with a trigger level that allows the burst to stabilize. Set the measurement interval to a time that is less than or equal to the burst duration.
 - c) If there are several carriers in a single antenna port, the peak power shall be determined for each individual carrier (by disabling the other carriers while measuring the required carrier) and the total peak power calculated from the sum of the individual carrier peak powers.
- 4) Record the maximum PAPR level associated with a probability of 0.1%

5.2.6 Peak-to-average power ratio

Use one of the procedures presented in 5.2(ANSI C63.26-2015) to measure the total peak power and record as P_{PK} .

Use one of the applicable procedure presented 5.2(ANSI C63.26-2015) to measure the total average power and record as P_{AG} . Determine the P.A.P.R from:

$$PAPR(\text{dB}) = P_{PK}(\text{dBm or dBW}) - P_{AG}(\text{dBm or dBW})$$

Test results

Test mode: LTE Band 25/2

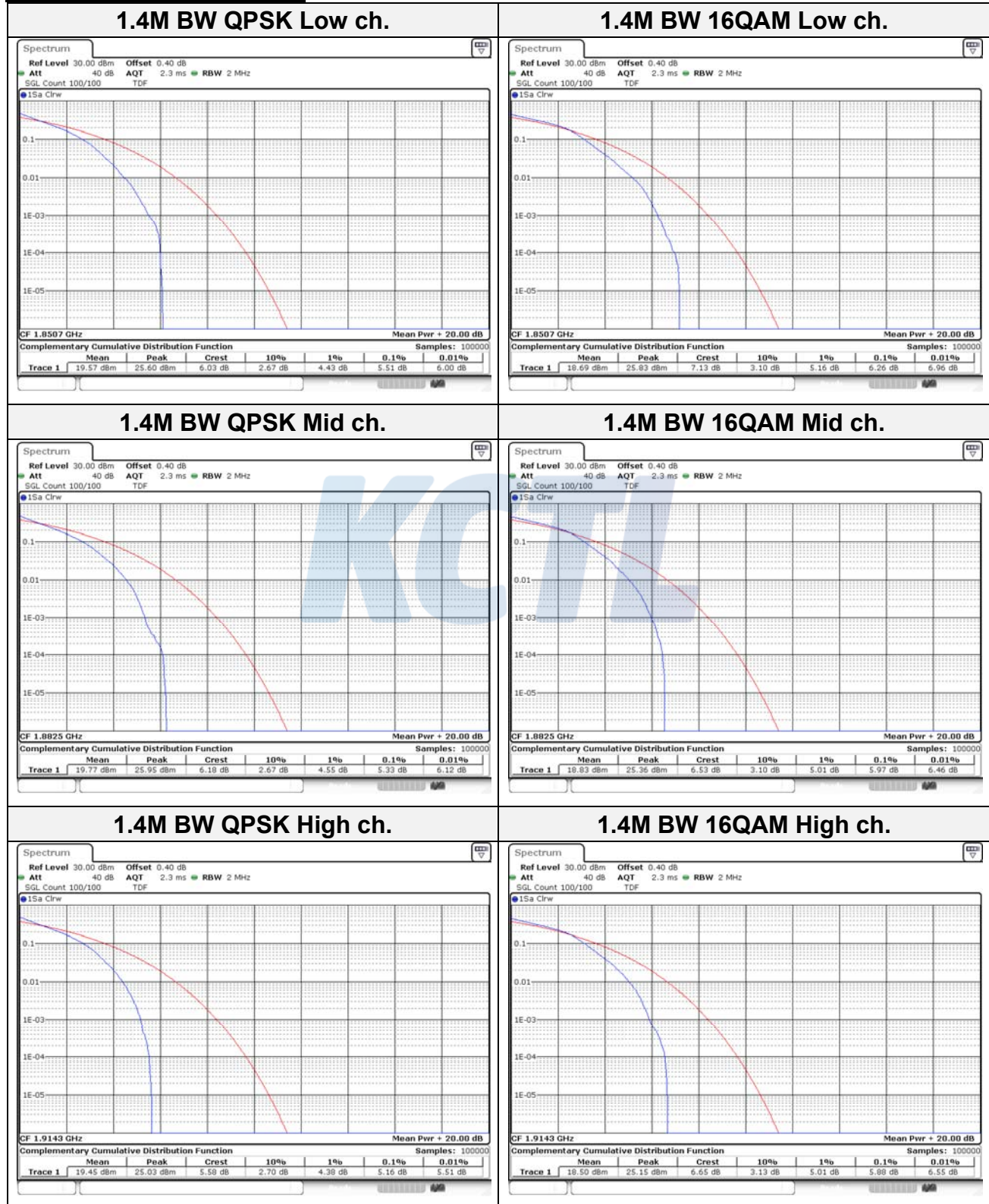

3M BW QPSK Low ch.

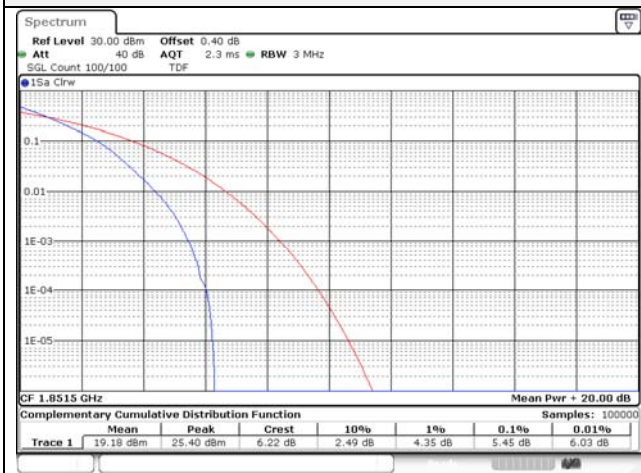

3M BW 16QAM Low ch.



3M BW QPSK Mid ch.

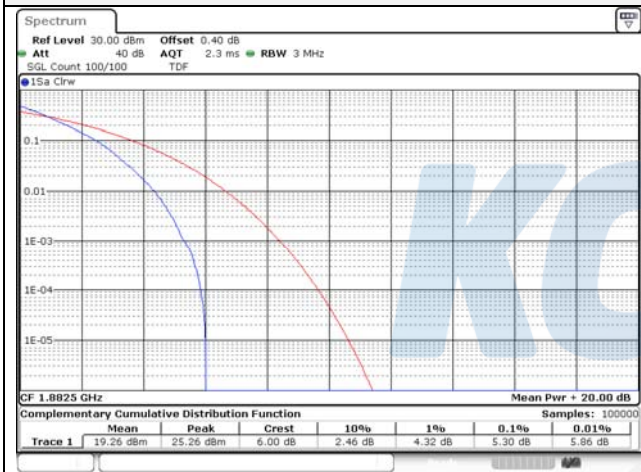

3M BW 16QAM Mid ch.

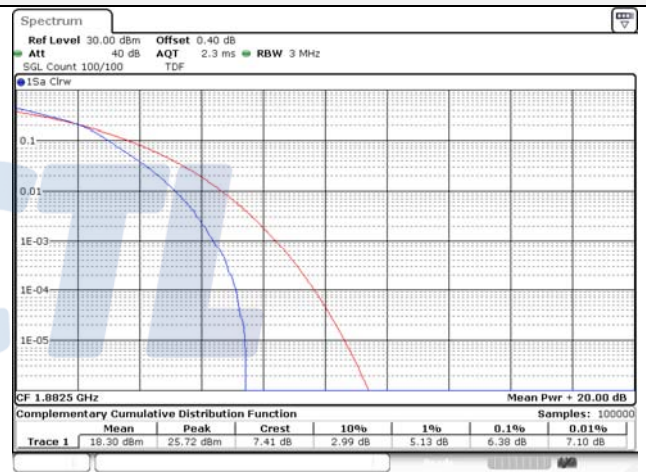

3M BW QPSK High ch.

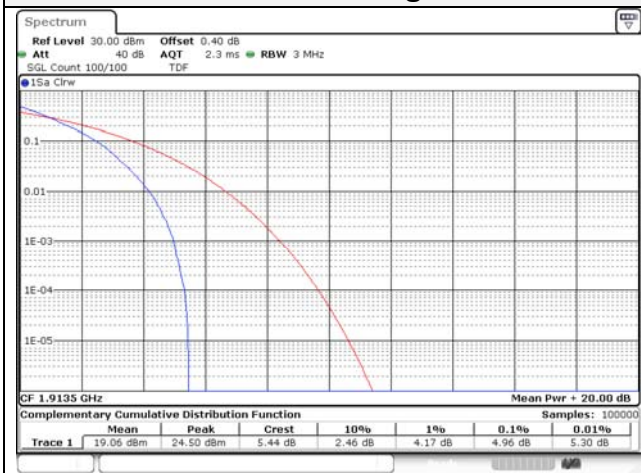

3M BW 16QAM High ch.

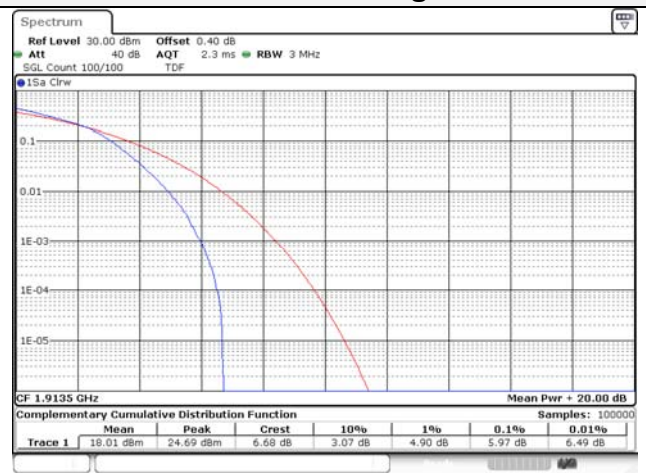

5M BW QPSK Low ch.

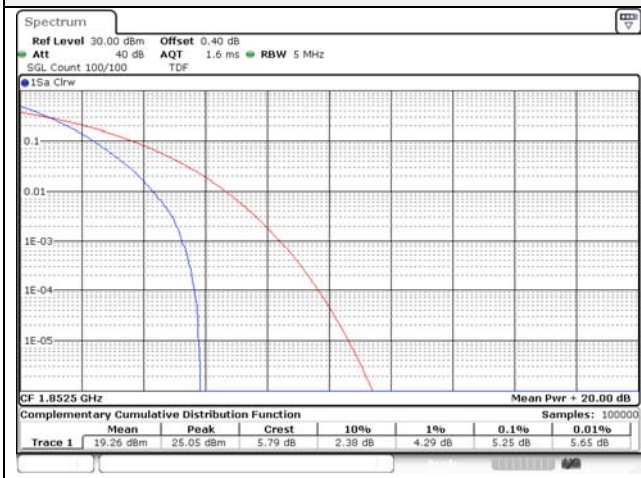

5M BW 16QAM Low ch.

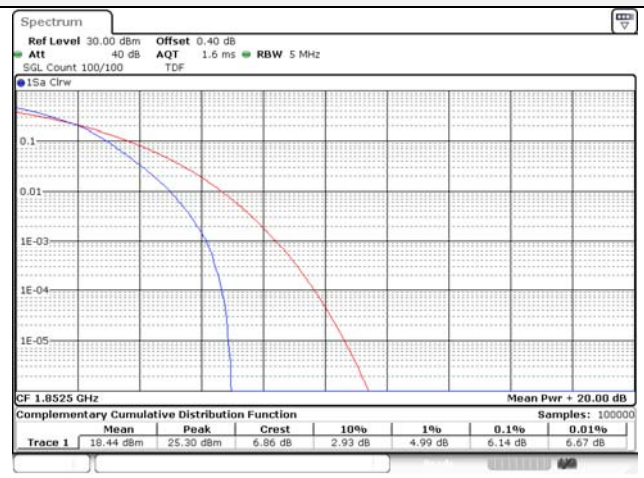

5M BW QPSK Mid ch.

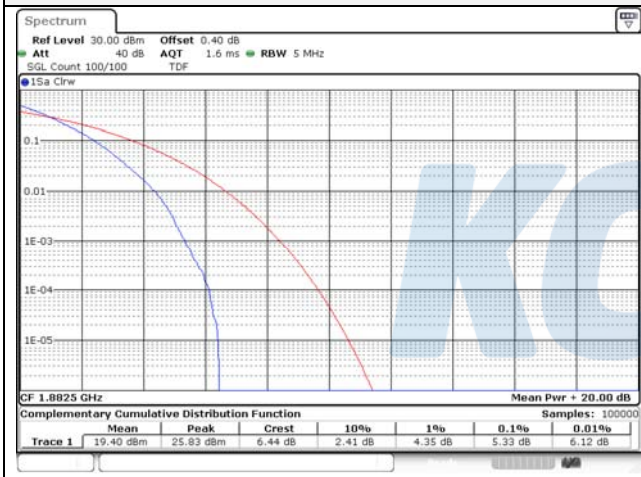

5M BW 16QAM Mid ch.

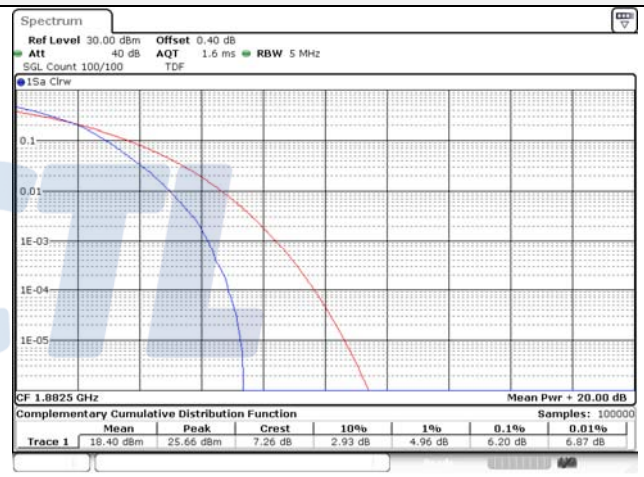

5M BW QPSK High ch.

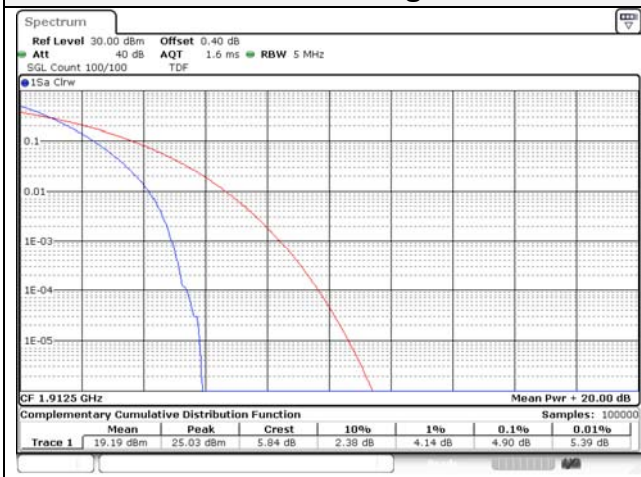

5M BW 16QAM High ch.

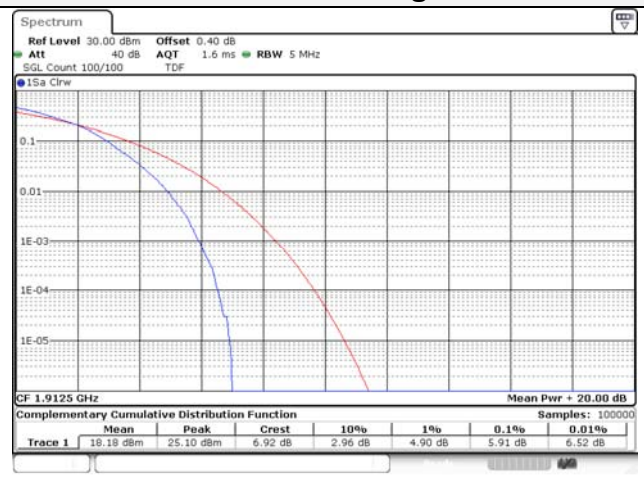

10M BW QPSK Low ch.

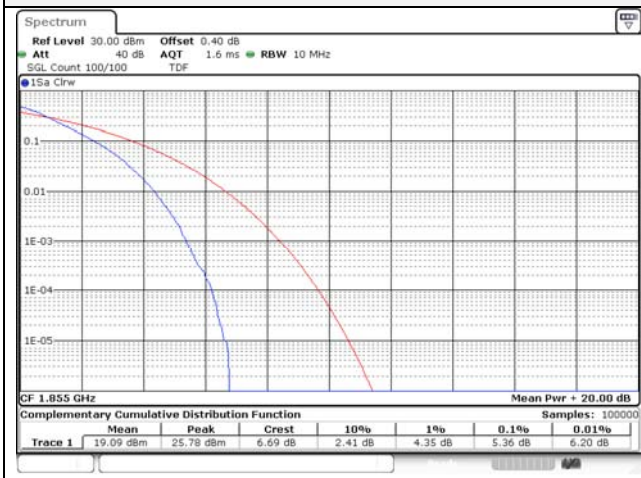

10M BW 16QAM Low ch.

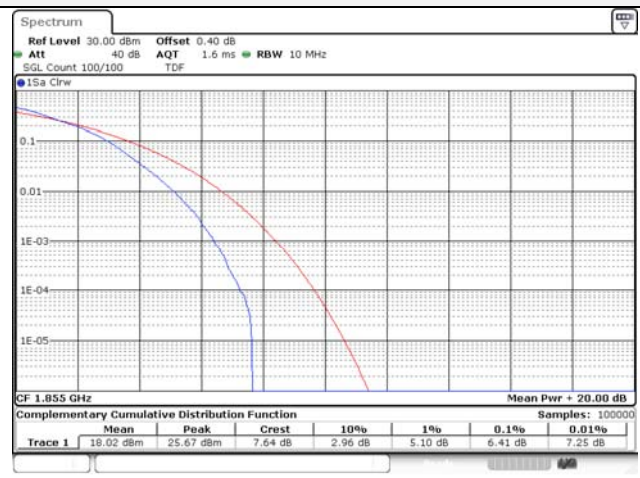

10M BW QPSK Mid ch.

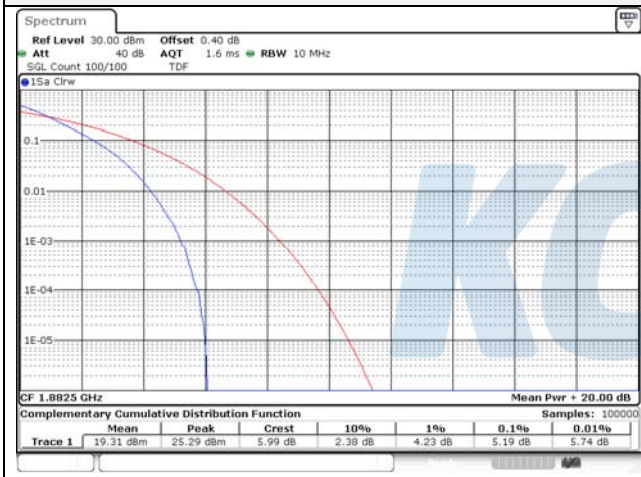

10M BW 16QAM Mid ch.

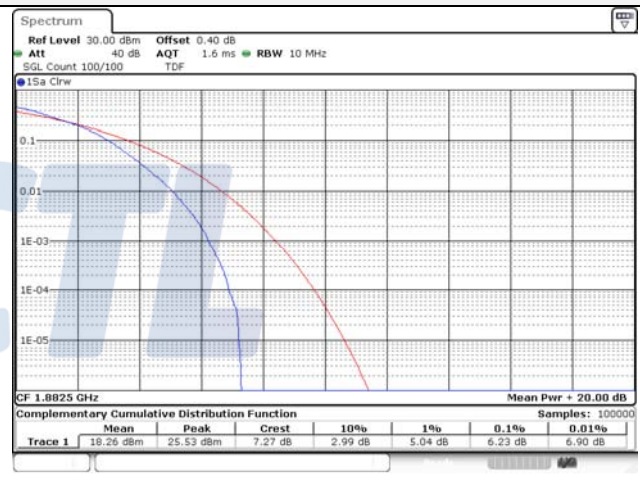

10M BW QPSK High ch.

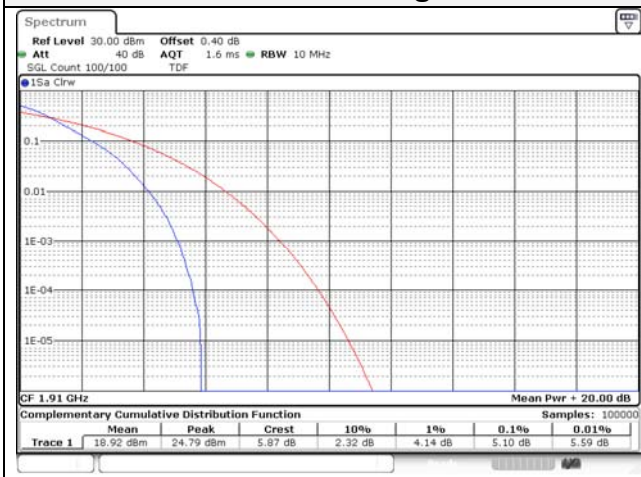

10M BW 16QAM High ch.

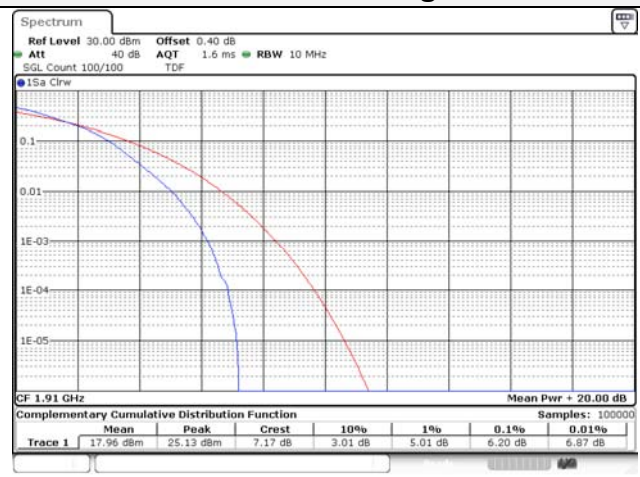

15M BW QPSK Low ch.

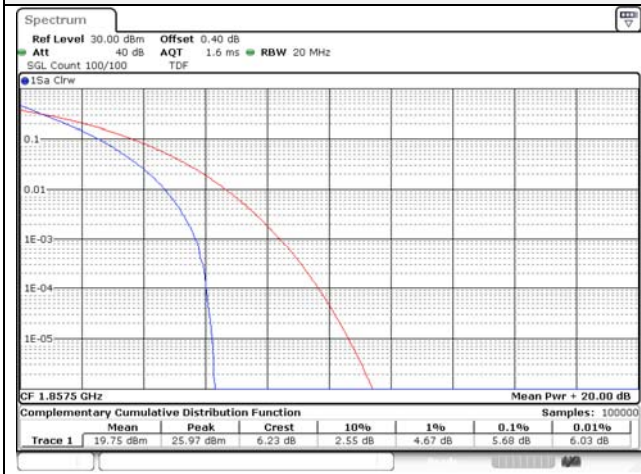

15M BW 16QAM Low ch.

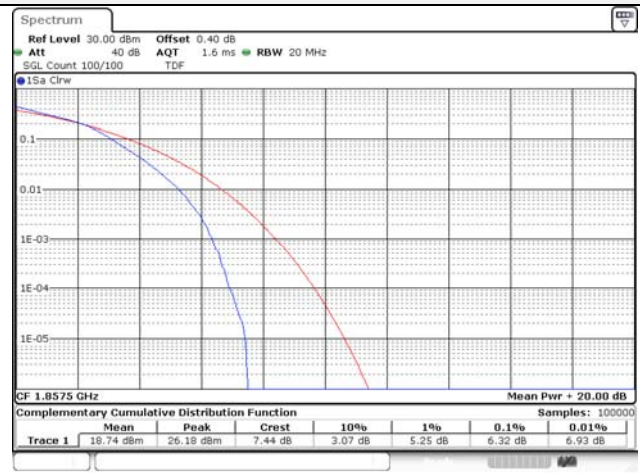

15M BW QPSK Mid ch.

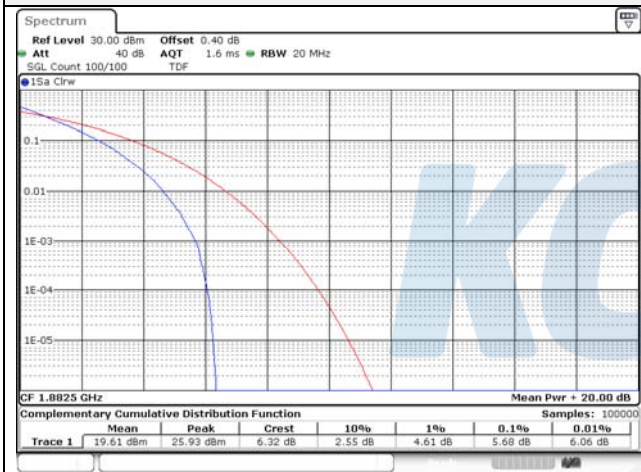

15M BW 16QAM Mid ch.

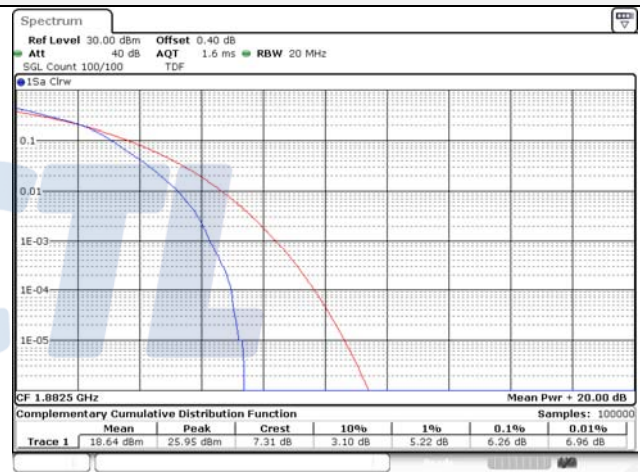

15M BW QPSK High ch.

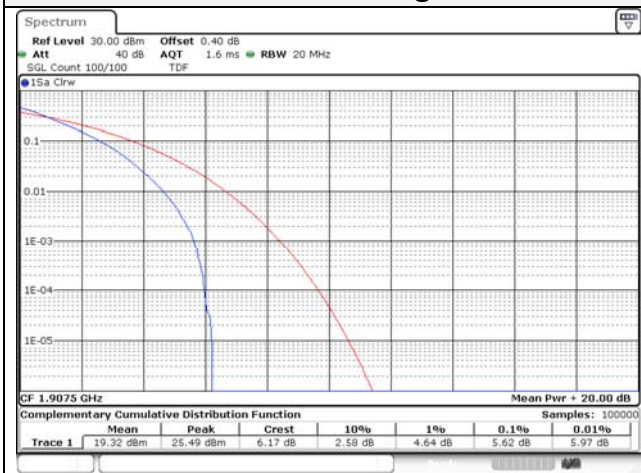

15M BW 16QAM High ch.



20M BW QPSK Low ch.

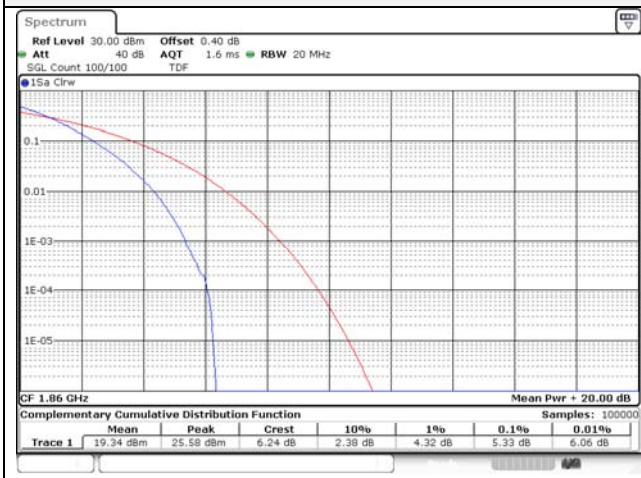

20M BW 16QAM Low ch.

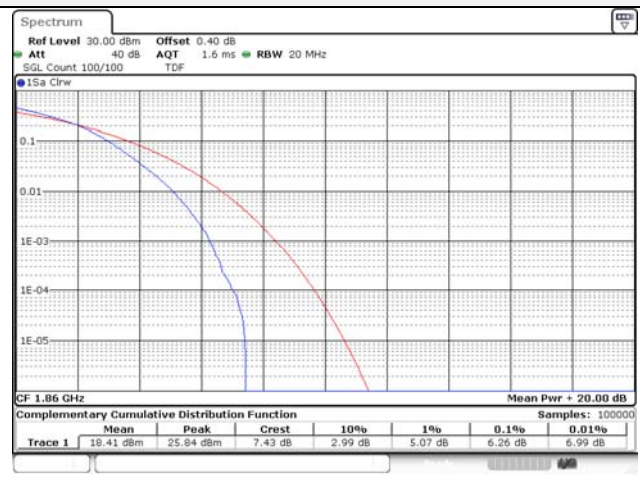

20M BW QPSK Mid ch.

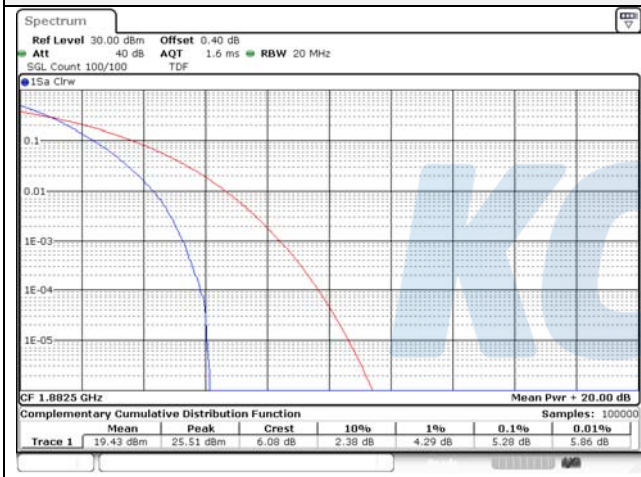

20M BW 16QAM Mid ch.

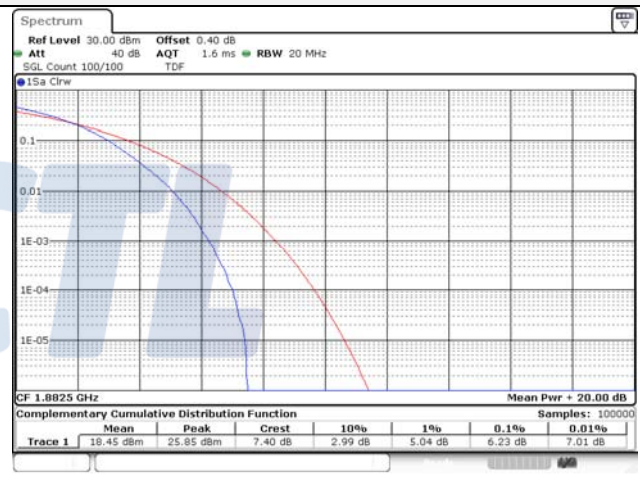

20M BW QPSK High ch.

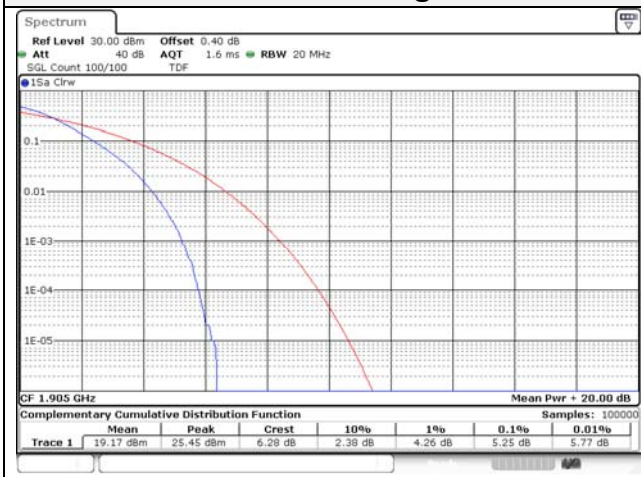

20M BW 16QAM High ch.

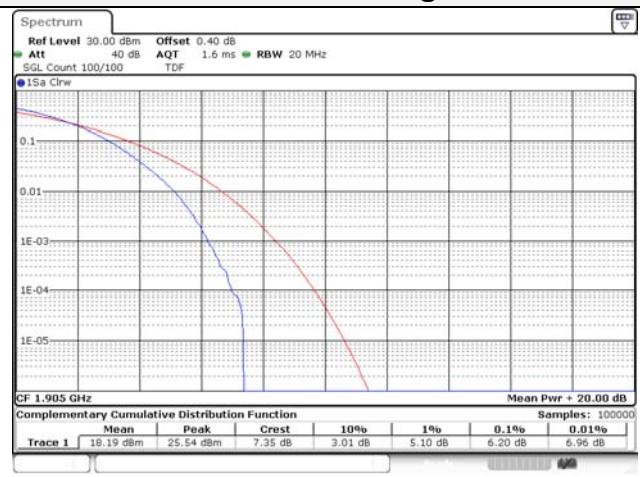

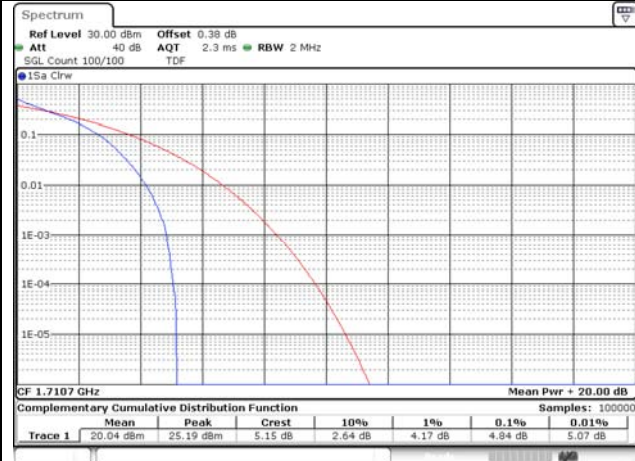
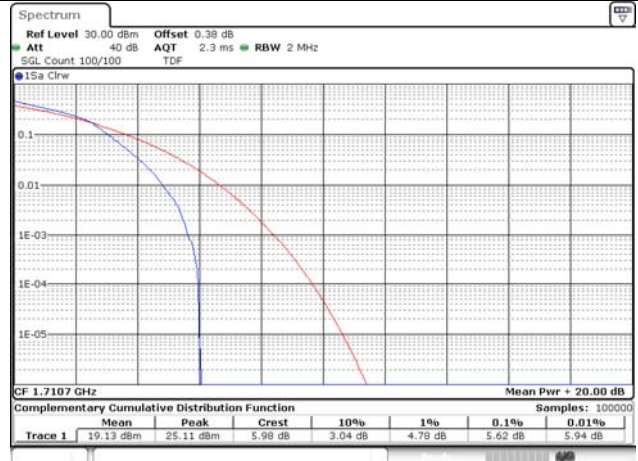
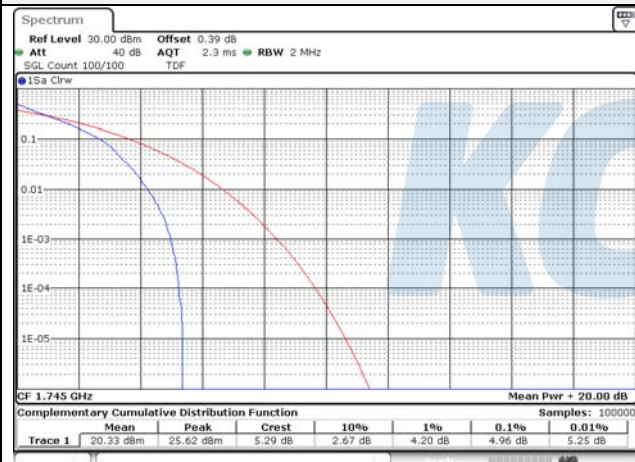
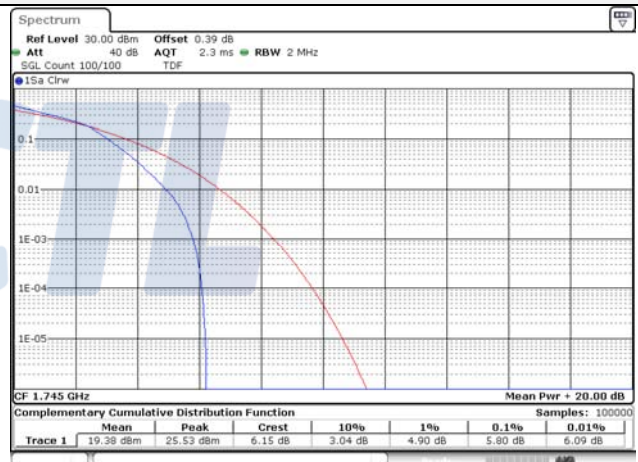
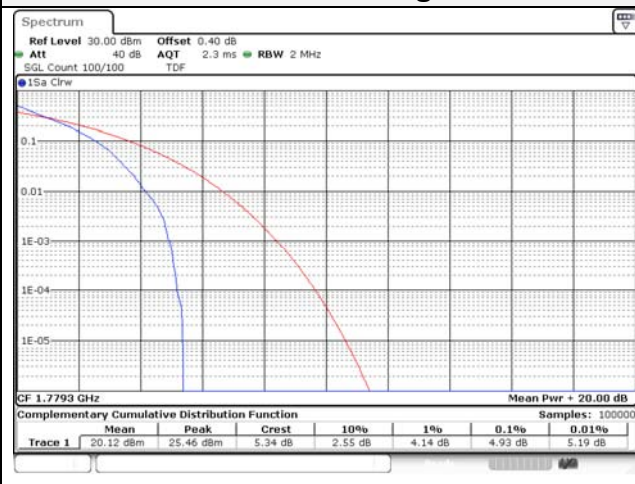
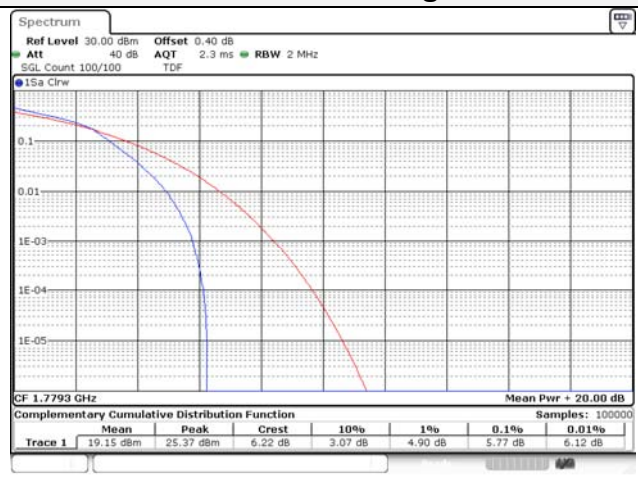
Test mode: LTE Band 66/4**1.4M BW QPSK Low ch.****1.4M BW 16QAM Low ch.****1.4M BW QPSK Mid ch.****1.4M BW 16QAM Mid ch.****1.4M BW QPSK High ch.****1.4M BW 16QAM High ch.**

3M BW QPSK Low ch.

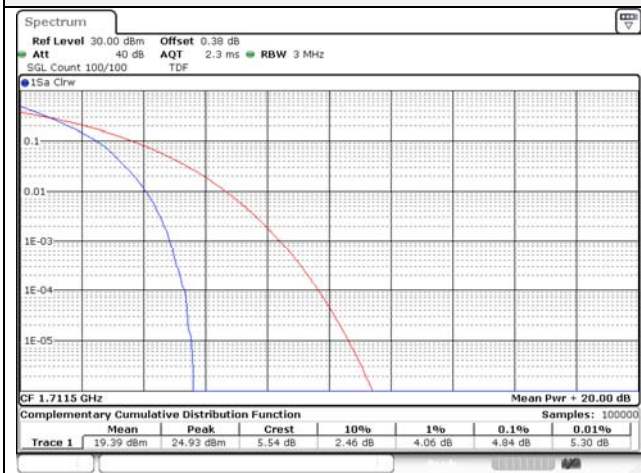

3M BW 16QAM Low ch.

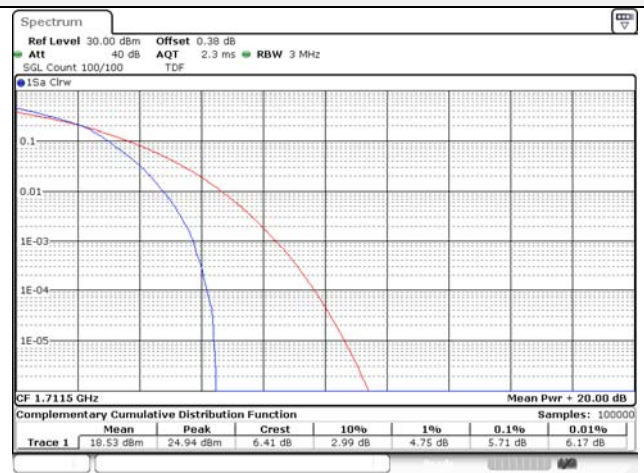

3M BW QPSK Mid ch.

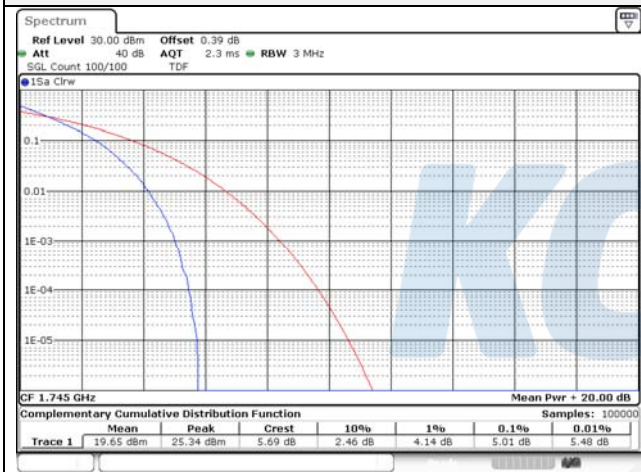

3M BW 16QAM Mid ch.

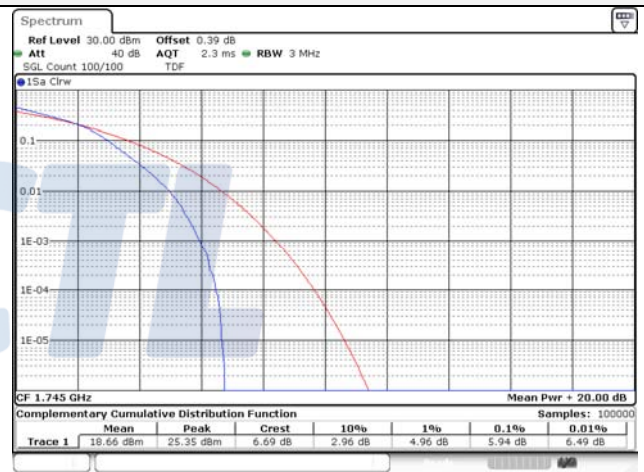

3M BW QPSK High ch.

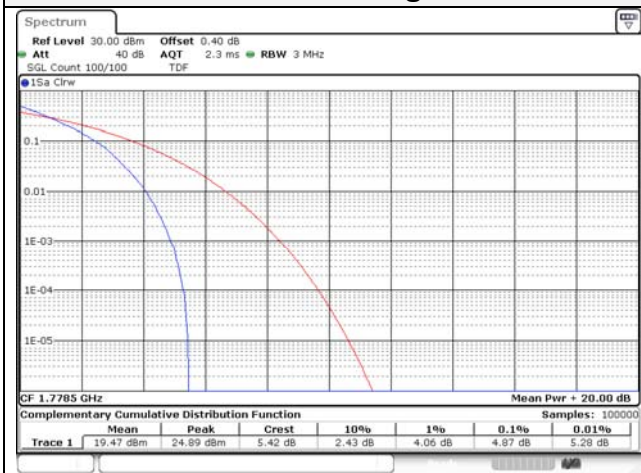

3M BW 16QAM High ch.

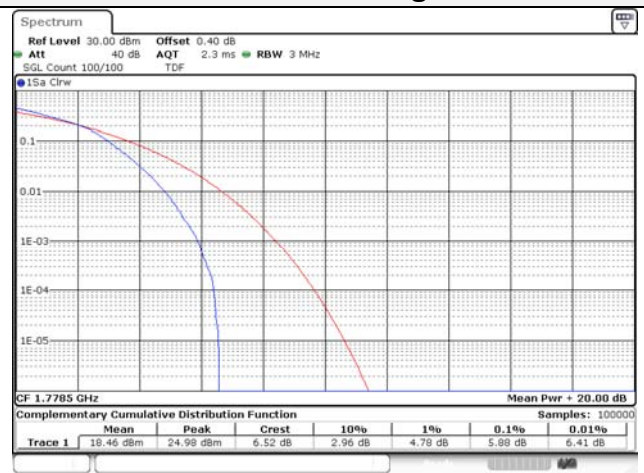

5M BW QPSK Low ch.

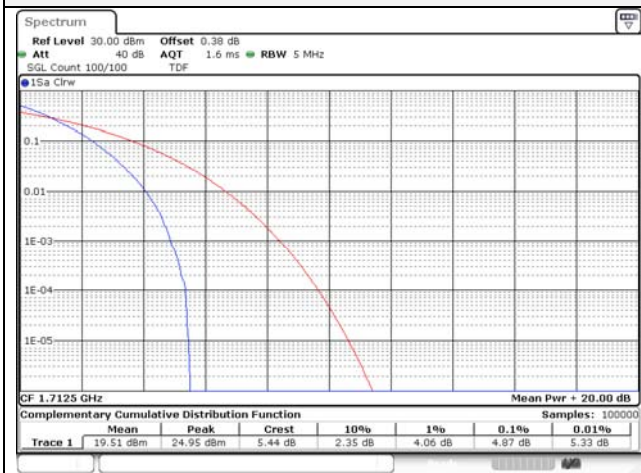

5M BW 16QAM Low ch.

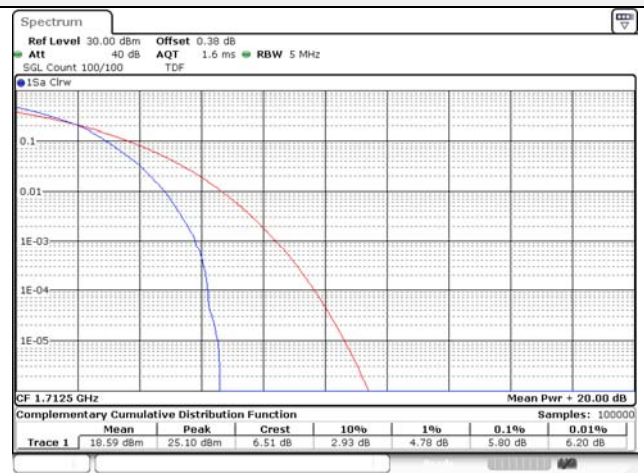

5M BW QPSK Mid ch.

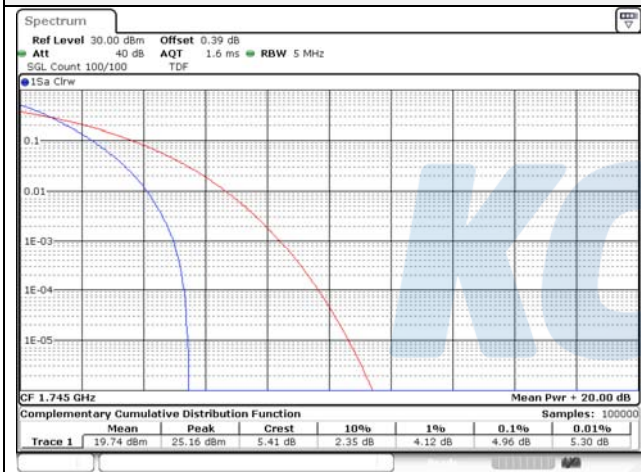

5M BW 16QAM Mid ch.

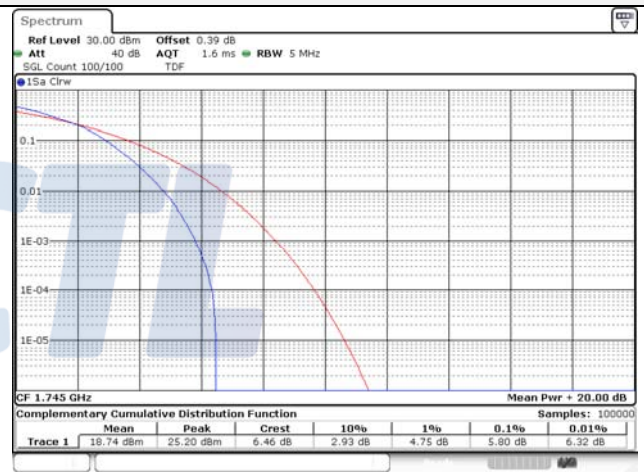

5M BW QPSK High ch.

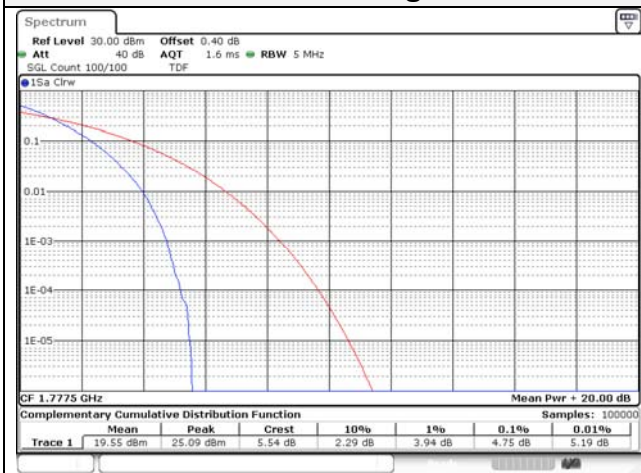

5M BW 16QAM High ch.

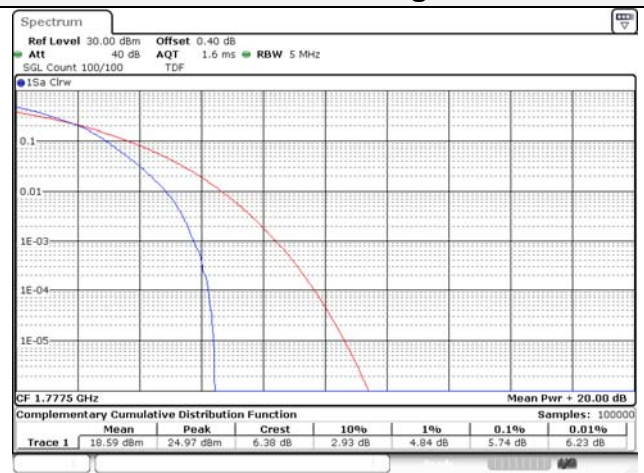

10M BW QPSK Low ch.

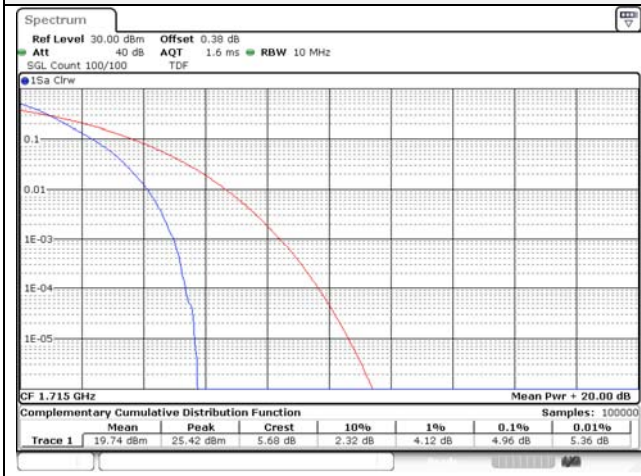

10M BW 16QAM Low ch.

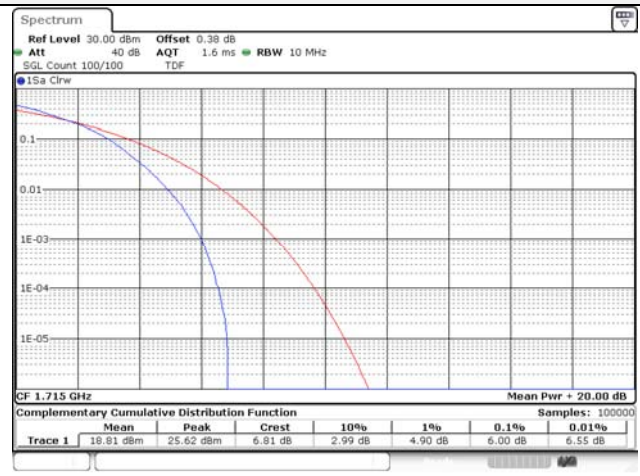

10M BW QPSK Mid ch.

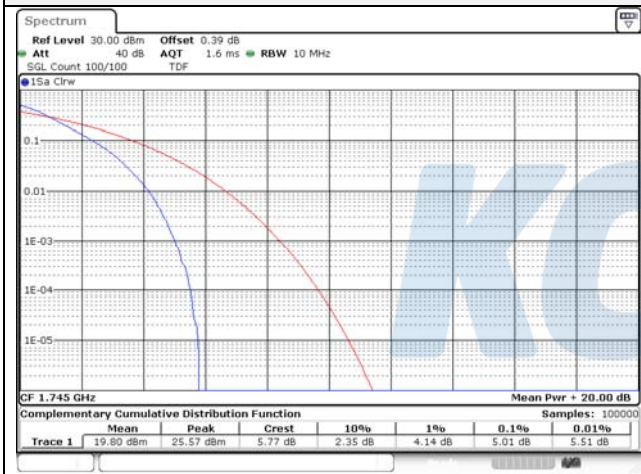

10M BW 16QAM Mid ch.

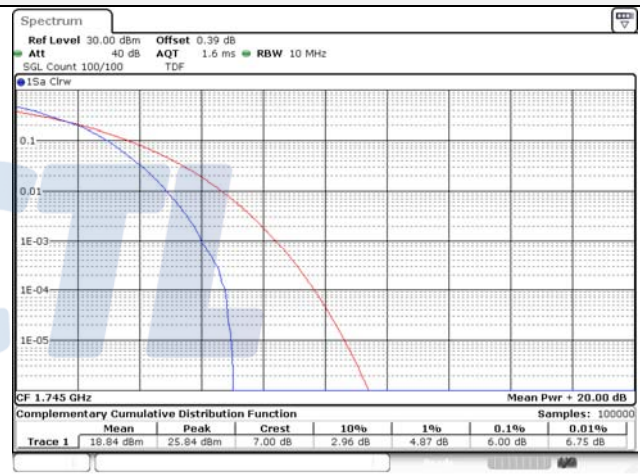

10M BW QPSK High ch.

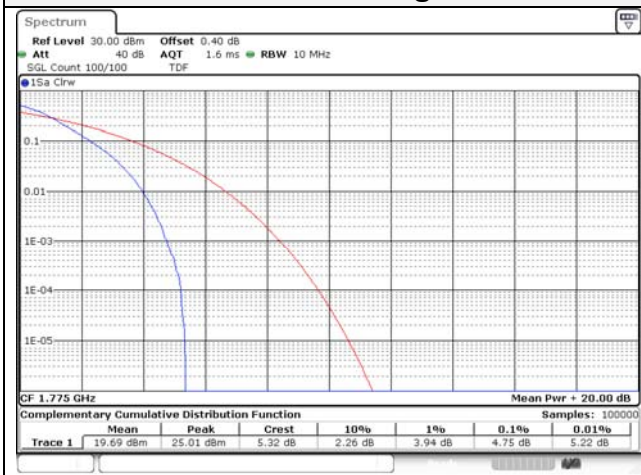

10M BW 16QAM High ch.

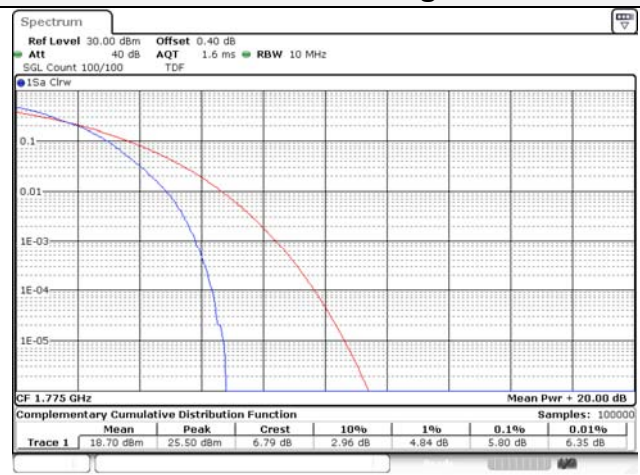

15M BW QPSK Low ch.

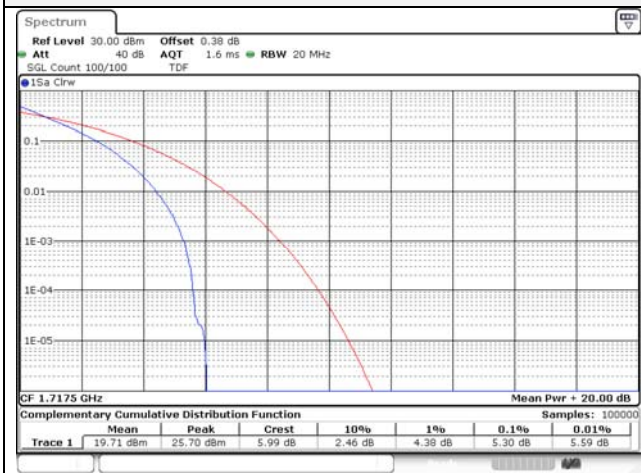

15M BW 16QAM Low ch.

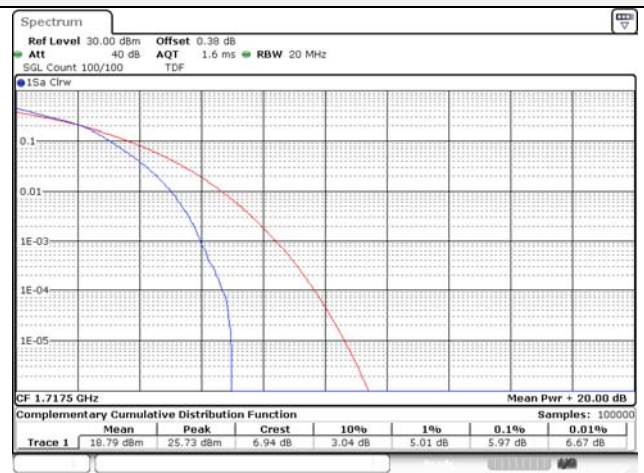

15M BW QPSK Mid ch.

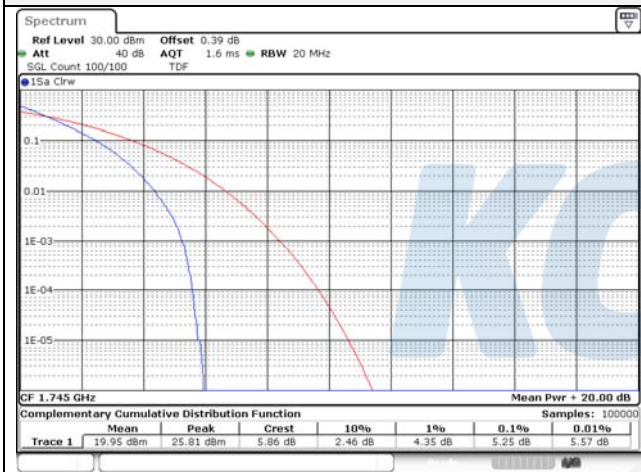

15M BW 16QAM Mid ch.

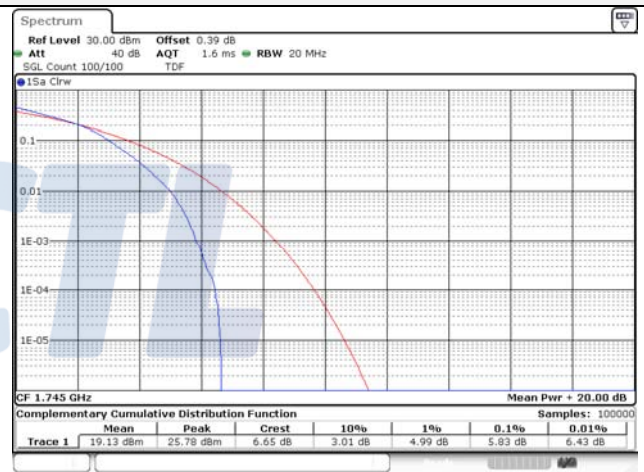

15M BW QPSK High ch.

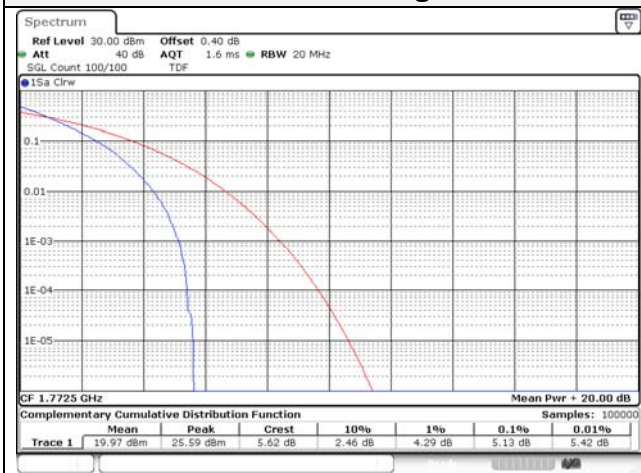

15M BW 16QAM High ch.



20M BW QPSK Low ch.

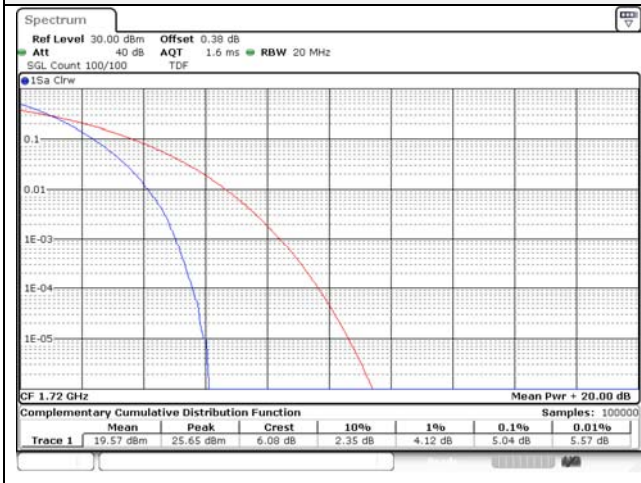

20M BW 16QAM Low ch.

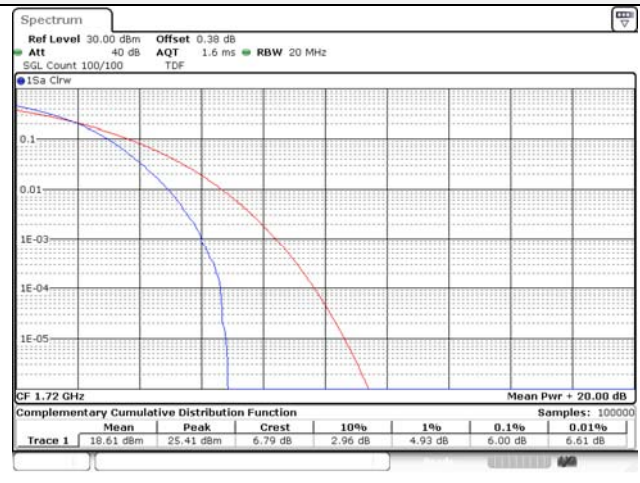

20M BW QPSK Mid ch.

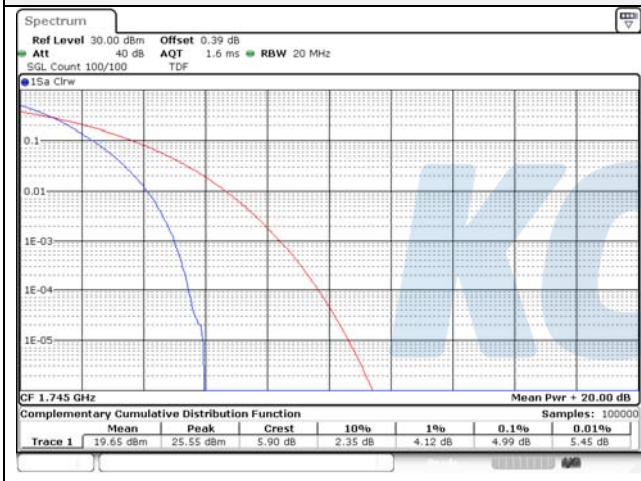

20M BW 16QAM Mid ch.

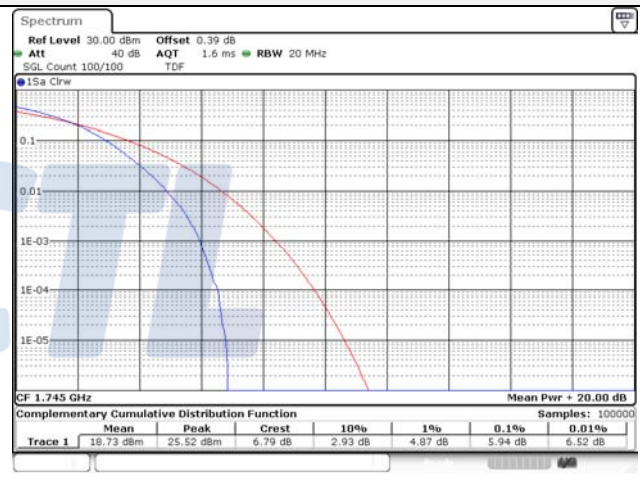

20M BW QPSK High ch.

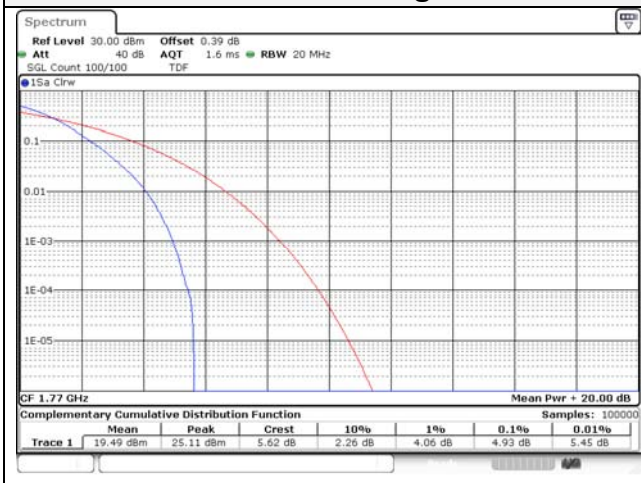

20M BW 16QAM High ch.

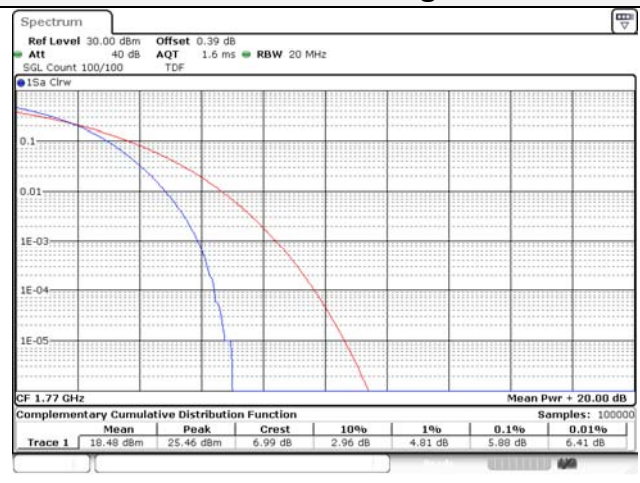

7.6. Frequency stability

Test setup

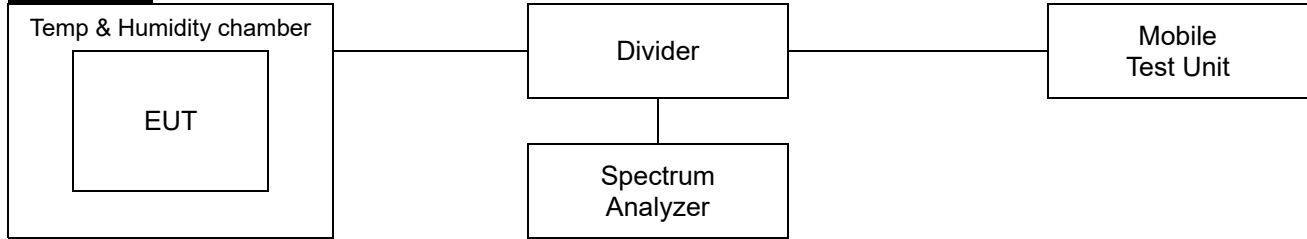

Limit

According to §2.1055(a),

The frequency stability shall be measured with variation of ambient temperature as follows:

- 1) From -30° to $+50^{\circ}$ centigrade for all equipment except that specified in paragraphs (a) (2) and (3) of this section.
- 2) From -20° to $+50^{\circ}$ centigrade for equipment to be licensed for use in the maritime services under part 80 of this chapter, except for class A, B, and S emergency position indicating radiobeacons (EPIRBS), and equipment to be licensed for use above 952 MHz at operational fixed stations in all services, stations in the local television transmission service and point-to-point microwave radio service under part 21 of this chapter, equipment licensed for use aboard aircraft in the aviation services under part 87 of this chapter, and equipment authorized for use in the family radio service under part 95 of this chapter.
- 3) From 0° to $+50^{\circ}$ centigrade for equipment to be licensed for use in the radio broadcast Services under part 73 of this chapter.

According to §2.1055(d),

The frequency stability shall be measured with variation of primary supply Voltage as follows:

- 1) Vary primary supply voltage from 85 to 115 percent of the nominal value for other than hand carried battery equipment.
- 2) For hand carried, battery powered equipment, reduce primary supply voltage to the battery operating and point which shall be specified by the manufacturer.
- 3) The supply voltage shall be measured at the input to the cable normally provided with the equipment, or at the power supply terminals if cables are not normally provided. Effects on frequency of transmitter keying (except for broadcast transmitters) and any heating element cycling at the nominal supply voltage and at each extreme also shall be shown.

According to §22.355 and RSS-132(5.3),

The carrier frequency of each transmitter in the public mobile services must be maintained within the tolerances given in Table of this section.

For mobile devices operating in the 824 to 849 MHz band at a power level than or equal to 3 Watts, the limit specified in Table C-1 is ± 2.5 ppm.

According to §24.235 and RSS-133(6.3),

The frequency stability shall be sufficient to ensure that the fundamental emission stays within the authorized frequency block.

The carrier frequency shall not depart from the reference frequency, in excess of ± 2.5 ppm for mobile stations and ± 1.0 ppm for base stations.

According to §27.54 and RSS-130(4.5),

The frequency stability shall be sufficient to ensure that the fundamental emission stays within the authorized frequency block.

According to §27.54 and RSS-139(6.4),

The frequency stability shall be sufficient to ensure that the fundamental emissions stay within the Authorized bands of operation.

Test procedure

ANSI 63.26-2015 – Section 5.6

Test settings

- 1) The carrier frequency of the transmitter is measured at room temperature.
(20°C to provide a reference)
- 2) The equipment is turned on in a “standby” condition for one minute before applying power to the transmitter. Measurement of the carrier frequency of the transmitter is made within one minute after applying power to the transmitter.
- 3) Frequency measurements are made at 10°C intervals ranging from -30°C to +50°C.
A period of at least one half-hour is provided to allow stabilization of the equipment at each Temperature level.

Test results

Test mode : LTE Band 12
 Frequency (Hz) : 707 500 000
 Channel : 23095
 Deviation limit(FCC&IC) : The frequency stability shall be sufficient to ensure that the fundamental emission stays within the authorized bands of operation.

Voltage (%)	Power (V)	Temp. (°C)	Frequency (Hz)	Frequency error (Hz)	Deviation	
					(ppm)	(%)
100%	3.85	+22(Ref)	707,499,998	-2.05	0.0	0.000000
		-30	707,499,998	-2.36	0.0	0.000000
		-20	707,499,998	-2.40	0.0	0.000000
		-10	707,499,998	-2.43	0.0	0.000000
		0	707,499,998	-1.93	0.0	0.000000
		+10	707,500,001	0.53	0.0	0.000000
		+20	707,500,000	0.19	0.0	0.000000
		+30	707,499,999	-0.97	0.0	0.000000
		+40	707,500,001	0.69	0.0	0.000000
		+50	707,500,001	0.99	0.0	0.000000
115%	4.43	+22(Ref)	707,499,999	-1.22	0.0	0.000000
End point	3.55	+22(Ref)	707,499,998	-1.63	0.0	0.000000

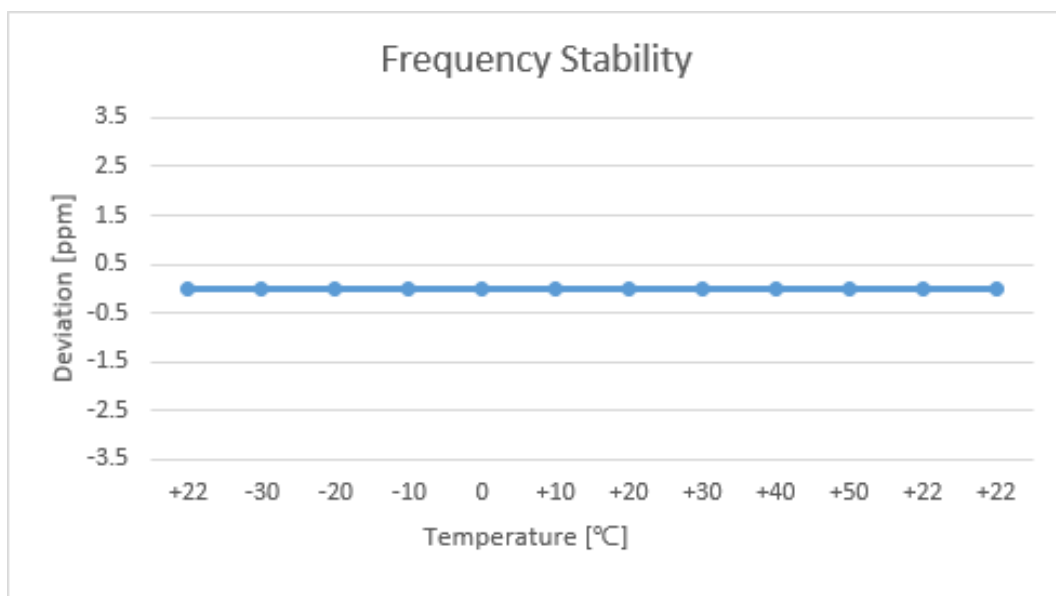

Test mode : LTE Band 13
 Frequency (Hz) : 782 000 000
 Channel : 23230
 Deviation limit(FCC&IC) : The frequency stability shall be sufficient to ensure that the fundamental emission stays within the authorized bands of operation.

Voltage (%)	Power (V)	Temp. (°C)	Frequency (Hz)	Frequency error (Hz)	Deviation	
					(ppm)	(%)
100%	3.85	+22(Ref)	781,999,999	-0.60	0.0	0.000000
		-30	781,999,998	-2.10	0.0	0.000000
		-20	781,999,997	-2.67	0.0	0.000000
		-10	781,999,997	-3.25	0.0	0.000000
		0	782,000,001	1.37	0.0	0.000000
		+10	782,000,002	2.15	0.0	0.000000
		+20	781,999,998	-1.55	0.0	0.000000
		+30	781,999,999	-0.97	0.0	0.000000
		+40	781,999,999	-0.91	0.0	0.000000
		+50	781,999,999	-0.82	0.0	0.000000
115%	4.43	+22(Ref)	781,999,999	-0.70	0.0	0.000000
End point	3.55	+22(Ref)	781,999,999	-0.84	0.0	0.000000

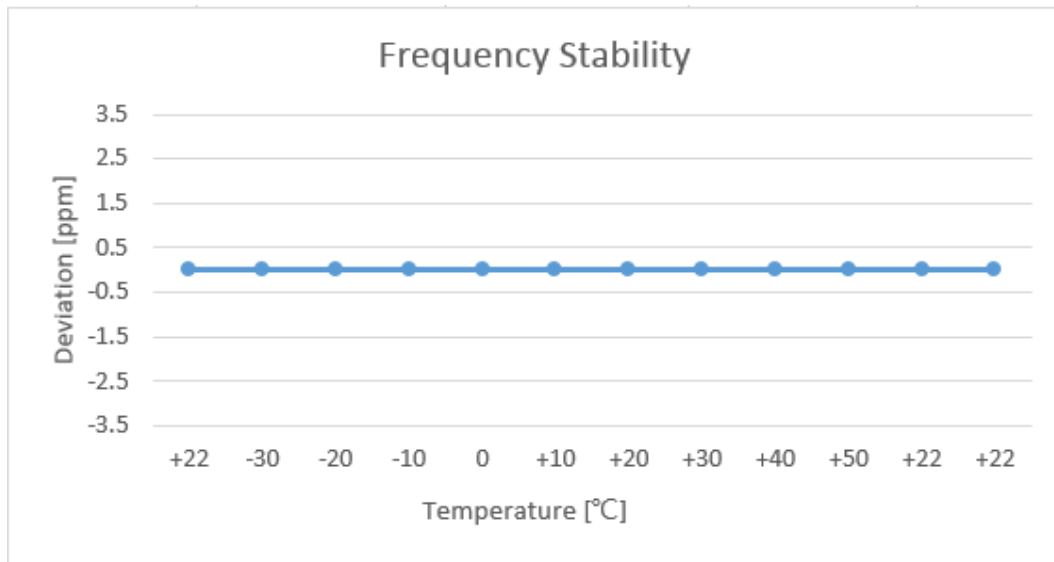

Test mode : LTE Band 25/2
 Frequency (Hz) : 1 882 500 000
 Channel : 26365
 Deviation limit(FCC&IC) : The frequency stability shall be sufficient to ensure that the fundamental emission stays within the authorized frequency block.
 Deviation limit(IC) : ±0.00025% or 2.5ppm

Voltage (%)	Power (V)	Temp. (°C)	Frequency (Hz)	Frequency error (Hz)	Deviation	
					(ppm)	(%)
100%	3.85	+22(Ref)	1,882,499,998	-1.62	0.0	0.000000
		-30	1,882,499,994	-6.39	0.0	0.000000
		-20	1,882,499,996	-4.19	0.0	0.000000
		-10	1,882,499,998	-2.39	0.0	0.000000
		0	1,882,499,997	-2.91	0.0	0.000000
		+10	1,882,499,997	-3.33	0.0	0.000000
		+20	1,882,499,997	-2.66	0.0	0.000000
		+30	1,882,499,999	-1.17	0.0	0.000000
		+40	1,882,499,998	-2.37	0.0	0.000000
		+50	1,882,499,996	-3.81	0.0	0.000000
115%	4.43	+22(Ref)	1,882,499,998	-1.86	0.0	0.000000
End point	3.55	+22(Ref)	1,882,499,999	-1.26	0.0	0.000000

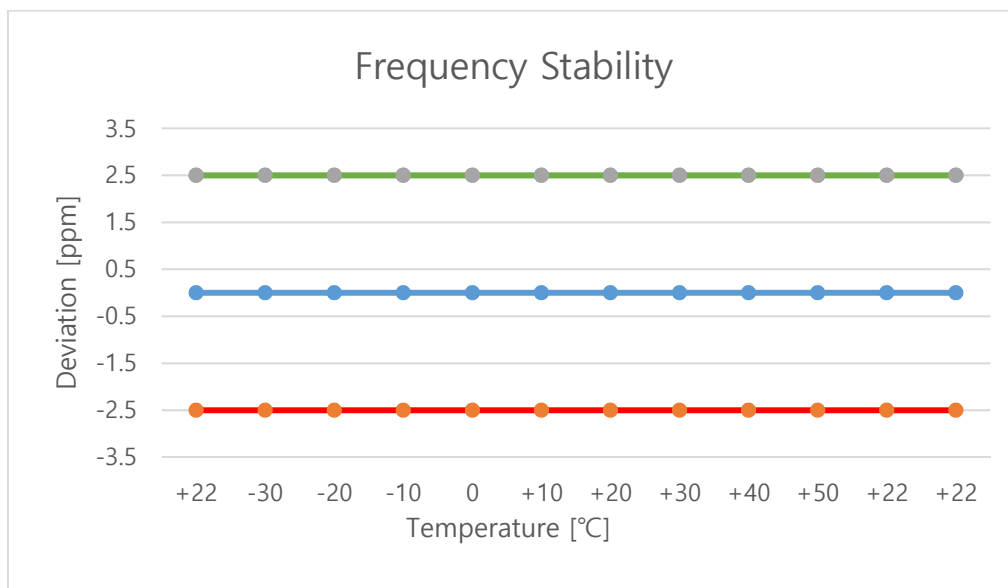

Test mode : LTE Band 26/5
 Frequency (Hz) : 836 500 000
 Channel : 26915
 Deviation limit(FCC&IC) : ±0.00025% or 2.5ppm

Voltage (%)	Power (V)	Temp. (°C)	Frequency (Hz)	Frequency error (Hz)	Deviation	
					(ppm)	(%)
100%	3.85	+22(Ref)	836,499,999	-0.73	0.0	0.000000
		-30	836,499,997	-3.48	0.0	0.000000
		-20	836,499,996	-3.61	0.0	0.000000
		-10	836,499,998	-2.32	0.0	0.000000
		0	836,499,997	-2.54	0.0	0.000000
		+10	836,499,997	-2.82	0.0	0.000000
		+20	836,499,998	-1.68	0.0	0.000000
		+30	836,499,999	-0.90	0.0	0.000000
		+40	836,499,999	-1.45	0.0	0.000000
		+50	836,499,997	-2.57	0.0	0.000000
115%	4.43	+22(Ref)	836,499,999	-0.84	0.0	0.000000
End point	3.55	+22(Ref)	836,500,000	-0.31	0.0	0.000000

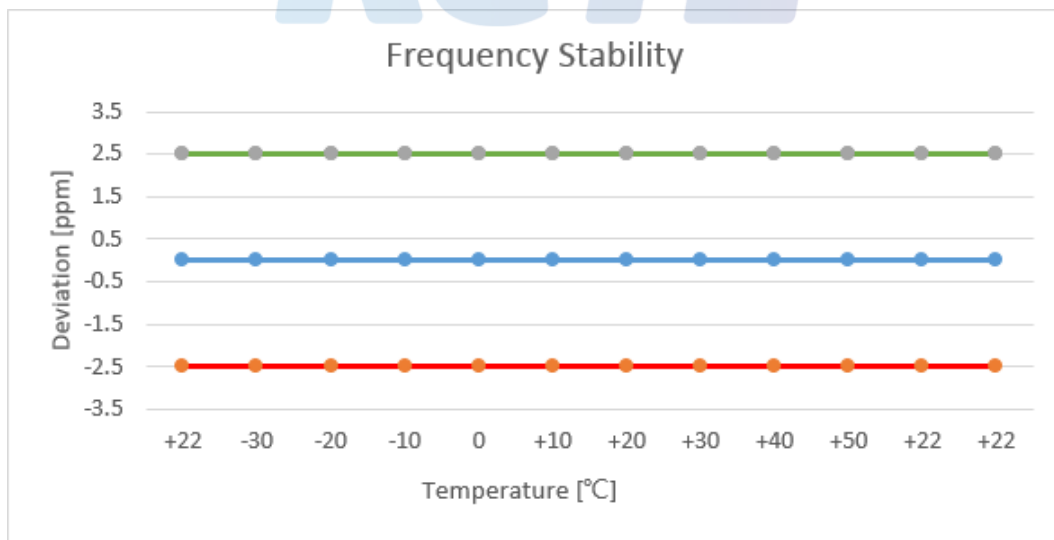

Test mode : LTE Band 66/4
 Frequency (Hz) : 1 745 000 000
 Channel : 132322
 Deviation limit(FCC&IC) : The frequency stability shall be sufficient to ensure that the fundamental emission stays within the authorized bands of operation.

Voltage (%)	Power (V)	Temp. (°C)	Frequency (Hz)	Frequency error (Hz)	Deviation	
					(ppm)	(%)
100%	3.85	+22(Ref)	1,744,999,999	-1.12	0.0	0.000000
		-30	1,744,999,996	-4.08	0.0	0.000000
		-20	1,744,999,996	-3.64	0.0	0.000000
		-10	1,744,999,997	-3.30	0.0	0.000000
		0	1,744,999,997	-3.03	0.0	0.000000
		+10	1,744,999,998	-2.47	0.0	0.000000
		+20	1,744,999,998	-1.95	0.0	0.000000
		+30	1,744,999,999	-0.89	0.0	0.000000
		+40	1,744,999,999	-1.49	0.0	0.000000
		+50	1,744,999,997	-2.62	0.0	0.000000
115%	4.43	+22(Ref)	1,744,999,998	-1.86	0.0	0.000000
End point	3.55	+22(Ref)	1,744,999,999	-0.99	0.0	0.000000

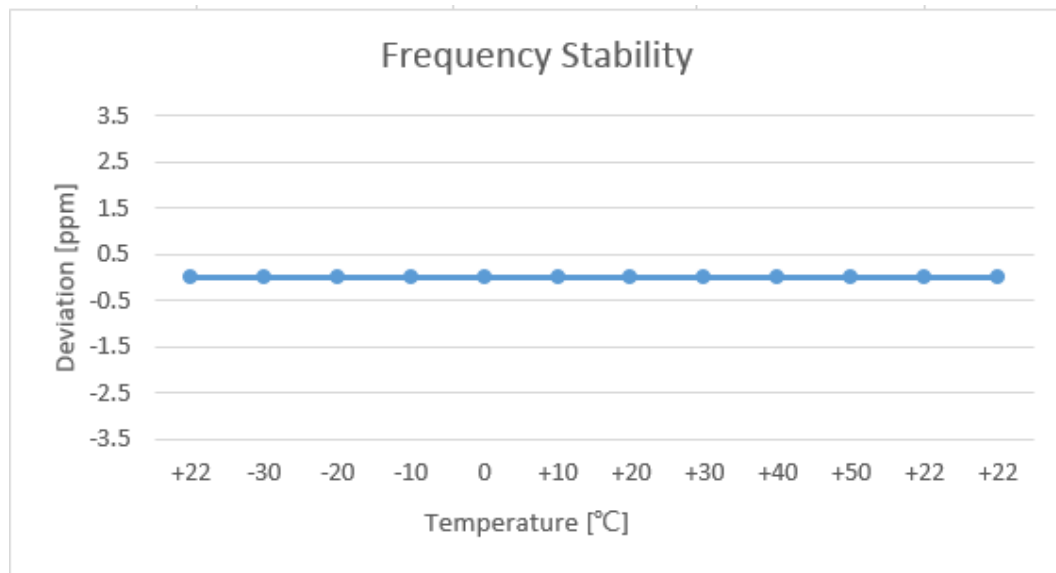

Test mode : LTE Band 71
 Frequency (Hz) : 680 500 000
 Channel : 133297
 Deviation limit(FCC&IC) : The frequency stability shall be sufficient to ensure that the fundamental emission stays within the authorized bands of operation.

Voltage (%)	Power (V)	Temp. (°C)	Frequency (Hz)	Frequency error (Hz)	Deviation	
					(ppm)	(%)
100%	3.85	+22(Ref)	680,500,001	1.10	0.0	0.000000
		-30	680,499,997	-2.55	0.0	0.000000
		-20	680,499,997	-2.77	0.0	0.000000
		-10	680,499,997	-3.35	0.0	0.000000
		0	680,499,998	-2.36	0.0	0.000000
		+10	680,499,998	-1.59	0.0	0.000000
		+20	680,499,999	-1.08	0.0	0.000000
		+30	680,500,000	-0.27	0.0	0.000000
		+40	680,499,999	-1.34	0.0	0.000000
		+50	680,499,998	-1.96	0.0	0.000000
115%	4.43	+22	680,500,001	0.67	0.0	0.000000
End point	2.55	+22	680,500,001	0.82	0.0	0.000000

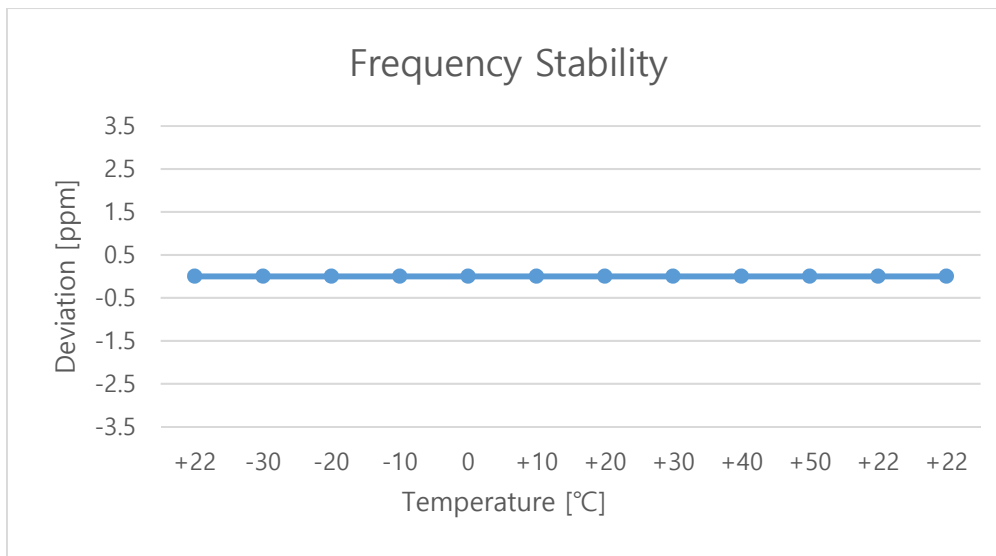

7.7. Radiated Power (ERP/EIRP)

Test setup

The diagram below shows the test setup that is utilized to make the measurements for emission from 30 MHz to 1 GHz emissions.

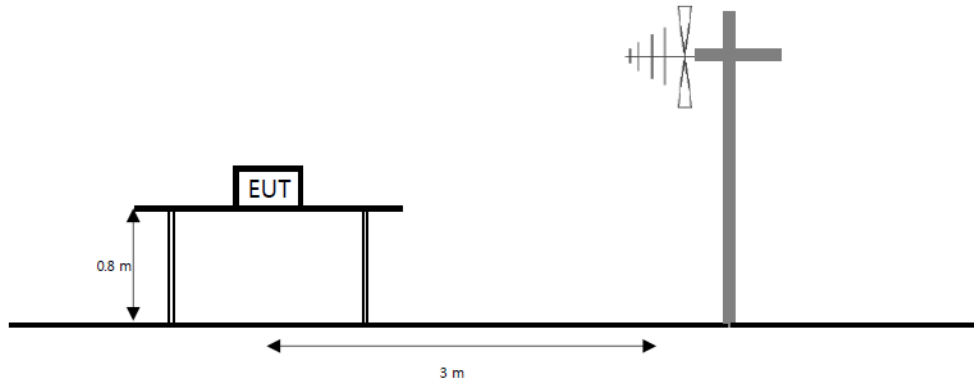

The diagram below shows the test setup that is utilized to make the measurements for emission from 1 GHz to the tenth harmonic of the highest fundamental frequency or to 40 GHz emissions, whichever is lower.

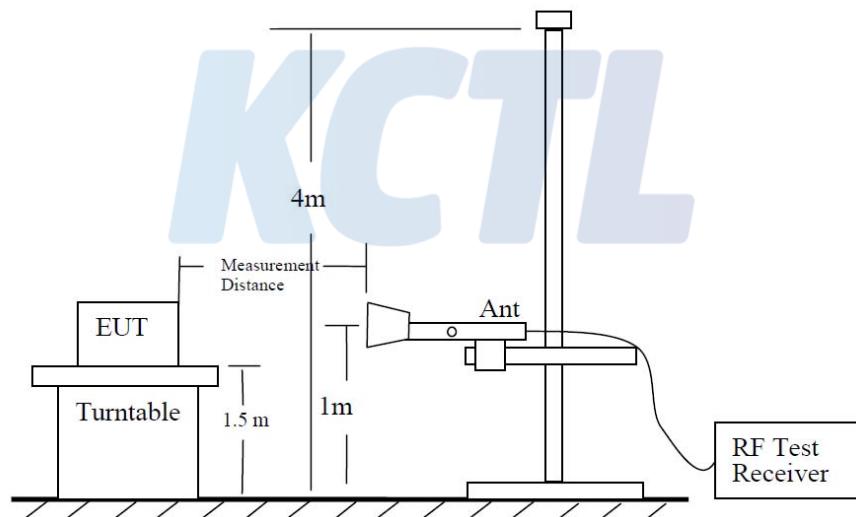

The diagram below shows the test setup for substituted method.

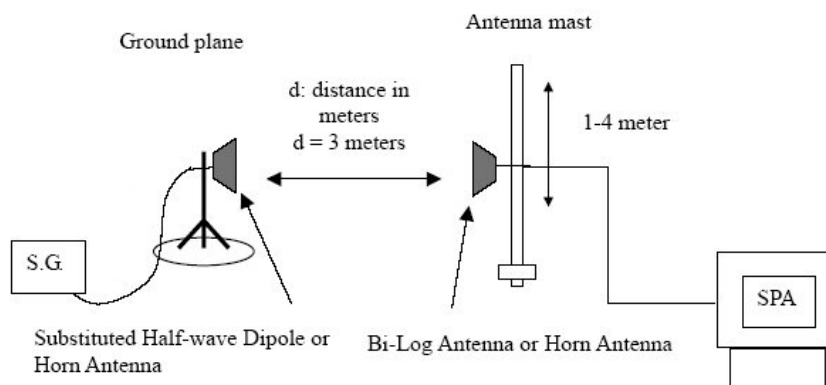

S

Limit

According to §22.913(a)(5), the ERP of transmitters in the cellular radiotelephone service must not exceed the limits in this section. The ERP of mobile transmitters and auxiliary test transmitters must not exceed 7 watts.

According to RSS-132(5.4), the equivalent isotropically radiated power (e.i.r.p) for mobile equipment shall not exceed 11.5 watts. Refer to SRSP-503 for base stations e.i.r.p limits.

According to §24.232(c) and RSS-133(6.4), Mobile and portable stations are limited to 2 watts EIRP and the equipment must employ a means for limiting power to the minimum necessary for successful communications.

According to §27.50(b)(10), 27.50(c)(10) and RSS-130(4.6), Portable stations (hand-held devices) in the 698 -746 MHz, 746-757 MHz, 776-788 MHz, and 805-806 MHz bands are limited 3 watts ERP.

According to §27.50(d)(4) and RSS-139(6.5), Fixed, mobile and portable (hand-held) stations operating in the 1710-1755 MHz and 1755-1780 MHz bands are limited to 1 watt EIRP.

Test procedure

971168 D01 v03r01 - Section 5.2 and 5.8, 412172 D01 v01r01

ANSI 63.26-2015 – Section 5.2

ANSI/TIA-603-E-2016 - Section 2.2.17

Test settings

- 1) RBW = 1 % to 5 % of the OBW.
- 2) VBW $\geq 3 \times$ RBW.
- 3) SPAN = 2 \times to 3 \times the OBW.
- 4) Number of measurement points in sweep $\geq 2 \times$ span / RBW.
- 5) Sweep time :
 - 1) Auto couple, or
 - 2) $\geq [10 \times (\text{number of points in sweep}) \times (\text{transmission period})]$ for single sweep (automation-compatible) measurement. Transmission period is the on and off time of the transmitter.
- 6) Detector = RMS
- 7) If the EUT can be configured to transmit continuously, then set the trigger to free run.
- 8) If the EUT cannot be configured to transmit continuously, then use a sweep trigger with the level set to enable triggering only on full power bursts and configure the EUT to transmit at full power for the entire duration of each sweep. Verify that the sweep time is less than or equal to the transmission burst duration. Time gating can also be used under similar constraints (i.e., configured such that measurement data is collected only during active full-power transmissions).
- 9) Trace mode = trace averaging (RMS) over 100 sweeps.
- 10) Compute the power by integrating the spectrum across the OBW of the signal using the instrument's band or channel power measurement function, with the band/channel limits set equal to the OBW band edges. If the instrument does not have a band or channel power function, then sum the spectrum levels (in linear power units) at intervals equal to the RBW extending across the entire OBW of the spectrum.
- 11) Allow trace to fully stabilize.

Notes:

1. On a test site, the EUT shall be placed at 80 cm height on a turn table, and in the position close To normal use as declared by the applicant.
2. The test antenna shall be oriented initially for vertical polarization located 3 m from EUT to Correspond to the fundamental frequency of the transmitter.
3. The turntable is rotated through 360°, and the receiving antenna scans in order to determine the Level of the maximized emission.
4. The test antenna shall be raised and lowered again through the specified range of height until the maximum signal level is detected by the measuring receiver.
5. The maximum signal level detected by the measuring receiver shall be noted.
6. The EUT was replaced by half-wave dipole (1 GHz below) or horn antenna (1 GHz above) connected to a signal generator.
The power is calculated by the following formula;
$$Pd(\text{dBm}) = Pg(\text{dBm}) - \text{Cable loss (dB)} + \text{Antenna gain (dB)}$$

Note. Pd is the dipole equivalent power and Pg is the generator output power into the substitution antenna.
7. The test antenna shall be raised and lowered through the specified range of height to ensure that The maximum signal is received.
8. The input signal to the substitution antenna shall be adjusted to the level that produces a level Detected by the measuring corrected for the change of input attenuator setting of the measuring Receiver.
9. The input level to the substitution antenna shall be recorded as power level in dBm, corrected for Any change of input attenuator setting of the measuring receiver.
10. The measurement shall be repeated with the test antenna and the substitution antenna Orientated for horizontal polarization.

Test results**Test mode: LTE Band 12**

Bandwidth	Modulation	Frequency	Pol.	Antenna Gain	C.L	Substitute Level	ERP	
		[MHz]	[V/H]	[dBi]	[dB]	[dBm]	[dBm]	[W]
1.4 M	QPSK	699.7	H	-0.70	4.60	18.67	13.37	0.022
		707.5	H	-0.60	4.66	18.24	12.98	0.020
		715.3	H	-0.80	4.69	18.37	12.88	0.019
	16QAM	699.7	H	-0.70	4.60	17.43	12.13	0.016
		707.5	H	-0.60	4.66	16.74	11.48	0.014
		715.3	H	-0.80	4.69	17.15	11.66	0.015
3 M	QPSK	700.5	H	-0.70	4.60	19.05	13.75	0.024
		707.5	H	-0.60	4.66	18.99	13.73	0.024
		714.5	H	-0.80	4.65	18.64	13.19	0.021
	16QAM	700.5	H	-0.70	4.60	17.70	12.40	0.017
		707.5	H	-0.60	4.66	17.84	12.58	0.018
		714.5	H	-0.80	4.65	17.17	11.72	0.015
5 M	QPSK	701.5	H	-0.70	4.65	19.35	14.00	0.025
		707.5	H	-0.60	4.66	19.85	14.59	0.029
		713.5	H	-0.80	4.66	19.07	13.61	0.023
	16QAM	701.5	H	-0.70	4.65	17.84	12.49	0.018
		707.5	H	-0.60	4.66	18.43	13.17	0.021
		713.5	H	-0.80	4.66	17.58	12.12	0.016
10 M	QPSK	704.0	H	-0.60	4.69	18.71	13.42	0.022
		707.5	H	-0.60	4.66	19.00	13.74	0.024
		711.0	H	-0.30	4.70	18.86	13.86	0.024
	16QAM	704.0	H	-0.60	4.69	17.31	12.02	0.016
		707.5	H	-0.60	4.66	17.76	12.50	0.018
		711.0	H	-0.30	4.70	17.30	12.30	0.017

Test mode: LTE Band 13

Bandwidth	Modulation	Frequency	Pol.	Antenna Gain	C.L	Substitute Level	ERP	
		[MHz]	[V/H]	[dBi]	[dB]	[dBm]	[dBm]	[W]
5 M	QPSK	779.5	H	0.60	4.84	14.61	10.37	0.011
		782.0	H	0.60	4.93	15.55	11.22	0.013
		784.5	H	0.10	4.91	16.20	11.39	0.014
	16QAM	779.5	H	0.60	4.84	13.45	9.21	0.008
		782.0	H	0.60	4.93	14.45	10.12	0.010
		784.5	H	0.10	4.91	14.73	9.92	0.010
10 M	QPSK	782.0	H	0.60	4.93	15.92	11.59	0.014
	16QAM	782.0	H	0.60	4.93	13.92	9.59	0.009

Note.

1. E.R.P & E.I.R.P(dBm) = Substitute Level(dB) + Antenna gain(dBi) - C.L(Cable loss) (dB)

Test mode: LTE Band 25/2

Bandwidth	Modulation	Frequency	Pol.	Antenna Gain	C.L	Substitute Level	EIRP	
		[MHz]	[V/H]	[dBi]	[dB]	[dBm]	[dBm]	[W]
1.4 M	QPSK	1 850.7	H	5.55	7.79	19.55	17.31	0.054
		1 882.5	H	5.45	7.86	19.24	16.83	0.048
		1 914.3	H	5.36	7.89	19.52	16.99	0.050
	16QAM	1 850.7	H	5.55	7.79	18.52	16.28	0.042
		1 882.5	H	5.45	7.86	17.76	15.35	0.034
		1 914.3	H	5.36	7.89	18.20	15.67	0.037
3 M	QPSK	1 851.5	H	5.55	7.79	19.74	17.50	0.056
		1 882.5	H	5.45	7.86	19.31	16.90	0.049
		1 913.5	H	5.36	7.89	19.61	17.08	0.051
	16QAM	1 851.5	H	5.55	7.79	18.43	16.19	0.042
		1 882.5	H	5.45	7.86	18.16	15.75	0.038
		1 913.5	H	5.36	7.89	18.10	15.57	0.036
5 M	QPSK	1 852.5	H	5.54	7.79	19.69	17.44	0.055
		1 882.5	H	5.45	7.86	19.31	16.90	0.049
		1 912.5	H	5.36	7.89	18.54	16.01	0.040
	16QAM	1 852.5	H	5.54	7.79	18.19	15.94	0.039
		1 882.5	H	5.45	7.86	17.87	15.46	0.035
		1 912.5	H	5.36	7.89	17.35	14.82	0.030
10 M	QPSK	1 855.0	H	5.54	7.80	19.70	17.43	0.055
		1 882.5	H	5.45	7.86	19.34	16.93	0.049
		1 910.0	H	5.37	7.89	18.54	16.02	0.040
	16QAM	1 855.0	H	5.54	7.80	18.37	16.10	0.041
		1 882.5	H	5.45	7.86	18.06	15.65	0.037
		1 910.0	H	5.37	7.89	18.26	15.74	0.037
15 M	QPSK	1 857.5	H	5.53	7.80	19.62	17.35	0.054
		1 882.5	H	5.45	7.86	20.32	17.91	0.062
		1 907.5	H	5.38	7.88	21.15	18.65	0.073
	16QAM	1 857.5	H	5.53	7.80	18.15	15.88	0.039
		1 882.5	H	5.45	7.86	18.91	16.50	0.045
		1 907.5	H	5.38	7.88	19.66	17.16	0.052
20 M	QPSK	1 860.0	H	5.52	7.81	20.10	17.81	0.060
		1 882.5	H	5.45	7.86	18.89	16.48	0.044
		1 905.0	H	5.39	7.88	18.65	16.15	0.041
	16QAM	1 860.0	H	5.52	7.81	19.00	16.71	0.047
		1 882.5	H	5.45	7.86	17.50	15.09	0.032
		1 905.0	H	5.39	7.88	18.23	15.73	0.037

Note.

1. E.R.P & E.I.R.P(dBm) = Substitute Level(dB) + Antenna gain(dBi) - C.L(Cable loss) (dB)

Test mode: LTE Band 26/5

Bandwidth	Modulation	Frequency	Pol.	Antenna Gain	C.L	Substitute Level	ERP		EIRP ^{Note.1}	
		[MHz]	[V/H]	[dBi]	[dB]	[dBm]	[dBm]	[W]	[dBm]	[W]
1.4 M	QPSK	824.7	H	-0.20	5.06	17.37	12.11	0.016	14.26	0.027
		836.5	H	-0.20	5.11	17.86	12.55	0.018	14.70	0.030
		848.3	H	-0.50	5.15	18.51	12.86	0.019	15.01	0.032
	16QAM	824.7	H	-0.20	5.06	16.35	11.09	0.013	13.24	0.021
		836.5	H	-0.20	5.11	16.90	11.59	0.014	13.74	0.024
		848.3	H	-0.50	5.15	17.11	11.46	0.014	13.61	0.023
3 M	QPSK	825.5	H	-0.20	5.07	18.51	13.24	0.021	15.39	0.035
		836.5	H	-0.20	5.11	17.92	12.61	0.018	14.76	0.030
		847.5	H	-0.50	5.15	18.30	12.65	0.018	14.80	0.030
	16QAM	825.5	H	-0.20	5.07	16.51	11.24	0.013	13.39	0.022
		836.5	H	-0.20	5.11	16.69	11.38	0.014	13.53	0.023
		847.5	H	-0.50	5.15	17.15	11.50	0.014	13.65	0.023
5 M	QPSK	826.5	H	-0.20	5.09	18.26	12.97	0.020	15.12	0.033
		836.5	H	-0.20	5.11	18.13	12.82	0.019	14.97	0.031
		846.5	H	-0.50	5.15	18.59	12.94	0.020	15.09	0.032
	16QAM	826.5	H	-0.20	5.09	17.02	11.73	0.015	13.88	0.024
		836.5	H	-0.20	5.11	16.81	11.50	0.014	13.65	0.023
		846.5	H	-0.50	5.15	17.07	11.42	0.014	13.57	0.023
10 M	QPSK	829.0	H	0.70	5.06	17.49	13.13	0.021	15.28	0.034
		836.5	H	-0.20	5.11	18.39	13.08	0.020	15.23	0.033
		844.0	H	-0.50	5.15	18.39	12.74	0.019	14.89	0.031
	16QAM	829.0	H	-0.70	5.06	17.74	11.98	0.016	14.13	0.026
		836.5	H	-0.20	5.11	17.06	11.75	0.015	13.90	0.025
		844.0	H	-0.50	5.15	17.01	11.36	0.014	13.51	0.022
15 M	QPSK	831.5	H	0.70	5.09	18.10	13.71	0.023	15.86	0.039
		836.5	H	-0.20	5.11	18.57	13.26	0.021	15.41	0.035
		841.5	H	-0.80	5.14	18.72	12.78	0.019	14.93	0.031
	16QAM	831.5	H	0.70	5.09	17.05	12.66	0.018	14.81	0.030
		836.5	H	-0.20	5.11	17.46	12.15	0.016	14.30	0.027
		841.5	H	-0.80	5.14	17.43	11.49	0.014	13.64	0.023

Note.

1. The E.I.R.P conversion formula for IC : E.I.R.P result (dBm)

= E.R.P result (dBm) + 2.15 (dB)

2. E.R.P & E.I.R.P(dBm) = Substitute Level(dB) + Antenna gain(dBi) - C.L(Cable loss) (dB)

Test mode: LTE Band 66/4

Bandwidth	Modulation	Frequency	Pol.	Antenna Gain	C.L	Substitute Level	EIRP	
		[MHz]	[V/H]	[dBi]	[dB]	[dBm]	[dBm]	[W]
1.4 M	QPSK	1 710.7	H	5.97	7.52	15.12	13.57	0.023
		1 745.0	H	5.87	7.60	15.79	14.05	0.025
		1 779.3	H	5.76	7.70	15.69	13.75	0.024
	16QAM	1 710.7	H	5.97	7.52	14.37	12.82	0.019
		1 745.0	H	5.87	7.60	14.15	12.41	0.017
		1 779.3	H	5.76	7.70	14.66	12.72	0.019
3 M	QPSK	1 711.5	H	5.97	7.53	15.07	13.51	0.022
		1 745.0	H	5.87	7.60	15.57	13.83	0.024
		1 778.5	H	5.76	7.70	15.59	13.65	0.023
	16QAM	1 711.5	H	5.97	7.53	13.46	11.90	0.015
		1 745.0	H	5.87	7.60	14.54	12.80	0.019
		1 778.5	H	5.76	7.70	14.88	12.94	0.020
5 M	QPSK	1 712.5	H	5.96	7.53	15.03	13.46	0.022
		1 745.0	H	5.87	7.60	15.45	13.71	0.023
		1 777.5	H	5.77	7.68	15.96	14.05	0.025
	16QAM	1 712.5	H	5.96	7.53	13.57	12.00	0.016
		1 745.0	H	5.87	7.60	13.88	12.14	0.016
		1 777.5	H	5.77	7.68	14.59	12.68	0.019
10 M	QPSK	1 715.0	H	5.96	7.52	15.85	14.28	0.027
		1 745.0	H	5.87	7.60	15.57	13.83	0.024
		1 775.0	H	5.78	7.68	15.18	13.27	0.021
	16QAM	1 715.0	H	5.96	7.52	14.74	13.17	0.021
		1 745.0	H	5.87	7.60	13.68	11.94	0.016
		1 775.0	H	5.78	7.68	14.08	12.17	0.016
15 M	QPSK	1 717.5	H	5.95	7.53	15.54	13.96	0.025
		1 745.0	H	5.87	7.60	15.46	13.72	0.024
		1 772.5	H	5.78	7.67	15.22	13.33	0.022
	16QAM	1 717.5	H	5.95	7.53	13.52	11.94	0.016
		1 745.0	H	5.87	7.60	13.92	12.18	0.017
		1 772.5	H	5.78	7.67	14.05	12.16	0.016
20 M	QPSK	1 720.0	H	5.94	7.53	14.47	12.88	0.019
		1 745.0	H	5.87	7.60	15.67	13.93	0.025
		1 770.0	H	5.79	7.66	15.89	14.02	0.025
	16QAM	1 720.0	H	5.94	7.53	12.91	11.32	0.014
		1 745.0	H	5.87	7.60	14.56	12.82	0.019
		1 770.0	H	5.79	7.66	14.75	12.88	0.019

Note.

1. E.R.P & E.I.R.P(dBm) = Substitute Level(dB) + Antenna gain(dBi) - C.L(Cable loss) (dB)

Test mode: LTE Band 71

Bandwidth	Modulation	Frequency	Pol.	Antenna Gain	C.L	Substitute Level	ERP	
		[MHz]	[V/H]	[dBi]	[dB]	[dBm]	[dBm]	[W]
5 M	QPSK	665.50	H	-1.20	4.53	18.35	12.62	0.018
		680.50	H	-0.90	4.56	18.23	12.77	0.019
		695.50	H	-0.30	4.63	17.74	12.81	0.019
	16QAM	665.50	H	-1.20	4.53	16.85	11.12	0.013
		680.50	H	-0.90	4.56	16.92	11.46	0.014
		695.50	H	-0.30	4.63	16.62	11.69	0.015
10 M	QPSK	668.00	H	-1.20	4.53	18.27	12.54	0.018
		680.50	H	-0.90	4.56	18.49	13.03	0.020
		693.00	H	-0.70	4.62	18.96	13.64	0.023
	16QAM	668.00	H	-1.20	4.53	16.74	11.01	0.013
		680.50	H	-0.90	4.56	17.38	11.92	0.016
		693.00	H	-0.70	4.62	17.58	12.26	0.017
15 M	QPSK	670.50	H	-1.40	4.56	18.42	12.46	0.018
		680.50	H	-0.90	4.56	19.24	13.78	0.024
		690.50	H	-0.70	4.58	19.26	13.98	0.025
	16QAM	670.50	H	-1.40	4.56	16.67	10.71	0.012
		680.50	H	-0.90	4.56	17.29	11.83	0.015
		690.50	H	-0.70	4.58	17.71	12.43	0.017
20 M	QPSK	673.00	H	-1.40	4.53	18.39	12.46	0.018
		680.50	H	-0.90	4.56	18.75	13.29	0.021
		688.00	H	-1.20	4.61	19.00	13.19	0.021
	16QAM	673.00	H	-1.40	4.53	17.01	11.08	0.013
		680.50	H	-0.90	4.56	16.52	11.06	0.013
		688.00	H	-1.20	4.61	17.28	11.47	0.014

Note.

1. E.R.P & E.I.R.P(dBm) = Substitute Level(dB) + Antenna gain(dBi) - C.L(Cable loss) (dB)

7.8. Radiated Spurious Emissions

Test setup

The diagram below shows the test setup that is utilized to make the measurements for emission from 30 MHz to 1 GHz emissions.

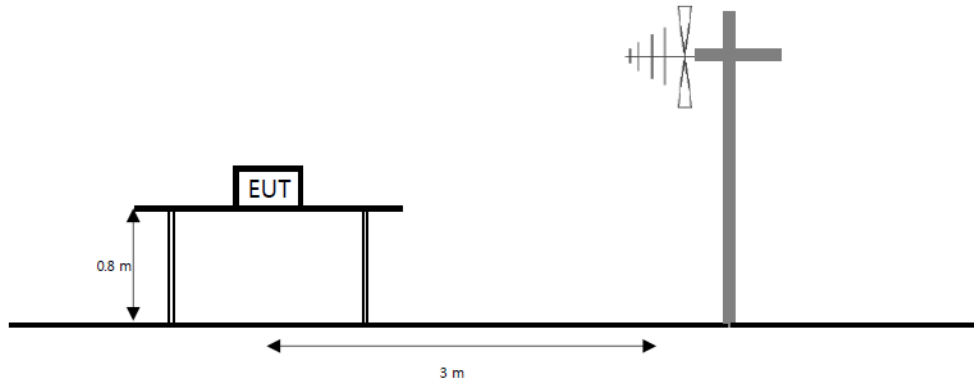

The diagram below shows the test setup that is utilized to make the measurements for emission from 1 GHz to the tenth harmonic of the highest fundamental frequency or to 40 GHz emissions, whichever is lower.

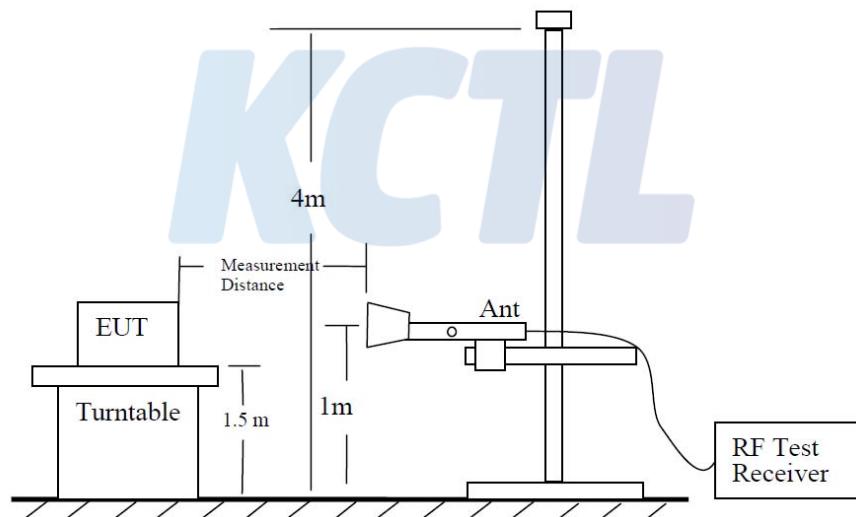

The diagram below shows the test setup for substituted method.

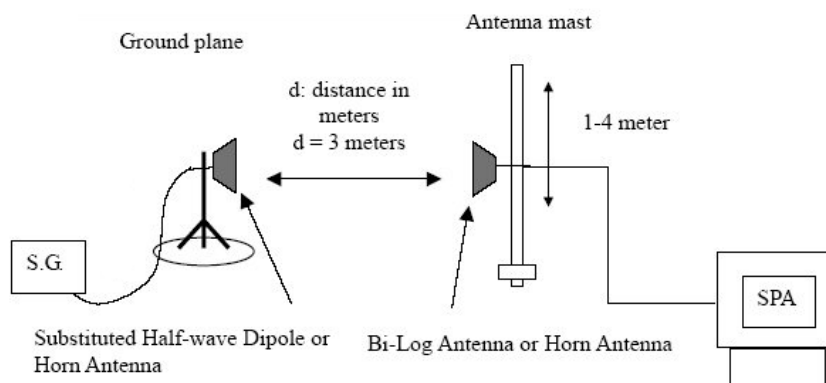

Limit

According to §22.917(a), §24.238(a) and RSS-132(5.5), RSS-133(6.5), the power of any emission outside of the authorized operating frequency ranges must be attenuated below the transmitting power (P) by a factor of at least $43 + 10\log(P_{\text{[Watts]}})$ dB.

According to §27.53(c)(2) and RSS-130(4.7), on any frequency outside the 776-788 MHz band, the power of any emission shall be attenuated outside the band below the transmitter power (P) by at least $43 + 10\log(P_{\text{[Watts]}})$ dB.

According to §27.53(f), for operations in the 746-758 MHz, 775-788 MHz, and 805-806 MHz bands, emissions in the band 1559-1610 MHz shall be limited to -70 dBW/MHz equivalent isotropically radiated power (EIRP) for wideband signals, and -80 dBW EIRP for discrete emissions of less than 700 Hz bandwidth. For the purpose of equipment authorization, a transmitter shall be tested with an antenna that is representative of the type that will be used with the equipment in normal operation.

According to §27.53(g) and RSS-130(4.7), for operations in the 600 MHz band and the 698-746 MHz band, the power of any emission outside a licensee's frequency band(s) of operation shall be attenuated below the transmitter power (P) within the licensed band(s) of operation, measured in watts, by at least $43 + 10\log(P_{\text{[Watts]}})$ dB.

According to §27.53(h) and RSS-139(6.6), the power of any emission outside a licensee's frequency block shall be attenuated below the transmitter power (P) in watts by at least $43 + 10\log(P_{\text{[Watts]}})$ dB.

Test procedure

971168 D01 v03r01 - Section 6.2

ANSI 63.26-2015 – Section 5.5

ANSI/TIA-603-E-2016 - Section 2.2.12

Test settings

- 1) RBW = 100 kHz for below 1 GHz and 1 MHz for above 1 GHz.
- 2) VBW $\geq 3 \times$ RBW.
- 3) Detector = RMS
- 4) Trace mode = Max hold
- 5) Sweep time = Auto couple
- 6) Number of sweep points $\geq 2 \times$ span / RBW
- 7) Allow trace to fully stabilize.

For the narrowband spurious settings:

- 1) RBW = 1 kHz
- 2) VBW = 3 kHz
- 3) Detector = RMS
- 4) Trace mode = Max hold
- 5) Sweep speed slow enough to maintain measurement calibration.

Notes:

1. On a test site, the EUT shall be placed at 80 cm height on a turn table, and in the position close to normal use as declared by the applicant.
2. The test antenna shall be oriented initially for vertical polarization located 3 m from EUT to correspond to the fundamental frequency of the transmitter.
3. The turntable is rotated through 360°, and the receiving antenna scans in order to determine the level of the maximized emission.
4. The test antenna shall be raised and lowered again through the specified range of height until the maximum signal level is detected by the measuring receiver.
5. The maximum signal level detected by the measuring receiver shall be noted.
6. The EUT was replaced by half-wave dipole (1 GHz below) or horn antenna (1 GHz above) connected to a signal generator.
7. The test antenna shall be raised and lowered through the specified range of height to ensure that the maximum signal is received.
8. The input signal to the substitution antenna shall be adjusted to the level that produces a level detected by the measuring corrected for the change of input attenuator setting of the measuring receiver.
9. The input level to the substitution antenna shall be recorded as power level in dBm, corrected for any change of input attenuator setting of the measuring receiver.
10. The measurement shall be repeated with the test antenna and the substitution antenna orientated for horizontal polarization.

Test results (Above 1 000 MHz)Test mode : LTE Band 12Frequency(MHz) : 701.5Channel : 23035Bandwidth(MHz) : 5

Mode	Frequency	Pol.	Antenna Gain	Cable loss	Substitute Level	Level	Limit	Margin
	[MHz]	[V/H]	[dBi]	[dB]	[dBm]	[dBm]	[dBm]	[dB]
QPSK	1 403.20	H	5.96	5.01	-52.15	-51.20	-13.00	38.20
	2 105.07	H	5.16	6.00	-49.06	-49.90	-13.00	36.90
	2 804.53	H	6.86	6.91	-59.35	-59.40	-13.00	46.40
	3 509.07	V	8.40	7.92	-56.98	-56.50	-13.00	43.50

Test mode : LTE Band 12Frequency(MHz) : 707.5Channel : 23095Bandwidth(MHz) : 5

Mode	Frequency	Pol.	Antenna Gain	Cable loss	Substitute Level	Level	Limit	Margin
	[MHz]	[V/H]	[dBi]	[dB]	[dBm]	[dBm]	[dBm]	[dB]
QPSK	1 416.00	V	6.05	5.03	-50.62	-49.60	-13.00	36.60
	2 123.20	H	5.17	6.02	-49.05	-49.90	-13.00	36.90
	2 831.73	H	6.99	6.95	-58.44	-58.40	-13.00	45.40
	3 538.67	V	8.42	7.97	-58.65	-58.20	-13.00	45.20

Test mode : LTE Band 12Frequency(MHz) : 713.5Channel : 23155Bandwidth(MHz) : 5

Mode	Frequency	Pol.	Antenna Gain	Cable loss	Substitute Level	Level	Limit	Margin
	[MHz]	[V/H]	[dBi]	[dB]	[dBm]	[dBm]	[dBm]	[dB]
QPSK	1 431.20	V	6.15	5.04	-54.81	-53.70	-13.00	40.70
	2 146.93	H	5.19	6.06	-48.03	-48.90	-13.00	35.90
	2 864.27	H	7.15	6.99	-60.26	-60.10	-13.00	47.10
	3 580.80	H	8.43	7.82	-58.61	-58.00	-13.00	45.00

Note.

1. ERP & E.I.R.P(dB m)= Substitute Level(dB) + Antenna gain(dBi) – Cable Loss(dB)

Test mode : LTE Band 13Frequency(MHz) : 782.0Channel : 23230Bandwidth(MHz) : 10

Mode	Frequency	Pol.	Antenna Gain	Cable loss	Substitute Level	Level	Limit	Margin
	[MHz]	[V/H]	[dBi]	[dB]	[dBm]	[dBm]	[dBm]	[dB]
QPSK	1 555.04	H	6.43	5.28	-46.15	-45.00	-13.00	32.00
	2 332.58	H	5.30	6.32	-49.98	-51.00	-13.00	38.00
	3 102.13	H	7.92	7.34	-61.18	-60.60	-13.00	47.60
	3 886.68	V	8.55	8.45	-57.60	-57.50	-13.00	44.50

Test mode : LTE Band 13Frequency(MHz) : 782.0 (1 559 – 1 610 MHz)Channel : 23230Bandwidth(MHz) : 10

Mode	Frequency	Pol.	Antenna Gain	Cable loss	Substitute Level	Level	Limit	Margin
	[MHz]	[V/H]	[dBi]	[dB]	[dBm]	[dBm]	[dBm]	[dB]
QPSK	1 571.48	V	6.39	5.29	-97.80	-96.70	-50.00	46.70

Note.

1. Limit Calculation(dBm)= 43 + 10log(P_[Watts])

Limit Calculation of wide-band (dBm/MHz) = -70dBW/MHz (-40 dBm/MHz)

Limit Calculation of narrow-band (dBm) = -80dBW (-50dBm)

2. ERP & E.I.R.P(dB m)= Substitute Level(dB) + Antenna gain(dBi) – Cable Loss(dB)

Test mode : LTE Band 25/2Frequency(MHz) : 1 857.5Channel : 26115Bandwidth(MHz) : 15

Mode	Frequency	Pol.	Antenna Gain	Cable loss	Substitute Level	Level	Limit	Margin
	[MHz]	[V/H]	[dBi]	[dB]	[dBm]	[dBm]	[dBm]	[dB]
QPSK	3 728.50	V	8.49	8.24	-47.95	-47.70	-13.00	34.70
	5 592.50	H	10.52	10.37	-46.55	-46.40	-13.00	33.40
	7 458.00	H	12.03	11.76	-52.47	-52.20	-13.00	39.20
	9 322.50	H	13.20	13.05	-51.05	-50.90	-13.00	37.90

Test mode : LTE Band 25/2Frequency(MHz) : 1 882.5Channel : 26365Bandwidth(MHz) : 15

Mode	Frequency	Pol.	Antenna Gain	Cable loss	Substitute Level	Level	Limit	Margin
	[MHz]	[V/H]	[dBi]	[dB]	[dBm]	[dBm]	[dBm]	[dB]
QPSK	3 765.50	H	8.51	8.30	-47.91	-47.70	-13.00	34.70
	5 648.00	V	10.53	10.56	-44.57	-44.60	-13.00	31.60
	7 530.50	V	12.13	11.80	-53.93	-53.60	-13.00	40.60
	9 412.50	H	13.20	13.10	-50.30	-50.20	-13.00	37.20

Test mode : LTE Band 25/2Frequency(MHz) : 1 907.5Channel : 26615Bandwidth(MHz) : 15

Mode	Frequency	Pol.	Antenna Gain	Cable loss	Substitute Level	Level	Limit	Margin
	[MHz]	[V/H]	[dBi]	[dB]	[dBm]	[dBm]	[dBm]	[dB]
QPSK	3 801.50	V	8.52	8.36	-47.46	-47.30	-13.00	34.30
	5 702.00	V	10.54	10.34	-45.90	-45.70	-13.00	32.70
	7 601.00	H	12.20	11.86	-53.54	-53.20	-13.00	40.20
	9 501.00	V	13.20	13.04	-48.96	-48.80	-13.00	35.80

Note.

1. ERP & E.I.R.P(dB m)= Substitute Level(dB) + Antenna gain(dBi) – Cable Loss(dB)

Test mode : LTE Band 26/5Frequency(MHz) : 831.5Channel : 26865Bandwidth(MHz) : 15

Mode	Frequency	Pol.	Antenna Gain	Cable loss	Substitute Level	Level	Limit	Margin
	[MHz]	[V/H]	[dBi]	[dB]	[dBm]	[dBm]	[dBm]	[dB]
QPSK	1 676.04	H	6.07	5.36	-52.51	-51.80	-13.00	38.80
	2 514.60	H	5.47	6.55	-48.52	-49.60	-13.00	36.60
	3 352.65	H	8.22	7.70	-49.92	-49.40	-13.00	36.40
	4 190.70	V	8.45	8.81	-46.04	-46.40	-13.00	33.40

Test mode : LTE Band 26/5Frequency(MHz) : 836.5Channel : 26915Bandwidth(MHz) : 15

Mode	Frequency	Pol.	Antenna Gain	Cable loss	Substitute Level	Level	Limit	Margin
	[MHz]	[V/H]	[dBi]	[dB]	[dBm]	[dBm]	[dBm]	[dB]
QPSK	1 686.54	V	6.04	5.36	-52.08	-51.40	-13.00	38.40
	2 529.60	V	5.54	6.57	-49.67	-50.70	-13.00	37.70
	3 372.65	H	8.25	7.73	-48.02	-47.50	-13.00	34.50
	4 215.70	V	8.43	8.88	-49.05	-49.50	-13.00	36.50

Test mode : LTE Band 26/5Frequency(MHz) : 841.5Channel : 26965Bandwidth(MHz) : 15

Mode	Frequency	Pol.	Antenna Gain	Cable loss	Substitute Level	Level	Limit	Margin
	[MHz]	[V/H]	[dBi]	[dB]	[dBm]	[dBm]	[dBm]	[dB]
QPSK	1 696.54	V	6.01	5.37	-51.74	-51.10	-13.00	38.10
	2 544.60	V	5.61	6.58	-48.43	-49.40	-13.00	36.40
	3 396.15	V	8.28	7.76	-57.72	-57.20	-13.00	44.20
	4 240.70	V	8.41	8.91	-48.10	-48.60	-13.00	35.60

Note.

1. ERP & E.I.R.P(dB m)= Substitute Level(dB) + Antenna gain(dBi) – Cable Loss(dB)

Test mode : LTE Band 66/4Frequency(MHz) : 1 715.0Channel : 132022Bandwidth(MHz) : 10

Mode	Frequency	Pol.	Antenna Gain	Cable loss	Substitute Level	Level	Limit	Margin
	[MHz]	[V/H]	[dBi]	[dB]	[dBm]	[dBm]	[dBm]	[dB]
QPSK	3 420.00	H	8.30	7.80	-59.90	-59.40	-13.00	46.40
	5 131.50	V	10.28	9.84	-43.84	-43.40	-13.00	30.40
	6 841.50	V	11.14	11.46	-53.18	-53.50	-13.00	40.50
	8 551.00	V	13.11	12.51	-52.00	-51.40	-13.00	38.40

Test mode : LTE Band 66/4Frequency(MHz) : 1 745.0Channel : 132322Bandwidth(MHz) : 10

Mode	Frequency	Pol.	Antenna Gain	Cable loss	Substitute Level	Level	Limit	Margin
	[MHz]	[V/H]	[dBi]	[dB]	[dBm]	[dBm]	[dBm]	[dB]
QPSK	3 498.50	H	8.40	7.91	-52.49	-52.00	-13.00	39.00
	5 248.50	V	10.35	9.98	-46.17	-45.80	-13.00	32.80
	7 000.50	H	11.30	11.45	-53.65	-53.80	-13.00	40.80
	8 751.00	H	13.15	12.64	-52.21	-51.70	-13.00	38.70

Test mode : LTE Band 66/4Frequency(MHz) : 1 775.0Channel : 132622Bandwidth(MHz) : 10

Mode	Frequency	Pol.	Antenna Gain	Cable loss	Substitute Level	Level	Limit	Margin
	[MHz]	[V/H]	[dBi]	[dB]	[dBm]	[dBm]	[dBm]	[dB]
QPSK	3 559.00	H	8.42	7.81	-48.91	-48.30	-13.00	35.30
	5 338.00	V	10.40	10.09	-42.61	-42.30	-13.00	29.30
	7 121.00	H	11.49	11.44	-54.85	-54.80	-13.00	41.80
	8 900.50	H	13.18	12.72	-51.96	-51.50	-13.00	38.50

Note.

1. ERP & E.I.R.P(dB m)= Substitute Level(dB) + Antenna gain(dBi) – Cable Loss(dB)

Test mode : LTE Band 71Frequency(MHz) : 670.5Channel : 133197Bandwidth(MHz) : 15

Mode	Frequency	Pol.	Antenna Gain	Cable loss	Substitute Level	Level	Limit	Margin
	[MHz]	[V/H]	[dBi]	[dB]	[dBm]	[dBm]	[dBm]	[dB]
QPSK	1 327.47	H	5.46	4.89	-56.87	-56.30	-13.00	43.30
	1 991.47	H	5.13	5.85	-53.68	-54.40	-13.00	41.40
	2 652.80	V	6.13	6.79	-57.44	-58.10	-13.00	45.10
	3 315.20	V	8.18	7.65	-58.73	-58.20	-13.00	45.20

Test mode : LTE Band 71Frequency(MHz) : 680.5Channel : 133297Bandwidth(MHz) : 15

Mode	Frequency	Pol.	Antenna Gain	Cable loss	Substitute Level	Level	Limit	Margin
	[MHz]	[V/H]	[dBi]	[dB]	[dBm]	[dBm]	[dBm]	[dB]
QPSK	1 346.93	H	5.59	4.92	-65.37	-64.70	-13.00	51.70
	2 019.73	H	5.11	5.88	-59.83	-60.60	-13.00	47.60
	2 692.53	H	6.32	6.75	-59.77	-60.20	-13.00	47.20
	3 365.33	V	8.24	7.72	-58.42	-57.90	-13.00	44.90

Test mode : LTE Band 71Frequency(MHz) : 690.5Channel : 13397Bandwidth(MHz) : 15

Mode	Frequency	Pol.	Antenna Gain	Cable loss	Substitute Level	Level	Limit	Margin
	[MHz]	[V/H]	[dBi]	[dB]	[dBm]	[dBm]	[dBm]	[dB]
QPSK	1 366.13	H	5.72	4.96	-66.36	-65.60	-13.00	52.60
	2 051.47	H	5.13	5.92	-53.01	-53.80	-13.00	40.80
	2 732.80	H	6.52	6.81	-58.31	-58.60	-13.00	45.60
	3 415.73	V	8.30	7.79	-58.71	-58.20	-13.00	45.20

Note.

1. ERP & E.I.R.P(dB m)= Substitute Level(dB) + Antenna gain(dBi) – Cable Loss(dB)

8. Measurement equipment

Equipment Name	Manufacturer	Model No.	Serial No.	Next Cal. Date
Spectrum Analyzer	R&S	FSV30	100807	20.07.30
Spectrum Analyzer	AGILENT	N9040B	MY57010132	20.07.31
Vector Signal Generator	R&S	SMBV100A	257566	20.07.16
Signal Generator	R&S	SMR40	100007	21.04.08
Signal Generator	R&S	SMB100A	176206	21.01.21
Wideband Radio Communication Tester	R&S	CMW500	141780	21.04.16*
Wideband Radio Communication Tester	R&S	CMW500	102572	20.09.19
DC Power Supply	AGILENT	E3632A	KR73001026	21.04.09
Power Divider	AGILENT	11636B	54456	21.01.06
Temp & Humid Chamber	ESPEC CORP.	SH-661	92004048	21.01.03
Biconical VHF-UHF Broadband Antenna	SCHWARZBECK	VUBA9117	275	22.04.09
Bilog Antenna	Teseq GmbH	CBL 6143A	35039	21.05.21
Horn Antenna	ETS.lindgren	3115	62589	20.08.01
Horn Antenna	ETS.lindgren	3117	161225	21.05.12*
Horn Antenna	ETS.lindgren	3116	00086632	21.02.17
Horn Antenna	ETS.lindgren	3116	00086635	21.05.12*
High pass Filter	Wainwright Instruments GmbH	WHKX3.0/18G-12SS	44	21.01.21
High pass Filter	Wainwright Instruments GmbH	WHKX1.0/1.5S-10SS	14	21.01.21
Attenuator	Weinschel ENGINEERING	10	AJ1239	21.05.15*
Attenuator	API Inmet	40AH2W-10	12	21.05.12*
Amplifier	SONOMA INSTRUMENT	310N	186280	21.01.21
Amplifier	L-3 Narda-MITEQ	AMF-7D-01001800-22-10P	2031196	21.02.12
Amplifier	L-3 Narda-MITEQ	JS44-18004000-33-8P	2000997	20.08.01
Antenna Mast	MATURO	EAS 1.5	042/8941211	N/A
Antenna Mast	MATURO	EAS 1.5	043/8941211	N/A
Turn Table	MATURO	TT 0.8 PF	041/8941211	N/A

*The equipment was used after finished calibration.

End of test report