

HIGH CHANNEL(9RU) HORIZONTAL

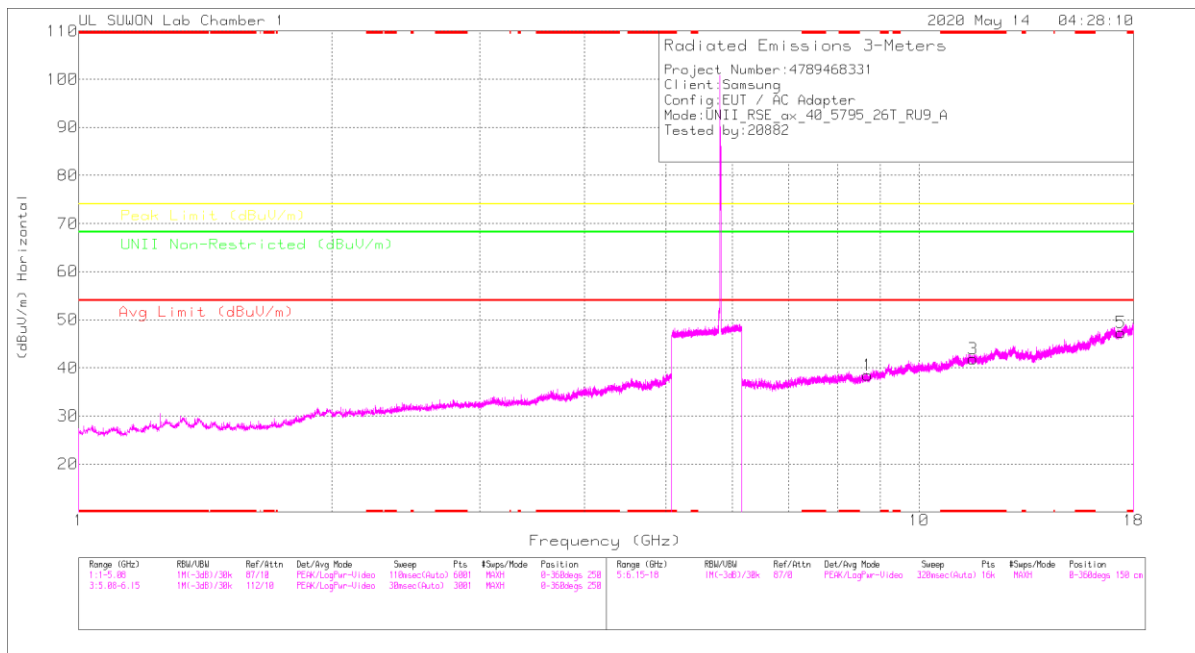

HIGH CHANNEL(9RU) VERTICAL

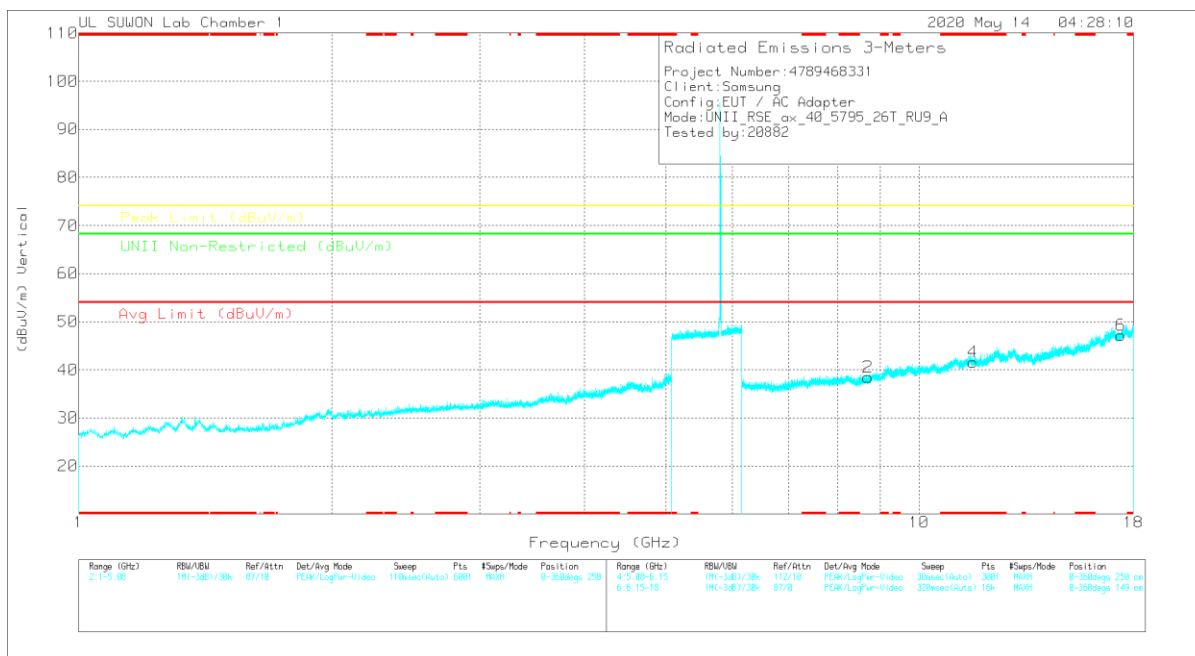

Note: Emission was scanned up to 40GHz; No emissions were detected above the noise floor which was at least 20dB below the specification limit.

HIGH CHANNEL(9RU) DATA

Radiated Emissions

Frequency (MHz)	Meas. Reading (dBμV)	Dist	317_0016B717	6GHz_HPS(B)	DC Cor (dB)	Corrected Reading (dBμV/m)	Avg Limit (dBμV/m)	Margin (dB)	Peak Limit (dBμV/m)	Margin (dB)	UNII Non-Restricted (dBμV/m)	Margin (dB)	Altitude (ft)	Height (m)	Polarity
8.69626	38.12	PK-U	36.4	-25.6	0	48.92	-	-	-	-	68.2	-19.28	360	100	H
8.69621	37.57	PK-U	36.4	-25.6	0	48.57	-	-	-	-	68.2	-19.63	360	100	V
* 11.59183	35.93	PK-U	38.6	-22.1	0	52.43	-	-	74	-21.57	-	-	360	100	H
* 11.59294	36.78	PK-U	38.6	-22.1	0	53.28	-	-	74	-20.72	-	-	360	100	V
17.38156	34.38	PK-U	41.2	-17.7	0	57.88	-	-	-	-	68.2	-10.32	360	100	H
17.38256	34.33	PK-U	41.2	-17.7	0	57.83	-	-	-	-	68.2	-10.37	360	100	V

* - indicates frequency in CFR47 Pt 15 / IC RSS-Restricted Band

PK-U - U-NII: Maximum Peak

**11.8.3. TX ABOVE 1GHz HE80(RU) MODE IN THE 5.8GHz BAND
 HARMONICS AND SPURIOUS EMISSIONS – ANT1**

MID CHANNEL(0RU) HORIZONTAL

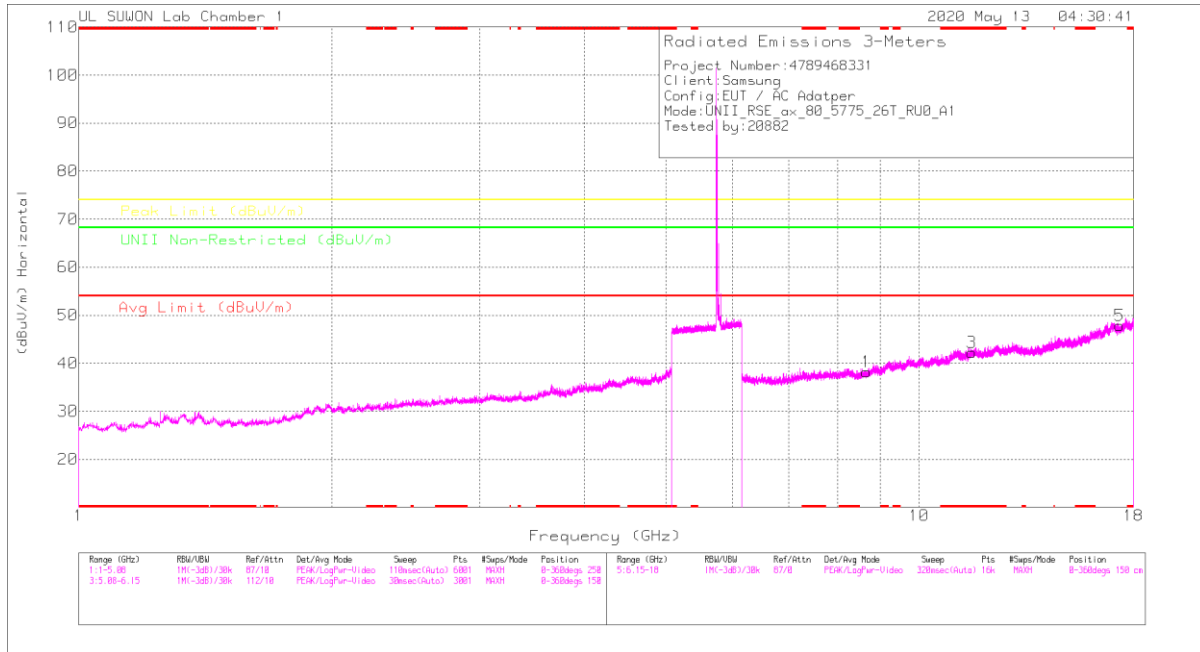

MID CHANNEL(0RU) VERTICAL

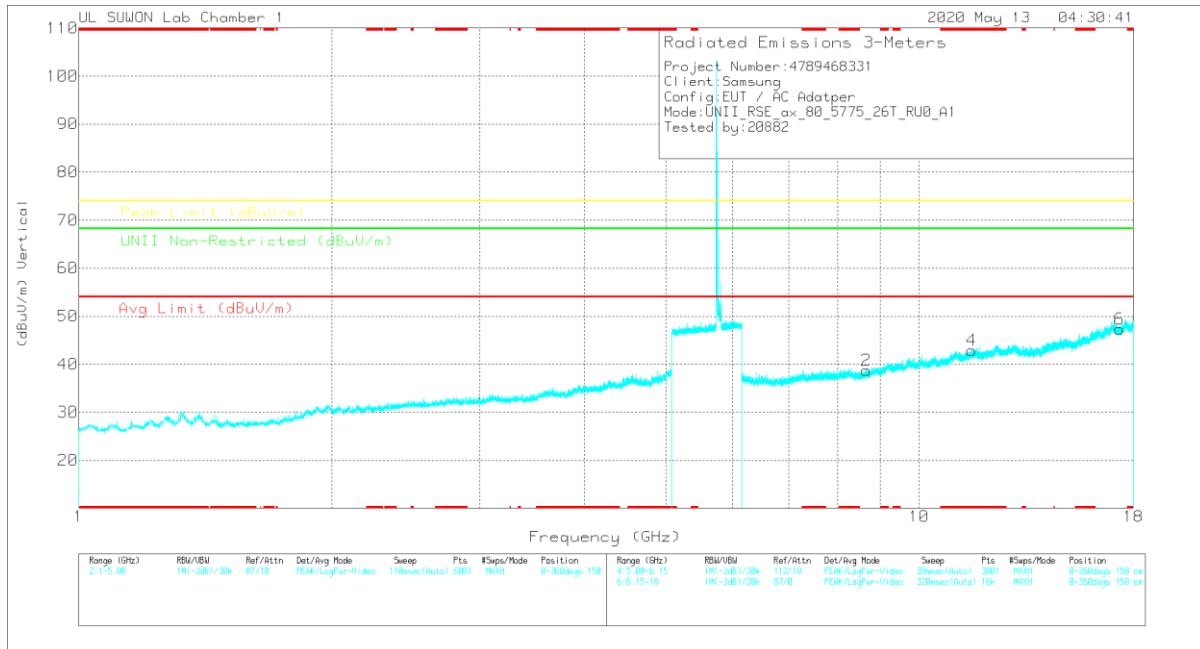

Note: Emission was scanned up to 40GHz; No emissions were detected above the noise floor which was at least 20dB below the specification limit.

MID CHANNEL(0RU) DATA

Radiated Emissions

Frequency (MHz)	Maxi ^r Reading (dBμV)	Dist	317_0016B717	6GHz_HPS(B)	DC Cor (dB)	Corrected Reading (dBμV/m)	Avg Limit (dBμV/m)	Margin (dB)	Peak Limit (dBμV/m)	Margin (dB)	UNII Non-Restricted (dBμV/m)	Margin (dB)	Altitude (Meters)	Height (m)	Polarity
8.66284	37.99	PK-U	36.4	-25.1	0	49.19	-	-	-	-	68.2	-19.01	360	100	H
8.66334	37.86	PK-U	36.4	-25.1	0	49.16	-	-	-	-	68.2	-19.04	360	100	V
* 11.55003	35.67	PK-U	38.6	-22.3	0	51.97	-	-	74	-22.03	-	-	360	100	H
* 11.55001	35.99	PK-U	38.6	-22.3	0	52.29	-	-	74	-21.71	-	-	360	100	V
17.32528	34.24	PK-U	41.2	-17.5	0	57.94	-	-	-	-	68.2	-10.26	360	100	H
17.3252	35.02	PK-U	41.2	-17.5	0	58.72	-	-	-	-	68.2	-9.48	360	100	V

* - indicates frequency in CFR47 Pt 15 / IC RSS-Restricted Band
 PK-U - U-NII: Maximum Peak

HARMONICS AND SPURIOUS EMISSIONS – ANT2

MID CHANNEL(0RU) HORIZONTAL

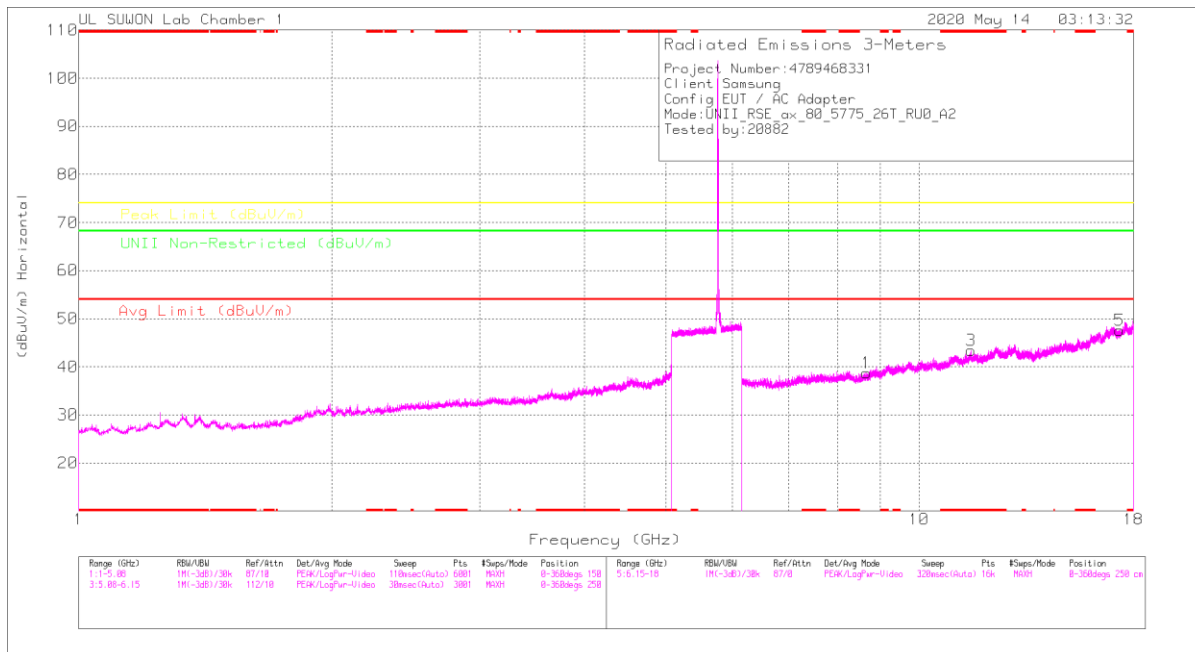

MID CHANNEL(0RU) VERTICAL

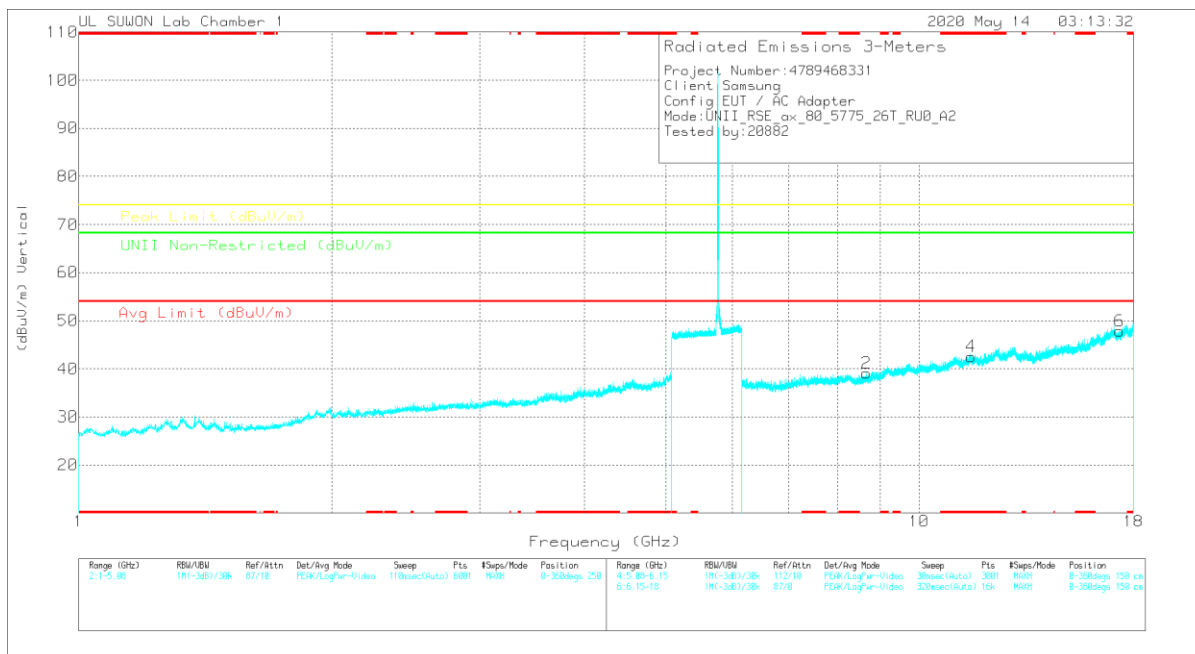

Note: Emission was scanned up to 40GHz; No emissions were detected above the noise floor which was at least 20dB below the specification limit.

MID CHANNEL(0RU) DATA

Radiated Emissions

Frequency (MHz)	Mask Reading (dBμV)	Dist	317_0016B717	6GHz_HPS(B)	DC Cor (dB)	Corrected Reading (dBμV/m)	Avg Limit (dBμV/m)	Margin (dB)	Peak Limit (dBμV/m)	Margin (dB)	UNI Non-Restricted (dBμV/m)	Margin (dB)	Altitude (Meters)	Height (m)	Polarity
8.66501	37.16	PK-U	36.4	-25.4	0	48.46	-	-	-	-	68.2	-19.74	360	100	H
8.66518	37.45	PK-U	36.4	-25.1	0	48.75	-	-	-	-	68.2	-19.45	360	100	V
* 11.5283	36.94	PK-U	38.5	-22.6	0	52.84	-	-	74	-21.16	-	-	360	100	H
* 11.52918	36.11	PK-U	38.5	-22.5	0	52.11	-	-	74	-21.89	-	-	360	100	V
17.31894	33.97	PK-U	41.3	-17.5	0	57.77	-	-	-	-	68.2	-10.43	360	100	H
17.32054	35.03	PK-U	41.3	-17.4	0	58.93	-	-	-	-	68.2	-9.27	360	100	V

* - indicates frequency in CFR47 Pt 15 / IC RSS-Restricted Band

PK-U - U-NII: Maximum Peak

HARMONICS AND SPURIOUS EMISSIONS – ANT1+ANT2

MID CHANNEL(18RU) HORIZONTAL

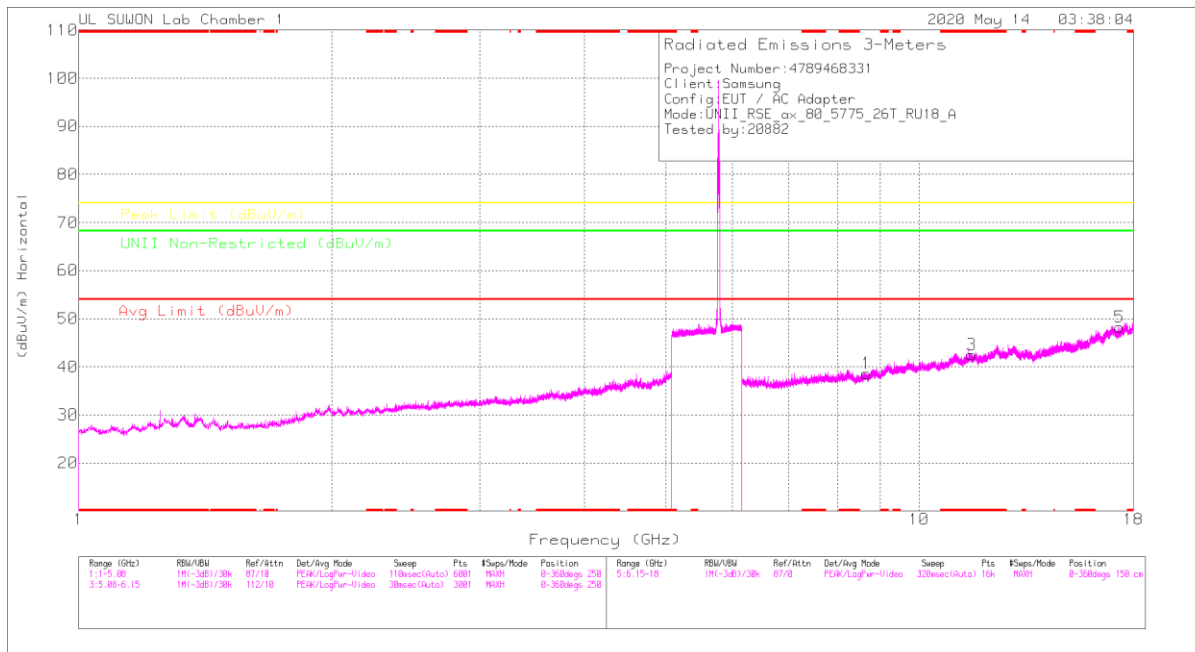

MID CHANNEL(18RU) VERTICAL

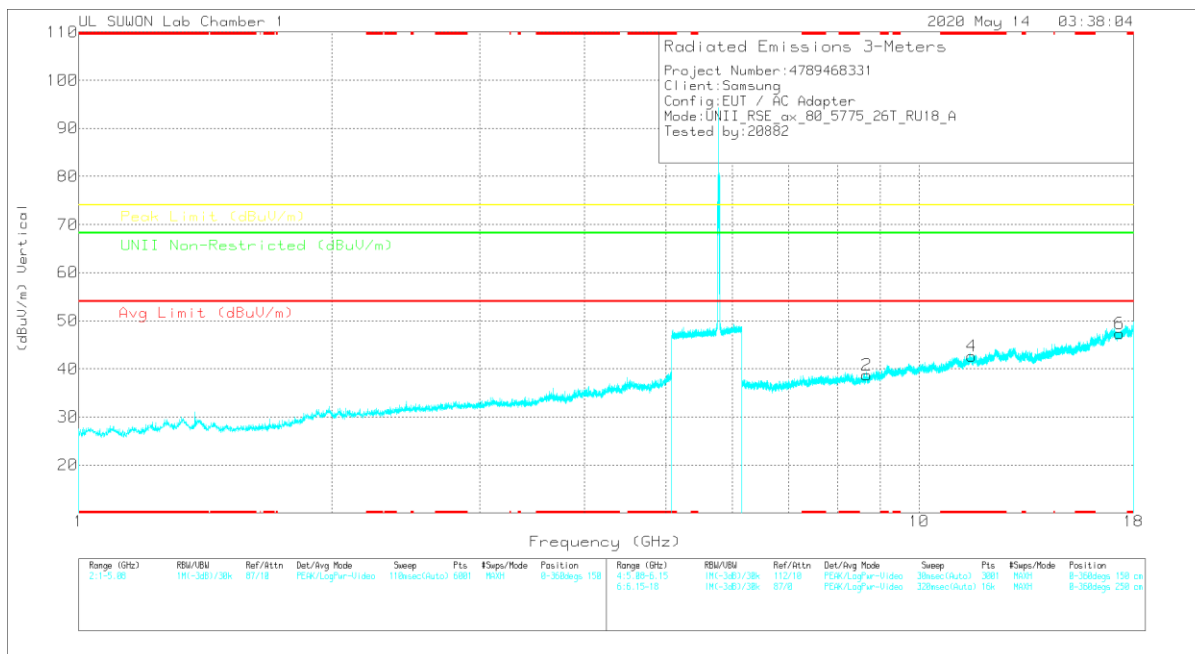

Note: Emission was scanned up to 40GHz; No emissions were detected above the noise floor which was at least 20dB below the specification limit.

MID CHANNEL(18RU) DATA

Radiated Emissions

Frequency (MHz)	Meas. Reading (dBµV)	Dist	317_0016B717	6GHz_HPS(B)	DC Cor (dB)	Corrected Reading (dBµV/m)	Aug Limit (dBµV/m)	Margin (dB)	Peak Limit (dBµV/m)	Margin (dB)	UNI Non-Restricted (dBµV/m)	Margin (dB)	Altitude (ft)	Height (m)	Polarity
8.66032	37.42	PK-U	36.4	-25	0	40.82	-	-	-	-	68.2	-19.38	360	100	H
8.66306	37.34	PK-U	36.4	-25.1	0	48.64	-	-	-	-	68.2	-19.56	360	100	V
* 11.54698	36.03	PK-U	38.5	-22.3	0	52.23	-	-	74	-21.77	-	-	360	100	H
* 11.54819	36.36	PK-U	38.5	-22.3	0	52.56	-	-	74	-21.44	-	-	360	100	V
17.32686	34.08	PK-U	41.2	-17.5	0	57.78	-	-	-	-	68.2	-10.42	360	100	H
17.32537	34.32	PK-U	41.2	-17.5	0	58.02	-	-	-	-	68.2	-10.18	360	100	V

* - indicates frequency in CFR47 Pt 15 / IC RSS-Restricted Band

PK-U - U-NII: Maximum Peak

11.9. Spurious Emissions for Simultaneous Transmission

11.9.1. Worst test case RSDB condition

Case 1	2.4 GHz WLAN ANT 1	5GHz WLAN ANT2
Mode	802.11b	802.11a
Channel	11	100
Frequency[MHz]	2462	5500
Data Rate	1Mbps	6Mbps
Axis (Worst)	X & Y	

Case 2	2.4 GHz WLAN ANT 2	5GHz WLAN ANT1
Mode	802.11b	802.11a
Channel	11	100
Frequency[MHz]	2462	5500
Data Rate	1Mbps	6Mbps
Axis (Worst)	Y & Z	

Case 3	2.4 GHz WLAN ANT1+ANT2	5GHz WLAN ANT1+ANT2
Mode	802.11g	802.11a
Channel	11	100
Frequency[MHz]	2462	5500
Data Rate	6Mbps	6Mbps
Axis (Worst)	Z	

Case 4	2.4 GHz WLAN ANT1+ANT2	5GHz WLAN ANT1+ANT2
Mode	802.11ax HE20(SU)	802.11ax HE20(SU)
Channel	11	100
Frequency[MHz]	2462	5500
Data Rate	MCS0	MCS0
Axis (Worst)	Z	

11.9.2. Worst test case non-DBS + Bluetooth condition

Case 5	2.4 GHz Bluetooth	5GHz WLAN ANT1+ANT2
Mode	BDR	802.11a
Channel	78	100
Frequency[MHz]	2480	5500
Data Rate	1Mbps	6Mbps
Axis (Worst)	X	

NOTE

The lowest margin condition among the channels and modes were selected for test. Low, mid, and high channels of 2.4GH WLAN were tested, and the worst case configuration & data were listed in the test report.

11.9.3. Test Results

Spurious emission for Simultaneous Transmission Case1. - X axis

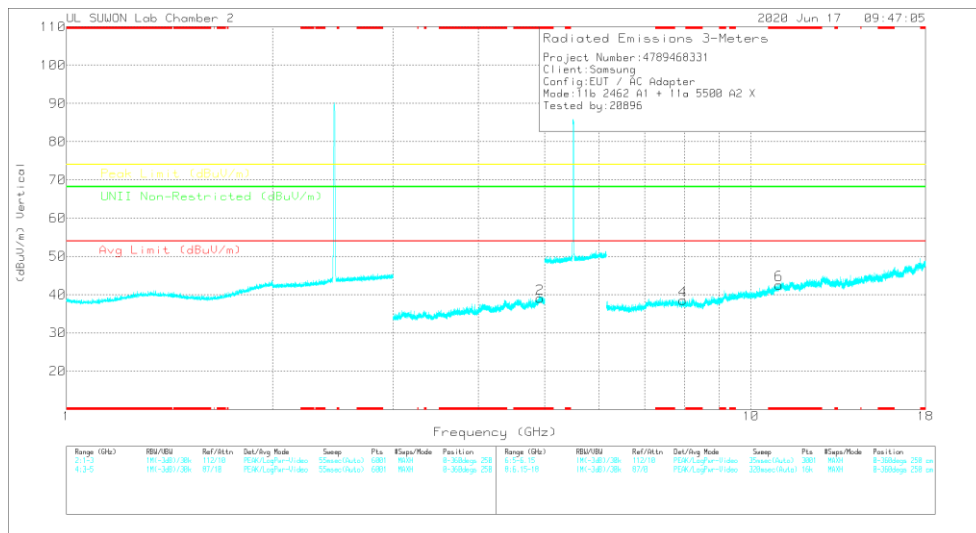
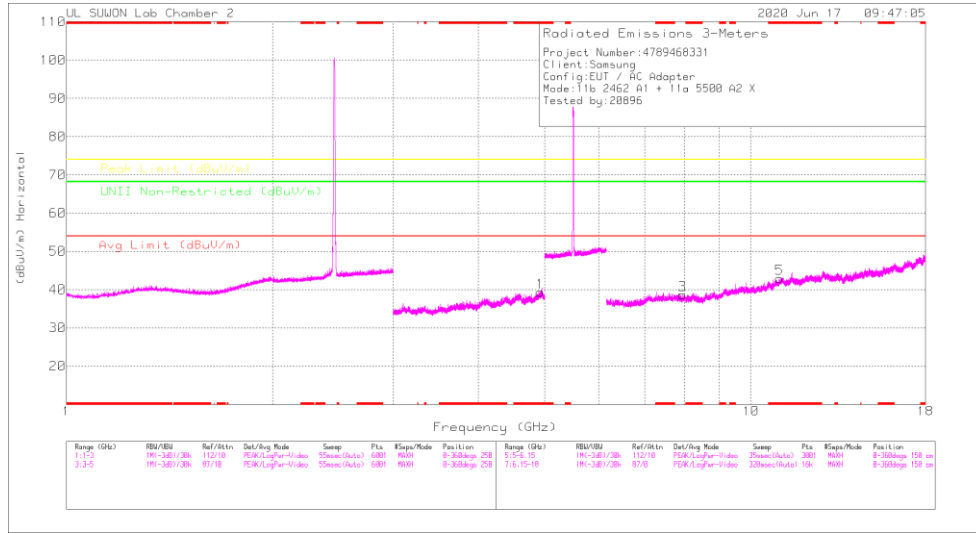

Radiated Emissions

Frequency (GHz)	Meas Reading (dBuV)	Det	317_00168724	5GHz_LF(dB)	DTS_Noise(dB)	DC Corr (dB)	Corrected Reading (dBuV/m)	Avg Limit (dBuV/m)	Margin (dB)	Peak Limit (dBuV/m)	Margin (dB)	UNII Non-Restricted (dBuV/m)	Margin (dB)	Azimuth (Degs)	Height (m)	Polarity
* 4.92323	42.29	PK2	34	-26	.4	0	50.69	-	-	74	-23.31	-	-	54	100	H
* 4.92396	30.49	MAv1	34	-25.9	.4	0	38.99	54	-15.01	-	-	-	-	54	100	H
* 4.92116	41.61	PK2	34	-25.9	.4	0	50.11	-	-	74	-23.89	-	-	324	100	V
* 4.92398	30.04	MAv1	34	-25.9	.4	0	38.54	54	-15.46	-	-	-	-	324	100	V

Frequency (GHz)	Meas Reading (dBuV)	Det	317_00168724	5GHz_HF(dB)	DC Corr (dB)	Corrected Reading (dBuV/m)	Avg Limit (dBuV/m)	Margin (dB)	Peak Limit (dBuV/m)	Margin (dB)	UNII Non-Restricted (dBuV/m)	Margin (dB)	Azimuth (Degs)	Height (m)	Polarity
7.94591	35.88	PK-U	35.9	-23.5	0	48.28	-	-	-	-	68.2	-19.92	360	100	H
7.9461	35.71	PK-U	35.9	-23.5	0	48.11	-	-	-	-	68.2	-20.09	360	100	V
* 11.01796	33.92	PK-U	38.1	-20	0	52.02	-	-	74	-21.98	-	-	360	100	H
* 11.02011	34.18	PK-U	38.1	-20	0	52.28	-	-	74	-21.72	-	-	360	100	V

* - indicates frequency in CFR47 Pt 15 / IC RSS-Restricted Band
 PK2 - KDB558074 Method: Maximum Peak
 MAv1 - KDB558074 Option 1 Maximum RMS Average
 PK-U - U-NII: Maximum Peak

Case1. – Y axis

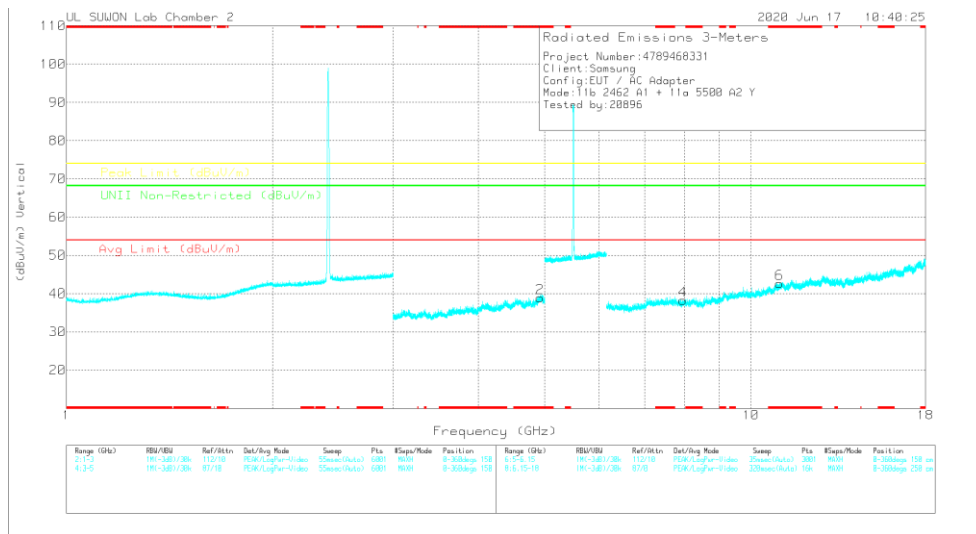
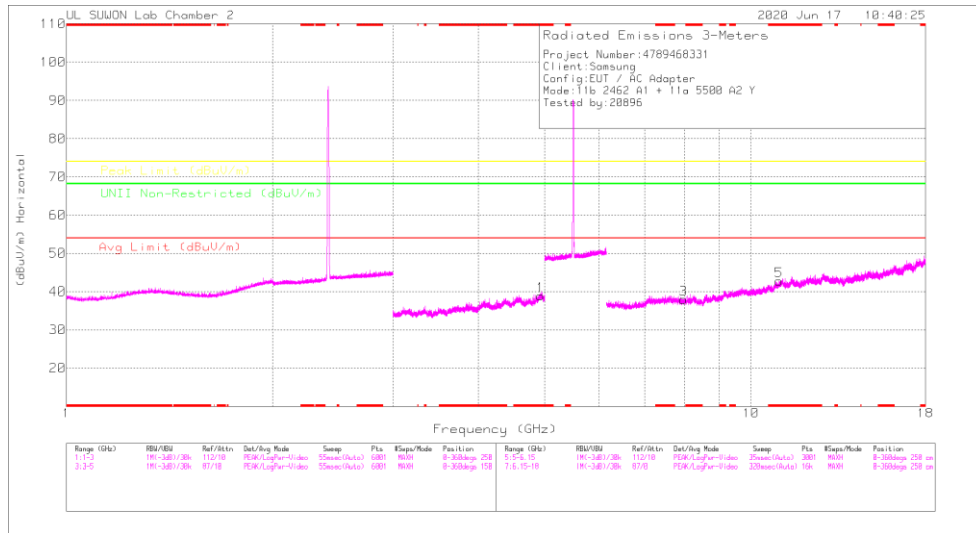

Radiated Emissions

Frequency (GHz)	Max Reading (dBuV)	Det	317_00168724	5GHz_LF(dB)	DTS_Noise(dB)	DC Corr (dB)	Corrected Reading (dBuV/m)	Avg Limit (dBV/m)	Margin (dB)	Peak Limit (dBV/m)	Margin (dB)	UNII Non-Restricted (dBV/m)	Margin (dB)	Azimuth (Degs)	Height (cm)	Polarity
* 4.92508	41.24	PK2	34	-26	.4	0	-42.64	-	-	74	-24.36	-	-	360	100	H
* 4.9253	40.91	PK2	34	-26	.4	0	-49.31	-	-	74	-24.69	-	-	360	100	V

Frequency (GHz)	Max Reading (dBuV)	Det	317_00168724	6GHz_HF(dB)	DC Corr (dB)	Corrected Reading (dBuV/m)	Avg Limit (dBV/m)	Margin (dB)	Peak Limit (dBV/m)	Margin (dB)	UNII Non-Restricted (dBV/m)	Margin (dB)	Azimuth (Degs)	Height (cm)	Polarity
7.9704	35.94	PK-U	35.9	-23.4	0	48.44	-	-	-	-	68.2	-19.76	360	100	H
7.96914	35.87	PK-U	35.9	-23.5	0	48.27	-	-	-	-	68.2	-19.93	360	100	V
* 11.00164	34.19	PK-U	38.1	-20	0	52.29	-	-	74	-21.71	-	-	360	100	H
* 11.00478	34.08	PK-U	38.1	-20	0	52.18	-	-	74	-21.82	-	-	360	100	V

* - indicates frequency in CFR47 Pt 15 / IC RSS-Restricted Band
 PK2 - KDB558074 Method: Maximum Peak
 PK-U - U-NII: Maximum Peak

Case2. – Y axis

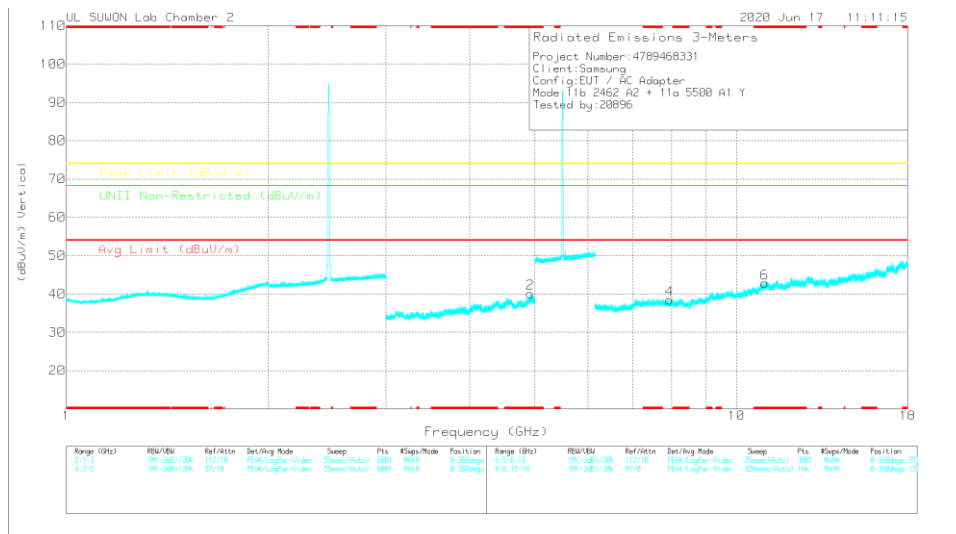
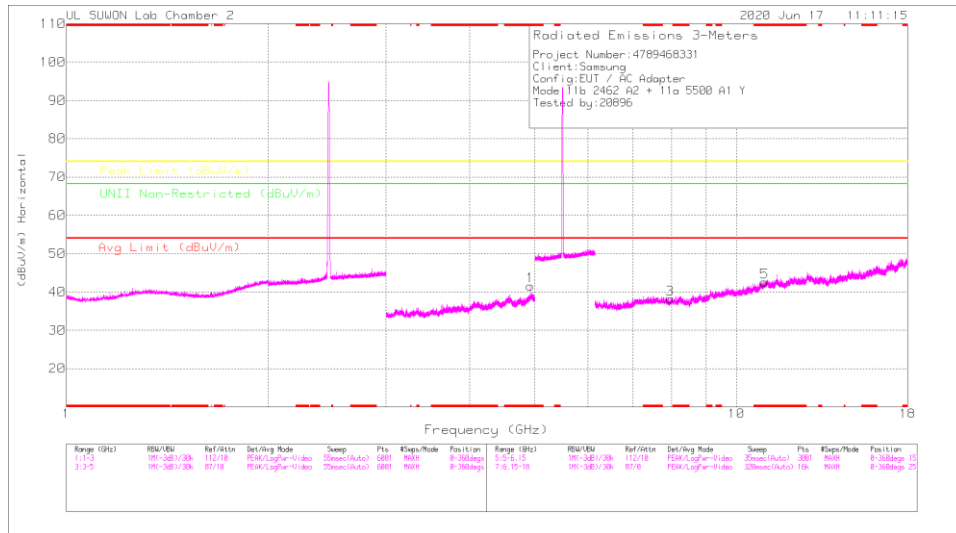

Radiated Emissions

Frequency (GHz)	Mean Reading (dBuV)	Det	317.00168724	50Hz_LF(dB)	DTS_Noise(dB)	DC Corr (dB)	Corrected Reading (dBuV/m)	Avg Limit (dBuV/m)	Margin (dB)	Peak Limit (dBuV/m)	Margin (dB)	UNII Non-Restricted (dBuV/m)	Margin (dB)	Azimuth (Degs)	Height (cm)	Polarity
* 4.92345	41.57	PK2	34	-25.9	-4	0	50.47	-	-	74	-23.53	-	-	113	115	H
* 4.92409	32.57	MAV1	34	-25.9	-4	0	41.07	54	-12.93	-	-	-	-	113	115	H
* 4.90561	41.34	PK2	34	-26.2	-3	0	49.44	-	-	74	-24.56	-	-	77	100	V
* 4.92409	30.85	MAV1	34	-25.9	-4	0	39.35	54	-14.65	-	-	-	-	77	100	V

Frequency (GHz)	Mean Reading (dBuV)	Det	317.00168724	60Hz_HF(dB)	DC Corr (dB)	Corrected Reading (dBuV/m)	Avg Limit (dBuV/m)	Margin (dB)	Peak Limit (dBuV/m)	Margin (dB)	UNII Non-Restricted (dBuV/m)	Margin (dB)	Azimuth (Degs)	Height (cm)	Polarity
7.95975	35.72	PK-U	35.9	-23.4	0	48.22	-	-	-	-	68.2	-19.98	0	100	H
7.95626	35.74	PK-U	35.9	-23.4	0	48.24	-	-	-	-	68.2	-19.96	0	100	V
* 11.01084	34.57	PK-U	38.1	-20	0	52.57	-	-	74	-21.33	-	-	0	100	H
* 11.01214	33.88	PK-U	38.1	-19.8	0	52.09	-	-	74	-21.91	-	-	0	100	V

* - indicates frequency in CFR47 Pt 15 / IC RSS-Restricted Band
 PK-U - U-NII: Maximum Peak

Case2. – Z axis

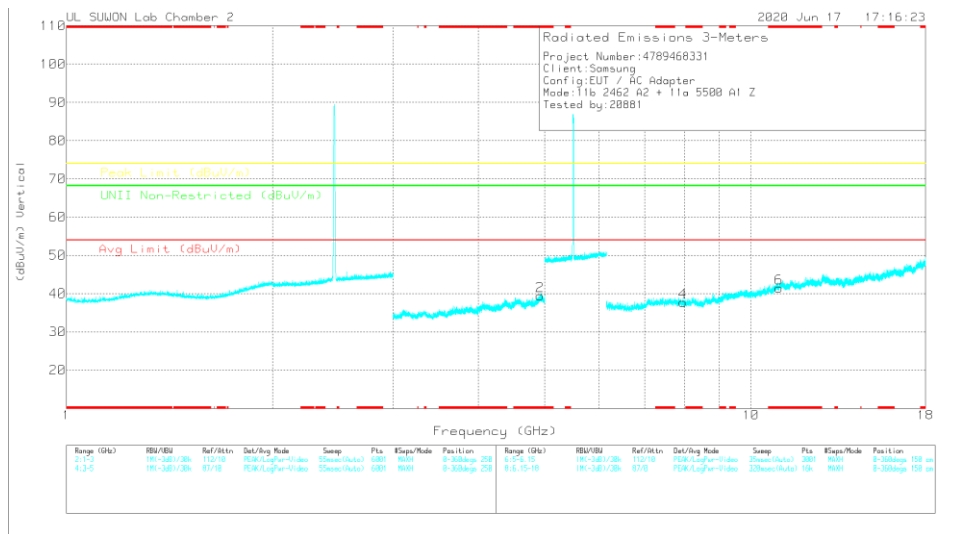
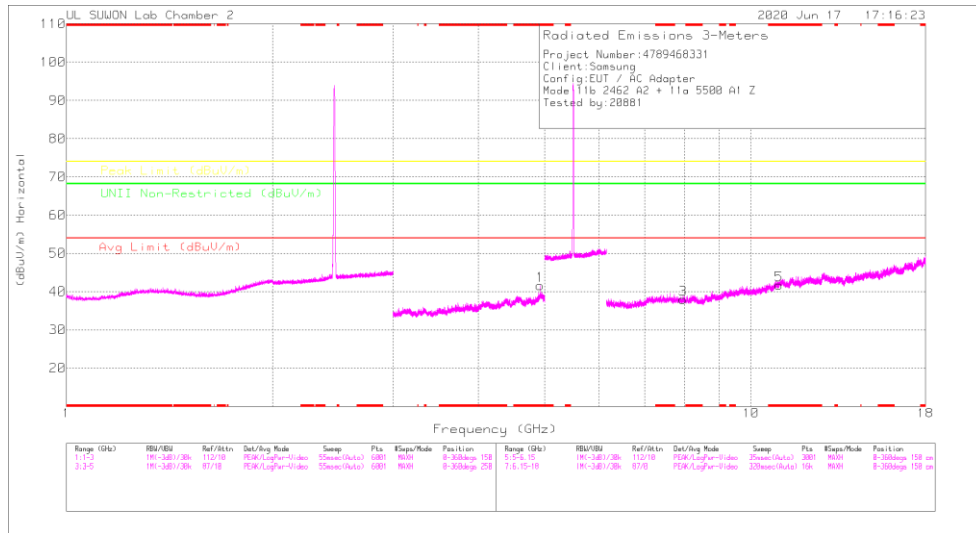

Radiated Emissions

Frequency (GHz)	Max Reading (dBuV)	Det	3117_00168724	5GHz_LFp[dB]	DTB_Noise[dB]	DC Corr (dB)	Corrected Reading (dBuV/m)	Avg Limit (dBV/m)	Margin (dB)	Peak Limit (dBuV/m)	Margin (dB)	UNII Non-Restricted (dBuV/m)	Margin (dB)	Azimuth (Degs)	Height (cm)	Polarity
* 4.92398	42.11	PK2	34	-25.9	.4	0	52.61	-	-	74	-23.39	-	-	122	113	H
* 4.92416	30.42	MAV1	34	-25.9	.4	-18	39.1	54	-14.9	-	-	-	-	122	113	H
* 4.9213	41.09	PK2	34	-25.9	.4	0	49.59	-	-	74	-24.41	-	-	97	101	V
* 4.92422	29.89	MAV1	34	-25.9	.4	-18	38.56	54	-15.44	-	-	-	-	97	101	V

Frequency (GHz)	Max Reading (dBuV)	Det	3117_00168724	6GHz_HFp[dB]	DC Corr (dB)	Corrected Reading (dBuV/m)	Avg Limit (dBuV/m)	Margin (dB)	Peak Limit (dBuV/m)	Margin (dB)	UNII Non-Restricted (dBuV/m)	Margin (dB)	Azimuth (Degs)	Height (cm)	Polarity
7.9617	35.87	PK-U	35.9	-23.4	0	48.37	-	-	-	-	68.2	-19.83	0	100	H
7.96021	36.27	PK-U	35.9	-23.4	0	48.77	-	-	-	-	68.2	-19.43	0	100	V
* 11.00145	33.81	PK-U	38.1	-20	0	51.81	-	-	74	-22.09	-	-	0	100	H
* 10.99862	34.4	PK-U	38.1	-20	0	52.5	-	-	74	-21.5	-	-	0	100	V

* - indicates frequency in CFR47 Pt 15 / IC RSS-Restricted Band
 PK2 - KDB558074 Method: Maximum Peak
 MAV1 - KDB558074 Option 1 Maximum RMS Average
 PK-U - U-NII: Maximum Peak

Case3. – Z axis

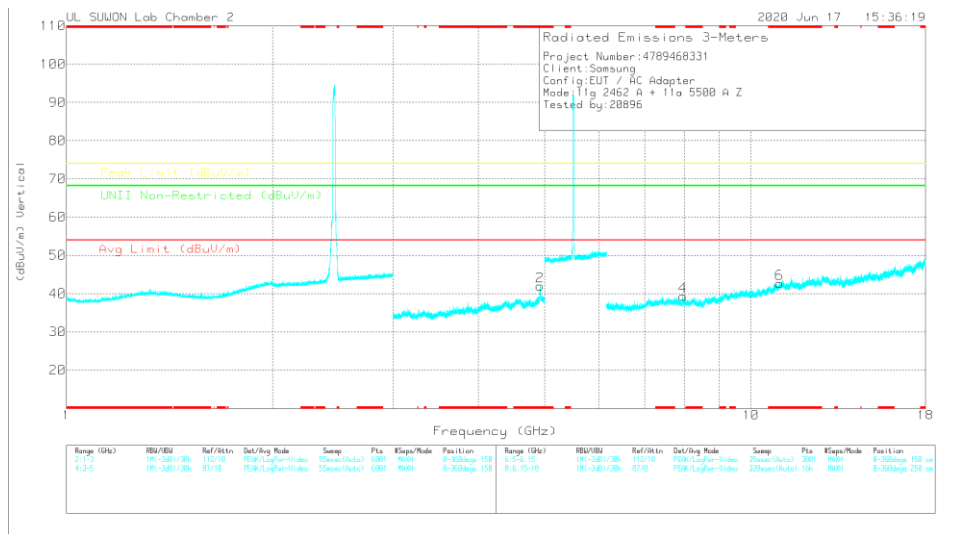
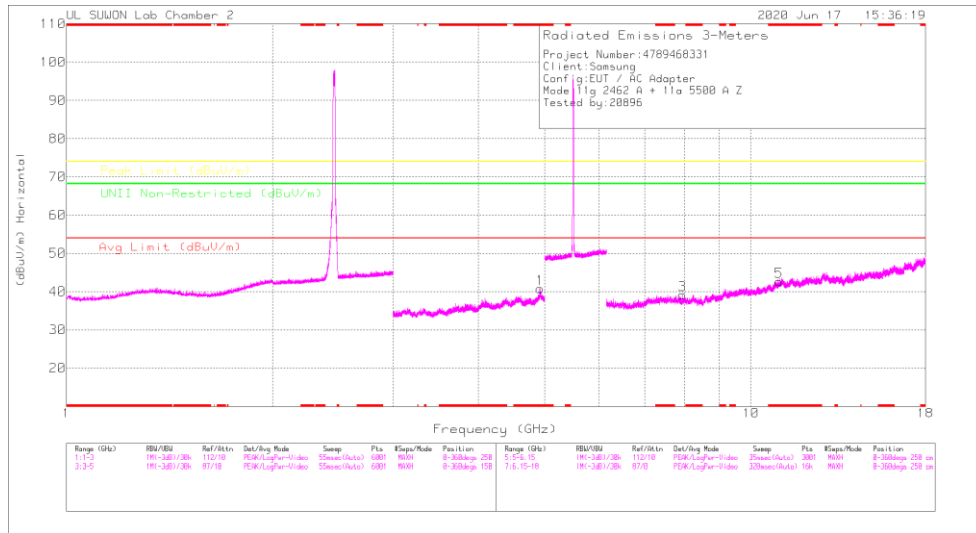

Radiated Emissions

Frequency (GHz)	Max Reading (dBuV)	Det	317, 00168724	5GHz_LF1(dB)	DTS_Noise(dB)	DC Corr (dB)	Corrected Reading (dBuV/m)	Avg Limit (dBuV/m)	Margin (dB)	Peak Limit (dBuV/m)	Margin (dB)	UNII Non-Restricted (dBuV/m)	Margin (dB)	Azimuth (Degs)	Height (cm)	Polarity
* 4.92795	44.53	PK2	34	-25.8	.4	0	53.53	-	-	74	-20.47	-	-	222	302	H
* 4.92227	32.43	MAV1	34	-25.9	.4	.15	41.08	54	-12.92	-	-	-	-	222	302	H
* 4.92782	46.52	PK2	34	-25.8	.4	0	55.12	-	-	74	-18.88	-	-	181	100	V
* 4.92227	33.1	MAV1	34	-25.9	.4	.15	41.75	54	-12.25	-	-	-	-	181	100	V

Frequency (GHz)	Max Reading (dBuV)	Det	317, 00168724	6GHz_HP1(dB)	DC Corr (dB)	Corrected Reading (dBuV/m)	Avg Limit (dBuV/m)	Margin (dB)	Peak Limit (dBuV/m)	Margin (dB)	UNII Non-Restricted (dBuV/m)	Margin (dB)	Azimuth (Degs)	Height (cm)	Polarity
7.96356	36.52	PK-U	35.9	-23.5	0	48.92	-	-	-	-	68.2	-18.28	0	100	H
7.95226	36.12	PK-U	35.9	-23.4	0	48.82	-	-	-	-	68.2	-18.58	0	100	V
* 10.99939	34.59	PK-U	38.1	-20	0	52.69	-	-	74	-21.31	-	-	0	100	H
* 10.99882	34.59	PK-U	38.1	-20	0	52.69	-	-	74	-21.31	-	-	0	100	V

* - indicates frequency in CFR47 Pt 15 / IC RSS-Restricted Band
 PK2 - KDB558074 Method: Maximum Peak
 MAV1 - KDB558074 Option 1 Maximum RMS Average
 PK-U - U-NII: Maximum Peak

Case4. - Z axis

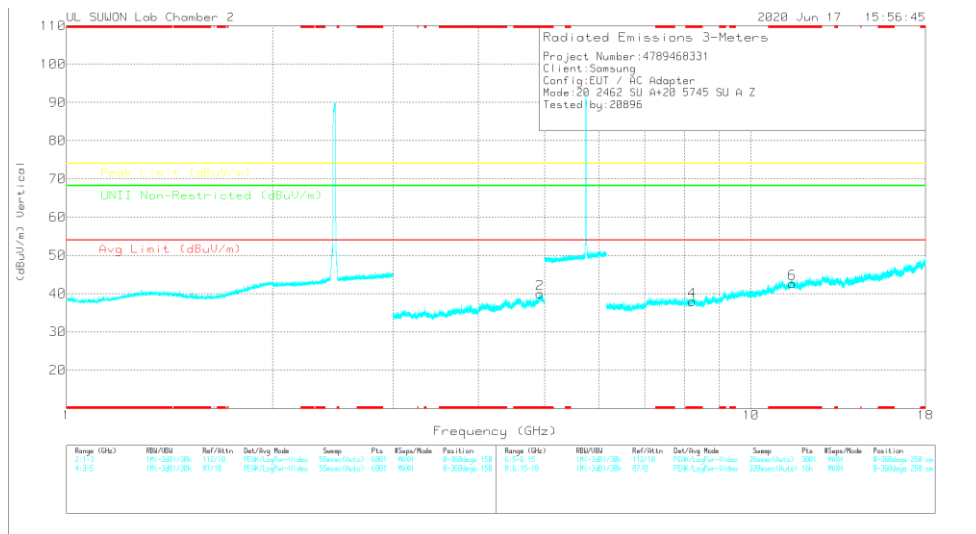
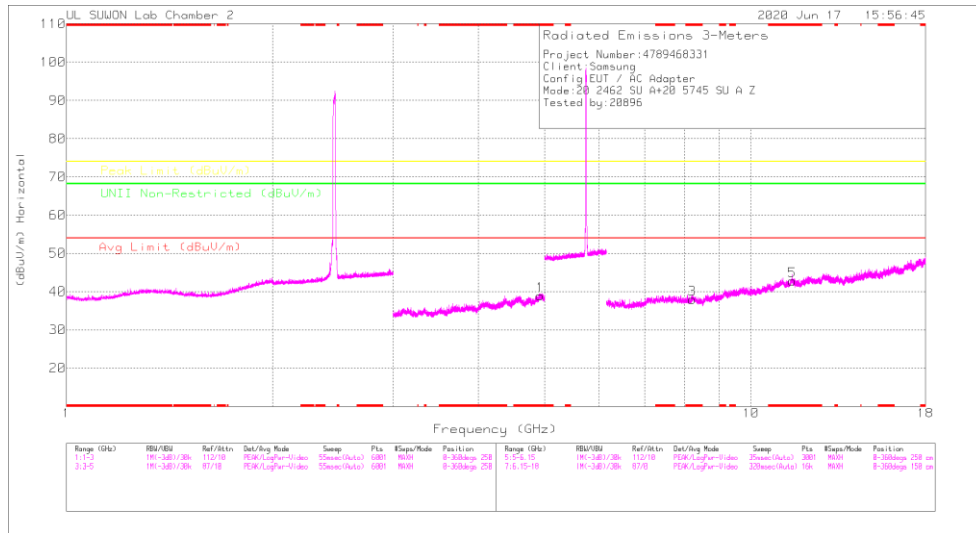

Radiated Emissions

Frequency (GHz)	Max Reading (dBuV)	Det	317_00168724	5GHz_LF(dB)	DTS_Noise(dB)	DC Corr (dB)	Corrected Reading (dBuV/m)	Avg Limit (dBuV/m)	Margin (dB)	Peak Limit (dBuV/m)	Margin (dB)	UNII Non-Restricted (dBuV/m)	Margin (dB)	Azimuth (Degs)	Height (cm)	Polarity
* 4.92271	41.18	PK2	34	-25.9	.4	0	42.68	-	-	74	-24.32	-	-	0	100	H
* 4.92471	41.41	PK2	34	-25.9	.4	0	49.91	-	-	74	-24.09	-	-	0	100	V

Frequency (GHz)	Max Reading (dBuV)	Det	317_00168724	6GHz_HF(dB)	DC Corr (dB)	Corrected Reading (dBuV/m)	Avg Limit (dBuV/m)	Margin (dB)	Peak Limit (dBuV/m)	Margin (dB)	UNII Non-Restricted (dBuV/m)	Margin (dB)	Azimuth (Degs)	Height (cm)	Polarity
* 8.20589	36.68	PK-U	36	-23.5	0	49.18	-	-	74	-24.82	-	-	0	100	H
* 8.20711	36.67	PK-U	36	-23.5	0	49.17	-	-	74	-24.83	-	-	0	100	V
* 11.49134	34.6	PK-U	38.3	-19.3	0	53.6	-	-	74	-20.4	-	-	0	100	H
* 11.48835	34.54	PK-U	38.3	-19.4	0	53.44	-	-	74	-20.56	-	-	0	100	V

* - indicates frequency in CFR47 Pt 15 / IC RSS-Restricted Band
 PK2 - KDB558074 Method: Maximum Peak
 PK-U - U-NII: Maximum Peak

Case5. – X axis

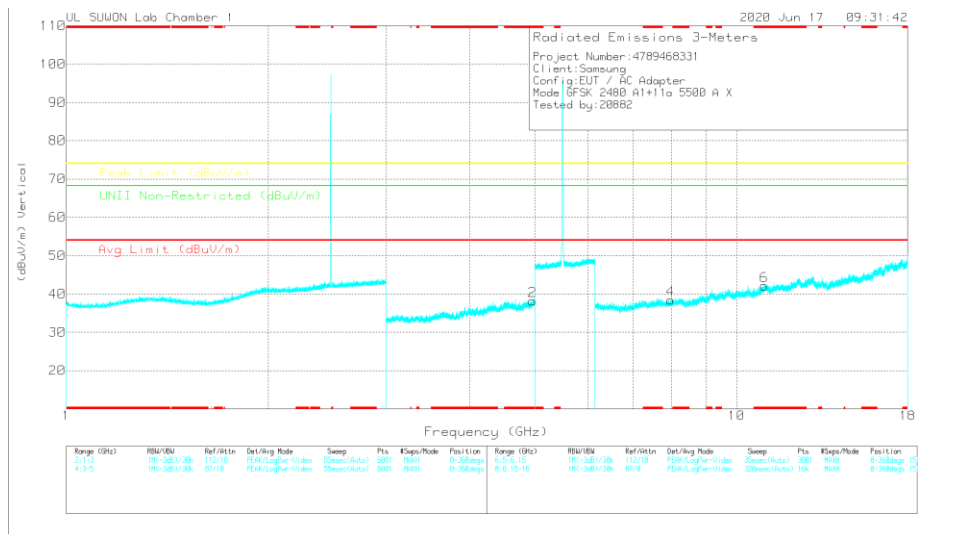
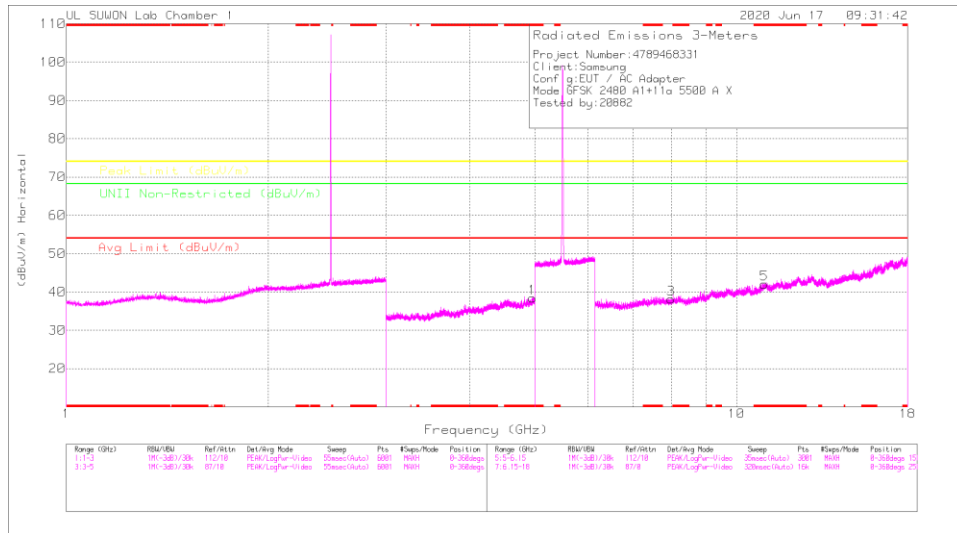

Radiated Emissions

Frequency (GHz)	Meter Reading (dBuV)	Det	3117.00168717	5GHz_LF[dB]	DTS_Noise[dB]	Corrected Reading (dBuV/m)	Avg Limit (dBuV/m)	Margin (dB)	Peak Limit (dBuV/m)	Margin (dB)	UNII Non-Restricted (dBuV/m)	Margin (dB)	Azimuth (Degs)	Height (cm)	Polarity
* 4.96093	42.52	PKFH	34.2	-30.3	.3	47.12	-	-	74	-26.88	-	-	0	100	H
* 4.96032	42.37	PKFH	34.2	-30.3	.3	46.57	-	-	74	-27.43	-	-	0	100	V

Frequency (GHz)	Meter Reading (dBuV)	Det	3117.00168717	6GHz_HP[dB]	Corrected Reading (dBuV/m)	Avg Limit (dBuV/m)	Margin (dB)	Peak Limit (dBuV/m)	Margin (dB)	UNII Non-Restricted (dBuV/m)	Margin (dB)	Azimuth (Degs)	Height (cm)	Polarity
7.9821	38.95	PK-U	36	-26.3	48.65	-	-	-	-	68.2	-19.55	0	100	H
7.98243	39.09	PK-U	36	-26.3	48.79	-	-	-	-	68.2	-19.41	0	100	V
* 11.00655	36.02	PK-U	38.2	-21.8	52.42	-	-	74	-21.58	-	-	0	100	H
* 11.00391	37.21	PK-U	38.2	-21.8	53.61	-	-	74	-20.39	-	-	0	100	V

* - indicates frequency in CFR47 Pt 15 / IC RSS-Restricted Band
 PKFH FHSS/BT RB=100k for Frequencies<1GHz / RB=1MHz for Frequencies>1GHz, VB=3 x RB, Peak
 PK-U - U-NII: Maximum Peak

12. WORST-CASE BELOW 1 GHz

SPURIOUS EMISSIONS 30 TO 1000 MHz (WORST-CASE CONFIGURATION, HORIZONTAL)

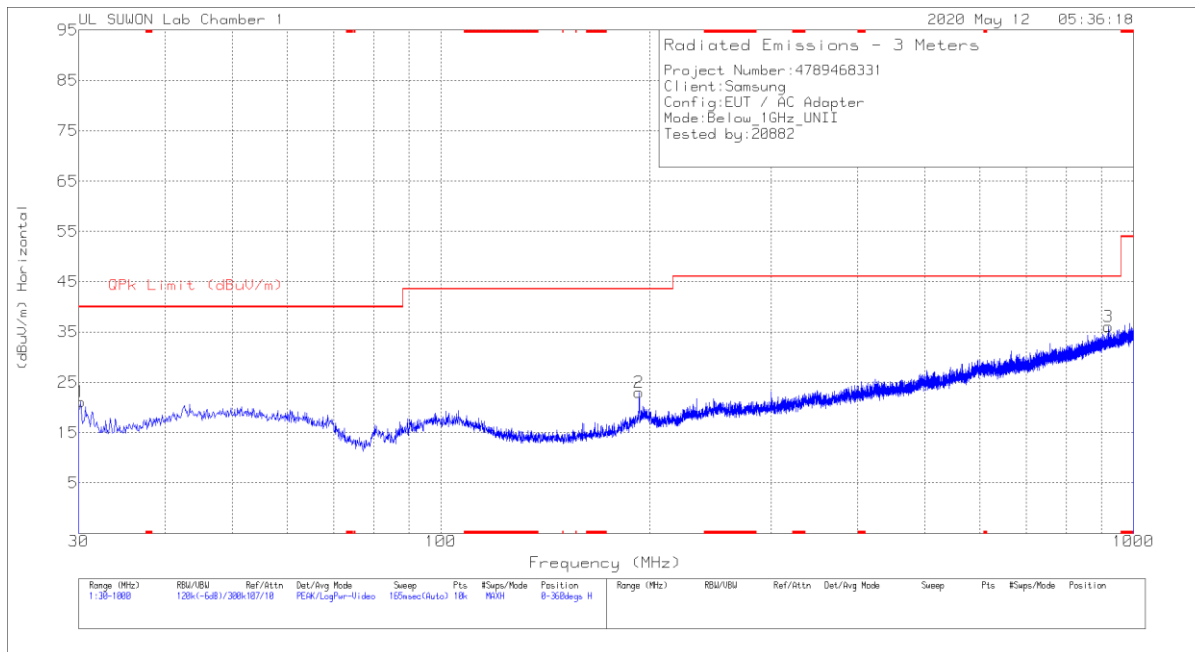

SPURIOUS EMISSIONS 30 TO 1000 MHz (WORST-CASE CONFIGURATION, VERTICAL)

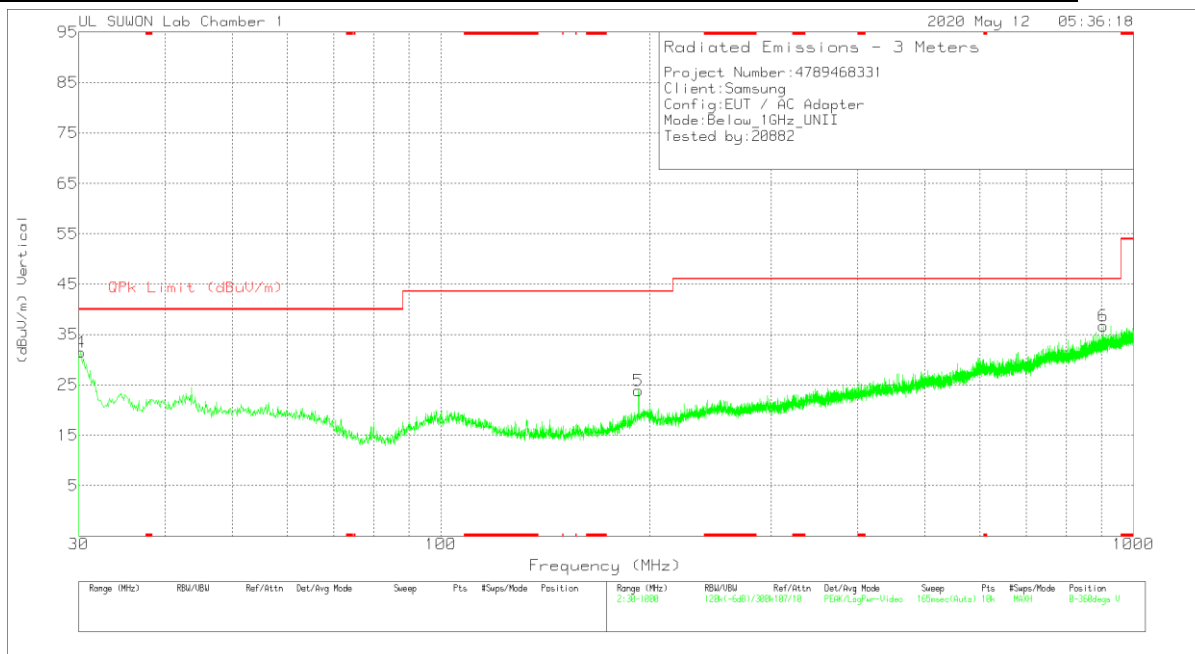

Below 1G Data

Trace Markers

Marker	Frequency (MHz)	Meter Reading (dBuV)	Det	VULB9163_750	Below_1G[dB]	DC Corr (dB)	Corrected Reading (dBuV/m)	QPk Limit (dBuV/m)	Margin (dB)	Azimuth (Degs)	Height (cm)	Polarity
1	30.194	36.06	Pk	16	-30.9	0	21.16	40	-18.84	0-360	300	H
2	193.348	33.85	Pk	17.7	-28.6	0	22.95	43.52	-20.57	0-360	100	H
3	920.169	31.04	Pk	28.5	-23.5	0	36.04	46.02	-9.98	0-360	400	H
4	30.194	45.33	Pk	16	-29.9	0	31.43	40	-8.57	0-360	100	V
5	192.96	33.87	Pk	17.6	-27.6	0	23.87	43.52	-19.65	0-360	100	V
6	904.94	31.57	Pk	28.3	-23.2	0	36.67	46.02	-9.35	0-360	300	V

* - indicates frequency in CFR47 Pt 15 / IC RSS-Restricted Band

Pk - Peak detector

13. AC POWER LINE CONDUCTED EMISSIONS

LIMITS

FCC §15.207 (a)
IC RSS-GEN Clause 8.8

Frequency of Emission (MHz)	Conducted Limit (dBuV)	
	Quasi-peak	Average
0.15-0.5	66 to 56 [*]	56 to 46 [*]
0.5-5	56	46
5-30	60	50

^{*}Decreases with the logarithm of the frequency.

TEST PROCEDURE

The EUT is placed on a non-conducting table 40 cm from the vertical ground plane and 80 cm above the horizontal ground plane. The EUT is configured in accordance with ANSI C63.10.

The receiver is set to a resolution bandwidth of 9 kHz. Peak detection is used unless otherwise noted as quasi-peak or average.

Line conducted data is recorded for both NEUTRAL and HOT lines.

RESULTS

WORST EMISSIONS

LINE 1 DATA

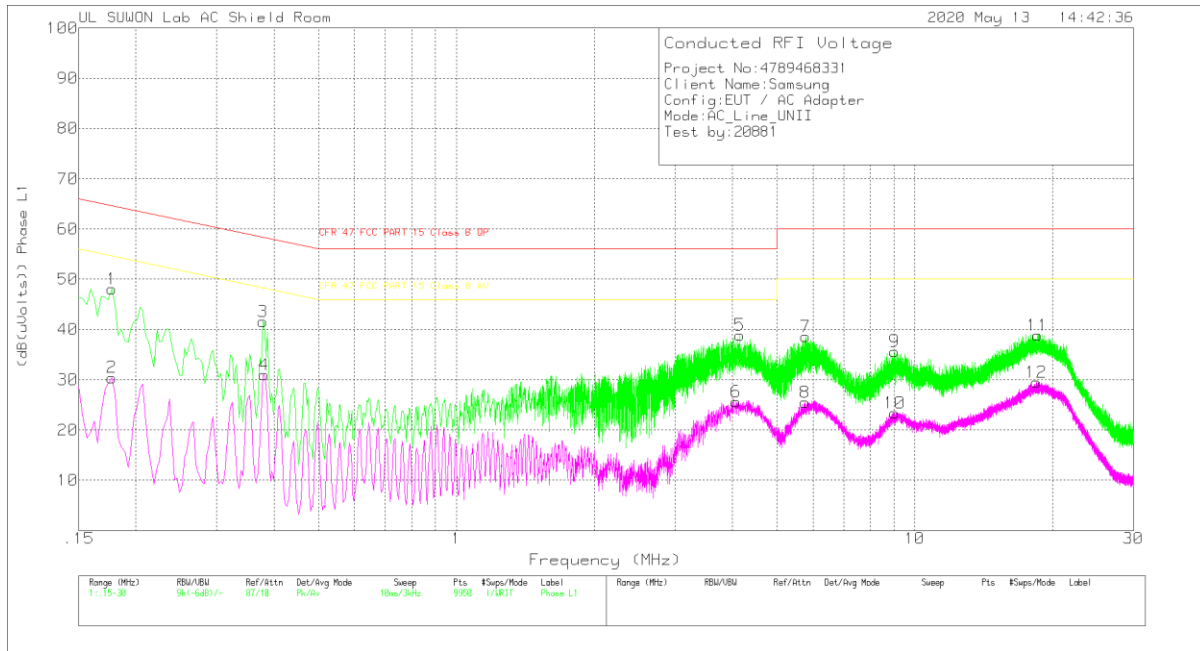

Trace Markers

Range 1: Phase L1 .15 - 30MHz

Marker	Frequency (MHz)	Meter Reading (dBuV)	Det	101836_With Ex_L1[dB]	CABLELOS S(dB)	Corrected Reading (dB(uVolts))	CFR 47 FCC PART 15 Class B QP	Margin (dB)	CFR 47 FCC PART 15 Class B AV	Margin (dB)
1	.177	37.87	Pk	10	.2	48.07	64.63	-16.56	-	-
2	.177	20.23	Av	10	.2	30.43	-	-	54.63	-24.2
3	.378	31.52	Pk	9.9	.2	41.62	58.32	-16.7	-	-
4	.381	20.89	Av	9.9	.2	30.99	-	-	48.26	-17.27
5	4.152	28.8	Pk	9.8	.3	38.9	56	-17.1	-	-
6	4.08	15.51	Av	9.8	.3	25.61	-	-	46	-20.39
7	5.784	28.52	Pk	9.8	.3	38.62	60	-21.38	-	-
8	5.76	15.43	Av	9.8	.3	25.53	-	-	50	-24.47
9	9.045	25.36	Pk	9.9	.4	35.66	60	-24.34	-	-
10	9.048	13.09	Av	9.9	.4	23.39	-	-	50	-26.61
11	18.519	28.2	Pk	10.2	.4	38.8	60	-21.2	-	-
12	18.423	18.86	Av	10.2	.4	29.46	-	-	50	-20.54

Pk - Peak detector

Av - Average detection

LINE 2 DATA

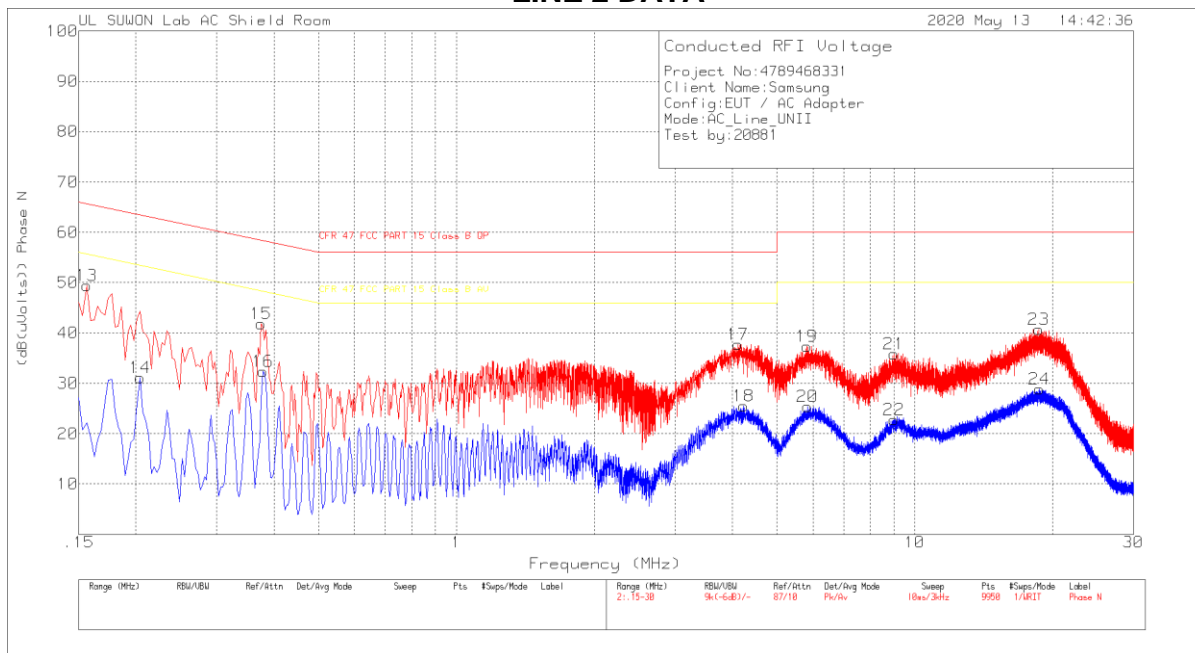

Trace Markers

Range 2: Phase N .15 - 30MHz

Marker	Frequency (MHz)	Meter Reading (dBuV)	Det	101836_Wit h EX_N[dB]	CABLELOS S(dB)	Corrected Reading (dB(uVolts))	CFR 47 FCC PART 15 Class B QP	Margin (dB)	CFR 47 FCC PART 15 Class B AV	Margin (dB)
13	.156	39.4	Pk	9.9	.1	49.4	65.67	-16.27	-	-
14	.204	21.01	Av	9.9	.2	31.11	-	-	53.45	-22.34
15	.375	31.69	Pk	9.9	.2	41.79	58.39	-16.6	-	-
16	.378	22.31	Av	9.9	.2	32.41	-	-	48.32	-15.91
17	4.119	27.62	Pk	9.8	.3	37.72	56	-18.28	-	-
18	4.227	15.46	Av	9.8	.3	25.56	-	-	46	-20.44
19	5.823	27.27	Pk	9.8	.3	37.37	60	-22.63	-	-
20	5.841	15.24	Av	9.8	.3	25.34	-	-	50	-24.66
21	9.012	25.52	Pk	9.9	.4	35.82	60	-24.18	-	-
22	9.006	12.44	Av	9.9	.4	22.74	-	-	50	-27.26
23	18.636	30.01	Pk	10.3	.4	40.71	60	-19.29	-	-
24	18.687	18.16	Av	10.3	.4	28.86	-	-	50	-21.14

Pk - Peak detector
 Av - Average detection

14. DYNAMIC FREQUENCY SELECTION

14.1. OVERVIEW

14.1.1. LIMITS

FCC

§15.407 (h), FCC KDB 905462 D02 “COMPLIANCE MEASUREMENT PROCEDURES FOR UNLICENSED-NATIONAL INFORMATION INFRASTRUCTURE DEVICES OPERATING IN THE 5250-5350 MHz AND 5470-5725 MHz BANDS INCORPORATING DYNAMIC FREQUENCY SELECTION” and KDB 905462 D03 “U-NII CLIENT DEVICES WITHOUT RADAR DETECTION CAPABILITY”.

Table 1: Applicability of DFS requirements prior to use of a channel

Requirement	Operational Mode		
	Master	Client (without radar detection)	Client (with radar detection)
Non-Occupancy Period	Yes	Not required	Yes
DFS Detection Threshold	Yes	Not required	Yes
Channel Availability Check Time	Yes	Not required	Not required
U-NII Detection Bandwidth	Yes	Not required	Yes

Table 2: Applicability of DFS requirements during normal operation

Requirement	Operational Mode		
	Master	Client (without DFS)	Client (with DFS)
DFS Detection Threshold	Yes	Not required	Yes
Channel Closing Transmission Time	Yes	Yes	Yes
Channel Move Time	Yes	Yes	Yes
U-NII Detection Bandwidth	Yes	Not required	Yes

Additional requirements for devices with multiple bandwidth modes	Master Device or Client with Radar DFS	Client (without DFS)
U-NII Detection Bandwidth and Statistical Performance Check	All BW modes must be tested	Not required
Channel Move Time and Channel Closing Transmission Time	Test using widest BW mode available	Test using the widest BW mode available for the link
All other tests	Any single BW mode	Not required
<p>Note: Frequencies selected for statistical performance check (Section 7.8.4) should include several frequencies within the radar detection bandwidth and frequencies near the edge of the radar detection bandwidth. For 802.11 devices it is suggested to select frequencies in all 20 MHz channel blocks and a null frequency between the bonded 20 MHz channel blocks.</p>		

Table 3: Interference Threshold values, Master or Client incorporating In-Service Monitoring

Maximum Transmit Power	Value (see notes)
E.I.R.P. \geq 200 mill watt	-64 dBm
E.I.R.P. $<$ 200 mill watt and power spectral density $<$ 10 dBm/MHz	-62 dBm
E.I.R.P. $<$ 200 mill watt that do not meet power spectral density requirement	-64 dBm
<p>Note 1: This is the level at the input of the receiver assuming a 0 dBi receive antenna Note 2: Throughout these test procedures an additional 1 dB has been added to the amplitude of the test transmission waveforms to account for variations in measurement equipment. This will ensure that the test signal is at or above the detection threshold level to trigger a DFS response. Note 3: E.I.R.P. is based on the highest antenna gain. For MIMO devices refer to KDB publication 662911 D01.</p>	

Table 4: DFS Response requirement values

Parameter	Value
<i>Non-occupancy period</i>	30 minutes
<i>Channel Availability Check Time</i>	60 seconds
<i>Channel Move Time</i>	10 seconds (See Note 1)
<i>Channel Closing Transmission Time</i>	200 milliseconds + approx. 60 milliseconds over remaining 10 second period. (See Notes 1 and 2)
<i>U-NII Detection Bandwidth</i>	Minimum 100% of the U- NII 99% transmission power bandwidth. (See Note 3)
<p>Note 1: <i>Channel Move Time</i> and the <i>Channel Closing Transmission Time</i> should be performed with Radar Type 0. The measurement timing begins at the end of the Radar Type 0 burst. Note 2: The <i>Channel Closing Transmission Time</i> is comprised of 200 milliseconds starting at the beginning of the <i>Channel Move Time</i> plus any additional intermittent control signals required to facilitate a <i>Channel</i> move (an aggregate of 60 milliseconds) during the remainder of the 10 second period. The aggregate duration of control signals will not count quiet periods in between transmissions. Note 3: During the <i>U-NII Detection Bandwidth</i> detection test, radar type 0 should be used. For each frequency step the minimum percentage of detection is 90 percent. Measurements are performed with no data traffic.</p>	

Table 5 – Short Pulse Radar Test Waveforms

Radar Type	Pulse Width (usec)	PRI (usec)	Pulses	Minimum Percentage of Successful Detection	Minimum Trials
0	1	1428	18	See Note 1	See Note 1
1	1	Test A: 15 unique PRI values randomly selected from the list of 23 PRI values in table 5a	Roundup: $\{(1/360) \times (19 \times 10^6 \text{ PRI}_{\text{usec}})\}$	60%	30
		Test B: 15 unique PRI values randomly selected within the range of 518-3066 usec. With a minimum increment of 1 usec, excluding PRI values selected in Test A			
2	1-5	150-230	23-29	60%	30
3	6-10	200-500	16-18	60%	30
4	11-20	200-500	12-16	60%	30
Aggregate (Radar Types 1-4)				80%	120
Note 1: Short Pulse Radar Type 0 should be used for the <i>Detection Bandwidth</i> test, <i>Channel Move Time</i> , and <i>Channel Closing Time</i> tests.					

Table 6 – Long Pulse Radar Test Signal

Radar Waveform Type	Pulse Width (µsec)	Chirp Width (MHz)	PRI (µsec)	Pulses per Burst	Number of Bursts	Minimum Percentage of Successful Detection	Minimum Trials
5	50-100	5-20	1000-2000	1-3	8-20	80%	30

Table 7 – Frequency Hopping Radar Test Signal

Radar Waveform Type	Pulse Width (µsec)	PRI (µsec)	Pulses per Hop	Hopping Rate (kHz)	Hopping Sequence Length (msec)	Minimum Percentage of Successful Detection	Minimum Trials
6	1	333	9	0.333	300	70%	30

14.1.2. TEST AND MEASUREMENT SYSTEM

CONDUCTED METHOD SYSTEM BLOCK DIAGRAM

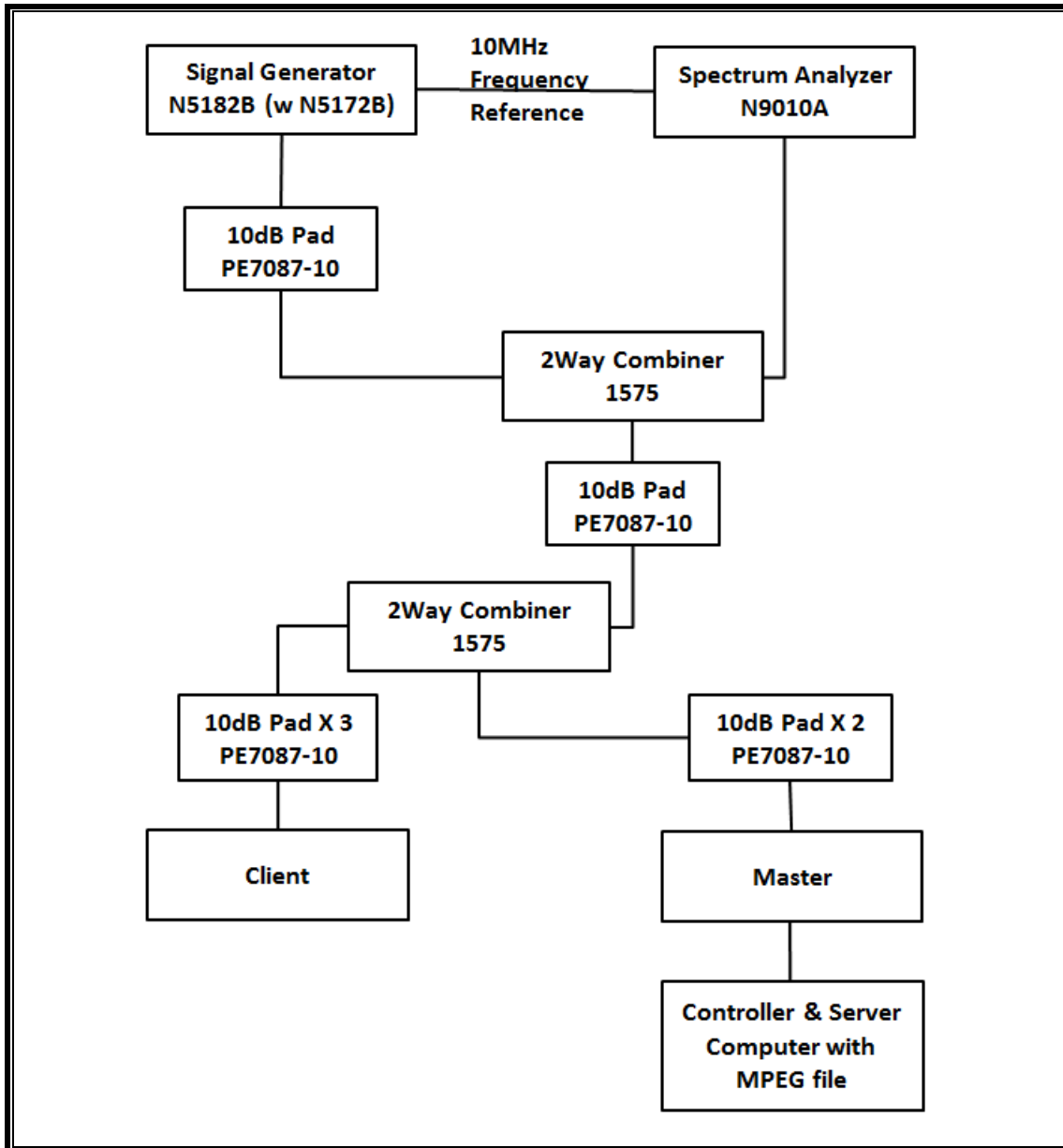

SYSTEM OVERVIEW

The short pulse and long pulse signal generating system utilizes the Keysite Signal Studio for Pulse Building as N5172B. The Vector Signal Generator has been validated by the NTIA. The hopping signal generating system utilizes the CCS simulated hopping method and system, which has been validated by the DoD, FCC and NTIA. The software selects waveform parameters from within the bounds of the signal type on a random basis using uniform distribution.

The short pulse types 1, 2, 3 and 4, and the long pulse type 5 parameters are randomized at run-time.

The hopping type 6 pulse parameters are fixed while the hopping sequence is based on the August 2005 NTIA Hopping Frequency List. The initial starting point randomized at run-time and each subsequent starting point is incremented by 475. Each frequency in the 100-length segment is compared to the boundaries of the EUT Detection Bandwidth and the software creates a hopping burst pattern in accordance with Section 7.4.1.3 Method #2 Simulated Frequency Hopping Radar Waveform Generating Subsystem of KDB 905462 D02. The frequency of the signal generator is incremented in 1 MHz steps from F_L to F_H for each successive trial. This incremental sequence is repeated as required to generate a minimum of 30 total trials and to maintain a uniform frequency distribution over the entire Detection Bandwidth.

The signal monitoring equipment consists of a spectrum analyzer. The aggregate ON time is calculated by multiplying the number of bins above a threshold during a particular observation period by the dwell time per bin, with the analyzer set to peak detection and max hold.

SYSTEM CALIBRATION

A 50-ohm load is connected in place of the spectrum analyzer, and the spectrum analyzer is connected to a horn antenna via a coaxial cable, with the reference level offset set to (horn antenna gain – coaxial cable loss). The signal generator is set to CW mode. The amplitude of the signal generator is adjusted to yield a level of –64 dBm as measured on the spectrum analyzer.

Without changing any of the instrument settings, the spectrum analyzer is reconnected to the Common port of the Spectrum Analyzer Combiner/Divider. The Reference Level Offset of the spectrum analyzer is adjusted so that the displayed amplitude of the signal is –64 dBm.

The spectrum analyzer displays the level of the signal generator as received at the antenna ports of the Master Device. The interference detection threshold may be varied from the calibrated value of –64 dBm and the spectrum analyzer will still indicate the level as received by the Master Device.

ADJUSTMENT OF DISPLAYED TRAFFIC LEVEL

A link is established between the Master and Slave and the distance between the units is adjusted as needed to provide a suitable received level at the Master and Slave devices. The video test file is streamed to generate WLAN traffic. The monitoring antenna is adjusted so that the WLAN traffic level, as displayed on the spectrum analyzer, is at lower amplitude than the radar detection threshold.

TEST AND MEASUREMENT EQUIPMENT

The following test and measurement equipment was utilized for the DFS tests documented in this report:

TEST EQUIPMENT LIST				
Description	Manufacturer	Model	S/N	Next Cal Due
Spectrum Analyzer, 7 GHz	Agilent / HP	N9010A	MY54200580	08-07-20
Vector Signal Generator, 6GHz	Agilent / HP	N5182B	MY53051241	08-06-20
Combiner	AEROFLEX/WEINSCHL	1575	2150	08-08-20
Combiner	AEROFLEX/WEINSCHL	1575	2781	08-08-20

14.1.3. SETUP OF EUT

CONDUCTED METHOD EUT TEST SETUP

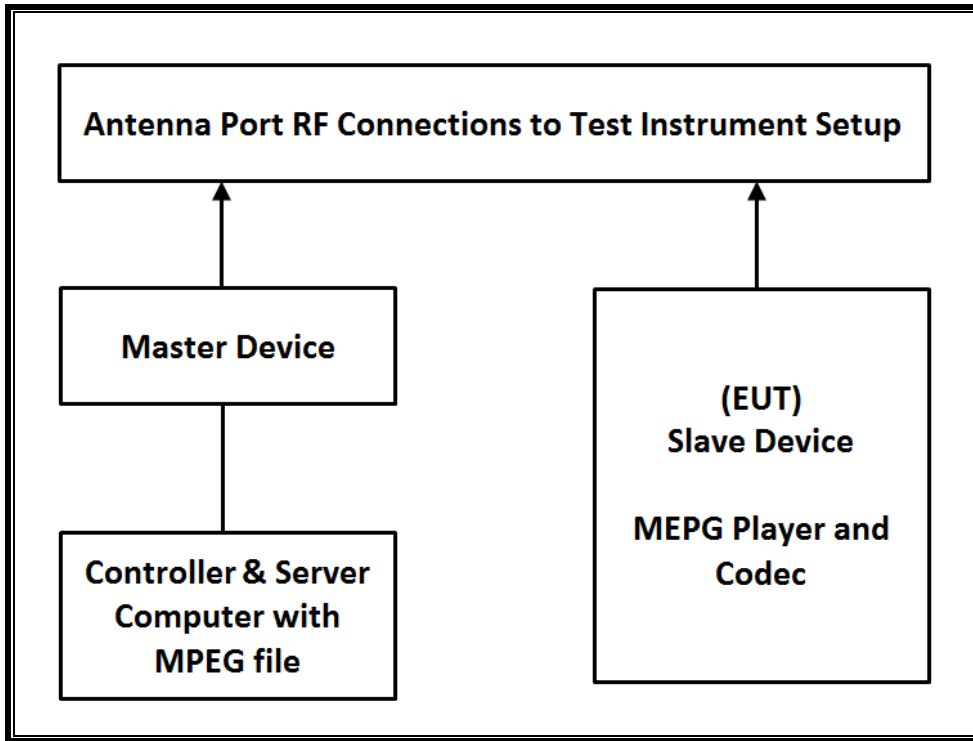

SUPPORT EQUIPMENT

The following support equipment was utilized for the DFS tests documented in this report:

PERIPHERAL SUPPORT EQUIPMENT LIST				
Description	Manufacturer	Model	Serial Number	FCC ID
Wireless Access Point	Cisco	AIR-CAP3702E-A-K9	FTX182276QX	LDK102087
Notebook PC (Controller/Server)	HP	HP EliteDesk 800 G1 TWR	CZC4125J25	DoC

14.1.4. DESCRIPTION OF EUT

The EUT operates over the 5250-5350 MHz and 5470-5725 MHz ranges.

The EUT is a Slave Device without Radar Detection.

The highest power level of the widest bandwidth (802.11ac VHT80) within these bands is 14.33 dBm in the 5250-5350 MHz band and 14.86 dBm in the 5470-5725 MHz band.

The antenna assembly utilized two antenna.

Gain of ANT1 : -5.01 dBi for UNII 2A and -5.85 dBi for UNII 2C.

Gain of ANT2 : -5.31 dBi for UNII 2A and -5.62 dBi for UNII 2C.

The rated output power of the Master unit is > 23dBm (EIRP). Therefore the required interference threshold level is -64 dBm. After correction for procedural adjustments, the required conducted threshold at the antenna port is $-64 + 1 = -63$ dBm.

The calibrated radiated DFS Detection Threshold level is set to -64 dBm. The tested level is lower than the required level hence it provides a margin to the limit.

The EUT uses one transmitter/receiver chain connected to an antenna to perform radiated tests.

WLAN traffic that meets or exceeds the minimum required loading was generated by transferring a data stream from the controller/server PC to the EUT using iPerf version 2.0.5 software package.

TPC is not required since the maximum EIRP is less than 500 mW (27 dBm).

The EUT utilizes the 802.11 architecture. Three nominal channel bandwidths are implemented: 20 MHz, 40 MHz and 80 MHz.

The software installed in the access point is 12.4(25d)JA1.

UNIFORM CHANNEL SPREADING

This requirement is not applicable to Slave radio devices.

OVERVIEW OF MASTER DEVICE WITH RESPECT TO §15.407 (h) REQUIREMENTS

The Master Device is a Cisco Access Point, FCC ID: LDK102087. The minimum antenna gain for the Master Device is 6 dBi.

The rated output power of the Master unit is > 23dBm (EIRP). Therefore the required interference threshold level is -64 dBm. After correction for procedural adjustments, the required radiated threshold at the antenna port is $-64 + 1 = -63$ dBm.

The calibrated radiated DFS Detection Threshold level is set to -64 dBm. The tested level is lower than the required level hence it provides a margin to the limit.

14.2. RESULTS FOR 80 MHz BANDWIDTH (UNII-2A BAND)

14.2.1. TEST CHANNEL

All tests were performed at a channel center frequency of 5290 MHz.

14.2.2. RADAR WAVEFORM AND TRAFFIC

RADAR WAVEFORM

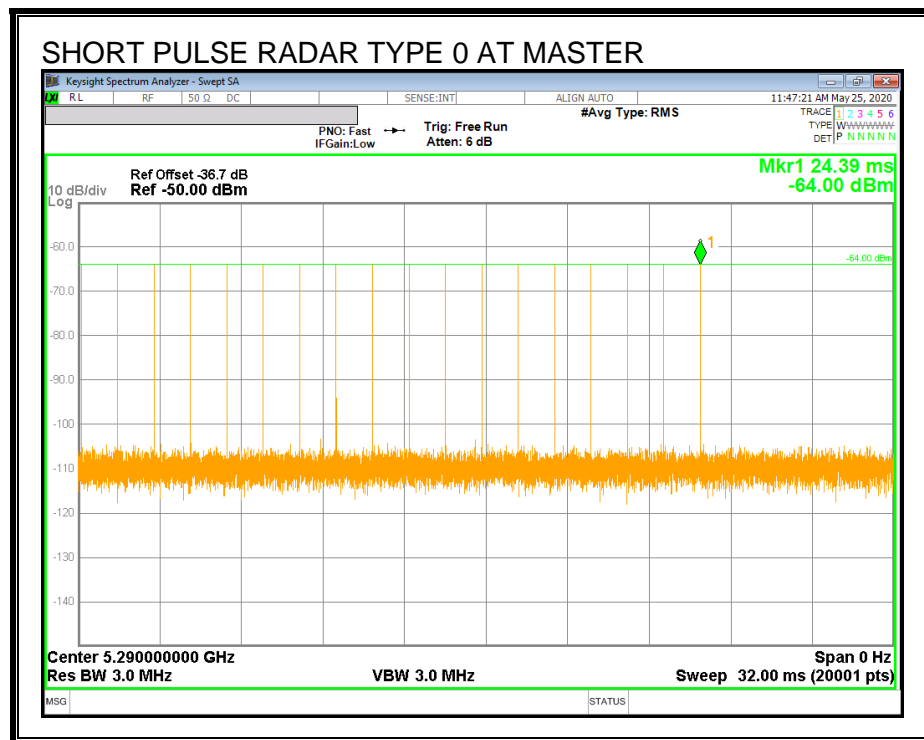

TRAFFIC

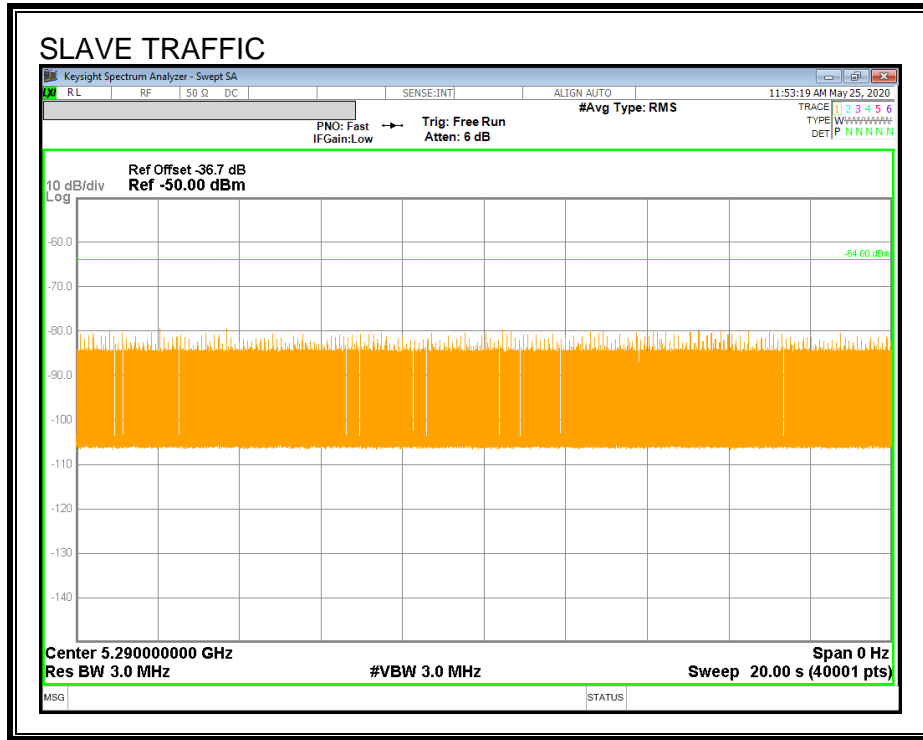

14.2.3. OVERLAPPING CHANNEL TESTS

RESULTS

These tests are not applicable.

14.2.4. MOVE AND CLOSING TIME

REPORTING NOTES

The reference marker is set at the end of last radar pulse.

The delta marker is set at the end of the last WLAN transmission following the radar pulse. This delta is the channel move time.

The aggregate channel closing transmission time is calculated as follows:

Aggregate Transmission Time =
(Number of analyzer bins showing transmission) * (dwell time per bin)

The observation period over which the aggregate time is calculated begins at (Reference Marker + 200 msec) and ends no earlier than (Reference Marker + 10 sec).

RESULTS

Channel Move Time (sec)	Limit (sec)
0.755	10

Aggregate Channel Closing Transmission Time (msec)	Limit (msec)
4.875	60

MOVE TIME & CHANNEL CLOSING TIME

AGGREGATE CHANNEL CLOSING TRANSMISSION TIME

No transmissions are observed during the aggregate monitoring period.

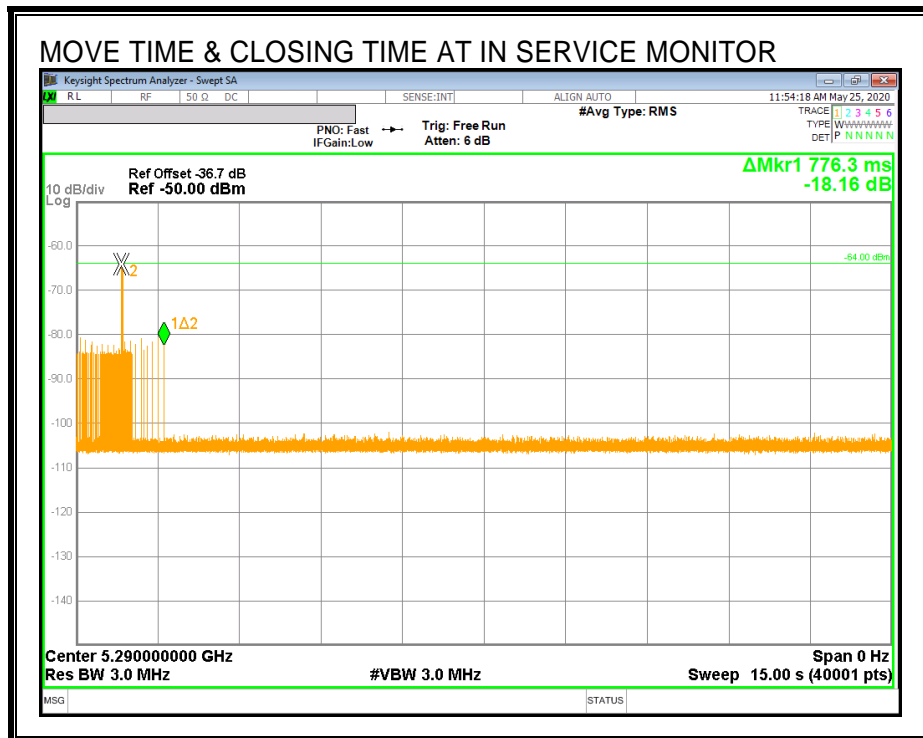
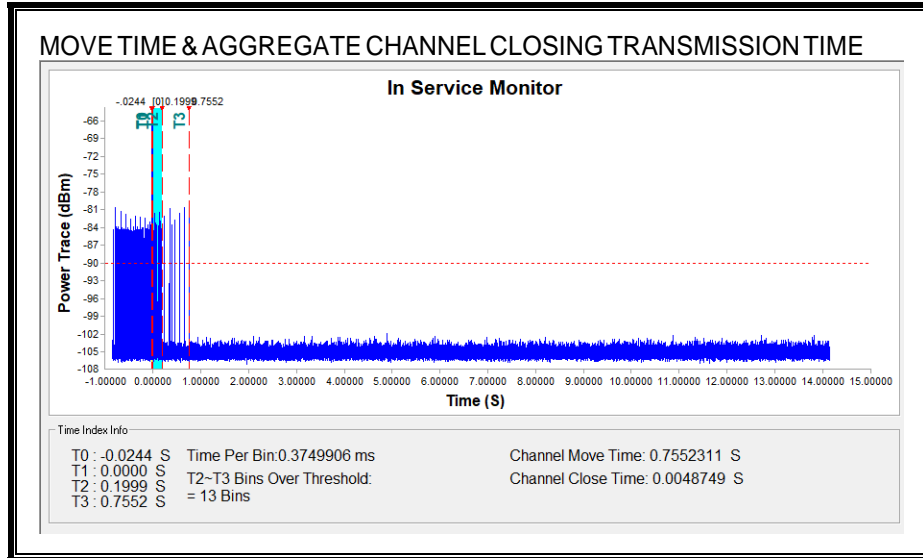

NON-OCCUPANCY PERIOD

RESULTS

No EUT transmissions were observed on the test channel during the 10-minute observation time.

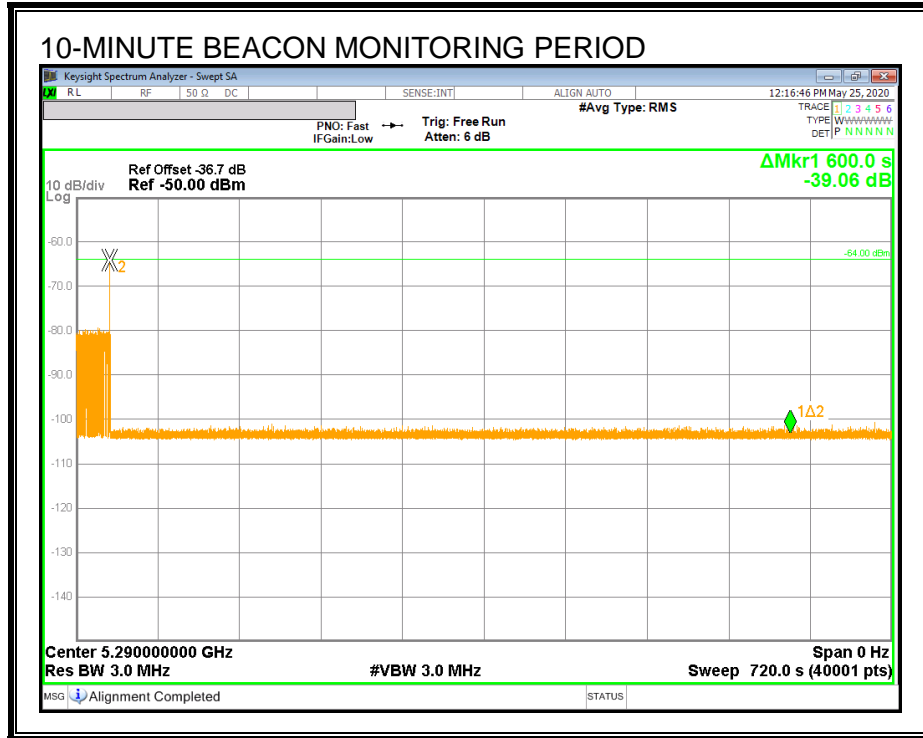

14.3. RESULTS FOR 80 MHz BANDWIDTH (UNII-2C BAND)

14.3.1. TEST CHANNEL

All tests were performed at a channel center frequency of 5530 MHz.

14.3.2. RADAR WAVEFORM AND TRAFFIC

RADAR WAVEFORM

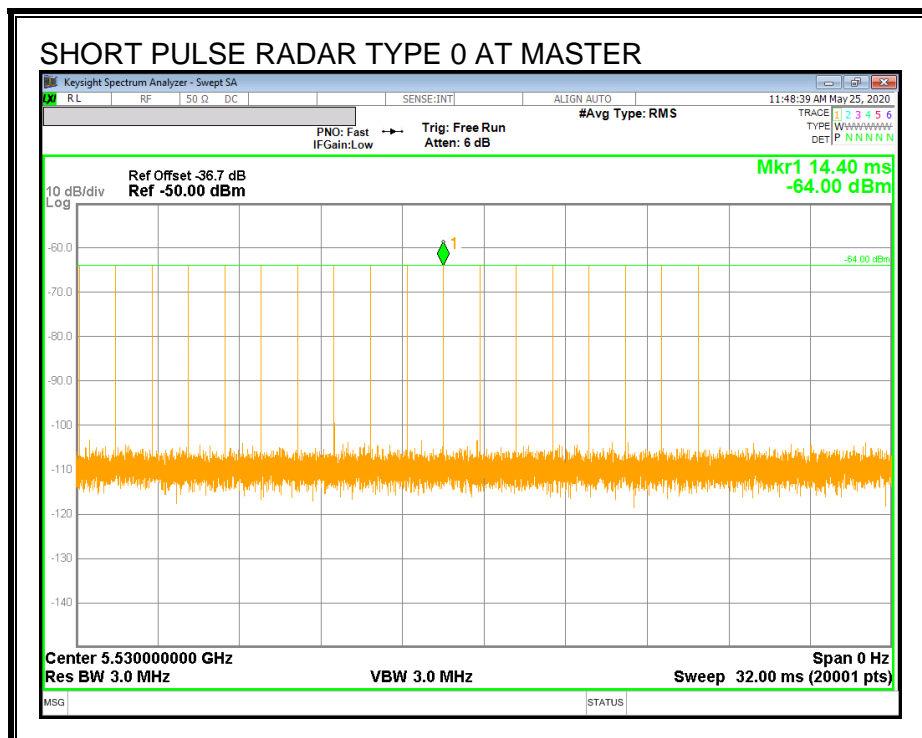

TRAFFIC

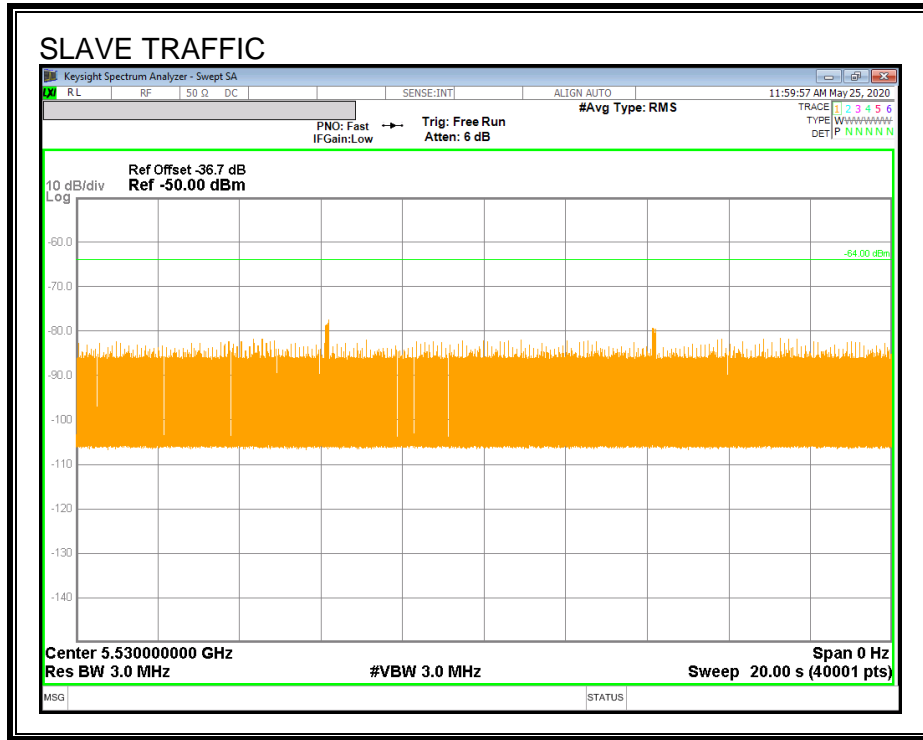

14.3.3. OVERLAPPING CHANNEL TESTS

RESULTS

These tests are not applicable.

14.3.4. MOVE AND CLOSING TIME

REPORTING NOTES

The reference marker is set at the end of last radar pulse.

The delta marker is set at the end of the last WLAN transmission following the radar pulse. This delta is the channel move time.

The aggregate channel closing transmission time is calculated as follows:

Aggregate Transmission Time =
(Number of analyzer bins showing transmission) * (dwell time per bin)

The observation period over which the aggregate time is calculated begins at (Reference Marker + 200 msec) and ends no earlier than (Reference Marker + 10 sec).

RESULTS

Channel Move Time (sec)	Limit (sec)
0.764	10

Aggregate Channel Closing Transmission Time (msec)	Limit (msec)
5.625	60

MOVE TIME & CHANNEL CLOSING TIME

AGGREGATE CHANNEL CLOSING TRANSMISSION TIME

No transmissions are observed during the aggregate monitoring period.

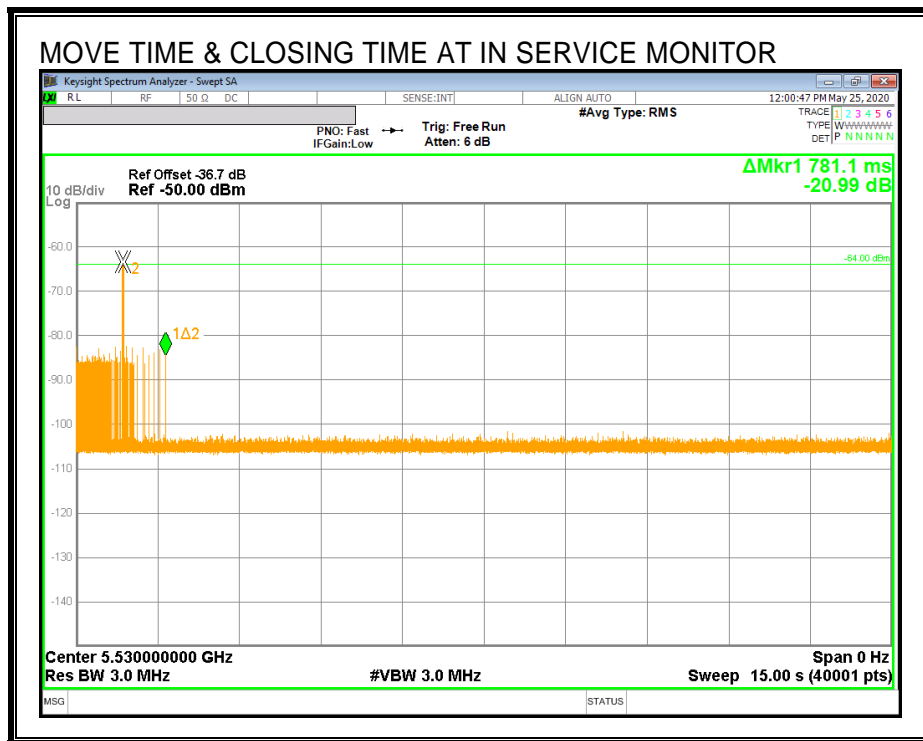
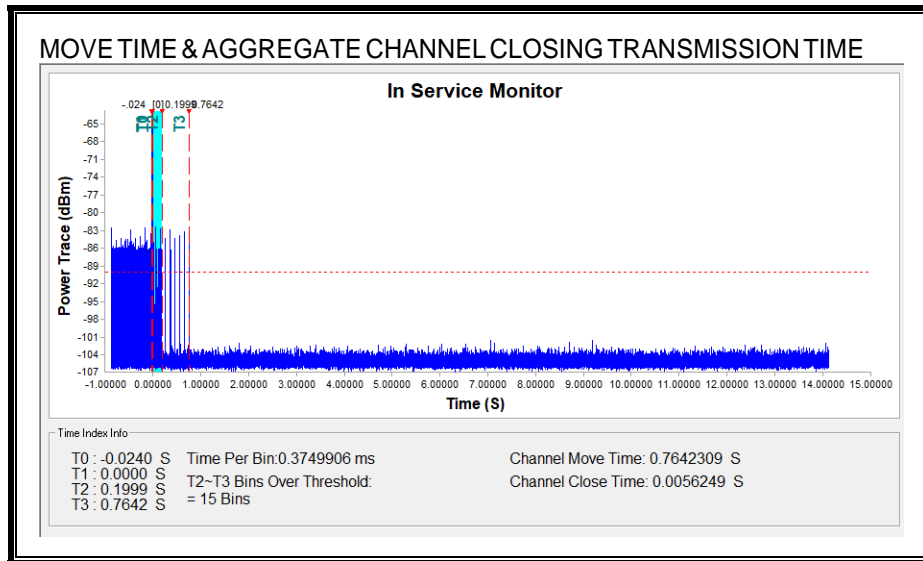

NON-OCCUPANCY PERIOD

RESULTS

No EUT transmissions were observed on the test channel during the 10-minute observation time.

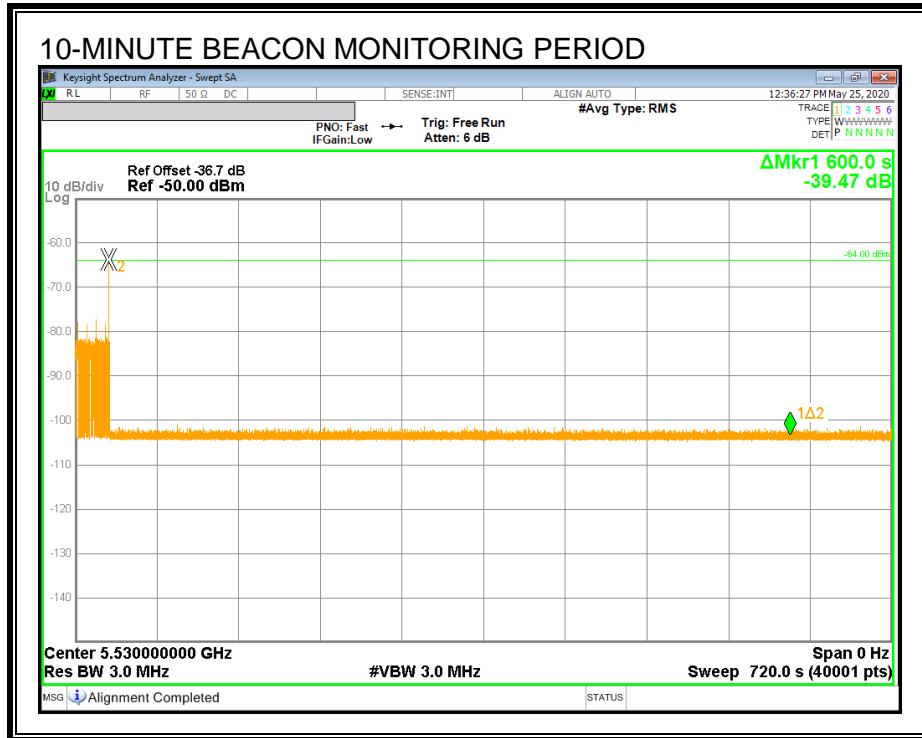

END OF TEST REPORT