



Accredited by the Swiss Accreditation Service (SAS)  
The Swiss Accreditation Service is one of the signatories to the EA  
Multilateral Agreement for the recognition of calibration certificates

Accreditation No.: **SCS 0108**

Client **PC Test**

Certificate No: **ES3-3287\_Sep17**

## CALIBRATION CERTIFICATE

Object **ES3DV3 - SN:3287**

Calibration procedure(s) **QA CAL-01.v9, QA CAL-23.v5, QA CAL-25.v6**  
**Calibration procedure for dosimetric E-field probes**

Calibration date: **September 18, 2017**

*SCV*  
*10/03/2017*

This calibration certificate documents the traceability to national standards, which realize the physical units of measurements (SI).  
The measurements and the uncertainties with confidence probability are given on the following pages and are part of the certificate.

All calibrations have been conducted in the closed laboratory facility: environment temperature (22 ± 3)°C and humidity < 70%.

Calibration Equipment used (M&TE critical for calibration)

| Primary Standards          | ID               | Cal Date (Certificate No.)        | Scheduled Calibration  |
|----------------------------|------------------|-----------------------------------|------------------------|
| Power meter NRP            | SN: 104778       | 04-Apr-17 (No. 217-02521/02522)   | Apr-18                 |
| Power sensor NRP-Z91       | SN: 103244       | 04-Apr-17 (No. 217-02521)         | Apr-18                 |
| Power sensor NRP-Z91       | SN: 103245       | 04-Apr-17 (No. 217-02525)         | Apr-18                 |
| Reference 20 dB Attenuator | SN: S5277 (20x)  | 07-Apr-17 (No. 217-02528)         | Apr-18                 |
| Reference Probe ES3DV2     | SN: 3013         | 31-Dec-16 (No. ES3-3013_Dec16)    | Dec-17                 |
| DAE4                       | SN: 660          | 7-Dec-16 (No. DAE4-660_Dec16)     | Dec-17                 |
| Secondary Standards        | ID               | Check Date (in house)             | Scheduled Check        |
| Power meter E4419B         | SN: GB41293874   | 06-Apr-16 (in house check Jun-16) | In house check: Jun-18 |
| Power sensor E4412A        | SN: MY41498087   | 06-Apr-16 (in house check Jun-16) | In house check: Jun-18 |
| Power sensor E4412A        | SN: 000110210    | 06-Apr-16 (in house check Jun-16) | In house check: Jun-18 |
| RF generator HP 8648C      | SN: US3642U01700 | 04-Aug-99 (in house check Jun-16) | In house check: Jun-18 |
| Network Analyzer HP 8753E  | SN: US37390585   | 18-Oct-01 (in house check Oct-16) | In house check: Oct-17 |

|   |                              |  |                            |
|---|------------------------------|--|----------------------------|
| Calibrated by:  | Name<br><b>Leif Klynsner</b> | Function<br><b>Laboratory Technician</b> | Signature<br>              |
| Approved by:  | Name<br><b>Katja Pokovlc</b> | Function<br><b>Technical Manager</b>     | Signature<br>              |
| This calibration certificate shall not be reproduced except in full without written approval of the laboratory. |                              |  | Issued: September 19, 2017 |



Accredited by the Swiss Accreditation Service (SAS)

Accreditation No.: **SCS 0108**

The Swiss Accreditation Service is one of the signatories to the EA  
Multilateral Agreement for the recognition of calibration certificates

**Glossary:**

|                          |   |
|--------------------------|---|
| TSL                      | tissue simulating liquid  |
| NORM <sub>x,y,z</sub>    | sensitivity in free space   |
| ConvF                    | sensitivity in TSL / NORM <sub>x,y,z</sub>  |
| DCP                      | diode compression point   |
| CF                       | crest factor (1/duty_cycle) of the RF signal  |
| A, B, C, D               | modulation dependent linearization parameters   |
| Polarization $\varphi$   | $\varphi$ rotation around probe axis  |
| Polarization $\vartheta$ | $\vartheta$ rotation around an axis that is in the plane normal to probe axis (at measurement center),<br>i.e., $\vartheta = 0$ is normal to probe axis |
| Connector Angle          | information used in DASY system to align probe sensor X to the robot coordinate system  |

**Calibration is Performed According to the Following Standards:**

- a) IEEE Std 1528-2013, "IEEE Recommended Practice for Determining the Peak Spatial-Averaged Specific Absorption Rate (SAR) in the Human Head from Wireless Communications Devices: Measurement Techniques", June 2013
- b) IEC 62209-1, "Measurement procedure for the assessment of Specific Absorption Rate (SAR) from hand-held and body-mounted devices used next to the ear (frequency range of 300 MHz to 6 GHz)", July 2016
- c) IEC 62209-2, "Procedure to determine the Specific Absorption Rate (SAR) for wireless communication devices used in close proximity to the human body (frequency range of 30 MHz to 6 GHz)", March 2010
- d) KDB 865664, "SAR Measurement Requirements for 100 MHz to 6 GHz"

**Methods Applied and Interpretation of Parameters:**

- **NORM<sub>x,y,z</sub>:** Assessed for E-field polarization  $\vartheta = 0$  ( $f \leq 900$  MHz in TEM-cell;  $f > 1800$  MHz: R22 waveguide). NORM<sub>x,y,z</sub> are only intermediate values, i.e., the uncertainties of NORM<sub>x,y,z</sub> does not affect the E<sup>2</sup>-field uncertainty inside TSL (see below ConvF).
- **NORM(f)<sub>x,y,z</sub> = NORM<sub>x,y,z</sub> \* frequency\_response** (see Frequency Response Chart). This linearization is implemented in DASY4 software versions later than 4.2. The uncertainty of the frequency response is included in the stated uncertainty of ConvF.
- **DCP<sub>x,y,z</sub>:** DCP are numerical linearization parameters assessed based on the data of power sweep with CW signal (no uncertainty required). DCP does not depend on frequency nor media.
- **PAR:** PAR is the Peak to Average Ratio that is not calibrated but determined based on the signal characteristics
- **A<sub>x,y,z</sub>; B<sub>x,y,z</sub>; C<sub>x,y,z</sub>; D<sub>x,y,z</sub>; VR<sub>x,y,z</sub>:** A, B, C, D are numerical linearization parameters assessed based on the data of power sweep for specific modulation signal. The parameters do not depend on frequency nor media. VR is the maximum calibration range expressed in RMS voltage across the diode.
- **ConvF and Boundary Effect Parameters:** Assessed in flat phantom using E-field (or Temperature Transfer Standard for  $f \leq 800$  MHz) and inside waveguide using analytical field distributions based on power measurements for  $f > 800$  MHz. The same setups are used for assessment of the parameters applied for boundary compensation (alpha, depth) of which typical uncertainty values are given. These parameters are used in DASY4 software to improve probe accuracy close to the boundary. The sensitivity in TSL corresponds to NORM<sub>x,y,z</sub> \* ConvF whereby the uncertainty corresponds to that given for ConvF. A frequency dependent ConvF is used in DASY version 4.4 and higher which allows extending the validity from  $\pm 50$  MHz to  $\pm 100$  MHz.
- **Spherical isotropy (3D deviation from isotropy):** in a field of low gradients realized using a flat phantom exposed by a patch antenna.
- **Sensor Offset:** The sensor offset corresponds to the offset of virtual measurement center from the probe tip (on probe axis). No tolerance required.
- **Connector Angle:** The angle is assessed using the information gained by determining the NORM<sub>x</sub> (no uncertainty required).

# Probe ES3DV3

## SN:3287

Manufactured: June 7, 2010  
Calibrated: September 18, 2017

Calibrated for DASY/EASY Systems  
(Note: non-compatible with DASY2 system!)

## DASY/EASY - Parameters of Probe: ES3DV3 - SN:3287

### Basic Calibration Parameters

|   | Sensor X | Sensor Y | Sensor Z | Unc (k=2)    |
|---|----------|----------|----------|--------------|
| Norm ( $\mu\text{V}/(\text{V}/\text{m})^2$ ) <sup>A</sup> | 0.87     | 0.98     | 1.00     | $\pm 10.1\%$ |
| DCP (mV) <sup>B</sup>                                     | 107.7    | 103.1    | 105.0    |              |

### Modulation Calibration Parameters

| UID | Communication System Name |   | A<br>dB | B<br>dB $\sqrt{\mu\text{V}}$ | C   | D<br>dB | VR<br>mV | Unc <sup>E</sup><br>(k=2) |
|-----|---------------------------|---|---------|------------------------------|-----|---------|----------|---------------------------|
| 0   | CW                        | X | 0.0     | 0.0                          | 1.0 | 0.00    | 191.5    | $\pm 3.3\%$               |
|     |                           | Y | 0.0     | 0.0                          | 1.0 |         | 198.9    |                           |
|     |                           | Z | 0.0     | 0.0                          | 1.0 |         | 180.8    |                           |

Note: For details on UID parameters see Appendix.

### Sensor Model Parameters

|   | C1<br>fF | C2<br>fF | $\alpha$<br>$\text{V}^{-1}$ | T1<br>$\text{ms}\cdot\text{V}^{-2}$ | T2<br>$\text{ms}\cdot\text{V}^{-1}$ | T3<br>ms | T4<br>$\text{V}^{-2}$ | T5<br>$\text{V}^{-1}$ | T6    |
|---|----------|----------|-----------------------------|-------------------------------------|-------------------------------------|----------|-----------------------|-----------------------|-------|
| X | 54.28    | 378.7    | 33.99                       | 28.46                               | 2.430                               | 5.072    | 1.313                 | 0.408                 | 1.009 |
| Y | 59.16    | 422.2    | 35.13                       | 29.85                               | 3.583                               | 5.094    | 0.041                 | 0.732                 | 1.008 |
| Z | 43.70    | 307.8    | 34.40                       | 28.00                               | 2.236                               | 5.100    | 1.282                 | 0.347                 | 1.010 |

The reported uncertainty of measurement is stated as the standard uncertainty of measurement multiplied by the coverage factor  $k=2$ , which for a normal distribution corresponds to a coverage probability of approximately 95%.

<sup>A</sup> The uncertainties of Norm X,Y,Z do not affect the  $E^2$ -field uncertainty inside TSL (see Pages 5 and 6).

<sup>B</sup> Numerical linearization parameter: uncertainty not required.

<sup>E</sup> Uncertainty is determined using the max. deviation from linear response applying rectangular distribution and is expressed for the square of the field value.

## DASY/EASY - Parameters of Probe: ES3DV3 - SN:3287

### Calibration Parameter Determined in Head Tissue Simulating Media

| f (MHz) <sup>C</sup> | Relative Permittivity <sup>F</sup> | Conductivity (S/m) <sup>F</sup> | ConvF X | ConvF Y | ConvF Z | Alpha <sup>G</sup> | Depth <sup>G</sup> (mm) | Unc (k=2) |
|----------------------|------------------------------------|---------------------------------|---------|---------|---------|--------------------|-------------------------|-----------|
| 750                  | 41.9                               | 0.89                            | 7.00    | 7.00    | 7.00    | 0.26               | 1.80                    | ± 12.0 %  |
| 835                  | 41.5                               | 0.90                            | 6.70    | 6.70    | 6.70    | 0.56               | 1.23                    | ± 12.0 %  |
| 1750                 | 40.1                               | 1.37                            | 5.57    | 5.57    | 5.57    | 0.53               | 1.28                    | ± 12.0 %  |
| 1900                 | 40.0                               | 1.40                            | 5.34    | 5.34    | 5.34    | 0.41               | 1.52                    | ± 12.0 %  |
| 2300                 | 39.5                               | 1.67                            | 4.94    | 4.94    | 4.94    | 0.42               | 1.57                    | ± 12.0 %  |
| 2450                 | 39.2                               | 1.80                            | 4.64    | 4.64    | 4.64    | 0.55               | 1.39                    | ± 12.0 %  |
| 2600                 | 39.0                               | 1.96                            | 4.44    | 4.44    | 4.44    | 0.58               | 1.43                    | ± 12.0 %  |

<sup>C</sup> Frequency validity above 300 MHz of ± 100 MHz only applies for DASY v4.4 and higher (see Page 2), else it is restricted to ± 50 MHz. The uncertainty is the RSS of the ConvF uncertainty at calibration frequency and the uncertainty for the indicated frequency band. Frequency validity below 300 MHz is ± 10, 25, 40, 50 and 70 MHz for ConvF assessments at 30, 64, 128, 150 and 220 MHz respectively. Above 5 GHz frequency validity can be extended to ± 110 MHz.

<sup>F</sup> At frequencies below 3 GHz, the validity of tissue parameters ( $\epsilon$  and  $\sigma$ ) can be relaxed to ± 10% if liquid compensation formula is applied to measured SAR values. At frequencies above 3 GHz, the validity of tissue parameters ( $\epsilon$  and  $\sigma$ ) is restricted to ± 5%. The uncertainty is the RSS of the ConvF uncertainty for indicated target tissue parameters.

<sup>G</sup> Alpha/Depth are determined during calibration. SPEAG warrants that the remaining deviation due to the boundary effect after compensation is always less than ± 1% for frequencies below 3 GHz and below ± 2% for frequencies between 3-6 GHz at any distance larger than half the probe tip diameter from the boundary.

## DASY/EASY - Parameters of Probe: ES3DV3 - SN:3287

### Calibration Parameter Determined in Body Tissue Simulating Media

| f (MHz) <sup>C</sup> | Relative Permittivity <sup>F</sup> | Conductivity (S/m) <sup>F</sup> | ConvF X | ConvF Y | ConvF Z | Alpha <sup>G</sup> | Depth <sup>G</sup> (mm) | Unc (k=2) |
|----------------------|------------------------------------|---------------------------------|---------|---------|---------|--------------------|-------------------------|-----------|
| 750                  | 55.5                               | 0.96                            | 6.71    | 6.71    | 6.71    | 0.45               | 1.38                    | ± 12.0 %  |
| 835                  | 55.2                               | 0.97                            | 6.56    | 6.56    | 6.56    | 0.80               | 1.05                    | ± 12.0 %  |
| 1750                 | 53.4                               | 1.49                            | 5.19    | 5.19    | 5.19    | 0.37               | 1.73                    | ± 12.0 %  |
| 1900                 | 53.3                               | 1.52                            | 5.00    | 5.00    | 5.00    | 0.47               | 1.51                    | ± 12.0 %  |
| 2300                 | 52.9                               | 1.81                            | 4.66    | 4.66    | 4.66    | 0.59               | 1.36                    | ± 12.0 %  |
| 2450                 | 52.7                               | 1.95                            | 4.47    | 4.47    | 4.47    | 0.55               | 1.20                    | ± 12.0 %  |
| 2600                 | 52.5                               | 2.16                            | 4.28    | 4.28    | 4.28    | 0.50               | 1.20                    | ± 12.0 %  |

<sup>C</sup> Frequency validity above 300 MHz of ± 100 MHz only applies for DASY v4.4 and higher (see Page 2), else it is restricted to ± 50 MHz. The uncertainty is the RSS of the ConvF uncertainty at calibration frequency and the uncertainty for the indicated frequency band. Frequency validity below 300 MHz is ± 10, 25, 40, 50 and 70 MHz for ConvF assessments at 30, 64, 128, 150 and 220 MHz respectively. Above 5 GHz frequency validity can be extended to ± 110 MHz.

<sup>F</sup> At frequencies below 3 GHz, the validity of tissue parameters ( $\epsilon$  and  $\sigma$ ) can be relaxed to ± 10% if liquid compensation formula is applied to measured SAR values. At frequencies above 3 GHz, the validity of tissue parameters ( $\epsilon$  and  $\sigma$ ) is restricted to ± 5%. The uncertainty is the RSS of the ConvF uncertainty for indicated target tissue parameters.

<sup>G</sup> Alpha/Depth are determined during calibration. SPEAG warrants that the remaining deviation due to the boundary effect after compensation is always less than ± 1% for frequencies below 3 GHz and below ± 2% for frequencies between 3-6 GHz at any distance larger than half the probe tip diameter from the boundary.

## Frequency Response of E-Field (TEM-Cell:ifi110 EXX, Waveguide: R22)

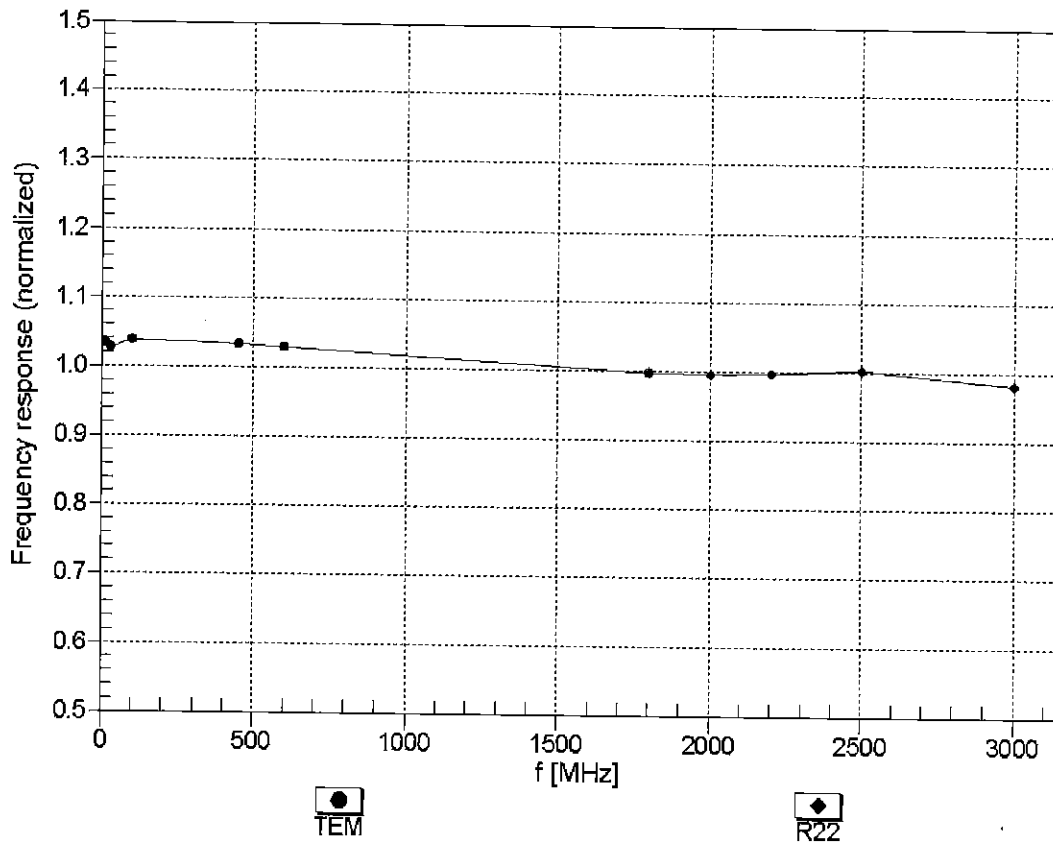

Uncertainty of Frequency Response of E-field:  $\pm 6.3\%$  (k=2)

## Receiving Pattern ( $\phi$ ), $\theta = 0^\circ$

f=600 MHz, TEM

f=1800 MHz, R22

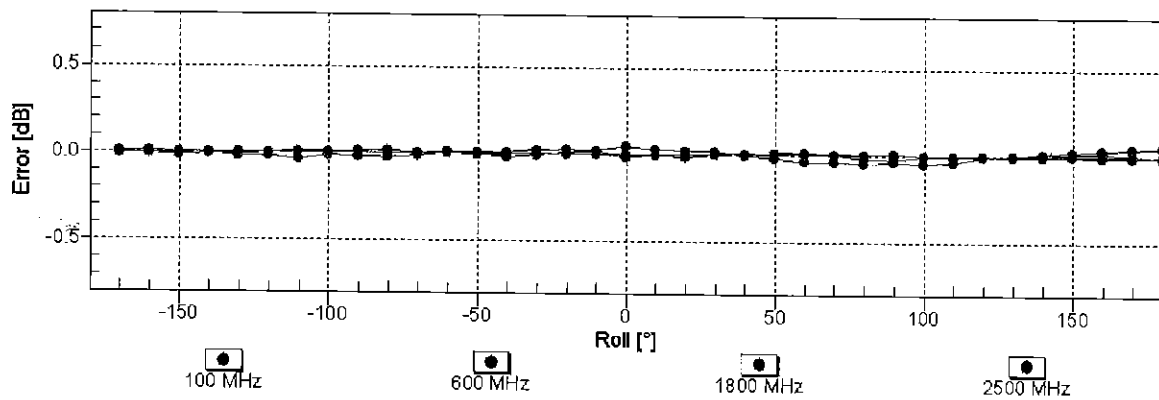
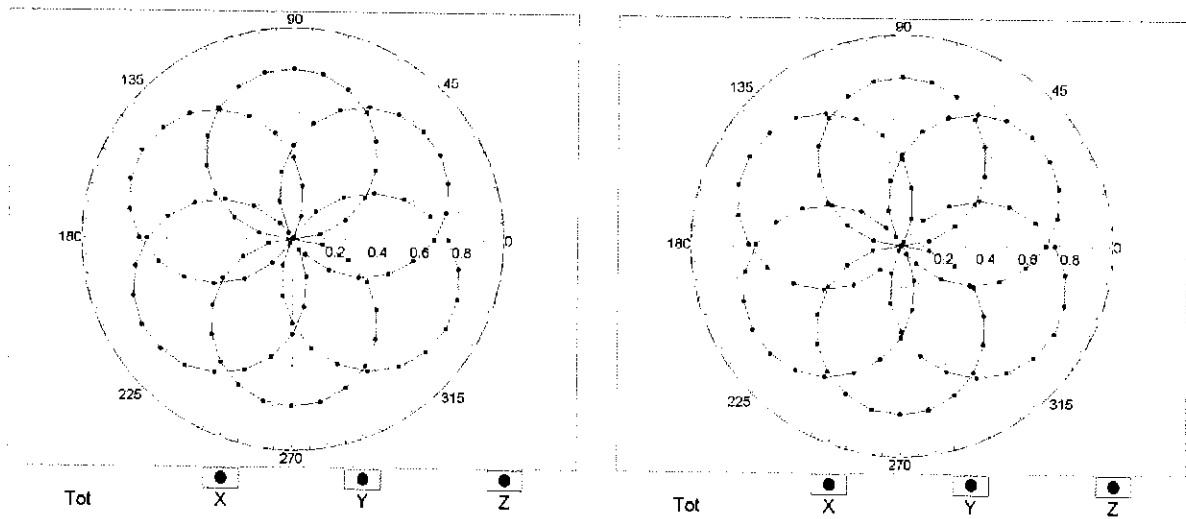

Uncertainty of Axial Isotropy Assessment:  $\pm 0.5\%$  (k=2)



### Dynamic Range $f(SAR_{head})$ (TEM cell , $f_{eval} = 1900$ MHz)

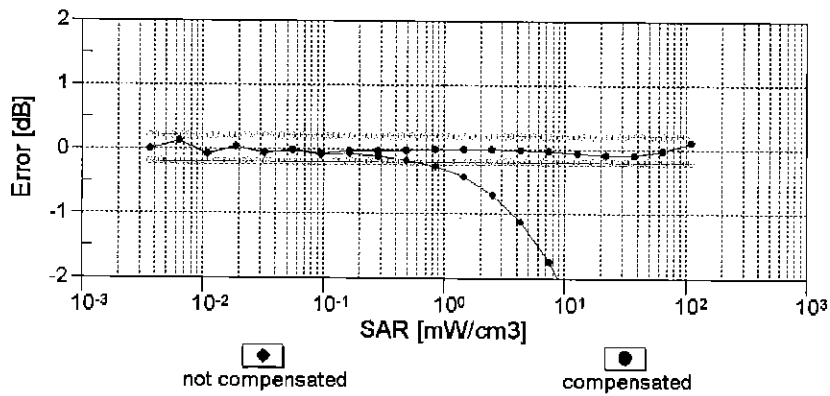
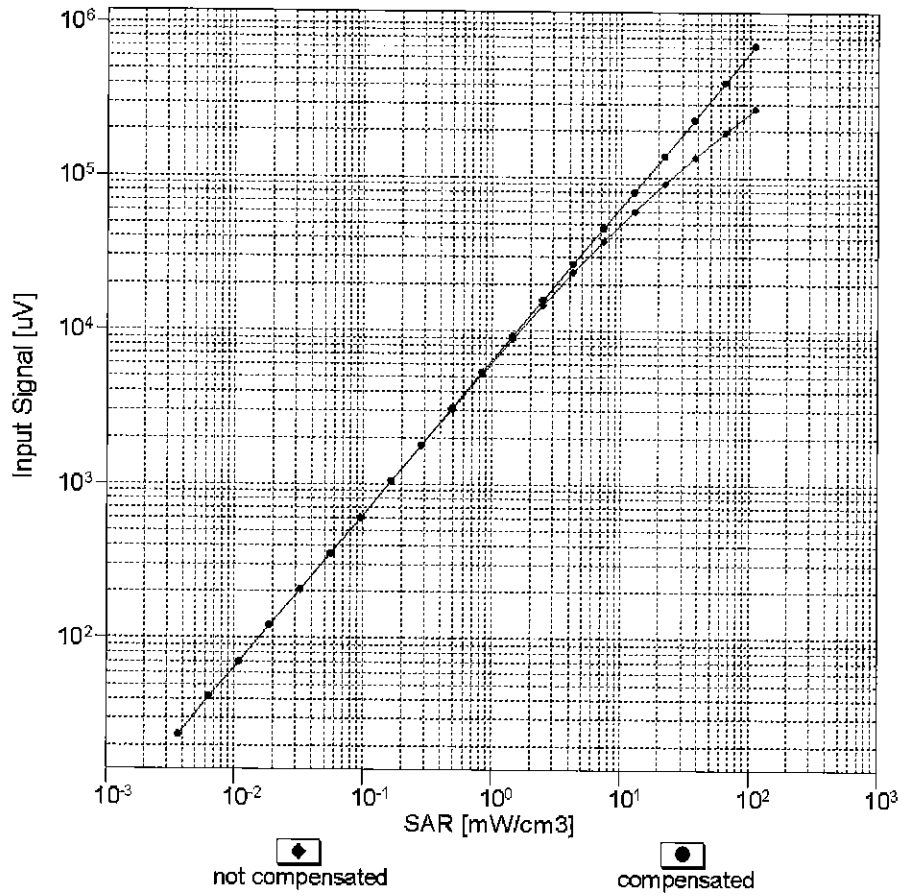

Uncertainty of Linearity Assessment:  $\pm 0.6\%$  ( $k=2$ )

# Conversion Factor Assessment

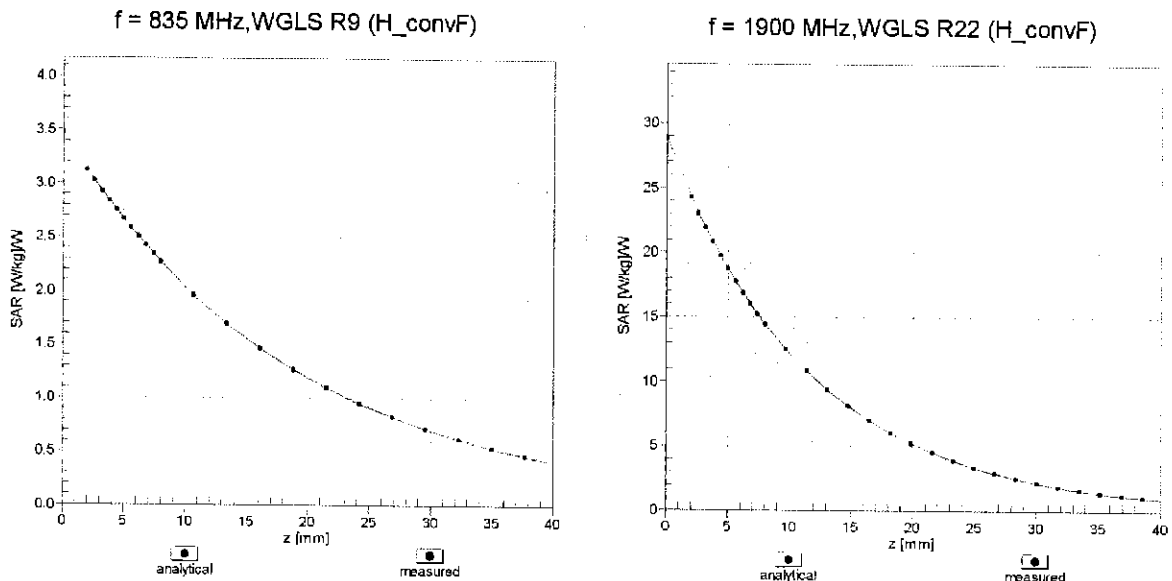

## Deviation from Isotropy in Liquid Error ( $\phi, \vartheta$ ), f = 900 MHz

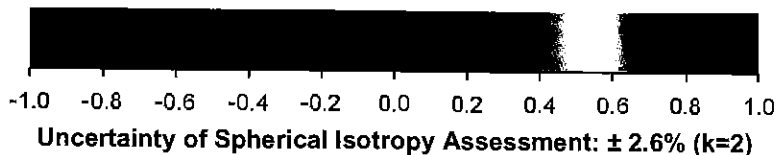
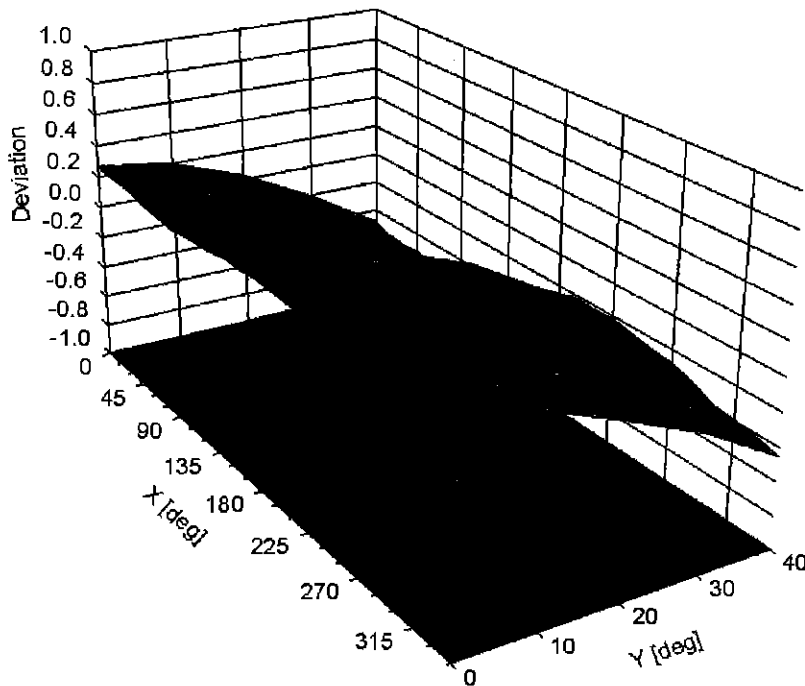

**DASY/EASY - Parameters of Probe: ES3DV3 - SN:3287****Other Probe Parameters**

|   |            |
|---|------------|
| Sensor Arrangement                            | Triangular |
| Connector Angle (°)                           | 89.6       |
| Mechanical Surface Detection Mode             | enabled    |
| Optical Surface Detection Mode                | disabled   |
| Probe Overall Length                          | 337 mm     |
| Probe Body Diameter                           | 10 mm      |
| Tip Length                                    | 10 mm      |
| Tip Diameter                                  | 4 mm       |
| Probe Tip to Sensor X Calibration Point       | 2 mm       |
| Probe Tip to Sensor Y Calibration Point       | 2 mm       |
| Probe Tip to Sensor Z Calibration Point       | 2 mm       |
| Recommended Measurement Distance from Surface | 3 mm       |

**Appendix: Modulation Calibration Parameters**

| UID           | Communication System Name                     |   | A<br>dB | B<br>dB $\sqrt{\mu V}$ | C     | D<br>dB | VR<br>mV | Max<br>Unc <sup>E</sup><br>(k=2) |
|---------------|---|---|---------|------------------------|-------|---------|----------|----------------------------------|
| 0             | CW  | X | 0.00    | 0.00                   | 1.00  | 0.00    | 191.5    | $\pm 3.3\%$                      |
|               |   | Y | 0.00    | 0.00                   | 1.00  |         | 198.9    |                                  |
|               |   | Z | 0.00    | 0.00                   | 1.00  |         | 180.8    |                                  |
| 10010-<br>CAA | SAR Validation (Square, 100ms, 10ms)          | X | 10.31   | 82.54                  | 19.92 | 10.00   | 25.0     | $\pm 9.6\%$                      |
|               |   | Y | 9.70    | 81.57                  | 20.65 |         | 25.0     |                                  |
|               |   | Z | 13.02   | 86.61                  | 21.44 |         | 25.0     |                                  |
| 10011-<br>CAB | UMTS-FDD (WCDMA)                              | X | 1.65    | 76.64                  | 20.39 | 0.00    | 150.0    | $\pm 9.6\%$                      |
|               |   | Y | 1.11    | 68.31                  | 15.89 |         | 150.0    |                                  |
|               |   | Z | 1.20    | 70.53                  | 17.08 |         | 150.0    |                                  |
| 10012-<br>CAB | IEEE 802.11b WiFi 2.4 GHz (DSSS, 1 Mbps)      | X | 1.42    | 67.62                  | 17.77 | 0.41    | 150.0    | $\pm 9.6\%$                      |
|               |   | Y | 1.35    | 65.44                  | 16.09 |         | 150.0    |                                  |
|               |   | Z | 1.35    | 66.18                  | 16.60 |         | 150.0    |                                  |
| 10013-<br>CAB | IEEE 802.11g WiFi 2.4 GHz (DSSS-OFDM, 6 Mbps) | X | 5.13    | 67.63                  | 17.69 | 1.46    | 150.0    | $\pm 9.6\%$                      |
|               |   | Y | 5.21    | 67.37                  | 17.49 |         | 150.0    |                                  |
|               |   | Z | 5.05    | 67.67                  | 17.63 |         | 150.0    |                                  |
| 10021-<br>DAC | GSM-FDD (TDMA, GMSK)                          | X | 36.11   | 104.66                 | 28.70 | 9.39    | 50.0     | $\pm 9.6\%$                      |
|               |   | Y | 17.06   | 92.75                  | 26.26 |         | 50.0     |                                  |
|               |   | Z | 74.47   | 117.68                 | 32.39 |         | 50.0     |                                  |
| 10023-<br>DAC | GPRS-FDD (TDMA, GMSK, TN 0)                   | X | 29.01   | 100.99                 | 27.69 | 9.57    | 50.0     | $\pm 9.6\%$                      |
|               |   | Y | 15.70   | 91.12                  | 25.76 |         | 50.0     |                                  |
|               |   | Z | 50.86   | 111.27                 | 30.76 |         | 50.0     |                                  |
| 10024-<br>DAC | GPRS-FDD (TDMA, GMSK, TN 0-1)                 | X | 100.00  | 118.25                 | 30.37 | 6.56    | 60.0     | $\pm 9.6\%$                      |
|               |   | Y | 79.14   | 117.46                 | 31.45 |         | 60.0     |                                  |
|               |   | Z | 100.00  | 119.51                 | 30.92 |         | 60.0     |                                  |
| 10025-<br>DAC | EDGE-FDD (TDMA, 8PSK, TN 0)                   | X | 18.01   | 104.77                 | 39.73 | 12.57   | 50.0     | $\pm 9.6\%$                      |
|               |   | Y | 13.85   | 93.70                  | 35.01 |         | 50.0     |                                  |
|               |   | Z | 19.28   | 108.70                 | 41.83 |         | 50.0     |                                  |
| 10026-<br>DAC | EDGE-FDD (TDMA, 8PSK, TN 0-1)                 | X | 22.37   | 106.73                 | 36.71 | 9.56    | 60.0     | $\pm 9.6\%$                      |
|               |   | Y | 15.21   | 95.13                  | 32.50 |         | 60.0     |                                  |
|               |   | Z | 23.85   | 109.99                 | 38.29 |         | 60.0     |                                  |
| 10027-<br>DAC | GPRS-FDD (TDMA, GMSK, TN 0-1-2)               | X | 100.00  | 117.60                 | 29.16 | 4.80    | 80.0     | $\pm 9.6\%$                      |
|               |   | Y | 100.00  | 119.86                 | 30.73 |         | 80.0     |                                  |
|               |   | Z | 100.00  | 118.96                 | 29.76 |         | 80.0     |                                  |
| 10028-<br>DAC | GPRS-FDD (TDMA, GMSK, TN 0-1-2-3)             | X | 100.00  | 118.56                 | 28.79 | 3.55    | 100.0    | $\pm 9.6\%$                      |
|               |   | Y | 100.00  | 119.98                 | 29.90 |         | 100.0    |                                  |
|               |   | Z | 100.00  | 119.90                 | 29.38 |         | 100.0    |                                  |
| 10029-<br>DAC | EDGE-FDD (TDMA, 8PSK, TN 0-1-2)               | X | 14.79   | 97.42                  | 32.53 | 7.80    | 80.0     | $\pm 9.6\%$                      |
|               |   | Y | 11.52   | 89.75                  | 29.55 |         | 80.0     |                                  |
|               |   | Z | 14.18   | 97.61                  | 32.99 |         | 80.0     |                                  |
| 10030-<br>CAA | IEEE 802.15.1 Bluetooth (GFSK, DH1)           | X | 100.00  | 116.89                 | 29.16 | 5.30    | 70.0     | $\pm 9.6\%$                      |
|               |   | Y | 100.00  | 119.53                 | 30.94 |         | 70.0     |                                  |
|               |   | Z | 100.00  | 118.05                 | 29.66 |         | 70.0     |                                  |
| 10031-<br>CAA | IEEE 802.15.1 Bluetooth (GFSK, DH3)           | X | 100.00  | 122.60                 | 28.99 | 1.88    | 100.0    | $\pm 9.6\%$                      |
|               |   | Y | 100.00  | 121.51                 | 28.91 |         | 100.0    |                                  |
|               |   | Z | 100.00  | 122.48                 | 28.93 |         | 100.0    |                                  |

|           |   |   |        |        |       |       |       |         |
|-----------|---|---|--------|--------|-------|-------|-------|---------|
| 10032-CAA | IEEE 802.15.1 Bluetooth (GFSK, DH5)                 | X | 100.00 | 133.16 | 32.27 | 1.17  | 100.0 | ± 9.6 % |
|           |   | Y | 100.00 | 126.43 | 29.83 |       | 100.0 |         |
|           |   | Z | 100.00 | 130.02 | 30.96 |       | 100.0 |         |
| 10033-CAA | IEEE 802.15.1 Bluetooth (PI/4-DQPSK, DH1)           | X | 32.57  | 106.74 | 29.49 | 5.30  | 70.0  | ± 9.6 % |
|           |   | Y | 13.39  | 91.56  | 25.42 |       | 70.0  |         |
|           |   | Z | 28.98  | 104.37 | 28.55 |       | 70.0  |         |
| 10034-CAA | IEEE 802.15.1 Bluetooth (PI/4-DQPSK, DH3)           | X | 45.93  | 114.88 | 30.10 | 1.88  | 100.0 | ± 9.6 % |
|           |   | Y | 7.50   | 87.12  | 22.45 |       | 100.0 |         |
|           |   | Z | 20.04  | 100.44 | 25.46 |       | 100.0 |         |
| 10035-CAA | IEEE 802.15.1 Bluetooth (PI/4-DQPSK, DH5)           | X | 21.96  | 105.92 | 27.68 | 1.17  | 100.0 | ± 9.6 % |
|           |   | Y | 4.51   | 81.47  | 20.26 |       | 100.0 |         |
|           |   | Z | 9.42   | 91.44  | 22.56 |       | 100.0 |         |
| 10036-CAA | IEEE 802.15.1 Bluetooth (8-DPSK, DH1)               | X | 45.23  | 112.33 | 31.05 | 5.30  | 70.0  | ± 9.6 % |
|           |   | Y | 15.39  | 94.09  | 26.30 |       | 70.0  |         |
|           |   | Z | 38.95  | 109.34 | 29.96 |       | 70.0  |         |
| 10037-CAA | IEEE 802.15.1 Bluetooth (8-DPSK, DH3)               | X | 39.94  | 112.82 | 29.55 | 1.88  | 100.0 | ± 9.6 % |
|           |   | Y | 7.15   | 86.45  | 22.19 |       | 100.0 |         |
|           |   | Z | 17.08  | 98.28  | 24.84 |       | 100.0 |         |
| 10038-CAA | IEEE 802.15.1 Bluetooth (8-DPSK, DH5)               | X | 24.74  | 108.13 | 28.38 | 1.17  | 100.0 | ± 9.6 % |
|           |   | Y | 4.66   | 82.21  | 20.61 |       | 100.0 |         |
|           |   | Z | 9.87   | 92.45  | 22.99 |       | 100.0 |         |
| 10039-CAB | CDMA2000 (1xRTT, RC1)                               | X | 7.01   | 92.94  | 24.21 | 0.00  | 150.0 | ± 9.6 % |
|           |   | Y | 2.15   | 73.76  | 17.15 |       | 150.0 |         |
|           |   | Z | 2.61   | 77.73  | 17.80 |       | 150.0 |         |
| 10042-CAB | IS-54 / IS-136 FDD (TDMA/FDM, PI/4-DQPSK, Halfrate) | X | 100.00 | 117.06 | 30.06 | 7.78  | 50.0  | ± 9.6 % |
|           |   | Y | 33.54  | 102.85 | 27.66 |       | 50.0  |         |
|           |   | Z | 100.00 | 118.08 | 30.50 |       | 50.0  |         |
| 10044-CAA | IS-91/EIA/TIA-553 FDD (FDMA, FM)                    | X | 0.00   | 127.60 | 2.39  | 0.00  | 150.0 | ± 9.6 % |
|           |   | Y | 0.00   | 96.78  | 0.00  |       | 150.0 |         |
|           |   | Z | 0.01   | 122.93 | 2.94  |       | 150.0 |         |
| 10048-CAA | DECT (TDD, TDMA/FDM, GFSK, Full Slot, 24)           | X | 13.06  | 86.13  | 24.73 | 13.80 | 25.0  | ± 9.6 % |
|           |   | Y | 11.09  | 82.14  | 24.36 |       | 25.0  |         |
|           |   | Z | 16.17  | 90.99  | 26.57 |       | 25.0  |         |
| 10049-CAA | DECT (TDD, TDMA/FDM, GFSK, Double Slot, 12)         | X | 16.50  | 91.24  | 25.09 | 10.79 | 40.0  | ± 9.6 % |
|           |   | Y | 12.58  | 86.37  | 24.53 |       | 40.0  |         |
|           |   | Z | 22.30  | 97.25  | 27.17 |       | 40.0  |         |
| 10056-CAA | UMTS-TDD (TD-SCDMA, 1.28 Mcps)                      | X | 15.28  | 90.62  | 25.52 | 9.03  | 50.0  | ± 9.6 % |
|           |   | Y | 11.72  | 85.08  | 24.19 |       | 50.0  |         |
|           |   | Z | 17.40  | 93.38  | 26.42 |       | 50.0  |         |
| 10058-DAC | EDGE-FDD (TDMA, 8PSK, TN 0-1-2-3)                   | X | 10.69  | 91.04  | 29.62 | 6.55  | 100.0 | ± 9.6 % |
|           |   | Y | 9.07   | 85.67  | 27.37 |       | 100.0 |         |
|           |   | Z | 9.88   | 90.10  | 29.57 |       | 100.0 |         |
| 10059-CAB | IEEE 802.11b WiFi 2.4 GHz (DSSS, 2 Mbps)            | X | 1.68   | 70.66  | 19.16 | 0.61  | 110.0 | ± 9.6 % |
|           |   | Y | 1.55   | 67.69  | 17.16 |       | 110.0 |         |
|           |   | Z | 1.56   | 68.66  | 17.81 |       | 110.0 |         |
| 10060-CAB | IEEE 802.11b WiFi 2.4 GHz (DSSS, 5.5 Mbps)          | X | 100.00 | 135.64 | 35.63 | 1.30  | 110.0 | ± 9.6 % |
|           |   | Y | 100.00 | 131.50 | 34.05 |       | 110.0 |         |
|           |   | Z | 100.00 | 134.30 | 35.03 |       | 110.0 |         |

|           |  |   |       |        |       |      |       |         |
|-----------|--|---|-------|--------|-------|------|-------|---------|
| 10061-CAB | IEEE 802.11b WiFi 2.4 GHz (DSSS, 11 Mbps)      | X | 54.02 | 125.97 | 35.38 | 2.04 | 110.0 | ± 9.6 % |
|           |  | Y | 8.96  | 93.29  | 26.14 |      | 110.0 |         |
|           |  | Z | 19.56 | 108.50 | 30.84 |      | 110.0 |         |
| 10062-CAB | IEEE 802.11a/h WiFi 5 GHz (OFDM, 6 Mbps)       | X | 4.87  | 67.49  | 17.06 | 0.49 | 100.0 | ± 9.6 % |
|           |  | Y | 4.91  | 67.10  | 16.78 |      | 100.0 |         |
|           |  | Z | 4.75  | 67.38  | 16.89 |      | 100.0 |         |
| 10063-CAB | IEEE 802.11a/h WiFi 5 GHz (OFDM, 9 Mbps)       | X | 4.91  | 67.64  | 17.19 | 0.72 | 100.0 | ± 9.6 % |
|           |  | Y | 4.96  | 67.27  | 16.93 |      | 100.0 |         |
|           |  | Z | 4.80  | 67.55  | 17.03 |      | 100.0 |         |
| 10064-CAB | IEEE 802.11a/h WiFi 5 GHz (OFDM, 12 Mbps)      | X | 5.22  | 67.92  | 17.42 | 0.86 | 100.0 | ± 9.6 % |
|           |  | Y | 5.29  | 67.61  | 17.19 |      | 100.0 |         |
|           |  | Z | 5.08  | 67.80  | 17.26 |      | 100.0 |         |
| 10065-CAB | IEEE 802.11a/h WiFi 5 GHz (OFDM, 18 Mbps)      | X | 5.13  | 67.94  | 17.58 | 1.21 | 100.0 | ± 9.6 % |
|           |  | Y | 5.21  | 67.67  | 17.37 |      | 100.0 |         |
|           |  | Z | 5.00  | 67.84  | 17.45 |      | 100.0 |         |
| 10066-CAB | IEEE 802.11a/h WiFi 5 GHz (OFDM, 24 Mbps)      | X | 5.18  | 68.06  | 17.79 | 1.46 | 100.0 | ± 9.6 % |
|           |  | Y | 5.27  | 67.81  | 17.60 |      | 100.0 |         |
|           |  | Z | 5.05  | 67.98  | 17.68 |      | 100.0 |         |
| 10067-CAB | IEEE 802.11a/h WiFi 5 GHz (OFDM, 36 Mbps)      | X | 5.49  | 68.19  | 18.21 | 2.04 | 100.0 | ± 9.6 % |
|           |  | Y | 5.60  | 67.98  | 18.05 |      | 100.0 |         |
|           |  | Z | 5.39  | 68.30  | 18.20 |      | 100.0 |         |
| 10068-CAB | IEEE 802.11a/h WiFi 5 GHz (OFDM, 48 Mbps)      | X | 5.62  | 68.50  | 18.55 | 2.55 | 100.0 | ± 9.6 % |
|           |  | Y | 5.76  | 68.37  | 18.43 |      | 100.0 |         |
|           |  | Z | 5.50  | 68.48  | 18.50 |      | 100.0 |         |
| 10069-CAB | IEEE 802.11a/h WiFi 5 GHz (OFDM, 54 Mbps)      | X | 5.69  | 68.44  | 18.72 | 2.67 | 100.0 | ± 9.6 % |
|           |  | Y | 5.84  | 68.31  | 18.60 |      | 100.0 |         |
|           |  | Z | 5.58  | 68.54  | 18.73 |      | 100.0 |         |
| 10071-CAB | IEEE 802.11g WiFi 2.4 GHz (DSSS/OFDM, 9 Mbps)  | X | 5.27  | 67.84  | 18.05 | 1.99 | 100.0 | ± 9.6 % |
|           |  | Y | 5.37  | 67.63  | 17.89 |      | 100.0 |         |
|           |  | Z | 5.20  | 67.92  | 18.02 |      | 100.0 |         |
| 10072-CAB | IEEE 802.11g WiFi 2.4 GHz (DSSS/OFDM, 12 Mbps) | X | 5.34  | 68.42  | 18.38 | 2.30 | 100.0 | ± 9.6 % |
|           |  | Y | 5.45  | 68.23  | 18.22 |      | 100.0 |         |
|           |  | Z | 5.25  | 68.45  | 18.35 |      | 100.0 |         |
| 10073-CAB | IEEE 802.11g WiFi 2.4 GHz (DSSS/OFDM, 18 Mbps) | X | 5.47  | 68.76  | 18.79 | 2.83 | 100.0 | ± 9.6 % |
|           |  | Y | 5.61  | 68.62  | 18.66 |      | 100.0 |         |
|           |  | Z | 5.40  | 68.87  | 18.81 |      | 100.0 |         |
| 10074-CAB | IEEE 802.11g WiFi 2.4 GHz (DSSS/OFDM, 24 Mbps) | X | 5.51  | 68.83  | 19.02 | 3.30 | 100.0 | ± 9.6 % |
|           |  | Y | 5.66  | 68.73  | 18.92 |      | 100.0 |         |
|           |  | Z | 5.46  | 68.99  | 19.07 |      | 100.0 |         |
| 10075-CAB | IEEE 802.11g WiFi 2.4 GHz (DSSS/OFDM, 36 Mbps) | X | 5.65  | 69.27  | 19.49 | 3.82 | 90.0  | ± 9.6 % |
|           |  | Y | 5.85  | 69.26  | 19.43 |      | 90.0  |         |
|           |  | Z | 5.60  | 69.37  | 19.53 |      | 90.0  |         |
| 10076-CAB | IEEE 802.11g WiFi 2.4 GHz (DSSS/OFDM, 48 Mbps) | X | 5.67  | 69.08  | 19.61 | 4.15 | 90.0  | ± 9.6 % |
|           |  | Y | 5.87  | 69.08  | 19.56 |      | 90.0  |         |
|           |  | Z | 5.65  | 69.30  | 19.73 |      | 90.0  |         |
| 10077-CAB | IEEE 802.11g WiFi 2.4 GHz (DSSS/OFDM, 54 Mbps) | X | 5.72  | 69.19  | 19.72 | 4.30 | 90.0  | ± 9.6 % |
|           |  | Y | 5.92  | 69.19  | 19.67 |      | 90.0  |         |
|           |  | Z | 5.70  | 69.44  | 19.85 |      | 90.0  |         |

|           |   |   |        |        |       |      |       |         |
|-----------|---|---|--------|--------|-------|------|-------|---------|
| 10081-CAB | CDMA2000 (1xRTT, RC3)                               | X | 2.28   | 81.48  | 20.27 | 0.00 | 150.0 | ± 9.6 % |
|           |   | Y | 1.00   | 67.64  | 14.10 |      | 150.0 |         |
|           |   | Z | 1.04   | 69.66  | 14.21 |      | 150.0 |         |
| 10082-CAB | IS-54 / IS-136 FDD (TDMA/FDM, PI/4-DQPSK, Fullrate) | X | 2.13   | 64.08  | 8.83  | 4.77 | 80.0  | ± 9.6 % |
|           |   | Y | 2.57   | 65.34  | 10.16 |      | 80.0  |         |
|           |   | Z | 2.13   | 64.35  | 9.02  |      | 80.0  |         |
| 10090-DAC | GPRS-FDD (TDMA, GMSK, TN 0-4)                       | X | 100.00 | 118.32 | 30.42 | 6.56 | 60.0  | ± 9.6 % |
|           |   | Y | 75.01  | 116.70 | 31.30 |      | 60.0  |         |
|           |   | Z | 100.00 | 119.58 | 30.97 |      | 60.0  |         |
| 10097-CAB | UMTS-FDD (HSDPA)                                    | X | 2.20   | 71.50  | 18.09 | 0.00 | 150.0 | ± 9.6 % |
|           |   | Y | 1.90   | 67.97  | 16.04 |      | 150.0 |         |
|           |   | Z | 1.97   | 69.50  | 16.62 |      | 150.0 |         |
| 10098-CAB | UMTS-FDD (HSUPA, Subtest 2)                         | X | 2.16   | 71.55  | 18.11 | 0.00 | 150.0 | ± 9.6 % |
|           |   | Y | 1.86   | 67.93  | 16.01 |      | 150.0 |         |
|           |   | Z | 1.93   | 69.49  | 16.61 |      | 150.0 |         |
| 10099-DAC | EDGE-FDD (TDMA, 8PSK, TN 0-4)                       | X | 22.24  | 106.54 | 36.64 | 9.56 | 60.0  | ± 9.6 % |
|           |   | Y | 15.16  | 95.02  | 32.46 |      | 60.0  |         |
|           |   | Z | 23.72  | 109.80 | 38.22 |      | 60.0  |         |
| 10100-CAD | LTE-FDD (SC-FDMA, 100% RB, 20 MHz, QPSK)            | X | 3.77   | 73.97  | 18.60 | 0.00 | 150.0 | ± 9.6 % |
|           |   | Y | 3.32   | 71.02  | 16.99 |      | 150.0 |         |
|           |   | Z | 3.27   | 71.57  | 17.41 |      | 150.0 |         |
| 10101-CAD | LTE-FDD (SC-FDMA, 100% RB, 20 MHz, 16-QAM)          | X | 3.50   | 69.24  | 17.00 | 0.00 | 150.0 | ± 9.6 % |
|           |   | Y | 3.39   | 67.99  | 16.16 |      | 150.0 |         |
|           |   | Z | 3.29   | 68.22  | 16.35 |      | 150.0 |         |
| 10102-CAD | LTE-FDD (SC-FDMA, 100% RB, 20 MHz, 64-QAM)          | X | 3.59   | 69.07  | 17.02 | 0.00 | 150.0 | ± 9.6 % |
|           |   | Y | 3.49   | 67.92  | 16.24 |      | 150.0 |         |
|           |   | Z | 3.39   | 68.14  | 16.41 |      | 150.0 |         |
| 10103-CAD | LTE-TDD (SC-FDMA, 100% RB, 20 MHz, QPSK)            | X | 9.27   | 79.88  | 21.95 | 3.98 | 65.0  | ± 9.6 % |
|           |   | Y | 8.43   | 77.27  | 20.93 |      | 65.0  |         |
|           |   | Z | 9.22   | 80.33  | 22.26 |      | 65.0  |         |
| 10104-CAD | LTE-TDD (SC-FDMA, 100% RB, 20 MHz, 16-QAM)          | X | 8.81   | 77.80  | 21.97 | 3.98 | 65.0  | ± 9.6 % |
|           |   | Y | 8.62   | 76.41  | 21.37 |      | 65.0  |         |
|           |   | Z | 8.59   | 77.82  | 22.06 |      | 65.0  |         |
| 10105-CAD | LTE-TDD (SC-FDMA, 100% RB, 20 MHz, 64-QAM)          | X | 8.19   | 76.36  | 21.65 | 3.98 | 65.0  | ± 9.6 % |
|           |   | Y | 7.71   | 74.18  | 20.67 |      | 65.0  |         |
|           |   | Z | 7.86   | 76.00  | 21.56 |      | 65.0  |         |
| 10108-CAE | LTE-FDD (SC-FDMA, 100% RB, 10 MHz, QPSK)            | X | 3.29   | 73.14  | 18.47 | 0.00 | 150.0 | ± 9.6 % |
|           |   | Y | 2.93   | 70.22  | 16.82 |      | 150.0 |         |
|           |   | Z | 2.85   | 70.87  | 17.28 |      | 150.0 |         |
| 10109-CAE | LTE-FDD (SC-FDMA, 100% RB, 10 MHz, 16-QAM)          | X | 3.18   | 69.27  | 17.05 | 0.00 | 150.0 | ± 9.6 % |
|           |   | Y | 3.05   | 67.82  | 16.11 |      | 150.0 |         |
|           |   | Z | 2.94   | 68.18  | 16.29 |      | 150.0 |         |
| 10110-CAE | LTE-FDD (SC-FDMA, 100% RB, 5 MHz, QPSK)             | X | 2.72   | 72.52  | 18.35 | 0.00 | 150.0 | ± 9.6 % |
|           |   | Y | 2.40   | 69.28  | 16.49 |      | 150.0 |         |
|           |   | Z | 2.33   | 70.22  | 16.99 |      | 150.0 |         |
| 10111-CAE | LTE-FDD (SC-FDMA, 100% RB, 5 MHz, 16-QAM)           | X | 2.96   | 70.65  | 17.72 | 0.00 | 150.0 | ± 9.6 % |
|           |   | Y | 2.76   | 68.51  | 16.45 |      | 150.0 |         |
|           |   | Z | 2.69   | 69.33  | 16.67 |      | 150.0 |         |

|           |  |   |       |       |       |      |       |         |
|-----------|--|---|-------|-------|-------|------|-------|---------|
| 10112-CAE | LTE-FDD (SC-FDMA, 100% RB, 10 MHz, 64-QAM)     | X | 3.29  | 69.10 | 17.02 | 0.00 | 150.0 | ± 9.6 % |
|           |  | Y | 3.17  | 67.76 | 16.14 |      | 150.0 |         |
|           |  | Z | 3.06  | 68.15 | 16.32 |      | 150.0 |         |
| 10113-CAE | LTE-FDD (SC-FDMA, 100% RB, 5 MHz, 64-QAM)      | X | 3.11  | 70.58 | 17.73 | 0.00 | 150.0 | ± 9.6 % |
|           |  | Y | 2.92  | 68.59 | 16.56 |      | 150.0 |         |
|           |  | Z | 2.83  | 69.41 | 16.76 |      | 150.0 |         |
| 10114-CAB | IEEE 802.11n (HT Greenfield, 13.5 Mbps, BPSK)  | X | 5.26  | 67.86 | 16.86 | 0.00 | 150.0 | ± 9.6 % |
|           |  | Y | 5.25  | 67.40 | 16.53 |      | 150.0 |         |
|           |  | Z | 5.14  | 67.65 | 16.68 |      | 150.0 |         |
| 10115-CAB | IEEE 802.11n (HT Greenfield, 81 Mbps, 16-QAM)  | X | 5.60  | 68.11 | 16.98 | 0.00 | 150.0 | ± 9.6 % |
|           |  | Y | 5.62  | 67.73 | 16.70 |      | 150.0 |         |
|           |  | Z | 5.40  | 67.70 | 16.71 |      | 150.0 |         |
| 10116-CAB | IEEE 802.11n (HT Greenfield, 135 Mbps, 64-QAM) | X | 5.38  | 68.12 | 16.91 | 0.00 | 150.0 | ± 9.6 % |
|           |  | Y | 5.38  | 67.68 | 16.59 |      | 150.0 |         |
|           |  | Z | 5.23  | 67.82 | 16.70 |      | 150.0 |         |
| 10117-CAB | IEEE 802.11n (HT Mixed, 13.5 Mbps, BPSK)       | X | 5.24  | 67.79 | 16.84 | 0.00 | 150.0 | ± 9.6 % |
|           |  | Y | 5.25  | 67.40 | 16.55 |      | 150.0 |         |
|           |  | Z | 5.10  | 67.49 | 16.62 |      | 150.0 |         |
| 10118-CAB | IEEE 802.11n (HT Mixed, 81 Mbps, 16-QAM)       | X | 5.68  | 68.30 | 17.08 | 0.00 | 150.0 | ± 9.6 % |
|           |  | Y | 5.70  | 67.92 | 16.80 |      | 150.0 |         |
|           |  | Z | 5.48  | 67.91 | 16.83 |      | 150.0 |         |
| 10119-CAB | IEEE 802.11n (HT Mixed, 135 Mbps, 64-QAM)      | X | 5.35  | 68.04 | 16.89 | 0.00 | 150.0 | ± 9.6 % |
|           |  | Y | 5.35  | 67.63 | 16.58 |      | 150.0 |         |
|           |  | Z | 5.21  | 67.79 | 16.69 |      | 150.0 |         |
| 10140-CAD | LTE-FDD (SC-FDMA, 100% RB, 15 MHz, 16-QAM)     | X | 3.63  | 69.06 | 16.93 | 0.00 | 150.0 | ± 9.6 % |
|           |  | Y | 3.53  | 67.92 | 16.17 |      | 150.0 |         |
|           |  | Z | 3.42  | 68.16 | 16.33 |      | 150.0 |         |
| 10141-CAD | LTE-FDD (SC-FDMA, 100% RB, 15 MHz, 64-QAM)     | X | 3.75  | 69.06 | 17.04 | 0.00 | 150.0 | ± 9.6 % |
|           |  | Y | 3.65  | 67.98 | 16.31 |      | 150.0 |         |
|           |  | Z | 3.54  | 68.23 | 16.48 |      | 150.0 |         |
| 10142-CAD | LTE-FDD (SC-FDMA, 100% RB, 3 MHz, QPSK)        | X | 2.58  | 73.34 | 18.51 | 0.00 | 150.0 | ± 9.6 % |
|           |  | Y | 2.18  | 69.29 | 16.31 |      | 150.0 |         |
|           |  | Z | 2.13  | 70.56 | 16.73 |      | 150.0 |         |
| 10143-CAD | LTE-FDD (SC-FDMA, 100% RB, 3 MHz, 16-QAM)      | X | 3.01  | 72.46 | 18.03 | 0.00 | 150.0 | ± 9.6 % |
|           |  | Y | 2.65  | 69.32 | 16.38 |      | 150.0 |         |
|           |  | Z | 2.60  | 70.44 | 16.44 |      | 150.0 |         |
| 10144-CAD | LTE-FDD (SC-FDMA, 100% RB, 3 MHz, 64-QAM)      | X | 2.64  | 69.45 | 16.13 | 0.00 | 150.0 | ± 9.6 % |
|           |  | Y | 2.44  | 67.23 | 14.90 |      | 150.0 |         |
|           |  | Z | 2.30  | 67.73 | 14.62 |      | 150.0 |         |
| 10145-CAE | LTE-FDD (SC-FDMA, 100% RB, 1.4 MHz, QPSK)      | X | 2.19  | 73.84 | 16.83 | 0.00 | 150.0 | ± 9.6 % |
|           |  | Y | 1.54  | 67.56 | 13.92 |      | 150.0 |         |
|           |  | Z | 1.24  | 66.10 | 11.96 |      | 150.0 |         |
| 10146-CAE | LTE-FDD (SC-FDMA, 100% RB, 1.4 MHz, 16-QAM)    | X | 6.00  | 80.94 | 18.56 | 0.00 | 150.0 | ± 9.6 % |
|           |  | Y | 2.97  | 71.15 | 15.11 |      | 150.0 |         |
|           |  | Z | 2.39  | 68.87 | 12.55 |      | 150.0 |         |
| 10147-CAE | LTE-FDD (SC-FDMA, 100% RB, 1.4 MHz, 64-QAM)    | X | 13.14 | 91.59 | 22.17 | 0.00 | 150.0 | ± 9.6 % |
|           |  | Y | 3.76  | 74.52 | 16.70 |      | 150.0 |         |
|           |  | Z | 3.21  | 72.37 | 14.16 |      | 150.0 |         |



|           |  |   |       |       |       |      |       |         |
|-----------|--|---|-------|-------|-------|------|-------|---------|
| 10149-CAD | LTE-FDD (SC-FDMA, 50% RB, 20 MHz, 16-QAM)  | X | 3.19  | 69.34 | 17.10 | 0.00 | 150.0 | ± 9.6 % |
|           |  | Y | 3.06  | 67.89 | 16.15 |      | 150.0 |         |
|           |  | Z | 2.95  | 68.25 | 16.34 |      | 150.0 |         |
| 10150-CAD | LTE-FDD (SC-FDMA, 50% RB, 20 MHz, 64-QAM)  | X | 3.29  | 69.16 | 17.06 | 0.00 | 150.0 | ± 9.6 % |
|           |  | Y | 3.18  | 67.81 | 16.18 |      | 150.0 |         |
|           |  | Z | 3.07  | 68.20 | 16.36 |      | 150.0 |         |
| 10151-CAD | LTE-TDD (SC-FDMA, 50% RB, 20 MHz, QPSK)    | X | 10.08 | 82.65 | 23.10 | 3.98 | 65.0  | ± 9.6 % |
|           |  | Y | 9.04  | 79.65 | 21.96 |      | 65.0  |         |
|           |  | Z | 10.06 | 83.26 | 23.42 |      | 65.0  |         |
| 10152-CAD | LTE-TDD (SC-FDMA, 50% RB, 20 MHz, 16-QAM)  | X | 8.50  | 78.17 | 21.88 | 3.98 | 65.0  | ± 9.6 % |
|           |  | Y | 8.23  | 76.54 | 21.20 |      | 65.0  |         |
|           |  | Z | 8.27  | 78.18 | 21.88 |      | 65.0  |         |
| 10153-CAD | LTE-TDD (SC-FDMA, 50% RB, 20 MHz, 64-QAM)  | X | 8.91  | 78.99 | 22.55 | 3.98 | 65.0  | ± 9.6 % |
|           |  | Y | 8.60  | 77.29 | 21.85 |      | 65.0  |         |
|           |  | Z | 8.71  | 79.10 | 22.58 |      | 65.0  |         |
| 10154-CAE | LTE-FDD (SC-FDMA, 50% RB, 10 MHz, QPSK)    | X | 2.81  | 73.15 | 18.70 | 0.00 | 150.0 | ± 9.6 % |
|           |  | Y | 2.46  | 69.77 | 16.80 |      | 150.0 |         |
|           |  | Z | 2.38  | 70.62 | 17.23 |      | 150.0 |         |
| 10155-CAE | LTE-FDD (SC-FDMA, 50% RB, 10 MHz, 16-QAM)  | X | 2.96  | 70.66 | 17.73 | 0.00 | 150.0 | ± 9.6 % |
|           |  | Y | 2.76  | 68.51 | 16.46 |      | 150.0 |         |
|           |  | Z | 2.69  | 69.35 | 16.69 |      | 150.0 |         |
| 10156-CAE | LTE-FDD (SC-FDMA, 50% RB, 5 MHz, QPSK)     | X | 2.55  | 74.52 | 18.86 | 0.00 | 150.0 | ± 9.6 % |
|           |  | Y | 2.05  | 69.58 | 16.30 |      | 150.0 |         |
|           |  | Z | 2.00  | 70.89 | 16.58 |      | 150.0 |         |
| 10157-CAE | LTE-FDD (SC-FDMA, 50% RB, 5 MHz, 16-QAM)   | X | 2.62  | 71.06 | 16.72 | 0.00 | 150.0 | ± 9.6 % |
|           |  | Y | 2.30  | 67.95 | 15.09 |      | 150.0 |         |
|           |  | Z | 2.17  | 68.55 | 14.74 |      | 150.0 |         |
| 10158-CAE | LTE-FDD (SC-FDMA, 50% RB, 10 MHz, 64-QAM)  | X | 3.11  | 70.65 | 17.78 | 0.00 | 150.0 | ± 9.6 % |
|           |  | Y | 2.92  | 68.65 | 16.60 |      | 150.0 |         |
|           |  | Z | 2.84  | 69.48 | 16.81 |      | 150.0 |         |
| 10159-CAE | LTE-FDD (SC-FDMA, 50% RB, 5 MHz, 64-QAM)   | X | 2.77  | 71.67 | 17.06 | 0.00 | 150.0 | ± 9.6 % |
|           |  | Y | 2.42  | 68.44 | 15.40 |      | 150.0 |         |
|           |  | Z | 2.27  | 68.98 | 14.99 |      | 150.0 |         |
| 10160-CAD | LTE-FDD (SC-FDMA, 50% RB, 15 MHz, QPSK)    | X | 3.14  | 71.31 | 17.89 | 0.00 | 150.0 | ± 9.6 % |
|           |  | Y | 2.90  | 69.12 | 16.57 |      | 150.0 |         |
|           |  | Z | 2.85  | 69.90 | 17.00 |      | 150.0 |         |
| 10161-CAD | LTE-FDD (SC-FDMA, 50% RB, 15 MHz, 16-QAM)  | X | 3.19  | 69.15 | 17.05 | 0.00 | 150.0 | ± 9.6 % |
|           |  | Y | 3.08  | 67.73 | 16.13 |      | 150.0 |         |
|           |  | Z | 2.97  | 68.19 | 16.30 |      | 150.0 |         |
| 10162-CAD | LTE-FDD (SC-FDMA, 50% RB, 15 MHz, 64-QAM)  | X | 3.30  | 69.19 | 17.10 | 0.00 | 150.0 | ± 9.6 % |
|           |  | Y | 3.18  | 67.80 | 16.21 |      | 150.0 |         |
|           |  | Z | 3.08  | 68.34 | 16.41 |      | 150.0 |         |
| 10166-CAE | LTE-FDD (SC-FDMA, 50% RB, 1.4 MHz, QPSK)   | X | 4.14  | 72.27 | 20.63 | 3.01 | 150.0 | ± 9.6 % |
|           |  | Y | 3.92  | 70.06 | 19.35 |      | 150.0 |         |
|           |  | Z | 3.85  | 71.64 | 20.32 |      | 150.0 |         |
| 10167-CAE | LTE-FDD (SC-FDMA, 50% RB, 1.4 MHz, 16-QAM) | X | 5.70  | 76.91 | 21.68 | 3.01 | 150.0 | ± 9.6 % |
|           |  | Y | 4.94  | 72.92 | 19.80 |      | 150.0 |         |
|           |  | Z | 5.14  | 76.11 | 21.32 |      | 150.0 |         |

|           |  |   |        |        |       |      |       |         |
|-----------|--|---|--------|--------|-------|------|-------|---------|
| 10168-CAE | LTE-FDD (SC-FDMA, 50% RB, 1.4 MHz, 64-QAM) | X | 6.50   | 79.76  | 23.17 | 3.01 | 150.0 | ± 9.6 % |
|           |  | Y | 5.42   | 74.94  | 21.01 |      | 150.0 |         |
|           |  | Z | 5.85   | 78.93  | 22.82 |      | 150.0 |         |
| 10169-CAD | LTE-FDD (SC-FDMA, 1 RB, 20 MHz, QPSK)      | X | 3.88   | 74.16  | 21.49 | 3.01 | 150.0 | ± 9.6 % |
|           |  | Y | 3.53   | 70.80  | 19.64 |      | 150.0 |         |
|           |  | Z | 3.37   | 71.79  | 20.43 |      | 150.0 |         |
| 10170-CAD | LTE-FDD (SC-FDMA, 1 RB, 20 MHz, 16-QAM)    | X | 7.14   | 85.17  | 25.38 | 3.01 | 150.0 | ± 9.6 % |
|           |  | Y | 5.02   | 76.66  | 21.81 |      | 150.0 |         |
|           |  | Z | 5.41   | 80.65  | 23.72 |      | 150.0 |         |
| 10171-AAD | LTE-FDD (SC-FDMA, 1 RB, 20 MHz, 64-QAM)    | X | 5.21   | 78.32  | 21.78 | 3.01 | 150.0 | ± 9.6 % |
|           |  | Y | 4.13   | 72.50  | 19.15 |      | 150.0 |         |
|           |  | Z | 4.25   | 75.40  | 20.64 |      | 150.0 |         |
| 10172-CAD | LTE-TDD (SC-FDMA, 1 RB, 20 MHz, QPSK)      | X | 82.16  | 130.26 | 39.09 | 6.02 | 65.0  | ± 9.6 % |
|           |  | Y | 17.62  | 97.94  | 29.93 |      | 65.0  |         |
|           |  | Z | 65.78  | 128.99 | 39.45 |      | 65.0  |         |
| 10173-CAD | LTE-TDD (SC-FDMA, 1 RB, 20 MHz, 16-QAM)    | X | 91.21  | 124.95 | 35.70 | 6.02 | 65.0  | ± 9.6 % |
|           |  | Y | 19.75  | 96.35  | 28.03 |      | 65.0  |         |
|           |  | Z | 100.00 | 129.35 | 37.29 |      | 65.0  |         |
| 10174-CAD | LTE-TDD (SC-FDMA, 1 RB, 20 MHz, 64-QAM)    | X | 55.61  | 114.43 | 32.46 | 6.02 | 65.0  | ± 9.6 % |
|           |  | Y | 16.76  | 92.45  | 26.36 |      | 65.0  |         |
|           |  | Z | 70.56  | 121.14 | 34.65 |      | 65.0  |         |
| 10175-CAE | LTE-FDD (SC-FDMA, 1 RB, 10 MHz, QPSK)      | X | 3.81   | 73.71  | 21.19 | 3.01 | 150.0 | ± 9.6 % |
|           |  | Y | 3.48   | 70.45  | 19.37 |      | 150.0 |         |
|           |  | Z | 3.32   | 71.46  | 20.19 |      | 150.0 |         |
| 10176-CAE | LTE-FDD (SC-FDMA, 1 RB, 10 MHz, 16-QAM)    | X | 7.15   | 85.21  | 25.39 | 3.01 | 150.0 | ± 9.6 % |
|           |  | Y | 5.03   | 76.68  | 21.82 |      | 150.0 |         |
|           |  | Z | 5.42   | 80.68  | 23.74 |      | 150.0 |         |
| 10177-CAG | LTE-FDD (SC-FDMA, 1 RB, 5 MHz, QPSK)       | X | 3.85   | 73.93  | 21.31 | 3.01 | 150.0 | ± 9.6 % |
|           |  | Y | 3.51   | 70.63  | 19.48 |      | 150.0 |         |
|           |  | Z | 3.35   | 71.61  | 20.27 |      | 150.0 |         |
| 10178-CAE | LTE-FDD (SC-FDMA, 1 RB, 5 MHz, 16-QAM)     | X | 7.01   | 84.77  | 25.21 | 3.01 | 150.0 | ± 9.6 % |
|           |  | Y | 4.96   | 76.40  | 21.67 |      | 150.0 |         |
|           |  | Z | 5.36   | 80.45  | 23.62 |      | 150.0 |         |
| 10179-CAE | LTE-FDD (SC-FDMA, 1 RB, 10 MHz, 64-QAM)    | X | 6.07   | 81.52  | 23.41 | 3.01 | 150.0 | ± 9.6 % |
|           |  | Y | 4.53   | 74.41  | 20.33 |      | 150.0 |         |
|           |  | Z | 4.79   | 77.92  | 22.06 |      | 150.0 |         |
| 10180-CAE | LTE-FDD (SC-FDMA, 1 RB, 5 MHz, 64-QAM)     | X | 5.18   | 78.18  | 21.70 | 3.01 | 150.0 | ± 9.6 % |
|           |  | Y | 4.12   | 72.40  | 19.09 |      | 150.0 |         |
|           |  | Z | 4.24   | 75.33  | 20.60 |      | 150.0 |         |
| 10181-CAD | LTE-FDD (SC-FDMA, 1 RB, 15 MHz, QPSK)      | X | 3.84   | 73.91  | 21.30 | 3.01 | 150.0 | ± 9.6 % |
|           |  | Y | 3.51   | 70.61  | 19.47 |      | 150.0 |         |
|           |  | Z | 3.35   | 71.60  | 20.27 |      | 150.0 |         |
| 10182-CAD | LTE-FDD (SC-FDMA, 1 RB, 15 MHz, 16-QAM)    | X | 6.99   | 84.74  | 25.19 | 3.01 | 150.0 | ± 9.6 % |
|           |  | Y | 4.95   | 76.38  | 21.66 |      | 150.0 |         |
|           |  | Z | 5.35   | 80.42  | 23.61 |      | 150.0 |         |
| 10183-AAC | LTE-FDD (SC-FDMA, 1 RB, 15 MHz, 64-QAM)    | X | 5.17   | 78.15  | 21.69 | 3.01 | 150.0 | ± 9.6 % |
|           |  | Y | 4.11   | 72.38  | 19.08 |      | 150.0 |         |
|           |  | Z | 4.23   | 75.30  | 20.59 |      | 150.0 |         |

|           |   |   |      |       |       |      |       |         |
|-----------|---|---|------|-------|-------|------|-------|---------|
| 10184-CAD | LTE-FDD (SC-FDMA, 1 RB, 3 MHz, QPSK)          | X | 3.86 | 73.96 | 21.33 | 3.01 | 150.0 | ± 9.6 % |
|           |   | Y | 3.52 | 70.65 | 19.50 |      | 150.0 |         |
|           |   | Z | 3.36 | 71.64 | 20.29 |      | 150.0 |         |
| 10185-CAD | LTE-FDD (SC-FDMA, 1 RB, 3 MHz, 16-QAM)        | X | 7.04 | 84.85 | 25.24 | 3.01 | 150.0 | ± 9.6 % |
|           |   | Y | 4.98 | 76.45 | 21.70 |      | 150.0 |         |
|           |   | Z | 5.38 | 80.50 | 23.65 |      | 150.0 |         |
| 10186-AAD | LTE-FDD (SC-FDMA, 1 RB, 3 MHz, 64-QAM)        | X | 5.20 | 78.24 | 21.73 | 3.01 | 150.0 | ± 9.6 % |
|           |   | Y | 4.13 | 72.45 | 19.11 |      | 150.0 |         |
|           |   | Z | 4.25 | 75.38 | 20.62 |      | 150.0 |         |
| 10187-CAE | LTE-FDD (SC-FDMA, 1 RB, 1.4 MHz, QPSK)        | X | 3.87 | 74.02 | 21.39 | 3.01 | 150.0 | ± 9.6 % |
|           |   | Y | 3.53 | 70.69 | 19.55 |      | 150.0 |         |
|           |   | Z | 3.37 | 71.71 | 20.36 |      | 150.0 |         |
| 10188-CAE | LTE-FDD (SC-FDMA, 1 RB, 1.4 MHz, 16-QAM)      | X | 7.44 | 86.01 | 25.76 | 3.01 | 150.0 | ± 9.6 % |
|           |   | Y | 5.15 | 77.16 | 22.09 |      | 150.0 |         |
|           |   | Z | 5.58 | 81.30 | 24.05 |      | 150.0 |         |
| 10189-AAE | LTE-FDD (SC-FDMA, 1 RB, 1.4 MHz, 64-QAM)      | X | 5.39 | 78.94 | 22.10 | 3.01 | 150.0 | ± 9.6 % |
|           |   | Y | 4.22 | 72.89 | 19.39 |      | 150.0 |         |
|           |   | Z | 4.36 | 75.91 | 20.93 |      | 150.0 |         |
| 10193-CAB | IEEE 802.11n (HT Greenfield, 6.5 Mbps, BPSK)  | X | 4.67 | 67.32 | 16.65 | 0.00 | 150.0 | ± 9.6 % |
|           |   | Y | 4.67 | 66.82 | 16.30 |      | 150.0 |         |
|           |   | Z | 4.53 | 67.11 | 16.38 |      | 150.0 |         |
| 10194-CAB | IEEE 802.11n (HT Greenfield, 39 Mbps, 16-QAM) | X | 4.85 | 67.66 | 16.76 | 0.00 | 150.0 | ± 9.6 % |
|           |   | Y | 4.86 | 67.18 | 16.41 |      | 150.0 |         |
|           |   | Z | 4.69 | 67.40 | 16.51 |      | 150.0 |         |
| 10195-CAB | IEEE 802.11n (HT Greenfield, 65 Mbps, 64-QAM) | X | 4.89 | 67.68 | 16.77 | 0.00 | 150.0 | ± 9.6 % |
|           |   | Y | 4.90 | 67.20 | 16.42 |      | 150.0 |         |
|           |   | Z | 4.73 | 67.43 | 16.52 |      | 150.0 |         |
| 10196-CAB | IEEE 802.11n (HT Mixed, 6.5 Mbps, BPSK)       | X | 4.68 | 67.41 | 16.68 | 0.00 | 150.0 | ± 9.6 % |
|           |   | Y | 4.68 | 66.91 | 16.33 |      | 150.0 |         |
|           |   | Z | 4.52 | 67.15 | 16.39 |      | 150.0 |         |
| 10197-CAB | IEEE 802.11n (HT Mixed, 39 Mbps, 16-QAM)      | X | 4.87 | 67.69 | 16.78 | 0.00 | 150.0 | ± 9.6 % |
|           |   | Y | 4.88 | 67.20 | 16.42 |      | 150.0 |         |
|           |   | Z | 4.70 | 67.42 | 16.52 |      | 150.0 |         |
| 10198-CAB | IEEE 802.11n (HT Mixed, 65 Mbps, 64-QAM)      | X | 4.90 | 67.70 | 16.79 | 0.00 | 150.0 | ± 9.6 % |
|           |   | Y | 4.91 | 67.21 | 16.43 |      | 150.0 |         |
|           |   | Z | 4.73 | 67.45 | 16.54 |      | 150.0 |         |
| 10219-CAB | IEEE 802.11n (HT Mixed, 7.2 Mbps, BPSK)       | X | 4.63 | 67.43 | 16.65 | 0.00 | 150.0 | ± 9.6 % |
|           |   | Y | 4.63 | 66.93 | 16.29 |      | 150.0 |         |
|           |   | Z | 4.47 | 67.18 | 16.36 |      | 150.0 |         |
| 10220-CAB | IEEE 802.11n (HT Mixed, 43.3 Mbps, 16-QAM)    | X | 4.86 | 67.66 | 16.77 | 0.00 | 150.0 | ± 9.6 % |
|           |   | Y | 4.88 | 67.19 | 16.42 |      | 150.0 |         |
|           |   | Z | 4.69 | 67.38 | 16.50 |      | 150.0 |         |
| 10221-CAB | IEEE 802.11n (HT Mixed, 72.2 Mbps, 64-QAM)    | X | 4.90 | 67.62 | 16.76 | 0.00 | 150.0 | ± 9.6 % |
|           |   | Y | 4.91 | 67.14 | 16.42 |      | 150.0 |         |
|           |   | Z | 4.74 | 67.37 | 16.52 |      | 150.0 |         |
| 10222-CAB | IEEE 802.11n (HT Mixed, 15 Mbps, BPSK)        | X | 5.22 | 67.81 | 16.85 | 0.00 | 150.0 | ± 9.6 % |
|           |   | Y | 5.23 | 67.42 | 16.55 |      | 150.0 |         |
|           |   | Z | 5.08 | 67.50 | 16.62 |      | 150.0 |         |

|           |   |   |        |        |       |      |       |         |
|-----------|---|---|--------|--------|-------|------|-------|---------|
| 10223-CAB | IEEE 802.11n (HT Mixed, 90 Mbps, 16-QAM)  | X | 5.53   | 67.97  | 16.94 | 0.00 | 150.0 | ± 9.6 % |
|           |   | Y | 5.59   | 67.74  | 16.73 |      | 150.0 |         |
|           |   | Z | 5.38   | 67.75  | 16.76 |      | 150.0 |         |
| 10224-CAB | IEEE 802.11n (HT Mixed, 150 Mbps, 64-QAM) | X | 5.26   | 67.91  | 16.83 | 0.00 | 150.0 | ± 9.6 % |
|           |   | Y | 5.27   | 67.51  | 16.52 |      | 150.0 |         |
|           |   | Z | 5.12   | 67.61  | 16.60 |      | 150.0 |         |
| 10225-CAB | UMTS-FDD (HSPA+)                          | X | 3.00   | 67.51  | 16.39 | 0.00 | 150.0 | ± 9.6 % |
|           |   | Y | 2.93   | 66.39  | 15.65 |      | 150.0 |         |
|           |   | Z | 2.82   | 66.88  | 15.63 |      | 150.0 |         |
| 10226-CAA | LTE-TDD (SC-FDMA, 1 RB, 1.4 MHz, 16-QAM)  | X | 100.00 | 126.81 | 36.25 | 6.02 | 65.0  | ± 9.6 % |
|           |   | Y | 20.60  | 97.21  | 28.37 |      | 65.0  |         |
|           |   | Z | 100.00 | 129.54 | 37.41 |      | 65.0  |         |
| 10227-CAA | LTE-TDD (SC-FDMA, 1 RB, 1.4 MHz, 64-QAM)  | X | 65.64  | 117.49 | 33.34 | 6.02 | 65.0  | ± 9.6 % |
|           |   | Y | 18.22  | 94.00  | 26.93 |      | 65.0  |         |
|           |   | Z | 85.61  | 124.65 | 35.59 |      | 65.0  |         |
| 10228-CAA | LTE-TDD (SC-FDMA, 1 RB, 1.4 MHz, QPSK)    | X | 79.85  | 130.36 | 39.26 | 6.02 | 65.0  | ± 9.6 % |
|           |   | Y | 20.21  | 101.07 | 31.01 |      | 65.0  |         |
|           |   | Z | 65.84  | 129.47 | 39.67 |      | 65.0  |         |
| 10229-CAB | LTE-TDD (SC-FDMA, 1 RB, 3 MHz, 16-QAM)    | X | 91.11  | 124.93 | 35.70 | 6.02 | 65.0  | ± 9.6 % |
|           |   | Y | 19.80  | 96.38  | 28.04 |      | 65.0  |         |
|           |   | Z | 100.00 | 129.35 | 37.29 |      | 65.0  |         |
| 10230-CAB | LTE-TDD (SC-FDMA, 1 RB, 3 MHz, 64-QAM)    | X | 60.15  | 115.83 | 32.84 | 6.02 | 65.0  | ± 9.6 % |
|           |   | Y | 17.60  | 93.31  | 26.65 |      | 65.0  |         |
|           |   | Z | 77.12  | 122.67 | 35.03 |      | 65.0  |         |
| 10231-CAB | LTE-TDD (SC-FDMA, 1 RB, 3 MHz, QPSK)      | X | 72.28  | 128.22 | 38.64 | 6.02 | 65.0  | ± 9.6 % |
|           |   | Y | 19.39  | 100.17 | 30.67 |      | 65.0  |         |
|           |   | Z | 59.87  | 127.39 | 39.07 |      | 65.0  |         |
| 10232-CAD | LTE-TDD (SC-FDMA, 1 RB, 5 MHz, 16-QAM)    | X | 91.25  | 124.96 | 35.71 | 6.02 | 65.0  | ± 9.6 % |
|           |   | Y | 19.78  | 96.37  | 28.04 |      | 65.0  |         |
|           |   | Z | 100.00 | 129.36 | 37.30 |      | 65.0  |         |
| 10233-CAD | LTE-TDD (SC-FDMA, 1 RB, 5 MHz, 64-QAM)    | X | 60.26  | 115.87 | 32.85 | 6.02 | 65.0  | ± 9.6 % |
|           |   | Y | 17.59  | 93.32  | 26.66 |      | 65.0  |         |
|           |   | Z | 77.19  | 122.70 | 35.04 |      | 65.0  |         |
| 10234-CAD | LTE-TDD (SC-FDMA, 1 RB, 5 MHz, QPSK)      | X | 65.41  | 125.97 | 37.96 | 6.02 | 65.0  | ± 9.6 % |
|           |   | Y | 18.62  | 99.23  | 30.29 |      | 65.0  |         |
|           |   | Z | 54.84  | 125.34 | 38.42 |      | 65.0  |         |
| 10235-CAD | LTE-TDD (SC-FDMA, 1 RB, 10 MHz, 16-QAM)   | X | 91.93  | 125.11 | 35.75 | 6.02 | 65.0  | ± 9.6 % |
|           |   | Y | 19.81  | 96.41  | 28.05 |      | 65.0  |         |
|           |   | Z | 100.00 | 129.37 | 37.30 |      | 65.0  |         |
| 10236-CAD | LTE-TDD (SC-FDMA, 1 RB, 10 MHz, 64-QAM)   | X | 61.00  | 116.05 | 32.90 | 6.02 | 65.0  | ± 9.6 % |
|           |   | Y | 17.69  | 93.40  | 26.68 |      | 65.0  |         |
|           |   | Z | 78.43  | 122.94 | 35.10 |      | 65.0  |         |
| 10237-CAD | LTE-TDD (SC-FDMA, 1 RB, 10 MHz, QPSK)     | X | 73.61  | 128.60 | 38.74 | 6.02 | 65.0  | ± 9.6 % |
|           |   | Y | 19.49  | 100.29 | 30.70 |      | 65.0  |         |
|           |   | Z | 60.90  | 127.76 | 39.16 |      | 65.0  |         |
| 10238-CAD | LTE-TDD (SC-FDMA, 1 RB, 15 MHz, 16-QAM)   | X | 91.47  | 125.02 | 35.72 | 6.02 | 65.0  | ± 9.6 % |
|           |   | Y | 19.78  | 96.38  | 28.04 |      | 65.0  |         |
|           |   | Z | 100.00 | 129.37 | 37.30 |      | 65.0  |         |

|           |  |   |       |        |       |      |      |         |
|-----------|--|---|-------|--------|-------|------|------|---------|
| 10239-CAD | LTE-TDD (SC-FDMA, 1 RB, 15 MHz, 64-QAM)    | X | 60.36 | 115.92 | 32.87 | 6.02 | 65.0 | ± 9.6 % |
|           |  | Y | 17.58 | 93.32  | 26.66 |      | 65.0 |         |
|           |  | Z | 77.24 | 122.72 | 35.05 |      | 65.0 |         |
| 10240-CAD | LTE-TDD (SC-FDMA, 1 RB, 15 MHz, QPSK)      | X | 73.31 | 128.53 | 38.72 | 6.02 | 65.0 | ± 9.6 % |
|           |  | Y | 19.44 | 100.25 | 30.69 |      | 65.0 |         |
|           |  | Z | 60.69 | 127.70 | 39.15 |      | 65.0 |         |
| 10241-CAA | LTE-TDD (SC-FDMA, 50% RB, 1.4 MHz, 16-QAM) | X | 14.22 | 90.30  | 28.70 | 6.98 | 65.0 | ± 9.6 % |
|           |  | Y | 11.91 | 84.78  | 26.56 |      | 65.0 |         |
|           |  | Z | 15.04 | 92.96  | 29.82 |      | 65.0 |         |
| 10242-CAA | LTE-TDD (SC-FDMA, 50% RB, 1.4 MHz, 64-QAM) | X | 12.20 | 86.96  | 27.37 | 6.98 | 65.0 | ± 9.6 % |
|           |  | Y | 11.04 | 83.09  | 25.82 |      | 65.0 |         |
|           |  | Z | 14.66 | 92.40  | 29.55 |      | 65.0 |         |
| 10243-CAA | LTE-TDD (SC-FDMA, 50% RB, 1.4 MHz, QPSK)   | X | 9.46  | 83.32  | 26.91 | 6.98 | 65.0 | ± 9.6 % |
|           |  | Y | 9.15  | 80.79  | 25.71 |      | 65.0 |         |
|           |  | Z | 10.96 | 87.97  | 28.96 |      | 65.0 |         |
| 10244-CAB | LTE-TDD (SC-FDMA, 50% RB, 3 MHz, 16-QAM)   | X | 10.76 | 82.68  | 21.60 | 3.98 | 65.0 | ± 9.6 % |
|           |  | Y | 9.17  | 79.37  | 20.74 |      | 65.0 |         |
|           |  | Z | 9.65  | 80.90  | 20.36 |      | 65.0 |         |
| 10245-CAB | LTE-TDD (SC-FDMA, 50% RB, 3 MHz, 64-QAM)   | X | 10.44 | 81.95  | 21.29 | 3.98 | 65.0 | ± 9.6 % |
|           |  | Y | 9.07  | 78.96  | 20.54 |      | 65.0 |         |
|           |  | Z | 9.24  | 79.99  | 19.97 |      | 65.0 |         |
| 10246-CAB | LTE-TDD (SC-FDMA, 50% RB, 3 MHz, QPSK)     | X | 11.35 | 86.57  | 23.09 | 3.98 | 65.0 | ± 9.6 % |
|           |  | Y | 8.94  | 81.85  | 21.69 |      | 65.0 |         |
|           |  | Z | 10.01 | 84.49  | 21.88 |      | 65.0 |         |
| 10247-CAD | LTE-TDD (SC-FDMA, 50% RB, 5 MHz, 16-QAM)   | X | 8.24  | 79.27  | 21.01 | 3.98 | 65.0 | ± 9.6 % |
|           |  | Y | 7.74  | 77.28  | 20.43 |      | 65.0 |         |
|           |  | Z | 7.64  | 78.13  | 20.10 |      | 65.0 |         |
| 10248-CAD | LTE-TDD (SC-FDMA, 50% RB, 5 MHz, 64-QAM)   | X | 8.11  | 78.56  | 20.72 | 3.98 | 65.0 | ± 9.6 % |
|           |  | Y | 7.73  | 76.82  | 20.23 |      | 65.0 |         |
|           |  | Z | 7.48  | 77.39  | 19.79 |      | 65.0 |         |
| 10249-CAD | LTE-TDD (SC-FDMA, 50% RB, 5 MHz, QPSK)     | X | 12.62 | 88.79  | 24.56 | 3.98 | 65.0 | ± 9.6 % |
|           |  | Y | 9.64  | 83.20  | 22.76 |      | 65.0 |         |
|           |  | Z | 12.16 | 88.40  | 24.15 |      | 65.0 |         |
| 10250-CAD | LTE-TDD (SC-FDMA, 50% RB, 10 MHz, 16-QAM)  | X | 9.13  | 81.24  | 23.10 | 3.98 | 65.0 | ± 9.6 % |
|           |  | Y | 8.50  | 78.84  | 22.20 |      | 65.0 |         |
|           |  | Z | 8.86  | 81.11  | 22.89 |      | 65.0 |         |
| 10251-CAD | LTE-TDD (SC-FDMA, 50% RB, 10 MHz, 64-QAM)  | X | 8.47  | 78.74  | 21.83 | 3.98 | 65.0 | ± 9.6 % |
|           |  | Y | 8.10  | 76.89  | 21.13 |      | 65.0 |         |
|           |  | Z | 8.20  | 78.63  | 21.61 |      | 65.0 |         |
| 10252-CAD | LTE-TDD (SC-FDMA, 50% RB, 10 MHz, QPSK)    | X | 11.59 | 86.92  | 24.65 | 3.98 | 65.0 | ± 9.6 % |
|           |  | Y | 9.53  | 82.29  | 23.01 |      | 65.0 |         |
|           |  | Z | 11.63 | 87.60  | 24.87 |      | 65.0 |         |
| 10253-CAD | LTE-TDD (SC-FDMA, 50% RB, 15 MHz, 16-QAM)  | X | 8.27  | 77.55  | 21.65 | 3.98 | 65.0 | ± 9.6 % |
|           |  | Y | 8.04  | 76.02  | 21.02 |      | 65.0 |         |
|           |  | Z | 8.09  | 77.65  | 21.62 |      | 65.0 |         |
| 10254-CAD | LTE-TDD (SC-FDMA, 50% RB, 15 MHz, 64-QAM)  | X | 8.67  | 78.35  | 22.26 | 3.98 | 65.0 | ± 9.6 % |
|           |  | Y | 8.41  | 76.75  | 21.61 |      | 65.0 |         |
|           |  | Z | 8.50  | 78.49  | 22.25 |      | 65.0 |         |

|           |   |   |       |       |       |      |      |         |
|-----------|---|---|-------|-------|-------|------|------|---------|
| 10255-CAD | LTE-TDD (SC-FDMA, 50% RB, 15 MHz, QPSK)     | X | 9.69  | 82.20 | 23.16 | 3.98 | 65.0 | ± 9.6 % |
|           |   | Y | 8.77  | 79.29 | 22.03 |      | 65.0 |         |
|           |   | Z | 9.70  | 82.84 | 23.45 |      | 65.0 |         |
| 10256-CAA | LTE-TDD (SC-FDMA, 100% RB, 1.4 MHz, 16-QAM) | X | 9.10  | 79.45 | 19.54 | 3.98 | 65.0 | ± 9.6 % |
|           |   | Y | 8.28  | 77.46 | 19.27 |      | 65.0 |         |
|           |   | Z | 7.50  | 76.38 | 17.64 |      | 65.0 |         |
| 10257-CAA | LTE-TDD (SC-FDMA, 100% RB, 1.4 MHz, 64-QAM) | X | 8.71  | 78.44 | 19.07 | 3.98 | 65.0 | ± 9.6 % |
|           |   | Y | 8.14  | 76.86 | 18.96 |      | 65.0 |         |
|           |   | Z | 7.10  | 75.27 | 17.09 |      | 65.0 |         |
| 10258-CAA | LTE-TDD (SC-FDMA, 100% RB, 1.4 MHz, QPSK)   | X | 9.16  | 82.49 | 20.98 | 3.98 | 65.0 | ± 9.6 % |
|           |   | Y | 7.92  | 79.54 | 20.28 |      | 65.0 |         |
|           |   | Z | 7.29  | 78.75 | 18.94 |      | 65.0 |         |
| 10259-CAB | LTE-TDD (SC-FDMA, 100% RB, 3 MHz, 16-QAM)   | X | 8.59  | 79.95 | 21.73 | 3.98 | 65.0 | ± 9.6 % |
|           |   | Y | 8.03  | 77.80 | 21.03 |      | 65.0 |         |
|           |   | Z | 8.13  | 79.27 | 21.11 |      | 65.0 |         |
| 10260-CAB | LTE-TDD (SC-FDMA, 100% RB, 3 MHz, 64-QAM)   | X | 8.53  | 79.55 | 21.59 | 3.98 | 65.0 | ± 9.6 % |
|           |   | Y | 8.06  | 77.57 | 20.96 |      | 65.0 |         |
|           |   | Z | 8.06  | 78.82 | 20.93 |      | 65.0 |         |
| 10261-CAB | LTE-TDD (SC-FDMA, 100% RB, 3 MHz, QPSK)     | X | 11.51 | 87.11 | 24.32 | 3.98 | 65.0 | ± 9.6 % |
|           |   | Y | 9.26  | 82.24 | 22.68 |      | 65.0 |         |
|           |   | Z | 11.28 | 87.12 | 24.13 |      | 65.0 |         |
| 10262-CAD | LTE-TDD (SC-FDMA, 100% RB, 5 MHz, 16-QAM)   | X | 9.12  | 81.19 | 23.06 | 3.98 | 65.0 | ± 9.6 % |
|           |   | Y | 8.49  | 78.79 | 22.16 |      | 65.0 |         |
|           |   | Z | 8.84  | 81.05 | 22.85 |      | 65.0 |         |
| 10263-CAD | LTE-TDD (SC-FDMA, 100% RB, 5 MHz, 64-QAM)   | X | 8.46  | 78.73 | 21.82 | 3.98 | 65.0 | ± 9.6 % |
|           |   | Y | 8.09  | 76.88 | 21.13 |      | 65.0 |         |
|           |   | Z | 8.19  | 78.61 | 21.60 |      | 65.0 |         |
| 10264-CAD | LTE-TDD (SC-FDMA, 100% RB, 5 MHz, QPSK)     | X | 11.49 | 86.74 | 24.57 | 3.98 | 65.0 | ± 9.6 % |
|           |   | Y | 9.47  | 82.16 | 22.94 |      | 65.0 |         |
|           |   | Z | 11.51 | 87.39 | 24.78 |      | 65.0 |         |
| 10265-CAD | LTE-TDD (SC-FDMA, 100% RB, 10 MHz, 16-QAM)  | X | 8.50  | 78.18 | 21.88 | 3.98 | 65.0 | ± 9.6 % |
|           |   | Y | 8.22  | 76.54 | 21.21 |      | 65.0 |         |
|           |   | Z | 8.27  | 78.18 | 21.88 |      | 65.0 |         |
| 10266-CAD | LTE-TDD (SC-FDMA, 100% RB, 10 MHz, 64-QAM)  | X | 8.90  | 78.98 | 22.54 | 3.98 | 65.0 | ± 9.6 % |
|           |   | Y | 8.60  | 77.28 | 21.84 |      | 65.0 |         |
|           |   | Z | 8.71  | 79.09 | 22.57 |      | 65.0 |         |
| 10267-CAD | LTE-TDD (SC-FDMA, 100% RB, 10 MHz, QPSK)    | X | 10.06 | 82.61 | 23.09 | 3.98 | 65.0 | ± 9.6 % |
|           |   | Y | 9.03  | 79.62 | 21.95 |      | 65.0 |         |
|           |   | Z | 10.04 | 83.22 | 23.41 |      | 65.0 |         |
| 10268-CAD | LTE-TDD (SC-FDMA, 100% RB, 15 MHz, 16-QAM)  | X | 8.87  | 77.45 | 21.95 | 3.98 | 65.0 | ± 9.6 % |
|           |   | Y | 8.72  | 76.18 | 21.40 |      | 65.0 |         |
|           |   | Z | 8.67  | 77.54 | 22.05 |      | 65.0 |         |
| 10269-CAD | LTE-TDD (SC-FDMA, 100% RB, 15 MHz, 64-QAM)  | X | 8.77  | 76.99 | 21.83 | 3.98 | 65.0 | ± 9.6 % |
|           |   | Y | 8.66  | 75.80 | 21.31 |      | 65.0 |         |
|           |   | Z | 8.60  | 77.10 | 21.92 |      | 65.0 |         |
| 10270-CAD | LTE-TDD (SC-FDMA, 100% RB, 15 MHz, QPSK)    | X | 9.16  | 79.20 | 21.93 | 3.98 | 65.0 | ± 9.6 % |
|           |   | Y | 8.71  | 77.35 | 21.19 |      | 65.0 |         |
|           |   | Z | 9.06  | 79.57 | 22.19 |      | 65.0 |         |

|           |  |   |        |        |       |      |       |         |
|-----------|--|---|--------|--------|-------|------|-------|---------|
| 10274-CAB | UMTS-FDD (HSUPA, Subtest 5, 3GPP Rel8.10)                          | X | 2.80   | 68.17  | 16.47 | 0.00 | 150.0 | ± 9.6 % |
|           |  | Y | 2.67   | 66.63  | 15.50 |      | 150.0 |         |
|           |  | Z | 2.65   | 67.51  | 15.70 |      | 150.0 |         |
| 10275-CAB | UMTS-FDD (HSUPA, Subtest 5, 3GPP Rel8.4)                           | X | 2.12   | 73.27  | 18.65 | 0.00 | 150.0 | ± 9.6 % |
|           |  | Y | 1.72   | 68.53  | 16.00 |      | 150.0 |         |
|           |  | Z | 1.76   | 70.05  | 16.72 |      | 150.0 |         |
| 10277-CAA | PHS (QPSK)   | X | 5.32   | 68.96  | 13.42 | 9.03 | 50.0  | ± 9.6 % |
|           |  | Y | 6.41   | 71.20  | 15.49 |      | 50.0  |         |
|           |  | Z | 5.12   | 68.74  | 13.08 |      | 50.0  |         |
| 10278-CAA | PHS (QPSK, BW 884MHz, Rolloff 0.5)                                 | X | 9.11   | 79.62  | 20.31 | 9.03 | 50.0  | ± 9.6 % |
|           |  | Y | 9.22   | 79.31  | 21.03 |      | 50.0  |         |
|           |  | Z | 8.20   | 77.78  | 19.21 |      | 50.0  |         |
| 10279-CAA | PHS (QPSK, BW 884MHz, Rolloff 0.38)                                | X | 9.25   | 79.80  | 20.39 | 9.03 | 50.0  | ± 9.6 % |
|           |  | Y | 9.36   | 79.46  | 21.09 |      | 50.0  |         |
|           |  | Z | 8.30   | 77.91  | 19.28 |      | 50.0  |         |
| 10290-AAB | CDMA2000, RC1, SO55, Full Rate                                     | X | 3.59   | 82.57  | 20.48 | 0.00 | 150.0 | ± 9.6 % |
|           |  | Y | 1.73   | 70.44  | 15.45 |      | 150.0 |         |
|           |  | Z | 1.75   | 72.09  | 15.26 |      | 150.0 |         |
| 10291-AAB | CDMA2000, RC3, SO55, Full Rate                                     | X | 2.13   | 80.55  | 19.92 | 0.00 | 150.0 | ± 9.6 % |
|           |  | Y | 0.98   | 67.37  | 13.95 |      | 150.0 |         |
|           |  | Z | 1.01   | 69.27  | 14.02 |      | 150.0 |         |
| 10292-AAB | CDMA2000, RC3, SO32, Full Rate                                     | X | 12.02  | 108.71 | 29.17 | 0.00 | 150.0 | ± 9.6 % |
|           |  | Y | 1.26   | 72.03  | 16.54 |      | 150.0 |         |
|           |  | Z | 1.93   | 79.12  | 18.49 |      | 150.0 |         |
| 10293-AAB | CDMA2000, RC3, SO3, Full Rate                                      | X | 100.00 | 144.61 | 38.38 | 0.00 | 150.0 | ± 9.6 % |
|           |  | Y | 1.90   | 78.46  | 19.68 |      | 150.0 |         |
|           |  | Z | 6.64   | 97.19  | 24.86 |      | 150.0 |         |
| 10295-AAB | CDMA2000, RC1, SO3, 1/8th Rate 25 fr.                              | X | 11.58  | 85.59  | 24.60 | 9.03 | 50.0  | ± 9.6 % |
|           |  | Y | 10.44  | 82.50  | 23.85 |      | 50.0  |         |
|           |  | Z | 13.98  | 88.93  | 25.45 |      | 50.0  |         |
| 10297-AAC | LTE-FDD (SC-FDMA, 50% RB, 20 MHz, QPSK)                            | X | 3.31   | 73.28  | 18.55 | 0.00 | 150.0 | ± 9.6 % |
|           |  | Y | 2.94   | 70.32  | 16.89 |      | 150.0 |         |
|           |  | Z | 2.86   | 70.97  | 17.35 |      | 150.0 |         |
| 10298-AAC | LTE-FDD (SC-FDMA, 50% RB, 3 MHz, QPSK)                             | X | 2.53   | 75.50  | 18.42 | 0.00 | 150.0 | ± 9.6 % |
|           |  | Y | 1.83   | 69.14  | 15.39 |      | 150.0 |         |
|           |  | Z | 1.69   | 69.62  | 14.84 |      | 150.0 |         |
| 10299-AAC | LTE-FDD (SC-FDMA, 50% RB, 3 MHz, 16-QAM)                           | X | 6.61   | 82.78  | 20.21 | 0.00 | 150.0 | ± 9.6 % |
|           |  | Y | 3.43   | 72.67  | 16.51 |      | 150.0 |         |
|           |  | Z | 3.82   | 74.80  | 16.21 |      | 150.0 |         |
| 10300-AAC | LTE-FDD (SC-FDMA, 50% RB, 3 MHz, 64-QAM)                           | X | 3.24   | 71.51  | 15.06 | 0.00 | 150.0 | ± 9.6 % |
|           |  | Y | 2.57   | 67.68  | 13.54 |      | 150.0 |         |
|           |  | Z | 2.21   | 66.93  | 12.03 |      | 150.0 |         |
| 10301-AAA | IEEE 802.16e WiMAX (29:18, 5ms, 10MHz, QPSK, PUSC)                 | X | 5.62   | 68.28  | 18.87 | 4.17 | 80.0  | ± 9.6 % |
|           |  | Y | 5.93   | 68.63  | 18.94 |      | 80.0  |         |
|           |  | Z | 5.89   | 69.91  | 19.47 |      | 80.0  |         |
| 10302-AAA | IEEE 802.16e WiMAX (29:18, 5ms, 10MHz, QPSK, PUSC, 3 CTRL symbols) | X | 6.17   | 69.25  | 19.82 | 4.96 | 80.0  | ± 9.6 % |
|           |  | Y | 6.38   | 69.08  | 19.58 |      | 80.0  |         |
|           |  | Z | 6.23   | 69.95  | 19.93 |      | 80.0  |         |

|           |   |   |       |       |       |       |       |         |
|-----------|---|---|-------|-------|-------|-------|-------|---------|
| 10303-AAA | IEEE 802.16e WiMAX (31:15, 5ms, 10MHz, 64QAM, PUSC)                 | X | 6.02  | 69.32 | 19.87 | 4.96  | 80.0  | ± 9.6 % |
|           |   | Y | 6.26  | 69.22 | 19.66 |       | 80.0  |         |
|           |   | Z | 6.09  | 70.04 | 19.96 |       | 80.0  |         |
| 10304-AAA | IEEE 802.16e WiMAX (29:18, 5ms, 10MHz, 64QAM, PUSC)                 | X | 5.67  | 68.65 | 19.09 | 4.17  | 80.0  | ± 9.6 % |
|           |   | Y | 5.85  | 68.42 | 18.82 |       | 80.0  |         |
|           |   | Z | 5.71  | 69.28 | 19.12 |       | 80.0  |         |
| 10305-AAA | IEEE 802.16e WiMAX (31:15, 10ms, 10MHz, 64QAM, PUSC, 15 symbols)    | X | 9.13  | 83.00 | 26.75 | 6.02  | 50.0  | ± 9.6 % |
|           |   | Y | 11.08 | 85.83 | 27.58 |       | 50.0  |         |
|           |   | Z | 11.97 | 88.64 | 28.23 |       | 50.0  |         |
| 10306-AAA | IEEE 802.16e WiMAX (29:18, 10ms, 10MHz, 64QAM, PUSC, 18 symbols)    | X | 6.47  | 72.26 | 21.90 | 6.02  | 50.0  | ± 9.6 % |
|           |   | Y | 6.84  | 72.27 | 21.68 |       | 50.0  |         |
|           |   | Z | 6.81  | 73.77 | 22.17 |       | 50.0  |         |
| 10307-AAA | IEEE 802.16e WiMAX (29:18, 10ms, 10MHz, QPSK, PUSC, 18 symbols)     | X | 6.58  | 73.04 | 22.08 | 6.02  | 50.0  | ± 9.6 % |
|           |   | Y | 8.34  | 78.37 | 24.64 |       | 50.0  |         |
|           |   | Z | 6.92  | 74.46 | 22.29 |       | 50.0  |         |
| 10308-AAA | IEEE 802.16e WiMAX (29:18, 10ms, 10MHz, 16QAM, PUSC)                | X | 6.66  | 73.56 | 22.34 | 6.02  | 50.0  | ± 9.6 % |
|           |   | Y | 8.60  | 79.30 | 25.04 |       | 50.0  |         |
|           |   | Z | 7.08  | 75.16 | 22.62 |       | 50.0  |         |
| 10309-AAA | IEEE 802.16e WiMAX (29:18, 10ms, 10MHz, 16QAM, AMC 2x3, 18 symbols) | X | 6.58  | 72.60 | 22.09 | 6.02  | 50.0  | ± 9.6 % |
|           |   | Y | 6.95  | 72.58 | 21.85 |       | 50.0  |         |
|           |   | Z | 6.90  | 74.05 | 22.35 |       | 50.0  |         |
| 10310-AAA | IEEE 802.16e WiMAX (29:18, 10ms, 10MHz, QPSK, AMC 2x3, 18 symbols)  | X | 6.50  | 72.56 | 21.95 | 6.02  | 50.0  | ± 9.6 % |
|           |   | Y | 6.87  | 72.52 | 21.70 |       | 50.0  |         |
|           |   | Z | 6.86  | 74.10 | 22.23 |       | 50.0  |         |
| 10311-AAC | LTE-FDD (SC-FDMA, 100% RB, 15 MHz, QPSK)                            | X | 3.70  | 72.28 | 18.01 | 0.00  | 150.0 | ± 9.6 % |
|           |   | Y | 3.30  | 69.61 | 16.53 |       | 150.0 |         |
|           |   | Z | 3.23  | 70.11 | 16.90 |       | 150.0 |         |
| 10313-AAA | iDEN 1:3  | X | 9.18  | 81.61 | 19.86 | 6.99  | 70.0  | ± 9.6 % |
|           |   | Y | 7.64  | 78.40 | 19.13 |       | 70.0  |         |
|           |   | Z | 9.78  | 83.14 | 20.58 |       | 70.0  |         |
| 10314-AAA | iDEN 1:6  | X | 13.83 | 90.60 | 25.32 | 10.00 | 30.0  | ± 9.6 % |
|           |   | Y | 9.35  | 83.01 | 23.15 |       | 30.0  |         |
|           |   | Z | 14.01 | 91.81 | 25.99 |       | 30.0  |         |
| 10315-AAB | IEEE 802.11b WiFi 2.4 GHz (DSSS, 1 Mbps, 96pc duty cycle)           | X | 1.27  | 67.24 | 17.67 | 0.17  | 150.0 | ± 9.6 % |
|           |   | Y | 1.20  | 64.93 | 15.83 |       | 150.0 |         |
|           |   | Z | 1.21  | 65.68 | 16.36 |       | 150.0 |         |
| 10316-AAB | IEEE 802.11g WiFi 2.4 GHz (ERP-OFDM, 6 Mbps, 96pc duty cycle)       | X | 4.76  | 67.47 | 16.83 | 0.17  | 150.0 | ± 9.6 % |
|           |   | Y | 4.78  | 67.03 | 16.51 |       | 150.0 |         |
|           |   | Z | 4.63  | 67.31 | 16.62 |       | 150.0 |         |
| 10317-AAB | IEEE 802.11a WiFi 5 GHz (OFDM, 6 Mbps, 96pc duty cycle)             | X | 4.76  | 67.47 | 16.83 | 0.17  | 150.0 | ± 9.6 % |
|           |   | Y | 4.78  | 67.03 | 16.51 |       | 150.0 |         |
|           |   | Z | 4.63  | 67.31 | 16.62 |       | 150.0 |         |
| 10400-AAC | IEEE 802.11ac WiFi (20MHz, 64-QAM, 99pc duty cycle)                 | X | 4.86  | 67.74 | 16.77 | 0.00  | 150.0 | ± 9.6 % |
|           |   | Y | 4.87  | 67.24 | 16.40 |       | 150.0 |         |
|           |   | Z | 4.68  | 67.47 | 16.52 |       | 150.0 |         |
| 10401-AAC | IEEE 802.11ac WiFi (40MHz, 64-QAM, 99pc duty cycle)                 | X | 5.51  | 67.76 | 16.81 | 0.00  | 150.0 | ± 9.6 % |
|           |   | Y | 5.52  | 67.36 | 16.52 |       | 150.0 |         |
|           |   | Z | 5.41  | 67.67 | 16.70 |       | 150.0 |         |



|           |  |   |        |        |       |      |       |         |
|-----------|--|---|--------|--------|-------|------|-------|---------|
| 10402-AAC | IEEE 802.11ac WiFi (80MHz, 64-QAM, 99pc duty cycle)                            | X | 5.79   | 68.18  | 16.86 | 0.00 | 150.0 | ± 9.6 % |
|           |  | Y | 5.81   | 67.85  | 16.61 |      | 150.0 |         |
|           |  | Z | 5.64   | 67.83  | 16.63 |      | 150.0 |         |
| 10403-AAB | CDMA2000 (1xEV-DO, Rev. 0)   | X | 3.59   | 82.57  | 20.48 | 0.00 | 115.0 | ± 9.6 % |
|           |  | Y | 1.73   | 70.44  | 15.45 |      | 115.0 |         |
|           |  | Z | 1.75   | 72.09  | 15.26 |      | 115.0 |         |
| 10404-AAB | CDMA2000 (1xEV-DO, Rev. A)   | X | 3.59   | 82.57  | 20.48 | 0.00 | 115.0 | ± 9.6 % |
|           |  | Y | 1.73   | 70.44  | 15.45 |      | 115.0 |         |
|           |  | Z | 1.75   | 72.09  | 15.26 |      | 115.0 |         |
| 10406-AAB | CDMA2000, RC3, SO32, SCH0, Full Rate   | X | 100.00 | 122.57 | 31.18 | 0.00 | 100.0 | ± 9.6 % |
|           |  | Y | 18.35  | 99.60  | 26.20 |      | 100.0 |         |
|           |  | Z | 100.00 | 120.33 | 29.78 |      | 100.0 |         |
| 10410-AAC | LTE-TDD (SC-FDMA, 1 RB, 10 MHz, QPSK, UL Subframe=2,3,4,7,8,9)                 | X | 100.00 | 120.29 | 30.51 | 3.23 | 80.0  | ± 9.6 % |
|           |  | Y | 100.00 | 120.68 | 31.13 |      | 80.0  |         |
|           |  | Z | 100.00 | 122.62 | 31.38 |      | 80.0  |         |
| 10415-AAA | IEEE 802.11b WiFi 2.4 GHz (DSSS, 1 Mbps, 99pc duty cycle)                      | X | 1.09   | 65.33  | 16.67 | 0.00 | 150.0 | ± 9.6 % |
|           |  | Y | 1.03   | 63.31  | 14.91 |      | 150.0 |         |
|           |  | Z | 1.05   | 64.05  | 15.43 |      | 150.0 |         |
| 10416-AAA | IEEE 802.11g WiFi 2.4 GHz (ERP-OFDM, 6 Mbps, 99pc duty cycle)                  | X | 4.67   | 67.36  | 16.71 | 0.00 | 150.0 | ± 9.6 % |
|           |  | Y | 4.67   | 66.86  | 16.34 |      | 150.0 |         |
|           |  | Z | 4.53   | 67.14  | 16.45 |      | 150.0 |         |
| 10417-AAA | IEEE 802.11a/h WiFi 5 GHz (OFDM, 6 Mbps, 99pc duty cycle)                      | X | 4.67   | 67.36  | 16.71 | 0.00 | 150.0 | ± 9.6 % |
|           |  | Y | 4.67   | 66.86  | 16.34 |      | 150.0 |         |
|           |  | Z | 4.53   | 67.14  | 16.45 |      | 150.0 |         |
| 10418-AAA | IEEE 802.11g WiFi 2.4 GHz (DSSS-OFDM, 6 Mbps, 99pc duty cycle, Long preamble)  | X | 4.66   | 67.53  | 16.73 | 0.00 | 150.0 | ± 9.6 % |
|           |  | Y | 4.66   | 67.00  | 16.35 |      | 150.0 |         |
|           |  | Z | 4.52   | 67.33  | 16.49 |      | 150.0 |         |
| 10419-AAA | IEEE 802.11g WiFi 2.4 GHz (DSSS-OFDM, 6 Mbps, 99pc duty cycle, Short preamble) | X | 4.68   | 67.47  | 16.73 | 0.00 | 150.0 | ± 9.6 % |
|           |  | Y | 4.68   | 66.95  | 16.36 |      | 150.0 |         |
|           |  | Z | 4.54   | 67.26  | 16.48 |      | 150.0 |         |
| 10422-AAA | IEEE 802.11n (HT Greenfield, 7.2 Mbps, BPSK)                                   | X | 4.80   | 67.45  | 16.73 | 0.00 | 150.0 | ± 9.6 % |
|           |  | Y | 4.81   | 66.96  | 16.37 |      | 150.0 |         |
|           |  | Z | 4.65   | 67.24  | 16.49 |      | 150.0 |         |
| 10423-AAA | IEEE 802.11n (HT Greenfield, 43.3 Mbps, 16-QAM)                                | X | 4.99   | 67.80  | 16.85 | 0.00 | 150.0 | ± 9.6 % |
|           |  | Y | 5.00   | 67.33  | 16.51 |      | 150.0 |         |
|           |  | Z | 4.80   | 67.54  | 16.59 |      | 150.0 |         |
| 10424-AAA | IEEE 802.11n (HT Greenfield, 72.2 Mbps, 64-QAM)                                | X | 4.90   | 67.76  | 16.83 | 0.00 | 150.0 | ± 9.6 % |
|           |  | Y | 4.91   | 67.27  | 16.47 |      | 150.0 |         |
|           |  | Z | 4.73   | 67.50  | 16.57 |      | 150.0 |         |
| 10425-AAA | IEEE 802.11n (HT Greenfield, 15 Mbps, BPSK)                                    | X | 5.49   | 68.02  | 16.94 | 0.00 | 150.0 | ± 9.6 % |
|           |  | Y | 5.50   | 67.62  | 16.64 |      | 150.0 |         |
|           |  | Z | 5.34   | 67.73  | 16.73 |      | 150.0 |         |
| 10426-AAA | IEEE 802.11n (HT Greenfield, 90 Mbps, 16-QAM)                                  | X | 5.49   | 68.02  | 16.94 | 0.00 | 150.0 | ± 9.6 % |
|           |  | Y | 5.51   | 67.65  | 16.65 |      | 150.0 |         |
|           |  | Z | 5.36   | 67.83  | 16.78 |      | 150.0 |         |

|           |  |   |        |        |       |      |       |         |
|-----------|--|---|--------|--------|-------|------|-------|---------|
| 10427-AAA | IEEE 802.11n (HT Greenfield, 150 Mbps, 64-QAM)                 | X | 5.50   | 68.00  | 16.93 | 0.00 | 150.0 | ± 9.6 % |
|           |  | Y | 5.52   | 67.64  | 16.64 |      | 150.0 |         |
|           |  | Z | 5.36   | 67.74  | 16.73 |      | 150.0 |         |
| 10430-AAB | LTE-FDD (OFDMA, 5 MHz, E-TM 3.1)                               | X | 4.54   | 72.09  | 19.09 | 0.00 | 150.0 | ± 9.6 % |
|           |  | Y | 4.40   | 70.73  | 18.36 |      | 150.0 |         |
|           |  | Z | 4.26   | 71.56  | 18.37 |      | 150.0 |         |
| 10431-AAB | LTE-FDD (OFDMA, 10 MHz, E-TM 3.1)                              | X | 4.40   | 68.10  | 16.85 | 0.00 | 150.0 | ± 9.6 % |
|           |  | Y | 4.40   | 67.42  | 16.40 |      | 150.0 |         |
|           |  | Z | 4.19   | 67.79  | 16.46 |      | 150.0 |         |
| 10432-AAB | LTE-FDD (OFDMA, 15 MHz, E-TM 3.1)                              | X | 4.68   | 67.87  | 16.83 | 0.00 | 150.0 | ± 9.6 % |
|           |  | Y | 4.69   | 67.31  | 16.44 |      | 150.0 |         |
|           |  | Z | 4.50   | 67.59  | 16.53 |      | 150.0 |         |
| 10433-AAB | LTE-FDD (OFDMA, 20 MHz, E-TM 3.1)                              | X | 4.92   | 67.80  | 16.85 | 0.00 | 150.0 | ± 9.6 % |
|           |  | Y | 4.93   | 67.31  | 16.50 |      | 150.0 |         |
|           |  | Z | 4.74   | 67.53  | 16.59 |      | 150.0 |         |
| 10434-AAA | W-CDMA (BS Test Model 1, 64 DPCH)                              | X | 4.73   | 73.25  | 19.23 | 0.00 | 150.0 | ± 9.6 % |
|           |  | Y | 4.51   | 71.54  | 18.38 |      | 150.0 |         |
|           |  | Z | 4.38   | 72.53  | 18.34 |      | 150.0 |         |
| 10435-AAC | LTE-TDD (SC-FDMA, 1 RB, 20 MHz, QPSK, UL Subframe=2,3,4,7,8,9) | X | 100.00 | 120.11 | 30.42 | 3.23 | 80.0  | ± 9.6 % |
|           |  | Y | 100.00 | 120.53 | 31.07 |      | 80.0  |         |
|           |  | Z | 100.00 | 122.42 | 31.29 |      | 80.0  |         |
| 10447-AAB | LTE-FDD (OFDMA, 5 MHz, E-TM 3.1, Clipping 44%)                 | X | 3.76   | 68.51  | 16.50 | 0.00 | 150.0 | ± 9.6 % |
|           |  | Y | 3.71   | 67.48  | 15.90 |      | 150.0 |         |
|           |  | Z | 3.49   | 67.91  | 15.73 |      | 150.0 |         |
| 10448-AAB | LTE-FDD (OFDMA, 10 MHz, E-TM 3.1, Clipping 44%)                | X | 4.23   | 67.89  | 16.73 | 0.00 | 150.0 | ± 9.6 % |
|           |  | Y | 4.22   | 67.19  | 16.26 |      | 150.0 |         |
|           |  | Z | 4.04   | 67.58  | 16.33 |      | 150.0 |         |
| 10449-AAB | LTE-FDD (OFDMA, 15 MHz, E-TM 3.1, Clipping 44%)                | X | 4.49   | 67.72  | 16.75 | 0.00 | 150.0 | ± 9.6 % |
|           |  | Y | 4.48   | 67.13  | 16.34 |      | 150.0 |         |
|           |  | Z | 4.32   | 67.42  | 16.43 |      | 150.0 |         |
| 10450-AAB | LTE-FDD (OFDMA, 20 MHz, E-TM 3.1, Clipping 44%)                | X | 4.67   | 67.59  | 16.73 | 0.00 | 150.0 | ± 9.6 % |
|           |  | Y | 4.66   | 67.07  | 16.35 |      | 150.0 |         |
|           |  | Z | 4.52   | 67.31  | 16.45 |      | 150.0 |         |
| 10451-AAA | W-CDMA (BS Test Model 1, 64 DPCH, Clipping 44%)                | X | 3.71   | 68.96  | 16.29 | 0.00 | 150.0 | ± 9.6 % |
|           |  | Y | 3.63   | 67.76  | 15.64 |      | 150.0 |         |
|           |  | Z | 3.37   | 68.05  | 15.28 |      | 150.0 |         |
| 10456-AAA | IEEE 802.11ac WiFi (160MHz, 64-QAM, 99pc duty cycle)           | X | 6.34   | 68.51  | 17.03 | 0.00 | 150.0 | ± 9.6 % |
|           |  | Y | 6.36   | 68.23  | 16.81 |      | 150.0 |         |
|           |  | Z | 6.24   | 68.31  | 16.89 |      | 150.0 |         |
| 10457-AAA | UMTS-FDD (DC-HSDPA)  | X | 3.87   | 65.97  | 16.44 | 0.00 | 150.0 | ± 9.6 % |
|           |  | Y | 3.87   | 65.48  | 16.06 |      | 150.0 |         |
|           |  | Z | 3.81   | 65.79  | 16.17 |      | 150.0 |         |
| 10458-AAA | CDMA2000 (1xEV-DO, Rev. B, 2 carriers)                         | X | 4.35   | 72.54  | 18.72 | 0.00 | 150.0 | ± 9.6 % |
|           |  | Y | 4.10   | 70.59  | 17.78 |      | 150.0 |         |
|           |  | Z | 4.02   | 71.83  | 17.67 |      | 150.0 |         |
| 10459-AAA | CDMA2000 (1xEV-DO, Rev. B, 3 carriers)                         | X | 5.25   | 68.89  | 18.60 | 0.00 | 150.0 | ± 9.6 % |
|           |  | Y | 5.22   | 68.08  | 18.20 |      | 150.0 |         |
|           |  | Z | 4.96   | 68.66  | 18.04 |      | 150.0 |         |

|           |   |   |        |        |       |      |       |         |
|-----------|---|---|--------|--------|-------|------|-------|---------|
| 10460-AAA | UMTS-FDD (WCDMA, AMR)   | X | 1.62   | 80.44  | 22.68 | 0.00 | 150.0 | ± 9.6 % |
|           |   | Y | 0.96   | 69.05  | 16.73 |      | 150.0 |         |
|           |   | Z | 1.09   | 72.04  | 18.32 |      | 150.0 |         |
| 10461-AAA | LTE-TDD (SC-FDMA, 1 RB, 1.4 MHz, QPSK, UL Subframe=2,3,4,7,8,9)   | X | 100.00 | 125.40 | 32.90 | 3.29 | 80.0  | ± 9.6 % |
|           |   | Y | 100.00 | 122.42 | 32.02 |      | 80.0  |         |
|           |   | Z | 100.00 | 127.89 | 33.84 |      | 80.0  |         |
| 10462-AAA | LTE-TDD (SC-FDMA, 1 RB, 1.4 MHz, 16-QAM, UL Subframe=2,3,4,7,8,9) | X | 100.00 | 109.25 | 25.21 | 3.23 | 80.0  | ± 9.6 % |
|           |   | Y | 100.00 | 110.42 | 26.29 |      | 80.0  |         |
|           |   | Z | 100.00 | 110.45 | 25.54 |      | 80.0  |         |
| 10463-AAA | LTE-TDD (SC-FDMA, 1 RB, 1.4 MHz, 64-QAM, UL Subframe=2,3,4,7,8,9) | X | 100.00 | 106.10 | 23.70 | 3.23 | 80.0  | ± 9.6 % |
|           |   | Y | 31.87  | 95.11  | 22.04 |      | 80.0  |         |
|           |   | Z | 100.00 | 107.01 | 23.88 |      | 80.0  |         |
| 10464-AAA | LTE-TDD (SC-FDMA, 1 RB, 3 MHz, QPSK, UL Subframe=2,3,4,7,8,9)     | X | 100.00 | 123.48 | 31.85 | 3.23 | 80.0  | ± 9.6 % |
|           |   | Y | 100.00 | 120.78 | 31.11 |      | 80.0  |         |
|           |   | Z | 100.00 | 125.94 | 32.77 |      | 80.0  |         |
| 10465-AAA | LTE-TDD (SC-FDMA, 1 RB, 3 MHz, 16-QAM, UL Subframe=2,3,4,7,8,9)   | X | 100.00 | 108.73 | 24.95 | 3.23 | 80.0  | ± 9.6 % |
|           |   | Y | 57.38  | 103.50 | 24.59 |      | 80.0  |         |
|           |   | Z | 100.00 | 109.93 | 25.28 |      | 80.0  |         |
| 10466-AAA | LTE-TDD (SC-FDMA, 1 RB, 3 MHz, 64-QAM, UL Subframe=2,3,4,7,8,9)   | X | 100.00 | 105.62 | 23.47 | 3.23 | 80.0  | ± 9.6 % |
|           |   | Y | 19.30  | 89.18  | 20.39 |      | 80.0  |         |
|           |   | Z | 100.00 | 106.51 | 23.65 |      | 80.0  |         |
| 10467-AAC | LTE-TDD (SC-FDMA, 1 RB, 5 MHz, QPSK, UL Subframe=2,3,4,7,8,9)     | X | 100.00 | 123.71 | 31.96 | 3.23 | 80.0  | ± 9.6 % |
|           |   | Y | 100.00 | 120.96 | 31.19 |      | 80.0  |         |
|           |   | Z | 100.00 | 126.19 | 32.89 |      | 80.0  |         |
| 10468-AAC | LTE-TDD (SC-FDMA, 1 RB, 5 MHz, 16-QAM, UL Subframe=2,3,4,7,8,9)   | X | 100.00 | 108.89 | 25.03 | 3.23 | 80.0  | ± 9.6 % |
|           |   | Y | 68.69  | 105.73 | 25.14 |      | 80.0  |         |
|           |   | Z | 100.00 | 110.12 | 25.37 |      | 80.0  |         |
| 10469-AAC | LTE-TDD (SC-FDMA, 1 RB, 5 MHz, 64-QAM, UL Subframe=2,3,4,7,8,9)   | X | 100.00 | 105.63 | 23.47 | 3.23 | 80.0  | ± 9.6 % |
|           |   | Y | 19.75  | 89.45  | 20.46 |      | 80.0  |         |
|           |   | Z | 100.00 | 106.53 | 23.66 |      | 80.0  |         |
| 10470-AAC | LTE-TDD (SC-FDMA, 1 RB, 10 MHz, QPSK, UL Subframe=2,3,4,7,8,9)    | X | 100.00 | 123.74 | 31.96 | 3.23 | 80.0  | ± 9.6 % |
|           |   | Y | 100.00 | 120.98 | 31.20 |      | 80.0  |         |
|           |   | Z | 100.00 | 126.22 | 32.89 |      | 80.0  |         |
| 10471-AAC | LTE-TDD (SC-FDMA, 1 RB, 10 MHz, 16-QAM, UL Subframe=2,3,4,7,8,9)  | X | 100.00 | 108.84 | 25.00 | 3.23 | 80.0  | ± 9.6 % |
|           |   | Y | 69.00  | 105.75 | 25.13 |      | 80.0  |         |
|           |   | Z | 100.00 | 110.07 | 25.35 |      | 80.0  |         |
| 10472-AAC | LTE-TDD (SC-FDMA, 1 RB, 10 MHz, 64-QAM, UL Subframe=2,3,4,7,8,9)  | X | 100.00 | 105.58 | 23.44 | 3.23 | 80.0  | ± 9.6 % |
|           |   | Y | 19.79  | 89.46  | 20.45 |      | 80.0  |         |
|           |   | Z | 100.00 | 106.47 | 23.62 |      | 80.0  |         |
| 10473-AAC | LTE-TDD (SC-FDMA, 1 RB, 15 MHz, QPSK, UL Subframe=2,3,4,7,8,9)    | X | 100.00 | 123.71 | 31.95 | 3.23 | 80.0  | ± 9.6 % |
|           |   | Y | 100.00 | 120.96 | 31.18 |      | 80.0  |         |
|           |   | Z | 100.00 | 126.20 | 32.88 |      | 80.0  |         |
| 10474-AAC | LTE-TDD (SC-FDMA, 1 RB, 15 MHz, 16-QAM, UL Subframe=2,3,4,7,8,9)  | X | 100.00 | 108.85 | 25.00 | 3.23 | 80.0  | ± 9.6 % |
|           |   | Y | 67.79  | 105.55 | 25.09 |      | 80.0  |         |
|           |   | Z | 100.00 | 110.08 | 25.35 |      | 80.0  |         |
| 10475-AAC | LTE-TDD (SC-FDMA, 1 RB, 15 MHz, 64-QAM, UL Subframe=2,3,4,7,8,9)  | X | 100.00 | 105.59 | 23.45 | 3.23 | 80.0  | ± 9.6 % |
|           |   | Y | 19.52  | 89.31  | 20.41 |      | 80.0  |         |
|           |   | Z | 100.00 | 106.49 | 23.63 |      | 80.0  |         |

|           |   |   |        |        |       |      |      |         |
|-----------|---|---|--------|--------|-------|------|------|---------|
| 10477-AAC | LTE-TDD (SC-FDMA, 1 RB, 20 MHz, 16-QAM, UL Subframe=2,3,4,7,8,9)    | X | 100.00 | 108.68 | 24.92 | 3.23 | 80.0 | ± 9.6 % |
|           |   | Y | 60.00  | 104.00 | 24.69 |      | 80.0 |         |
|           |   | Z | 100.00 | 109.90 | 25.26 |      | 80.0 |         |
| 10478-AAC | LTE-TDD (SC-FDMA, 1 RB, 20 MHz, 64-QAM, UL Subframe=2,3,4,7,8,9)    | X | 100.00 | 105.53 | 23.42 | 3.23 | 80.0 | ± 9.6 % |
|           |   | Y | 19.24  | 89.12  | 20.35 |      | 80.0 |         |
|           |   | Z | 100.00 | 106.43 | 23.60 |      | 80.0 |         |
| 10479-AAA | LTE-TDD (SC-FDMA, 50% RB, 1.4 MHz, QPSK, UL Subframe=2,3,4,7,8,9)   | X | 94.50  | 124.14 | 33.84 | 3.23 | 80.0 | ± 9.6 % |
|           |   | Y | 12.50  | 90.83  | 25.02 |      | 80.0 |         |
|           |   | Z | 100.00 | 124.95 | 33.67 |      | 80.0 |         |
| 10480-AAA | LTE-TDD (SC-FDMA, 50% RB, 1.4 MHz, 16-QAM, UL Subframe=2,3,4,7,8,9) | X | 95.67  | 115.16 | 29.54 | 3.23 | 80.0 | ± 9.6 % |
|           |   | Y | 12.83  | 86.63  | 22.28 |      | 80.0 |         |
|           |   | Z | 100.00 | 114.83 | 28.84 |      | 80.0 |         |
| 10481-AAA | LTE-TDD (SC-FDMA, 50% RB, 1.4 MHz, 64-QAM, UL Subframe=2,3,4,7,8,9) | X | 58.64  | 107.02 | 27.16 | 3.23 | 80.0 | ± 9.6 % |
|           |   | Y | 11.35  | 84.25  | 21.22 |      | 80.0 |         |
|           |   | Z | 80.09  | 110.11 | 27.23 |      | 80.0 |         |
| 10482-AAA | LTE-TDD (SC-FDMA, 50% RB, 3 MHz, QPSK, UL Subframe=2,3,4,7,8,9)     | X | 12.89  | 91.14  | 23.86 | 2.23 | 80.0 | ± 9.6 % |
|           |   | Y | 6.25   | 79.51  | 20.15 |      | 80.0 |         |
|           |   | Z | 8.39   | 84.42  | 21.05 |      | 80.0 |         |
| 10483-AAA | LTE-TDD (SC-FDMA, 50% RB, 3 MHz, 16-QAM, UL Subframe=2,3,4,7,8,9)   | X | 18.92  | 92.85  | 24.00 | 2.23 | 80.0 | ± 9.6 % |
|           |   | Y | 8.58   | 80.90  | 20.47 |      | 80.0 |         |
|           |   | Z | 13.62  | 87.31  | 21.48 |      | 80.0 |         |
| 10484-AAA | LTE-TDD (SC-FDMA, 50% RB, 3 MHz, 64-QAM, UL Subframe=2,3,4,7,8,9)   | X | 15.36  | 89.71  | 23.07 | 2.23 | 80.0 | ± 9.6 % |
|           |   | Y | 7.99   | 79.65  | 20.04 |      | 80.0 |         |
|           |   | Z | 10.91  | 84.16  | 20.49 |      | 80.0 |         |
| 10485-AAC | LTE-TDD (SC-FDMA, 50% RB, 5 MHz, QPSK, UL Subframe=2,3,4,7,8,9)     | X | 10.83  | 89.50  | 24.25 | 2.23 | 80.0 | ± 9.6 % |
|           |   | Y | 6.29   | 79.77  | 20.91 |      | 80.0 |         |
|           |   | Z | 8.35   | 85.48  | 22.54 |      | 80.0 |         |
| 10486-AAC | LTE-TDD (SC-FDMA, 50% RB, 5 MHz, 16-QAM, UL Subframe=2,3,4,7,8,9)   | X | 6.33   | 78.08  | 19.97 | 2.23 | 80.0 | ± 9.6 % |
|           |   | Y | 5.11   | 73.82  | 18.38 |      | 80.0 |         |
|           |   | Z | 5.40   | 75.74  | 18.50 |      | 80.0 |         |
| 10487-AAC | LTE-TDD (SC-FDMA, 50% RB, 5 MHz, 64-QAM, UL Subframe=2,3,4,7,8,9)   | X | 6.09   | 77.15  | 19.61 | 2.23 | 80.0 | ± 9.6 % |
|           |   | Y | 5.06   | 73.33  | 18.18 |      | 80.0 |         |
|           |   | Z | 5.20   | 74.88  | 18.15 |      | 80.0 |         |
| 10488-AAC | LTE-TDD (SC-FDMA, 50% RB, 10 MHz, QPSK, UL Subframe=2,3,4,7,8,9)    | X | 7.97   | 83.54  | 22.89 | 2.23 | 80.0 | ± 9.6 % |
|           |   | Y | 6.02   | 77.67  | 20.60 |      | 80.0 |         |
|           |   | Z | 6.66   | 81.06  | 21.92 |      | 80.0 |         |
| 10489-AAC | LTE-TDD (SC-FDMA, 50% RB, 10 MHz, 16-QAM, UL Subframe=2,3,4,7,8,9)  | X | 5.54   | 75.17  | 19.93 | 2.23 | 80.0 | ± 9.6 % |
|           |   | Y | 5.05   | 72.55  | 18.77 |      | 80.0 |         |
|           |   | Z | 5.10   | 74.15  | 19.29 |      | 80.0 |         |
| 10490-AAC | LTE-TDD (SC-FDMA, 50% RB, 10 MHz, 64-QAM, UL Subframe=2,3,4,7,8,9)  | X | 5.52   | 74.58  | 19.72 | 2.23 | 80.0 | ± 9.6 % |
|           |   | Y | 5.10   | 72.20  | 18.66 |      | 80.0 |         |
|           |   | Z | 5.11   | 73.70  | 19.12 |      | 80.0 |         |
| 10491-AAC | LTE-TDD (SC-FDMA, 50% RB, 15 MHz, QPSK, UL Subframe=2,3,4,7,8,9)    | X | 6.68   | 78.67  | 21.27 | 2.23 | 80.0 | ± 9.6 % |
|           |   | Y | 5.75   | 75.05  | 19.71 |      | 80.0 |         |
|           |   | Z | 5.90   | 77.08  | 20.64 |      | 80.0 |         |
| 10492-AAC | LTE-TDD (SC-FDMA, 50% RB, 15 MHz, 16-QAM, UL Subframe=2,3,4,7,8,9)  | X | 5.47   | 73.05  | 19.35 | 2.23 | 80.0 | ± 9.6 % |
|           |   | Y | 5.22   | 71.31  | 18.50 |      | 80.0 |         |
|           |   | Z | 5.12   | 72.35  | 18.92 |      | 80.0 |         |

|           |  |   |       |       |       |      |      |         |
|-----------|--|---|-------|-------|-------|------|------|---------|
| 10493-AAC | LTE-TDD (SC-FDMA, 50% RB, 15 MHz, 64-QAM, UL Subframe=2,3,4,7,8,9)   | X | 5.48  | 72.72 | 19.22 | 2.23 | 80.0 | ± 9.6 % |
|           |  | Y | 5.27  | 71.08 | 18.43 |      | 80.0 |         |
|           |  | Z | 5.15  | 72.07 | 18.82 |      | 80.0 |         |
| 10494-AAC | LTE-TDD (SC-FDMA, 50% RB, 20 MHz, QPSK, UL Subframe=2,3,4,7,8,9)     | X | 7.90  | 81.45 | 22.09 | 2.23 | 80.0 | ± 9.6 % |
|           |  | Y | 6.41  | 76.92 | 20.25 |      | 80.0 |         |
|           |  | Z | 6.69  | 79.16 | 21.27 |      | 80.0 |         |
| 10495-AAC | LTE-TDD (SC-FDMA, 50% RB, 20 MHz, 16-QAM, UL Subframe=2,3,4,7,8,9)   | X | 5.61  | 73.73 | 19.62 | 2.23 | 80.0 | ± 9.6 % |
|           |  | Y | 5.32  | 71.86 | 18.72 |      | 80.0 |         |
|           |  | Z | 5.21  | 72.81 | 19.16 |      | 80.0 |         |
| 10496-AAC | LTE-TDD (SC-FDMA, 50% RB, 20 MHz, 64-QAM, UL Subframe=2,3,4,7,8,9)   | X | 5.57  | 73.09 | 19.41 | 2.23 | 80.0 | ± 9.6 % |
|           |  | Y | 5.35  | 71.43 | 18.59 |      | 80.0 |         |
|           |  | Z | 5.21  | 72.31 | 18.99 |      | 80.0 |         |
| 10497-AAA | LTE-TDD (SC-FDMA, 100% RB, 1.4 MHz, QPSK, UL Subframe=2,3,4,7,8,9)   | X | 10.14 | 86.59 | 21.54 | 2.23 | 80.0 | ± 9.6 % |
|           |  | Y | 5.12  | 76.51 | 18.39 |      | 80.0 |         |
|           |  | Z | 5.35  | 77.20 | 17.46 |      | 80.0 |         |
| 10498-AAA | LTE-TDD (SC-FDMA, 100% RB, 1.4 MHz, 16-QAM, UL Subframe=2,3,4,7,8,9) | X | 4.29  | 72.00 | 15.43 | 2.23 | 80.0 | ± 9.6 % |
|           |  | Y | 3.72  | 69.52 | 14.77 |      | 80.0 |         |
|           |  | Z | 2.43  | 65.17 | 11.54 |      | 80.0 |         |
| 10499-AAA | LTE-TDD (SC-FDMA, 100% RB, 1.4 MHz, 64-QAM, UL Subframe=2,3,4,7,8,9) | X | 3.97  | 70.70 | 14.77 | 2.23 | 80.0 | ± 9.6 % |
|           |  | Y | 3.61  | 68.83 | 14.36 |      | 80.0 |         |
|           |  | Z | 2.26  | 64.14 | 10.91 |      | 80.0 |         |
| 10500-AAA | LTE-TDD (SC-FDMA, 100% RB, 3 MHz, QPSK, UL Subframe=2,3,4,7,8,9)     | X | 8.79  | 85.79 | 23.33 | 2.23 | 80.0 | ± 9.6 % |
|           |  | Y | 5.95  | 78.30 | 20.59 |      | 80.0 |         |
|           |  | Z | 7.25  | 82.97 | 22.08 |      | 80.0 |         |
| 10501-AAA | LTE-TDD (SC-FDMA, 100% RB, 3 MHz, 16-QAM, UL Subframe=2,3,4,7,8,9)   | X | 5.90  | 76.65 | 19.85 | 2.23 | 80.0 | ± 9.6 % |
|           |  | Y | 5.06  | 73.18 | 18.47 |      | 80.0 |         |
|           |  | Z | 5.28  | 75.13 | 18.80 |      | 80.0 |         |
| 10502-AAA | LTE-TDD (SC-FDMA, 100% RB, 3 MHz, 64-QAM, UL Subframe=2,3,4,7,8,9)   | X | 5.87  | 76.18 | 19.62 | 2.23 | 80.0 | ± 9.6 % |
|           |  | Y | 5.09  | 72.91 | 18.33 |      | 80.0 |         |
|           |  | Z | 5.26  | 74.71 | 18.58 |      | 80.0 |         |
| 10503-AAC | LTE-TDD (SC-FDMA, 100% RB, 5 MHz, QPSK, UL Subframe=2,3,4,7,8,9)     | X | 7.83  | 83.24 | 22.77 | 2.23 | 80.0 | ± 9.6 % |
|           |  | Y | 5.94  | 77.45 | 20.51 |      | 80.0 |         |
|           |  | Z | 6.55  | 80.79 | 21.81 |      | 80.0 |         |
| 10504-AAC | LTE-TDD (SC-FDMA, 100% RB, 5 MHz, 16-QAM, UL Subframe=2,3,4,7,8,9)   | X | 5.51  | 75.05 | 19.87 | 2.23 | 80.0 | ± 9.6 % |
|           |  | Y | 5.02  | 72.46 | 18.72 |      | 80.0 |         |
|           |  | Z | 5.07  | 74.04 | 19.23 |      | 80.0 |         |
| 10505-AAC | LTE-TDD (SC-FDMA, 100% RB, 5 MHz, 64-QAM, UL Subframe=2,3,4,7,8,9)   | X | 5.49  | 74.47 | 19.66 | 2.23 | 80.0 | ± 9.6 % |
|           |  | Y | 5.07  | 72.10 | 18.60 |      | 80.0 |         |
|           |  | Z | 5.08  | 73.60 | 19.06 |      | 80.0 |         |
| 10506-AAC | LTE-TDD (SC-FDMA, 100% RB, 10 MHz, QPSK, UL Subframe=2,3,4,7,8,9)    | X | 7.81  | 81.23 | 22.00 | 2.23 | 80.0 | ± 9.6 % |
|           |  | Y | 6.35  | 76.76 | 20.18 |      | 80.0 |         |
|           |  | Z | 6.62  | 78.99 | 21.19 |      | 80.0 |         |
| 10507-AAC | LTE-TDD (SC-FDMA, 100% RB, 10 MHz, 16-QAM, UL Subframe=2,3,4,7,8,9)  | X | 5.58  | 73.65 | 19.59 | 2.23 | 80.0 | ± 9.6 % |
|           |  | Y | 5.30  | 71.80 | 18.69 |      | 80.0 |         |
|           |  | Z | 5.19  | 72.75 | 19.13 |      | 80.0 |         |

|           |   |   |      |        |       |      |       |         |
|-----------|---|---|------|--------|-------|------|-------|---------|
| 10508-AAC | LTE-TDD (SC-FDMA, 100% RB, 10 MHz, 64-QAM, UL Subframe=2,3,4,7,8,9) | X | 5.55 | 73.01  | 19.36 | 2.23 | 80.0  | ± 9.6 % |
|           |   | Y | 5.33 | 71.35  | 18.55 |      | 80.0  |         |
|           |   | Z | 5.19 | 72.24  | 18.95 |      | 80.0  |         |
| 10509-AAC | LTE-TDD (SC-FDMA, 100% RB, 15 MHz, QPSK, UL Subframe=2,3,4,7,8,9)   | X | 7.03 | 77.40  | 20.60 | 2.23 | 80.0  | ± 9.6 % |
|           |   | Y | 6.25 | 74.54  | 19.35 |      | 80.0  |         |
|           |   | Z | 6.27 | 75.89  | 20.05 |      | 80.0  |         |
| 10510-AAC | LTE-TDD (SC-FDMA, 100% RB, 15 MHz, 16-QAM, UL Subframe=2,3,4,7,8,9) | X | 5.86 | 72.49  | 19.18 | 2.23 | 80.0  | ± 9.6 % |
|           |   | Y | 5.70 | 71.14  | 18.49 |      | 80.0  |         |
|           |   | Z | 5.51 | 71.73  | 18.83 |      | 80.0  |         |
| 10511-AAC | LTE-TDD (SC-FDMA, 100% RB, 15 MHz, 64-QAM, UL Subframe=2,3,4,7,8,9) | X | 5.83 | 72.01  | 19.03 | 2.23 | 80.0  | ± 9.6 % |
|           |   | Y | 5.71 | 70.79  | 18.40 |      | 80.0  |         |
|           |   | Z | 5.52 | 71.35  | 18.71 |      | 80.0  |         |
| 10512-AAC | LTE-TDD (SC-FDMA, 100% RB, 20 MHz, QPSK, UL Subframe=2,3,4,7,8,9)   | X | 8.18 | 80.50  | 21.58 | 2.23 | 80.0  | ± 9.6 % |
|           |   | Y | 6.82 | 76.59  | 19.98 |      | 80.0  |         |
|           |   | Z | 6.97 | 78.23  | 20.79 |      | 80.0  |         |
| 10513-AAC | LTE-TDD (SC-FDMA, 100% RB, 20 MHz, 16-QAM, UL Subframe=2,3,4,7,8,9) | X | 5.86 | 73.15  | 19.44 | 2.23 | 80.0  | ± 9.6 % |
|           |   | Y | 5.65 | 71.64  | 18.67 |      | 80.0  |         |
|           |   | Z | 5.45 | 72.18  | 19.02 |      | 80.0  |         |
| 10514-AAC | LTE-TDD (SC-FDMA, 100% RB, 20 MHz, 64-QAM, UL Subframe=2,3,4,7,8,9) | X | 5.75 | 72.41  | 19.20 | 2.23 | 80.0  | ± 9.6 % |
|           |   | Y | 5.60 | 71.07  | 18.51 |      | 80.0  |         |
|           |   | Z | 5.40 | 71.58  | 18.82 |      | 80.0  |         |
| 10515-AAA | IEEE 802.11b WiFi 2.4 GHz (DSSS, 2 Mbps, 99pc duty cycle)           | X | 1.06 | 65.76  | 16.90 | 0.00 | 150.0 | ± 9.6 % |
|           |   | Y | 1.00 | 63.51  | 14.99 |      | 150.0 |         |
|           |   | Z | 1.02 | 64.32  | 15.55 |      | 150.0 |         |
| 10516-AAA | IEEE 802.11b WiFi 2.4 GHz (DSSS, 5.5 Mbps, 99pc duty cycle)         | X | 5.87 | 117.81 | 35.86 | 0.00 | 150.0 | ± 9.6 % |
|           |   | Y | 0.66 | 71.85  | 18.17 |      | 150.0 |         |
|           |   | Z | 0.94 | 79.02  | 21.78 |      | 150.0 |         |
| 10517-AAA | IEEE 802.11b WiFi 2.4 GHz (DSSS, 11 Mbps, 99pc duty cycle)          | X | 1.03 | 70.61  | 19.18 | 0.00 | 150.0 | ± 9.6 % |
|           |   | Y | 0.86 | 65.67  | 15.75 |      | 150.0 |         |
|           |   | Z | 0.90 | 67.08  | 16.71 |      | 150.0 |         |
| 10518-AAA | IEEE 802.11a/h WiFi 5 GHz (OFDM, 9 Mbps, 99pc duty cycle)           | X | 4.67 | 67.45  | 16.69 | 0.00 | 150.0 | ± 9.6 % |
|           |   | Y | 4.67 | 66.94  | 16.33 |      | 150.0 |         |
|           |   | Z | 4.52 | 67.23  | 16.44 |      | 150.0 |         |
| 10519-AAA | IEEE 802.11a/h WiFi 5 GHz (OFDM, 12 Mbps, 99pc duty cycle)          | X | 4.87 | 67.70  | 16.81 | 0.00 | 150.0 | ± 9.6 % |
|           |   | Y | 4.88 | 67.22  | 16.46 |      | 150.0 |         |
|           |   | Z | 4.69 | 67.43  | 16.54 |      | 150.0 |         |
| 10520-AAA | IEEE 802.11a/h WiFi 5 GHz (OFDM, 18 Mbps, 99pc duty cycle)          | X | 4.72 | 67.70  | 16.76 | 0.00 | 150.0 | ± 9.6 % |
|           |   | Y | 4.73 | 67.19  | 16.39 |      | 150.0 |         |
|           |   | Z | 4.54 | 67.39  | 16.47 |      | 150.0 |         |
| 10521-AAA | IEEE 802.11a/h WiFi 5 GHz (OFDM, 24 Mbps, 99pc duty cycle)          | X | 4.66 | 67.72  | 16.76 | 0.00 | 150.0 | ± 9.6 % |
|           |   | Y | 4.66 | 67.20  | 16.38 |      | 150.0 |         |
|           |   | Z | 4.48 | 67.38  | 16.46 |      | 150.0 |         |
| 10522-AAA | IEEE 802.11a/h WiFi 5 GHz (OFDM, 36 Mbps, 99pc duty cycle)          | X | 4.71 | 67.76  | 16.82 | 0.00 | 150.0 | ± 9.6 % |
|           |   | Y | 4.71 | 67.20  | 16.42 |      | 150.0 |         |
|           |   | Z | 4.54 | 67.51  | 16.56 |      | 150.0 |         |

|           |  |   |      |       |       |      |       |         |
|-----------|--|---|------|-------|-------|------|-------|---------|
| 10523-AAA | IEEE 802.11a/h WiFi 5 GHz (OFDM, 48 Mbps, 99pc duty cycle) | X | 4.59 | 67.65 | 16.68 | 0.00 | 150.0 | ± 9.6 % |
|           |  | Y | 4.58 | 67.09 | 16.28 |      | 150.0 |         |
|           |  | Z | 4.43 | 67.41 | 16.42 |      | 150.0 |         |
| 10524-AAA | IEEE 802.11a/h WiFi 5 GHz (OFDM, 54 Mbps, 99pc duty cycle) | X | 4.66 | 67.69 | 16.79 | 0.00 | 150.0 | ± 9.6 % |
|           |  | Y | 4.66 | 67.15 | 16.40 |      | 150.0 |         |
|           |  | Z | 4.48 | 67.43 | 16.53 |      | 150.0 |         |
| 10525-AAA | IEEE 802.11ac WiFi (20MHz, MCS0, 99pc duty cycle)          | X | 4.63 | 66.73 | 16.38 | 0.00 | 150.0 | ± 9.6 % |
|           |  | Y | 4.62 | 66.18 | 15.99 |      | 150.0 |         |
|           |  | Z | 4.49 | 66.49 | 16.12 |      | 150.0 |         |
| 10526-AAA | IEEE 802.11ac WiFi (20MHz, MCS1, 99pc duty cycle)          | X | 4.82 | 67.13 | 16.53 | 0.00 | 150.0 | ± 9.6 % |
|           |  | Y | 4.82 | 66.58 | 16.14 |      | 150.0 |         |
|           |  | Z | 4.64 | 66.83 | 16.26 |      | 150.0 |         |
| 10527-AAA | IEEE 802.11ac WiFi (20MHz, MCS2, 99pc duty cycle)          | X | 4.74 | 67.11 | 16.49 | 0.00 | 150.0 | ± 9.6 % |
|           |  | Y | 4.73 | 66.55 | 16.09 |      | 150.0 |         |
|           |  | Z | 4.57 | 66.80 | 16.20 |      | 150.0 |         |
| 10528-AAA | IEEE 802.11ac WiFi (20MHz, MCS3, 99pc duty cycle)          | X | 4.76 | 67.13 | 16.52 | 0.00 | 150.0 | ± 9.6 % |
|           |  | Y | 4.75 | 66.57 | 16.12 |      | 150.0 |         |
|           |  | Z | 4.58 | 66.81 | 16.23 |      | 150.0 |         |
| 10529-AAA | IEEE 802.11ac WiFi (20MHz, MCS4, 99pc duty cycle)          | X | 4.76 | 67.13 | 16.52 | 0.00 | 150.0 | ± 9.6 % |
|           |  | Y | 4.75 | 66.57 | 16.12 |      | 150.0 |         |
|           |  | Z | 4.58 | 66.81 | 16.23 |      | 150.0 |         |
| 10531-AAA | IEEE 802.11ac WiFi (20MHz, MCS6, 99pc duty cycle)          | X | 4.77 | 67.27 | 16.55 | 0.00 | 150.0 | ± 9.6 % |
|           |  | Y | 4.76 | 66.71 | 16.15 |      | 150.0 |         |
|           |  | Z | 4.56 | 66.89 | 16.24 |      | 150.0 |         |
| 10532-AAA | IEEE 802.11ac WiFi (20MHz, MCS7, 99pc duty cycle)          | X | 4.62 | 67.15 | 16.50 | 0.00 | 150.0 | ± 9.6 % |
|           |  | Y | 4.61 | 66.57 | 16.09 |      | 150.0 |         |
|           |  | Z | 4.43 | 66.75 | 16.17 |      | 150.0 |         |
| 10533-AAA | IEEE 802.11ac WiFi (20MHz, MCS8, 99pc duty cycle)          | X | 4.77 | 67.17 | 16.50 | 0.00 | 150.0 | ± 9.6 % |
|           |  | Y | 4.76 | 66.59 | 16.10 |      | 150.0 |         |
|           |  | Z | 4.59 | 66.88 | 16.23 |      | 150.0 |         |
| 10534-AAA | IEEE 802.11ac WiFi (40MHz, MCS0, 99pc duty cycle)          | X | 5.27 | 67.15 | 16.50 | 0.00 | 150.0 | ± 9.6 % |
|           |  | Y | 5.27 | 66.72 | 16.17 |      | 150.0 |         |
|           |  | Z | 5.12 | 66.84 | 16.26 |      | 150.0 |         |
| 10535-AAA | IEEE 802.11ac WiFi (40MHz, MCS1, 99pc duty cycle)          | X | 5.34 | 67.31 | 16.57 | 0.00 | 150.0 | ± 9.6 % |
|           |  | Y | 5.34 | 66.86 | 16.23 |      | 150.0 |         |
|           |  | Z | 5.19 | 67.03 | 16.35 |      | 150.0 |         |
| 10536-AAA | IEEE 802.11ac WiFi (40MHz, MCS2, 99pc duty cycle)          | X | 5.22 | 67.31 | 16.55 | 0.00 | 150.0 | ± 9.6 % |
|           |  | Y | 5.21 | 66.84 | 16.21 |      | 150.0 |         |
|           |  | Z | 5.06 | 66.99 | 16.32 |      | 150.0 |         |
| 10537-AAA | IEEE 802.11ac WiFi (40MHz, MCS3, 99pc duty cycle)          | X | 5.27 | 67.26 | 16.52 | 0.00 | 150.0 | ± 9.6 % |
|           |  | Y | 5.28 | 66.82 | 16.20 |      | 150.0 |         |
|           |  | Z | 5.12 | 66.94 | 16.29 |      | 150.0 |         |
| 10538-AAA | IEEE 802.11ac WiFi (40MHz, MCS4, 99pc duty cycle)          | X | 5.37 | 67.28 | 16.57 | 0.00 | 150.0 | ± 9.6 % |
|           |  | Y | 5.39 | 66.89 | 16.27 |      | 150.0 |         |
|           |  | Z | 5.20 | 66.94 | 16.33 |      | 150.0 |         |
| 10540-AAA | IEEE 802.11ac WiFi (40MHz, MCS6, 99pc duty cycle)          | X | 5.29 | 67.28 | 16.59 | 0.00 | 150.0 | ± 9.6 % |
|           |  | Y | 5.29 | 66.84 | 16.26 |      | 150.0 |         |
|           |  | Z | 5.13 | 66.94 | 16.35 |      | 150.0 |         |

|           |  |   |      |       |       |      |       |         |
|-----------|--|---|------|-------|-------|------|-------|---------|
| 10541-AAA | IEEE 802.11ac WiFi (40MHz, MCS7, 99pc duty cycle)  | X | 5.26 | 67.15 | 16.52 | 0.00 | 150.0 | ± 9.6 % |
|           |  | Y | 5.27 | 66.73 | 16.20 |      | 150.0 |         |
|           |  | Z | 5.11 | 66.82 | 16.27 |      | 150.0 |         |
| 10542-AAA | IEEE 802.11ac WiFi (40MHz, MCS8, 99pc duty cycle)  | X | 5.42 | 67.19 | 16.55 | 0.00 | 150.0 | ± 9.6 % |
|           |  | Y | 5.42 | 66.79 | 16.25 |      | 150.0 |         |
|           |  | Z | 5.26 | 66.90 | 16.33 |      | 150.0 |         |
| 10543-AAA | IEEE 802.11ac WiFi (40MHz, MCS9, 99pc duty cycle)  | X | 5.49 | 67.21 | 16.57 | 0.00 | 150.0 | ± 9.6 % |
|           |  | Y | 5.51 | 66.80 | 16.27 |      | 150.0 |         |
|           |  | Z | 5.32 | 66.91 | 16.36 |      | 150.0 |         |
| 10544-AAA | IEEE 802.11ac WiFi (80MHz, MCS0, 99pc duty cycle)  | X | 5.57 | 67.22 | 16.46 | 0.00 | 150.0 | ± 9.6 % |
|           |  | Y | 5.56 | 66.82 | 16.16 |      | 150.0 |         |
|           |  | Z | 5.45 | 66.92 | 16.24 |      | 150.0 |         |
| 10545-AAA | IEEE 802.11ac WiFi (80MHz, MCS1, 99pc duty cycle)  | X | 5.77 | 67.65 | 16.61 | 0.00 | 150.0 | ± 9.6 % |
|           |  | Y | 5.78 | 67.25 | 16.32 |      | 150.0 |         |
|           |  | Z | 5.64 | 67.38 | 16.42 |      | 150.0 |         |
| 10546-AAA | IEEE 802.11ac WiFi (80MHz, MCS2, 99pc duty cycle)  | X | 5.65 | 67.48 | 16.55 | 0.00 | 150.0 | ± 9.6 % |
|           |  | Y | 5.65 | 67.10 | 16.26 |      | 150.0 |         |
|           |  | Z | 5.50 | 67.09 | 16.30 |      | 150.0 |         |
| 10547-AAA | IEEE 802.11ac WiFi (80MHz, MCS3, 99pc duty cycle)  | X | 5.73 | 67.53 | 16.56 | 0.00 | 150.0 | ± 9.6 % |
|           |  | Y | 5.74 | 67.18 | 16.29 |      | 150.0 |         |
|           |  | Z | 5.57 | 67.16 | 16.32 |      | 150.0 |         |
| 10548-AAA | IEEE 802.11ac WiFi (80MHz, MCS4, 99pc duty cycle)  | X | 6.02 | 68.59 | 17.06 | 0.00 | 150.0 | ± 9.6 % |
|           |  | Y | 6.08 | 68.34 | 16.83 |      | 150.0 |         |
|           |  | Z | 5.80 | 68.04 | 16.74 |      | 150.0 |         |
| 10550-AAA | IEEE 802.11ac WiFi (80MHz, MCS6, 99pc duty cycle)  | X | 5.67 | 67.46 | 16.54 | 0.00 | 150.0 | ± 9.6 % |
|           |  | Y | 5.67 | 67.06 | 16.25 |      | 150.0 |         |
|           |  | Z | 5.54 | 67.19 | 16.36 |      | 150.0 |         |
| 10551-AAA | IEEE 802.11ac WiFi (80MHz, MCS7, 99pc duty cycle)  | X | 5.68 | 67.52 | 16.53 | 0.00 | 150.0 | ± 9.6 % |
|           |  | Y | 5.69 | 67.13 | 16.25 |      | 150.0 |         |
|           |  | Z | 5.53 | 67.15 | 16.30 |      | 150.0 |         |
| 10552-AAA | IEEE 802.11ac WiFi (80MHz, MCS8, 99pc duty cycle)  | X | 5.59 | 67.30 | 16.44 | 0.00 | 150.0 | ± 9.6 % |
|           |  | Y | 5.59 | 66.90 | 16.14 |      | 150.0 |         |
|           |  | Z | 5.46 | 67.00 | 16.23 |      | 150.0 |         |
| 10553-AAA | IEEE 802.11ac WiFi (80MHz, MCS9, 99pc duty cycle)  | X | 5.68 | 67.34 | 16.48 | 0.00 | 150.0 | ± 9.6 % |
|           |  | Y | 5.68 | 66.95 | 16.20 |      | 150.0 |         |
|           |  | Z | 5.53 | 67.00 | 16.26 |      | 150.0 |         |
| 10554-AAB | IEEE 802.11ac WiFi (160MHz, MCS0, 99pc duty cycle) | X | 5.97 | 67.57 | 16.52 | 0.00 | 150.0 | ± 9.6 % |
|           |  | Y | 5.97 | 67.21 | 16.26 |      | 150.0 |         |
|           |  | Z | 5.86 | 67.27 | 16.32 |      | 150.0 |         |
| 10555-AAB | IEEE 802.11ac WiFi (160MHz, MCS1, 99pc duty cycle) | X | 6.11 | 67.88 | 16.66 | 0.00 | 150.0 | ± 9.6 % |
|           |  | Y | 6.11 | 67.54 | 16.39 |      | 150.0 |         |
|           |  | Z | 5.98 | 67.57 | 16.45 |      | 150.0 |         |
| 10556-AAB | IEEE 802.11ac WiFi (160MHz, MCS2, 99pc duty cycle) | X | 6.13 | 67.93 | 16.67 | 0.00 | 150.0 | ± 9.6 % |
|           |  | Y | 6.13 | 67.56 | 16.40 |      | 150.0 |         |
|           |  | Z | 6.01 | 67.63 | 16.48 |      | 150.0 |         |
| 10557-AAB | IEEE 802.11ac WiFi (160MHz, MCS3, 99pc duty cycle) | X | 6.10 | 67.85 | 16.65 | 0.00 | 150.0 | ± 9.6 % |
|           |  | Y | 6.11 | 67.51 | 16.40 |      | 150.0 |         |
|           |  | Z | 5.97 | 67.50 | 16.43 |      | 150.0 |         |



|           |   |   |        |        |       |      |       |         |
|-----------|---|---|--------|--------|-------|------|-------|---------|
| 10558-AAB | IEEE 802.11ac WiFi (160MHz, MCS4, 99pc duty cycle)              | X | 6.16   | 68.03  | 16.76 | 0.00 | 150.0 | ± 9.6 % |
|           |   | Y | 6.17   | 67.70  | 16.50 |      | 150.0 |         |
|           |   | Z | 6.01   | 67.66  | 16.53 |      | 150.0 |         |
| 10560-AAB | IEEE 802.11ac WiFi (160MHz, MCS6, 99pc duty cycle)              | X | 6.15   | 67.86  | 16.71 | 0.00 | 150.0 | ± 9.6 % |
|           |   | Y | 6.16   | 67.52  | 16.45 |      | 150.0 |         |
|           |   | Z | 6.00   | 67.50  | 16.49 |      | 150.0 |         |
| 10561-AAB | IEEE 802.11ac WiFi (160MHz, MCS7, 99pc duty cycle)              | X | 6.06   | 67.83  | 16.73 | 0.00 | 150.0 | ± 9.6 % |
|           |   | Y | 6.07   | 67.48  | 16.47 |      | 150.0 |         |
|           |   | Z | 5.94   | 67.50  | 16.52 |      | 150.0 |         |
| 10562-AAB | IEEE 802.11ac WiFi (160MHz, MCS8, 99pc duty cycle)              | X | 6.21   | 68.28  | 16.96 | 0.00 | 150.0 | ± 9.6 % |
|           |   | Y | 6.23   | 67.97  | 16.72 |      | 150.0 |         |
|           |   | Z | 6.03   | 67.79  | 16.67 |      | 150.0 |         |
| 10563-AAB | IEEE 802.11ac WiFi (160MHz, MCS9, 99pc duty cycle)              | X | 6.55   | 68.85  | 17.19 | 0.00 | 150.0 | ± 9.6 % |
|           |   | Y | 6.59   | 68.58  | 16.96 |      | 150.0 |         |
|           |   | Z | 6.12   | 67.71  | 16.59 |      | 150.0 |         |
| 10564-AAA | IEEE 802.11g WiFi 2.4 GHz (DSSS-OFDM, 9 Mbps, 99pc duty cycle)  | X | 4.99   | 67.50  | 16.82 | 0.46 | 150.0 | ± 9.6 % |
|           |   | Y | 5.01   | 67.06  | 16.50 |      | 150.0 |         |
|           |   | Z | 4.85   | 67.32  | 16.61 |      | 150.0 |         |
| 10565-AAA | IEEE 802.11g WiFi 2.4 GHz (DSSS-OFDM, 12 Mbps, 99pc duty cycle) | X | 5.24   | 67.95  | 17.13 | 0.46 | 150.0 | ± 9.6 % |
|           |   | Y | 5.26   | 67.54  | 16.83 |      | 150.0 |         |
|           |   | Z | 5.06   | 67.72  | 16.90 |      | 150.0 |         |
| 10566-AAA | IEEE 802.11g WiFi 2.4 GHz (DSSS-OFDM, 18 Mbps, 99pc duty cycle) | X | 5.07   | 67.84  | 16.98 | 0.46 | 150.0 | ± 9.6 % |
|           |   | Y | 5.10   | 67.41  | 16.66 |      | 150.0 |         |
|           |   | Z | 4.90   | 67.58  | 16.73 |      | 150.0 |         |
| 10567-AAA | IEEE 802.11g WiFi 2.4 GHz (DSSS-OFDM, 24 Mbps, 99pc duty cycle) | X | 5.11   | 68.24  | 17.33 | 0.46 | 150.0 | ± 9.6 % |
|           |   | Y | 5.13   | 67.80  | 17.01 |      | 150.0 |         |
|           |   | Z | 4.93   | 67.94  | 17.07 |      | 150.0 |         |
| 10568-AAA | IEEE 802.11g WiFi 2.4 GHz (DSSS-OFDM, 36 Mbps, 99pc duty cycle) | X | 4.99   | 67.61  | 16.75 | 0.46 | 150.0 | ± 9.6 % |
|           |   | Y | 5.01   | 67.15  | 16.42 |      | 150.0 |         |
|           |   | Z | 4.83   | 67.42  | 16.55 |      | 150.0 |         |
| 10569-AAA | IEEE 802.11g WiFi 2.4 GHz (DSSS-OFDM, 48 Mbps, 99pc duty cycle) | X | 5.06   | 68.33  | 17.39 | 0.46 | 150.0 | ± 9.6 % |
|           |   | Y | 5.07   | 67.85  | 17.05 |      | 150.0 |         |
|           |   | Z | 4.91   | 68.11  | 17.17 |      | 150.0 |         |
| 10570-AAA | IEEE 802.11g WiFi 2.4 GHz (DSSS-OFDM, 54 Mbps, 99pc duty cycle) | X | 5.09   | 68.14  | 17.31 | 0.46 | 150.0 | ± 9.6 % |
|           |   | Y | 5.11   | 67.68  | 16.98 |      | 150.0 |         |
|           |   | Z | 4.92   | 67.93  | 17.09 |      | 150.0 |         |
| 10571-AAA | IEEE 802.11b WiFi 2.4 GHz (DSSS, 1 Mbps, 90pc duty cycle)       | X | 1.50   | 68.95  | 18.38 | 0.46 | 130.0 | ± 9.6 % |
|           |   | Y | 1.40   | 66.38  | 16.51 |      | 130.0 |         |
|           |   | Z | 1.40   | 67.23  | 17.09 |      | 130.0 |         |
| 10572-AAA | IEEE 802.11b WiFi 2.4 GHz (DSSS, 2 Mbps, 90pc duty cycle)       | X | 1.55   | 69.98  | 18.93 | 0.46 | 130.0 | ± 9.6 % |
|           |   | Y | 1.43   | 67.06  | 16.91 |      | 130.0 |         |
|           |   | Z | 1.44   | 67.99  | 17.53 |      | 130.0 |         |
| 10573-AAA | IEEE 802.11b WiFi 2.4 GHz (DSSS, 5.5 Mbps, 90pc duty cycle)     | X | 100.00 | 153.35 | 41.94 | 0.46 | 130.0 | ± 9.6 % |
|           |   | Y | 5.15   | 96.81  | 26.53 |      | 130.0 |         |
|           |   | Z | 50.11  | 136.49 | 37.17 |      | 130.0 |         |
| 10574-AAA | IEEE 802.11b WiFi 2.4 GHz (DSSS, 11 Mbps, 90pc duty cycle)      | X | 2.59   | 83.81  | 24.92 | 0.46 | 130.0 | ± 9.6 % |
|           |   | Y | 1.75   | 74.27  | 20.26 |      | 130.0 |         |
|           |   | Z | 1.86   | 76.56  | 21.49 |      | 130.0 |         |

|           |   |   |      |       |       |      |       |         |
|-----------|---|---|------|-------|-------|------|-------|---------|
| 10575-AAA | IEEE 802.11g WiFi 2.4 GHz (DSSS-OFDM, 6 Mbps, 90pc duty cycle)  | X | 4.81 | 67.37 | 16.92 | 0.46 | 130.0 | ± 9.6 % |
|           |   | Y | 4.84 | 66.96 | 16.62 |      | 130.0 |         |
|           |   | Z | 4.68 | 67.23 | 16.73 |      | 130.0 |         |
| 10576-AAA | IEEE 802.11g WiFi 2.4 GHz (DSSS-OFDM, 9 Mbps, 90pc duty cycle)  | X | 4.84 | 67.54 | 16.99 | 0.46 | 130.0 | ± 9.6 % |
|           |   | Y | 4.86 | 67.12 | 16.68 |      | 130.0 |         |
|           |   | Z | 4.71 | 67.40 | 16.79 |      | 130.0 |         |
| 10577-AAA | IEEE 802.11g WiFi 2.4 GHz (DSSS-OFDM, 12 Mbps, 90pc duty cycle) | X | 5.05 | 67.83 | 17.14 | 0.46 | 130.0 | ± 9.6 % |
|           |   | Y | 5.09 | 67.44 | 16.86 |      | 130.0 |         |
|           |   | Z | 4.89 | 67.64 | 16.94 |      | 130.0 |         |
| 10578-AAA | IEEE 802.11g WiFi 2.4 GHz (DSSS-OFDM, 18 Mbps, 90pc duty cycle) | X | 4.96 | 68.04 | 17.27 | 0.46 | 130.0 | ± 9.6 % |
|           |   | Y | 4.99 | 67.62 | 16.97 |      | 130.0 |         |
|           |   | Z | 4.79 | 67.80 | 17.04 |      | 130.0 |         |
| 10579-AAA | IEEE 802.11g WiFi 2.4 GHz (DSSS-OFDM, 24 Mbps, 90pc duty cycle) | X | 4.73 | 67.38 | 16.62 | 0.46 | 130.0 | ± 9.6 % |
|           |   | Y | 4.76 | 66.96 | 16.31 |      | 130.0 |         |
|           |   | Z | 4.57 | 67.14 | 16.40 |      | 130.0 |         |
| 10580-AAA | IEEE 802.11g WiFi 2.4 GHz (DSSS-OFDM, 36 Mbps, 90pc duty cycle) | X | 4.77 | 67.37 | 16.62 | 0.46 | 130.0 | ± 9.6 % |
|           |   | Y | 4.80 | 66.94 | 16.31 |      | 130.0 |         |
|           |   | Z | 4.61 | 67.21 | 16.43 |      | 130.0 |         |
| 10581-AAA | IEEE 802.11g WiFi 2.4 GHz (DSSS-OFDM, 48 Mbps, 90pc duty cycle) | X | 4.86 | 68.14 | 17.25 | 0.46 | 130.0 | ± 9.6 % |
|           |   | Y | 4.89 | 67.70 | 16.92 |      | 130.0 |         |
|           |   | Z | 4.70 | 67.90 | 17.02 |      | 130.0 |         |
| 10582-AAA | IEEE 802.11g WiFi 2.4 GHz (DSSS-OFDM, 54 Mbps, 90pc duty cycle) | X | 4.67 | 67.12 | 16.41 | 0.46 | 130.0 | ± 9.6 % |
|           |   | Y | 4.71 | 66.71 | 16.10 |      | 130.0 |         |
|           |   | Z | 4.51 | 66.92 | 16.20 |      | 130.0 |         |
| 10583-AAA | IEEE 802.11a/h WiFi 5 GHz (OFDM, 6 Mbps, 90pc duty cycle)       | X | 4.81 | 67.37 | 16.92 | 0.46 | 130.0 | ± 9.6 % |
|           |   | Y | 4.84 | 66.96 | 16.62 |      | 130.0 |         |
|           |   | Z | 4.68 | 67.23 | 16.73 |      | 130.0 |         |
| 10584-AAA | IEEE 802.11a/h WiFi 5 GHz (OFDM, 9 Mbps, 90pc duty cycle)       | X | 4.84 | 67.54 | 16.99 | 0.46 | 130.0 | ± 9.6 % |
|           |   | Y | 4.86 | 67.12 | 16.68 |      | 130.0 |         |
|           |   | Z | 4.71 | 67.40 | 16.79 |      | 130.0 |         |
| 10585-AAA | IEEE 802.11a/h WiFi 5 GHz (OFDM, 12 Mbps, 90pc duty cycle)      | X | 5.05 | 67.83 | 17.14 | 0.46 | 130.0 | ± 9.6 % |
|           |   | Y | 5.09 | 67.44 | 16.86 |      | 130.0 |         |
|           |   | Z | 4.89 | 67.64 | 16.94 |      | 130.0 |         |
| 10586-AAA | IEEE 802.11a/h WiFi 5 GHz (OFDM, 18 Mbps, 90pc duty cycle)      | X | 4.96 | 68.04 | 17.27 | 0.46 | 130.0 | ± 9.6 % |
|           |   | Y | 4.99 | 67.62 | 16.97 |      | 130.0 |         |
|           |   | Z | 4.79 | 67.80 | 17.04 |      | 130.0 |         |
| 10587-AAA | IEEE 802.11a/h WiFi 5 GHz (OFDM, 24 Mbps, 90pc duty cycle)      | X | 4.73 | 67.38 | 16.62 | 0.46 | 130.0 | ± 9.6 % |
|           |   | Y | 4.76 | 66.96 | 16.31 |      | 130.0 |         |
|           |   | Z | 4.57 | 67.14 | 16.40 |      | 130.0 |         |
| 10588-AAA | IEEE 802.11a/h WiFi 5 GHz (OFDM, 36 Mbps, 90pc duty cycle)      | X | 4.77 | 67.37 | 16.62 | 0.46 | 130.0 | ± 9.6 % |
|           |   | Y | 4.80 | 66.94 | 16.31 |      | 130.0 |         |
|           |   | Z | 4.61 | 67.21 | 16.43 |      | 130.0 |         |
| 10589-AAA | IEEE 802.11a/h WiFi 5 GHz (OFDM, 48 Mbps, 90pc duty cycle)      | X | 4.86 | 68.14 | 17.25 | 0.46 | 130.0 | ± 9.6 % |
|           |   | Y | 4.89 | 67.70 | 16.92 |      | 130.0 |         |
|           |   | Z | 4.70 | 67.90 | 17.02 |      | 130.0 |         |
| 10590-AAA | IEEE 802.11a/h WiFi 5 GHz (OFDM, 54 Mbps, 90pc duty cycle)      | X | 4.67 | 67.12 | 16.41 | 0.46 | 130.0 | ± 9.6 % |
|           |   | Y | 4.71 | 66.71 | 16.10 |      | 130.0 |         |
|           |   | Z | 4.51 | 66.92 | 16.20 |      | 130.0 |         |

|           |   |   |      |       |       |      |       |         |
|-----------|---|---|------|-------|-------|------|-------|---------|
| 10591-AAA | IEEE 802.11n (HT Mixed, 20MHz, MCS0, 90pc duty cycle) | X | 4.95 | 67.39 | 16.99 | 0.46 | 130.0 | ± 9.6 % |
|           |   | Y | 4.98 | 67.01 | 16.71 |      | 130.0 |         |
|           |   | Z | 4.83 | 67.26 | 16.81 |      | 130.0 |         |
| 10592-AAA | IEEE 802.11n (HT Mixed, 20MHz, MCS1, 90pc duty cycle) | X | 5.12 | 67.74 | 17.12 | 0.46 | 130.0 | ± 9.6 % |
|           |   | Y | 5.15 | 67.35 | 16.84 |      | 130.0 |         |
|           |   | Z | 4.97 | 67.58 | 16.94 |      | 130.0 |         |
| 10593-AAA | IEEE 802.11n (HT Mixed, 20MHz, MCS2, 90pc duty cycle) | X | 5.04 | 67.68 | 17.02 | 0.46 | 130.0 | ± 9.6 % |
|           |   | Y | 5.08 | 67.30 | 16.74 |      | 130.0 |         |
|           |   | Z | 4.89 | 67.49 | 16.82 |      | 130.0 |         |
| 10594-AAA | IEEE 802.11n (HT Mixed, 20MHz, MCS3, 90pc duty cycle) | X | 5.10 | 67.84 | 17.17 | 0.46 | 130.0 | ± 9.6 % |
|           |   | Y | 5.14 | 67.45 | 16.88 |      | 130.0 |         |
|           |   | Z | 4.94 | 67.65 | 16.97 |      | 130.0 |         |
| 10595-AAA | IEEE 802.11n (HT Mixed, 20MHz, MCS4, 90pc duty cycle) | X | 5.07 | 67.81 | 17.07 | 0.46 | 130.0 | ± 9.6 % |
|           |   | Y | 5.11 | 67.42 | 16.78 |      | 130.0 |         |
|           |   | Z | 4.91 | 67.63 | 16.88 |      | 130.0 |         |
| 10596-AAA | IEEE 802.11n (HT Mixed, 20MHz, MCS5, 90pc duty cycle) | X | 5.01 | 67.82 | 17.09 | 0.46 | 130.0 | ± 9.6 % |
|           |   | Y | 5.05 | 67.42 | 16.79 |      | 130.0 |         |
|           |   | Z | 4.85 | 67.64 | 16.90 |      | 130.0 |         |
| 10597-AAA | IEEE 802.11n (HT Mixed, 20MHz, MCS6, 90pc duty cycle) | X | 4.96 | 67.75 | 16.98 | 0.46 | 130.0 | ± 9.6 % |
|           |   | Y | 5.00 | 67.35 | 16.69 |      | 130.0 |         |
|           |   | Z | 4.80 | 67.53 | 16.77 |      | 130.0 |         |
| 10598-AAA | IEEE 802.11n (HT Mixed, 20MHz, MCS7, 90pc duty cycle) | X | 4.95 | 68.01 | 17.26 | 0.46 | 130.0 | ± 9.6 % |
|           |   | Y | 4.98 | 67.61 | 16.96 |      | 130.0 |         |
|           |   | Z | 4.78 | 67.73 | 17.01 |      | 130.0 |         |
| 10599-AAA | IEEE 802.11n (HT Mixed, 40MHz, MCS0, 90pc duty cycle) | X | 5.60 | 67.86 | 17.12 | 0.46 | 130.0 | ± 9.6 % |
|           |   | Y | 5.66 | 67.61 | 16.91 |      | 130.0 |         |
|           |   | Z | 5.48 | 67.70 | 16.99 |      | 130.0 |         |
| 10600-AAA | IEEE 802.11n (HT Mixed, 40MHz, MCS1, 90pc duty cycle) | X | 5.78 | 68.39 | 17.36 | 0.46 | 130.0 | ± 9.6 % |
|           |   | Y | 5.85 | 68.19 | 17.17 |      | 130.0 |         |
|           |   | Z | 5.62 | 68.16 | 17.20 |      | 130.0 |         |
| 10601-AAA | IEEE 802.11n (HT Mixed, 40MHz, MCS2, 90pc duty cycle) | X | 5.65 | 68.09 | 17.22 | 0.46 | 130.0 | ± 9.6 % |
|           |   | Y | 5.71 | 67.83 | 17.01 |      | 130.0 |         |
|           |   | Z | 5.51 | 67.89 | 17.08 |      | 130.0 |         |
| 10602-AAA | IEEE 802.11n (HT Mixed, 40MHz, MCS3, 90pc duty cycle) | X | 5.73 | 68.07 | 17.13 | 0.46 | 130.0 | ± 9.6 % |
|           |   | Y | 5.79 | 67.82 | 16.93 |      | 130.0 |         |
|           |   | Z | 5.63 | 68.04 | 17.07 |      | 130.0 |         |
| 10603-AAA | IEEE 802.11n (HT Mixed, 40MHz, MCS4, 90pc duty cycle) | X | 5.82 | 68.41 | 17.43 | 0.46 | 130.0 | ± 9.6 % |
|           |   | Y | 5.87 | 68.11 | 17.19 |      | 130.0 |         |
|           |   | Z | 5.69 | 68.27 | 17.32 |      | 130.0 |         |
| 10604-AAA | IEEE 802.11n (HT Mixed, 40MHz, MCS5, 90pc duty cycle) | X | 5.61 | 67.82 | 17.13 | 0.46 | 130.0 | ± 9.6 % |
|           |   | Y | 5.66 | 67.56 | 16.91 |      | 130.0 |         |
|           |   | Z | 5.56 | 67.91 | 17.12 |      | 130.0 |         |
| 10605-AAA | IEEE 802.11n (HT Mixed, 40MHz, MCS6, 90pc duty cycle) | X | 5.73 | 68.17 | 17.30 | 0.46 | 130.0 | ± 9.6 % |
|           |   | Y | 5.77 | 67.87 | 17.07 |      | 130.0 |         |
|           |   | Z | 5.62 | 68.08 | 17.21 |      | 130.0 |         |
| 10606-AAA | IEEE 802.11n (HT Mixed, 40MHz, MCS7, 90pc duty cycle) | X | 5.50 | 67.62 | 16.90 | 0.46 | 130.0 | ± 9.6 % |
|           |   | Y | 5.53 | 67.31 | 16.65 |      | 130.0 |         |
|           |   | Z | 5.35 | 67.34 | 16.70 |      | 130.0 |         |

|           |   |   |      |       |       |      |       |         |
|-----------|---|---|------|-------|-------|------|-------|---------|
| 10607-AAA | IEEE 802.11ac WiFi (20MHz, MCS0, 90pc duty cycle) | X | 4.80 | 66.75 | 16.64 | 0.46 | 130.0 | ± 9.6 % |
|           |   | Y | 4.81 | 66.30 | 16.32 |      | 130.0 |         |
|           |   | Z | 4.67 | 66.60 | 16.45 |      | 130.0 |         |
| 10608-AAA | IEEE 802.11ac WiFi (20MHz, MCS1, 90pc duty cycle) | X | 5.00 | 67.18 | 16.81 | 0.46 | 130.0 | ± 9.6 % |
|           |   | Y | 5.02 | 66.72 | 16.48 |      | 130.0 |         |
|           |   | Z | 4.84 | 66.98 | 16.61 |      | 130.0 |         |
| 10609-AAA | IEEE 802.11ac WiFi (20MHz, MCS2, 90pc duty cycle) | X | 4.89 | 67.06 | 16.67 | 0.46 | 130.0 | ± 9.6 % |
|           |   | Y | 4.91 | 66.60 | 16.34 |      | 130.0 |         |
|           |   | Z | 4.73 | 66.84 | 16.45 |      | 130.0 |         |
| 10610-AAA | IEEE 802.11ac WiFi (20MHz, MCS3, 90pc duty cycle) | X | 4.94 | 67.21 | 16.82 | 0.46 | 130.0 | ± 9.6 % |
|           |   | Y | 4.96 | 66.76 | 16.50 |      | 130.0 |         |
|           |   | Z | 4.78 | 66.99 | 16.61 |      | 130.0 |         |
| 10611-AAA | IEEE 802.11ac WiFi (20MHz, MCS4, 90pc duty cycle) | X | 4.86 | 67.03 | 16.68 | 0.46 | 130.0 | ± 9.6 % |
|           |   | Y | 4.89 | 66.59 | 16.36 |      | 130.0 |         |
|           |   | Z | 4.70 | 66.81 | 16.46 |      | 130.0 |         |
| 10612-AAA | IEEE 802.11ac WiFi (20MHz, MCS5, 90pc duty cycle) | X | 4.88 | 67.21 | 16.74 | 0.46 | 130.0 | ± 9.6 % |
|           |   | Y | 4.90 | 66.74 | 16.40 |      | 130.0 |         |
|           |   | Z | 4.71 | 66.99 | 16.53 |      | 130.0 |         |
| 10613-AAA | IEEE 802.11ac WiFi (20MHz, MCS6, 90pc duty cycle) | X | 4.89 | 67.11 | 16.63 | 0.46 | 130.0 | ± 9.6 % |
|           |   | Y | 4.91 | 66.65 | 16.30 |      | 130.0 |         |
|           |   | Z | 4.71 | 66.83 | 16.39 |      | 130.0 |         |
| 10614-AAA | IEEE 802.11ac WiFi (20MHz, MCS7, 90pc duty cycle) | X | 4.83 | 67.31 | 16.87 | 0.46 | 130.0 | ± 9.6 % |
|           |   | Y | 4.85 | 66.84 | 16.53 |      | 130.0 |         |
|           |   | Z | 4.66 | 67.02 | 16.61 |      | 130.0 |         |
| 10615-AAA | IEEE 802.11ac WiFi (20MHz, MCS8, 90pc duty cycle) | X | 4.86 | 66.85 | 16.46 | 0.46 | 130.0 | ± 9.6 % |
|           |   | Y | 4.89 | 66.40 | 16.13 |      | 130.0 |         |
|           |   | Z | 4.70 | 66.67 | 16.26 |      | 130.0 |         |
| 10616-AAA | IEEE 802.11ac WiFi (40MHz, MCS0, 90pc duty cycle) | X | 5.44 | 67.18 | 16.77 | 0.46 | 130.0 | ± 9.6 % |
|           |   | Y | 5.47 | 66.84 | 16.51 |      | 130.0 |         |
|           |   | Z | 5.30 | 66.94 | 16.59 |      | 130.0 |         |
| 10617-AAA | IEEE 802.11ac WiFi (40MHz, MCS1, 90pc duty cycle) | X | 5.50 | 67.33 | 16.81 | 0.46 | 130.0 | ± 9.6 % |
|           |   | Y | 5.52 | 66.94 | 16.53 |      | 130.0 |         |
|           |   | Z | 5.38 | 67.17 | 16.68 |      | 130.0 |         |
| 10618-AAA | IEEE 802.11ac WiFi (40MHz, MCS2, 90pc duty cycle) | X | 5.40 | 67.39 | 16.87 | 0.46 | 130.0 | ± 9.6 % |
|           |   | Y | 5.42 | 67.02 | 16.59 |      | 130.0 |         |
|           |   | Z | 5.27 | 67.18 | 16.70 |      | 130.0 |         |
| 10619-AAA | IEEE 802.11ac WiFi (40MHz, MCS3, 90pc duty cycle) | X | 5.42 | 67.21 | 16.71 | 0.46 | 130.0 | ± 9.6 % |
|           |   | Y | 5.44 | 66.85 | 16.44 |      | 130.0 |         |
|           |   | Z | 5.28 | 66.96 | 16.53 |      | 130.0 |         |
| 10620-AAA | IEEE 802.11ac WiFi (40MHz, MCS4, 90pc duty cycle) | X | 5.51 | 67.25 | 16.78 | 0.46 | 130.0 | ± 9.6 % |
|           |   | Y | 5.56 | 66.94 | 16.53 |      | 130.0 |         |
|           |   | Z | 5.36 | 66.98 | 16.59 |      | 130.0 |         |
| 10621-AAA | IEEE 802.11ac WiFi (40MHz, MCS5, 90pc duty cycle) | X | 5.50 | 67.33 | 16.93 | 0.46 | 130.0 | ± 9.6 % |
|           |   | Y | 5.53 | 67.00 | 16.68 |      | 130.0 |         |
|           |   | Z | 5.36 | 67.10 | 16.76 |      | 130.0 |         |
| 10622-AAA | IEEE 802.11ac WiFi (40MHz, MCS6, 90pc duty cycle) | X | 5.51 | 67.50 | 17.01 | 0.46 | 130.0 | ± 9.6 % |
|           |   | Y | 5.53 | 67.13 | 16.73 |      | 130.0 |         |
|           |   | Z | 5.38 | 67.30 | 16.85 |      | 130.0 |         |

|           |  |   |      |       |       |      |       |         |
|-----------|--|---|------|-------|-------|------|-------|---------|
| 10623-AAA | IEEE 802.11ac WiFi (40MHz, MCS7, 90pc duty cycle)  | X | 5.39 | 67.03 | 16.66 | 0.46 | 130.0 | ± 9.6 % |
|           |  | Y | 5.41 | 66.69 | 16.40 |      | 130.0 |         |
|           |  | Z | 5.25 | 66.80 | 16.48 |      | 130.0 |         |
| 10624-AAA | IEEE 802.11ac WiFi (40MHz, MCS8, 90pc duty cycle)  | X | 5.58 | 67.21 | 16.80 | 0.46 | 130.0 | ± 9.6 % |
|           |  | Y | 5.61 | 66.88 | 16.56 |      | 130.0 |         |
|           |  | Z | 5.44 | 66.99 | 16.64 |      | 130.0 |         |
| 10625-AAA | IEEE 802.11ac WiFi (40MHz, MCS9, 90pc duty cycle)  | X | 5.99 | 68.31 | 17.39 | 0.46 | 130.0 | ± 9.6 % |
|           |  | Y | 6.04 | 68.02 | 17.17 |      | 130.0 |         |
|           |  | Z | 5.71 | 67.69 | 17.04 |      | 130.0 |         |
| 10626-AAA | IEEE 802.11ac WiFi (80MHz, MCS0, 90pc duty cycle)  | X | 5.71 | 67.19 | 16.69 | 0.46 | 130.0 | ± 9.6 % |
|           |  | Y | 5.72 | 66.86 | 16.44 |      | 130.0 |         |
|           |  | Z | 5.61 | 66.97 | 16.54 |      | 130.0 |         |
| 10627-AAA | IEEE 802.11ac WiFi (80MHz, MCS1, 90pc duty cycle)  | X | 5.96 | 67.77 | 16.93 | 0.46 | 130.0 | ± 9.6 % |
|           |  | Y | 5.99 | 67.46 | 16.69 |      | 130.0 |         |
|           |  | Z | 5.86 | 67.59 | 16.81 |      | 130.0 |         |
| 10628-AAA | IEEE 802.11ac WiFi (80MHz, MCS2, 90pc duty cycle)  | X | 5.76 | 67.34 | 16.66 | 0.46 | 130.0 | ± 9.6 % |
|           |  | Y | 5.79 | 67.03 | 16.42 |      | 130.0 |         |
|           |  | Z | 5.63 | 67.03 | 16.47 |      | 130.0 |         |
| 10629-AAA | IEEE 802.11ac WiFi (80MHz, MCS3, 90pc duty cycle)  | X | 5.85 | 67.42 | 16.69 | 0.46 | 130.0 | ± 9.6 % |
|           |  | Y | 5.87 | 67.09 | 16.44 |      | 130.0 |         |
|           |  | Z | 5.71 | 67.12 | 16.51 |      | 130.0 |         |
| 10630-AAA | IEEE 802.11ac WiFi (80MHz, MCS4, 90pc duty cycle)  | X | 6.37 | 69.15 | 17.55 | 0.46 | 130.0 | ± 9.6 % |
|           |  | Y | 6.48 | 69.04 | 17.41 |      | 130.0 |         |
|           |  | Z | 6.10 | 68.51 | 17.21 |      | 130.0 |         |
| 10631-AAA | IEEE 802.11ac WiFi (80MHz, MCS5, 90pc duty cycle)  | X | 6.23 | 68.84 | 17.58 | 0.46 | 130.0 | ± 9.6 % |
|           |  | Y | 6.30 | 68.64 | 17.40 |      | 130.0 |         |
|           |  | Z | 6.00 | 68.26 | 17.26 |      | 130.0 |         |
| 10632-AAA | IEEE 802.11ac WiFi (80MHz, MCS6, 90pc duty cycle)  | X | 5.93 | 67.81 | 17.09 | 0.46 | 130.0 | ± 9.6 % |
|           |  | Y | 5.96 | 67.50 | 16.85 |      | 130.0 |         |
|           |  | Z | 5.82 | 67.64 | 16.97 |      | 130.0 |         |
| 10633-AAA | IEEE 802.11ac WiFi (80MHz, MCS7, 90pc duty cycle)  | X | 5.83 | 67.50 | 16.76 | 0.46 | 130.0 | ± 9.6 % |
|           |  | Y | 5.88 | 67.25 | 16.56 |      | 130.0 |         |
|           |  | Z | 5.69 | 67.21 | 16.59 |      | 130.0 |         |
| 10634-AAA | IEEE 802.11ac WiFi (80MHz, MCS8, 90pc duty cycle)  | X | 5.81 | 67.52 | 16.84 | 0.46 | 130.0 | ± 9.6 % |
|           |  | Y | 5.85 | 67.23 | 16.61 |      | 130.0 |         |
|           |  | Z | 5.67 | 67.21 | 16.64 |      | 130.0 |         |
| 10635-AAA | IEEE 802.11ac WiFi (80MHz, MCS9, 90pc duty cycle)  | X | 5.70 | 66.87 | 16.25 | 0.46 | 130.0 | ± 9.6 % |
|           |  | Y | 5.74 | 66.58 | 16.02 |      | 130.0 |         |
|           |  | Z | 5.55 | 66.58 | 16.07 |      | 130.0 |         |
| 10636-AAB | IEEE 802.11ac WiFi (160MHz, MCS0, 90pc duty cycle) | X | 6.12 | 67.55 | 16.76 | 0.46 | 130.0 | ± 9.6 % |
|           |  | Y | 6.14 | 67.26 | 16.54 |      | 130.0 |         |
|           |  | Z | 6.03 | 67.32 | 16.61 |      | 130.0 |         |
| 10637-AAB | IEEE 802.11ac WiFi (160MHz, MCS1, 90pc duty cycle) | X | 6.28 | 67.94 | 16.93 | 0.46 | 130.0 | ± 9.6 % |
|           |  | Y | 6.31 | 67.65 | 16.72 |      | 130.0 |         |
|           |  | Z | 6.19 | 67.72 | 16.79 |      | 130.0 |         |
| 10638-AAB | IEEE 802.11ac WiFi (160MHz, MCS2, 90pc duty cycle) | X | 6.28 | 67.91 | 16.90 | 0.46 | 130.0 | ± 9.6 % |
|           |  | Y | 6.31 | 67.62 | 16.68 |      | 130.0 |         |
|           |  | Z | 6.18 | 67.68 | 16.75 |      | 130.0 |         |

|           |  |   |        |        |       |      |       |         |
|-----------|--|---|--------|--------|-------|------|-------|---------|
| 10639-AAB | IEEE 802.11ac WiFi (160MHz, MCS3, 90pc duty cycle)     | X | 6.27   | 67.88  | 16.93 | 0.46 | 130.0 | ± 9.6 % |
|           |  | Y | 6.30   | 67.62  | 16.73 |      | 130.0 |         |
|           |  | Z | 6.15   | 67.59  | 16.75 |      | 130.0 |         |
| 10640-AAB | IEEE 802.11ac WiFi (160MHz, MCS4, 90pc duty cycle)     | X | 6.29   | 67.93  | 16.90 | 0.46 | 130.0 | ± 9.6 % |
|           |  | Y | 6.33   | 67.70  | 16.71 |      | 130.0 |         |
|           |  | Z | 6.15   | 67.62  | 16.71 |      | 130.0 |         |
| 10641-AAB | IEEE 802.11ac WiFi (160MHz, MCS5, 90pc duty cycle)     | X | 6.30   | 67.74  | 16.81 | 0.46 | 130.0 | ± 9.6 % |
|           |  | Y | 6.32   | 67.44  | 16.59 |      | 130.0 |         |
|           |  | Z | 6.22   | 67.59  | 16.72 |      | 130.0 |         |
| 10642-AAB | IEEE 802.11ac WiFi (160MHz, MCS6, 90pc duty cycle)     | X | 6.36   | 68.03  | 17.13 | 0.46 | 130.0 | ± 9.6 % |
|           |  | Y | 6.39   | 67.76  | 16.92 |      | 130.0 |         |
|           |  | Z | 6.23   | 67.75  | 16.95 |      | 130.0 |         |
| 10643-AAB | IEEE 802.11ac WiFi (160MHz, MCS7, 90pc duty cycle)     | X | 6.19   | 67.72  | 16.88 | 0.46 | 130.0 | ± 9.6 % |
|           |  | Y | 6.22   | 67.45  | 16.67 |      | 130.0 |         |
|           |  | Z | 6.09   | 67.50  | 16.74 |      | 130.0 |         |
| 10644-AAB | IEEE 802.11ac WiFi (160MHz, MCS8, 90pc duty cycle)     | X | 6.39   | 68.34  | 17.21 | 0.46 | 130.0 | ± 9.6 % |
|           |  | Y | 6.45   | 68.14  | 17.04 |      | 130.0 |         |
|           |  | Z | 6.20   | 67.86  | 16.93 |      | 130.0 |         |
| 10645-AAB | IEEE 802.11ac WiFi (160MHz, MCS9, 90pc duty cycle)     | X | 6.86   | 69.27  | 17.61 | 0.46 | 130.0 | ± 9.6 % |
|           |  | Y | 6.87   | 68.89  | 17.35 |      | 130.0 |         |
|           |  | Z | 6.34   | 67.93  | 16.93 |      | 130.0 |         |
| 10646-AAD | LTE-TDD (SC-FDMA, 1 RB, 5 MHz, QPSK, UL Subframe=2,7)  | X | 58.91  | 128.47 | 41.72 | 9.30 | 60.0  | ± 9.6 % |
|           |  | Y | 22.23  | 103.66 | 34.19 |      | 60.0  |         |
|           |  | Z | 97.77  | 144.05 | 46.65 |      | 60.0  |         |
| 10647-AAC | LTE-TDD (SC-FDMA, 1 RB, 20 MHz, QPSK, UL Subframe=2,7) | X | 62.96  | 130.94 | 42.54 | 9.30 | 60.0  | ± 9.6 % |
|           |  | Y | 22.84  | 105.02 | 34.74 |      | 60.0  |         |
|           |  | Z | 100.00 | 145.78 | 47.28 |      | 60.0  |         |
| 10648-AAA | CDMA2000 (1x Advanced)                                 | X | 1.21   | 71.90  | 15.83 | 0.00 | 150.0 | ± 9.6 % |
|           |  | Y | 0.81   | 64.89  | 12.16 |      | 150.0 |         |
|           |  | Z | 0.74   | 65.22  | 11.47 |      | 150.0 |         |
| 10652-AAB | LTE-TDD (OFDMA, 5 MHz, E-TM 3.1, Clipping 44%)         | X | 4.72   | 70.40  | 18.28 | 2.23 | 80.0  | ± 9.6 % |
|           |  | Y | 4.59   | 69.04  | 17.59 |      | 80.0  |         |
|           |  | Z | 4.50   | 69.96  | 17.82 |      | 80.0  |         |
| 10653-AAB | LTE-TDD (OFDMA, 10 MHz, E-TM 3.1, Clipping 44%)        | X | 5.05   | 69.01  | 18.05 | 2.23 | 80.0  | ± 9.6 % |
|           |  | Y | 5.03   | 68.18  | 17.58 |      | 80.0  |         |
|           |  | Z | 4.88   | 68.67  | 17.76 |      | 80.0  |         |
| 10654-AAB | LTE-TDD (OFDMA, 15 MHz, E-TM 3.1, Clipping 44%)        | X | 4.97   | 68.58  | 18.01 | 2.23 | 80.0  | ± 9.6 % |
|           |  | Y | 4.96   | 67.84  | 17.57 |      | 80.0  |         |
|           |  | Z | 4.83   | 68.24  | 17.75 |      | 80.0  |         |
| 10655-AAB | LTE-TDD (OFDMA, 20 MHz, E-TM 3.1, Clipping 44%)        | X | 5.02   | 68.56  | 18.04 | 2.23 | 80.0  | ± 9.6 % |
|           |  | Y | 5.02   | 67.86  | 17.60 |      | 80.0  |         |
|           |  | Z | 4.89   | 68.17  | 17.77 |      | 80.0  |         |

<sup>E</sup> Uncertainty is determined using the max. deviation from linear response applying rectangular distribution and is expressed for the square of the field value.



Accredited by the Swiss Accreditation Service (SAS)  
The Swiss Accreditation Service is one of the signatories to the EA  
Multilateral Agreement for the recognition of calibration certificates

Accreditation No.: **SCS 0108**

Client **PC Test**

Certificate No: **ES3-3347\_Mar18**

## CALIBRATION CERTIFICATE

Object **ES3DV3 - SN:3347**

Calibration procedure(s) **QA CAL-01.v9, QA CAL-23.v5, QA CAL-25.v6  
Calibration procedure for dosimetric E-field probes**

*BM  
04-05-2018*

Calibration date: **March 27, 2018**

This calibration certificate documents the traceability to national standards, which realize the physical units of measurements (SI).  
The measurements and the uncertainties with confidence probability are given on the following pages and are part of the certificate.

All calibrations have been conducted in the closed laboratory facility: environment temperature (22 ± 3)°C and humidity < 70%.

Calibration Equipment used (M&TE critical for calibration)

| Primary Standards          | ID               | Cal Date (Certificate No.)        | Scheduled Calibration  |
|----------------------------|------------------|-----------------------------------|------------------------|
| Power meter NRP            | SN: 104778       | 04-Apr-17 (No. 217-02521/02522)   | Apr-18                 |
| Power sensor NRP-Z91       | SN: 103244       | 04-Apr-17 (No. 217-02521)         | Apr-18                 |
| Power sensor NRP-Z91       | SN: 103245       | 04-Apr-17 (No. 217-02525)         | Apr-18                 |
| Reference 20 dB Attenuator | SN: S5277 (20x)  | 07-Apr-17 (No. 217-02528)         | Apr-18                 |
| Reference Probe ES3DV2     | SN: 3013         | 30-Dec-17 (No. ES3-3013_Dec17)    | Dec-18                 |
| DAE4                       | SN: 660          | 21-Dec-17 (No. DAE4-660_Dec17)    | Dec-18                 |
| Secondary Standards        | ID               | Check Date (in house)             | Scheduled Check        |
| Power meter E4419B         | SN: GB41293874   | 06-Apr-16 (in house check Jun-16) | In house check: Jun-18 |
| Power sensor E4412A        | SN: MY41498087   | 06-Apr-16 (in house check Jun-16) | In house check: Jun-18 |
| Power sensor E4412A        | SN: 000110210    | 06-Apr-16 (in house check Jun-16) | In house check: Jun-18 |
| RF generator HP 8648C      | SN: US3642U01700 | 04-Aug-99 (in house check Jun-16) | In house check: Jun-18 |
| Network Analyzer HP 8753E  | SN: US37390585   | 18-Oct-01 (in house check Oct-17) | In house check: Oct-18 |

|   |                       |                                   |                             |
|---|-----------------------|-----------------------------------|-----------------------------|
| Calibrated by:  | Name<br>Michael Weber | Function<br>Laboratory Technician | Signature<br><i>M Weber</i> |
| Approved by:  | Katja Pokovic         | Technical Manager                 | <i>[Signature]</i>          |
|   |                       |                                   | Issued: March 27, 2018      |
| This calibration certificate shall not be reproduced except in full without written approval of the laboratory. |                       |                                   |                             |



Accredited by the Swiss Accreditation Service (SAS)

Accreditation No.: **SCS 0108**

The Swiss Accreditation Service is one of the signatories to the EA Multilateral Agreement for the recognition of calibration certificates

### Glossary:

|                          |  |
|--------------------------|--|
| TSL                      | tissue simulating liquid   |
| NORM <sub>x,y,z</sub>    | sensitivity in free space  |
| ConvF                    | sensitivity in TSL / NORM <sub>x,y,z</sub>   |
| DCP                      | diode compression point  |
| CF                       | crest factor (1/duty_cycle) of the RF signal   |
| A, B, C, D               | modulation dependent linearization parameters  |
| Polarization $\varphi$   | $\varphi$ rotation around probe axis   |
| Polarization $\vartheta$ | $\vartheta$ rotation around an axis that is in the plane normal to probe axis (at measurement center), i.e., $\vartheta = 0$ is normal to probe axis |
| Connector Angle          | information used in DASY system to align probe sensor X to the robot coordinate system   |

### Calibration is Performed According to the Following Standards:

- IEEE Std 1528-2013, "IEEE Recommended Practice for Determining the Peak Spatial-Averaged Specific Absorption Rate (SAR) in the Human Head from Wireless Communications Devices: Measurement Techniques", June 2013
- IEC 62209-1, "Measurement procedure for the assessment of Specific Absorption Rate (SAR) from hand-held and body-mounted devices used next to the ear (frequency range of 300 MHz to 6 GHz)", July 2016
- IEC 62209-2, "Procedure to determine the Specific Absorption Rate (SAR) for wireless communication devices used in close proximity to the human body (frequency range of 30 MHz to 6 GHz)", March 2010
- KDB 865664, "SAR Measurement Requirements for 100 MHz to 6 GHz"

### Methods Applied and Interpretation of Parameters:

- NORM<sub>x,y,z</sub>**: Assessed for E-field polarization  $\vartheta = 0$  ( $f \leq 900$  MHz in TEM-cell;  $f > 1800$  MHz: R22 waveguide). NORM<sub>x,y,z</sub> are only intermediate values, i.e., the uncertainties of NORM<sub>x,y,z</sub> does not affect the  $E^2$ -field uncertainty inside TSL (see below *ConvF*).
- NORM(f)<sub>x,y,z</sub>** = NORM<sub>x,y,z</sub> \* *frequency\_response* (see Frequency Response Chart). This linearization is implemented in DASY4 software versions later than 4.2. The uncertainty of the frequency response is included in the stated uncertainty of *ConvF*.
- DCP<sub>x,y,z</sub>**: DCP are numerical linearization parameters assessed based on the data of power sweep with CW signal (no uncertainty required). DCP does not depend on frequency nor media.
- PAR**: PAR is the Peak to Average Ratio that is not calibrated but determined based on the signal characteristics
- A<sub>x,y,z</sub>; B<sub>x,y,z</sub>; C<sub>x,y,z</sub>; D<sub>x,y,z</sub>; VR<sub>x,y,z</sub>; A, B, C, D** are numerical linearization parameters assessed based on the data of power sweep for specific modulation signal. The parameters do not depend on frequency nor media. VR is the maximum calibration range expressed in RMS voltage across the diode.
- ConvF and Boundary Effect Parameters**: Assessed in flat phantom using E-field (or Temperature Transfer Standard for  $f \leq 800$  MHz) and inside waveguide using analytical field distributions based on power measurements for  $f > 800$  MHz. The same setups are used for assessment of the parameters applied for boundary compensation (alpha, depth) of which typical uncertainty values are given. These parameters are used in DASY4 software to improve probe accuracy close to the boundary. The sensitivity in TSL corresponds to NORM<sub>x,y,z</sub> \* *ConvF* whereby the uncertainty corresponds to that given for *ConvF*. A frequency dependent *ConvF* is used in DASY version 4.4 and higher which allows extending the validity from  $\pm 50$  MHz to  $\pm 100$  MHz.
- Spherical isotropy (3D deviation from isotropy)**: in a field of low gradients realized using a flat phantom exposed by a patch antenna.
- Sensor Offset**: The sensor offset corresponds to the offset of virtual measurement center from the probe tip (on probe axis). No tolerance required.
- Connector Angle**: The angle is assessed using the information gained by determining the NORM<sub>x</sub> (no uncertainty required).



# Probe ES3DV3

## SN:3347

|               |                |
|---------------|----------------|
| Manufactured: | March 15, 2012 |
| Repaired:     | March 15, 2018 |
| Calibrated:   | March 27, 2018 |

Calibrated for DASY/EASY Systems  
(Note: non-compatible with DASY2 system!)

## DASY/EASY - Parameters of Probe: ES3DV3 - SN:3347

### Basic Calibration Parameters

|   | Sensor X | Sensor Y | Sensor Z | Unc (k=2)     |
|---|----------|----------|----------|---------------|
| Norm ( $\mu\text{V}/(\text{V}/\text{m})^2$ ) <sup>A</sup> | 1.15     | 1.18     | 1.21     | $\pm 10.1 \%$ |
| DCP (mV) <sup>B</sup>                                     | 101.9    | 105.1    | 102.9    |               |

### Modulation Calibration Parameters

| UID | Communication System Name |   | A<br>dB | B<br>dB/ $\mu\text{V}$ | C   | D<br>dB | VR<br>mV | Unc <sup>E</sup><br>(k=2) |
|-----|---------------------------|---|---------|------------------------|-----|---------|----------|---------------------------|
| 0   | CW                        | X | 0.0     | 0.0                    | 1.0 | 0.00    | 201.8    | $\pm 3.3 \%$              |
|     |                           | Y | 0.0     | 0.0                    | 1.0 |         | 203.9    |                           |
|     |                           | Z | 0.0     | 0.0                    | 1.0 |         | 204.8    |                           |

Note: For details on UID parameters see Appendix.

### Sensor Model Parameters

|   | C1<br>fF | C2<br>fF | $\alpha$<br>$\text{V}^{-1}$ | T1<br>$\text{ms}\cdot\text{V}^{-2}$ | T2<br>$\text{ms}\cdot\text{V}^{-1}$ | T3<br>ms | T4<br>$\text{V}^{-2}$ | T5<br>$\text{V}^{-1}$ | T6    |
|---|----------|----------|-----------------------------|-------------------------------------|-------------------------------------|----------|-----------------------|-----------------------|-------|
| X | 52.41    | 376.6    | 35.43                       | 28.01                               | 1.852                               | 5.10     | 0.578                 | 0.488                 | 1.008 |
| Y | 42.65    | 300.9    | 34.31                       | 25.12                               | 1.310                               | 5.10     | 1.279                 | 0.204                 | 1.011 |
| Z | 48.12    | 344.8    | 35.26                       | 27.10                               | 1.587                               | 5.10     | 0.868                 | 0.385                 | 1.009 |

The reported uncertainty of measurement is stated as the standard uncertainty of measurement multiplied by the coverage factor  $k=2$ , which for a normal distribution corresponds to a coverage probability of approximately 95%.

<sup>A</sup> The uncertainties of Norm X,Y,Z do not affect the  $E^2$ -field uncertainty inside TSL (see Pages 5 and 6).

<sup>B</sup> Numerical linearization parameter: uncertainty not required.

<sup>E</sup> Uncertainty is determined using the max. deviation from linear response applying rectangular distribution and is expressed for the square of the field value.

## DASY/EASY - Parameters of Probe: ES3DV3 - SN:3347

### Calibration Parameter Determined in Head Tissue Simulating Media

| f (MHz) <sup>C</sup> | Relative Permittivity <sup>F</sup> | Conductivity (S/m) <sup>F</sup> | ConvF X | ConvF Y | ConvF Z | Alpha <sup>G</sup> | Depth <sup>G</sup> (mm) | Unc (k=2) |
|----------------------|------------------------------------|---------------------------------|---------|---------|---------|--------------------|-------------------------|-----------|
| 750                  | 41.9                               | 0.89                            | 6.77    | 6.77    | 6.77    | 0.65               | 1.32                    | ± 12.0 %  |
| 835                  | 41.5                               | 0.90                            | 6.41    | 6.41    | 6.41    | 0.40               | 1.64                    | ± 12.0 %  |
| 1750                 | 40.1                               | 1.37                            | 5.58    | 5.58    | 5.58    | 0.54               | 1.42                    | ± 12.0 %  |
| 1900                 | 40.0                               | 1.40                            | 5.36    | 5.36    | 5.36    | 0.80               | 1.16                    | ± 12.0 %  |
| 2300                 | 39.5                               | 1.67                            | 5.11    | 5.11    | 5.11    | 0.74               | 1.29                    | ± 12.0 %  |
| 2450                 | 39.2                               | 1.80                            | 4.81    | 4.81    | 4.81    | 0.80               | 1.24                    | ± 12.0 %  |
| 2600                 | 39.0                               | 1.96                            | 4.66    | 4.66    | 4.66    | 0.75               | 1.25                    | ± 12.0 %  |

<sup>C</sup> Frequency validity above 300 MHz of ± 100 MHz only applies for DASY v4.4 and higher (see Page 2), else it is restricted to ± 50 MHz. The uncertainty is the RSS of the ConvF uncertainty at calibration frequency and the uncertainty for the indicated frequency band. Frequency validity below 300 MHz is ± 10, 25, 40, 50 and 70 MHz for ConvF assessments at 30, 64, 128, 150 and 220 MHz respectively. Above 5 GHz frequency validity can be extended to ± 110 MHz.

<sup>F</sup> At frequencies below 3 GHz, the validity of tissue parameters ( $\epsilon$  and  $\sigma$ ) can be relaxed to ± 10% if liquid compensation formula is applied to measured SAR values. At frequencies above 3 GHz, the validity of tissue parameters ( $\epsilon$  and  $\sigma$ ) is restricted to ± 5%. The uncertainty is the RSS of the ConvF uncertainty for indicated target tissue parameters.

<sup>G</sup> Alpha/Depth are determined during calibration. SPEAG warrants that the remaining deviation due to the boundary effect after compensation is always less than ± 1% for frequencies below 3 GHz and below ± 2% for frequencies between 3-6 GHz at any distance larger than half the probe tip diameter from the boundary.

## DASY/EASY - Parameters of Probe: ES3DV3 - SN:3347

### Calibration Parameter Determined in Body Tissue Simulating Media

| f (MHz) <sup>C</sup> | Relative Permittivity <sup>F</sup> | Conductivity (S/m) <sup>F</sup> | ConvF X | ConvF Y | ConvF Z | Alpha <sup>G</sup> | Depth <sup>G</sup> (mm) | Unc (k=2) |
|----------------------|------------------------------------|---------------------------------|---------|---------|---------|--------------------|-------------------------|-----------|
| 750                  | 55.5                               | 0.96                            | 6.59    | 6.59    | 6.59    | 0.77               | 1.22                    | ± 12.0 %  |
| 835                  | 55.2                               | 0.97                            | 6.37    | 6.37    | 6.37    | 0.80               | 1.17                    | ± 12.0 %  |
| 1750                 | 53.4                               | 1.49                            | 5.17    | 5.17    | 5.17    | 0.49               | 1.59                    | ± 12.0 %  |
| 1900                 | 53.3                               | 1.52                            | 4.94    | 4.94    | 4.94    | 0.52               | 1.49                    | ± 12.0 %  |
| 2300                 | 52.9                               | 1.81                            | 4.74    | 4.74    | 4.74    | 0.80               | 1.25                    | ± 12.0 %  |
| 2450                 | 52.7                               | 1.95                            | 4.64    | 4.64    | 4.64    | 0.75               | 1.20                    | ± 12.0 %  |
| 2600                 | 52.5                               | 2.16                            | 4.49    | 4.49    | 4.49    | 0.80               | 1.20                    | ± 12.0 %  |

<sup>C</sup> Frequency validity above 300 MHz of ± 100 MHz only applies for DASY v4.4 and higher (see Page 2), else it is restricted to ± 50 MHz. The uncertainty is the RSS of the ConvF uncertainty at calibration frequency and the uncertainty for the indicated frequency band. Frequency validity below 300 MHz is ± 10, 25, 40, 50 and 70 MHz for ConvF assessments at 30, 64, 128, 150 and 220 MHz respectively. Above 5 GHz frequency validity can be extended to ± 110 MHz.

<sup>F</sup> At frequencies below 3 GHz, the validity of tissue parameters ( $\epsilon$  and  $\sigma$ ) can be relaxed to ± 10% if liquid compensation formula is applied to measured SAR values. At frequencies above 3 GHz, the validity of tissue parameters ( $\epsilon$  and  $\sigma$ ) is restricted to ± 5%. The uncertainty is the RSS of the ConvF uncertainty for indicated target tissue parameters.

<sup>G</sup> Alpha/Depth are determined during calibration. SPEAG warrants that the remaining deviation due to the boundary effect after compensation is always less than ± 1% for frequencies below 3 GHz and below ± 2% for frequencies between 3-6 GHz at any distance larger than half the probe tip diameter from the boundary.

### Frequency Response of E-Field (TEM-Cell:ifi110 EXX, Waveguide: R22)

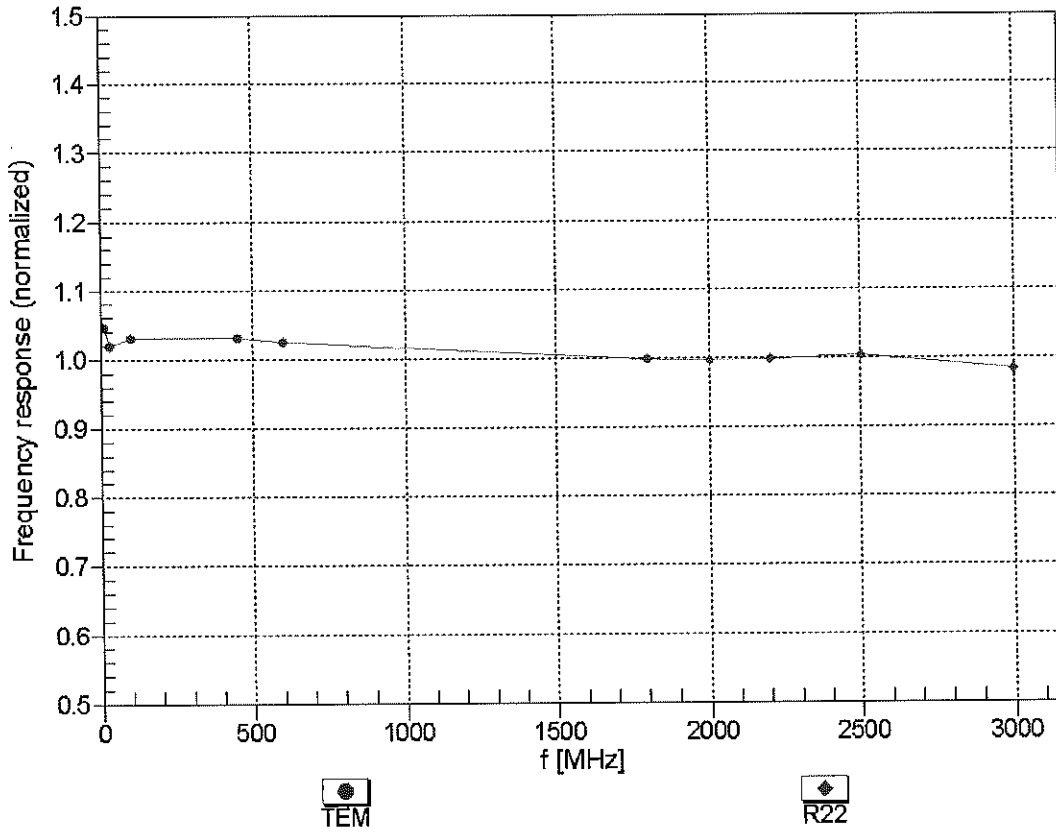

Uncertainty of Frequency Response of E-field:  $\pm 6.3\%$  (k=2)

### Receiving Pattern ( $\phi$ ), $\theta = 0^\circ$

f=600 MHz, TEM

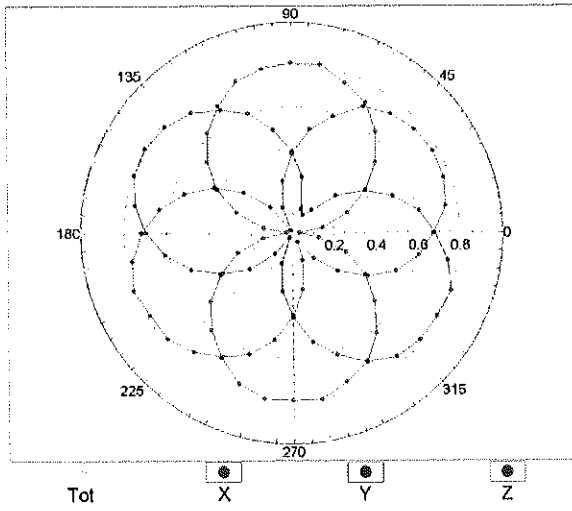

f=1800 MHz, R22

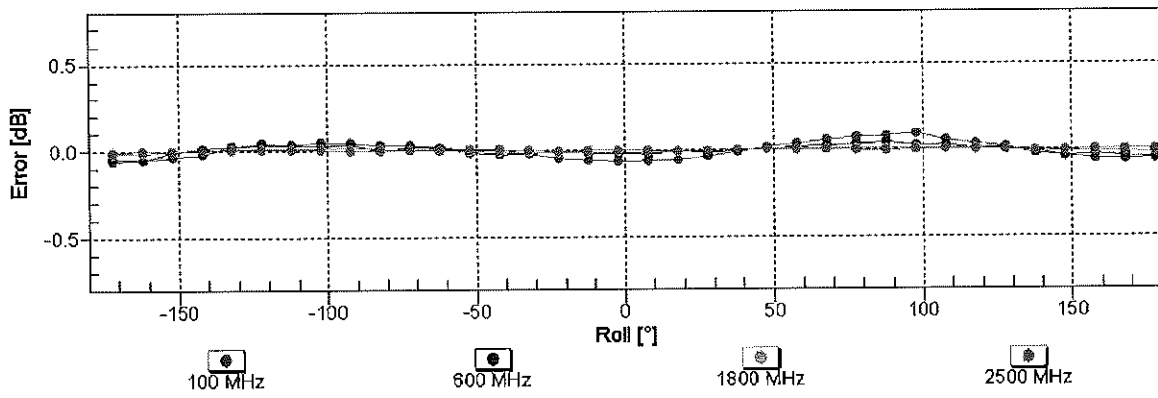
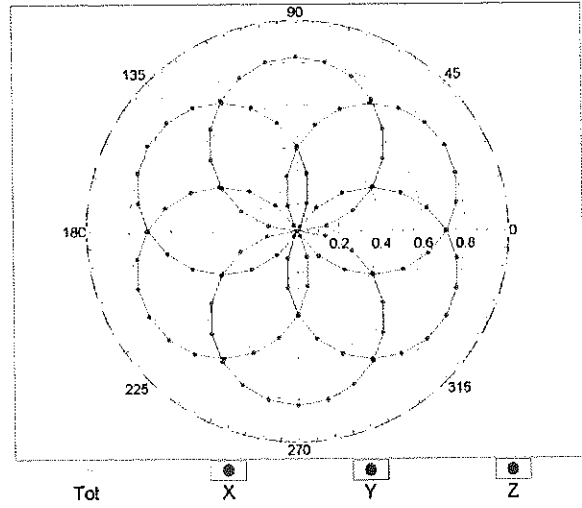

Uncertainty of Axial Isotropy Assessment:  $\pm 0.5\%$  (k=2)

### Dynamic Range f(SAR<sub>head</sub>) (TEM cell , f<sub>eval</sub>= 1900 MHz)

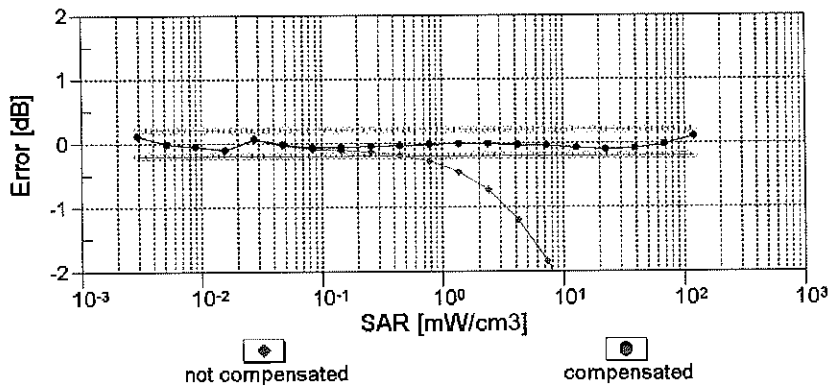
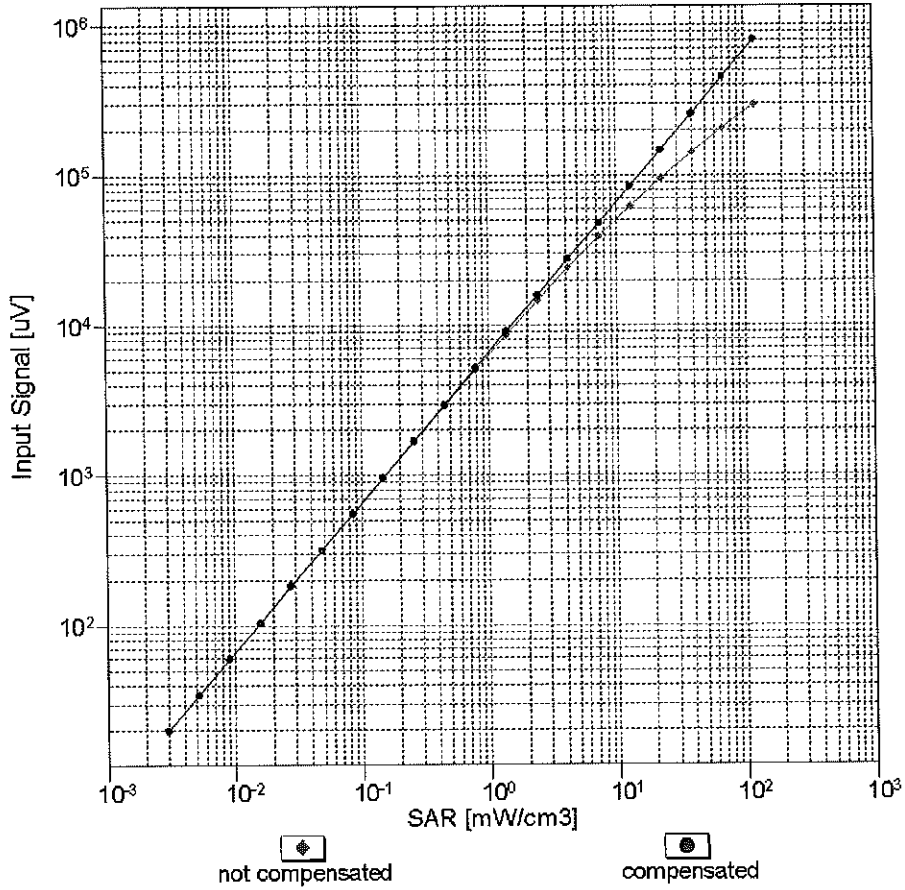

Uncertainty of Linearity Assessment: ± 0.6% (k=2)

# Conversion Factor Assessment

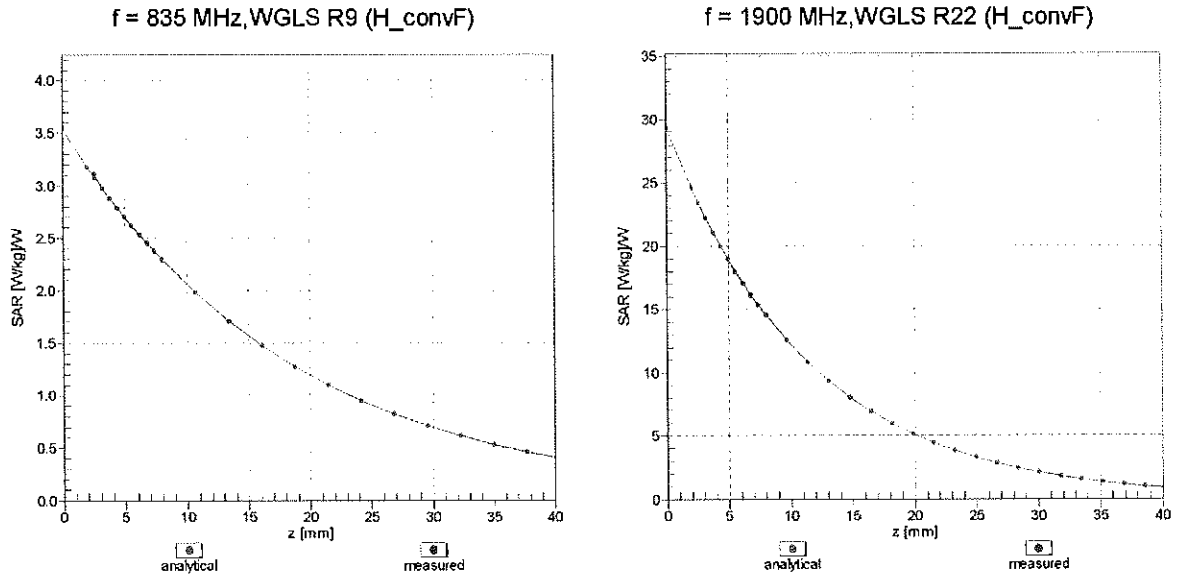

## Deviation from Isotropy in Liquid Error ( $\phi, \theta$ ), f = 900 MHz

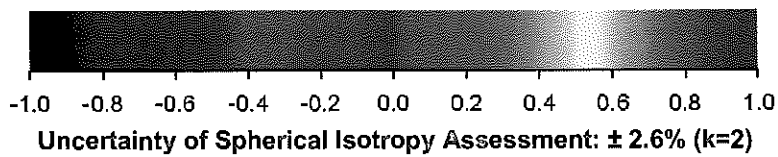
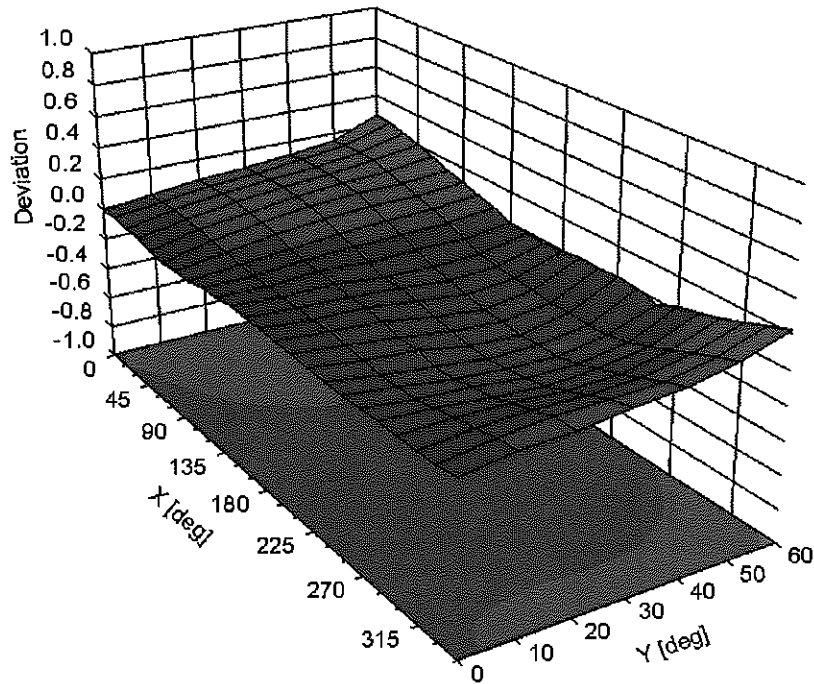



**DASY/EASY - Parameters of Probe: ES3DV3 - SN:3347****Other Probe Parameters**

|   |            |
|---|------------|
| Sensor Arrangement                            | Triangular |
| Connector Angle (°)                           | -16.5      |
| Mechanical Surface Detection Mode             | enabled    |
| Optical Surface Detection Mode                | disabled   |
| Probe Overall Length                          | 337 mm     |
| Probe Body Diameter                           | 10 mm      |
| Tip Length                                    | 10 mm      |
| Tip Diameter                                  | 4 mm       |
| Probe Tip to Sensor X Calibration Point       | 2 mm       |
| Probe Tip to Sensor Y Calibration Point       | 2 mm       |
| Probe Tip to Sensor Z Calibration Point       | 2 mm       |
| Recommended Measurement Distance from Surface | 3 mm       |

**Appendix: Modulation Calibration Parameters**

| UID           | Communication System Name                     |   | A<br>dB | B<br>dB√μV | C     | D<br>dB | VR<br>mV | Max<br>Unc <sup>E</sup><br>(k=2) |
|---------------|---|---|---------|------------|-------|---------|----------|----------------------------------|
| 0             | CW  | X | 0.00    | 0.00       | 1.00  | 0.00    | 201.8    | ± 3.3 %                          |
|               |   | Y | 0.00    | 0.00       | 1.00  |         | 203.9    |                                  |
|               |   | Z | 0.00    | 0.00       | 1.00  |         | 204.8    |                                  |
| 10010-<br>CAA | SAR Validation (Square, 100ms, 10ms)          | X | 7.57    | 78.06      | 17.49 | 10.00   | 25.0     | ± 9.6 %                          |
|               |   | Y | 9.85    | 82.39      | 18.69 |         | 25.0     |                                  |
|               |   | Z | 7.35    | 77.81      | 17.08 |         | 25.0     |                                  |
| 10011-<br>CAB | UMTS-FDD (WCDMA)                              | X | 0.93    | 66.02      | 14.08 | 0.00    | 150.0    | ± 9.6 %                          |
|               |   | Y | 0.97    | 66.67      | 14.52 |         | 150.0    |                                  |
|               |   | Z | 0.93    | 66.21      | 14.17 |         | 150.0    |                                  |
| 10012-<br>CAB | IEEE 802.11b WiFi 2.4 GHz (DSSS, 1 Mbps)      | X | 1.22    | 64.40      | 15.16 | 0.41    | 150.0    | ± 9.6 %                          |
|               |   | Y | 1.24    | 64.68      | 15.35 |         | 150.0    |                                  |
|               |   | Z | 1.21    | 64.49      | 15.23 |         | 150.0    |                                  |
| 10013-<br>CAB | IEEE 802.11g WiFi 2.4 GHz (DSSS-OFDM, 6 Mbps) | X | 5.02    | 67.09      | 17.26 | 1.46    | 150.0    | ± 9.6 %                          |
|               |   | Y | 4.93    | 67.32      | 17.31 |         | 150.0    |                                  |
|               |   | Z | 4.97    | 67.16      | 17.27 |         | 150.0    |                                  |
| 10021-<br>DAC | GSM-FDD (TDMA, GMSK)                          | X | 91.36   | 118.07     | 31.34 | 9.39    | 50.0     | ± 9.6 %                          |
|               |   | Y | 100.00  | 119.30     | 31.14 |         | 50.0     |                                  |
|               |   | Z | 100.00  | 118.75     | 31.10 |         | 50.0     |                                  |
| 10023-<br>DAC | GPRS-FDD (TDMA, GMSK, TN 0)                   | X | 58.54   | 111.16     | 29.65 | 9.57    | 50.0     | ± 9.6 %                          |
|               |   | Y | 100.00  | 119.20     | 31.14 |         | 50.0     |                                  |
|               |   | Z | 100.00  | 118.71     | 31.13 |         | 50.0     |                                  |
| 10024-<br>DAC | GPRS-FDD (TDMA, GMSK, TN 0-1)                 | X | 100.00  | 115.85     | 28.82 | 6.56    | 60.0     | ± 9.6 %                          |
|               |   | Y | 100.00  | 116.32     | 28.70 |         | 60.0     |                                  |
|               |   | Z | 100.00  | 115.26     | 28.36 |         | 60.0     |                                  |
| 10025-<br>DAC | EDGE-FDD (TDMA, 8PSK, TN 0)                   | X | 19.84   | 109.66     | 41.73 | 12.57   | 50.0     | ± 9.6 %                          |
|               |   | Y | 49.03   | 143.08     | 53.86 |         | 50.0     |                                  |
|               |   | Z | 21.37   | 113.26     | 43.24 |         | 50.0     |                                  |
| 10026-<br>DAC | EDGE-FDD (TDMA, 8PSK, TN 0-1)                 | X | 21.22   | 106.46     | 36.65 | 9.56    | 60.0     | ± 9.6 %                          |
|               |   | Y | 31.58   | 119.85     | 41.69 |         | 60.0     |                                  |
|               |   | Z | 22.56   | 108.96     | 37.62 |         | 60.0     |                                  |
| 10027-<br>DAC | GPRS-FDD (TDMA, GMSK, TN 0-1-2)               | X | 100.00  | 114.36     | 27.28 | 4.80    | 80.0     | ± 9.6 %                          |
|               |   | Y | 100.00  | 115.58     | 27.56 |         | 80.0     |                                  |
|               |   | Z | 100.00  | 113.91     | 26.92 |         | 80.0     |                                  |
| 10028-<br>DAC | GPRS-FDD (TDMA, GMSK, TN 0-1-2-3)             | X | 100.00  | 113.86     | 26.30 | 3.55    | 100.0    | ± 9.6 %                          |
|               |   | Y | 100.00  | 115.98     | 27.02 |         | 100.0    |                                  |
|               |   | Z | 100.00  | 113.53     | 26.01 |         | 100.0    |                                  |
| 10029-<br>DAC | EDGE-FDD (TDMA, 8PSK, TN 0-1-2)               | X | 12.94   | 95.02      | 31.64 | 7.80    | 80.0     | ± 9.6 %                          |
|               |   | Y | 14.07   | 99.40      | 33.81 |         | 80.0     |                                  |
|               |   | Z | 12.89   | 95.72      | 32.02 |         | 80.0     |                                  |
| 10030-<br>CAA | IEEE 802.15.1 Bluetooth (GFSK, DH1)           | X | 100.00  | 113.99     | 27.43 | 5.30    | 70.0     | ± 9.6 %                          |
|               |   | Y | 100.00  | 114.60     | 27.41 |         | 70.0     |                                  |
|               |   | Z | 100.00  | 113.38     | 26.98 |         | 70.0     |                                  |
| 10031-<br>CAA | IEEE 802.15.1 Bluetooth (GFSK, DH3)           | X | 100.00  | 111.77     | 23.93 | 1.88    | 100.0    | ± 9.6 %                          |
|               |   | Y | 100.00  | 115.39     | 25.33 |         | 100.0    |                                  |
|               |   | Z | 100.00  | 111.26     | 23.59 |         | 100.0    |                                  |

|           |   |   |        |        |       |       |       |         |
|-----------|---|---|--------|--------|-------|-------|-------|---------|
| 10032-CAA | IEEE 802.15.1 Bluetooth (GFSK, DH5)                 | X | 100.00 | 111.85 | 22.94 | 1.17  | 100.0 | ± 9.6 % |
|           |   | Y | 100.00 | 118.40 | 25.59 |       | 100.0 |         |
|           |   | Z | 100.00 | 111.34 | 22.62 |       | 100.0 |         |
| 10033-CAA | IEEE 802.15.1 Bluetooth (PI/4-DQPSK, DH1)           | X | 23.91  | 101.19 | 27.41 | 5.30  | 70.0  | ± 9.6 % |
|           |   | Y | 36.18  | 107.81 | 28.88 |       | 70.0  |         |
|           |   | Z | 30.63  | 104.89 | 28.18 |       | 70.0  |         |
| 10034-CAA | IEEE 802.15.1 Bluetooth (PI/4-DQPSK, DH3)           | X | 6.24   | 84.08  | 20.44 | 1.88  | 100.0 | ± 9.6 % |
|           |   | Y | 7.24   | 85.92  | 20.55 |       | 100.0 |         |
|           |   | Z | 6.85   | 85.19  | 20.50 |       | 100.0 |         |
| 10035-CAA | IEEE 802.15.1 Bluetooth (PI/4-DQPSK, DH5)           | X | 3.29   | 76.95  | 17.63 | 1.17  | 100.0 | ± 9.6 % |
|           |   | Y | 3.58   | 78.09  | 17.57 |       | 100.0 |         |
|           |   | Z | 3.42   | 77.43  | 17.51 |       | 100.0 |         |
| 10036-CAA | IEEE 802.15.1 Bluetooth (8-DPSK, DH1)               | X | 32.79  | 106.39 | 28.91 | 5.30  | 70.0  | ± 9.6 % |
|           |   | Y | 55.24  | 114.58 | 30.68 |       | 70.0  |         |
|           |   | Z | 45.73  | 111.34 | 29.95 |       | 70.0  |         |
| 10037-CAA | IEEE 802.15.1 Bluetooth (8-DPSK, DH3)               | X | 5.86   | 83.28  | 20.13 | 1.88  | 100.0 | ± 9.6 % |
|           |   | Y | 6.54   | 84.66  | 20.12 |       | 100.0 |         |
|           |   | Z | 6.31   | 84.13  | 20.12 |       | 100.0 |         |
| 10038-CAA | IEEE 802.15.1 Bluetooth (8-DPSK, DH5)               | X | 3.39   | 77.59  | 17.96 | 1.17  | 100.0 | ± 9.6 % |
|           |   | Y | 3.66   | 78.64  | 17.87 |       | 100.0 |         |
|           |   | Z | 3.53   | 78.11  | 17.85 |       | 100.0 |         |
| 10039-CAB | CDMA2000 (1xRTT, RC1)                               | X | 1.52   | 69.16  | 14.18 | 0.00  | 150.0 | ± 9.6 % |
|           |   | Y | 1.40   | 68.90  | 13.55 |       | 150.0 |         |
|           |   | Z | 1.46   | 69.03  | 13.83 |       | 150.0 |         |
| 10042-CAB | IS-54 / IS-136 FDD (TDMA/FDM, PI/4-DQPSK, Halfrate) | X | 100.00 | 114.62 | 28.47 | 7.78  | 50.0  | ± 9.6 % |
|           |   | Y | 100.00 | 114.70 | 28.14 |       | 50.0  |         |
|           |   | Z | 100.00 | 113.88 | 27.92 |       | 50.0  |         |
| 10044-CAA | IS-91/EIA/TIA-553 FDD (FDMA, FM)                    | X | 0.01   | 121.88 | 0.68  | 0.00  | 150.0 | ± 9.6 % |
|           |   | Y | 0.00   | 97.83  | 1.91  |       | 150.0 |         |
|           |   | Z | 0.01   | 122.55 | 0.35  |       | 150.0 |         |
| 10048-CAA | DECT (TDD, TDMA/FDM, GFSK, Full Slot, 24)           | X | 17.94  | 92.17  | 26.06 | 13.80 | 25.0  | ± 9.6 % |
|           |   | Y | 42.19  | 107.21 | 29.95 |       | 25.0  |         |
|           |   | Z | 24.74  | 97.63  | 27.36 |       | 25.0  |         |
| 10049-CAA | DECT (TDD, TDMA/FDM, GFSK, Double Slot, 12)         | X | 22.69  | 96.29  | 25.94 | 10.79 | 40.0  | ± 9.6 % |
|           |   | Y | 68.20  | 113.74 | 30.23 |       | 40.0  |         |
|           |   | Z | 32.65  | 101.85 | 27.19 |       | 40.0  |         |
| 10056-CAA | UMTS-TDD (TD-SCDMA, 1.28 Mcps)                      | X | 16.99  | 92.79  | 25.84 | 9.03  | 50.0  | ± 9.6 % |
|           |   | Y | 27.63  | 101.84 | 28.34 |       | 50.0  |         |
|           |   | Z | 20.13  | 95.81  | 26.57 |       | 50.0  |         |
| 10058-DAC | EDGE-FDD (TDMA, 8PSK, TN 0-1-2-3)                   | X | 9.12   | 87.95  | 28.36 | 6.55  | 100.0 | ± 9.6 % |
|           |   | Y | 8.98   | 89.45  | 29.43 |       | 100.0 |         |
|           |   | Z | 8.90   | 88.06  | 28.51 |       | 100.0 |         |
| 10059-CAB | IEEE 802.11b WiFi 2.4 GHz (DSSS, 2 Mbps)            | X | 1.37   | 66.39  | 16.16 | 0.61  | 110.0 | ± 9.6 % |
|           |   | Y | 1.38   | 66.59  | 16.33 |       | 110.0 |         |
|           |   | Z | 1.36   | 66.49  | 16.23 |       | 110.0 |         |
| 10060-CAB | IEEE 802.11b WiFi 2.4 GHz (DSSS, 5.5 Mbps)          | X | 100.00 | 128.08 | 31.98 | 1.30  | 110.0 | ± 9.6 % |
|           |   | Y | 100.00 | 131.22 | 33.31 |       | 110.0 |         |
|           |   | Z | 100.00 | 128.65 | 32.15 |       | 110.0 |         |

|           |  |   |       |       |       |      |       |         |
|-----------|--|---|-------|-------|-------|------|-------|---------|
| 10061-CAB | IEEE 802.11b WiFi 2.4 GHz (DSSS, 11 Mbps)      | X | 9.25  | 94.71 | 26.12 | 2.04 | 110.0 | ± 9.6 % |
|           |  | Y | 9.59  | 96.73 | 27.06 |      | 110.0 |         |
|           |  | Z | 10.28 | 96.95 | 26.85 |      | 110.0 |         |
| 10062-CAC | IEEE 802.11a/h WiFi 5 GHz (OFDM, 6 Mbps)       | X | 4.74  | 66.85 | 16.53 | 0.49 | 100.0 | ± 9.6 % |
|           |  | Y | 4.66  | 67.04 | 16.57 |      | 100.0 |         |
|           |  | Z | 4.70  | 66.90 | 16.54 |      | 100.0 |         |
| 10063-CAC | IEEE 802.11a/h WiFi 5 GHz (OFDM, 9 Mbps)       | X | 4.78  | 67.00 | 16.67 | 0.72 | 100.0 | ± 9.6 % |
|           |  | Y | 4.69  | 67.19 | 16.70 |      | 100.0 |         |
|           |  | Z | 4.73  | 67.05 | 16.68 |      | 100.0 |         |
| 10064-CAC | IEEE 802.11a/h WiFi 5 GHz (OFDM, 12 Mbps)      | X | 5.09  | 67.32 | 16.93 | 0.86 | 100.0 | ± 9.6 % |
|           |  | Y | 4.97  | 67.46 | 16.94 |      | 100.0 |         |
|           |  | Z | 5.03  | 67.35 | 16.93 |      | 100.0 |         |
| 10065-CAC | IEEE 802.11a/h WiFi 5 GHz (OFDM, 18 Mbps)      | X | 4.99  | 67.34 | 17.10 | 1.21 | 100.0 | ± 9.6 % |
|           |  | Y | 4.88  | 67.46 | 17.11 |      | 100.0 |         |
|           |  | Z | 4.93  | 67.36 | 17.10 |      | 100.0 |         |
| 10066-CAC | IEEE 802.11a/h WiFi 5 GHz (OFDM, 24 Mbps)      | X | 5.05  | 67.46 | 17.33 | 1.46 | 100.0 | ± 9.6 % |
|           |  | Y | 4.92  | 67.57 | 17.33 |      | 100.0 |         |
|           |  | Z | 4.98  | 67.48 | 17.32 |      | 100.0 |         |
| 10067-CAC | IEEE 802.11a/h WiFi 5 GHz (OFDM, 36 Mbps)      | X | 5.36  | 67.67 | 17.81 | 2.04 | 100.0 | ± 9.6 % |
|           |  | Y | 5.25  | 67.92 | 17.88 |      | 100.0 |         |
|           |  | Z | 5.30  | 67.73 | 17.82 |      | 100.0 |         |
| 10068-CAC | IEEE 802.11a/h WiFi 5 GHz (OFDM, 48 Mbps)      | X | 5.48  | 67.95 | 18.15 | 2.55 | 100.0 | ± 9.6 % |
|           |  | Y | 5.33  | 68.04 | 18.16 |      | 100.0 |         |
|           |  | Z | 5.40  | 67.94 | 18.13 |      | 100.0 |         |
| 10069-CAC | IEEE 802.11a/h WiFi 5 GHz (OFDM, 54 Mbps)      | X | 5.56  | 67.94 | 18.35 | 2.67 | 100.0 | ± 9.6 % |
|           |  | Y | 5.42  | 68.11 | 18.40 |      | 100.0 |         |
|           |  | Z | 5.49  | 67.96 | 18.34 |      | 100.0 |         |
| 10071-CAB | IEEE 802.11g WiFi 2.4 GHz (DSSS/OFDM, 9 Mbps)  | X | 5.16  | 67.32 | 17.64 | 1.99 | 100.0 | ± 9.6 % |
|           |  | Y | 5.07  | 67.53 | 17.70 |      | 100.0 |         |
|           |  | Z | 5.11  | 67.37 | 17.65 |      | 100.0 |         |
| 10072-CAB | IEEE 802.11g WiFi 2.4 GHz (DSSS/OFDM, 12 Mbps) | X | 5.20  | 67.83 | 17.95 | 2.30 | 100.0 | ± 9.6 % |
|           |  | Y | 5.09  | 67.99 | 18.00 |      | 100.0 |         |
|           |  | Z | 5.14  | 67.86 | 17.96 |      | 100.0 |         |
| 10073-CAB | IEEE 802.11g WiFi 2.4 GHz (DSSS/OFDM, 18 Mbps) | X | 5.32  | 68.17 | 18.37 | 2.83 | 100.0 | ± 9.6 % |
|           |  | Y | 5.22  | 68.36 | 18.44 |      | 100.0 |         |
|           |  | Z | 5.26  | 68.20 | 18.38 |      | 100.0 |         |
| 10074-CAB | IEEE 802.11g WiFi 2.4 GHz (DSSS/OFDM, 24 Mbps) | X | 5.35  | 68.22 | 18.60 | 3.30 | 100.0 | ± 9.6 % |
|           |  | Y | 5.26  | 68.43 | 18.68 |      | 100.0 |         |
|           |  | Z | 5.29  | 68.25 | 18.61 |      | 100.0 |         |
| 10075-CAB | IEEE 802.11g WiFi 2.4 GHz (DSSS/OFDM, 36 Mbps) | X | 5.48  | 68.62 | 19.07 | 3.82 | 90.0  | ± 9.6 % |
|           |  | Y | 5.35  | 68.73 | 19.11 |      | 90.0  |         |
|           |  | Z | 5.40  | 68.60 | 19.05 |      | 90.0  |         |
| 10076-CAB | IEEE 802.11g WiFi 2.4 GHz (DSSS/OFDM, 48 Mbps) | X | 5.50  | 68.45 | 19.21 | 4.15 | 90.0  | ± 9.6 % |
|           |  | Y | 5.40  | 68.64 | 19.31 |      | 90.0  |         |
|           |  | Z | 5.44  | 68.46 | 19.21 |      | 90.0  |         |
| 10077-CAB | IEEE 802.11g WiFi 2.4 GHz (DSSS/OFDM, 54 Mbps) | X | 5.54  | 68.54 | 19.31 | 4.30 | 90.0  | ± 9.6 % |
|           |  | Y | 5.44  | 68.76 | 19.43 |      | 90.0  |         |
|           |  | Z | 5.48  | 68.56 | 19.32 |      | 90.0  |         |

|           |   |   |        |        |       |      |       |         |
|-----------|---|---|--------|--------|-------|------|-------|---------|
| 10081-CAB | CDMA2000 (1xRTT, RC3)                               | X | 0.74   | 64.32  | 11.31 | 0.00 | 150.0 | ± 9.6 % |
|           |   | Y | 0.70   | 64.20  | 10.81 |      | 150.0 |         |
|           |   | Z | 0.71   | 64.15  | 10.92 |      | 150.0 |         |
| 10082-CAB | IS-54 / IS-136 FDD (TDMA/FDM, PI/4-DQPSK, Fullrate) | X | 1.69   | 62.26  | 7.32  | 4.77 | 80.0  | ± 9.6 % |
|           |   | Y | 1.49   | 62.02  | 6.99  |      | 80.0  |         |
|           |   | Z | 1.55   | 61.83  | 6.90  |      | 80.0  |         |
| 10090-DAC | GPRS-FDD (TDMA, GMSK, TN 0-4)                       | X | 100.00 | 115.94 | 28.89 | 6.56 | 60.0  | ± 9.6 % |
|           |   | Y | 100.00 | 116.39 | 28.75 |      | 60.0  |         |
|           |   | Z | 100.00 | 115.35 | 28.42 |      | 60.0  |         |
| 10097-CAB | UMTS-FDD (HSDPA)                                    | X | 1.73   | 66.76  | 14.97 | 0.00 | 150.0 | ± 9.6 % |
|           |   | Y | 1.76   | 67.41  | 15.16 |      | 150.0 |         |
|           |   | Z | 1.72   | 67.00  | 15.02 |      | 150.0 |         |
| 10098-CAB | UMTS-FDD (HSUPA, Subtest 2)                         | X | 1.69   | 66.71  | 14.93 | 0.00 | 150.0 | ± 9.6 % |
|           |   | Y | 1.72   | 67.36  | 15.13 |      | 150.0 |         |
|           |   | Z | 1.69   | 66.94  | 14.98 |      | 150.0 |         |
| 10099-DAC | EDGE-FDD (TDMA, 8PSK, TN 0-4)                       | X | 21.17  | 106.37 | 36.62 | 9.56 | 60.0  | ± 9.6 % |
|           |   | Y | 31.53  | 119.75 | 41.66 |      | 60.0  |         |
|           |   | Z | 22.53  | 108.88 | 37.59 |      | 60.0  |         |
| 10100-CAD | LTE-FDD (SC-FDMA, 100% RB, 20 MHz, QPSK)            | X | 3.02   | 69.66  | 16.13 | 0.00 | 150.0 | ± 9.6 % |
|           |   | Y | 2.98   | 69.86  | 16.33 |      | 150.0 |         |
|           |   | Z | 2.99   | 69.71  | 16.19 |      | 150.0 |         |
| 10101-CAD | LTE-FDD (SC-FDMA, 100% RB, 20 MHz, 16-QAM)          | X | 3.20   | 67.30  | 15.63 | 0.00 | 150.0 | ± 9.6 % |
|           |   | Y | 3.15   | 67.42  | 15.72 |      | 150.0 |         |
|           |   | Z | 3.17   | 67.31  | 15.65 |      | 150.0 |         |
| 10102-CAD | LTE-FDD (SC-FDMA, 100% RB, 20 MHz, 64-QAM)          | X | 3.31   | 67.28  | 15.74 | 0.00 | 150.0 | ± 9.6 % |
|           |   | Y | 3.26   | 67.39  | 15.81 |      | 150.0 |         |
|           |   | Z | 3.27   | 67.30  | 15.76 |      | 150.0 |         |
| 10103-CAD | LTE-TDD (SC-FDMA, 100% RB, 20 MHz, QPSK)            | X | 8.39   | 78.42  | 21.27 | 3.98 | 65.0  | ± 9.6 % |
|           |   | Y | 8.55   | 79.75  | 21.92 |      | 65.0  |         |
|           |   | Z | 8.43   | 78.92  | 21.50 |      | 65.0  |         |
| 10104-CAD | LTE-TDD (SC-FDMA, 100% RB, 20 MHz, 16-QAM)          | X | 8.28   | 76.92  | 21.52 | 3.98 | 65.0  | ± 9.6 % |
|           |   | Y | 8.11   | 77.48  | 21.85 |      | 65.0  |         |
|           |   | Z | 8.18   | 77.09  | 21.61 |      | 65.0  |         |
| 10105-CAD | LTE-TDD (SC-FDMA, 100% RB, 20 MHz, 64-QAM)          | X | 7.63   | 75.31  | 21.13 | 3.98 | 65.0  | ± 9.6 % |
|           |   | Y | 7.72   | 76.48  | 21.73 |      | 65.0  |         |
|           |   | Z | 7.57   | 75.55  | 21.26 |      | 65.0  |         |
| 10108-CAE | LTE-FDD (SC-FDMA, 100% RB, 10 MHz, QPSK)            | X | 2.65   | 68.92  | 15.95 | 0.00 | 150.0 | ± 9.6 % |
|           |   | Y | 2.59   | 69.14  | 16.15 |      | 150.0 |         |
|           |   | Z | 2.61   | 68.99  | 16.01 |      | 150.0 |         |
| 10109-CAE | LTE-FDD (SC-FDMA, 100% RB, 10 MHz, 16-QAM)          | X | 2.86   | 67.08  | 15.50 | 0.00 | 150.0 | ± 9.6 % |
|           |   | Y | 2.80   | 67.24  | 15.55 |      | 150.0 |         |
|           |   | Z | 2.82   | 67.11  | 15.51 |      | 150.0 |         |
| 10110-CAE | LTE-FDD (SC-FDMA, 100% RB, 5 MHz, QPSK)             | X | 2.15   | 67.97  | 15.52 | 0.00 | 150.0 | ± 9.6 % |
|           |   | Y | 2.09   | 68.27  | 15.68 |      | 150.0 |         |
|           |   | Z | 2.11   | 68.06  | 15.56 |      | 150.0 |         |
| 10111-CAE | LTE-FDD (SC-FDMA, 100% RB, 5 MHz, 16-QAM)           | X | 2.54   | 67.60  | 15.65 | 0.00 | 150.0 | ± 9.6 % |
|           |   | Y | 2.49   | 67.90  | 15.64 |      | 150.0 |         |
|           |   | Z | 2.51   | 67.74  | 15.66 |      | 150.0 |         |

|           |  |   |      |       |       |      |       |         |
|-----------|--|---|------|-------|-------|------|-------|---------|
| 10112-CAE | LTE-FDD (SC-FDMA, 100% RB, 10 MHz, 64-QAM)     | X | 2.98 | 67.08 | 15.57 | 0.00 | 150.0 | ± 9.6 % |
|           |  | Y | 2.92 | 67.27 | 15.62 |      | 150.0 |         |
|           |  | Z | 2.94 | 67.13 | 15.58 |      | 150.0 |         |
| 10113-CAE | LTE-FDD (SC-FDMA, 100% RB, 5 MHz, 64-QAM)      | X | 2.70 | 67.76 | 15.81 | 0.00 | 150.0 | ± 9.6 % |
|           |  | Y | 2.63 | 68.07 | 15.78 |      | 150.0 |         |
|           |  | Z | 2.66 | 67.92 | 15.82 |      | 150.0 |         |
| 10114-CAC | IEEE 802.11n (HT Greenfield, 13.5 Mbps, BPSK)  | X | 5.13 | 67.22 | 16.34 | 0.00 | 150.0 | ± 9.6 % |
|           |  | Y | 5.06 | 67.35 | 16.39 |      | 150.0 |         |
|           |  | Z | 5.10 | 67.28 | 16.37 |      | 150.0 |         |
| 10115-CAC | IEEE 802.11n (HT Greenfield, 81 Mbps, 16-QAM)  | X | 5.46 | 67.47 | 16.48 | 0.00 | 150.0 | ± 9.6 % |
|           |  | Y | 5.32 | 67.42 | 16.43 |      | 150.0 |         |
|           |  | Z | 5.39 | 67.43 | 16.46 |      | 150.0 |         |
| 10116-CAC | IEEE 802.11n (HT Greenfield, 135 Mbps, 64-QAM) | X | 5.25 | 67.46 | 16.39 | 0.00 | 150.0 | ± 9.6 % |
|           |  | Y | 5.15 | 67.53 | 16.41 |      | 150.0 |         |
|           |  | Z | 5.20 | 67.47 | 16.40 |      | 150.0 |         |
| 10117-CAC | IEEE 802.11n (HT Mixed, 13.5 Mbps, BPSK)       | X | 5.10 | 67.11 | 16.30 | 0.00 | 150.0 | ± 9.6 % |
|           |  | Y | 5.03 | 67.22 | 16.34 |      | 150.0 |         |
|           |  | Z | 5.06 | 67.11 | 16.31 |      | 150.0 |         |
| 10118-CAC | IEEE 802.11n (HT Mixed, 81 Mbps, 16-QAM)       | X | 5.56 | 67.71 | 16.61 | 0.00 | 150.0 | ± 9.6 % |
|           |  | Y | 5.40 | 67.63 | 16.55 |      | 150.0 |         |
|           |  | Z | 5.48 | 67.67 | 16.59 |      | 150.0 |         |
| 10119-CAC | IEEE 802.11n (HT Mixed, 135 Mbps, 64-QAM)      | X | 5.22 | 67.39 | 16.37 | 0.00 | 150.0 | ± 9.6 % |
|           |  | Y | 5.13 | 67.49 | 16.40 |      | 150.0 |         |
|           |  | Z | 5.18 | 67.42 | 16.38 |      | 150.0 |         |
| 10140-CAD | LTE-FDD (SC-FDMA, 100% RB, 15 MHz, 16-QAM)     | X | 3.35 | 67.28 | 15.66 | 0.00 | 150.0 | ± 9.6 % |
|           |  | Y | 3.29 | 67.41 | 15.73 |      | 150.0 |         |
|           |  | Z | 3.31 | 67.30 | 15.68 |      | 150.0 |         |
| 10141-CAD | LTE-FDD (SC-FDMA, 100% RB, 15 MHz, 64-QAM)     | X | 3.47 | 67.38 | 15.84 | 0.00 | 150.0 | ± 9.6 % |
|           |  | Y | 3.41 | 67.52 | 15.90 |      | 150.0 |         |
|           |  | Z | 3.43 | 67.42 | 15.86 |      | 150.0 |         |
| 10142-CAD | LTE-FDD (SC-FDMA, 100% RB, 3 MHz, QPSK)        | X | 1.91 | 67.75 | 15.10 | 0.00 | 150.0 | ± 9.6 % |
|           |  | Y | 1.84 | 68.07 | 15.11 |      | 150.0 |         |
|           |  | Z | 1.87 | 67.86 | 15.08 |      | 150.0 |         |
| 10143-CAD | LTE-FDD (SC-FDMA, 100% RB, 3 MHz, 16-QAM)      | X | 2.37 | 68.04 | 15.25 | 0.00 | 150.0 | ± 9.6 % |
|           |  | Y | 2.29 | 68.28 | 15.02 |      | 150.0 |         |
|           |  | Z | 2.33 | 68.17 | 15.16 |      | 150.0 |         |
| 10144-CAD | LTE-FDD (SC-FDMA, 100% RB, 3 MHz, 64-QAM)      | X | 2.20 | 66.14 | 13.84 | 0.00 | 150.0 | ± 9.6 % |
|           |  | Y | 2.08 | 66.17 | 13.48 |      | 150.0 |         |
|           |  | Z | 2.13 | 66.11 | 13.65 |      | 150.0 |         |
| 10145-CAE | LTE-FDD (SC-FDMA, 100% RB, 1.4 MHz, QPSK)      | X | 1.17 | 64.40 | 11.32 | 0.00 | 150.0 | ± 9.6 % |
|           |  | Y | 0.99 | 63.23 | 9.93  |      | 150.0 |         |
|           |  | Z | 1.08 | 63.80 | 10.61 |      | 150.0 |         |
| 10146-CAE | LTE-FDD (SC-FDMA, 100% RB, 1.4 MHz, 16-QAM)    | X | 2.07 | 66.79 | 12.08 | 0.00 | 150.0 | ± 9.6 % |
|           |  | Y | 1.74 | 65.46 | 10.58 |      | 150.0 |         |
|           |  | Z | 1.93 | 66.25 | 11.43 |      | 150.0 |         |
| 10147-CAE | LTE-FDD (SC-FDMA, 100% RB, 1.4 MHz, 64-QAM)    | X | 2.41 | 68.68 | 13.11 | 0.00 | 150.0 | ± 9.6 % |
|           |  | Y | 2.02 | 67.13 | 11.50 |      | 150.0 |         |
|           |  | Z | 2.26 | 68.13 | 12.45 |      | 150.0 |         |

|           |  |   |      |       |       |      |       |         |
|-----------|--|---|------|-------|-------|------|-------|---------|
| 10149-CAD | LTE-FDD (SC-FDMA, 50% RB, 20 MHz, 16-QAM)  | X | 2.87 | 67.13 | 15.54 | 0.00 | 150.0 | ± 9.6 % |
|           |  | Y | 2.81 | 67.29 | 15.59 |      | 150.0 |         |
|           |  | Z | 2.83 | 67.17 | 15.55 |      | 150.0 |         |
| 10150-CAD | LTE-FDD (SC-FDMA, 50% RB, 20 MHz, 64-QAM)  | X | 2.99 | 67.13 | 15.61 | 0.00 | 150.0 | ± 9.6 % |
|           |  | Y | 2.93 | 67.31 | 15.66 |      | 150.0 |         |
|           |  | Z | 2.95 | 67.18 | 15.62 |      | 150.0 |         |
| 10151-CAD | LTE-TDD (SC-FDMA, 50% RB, 20 MHz, QPSK)    | X | 9.21 | 81.33 | 22.45 | 3.98 | 65.0  | ± 9.6 % |
|           |  | Y | 9.55 | 83.12 | 23.24 |      | 65.0  |         |
|           |  | Z | 9.38 | 82.15 | 22.79 |      | 65.0  |         |
| 10152-CAD | LTE-TDD (SC-FDMA, 50% RB, 20 MHz, 16-QAM)  | X | 7.89 | 77.12 | 21.32 | 3.98 | 65.0  | ± 9.6 % |
|           |  | Y | 7.75 | 77.78 | 21.62 |      | 65.0  |         |
|           |  | Z | 7.80 | 77.32 | 21.39 |      | 65.0  |         |
| 10153-CAD | LTE-TDD (SC-FDMA, 50% RB, 20 MHz, 64-QAM)  | X | 8.33 | 78.05 | 22.06 | 3.98 | 65.0  | ± 9.6 % |
|           |  | Y | 8.20 | 78.76 | 22.36 |      | 65.0  |         |
|           |  | Z | 8.27 | 78.34 | 22.17 |      | 65.0  |         |
| 10154-CAE | LTE-FDD (SC-FDMA, 50% RB, 10 MHz, QPSK)    | X | 2.19 | 68.34 | 15.77 | 0.00 | 150.0 | ± 9.6 % |
|           |  | Y | 2.13 | 68.58 | 15.88 |      | 150.0 |         |
|           |  | Z | 2.15 | 68.43 | 15.80 |      | 150.0 |         |
| 10155-CAE | LTE-FDD (SC-FDMA, 50% RB, 10 MHz, 16-QAM)  | X | 2.54 | 67.61 | 15.66 | 0.00 | 150.0 | ± 9.6 % |
|           |  | Y | 2.49 | 67.93 | 15.66 |      | 150.0 |         |
|           |  | Z | 2.51 | 67.76 | 15.67 |      | 150.0 |         |
| 10156-CAE | LTE-FDD (SC-FDMA, 50% RB, 5 MHz, QPSK)     | X | 1.75 | 67.70 | 14.83 | 0.00 | 150.0 | ± 9.6 % |
|           |  | Y | 1.67 | 67.86 | 14.67 |      | 150.0 |         |
|           |  | Z | 1.70 | 67.75 | 14.73 |      | 150.0 |         |
| 10157-CAE | LTE-FDD (SC-FDMA, 50% RB, 5 MHz, 16-QAM)   | X | 2.01 | 66.49 | 13.77 | 0.00 | 150.0 | ± 9.6 % |
|           |  | Y | 1.89 | 66.41 | 13.28 |      | 150.0 |         |
|           |  | Z | 1.95 | 66.44 | 13.53 |      | 150.0 |         |
| 10158-CAE | LTE-FDD (SC-FDMA, 50% RB, 10 MHz, 64-QAM)  | X | 2.70 | 67.82 | 15.85 | 0.00 | 150.0 | ± 9.6 % |
|           |  | Y | 2.64 | 68.13 | 15.83 |      | 150.0 |         |
|           |  | Z | 2.67 | 67.98 | 15.86 |      | 150.0 |         |
| 10159-CAE | LTE-FDD (SC-FDMA, 50% RB, 5 MHz, 64-QAM)   | X | 2.11 | 66.90 | 14.04 | 0.00 | 150.0 | ± 9.6 % |
|           |  | Y | 1.98 | 66.74 | 13.50 |      | 150.0 |         |
|           |  | Z | 2.04 | 66.83 | 13.79 |      | 150.0 |         |
| 10160-CAD | LTE-FDD (SC-FDMA, 50% RB, 15 MHz, QPSK)    | X | 2.69 | 68.21 | 15.87 | 0.00 | 150.0 | ± 9.6 % |
|           |  | Y | 2.64 | 68.50 | 16.02 |      | 150.0 |         |
|           |  | Z | 2.66 | 68.34 | 15.93 |      | 150.0 |         |
| 10161-CAD | LTE-FDD (SC-FDMA, 50% RB, 15 MHz, 16-QAM)  | X | 2.88 | 67.04 | 15.53 | 0.00 | 150.0 | ± 9.6 % |
|           |  | Y | 2.82 | 67.25 | 15.56 |      | 150.0 |         |
|           |  | Z | 2.84 | 67.11 | 15.53 |      | 150.0 |         |
| 10162-CAD | LTE-FDD (SC-FDMA, 50% RB, 15 MHz, 64-QAM)  | X | 2.99 | 67.17 | 15.64 | 0.00 | 150.0 | ± 9.6 % |
|           |  | Y | 2.93 | 67.43 | 15.68 |      | 150.0 |         |
|           |  | Z | 2.96 | 67.27 | 15.66 |      | 150.0 |         |
| 10166-CAE | LTE-FDD (SC-FDMA, 50% RB, 1.4 MHz, QPSK)   | X | 3.67 | 69.76 | 19.07 | 3.01 | 150.0 | ± 9.6 % |
|           |  | Y | 3.59 | 70.61 | 19.72 |      | 150.0 |         |
|           |  | Z | 3.64 | 70.17 | 19.36 |      | 150.0 |         |
| 10167-CAE | LTE-FDD (SC-FDMA, 50% RB, 1.4 MHz, 16-QAM) | X | 4.60 | 72.78 | 19.56 | 3.01 | 150.0 | ± 9.6 % |
|           |  | Y | 4.59 | 74.59 | 20.58 |      | 150.0 |         |
|           |  | Z | 4.60 | 73.54 | 19.97 |      | 150.0 |         |

|           |  |   |        |        |       |      |       |         |
|-----------|--|---|--------|--------|-------|------|-------|---------|
| 10168-CAE | LTE-FDD (SC-FDMA, 50% RB, 1.4 MHz, 64-QAM) | X | 5.10   | 75.00  | 20.86 | 3.01 | 150.0 | ± 9.6 % |
|           |  | Y | 5.17   | 77.15  | 22.00 |      | 150.0 |         |
|           |  | Z | 5.18   | 76.08  | 21.41 |      | 150.0 |         |
| 10169-CAD | LTE-FDD (SC-FDMA, 1 RB, 20 MHz, QPSK)      | X | 3.14   | 69.82  | 19.09 | 3.01 | 150.0 | ± 9.6 % |
|           |  | Y | 2.99   | 70.11  | 19.57 |      | 150.0 |         |
|           |  | Z | 3.08   | 69.99  | 19.30 |      | 150.0 |         |
| 10170-CAD | LTE-FDD (SC-FDMA, 1 RB, 20 MHz, 16-QAM)    | X | 4.48   | 76.11  | 21.47 | 3.01 | 150.0 | ± 9.6 % |
|           |  | Y | 4.42   | 77.92  | 22.61 |      | 150.0 |         |
|           |  | Z | 4.51   | 77.09  | 22.03 |      | 150.0 |         |
| 10171-AAD | LTE-FDD (SC-FDMA, 1 RB, 20 MHz, 64-QAM)    | X | 3.64   | 71.74  | 18.65 | 3.01 | 150.0 | ± 9.6 % |
|           |  | Y | 3.56   | 73.31  | 19.70 |      | 150.0 |         |
|           |  | Z | 3.59   | 72.29  | 19.01 |      | 150.0 |         |
| 10172-CAD | LTE-TDD (SC-FDMA, 1 RB, 20 MHz, QPSK)      | X | 21.10  | 104.74 | 32.18 | 6.02 | 65.0  | ± 9.6 % |
|           |  | Y | 44.31  | 124.23 | 38.59 |      | 65.0  |         |
|           |  | Z | 24.87  | 109.58 | 33.89 |      | 65.0  |         |
| 10173-CAD | LTE-TDD (SC-FDMA, 1 RB, 20 MHz, 16-QAM)    | X | 37.36  | 109.91 | 31.76 | 6.02 | 65.0  | ± 9.6 % |
|           |  | Y | 100.00 | 131.53 | 37.83 |      | 65.0  |         |
|           |  | Z | 66.45  | 121.49 | 34.95 |      | 65.0  |         |
| 10174-CAD | LTE-TDD (SC-FDMA, 1 RB, 20 MHz, 64-QAM)    | X | 28.71  | 103.81 | 29.50 | 6.02 | 65.0  | ± 9.6 % |
|           |  | Y | 93.12  | 128.22 | 36.43 |      | 65.0  |         |
|           |  | Z | 36.57  | 109.34 | 31.20 |      | 65.0  |         |
| 10175-CAE | LTE-FDD (SC-FDMA, 1 RB, 10 MHz, QPSK)      | X | 3.10   | 69.50  | 18.83 | 3.01 | 150.0 | ± 9.6 % |
|           |  | Y | 2.96   | 69.84  | 19.35 |      | 150.0 |         |
|           |  | Z | 3.04   | 69.66  | 19.04 |      | 150.0 |         |
| 10176-CAE | LTE-FDD (SC-FDMA, 1 RB, 10 MHz, 16-QAM)    | X | 4.49   | 76.13  | 21.48 | 3.01 | 150.0 | ± 9.6 % |
|           |  | Y | 4.43   | 77.95  | 22.63 |      | 150.0 |         |
|           |  | Z | 4.52   | 77.11  | 22.04 |      | 150.0 |         |
| 10177-CAG | LTE-FDD (SC-FDMA, 1 RB, 5 MHz, QPSK)       | X | 3.13   | 69.65  | 18.93 | 3.01 | 150.0 | ± 9.6 % |
|           |  | Y | 2.98   | 69.97  | 19.42 |      | 150.0 |         |
|           |  | Z | 3.07   | 69.81  | 19.14 |      | 150.0 |         |
| 10178-CAE | LTE-FDD (SC-FDMA, 1 RB, 5 MHz, 16-QAM)     | X | 4.43   | 75.88  | 21.35 | 3.01 | 150.0 | ± 9.6 % |
|           |  | Y | 4.39   | 77.75  | 22.52 |      | 150.0 |         |
|           |  | Z | 4.47   | 76.86  | 21.91 |      | 150.0 |         |
| 10179-CAE | LTE-FDD (SC-FDMA, 1 RB, 10 MHz, 64-QAM)    | X | 4.01   | 73.75  | 19.90 | 3.01 | 150.0 | ± 9.6 % |
|           |  | Y | 3.96   | 75.54  | 21.04 |      | 150.0 |         |
|           |  | Z | 4.01   | 74.52  | 20.37 |      | 150.0 |         |
| 10180-CAE | LTE-FDD (SC-FDMA, 1 RB, 5 MHz, 64-QAM)     | X | 3.63   | 71.66  | 18.60 | 3.01 | 150.0 | ± 9.6 % |
|           |  | Y | 3.55   | 73.25  | 19.66 |      | 150.0 |         |
|           |  | Z | 3.59   | 72.21  | 18.96 |      | 150.0 |         |
| 10181-CAD | LTE-FDD (SC-FDMA, 1 RB, 15 MHz, QPSK)      | X | 3.13   | 69.64  | 18.92 | 3.01 | 150.0 | ± 9.6 % |
|           |  | Y | 2.98   | 69.95  | 19.42 |      | 150.0 |         |
|           |  | Z | 3.06   | 69.80  | 19.13 |      | 150.0 |         |
| 10182-CAD | LTE-FDD (SC-FDMA, 1 RB, 15 MHz, 16-QAM)    | X | 4.42   | 75.86  | 21.34 | 3.01 | 150.0 | ± 9.6 % |
|           |  | Y | 4.38   | 77.72  | 22.51 |      | 150.0 |         |
|           |  | Z | 4.46   | 76.83  | 21.90 |      | 150.0 |         |
| 10183-AAC | LTE-FDD (SC-FDMA, 1 RB, 15 MHz, 64-QAM)    | X | 3.62   | 71.63  | 18.59 | 3.01 | 150.0 | ± 9.6 % |
|           |  | Y | 3.55   | 73.22  | 19.65 |      | 150.0 |         |
|           |  | Z | 3.58   | 72.19  | 18.94 |      | 150.0 |         |



|           |   |   |      |       |       |      |       |         |
|-----------|---|---|------|-------|-------|------|-------|---------|
| 10184-CAD | LTE-FDD (SC-FDMA, 1 RB, 3 MHz, QPSK)          | X | 3.14 | 69.68 | 18.95 | 3.01 | 150.0 | ± 9.6 % |
|           |   | Y | 2.99 | 69.99 | 19.44 |      | 150.0 |         |
|           |   | Z | 3.07 | 69.84 | 19.16 |      | 150.0 |         |
| 10185-CAD | LTE-FDD (SC-FDMA, 1 RB, 3 MHz, 16-QAM)        | X | 4.45 | 75.93 | 21.38 | 3.01 | 150.0 | ± 9.6 % |
|           |   | Y | 4.40 | 77.80 | 22.55 |      | 150.0 |         |
|           |   | Z | 4.48 | 76.92 | 21.94 |      | 150.0 |         |
| 10186-AAD | LTE-FDD (SC-FDMA, 1 RB, 3 MHz, 64-QAM)        | X | 3.64 | 71.70 | 18.62 | 3.01 | 150.0 | ± 9.6 % |
|           |   | Y | 3.56 | 73.30 | 19.69 |      | 150.0 |         |
|           |   | Z | 3.60 | 72.26 | 18.98 |      | 150.0 |         |
| 10187-CAE | LTE-FDD (SC-FDMA, 1 RB, 1.4 MHz, QPSK)        | X | 3.15 | 69.73 | 19.01 | 3.01 | 150.0 | ± 9.6 % |
|           |   | Y | 3.00 | 70.06 | 19.51 |      | 150.0 |         |
|           |   | Z | 3.08 | 69.90 | 19.22 |      | 150.0 |         |
| 10188-CAE | LTE-FDD (SC-FDMA, 1 RB, 1.4 MHz, 16-QAM)      | X | 4.60 | 76.65 | 21.77 | 3.01 | 150.0 | ± 9.6 % |
|           |   | Y | 4.55 | 78.49 | 22.93 |      | 150.0 |         |
|           |   | Z | 4.65 | 77.69 | 22.36 |      | 150.0 |         |
| 10189-AAE | LTE-FDD (SC-FDMA, 1 RB, 1.4 MHz, 64-QAM)      | X | 3.72 | 72.15 | 18.90 | 3.01 | 150.0 | ± 9.6 % |
|           |   | Y | 3.65 | 73.76 | 19.97 |      | 150.0 |         |
|           |   | Z | 3.69 | 72.74 | 19.28 |      | 150.0 |         |
| 10193-CAC | IEEE 802.11n (HT Greenfield, 6.5 Mbps, BPSK)  | X | 4.52 | 66.58 | 16.02 | 0.00 | 150.0 | ± 9.6 % |
|           |   | Y | 4.45 | 66.79 | 16.05 |      | 150.0 |         |
|           |   | Z | 4.48 | 66.63 | 16.03 |      | 150.0 |         |
| 10194-CAC | IEEE 802.11n (HT Greenfield, 39 Mbps, 16-QAM) | X | 4.70 | 66.91 | 16.15 | 0.00 | 150.0 | ± 9.6 % |
|           |   | Y | 4.60 | 67.08 | 16.18 |      | 150.0 |         |
|           |   | Z | 4.65 | 66.95 | 16.16 |      | 150.0 |         |
| 10195-CAC | IEEE 802.11n (HT Greenfield, 65 Mbps, 64-QAM) | X | 4.74 | 66.94 | 16.17 | 0.00 | 150.0 | ± 9.6 % |
|           |   | Y | 4.65 | 67.11 | 16.20 |      | 150.0 |         |
|           |   | Z | 4.69 | 66.98 | 16.18 |      | 150.0 |         |
| 10196-CAC | IEEE 802.11n (HT Mixed, 6.5 Mbps, BPSK)       | X | 4.53 | 66.65 | 16.05 | 0.00 | 150.0 | ± 9.6 % |
|           |   | Y | 4.44 | 66.83 | 16.06 |      | 150.0 |         |
|           |   | Z | 4.48 | 66.69 | 16.05 |      | 150.0 |         |
| 10197-CAC | IEEE 802.11n (HT Mixed, 39 Mbps, 16-QAM)      | X | 4.72 | 66.93 | 16.16 | 0.00 | 150.0 | ± 9.6 % |
|           |   | Y | 4.62 | 67.10 | 16.19 |      | 150.0 |         |
|           |   | Z | 4.66 | 66.97 | 16.17 |      | 150.0 |         |
| 10198-CAC | IEEE 802.11n (HT Mixed, 65 Mbps, 64-QAM)      | X | 4.75 | 66.96 | 16.18 | 0.00 | 150.0 | ± 9.6 % |
|           |   | Y | 4.64 | 67.13 | 16.21 |      | 150.0 |         |
|           |   | Z | 4.69 | 67.00 | 16.19 |      | 150.0 |         |
| 10219-CAC | IEEE 802.11n (HT Mixed, 7.2 Mbps, BPSK)       | X | 4.48 | 66.66 | 16.00 | 0.00 | 150.0 | ± 9.6 % |
|           |   | Y | 4.39 | 66.84 | 16.01 |      | 150.0 |         |
|           |   | Z | 4.43 | 66.70 | 16.00 |      | 150.0 |         |
| 10220-CAC | IEEE 802.11n (HT Mixed, 43.3 Mbps, 16-QAM)    | X | 4.71 | 66.91 | 16.16 | 0.00 | 150.0 | ± 9.6 % |
|           |   | Y | 4.61 | 67.06 | 16.18 |      | 150.0 |         |
|           |   | Z | 4.66 | 66.94 | 16.16 |      | 150.0 |         |
| 10221-CAC | IEEE 802.11n (HT Mixed, 72.2 Mbps, 64-QAM)    | X | 4.76 | 66.89 | 16.17 | 0.00 | 150.0 | ± 9.6 % |
|           |   | Y | 4.65 | 67.06 | 16.20 |      | 150.0 |         |
|           |   | Z | 4.70 | 66.93 | 16.18 |      | 150.0 |         |
| 10222-CAC | IEEE 802.11n (HT Mixed, 15 Mbps, BPSK)        | X | 5.08 | 67.11 | 16.29 | 0.00 | 150.0 | ± 9.6 % |
|           |   | Y | 5.00 | 67.21 | 16.33 |      | 150.0 |         |
|           |   | Z | 5.03 | 67.12 | 16.30 |      | 150.0 |         |

|           |   |   |        |        |       |      |       |         |
|-----------|---|---|--------|--------|-------|------|-------|---------|
| 10223-CAC | IEEE 802.11n (HT Mixed, 90 Mbps, 16-QAM)  | X | 5.40   | 67.34  | 16.44 | 0.00 | 150.0 | ± 9.6 % |
|           |   | Y | 5.30   | 67.47  | 16.48 |      | 150.0 |         |
|           |   | Z | 5.35   | 67.37  | 16.45 |      | 150.0 |         |
| 10224-CAC | IEEE 802.11n (HT Mixed, 150 Mbps, 64-QAM) | X | 5.12   | 67.22  | 16.27 | 0.00 | 150.0 | ± 9.6 % |
|           |   | Y | 5.04   | 67.32  | 16.31 |      | 150.0 |         |
|           |   | Z | 5.08   | 67.23  | 16.28 |      | 150.0 |         |
| 10225-CAB | UMTS-FDD (HSPA+)                          | X | 2.77   | 65.87  | 15.07 | 0.00 | 150.0 | ± 9.6 % |
|           |   | Y | 2.71   | 66.11  | 14.95 |      | 150.0 |         |
|           |   | Z | 2.73   | 65.95  | 15.01 |      | 150.0 |         |
| 10226-CAA | LTE-TDD (SC-FDMA, 1 RB, 1.4 MHz, 16-QAM)  | X | 40.90  | 111.69 | 32.33 | 6.02 | 65.0  | ± 9.6 % |
|           |   | Y | 100.00 | 131.74 | 37.97 |      | 65.0  |         |
|           |   | Z | 76.08  | 124.13 | 35.71 |      | 65.0  |         |
| 10227-CAA | LTE-TDD (SC-FDMA, 1 RB, 1.4 MHz, 64-QAM)  | X | 32.04  | 105.79 | 30.14 | 6.02 | 65.0  | ± 9.6 % |
|           |   | Y | 100.00 | 129.20 | 36.63 |      | 65.0  |         |
|           |   | Z | 56.03  | 116.66 | 33.17 |      | 65.0  |         |
| 10228-CAA | LTE-TDD (SC-FDMA, 1 RB, 1.4 MHz, QPSK)    | X | 32.49  | 113.40 | 34.73 | 6.02 | 65.0  | ± 9.6 % |
|           |   | Y | 63.93  | 131.79 | 40.55 |      | 65.0  |         |
|           |   | Z | 42.68  | 120.45 | 36.94 |      | 65.0  |         |
| 10229-CAB | LTE-TDD (SC-FDMA, 1 RB, 3 MHz, 16-QAM)    | X | 37.48  | 109.96 | 31.78 | 6.02 | 65.0  | ± 9.6 % |
|           |   | Y | 100.00 | 131.51 | 37.84 |      | 65.0  |         |
|           |   | Z | 66.68  | 121.54 | 34.97 |      | 65.0  |         |
| 10230-CAB | LTE-TDD (SC-FDMA, 1 RB, 3 MHz, 64-QAM)    | X | 29.78  | 104.42 | 29.68 | 6.02 | 65.0  | ± 9.6 % |
|           |   | Y | 100.00 | 129.07 | 36.54 |      | 65.0  |         |
|           |   | Z | 50.21  | 114.61 | 32.57 |      | 65.0  |         |
| 10231-CAB | LTE-TDD (SC-FDMA, 1 RB, 3 MHz, QPSK)      | X | 30.12  | 111.79 | 34.20 | 6.02 | 65.0  | ± 9.6 % |
|           |   | Y | 57.30  | 129.38 | 39.87 |      | 65.0  |         |
|           |   | Z | 38.78  | 118.39 | 36.30 |      | 65.0  |         |
| 10232-CAD | LTE-TDD (SC-FDMA, 1 RB, 5 MHz, 16-QAM)    | X | 37.48  | 109.97 | 31.78 | 6.02 | 65.0  | ± 9.6 % |
|           |   | Y | 100.00 | 131.53 | 37.84 |      | 65.0  |         |
|           |   | Z | 66.72  | 121.56 | 34.98 |      | 65.0  |         |
| 10233-CAD | LTE-TDD (SC-FDMA, 1 RB, 5 MHz, 64-QAM)    | X | 29.77  | 104.42 | 29.68 | 6.02 | 65.0  | ± 9.6 % |
|           |   | Y | 100.00 | 129.09 | 36.55 |      | 65.0  |         |
|           |   | Z | 50.19  | 114.62 | 32.57 |      | 65.0  |         |
| 10234-CAD | LTE-TDD (SC-FDMA, 1 RB, 5 MHz, QPSK)      | X | 28.05  | 110.17 | 33.63 | 6.02 | 65.0  | ± 9.6 % |
|           |   | Y | 51.99  | 127.09 | 39.16 |      | 65.0  |         |
|           |   | Z | 35.54  | 116.41 | 35.65 |      | 65.0  |         |
| 10235-CAD | LTE-TDD (SC-FDMA, 1 RB, 10 MHz, 16-QAM)   | X | 37.64  | 110.05 | 31.80 | 6.02 | 65.0  | ± 9.6 % |
|           |   | Y | 100.00 | 131.54 | 37.84 |      | 65.0  |         |
|           |   | Z | 67.18  | 121.70 | 35.01 |      | 65.0  |         |
| 10236-CAD | LTE-TDD (SC-FDMA, 1 RB, 10 MHz, 64-QAM)   | X | 30.09  | 104.58 | 29.72 | 6.02 | 65.0  | ± 9.6 % |
|           |   | Y | 100.00 | 129.03 | 36.52 |      | 65.0  |         |
|           |   | Z | 50.96  | 114.84 | 32.62 |      | 65.0  |         |
| 10237-CAD | LTE-TDD (SC-FDMA, 1 RB, 10 MHz, QPSK)     | X | 30.42  | 112.00 | 34.26 | 6.02 | 65.0  | ± 9.6 % |
|           |   | Y | 58.39  | 129.80 | 39.98 |      | 65.0  |         |
|           |   | Z | 39.25  | 118.66 | 36.38 |      | 65.0  |         |
| 10238-CAD | LTE-TDD (SC-FDMA, 1 RB, 15 MHz, 16-QAM)   | X | 37.48  | 109.98 | 31.78 | 6.02 | 65.0  | ± 9.6 % |
|           |   | Y | 100.00 | 131.54 | 37.84 |      | 65.0  |         |
|           |   | Z | 66.77  | 121.59 | 34.98 |      | 65.0  |         |

|           |  |   |        |        |       |      |      |         |
|-----------|--|---|--------|--------|-------|------|------|---------|
| 10239-CAD | LTE-TDD (SC-FDMA, 1 RB, 15 MHz, 64-QAM)    | X | 29.75  | 104.43 | 29.68 | 6.02 | 65.0 | ± 9.6 % |
|           |  | Y | 100.00 | 129.11 | 36.55 |      | 65.0 |         |
|           |  | Z | 50.17  | 114.63 | 32.57 |      | 65.0 |         |
| 10240-CAD | LTE-TDD (SC-FDMA, 1 RB, 15 MHz, QPSK)      | X | 30.30  | 111.94 | 34.24 | 6.02 | 65.0 | ± 9.6 % |
|           |  | Y | 58.14  | 129.72 | 39.96 |      | 65.0 |         |
|           |  | Z | 39.09  | 118.59 | 36.36 |      | 65.0 |         |
| 10241-CAA | LTE-TDD (SC-FDMA, 50% RB, 1.4 MHz, 16-QAM) | X | 11.80  | 86.80  | 27.35 | 6.98 | 65.0 | ± 9.6 % |
|           |  | Y | 13.67  | 92.53  | 29.81 |      | 65.0 |         |
|           |  | Z | 12.27  | 88.56  | 28.08 |      | 65.0 |         |
| 10242-CAA | LTE-TDD (SC-FDMA, 50% RB, 1.4 MHz, 64-QAM) | X | 10.15  | 83.59  | 26.03 | 6.98 | 65.0 | ± 9.6 % |
|           |  | Y | 12.26  | 90.20  | 28.90 |      | 65.0 |         |
|           |  | Z | 10.49  | 85.23  | 26.75 |      | 65.0 |         |
| 10243-CAA | LTE-TDD (SC-FDMA, 50% RB, 1.4 MHz, QPSK)   | X | 8.15   | 80.45  | 25.67 | 6.98 | 65.0 | ± 9.6 % |
|           |  | Y | 9.07   | 85.16  | 28.03 |      | 65.0 |         |
|           |  | Z | 8.20   | 81.43  | 26.18 |      | 65.0 |         |
| 10244-CAB | LTE-TDD (SC-FDMA, 50% RB, 3 MHz, 16-QAM)   | X | 8.77   | 79.58  | 20.12 | 3.98 | 65.0 | ± 9.6 % |
|           |  | Y | 8.68   | 79.98  | 19.73 |      | 65.0 |         |
|           |  | Z | 8.93   | 80.10  | 20.07 |      | 65.0 |         |
| 10245-CAB | LTE-TDD (SC-FDMA, 50% RB, 3 MHz, 64-QAM)   | X | 8.56   | 78.94  | 19.83 | 3.98 | 65.0 | ± 9.6 % |
|           |  | Y | 8.27   | 79.00  | 19.30 |      | 65.0 |         |
|           |  | Z | 8.60   | 79.28  | 19.71 |      | 65.0 |         |
| 10246-CAB | LTE-TDD (SC-FDMA, 50% RB, 3 MHz, QPSK)     | X | 9.05   | 82.96  | 21.42 | 3.98 | 65.0 | ± 9.6 % |
|           |  | Y | 8.67   | 82.79  | 20.89 |      | 65.0 |         |
|           |  | Z | 9.07   | 83.18  | 21.25 |      | 65.0 |         |
| 10247-CAD | LTE-TDD (SC-FDMA, 50% RB, 5 MHz, 16-QAM)   | X | 7.31   | 77.47  | 20.01 | 3.98 | 65.0 | ± 9.6 % |
|           |  | Y | 6.88   | 77.10  | 19.42 |      | 65.0 |         |
|           |  | Z | 7.16   | 77.42  | 19.78 |      | 65.0 |         |
| 10248-CAD | LTE-TDD (SC-FDMA, 50% RB, 5 MHz, 64-QAM)   | X | 7.23   | 76.85  | 19.75 | 3.98 | 65.0 | ± 9.6 % |
|           |  | Y | 6.75   | 76.40  | 19.13 |      | 65.0 |         |
|           |  | Z | 7.04   | 76.72  | 19.48 |      | 65.0 |         |
| 10249-CAD | LTE-TDD (SC-FDMA, 50% RB, 5 MHz, QPSK)     | X | 10.55  | 85.88  | 23.24 | 3.98 | 65.0 | ± 9.6 % |
|           |  | Y | 11.23  | 87.71  | 23.62 |      | 65.0 |         |
|           |  | Z | 11.08  | 87.02  | 23.49 |      | 65.0 |         |
| 10250-CAD | LTE-TDD (SC-FDMA, 50% RB, 10 MHz, 16-QAM)  | X | 8.37   | 79.97  | 22.44 | 3.98 | 65.0 | ± 9.6 % |
|           |  | Y | 8.25   | 80.64  | 22.58 |      | 65.0 |         |
|           |  | Z | 8.37   | 80.40  | 22.54 |      | 65.0 |         |
| 10251-CAD | LTE-TDD (SC-FDMA, 50% RB, 10 MHz, 64-QAM)  | X | 7.79   | 77.55  | 21.17 | 3.98 | 65.0 | ± 9.6 % |
|           |  | Y | 7.62   | 78.12  | 21.26 |      | 65.0 |         |
|           |  | Z | 7.71   | 77.78  | 21.18 |      | 65.0 |         |
| 10252-CAD | LTE-TDD (SC-FDMA, 50% RB, 10 MHz, QPSK)    | X | 10.26  | 85.03  | 23.77 | 3.98 | 65.0 | ± 9.6 % |
|           |  | Y | 11.07  | 87.53  | 24.67 |      | 65.0 |         |
|           |  | Z | 10.72  | 86.30  | 24.20 |      | 65.0 |         |
| 10253-CAD | LTE-TDD (SC-FDMA, 50% RB, 15 MHz, 16-QAM)  | X | 7.69   | 76.53  | 21.09 | 3.98 | 65.0 | ± 9.6 % |
|           |  | Y | 7.57   | 77.22  | 21.35 |      | 65.0 |         |
|           |  | Z | 7.61   | 76.75  | 21.15 |      | 65.0 |         |
| 10254-CAD | LTE-TDD (SC-FDMA, 50% RB, 15 MHz, 64-QAM)  | X | 8.11   | 77.42  | 21.76 | 3.98 | 65.0 | ± 9.6 % |
|           |  | Y | 7.99   | 78.11  | 22.01 |      | 65.0 |         |
|           |  | Z | 8.04   | 77.70  | 21.84 |      | 65.0 |         |

|           |   |   |       |       |       |      |      |         |
|-----------|---|---|-------|-------|-------|------|------|---------|
| 10255-CAD | LTE-TDD (SC-FDMA, 50% RB, 15 MHz, QPSK)     | X | 8.87  | 80.90 | 22.51 | 3.98 | 65.0 | ± 9.6 % |
|           |   | Y | 9.18  | 82.66 | 23.26 |      | 65.0 |         |
|           |   | Z | 9.01  | 81.69 | 22.82 |      | 65.0 |         |
| 10256-CAA | LTE-TDD (SC-FDMA, 100% RB, 1.4 MHz, 16-QAM) | X | 7.19  | 76.04 | 17.83 | 3.98 | 65.0 | ± 9.6 % |
|           |   | Y | 6.37  | 74.72 | 16.60 |      | 65.0 |         |
|           |   | Z | 6.91  | 75.63 | 17.34 |      | 65.0 |         |
| 10257-CAA | LTE-TDD (SC-FDMA, 100% RB, 1.4 MHz, 64-QAM) | X | 6.95  | 75.20 | 17.41 | 3.98 | 65.0 | ± 9.6 % |
|           |   | Y | 6.01  | 73.59 | 16.03 |      | 65.0 |         |
|           |   | Z | 6.60  | 74.62 | 16.84 |      | 65.0 |         |
| 10258-CAA | LTE-TDD (SC-FDMA, 100% RB, 1.4 MHz, QPSK)   | X | 7.08  | 78.57 | 19.08 | 3.98 | 65.0 | ± 9.6 % |
|           |   | Y | 5.96  | 76.36 | 17.58 |      | 65.0 |         |
|           |   | Z | 6.63  | 77.70 | 18.41 |      | 65.0 |         |
| 10259-CAB | LTE-TDD (SC-FDMA, 100% RB, 3 MHz, 16-QAM)   | X | 7.72  | 78.37 | 20.87 | 3.98 | 65.0 | ± 9.6 % |
|           |   | Y | 7.43  | 78.48 | 20.58 |      | 65.0 |         |
|           |   | Z | 7.64  | 78.54 | 20.77 |      | 65.0 |         |
| 10260-CAB | LTE-TDD (SC-FDMA, 100% RB, 3 MHz, 64-QAM)   | X | 7.71  | 78.04 | 20.75 | 3.98 | 65.0 | ± 9.6 % |
|           |   | Y | 7.37  | 78.04 | 20.41 |      | 65.0 |         |
|           |   | Z | 7.60  | 78.14 | 20.63 |      | 65.0 |         |
| 10261-CAB | LTE-TDD (SC-FDMA, 100% RB, 3 MHz, QPSK)     | X | 9.91  | 84.71 | 23.20 | 3.98 | 65.0 | ± 9.6 % |
|           |   | Y | 10.51 | 86.66 | 23.72 |      | 65.0 |         |
|           |   | Z | 10.31 | 85.78 | 23.47 |      | 65.0 |         |
| 10262-CAD | LTE-TDD (SC-FDMA, 100% RB, 5 MHz, 16-QAM)   | X | 8.35  | 79.91 | 22.40 | 3.98 | 65.0 | ± 9.6 % |
|           |   | Y | 8.23  | 80.57 | 22.53 |      | 65.0 |         |
|           |   | Z | 8.35  | 80.33 | 22.49 |      | 65.0 |         |
| 10263-CAD | LTE-TDD (SC-FDMA, 100% RB, 5 MHz, 64-QAM)   | X | 7.78  | 77.53 | 21.17 | 3.98 | 65.0 | ± 9.6 % |
|           |   | Y | 7.61  | 78.09 | 21.25 |      | 65.0 |         |
|           |   | Z | 7.70  | 77.76 | 21.18 |      | 65.0 |         |
| 10264-CAD | LTE-TDD (SC-FDMA, 100% RB, 5 MHz, QPSK)     | X | 10.16 | 84.83 | 23.68 | 3.98 | 65.0 | ± 9.6 % |
|           |   | Y | 10.94 | 87.30 | 24.57 |      | 65.0 |         |
|           |   | Z | 10.60 | 86.08 | 24.10 |      | 65.0 |         |
| 10265-CAD | LTE-TDD (SC-FDMA, 100% RB, 10 MHz, 16-QAM)  | X | 7.89  | 77.12 | 21.33 | 3.98 | 65.0 | ± 9.6 % |
|           |   | Y | 7.75  | 77.78 | 21.62 |      | 65.0 |         |
|           |   | Z | 7.80  | 77.33 | 21.40 |      | 65.0 |         |
| 10266-CAD | LTE-TDD (SC-FDMA, 100% RB, 10 MHz, 64-QAM)  | X | 8.32  | 78.04 | 22.05 | 3.98 | 65.0 | ± 9.6 % |
|           |   | Y | 8.20  | 78.75 | 22.36 |      | 65.0 |         |
|           |   | Z | 8.26  | 78.33 | 22.16 |      | 65.0 |         |
| 10267-CAD | LTE-TDD (SC-FDMA, 100% RB, 10 MHz, QPSK)    | X | 9.19  | 81.29 | 22.44 | 3.98 | 65.0 | ± 9.6 % |
|           |   | Y | 9.53  | 83.07 | 23.22 |      | 65.0 |         |
|           |   | Z | 9.36  | 82.10 | 22.77 |      | 65.0 |         |
| 10268-CAD | LTE-TDD (SC-FDMA, 100% RB, 15 MHz, 16-QAM)  | X | 8.37  | 76.65 | 21.54 | 3.98 | 65.0 | ± 9.6 % |
|           |   | Y | 8.20  | 77.22 | 21.85 |      | 65.0 |         |
|           |   | Z | 8.27  | 76.83 | 21.63 |      | 65.0 |         |
| 10269-CAD | LTE-TDD (SC-FDMA, 100% RB, 15 MHz, 64-QAM)  | X | 8.29  | 76.22 | 21.43 | 3.98 | 65.0 | ± 9.6 % |
|           |   | Y | 8.13  | 76.76 | 21.72 |      | 65.0 |         |
|           |   | Z | 8.20  | 76.38 | 21.51 |      | 65.0 |         |
| 10270-CAD | LTE-TDD (SC-FDMA, 100% RB, 15 MHz, QPSK)    | X | 8.55  | 78.25 | 21.44 | 3.98 | 65.0 | ± 9.6 % |
|           |   | Y | 8.58  | 79.32 | 21.98 |      | 65.0 |         |
|           |   | Z | 8.56  | 78.72 | 21.66 |      | 65.0 |         |

|           |  |   |       |       |       |      |       |         |
|-----------|--|---|-------|-------|-------|------|-------|---------|
| 10274-CAB | UMTS-FDD (HSUPA, Subtest 5, 3GPP Rel8.10)                          | X | 2.53  | 66.08 | 14.88 | 0.00 | 150.0 | ± 9.6 % |
|           |  | Y | 2.52  | 66.54 | 14.91 |      | 150.0 |         |
|           |  | Z | 2.51  | 66.24 | 14.87 |      | 150.0 |         |
| 10275-CAB | UMTS-FDD (HSUPA, Subtest 5, 3GPP Rel8.4)                           | X | 1.51  | 66.90 | 14.72 | 0.00 | 150.0 | ± 9.6 % |
|           |  | Y | 1.52  | 67.44 | 14.98 |      | 150.0 |         |
|           |  | Z | 1.50  | 67.06 | 14.77 |      | 150.0 |         |
| 10277-CAA | PHS (QPSK)   | X | 4.49  | 67.07 | 11.86 | 9.03 | 50.0  | ± 9.6 % |
|           |  | Y | 3.76  | 65.67 | 10.51 |      | 50.0  |         |
|           |  | Z | 4.09  | 66.15 | 11.03 |      | 50.0  |         |
| 10278-CAA | PHS (QPSK, BW 884MHz, Rolloff 0.5)                                 | X | 8.37  | 78.55 | 19.37 | 9.03 | 50.0  | ± 9.6 % |
|           |  | Y | 7.19  | 76.56 | 17.89 |      | 50.0  |         |
|           |  | Z | 7.75  | 77.39 | 18.52 |      | 50.0  |         |
| 10279-CAA | PHS (QPSK, BW 884MHz, Rolloff 0.38)                                | X | 8.51  | 78.75 | 19.47 | 9.03 | 50.0  | ± 9.6 % |
|           |  | Y | 7.31  | 76.76 | 18.01 |      | 50.0  |         |
|           |  | Z | 7.88  | 77.58 | 18.63 |      | 50.0  |         |
| 10290-AAB | CDMA2000, RC1, SO55, Full Rate                                     | X | 1.28  | 66.85 | 12.83 | 0.00 | 150.0 | ± 9.6 % |
|           |  | Y | 1.15  | 66.36 | 12.07 |      | 150.0 |         |
|           |  | Z | 1.21  | 66.57 | 12.40 |      | 150.0 |         |
| 10291-AAB | CDMA2000, RC3, SO55, Full Rate                                     | X | 0.73  | 64.15 | 11.20 | 0.00 | 150.0 | ± 9.6 % |
|           |  | Y | 0.69  | 64.04 | 10.71 |      | 150.0 |         |
|           |  | Z | 0.69  | 63.98 | 10.82 |      | 150.0 |         |
| 10292-AAB | CDMA2000, RC3, SO32, Full Rate                                     | X | 0.85  | 66.79 | 12.92 | 0.00 | 150.0 | ± 9.6 % |
|           |  | Y | 0.83  | 67.15 | 12.67 |      | 150.0 |         |
|           |  | Z | 0.82  | 66.81 | 12.63 |      | 150.0 |         |
| 10293-AAB | CDMA2000, RC3, SO3, Full Rate                                      | X | 1.14  | 70.77 | 15.25 | 0.00 | 150.0 | ± 9.6 % |
|           |  | Y | 1.22  | 72.07 | 15.35 |      | 150.0 |         |
|           |  | Z | 1.16  | 71.38 | 15.20 |      | 150.0 |         |
| 10295-AAB | CDMA2000, RC1, SO3, 1/8th Rate 25 fr.                              | X | 11.92 | 86.64 | 24.71 | 9.03 | 50.0  | ± 9.6 % |
|           |  | Y | 15.63 | 91.98 | 26.09 |      | 50.0  |         |
|           |  | Z | 13.21 | 88.61 | 25.13 |      | 50.0  |         |
| 10297-AAC | LTE-FDD (SC-FDMA, 50% RB, 20 MHz, QPSK)                            | X | 2.66  | 69.01 | 16.01 | 0.00 | 150.0 | ± 9.6 % |
|           |  | Y | 2.60  | 69.22 | 16.21 |      | 150.0 |         |
|           |  | Z | 2.62  | 69.08 | 16.08 |      | 150.0 |         |
| 10298-AAC | LTE-FDD (SC-FDMA, 50% RB, 3 MHz, QPSK)                             | X | 1.46  | 66.51 | 13.33 | 0.00 | 150.0 | ± 9.6 % |
|           |  | Y | 1.32  | 65.99 | 12.56 |      | 150.0 |         |
|           |  | Z | 1.39  | 66.26 | 12.94 |      | 150.0 |         |
| 10299-AAC | LTE-FDD (SC-FDMA, 50% RB, 3 MHz, 16-QAM)                           | X | 2.70  | 69.70 | 14.37 | 0.00 | 150.0 | ± 9.6 % |
|           |  | Y | 2.67  | 70.31 | 14.00 |      | 150.0 |         |
|           |  | Z | 2.72  | 70.11 | 14.27 |      | 150.0 |         |
| 10300-AAC | LTE-FDD (SC-FDMA, 50% RB, 3 MHz, 64-QAM)                           | X | 2.09  | 65.56 | 11.69 | 0.00 | 150.0 | ± 9.6 % |
|           |  | Y | 1.84  | 65.02 | 10.77 |      | 150.0 |         |
|           |  | Z | 1.98  | 65.35 | 11.29 |      | 150.0 |         |
| 10301-AAA | IEEE 802.16e WiMAX (29:18, 5ms, 10MHz, QPSK, PUSC)                 | X | 5.46  | 67.87 | 18.50 | 4.17 | 80.0  | ± 9.6 % |
|           |  | Y | 5.32  | 68.03 | 18.43 |      | 80.0  |         |
|           |  | Z | 5.39  | 67.94 | 18.48 |      | 80.0  |         |
| 10302-AAA | IEEE 802.16e WiMAX (29:18, 5ms, 10MHz, QPSK, PUSC, 3 CTRL symbols) | X | 5.85  | 67.98 | 18.95 | 4.96 | 80.0  | ± 9.6 % |
|           |  | Y | 5.80  | 68.69 | 19.24 |      | 80.0  |         |
|           |  | Z | 5.75  | 67.96 | 18.88 |      | 80.0  |         |

|           |   |   |       |       |       |       |       |         |
|-----------|---|---|-------|-------|-------|-------|-------|---------|
| 10303-AAA | IEEE 802.16e WiMAX (31:15, 5ms, 10MHz, 64QAM, PUSC)                 | X | 5.66  | 67.92 | 18.92 | 4.96  | 80.0  | ± 9.6 % |
|           |   | Y | 5.61  | 68.61 | 19.19 |       | 80.0  |         |
|           |   | Z | 5.56  | 67.86 | 18.83 |       | 80.0  |         |
| 10304-AAA | IEEE 802.16e WiMAX (29:18, 5ms, 10MHz, 64QAM, PUSC)                 | X | 5.35  | 67.35 | 18.18 | 4.17  | 80.0  | ± 9.6 % |
|           |   | Y | 5.30  | 68.04 | 18.43 |       | 80.0  |         |
|           |   | Z | 5.26  | 67.36 | 18.12 |       | 80.0  |         |
| 10305-AAA | IEEE 802.16e WiMAX (31:15, 10ms, 10MHz, 64QAM, PUSC, 15 symbols)    | X | 7.05  | 76.99 | 23.82 | 6.02  | 50.0  | ± 9.6 % |
|           |   | Y | 7.19  | 78.32 | 24.16 |       | 50.0  |         |
|           |   | Z | 6.80  | 76.50 | 23.43 |       | 50.0  |         |
| 10306-AAA | IEEE 802.16e WiMAX (29:18, 10ms, 10MHz, 64QAM, PUSC, 18 symbols)    | X | 5.82  | 69.84 | 20.44 | 6.02  | 50.0  | ± 9.6 % |
|           |   | Y | 5.84  | 70.99 | 20.86 |       | 50.0  |         |
|           |   | Z | 6.02  | 71.90 | 21.62 |       | 50.0  |         |
| 10307-AAA | IEEE 802.16e WiMAX (29:18, 10ms, 10MHz, QPSK, PUSC, 18 symbols)     | X | 6.31  | 73.07 | 22.13 | 6.02  | 50.0  | ± 9.6 % |
|           |   | Y | 5.83  | 71.38 | 20.88 |       | 50.0  |         |
|           |   | Z | 6.11  | 72.72 | 21.84 |       | 50.0  |         |
| 10308-AAA | IEEE 802.16e WiMAX (29:18, 10ms, 10MHz, 16QAM, PUSC)                | X | 6.39  | 73.64 | 22.41 | 6.02  | 50.0  | ± 9.6 % |
|           |   | Y | 5.90  | 71.88 | 21.13 |       | 50.0  |         |
|           |   | Z | 6.20  | 73.31 | 22.13 |       | 50.0  |         |
| 10309-AAA | IEEE 802.16e WiMAX (29:18, 10ms, 10MHz, 16QAM, AMC 2x3, 18 symbols) | X | 5.91  | 70.12 | 20.60 | 6.02  | 50.0  | ± 9.6 % |
|           |   | Y | 5.91  | 71.23 | 21.02 |       | 50.0  |         |
|           |   | Z | 6.11  | 72.19 | 21.79 |       | 50.0  |         |
| 10310-AAA | IEEE 802.16e WiMAX (29:18, 10ms, 10MHz, QPSK, AMC 2x3, 18 symbols)  | X | 6.22  | 72.50 | 21.95 | 6.02  | 50.0  | ± 9.6 % |
|           |   | Y | 5.84  | 71.19 | 20.88 |       | 50.0  |         |
|           |   | Z | 6.05  | 72.25 | 21.70 |       | 50.0  |         |
| 10311-AAC | LTE-FDD (SC-FDMA, 100% RB, 15 MHz, QPSK)                            | X | 3.00  | 68.33 | 15.71 | 0.00  | 150.0 | ± 9.6 % |
|           |   | Y | 2.96  | 68.52 | 15.89 |       | 150.0 |         |
|           |   | Z | 2.97  | 68.38 | 15.77 |       | 150.0 |         |
| 10313-AAA | iDEN 1:3  | X | 6.99  | 77.76 | 18.02 | 6.99  | 70.0  | ± 9.6 % |
|           |   | Y | 8.29  | 81.34 | 19.42 |       | 70.0  |         |
|           |   | Z | 7.24  | 78.54 | 18.23 |       | 70.0  |         |
| 10314-AAA | iDEN 1:6  | X | 10.49 | 86.54 | 23.63 | 10.00 | 30.0  | ± 9.6 % |
|           |   | Y | 12.83 | 91.81 | 25.63 |       | 30.0  |         |
|           |   | Z | 11.85 | 89.04 | 24.41 |       | 30.0  |         |
| 10315-AAB | IEEE 802.11b WiFi 2.4 GHz (DSSS, 1 Mbps, 96pc duty cycle)           | X | 1.08  | 63.85 | 14.84 | 0.17  | 150.0 | ± 9.6 % |
|           |   | Y | 1.11  | 64.19 | 15.04 |       | 150.0 |         |
|           |   | Z | 1.08  | 63.97 | 14.91 |       | 150.0 |         |
| 10316-AAB | IEEE 802.11g WiFi 2.4 GHz (ERP-OFDM, 6 Mbps, 96pc duty cycle)       | X | 4.62  | 66.77 | 16.25 | 0.17  | 150.0 | ± 9.6 % |
|           |   | Y | 4.54  | 66.97 | 16.29 |       | 150.0 |         |
|           |   | Z | 4.57  | 66.82 | 16.26 |       | 150.0 |         |
| 10317-AAC | IEEE 802.11a WiFi 5 GHz (OFDM, 6 Mbps, 96pc duty cycle)             | X | 4.62  | 66.77 | 16.25 | 0.17  | 150.0 | ± 9.6 % |
|           |   | Y | 4.54  | 66.97 | 16.29 |       | 150.0 |         |
|           |   | Z | 4.57  | 66.82 | 16.26 |       | 150.0 |         |
| 10400-AAD | IEEE 802.11ac WiFi (20MHz, 64-QAM, 99pc duty cycle)                 | X | 4.70  | 66.97 | 16.15 | 0.00  | 150.0 | ± 9.6 % |
|           |   | Y | 4.59  | 67.15 | 16.19 |       | 150.0 |         |
|           |   | Z | 4.64  | 67.01 | 16.16 |       | 150.0 |         |
| 10401-AAD | IEEE 802.11ac WiFi (40MHz, 64-QAM, 99pc duty cycle)                 | X | 5.41  | 67.24 | 16.37 | 0.00  | 150.0 | ± 9.6 % |
|           |   | Y | 5.32  | 67.38 | 16.42 |       | 150.0 |         |
|           |   | Z | 5.38  | 67.33 | 16.41 |       | 150.0 |         |

|           |   |   |        |        |       |      |       |         |
|-----------|---|---|--------|--------|-------|------|-------|---------|
| 10402-AAD | IEEE 802.11ac WiFi (80MHz, 64-QAM, 99pc duty cycle)                             | X | 5.66   | 67.55  | 16.37 | 0.00 | 150.0 | ± 9.6 % |
|           |   | Y | 5.56   | 67.58  | 16.37 |      | 150.0 |         |
|           |   | Z | 5.60   | 67.52  | 16.36 |      | 150.0 |         |
| 10403-AAB | CDMA2000 (1xEV-DO, Rev. 0)  | X | 1.28   | 66.85  | 12.83 | 0.00 | 115.0 | ± 9.6 % |
|           |   | Y | 1.15   | 66.36  | 12.07 |      | 115.0 |         |
|           |   | Z | 1.21   | 66.57  | 12.40 |      | 115.0 |         |
| 10404-AAB | CDMA2000 (1xEV-DO, Rev. A)  | X | 1.28   | 66.85  | 12.83 | 0.00 | 115.0 | ± 9.6 % |
|           |   | Y | 1.15   | 66.36  | 12.07 |      | 115.0 |         |
|           |   | Z | 1.21   | 66.57  | 12.40 |      | 115.0 |         |
| 10406-AAB | CDMA2000, RC3, SO32, SCH0, Full Rate  | X | 31.97  | 105.65 | 26.52 | 0.00 | 100.0 | ± 9.6 % |
|           |   | Y | 100.00 | 119.11 | 28.78 |      | 100.0 |         |
|           |   | Z | 100.00 | 120.25 | 29.60 |      | 100.0 |         |
| 10410-AAD | LTE-TDD (SC-FDMA, 1 RB, 10 MHz, QPSK, UL Subframe=2,3,4,7,8,9, Subframe Conf=4) | X | 100.00 | 119.16 | 29.68 | 3.23 | 80.0  | ± 9.6 % |
|           |   | Y | 100.00 | 122.81 | 30.98 |      | 80.0  |         |
|           |   | Z | 100.00 | 120.19 | 29.97 |      | 80.0  |         |
| 10415-AAA | IEEE 802.11b WiFi 2.4 GHz (DSSS, 1 Mbps, 99pc duty cycle)                       | X | 0.96   | 62.46  | 13.98 | 0.00 | 150.0 | ± 9.6 % |
|           |   | Y | 0.99   | 62.90  | 14.23 |      | 150.0 |         |
|           |   | Z | 0.95   | 62.59  | 14.06 |      | 150.0 |         |
| 10416-AAA | IEEE 802.11g WiFi 2.4 GHz (ERP-OFDM, 6 Mbps, 99pc duty cycle)                   | X | 4.53   | 66.62  | 16.09 | 0.00 | 150.0 | ± 9.6 % |
|           |   | Y | 4.45   | 66.83  | 16.13 |      | 150.0 |         |
|           |   | Z | 4.48   | 66.68  | 16.10 |      | 150.0 |         |
| 10417-AAB | IEEE 802.11a/h WiFi 5 GHz (OFDM, 6 Mbps, 99pc duty cycle)                       | X | 4.53   | 66.62  | 16.09 | 0.00 | 150.0 | ± 9.6 % |
|           |   | Y | 4.45   | 66.83  | 16.13 |      | 150.0 |         |
|           |   | Z | 4.48   | 66.68  | 16.10 |      | 150.0 |         |
| 10418-AAA | IEEE 802.11g WiFi 2.4 GHz (DSSS-OFDM, 6 Mbps, 99pc duty cycle, Long preamble)   | X | 4.51   | 66.76  | 16.09 | 0.00 | 150.0 | ± 9.6 % |
|           |   | Y | 4.44   | 67.00  | 16.16 |      | 150.0 |         |
|           |   | Z | 4.47   | 66.83  | 16.12 |      | 150.0 |         |
| 10419-AAA | IEEE 802.11g WiFi 2.4 GHz (DSSS-OFDM, 6 Mbps, 99pc duty cycle, Short preamble)  | X | 4.54   | 66.72  | 16.10 | 0.00 | 150.0 | ± 9.6 % |
|           |   | Y | 4.46   | 66.94  | 16.15 |      | 150.0 |         |
|           |   | Z | 4.49   | 66.78  | 16.12 |      | 150.0 |         |
| 10422-AAB | IEEE 802.11n (HT Greenfield, 7.2 Mbps, BPSK)                                    | X | 4.66   | 66.73  | 16.13 | 0.00 | 150.0 | ± 9.6 % |
|           |   | Y | 4.57   | 66.94  | 16.17 |      | 150.0 |         |
|           |   | Z | 4.61   | 66.79  | 16.14 |      | 150.0 |         |
| 10423-AAB | IEEE 802.11n (HT Greenfield, 43.3 Mbps, 16-QAM)                                 | X | 4.83   | 67.07  | 16.25 | 0.00 | 150.0 | ± 9.6 % |
|           |   | Y | 4.72   | 67.22  | 16.28 |      | 150.0 |         |
|           |   | Z | 4.77   | 67.10  | 16.25 |      | 150.0 |         |
| 10424-AAB | IEEE 802.11n (HT Greenfield, 72.2 Mbps, 64-QAM)                                 | X | 4.75   | 67.01  | 16.22 | 0.00 | 150.0 | ± 9.6 % |
|           |   | Y | 4.64   | 67.18  | 16.25 |      | 150.0 |         |
|           |   | Z | 4.69   | 67.05  | 16.23 |      | 150.0 |         |
| 10425-AAB | IEEE 802.11n (HT Greenfield, 15 Mbps, BPSK)                                     | X | 5.37   | 67.43  | 16.45 | 0.00 | 150.0 | ± 9.6 % |
|           |   | Y | 5.26   | 67.46  | 16.45 |      | 150.0 |         |
|           |   | Z | 5.32   | 67.43  | 16.46 |      | 150.0 |         |
| 10426-AAB | IEEE 802.11n (HT Greenfield, 90 Mbps, 16-QAM)                                   | X | 5.37   | 67.44  | 16.46 | 0.00 | 150.0 | ± 9.6 % |
|           |   | Y | 5.28   | 67.55  | 16.49 |      | 150.0 |         |
|           |   | Z | 5.33   | 67.49  | 16.49 |      | 150.0 |         |

|           |  |   |        |        |       |      |       |         |
|-----------|--|---|--------|--------|-------|------|-------|---------|
| 10427-AAB | IEEE 802.11n (HT Greenfield, 150 Mbps, 64-QAM)                 | X | 5.38   | 67.41  | 16.44 | 0.00 | 150.0 | ± 9.6 % |
|           |  | Y | 5.27   | 67.46  | 16.44 |      | 150.0 |         |
|           |  | Z | 5.33   | 67.43  | 16.45 |      | 150.0 |         |
| 10430-AAB | LTE-FDD (OFDMA, 5 MHz, E-TM 3.1)                               | X | 4.17   | 70.27  | 17.81 | 0.00 | 150.0 | ± 9.6 % |
|           |  | Y | 4.03   | 70.48  | 17.58 |      | 150.0 |         |
|           |  | Z | 4.14   | 70.57  | 17.85 |      | 150.0 |         |
| 10431-AAB | LTE-FDD (OFDMA, 10 MHz, E-TM 3.1)                              | X | 4.21   | 67.11  | 16.05 | 0.00 | 150.0 | ± 9.6 % |
|           |  | Y | 4.09   | 67.33  | 16.03 |      | 150.0 |         |
|           |  | Z | 4.15   | 67.18  | 16.04 |      | 150.0 |         |
| 10432-AAB | LTE-FDD (OFDMA, 15 MHz, E-TM 3.1)                              | X | 4.51   | 67.03  | 16.15 | 0.00 | 150.0 | ± 9.6 % |
|           |  | Y | 4.40   | 67.23  | 16.17 |      | 150.0 |         |
|           |  | Z | 4.46   | 67.08  | 16.15 |      | 150.0 |         |
| 10433-AAB | LTE-FDD (OFDMA, 20 MHz, E-TM 3.1)                              | X | 4.76   | 67.04  | 16.24 | 0.00 | 150.0 | ± 9.6 % |
|           |  | Y | 4.66   | 67.21  | 16.27 |      | 150.0 |         |
|           |  | Z | 4.71   | 67.08  | 16.24 |      | 150.0 |         |
| 10434-AAA | W-CDMA (BS Test Model 1, 64 DPCH)                              | X | 4.23   | 70.97  | 17.72 | 0.00 | 150.0 | ± 9.6 % |
|           |  | Y | 4.07   | 71.14  | 17.40 |      | 150.0 |         |
|           |  | Z | 4.21   | 71.31  | 17.74 |      | 150.0 |         |
| 10435-AAC | LTE-TDD (SC-FDMA, 1 RB, 20 MHz, QPSK, UL Subframe=2,3,4,7,8,9) | X | 100.00 | 118.98 | 29.60 | 3.23 | 80.0  | ± 9.6 % |
|           |  | Y | 100.00 | 122.59 | 30.87 |      | 80.0  |         |
|           |  | Z | 100.00 | 119.99 | 29.88 |      | 80.0  |         |
| 10447-AAB | LTE-FDD (OFDMA, 5 MHz, E-TM 3.1, Clipping 44%)                 | X | 3.49   | 66.99  | 15.32 | 0.00 | 150.0 | ± 9.6 % |
|           |  | Y | 3.34   | 67.16  | 15.09 |      | 150.0 |         |
|           |  | Z | 3.41   | 67.04  | 15.22 |      | 150.0 |         |
| 10448-AAB | LTE-FDD (OFDMA, 10 MHz, E-TM 3.1, Clipping 44%)                | X | 4.04   | 66.88  | 15.90 | 0.00 | 150.0 | ± 9.6 % |
|           |  | Y | 3.94   | 67.12  | 15.89 |      | 150.0 |         |
|           |  | Z | 3.99   | 66.95  | 15.89 |      | 150.0 |         |
| 10449-AAB | LTE-FDD (OFDMA, 15 MHz, E-TM 3.1, Clipping 44%)                | X | 4.32   | 66.84  | 16.03 | 0.00 | 150.0 | ± 9.6 % |
|           |  | Y | 4.23   | 67.04  | 16.06 |      | 150.0 |         |
|           |  | Z | 4.27   | 66.90  | 16.04 |      | 150.0 |         |
| 10450-AAB | LTE-FDD (OFDMA, 20 MHz, E-TM 3.1, Clipping 44%)                | X | 4.51   | 66.79  | 16.08 | 0.00 | 150.0 | ± 9.6 % |
|           |  | Y | 4.44   | 66.97  | 16.11 |      | 150.0 |         |
|           |  | Z | 4.47   | 66.83  | 16.09 |      | 150.0 |         |
| 10451-AAA | W-CDMA (BS Test Model 1, 64 DPCH, Clipping 44%)                | X | 3.37   | 67.12  | 14.92 | 0.00 | 150.0 | ± 9.6 % |
|           |  | Y | 3.19   | 67.13  | 14.54 |      | 150.0 |         |
|           |  | Z | 3.28   | 67.11  | 14.76 |      | 150.0 |         |
| 10456-AAB | IEEE 802.11ac WiFi (160MHz, 64-QAM, 99pc duty cycle)           | X | 6.23   | 67.99  | 16.62 | 0.00 | 150.0 | ± 9.6 % |
|           |  | Y | 6.17   | 68.10  | 16.67 |      | 150.0 |         |
|           |  | Z | 6.19   | 67.99  | 16.63 |      | 150.0 |         |
| 10457-AAA | UMTS-FDD (DC-HSDPA)  | X | 3.77   | 65.25  | 15.79 | 0.00 | 150.0 | ± 9.6 % |
|           |  | Y | 3.75   | 65.50  | 15.83 |      | 150.0 |         |
|           |  | Z | 3.75   | 65.32  | 15.80 |      | 150.0 |         |
| 10458-AAA | CDMA2000 (1xEV-DO, Rev. B, 2 carriers)                         | X | 3.87   | 70.16  | 17.10 | 0.00 | 150.0 | ± 9.6 % |
|           |  | Y | 3.71   | 70.34  | 16.66 |      | 150.0 |         |
|           |  | Z | 3.84   | 70.49  | 17.05 |      | 150.0 |         |
| 10459-AAA | CDMA2000 (1xEV-DO, Rev. B, 3 carriers)                         | X | 5.00   | 67.94  | 17.87 | 0.00 | 150.0 | ± 9.6 % |
|           |  | Y | 4.81   | 68.13  | 17.56 |      | 150.0 |         |
|           |  | Z | 4.96   | 68.23  | 17.89 |      | 150.0 |         |



|           |   |   |        |        |       |      |       |         |
|-----------|---|---|--------|--------|-------|------|-------|---------|
| 10460-AAA | UMTS-FDD (WCDMA, AMR)   | X | 0.79   | 66.34  | 14.61 | 0.00 | 150.0 | ± 9.6 % |
|           |   | Y | 0.84   | 67.16  | 15.15 |      | 150.0 |         |
|           |   | Z | 0.79   | 66.65  | 14.76 |      | 150.0 |         |
| 10461-AAA | LTE-TDD (SC-FDMA, 1 RB, 1.4 MHz, QPSK, UL Subframe=2,3,4,7,8,9)   | X | 100.00 | 122.59 | 31.33 | 3.29 | 80.0  | ± 9.6 % |
|           |   | Y | 100.00 | 128.70 | 33.71 |      | 80.0  |         |
|           |   | Z | 100.00 | 124.88 | 32.17 |      | 80.0  |         |
| 10462-AAA | LTE-TDD (SC-FDMA, 1 RB, 1.4 MHz, 16-QAM, UL Subframe=2,3,4,7,8,9) | X | 21.46  | 90.49  | 19.92 | 3.23 | 80.0  | ± 9.6 % |
|           |   | Y | 100.00 | 107.87 | 23.85 |      | 80.0  |         |
|           |   | Z | 100.00 | 106.49 | 23.49 |      | 80.0  |         |
| 10463-AAA | LTE-TDD (SC-FDMA, 1 RB, 1.4 MHz, 64-QAM, UL Subframe=2,3,4,7,8,9) | X | 5.25   | 74.65  | 14.70 | 3.23 | 80.0  | ± 9.6 % |
|           |   | Y | 19.71  | 88.51  | 18.38 |      | 80.0  |         |
|           |   | Z | 7.19   | 78.06  | 15.56 |      | 80.0  |         |
| 10464-AAA | LTE-TDD (SC-FDMA, 1 RB, 3 MHz, QPSK, UL Subframe=2,3,4,7,8,9)     | X | 100.00 | 120.34 | 30.14 | 3.23 | 80.0  | ± 9.6 % |
|           |   | Y | 100.00 | 126.35 | 32.46 |      | 80.0  |         |
|           |   | Z | 100.00 | 122.50 | 30.92 |      | 80.0  |         |
| 10465-AAA | LTE-TDD (SC-FDMA, 1 RB, 3 MHz, 16-QAM, UL Subframe=2,3,4,7,8,9)   | X | 11.73  | 83.97  | 18.05 | 3.23 | 80.0  | ± 9.6 % |
|           |   | Y | 100.00 | 107.24 | 23.55 |      | 80.0  |         |
|           |   | Z | 41.80  | 97.17  | 21.26 |      | 80.0  |         |
| 10466-AAA | LTE-TDD (SC-FDMA, 1 RB, 3 MHz, 64-QAM, UL Subframe=2,3,4,7,8,9)   | X | 4.09   | 72.04  | 13.74 | 3.23 | 80.0  | ± 9.6 % |
|           |   | Y | 8.97   | 80.87  | 16.24 |      | 80.0  |         |
|           |   | Z | 4.77   | 73.97  | 14.19 |      | 80.0  |         |
| 10467-AAC | LTE-TDD (SC-FDMA, 1 RB, 5 MHz, QPSK, UL Subframe=2,3,4,7,8,9)     | X | 100.00 | 120.57 | 30.24 | 3.23 | 80.0  | ± 9.6 % |
|           |   | Y | 100.00 | 126.64 | 32.58 |      | 80.0  |         |
|           |   | Z | 100.00 | 122.76 | 31.03 |      | 80.0  |         |
| 10468-AAC | LTE-TDD (SC-FDMA, 1 RB, 5 MHz, 16-QAM, UL Subframe=2,3,4,7,8,9)   | X | 13.52  | 85.52  | 18.51 | 3.23 | 80.0  | ± 9.6 % |
|           |   | Y | 100.00 | 107.47 | 23.65 |      | 80.0  |         |
|           |   | Z | 60.78  | 101.09 | 22.20 |      | 80.0  |         |
| 10469-AAC | LTE-TDD (SC-FDMA, 1 RB, 5 MHz, 64-QAM, UL Subframe=2,3,4,7,8,9)   | X | 4.11   | 72.11  | 13.77 | 3.23 | 80.0  | ± 9.6 % |
|           |   | Y | 9.29   | 81.22  | 16.33 |      | 80.0  |         |
|           |   | Z | 4.83   | 74.11  | 14.24 |      | 80.0  |         |
| 10470-AAC | LTE-TDD (SC-FDMA, 1 RB, 10 MHz, QPSK, UL Subframe=2,3,4,7,8,9)    | X | 100.00 | 120.59 | 30.24 | 3.23 | 80.0  | ± 9.6 % |
|           |   | Y | 100.00 | 126.67 | 32.59 |      | 80.0  |         |
|           |   | Z | 100.00 | 122.78 | 31.03 |      | 80.0  |         |
| 10471-AAC | LTE-TDD (SC-FDMA, 1 RB, 10 MHz, 16-QAM, UL Subframe=2,3,4,7,8,9)  | X | 13.37  | 85.38  | 18.46 | 3.23 | 80.0  | ± 9.6 % |
|           |   | Y | 100.00 | 107.40 | 23.62 |      | 80.0  |         |
|           |   | Z | 59.33  | 100.79 | 22.11 |      | 80.0  |         |
| 10472-AAC | LTE-TDD (SC-FDMA, 1 RB, 10 MHz, 64-QAM, UL Subframe=2,3,4,7,8,9)  | X | 4.08   | 72.03  | 13.72 | 3.23 | 80.0  | ± 9.6 % |
|           |   | Y | 9.15   | 81.05  | 16.27 |      | 80.0  |         |
|           |   | Z | 4.78   | 73.98  | 14.18 |      | 80.0  |         |
| 10473-AAC | LTE-TDD (SC-FDMA, 1 RB, 15 MHz, QPSK, UL Subframe=2,3,4,7,8,9)    | X | 100.00 | 120.56 | 30.23 | 3.23 | 80.0  | ± 9.6 % |
|           |   | Y | 100.00 | 126.64 | 32.58 |      | 80.0  |         |
|           |   | Z | 100.00 | 122.75 | 31.02 |      | 80.0  |         |
| 10474-AAC | LTE-TDD (SC-FDMA, 1 RB, 15 MHz, 16-QAM, UL Subframe=2,3,4,7,8,9)  | X | 13.19  | 85.24  | 18.42 | 3.23 | 80.0  | ± 9.6 % |
|           |   | Y | 100.00 | 107.40 | 23.61 |      | 80.0  |         |
|           |   | Z | 57.55  | 100.49 | 22.04 |      | 80.0  |         |
| 10475-AAC | LTE-TDD (SC-FDMA, 1 RB, 15 MHz, 64-QAM, UL Subframe=2,3,4,7,8,9)  | X | 4.06   | 71.97  | 13.71 | 3.23 | 80.0  | ± 9.6 % |
|           |   | Y | 8.99   | 80.90  | 16.23 |      | 80.0  |         |
|           |   | Z | 4.73   | 73.90  | 14.15 |      | 80.0  |         |

|           |   |   |        |        |       |      |      |         |
|-----------|---|---|--------|--------|-------|------|------|---------|
| 10477-AAC | LTE-TDD (SC-FDMA, 1 RB, 20 MHz, 16-QAM, UL Subframe=2,3,4,7,8,9)    | X | 11.86  | 84.06  | 18.05 | 3.23 | 80.0 | ± 9.6 % |
|           |   | Y | 100.00 | 107.19 | 23.51 |      | 80.0 |         |
|           |   | Z | 43.65  | 97.56  | 21.32 |      | 80.0 |         |
| 10478-AAC | LTE-TDD (SC-FDMA, 1 RB, 20 MHz, 64-QAM, UL Subframe=2,3,4,7,8,9)    | X | 4.02   | 71.87  | 13.66 | 3.23 | 80.0 | ± 9.6 % |
|           |   | Y | 8.76   | 80.61  | 16.13 |      | 80.0 |         |
|           |   | Z | 4.66   | 73.74  | 14.09 |      | 80.0 |         |
| 10479-AAA | LTE-TDD (SC-FDMA, 50% RB, 1.4 MHz, QPSK, UL Subframe=2,3,4,7,8,9)   | X | 14.17  | 93.60  | 25.28 | 3.23 | 80.0 | ± 9.6 % |
|           |   | Y | 63.86  | 118.32 | 31.85 |      | 80.0 |         |
|           |   | Z | 30.71  | 105.97 | 28.68 |      | 80.0 |         |
| 10480-AAA | LTE-TDD (SC-FDMA, 50% RB, 1.4 MHz, 16-QAM, UL Subframe=2,3,4,7,8,9) | X | 12.48  | 86.47  | 21.39 | 3.23 | 80.0 | ± 9.6 % |
|           |   | Y | 53.06  | 106.13 | 26.31 |      | 80.0 |         |
|           |   | Z | 23.73  | 95.20  | 23.69 |      | 80.0 |         |
| 10481-AAA | LTE-TDD (SC-FDMA, 50% RB, 1.4 MHz, 64-QAM, UL Subframe=2,3,4,7,8,9) | X | 9.79   | 82.49  | 19.78 | 3.23 | 80.0 | ± 9.6 % |
|           |   | Y | 26.62  | 95.88  | 23.20 |      | 80.0 |         |
|           |   | Z | 15.46  | 88.60  | 21.40 |      | 80.0 |         |
| 10482-AAA | LTE-TDD (SC-FDMA, 50% RB, 3 MHz, QPSK, UL Subframe=2,3,4,7,8,9)     | X | 4.76   | 76.35  | 18.33 | 2.23 | 80.0 | ± 9.6 % |
|           |   | Y | 4.38   | 75.77  | 17.66 |      | 80.0 |         |
|           |   | Z | 4.74   | 76.54  | 18.16 |      | 80.0 |         |
| 10483-AAA | LTE-TDD (SC-FDMA, 50% RB, 3 MHz, 16-QAM, UL Subframe=2,3,4,7,8,9)   | X | 6.86   | 78.09  | 18.71 | 2.23 | 80.0 | ± 9.6 % |
|           |   | Y | 7.58   | 79.80  | 18.72 |      | 80.0 |         |
|           |   | Z | 7.91   | 80.19  | 19.17 |      | 80.0 |         |
| 10484-AAA | LTE-TDD (SC-FDMA, 50% RB, 3 MHz, 64-QAM, UL Subframe=2,3,4,7,8,9)   | X | 6.29   | 76.73  | 18.22 | 2.23 | 80.0 | ± 9.6 % |
|           |   | Y | 6.51   | 77.64  | 17.97 |      | 80.0 |         |
|           |   | Z | 6.95   | 78.27  | 18.51 |      | 80.0 |         |
| 10485-AAC | LTE-TDD (SC-FDMA, 50% RB, 5 MHz, QPSK, UL Subframe=2,3,4,7,8,9)     | X | 5.21   | 77.92  | 19.79 | 2.23 | 80.0 | ± 9.6 % |
|           |   | Y | 5.14   | 78.56  | 19.82 |      | 80.0 |         |
|           |   | Z | 5.34   | 78.68  | 19.95 |      | 80.0 |         |
| 10486-AAC | LTE-TDD (SC-FDMA, 50% RB, 5 MHz, 16-QAM, UL Subframe=2,3,4,7,8,9)   | X | 4.30   | 72.12  | 17.19 | 2.23 | 80.0 | ± 9.6 % |
|           |   | Y | 4.02   | 71.85  | 16.65 |      | 80.0 |         |
|           |   | Z | 4.23   | 72.22  | 17.03 |      | 80.0 |         |
| 10487-AAC | LTE-TDD (SC-FDMA, 50% RB, 5 MHz, 64-QAM, UL Subframe=2,3,4,7,8,9)   | X | 4.25   | 71.63  | 16.98 | 2.23 | 80.0 | ± 9.6 % |
|           |   | Y | 3.95   | 71.26  | 16.39 |      | 80.0 |         |
|           |   | Z | 4.16   | 71.66  | 16.79 |      | 80.0 |         |
| 10488-AAC | LTE-TDD (SC-FDMA, 50% RB, 10 MHz, QPSK, UL Subframe=2,3,4,7,8,9)    | X | 5.17   | 76.41  | 19.90 | 2.23 | 80.0 | ± 9.6 % |
|           |   | Y | 5.01   | 76.93  | 20.15 |      | 80.0 |         |
|           |   | Z | 5.17   | 76.91  | 20.10 |      | 80.0 |         |
| 10489-AAC | LTE-TDD (SC-FDMA, 50% RB, 10 MHz, 16-QAM, UL Subframe=2,3,4,7,8,9)  | X | 4.47   | 71.61  | 18.14 | 2.23 | 80.0 | ± 9.6 % |
|           |   | Y | 4.30   | 71.84  | 18.12 |      | 80.0 |         |
|           |   | Z | 4.42   | 71.84  | 18.19 |      | 80.0 |         |
| 10490-AAC | LTE-TDD (SC-FDMA, 50% RB, 10 MHz, 64-QAM, UL Subframe=2,3,4,7,8,9)  | X | 4.53   | 71.33  | 18.05 | 2.23 | 80.0 | ± 9.6 % |
|           |   | Y | 4.36   | 71.56  | 18.01 |      | 80.0 |         |
|           |   | Z | 4.48   | 71.55  | 18.09 |      | 80.0 |         |
| 10491-AAC | LTE-TDD (SC-FDMA, 50% RB, 15 MHz, QPSK, UL Subframe=2,3,4,7,8,9)    | X | 5.06   | 74.04  | 19.16 | 2.23 | 80.0 | ± 9.6 % |
|           |   | Y | 4.88   | 74.37  | 19.37 |      | 80.0 |         |
|           |   | Z | 5.01   | 74.33  | 19.30 |      | 80.0 |         |
| 10492-AAC | LTE-TDD (SC-FDMA, 50% RB, 15 MHz, 16-QAM, UL Subframe=2,3,4,7,8,9)  | X | 4.71   | 70.55  | 18.02 | 2.23 | 80.0 | ± 9.6 % |
|           |   | Y | 4.54   | 70.71  | 18.05 |      | 80.0 |         |
|           |   | Z | 4.64   | 70.68  | 18.06 |      | 80.0 |         |

|           |  |   |      |       |       |      |      |         |
|-----------|--|---|------|-------|-------|------|------|---------|
| 10493-AAC | LTE-TDD (SC-FDMA, 50% RB, 15 MHz, 64-QAM, UL Subframe=2,3,4,7,8,9)   | X | 4.76 | 70.36 | 17.96 | 2.23 | 80.0 | ± 9.6 % |
|           |  | Y | 4.58 | 70.52 | 17.98 |      | 80.0 |         |
|           |  | Z | 4.69 | 70.49 | 18.00 |      | 80.0 |         |
| 10494-AAC | LTE-TDD (SC-FDMA, 50% RB, 20 MHz, QPSK, UL Subframe=2,3,4,7,8,9)     | X | 5.60 | 75.75 | 19.64 | 2.23 | 80.0 | ± 9.6 % |
|           |  | Y | 5.37 | 76.02 | 19.87 |      | 80.0 |         |
|           |  | Z | 5.56 | 76.06 | 19.81 |      | 80.0 |         |
| 10495-AAC | LTE-TDD (SC-FDMA, 50% RB, 20 MHz, 16-QAM, UL Subframe=2,3,4,7,8,9)   | X | 4.78 | 71.03 | 18.23 | 2.23 | 80.0 | ± 9.6 % |
|           |  | Y | 4.59 | 71.11 | 18.27 |      | 80.0 |         |
|           |  | Z | 4.71 | 71.14 | 18.28 |      | 80.0 |         |
| 10496-AAC | LTE-TDD (SC-FDMA, 50% RB, 20 MHz, 64-QAM, UL Subframe=2,3,4,7,8,9)   | X | 4.83 | 70.65 | 18.12 | 2.23 | 80.0 | ± 9.6 % |
|           |  | Y | 4.64 | 70.74 | 18.15 |      | 80.0 |         |
|           |  | Z | 4.75 | 70.76 | 18.17 |      | 80.0 |         |
| 10497-AAA | LTE-TDD (SC-FDMA, 100% RB, 1.4 MHz, QPSK, UL Subframe=2,3,4,7,8,9)   | X | 3.37 | 71.45 | 15.57 | 2.23 | 80.0 | ± 9.6 % |
|           |  | Y | 2.72 | 69.17 | 13.95 |      | 80.0 |         |
|           |  | Z | 3.09 | 70.50 | 14.83 |      | 80.0 |         |
| 10498-AAA | LTE-TDD (SC-FDMA, 100% RB, 1.4 MHz, 16-QAM, UL Subframe=2,3,4,7,8,9) | X | 2.40 | 64.81 | 11.76 | 2.23 | 80.0 | ± 9.6 % |
|           |  | Y | 1.75 | 62.03 | 9.60  |      | 80.0 |         |
|           |  | Z | 2.07 | 63.39 | 10.68 |      | 80.0 |         |
| 10499-AAA | LTE-TDD (SC-FDMA, 100% RB, 1.4 MHz, 64-QAM, UL Subframe=2,3,4,7,8,9) | X | 2.32 | 64.18 | 11.33 | 2.23 | 80.0 | ± 9.6 % |
|           |  | Y | 1.68 | 61.41 | 9.14  |      | 80.0 |         |
|           |  | Z | 1.99 | 62.76 | 10.23 |      | 80.0 |         |
| 10500-AAA | LTE-TDD (SC-FDMA, 100% RB, 3 MHz, QPSK, UL Subframe=2,3,4,7,8,9)     | X | 5.05 | 76.85 | 19.69 | 2.23 | 80.0 | ± 9.6 % |
|           |  | Y | 4.98 | 77.59 | 19.85 |      | 80.0 |         |
|           |  | Z | 5.12 | 77.53 | 19.88 |      | 80.0 |         |
| 10501-AAA | LTE-TDD (SC-FDMA, 100% RB, 3 MHz, 16-QAM, UL Subframe=2,3,4,7,8,9)   | X | 4.38 | 71.91 | 17.55 | 2.23 | 80.0 | ± 9.6 % |
|           |  | Y | 4.19 | 72.01 | 17.27 |      | 80.0 |         |
|           |  | Z | 4.33 | 72.13 | 17.50 |      | 80.0 |         |
| 10502-AAA | LTE-TDD (SC-FDMA, 100% RB, 3 MHz, 64-QAM, UL Subframe=2,3,4,7,8,9)   | X | 4.41 | 71.66 | 17.40 | 2.23 | 80.0 | ± 9.6 % |
|           |  | Y | 4.21 | 71.71 | 17.09 |      | 80.0 |         |
|           |  | Z | 4.36 | 71.85 | 17.33 |      | 80.0 |         |
| 10503-AAC | LTE-TDD (SC-FDMA, 100% RB, 5 MHz, QPSK, UL Subframe=2,3,4,7,8,9)     | X | 5.10 | 76.19 | 19.80 | 2.23 | 80.0 | ± 9.6 % |
|           |  | Y | 4.94 | 76.71 | 20.05 |      | 80.0 |         |
|           |  | Z | 5.10 | 76.67 | 19.99 |      | 80.0 |         |
| 10504-AAC | LTE-TDD (SC-FDMA, 100% RB, 5 MHz, 16-QAM, UL Subframe=2,3,4,7,8,9)   | X | 4.44 | 71.51 | 18.08 | 2.23 | 80.0 | ± 9.6 % |
|           |  | Y | 4.28 | 71.74 | 18.06 |      | 80.0 |         |
|           |  | Z | 4.39 | 71.73 | 18.13 |      | 80.0 |         |
| 10505-AAC | LTE-TDD (SC-FDMA, 100% RB, 5 MHz, 64-QAM, UL Subframe=2,3,4,7,8,9)   | X | 4.51 | 71.23 | 18.00 | 2.23 | 80.0 | ± 9.6 % |
|           |  | Y | 4.34 | 71.46 | 17.96 |      | 80.0 |         |
|           |  | Z | 4.45 | 71.44 | 18.03 |      | 80.0 |         |
| 10506-AAC | LTE-TDD (SC-FDMA, 100% RB, 10 MHz, QPSK, UL Subframe=2,3,4,7,8,9)    | X | 5.55 | 75.59 | 19.57 | 2.23 | 80.0 | ± 9.6 % |
|           |  | Y | 5.33 | 75.87 | 19.80 |      | 80.0 |         |
|           |  | Z | 5.51 | 75.90 | 19.73 |      | 80.0 |         |
| 10507-AAC | LTE-TDD (SC-FDMA, 100% RB, 10 MHz, 16-QAM, UL Subframe=2,3,4,7,8,9)  | X | 4.76 | 70.96 | 18.19 | 2.23 | 80.0 | ± 9.6 % |
|           |  | Y | 4.57 | 71.05 | 18.23 |      | 80.0 |         |
|           |  | Z | 4.69 | 71.07 | 18.24 |      | 80.0 |         |

|           |   |   |      |       |       |      |       |         |
|-----------|---|---|------|-------|-------|------|-------|---------|
| 10508-AAC | LTE-TDD (SC-FDMA, 100% RB, 10 MHz, 64-QAM, UL Subframe=2,3,4,7,8,9) | X | 4.81 | 70.58 | 18.08 | 2.23 | 80.0  | ± 9.6 % |
|           |   | Y | 4.62 | 70.68 | 18.11 |      | 80.0  |         |
|           |   | Z | 4.73 | 70.68 | 18.12 |      | 80.0  |         |
| 10509-AAC | LTE-TDD (SC-FDMA, 100% RB, 15 MHz, QPSK, UL Subframe=2,3,4,7,8,9)   | X | 5.59 | 73.58 | 18.84 | 2.23 | 80.0  | ± 9.6 % |
|           |   | Y | 5.39 | 73.76 | 19.02 |      | 80.0  |         |
|           |   | Z | 5.53 | 73.76 | 18.95 |      | 80.0  |         |
| 10510-AAC | LTE-TDD (SC-FDMA, 100% RB, 15 MHz, 16-QAM, UL Subframe=2,3,4,7,8,9) | X | 5.20 | 70.42 | 18.08 | 2.23 | 80.0  | ± 9.6 % |
|           |   | Y | 4.99 | 70.43 | 18.12 |      | 80.0  |         |
|           |   | Z | 5.11 | 70.45 | 18.12 |      | 80.0  |         |
| 10511-AAC | LTE-TDD (SC-FDMA, 100% RB, 15 MHz, 64-QAM, UL Subframe=2,3,4,7,8,9) | X | 5.22 | 70.10 | 18.00 | 2.23 | 80.0  | ± 9.6 % |
|           |   | Y | 5.03 | 70.13 | 18.04 |      | 80.0  |         |
|           |   | Z | 5.14 | 70.14 | 18.03 |      | 80.0  |         |
| 10512-AAC | LTE-TDD (SC-FDMA, 100% RB, 20 MHz, QPSK, UL Subframe=2,3,4,7,8,9)   | X | 6.02 | 75.44 | 19.39 | 2.23 | 80.0  | ± 9.6 % |
|           |   | Y | 5.78 | 75.56 | 19.57 |      | 80.0  |         |
|           |   | Z | 5.97 | 75.65 | 19.51 |      | 80.0  |         |
| 10513-AAC | LTE-TDD (SC-FDMA, 100% RB, 20 MHz, 16-QAM, UL Subframe=2,3,4,7,8,9) | X | 5.12 | 70.82 | 18.23 | 2.23 | 80.0  | ± 9.6 % |
|           |   | Y | 4.91 | 70.75 | 18.25 |      | 80.0  |         |
|           |   | Z | 5.03 | 70.83 | 18.26 |      | 80.0  |         |
| 10514-AAC | LTE-TDD (SC-FDMA, 100% RB, 20 MHz, 64-QAM, UL Subframe=2,3,4,7,8,9) | X | 5.09 | 70.31 | 18.08 | 2.23 | 80.0  | ± 9.6 % |
|           |   | Y | 4.90 | 70.27 | 18.11 |      | 80.0  |         |
|           |   | Z | 5.01 | 70.33 | 18.11 |      | 80.0  |         |
| 10515-AAA | IEEE 802.11b WiFi 2.4 GHz (DSSS, 2 Mbps, 99pc duty cycle)           | X | 0.92 | 62.60 | 13.99 | 0.00 | 150.0 | ± 9.6 % |
|           |   | Y | 0.95 | 63.05 | 14.27 |      | 150.0 |         |
|           |   | Z | 0.91 | 62.72 | 14.07 |      | 150.0 |         |
| 10516-AAA | IEEE 802.11b WiFi 2.4 GHz (DSSS, 5.5 Mbps, 99pc duty cycle)         | X | 0.48 | 67.26 | 14.71 | 0.00 | 150.0 | ± 9.6 % |
|           |   | Y | 0.54 | 68.48 | 15.75 |      | 150.0 |         |
|           |   | Z | 0.49 | 67.82 | 15.05 |      | 150.0 |         |
| 10517-AAA | IEEE 802.11b WiFi 2.4 GHz (DSSS, 11 Mbps, 99pc duty cycle)          | X | 0.75 | 64.05 | 14.24 | 0.00 | 150.0 | ± 9.6 % |
|           |   | Y | 0.79 | 64.60 | 14.65 |      | 150.0 |         |
|           |   | Z | 0.75 | 64.23 | 14.37 |      | 150.0 |         |
| 10518-AAB | IEEE 802.11a/h WiFi 5 GHz (OFDM, 9 Mbps, 99pc duty cycle)           | X | 4.52 | 66.69 | 16.06 | 0.00 | 150.0 | ± 9.6 % |
|           |   | Y | 4.44 | 66.90 | 16.10 |      | 150.0 |         |
|           |   | Z | 4.47 | 66.75 | 16.07 |      | 150.0 |         |
| 10519-AAB | IEEE 802.11a/h WiFi 5 GHz (OFDM, 12 Mbps, 99pc duty cycle)          | X | 4.71 | 66.95 | 16.20 | 0.00 | 150.0 | ± 9.6 % |
|           |   | Y | 4.60 | 67.11 | 16.21 |      | 150.0 |         |
|           |   | Z | 4.65 | 66.98 | 16.20 |      | 150.0 |         |
| 10520-AAB | IEEE 802.11a/h WiFi 5 GHz (OFDM, 18 Mbps, 99pc duty cycle)          | X | 4.56 | 66.90 | 16.11 | 0.00 | 150.0 | ± 9.6 % |
|           |   | Y | 4.46 | 67.05 | 16.12 |      | 150.0 |         |
|           |   | Z | 4.50 | 66.93 | 16.11 |      | 150.0 |         |
| 10521-AAB | IEEE 802.11a/h WiFi 5 GHz (OFDM, 24 Mbps, 99pc duty cycle)          | X | 4.49 | 66.89 | 16.09 | 0.00 | 150.0 | ± 9.6 % |
|           |   | Y | 4.39 | 67.03 | 16.11 |      | 150.0 |         |
|           |   | Z | 4.44 | 66.91 | 16.09 |      | 150.0 |         |
| 10522-AAB | IEEE 802.11a/h WiFi 5 GHz (OFDM, 36 Mbps, 99pc duty cycle)          | X | 4.55 | 66.96 | 16.17 | 0.00 | 150.0 | ± 9.6 % |
|           |   | Y | 4.45 | 67.16 | 16.21 |      | 150.0 |         |
|           |   | Z | 4.50 | 67.02 | 16.19 |      | 150.0 |         |

|           |  |   |      |       |       |      |       |         |
|-----------|--|---|------|-------|-------|------|-------|---------|
| 10523-AAB | IEEE 802.11a/h WiFi 5 GHz (OFDM, 48 Mbps, 99pc duty cycle) | X | 4.43 | 66.81 | 16.00 | 0.00 | 150.0 | ± 9.6 % |
|           |  | Y | 4.35 | 67.05 | 16.07 |      | 150.0 |         |
|           |  | Z | 4.38 | 66.88 | 16.02 |      | 150.0 |         |
| 10524-AAB | IEEE 802.11a/h WiFi 5 GHz (OFDM, 54 Mbps, 99pc duty cycle) | X | 4.50 | 66.89 | 16.14 | 0.00 | 150.0 | ± 9.6 % |
|           |  | Y | 4.39 | 67.08 | 16.18 |      | 150.0 |         |
|           |  | Z | 4.44 | 66.94 | 16.15 |      | 150.0 |         |
| 10525-AAB | IEEE 802.11ac WiFi (20MHz, MCS0, 99pc duty cycle)          | X | 4.47 | 65.92 | 15.72 | 0.00 | 150.0 | ± 9.6 % |
|           |  | Y | 4.40 | 66.15 | 15.78 |      | 150.0 |         |
|           |  | Z | 4.43 | 65.98 | 15.74 |      | 150.0 |         |
| 10526-AAB | IEEE 802.11ac WiFi (20MHz, MCS1, 99pc duty cycle)          | X | 4.65 | 66.29 | 15.87 | 0.00 | 150.0 | ± 9.6 % |
|           |  | Y | 4.55 | 66.47 | 15.91 |      | 150.0 |         |
|           |  | Z | 4.59 | 66.34 | 15.88 |      | 150.0 |         |
| 10527-AAB | IEEE 802.11ac WiFi (20MHz, MCS2, 99pc duty cycle)          | X | 4.57 | 66.25 | 15.81 | 0.00 | 150.0 | ± 9.6 % |
|           |  | Y | 4.47 | 66.43 | 15.85 |      | 150.0 |         |
|           |  | Z | 4.52 | 66.29 | 15.82 |      | 150.0 |         |
| 10528-AAB | IEEE 802.11ac WiFi (20MHz, MCS3, 99pc duty cycle)          | X | 4.58 | 66.27 | 15.84 | 0.00 | 150.0 | ± 9.6 % |
|           |  | Y | 4.49 | 66.45 | 15.88 |      | 150.0 |         |
|           |  | Z | 4.53 | 66.31 | 15.85 |      | 150.0 |         |
| 10529-AAB | IEEE 802.11ac WiFi (20MHz, MCS4, 99pc duty cycle)          | X | 4.58 | 66.27 | 15.84 | 0.00 | 150.0 | ± 9.6 % |
|           |  | Y | 4.49 | 66.45 | 15.88 |      | 150.0 |         |
|           |  | Z | 4.53 | 66.31 | 15.85 |      | 150.0 |         |
| 10531-AAB | IEEE 802.11ac WiFi (20MHz, MCS6, 99pc duty cycle)          | X | 4.58 | 66.38 | 15.85 | 0.00 | 150.0 | ± 9.6 % |
|           |  | Y | 4.46 | 66.51 | 15.87 |      | 150.0 |         |
|           |  | Z | 4.52 | 66.40 | 15.86 |      | 150.0 |         |
| 10532-AAB | IEEE 802.11ac WiFi (20MHz, MCS7, 99pc duty cycle)          | X | 4.44 | 66.22 | 15.78 | 0.00 | 150.0 | ± 9.6 % |
|           |  | Y | 4.33 | 66.36 | 15.80 |      | 150.0 |         |
|           |  | Z | 4.38 | 66.25 | 15.78 |      | 150.0 |         |
| 10533-AAB | IEEE 802.11ac WiFi (20MHz, MCS8, 99pc duty cycle)          | X | 4.59 | 66.30 | 15.83 | 0.00 | 150.0 | ± 9.6 % |
|           |  | Y | 4.49 | 66.51 | 15.88 |      | 150.0 |         |
|           |  | Z | 4.54 | 66.36 | 15.84 |      | 150.0 |         |
| 10534-AAB | IEEE 802.11ac WiFi (40MHz, MCS0, 99pc duty cycle)          | X | 5.13 | 66.43 | 15.94 | 0.00 | 150.0 | ± 9.6 % |
|           |  | Y | 5.04 | 66.54 | 15.97 |      | 150.0 |         |
|           |  | Z | 5.08 | 66.45 | 15.95 |      | 150.0 |         |
| 10535-AAB | IEEE 802.11ac WiFi (40MHz, MCS1, 99pc duty cycle)          | X | 5.20 | 66.61 | 16.01 | 0.00 | 150.0 | ± 9.6 % |
|           |  | Y | 5.10 | 66.71 | 16.05 |      | 150.0 |         |
|           |  | Z | 5.15 | 66.64 | 16.04 |      | 150.0 |         |
| 10536-AAB | IEEE 802.11ac WiFi (40MHz, MCS2, 99pc duty cycle)          | X | 5.06 | 66.54 | 15.96 | 0.00 | 150.0 | ± 9.6 % |
|           |  | Y | 4.98 | 66.67 | 16.01 |      | 150.0 |         |
|           |  | Z | 5.01 | 66.57 | 15.98 |      | 150.0 |         |
| 10537-AAB | IEEE 802.11ac WiFi (40MHz, MCS3, 99pc duty cycle)          | X | 5.12 | 66.52 | 15.95 | 0.00 | 150.0 | ± 9.6 % |
|           |  | Y | 5.03 | 66.63 | 15.99 |      | 150.0 |         |
|           |  | Z | 5.07 | 66.54 | 15.97 |      | 150.0 |         |
| 10538-AAB | IEEE 802.11ac WiFi (40MHz, MCS4, 99pc duty cycle)          | X | 5.22 | 66.56 | 16.02 | 0.00 | 150.0 | ± 9.6 % |
|           |  | Y | 5.11 | 66.64 | 16.04 |      | 150.0 |         |
|           |  | Z | 5.16 | 66.56 | 16.02 |      | 150.0 |         |
| 10540-AAB | IEEE 802.11ac WiFi (40MHz, MCS6, 99pc duty cycle)          | X | 5.14 | 66.57 | 16.03 | 0.00 | 150.0 | ± 9.6 % |
|           |  | Y | 5.04 | 66.62 | 16.05 |      | 150.0 |         |
|           |  | Z | 5.10 | 66.60 | 16.05 |      | 150.0 |         |

|           |  |   |      |       |       |      |       |         |
|-----------|--|---|------|-------|-------|------|-------|---------|
| 10541-AAB | IEEE 802.11ac WiFi (40MHz, MCS7, 99pc duty cycle)  | X | 5.11 | 66.43 | 15.96 | 0.00 | 150.0 | ± 9.6 % |
|           |  | Y | 5.02 | 66.51 | 15.98 |      | 150.0 |         |
|           |  | Z | 5.07 | 66.45 | 15.97 |      | 150.0 |         |
| 10542-AAB | IEEE 802.11ac WiFi (40MHz, MCS8, 99pc duty cycle)  | X | 5.27 | 66.51 | 16.02 | 0.00 | 150.0 | ± 9.6 % |
|           |  | Y | 5.18 | 66.61 | 16.04 |      | 150.0 |         |
|           |  | Z | 5.22 | 66.53 | 16.03 |      | 150.0 |         |
| 10543-AAB | IEEE 802.11ac WiFi (40MHz, MCS9, 99pc duty cycle)  | X | 5.36 | 66.57 | 16.06 | 0.00 | 150.0 | ± 9.6 % |
|           |  | Y | 5.24 | 66.63 | 16.08 |      | 150.0 |         |
|           |  | Z | 5.30 | 66.57 | 16.07 |      | 150.0 |         |
| 10544-AAB | IEEE 802.11ac WiFi (80MHz, MCS0, 99pc duty cycle)  | X | 5.43 | 66.55 | 15.94 | 0.00 | 150.0 | ± 9.6 % |
|           |  | Y | 5.37 | 66.65 | 15.97 |      | 150.0 |         |
|           |  | Z | 5.40 | 66.56 | 15.95 |      | 150.0 |         |
| 10545-AAB | IEEE 802.11ac WiFi (80MHz, MCS1, 99pc duty cycle)  | X | 5.64 | 67.00 | 16.11 | 0.00 | 150.0 | ± 9.6 % |
|           |  | Y | 5.55 | 67.08 | 16.15 |      | 150.0 |         |
|           |  | Z | 5.60 | 67.02 | 16.13 |      | 150.0 |         |
| 10546-AAB | IEEE 802.11ac WiFi (80MHz, MCS2, 99pc duty cycle)  | X | 5.50 | 66.78 | 16.02 | 0.00 | 150.0 | ± 9.6 % |
|           |  | Y | 5.41 | 66.80 | 16.02 |      | 150.0 |         |
|           |  | Z | 5.46 | 66.76 | 16.01 |      | 150.0 |         |
| 10547-AAB | IEEE 802.11ac WiFi (80MHz, MCS3, 99pc duty cycle)  | X | 5.58 | 66.83 | 16.03 | 0.00 | 150.0 | ± 9.6 % |
|           |  | Y | 5.49 | 66.87 | 16.05 |      | 150.0 |         |
|           |  | Z | 5.53 | 66.81 | 16.03 |      | 150.0 |         |
| 10548-AAB | IEEE 802.11ac WiFi (80MHz, MCS4, 99pc duty cycle)  | X | 5.89 | 67.94 | 16.56 | 0.00 | 150.0 | ± 9.6 % |
|           |  | Y | 5.69 | 67.68 | 16.43 |      | 150.0 |         |
|           |  | Z | 5.80 | 67.83 | 16.51 |      | 150.0 |         |
| 10550-AAB | IEEE 802.11ac WiFi (80MHz, MCS6, 99pc duty cycle)  | X | 5.53 | 66.79 | 16.03 | 0.00 | 150.0 | ± 9.6 % |
|           |  | Y | 5.46 | 66.91 | 16.08 |      | 150.0 |         |
|           |  | Z | 5.49 | 66.81 | 16.05 |      | 150.0 |         |
| 10551-AAB | IEEE 802.11ac WiFi (80MHz, MCS7, 99pc duty cycle)  | X | 5.53 | 66.82 | 16.01 | 0.00 | 150.0 | ± 9.6 % |
|           |  | Y | 5.44 | 66.85 | 16.02 |      | 150.0 |         |
|           |  | Z | 5.49 | 66.83 | 16.02 |      | 150.0 |         |
| 10552-AAB | IEEE 802.11ac WiFi (80MHz, MCS8, 99pc duty cycle)  | X | 5.44 | 66.61 | 15.91 | 0.00 | 150.0 | ± 9.6 % |
|           |  | Y | 5.38 | 66.72 | 15.95 |      | 150.0 |         |
|           |  | Z | 5.40 | 66.62 | 15.92 |      | 150.0 |         |
| 10553-AAB | IEEE 802.11ac WiFi (80MHz, MCS9, 99pc duty cycle)  | X | 5.53 | 66.66 | 15.96 | 0.00 | 150.0 | ± 9.6 % |
|           |  | Y | 5.45 | 66.72 | 15.99 |      | 150.0 |         |
|           |  | Z | 5.48 | 66.65 | 15.97 |      | 150.0 |         |
| 10554-AAC | IEEE 802.11ac WiFi (160MHz, MCS0, 99pc duty cycle) | X | 5.84 | 66.93 | 16.04 | 0.00 | 150.0 | ± 9.6 % |
|           |  | Y | 5.78 | 67.01 | 16.06 |      | 150.0 |         |
|           |  | Z | 5.81 | 66.94 | 16.05 |      | 150.0 |         |
| 10555-AAC | IEEE 802.11ac WiFi (160MHz, MCS1, 99pc duty cycle) | X | 5.98 | 67.25 | 16.17 | 0.00 | 150.0 | ± 9.6 % |
|           |  | Y | 5.90 | 67.29 | 16.19 |      | 150.0 |         |
|           |  | Z | 5.94 | 67.25 | 16.18 |      | 150.0 |         |
| 10556-AAC | IEEE 802.11ac WiFi (160MHz, MCS2, 99pc duty cycle) | X | 6.00 | 67.29 | 16.19 | 0.00 | 150.0 | ± 9.6 % |
|           |  | Y | 5.93 | 67.35 | 16.21 |      | 150.0 |         |
|           |  | Z | 5.96 | 67.30 | 16.20 |      | 150.0 |         |
| 10557-AAC | IEEE 802.11ac WiFi (160MHz, MCS3, 99pc duty cycle) | X | 5.96 | 67.20 | 16.16 | 0.00 | 150.0 | ± 9.6 % |
|           |  | Y | 5.88 | 67.23 | 16.17 |      | 150.0 |         |
|           |  | Z | 5.92 | 67.18 | 16.16 |      | 150.0 |         |

|           |   |   |      |       |       |      |       |         |
|-----------|---|---|------|-------|-------|------|-------|---------|
| 10558-AAC | IEEE 802.11ac WiFi (160MHz, MCS4, 99pc duty cycle)              | X | 6.01 | 67.37 | 16.26 | 0.00 | 150.0 | ± 9.6 % |
|           |   | Y | 5.92 | 67.38 | 16.26 |      | 150.0 |         |
|           |   | Z | 5.97 | 67.35 | 16.26 |      | 150.0 |         |
| 10560-AAC | IEEE 802.11ac WiFi (160MHz, MCS6, 99pc duty cycle)              | X | 6.01 | 67.21 | 16.22 | 0.00 | 150.0 | ± 9.6 % |
|           |   | Y | 5.92 | 67.24 | 16.23 |      | 150.0 |         |
|           |   | Z | 5.96 | 67.19 | 16.22 |      | 150.0 |         |
| 10561-AAC | IEEE 802.11ac WiFi (160MHz, MCS7, 99pc duty cycle)              | X | 5.93 | 67.18 | 16.25 | 0.00 | 150.0 | ± 9.6 % |
|           |   | Y | 5.85 | 67.23 | 16.26 |      | 150.0 |         |
|           |   | Z | 5.89 | 67.18 | 16.25 |      | 150.0 |         |
| 10562-AAC | IEEE 802.11ac WiFi (160MHz, MCS8, 99pc duty cycle)              | X | 6.07 | 67.61 | 16.46 | 0.00 | 150.0 | ± 9.6 % |
|           |   | Y | 5.94 | 67.50 | 16.40 |      | 150.0 |         |
|           |   | Z | 6.01 | 67.54 | 16.43 |      | 150.0 |         |
| 10563-AAC | IEEE 802.11ac WiFi (160MHz, MCS9, 99pc duty cycle)              | X | 6.39 | 68.16 | 16.69 | 0.00 | 150.0 | ± 9.6 % |
|           |   | Y | 6.02 | 67.41 | 16.31 |      | 150.0 |         |
|           |   | Z | 6.19 | 67.71 | 16.48 |      | 150.0 |         |
| 10564-AAA | IEEE 802.11g WiFi 2.4 GHz (DSSS-OFDM, 9 Mbps, 99pc duty cycle)  | X | 4.86 | 66.83 | 16.26 | 0.46 | 150.0 | ± 9.6 % |
|           |   | Y | 4.78 | 67.03 | 16.31 |      | 150.0 |         |
|           |   | Z | 4.81 | 66.87 | 16.27 |      | 150.0 |         |
| 10565-AAA | IEEE 802.11g WiFi 2.4 GHz (DSSS-OFDM, 12 Mbps, 99pc duty cycle) | X | 5.09 | 67.28 | 16.58 | 0.46 | 150.0 | ± 9.6 % |
|           |   | Y | 4.98 | 67.43 | 16.60 |      | 150.0 |         |
|           |   | Z | 5.03 | 67.31 | 16.59 |      | 150.0 |         |
| 10566-AAA | IEEE 802.11g WiFi 2.4 GHz (DSSS-OFDM, 18 Mbps, 99pc duty cycle) | X | 4.93 | 67.13 | 16.40 | 0.46 | 150.0 | ± 9.6 % |
|           |   | Y | 4.82 | 67.27 | 16.42 |      | 150.0 |         |
|           |   | Z | 4.87 | 67.15 | 16.40 |      | 150.0 |         |
| 10567-AAA | IEEE 802.11g WiFi 2.4 GHz (DSSS-OFDM, 24 Mbps, 99pc duty cycle) | X | 4.95 | 67.50 | 16.74 | 0.46 | 150.0 | ± 9.6 % |
|           |   | Y | 4.84 | 67.61 | 16.74 |      | 150.0 |         |
|           |   | Z | 4.90 | 67.52 | 16.74 |      | 150.0 |         |
| 10568-AAA | IEEE 802.11g WiFi 2.4 GHz (DSSS-OFDM, 36 Mbps, 99pc duty cycle) | X | 4.85 | 66.93 | 16.19 | 0.46 | 150.0 | ± 9.6 % |
|           |   | Y | 4.74 | 67.12 | 16.24 |      | 150.0 |         |
|           |   | Z | 4.79 | 66.97 | 16.19 |      | 150.0 |         |
| 10569-AAA | IEEE 802.11g WiFi 2.4 GHz (DSSS-OFDM, 48 Mbps, 99pc duty cycle) | X | 4.91 | 67.57 | 16.79 | 0.46 | 150.0 | ± 9.6 % |
|           |   | Y | 4.82 | 67.76 | 16.84 |      | 150.0 |         |
|           |   | Z | 4.86 | 67.64 | 16.82 |      | 150.0 |         |
| 10570-AAA | IEEE 802.11g WiFi 2.4 GHz (DSSS-OFDM, 54 Mbps, 99pc duty cycle) | X | 4.94 | 67.43 | 16.73 | 0.46 | 150.0 | ± 9.6 % |
|           |   | Y | 4.84 | 67.60 | 16.77 |      | 150.0 |         |
|           |   | Z | 4.89 | 67.48 | 16.75 |      | 150.0 |         |
| 10571-AAA | IEEE 802.11b WiFi 2.4 GHz (DSSS, 1 Mbps, 90pc duty cycle)       | X | 1.25 | 65.19 | 15.53 | 0.46 | 130.0 | ± 9.6 % |
|           |   | Y | 1.27 | 65.45 | 15.71 |      | 130.0 |         |
|           |   | Z | 1.24 | 65.29 | 15.60 |      | 130.0 |         |
| 10572-AAA | IEEE 802.11b WiFi 2.4 GHz (DSSS, 2 Mbps, 90pc duty cycle)       | X | 1.27 | 65.79 | 15.87 | 0.46 | 130.0 | ± 9.6 % |
|           |   | Y | 1.28 | 66.03 | 16.05 |      | 130.0 |         |
|           |   | Z | 1.26 | 65.90 | 15.96 |      | 130.0 |         |
| 10573-AAA | IEEE 802.11b WiFi 2.4 GHz (DSSS, 5.5 Mbps, 90pc duty cycle)     | X | 2.61 | 85.52 | 21.81 | 0.46 | 130.0 | ± 9.6 % |
|           |   | Y | 2.97 | 88.51 | 23.34 |      | 130.0 |         |
|           |   | Z | 3.01 | 88.05 | 22.71 |      | 130.0 |         |
| 10574-AAA | IEEE 802.11b WiFi 2.4 GHz (DSSS, 11 Mbps, 90pc duty cycle)      | X | 1.44 | 71.64 | 18.59 | 0.46 | 130.0 | ± 9.6 % |
|           |   | Y | 1.44 | 71.68 | 18.74 |      | 130.0 |         |
|           |   | Z | 1.45 | 72.00 | 18.80 |      | 130.0 |         |

|           |   |   |      |       |       |      |       |         |
|-----------|---|---|------|-------|-------|------|-------|---------|
| 10575-AAA | IEEE 802.11g WiFi 2.4 GHz (DSSS-OFDM, 6 Mbps, 90pc duty cycle)  | X | 4.68 | 66.71 | 16.37 | 0.46 | 130.0 | ± 9.6 % |
|           |   | Y | 4.59 | 66.91 | 16.41 |      | 130.0 |         |
|           |   | Z | 4.63 | 66.76 | 16.38 |      | 130.0 |         |
| 10576-AAA | IEEE 802.11g WiFi 2.4 GHz (DSSS-OFDM, 9 Mbps, 90pc duty cycle)  | X | 4.70 | 66.86 | 16.43 | 0.46 | 130.0 | ± 9.6 % |
|           |   | Y | 4.61 | 67.07 | 16.47 |      | 130.0 |         |
|           |   | Z | 4.65 | 66.92 | 16.44 |      | 130.0 |         |
| 10577-AAA | IEEE 802.11g WiFi 2.4 GHz (DSSS-OFDM, 12 Mbps, 90pc duty cycle) | X | 4.91 | 67.16 | 16.60 | 0.46 | 130.0 | ± 9.6 % |
|           |   | Y | 4.79 | 67.31 | 16.62 |      | 130.0 |         |
|           |   | Z | 4.85 | 67.20 | 16.60 |      | 130.0 |         |
| 10578-AAA | IEEE 802.11g WiFi 2.4 GHz (DSSS-OFDM, 18 Mbps, 90pc duty cycle) | X | 4.81 | 67.32 | 16.69 | 0.46 | 130.0 | ± 9.6 % |
|           |   | Y | 4.69 | 67.44 | 16.70 |      | 130.0 |         |
|           |   | Z | 4.75 | 67.35 | 16.70 |      | 130.0 |         |
| 10579-AAA | IEEE 802.11g WiFi 2.4 GHz (DSSS-OFDM, 24 Mbps, 90pc duty cycle) | X | 4.58 | 66.65 | 16.03 | 0.46 | 130.0 | ± 9.6 % |
|           |   | Y | 4.47 | 66.80 | 16.06 |      | 130.0 |         |
|           |   | Z | 4.52 | 66.66 | 16.02 |      | 130.0 |         |
| 10580-AAA | IEEE 802.11g WiFi 2.4 GHz (DSSS-OFDM, 36 Mbps, 90pc duty cycle) | X | 4.63 | 66.68 | 16.05 | 0.46 | 130.0 | ± 9.6 % |
|           |   | Y | 4.52 | 66.87 | 16.11 |      | 130.0 |         |
|           |   | Z | 4.57 | 66.71 | 16.05 |      | 130.0 |         |
| 10581-AAA | IEEE 802.11g WiFi 2.4 GHz (DSSS-OFDM, 48 Mbps, 90pc duty cycle) | X | 4.71 | 67.36 | 16.64 | 0.46 | 130.0 | ± 9.6 % |
|           |   | Y | 4.60 | 67.52 | 16.66 |      | 130.0 |         |
|           |   | Z | 4.65 | 67.41 | 16.65 |      | 130.0 |         |
| 10582-AAA | IEEE 802.11g WiFi 2.4 GHz (DSSS-OFDM, 54 Mbps, 90pc duty cycle) | X | 4.53 | 66.42 | 15.83 | 0.46 | 130.0 | ± 9.6 % |
|           |   | Y | 4.41 | 66.60 | 15.88 |      | 130.0 |         |
|           |   | Z | 4.46 | 66.43 | 15.82 |      | 130.0 |         |
| 10583-AAB | IEEE 802.11a/h WiFi 5 GHz (OFDM, 6 Mbps, 90pc duty cycle)       | X | 4.68 | 66.71 | 16.37 | 0.46 | 130.0 | ± 9.6 % |
|           |   | Y | 4.59 | 66.91 | 16.41 |      | 130.0 |         |
|           |   | Z | 4.63 | 66.76 | 16.38 |      | 130.0 |         |
| 10584-AAB | IEEE 802.11a/h WiFi 5 GHz (OFDM, 9 Mbps, 90pc duty cycle)       | X | 4.70 | 66.86 | 16.43 | 0.46 | 130.0 | ± 9.6 % |
|           |   | Y | 4.61 | 67.07 | 16.47 |      | 130.0 |         |
|           |   | Z | 4.65 | 66.92 | 16.44 |      | 130.0 |         |
| 10585-AAB | IEEE 802.11a/h WiFi 5 GHz (OFDM, 12 Mbps, 90pc duty cycle)      | X | 4.91 | 67.16 | 16.60 | 0.46 | 130.0 | ± 9.6 % |
|           |   | Y | 4.79 | 67.31 | 16.62 |      | 130.0 |         |
|           |   | Z | 4.85 | 67.20 | 16.60 |      | 130.0 |         |
| 10586-AAB | IEEE 802.11a/h WiFi 5 GHz (OFDM, 18 Mbps, 90pc duty cycle)      | X | 4.81 | 67.32 | 16.69 | 0.46 | 130.0 | ± 9.6 % |
|           |   | Y | 4.69 | 67.44 | 16.70 |      | 130.0 |         |
|           |   | Z | 4.75 | 67.35 | 16.70 |      | 130.0 |         |
| 10587-AAB | IEEE 802.11a/h WiFi 5 GHz (OFDM, 24 Mbps, 90pc duty cycle)      | X | 4.58 | 66.65 | 16.03 | 0.46 | 130.0 | ± 9.6 % |
|           |   | Y | 4.47 | 66.80 | 16.06 |      | 130.0 |         |
|           |   | Z | 4.52 | 66.66 | 16.02 |      | 130.0 |         |
| 10588-AAB | IEEE 802.11a/h WiFi 5 GHz (OFDM, 36 Mbps, 90pc duty cycle)      | X | 4.63 | 66.68 | 16.05 | 0.46 | 130.0 | ± 9.6 % |
|           |   | Y | 4.52 | 66.87 | 16.11 |      | 130.0 |         |
|           |   | Z | 4.57 | 66.71 | 16.05 |      | 130.0 |         |
| 10589-AAB | IEEE 802.11a/h WiFi 5 GHz (OFDM, 48 Mbps, 90pc duty cycle)      | X | 4.71 | 67.36 | 16.64 | 0.46 | 130.0 | ± 9.6 % |
|           |   | Y | 4.60 | 67.52 | 16.66 |      | 130.0 |         |
|           |   | Z | 4.65 | 67.41 | 16.65 |      | 130.0 |         |
| 10590-AAB | IEEE 802.11a/h WiFi 5 GHz (OFDM, 54 Mbps, 90pc duty cycle)      | X | 4.53 | 66.42 | 15.83 | 0.46 | 130.0 | ± 9.6 % |
|           |   | Y | 4.41 | 66.60 | 15.88 |      | 130.0 |         |
|           |   | Z | 4.46 | 66.43 | 15.82 |      | 130.0 |         |



|           |   |   |      |       |       |      |       |         |
|-----------|---|---|------|-------|-------|------|-------|---------|
| 10591-AAB | IEEE 802.11n (HT Mixed, 20MHz, MCS0, 90pc duty cycle) | X | 4.83 | 66.77 | 16.47 | 0.46 | 130.0 | ± 9.6 % |
|           |   | Y | 4.74 | 66.96 | 16.50 |      | 130.0 |         |
|           |   | Z | 4.78 | 66.82 | 16.48 |      | 130.0 |         |
| 10592-AAB | IEEE 802.11n (HT Mixed, 20MHz, MCS1, 90pc duty cycle) | X | 4.98 | 67.10 | 16.60 | 0.46 | 130.0 | ± 9.6 % |
|           |   | Y | 4.87 | 67.27 | 16.63 |      | 130.0 |         |
|           |   | Z | 4.93 | 67.14 | 16.61 |      | 130.0 |         |
| 10593-AAB | IEEE 802.11n (HT Mixed, 20MHz, MCS2, 90pc duty cycle) | X | 4.91 | 67.02 | 16.48 | 0.46 | 130.0 | ± 9.6 % |
|           |   | Y | 4.80 | 67.17 | 16.51 |      | 130.0 |         |
|           |   | Z | 4.85 | 67.05 | 16.49 |      | 130.0 |         |
| 10594-AAB | IEEE 802.11n (HT Mixed, 20MHz, MCS3, 90pc duty cycle) | X | 4.96 | 67.18 | 16.63 | 0.46 | 130.0 | ± 9.6 % |
|           |   | Y | 4.85 | 67.33 | 16.66 |      | 130.0 |         |
|           |   | Z | 4.90 | 67.22 | 16.64 |      | 130.0 |         |
| 10595-AAB | IEEE 802.11n (HT Mixed, 20MHz, MCS4, 90pc duty cycle) | X | 4.93 | 67.14 | 16.53 | 0.46 | 130.0 | ± 9.6 % |
|           |   | Y | 4.82 | 67.31 | 16.57 |      | 130.0 |         |
|           |   | Z | 4.87 | 67.18 | 16.54 |      | 130.0 |         |
| 10596-AAB | IEEE 802.11n (HT Mixed, 20MHz, MCS5, 90pc duty cycle) | X | 4.87 | 67.14 | 16.54 | 0.46 | 130.0 | ± 9.6 % |
|           |   | Y | 4.76 | 67.30 | 16.57 |      | 130.0 |         |
|           |   | Z | 4.81 | 67.18 | 16.54 |      | 130.0 |         |
| 10597-AAB | IEEE 802.11n (HT Mixed, 20MHz, MCS6, 90pc duty cycle) | X | 4.82 | 67.05 | 16.42 | 0.46 | 130.0 | ± 9.6 % |
|           |   | Y | 4.71 | 67.19 | 16.44 |      | 130.0 |         |
|           |   | Z | 4.76 | 67.07 | 16.42 |      | 130.0 |         |
| 10598-AAB | IEEE 802.11n (HT Mixed, 20MHz, MCS7, 90pc duty cycle) | X | 4.80 | 67.28 | 16.68 | 0.46 | 130.0 | ± 9.6 % |
|           |   | Y | 4.69 | 67.37 | 16.67 |      | 130.0 |         |
|           |   | Z | 4.74 | 67.29 | 16.67 |      | 130.0 |         |
| 10599-AAB | IEEE 802.11n (HT Mixed, 40MHz, MCS0, 90pc duty cycle) | X | 5.50 | 67.33 | 16.69 | 0.46 | 130.0 | ± 9.6 % |
|           |   | Y | 5.40 | 67.43 | 16.72 |      | 130.0 |         |
|           |   | Z | 5.46 | 67.38 | 16.72 |      | 130.0 |         |
| 10600-AAB | IEEE 802.11n (HT Mixed, 40MHz, MCS1, 90pc duty cycle) | X | 5.67 | 67.87 | 16.93 | 0.46 | 130.0 | ± 9.6 % |
|           |   | Y | 5.53 | 67.86 | 16.92 |      | 130.0 |         |
|           |   | Z | 5.61 | 67.87 | 16.94 |      | 130.0 |         |
| 10601-AAB | IEEE 802.11n (HT Mixed, 40MHz, MCS2, 90pc duty cycle) | X | 5.54 | 67.56 | 16.79 | 0.46 | 130.0 | ± 9.6 % |
|           |   | Y | 5.42 | 67.61 | 16.80 |      | 130.0 |         |
|           |   | Z | 5.48 | 67.56 | 16.80 |      | 130.0 |         |
| 10602-AAB | IEEE 802.11n (HT Mixed, 40MHz, MCS3, 90pc duty cycle) | X | 5.63 | 67.58 | 16.72 | 0.46 | 130.0 | ± 9.6 % |
|           |   | Y | 5.55 | 67.79 | 16.82 |      | 130.0 |         |
|           |   | Z | 5.59 | 67.64 | 16.76 |      | 130.0 |         |
| 10603-AAB | IEEE 802.11n (HT Mixed, 40MHz, MCS4, 90pc duty cycle) | X | 5.71 | 67.86 | 16.99 | 0.46 | 130.0 | ± 9.6 % |
|           |   | Y | 5.61 | 68.00 | 17.05 |      | 130.0 |         |
|           |   | Z | 5.65 | 67.89 | 17.01 |      | 130.0 |         |
| 10604-AAB | IEEE 802.11n (HT Mixed, 40MHz, MCS5, 90pc duty cycle) | X | 5.50 | 67.29 | 16.70 | 0.46 | 130.0 | ± 9.6 % |
|           |   | Y | 5.49 | 67.68 | 16.88 |      | 130.0 |         |
|           |   | Z | 5.47 | 67.39 | 16.75 |      | 130.0 |         |
| 10605-AAB | IEEE 802.11n (HT Mixed, 40MHz, MCS6, 90pc duty cycle) | X | 5.63 | 67.69 | 16.90 | 0.46 | 130.0 | ± 9.6 % |
|           |   | Y | 5.53 | 67.80 | 16.94 |      | 130.0 |         |
|           |   | Z | 5.59 | 67.74 | 16.92 |      | 130.0 |         |
| 10606-AAB | IEEE 802.11n (HT Mixed, 40MHz, MCS7, 90pc duty cycle) | X | 5.39 | 67.07 | 16.45 | 0.46 | 130.0 | ± 9.6 % |
|           |   | Y | 5.27 | 67.10 | 16.45 |      | 130.0 |         |
|           |   | Z | 5.31 | 66.99 | 16.41 |      | 130.0 |         |

|           |   |   |      |       |       |      |       |         |
|-----------|---|---|------|-------|-------|------|-------|---------|
| 10607-AAB | IEEE 802.11ac WiFi (20MHz, MCS0, 90pc duty cycle) | X | 4.65 | 66.04 | 16.07 | 0.46 | 130.0 | ± 9.6 % |
|           |   | Y | 4.58 | 66.26 | 16.12 |      | 130.0 |         |
|           |   | Z | 4.61 | 66.10 | 16.08 |      | 130.0 |         |
| 10608-AAB | IEEE 802.11ac WiFi (20MHz, MCS1, 90pc duty cycle) | X | 4.85 | 66.45 | 16.23 | 0.46 | 130.0 | ± 9.6 % |
|           |   | Y | 4.74 | 66.63 | 16.28 |      | 130.0 |         |
|           |   | Z | 4.79 | 66.50 | 16.25 |      | 130.0 |         |
| 10609-AAB | IEEE 802.11ac WiFi (20MHz, MCS2, 90pc duty cycle) | X | 4.74 | 66.30 | 16.07 | 0.46 | 130.0 | ± 9.6 % |
|           |   | Y | 4.63 | 66.48 | 16.11 |      | 130.0 |         |
|           |   | Z | 4.68 | 66.35 | 16.08 |      | 130.0 |         |
| 10610-AAB | IEEE 802.11ac WiFi (20MHz, MCS3, 90pc duty cycle) | X | 4.79 | 66.46 | 16.23 | 0.46 | 130.0 | ± 9.6 % |
|           |   | Y | 4.68 | 66.63 | 16.27 |      | 130.0 |         |
|           |   | Z | 4.73 | 66.50 | 16.25 |      | 130.0 |         |
| 10611-AAB | IEEE 802.11ac WiFi (20MHz, MCS4, 90pc duty cycle) | X | 4.70 | 66.28 | 16.09 | 0.46 | 130.0 | ± 9.6 % |
|           |   | Y | 4.60 | 66.45 | 16.12 |      | 130.0 |         |
|           |   | Z | 4.65 | 66.31 | 16.10 |      | 130.0 |         |
| 10612-AAB | IEEE 802.11ac WiFi (20MHz, MCS5, 90pc duty cycle) | X | 4.72 | 66.43 | 16.13 | 0.46 | 130.0 | ± 9.6 % |
|           |   | Y | 4.60 | 66.61 | 16.18 |      | 130.0 |         |
|           |   | Z | 4.66 | 66.47 | 16.14 |      | 130.0 |         |
| 10613-AAB | IEEE 802.11ac WiFi (20MHz, MCS6, 90pc duty cycle) | X | 4.72 | 66.33 | 16.02 | 0.46 | 130.0 | ± 9.6 % |
|           |   | Y | 4.60 | 66.47 | 16.05 |      | 130.0 |         |
|           |   | Z | 4.66 | 66.35 | 16.02 |      | 130.0 |         |
| 10614-AAB | IEEE 802.11ac WiFi (20MHz, MCS7, 90pc duty cycle) | X | 4.66 | 66.50 | 16.24 | 0.46 | 130.0 | ± 9.6 % |
|           |   | Y | 4.55 | 66.62 | 16.25 |      | 130.0 |         |
|           |   | Z | 4.60 | 66.53 | 16.25 |      | 130.0 |         |
| 10615-AAB | IEEE 802.11ac WiFi (20MHz, MCS8, 90pc duty cycle) | X | 4.71 | 66.12 | 15.87 | 0.46 | 130.0 | ± 9.6 % |
|           |   | Y | 4.60 | 66.33 | 15.93 |      | 130.0 |         |
|           |   | Z | 4.65 | 66.16 | 15.88 |      | 130.0 |         |
| 10616-AAB | IEEE 802.11ac WiFi (40MHz, MCS0, 90pc duty cycle) | X | 5.31 | 66.56 | 16.28 | 0.46 | 130.0 | ± 9.6 % |
|           |   | Y | 5.21 | 66.65 | 16.31 |      | 130.0 |         |
|           |   | Z | 5.26 | 66.57 | 16.29 |      | 130.0 |         |
| 10617-AAB | IEEE 802.11ac WiFi (40MHz, MCS1, 90pc duty cycle) | X | 5.38 | 66.74 | 16.35 | 0.46 | 130.0 | ± 9.6 % |
|           |   | Y | 5.29 | 66.86 | 16.39 |      | 130.0 |         |
|           |   | Z | 5.34 | 66.79 | 16.37 |      | 130.0 |         |
| 10618-AAB | IEEE 802.11ac WiFi (40MHz, MCS2, 90pc duty cycle) | X | 5.26 | 66.74 | 16.36 | 0.46 | 130.0 | ± 9.6 % |
|           |   | Y | 5.18 | 66.87 | 16.40 |      | 130.0 |         |
|           |   | Z | 5.22 | 66.77 | 16.38 |      | 130.0 |         |
| 10619-AAB | IEEE 802.11ac WiFi (40MHz, MCS3, 90pc duty cycle) | X | 5.29 | 66.59 | 16.22 | 0.46 | 130.0 | ± 9.6 % |
|           |   | Y | 5.19 | 66.67 | 16.25 |      | 130.0 |         |
|           |   | Z | 5.23 | 66.58 | 16.22 |      | 130.0 |         |
| 10620-AAB | IEEE 802.11ac WiFi (40MHz, MCS4, 90pc duty cycle) | X | 5.38 | 66.62 | 16.29 | 0.46 | 130.0 | ± 9.6 % |
|           |   | Y | 5.27 | 66.70 | 16.31 |      | 130.0 |         |
|           |   | Z | 5.32 | 66.62 | 16.29 |      | 130.0 |         |
| 10621-AAB | IEEE 802.11ac WiFi (40MHz, MCS5, 90pc duty cycle) | X | 5.37 | 66.71 | 16.45 | 0.46 | 130.0 | ± 9.6 % |
|           |   | Y | 5.27 | 66.80 | 16.47 |      | 130.0 |         |
|           |   | Z | 5.32 | 66.74 | 16.47 |      | 130.0 |         |
| 10622-AAB | IEEE 802.11ac WiFi (40MHz, MCS6, 90pc duty cycle) | X | 5.39 | 66.89 | 16.53 | 0.46 | 130.0 | ± 9.6 % |
|           |   | Y | 5.29 | 66.97 | 16.55 |      | 130.0 |         |
|           |   | Z | 5.34 | 66.92 | 16.55 |      | 130.0 |         |

|           |  |   |      |       |       |      |       |         |
|-----------|--|---|------|-------|-------|------|-------|---------|
| 10623-AAB | IEEE 802.11ac WiFi (40MHz, MCS7, 90pc duty cycle)  | X | 5.26 | 66.41 | 16.17 | 0.46 | 130.0 | ± 9.6 % |
|           |  | Y | 5.16 | 66.51 | 16.20 |      | 130.0 |         |
|           |  | Z | 5.21 | 66.44 | 16.19 |      | 130.0 |         |
| 10624-AAB | IEEE 802.11ac WiFi (40MHz, MCS8, 90pc duty cycle)  | X | 5.45 | 66.63 | 16.34 | 0.46 | 130.0 | ± 9.6 % |
|           |  | Y | 5.35 | 66.71 | 16.36 |      | 130.0 |         |
|           |  | Z | 5.40 | 66.64 | 16.35 |      | 130.0 |         |
| 10625-AAB | IEEE 802.11ac WiFi (40MHz, MCS9, 90pc duty cycle)  | X | 5.87 | 67.75 | 16.95 | 0.46 | 130.0 | ± 9.6 % |
|           |  | Y | 5.59 | 67.32 | 16.72 |      | 130.0 |         |
|           |  | Z | 5.77 | 67.62 | 16.89 |      | 130.0 |         |
| 10626-AAB | IEEE 802.11ac WiFi (80MHz, MCS0, 90pc duty cycle)  | X | 5.59 | 66.61 | 16.24 | 0.46 | 130.0 | ± 9.6 % |
|           |  | Y | 5.53 | 66.71 | 16.27 |      | 130.0 |         |
|           |  | Z | 5.56 | 66.63 | 16.25 |      | 130.0 |         |
| 10627-AAB | IEEE 802.11ac WiFi (80MHz, MCS1, 90pc duty cycle)  | X | 5.86 | 67.23 | 16.51 | 0.46 | 130.0 | ± 9.6 % |
|           |  | Y | 5.77 | 67.31 | 16.54 |      | 130.0 |         |
|           |  | Z | 5.82 | 67.26 | 16.53 |      | 130.0 |         |
| 10628-AAB | IEEE 802.11ac WiFi (80MHz, MCS2, 90pc duty cycle)  | X | 5.64 | 66.75 | 16.20 | 0.46 | 130.0 | ± 9.6 % |
|           |  | Y | 5.54 | 66.76 | 16.20 |      | 130.0 |         |
|           |  | Z | 5.59 | 66.73 | 16.20 |      | 130.0 |         |
| 10629-AAB | IEEE 802.11ac WiFi (80MHz, MCS3, 90pc duty cycle)  | X | 5.74 | 66.86 | 16.25 | 0.46 | 130.0 | ± 9.6 % |
|           |  | Y | 5.63 | 66.85 | 16.25 |      | 130.0 |         |
|           |  | Z | 5.67 | 66.78 | 16.22 |      | 130.0 |         |
| 10630-AAB | IEEE 802.11ac WiFi (80MHz, MCS4, 90pc duty cycle)  | X | 6.27 | 68.62 | 17.13 | 0.46 | 130.0 | ± 9.6 % |
|           |  | Y | 5.98 | 68.12 | 16.89 |      | 130.0 |         |
|           |  | Z | 6.16 | 68.44 | 17.05 |      | 130.0 |         |
| 10631-AAB | IEEE 802.11ac WiFi (80MHz, MCS5, 90pc duty cycle)  | X | 6.08 | 68.18 | 17.10 | 0.46 | 130.0 | ± 9.6 % |
|           |  | Y | 5.89 | 67.92 | 16.96 |      | 130.0 |         |
|           |  | Z | 6.00 | 68.07 | 17.05 |      | 130.0 |         |
| 10632-AAB | IEEE 802.11ac WiFi (80MHz, MCS6, 90pc duty cycle)  | X | 5.81 | 67.25 | 16.65 | 0.46 | 130.0 | ± 9.6 % |
|           |  | Y | 5.73 | 67.36 | 16.70 |      | 130.0 |         |
|           |  | Z | 5.78 | 67.29 | 16.68 |      | 130.0 |         |
| 10633-AAB | IEEE 802.11ac WiFi (80MHz, MCS7, 90pc duty cycle)  | X | 5.70 | 66.88 | 16.30 | 0.46 | 130.0 | ± 9.6 % |
|           |  | Y | 5.61 | 66.94 | 16.32 |      | 130.0 |         |
|           |  | Z | 5.64 | 66.86 | 16.29 |      | 130.0 |         |
| 10634-AAB | IEEE 802.11ac WiFi (80MHz, MCS8, 90pc duty cycle)  | X | 5.68 | 66.90 | 16.36 | 0.46 | 130.0 | ± 9.6 % |
|           |  | Y | 5.59 | 66.94 | 16.37 |      | 130.0 |         |
|           |  | Z | 5.63 | 66.89 | 16.36 |      | 130.0 |         |
| 10635-AAB | IEEE 802.11ac WiFi (80MHz, MCS9, 90pc duty cycle)  | X | 5.57 | 66.28 | 15.80 | 0.46 | 130.0 | ± 9.6 % |
|           |  | Y | 5.47 | 66.33 | 15.83 |      | 130.0 |         |
|           |  | Z | 5.52 | 66.25 | 15.79 |      | 130.0 |         |
| 10636-AAC | IEEE 802.11ac WiFi (160MHz, MCS0, 90pc duty cycle) | X | 6.01 | 67.00 | 16.34 | 0.46 | 130.0 | ± 9.6 % |
|           |  | Y | 5.95 | 67.08 | 16.37 |      | 130.0 |         |
|           |  | Z | 5.98 | 67.00 | 16.35 |      | 130.0 |         |
| 10637-AAC | IEEE 802.11ac WiFi (160MHz, MCS1, 90pc duty cycle) | X | 6.18 | 67.41 | 16.53 | 0.46 | 130.0 | ± 9.6 % |
|           |  | Y | 6.10 | 67.45 | 16.54 |      | 130.0 |         |
|           |  | Z | 6.14 | 67.41 | 16.54 |      | 130.0 |         |
| 10638-AAC | IEEE 802.11ac WiFi (160MHz, MCS2, 90pc duty cycle) | X | 6.18 | 67.38 | 16.49 | 0.46 | 130.0 | ± 9.6 % |
|           |  | Y | 6.10 | 67.42 | 16.51 |      | 130.0 |         |
|           |  | Z | 6.14 | 67.38 | 16.50 |      | 130.0 |         |

|           |  |   |        |        |       |       |       |         |
|-----------|--|---|--------|--------|-------|-------|-------|---------|
| 10639-AAC | IEEE 802.11ac WiFi (160MHz, MCS3, 90pc duty cycle)     | X | 6.15   | 67.32  | 16.51 | 0.46  | 130.0 | ± 9.6 % |
|           |  | Y | 6.07   | 67.34  | 16.50 |       | 130.0 |         |
|           |  | Z | 6.11   | 67.30  | 16.50 |       | 130.0 |         |
| 10640-AAC | IEEE 802.11ac WiFi (160MHz, MCS4, 90pc duty cycle)     | X | 6.17   | 67.36  | 16.47 | 0.46  | 130.0 | ± 9.6 % |
|           |  | Y | 6.07   | 67.36  | 16.47 |       | 130.0 |         |
|           |  | Z | 6.11   | 67.32  | 16.45 |       | 130.0 |         |
| 10641-AAC | IEEE 802.11ac WiFi (160MHz, MCS5, 90pc duty cycle)     | X | 6.20   | 67.22  | 16.42 | 0.46  | 130.0 | ± 9.6 % |
|           |  | Y | 6.14   | 67.34  | 16.48 |       | 130.0 |         |
|           |  | Z | 6.17   | 67.26  | 16.44 |       | 130.0 |         |
| 10642-AAC | IEEE 802.11ac WiFi (160MHz, MCS6, 90pc duty cycle)     | X | 6.24   | 67.47  | 16.71 | 0.46  | 130.0 | ± 9.6 % |
|           |  | Y | 6.15   | 67.50  | 16.71 |       | 130.0 |         |
|           |  | Z | 6.19   | 67.46  | 16.71 |       | 130.0 |         |
| 10643-AAC | IEEE 802.11ac WiFi (160MHz, MCS7, 90pc duty cycle)     | X | 6.08   | 67.18  | 16.46 | 0.46  | 130.0 | ± 9.6 % |
|           |  | Y | 6.01   | 67.25  | 16.50 |       | 130.0 |         |
|           |  | Z | 6.04   | 67.18  | 16.47 |       | 130.0 |         |
| 10644-AAC | IEEE 802.11ac WiFi (160MHz, MCS8, 90pc duty cycle)     | X | 6.27   | 67.76  | 16.77 | 0.46  | 130.0 | ± 9.6 % |
|           |  | Y | 6.11   | 67.57  | 16.67 |       | 130.0 |         |
|           |  | Z | 6.19   | 67.64  | 16.72 |       | 130.0 |         |
| 10645-AAC | IEEE 802.11ac WiFi (160MHz, MCS9, 90pc duty cycle)     | X | 6.75   | 68.75  | 17.22 | 0.46  | 130.0 | ± 9.6 % |
|           |  | Y | 6.24   | 67.62  | 16.66 |       | 130.0 |         |
|           |  | Z | 6.47   | 68.11  | 16.92 |       | 130.0 |         |
| 10646-AAD | LTE-TDD (SC-FDMA, 1 RB, 5 MHz, QPSK, UL Subframe=2,7)  | X | 46.96  | 124.69 | 40.77 | 9.30  | 60.0  | ± 9.6 % |
|           |  | Y | 100.00 | 148.37 | 48.20 |       | 60.0  |         |
|           |  | Z | 67.01  | 134.85 | 43.85 |       | 60.0  |         |
| 10647-AAC | LTE-TDD (SC-FDMA, 1 RB, 20 MHz, QPSK, UL Subframe=2,7) | X | 46.42  | 125.36 | 41.11 | 9.30  | 60.0  | ± 9.6 % |
|           |  | Y | 100.00 | 149.72 | 48.78 |       | 60.0  |         |
|           |  | Z | 63.71  | 134.73 | 44.00 |       | 60.0  |         |
| 10648-AAA | CDMA2000 (1x Advanced)                                 | X | 0.63   | 62.54  | 9.79  | 0.00  | 150.0 | ± 9.6 % |
|           |  | Y | 0.58   | 62.24  | 9.19  |       | 150.0 |         |
|           |  | Z | 0.59   | 62.30  | 9.35  |       | 150.0 |         |
| 10652-AAB | LTE-TDD (OFDMA, 5 MHz, E-TM 3.1, Clipping 44%)         | X | 4.19   | 68.34  | 17.06 | 2.23  | 80.0  | ± 9.6 % |
|           |  | Y | 4.08   | 68.62  | 17.03 |       | 80.0  |         |
|           |  | Z | 4.14   | 68.48  | 17.06 |       | 80.0  |         |
| 10653-AAB | LTE-TDD (OFDMA, 10 MHz, E-TM 3.1, Clipping 44%)        | X | 4.68   | 67.61  | 17.18 | 2.23  | 80.0  | ± 9.6 % |
|           |  | Y | 4.56   | 67.77  | 17.19 |       | 80.0  |         |
|           |  | Z | 4.62   | 67.66  | 17.19 |       | 80.0  |         |
| 10654-AAB | LTE-TDD (OFDMA, 15 MHz, E-TM 3.1, Clipping 44%)        | X | 4.63   | 67.27  | 17.19 | 2.23  | 80.0  | ± 9.6 % |
|           |  | Y | 4.54   | 67.39  | 17.21 |       | 80.0  |         |
|           |  | Z | 4.58   | 67.31  | 17.20 |       | 80.0  |         |
| 10655-AAB | LTE-TDD (OFDMA, 20 MHz, E-TM 3.1, Clipping 44%)        | X | 4.69   | 67.27  | 17.23 | 2.23  | 80.0  | ± 9.6 % |
|           |  | Y | 4.60   | 67.35  | 17.25 |       | 80.0  |         |
|           |  | Z | 4.64   | 67.28  | 17.23 |       | 80.0  |         |
| 10658-AAA | Pulse Waveform (200Hz, 10%)                            | X | 19.17  | 92.59  | 24.24 | 10.00 | 50.0  | ± 9.6 % |
|           |  | Y | 41.94  | 104.68 | 27.26 |       | 50.0  |         |
|           |  | Z | 24.50  | 96.17  | 24.98 |       | 50.0  |         |
| 10659-AAA | Pulse Waveform (200Hz, 20%)                            | X | 100.00 | 114.36 | 28.32 | 6.99  | 60.0  | ± 9.6 % |
|           |  | Y | 100.00 | 114.20 | 27.89 |       | 60.0  |         |
|           |  | Z | 100.00 | 113.56 | 27.75 |       | 60.0  |         |

|           |                             |   |        |        |       |      |       |         |
|-----------|-----------------------------|---|--------|--------|-------|------|-------|---------|
| 10660-AAA | Pulse Waveform (200Hz, 40%) | X | 100.00 | 111.43 | 25.50 | 3.98 | 80.0  | ± 9.6 % |
|           |                             | Y | 100.00 | 112.46 | 25.73 |      | 80.0  |         |
|           |                             | Z | 100.00 | 110.79 | 25.07 |      | 80.0  |         |
| 10661-AAA | Pulse Waveform (200Hz, 60%) | X | 100.00 | 110.47 | 23.74 | 2.22 | 100.0 | ± 9.6 % |
|           |                             | Y | 100.00 | 113.22 | 24.78 |      | 100.0 |         |
|           |                             | Z | 100.00 | 109.90 | 23.38 |      | 100.0 |         |
| 10662-AAA | Pulse Waveform (200Hz, 80%) | X | 100.00 | 107.83 | 20.92 | 0.97 | 120.0 | ± 9.6 % |
|           |                             | Y | 100.00 | 115.39 | 23.98 |      | 120.0 |         |
|           |                             | Z | 100.00 | 107.00 | 20.48 |      | 120.0 |         |

<sup>E</sup> Uncertainty is determined using the max. deviation from linear response applying rectangular distribution and is expressed for the square of the field value.



Accredited by the Swiss Accreditation Service (SAS)  
The Swiss Accreditation Service is one of the signatories to the EA  
Multilateral Agreement for the recognition of calibration certificates

Accreditation No.: **SCS 0108**

Client **PC Test**

Certificate No: **ES3-3319\_Mar18**

## CALIBRATION CERTIFICATE

Object **ES3DV3 - SN:3319**

Calibration procedure(s) **QA CAL-01.v9, QA CAL-23.v5, QA CAL-25.v6  
Calibration procedure for dosimetric E-field probes**

*BN ✓  
03/30/2018*

Calibration date: **March 13, 2018**

This calibration certificate documents the traceability to national standards, which realize the physical units of measurements (SI).  
The measurements and the uncertainties with confidence probability are given on the following pages and are part of the certificate.

All calibrations have been conducted in the closed laboratory facility: environment temperature (22 ± 3)°C and humidity < 70%.

Calibration Equipment used (M&TE critical for calibration)

| Primary Standards          | ID               | Cal Date (Certificate No.)        | Scheduled Calibration  |
|----------------------------|------------------|-----------------------------------|------------------------|
| Power meter NRP            | SN: 104778       | 04-Apr-17 (No. 217-02521/02522)   | Apr-18                 |
| Power sensor NRP-Z91       | SN: 103244       | 04-Apr-17 (No. 217-02521)         | Apr-18                 |
| Power sensor NRP-Z91       | SN: 103245       | 04-Apr-17 (No. 217-02525)         | Apr-18                 |
| Reference 20 dB Attenuator | SN: S5277 (20x)  | 07-Apr-17 (No. 217-02528)         | Apr-18                 |
| Reference Probe ES3DV2     | SN: 3013         | 30-Dec-17 (No. ES3-3013_Dec17)    | Dec-18                 |
| DAE4                       | SN: 660          | 21-Dec-17 (No. DAE4-660_Dec17)    | Dec-18                 |
| Secondary Standards        | ID               | Check Date (in house)             | Scheduled Check        |
| Power meter E4419B         | SN: GB41293874   | 06-Apr-16 (in house check Jun-16) | In house check: Jun-18 |
| Power sensor E4412A        | SN: MY41498087   | 06-Apr-16 (in house check Jun-16) | In house check: Jun-18 |
| Power sensor E4412A        | SN: 000110210    | 06-Apr-16 (in house check Jun-16) | In house check: Jun-18 |
| RF generator HP 8648C      | SN: US3642U01700 | 04-Aug-99 (in house check Jun-16) | In house check: Jun-18 |
| Network Analyzer HP 8753E  | SN: US37390585   | 18-Oct-01 (in house check Oct-17) | In house check: Oct-18 |

|   | Name           | Function              | Signature              |
|---|----------------|-----------------------|------------------------|
| Calibrated by:  | Jeton Kastrati | Laboratory Technician |                        |
| Approved by:  | Katja Pokovic  | Technical Manager     |                        |
|   |                |                       | Issued: March 15, 2018 |
| This calibration certificate shall not be reproduced except in full without written approval of the laboratory. |                |                       |                        |



Accredited by the Swiss Accreditation Service (SAS)

Accreditation No.: **SCS 0108**

The Swiss Accreditation Service is one of the signatories to the EA  
Multilateral Agreement for the recognition of calibration certificates

### Glossary:

|                       |   |
|-----------------------|---|
| TSL                   | tissue simulating liquid  |
| NORM <sub>x,y,z</sub> | sensitivity in free space   |
| ConvF                 | sensitivity in TSL / NORM <sub>x,y,z</sub>  |
| DCP                   | diode compression point   |
| CF                    | crest factor (1/duty_cycle) of the RF signal  |
| A, B, C, D            | modulation dependent linearization parameters   |
| Polarization φ        | φ rotation around probe axis  |
| Polarization θ        | θ rotation around an axis that is in the plane normal to probe axis (at measurement center),<br>i.e., θ = 0 is normal to probe axis |
| Connector Angle       | information used in DASY system to align probe sensor X to the robot coordinate system  |

### Calibration is Performed According to the Following Standards:

- IEEE Std 1528-2013, "IEEE Recommended Practice for Determining the Peak Spatial-Averaged Specific Absorption Rate (SAR) in the Human Head from Wireless Communications Devices: Measurement Techniques", June 2013
- IEC 62209-1, "Measurement procedure for the assessment of Specific Absorption Rate (SAR) from hand-held and body-mounted devices used next to the ear (frequency range of 300 MHz to 6 GHz)", July 2016
- IEC 62209-2, "Procedure to determine the Specific Absorption Rate (SAR) for wireless communication devices used in close proximity to the human body (frequency range of 30 MHz to 6 GHz)", March 2010
- KDB 865664, "SAR Measurement Requirements for 100 MHz to 6 GHz"

### Methods Applied and Interpretation of Parameters:

- NORM<sub>x,y,z</sub>**: Assessed for E-field polarization θ = 0 (f ≤ 900 MHz in TEM-cell; f > 1800 MHz: R22 waveguide). NORM<sub>x,y,z</sub> are only intermediate values, i.e., the uncertainties of NORM<sub>x,y,z</sub> does not affect the E<sup>2</sup>-field uncertainty inside TSL (see below ConvF).
- NORM(f)<sub>x,y,z</sub>** = NORM<sub>x,y,z</sub> \* frequency\_response (see Frequency Response Chart). This linearization is implemented in DASY4 software versions later than 4.2. The uncertainty of the frequency response is included in the stated uncertainty of ConvF.
- DCP<sub>x,y,z</sub>**: DCP are numerical linearization parameters assessed based on the data of power sweep with CW signal (no uncertainty required). DCP does not depend on frequency nor media.
- PAR**: PAR is the Peak to Average Ratio that is not calibrated but determined based on the signal characteristics
- A<sub>x,y,z</sub>; B<sub>x,y,z</sub>; C<sub>x,y,z</sub>; D<sub>x,y,z</sub>; VR<sub>x,y,z</sub>; A, B, C, D** are numerical linearization parameters assessed based on the data of power sweep for specific modulation signal. The parameters do not depend on frequency nor media. VR is the maximum calibration range expressed in RMS voltage across the diode.
- ConvF and Boundary Effect Parameters**: Assessed in flat phantom using E-field (or Temperature Transfer Standard for f ≤ 800 MHz) and inside waveguide using analytical field distributions based on power measurements for f > 800 MHz. The same setups are used for assessment of the parameters applied for boundary compensation (alpha, depth) of which typical uncertainty values are given. These parameters are used in DASY4 software to improve probe accuracy close to the boundary. The sensitivity in TSL corresponds to NORM<sub>x,y,z</sub> \* ConvF whereby the uncertainty corresponds to that given for ConvF. A frequency dependent ConvF is used in DASY version 4.4 and higher which allows extending the validity from ± 50 MHz to ± 100 MHz.
- Spherical isotropy (3D deviation from isotropy)**: in a field of low gradients realized using a flat phantom exposed by a patch antenna.
- Sensor Offset**: The sensor offset corresponds to the offset of virtual measurement center from the probe tip (on probe axis). No tolerance required.
- Connector Angle**: The angle is assessed using the information gained by determining the NORM<sub>x</sub> (no uncertainty required).

# Probe ES3DV3

## SN:3319

Manufactured: January 10, 2012  
Calibrated: March 13, 2018

**Calibrated for DASY/EASY Systems**  
(Note: non-compatible with DASY2 system!)



## DASY/EASY - Parameters of Probe: ES3DV3 - SN:3319

### Basic Calibration Parameters

|   | Sensor X | Sensor Y | Sensor Z | Unc (k=2)     |
|---|----------|----------|----------|---------------|
| Norm ( $\mu\text{V}/(\text{V}/\text{m})^2$ ) <sup>A</sup> | 1.08     | 1.05     | 1.12     | $\pm 10.1 \%$ |
| DCP (mV) <sup>B</sup>                                     | 104.0    | 103.0    | 104.0    |               |

### Modulation Calibration Parameters

| UID | Communication System Name |   | A<br>dB | B<br>dB $\sqrt{\mu\text{V}}$ | C   | D<br>dB | VR<br>mV | Unc <sup>E</sup><br>(k=2) |
|-----|---------------------------|---|---------|------------------------------|-----|---------|----------|---------------------------|
| 0   | CW                        | X | 0.0     | 0.0                          | 1.0 | 0.00    | 197.9    | $\pm 3.8 \%$              |
|     |                           | Y | 0.0     | 0.0                          | 1.0 |         | 198.2    |                           |
|     |                           | Z | 0.0     | 0.0                          | 1.0 |         | 200.6    |                           |

Note: For details on UID parameters see Appendix.

### Sensor Model Parameters

|   | C1<br>fF | C2<br>fF | $\alpha$<br>$\text{V}^{-1}$ | T1<br>$\text{ms}\cdot\text{V}^{-2}$ | T2<br>$\text{ms}\cdot\text{V}^{-1}$ | T3<br>ms | T4<br>$\text{V}^{-2}$ | T5<br>$\text{V}^{-1}$ | T6    |
|---|----------|----------|-----------------------------|-------------------------------------|-------------------------------------|----------|-----------------------|-----------------------|-------|
| X | 60.52    | 430.8    | 35.08                       | 29.64                               | 3.011                               | 5.10     | 0.615                 | 0.538                 | 1.010 |
| Y | 55.79    | 400.8    | 35.48                       | 29.01                               | 2.492                               | 5.10     | 0.600                 | 0.518                 | 1.009 |
| Z | 63.98    | 455.3    | 34.93                       | 29.72                               | 3.442                               | 5.10     | 0.679                 | 0.571                 | 1.011 |

The reported uncertainty of measurement is stated as the standard uncertainty of measurement multiplied by the coverage factor  $k=2$ , which for a normal distribution corresponds to a coverage probability of approximately 95%.

<sup>A</sup> The uncertainties of Norm X,Y,Z do not affect the  $E^2$ -field uncertainty inside TSL (see Pages 5 and 6).

<sup>B</sup> Numerical linearization parameter: uncertainty not required.

<sup>E</sup> Uncertainty is determined using the max. deviation from linear response applying rectangular distribution and is expressed for the square of the field value.

## DASY/EASY - Parameters of Probe: ES3DV3 - SN:3319

### Calibration Parameter Determined in Head Tissue Simulating Media

| f (MHz) <sup>C</sup> | Relative Permittivity <sup>F</sup> | Conductivity (S/m) <sup>F</sup> | ConvF X | ConvF Y | ConvF Z | Alpha <sup>G</sup> | Depth <sup>G</sup> (mm) | Unc (k=2) |
|----------------------|------------------------------------|---------------------------------|---------|---------|---------|--------------------|-------------------------|-----------|
| 750                  | 41.9                               | 0.89                            | 6.70    | 6.70    | 6.70    | 0.80               | 1.21                    | ± 12.0 %  |
| 835                  | 41.5                               | 0.90                            | 6.44    | 6.44    | 6.44    | 0.80               | 1.17                    | ± 12.0 %  |
| 1750                 | 40.1                               | 1.37                            | 5.49    | 5.49    | 5.49    | 0.65               | 1.43                    | ± 12.0 %  |
| 1900                 | 40.0                               | 1.40                            | 5.29    | 5.29    | 5.29    | 0.76               | 1.30                    | ± 12.0 %  |
| 2300                 | 39.5                               | 1.67                            | 5.06    | 5.06    | 5.06    | 0.72               | 1.29                    | ± 12.0 %  |
| 2450                 | 39.2                               | 1.80                            | 4.71    | 4.71    | 4.71    | 0.77               | 1.30                    | ± 12.0 %  |
| 2600                 | 39.0                               | 1.96                            | 4.55    | 4.55    | 4.55    | 0.80               | 1.31                    | ± 12.0 %  |

<sup>C</sup> Frequency validity above 300 MHz of ± 100 MHz only applies for DASY v4.4 and higher (see Page 2), else it is restricted to ± 50 MHz. The uncertainty is the RSS of the ConvF uncertainty at calibration frequency and the uncertainty for the indicated frequency band. Frequency validity below 300 MHz is ± 10, 25, 40, 50 and 70 MHz for ConvF assessments at 30, 64, 128, 150 and 220 MHz respectively. Above 5 GHz frequency validity can be extended to ± 110 MHz.

<sup>F</sup> At frequencies below 3 GHz, the validity of tissue parameters ( $\epsilon$  and  $\sigma$ ) can be relaxed to ± 10% if liquid compensation formula is applied to measured SAR values. At frequencies above 3 GHz, the validity of tissue parameters ( $\epsilon$  and  $\sigma$ ) is restricted to ± 5%. The uncertainty is the RSS of the ConvF uncertainty for indicated target tissue parameters.

<sup>G</sup> Alpha/Depth are determined during calibration. SPEAG warrants that the remaining deviation due to the boundary effect after compensation is always less than ± 1% for frequencies below 3 GHz and below ± 2% for frequencies between 3-6 GHz at any distance larger than half the probe tip diameter from the boundary.

## DASY/EASY - Parameters of Probe: ES3DV3 - SN:3319

### Calibration Parameter Determined in Body Tissue Simulating Media

| f (MHz) <sup>C</sup> | Relative Permittivity <sup>F</sup> | Conductivity (S/m) <sup>F</sup> | ConvF X | ConvF Y | ConvF Z | Alpha <sup>G</sup> | Depth <sup>G</sup> (mm) | Unc (k=2) |
|----------------------|------------------------------------|---------------------------------|---------|---------|---------|--------------------|-------------------------|-----------|
| 750                  | 55.5                               | 0.96                            | 6.32    | 6.32    | 6.32    | 0.65               | 1.26                    | ± 12.0 %  |
| 835                  | 55.2                               | 0.97                            | 6.20    | 6.20    | 6.20    | 0.80               | 1.14                    | ± 12.0 %  |
| 1750                 | 53.4                               | 1.49                            | 5.05    | 5.05    | 5.05    | 0.76               | 1.27                    | ± 12.0 %  |
| 1900                 | 53.3                               | 1.52                            | 4.84    | 4.84    | 4.84    | 0.55               | 1.56                    | ± 12.0 %  |
| 2300                 | 52.9                               | 1.81                            | 4.63    | 4.63    | 4.63    | 0.80               | 1.30                    | ± 12.0 %  |
| 2450                 | 52.7                               | 1.95                            | 4.51    | 4.51    | 4.51    | 0.80               | 1.25                    | ± 12.0 %  |
| 2600                 | 52.5                               | 2.16                            | 4.33    | 4.33    | 4.33    | 0.80               | 1.20                    | ± 12.0 %  |

<sup>C</sup> Frequency validity above 300 MHz of ± 100 MHz only applies for DASY v4.4 and higher (see Page 2), else it is restricted to ± 50 MHz. The uncertainty is the RSS of the ConvF uncertainty at calibration frequency and the uncertainty for the indicated frequency band. Frequency validity below 300 MHz is ± 10, 25, 40, 50 and 70 MHz for ConvF assessments at 30, 64, 128, 150 and 220 MHz respectively. Above 5 GHz frequency validity can be extended to ± 110 MHz.

<sup>F</sup> At frequencies below 3 GHz, the validity of tissue parameters ( $\epsilon$  and  $\sigma$ ) can be relaxed to ± 10% if liquid compensation formula is applied to measured SAR values. At frequencies above 3 GHz, the validity of tissue parameters ( $\epsilon$  and  $\sigma$ ) is restricted to ± 5%. The uncertainty is the RSS of the ConvF uncertainty for indicated target tissue parameters.

<sup>G</sup> Alpha/Depth are determined during calibration. SPEAG warrants that the remaining deviation due to the boundary effect after compensation is always less than ± 1% for frequencies below 3 GHz and below ± 2% for frequencies between 3-6 GHz at any distance larger than half the probe tip diameter from the boundary.

### Frequency Response of E-Field (TEM-Cell:ifi110 EXX, Waveguide: R22)

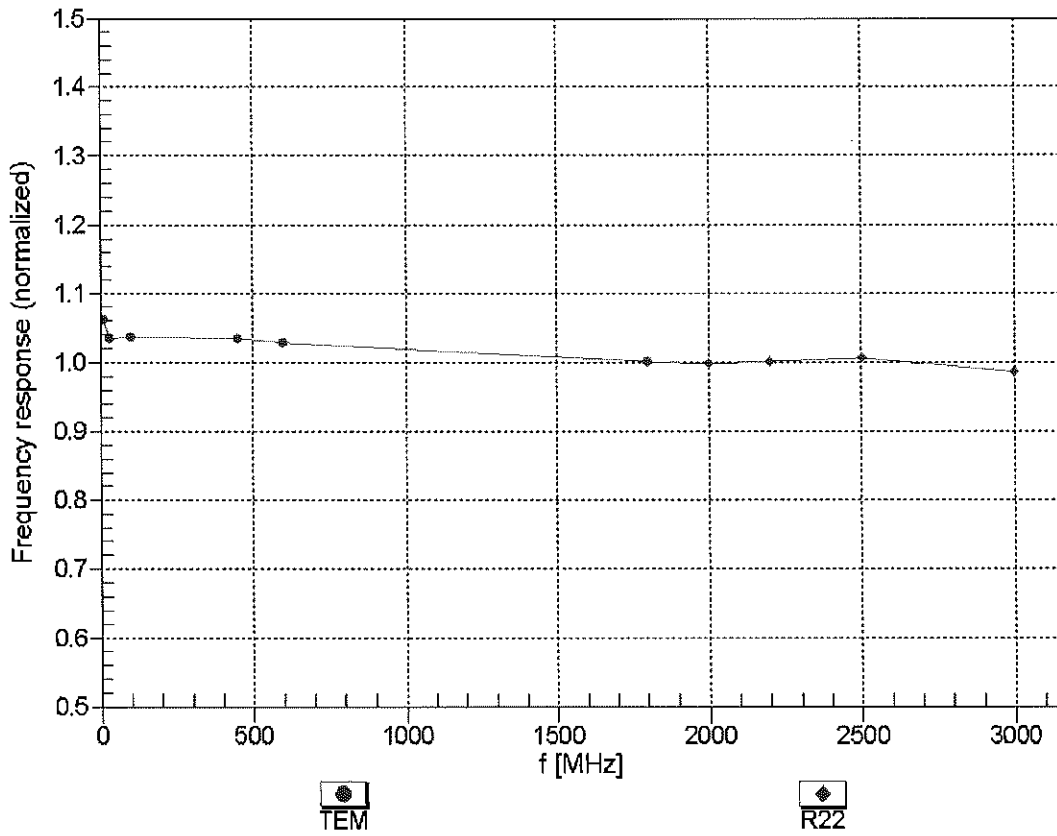

Uncertainty of Frequency Response of E-field:  $\pm 6.3\%$  (k=2)

### Receiving Pattern ( $\phi$ ), $\theta = 0^\circ$

f=600 MHz,TEM

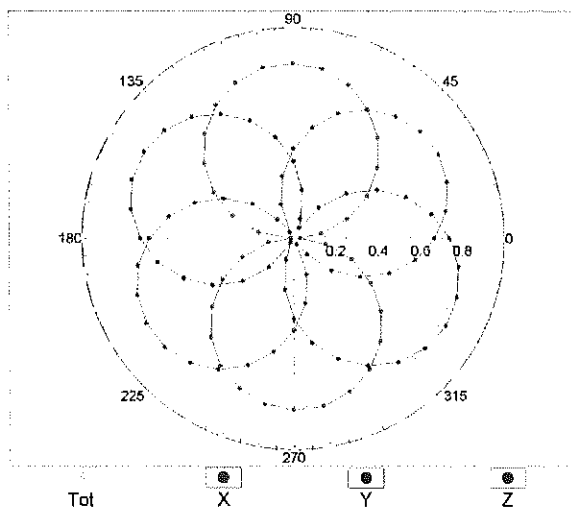

f=1800 MHz,R22

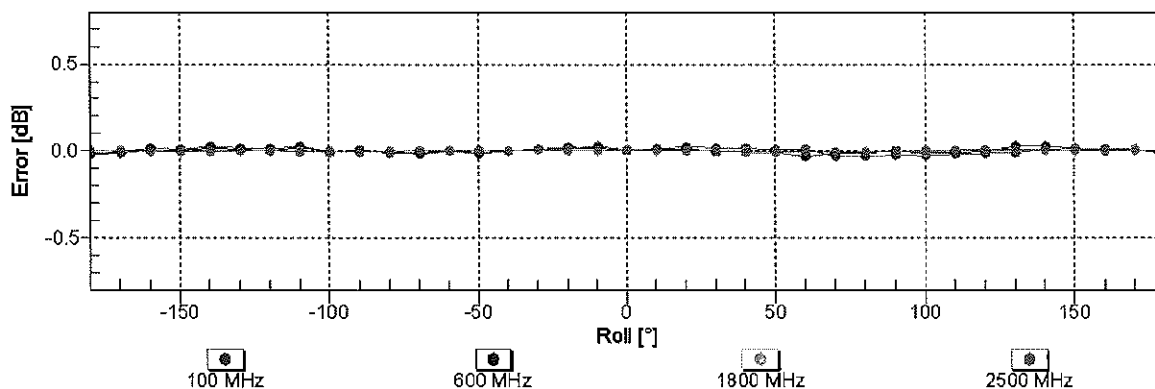
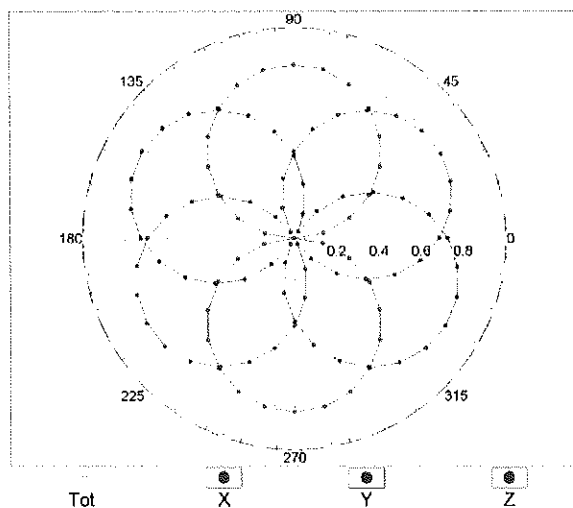

Uncertainty of Axial Isotropy Assessment:  $\pm 0.5\%$  (k=2)

### Dynamic Range $f(SAR_{head})$ (TEM cell , $f_{eval}= 1900$ MHz)

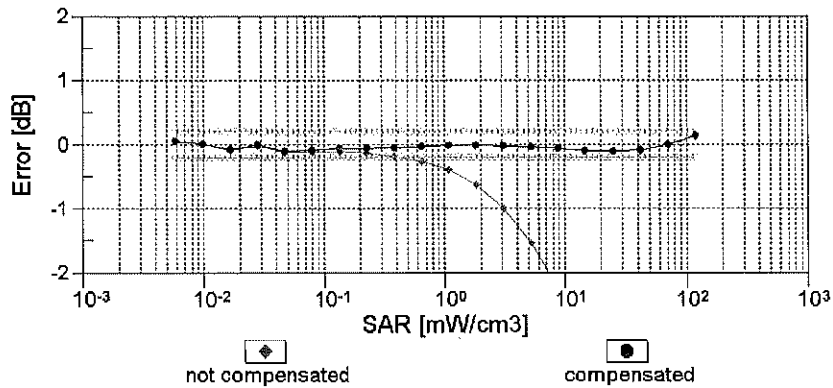
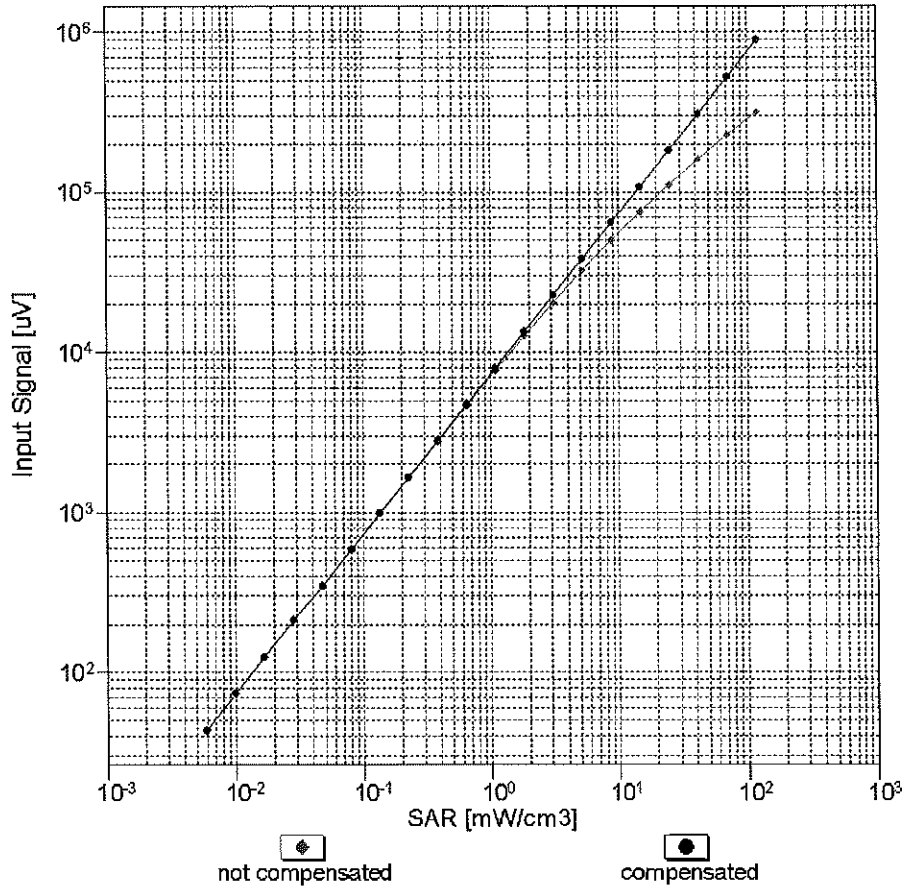

Uncertainty of Linearity Assessment:  $\pm 0.6\%$  (k=2)



# Conversion Factor Assessment

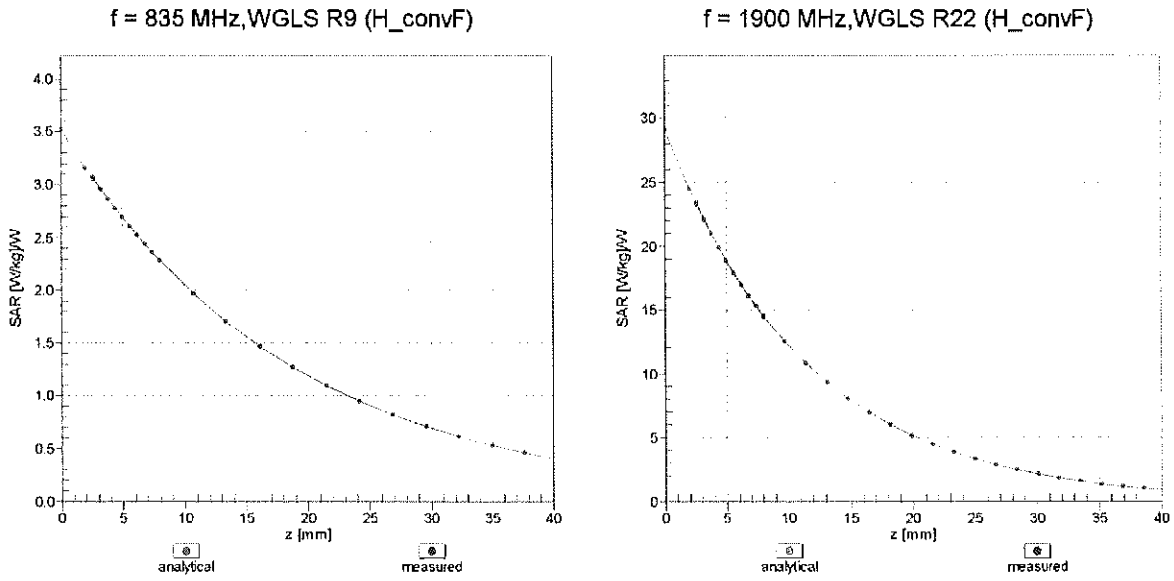

## Deviation from Isotropy in Liquid Error ( $\phi, \theta$ ), f = 900 MHz

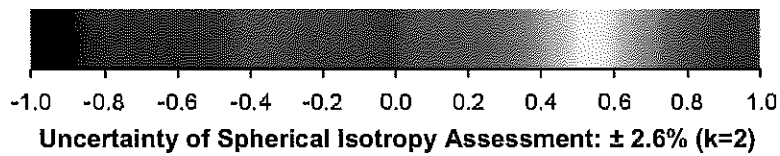
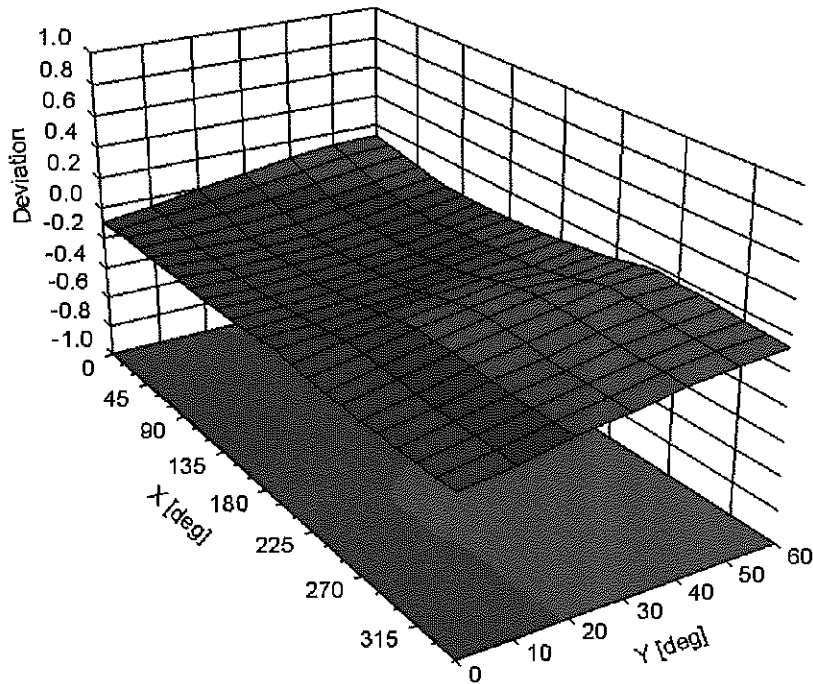



## DASY/EASY - Parameters of Probe: ES3DV3 - SN:3319

### Other Probe Parameters

|   |            |
|---|------------|
| Sensor Arrangement                            | Triangular |
| Connector Angle (°)                           | 60.4       |
| Mechanical Surface Detection Mode             | enabled    |
| Optical Surface Detection Mode                | disabled   |
| Probe Overall Length                          | 337 mm     |
| Probe Body Diameter                           | 10 mm      |
| Tip Length                                    | 10 mm      |
| Tip Diameter                                  | 4 mm       |
| Probe Tip to Sensor X Calibration Point       | 2 mm       |
| Probe Tip to Sensor Y Calibration Point       | 2 mm       |
| Probe Tip to Sensor Z Calibration Point       | 2 mm       |
| Recommended Measurement Distance from Surface | 3 mm       |

**Appendix: Modulation Calibration Parameters**

| UID           | Communication System Name                     |   | A<br>dB | B<br>dB $\mu$ V | C     | D<br>dB | VR<br>mV | Max<br>Unc <sup>E</sup><br>(k=2) |
|---------------|---|---|---------|-----------------|-------|---------|----------|----------------------------------|
| 0             | CW  | X | 0.00    | 0.00            | 1.00  | 0.00    | 197.9    | $\pm 3.8\%$                      |
|               |   | Y | 0.00    | 0.00            | 1.00  |         | 198.2    |                                  |
|               |   | Z | 0.00    | 0.00            | 1.00  |         | 200.6    |                                  |
| 10010-<br>CAA | SAR Validation (Square, 100ms, 10ms)          | X | 9.56    | 81.28           | 19.98 | 10.00   | 25.0     | $\pm 9.6\%$                      |
|               |   | Y | 8.09    | 78.70           | 18.35 |         | 25.0     |                                  |
|               |   | Z | 8.70    | 79.52           | 19.57 |         | 25.0     |                                  |
| 10011-<br>CAB | UMTS-FDD (WCDMA)                              | X | 1.34    | 72.37           | 18.08 | 0.00    | 150.0    | $\pm 9.6\%$                      |
|               |   | Y | 0.99    | 67.12           | 14.82 |         | 150.0    |                                  |
|               |   | Z | 1.12    | 68.87           | 16.00 |         | 150.0    |                                  |
| 10012-<br>CAB | IEEE 802.11b WiFi 2.4 GHz (DSSS, 1 Mbps)      | X | 1.37    | 66.58           | 17.00 | 0.41    | 150.0    | $\pm 9.6\%$                      |
|               |   | Y | 1.25    | 64.92           | 15.59 |         | 150.0    |                                  |
|               |   | Z | 1.32    | 65.58           | 16.11 |         | 150.0    |                                  |
| 10013-<br>CAB | IEEE 802.11g WiFi 2.4 GHz (DSSS-OFDM, 6 Mbps) | X | 5.18    | 67.48           | 17.64 | 1.46    | 150.0    | $\pm 9.6\%$                      |
|               |   | Y | 5.08    | 67.20           | 17.36 |         | 150.0    |                                  |
|               |   | Z | 5.20    | 67.32           | 17.47 |         | 150.0    |                                  |
| 10021-<br>DAC | GSM-FDD (TDMA, GMSK)                          | X | 20.40   | 95.52           | 26.57 | 9.39    | 50.0     | $\pm 9.6\%$                      |
|               |   | Y | 29.46   | 101.11          | 27.60 |         | 50.0     |                                  |
|               |   | Z | 14.66   | 89.52           | 24.83 |         | 50.0     |                                  |
| 10023-<br>DAC | GPRS-FDD (TDMA, GMSK, TN 0)                   | X | 18.37   | 93.61           | 26.02 | 9.57    | 50.0     | $\pm 9.6\%$                      |
|               |   | Y | 24.41   | 97.95           | 26.72 |         | 50.0     |                                  |
|               |   | Z | 13.84   | 88.39           | 24.49 |         | 50.0     |                                  |
| 10024-<br>DAC | GPRS-FDD (TDMA, GMSK, TN 0-1)                 | X | 100.00  | 119.56          | 31.31 | 6.56    | 60.0     | $\pm 9.6\%$                      |
|               |   | Y | 100.00  | 117.39          | 29.93 |         | 60.0     |                                  |
|               |   | Z | 47.21   | 108.31          | 28.71 |         | 60.0     |                                  |
| 10025-<br>DAC | EDGE-FDD (TDMA, 8PSK, TN 0)                   | X | 21.09   | 108.48          | 41.18 | 12.57   | 50.0     | $\pm 9.6\%$                      |
|               |   | Y | 17.11   | 102.80          | 38.82 |         | 50.0     |                                  |
|               |   | Z | 18.44   | 103.12          | 38.97 |         | 50.0     |                                  |
| 10026-<br>DAC | EDGE-FDD (TDMA, 8PSK, TN 0-1)                 | X | 21.59   | 105.09          | 36.25 | 9.56    | 60.0     | $\pm 9.6\%$                      |
|               |   | Y | 18.95   | 102.20          | 35.03 |         | 60.0     |                                  |
|               |   | Z | 18.49   | 100.22          | 34.38 |         | 60.0     |                                  |
| 10027-<br>DAC | GPRS-FDD (TDMA, GMSK, TN 0-1-2)               | X | 100.00  | 118.49          | 29.83 | 4.80    | 80.0     | $\pm 9.6\%$                      |
|               |   | Y | 100.00  | 115.83          | 28.28 |         | 80.0     |                                  |
|               |   | Z | 100.00  | 118.30          | 29.89 |         | 80.0     |                                  |
| 10028-<br>DAC | GPRS-FDD (TDMA, GMSK, TN 0-1-2-3)             | X | 100.00  | 118.84          | 29.14 | 3.55    | 100.0    | $\pm 9.6\%$                      |
|               |   | Y | 100.00  | 115.36          | 27.25 |         | 100.0    |                                  |
|               |   | Z | 100.00  | 118.10          | 28.92 |         | 100.0    |                                  |
| 10029-<br>DAC | EDGE-FDD (TDMA, 8PSK, TN 0-1-2)               | X | 15.08   | 97.16           | 32.49 | 7.80    | 80.0     | $\pm 9.6\%$                      |
|               |   | Y | 12.90   | 93.80           | 31.06 |         | 80.0     |                                  |
|               |   | Z | 13.60   | 93.82           | 31.09 |         | 80.0     |                                  |
| 10030-<br>CAA | IEEE 802.15.1 Bluetooth (GFSK, DH1)           | X | 100.00  | 118.11          | 30.01 | 5.30    | 70.0     | $\pm 9.6\%$                      |
|               |   | Y | 100.00  | 115.58          | 28.50 |         | 70.0     |                                  |
|               |   | Z | 100.00  | 118.16          | 30.20 |         | 70.0     |                                  |
| 10031-<br>CAA | IEEE 802.15.1 Bluetooth (GFSK, DH3)           | X | 100.00  | 121.01          | 28.44 | 1.88    | 100.0    | $\pm 9.6\%$                      |
|               |   | Y | 100.00  | 114.03          | 25.11 |         | 100.0    |                                  |
|               |   | Z | 100.00  | 118.73          | 27.54 |         | 100.0    |                                  |

|           |   |   |        |        |       |       |       |         |
|-----------|---|---|--------|--------|-------|-------|-------|---------|
| 10032-CAA | IEEE 802.15.1 Bluetooth (GFSK, DH5)                 | X | 100.00 | 127.26 | 29.88 | 1.17  | 100.0 | ± 9.6 % |
|           |   | Y | 100.00 | 114.89 | 24.38 |       | 100.0 |         |
|           |   | Z | 100.00 | 122.11 | 27.79 |       | 100.0 |         |
| 10033-CAA | IEEE 802.15.1 Bluetooth (PI/4-DQPSK, DH1)           | X | 21.21  | 99.84  | 27.91 | 5.30  | 70.0  | ± 9.6 % |
|           |   | Y | 19.09  | 97.43  | 26.61 |       | 70.0  |         |
|           |   | Z | 13.98  | 92.26  | 25.56 |       | 70.0  |         |
| 10034-CAA | IEEE 802.15.1 Bluetooth (PI/4-DQPSK, DH3)           | X | 14.93  | 98.23  | 25.94 | 1.88  | 100.0 | ± 9.6 % |
|           |   | Y | 7.46   | 86.71  | 21.62 |       | 100.0 |         |
|           |   | Z | 7.45   | 87.10  | 22.42 |       | 100.0 |         |
| 10035-CAA | IEEE 802.15.1 Bluetooth (PI/4-DQPSK, DH5)           | X | 7.98   | 90.77  | 23.49 | 1.17  | 100.0 | ± 9.6 % |
|           |   | Y | 3.97   | 79.58  | 18.90 |       | 100.0 |         |
|           |   | Z | 4.48   | 81.52  | 20.27 |       | 100.0 |         |
| 10036-CAA | IEEE 802.15.1 Bluetooth (8-DPSK, DH1)               | X | 26.12  | 103.52 | 29.04 | 5.30  | 70.0  | ± 9.6 % |
|           |   | Y | 24.16  | 101.42 | 27.84 |       | 70.0  |         |
|           |   | Z | 15.99  | 94.67  | 26.38 |       | 70.0  |         |
| 10037-CAA | IEEE 802.15.1 Bluetooth (8-DPSK, DH3)               | X | 14.25  | 97.55  | 25.70 | 1.88  | 100.0 | ± 9.6 % |
|           |   | Y | 7.04   | 85.92  | 21.32 |       | 100.0 |         |
|           |   | Z | 7.24   | 86.72  | 22.25 |       | 100.0 |         |
| 10038-CAA | IEEE 802.15.1 Bluetooth (8-DPSK, DH5)               | X | 8.53   | 92.07  | 23.99 | 1.17  | 100.0 | ± 9.6 % |
|           |   | Y | 4.13   | 80.37  | 19.27 |       | 100.0 |         |
|           |   | Z | 4.65   | 82.31  | 20.62 |       | 100.0 |         |
| 10039-CAB | CDMA2000 (1xRTT, RC1)                               | X | 2.96   | 79.09  | 19.43 | 0.00  | 150.0 | ± 9.6 % |
|           |   | Y | 1.75   | 71.10  | 15.36 |       | 150.0 |         |
|           |   | Z | 2.10   | 73.23  | 16.92 |       | 150.0 |         |
| 10042-CAB | IS-54 / IS-136 FDD (TDMA/FDM, PI/4-DQPSK, Halfrate) | X | 53.77  | 109.05 | 28.70 | 7.78  | 50.0  | ± 9.6 % |
|           |   | Y | 79.10  | 112.95 | 28.86 |       | 50.0  |         |
|           |   | Z | 23.46  | 96.42  | 25.41 |       | 50.0  |         |
| 10044-CAA | IS-91/EIA/TIA-553 FDD (FDMA, FM)                    | X | 0.00   | 123.18 | 1.26  | 0.00  | 150.0 | ± 9.6 % |
|           |   | Y | 0.02   | 127.84 | 0.07  |       | 150.0 |         |
|           |   | Z | 0.00   | 110.77 | 4.52  |       | 150.0 |         |
| 10048-CAA | DECT (TDD, TDMA/FDM, GFSK, Full Slot, 24)           | X | 11.41  | 83.11  | 24.20 | 13.80 | 25.0  | ± 9.6 % |
|           |   | Y | 12.66  | 85.48  | 24.49 |       | 25.0  |         |
|           |   | Z | 10.45  | 80.79  | 23.56 |       | 25.0  |         |
| 10049-CAA | DECT (TDD, TDMA/FDM, GFSK, Double Slot, 12)         | X | 13.41  | 87.55  | 24.40 | 10.79 | 40.0  | ± 9.6 % |
|           |   | Y | 15.25  | 89.77  | 24.55 |       | 40.0  |         |
|           |   | Z | 11.61  | 84.53  | 23.55 |       | 40.0  |         |
| 10056-CAA | UMTS-TDD (TD-SCDMA, 1.28 Mcps)                      | X | 13.37  | 87.98  | 25.03 | 9.03  | 50.0  | ± 9.6 % |
|           |   | Y | 13.72  | 88.51  | 24.74 |       | 50.0  |         |
|           |   | Z | 11.72  | 85.02  | 24.05 |       | 50.0  |         |
| 10058-DAC | EDGE-FDD (TDMA, 8PSK, TN 0-1-2-3)                   | X | 11.14  | 91.28  | 29.72 | 6.55  | 100.0 | ± 9.6 % |
|           |   | Y | 9.52   | 87.98  | 28.26 |       | 100.0 |         |
|           |   | Z | 10.41  | 88.91  | 28.62 |       | 100.0 |         |
| 10059-CAB | IEEE 802.11b WiFi 2.4 GHz (DSSS, 2 Mbps)            | X | 1.60   | 69.38  | 18.31 | 0.61  | 110.0 | ± 9.6 % |
|           |   | Y | 1.43   | 67.15  | 16.67 |       | 110.0 |         |
|           |   | Z | 1.53   | 67.97  | 17.25 |       | 110.0 |         |
| 10060-CAB | IEEE 802.11b WiFi 2.4 GHz (DSSS, 5.5 Mbps)          | X | 100.00 | 133.15 | 34.60 | 1.30  | 110.0 | ± 9.6 % |
|           |   | Y | 100.00 | 128.63 | 32.36 |       | 110.0 |         |
|           |   | Z | 100.00 | 130.16 | 33.31 |       | 110.0 |         |

|           |  |   |       |        |       |      |       |         |
|-----------|--|---|-------|--------|-------|------|-------|---------|
| 10061-CAB | IEEE 802.11b WiFi 2.4 GHz (DSSS, 11 Mbps)      | X | 24.68 | 111.64 | 31.63 | 2.04 | 110.0 | ± 9.6 % |
|           |  | Y | 11.26 | 97.49  | 27.04 |      | 110.0 |         |
|           |  | Z | 10.95 | 96.57  | 26.98 |      | 110.0 |         |
| 10062-CAC | IEEE 802.11a/h WiFi 5 GHz (OFDM, 6 Mbps)       | X | 4.90  | 67.24  | 16.94 | 0.49 | 100.0 | ± 9.6 % |
|           |  | Y | 4.79  | 66.94  | 16.63 |      | 100.0 |         |
|           |  | Z | 4.90  | 67.05  | 16.74 |      | 100.0 |         |
| 10063-CAC | IEEE 802.11a/h WiFi 5 GHz (OFDM, 9 Mbps)       | X | 4.95  | 67.42  | 17.09 | 0.72 | 100.0 | ± 9.6 % |
|           |  | Y | 4.84  | 67.10  | 16.77 |      | 100.0 |         |
|           |  | Z | 4.95  | 67.23  | 16.89 |      | 100.0 |         |
| 10064-CAC | IEEE 802.11a/h WiFi 5 GHz (OFDM, 12 Mbps)      | X | 5.28  | 67.75  | 17.35 | 0.86 | 100.0 | ± 9.6 % |
|           |  | Y | 5.16  | 67.43  | 17.04 |      | 100.0 |         |
|           |  | Z | 5.30  | 67.59  | 17.17 |      | 100.0 |         |
| 10065-CAC | IEEE 802.11a/h WiFi 5 GHz (OFDM, 18 Mbps)      | X | 5.19  | 67.81  | 17.53 | 1.21 | 100.0 | ± 9.6 % |
|           |  | Y | 5.07  | 67.47  | 17.22 |      | 100.0 |         |
|           |  | Z | 5.21  | 67.65  | 17.35 |      | 100.0 |         |
| 10066-CAC | IEEE 802.11a/h WiFi 5 GHz (OFDM, 24 Mbps)      | X | 5.25  | 67.95  | 17.76 | 1.46 | 100.0 | ± 9.6 % |
|           |  | Y | 5.12  | 67.61  | 17.44 |      | 100.0 |         |
|           |  | Z | 5.27  | 67.80  | 17.59 |      | 100.0 |         |
| 10067-CAC | IEEE 802.11a/h WiFi 5 GHz (OFDM, 36 Mbps)      | X | 5.57  | 68.10  | 18.21 | 2.04 | 100.0 | ± 9.6 % |
|           |  | Y | 5.44  | 67.80  | 17.92 |      | 100.0 |         |
|           |  | Z | 5.60  | 67.97  | 18.05 |      | 100.0 |         |
| 10068-CAC | IEEE 802.11a/h WiFi 5 GHz (OFDM, 48 Mbps)      | X | 5.73  | 68.50  | 18.60 | 2.55 | 100.0 | ± 9.6 % |
|           |  | Y | 5.58  | 68.13  | 18.28 |      | 100.0 |         |
|           |  | Z | 5.77  | 68.41  | 18.46 |      | 100.0 |         |
| 10069-CAC | IEEE 802.11a/h WiFi 5 GHz (OFDM, 54 Mbps)      | X | 5.81  | 68.43  | 18.78 | 2.67 | 100.0 | ± 9.6 % |
|           |  | Y | 5.66  | 68.09  | 18.46 |      | 100.0 |         |
|           |  | Z | 5.84  | 68.33  | 18.64 |      | 100.0 |         |
| 10071-CAB | IEEE 802.11g WiFi 2.4 GHz (DSSS/OFDM, 9 Mbps)  | X | 5.34  | 67.73  | 18.04 | 1.99 | 100.0 | ± 9.6 % |
|           |  | Y | 5.22  | 67.44  | 17.75 |      | 100.0 |         |
|           |  | Z | 5.35  | 67.60  | 17.87 |      | 100.0 |         |
| 10072-CAB | IEEE 802.11g WiFi 2.4 GHz (DSSS/OFDM, 12 Mbps) | X | 5.42  | 68.35  | 18.39 | 2.30 | 100.0 | ± 9.6 % |
|           |  | Y | 5.29  | 68.00  | 18.07 |      | 100.0 |         |
|           |  | Z | 5.44  | 68.21  | 18.22 |      | 100.0 |         |
| 10073-CAB | IEEE 802.11g WiFi 2.4 GHz (DSSS/OFDM, 18 Mbps) | X | 5.57  | 68.74  | 18.83 | 2.83 | 100.0 | ± 9.6 % |
|           |  | Y | 5.42  | 68.36  | 18.50 |      | 100.0 |         |
|           |  | Z | 5.60  | 68.62  | 18.66 |      | 100.0 |         |
| 10074-CAB | IEEE 802.11g WiFi 2.4 GHz (DSSS/OFDM, 24 Mbps) | X | 5.61  | 68.84  | 19.10 | 3.30 | 100.0 | ± 9.6 % |
|           |  | Y | 5.46  | 68.44  | 18.75 |      | 100.0 |         |
|           |  | Z | 5.65  | 68.74  | 18.95 |      | 100.0 |         |
| 10075-CAB | IEEE 802.11g WiFi 2.4 GHz (DSSS/OFDM, 36 Mbps) | X | 5.79  | 69.40  | 19.63 | 3.82 | 90.0  | ± 9.6 % |
|           |  | Y | 5.61  | 68.91  | 19.24 |      | 90.0  |         |
|           |  | Z | 5.85  | 69.35  | 19.51 |      | 90.0  |         |
| 10076-CAB | IEEE 802.11g WiFi 2.4 GHz (DSSS/OFDM, 48 Mbps) | X | 5.80  | 69.20  | 19.75 | 4.15 | 90.0  | ± 9.6 % |
|           |  | Y | 5.64  | 68.73  | 19.37 |      | 90.0  |         |
|           |  | Z | 5.86  | 69.15  | 19.63 |      | 90.0  |         |
| 10077-CAB | IEEE 802.11g WiFi 2.4 GHz (DSSS/OFDM, 54 Mbps) | X | 5.84  | 69.30  | 19.86 | 4.30 | 90.0  | ± 9.6 % |
|           |  | Y | 5.68  | 68.82  | 19.47 |      | 90.0  |         |
|           |  | Z | 5.90  | 69.25  | 19.74 |      | 90.0  |         |

|           |   |   |        |        |       |      |       |         |
|-----------|---|---|--------|--------|-------|------|-------|---------|
| 10081-CAB | CDMA2000 (1xRTT, RC3)                               | X | 1.29   | 72.14  | 16.36 | 0.00 | 150.0 | ± 9.6 % |
|           |   | Y | 0.81   | 65.51  | 12.24 |      | 150.0 |         |
|           |   | Z | 0.99   | 67.68  | 14.05 |      | 150.0 |         |
| 10082-CAB | IS-54 / IS-136 FDD (TDMA/FDM, PI/4-DQPSK, Fullrate) | X | 2.36   | 64.73  | 9.48  | 4.77 | 80.0  | ± 9.6 % |
|           |   | Y | 1.97   | 63.15  | 8.18  |      | 80.0  |         |
|           |   | Z | 2.45   | 64.78  | 9.67  |      | 80.0  |         |
| 10090-DAC | GPRS-FDD (TDMA, GMSK, TN 0-4)                       | X | 100.00 | 119.65 | 31.37 | 6.56 | 60.0  | ± 9.6 % |
|           |   | Y | 100.00 | 117.49 | 29.99 |      | 60.0  |         |
|           |   | Z | 45.52  | 107.81 | 28.61 |      | 60.0  |         |
| 10097-CAB | UMTS-FDD (HSDPA)                                    | X | 2.00   | 69.44  | 16.95 | 0.00 | 150.0 | ± 9.6 % |
|           |   | Y | 1.78   | 67.32  | 15.42 |      | 150.0 |         |
|           |   | Z | 1.87   | 67.93  | 15.97 |      | 150.0 |         |
| 10098-CAB | UMTS-FDD (HSUPA, Subtest 2)                         | X | 1.97   | 69.46  | 16.95 | 0.00 | 150.0 | ± 9.6 % |
|           |   | Y | 1.74   | 67.28  | 15.38 |      | 150.0 |         |
|           |   | Z | 1.84   | 67.91  | 15.95 |      | 150.0 |         |
| 10099-DAC | EDGE-FDD (TDMA, 8PSK, TN 0-4)                       | X | 21.45  | 104.88 | 36.18 | 9.56 | 60.0  | ± 9.6 % |
|           |   | Y | 18.89  | 102.07 | 34.98 |      | 60.0  |         |
|           |   | Z | 18.39  | 100.05 | 34.32 |      | 60.0  |         |
| 10100-CAD | LTE-FDD (SC-FDMA, 100% RB, 20 MHz, QPSK)            | X | 3.55   | 72.46  | 17.74 | 0.00 | 150.0 | ± 9.6 % |
|           |   | Y | 3.14   | 70.29  | 16.48 |      | 150.0 |         |
|           |   | Z | 3.35   | 71.19  | 16.95 |      | 150.0 |         |
| 10101-CAD | LTE-FDD (SC-FDMA, 100% RB, 20 MHz, 16-QAM)          | X | 3.45   | 68.62  | 16.57 | 0.00 | 150.0 | ± 9.6 % |
|           |   | Y | 3.26   | 67.61  | 15.85 |      | 150.0 |         |
|           |   | Z | 3.39   | 68.08  | 16.14 |      | 150.0 |         |
| 10102-CAD | LTE-FDD (SC-FDMA, 100% RB, 20 MHz, 64-QAM)          | X | 3.54   | 68.46  | 16.61 | 0.00 | 150.0 | ± 9.6 % |
|           |   | Y | 3.37   | 67.56  | 15.95 |      | 150.0 |         |
|           |   | Z | 3.49   | 67.97  | 16.20 |      | 150.0 |         |
| 10103-CAD | LTE-TDD (SC-FDMA, 100% RB, 20 MHz, QPSK)            | X | 8.98   | 78.82  | 21.57 | 3.98 | 65.0  | ± 9.6 % |
|           |   | Y | 8.50   | 78.15  | 21.17 |      | 65.0  |         |
|           |   | Z | 8.60   | 77.58  | 20.95 |      | 65.0  |         |
| 10104-CAD | LTE-TDD (SC-FDMA, 100% RB, 20 MHz, 16-QAM)          | X | 8.85   | 77.44  | 21.89 | 3.98 | 65.0  | ± 9.6 % |
|           |   | Y | 8.45   | 76.83  | 21.49 |      | 65.0  |         |
|           |   | Z | 8.72   | 76.72  | 21.48 |      | 65.0  |         |
| 10105-CAD | LTE-TDD (SC-FDMA, 100% RB, 20 MHz, 64-QAM)          | X | 8.33   | 76.23  | 21.66 | 3.98 | 65.0  | ± 9.6 % |
|           |   | Y | 7.79   | 75.22  | 21.09 |      | 65.0  |         |
|           |   | Z | 7.71   | 74.28  | 20.69 |      | 65.0  |         |
| 10108-CAE | LTE-FDD (SC-FDMA, 100% RB, 10 MHz, QPSK)            | X | 3.11   | 71.64  | 17.59 | 0.00 | 150.0 | ± 9.6 % |
|           |   | Y | 2.75   | 69.54  | 16.32 |      | 150.0 |         |
|           |   | Z | 2.95   | 70.37  | 16.78 |      | 150.0 |         |
| 10109-CAE | LTE-FDD (SC-FDMA, 100% RB, 10 MHz, 16-QAM)          | X | 3.12   | 68.50  | 16.56 | 0.00 | 150.0 | ± 9.6 % |
|           |   | Y | 2.92   | 67.41  | 15.75 |      | 150.0 |         |
|           |   | Z | 3.06   | 67.87  | 16.07 |      | 150.0 |         |
| 10110-CAE | LTE-FDD (SC-FDMA, 100% RB, 5 MHz, QPSK)             | X | 2.56   | 70.84  | 17.38 | 0.00 | 150.0 | ± 9.6 % |
|           |   | Y | 2.24   | 68.61  | 15.94 |      | 150.0 |         |
|           |   | Z | 2.42   | 69.44  | 16.48 |      | 150.0 |         |
| 10111-CAE | LTE-FDD (SC-FDMA, 100% RB, 5 MHz, 16-QAM)           | X | 2.84   | 69.29  | 16.96 | 0.00 | 150.0 | ± 9.6 % |
|           |   | Y | 2.62   | 68.02  | 15.99 |      | 150.0 |         |
|           |   | Z | 2.75   | 68.36  | 16.33 |      | 150.0 |         |

|           |  |   |      |       |       |      |       |         |
|-----------|--|---|------|-------|-------|------|-------|---------|
| 10112-CAE | LTE-FDD (SC-FDMA, 100% RB, 10 MHz, 64-QAM)     | X | 3.23 | 68.35 | 16.55 | 0.00 | 150.0 | ± 9.6 % |
|           |  | Y | 3.05 | 67.38 | 15.81 |      | 150.0 |         |
|           |  | Z | 3.18 | 67.77 | 16.10 |      | 150.0 |         |
| 10113-CAE | LTE-FDD (SC-FDMA, 100% RB, 5 MHz, 64-QAM)      | X | 2.98 | 69.28 | 17.01 | 0.00 | 150.0 | ± 9.6 % |
|           |  | Y | 2.77 | 68.14 | 16.13 |      | 150.0 |         |
|           |  | Z | 2.90 | 68.40 | 16.43 |      | 150.0 |         |
| 10114-CAC | IEEE 802.11n (HT Greenfield, 13.5 Mbps, BPSK)  | X | 5.25 | 67.55 | 16.67 | 0.00 | 150.0 | ± 9.6 % |
|           |  | Y | 5.16 | 67.27 | 16.41 |      | 150.0 |         |
|           |  | Z | 5.23 | 67.36 | 16.47 |      | 150.0 |         |
| 10115-CAC | IEEE 802.11n (HT Greenfield, 81 Mbps, 16-QAM)  | X | 5.62 | 67.87 | 16.84 | 0.00 | 150.0 | ± 9.6 % |
|           |  | Y | 5.53 | 67.61 | 16.59 |      | 150.0 |         |
|           |  | Z | 5.61 | 67.68 | 16.64 |      | 150.0 |         |
| 10116-CAC | IEEE 802.11n (HT Greenfield, 135 Mbps, 64-QAM) | X | 5.38 | 67.84 | 16.74 | 0.00 | 150.0 | ± 9.6 % |
|           |  | Y | 5.28 | 67.54 | 16.47 |      | 150.0 |         |
|           |  | Z | 5.37 | 67.64 | 16.53 |      | 150.0 |         |
| 10117-CAC | IEEE 802.11n (HT Mixed, 13.5 Mbps, BPSK)       | X | 5.26 | 67.57 | 16.70 | 0.00 | 150.0 | ± 9.6 % |
|           |  | Y | 5.15 | 67.22 | 16.40 |      | 150.0 |         |
|           |  | Z | 5.24 | 67.39 | 16.51 |      | 150.0 |         |
| 10118-CAC | IEEE 802.11n (HT Mixed, 81 Mbps, 16-QAM)       | X | 5.70 | 68.05 | 16.94 | 0.00 | 150.0 | ± 9.6 % |
|           |  | Y | 5.61 | 67.82 | 16.70 |      | 150.0 |         |
|           |  | Z | 5.67 | 67.81 | 16.71 |      | 150.0 |         |
| 10119-CAC | IEEE 802.11n (HT Mixed, 135 Mbps, 64-QAM)      | X | 5.36 | 67.79 | 16.73 | 0.00 | 150.0 | ± 9.6 % |
|           |  | Y | 5.26 | 67.48 | 16.45 |      | 150.0 |         |
|           |  | Z | 5.34 | 67.59 | 16.52 |      | 150.0 |         |
| 10140-CAD | LTE-FDD (SC-FDMA, 100% RB, 15 MHz, 16-QAM)     | X | 3.59 | 68.46 | 16.53 | 0.00 | 150.0 | ± 9.6 % |
|           |  | Y | 3.41 | 67.56 | 15.87 |      | 150.0 |         |
|           |  | Z | 3.54 | 67.97 | 16.13 |      | 150.0 |         |
| 10141-CAD | LTE-FDD (SC-FDMA, 100% RB, 15 MHz, 64-QAM)     | X | 3.70 | 68.46 | 16.65 | 0.00 | 150.0 | ± 9.6 % |
|           |  | Y | 3.53 | 67.64 | 16.03 |      | 150.0 |         |
|           |  | Z | 3.65 | 67.99 | 16.26 |      | 150.0 |         |
| 10142-CAD | LTE-FDD (SC-FDMA, 100% RB, 3 MHz, QPSK)        | X | 2.36 | 71.08 | 17.31 | 0.00 | 150.0 | ± 9.6 % |
|           |  | Y | 2.01 | 68.49 | 15.62 |      | 150.0 |         |
|           |  | Z | 2.20 | 69.37 | 16.30 |      | 150.0 |         |
| 10143-CAD | LTE-FDD (SC-FDMA, 100% RB, 3 MHz, 16-QAM)      | X | 2.76 | 70.34 | 17.00 | 0.00 | 150.0 | ± 9.6 % |
|           |  | Y | 2.47 | 68.62 | 15.73 |      | 150.0 |         |
|           |  | Z | 2.62 | 69.02 | 16.23 |      | 150.0 |         |
| 10144-CAD | LTE-FDD (SC-FDMA, 100% RB, 3 MHz, 64-QAM)      | X | 2.54 | 68.16 | 15.50 | 0.00 | 150.0 | ± 9.6 % |
|           |  | Y | 2.28 | 66.60 | 14.27 |      | 150.0 |         |
|           |  | Z | 2.46 | 67.23 | 14.93 |      | 150.0 |         |
| 10145-CAE | LTE-FDD (SC-FDMA, 100% RB, 1.4 MHz, QPSK)      | X | 1.75 | 69.86 | 15.18 | 0.00 | 150.0 | ± 9.6 % |
|           |  | Y | 1.29 | 65.55 | 12.27 |      | 150.0 |         |
|           |  | Z | 1.55 | 67.61 | 14.05 |      | 150.0 |         |
| 10146-CAE | LTE-FDD (SC-FDMA, 100% RB, 1.4 MHz, 16-QAM)    | X | 4.07 | 76.05 | 17.30 | 0.00 | 150.0 | ± 9.6 % |
|           |  | Y | 2.52 | 69.20 | 13.62 |      | 150.0 |         |
|           |  | Z | 3.50 | 73.50 | 16.33 |      | 150.0 |         |
| 10147-CAE | LTE-FDD (SC-FDMA, 100% RB, 1.4 MHz, 64-QAM)    | X | 5.72 | 80.95 | 19.32 | 0.00 | 150.0 | ± 9.6 % |
|           |  | Y | 3.13 | 72.10 | 15.05 |      | 150.0 |         |
|           |  | Z | 4.43 | 76.91 | 17.88 |      | 150.0 |         |

|           |  |   |      |       |       |      |       |         |
|-----------|--|---|------|-------|-------|------|-------|---------|
| 10149-CAD | LTE-FDD (SC-FDMA, 50% RB, 20 MHz, 16-QAM)  | X | 3.13 | 68.56 | 16.60 | 0.00 | 150.0 | ± 9.6 % |
|           |  | Y | 2.93 | 67.47 | 15.80 |      | 150.0 |         |
|           |  | Z | 3.07 | 67.93 | 16.12 |      | 150.0 |         |
| 10150-CAD | LTE-FDD (SC-FDMA, 50% RB, 20 MHz, 64-QAM)  | X | 3.24 | 68.40 | 16.59 | 0.00 | 150.0 | ± 9.6 % |
|           |  | Y | 3.05 | 67.43 | 15.85 |      | 150.0 |         |
|           |  | Z | 3.18 | 67.82 | 16.13 |      | 150.0 |         |
| 10151-CAD | LTE-TDD (SC-FDMA, 50% RB, 20 MHz, QPSK)    | X | 9.59 | 81.21 | 22.61 | 3.98 | 65.0  | ± 9.6 % |
|           |  | Y | 9.21 | 80.79 | 22.27 |      | 65.0  |         |
|           |  | Z | 9.05 | 79.62 | 21.87 |      | 65.0  |         |
| 10152-CAD | LTE-TDD (SC-FDMA, 50% RB, 20 MHz, 16-QAM)  | X | 8.53 | 77.77 | 21.82 | 3.98 | 65.0  | ± 9.6 % |
|           |  | Y | 8.07 | 77.03 | 21.32 |      | 65.0  |         |
|           |  | Z | 8.36 | 76.93 | 21.37 |      | 65.0  |         |
| 10153-CAD | LTE-TDD (SC-FDMA, 50% RB, 20 MHz, 64-QAM)  | X | 8.87 | 78.41 | 22.41 | 3.98 | 65.0  | ± 9.6 % |
|           |  | Y | 8.48 | 77.88 | 22.02 |      | 65.0  |         |
|           |  | Z | 8.68 | 77.54 | 21.94 |      | 65.0  |         |
| 10154-CAE | LTE-FDD (SC-FDMA, 50% RB, 10 MHz, QPSK)    | X | 2.63 | 71.34 | 17.67 | 0.00 | 150.0 | ± 9.6 % |
|           |  | Y | 2.29 | 69.04 | 16.21 |      | 150.0 |         |
|           |  | Z | 2.48 | 69.88 | 16.75 |      | 150.0 |         |
| 10155-CAE | LTE-FDD (SC-FDMA, 50% RB, 10 MHz, 16-QAM)  | X | 2.84 | 69.30 | 16.97 | 0.00 | 150.0 | ± 9.6 % |
|           |  | Y | 2.62 | 68.03 | 16.00 |      | 150.0 |         |
|           |  | Z | 2.75 | 68.36 | 16.34 |      | 150.0 |         |
| 10156-CAE | LTE-FDD (SC-FDMA, 50% RB, 5 MHz, QPSK)     | X | 2.26 | 71.67 | 17.44 | 0.00 | 150.0 | ± 9.6 % |
|           |  | Y | 1.86 | 68.59 | 15.46 |      | 150.0 |         |
|           |  | Z | 2.07 | 69.64 | 16.29 |      | 150.0 |         |
| 10157-CAE | LTE-FDD (SC-FDMA, 50% RB, 5 MHz, 16-QAM)   | X | 2.42 | 69.16 | 15.83 | 0.00 | 150.0 | ± 9.6 % |
|           |  | Y | 2.11 | 67.12 | 14.31 |      | 150.0 |         |
|           |  | Z | 2.30 | 67.87 | 15.10 |      | 150.0 |         |
| 10158-CAE | LTE-FDD (SC-FDMA, 50% RB, 10 MHz, 64-QAM)  | X | 2.99 | 69.33 | 17.05 | 0.00 | 150.0 | ± 9.6 % |
|           |  | Y | 2.78 | 68.20 | 16.17 |      | 150.0 |         |
|           |  | Z | 2.90 | 68.44 | 16.46 |      | 150.0 |         |
| 10159-CAE | LTE-FDD (SC-FDMA, 50% RB, 5 MHz, 64-QAM)   | X | 2.55 | 69.60 | 16.11 | 0.00 | 150.0 | ± 9.6 % |
|           |  | Y | 2.22 | 67.56 | 14.60 |      | 150.0 |         |
|           |  | Z | 2.41 | 68.28 | 15.37 |      | 150.0 |         |
| 10160-CAD | LTE-FDD (SC-FDMA, 50% RB, 15 MHz, QPSK)    | X | 3.02 | 70.16 | 17.19 | 0.00 | 150.0 | ± 9.6 % |
|           |  | Y | 2.77 | 68.66 | 16.17 |      | 150.0 |         |
|           |  | Z | 2.91 | 69.14 | 16.50 |      | 150.0 |         |
| 10161-CAD | LTE-FDD (SC-FDMA, 50% RB, 15 MHz, 16-QAM)  | X | 3.13 | 68.32 | 16.54 | 0.00 | 150.0 | ± 9.6 % |
|           |  | Y | 2.95 | 67.34 | 15.78 |      | 150.0 |         |
|           |  | Z | 3.07 | 67.70 | 16.08 |      | 150.0 |         |
| 10162-CAD | LTE-FDD (SC-FDMA, 50% RB, 15 MHz, 64-QAM)  | X | 3.23 | 68.35 | 16.60 | 0.00 | 150.0 | ± 9.6 % |
|           |  | Y | 3.06 | 67.45 | 15.88 |      | 150.0 |         |
|           |  | Z | 3.18 | 67.74 | 16.14 |      | 150.0 |         |
| 10166-CAE | LTE-FDD (SC-FDMA, 50% RB, 1.4 MHz, QPSK)   | X | 4.02 | 71.10 | 20.08 | 3.01 | 150.0 | ± 9.6 % |
|           |  | Y | 3.79 | 70.19 | 19.37 |      | 150.0 |         |
|           |  | Z | 4.03 | 70.69 | 19.72 |      | 150.0 |         |
| 10167-CAE | LTE-FDD (SC-FDMA, 50% RB, 1.4 MHz, 16-QAM) | X | 5.24 | 74.71 | 20.79 | 3.01 | 150.0 | ± 9.6 % |
|           |  | Y | 4.82 | 73.39 | 19.92 |      | 150.0 |         |
|           |  | Z | 5.25 | 74.14 | 20.39 |      | 150.0 |         |

|           |  |   |       |        |       |      |       |         |
|-----------|--|---|-------|--------|-------|------|-------|---------|
| 10168-CAE | LTE-FDD (SC-FDMA, 50% RB, 1.4 MHz, 64-QAM) | X | 5.76  | 76.76  | 21.96 | 3.01 | 150.0 | ± 9.6 % |
|           |  | Y | 5.36  | 75.66  | 21.24 |      | 150.0 |         |
|           |  | Z | 5.73  | 75.99  | 21.47 |      | 150.0 |         |
| 10169-CAD | LTE-FDD (SC-FDMA, 1 RB, 20 MHz, QPSK)      | X | 3.69  | 72.72  | 20.82 | 3.01 | 150.0 | ± 9.6 % |
|           |  | Y | 3.33  | 70.78  | 19.63 |      | 150.0 |         |
|           |  | Z | 3.78  | 72.61  | 20.53 |      | 150.0 |         |
| 10170-CAD | LTE-FDD (SC-FDMA, 1 RB, 20 MHz, 16-QAM)    | X | 5.76  | 80.54  | 23.62 | 3.01 | 150.0 | ± 9.6 % |
|           |  | Y | 4.94  | 77.74  | 22.22 |      | 150.0 |         |
|           |  | Z | 5.83  | 79.90  | 23.09 |      | 150.0 |         |
| 10171-AAD | LTE-FDD (SC-FDMA, 1 RB, 20 MHz, 64-QAM)    | X | 4.61  | 75.69  | 20.76 | 3.01 | 150.0 | ± 9.6 % |
|           |  | Y | 3.94  | 72.92  | 19.25 |      | 150.0 |         |
|           |  | Z | 4.70  | 75.28  | 20.35 |      | 150.0 |         |
| 10172-CAD | LTE-TDD (SC-FDMA, 1 RB, 20 MHz, QPSK)      | X | 36.99 | 114.19 | 35.08 | 6.02 | 65.0  | ± 9.6 % |
|           |  | Y | 22.97 | 105.21 | 32.24 |      | 65.0  |         |
|           |  | Z | 26.68 | 106.36 | 32.56 |      | 65.0  |         |
| 10173-CAD | LTE-TDD (SC-FDMA, 1 RB, 20 MHz, 16-QAM)    | X | 41.01 | 110.69 | 32.32 | 6.02 | 65.0  | ± 9.6 % |
|           |  | Y | 35.83 | 108.35 | 31.36 |      | 65.0  |         |
|           |  | Z | 28.00 | 102.66 | 29.85 |      | 65.0  |         |
| 10174-CAD | LTE-TDD (SC-FDMA, 1 RB, 20 MHz, 64-QAM)    | X | 30.73 | 104.07 | 29.95 | 6.02 | 65.0  | ± 9.6 % |
|           |  | Y | 27.27 | 102.14 | 29.08 |      | 65.0  |         |
|           |  | Z | 22.20 | 97.35  | 27.81 |      | 65.0  |         |
| 10175-CAE | LTE-FDD (SC-FDMA, 1 RB, 10 MHz, QPSK)      | X | 3.64  | 72.35  | 20.56 | 3.01 | 150.0 | ± 9.6 % |
|           |  | Y | 3.28  | 70.42  | 19.36 |      | 150.0 |         |
|           |  | Z | 3.72  | 72.25  | 20.28 |      | 150.0 |         |
| 10176-CAE | LTE-FDD (SC-FDMA, 1 RB, 10 MHz, 16-QAM)    | X | 5.77  | 80.56  | 23.63 | 3.01 | 150.0 | ± 9.6 % |
|           |  | Y | 4.95  | 77.76  | 22.23 |      | 150.0 |         |
|           |  | Z | 5.84  | 79.92  | 23.10 |      | 150.0 |         |
| 10177-CAG | LTE-FDD (SC-FDMA, 1 RB, 5 MHz, QPSK)       | X | 3.67  | 72.53  | 20.66 | 3.01 | 150.0 | ± 9.6 % |
|           |  | Y | 3.31  | 70.60  | 19.46 |      | 150.0 |         |
|           |  | Z | 3.76  | 72.42  | 20.38 |      | 150.0 |         |
| 10178-CAE | LTE-FDD (SC-FDMA, 1 RB, 5 MHz, 16-QAM)     | X | 5.68  | 80.23  | 23.47 | 3.01 | 150.0 | ± 9.6 % |
|           |  | Y | 4.88  | 77.46  | 22.08 |      | 150.0 |         |
|           |  | Z | 5.74  | 79.60  | 22.95 |      | 150.0 |         |
| 10179-CAE | LTE-FDD (SC-FDMA, 1 RB, 10 MHz, 64-QAM)    | X | 5.14  | 77.96  | 22.04 | 3.01 | 150.0 | ± 9.6 % |
|           |  | Y | 4.38  | 75.13  | 20.57 |      | 150.0 |         |
|           |  | Z | 5.21  | 77.41  | 21.56 |      | 150.0 |         |
| 10180-CAE | LTE-FDD (SC-FDMA, 1 RB, 5 MHz, 64-QAM)     | X | 4.59  | 75.59  | 20.70 | 3.01 | 150.0 | ± 9.6 % |
|           |  | Y | 3.92  | 72.83  | 19.19 |      | 150.0 |         |
|           |  | Z | 4.68  | 75.18  | 20.29 |      | 150.0 |         |
| 10181-CAD | LTE-FDD (SC-FDMA, 1 RB, 15 MHz, QPSK)      | X | 3.66  | 72.51  | 20.66 | 3.01 | 150.0 | ± 9.6 % |
|           |  | Y | 3.30  | 70.58  | 19.46 |      | 150.0 |         |
|           |  | Z | 3.75  | 72.41  | 20.37 |      | 150.0 |         |
| 10182-CAD | LTE-FDD (SC-FDMA, 1 RB, 15 MHz, 16-QAM)    | X | 5.67  | 80.21  | 23.46 | 3.01 | 150.0 | ± 9.6 % |
|           |  | Y | 4.87  | 77.43  | 22.07 |      | 150.0 |         |
|           |  | Z | 5.73  | 79.57  | 22.94 |      | 150.0 |         |
| 10183-AAC | LTE-FDD (SC-FDMA, 1 RB, 15 MHz, 64-QAM)    | X | 4.58  | 75.56  | 20.68 | 3.01 | 150.0 | ± 9.6 % |
|           |  | Y | 3.92  | 72.80  | 19.18 |      | 150.0 |         |
|           |  | Z | 4.67  | 75.15  | 20.27 |      | 150.0 |         |



|           |   |   |      |       |       |      |       |         |
|-----------|---|---|------|-------|-------|------|-------|---------|
| 10184-CAD | LTE-FDD (SC-FDMA, 1 RB, 3 MHz, QPSK)          | X | 3.68 | 72.56 | 20.68 | 3.01 | 150.0 | ± 9.6 % |
|           |   | Y | 3.32 | 70.63 | 19.48 |      | 150.0 |         |
|           |   | Z | 3.77 | 72.45 | 20.39 |      | 150.0 |         |
| 10185-CAD | LTE-FDD (SC-FDMA, 1 RB, 3 MHz, 16-QAM)        | X | 5.70 | 80.29 | 23.50 | 3.01 | 150.0 | ± 9.6 % |
|           |   | Y | 4.90 | 77.51 | 22.11 |      | 150.0 |         |
|           |   | Z | 5.76 | 79.65 | 22.97 |      | 150.0 |         |
| 10186-AAD | LTE-FDD (SC-FDMA, 1 RB, 3 MHz, 64-QAM)        | X | 4.61 | 75.64 | 20.72 | 3.01 | 150.0 | ± 9.6 % |
|           |   | Y | 3.94 | 72.88 | 19.21 |      | 150.0 |         |
|           |   | Z | 4.69 | 75.23 | 20.31 |      | 150.0 |         |
| 10187-CAE | LTE-FDD (SC-FDMA, 1 RB, 1.4 MHz, QPSK)        | X | 3.69 | 72.61 | 20.73 | 3.01 | 150.0 | ± 9.6 % |
|           |   | Y | 3.33 | 70.68 | 19.54 |      | 150.0 |         |
|           |   | Z | 3.77 | 72.50 | 20.44 |      | 150.0 |         |
| 10188-CAE | LTE-FDD (SC-FDMA, 1 RB, 1.4 MHz, 16-QAM)      | X | 5.93 | 81.11 | 23.91 | 3.01 | 150.0 | ± 9.6 % |
|           |   | Y | 5.09 | 78.33 | 22.53 |      | 150.0 |         |
|           |   | Z | 5.99 | 80.44 | 23.37 |      | 150.0 |         |
| 10189-AAE | LTE-FDD (SC-FDMA, 1 RB, 1.4 MHz, 64-QAM)      | X | 4.73 | 76.16 | 21.02 | 3.01 | 150.0 | ± 9.6 % |
|           |   | Y | 4.04 | 73.37 | 19.51 |      | 150.0 |         |
|           |   | Z | 4.82 | 75.73 | 20.60 |      | 150.0 |         |
| 10193-CAC | IEEE 802.11n (HT Greenfield, 6.5 Mbps, BPSK)  | X | 4.67 | 66.99 | 16.47 | 0.00 | 150.0 | ± 9.6 % |
|           |   | Y | 4.56 | 66.66 | 16.13 |      | 150.0 |         |
|           |   | Z | 4.66 | 66.78 | 16.26 |      | 150.0 |         |
| 10194-CAC | IEEE 802.11n (HT Greenfield, 39 Mbps, 16-QAM) | X | 4.87 | 67.36 | 16.58 | 0.00 | 150.0 | ± 9.6 % |
|           |   | Y | 4.75 | 67.00 | 16.25 |      | 150.0 |         |
|           |   | Z | 4.87 | 67.15 | 16.37 |      | 150.0 |         |
| 10195-CAC | IEEE 802.11n (HT Greenfield, 65 Mbps, 64-QAM) | X | 4.91 | 67.37 | 16.59 | 0.00 | 150.0 | ± 9.6 % |
|           |   | Y | 4.79 | 67.03 | 16.27 |      | 150.0 |         |
|           |   | Z | 4.91 | 67.16 | 16.38 |      | 150.0 |         |
| 10196-CAC | IEEE 802.11n (HT Mixed, 6.5 Mbps, BPSK)       | X | 4.69 | 67.10 | 16.51 | 0.00 | 150.0 | ± 9.6 % |
|           |   | Y | 4.58 | 66.74 | 16.16 |      | 150.0 |         |
|           |   | Z | 4.69 | 66.88 | 16.30 |      | 150.0 |         |
| 10197-CAC | IEEE 802.11n (HT Mixed, 39 Mbps, 16-QAM)      | X | 4.89 | 67.38 | 16.59 | 0.00 | 150.0 | ± 9.6 % |
|           |   | Y | 4.77 | 67.03 | 16.26 |      | 150.0 |         |
|           |   | Z | 4.88 | 67.17 | 16.38 |      | 150.0 |         |
| 10198-CAC | IEEE 802.11n (HT Mixed, 65 Mbps, 64-QAM)      | X | 4.92 | 67.39 | 16.60 | 0.00 | 150.0 | ± 9.6 % |
|           |   | Y | 4.80 | 67.05 | 16.28 |      | 150.0 |         |
|           |   | Z | 4.91 | 67.18 | 16.39 |      | 150.0 |         |
| 10219-CAC | IEEE 802.11n (HT Mixed, 7.2 Mbps, BPSK)       | X | 4.64 | 67.11 | 16.47 | 0.00 | 150.0 | ± 9.6 % |
|           |   | Y | 4.53 | 66.75 | 16.12 |      | 150.0 |         |
|           |   | Z | 4.64 | 66.90 | 16.26 |      | 150.0 |         |
| 10220-CAC | IEEE 802.11n (HT Mixed, 43.3 Mbps, 16-QAM)    | X | 4.88 | 67.37 | 16.59 | 0.00 | 150.0 | ± 9.6 % |
|           |   | Y | 4.76 | 67.01 | 16.26 |      | 150.0 |         |
|           |   | Z | 4.88 | 67.17 | 16.38 |      | 150.0 |         |
| 10221-CAC | IEEE 802.11n (HT Mixed, 72.2 Mbps, 64-QAM)    | X | 4.92 | 67.32 | 16.59 | 0.00 | 150.0 | ± 9.6 % |
|           |   | Y | 4.80 | 66.98 | 16.27 |      | 150.0 |         |
|           |   | Z | 4.92 | 67.11 | 16.38 |      | 150.0 |         |
| 10222-CAC | IEEE 802.11n (HT Mixed, 15 Mbps, BPSK)        | X | 5.23 | 67.59 | 16.70 | 0.00 | 150.0 | ± 9.6 % |
|           |   | Y | 5.12 | 67.23 | 16.39 |      | 150.0 |         |
|           |   | Z | 5.22 | 67.42 | 16.51 |      | 150.0 |         |

|           |   |   |       |        |       |      |       |         |
|-----------|---|---|-------|--------|-------|------|-------|---------|
| 10223-CAC | IEEE 802.11n (HT Mixed, 90 Mbps, 16-QAM)  | X | 5.61  | 67.92  | 16.89 | 0.00 | 150.0 | ± 9.6 % |
|           |   | Y | 5.46  | 67.48  | 16.54 |      | 150.0 |         |
|           |   | Z | 5.61  | 67.78  | 16.72 |      | 150.0 |         |
| 10224-CAC | IEEE 802.11n (HT Mixed, 150 Mbps, 64-QAM) | X | 5.28  | 67.68  | 16.67 | 0.00 | 150.0 | ± 9.6 % |
|           |   | Y | 5.17  | 67.32  | 16.37 |      | 150.0 |         |
|           |   | Z | 5.27  | 67.52  | 16.48 |      | 150.0 |         |
| 10225-CAB | UMTS-FDD (HSPA+)                          | X | 2.96  | 66.82  | 16.01 | 0.00 | 150.0 | ± 9.6 % |
|           |   | Y | 2.82  | 66.09  | 15.31 |      | 150.0 |         |
|           |   | Z | 2.93  | 66.33  | 15.63 |      | 150.0 |         |
| 10226-CAA | LTE-TDD (SC-FDMA, 1 RB, 1.4 MHz, 16-QAM)  | X | 43.59 | 111.94 | 32.75 | 6.02 | 65.0  | ± 9.6 % |
|           |   | Y | 38.77 | 109.92 | 31.88 |      | 65.0  |         |
|           |   | Z | 29.30 | 103.58 | 30.20 |      | 65.0  |         |
| 10227-CAA | LTE-TDD (SC-FDMA, 1 RB, 1.4 MHz, 64-QAM)  | X | 32.72 | 105.33 | 30.40 | 6.02 | 65.0  | ± 9.6 % |
|           |   | Y | 30.31 | 104.10 | 29.73 |      | 65.0  |         |
|           |   | Z | 23.58 | 98.50  | 28.23 |      | 65.0  |         |
| 10228-CAA | LTE-TDD (SC-FDMA, 1 RB, 1.4 MHz, QPSK)    | X | 45.04 | 118.57 | 36.38 | 6.02 | 65.0  | ± 9.6 % |
|           |   | Y | 33.63 | 112.96 | 34.54 |      | 65.0  |         |
|           |   | Z | 30.07 | 109.15 | 33.47 |      | 65.0  |         |
| 10229-CAB | LTE-TDD (SC-FDMA, 1 RB, 3 MHz, 16-QAM)    | X | 40.99 | 110.67 | 32.33 | 6.02 | 65.0  | ± 9.6 % |
|           |   | Y | 35.91 | 108.38 | 31.38 |      | 65.0  |         |
|           |   | Z | 28.02 | 102.65 | 29.86 |      | 65.0  |         |
| 10230-CAB | LTE-TDD (SC-FDMA, 1 RB, 3 MHz, 64-QAM)    | X | 31.17 | 104.37 | 30.06 | 6.02 | 65.0  | ± 9.6 % |
|           |   | Y | 28.46 | 102.90 | 29.31 |      | 65.0  |         |
|           |   | Z | 22.72 | 97.78  | 27.95 |      | 65.0  |         |
| 10231-CAB | LTE-TDD (SC-FDMA, 1 RB, 3 MHz, QPSK)      | X | 42.43 | 117.25 | 35.96 | 6.02 | 65.0  | ± 9.6 % |
|           |   | Y | 31.37 | 111.47 | 34.05 |      | 65.0  |         |
|           |   | Z | 28.77 | 108.18 | 33.13 |      | 65.0  |         |
| 10232-CAD | LTE-TDD (SC-FDMA, 1 RB, 5 MHz, 16-QAM)    | X | 40.99 | 110.68 | 32.33 | 6.02 | 65.0  | ± 9.6 % |
|           |   | Y | 35.90 | 108.38 | 31.38 |      | 65.0  |         |
|           |   | Z | 28.01 | 102.65 | 29.86 |      | 65.0  |         |
| 10233-CAD | LTE-TDD (SC-FDMA, 1 RB, 5 MHz, 64-QAM)    | X | 31.21 | 104.41 | 30.07 | 6.02 | 65.0  | ± 9.6 % |
|           |   | Y | 28.46 | 102.91 | 29.32 |      | 65.0  |         |
|           |   | Z | 22.74 | 97.80  | 27.96 |      | 65.0  |         |
| 10234-CAD | LTE-TDD (SC-FDMA, 1 RB, 5 MHz, QPSK)      | X | 39.80 | 115.77 | 35.45 | 6.02 | 65.0  | ± 9.6 % |
|           |   | Y | 29.32 | 109.94 | 33.51 |      | 65.0  |         |
|           |   | Z | 27.42 | 107.07 | 32.71 |      | 65.0  |         |
| 10235-CAD | LTE-TDD (SC-FDMA, 1 RB, 10 MHz, 16-QAM)   | X | 41.16 | 110.77 | 32.35 | 6.02 | 65.0  | ± 9.6 % |
|           |   | Y | 36.04 | 108.46 | 31.40 |      | 65.0  |         |
|           |   | Z | 28.08 | 102.71 | 29.87 |      | 65.0  |         |
| 10236-CAD | LTE-TDD (SC-FDMA, 1 RB, 10 MHz, 64-QAM)   | X | 31.50 | 104.54 | 30.10 | 6.02 | 65.0  | ± 9.6 % |
|           |   | Y | 28.73 | 103.05 | 29.35 |      | 65.0  |         |
|           |   | Z | 22.90 | 97.90  | 27.98 |      | 65.0  |         |
| 10237-CAD | LTE-TDD (SC-FDMA, 1 RB, 10 MHz, QPSK)     | X | 42.99 | 117.54 | 36.03 | 6.02 | 65.0  | ± 9.6 % |
|           |   | Y | 31.67 | 111.68 | 34.11 |      | 65.0  |         |
|           |   | Z | 29.03 | 108.38 | 33.18 |      | 65.0  |         |
| 10238-CAD | LTE-TDD (SC-FDMA, 1 RB, 15 MHz, 16-QAM)   | X | 41.04 | 110.71 | 32.33 | 6.02 | 65.0  | ± 9.6 % |
|           |   | Y | 35.91 | 108.40 | 31.38 |      | 65.0  |         |
|           |   | Z | 28.02 | 102.67 | 29.86 |      | 65.0  |         |

|           |  |   |       |        |       |      |      |         |
|-----------|--|---|-------|--------|-------|------|------|---------|
| 10239-CAD | LTE-TDD (SC-FDMA, 1 RB, 15 MHz, 64-QAM)    | X | 31.24 | 104.44 | 30.08 | 6.02 | 65.0 | ± 9.6 % |
|           |  | Y | 28.46 | 102.92 | 29.32 |      | 65.0 |         |
|           |  | Z | 22.74 | 97.82  | 27.96 |      | 65.0 |         |
| 10240-CAD | LTE-TDD (SC-FDMA, 1 RB, 15 MHz, QPSK)      | X | 42.83 | 117.47 | 36.01 | 6.02 | 65.0 | ± 9.6 % |
|           |  | Y | 31.56 | 111.62 | 34.09 |      | 65.0 |         |
|           |  | Z | 28.94 | 108.32 | 33.17 |      | 65.0 |         |
| 10241-CAA | LTE-TDD (SC-FDMA, 50% RB, 1.4 MHz, 16-QAM) | X | 13.21 | 88.13  | 28.12 | 6.98 | 65.0 | ± 9.6 % |
|           |  | Y | 12.19 | 86.75  | 27.34 |      | 65.0 |         |
|           |  | Z | 12.93 | 86.92  | 27.56 |      | 65.0 |         |
| 10242-CAA | LTE-TDD (SC-FDMA, 50% RB, 1.4 MHz, 64-QAM) | X | 11.82 | 85.64  | 27.08 | 6.98 | 65.0 | ± 9.6 % |
|           |  | Y | 11.88 | 86.18  | 27.05 |      | 65.0 |         |
|           |  | Z | 11.71 | 84.70  | 26.62 |      | 65.0 |         |
| 10243-CAA | LTE-TDD (SC-FDMA, 50% RB, 1.4 MHz, QPSK)   | X | 9.69  | 83.18  | 27.04 | 6.98 | 65.0 | ± 9.6 % |
|           |  | Y | 8.48  | 80.58  | 25.71 |      | 65.0 |         |
|           |  | Z | 9.71  | 82.55  | 26.66 |      | 65.0 |         |
| 10244-CAB | LTE-TDD (SC-FDMA, 50% RB, 3 MHz, 16-QAM)   | X | 10.16 | 81.71  | 21.73 | 3.98 | 65.0 | ± 9.6 % |
|           |  | Y | 9.31  | 80.28  | 20.70 |      | 65.0 |         |
|           |  | Z | 9.66  | 80.44  | 21.31 |      | 65.0 |         |
| 10245-CAB | LTE-TDD (SC-FDMA, 50% RB, 3 MHz, 64-QAM)   | X | 9.99  | 81.19  | 21.49 | 3.98 | 65.0 | ± 9.6 % |
|           |  | Y | 9.12  | 79.71  | 20.44 |      | 65.0 |         |
|           |  | Z | 9.56  | 80.04  | 21.12 |      | 65.0 |         |
| 10246-CAB | LTE-TDD (SC-FDMA, 50% RB, 3 MHz, QPSK)     | X | 10.26 | 84.67  | 22.74 | 3.98 | 65.0 | ± 9.6 % |
|           |  | Y | 9.22  | 82.91  | 21.64 |      | 65.0 |         |
|           |  | Z | 9.02  | 82.03  | 21.79 |      | 65.0 |         |
| 10247-CAD | LTE-TDD (SC-FDMA, 50% RB, 5 MHz, 16-QAM)   | X | 8.13  | 78.66  | 21.05 | 3.98 | 65.0 | ± 9.6 % |
|           |  | Y | 7.56  | 77.60  | 20.25 |      | 65.0 |         |
|           |  | Z | 7.81  | 77.51  | 20.59 |      | 65.0 |         |
| 10248-CAD | LTE-TDD (SC-FDMA, 50% RB, 5 MHz, 64-QAM)   | X | 8.10  | 78.15  | 20.84 | 3.98 | 65.0 | ± 9.6 % |
|           |  | Y | 7.50  | 77.03  | 20.01 |      | 65.0 |         |
|           |  | Z | 7.84  | 77.14  | 20.44 |      | 65.0 |         |
| 10249-CAD | LTE-TDD (SC-FDMA, 50% RB, 5 MHz, QPSK)     | X | 11.10 | 86.20  | 23.88 | 3.98 | 65.0 | ± 9.6 % |
|           |  | Y | 10.38 | 85.15  | 23.14 |      | 65.0 |         |
|           |  | Z | 9.69  | 83.27  | 22.77 |      | 65.0 |         |
| 10250-CAD | LTE-TDD (SC-FDMA, 50% RB, 10 MHz, 16-QAM)  | X | 8.90  | 80.26  | 22.85 | 3.98 | 65.0 | ± 9.6 % |
|           |  | Y | 8.50  | 79.72  | 22.41 |      | 65.0 |         |
|           |  | Z | 8.55  | 78.98  | 22.26 |      | 65.0 |         |
| 10251-CAD | LTE-TDD (SC-FDMA, 50% RB, 10 MHz, 64-QAM)  | X | 8.43  | 78.18  | 21.77 | 3.98 | 65.0 | ± 9.6 % |
|           |  | Y | 7.97  | 77.44  | 21.21 |      | 65.0 |         |
|           |  | Z | 8.21  | 77.20  | 21.30 |      | 65.0 |         |
| 10252-CAD | LTE-TDD (SC-FDMA, 50% RB, 10 MHz, QPSK)    | X | 10.55 | 84.69  | 23.95 | 3.98 | 65.0 | ± 9.6 % |
|           |  | Y | 10.10 | 84.18  | 23.52 |      | 65.0 |         |
|           |  | Z | 9.56  | 82.30  | 22.95 |      | 65.0 |         |
| 10253-CAD | LTE-TDD (SC-FDMA, 50% RB, 15 MHz, 16-QAM)  | X | 8.29  | 77.16  | 21.61 | 3.98 | 65.0 | ± 9.6 % |
|           |  | Y | 7.87  | 76.45  | 21.11 |      | 65.0 |         |
|           |  | Z | 8.15  | 76.38  | 21.20 |      | 65.0 |         |
| 10254-CAD | LTE-TDD (SC-FDMA, 50% RB, 15 MHz, 64-QAM)  | X | 8.65  | 77.83  | 22.17 | 3.98 | 65.0 | ± 9.6 % |
|           |  | Y | 8.27  | 77.28  | 21.75 |      | 65.0 |         |
|           |  | Z | 8.49  | 77.01  | 21.74 |      | 65.0 |         |

|           |   |   |       |       |       |      |      |         |
|-----------|---|---|-------|-------|-------|------|------|---------|
| 10255-CAD | LTE-TDD (SC-FDMA, 50% RB, 15 MHz, QPSK)     | X | 9.28  | 80.86 | 22.71 | 3.98 | 65.0 | ± 9.6 % |
|           |   | Y | 8.89  | 80.40 | 22.35 |      | 65.0 |         |
|           |   | Z | 8.80  | 79.34 | 21.99 |      | 65.0 |         |
| 10256-CAA | LTE-TDD (SC-FDMA, 100% RB, 1.4 MHz, 16-QAM) | X | 9.13  | 79.62 | 20.18 | 3.98 | 65.0 | ± 9.6 % |
|           |   | Y | 7.96  | 77.38 | 18.74 |      | 65.0 |         |
|           |   | Z | 8.84  | 78.74 | 19.97 |      | 65.0 |         |
| 10257-CAA | LTE-TDD (SC-FDMA, 100% RB, 1.4 MHz, 64-QAM) | X | 8.90  | 78.86 | 19.81 | 3.98 | 65.0 | ± 9.6 % |
|           |   | Y | 7.73  | 76.58 | 18.34 |      | 65.0 |         |
|           |   | Z | 8.71  | 78.17 | 19.67 |      | 65.0 |         |
| 10258-CAA | LTE-TDD (SC-FDMA, 100% RB, 1.4 MHz, QPSK)   | X | 8.90  | 81.94 | 21.19 | 3.98 | 65.0 | ± 9.6 % |
|           |   | Y | 7.60  | 79.37 | 19.69 |      | 65.0 |         |
|           |   | Z | 8.10  | 80.01 | 20.54 |      | 65.0 |         |
| 10259-CAB | LTE-TDD (SC-FDMA, 100% RB, 3 MHz, 16-QAM)   | X | 8.43  | 79.20 | 21.67 | 3.98 | 65.0 | ± 9.6 % |
|           |   | Y | 7.92  | 78.34 | 21.01 |      | 65.0 |         |
|           |   | Z | 8.11  | 78.01 | 21.17 |      | 65.0 |         |
| 10260-CAB | LTE-TDD (SC-FDMA, 100% RB, 3 MHz, 64-QAM)   | X | 8.43  | 78.91 | 21.57 | 3.98 | 65.0 | ± 9.6 % |
|           |   | Y | 7.92  | 78.05 | 20.91 |      | 65.0 |         |
|           |   | Z | 8.14  | 77.80 | 21.11 |      | 65.0 |         |
| 10261-CAB | LTE-TDD (SC-FDMA, 100% RB, 3 MHz, QPSK)     | X | 10.44 | 84.93 | 23.72 | 3.98 | 65.0 | ± 9.6 % |
|           |   | Y | 9.81  | 84.03 | 23.07 |      | 65.0 |         |
|           |   | Z | 9.35  | 82.40 | 22.71 |      | 65.0 |         |
| 10262-CAD | LTE-TDD (SC-FDMA, 100% RB, 5 MHz, 16-QAM)   | X | 8.89  | 80.23 | 22.82 | 3.98 | 65.0 | ± 9.6 % |
|           |   | Y | 8.49  | 79.67 | 22.37 |      | 65.0 |         |
|           |   | Z | 8.55  | 78.95 | 22.23 |      | 65.0 |         |
| 10263-CAD | LTE-TDD (SC-FDMA, 100% RB, 5 MHz, 64-QAM)   | X | 8.43  | 78.18 | 21.77 | 3.98 | 65.0 | ± 9.6 % |
|           |   | Y | 7.96  | 77.43 | 21.21 |      | 65.0 |         |
|           |   | Z | 8.21  | 77.20 | 21.30 |      | 65.0 |         |
| 10264-CAD | LTE-TDD (SC-FDMA, 100% RB, 5 MHz, QPSK)     | X | 10.49 | 84.56 | 23.88 | 3.98 | 65.0 | ± 9.6 % |
|           |   | Y | 10.02 | 84.01 | 23.44 |      | 65.0 |         |
|           |   | Z | 9.51  | 82.19 | 22.89 |      | 65.0 |         |
| 10265-CAD | LTE-TDD (SC-FDMA, 100% RB, 10 MHz, 16-QAM)  | X | 8.52  | 77.77 | 21.82 | 3.98 | 65.0 | ± 9.6 % |
|           |   | Y | 8.07  | 77.03 | 21.32 |      | 65.0 |         |
|           |   | Z | 8.36  | 76.93 | 21.38 |      | 65.0 |         |
| 10266-CAD | LTE-TDD (SC-FDMA, 100% RB, 10 MHz, 64-QAM)  | X | 8.87  | 78.41 | 22.40 | 3.98 | 65.0 | ± 9.6 % |
|           |   | Y | 8.48  | 77.88 | 22.01 |      | 65.0 |         |
|           |   | Z | 8.68  | 77.54 | 21.94 |      | 65.0 |         |
| 10267-CAD | LTE-TDD (SC-FDMA, 100% RB, 10 MHz, QPSK)    | X | 9.58  | 81.18 | 22.60 | 3.98 | 65.0 | ± 9.6 % |
|           |   | Y | 9.19  | 80.75 | 22.26 |      | 65.0 |         |
|           |   | Z | 9.04  | 79.59 | 21.85 |      | 65.0 |         |
| 10268-CAD | LTE-TDD (SC-FDMA, 100% RB, 15 MHz, 16-QAM)  | X | 8.91  | 77.09 | 21.88 | 3.98 | 65.0 | ± 9.6 % |
|           |   | Y | 8.54  | 76.56 | 21.51 |      | 65.0 |         |
|           |   | Z | 8.80  | 76.43 | 21.50 |      | 65.0 |         |
| 10269-CAD | LTE-TDD (SC-FDMA, 100% RB, 15 MHz, 64-QAM)  | X | 8.82  | 76.67 | 21.78 | 3.98 | 65.0 | ± 9.6 % |
|           |   | Y | 8.46  | 76.15 | 21.41 |      | 65.0 |         |
|           |   | Z | 8.73  | 76.06 | 21.42 |      | 65.0 |         |
| 10270-CAD | LTE-TDD (SC-FDMA, 100% RB, 15 MHz, QPSK)    | X | 8.97  | 78.33 | 21.62 | 3.98 | 65.0 | ± 9.6 % |
|           |   | Y | 8.64  | 77.97 | 21.34 |      | 65.0 |         |
|           |   | Z | 8.71  | 77.32 | 21.10 |      | 65.0 |         |

|           |  |   |       |       |       |      |       |         |
|-----------|--|---|-------|-------|-------|------|-------|---------|
| 10274-CAB | UMTS-FDD (HSUPA, Subtest 5, 3GPP Rel8.10)                          | X | 2.72  | 67.23 | 15.95 | 0.00 | 150.0 | ± 9.6 % |
|           |  | Y | 2.57  | 66.31 | 15.13 |      | 150.0 |         |
|           |  | Z | 2.65  | 66.56 | 15.46 |      | 150.0 |         |
| 10275-CAB | UMTS-FDD (HSUPA, Subtest 5, 3GPP Rel8.4)                           | X | 1.89  | 70.77 | 17.26 | 0.00 | 150.0 | ± 9.6 % |
|           |  | Y | 1.58  | 67.67 | 15.25 |      | 150.0 |         |
|           |  | Z | 1.72  | 68.75 | 16.01 |      | 150.0 |         |
| 10277-CAA | PHS (QPSK)   | X | 6.00  | 70.47 | 14.76 | 9.03 | 50.0  | ± 9.6 % |
|           |  | Y | 5.21  | 68.57 | 13.21 |      | 50.0  |         |
|           |  | Z | 6.28  | 70.88 | 15.27 |      | 50.0  |         |
| 10278-CAA | PHS (QPSK, BW 884MHz, Rolloff 0.5)                                 | X | 9.55  | 80.33 | 21.17 | 9.03 | 50.0  | ± 9.6 % |
|           |  | Y | 8.72  | 78.79 | 19.97 |      | 50.0  |         |
|           |  | Z | 9.29  | 79.51 | 21.06 |      | 50.0  |         |
| 10279-CAA | PHS (QPSK, BW 884MHz, Rolloff 0.38)                                | X | 9.72  | 80.54 | 21.26 | 9.03 | 50.0  | ± 9.6 % |
|           |  | Y | 8.86  | 78.97 | 20.05 |      | 50.0  |         |
|           |  | Z | 9.46  | 79.72 | 21.15 |      | 50.0  |         |
| 10290-AAB | CDMA2000, RC1, SO55, Full Rate                                     | X | 2.18  | 74.40 | 17.31 | 0.00 | 150.0 | ± 9.6 % |
|           |  | Y | 1.44  | 68.27 | 13.81 |      | 150.0 |         |
|           |  | Z | 1.72  | 70.30 | 15.40 |      | 150.0 |         |
| 10291-AAB | CDMA2000, RC3, SO55, Full Rate                                     | X | 1.24  | 71.68 | 16.15 | 0.00 | 150.0 | ± 9.6 % |
|           |  | Y | 0.80  | 65.30 | 12.12 |      | 150.0 |         |
|           |  | Z | 0.97  | 67.39 | 13.90 |      | 150.0 |         |
| 10292-AAB | CDMA2000, RC3, SO32, Full Rate                                     | X | 2.10  | 80.68 | 20.23 | 0.00 | 150.0 | ± 9.6 % |
|           |  | Y | 0.98  | 68.86 | 14.25 |      | 150.0 |         |
|           |  | Z | 1.23  | 71.77 | 16.34 |      | 150.0 |         |
| 10293-AAB | CDMA2000, RC3, SO3, Full Rate                                      | X | 4.35  | 92.52 | 24.81 | 0.00 | 150.0 | ± 9.6 % |
|           |  | Y | 1.43  | 74.29 | 17.12 |      | 150.0 |         |
|           |  | Z | 1.75  | 77.17 | 19.08 |      | 150.0 |         |
| 10295-AAB | CDMA2000, RC1, SO3, 1/8th Rate 25 fr.                              | X | 11.19 | 84.61 | 24.64 | 9.03 | 50.0  | ± 9.6 % |
|           |  | Y | 11.12 | 84.62 | 24.20 |      | 50.0  |         |
|           |  | Z | 10.33 | 82.52 | 23.91 |      | 50.0  |         |
| 10297-AAC | LTE-FDD (SC-FDMA, 50% RB, 20 MHz, QPSK)                            | X | 3.13  | 71.75 | 17.66 | 0.00 | 150.0 | ± 9.6 % |
|           |  | Y | 2.77  | 69.64 | 16.38 |      | 150.0 |         |
|           |  | Z | 2.96  | 70.46 | 16.84 |      | 150.0 |         |
| 10298-AAC | LTE-FDD (SC-FDMA, 50% RB, 3 MHz, QPSK)                             | X | 2.07  | 71.56 | 16.68 | 0.00 | 150.0 | ± 9.6 % |
|           |  | Y | 1.59  | 67.63 | 14.15 |      | 150.0 |         |
|           |  | Z | 1.84  | 69.13 | 15.41 |      | 150.0 |         |
| 10299-AAC | LTE-FDD (SC-FDMA, 50% RB, 3 MHz, 16-QAM)                           | X | 4.44  | 77.05 | 18.50 | 0.00 | 150.0 | ± 9.6 % |
|           |  | Y | 3.17  | 71.89 | 15.69 |      | 150.0 |         |
|           |  | Z | 3.89  | 74.52 | 17.46 |      | 150.0 |         |
| 10300-AAC | LTE-FDD (SC-FDMA, 50% RB, 3 MHz, 64-QAM)                           | X | 2.98  | 70.18 | 14.87 | 0.00 | 150.0 | ± 9.6 % |
|           |  | Y | 2.33  | 66.80 | 12.64 |      | 150.0 |         |
|           |  | Z | 2.88  | 69.22 | 14.45 |      | 150.0 |         |
| 10301-AAA | IEEE 802.16e WiMAX (29:18, 5ms, 10MHz, QPSK, PUSC)                 | X | 5.88  | 68.71 | 19.12 | 4.17 | 80.0  | ± 9.6 % |
|           |  | Y | 5.67  | 68.35 | 18.79 |      | 80.0  |         |
|           |  | Z | 5.96  | 68.70 | 19.05 |      | 80.0  |         |
| 10302-AAA | IEEE 802.16e WiMAX (29:18, 5ms, 10MHz, QPSK, PUSC, 3 CTRL symbols) | X | 6.49  | 69.93 | 20.23 | 4.96 | 80.0  | ± 9.6 % |
|           |  | Y | 6.06  | 68.48 | 19.24 |      | 80.0  |         |
|           |  | Z | 6.58  | 69.96 | 20.17 |      | 80.0  |         |

|           |   |   |       |       |       |       |       |         |
|-----------|---|---|-------|-------|-------|-------|-------|---------|
| 10303-AAA | IEEE 802.16e WiMAX (31:15, 5ms, 10MHz, 64QAM, PUSC)                 | X | 6.38  | 70.18 | 20.37 | 4.96  | 80.0  | ± 9.6 % |
|           |   | Y | 5.90  | 68.52 | 19.27 |       | 80.0  |         |
|           |   | Z | 6.49  | 70.27 | 20.35 |       | 80.0  |         |
| 10304-AAA | IEEE 802.16e WiMAX (29:18, 5ms, 10MHz, 64QAM, PUSC)                 | X | 5.94  | 69.20 | 19.41 | 4.17  | 80.0  | ± 9.6 % |
|           |   | Y | 5.55  | 67.84 | 18.48 |       | 80.0  |         |
|           |   | Z | 6.02  | 69.19 | 19.33 |       | 80.0  |         |
| 10305-AAA | IEEE 802.16e WiMAX (31:15, 10ms, 10MHz, 64QAM, PUSC, 15 symbols)    | X | 8.63  | 79.84 | 25.16 | 6.02  | 50.0  | ± 9.6 % |
|           |   | Y | 8.50  | 80.74 | 25.49 |       | 50.0  |         |
|           |   | Z | 9.07  | 80.51 | 25.38 |       | 50.0  |         |
| 10306-AAA | IEEE 802.16e WiMAX (29:18, 10ms, 10MHz, 64QAM, PUSC, 18 symbols)    | X | 7.19  | 74.26 | 22.98 | 6.02  | 50.0  | ± 9.6 % |
|           |   | Y | 6.24  | 70.98 | 21.03 |       | 50.0  |         |
|           |   | Z | 7.44  | 74.65 | 23.11 |       | 50.0  |         |
| 10307-AAA | IEEE 802.16e WiMAX (29:18, 10ms, 10MHz, QPSK, PUSC, 18 symbols)     | X | 7.43  | 75.32 | 23.26 | 6.02  | 50.0  | ± 9.6 % |
|           |   | Y | 7.08  | 75.34 | 23.24 |       | 50.0  |         |
|           |   | Z | 7.71  | 75.76 | 23.39 |       | 50.0  |         |
| 10308-AAA | IEEE 802.16e WiMAX (29:18, 10ms, 10MHz, 16QAM, PUSC)                | X | 7.56  | 75.95 | 23.55 | 6.02  | 50.0  | ± 9.6 % |
|           |   | Y | 7.22  | 76.07 | 23.58 |       | 50.0  |         |
|           |   | Z | 7.85  | 76.40 | 23.68 |       | 50.0  |         |
| 10309-AAA | IEEE 802.16e WiMAX (29:18, 10ms, 10MHz, 16QAM, AMC 2x3, 18 symbols) | X | 7.34  | 74.67 | 23.20 | 6.02  | 50.0  | ± 9.6 % |
|           |   | Y | 6.34  | 71.28 | 21.21 |       | 50.0  |         |
|           |   | Z | 7.59  | 75.05 | 23.31 |       | 50.0  |         |
| 10310-AAA | IEEE 802.16e WiMAX (29:18, 10ms, 10MHz, QPSK, AMC 2x3, 18 symbols)  | X | 7.26  | 74.63 | 23.05 | 6.02  | 50.0  | ± 9.6 % |
|           |   | Y | 6.24  | 71.19 | 21.04 |       | 50.0  |         |
|           |   | Z | 7.51  | 75.03 | 23.17 |       | 50.0  |         |
| 10311-AAC | LTE-FDD (SC-FDMA, 100% RB, 15 MHz, QPSK)                            | X | 3.50  | 70.87 | 17.20 | 0.00  | 150.0 | ± 9.6 % |
|           |   | Y | 3.12  | 68.92 | 16.05 |       | 150.0 |         |
|           |   | Z | 3.32  | 69.72 | 16.47 |       | 150.0 |         |
| 10313-AAA | IDEN 1:3  | X | 8.27  | 79.76 | 19.38 | 6.99  | 70.0  | ± 9.6 % |
|           |   | Y | 7.09  | 77.48 | 18.12 |       | 70.0  |         |
|           |   | Z | 7.27  | 77.42 | 18.52 |       | 70.0  |         |
| 10314-AAA | IDEN 1:6  | X | 10.52 | 85.41 | 23.73 | 10.00 | 30.0  | ± 9.6 % |
|           |   | Y | 9.80  | 84.47 | 23.05 |       | 30.0  |         |
|           |   | Z | 8.56  | 81.26 | 22.24 |       | 30.0  |         |
| 10315-AAB | IEEE 802.11b WiFi 2.4 GHz (DSSS, 1 Mbps, 96pc duty cycle)           | X | 1.21  | 66.04 | 16.76 | 0.17  | 150.0 | ± 9.6 % |
|           |   | Y | 1.11  | 64.36 | 15.28 |       | 150.0 |         |
|           |   | Z | 1.16  | 64.99 | 15.81 |       | 150.0 |         |
| 10316-AAB | IEEE 802.11g WiFi 2.4 GHz (ERP-OFDM, 6 Mbps, 96pc duty cycle)       | X | 4.78  | 67.20 | 16.69 | 0.17  | 150.0 | ± 9.6 % |
|           |   | Y | 4.67  | 66.87 | 16.36 |       | 150.0 |         |
|           |   | Z | 4.78  | 67.00 | 16.48 |       | 150.0 |         |
| 10317-AAC | IEEE 802.11a WiFi 5 GHz (OFDM, 6 Mbps, 96pc duty cycle)             | X | 4.78  | 67.20 | 16.69 | 0.17  | 150.0 | ± 9.6 % |
|           |   | Y | 4.67  | 66.87 | 16.36 |       | 150.0 |         |
|           |   | Z | 4.78  | 67.00 | 16.48 |       | 150.0 |         |
| 10400-AAD | IEEE 802.11ac WiFi (20MHz, 64-QAM, 99pc duty cycle)                 | X | 4.88  | 67.44 | 16.59 | 0.00  | 150.0 | ± 9.6 % |
|           |   | Y | 4.75  | 67.07 | 16.25 |       | 150.0 |         |
|           |   | Z | 4.88  | 67.23 | 16.38 |       | 150.0 |         |
| 10401-AAD | IEEE 802.11ac WiFi (40MHz, 64-QAM, 99pc duty cycle)                 | X | 5.52  | 67.51 | 16.67 | 0.00  | 150.0 | ± 9.6 % |
|           |   | Y | 5.43  | 67.26 | 16.42 |       | 150.0 |         |
|           |   | Z | 5.50  | 67.29 | 16.46 |       | 150.0 |         |

|           |   |   |        |        |       |      |       |         |
|-----------|---|---|--------|--------|-------|------|-------|---------|
| 10402-AAD | IEEE 802.11ac WiFi (80MHz, 64-QAM, 99pc duty cycle)                             | X | 5.81   | 67.99  | 16.74 | 0.00 | 150.0 | ± 9.6 % |
|           |   | Y | 5.71   | 67.67  | 16.46 |      | 150.0 |         |
|           |   | Z | 5.80   | 67.83  | 16.56 |      | 150.0 |         |
| 10403-AAB | CDMA2000 (1xEV-DO, Rev. 0)  | X | 2.18   | 74.40  | 17.31 | 0.00 | 115.0 | ± 9.6 % |
|           |   | Y | 1.44   | 68.27  | 13.81 |      | 115.0 |         |
|           |   | Z | 1.72   | 70.30  | 15.40 |      | 115.0 |         |
| 10404-AAB | CDMA2000 (1xEV-DO, Rev. A)  | X | 2.18   | 74.40  | 17.31 | 0.00 | 115.0 | ± 9.6 % |
|           |   | Y | 1.44   | 68.27  | 13.81 |      | 115.0 |         |
|           |   | Z | 1.72   | 70.30  | 15.40 |      | 115.0 |         |
| 10406-AAB | CDMA2000, RC3, SO32, SCH0, Full Rate  | X | 100.00 | 125.34 | 32.57 | 0.00 | 100.0 | ± 9.6 % |
|           |   | Y | 100.00 | 122.30 | 30.90 |      | 100.0 |         |
|           |   | Z | 100.00 | 123.59 | 31.86 |      | 100.0 |         |
| 10410-AAD | LTE-TDD (SC-FDMA, 1 RB, 10 MHz, QPSK, UL Subframe=2,3,4,7,8,9, Subframe Conf=4) | X | 100.00 | 121.08 | 31.14 | 3.23 | 80.0  | ± 9.6 % |
|           |   | Y | 100.00 | 119.39 | 30.03 |      | 80.0  |         |
|           |   | Z | 100.00 | 119.84 | 30.69 |      | 80.0  |         |
| 10415-AAA | IEEE 802.11b WiFi 2.4 GHz (DSSS, 1 Mbps, 99pc duty cycle)                       | X | 1.04   | 64.21  | 15.75 | 0.00 | 150.0 | ± 9.6 % |
|           |   | Y | 0.96   | 62.81  | 14.37 |      | 150.0 |         |
|           |   | Z | 1.00   | 63.31  | 14.86 |      | 150.0 |         |
| 10416-AAA | IEEE 802.11g WiFi 2.4 GHz (ERP-OFDM, 6 Mbps, 99pc duty cycle)                   | X | 4.68   | 67.03  | 16.52 | 0.00 | 150.0 | ± 9.6 % |
|           |   | Y | 4.57   | 66.70  | 16.19 |      | 150.0 |         |
|           |   | Z | 4.67   | 66.81  | 16.30 |      | 150.0 |         |
| 10417-AAB | IEEE 802.11a/h WiFi 5 GHz (OFDM, 6 Mbps, 99pc duty cycle)                       | X | 4.68   | 67.03  | 16.52 | 0.00 | 150.0 | ± 9.6 % |
|           |   | Y | 4.57   | 66.70  | 16.19 |      | 150.0 |         |
|           |   | Z | 4.67   | 66.81  | 16.30 |      | 150.0 |         |
| 10418-AAA | IEEE 802.11g WiFi 2.4 GHz (DSSS-OFDM, 6 Mbps, 99pc duty cycle, Long preamble)   | X | 4.66   | 67.18  | 16.53 | 0.00 | 150.0 | ± 9.6 % |
|           |   | Y | 4.55   | 66.84  | 16.19 |      | 150.0 |         |
|           |   | Z | 4.65   | 66.94  | 16.30 |      | 150.0 |         |
| 10419-AAA | IEEE 802.11g WiFi 2.4 GHz (DSSS-OFDM, 6 Mbps, 99pc duty cycle, Short preamble)  | X | 4.69   | 67.13  | 16.53 | 0.00 | 150.0 | ± 9.6 % |
|           |   | Y | 4.58   | 66.80  | 16.20 |      | 150.0 |         |
|           |   | Z | 4.68   | 66.91  | 16.31 |      | 150.0 |         |
| 10422-AAB | IEEE 802.11n (HT Greenfield, 7.2 Mbps, BPSK)                                    | X | 4.81   | 67.13  | 16.54 | 0.00 | 150.0 | ± 9.6 % |
|           |   | Y | 4.70   | 66.81  | 16.22 |      | 150.0 |         |
|           |   | Z | 4.80   | 66.92  | 16.33 |      | 150.0 |         |
| 10423-AAB | IEEE 802.11n (HT Greenfield, 43.3 Mbps, 16-QAM)                                 | X | 5.01   | 67.51  | 16.68 | 0.00 | 150.0 | ± 9.6 % |
|           |   | Y | 4.89   | 67.16  | 16.35 |      | 150.0 |         |
|           |   | Z | 5.01   | 67.31  | 16.47 |      | 150.0 |         |
| 10424-AAB | IEEE 802.11n (HT Greenfield, 72.2 Mbps, 64-QAM)                                 | X | 4.92   | 67.45  | 16.65 | 0.00 | 150.0 | ± 9.6 % |
|           |   | Y | 4.80   | 67.10  | 16.32 |      | 150.0 |         |
|           |   | Z | 4.92   | 67.24  | 16.43 |      | 150.0 |         |
| 10425-AAB | IEEE 802.11n (HT Greenfield, 15 Mbps, BPSK)                                     | X | 5.50   | 67.77  | 16.79 | 0.00 | 150.0 | ± 9.6 % |
|           |   | Y | 5.41   | 67.50  | 16.53 |      | 150.0 |         |
|           |   | Z | 5.49   | 67.58  | 16.59 |      | 150.0 |         |
| 10426-AAB | IEEE 802.11n (HT Greenfield, 90 Mbps, 16-QAM)                                   | X | 5.51   | 67.80  | 16.80 | 0.00 | 150.0 | ± 9.6 % |
|           |   | Y | 5.41   | 67.51  | 16.53 |      | 150.0 |         |
|           |   | Z | 5.50   | 67.62  | 16.60 |      | 150.0 |         |

|           |  |   |        |        |       |      |       |         |
|-----------|--|---|--------|--------|-------|------|-------|---------|
| 10427-AAB | IEEE 802.11n (HT Greenfield, 150 Mbps, 64-QAM)                 | X | 5.53   | 67.79  | 16.79 | 0.00 | 150.0 | ± 9.6 % |
|           |  | Y | 5.42   | 67.48  | 16.51 |      | 150.0 |         |
|           |  | Z | 5.52   | 67.63  | 16.61 |      | 150.0 |         |
| 10430-AAB | LTE-FDD (OFDMA, 5 MHz, E-TM 3.1)                               | X | 4.38   | 70.70  | 18.40 | 0.00 | 150.0 | ± 9.6 % |
|           |  | Y | 4.25   | 70.46  | 18.05 |      | 150.0 |         |
|           |  | Z | 4.31   | 70.02  | 17.98 |      | 150.0 |         |
| 10431-AAB | LTE-FDD (OFDMA, 10 MHz, E-TM 3.1)                              | X | 4.42   | 67.67  | 16.62 | 0.00 | 150.0 | ± 9.6 % |
|           |  | Y | 4.27   | 67.23  | 16.20 |      | 150.0 |         |
|           |  | Z | 4.41   | 67.37  | 16.37 |      | 150.0 |         |
| 10432-AAB | LTE-FDD (OFDMA, 15 MHz, E-TM 3.1)                              | X | 4.70   | 67.52  | 16.63 | 0.00 | 150.0 | ± 9.6 % |
|           |  | Y | 4.57   | 67.13  | 16.26 |      | 150.0 |         |
|           |  | Z | 4.70   | 67.28  | 16.40 |      | 150.0 |         |
| 10433-AAB | LTE-FDD (OFDMA, 20 MHz, E-TM 3.1)                              | X | 4.94   | 67.50  | 16.67 | 0.00 | 150.0 | ± 9.6 % |
|           |  | Y | 4.82   | 67.14  | 16.34 |      | 150.0 |         |
|           |  | Z | 4.94   | 67.29  | 16.46 |      | 150.0 |         |
| 10434-AAA | W-CDMA (BS Test Model 1, 64 DPCH)                              | X | 4.49   | 71.52  | 18.43 | 0.00 | 150.0 | ± 9.6 % |
|           |  | Y | 4.34   | 71.22  | 18.01 |      | 150.0 |         |
|           |  | Z | 4.39   | 70.68  | 17.96 |      | 150.0 |         |
| 10435-AAC | LTE-TDD (SC-FDMA, 1 RB, 20 MHz, QPSK, UL Subframe=2,3,4,7,8,9) | X | 100.00 | 120.92 | 31.06 | 3.23 | 80.0  | ± 9.6 % |
|           |  | Y | 100.00 | 119.22 | 29.95 |      | 80.0  |         |
|           |  | Z | 100.00 | 119.70 | 30.62 |      | 80.0  |         |
| 10447-AAB | LTE-FDD (OFDMA, 5 MHz, E-TM 3.1, Clipping 44%)                 | X | 3.75   | 67.86  | 16.21 | 0.00 | 150.0 | ± 9.6 % |
|           |  | Y | 3.56   | 67.20  | 15.57 |      | 150.0 |         |
|           |  | Z | 3.73   | 67.41  | 15.90 |      | 150.0 |         |
| 10448-AAB | LTE-FDD (OFDMA, 10 MHz, E-TM 3.1, Clipping 44%)                | X | 4.24   | 67.45  | 16.49 | 0.00 | 150.0 | ± 9.6 % |
|           |  | Y | 4.10   | 67.00  | 16.05 |      | 150.0 |         |
|           |  | Z | 4.22   | 67.14  | 16.23 |      | 150.0 |         |
| 10449-AAB | LTE-FDD (OFDMA, 15 MHz, E-TM 3.1, Clipping 44%)                | X | 4.49   | 67.35  | 16.53 | 0.00 | 150.0 | ± 9.6 % |
|           |  | Y | 4.37   | 66.95  | 16.16 |      | 150.0 |         |
|           |  | Z | 4.48   | 67.09  | 16.30 |      | 150.0 |         |
| 10450-AAB | LTE-FDD (OFDMA, 20 MHz, E-TM 3.1, Clipping 44%)                | X | 4.67   | 67.26  | 16.53 | 0.00 | 150.0 | ± 9.6 % |
|           |  | Y | 4.56   | 66.89  | 16.18 |      | 150.0 |         |
|           |  | Z | 4.66   | 67.04  | 16.31 |      | 150.0 |         |
| 10451-AAA | W-CDMA (BS Test Model 1, 64 DPCH, Clipping 44%)                | X | 3.69   | 68.21  | 15.98 | 0.00 | 150.0 | ± 9.6 % |
|           |  | Y | 3.47   | 67.39  | 15.23 |      | 150.0 |         |
|           |  | Z | 3.66   | 67.69  | 15.67 |      | 150.0 |         |
| 10456-AAB | IEEE 802.11ac WiFi (160MHz, 64-QAM, 99pc duty cycle)           | X | 6.36   | 68.35  | 16.93 | 0.00 | 150.0 | ± 9.6 % |
|           |  | Y | 6.27   | 68.07  | 16.69 |      | 150.0 |         |
|           |  | Z | 6.35   | 68.21  | 16.77 |      | 150.0 |         |
| 10457-AAA | UMTS-FDD (DC-HSDPA)  | X | 3.86   | 65.66  | 16.26 | 0.00 | 150.0 | ± 9.6 % |
|           |  | Y | 3.78   | 65.32  | 15.90 |      | 150.0 |         |
|           |  | Z | 3.84   | 65.45  | 16.04 |      | 150.0 |         |
| 10458-AAA | CDMA2000 (1xEV-DO, Rev. B, 2 carriers)                         | X | 4.10   | 70.68  | 17.90 | 0.00 | 150.0 | ± 9.6 % |
|           |  | Y | 3.95   | 70.36  | 17.40 |      | 150.0 |         |
|           |  | Z | 3.98   | 69.73  | 17.40 |      | 150.0 |         |
| 10459-AAA | CDMA2000 (1xEV-DO, Rev. B, 3 carriers)                         | X | 5.16   | 67.87  | 18.15 | 0.00 | 150.0 | ± 9.6 % |
|           |  | Y | 5.08   | 67.96  | 18.01 |      | 150.0 |         |
|           |  | Z | 5.12   | 67.39  | 17.86 |      | 150.0 |         |



|           |   |   |        |        |       |      |       |         |
|-----------|---|---|--------|--------|-------|------|-------|---------|
| 10460-AAA | UMTS-FDD (WCDMA, AMR)   | X | 1.21   | 74.36  | 19.56 | 0.00 | 150.0 | ± 9.6 % |
|           |   | Y | 0.84   | 67.73  | 15.53 |      | 150.0 |         |
|           |   | Z | 0.96   | 69.69  | 16.87 |      | 150.0 |         |
| 10461-AAA | LTE-TDD (SC-FDMA, 1 RB, 1.4 MHz, QPSK, UL Subframe=2,3,4,7,8,9)   | X | 100.00 | 124.72 | 32.88 | 3.29 | 80.0  | ± 9.6 % |
|           |   | Y | 100.00 | 122.71 | 31.63 |      | 80.0  |         |
|           |   | Z | 100.00 | 122.27 | 31.89 |      | 80.0  |         |
| 10462-AAA | LTE-TDD (SC-FDMA, 1 RB, 1.4 MHz, 16-QAM, UL Subframe=2,3,4,7,8,9) | X | 100.00 | 110.81 | 26.22 | 3.23 | 80.0  | ± 9.6 % |
|           |   | Y | 100.00 | 107.68 | 24.48 |      | 80.0  |         |
|           |   | Z | 100.00 | 109.58 | 25.81 |      | 80.0  |         |
| 10463-AAA | LTE-TDD (SC-FDMA, 1 RB, 1.4 MHz, 64-QAM, UL Subframe=2,3,4,7,8,9) | X | 100.00 | 108.02 | 24.88 | 3.23 | 80.0  | ± 9.6 % |
|           |   | Y | 17.57  | 87.04  | 18.79 |      | 80.0  |         |
|           |   | Z | 57.71  | 101.03 | 23.21 |      | 80.0  |         |
| 10464-AAA | LTE-TDD (SC-FDMA, 1 RB, 3 MHz, QPSK, UL Subframe=2,3,4,7,8,9)     | X | 100.00 | 122.99 | 31.92 | 3.23 | 80.0  | ± 9.6 % |
|           |   | Y | 100.00 | 120.66 | 30.52 |      | 80.0  |         |
|           |   | Z | 100.00 | 120.59 | 30.96 |      | 80.0  |         |
| 10465-AAA | LTE-TDD (SC-FDMA, 1 RB, 3 MHz, 16-QAM, UL Subframe=2,3,4,7,8,9)   | X | 100.00 | 110.36 | 26.00 | 3.23 | 80.0  | ± 9.6 % |
|           |   | Y | 69.93  | 103.37 | 23.39 |      | 80.0  |         |
|           |   | Z | 100.00 | 109.17 | 25.60 |      | 80.0  |         |
| 10466-AAA | LTE-TDD (SC-FDMA, 1 RB, 3 MHz, 64-QAM, UL Subframe=2,3,4,7,8,9)   | X | 100.00 | 107.59 | 24.67 | 3.23 | 80.0  | ± 9.6 % |
|           |   | Y | 10.32  | 81.39  | 17.12 |      | 80.0  |         |
|           |   | Z | 32.56  | 94.43  | 21.51 |      | 80.0  |         |
| 10467-AAC | LTE-TDD (SC-FDMA, 1 RB, 5 MHz, QPSK, UL Subframe=2,3,4,7,8,9)     | X | 100.00 | 123.18 | 32.01 | 3.23 | 80.0  | ± 9.6 % |
|           |   | Y | 100.00 | 120.88 | 30.62 |      | 80.0  |         |
|           |   | Z | 100.00 | 120.77 | 31.04 |      | 80.0  |         |
| 10468-AAC | LTE-TDD (SC-FDMA, 1 RB, 5 MHz, 16-QAM, UL Subframe=2,3,4,7,8,9)   | X | 100.00 | 110.50 | 26.06 | 3.23 | 80.0  | ± 9.6 % |
|           |   | Y | 95.55  | 106.84 | 24.20 |      | 80.0  |         |
|           |   | Z | 100.00 | 109.30 | 25.66 |      | 80.0  |         |
| 10469-AAC | LTE-TDD (SC-FDMA, 1 RB, 5 MHz, 64-QAM, UL Subframe=2,3,4,7,8,9)   | X | 100.00 | 107.60 | 24.67 | 3.23 | 80.0  | ± 9.6 % |
|           |   | Y | 10.51  | 81.58  | 17.17 |      | 80.0  |         |
|           |   | Z | 33.51  | 94.76  | 21.58 |      | 80.0  |         |
| 10470-AAC | LTE-TDD (SC-FDMA, 1 RB, 10 MHz, QPSK, UL Subframe=2,3,4,7,8,9)    | X | 100.00 | 123.21 | 32.02 | 3.23 | 80.0  | ± 9.6 % |
|           |   | Y | 100.00 | 120.90 | 30.62 |      | 80.0  |         |
|           |   | Z | 100.00 | 120.79 | 31.05 |      | 80.0  |         |
| 10471-AAC | LTE-TDD (SC-FDMA, 1 RB, 10 MHz, 16-QAM, UL Subframe=2,3,4,7,8,9)  | X | 100.00 | 110.46 | 26.04 | 3.23 | 80.0  | ± 9.6 % |
|           |   | Y | 94.56  | 106.68 | 24.14 |      | 80.0  |         |
|           |   | Z | 100.00 | 109.26 | 25.63 |      | 80.0  |         |
| 10472-AAC | LTE-TDD (SC-FDMA, 1 RB, 10 MHz, 64-QAM, UL Subframe=2,3,4,7,8,9)  | X | 100.00 | 107.56 | 24.64 | 3.23 | 80.0  | ± 9.6 % |
|           |   | Y | 10.43  | 81.48  | 17.13 |      | 80.0  |         |
|           |   | Z | 33.64  | 94.78  | 21.58 |      | 80.0  |         |
| 10473-AAC | LTE-TDD (SC-FDMA, 1 RB, 15 MHz, QPSK, UL Subframe=2,3,4,7,8,9)    | X | 100.00 | 123.19 | 32.00 | 3.23 | 80.0  | ± 9.6 % |
|           |   | Y | 100.00 | 120.87 | 30.61 |      | 80.0  |         |
|           |   | Z | 100.00 | 120.77 | 31.03 |      | 80.0  |         |
| 10474-AAC | LTE-TDD (SC-FDMA, 1 RB, 15 MHz, 16-QAM, UL Subframe=2,3,4,7,8,9)  | X | 100.00 | 110.47 | 26.04 | 3.23 | 80.0  | ± 9.6 % |
|           |   | Y | 92.06  | 106.40 | 24.08 |      | 80.0  |         |
|           |   | Z | 100.00 | 109.26 | 25.64 |      | 80.0  |         |
| 10475-AAC | LTE-TDD (SC-FDMA, 1 RB, 15 MHz, 64-QAM, UL Subframe=2,3,4,7,8,9)  | X | 100.00 | 107.57 | 24.65 | 3.23 | 80.0  | ± 9.6 % |
|           |   | Y | 10.30  | 81.37  | 17.09 |      | 80.0  |         |
|           |   | Z | 33.12  | 94.61  | 21.54 |      | 80.0  |         |

|           |   |   |        |        |       |      |      |         |
|-----------|---|---|--------|--------|-------|------|------|---------|
| 10477-AAC | LTE-TDD (SC-FDMA, 1 RB, 20 MHz, 16-QAM, UL Subframe=2,3,4,7,8,9)    | X | 100.00 | 110.32 | 25.97 | 3.23 | 80.0 | ± 9.6 % |
|           |   | Y | 73.47  | 103.85 | 23.47 |      | 80.0 |         |
|           |   | Z | 100.00 | 109.13 | 25.57 |      | 80.0 |         |
| 10478-AAC | LTE-TDD (SC-FDMA, 1 RB, 20 MHz, 64-QAM, UL Subframe=2,3,4,7,8,9)    | X | 100.00 | 107.52 | 24.63 | 3.23 | 80.0 | ± 9.6 % |
|           |   | Y | 10.13  | 81.17  | 17.03 |      | 80.0 |         |
|           |   | Z | 32.56  | 94.40  | 21.47 |      | 80.0 |         |
| 10479-AAA | LTE-TDD (SC-FDMA, 50% RB, 1.4 MHz, QPSK, UL Subframe=2,3,4,7,8,9)   | X | 23.24  | 102.02 | 28.60 | 3.23 | 80.0 | ± 9.6 % |
|           |   | Y | 17.72  | 96.96  | 26.53 |      | 80.0 |         |
|           |   | Z | 12.62  | 91.31  | 25.32 |      | 80.0 |         |
| 10480-AAA | LTE-TDD (SC-FDMA, 50% RB, 1.4 MHz, 16-QAM, UL Subframe=2,3,4,7,8,9) | X | 23.79  | 96.38  | 25.31 | 3.23 | 80.0 | ± 9.6 % |
|           |   | Y | 16.50  | 90.35  | 22.90 |      | 80.0 |         |
|           |   | Z | 13.56  | 87.65  | 22.71 |      | 80.0 |         |
| 10481-AAA | LTE-TDD (SC-FDMA, 50% RB, 1.4 MHz, 64-QAM, UL Subframe=2,3,4,7,8,9) | X | 19.64  | 92.74  | 23.93 | 3.23 | 80.0 | ± 9.6 % |
|           |   | Y | 13.10  | 86.39  | 21.35 |      | 80.0 |         |
|           |   | Z | 12.05  | 85.29  | 21.66 |      | 80.0 |         |
| 10482-AAA | LTE-TDD (SC-FDMA, 50% RB, 3 MHz, QPSK, UL Subframe=2,3,4,7,8,9)     | X | 8.49   | 84.69  | 22.05 | 2.23 | 80.0 | ± 9.6 % |
|           |   | Y | 5.66   | 78.52  | 19.36 |      | 80.0 |         |
|           |   | Z | 6.07   | 79.11  | 20.05 |      | 80.0 |         |
| 10483-AAA | LTE-TDD (SC-FDMA, 50% RB, 3 MHz, 16-QAM, UL Subframe=2,3,4,7,8,9)   | X | 11.70  | 86.22  | 22.45 | 2.23 | 80.0 | ± 9.6 % |
|           |   | Y | 8.73   | 81.47  | 20.24 |      | 80.0 |         |
|           |   | Z | 8.71   | 81.39  | 20.85 |      | 80.0 |         |
| 10484-AAA | LTE-TDD (SC-FDMA, 50% RB, 3 MHz, 64-QAM, UL Subframe=2,3,4,7,8,9)   | X | 10.50  | 84.41  | 21.86 | 2.23 | 80.0 | ± 9.6 % |
|           |   | Y | 7.92   | 79.90  | 19.71 |      | 80.0 |         |
|           |   | Z | 8.18   | 80.26  | 20.46 |      | 80.0 |         |
| 10485-AAC | LTE-TDD (SC-FDMA, 50% RB, 5 MHz, QPSK, UL Subframe=2,3,4,7,8,9)     | X | 8.12   | 84.44  | 22.68 | 2.23 | 80.0 | ± 9.6 % |
|           |   | Y | 5.95   | 79.56  | 20.54 |      | 80.0 |         |
|           |   | Z | 6.24   | 79.61  | 20.83 |      | 80.0 |         |
| 10486-AAC | LTE-TDD (SC-FDMA, 50% RB, 5 MHz, 16-QAM, UL Subframe=2,3,4,7,8,9)   | X | 5.60   | 75.72  | 19.25 | 2.23 | 80.0 | ± 9.6 % |
|           |   | Y | 4.71   | 73.16  | 17.81 |      | 80.0 |         |
|           |   | Z | 5.00   | 73.46  | 18.29 |      | 80.0 |         |
| 10487-AAC | LTE-TDD (SC-FDMA, 50% RB, 5 MHz, 64-QAM, UL Subframe=2,3,4,7,8,9)   | X | 5.48   | 75.06  | 18.99 | 2.23 | 80.0 | ± 9.6 % |
|           |   | Y | 4.65   | 72.64  | 17.60 |      | 80.0 |         |
|           |   | Z | 4.96   | 73.01  | 18.11 |      | 80.0 |         |
| 10488-AAC | LTE-TDD (SC-FDMA, 50% RB, 10 MHz, QPSK, UL Subframe=2,3,4,7,8,9)    | X | 7.06   | 80.88  | 21.92 | 2.23 | 80.0 | ± 9.6 % |
|           |   | Y | 5.70   | 77.55  | 20.40 |      | 80.0 |         |
|           |   | Z | 6.08   | 77.77  | 20.57 |      | 80.0 |         |
| 10489-AAC | LTE-TDD (SC-FDMA, 50% RB, 10 MHz, 16-QAM, UL Subframe=2,3,4,7,8,9)  | X | 5.31   | 73.88  | 19.45 | 2.23 | 80.0 | ± 9.6 % |
|           |   | Y | 4.75   | 72.25  | 18.50 |      | 80.0 |         |
|           |   | Z | 5.02   | 72.44  | 18.71 |      | 80.0 |         |
| 10490-AAC | LTE-TDD (SC-FDMA, 50% RB, 10 MHz, 64-QAM, UL Subframe=2,3,4,7,8,9)  | X | 5.32   | 73.40  | 19.28 | 2.23 | 80.0 | ± 9.6 % |
|           |   | Y | 4.80   | 71.92  | 18.39 |      | 80.0 |         |
|           |   | Z | 5.07   | 72.08  | 18.60 |      | 80.0 |         |
| 10491-AAC | LTE-TDD (SC-FDMA, 50% RB, 15 MHz, QPSK, UL Subframe=2,3,4,7,8,9)    | X | 6.29   | 77.08  | 20.62 | 2.23 | 80.0 | ± 9.6 % |
|           |   | Y | 5.44   | 74.84  | 19.51 |      | 80.0 |         |
|           |   | Z | 5.78   | 75.12  | 19.66 |      | 80.0 |         |
| 10492-AAC | LTE-TDD (SC-FDMA, 50% RB, 15 MHz, 16-QAM, UL Subframe=2,3,4,7,8,9)  | X | 5.38   | 72.26  | 19.03 | 2.23 | 80.0 | ± 9.6 % |
|           |   | Y | 4.95   | 71.03  | 18.29 |      | 80.0 |         |
|           |   | Z | 5.22   | 71.29  | 18.47 |      | 80.0 |         |

|           |  |   |      |       |       |      |      |         |
|-----------|--|---|------|-------|-------|------|------|---------|
| 10493-AAC | LTE-TDD (SC-FDMA, 50% RB, 15 MHz, 64-QAM, UL Subframe=2,3,4,7,8,9)   | X | 5.41 | 71.97 | 18.93 | 2.23 | 80.0 | ± 9.6 % |
|           |  | Y | 4.99 | 70.82 | 18.22 |      | 80.0 |         |
|           |  | Z | 5.27 | 71.06 | 18.40 |      | 80.0 |         |
| 10494-AAC | LTE-TDD (SC-FDMA, 50% RB, 20 MHz, QPSK, UL Subframe=2,3,4,7,8,9)     | X | 7.26 | 79.46 | 21.31 | 2.23 | 80.0 | ± 9.6 % |
|           |  | Y | 6.08 | 76.70 | 20.04 |      | 80.0 |         |
|           |  | Z | 6.47 | 77.03 | 20.19 |      | 80.0 |         |
| 10495-AAC | LTE-TDD (SC-FDMA, 50% RB, 20 MHz, 16-QAM, UL Subframe=2,3,4,7,8,9)   | X | 5.52 | 72.92 | 19.28 | 2.23 | 80.0 | ± 9.6 % |
|           |  | Y | 5.04 | 71.57 | 18.51 |      | 80.0 |         |
|           |  | Z | 5.33 | 71.88 | 18.69 |      | 80.0 |         |
| 10496-AAC | LTE-TDD (SC-FDMA, 50% RB, 20 MHz, 64-QAM, UL Subframe=2,3,4,7,8,9)   | X | 5.51 | 72.36 | 19.10 | 2.23 | 80.0 | ± 9.6 % |
|           |  | Y | 5.07 | 71.15 | 18.38 |      | 80.0 |         |
|           |  | Z | 5.35 | 71.43 | 18.55 |      | 80.0 |         |
| 10497-AAA | LTE-TDD (SC-FDMA, 100% RB, 1.4 MHz, QPSK, UL Subframe=2,3,4,7,8,9)   | X | 6.84 | 81.16 | 20.14 | 2.23 | 80.0 | ± 9.6 % |
|           |  | Y | 4.18 | 74.07 | 16.91 |      | 80.0 |         |
|           |  | Z | 4.97 | 76.21 | 18.38 |      | 80.0 |         |
| 10498-AAA | LTE-TDD (SC-FDMA, 100% RB, 1.4 MHz, 16-QAM, UL Subframe=2,3,4,7,8,9) | X | 4.23 | 71.63 | 15.72 | 2.23 | 80.0 | ± 9.6 % |
|           |  | Y | 2.88 | 66.72 | 12.99 |      | 80.0 |         |
|           |  | Z | 3.81 | 69.89 | 15.10 |      | 80.0 |         |
| 10499-AAA | LTE-TDD (SC-FDMA, 100% RB, 1.4 MHz, 64-QAM, UL Subframe=2,3,4,7,8,9) | X | 4.07 | 70.79 | 15.25 | 2.23 | 80.0 | ± 9.6 % |
|           |  | Y | 2.78 | 66.03 | 12.55 |      | 80.0 |         |
|           |  | Z | 3.73 | 69.33 | 14.75 |      | 80.0 |         |
| 10500-AAA | LTE-TDD (SC-FDMA, 100% RB, 3 MHz, QPSK, UL Subframe=2,3,4,7,8,9)     | X | 7.25 | 82.07 | 22.09 | 2.23 | 80.0 | ± 9.6 % |
|           |  | Y | 5.64 | 78.16 | 20.30 |      | 80.0 |         |
|           |  | Z | 5.95 | 78.24 | 20.53 |      | 80.0 |         |
| 10501-AAA | LTE-TDD (SC-FDMA, 100% RB, 3 MHz, 16-QAM, UL Subframe=2,3,4,7,8,9)   | X | 5.43 | 74.78 | 19.24 | 2.23 | 80.0 | ± 9.6 % |
|           |  | Y | 4.72 | 72.72 | 18.04 |      | 80.0 |         |
|           |  | Z | 4.99 | 72.91 | 18.39 |      | 80.0 |         |
| 10502-AAA | LTE-TDD (SC-FDMA, 100% RB, 3 MHz, 64-QAM, UL Subframe=2,3,4,7,8,9)   | X | 5.43 | 74.40 | 19.05 | 2.23 | 80.0 | ± 9.6 % |
|           |  | Y | 4.75 | 72.45 | 17.89 |      | 80.0 |         |
|           |  | Z | 5.01 | 72.63 | 18.25 |      | 80.0 |         |
| 10503-AAC | LTE-TDD (SC-FDMA, 100% RB, 5 MHz, QPSK, UL Subframe=2,3,4,7,8,9)     | X | 6.96 | 80.64 | 21.82 | 2.23 | 80.0 | ± 9.6 % |
|           |  | Y | 5.62 | 77.31 | 20.29 |      | 80.0 |         |
|           |  | Z | 6.00 | 77.58 | 20.48 |      | 80.0 |         |
| 10504-AAC | LTE-TDD (SC-FDMA, 100% RB, 5 MHz, 16-QAM, UL Subframe=2,3,4,7,8,9)   | X | 5.28 | 73.79 | 19.40 | 2.23 | 80.0 | ± 9.6 % |
|           |  | Y | 4.72 | 72.15 | 18.44 |      | 80.0 |         |
|           |  | Z | 5.00 | 72.37 | 18.67 |      | 80.0 |         |
| 10505-AAC | LTE-TDD (SC-FDMA, 100% RB, 5 MHz, 64-QAM, UL Subframe=2,3,4,7,8,9)   | X | 5.30 | 73.31 | 19.23 | 2.23 | 80.0 | ± 9.6 % |
|           |  | Y | 4.78 | 71.81 | 18.34 |      | 80.0 |         |
|           |  | Z | 5.05 | 72.00 | 18.55 |      | 80.0 |         |
| 10506-AAC | LTE-TDD (SC-FDMA, 100% RB, 10 MHz, QPSK, UL Subframe=2,3,4,7,8,9)    | X | 7.19 | 79.29 | 21.23 | 2.23 | 80.0 | ± 9.6 % |
|           |  | Y | 6.02 | 76.53 | 19.97 |      | 80.0 |         |
|           |  | Z | 6.42 | 76.89 | 20.13 |      | 80.0 |         |
| 10507-AAC | LTE-TDD (SC-FDMA, 100% RB, 10 MHz, 16-QAM, UL Subframe=2,3,4,7,8,9)  | X | 5.49 | 72.85 | 19.25 | 2.23 | 80.0 | ± 9.6 % |
|           |  | Y | 5.02 | 71.50 | 18.47 |      | 80.0 |         |
|           |  | Z | 5.31 | 71.82 | 18.66 |      | 80.0 |         |

|           |   |   |      |       |       |      |       |         |
|-----------|---|---|------|-------|-------|------|-------|---------|
| 10508-AAC | LTE-TDD (SC-FDMA, 100% RB, 10 MHz, 64-QAM, UL Subframe=2,3,4,7,8,9) | X | 5.49 | 72.29 | 19.06 | 2.23 | 80.0  | ± 9.6 % |
|           |   | Y | 5.05 | 71.07 | 18.34 |      | 80.0  |         |
|           |   | Z | 5.33 | 71.37 | 18.52 |      | 80.0  |         |
| 10509-AAC | LTE-TDD (SC-FDMA, 100% RB, 15 MHz, QPSK, UL Subframe=2,3,4,7,8,9)   | X | 6.71 | 76.12 | 20.06 | 2.23 | 80.0  | ± 9.6 % |
|           |   | Y | 5.94 | 74.25 | 19.13 |      | 80.0  |         |
|           |   | Z | 6.28 | 74.57 | 19.27 |      | 80.0  |         |
| 10510-AAC | LTE-TDD (SC-FDMA, 100% RB, 15 MHz, 16-QAM, UL Subframe=2,3,4,7,8,9) | X | 5.84 | 71.95 | 18.94 | 2.23 | 80.0  | ± 9.6 % |
|           |   | Y | 5.42 | 70.86 | 18.30 |      | 80.0  |         |
|           |   | Z | 5.71 | 71.20 | 18.47 |      | 80.0  |         |
| 10511-AAC | LTE-TDD (SC-FDMA, 100% RB, 15 MHz, 64-QAM, UL Subframe=2,3,4,7,8,9) | X | 5.82 | 71.51 | 18.81 | 2.23 | 80.0  | ± 9.6 % |
|           |   | Y | 5.44 | 70.51 | 18.21 |      | 80.0  |         |
|           |   | Z | 5.71 | 70.83 | 18.37 |      | 80.0  |         |
| 10512-AAC | LTE-TDD (SC-FDMA, 100% RB, 20 MHz, QPSK, UL Subframe=2,3,4,7,8,9)   | X | 7.61 | 78.80 | 20.90 | 2.23 | 80.0  | ± 9.6 % |
|           |   | Y | 6.48 | 76.29 | 19.75 |      | 80.0  |         |
|           |   | Z | 6.88 | 76.71 | 19.92 |      | 80.0  |         |
| 10513-AAC | LTE-TDD (SC-FDMA, 100% RB, 20 MHz, 16-QAM, UL Subframe=2,3,4,7,8,9) | X | 5.82 | 72.58 | 19.18 | 2.23 | 80.0  | ± 9.6 % |
|           |   | Y | 5.36 | 71.33 | 18.47 |      | 80.0  |         |
|           |   | Z | 5.67 | 71.74 | 18.66 |      | 80.0  |         |
| 10514-AAC | LTE-TDD (SC-FDMA, 100% RB, 20 MHz, 64-QAM, UL Subframe=2,3,4,7,8,9) | X | 5.73 | 71.89 | 18.96 | 2.23 | 80.0  | ± 9.6 % |
|           |   | Y | 5.32 | 70.77 | 18.31 |      | 80.0  |         |
|           |   | Z | 5.61 | 71.15 | 18.49 |      | 80.0  |         |
| 10515-AAA | IEEE 802.11b WiFi 2.4 GHz (DSSS, 2 Mbps, 99pc duty cycle)           | X | 1.00 | 64.53 | 15.90 | 0.00 | 150.0 | ± 9.6 % |
|           |   | Y | 0.92 | 62.98 | 14.41 |      | 150.0 |         |
|           |   | Z | 0.96 | 63.54 | 14.94 |      | 150.0 |         |
| 10516-AAA | IEEE 802.11b WiFi 2.4 GHz (DSSS, 5.5 Mbps, 99pc duty cycle)         | X | 1.68 | 91.06 | 26.34 | 0.00 | 150.0 | ± 9.6 % |
|           |   | Y | 0.55 | 69.99 | 16.34 |      | 150.0 |         |
|           |   | Z | 0.73 | 74.56 | 19.01 |      | 150.0 |         |
| 10517-AAA | IEEE 802.11b WiFi 2.4 GHz (DSSS, 11 Mbps, 99pc duty cycle)          | X | 0.92 | 68.12 | 17.45 | 0.00 | 150.0 | ± 9.6 % |
|           |   | Y | 0.77 | 64.83 | 14.89 |      | 150.0 |         |
|           |   | Z | 0.84 | 65.95 | 15.79 |      | 150.0 |         |
| 10518-AAB | IEEE 802.11a/h WiFi 5 GHz (OFDM, 9 Mbps, 99pc duty cycle)           | X | 4.67 | 67.12 | 16.50 | 0.00 | 150.0 | ± 9.6 % |
|           |   | Y | 4.56 | 66.77 | 16.17 |      | 150.0 |         |
|           |   | Z | 4.66 | 66.89 | 16.28 |      | 150.0 |         |
| 10519-AAB | IEEE 802.11a/h WiFi 5 GHz (OFDM, 12 Mbps, 99pc duty cycle)          | X | 4.89 | 67.40 | 16.64 | 0.00 | 150.0 | ± 9.6 % |
|           |   | Y | 4.77 | 67.04 | 16.30 |      | 150.0 |         |
|           |   | Z | 4.89 | 67.19 | 16.43 |      | 150.0 |         |
| 10520-AAB | IEEE 802.11a/h WiFi 5 GHz (OFDM, 18 Mbps, 99pc duty cycle)          | X | 4.74 | 67.39 | 16.57 | 0.00 | 150.0 | ± 9.6 % |
|           |   | Y | 4.61 | 67.01 | 16.22 |      | 150.0 |         |
|           |   | Z | 4.74 | 67.17 | 16.35 |      | 150.0 |         |
| 10521-AAB | IEEE 802.11a/h WiFi 5 GHz (OFDM, 24 Mbps, 99pc duty cycle)          | X | 4.67 | 67.41 | 16.56 | 0.00 | 150.0 | ± 9.6 % |
|           |   | Y | 4.55 | 67.00 | 16.20 |      | 150.0 |         |
|           |   | Z | 4.67 | 67.18 | 16.34 |      | 150.0 |         |
| 10522-AAB | IEEE 802.11a/h WiFi 5 GHz (OFDM, 36 Mbps, 99pc duty cycle)          | X | 4.72 | 67.39 | 16.60 | 0.00 | 150.0 | ± 9.6 % |
|           |   | Y | 4.60 | 67.04 | 16.27 |      | 150.0 |         |
|           |   | Z | 4.71 | 67.14 | 16.36 |      | 150.0 |         |

|           |  |   |      |       |       |      |       |         |
|-----------|--|---|------|-------|-------|------|-------|---------|
| 10523-AAB | IEEE 802.11a/h WiFi 5 GHz (OFDM, 48 Mbps, 99pc duty cycle) | X | 4.59 | 67.29 | 16.46 | 0.00 | 150.0 | ± 9.6 % |
|           |  | Y | 4.47 | 66.91 | 16.11 |      | 150.0 |         |
|           |  | Z | 4.58 | 67.04 | 16.22 |      | 150.0 |         |
| 10524-AAB | IEEE 802.11a/h WiFi 5 GHz (OFDM, 54 Mbps, 99pc duty cycle) | X | 4.67 | 67.35 | 16.59 | 0.00 | 150.0 | ± 9.6 % |
|           |  | Y | 4.55 | 66.98 | 16.24 |      | 150.0 |         |
|           |  | Z | 4.67 | 67.11 | 16.36 |      | 150.0 |         |
| 10525-AAB | IEEE 802.11ac WiFi (20MHz, MCS0, 99pc duty cycle)          | X | 4.63 | 66.37 | 16.17 | 0.00 | 150.0 | ± 9.6 % |
|           |  | Y | 4.52 | 66.01 | 15.83 |      | 150.0 |         |
|           |  | Z | 4.62 | 66.13 | 15.94 |      | 150.0 |         |
| 10526-AAB | IEEE 802.11ac WiFi (20MHz, MCS1, 99pc duty cycle)          | X | 4.83 | 66.78 | 16.32 | 0.00 | 150.0 | ± 9.6 % |
|           |  | Y | 4.70 | 66.40 | 15.97 |      | 150.0 |         |
|           |  | Z | 4.82 | 66.54 | 16.09 |      | 150.0 |         |
| 10527-AAB | IEEE 802.11ac WiFi (20MHz, MCS2, 99pc duty cycle)          | X | 4.75 | 66.76 | 16.27 | 0.00 | 150.0 | ± 9.6 % |
|           |  | Y | 4.62 | 66.36 | 15.92 |      | 150.0 |         |
|           |  | Z | 4.74 | 66.51 | 16.04 |      | 150.0 |         |
| 10528-AAB | IEEE 802.11ac WiFi (20MHz, MCS3, 99pc duty cycle)          | X | 4.77 | 66.78 | 16.31 | 0.00 | 150.0 | ± 9.6 % |
|           |  | Y | 4.64 | 66.38 | 15.95 |      | 150.0 |         |
|           |  | Z | 4.76 | 66.54 | 16.08 |      | 150.0 |         |
| 10529-AAB | IEEE 802.11ac WiFi (20MHz, MCS4, 99pc duty cycle)          | X | 4.77 | 66.78 | 16.31 | 0.00 | 150.0 | ± 9.6 % |
|           |  | Y | 4.64 | 66.38 | 15.95 |      | 150.0 |         |
|           |  | Z | 4.76 | 66.54 | 16.08 |      | 150.0 |         |
| 10531-AAB | IEEE 802.11ac WiFi (20MHz, MCS6, 99pc duty cycle)          | X | 4.78 | 66.93 | 16.34 | 0.00 | 150.0 | ± 9.6 % |
|           |  | Y | 4.64 | 66.50 | 15.97 |      | 150.0 |         |
|           |  | Z | 4.77 | 66.69 | 16.10 |      | 150.0 |         |
| 10532-AAB | IEEE 802.11ac WiFi (20MHz, MCS7, 99pc duty cycle)          | X | 4.63 | 66.80 | 16.29 | 0.00 | 150.0 | ± 9.6 % |
|           |  | Y | 4.49 | 66.35 | 15.90 |      | 150.0 |         |
|           |  | Z | 4.62 | 66.56 | 16.05 |      | 150.0 |         |
| 10533-AAB | IEEE 802.11ac WiFi (20MHz, MCS8, 99pc duty cycle)          | X | 4.78 | 66.80 | 16.29 | 0.00 | 150.0 | ± 9.6 % |
|           |  | Y | 4.65 | 66.41 | 15.94 |      | 150.0 |         |
|           |  | Z | 4.77 | 66.55 | 16.05 |      | 150.0 |         |
| 10534-AAB | IEEE 802.11ac WiFi (40MHz, MCS0, 99pc duty cycle)          | X | 5.28 | 66.88 | 16.33 | 0.00 | 150.0 | ± 9.6 % |
|           |  | Y | 5.17 | 66.53 | 16.03 |      | 150.0 |         |
|           |  | Z | 5.27 | 66.70 | 16.13 |      | 150.0 |         |
| 10535-AAB | IEEE 802.11ac WiFi (40MHz, MCS1, 99pc duty cycle)          | X | 5.35 | 67.03 | 16.39 | 0.00 | 150.0 | ± 9.6 % |
|           |  | Y | 5.24 | 66.69 | 16.10 |      | 150.0 |         |
|           |  | Z | 5.34 | 66.84 | 16.18 |      | 150.0 |         |
| 10536-AAB | IEEE 802.11ac WiFi (40MHz, MCS2, 99pc duty cycle)          | X | 5.22 | 67.03 | 16.37 | 0.00 | 150.0 | ± 9.6 % |
|           |  | Y | 5.10 | 66.65 | 16.06 |      | 150.0 |         |
|           |  | Z | 5.21 | 66.83 | 16.16 |      | 150.0 |         |
| 10537-AAB | IEEE 802.11ac WiFi (40MHz, MCS3, 99pc duty cycle)          | X | 5.29 | 67.00 | 16.36 | 0.00 | 150.0 | ± 9.6 % |
|           |  | Y | 5.17 | 66.63 | 16.05 |      | 150.0 |         |
|           |  | Z | 5.27 | 66.80 | 16.15 |      | 150.0 |         |
| 10538-AAB | IEEE 802.11ac WiFi (40MHz, MCS4, 99pc duty cycle)          | X | 5.40 | 67.06 | 16.43 | 0.00 | 150.0 | ± 9.6 % |
|           |  | Y | 5.27 | 66.69 | 16.12 |      | 150.0 |         |
|           |  | Z | 5.39 | 66.88 | 16.23 |      | 150.0 |         |
| 10540-AAB | IEEE 802.11ac WiFi (40MHz, MCS6, 99pc duty cycle)          | X | 5.30 | 67.01 | 16.42 | 0.00 | 150.0 | ± 9.6 % |
|           |  | Y | 5.19 | 66.66 | 16.12 |      | 150.0 |         |
|           |  | Z | 5.29 | 66.82 | 16.22 |      | 150.0 |         |

|           |  |   |      |       |       |      |       |         |
|-----------|--|---|------|-------|-------|------|-------|---------|
| 10541-AAB | IEEE 802.11ac WiFi (40MHz, MCS7, 99pc duty cycle)  | X | 5.28 | 66.90 | 16.36 | 0.00 | 150.0 | ± 9.6 % |
|           |  | Y | 5.16 | 66.53 | 16.05 |      | 150.0 |         |
|           |  | Z | 5.27 | 66.74 | 16.17 |      | 150.0 |         |
| 10542-AAB | IEEE 802.11ac WiFi (40MHz, MCS8, 99pc duty cycle)  | X | 5.43 | 66.95 | 16.40 | 0.00 | 150.0 | ± 9.6 % |
|           |  | Y | 5.32 | 66.61 | 16.11 |      | 150.0 |         |
|           |  | Z | 5.42 | 66.77 | 16.20 |      | 150.0 |         |
| 10543-AAB | IEEE 802.11ac WiFi (40MHz, MCS9, 99pc duty cycle)  | X | 5.51 | 66.95 | 16.41 | 0.00 | 150.0 | ± 9.6 % |
|           |  | Y | 5.40 | 66.65 | 16.14 |      | 150.0 |         |
|           |  | Z | 5.51 | 66.78 | 16.22 |      | 150.0 |         |
| 10544-AAB | IEEE 802.11ac WiFi (80MHz, MCS0, 99pc duty cycle)  | X | 5.56 | 66.97 | 16.30 | 0.00 | 150.0 | ± 9.6 % |
|           |  | Y | 5.46 | 66.64 | 16.02 |      | 150.0 |         |
|           |  | Z | 5.54 | 66.80 | 16.11 |      | 150.0 |         |
| 10545-AAB | IEEE 802.11ac WiFi (80MHz, MCS1, 99pc duty cycle)  | X | 5.78 | 67.41 | 16.46 | 0.00 | 150.0 | ± 9.6 % |
|           |  | Y | 5.68 | 67.09 | 16.19 |      | 150.0 |         |
|           |  | Z | 5.76 | 67.21 | 16.25 |      | 150.0 |         |
| 10546-AAB | IEEE 802.11ac WiFi (80MHz, MCS2, 99pc duty cycle)  | X | 5.66 | 67.27 | 16.41 | 0.00 | 150.0 | ± 9.6 % |
|           |  | Y | 5.55 | 66.90 | 16.11 |      | 150.0 |         |
|           |  | Z | 5.65 | 67.10 | 16.22 |      | 150.0 |         |
| 10547-AAB | IEEE 802.11ac WiFi (80MHz, MCS3, 99pc duty cycle)  | X | 5.75 | 67.34 | 16.43 | 0.00 | 150.0 | ± 9.6 % |
|           |  | Y | 5.64 | 66.99 | 16.14 |      | 150.0 |         |
|           |  | Z | 5.73 | 67.16 | 16.24 |      | 150.0 |         |
| 10548-AAB | IEEE 802.11ac WiFi (80MHz, MCS4, 99pc duty cycle)  | X | 6.10 | 68.57 | 17.02 | 0.00 | 150.0 | ± 9.6 % |
|           |  | Y | 5.97 | 68.15 | 16.70 |      | 150.0 |         |
|           |  | Z | 6.06 | 68.30 | 16.78 |      | 150.0 |         |
| 10550-AAB | IEEE 802.11ac WiFi (80MHz, MCS6, 99pc duty cycle)  | X | 5.68 | 67.21 | 16.39 | 0.00 | 150.0 | ± 9.6 % |
|           |  | Y | 5.57 | 66.88 | 16.11 |      | 150.0 |         |
|           |  | Z | 5.66 | 67.04 | 16.20 |      | 150.0 |         |
| 10551-AAB | IEEE 802.11ac WiFi (80MHz, MCS7, 99pc duty cycle)  | X | 5.70 | 67.30 | 16.39 | 0.00 | 150.0 | ± 9.6 % |
|           |  | Y | 5.58 | 66.93 | 16.09 |      | 150.0 |         |
|           |  | Z | 5.68 | 67.15 | 16.21 |      | 150.0 |         |
| 10552-AAB | IEEE 802.11ac WiFi (80MHz, MCS8, 99pc duty cycle)  | X | 5.59 | 67.05 | 16.28 | 0.00 | 150.0 | ± 9.6 % |
|           |  | Y | 5.48 | 66.70 | 15.99 |      | 150.0 |         |
|           |  | Z | 5.58 | 66.90 | 16.10 |      | 150.0 |         |
| 10553-AAB | IEEE 802.11ac WiFi (80MHz, MCS9, 99pc duty cycle)  | X | 5.69 | 67.10 | 16.33 | 0.00 | 150.0 | ± 9.6 % |
|           |  | Y | 5.57 | 66.76 | 16.05 |      | 150.0 |         |
|           |  | Z | 5.67 | 66.95 | 16.15 |      | 150.0 |         |
| 10554-AAC | IEEE 802.11ac WiFi (160MHz, MCS0, 99pc duty cycle) | X | 5.97 | 67.34 | 16.39 | 0.00 | 150.0 | ± 9.6 % |
|           |  | Y | 5.87 | 67.02 | 16.12 |      | 150.0 |         |
|           |  | Z | 5.94 | 67.19 | 16.21 |      | 150.0 |         |
| 10555-AAC | IEEE 802.11ac WiFi (160MHz, MCS1, 99pc duty cycle) | X | 6.12 | 67.69 | 16.53 | 0.00 | 150.0 | ± 9.6 % |
|           |  | Y | 6.01 | 67.35 | 16.26 |      | 150.0 |         |
|           |  | Z | 6.10 | 67.54 | 16.36 |      | 150.0 |         |
| 10556-AAC | IEEE 802.11ac WiFi (160MHz, MCS2, 99pc duty cycle) | X | 6.13 | 67.71 | 16.53 | 0.00 | 150.0 | ± 9.6 % |
|           |  | Y | 6.03 | 67.38 | 16.27 |      | 150.0 |         |
|           |  | Z | 6.11 | 67.54 | 16.35 |      | 150.0 |         |
| 10557-AAC | IEEE 802.11ac WiFi (160MHz, MCS3, 99pc duty cycle) | X | 6.12 | 67.66 | 16.53 | 0.00 | 150.0 | ± 9.6 % |
|           |  | Y | 6.00 | 67.31 | 16.25 |      | 150.0 |         |
|           |  | Z | 6.10 | 67.52 | 16.36 |      | 150.0 |         |

|           |   |   |        |        |       |      |       |         |
|-----------|---|---|--------|--------|-------|------|-------|---------|
| 10558-AAC | IEEE 802.11ac WiFi (160MHz, MCS4, 99pc duty cycle)              | X | 6.18   | 67.86  | 16.65 | 0.00 | 150.0 | ± 9.6 % |
|           |   | Y | 6.06   | 67.49  | 16.36 |      | 150.0 |         |
|           |   | Z | 6.16   | 67.71  | 16.47 |      | 150.0 |         |
| 10560-AAC | IEEE 802.11ac WiFi (160MHz, MCS6, 99pc duty cycle)              | X | 6.16   | 67.67  | 16.59 | 0.00 | 150.0 | ± 9.6 % |
|           |   | Y | 6.05   | 67.32  | 16.31 |      | 150.0 |         |
|           |   | Z | 6.15   | 67.54  | 16.42 |      | 150.0 |         |
| 10561-AAC | IEEE 802.11ac WiFi (160MHz, MCS7, 99pc duty cycle)              | X | 6.08   | 67.64  | 16.61 | 0.00 | 150.0 | ± 9.6 % |
|           |   | Y | 5.97   | 67.29  | 16.33 |      | 150.0 |         |
|           |   | Z | 6.06   | 67.49  | 16.44 |      | 150.0 |         |
| 10562-AAC | IEEE 802.11ac WiFi (160MHz, MCS8, 99pc duty cycle)              | X | 6.25   | 68.16  | 16.88 | 0.00 | 150.0 | ± 9.6 % |
|           |   | Y | 6.13   | 67.77  | 16.57 |      | 150.0 |         |
|           |   | Z | 6.23   | 68.01  | 16.70 |      | 150.0 |         |
| 10563-AAC | IEEE 802.11ac WiFi (160MHz, MCS9, 99pc duty cycle)              | X | 6.60   | 68.73  | 17.10 | 0.00 | 150.0 | ± 9.6 % |
|           |   | Y | 6.50   | 68.45  | 16.86 |      | 150.0 |         |
|           |   | Z | 6.53   | 68.43  | 16.86 |      | 150.0 |         |
| 10564-AAA | IEEE 802.11g WiFi 2.4 GHz (DSSS-OFDM, 9 Mbps, 99pc duty cycle)  | X | 5.01   | 67.24  | 16.68 | 0.46 | 150.0 | ± 9.6 % |
|           |   | Y | 4.90   | 66.90  | 16.36 |      | 150.0 |         |
|           |   | Z | 5.01   | 67.05  | 16.49 |      | 150.0 |         |
| 10565-AAA | IEEE 802.11g WiFi 2.4 GHz (DSSS-OFDM, 12 Mbps, 99pc duty cycle) | X | 5.27   | 67.70  | 16.99 | 0.46 | 150.0 | ± 9.6 % |
|           |   | Y | 5.15   | 67.37  | 16.68 |      | 150.0 |         |
|           |   | Z | 5.27   | 67.52  | 16.80 |      | 150.0 |         |
| 10566-AAA | IEEE 802.11g WiFi 2.4 GHz (DSSS-OFDM, 18 Mbps, 99pc duty cycle) | X | 5.11   | 67.60  | 16.84 | 0.46 | 150.0 | ± 9.6 % |
|           |   | Y | 4.98   | 67.23  | 16.50 |      | 150.0 |         |
|           |   | Z | 5.11   | 67.41  | 16.64 |      | 150.0 |         |
| 10567-AAA | IEEE 802.11g WiFi 2.4 GHz (DSSS-OFDM, 24 Mbps, 99pc duty cycle) | X | 5.13   | 67.96  | 17.16 | 0.46 | 150.0 | ± 9.6 % |
|           |   | Y | 5.01   | 67.61  | 16.84 |      | 150.0 |         |
|           |   | Z | 5.13   | 67.75  | 16.95 |      | 150.0 |         |
| 10568-AAA | IEEE 802.11g WiFi 2.4 GHz (DSSS-OFDM, 36 Mbps, 99pc duty cycle) | X | 5.02   | 67.36  | 16.62 | 0.46 | 150.0 | ± 9.6 % |
|           |   | Y | 4.90   | 67.01  | 16.28 |      | 150.0 |         |
|           |   | Z | 5.02   | 67.16  | 16.41 |      | 150.0 |         |
| 10569-AAA | IEEE 802.11g WiFi 2.4 GHz (DSSS-OFDM, 48 Mbps, 99pc duty cycle) | X | 5.07   | 67.97  | 17.18 | 0.46 | 150.0 | ± 9.6 % |
|           |   | Y | 4.96   | 67.67  | 16.89 |      | 150.0 |         |
|           |   | Z | 5.06   | 67.76  | 16.96 |      | 150.0 |         |
| 10570-AAA | IEEE 802.11g WiFi 2.4 GHz (DSSS-OFDM, 54 Mbps, 99pc duty cycle) | X | 5.11   | 67.83  | 17.12 | 0.46 | 150.0 | ± 9.6 % |
|           |   | Y | 5.00   | 67.52  | 16.83 |      | 150.0 |         |
|           |   | Z | 5.11   | 67.61  | 16.91 |      | 150.0 |         |
| 10571-AAA | IEEE 802.11b WiFi 2.4 GHz (DSSS, 1 Mbps, 90pc duty cycle)       | X | 1.43   | 67.78  | 17.55 | 0.46 | 130.0 | ± 9.6 % |
|           |   | Y | 1.29   | 65.83  | 16.01 |      | 130.0 |         |
|           |   | Z | 1.37   | 66.57  | 16.56 |      | 130.0 |         |
| 10572-AAA | IEEE 802.11b WiFi 2.4 GHz (DSSS, 2 Mbps, 90pc duty cycle)       | X | 1.47   | 68.62  | 18.01 | 0.46 | 130.0 | ± 9.6 % |
|           |   | Y | 1.32   | 66.50  | 16.39 |      | 130.0 |         |
|           |   | Z | 1.40   | 67.26  | 16.95 |      | 130.0 |         |
| 10573-AAA | IEEE 802.11b WiFi 2.4 GHz (DSSS, 5.5 Mbps, 90pc duty cycle)     | X | 100.00 | 147.77 | 39.50 | 0.46 | 130.0 | ± 9.6 % |
|           |   | Y | 5.11   | 95.86  | 25.26 |      | 130.0 |         |
|           |   | Z | 11.46  | 108.94 | 29.46 |      | 130.0 |         |
| 10574-AAA | IEEE 802.11b WiFi 2.4 GHz (DSSS, 11 Mbps, 90pc duty cycle)      | X | 2.11   | 79.07  | 22.64 | 0.46 | 130.0 | ± 9.6 % |
|           |   | Y | 1.59   | 73.49  | 19.59 |      | 130.0 |         |
|           |   | Z | 1.75   | 74.78  | 20.34 |      | 130.0 |         |

|           |   |   |      |       |       |      |       |         |
|-----------|---|---|------|-------|-------|------|-------|---------|
| 10575-AAA | IEEE 802.11g WiFi 2.4 GHz (DSSS-OFDM, 6 Mbps, 90pc duty cycle)  | X | 4.84 | 67.12 | 16.79 | 0.46 | 130.0 | ± 9.6 % |
|           |   | Y | 4.72 | 66.80 | 16.47 |      | 130.0 |         |
|           |   | Z | 4.83 | 66.93 | 16.59 |      | 130.0 |         |
| 10576-AAA | IEEE 802.11g WiFi 2.4 GHz (DSSS-OFDM, 9 Mbps, 90pc duty cycle)  | X | 4.86 | 67.28 | 16.85 | 0.46 | 130.0 | ± 9.6 % |
|           |   | Y | 4.75 | 66.95 | 16.53 |      | 130.0 |         |
|           |   | Z | 4.86 | 67.08 | 16.65 |      | 130.0 |         |
| 10577-AAA | IEEE 802.11g WiFi 2.4 GHz (DSSS-OFDM, 12 Mbps, 90pc duty cycle) | X | 5.09 | 67.60 | 17.02 | 0.46 | 130.0 | ± 9.6 % |
|           |   | Y | 4.97 | 67.26 | 16.71 |      | 130.0 |         |
|           |   | Z | 5.10 | 67.41 | 16.83 |      | 130.0 |         |
| 10578-AAA | IEEE 802.11g WiFi 2.4 GHz (DSSS-OFDM, 18 Mbps, 90pc duty cycle) | X | 4.99 | 67.77 | 17.12 | 0.46 | 130.0 | ± 9.6 % |
|           |   | Y | 4.86 | 67.43 | 16.80 |      | 130.0 |         |
|           |   | Z | 4.99 | 67.57 | 16.91 |      | 130.0 |         |
| 10579-AAA | IEEE 802.11g WiFi 2.4 GHz (DSSS-OFDM, 24 Mbps, 90pc duty cycle) | X | 4.77 | 67.19 | 16.53 | 0.46 | 130.0 | ± 9.6 % |
|           |   | Y | 4.64 | 66.77 | 16.15 |      | 130.0 |         |
|           |   | Z | 4.78 | 67.01 | 16.33 |      | 130.0 |         |
| 10580-AAA | IEEE 802.11g WiFi 2.4 GHz (DSSS-OFDM, 36 Mbps, 90pc duty cycle) | X | 4.81 | 67.17 | 16.53 | 0.46 | 130.0 | ± 9.6 % |
|           |   | Y | 4.68 | 66.78 | 16.16 |      | 130.0 |         |
|           |   | Z | 4.82 | 66.97 | 16.32 |      | 130.0 |         |
| 10581-AAA | IEEE 802.11g WiFi 2.4 GHz (DSSS-OFDM, 48 Mbps, 90pc duty cycle) | X | 4.90 | 67.87 | 17.09 | 0.46 | 130.0 | ± 9.6 % |
|           |   | Y | 4.77 | 67.49 | 16.75 |      | 130.0 |         |
|           |   | Z | 4.90 | 67.66 | 16.87 |      | 130.0 |         |
| 10582-AAA | IEEE 802.11g WiFi 2.4 GHz (DSSS-OFDM, 54 Mbps, 90pc duty cycle) | X | 4.73 | 66.96 | 16.34 | 0.46 | 130.0 | ± 9.6 % |
|           |   | Y | 4.59 | 66.53 | 15.94 |      | 130.0 |         |
|           |   | Z | 4.73 | 66.78 | 16.14 |      | 130.0 |         |
| 10583-AAB | IEEE 802.11a/h WiFi 5 GHz (OFDM, 6 Mbps, 90pc duty cycle)       | X | 4.84 | 67.12 | 16.79 | 0.46 | 130.0 | ± 9.6 % |
|           |   | Y | 4.72 | 66.80 | 16.47 |      | 130.0 |         |
|           |   | Z | 4.83 | 66.93 | 16.59 |      | 130.0 |         |
| 10584-AAB | IEEE 802.11a/h WiFi 5 GHz (OFDM, 9 Mbps, 90pc duty cycle)       | X | 4.86 | 67.28 | 16.85 | 0.46 | 130.0 | ± 9.6 % |
|           |   | Y | 4.75 | 66.95 | 16.53 |      | 130.0 |         |
|           |   | Z | 4.86 | 67.08 | 16.65 |      | 130.0 |         |
| 10585-AAB | IEEE 802.11a/h WiFi 5 GHz (OFDM, 12 Mbps, 90pc duty cycle)      | X | 5.09 | 67.60 | 17.02 | 0.46 | 130.0 | ± 9.6 % |
|           |   | Y | 4.97 | 67.26 | 16.71 |      | 130.0 |         |
|           |   | Z | 5.10 | 67.41 | 16.83 |      | 130.0 |         |
| 10586-AAB | IEEE 802.11a/h WiFi 5 GHz (OFDM, 18 Mbps, 90pc duty cycle)      | X | 4.99 | 67.77 | 17.12 | 0.46 | 130.0 | ± 9.6 % |
|           |   | Y | 4.86 | 67.43 | 16.80 |      | 130.0 |         |
|           |   | Z | 4.99 | 67.57 | 16.91 |      | 130.0 |         |
| 10587-AAB | IEEE 802.11a/h WiFi 5 GHz (OFDM, 24 Mbps, 90pc duty cycle)      | X | 4.77 | 67.19 | 16.53 | 0.46 | 130.0 | ± 9.6 % |
|           |   | Y | 4.64 | 66.77 | 16.15 |      | 130.0 |         |
|           |   | Z | 4.78 | 67.01 | 16.33 |      | 130.0 |         |
| 10588-AAB | IEEE 802.11a/h WiFi 5 GHz (OFDM, 36 Mbps, 90pc duty cycle)      | X | 4.81 | 67.17 | 16.53 | 0.46 | 130.0 | ± 9.6 % |
|           |   | Y | 4.68 | 66.78 | 16.16 |      | 130.0 |         |
|           |   | Z | 4.82 | 66.97 | 16.32 |      | 130.0 |         |
| 10589-AAB | IEEE 802.11a/h WiFi 5 GHz (OFDM, 48 Mbps, 90pc duty cycle)      | X | 4.90 | 67.87 | 17.09 | 0.46 | 130.0 | ± 9.6 % |
|           |   | Y | 4.77 | 67.49 | 16.75 |      | 130.0 |         |
|           |   | Z | 4.90 | 67.66 | 16.87 |      | 130.0 |         |
| 10590-AAB | IEEE 802.11a/h WiFi 5 GHz (OFDM, 54 Mbps, 90pc duty cycle)      | X | 4.73 | 66.96 | 16.34 | 0.46 | 130.0 | ± 9.6 % |
|           |   | Y | 4.59 | 66.53 | 15.94 |      | 130.0 |         |
|           |   | Z | 4.73 | 66.78 | 16.14 |      | 130.0 |         |



|           |   |   |      |       |       |      |       |         |
|-----------|---|---|------|-------|-------|------|-------|---------|
| 10591-AAB | IEEE 802.11n (HT Mixed, 20MHz, MCS0, 90pc duty cycle) | X | 4.98 | 67.15 | 16.87 | 0.46 | 130.0 | ± 9.6 % |
|           |   | Y | 4.87 | 66.85 | 16.57 |      | 130.0 |         |
|           |   | Z | 4.98 | 66.97 | 16.68 |      | 130.0 |         |
| 10592-AAB | IEEE 802.11n (HT Mixed, 20MHz, MCS1, 90pc duty cycle) | X | 5.15 | 67.50 | 16.99 | 0.46 | 130.0 | ± 9.6 % |
|           |   | Y | 5.04 | 67.19 | 16.69 |      | 130.0 |         |
|           |   | Z | 5.16 | 67.32 | 16.80 |      | 130.0 |         |
| 10593-AAB | IEEE 802.11n (HT Mixed, 20MHz, MCS2, 90pc duty cycle) | X | 5.09 | 67.46 | 16.91 | 0.46 | 130.0 | ± 9.6 % |
|           |   | Y | 4.96 | 67.12 | 16.59 |      | 130.0 |         |
|           |   | Z | 5.09 | 67.29 | 16.72 |      | 130.0 |         |
| 10594-AAB | IEEE 802.11n (HT Mixed, 20MHz, MCS3, 90pc duty cycle) | X | 5.14 | 67.60 | 17.04 | 0.46 | 130.0 | ± 9.6 % |
|           |   | Y | 5.02 | 67.28 | 16.73 |      | 130.0 |         |
|           |   | Z | 5.14 | 67.42 | 16.84 |      | 130.0 |         |
| 10595-AAB | IEEE 802.11n (HT Mixed, 20MHz, MCS4, 90pc duty cycle) | X | 5.11 | 67.58 | 16.95 | 0.46 | 130.0 | ± 9.6 % |
|           |   | Y | 4.99 | 67.24 | 16.64 |      | 130.0 |         |
|           |   | Z | 5.12 | 67.40 | 16.76 |      | 130.0 |         |
| 10596-AAB | IEEE 802.11n (HT Mixed, 20MHz, MCS5, 90pc duty cycle) | X | 5.05 | 67.59 | 16.96 | 0.46 | 130.0 | ± 9.6 % |
|           |   | Y | 4.93 | 67.24 | 16.64 |      | 130.0 |         |
|           |   | Z | 5.06 | 67.40 | 16.76 |      | 130.0 |         |
| 10597-AAB | IEEE 802.11n (HT Mixed, 20MHz, MCS6, 90pc duty cycle) | X | 5.00 | 67.53 | 16.87 | 0.46 | 130.0 | ± 9.6 % |
|           |   | Y | 4.88 | 67.16 | 16.53 |      | 130.0 |         |
|           |   | Z | 5.01 | 67.35 | 16.68 |      | 130.0 |         |
| 10598-AAB | IEEE 802.11n (HT Mixed, 20MHz, MCS7, 90pc duty cycle) | X | 4.98 | 67.77 | 17.12 | 0.46 | 130.0 | ± 9.6 % |
|           |   | Y | 4.86 | 67.40 | 16.79 |      | 130.0 |         |
|           |   | Z | 4.99 | 67.58 | 16.92 |      | 130.0 |         |
| 10599-AAB | IEEE 802.11n (HT Mixed, 40MHz, MCS0, 90pc duty cycle) | X | 5.65 | 67.74 | 17.05 | 0.46 | 130.0 | ± 9.6 % |
|           |   | Y | 5.54 | 67.42 | 16.77 |      | 130.0 |         |
|           |   | Z | 5.65 | 67.58 | 16.87 |      | 130.0 |         |
| 10600-AAB | IEEE 802.11n (HT Mixed, 40MHz, MCS1, 90pc duty cycle) | X | 5.86 | 68.37 | 17.35 | 0.46 | 130.0 | ± 9.6 % |
|           |   | Y | 5.74 | 68.03 | 17.05 |      | 130.0 |         |
|           |   | Z | 5.87 | 68.25 | 17.19 |      | 130.0 |         |
| 10601-AAB | IEEE 802.11n (HT Mixed, 40MHz, MCS2, 90pc duty cycle) | X | 5.71 | 67.99 | 17.17 | 0.46 | 130.0 | ± 9.6 % |
|           |   | Y | 5.59 | 67.67 | 16.88 |      | 130.0 |         |
|           |   | Z | 5.71 | 67.84 | 16.99 |      | 130.0 |         |
| 10602-AAB | IEEE 802.11n (HT Mixed, 40MHz, MCS3, 90pc duty cycle) | X | 5.80 | 67.99 | 17.09 | 0.46 | 130.0 | ± 9.6 % |
|           |   | Y | 5.68 | 67.66 | 16.80 |      | 130.0 |         |
|           |   | Z | 5.80 | 67.87 | 16.93 |      | 130.0 |         |
| 10603-AAB | IEEE 802.11n (HT Mixed, 40MHz, MCS4, 90pc duty cycle) | X | 5.88 | 68.27 | 17.35 | 0.46 | 130.0 | ± 9.6 % |
|           |   | Y | 5.76 | 67.95 | 17.07 |      | 130.0 |         |
|           |   | Z | 5.91 | 68.22 | 17.22 |      | 130.0 |         |
| 10604-AAB | IEEE 802.11n (HT Mixed, 40MHz, MCS5, 90pc duty cycle) | X | 5.65 | 67.69 | 17.05 | 0.46 | 130.0 | ± 9.6 % |
|           |   | Y | 5.55 | 67.38 | 16.78 |      | 130.0 |         |
|           |   | Z | 5.65 | 67.55 | 16.88 |      | 130.0 |         |
| 10605-AAB | IEEE 802.11n (HT Mixed, 40MHz, MCS6, 90pc duty cycle) | X | 5.77 | 68.03 | 17.23 | 0.46 | 130.0 | ± 9.6 % |
|           |   | Y | 5.67 | 67.75 | 16.97 |      | 130.0 |         |
|           |   | Z | 5.76 | 67.86 | 17.04 |      | 130.0 |         |
| 10606-AAB | IEEE 802.11n (HT Mixed, 40MHz, MCS7, 90pc duty cycle) | X | 5.54 | 67.48 | 16.82 | 0.46 | 130.0 | ± 9.6 % |
|           |   | Y | 5.42 | 67.14 | 16.52 |      | 130.0 |         |
|           |   | Z | 5.54 | 67.37 | 16.67 |      | 130.0 |         |

|           |   |   |      |       |       |      |       |         |
|-----------|---|---|------|-------|-------|------|-------|---------|
| 10607-AAB | IEEE 802.11ac WiFi (20MHz, MCS0, 90pc duty cycle) | X | 4.81 | 66.46 | 16.48 | 0.46 | 130.0 | ± 9.6 % |
|           |   | Y | 4.70 | 66.13 | 16.17 |      | 130.0 |         |
|           |   | Z | 4.81 | 66.25 | 16.27 |      | 130.0 |         |
| 10608-AAB | IEEE 802.11ac WiFi (20MHz, MCS1, 90pc duty cycle) | X | 5.03 | 66.90 | 16.65 | 0.46 | 130.0 | ± 9.6 % |
|           |   | Y | 4.90 | 66.55 | 16.34 |      | 130.0 |         |
|           |   | Z | 5.02 | 66.68 | 16.44 |      | 130.0 |         |
| 10609-AAB | IEEE 802.11ac WiFi (20MHz, MCS2, 90pc duty cycle) | X | 4.92 | 66.79 | 16.52 | 0.46 | 130.0 | ± 9.6 % |
|           |   | Y | 4.79 | 66.41 | 16.18 |      | 130.0 |         |
|           |   | Z | 4.92 | 66.57 | 16.31 |      | 130.0 |         |
| 10610-AAB | IEEE 802.11ac WiFi (20MHz, MCS3, 90pc duty cycle) | X | 4.97 | 66.94 | 16.67 | 0.46 | 130.0 | ± 9.6 % |
|           |   | Y | 4.84 | 66.57 | 16.34 |      | 130.0 |         |
|           |   | Z | 4.97 | 66.72 | 16.46 |      | 130.0 |         |
| 10611-AAB | IEEE 802.11ac WiFi (20MHz, MCS4, 90pc duty cycle) | X | 4.89 | 66.78 | 16.54 | 0.46 | 130.0 | ± 9.6 % |
|           |   | Y | 4.76 | 66.39 | 16.20 |      | 130.0 |         |
|           |   | Z | 4.89 | 66.57 | 16.33 |      | 130.0 |         |
| 10612-AAB | IEEE 802.11ac WiFi (20MHz, MCS5, 90pc duty cycle) | X | 4.92 | 66.95 | 16.59 | 0.46 | 130.0 | ± 9.6 % |
|           |   | Y | 4.78 | 66.55 | 16.24 |      | 130.0 |         |
|           |   | Z | 4.91 | 66.73 | 16.37 |      | 130.0 |         |
| 10613-AAB | IEEE 802.11ac WiFi (20MHz, MCS6, 90pc duty cycle) | X | 4.93 | 66.87 | 16.50 | 0.46 | 130.0 | ± 9.6 % |
|           |   | Y | 4.79 | 66.46 | 16.14 |      | 130.0 |         |
|           |   | Z | 4.93 | 66.66 | 16.28 |      | 130.0 |         |
| 10614-AAB | IEEE 802.11ac WiFi (20MHz, MCS7, 90pc duty cycle) | X | 4.85 | 67.03 | 16.71 | 0.46 | 130.0 | ± 9.6 % |
|           |   | Y | 4.72 | 66.63 | 16.36 |      | 130.0 |         |
|           |   | Z | 4.85 | 66.82 | 16.49 |      | 130.0 |         |
| 10615-AAB | IEEE 802.11ac WiFi (20MHz, MCS8, 90pc duty cycle) | X | 4.90 | 66.61 | 16.33 | 0.46 | 130.0 | ± 9.6 % |
|           |   | Y | 4.76 | 66.22 | 15.98 |      | 130.0 |         |
|           |   | Z | 4.90 | 66.40 | 16.12 |      | 130.0 |         |
| 10616-AAB | IEEE 802.11ac WiFi (40MHz, MCS0, 90pc duty cycle) | X | 5.47 | 66.98 | 16.66 | 0.46 | 130.0 | ± 9.6 % |
|           |   | Y | 5.36 | 66.66 | 16.38 |      | 130.0 |         |
|           |   | Z | 5.46 | 66.82 | 16.47 |      | 130.0 |         |
| 10617-AAB | IEEE 802.11ac WiFi (40MHz, MCS1, 90pc duty cycle) | X | 5.52 | 67.09 | 16.68 | 0.46 | 130.0 | ± 9.6 % |
|           |   | Y | 5.42 | 66.80 | 16.41 |      | 130.0 |         |
|           |   | Z | 5.52 | 66.93 | 16.49 |      | 130.0 |         |
| 10618-AAB | IEEE 802.11ac WiFi (40MHz, MCS2, 90pc duty cycle) | X | 5.42 | 67.18 | 16.74 | 0.46 | 130.0 | ± 9.6 % |
|           |   | Y | 5.31 | 66.84 | 16.45 |      | 130.0 |         |
|           |   | Z | 5.41 | 67.00 | 16.54 |      | 130.0 |         |
| 10619-AAB | IEEE 802.11ac WiFi (40MHz, MCS3, 90pc duty cycle) | X | 5.45 | 67.00 | 16.59 | 0.46 | 130.0 | ± 9.6 % |
|           |   | Y | 5.34 | 66.68 | 16.31 |      | 130.0 |         |
|           |   | Z | 5.44 | 66.82 | 16.40 |      | 130.0 |         |
| 10620-AAB | IEEE 802.11ac WiFi (40MHz, MCS4, 90pc duty cycle) | X | 5.56 | 67.11 | 16.69 | 0.46 | 130.0 | ± 9.6 % |
|           |   | Y | 5.44 | 66.75 | 16.39 |      | 130.0 |         |
|           |   | Z | 5.56 | 66.95 | 16.51 |      | 130.0 |         |
| 10621-AAB | IEEE 802.11ac WiFi (40MHz, MCS5, 90pc duty cycle) | X | 5.53 | 67.13 | 16.81 | 0.46 | 130.0 | ± 9.6 % |
|           |   | Y | 5.42 | 66.81 | 16.54 |      | 130.0 |         |
|           |   | Z | 5.53 | 66.98 | 16.63 |      | 130.0 |         |
| 10622-AAB | IEEE 802.11ac WiFi (40MHz, MCS6, 90pc duty cycle) | X | 5.53 | 67.27 | 16.87 | 0.46 | 130.0 | ± 9.6 % |
|           |   | Y | 5.43 | 66.97 | 16.61 |      | 130.0 |         |
|           |   | Z | 5.52 | 67.09 | 16.67 |      | 130.0 |         |

|           |  |   |      |       |       |      |       |         |
|-----------|--|---|------|-------|-------|------|-------|---------|
| 10623-AAB | IEEE 802.11ac WiFi (40MHz, MCS7, 90pc duty cycle)  | X | 5.42 | 66.86 | 16.56 | 0.46 | 130.0 | ± 9.6 % |
|           |  | Y | 5.30 | 66.51 | 16.26 |      | 130.0 |         |
|           |  | Z | 5.42 | 66.73 | 16.39 |      | 130.0 |         |
| 10624-AAB | IEEE 802.11ac WiFi (40MHz, MCS8, 90pc duty cycle)  | X | 5.61 | 67.03 | 16.70 | 0.46 | 130.0 | ± 9.6 % |
|           |  | Y | 5.50 | 66.72 | 16.43 |      | 130.0 |         |
|           |  | Z | 5.60 | 66.86 | 16.51 |      | 130.0 |         |
| 10625-AAB | IEEE 802.11ac WiFi (40MHz, MCS9, 90pc duty cycle)  | X | 6.05 | 68.19 | 17.33 | 0.46 | 130.0 | ± 9.6 % |
|           |  | Y | 5.94 | 67.90 | 17.07 |      | 130.0 |         |
|           |  | Z | 6.01 | 67.90 | 17.08 |      | 130.0 |         |
| 10626-AAB | IEEE 802.11ac WiFi (80MHz, MCS0, 90pc duty cycle)  | X | 5.72 | 66.99 | 16.57 | 0.46 | 130.0 | ± 9.6 % |
|           |  | Y | 5.63 | 66.69 | 16.31 |      | 130.0 |         |
|           |  | Z | 5.71 | 66.84 | 16.40 |      | 130.0 |         |
| 10627-AAB | IEEE 802.11ac WiFi (80MHz, MCS1, 90pc duty cycle)  | X | 5.99 | 67.59 | 16.82 | 0.46 | 130.0 | ± 9.6 % |
|           |  | Y | 5.90 | 67.32 | 16.58 |      | 130.0 |         |
|           |  | Z | 5.97 | 67.39 | 16.62 |      | 130.0 |         |
| 10628-AAB | IEEE 802.11ac WiFi (80MHz, MCS2, 90pc duty cycle)  | X | 5.80 | 67.20 | 16.57 | 0.46 | 130.0 | ± 9.6 % |
|           |  | Y | 5.69 | 66.85 | 16.29 |      | 130.0 |         |
|           |  | Z | 5.79 | 67.05 | 16.40 |      | 130.0 |         |
| 10629-AAB | IEEE 802.11ac WiFi (80MHz, MCS3, 90pc duty cycle)  | X | 5.88 | 67.25 | 16.59 | 0.46 | 130.0 | ± 9.6 % |
|           |  | Y | 5.77 | 66.92 | 16.31 |      | 130.0 |         |
|           |  | Z | 5.87 | 67.12 | 16.43 |      | 130.0 |         |
| 10630-AAB | IEEE 802.11ac WiFi (80MHz, MCS4, 90pc duty cycle)  | X | 6.51 | 69.31 | 17.62 | 0.46 | 130.0 | ± 9.6 % |
|           |  | Y | 6.37 | 68.86 | 17.28 |      | 130.0 |         |
|           |  | Z | 6.46 | 69.04 | 17.39 |      | 130.0 |         |
| 10631-AAB | IEEE 802.11ac WiFi (80MHz, MCS5, 90pc duty cycle)  | X | 6.31 | 68.81 | 17.54 | 0.46 | 130.0 | ± 9.6 % |
|           |  | Y | 6.17 | 68.39 | 17.24 |      | 130.0 |         |
|           |  | Z | 6.30 | 68.62 | 17.35 |      | 130.0 |         |
| 10632-AAB | IEEE 802.11ac WiFi (80MHz, MCS6, 90pc duty cycle)  | X | 5.95 | 67.61 | 16.96 | 0.46 | 130.0 | ± 9.6 % |
|           |  | Y | 5.85 | 67.34 | 16.73 |      | 130.0 |         |
|           |  | Z | 5.94 | 67.45 | 16.78 |      | 130.0 |         |
| 10633-AAB | IEEE 802.11ac WiFi (80MHz, MCS7, 90pc duty cycle)  | X | 5.89 | 67.42 | 16.71 | 0.46 | 130.0 | ± 9.6 % |
|           |  | Y | 5.75 | 67.01 | 16.39 |      | 130.0 |         |
|           |  | Z | 5.89 | 67.32 | 16.56 |      | 130.0 |         |
| 10634-AAB | IEEE 802.11ac WiFi (80MHz, MCS8, 90pc duty cycle)  | X | 5.85 | 67.37 | 16.74 | 0.46 | 130.0 | ± 9.6 % |
|           |  | Y | 5.73 | 67.02 | 16.46 |      | 130.0 |         |
|           |  | Z | 5.86 | 67.27 | 16.59 |      | 130.0 |         |
| 10635-AAB | IEEE 802.11ac WiFi (80MHz, MCS9, 90pc duty cycle)  | X | 5.75 | 66.78 | 16.20 | 0.46 | 130.0 | ± 9.6 % |
|           |  | Y | 5.62 | 66.39 | 15.89 |      | 130.0 |         |
|           |  | Z | 5.75 | 66.67 | 16.05 |      | 130.0 |         |
| 10636-AAC | IEEE 802.11ac WiFi (160MHz, MCS0, 90pc duty cycle) | X | 6.13 | 67.38 | 16.66 | 0.46 | 130.0 | ± 9.6 % |
|           |  | Y | 6.05 | 67.09 | 16.42 |      | 130.0 |         |
|           |  | Z | 6.12 | 67.24 | 16.50 |      | 130.0 |         |
| 10637-AAC | IEEE 802.11ac WiFi (160MHz, MCS1, 90pc duty cycle) | X | 6.31 | 67.79 | 16.85 | 0.46 | 130.0 | ± 9.6 % |
|           |  | Y | 6.21 | 67.50 | 16.60 |      | 130.0 |         |
|           |  | Z | 6.29 | 67.65 | 16.68 |      | 130.0 |         |
| 10638-AAC | IEEE 802.11ac WiFi (160MHz, MCS2, 90pc duty cycle) | X | 6.31 | 67.76 | 16.81 | 0.46 | 130.0 | ± 9.6 % |
|           |  | Y | 6.21 | 67.47 | 16.56 |      | 130.0 |         |
|           |  | Z | 6.29 | 67.60 | 16.64 |      | 130.0 |         |

|           |  |   |       |        |       |       |       |         |
|-----------|--|---|-------|--------|-------|-------|-------|---------|
| 10639-AAC | IEEE 802.11ac WiFi (160MHz, MCS3, 90pc duty cycle)     | X | 6.30  | 67.76  | 16.86 | 0.46  | 130.0 | ± 9.6 % |
|           |  | Y | 6.20  | 67.43  | 16.59 |       | 130.0 |         |
|           |  | Z | 6.29  | 67.63  | 16.70 |       | 130.0 |         |
| 10640-AAC | IEEE 802.11ac WiFi (160MHz, MCS4, 90pc duty cycle)     | X | 6.34  | 67.87  | 16.86 | 0.46  | 130.0 | ± 9.6 % |
|           |  | Y | 6.22  | 67.50  | 16.57 |       | 130.0 |         |
|           |  | Z | 6.33  | 67.75  | 16.70 |       | 130.0 |         |
| 10641-AAC | IEEE 802.11ac WiFi (160MHz, MCS5, 90pc duty cycle)     | X | 6.33  | 67.58  | 16.73 | 0.46  | 130.0 | ± 9.6 % |
|           |  | Y | 6.23  | 67.29  | 16.48 |       | 130.0 |         |
|           |  | Z | 6.31  | 67.45  | 16.57 |       | 130.0 |         |
| 10642-AAC | IEEE 802.11ac WiFi (160MHz, MCS6, 90pc duty cycle)     | X | 6.39  | 67.88  | 17.04 | 0.46  | 130.0 | ± 9.6 % |
|           |  | Y | 6.28  | 67.58  | 16.79 |       | 130.0 |         |
|           |  | Z | 6.38  | 67.76  | 16.88 |       | 130.0 |         |
| 10643-AAC | IEEE 802.11ac WiFi (160MHz, MCS7, 90pc duty cycle)     | X | 6.22  | 67.60  | 16.81 | 0.46  | 130.0 | ± 9.6 % |
|           |  | Y | 6.12  | 67.28  | 16.54 |       | 130.0 |         |
|           |  | Z | 6.21  | 67.48  | 16.65 |       | 130.0 |         |
| 10644-AAC | IEEE 802.11ac WiFi (160MHz, MCS8, 90pc duty cycle)     | X | 6.47  | 68.34  | 17.21 | 0.46  | 130.0 | ± 9.6 % |
|           |  | Y | 6.34  | 67.93  | 16.89 |       | 130.0 |         |
|           |  | Z | 6.46  | 68.22  | 17.05 |       | 130.0 |         |
| 10645-AAC | IEEE 802.11ac WiFi (160MHz, MCS9, 90pc duty cycle)     | X | 6.86  | 69.01  | 17.48 | 0.46  | 130.0 | ± 9.6 % |
|           |  | Y | 6.84  | 68.95  | 17.35 |       | 130.0 |         |
|           |  | Z | 6.77  | 68.66  | 17.21 |       | 130.0 |         |
| 10646-AAD | LTE-TDD (SC-FDMA, 1 RB, 5 MHz, QPSK, UL Subframe=2,7)  | X | 39.97 | 118.78 | 39.16 | 9.30  | 60.0  | ± 9.6 % |
|           |  | Y | 36.64 | 117.33 | 38.51 |       | 60.0  |         |
|           |  | Z | 28.19 | 109.42 | 36.13 |       | 60.0  |         |
| 10647-AAC | LTE-TDD (SC-FDMA, 1 RB, 20 MHz, QPSK, UL Subframe=2,7) | X | 43.22 | 121.45 | 40.07 | 9.30  | 60.0  | ± 9.6 % |
|           |  | Y | 37.61 | 118.78 | 39.06 |       | 60.0  |         |
|           |  | Z | 29.77 | 111.44 | 36.87 |       | 60.0  |         |
| 10648-AAA | CDMA2000 (1x Advanced)                                 | X | 0.92  | 67.44  | 13.60 | 0.00  | 150.0 | ± 9.6 % |
|           |  | Y | 0.67  | 63.31  | 10.51 |       | 150.0 |         |
|           |  | Z | 0.80  | 64.88  | 12.09 |       | 150.0 |         |
| 10652-AAB | LTE-TDD (OFDMA, 5 MHz, E-TM 3.1, Clipping 44%)         | X | 4.65  | 69.66  | 17.99 | 2.23  | 80.0  | ± 9.6 % |
|           |  | Y | 4.35  | 68.72  | 17.32 |       | 80.0  |         |
|           |  | Z | 4.56  | 68.93  | 17.55 |       | 80.0  |         |
| 10653-AAB | LTE-TDD (OFDMA, 10 MHz, E-TM 3.1, Clipping 44%)        | X | 5.05  | 68.61  | 17.89 | 2.23  | 80.0  | ± 9.6 % |
|           |  | Y | 4.81  | 67.90  | 17.37 |       | 80.0  |         |
|           |  | Z | 5.01  | 68.17  | 17.57 |       | 80.0  |         |
| 10654-AAB | LTE-TDD (OFDMA, 15 MHz, E-TM 3.1, Clipping 44%)        | X | 4.97  | 68.24  | 17.87 | 2.23  | 80.0  | ± 9.6 % |
|           |  | Y | 4.75  | 67.55  | 17.37 |       | 80.0  |         |
|           |  | Z | 4.94  | 67.85  | 17.56 |       | 80.0  |         |
| 10655-AAB | LTE-TDD (OFDMA, 20 MHz, E-TM 3.1, Clipping 44%)        | X | 5.03  | 68.27  | 17.91 | 2.23  | 80.0  | ± 9.6 % |
|           |  | Y | 4.81  | 67.56  | 17.41 |       | 80.0  |         |
|           |  | Z | 4.99  | 67.90  | 17.61 |       | 80.0  |         |
| 10658-AAA | Pulse Waveform (200Hz, 10%)                            | X | 13.25 | 86.83  | 23.62 | 10.00 | 50.0  | ± 9.6 % |
|           |  | Y | 14.38 | 88.09  | 23.44 |       | 50.0  |         |
|           |  | Z | 11.47 | 83.98  | 22.82 |       | 50.0  |         |
| 10659-AAA | Pulse Waveform (200Hz, 20%)                            | X | 55.89 | 109.63 | 28.77 | 6.99  | 60.0  | ± 9.6 % |
|           |  | Y | 73.21 | 111.71 | 28.47 |       | 60.0  |         |
|           |  | Z | 23.49 | 96.54  | 25.38 |       | 60.0  |         |

|           |                             |   |        |        |       |      |       |         |
|-----------|-----------------------------|---|--------|--------|-------|------|-------|---------|
| 10660-AAA | Pulse Waveform (200Hz, 40%) | X | 100.00 | 116.44 | 28.38 | 3.98 | 80.0  | ± 9.6 % |
|           |                             | Y | 100.00 | 113.18 | 26.58 |      | 80.0  |         |
|           |                             | Z | 100.00 | 116.19 | 28.39 |      | 80.0  |         |
| 10661-AAA | Pulse Waveform (200Hz, 60%) | X | 100.00 | 118.35 | 27.71 | 2.22 | 100.0 | ± 9.6 % |
|           |                             | Y | 100.00 | 112.59 | 24.89 |      | 100.0 |         |
|           |                             | Z | 100.00 | 116.83 | 27.13 |      | 100.0 |         |
| 10662-AAA | Pulse Waveform (200Hz, 80%) | X | 100.00 | 126.67 | 29.16 | 0.97 | 120.0 | ± 9.6 % |
|           |                             | Y | 100.00 | 111.31 | 22.51 |      | 120.0 |         |
|           |                             | Z | 100.00 | 120.40 | 26.63 |      | 120.0 |         |

<sup>E</sup> Uncertainty is determined using the max. deviation from linear response applying rectangular distribution and is expressed for the square of the field value.

**Calibration Laboratory of  
Schmid & Partner  
Engineering AG**  
Zeughausstrasse 43, 8004 Zurich, Switzerland



**S** Schweizerischer Kalibrierdienst  
**C** Service suisse d'étalonnage  
**S** Servizio svizzero di taratura  
Swiss Calibration Service

Accredited by the Swiss Accreditation Service (SAS)  
The Swiss Accreditation Service is one of the signatories to the EA  
Multilateral Agreement for the recognition of calibration certificates

Accreditation No.: **SCS 0108**

Client **PC Test**

Certificate No: **ES3-3318\_Sep17**

**CALIBRATION CERTIFICATE**

Object: **ES3DV3 - SN:3318**

Calibration procedure(s): **QA CAL-01.v9, QA CAL-23.v5, QA CAL-25.v6**  
**Calibration procedure for dosimetric E-field probes**

Calibration date: **September 22, 2017**

*SLV*  
*10/03/2017*

This calibration certificate documents the traceability to national standards, which realize the physical units of measurements (SI).  
The measurements and the uncertainties with confidence probability are given on the following pages and are part of the certificate.

All calibrations have been conducted in the closed laboratory facility: environment temperature (22 ± 3)°C and humidity < 70%.

Calibration Equipment used (M&TE critical for calibration)

| Primary Standards          | ID               | Cal Date (Certificate No.)        | Scheduled Calibration  |
|----------------------------|------------------|-----------------------------------|------------------------|
| Power meter NRP            | SN: 104778       | 04-Apr-17 (No. 217-02521/02522)   | Apr-18                 |
| Power sensor NRP-Z91       | SN: 103244       | 04-Apr-17 (No. 217-02521)         | Apr-18                 |
| Power sensor NRP-Z91       | SN: 103245       | 04-Apr-17 (No. 217-02525)         | Apr-18                 |
| Reference 20 dB Attenuator | SN: S5277 (20x)  | 07-Apr-17 (No. 217-02528)         | Apr-18                 |
| Reference Probe ES3DV2     | SN: 3013         | 31-Dec-16 (No. ES3-3013_Dec16)    | Dec-17                 |
| DAE4                       | SN: 660          | 7-Dec-16 (No. DAE4-660_Dec16)     | Dec-17                 |
| Secondary Standards        | ID               | Check Date (in house)             | Scheduled Check        |
| Power meter E4419B         | SN: GB41293874   | 06-Apr-16 (in house check Jun-16) | In house check: Jun-18 |
| Power sensor E4412A        | SN: MY41498087   | 06-Apr-16 (in house check Jun-16) | In house check: Jun-18 |
| Power sensor E4412A        | SN: 000110210    | 06-Apr-16 (in house check Jun-16) | In house check: Jun-18 |
| RF generator HP 8648C      | SN: US3642U01700 | 04-Aug-99 (in house check Jun-16) | In house check: Jun-18 |
| Network Analyzer HP 8753E  | SN: US37390585   | 18-Oct-01 (in house check Oct-16) | In house check: Oct-17 |

Calibrated by: **Jeton Kastrati** (Name), **Laboratory Technician** (Function), *[Signature]* (Signature)

Approved by: **Katja Pokovic** (Name), **Technical Manager** (Function), *[Signature]* (Signature)

Issued: September 22, 2017

This calibration certificate shall not be reproduced except in full without written approval of the laboratory.



Accredited by the Swiss Accreditation Service (SAS)  
The Swiss Accreditation Service is one of the signatories to the EA  
Multilateral Agreement for the recognition of calibration certificates

Accreditation No.: **SCS 0108**

**Glossary:**

|                          |   |
|--------------------------|---|
| TSL                      | tissue simulating liquid  |
| NORM <sub>x,y,z</sub>    | sensitivity in free space   |
| ConvF                    | sensitivity in TSL / NORM <sub>x,y,z</sub>  |
| DCP                      | diode compression point   |
| CF                       | crest factor (1/duty_cycle) of the RF signal  |
| A, B, C, D               | modulation dependent linearization parameters   |
| Polarization $\phi$      | $\phi$ rotation around probe axis   |
| Polarization $\vartheta$ | $\vartheta$ rotation around an axis that is in the plane normal to probe axis (at measurement center),<br>i.e., $\vartheta = 0$ is normal to probe axis |
| Connector Angle          | information used in DASY system to align probe sensor X to the robot coordinate system  |

**Calibration is Performed According to the Following Standards:**

- a) IEEE Std 1528-2013, "IEEE Recommended Practice for Determining the Peak Spatial-Averaged Specific Absorption Rate (SAR) in the Human Head from Wireless Communications Devices: Measurement Techniques", June 2013
- b) IEC 62209-1, "Measurement procedure for the assessment of Specific Absorption Rate (SAR) from hand-held and body-mounted devices used next to the ear (frequency range of 300 MHz to 6 GHz)", July 2016
- c) IEC 62209-2, "Procedure to determine the Specific Absorption Rate (SAR) for wireless communication devices used in close proximity to the human body (frequency range of 30 MHz to 6 GHz)", March 2010
- d) KDB 865664, "SAR Measurement Requirements for 100 MHz to 6 GHz"

**Methods Applied and Interpretation of Parameters:**

- **NORM<sub>x,y,z</sub>**: Assessed for E-field polarization  $\vartheta = 0$  ( $f \leq 900$  MHz in TEM-cell;  $f > 1800$  MHz: R22 waveguide). NORM<sub>x,y,z</sub> are only intermediate values, i.e., the uncertainties of NORM<sub>x,y,z</sub> does not affect the E<sup>2</sup>-field uncertainty inside TSL (see below ConvF).
- **NORM(f)<sub>x,y,z</sub>** = NORM<sub>x,y,z</sub> \* frequency\_response (see Frequency Response Chart). This linearization is implemented in DASY4 software versions later than 4.2. The uncertainty of the frequency response is included in the stated uncertainty of ConvF.
- **DCP<sub>x,y,z</sub>**: DCP are numerical linearization parameters assessed based on the data of power sweep with CW signal (no uncertainty required). DCP does not depend on frequency nor media.
- **PAR**: PAR is the Peak to Average Ratio that is not calibrated but determined based on the signal characteristics
- **A<sub>x,y,z</sub>; B<sub>x,y,z</sub>; C<sub>x,y,z</sub>; D<sub>x,y,z</sub>; VR<sub>x,y,z</sub>; A, B, C, D** are numerical linearization parameters assessed based on the data of power sweep for specific modulation signal. The parameters do not depend on frequency nor media. VR is the maximum calibration range expressed in RMS voltage across the diode.
- **ConvF and Boundary Effect Parameters**: Assessed in flat phantom using E-field (or Temperature Transfer Standard for  $f \leq 800$  MHz) and inside waveguide using analytical field distributions based on power measurements for  $f > 800$  MHz. The same setups are used for assessment of the parameters applied for boundary compensation (alpha, depth) of which typical uncertainty values are given. These parameters are used in DASY4 software to improve probe accuracy close to the boundary. The sensitivity in TSL corresponds to NORM<sub>x,y,z</sub> \* ConvF whereby the uncertainty corresponds to that given for ConvF. A frequency dependent ConvF is used in DASY version 4.4 and higher which allows extending the validity from  $\pm 50$  MHz to  $\pm 100$  MHz.
- **Spherical isotropy (3D deviation from isotropy)**: in a field of low gradients realized using a flat phantom exposed by a patch antenna.
- **Sensor Offset**: The sensor offset corresponds to the offset of virtual measurement center from the probe tip (on probe axis). No tolerance required.
- **Connector Angle**: The angle is assessed using the information gained by determining the NORM<sub>x</sub> (no uncertainty required).

# Probe ES3DV3

## SN:3318

|               |                    |
|---------------|--------------------|
| Manufactured: | January 10, 2012   |
| Repaired:     | September 18, 2017 |
| Calibrated:   | September 22, 2017 |

**Calibrated for DASY/EASY Systems**  
(Note: non-compatible with DASY2 system!)



## DASY/EASY - Parameters of Probe: ES3DV3 - SN:3318

### Basic Calibration Parameters

|   | Sensor X | Sensor Y | Sensor Z | Unc (k=2)     |
|---|----------|----------|----------|---------------|
| Norm ( $\mu\text{V}/(\text{V}/\text{m})^2$ ) <sup>A</sup> | 1.02     | 1.12     | 0.98     | $\pm 10.1 \%$ |
| DCP (mV) <sup>B</sup>                                     | 103.7    | 104.0    | 102.5    |               |

### Modulation Calibration Parameters

| UID | Communication System Name |   | A<br>dB | B<br>dB $\sqrt{\mu\text{V}}$ | C   | D<br>dB | VR<br>mV | Unc <sup>E</sup><br>(k=2) |
|-----|---------------------------|---|---------|------------------------------|-----|---------|----------|---------------------------|
| 0   | CW                        | X | 0.0     | 0.0                          | 1.0 | 0.00    | 183.4    | $\pm 3.5 \%$              |
|     |                           | Y | 0.0     | 0.0                          | 1.0 |         | 193.5    |                           |
|     |                           | Z | 0.0     | 0.0                          | 1.0 |         | 183.0    |                           |

Note: For details on UID parameters see Appendix.

### Sensor Model Parameters

|   | C1<br>fF | C2<br>fF | $\alpha$<br>$\text{V}^{-1}$ | T1<br>$\text{ms}\cdot\text{V}^{-2}$ | T2<br>$\text{ms}\cdot\text{V}^{-1}$ | T3<br>ms | T4<br>$\text{V}^{-2}$ | T5<br>$\text{V}^{-1}$ | T6    |
|---|----------|----------|-----------------------------|-------------------------------------|-------------------------------------|----------|-----------------------|-----------------------|-------|
| X | 40.36    | 285.5    | 34.97                       | 23.53                               | 0.939                               | 5.100    | 1.568                 | 0.156                 | 1.011 |
| Y | 40.15    | 284.7    | 34.96                       | 25.8                                | 1.330                               | 5.092    | 1.283                 | 0.265                 | 1.008 |
| Z | 38.32    | 269.2    | 34.28                       | 24.09                               | 0.917                               | 5.100    | 0.995                 | 0.237                 | 1.007 |

The reported uncertainty of measurement is stated as the standard uncertainty of measurement multiplied by the coverage factor  $k=2$ , which for a normal distribution corresponds to a coverage probability of approximately 95%.

<sup>A</sup> The uncertainties of Norm X,Y,Z do not affect the  $E^2$ -field uncertainty inside TSL (see Pages 5 and 6).

<sup>B</sup> Numerical linearization parameter: uncertainty not required.

<sup>E</sup> Uncertainty is determined using the max. deviation from linear response applying rectangular distribution and is expressed for the square of the field value.

## DASY/EASY - Parameters of Probe: ES3DV3 - SN:3318

### Calibration Parameter Determined in Head Tissue Simulating Media

| f (MHz) <sup>C</sup> | Relative Permittivity <sup>F</sup> | Conductivity (S/m) <sup>F</sup> | ConvF X | ConvF Y | ConvF Z | Alpha <sup>G</sup> | Depth (mm) <sup>G</sup> | Unc (k=2) |
|----------------------|------------------------------------|---------------------------------|---------|---------|---------|--------------------|-------------------------|-----------|
| 750                  | 41.9                               | 0.89                            | 6.72    | 6.72    | 6.72    | 0.80               | 1.15                    | ± 12.0 %  |
| 835                  | 41.5                               | 0.90                            | 6.42    | 6.42    | 6.42    | 0.71               | 1.26                    | ± 12.0 %  |
| 1750                 | 40.1                               | 1.37                            | 5.50    | 5.50    | 5.50    | 0.49               | 1.50                    | ± 12.0 %  |
| 1900                 | 40.0                               | 1.40                            | 5.31    | 5.31    | 5.31    | 0.65               | 1.29                    | ± 12.0 %  |
| 2300                 | 39.5                               | 1.67                            | 4.96    | 4.96    | 4.96    | 0.72               | 1.27                    | ± 12.0 %  |
| 2450                 | 39.2                               | 1.80                            | 4.71    | 4.71    | 4.71    | 0.77               | 1.26                    | ± 12.0 %  |
| 2600                 | 39.0                               | 1.96                            | 4.58    | 4.58    | 4.58    | 0.75               | 1.32                    | ± 12.0 %  |

<sup>C</sup> Frequency validity above 300 MHz of ± 100 MHz only applies for DASY v4.4 and higher (see Page 2), else it is restricted to ± 50 MHz. The uncertainty is the RSS of the ConvF uncertainty at calibration frequency and the uncertainty for the indicated frequency band. Frequency validity below 300 MHz is ± 10, 25, 40, 50 and 70 MHz for ConvF assessments at 30, 64, 128, 150 and 220 MHz respectively. Above 5 GHz frequency validity can be extended to ± 110 MHz.

<sup>F</sup> At frequencies below 3 GHz, the validity of tissue parameters ( $\epsilon$  and  $\sigma$ ) can be relaxed to ± 10% if liquid compensation formula is applied to measured SAR values. At frequencies above 3 GHz, the validity of tissue parameters ( $\epsilon$  and  $\sigma$ ) is restricted to ± 5%. The uncertainty is the RSS of the ConvF uncertainty for indicated target tissue parameters.

<sup>G</sup> Alpha/Depth are determined during calibration. SPEAG warrants that the remaining deviation due to the boundary effect after compensation is always less than ± 1% for frequencies below 3 GHz and below ± 2% for frequencies between 3-6 GHz at any distance larger than half the probe tip diameter from the boundary.

## DASY/EASY - Parameters of Probe: ES3DV3 - SN:3318

### Calibration Parameter Determined in Body Tissue Simulating Media

| f (MHz) <sup>C</sup> | Relative Permittivity <sup>F</sup> | Conductivity (S/m) <sup>F</sup> | ConvF X | ConvF Y | ConvF Z | Alpha <sup>G</sup> | Depth <sup>G</sup> (mm) | Unc (k=2) |
|----------------------|------------------------------------|---------------------------------|---------|---------|---------|--------------------|-------------------------|-----------|
| 750                  | 55.5                               | 0.96                            | 6.46    | 6.46    | 6.46    | 0.80               | 1.21                    | ± 12.0 %  |
| 835                  | 55.2                               | 0.97                            | 6.32    | 6.32    | 6.32    | 0.80               | 1.20                    | ± 12.0 %  |
| 1750                 | 53.4                               | 1.49                            | 5.18    | 5.18    | 5.18    | 0.65               | 1.36                    | ± 12.0 %  |
| 1900                 | 53.3                               | 1.52                            | 4.96    | 4.96    | 4.96    | 0.57               | 1.49                    | ± 12.0 %  |
| 2300                 | 52.9                               | 1.81                            | 4.71    | 4.71    | 4.71    | 0.73               | 1.33                    | ± 12.0 %  |
| 2450                 | 52.7                               | 1.95                            | 4.55    | 4.55    | 4.55    | 0.80               | 1.12                    | ± 12.0 %  |
| 2600                 | 52.5                               | 2.16                            | 4.34    | 4.34    | 4.34    | 0.80               | 1.13                    | ± 12.0 %  |

<sup>C</sup> Frequency validity above 300 MHz of ± 100 MHz only applies for DASY v4.4 and higher (see Page 2), else it is restricted to ± 50 MHz. The uncertainty is the RSS of the ConvF uncertainty at calibration frequency and the uncertainty for the indicated frequency band. Frequency validity below 300 MHz is ± 10, 25, 40, 50 and 70 MHz for ConvF assessments at 30, 64, 128, 150 and 220 MHz respectively. Above 5 GHz frequency validity can be extended to ± 110 MHz.

<sup>F</sup> At frequencies below 3 GHz, the validity of tissue parameters ( $\epsilon$  and  $\sigma$ ) can be relaxed to ± 10% if liquid compensation formula is applied to measured SAR values. At frequencies above 3 GHz, the validity of tissue parameters ( $\epsilon$  and  $\sigma$ ) is restricted to ± 5%. The uncertainty is the RSS of the ConvF uncertainty for indicated target tissue parameters.

<sup>G</sup> Alpha/Depth are determined during calibration. SPEAG warrants that the remaining deviation due to the boundary effect after compensation is always less than ± 1% for frequencies below 3 GHz and below ± 2% for frequencies between 3-6 GHz at any distance larger than half the probe tip diameter from the boundary.

## Frequency Response of E-Field (TEM-Cell:ifi110 EXX, Waveguide: R22)

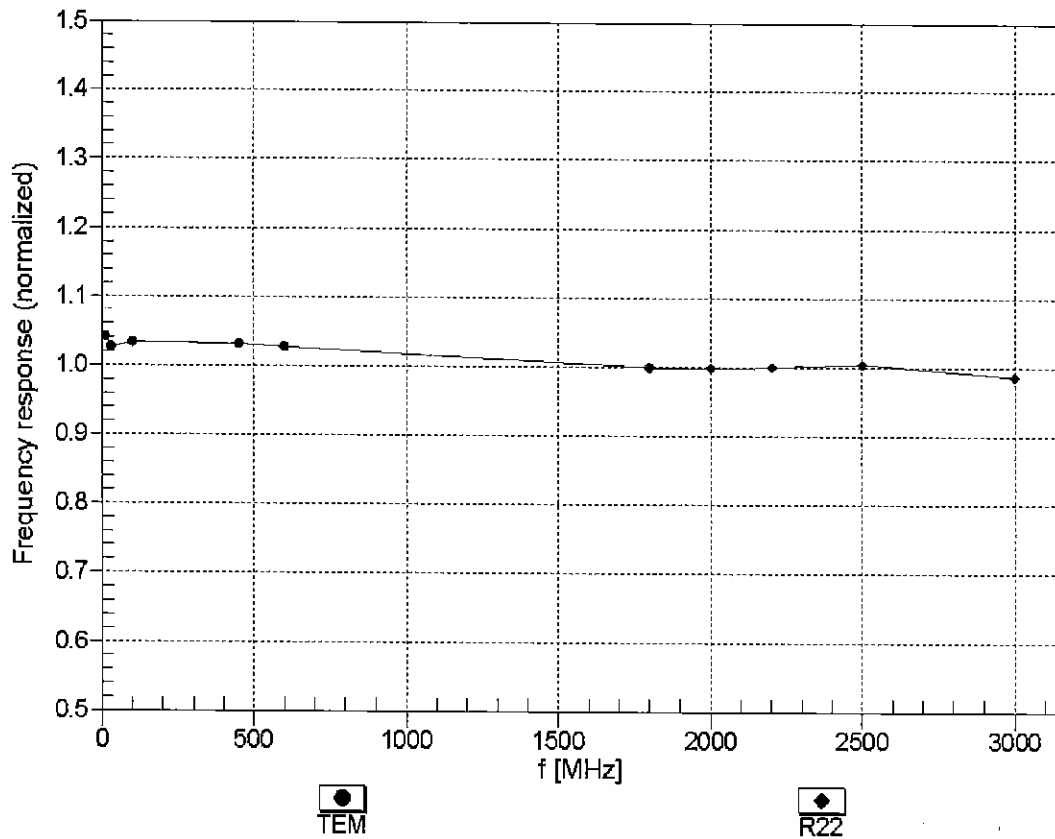

**Uncertainty of Frequency Response of E-field:  $\pm 6.3\%$  ( $k=2$ )**

### Receiving Pattern ( $\phi$ ), $\theta = 0^\circ$

f=600 MHz, TEM

f=1800 MHz, R22

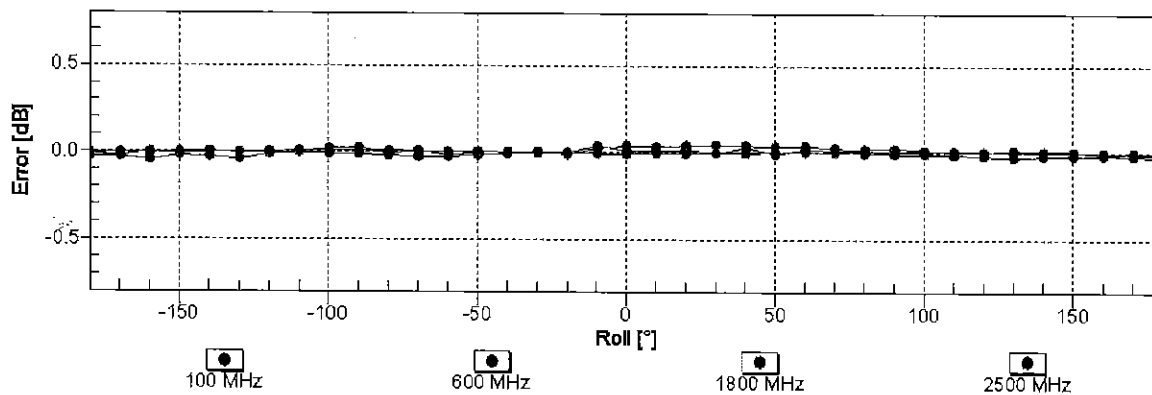
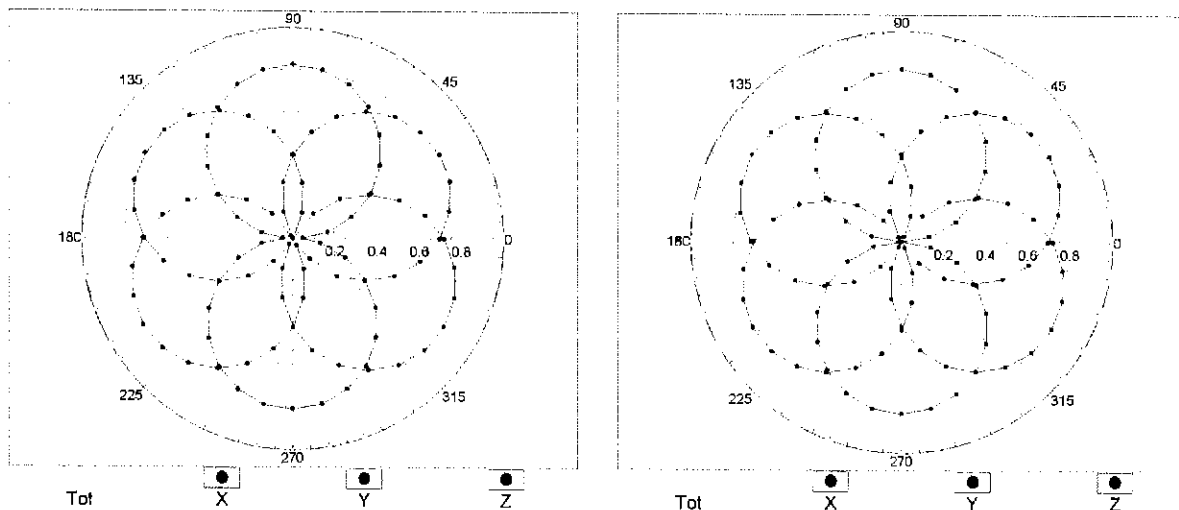

Uncertainty of Axial Isotropy Assessment:  $\pm 0.5\%$  (k=2)

### Dynamic Range $f(SAR_{head})$ (TEM cell , $f_{eval}= 1900$ MHz)

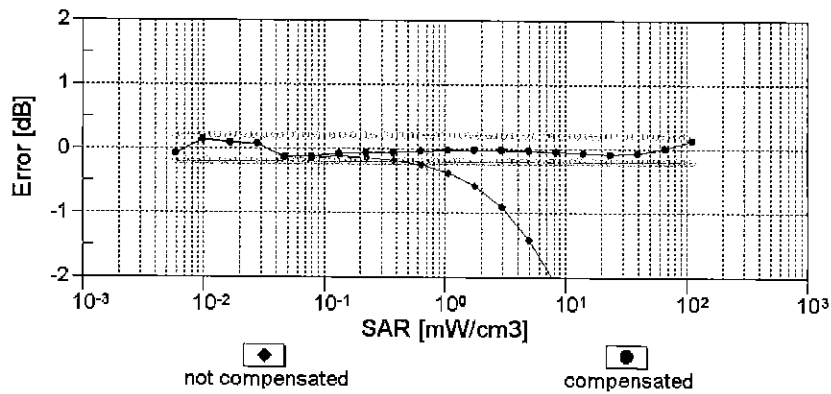
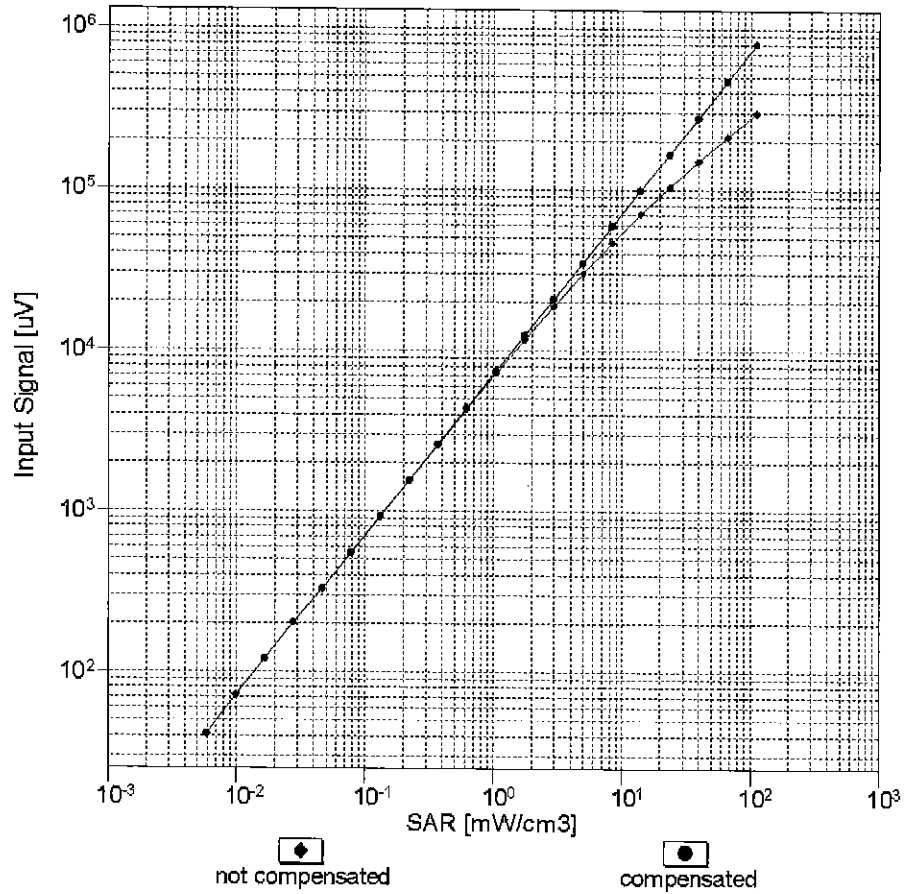

Uncertainty of Linearity Assessment:  $\pm 0.6\%$  (k=2)

# Conversion Factor Assessment

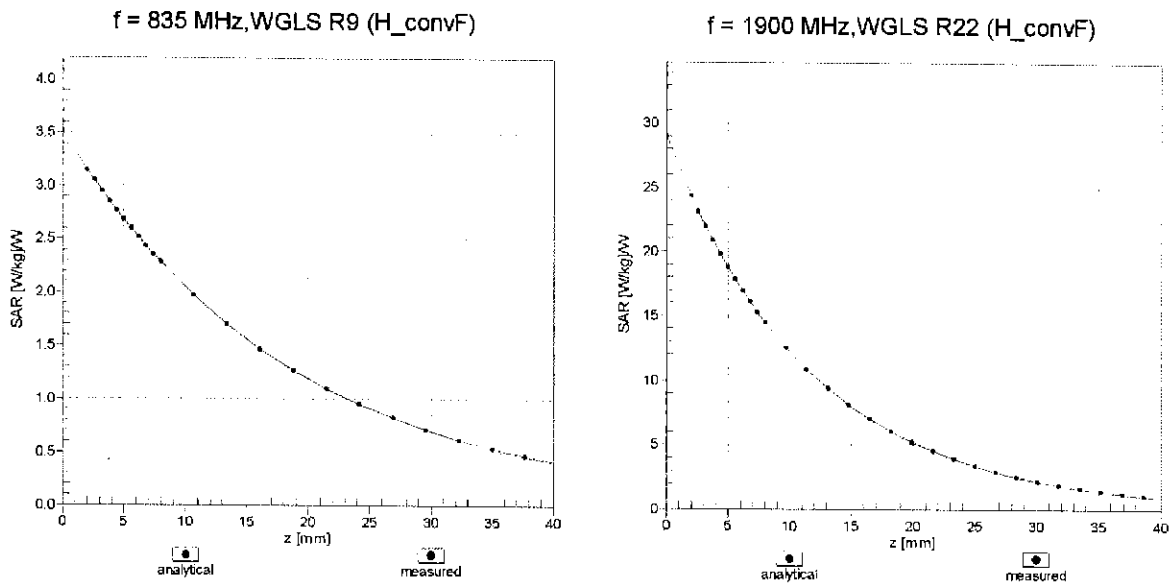

## Deviation from Isotropy in Liquid

Error ( $\phi$ ,  $\theta$ ), f = 900 MHz

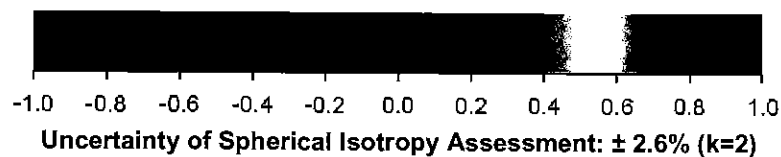
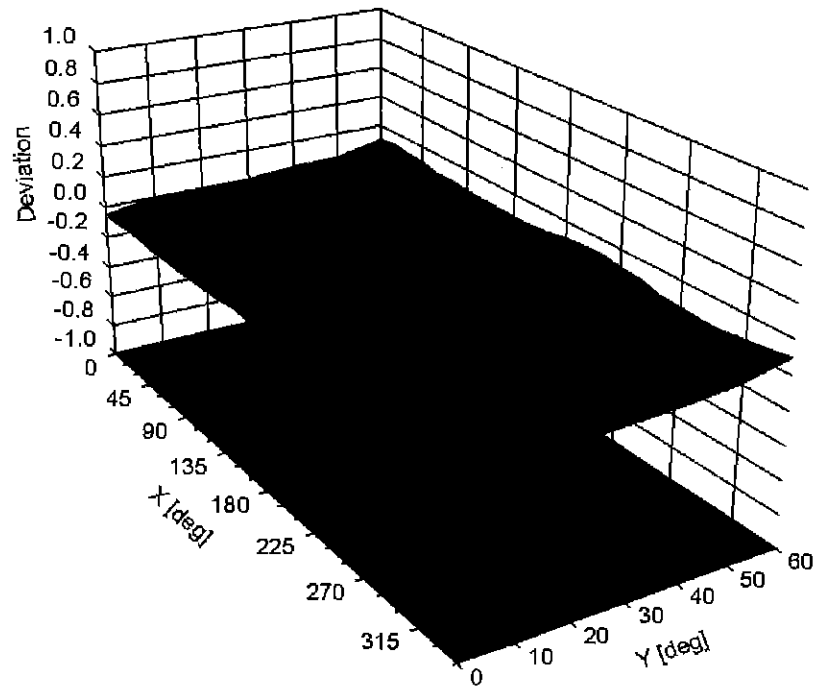

**DASY/EASY - Parameters of Probe: ES3DV3 - SN:3318****Other Probe Parameters**

|   |            |
|---|------------|
| Sensor Arrangement                            | Triangular |
| Connector Angle (°)                           | 80.2       |
| Mechanical Surface Detection Mode             | enabled    |
| Optical Surface Detection Mode                | disabled   |
| Probe Overall Length                          | 337 mm     |
| Probe Body Diameter                           | 10 mm      |
| Tip Length                                    | 10 mm      |
| Tip Diameter                                  | 4 mm       |
| Probe Tip to Sensor X Calibration Point       | 2 mm       |
| Probe Tip to Sensor Y Calibration Point       | 2 mm       |
| Probe Tip to Sensor Z Calibration Point       | 2 mm       |
| Recommended Measurement Distance from Surface | 3 mm       |



**Appendix: Modulation Calibration Parameters**

| UID           | Communication System Name                     |   | A<br>dB | B<br>dB/μV | C     | D<br>dB | VR<br>mV | Max<br>Unc <sup>E</sup><br>(k=2) |
|---------------|---|---|---------|------------|-------|---------|----------|----------------------------------|
| 0             | CW  | X | 0.00    | 0.00       | 1.00  | 0.00    | 183.4    | ± 3.5 %                          |
|               |   | Y | 0.00    | 0.00       | 1.00  |         | 193.5    |                                  |
|               |   | Z | 0.00    | 0.00       | 1.00  |         | 183.0    |                                  |
| 10010-<br>CAA | SAR Validation (Square, 100ms, 10ms)          | X | 100.00  | 113.13     | 27.11 | 10.00   | 25.0     | ± 9.6 %                          |
|               |   | Y | 56.27   | 106.32     | 26.04 |         | 25.0     |                                  |
|               |   | Z | 48.42   | 102.92     | 24.36 |         | 25.0     |                                  |
| 10011-<br>CAB | UMTS-FDD (WCDMA)                              | X | 2.66    | 86.53      | 24.90 | 0.00    | 150.0    | ± 9.6 %                          |
|               |   | Y | 1.68    | 77.14      | 20.67 |         | 150.0    |                                  |
|               |   | Z | 1.29    | 72.20      | 18.01 |         | 150.0    |                                  |
| 10012-<br>CAB | IEEE 802.11b WiFi 2.4 GHz (DSSS, 1 Mbps)      | X | 1.46    | 68.78      | 18.94 | 0.41    | 150.0    | ± 9.6 %                          |
|               |   | Y | 1.42    | 67.66      | 17.93 |         | 150.0    |                                  |
|               |   | Z | 1.34    | 66.38      | 16.88 |         | 150.0    |                                  |
| 10013-<br>CAB | IEEE 802.11g WiFi 2.4 GHz (DSSS-OFDM, 6 Mbps) | X | 5.02    | 68.02      | 18.09 | 1.46    | 150.0    | ± 9.6 %                          |
|               |   | Y | 5.02    | 67.88      | 17.89 |         | 150.0    |                                  |
|               |   | Z | 4.94    | 67.70      | 17.67 |         | 150.0    |                                  |
| 10021-<br>DAC | GSM-FDD (TDMA, GMSK)                          | X | 100.00  | 121.76     | 31.97 | 9.39    | 50.0     | ± 9.6 %                          |
|               |   | Y | 100.00  | 121.57     | 32.33 |         | 50.0     |                                  |
|               |   | Z | 100.00  | 120.24     | 31.25 |         | 50.0     |                                  |
| 10023-<br>DAC | GPRS-FDD (TDMA, GMSK, TN 0)                   | X | 100.00  | 121.43     | 31.86 | 9.57    | 50.0     | ± 9.6 %                          |
|               |   | Y | 100.00  | 121.34     | 32.26 |         | 50.0     |                                  |
|               |   | Z | 100.00  | 119.95     | 31.15 |         | 50.0     |                                  |
| 10024-<br>DAC | GPRS-FDD (TDMA, GMSK, TN 0-1)                 | X | 100.00  | 120.99     | 30.63 | 6.56    | 60.0     | ± 9.6 %                          |
|               |   | Y | 100.00  | 119.61     | 30.34 |         | 60.0     |                                  |
|               |   | Z | 100.00  | 118.45     | 29.44 |         | 60.0     |                                  |
| 10025-<br>DAC | EDGE-FDD (TDMA, 8PSK, TN 0)                   | X | 27.34   | 129.78     | 51.29 | 12.57   | 50.0     | ± 9.6 %                          |
|               |   | Y | 16.72   | 108.51     | 42.49 |         | 50.0     |                                  |
|               |   | Z | 41.36   | 141.52     | 54.29 |         | 50.0     |                                  |
| 10026-<br>DAC | EDGE-FDD (TDMA, 8PSK, TN 0-1)                 | X | 51.11   | 136.85     | 47.83 | 9.56    | 60.0     | ± 9.6 %                          |
|               |   | Y | 25.23   | 114.58     | 40.30 |         | 60.0     |                                  |
|               |   | Z | 34.77   | 125.06     | 43.92 |         | 60.0     |                                  |
| 10027-<br>DAC | GPRS-FDD (TDMA, GMSK, TN 0-1-2)               | X | 100.00  | 123.21     | 30.86 | 4.80    | 80.0     | ± 9.6 %                          |
|               |   | Y | 100.00  | 120.40     | 29.90 |         | 80.0     |                                  |
|               |   | Z | 100.00  | 119.24     | 29.05 |         | 80.0     |                                  |
| 10028-<br>DAC | GPRS-FDD (TDMA, GMSK, TN 0-1-2-3)             | X | 100.00  | 127.88     | 32.20 | 3.55    | 100.0    | ± 9.6 %                          |
|               |   | Y | 100.00  | 123.11     | 30.36 |         | 100.0    |                                  |
|               |   | Z | 100.00  | 121.73     | 29.45 |         | 100.0    |                                  |
| 10029-<br>DAC | EDGE-FDD (TDMA, 8PSK, TN 0-1-2)               | X | 16.47   | 106.41     | 37.26 | 7.80    | 80.0     | ± 9.6 %                          |
|               |   | Y | 13.16   | 98.31      | 33.75 |         | 80.0     |                                  |
|               |   | Z | 13.79   | 100.84     | 34.87 |         | 80.0     |                                  |
| 10030-<br>CAA | IEEE 802.15.1 Bluetooth (GFSK, DH1)           | X | 100.00  | 120.38     | 29.87 | 5.30    | 70.0     | ± 9.6 %                          |
|               |   | Y | 100.00  | 118.42     | 29.28 |         | 70.0     |                                  |
|               |   | Z | 100.00  | 117.17     | 28.39 |         | 70.0     |                                  |
| 10031-<br>CAA | IEEE 802.15.1 Bluetooth (GFSK, DH3)           | X | 100.00  | 140.58     | 36.01 | 1.88    | 100.0    | ± 9.6 %                          |
|               |   | Y | 100.00  | 129.80     | 31.70 |         | 100.0    |                                  |
|               |   | Z | 100.00  | 126.35     | 29.95 |         | 100.0    |                                  |

|           |   |   |        |        |       |       |       |         |
|-----------|---|---|--------|--------|-------|-------|-------|---------|
| 10032-CAA | IEEE 802.15.1 Bluetooth (GFSK, DH5)                 | X | 100.00 | 168.14 | 46.04 | 1.17  | 100.0 | ± 9.6 % |
|           |   | Y | 100.00 | 146.16 | 37.32 |       | 100.0 |         |
|           |   | Z | 100.00 | 139.03 | 34.08 |       | 100.0 |         |
| 10033-CAA | IEEE 802.15.1 Bluetooth (PI/4-DQPSK, DH1)           | X | 100.00 | 128.00 | 34.78 | 5.30  | 70.0  | ± 9.6 % |
|           |   | Y | 100.00 | 125.47 | 33.78 |       | 70.0  |         |
|           |   | Z | 100.00 | 124.94 | 33.27 |       | 70.0  |         |
| 10034-CAA | IEEE 802.15.1 Bluetooth (PI/4-DQPSK, DH3)           | X | 100.00 | 127.76 | 32.85 | 1.88  | 100.0 | ± 9.6 % |
|           |   | Y | 100.00 | 124.38 | 31.40 |       | 100.0 |         |
|           |   | Z | 100.00 | 122.39 | 30.30 |       | 100.0 |         |
| 10035-CAA | IEEE 802.15.1 Bluetooth (PI/4-DQPSK, DH5)           | X | 100.00 | 129.00 | 32.88 | 1.17  | 100.0 | ± 9.6 % |
|           |   | Y | 100.00 | 125.22 | 31.24 |       | 100.0 |         |
|           |   | Z | 42.89  | 111.69 | 27.45 |       | 100.0 |         |
| 10036-CAA | IEEE 802.15.1 Bluetooth (8-DPSK, DH1)               | X | 100.00 | 128.35 | 34.94 | 5.30  | 70.0  | ± 9.6 % |
|           |   | Y | 100.00 | 125.78 | 33.93 |       | 70.0  |         |
|           |   | Z | 100.00 | 125.27 | 33.42 |       | 70.0  |         |
| 10037-CAA | IEEE 802.15.1 Bluetooth (8-DPSK, DH3)               | X | 100.00 | 127.83 | 32.85 | 1.88  | 100.0 | ± 9.6 % |
|           |   | Y | 100.00 | 124.40 | 31.38 |       | 100.0 |         |
|           |   | Z | 100.00 | 122.41 | 30.28 |       | 100.0 |         |
| 10038-CAA | IEEE 802.15.1 Bluetooth (8-DPSK, DH5)               | X | 100.00 | 129.90 | 33.29 | 1.17  | 100.0 | ± 9.6 % |
|           |   | Y | 100.00 | 126.04 | 31.61 |       | 100.0 |         |
|           |   | Z | 46.73  | 113.50 | 28.05 |       | 100.0 |         |
| 10039-CAB | CDMA2000 (1xRTT, RC1)                               | X | 100.00 | 131.54 | 33.19 | 0.00  | 150.0 | ± 9.6 % |
|           |   | Y | 52.05  | 119.24 | 29.67 |       | 150.0 |         |
|           |   | Z | 3.76   | 82.84  | 19.15 |       | 150.0 |         |
| 10042-CAB | IS-54 / IS-136 FDD (TDMA/FDM, PI/4-DQPSK, Halfrate) | X | 100.00 | 118.03 | 29.44 | 7.78  | 50.0  | ± 9.6 % |
|           |   | Y | 100.00 | 117.44 | 29.54 |       | 50.0  |         |
|           |   | Z | 100.00 | 116.07 | 28.52 |       | 50.0  |         |
| 10044-CAA | IS-91/EIA/TIA-553 FDD (FDMA, FM)                    | X | 0.01   | 105.46 | 9.85  | 0.00  | 150.0 | ± 9.6 % |
|           |   | Y | 0.03   | 60.00  | 39.49 |       | 150.0 |         |
|           |   | Z | 0.02   | 60.00  | 28.89 |       | 150.0 |         |
| 10048-CAA | DECT (TDD, TDMA/FDM, GFSK, Full Slot, 24)           | X | 100.00 | 123.25 | 33.96 | 13.80 | 25.0  | ± 9.6 % |
|           |   | Y | 100.00 | 123.00 | 34.45 |       | 25.0  |         |
|           |   | Z | 100.00 | 122.08 | 33.38 |       | 25.0  |         |
| 10049-CAA | DECT (TDD, TDMA/FDM, GFSK, Double Slot, 12)         | X | 100.00 | 121.02 | 31.95 | 10.79 | 40.0  | ± 9.6 % |
|           |   | Y | 100.00 | 121.43 | 32.63 |       | 40.0  |         |
|           |   | Z | 100.00 | 119.80 | 31.36 |       | 40.0  |         |
| 10056-CAA | UMTS-TDD (TD-SCDMA, 1.28 Mcps)                      | X | 100.00 | 126.02 | 35.11 | 9.03  | 50.0  | ± 9.6 % |
|           |   | Y | 69.75  | 118.57 | 33.24 |       | 50.0  |         |
|           |   | Z | 100.00 | 124.37 | 34.25 |       | 50.0  |         |
| 10058-DAC | EDGE-FDD (TDMA, 8PSK, TN 0-1-2-3)                   | X | 9.73   | 93.83  | 32.07 | 6.55  | 100.0 | ± 9.6 % |
|           |   | Y | 8.94   | 89.89  | 29.98 |       | 100.0 |         |
|           |   | Z | 8.70   | 90.23  | 30.24 |       | 100.0 |         |
| 10059-CAB | IEEE 802.11b WiFi 2.4 GHz (DSSS, 2 Mbps)            | X | 1.70   | 72.06  | 20.55 | 0.61  | 110.0 | ± 9.6 % |
|           |   | Y | 1.64   | 70.58  | 19.34 |       | 110.0 |         |
|           |   | Z | 1.50   | 68.77  | 18.10 |       | 110.0 |         |
| 10060-CAB | IEEE 802.11b WiFi 2.4 GHz (DSSS, 5.5 Mbps)          | X | 100.00 | 148.21 | 40.90 | 1.30  | 110.0 | ± 9.6 % |
|           |   | Y | 100.00 | 141.35 | 37.99 |       | 110.0 |         |
|           |   | Z | 100.00 | 139.41 | 36.95 |       | 110.0 |         |

|           |  |   |        |        |       |      |       |         |
|-----------|--|---|--------|--------|-------|------|-------|---------|
| 10061-CAB | IEEE 802.11b WiFi 2.4 GHz (DSSS, 11 Mbps)      | X | 100.00 | 146.12 | 41.94 | 2.04 | 110.0 | ± 9.6 % |
|           |  | Y | 100.00 | 141.22 | 39.79 |      | 110.0 |         |
|           |  | Z | 39.08  | 124.31 | 35.57 |      | 110.0 |         |
| 10062-CAB | IEEE 802.11a/h WiFi 5 GHz (OFDM, 6 Mbps)       | X | 4.78   | 67.89  | 17.44 | 0.49 | 100.0 | ± 9.6 % |
|           |  | Y | 4.76   | 67.70  | 17.22 |      | 100.0 |         |
|           |  | Z | 4.68   | 67.49  | 16.96 |      | 100.0 |         |
| 10063-CAB | IEEE 802.11a/h WiFi 5 GHz (OFDM, 9 Mbps)       | X | 4.81   | 68.05  | 17.58 | 0.72 | 100.0 | ± 9.6 % |
|           |  | Y | 4.79   | 67.86  | 17.35 |      | 100.0 |         |
|           |  | Z | 4.71   | 67.65  | 17.10 |      | 100.0 |         |
| 10064-CAB | IEEE 802.11a/h WiFi 5 GHz (OFDM, 12 Mbps)      | X | 5.07   | 68.24  | 17.76 | 0.86 | 100.0 | ± 9.6 % |
|           |  | Y | 5.05   | 68.06  | 17.55 |      | 100.0 |         |
|           |  | Z | 4.97   | 67.86  | 17.30 |      | 100.0 |         |
| 10065-CAB | IEEE 802.11a/h WiFi 5 GHz (OFDM, 18 Mbps)      | X | 4.97   | 68.22  | 17.93 | 1.21 | 100.0 | ± 9.6 % |
|           |  | Y | 4.96   | 68.06  | 17.72 |      | 100.0 |         |
|           |  | Z | 4.87   | 67.84  | 17.47 |      | 100.0 |         |
| 10066-CAB | IEEE 802.11a/h WiFi 5 GHz (OFDM, 24 Mbps)      | X | 5.00   | 68.29  | 18.13 | 1.46 | 100.0 | ± 9.6 % |
|           |  | Y | 5.00   | 68.14  | 17.92 |      | 100.0 |         |
|           |  | Z | 4.91   | 67.92  | 17.68 |      | 100.0 |         |
| 10067-CAB | IEEE 802.11a/h WiFi 5 GHz (OFDM, 36 Mbps)      | X | 5.32   | 68.56  | 18.62 | 2.04 | 100.0 | ± 9.6 % |
|           |  | Y | 5.32   | 68.43  | 18.41 |      | 100.0 |         |
|           |  | Z | 5.23   | 68.26  | 18.21 |      | 100.0 |         |
| 10068-CAB | IEEE 802.11a/h WiFi 5 GHz (OFDM, 48 Mbps)      | X | 5.38   | 68.60  | 18.85 | 2.55 | 100.0 | ± 9.6 % |
|           |  | Y | 5.39   | 68.49  | 18.65 |      | 100.0 |         |
|           |  | Z | 5.29   | 68.30  | 18.45 |      | 100.0 |         |
| 10069-CAB | IEEE 802.11a/h WiFi 5 GHz (OFDM, 54 Mbps)      | X | 5.45   | 68.63  | 19.05 | 2.67 | 100.0 | ± 9.6 % |
|           |  | Y | 5.47   | 68.52  | 18.85 |      | 100.0 |         |
|           |  | Z | 5.37   | 68.35  | 18.66 |      | 100.0 |         |
| 10071-CAB | IEEE 802.11g WiFi 2.4 GHz (DSSS/OFDM, 9 Mbps)  | X | 5.14   | 68.16  | 18.43 | 1.99 | 100.0 | ± 9.6 % |
|           |  | Y | 5.15   | 68.05  | 18.24 |      | 100.0 |         |
|           |  | Z | 5.06   | 67.88  | 18.03 |      | 100.0 |         |
| 10072-CAB | IEEE 802.11g WiFi 2.4 GHz (DSSS/OFDM, 12 Mbps) | X | 5.16   | 68.64  | 18.75 | 2.30 | 100.0 | ± 9.6 % |
|           |  | Y | 5.17   | 68.53  | 18.56 |      | 100.0 |         |
|           |  | Z | 5.08   | 68.32  | 18.34 |      | 100.0 |         |
| 10073-CAB | IEEE 802.11g WiFi 2.4 GHz (DSSS/OFDM, 18 Mbps) | X | 5.27   | 68.97  | 19.18 | 2.83 | 100.0 | ± 9.6 % |
|           |  | Y | 5.29   | 68.88  | 18.98 |      | 100.0 |         |
|           |  | Z | 5.19   | 68.68  | 18.77 |      | 100.0 |         |
| 10074-CAB | IEEE 802.11g WiFi 2.4 GHz (DSSS/OFDM, 24 Mbps) | X | 5.29   | 68.99  | 19.39 | 3.30 | 100.0 | ± 9.6 % |
|           |  | Y | 5.33   | 68.94  | 19.20 |      | 100.0 |         |
|           |  | Z | 5.23   | 68.74  | 19.00 |      | 100.0 |         |
| 10075-CAB | IEEE 802.11g WiFi 2.4 GHz (DSSS/OFDM, 36 Mbps) | X | 5.36   | 69.20  | 19.76 | 3.82 | 90.0  | ± 9.6 % |
|           |  | Y | 5.42   | 69.18  | 19.58 |      | 90.0  |         |
|           |  | Z | 5.30   | 68.95  | 19.38 |      | 90.0  |         |
| 10076-CAB | IEEE 802.11g WiFi 2.4 GHz (DSSS/OFDM, 48 Mbps) | X | 5.40   | 69.06  | 19.93 | 4.15 | 90.0  | ± 9.6 % |
|           |  | Y | 5.47   | 69.07  | 19.76 |      | 90.0  |         |
|           |  | Z | 5.35   | 68.86  | 19.58 |      | 90.0  |         |
| 10077-CAB | IEEE 802.11g WiFi 2.4 GHz (DSSS/OFDM, 54 Mbps) | X | 5.44   | 69.18  | 20.05 | 4.30 | 90.0  | ± 9.6 % |
|           |  | Y | 5.51   | 69.19  | 19.88 |      | 90.0  |         |
|           |  | Z | 5.40   | 68.99  | 19.71 |      | 90.0  |         |

|           |   |   |        |        |       |      |       |         |
|-----------|---|---|--------|--------|-------|------|-------|---------|
| 10081-CAB | CDMA2000 (1xRTT, RC3)                               | X | 100.00 | 135.94 | 34.03 | 0.00 | 150.0 | ± 9.6 % |
|           |   | Y | 4.36   | 89.76  | 21.79 |      | 150.0 |         |
|           |   | Z | 1.23   | 72.30  | 14.98 |      | 150.0 |         |
| 10082-CAB | IS-54 / IS-136 FDD (TDMA/FDM, PI/4-DQPSK, Fullrate) | X | 1.46   | 62.74  | 7.36  | 4.77 | 80.0  | ± 9.6 % |
|           |   | Y | 1.67   | 63.13  | 7.83  |      | 80.0  |         |
|           |   | Z | 1.40   | 62.09  | 6.92  |      | 80.0  |         |
| 10090-DAC | GPRS-FDD (TDMA, GMSK, TN 0-4)                       | X | 100.00 | 121.01 | 30.66 | 6.56 | 60.0  | ± 9.6 % |
|           |   | Y | 100.00 | 119.66 | 30.39 |      | 60.0  |         |
|           |   | Z | 100.00 | 118.49 | 29.48 |      | 60.0  |         |
| 10097-CAB | UMTS-FDD (HSDPA)                                    | X | 2.68   | 75.81  | 20.12 | 0.00 | 150.0 | ± 9.6 % |
|           |   | Y | 2.34   | 73.02  | 18.58 |      | 150.0 |         |
|           |   | Z | 2.07   | 70.78  | 17.18 |      | 150.0 |         |
| 10098-CAB | UMTS-FDD (HSUPA, Subtest 2)                         | X | 2.65   | 75.95  | 20.19 | 0.00 | 150.0 | ± 9.6 % |
|           |   | Y | 2.30   | 73.06  | 18.61 |      | 150.0 |         |
|           |   | Z | 2.03   | 70.77  | 17.19 |      | 150.0 |         |
| 10099-DAC | EDGE-FDD (TDMA, 8PSK, TN 0-4)                       | X | 51.37  | 136.92 | 47.83 | 9.56 | 60.0  | ± 9.6 % |
|           |   | Y | 25.26  | 114.55 | 40.28 |      | 60.0  |         |
|           |   | Z | 34.93  | 125.12 | 43.92 |      | 60.0  |         |
| 10100-CAD | LTE-FDD (SC-FDMA, 100% RB, 20 MHz, QPSK)            | X | 3.91   | 75.35  | 19.66 | 0.00 | 150.0 | ± 9.6 % |
|           |   | Y | 3.58   | 73.57  | 18.67 |      | 150.0 |         |
|           |   | Z | 3.29   | 72.01  | 17.75 |      | 150.0 |         |
| 10101-CAD | LTE-FDD (SC-FDMA, 100% RB, 20 MHz, 16-QAM)          | X | 3.50   | 69.80  | 17.58 | 0.00 | 150.0 | ± 9.6 % |
|           |   | Y | 3.39   | 69.08  | 17.05 |      | 150.0 |         |
|           |   | Z | 3.27   | 68.42  | 16.53 |      | 150.0 |         |
| 10102-CAD | LTE-FDD (SC-FDMA, 100% RB, 20 MHz, 64-QAM)          | X | 3.58   | 69.60  | 17.56 | 0.00 | 150.0 | ± 9.6 % |
|           |   | Y | 3.49   | 68.97  | 17.09 |      | 150.0 |         |
|           |   | Z | 3.37   | 68.35  | 16.58 |      | 150.0 |         |
| 10103-CAD | LTE-TDD (SC-FDMA, 100% RB, 20 MHz, QPSK)            | X | 10.46  | 84.85  | 24.49 | 3.98 | 65.0  | ± 9.6 % |
|           |   | Y | 9.76   | 82.69  | 23.44 |      | 65.0  |         |
|           |   | Z | 9.49   | 82.61  | 23.35 |      | 65.0  |         |
| 10104-CAD | LTE-TDD (SC-FDMA, 100% RB, 20 MHz, 16-QAM)          | X | 8.62   | 79.80  | 23.37 | 3.98 | 65.0  | ± 9.6 % |
|           |   | Y | 8.54   | 78.80  | 22.69 |      | 65.0  |         |
|           |   | Z | 8.26   | 78.63  | 22.58 |      | 65.0  |         |
| 10105-CAD | LTE-TDD (SC-FDMA, 100% RB, 20 MHz, 64-QAM)          | X | 8.48   | 79.41  | 23.51 | 3.98 | 65.0  | ± 9.6 % |
|           |   | Y | 7.84   | 77.04  | 22.24 |      | 65.0  |         |
|           |   | Z | 7.95   | 77.81  | 22.54 |      | 65.0  |         |
| 10108-CAE | LTE-FDD (SC-FDMA, 100% RB, 10 MHz, QPSK)            | X | 3.42   | 74.91  | 19.71 | 0.00 | 150.0 | ± 9.6 % |
|           |   | Y | 3.13   | 73.04  | 18.65 |      | 150.0 |         |
|           |   | Z | 2.86   | 71.41  | 17.66 |      | 150.0 |         |
| 10109-CAE | LTE-FDD (SC-FDMA, 100% RB, 10 MHz, 16-QAM)          | X | 3.19   | 70.21  | 17.75 | 0.00 | 150.0 | ± 9.6 % |
|           |   | Y | 3.07   | 69.34  | 17.14 |      | 150.0 |         |
|           |   | Z | 2.93   | 68.52  | 16.50 |      | 150.0 |         |
| 10110-CAE | LTE-FDD (SC-FDMA, 100% RB, 5 MHz, QPSK)             | X | 2.94   | 75.32  | 19.95 | 0.00 | 150.0 | ± 9.6 % |
|           |   | Y | 2.62   | 72.92  | 18.60 |      | 150.0 |         |
|           |   | Z | 2.34   | 70.98  | 17.41 |      | 150.0 |         |
| 10111-CAE | LTE-FDD (SC-FDMA, 100% RB, 5 MHz, 16-QAM)           | X | 3.13   | 72.86  | 18.80 | 0.00 | 150.0 | ± 9.6 % |
|           |   | Y | 2.95   | 71.56  | 17.99 |      | 150.0 |         |
|           |   | Z | 2.72   | 70.10  | 16.99 |      | 150.0 |         |

|           |  |   |        |        |       |      |       |         |
|-----------|--|---|--------|--------|-------|------|-------|---------|
| 10112-CAE | LTE-FDD (SC-FDMA, 100% RB, 10 MHz, 64-QAM)     | X | 3.29   | 70.03  | 17.69 | 0.00 | 150.0 | ± 9.6 % |
|           |  | Y | 3.18   | 69.26  | 17.13 |      | 150.0 |         |
|           |  | Z | 3.05   | 68.50  | 16.53 |      | 150.0 |         |
| 10113-CAE | LTE-FDD (SC-FDMA, 100% RB, 5 MHz, 64-QAM)      | X | 3.26   | 72.71  | 18.75 | 0.00 | 150.0 | ± 9.6 % |
|           |  | Y | 3.09   | 71.55  | 18.02 |      | 150.0 |         |
|           |  | Z | 2.86   | 70.17  | 17.07 |      | 150.0 |         |
| 10114-CAB | IEEE 802.11n (HT Greenfield, 13.5 Mbps, BPSK)  | X | 5.20   | 68.15  | 17.23 | 0.00 | 150.0 | ± 9.6 % |
|           |  | Y | 5.17   | 67.92  | 17.01 |      | 150.0 |         |
|           |  | Z | 5.08   | 67.68  | 16.75 |      | 150.0 |         |
| 10115-CAB | IEEE 802.11n (HT Greenfield, 81 Mbps, 16-QAM)  | X | 5.45   | 68.16  | 17.22 | 0.00 | 150.0 | ± 9.6 % |
|           |  | Y | 5.42   | 67.95  | 17.02 |      | 150.0 |         |
|           |  | Z | 5.33   | 67.74  | 16.77 |      | 150.0 |         |
| 10116-CAB | IEEE 802.11n (HT Greenfield, 135 Mbps, 64-QAM) | X | 5.30   | 68.36  | 17.26 | 0.00 | 150.0 | ± 9.6 % |
|           |  | Y | 5.26   | 68.13  | 17.04 |      | 150.0 |         |
|           |  | Z | 5.17   | 67.89  | 16.78 |      | 150.0 |         |
| 10117-CAB | IEEE 802.11n (HT Mixed, 13.5 Mbps, BPSK)       | X | 5.18   | 68.04  | 17.19 | 0.00 | 150.0 | ± 9.6 % |
|           |  | Y | 5.14   | 67.83  | 16.98 |      | 150.0 |         |
|           |  | Z | 5.07   | 67.63  | 16.74 |      | 150.0 |         |
| 10118-CAB | IEEE 802.11n (HT Mixed, 81 Mbps, 16-QAM)       | X | 5.54   | 68.41  | 17.35 | 0.00 | 150.0 | ± 9.6 % |
|           |  | Y | 5.51   | 68.19  | 17.14 |      | 150.0 |         |
|           |  | Z | 5.41   | 67.95  | 16.89 |      | 150.0 |         |
| 10119-CAB | IEEE 802.11n (HT Mixed, 135 Mbps, 64-QAM)      | X | 5.29   | 68.34  | 17.26 | 0.00 | 150.0 | ± 9.6 % |
|           |  | Y | 5.25   | 68.12  | 17.04 |      | 150.0 |         |
|           |  | Z | 5.16   | 67.88  | 16.78 |      | 150.0 |         |
| 10140-CAD | LTE-FDD (SC-FDMA, 100% RB, 15 MHz, 16-QAM)     | X | 3.61   | 69.64  | 17.49 | 0.00 | 150.0 | ± 9.6 % |
|           |  | Y | 3.52   | 68.99  | 17.00 |      | 150.0 |         |
|           |  | Z | 3.39   | 68.38  | 16.51 |      | 150.0 |         |
| 10141-CAD | LTE-FDD (SC-FDMA, 100% RB, 15 MHz, 64-QAM)     | X | 3.73   | 69.64  | 17.59 | 0.00 | 150.0 | ± 9.6 % |
|           |  | Y | 3.64   | 69.06  | 17.15 |      | 150.0 |         |
|           |  | Z | 3.51   | 68.48  | 16.66 |      | 150.0 |         |
| 10142-CAD | LTE-FDD (SC-FDMA, 100% RB, 3 MHz, QPSK)        | X | 3.10   | 78.13  | 20.64 | 0.00 | 150.0 | ± 9.6 % |
|           |  | Y | 2.57   | 74.51  | 18.81 |      | 150.0 |         |
|           |  | Z | 2.18   | 71.67  | 17.19 |      | 150.0 |         |
| 10143-CAD | LTE-FDD (SC-FDMA, 100% RB, 3 MHz, 16-QAM)      | X | 3.55   | 76.59  | 19.53 | 0.00 | 150.0 | ± 9.6 % |
|           |  | Y | 3.13   | 74.18  | 18.27 |      | 150.0 |         |
|           |  | Z | 2.68   | 71.54  | 16.74 |      | 150.0 |         |
| 10144-CAD | LTE-FDD (SC-FDMA, 100% RB, 3 MHz, 64-QAM)      | X | 2.79   | 71.64  | 16.81 | 0.00 | 150.0 | ± 9.6 % |
|           |  | Y | 2.50   | 69.67  | 15.66 |      | 150.0 |         |
|           |  | Z | 2.26   | 68.10  | 14.57 |      | 150.0 |         |
| 10145-CAE | LTE-FDD (SC-FDMA, 100% RB, 1.4 MHz, QPSK)      | X | 3.29   | 79.35  | 17.65 | 0.00 | 150.0 | ± 9.6 % |
|           |  | Y | 1.58   | 69.65  | 13.52 |      | 150.0 |         |
|           |  | Z | 1.10   | 65.19  | 10.91 |      | 150.0 |         |
| 10146-CAE | LTE-FDD (SC-FDMA, 100% RB, 1.4 MHz, 16-QAM)    | X | 10.51  | 86.51  | 18.78 | 0.00 | 150.0 | ± 9.6 % |
|           |  | Y | 2.34   | 69.06  | 12.29 |      | 150.0 |         |
|           |  | Z | 1.46   | 64.05  | 9.40  |      | 150.0 |         |
| 10147-CAE | LTE-FDD (SC-FDMA, 100% RB, 1.4 MHz, 64-QAM)    | X | 100.00 | 112.53 | 25.58 | 0.00 | 150.0 | ± 9.6 % |
|           |  | Y | 3.94   | 74.93  | 14.77 |      | 150.0 |         |
|           |  | Z | 1.65   | 65.37  | 10.17 |      | 150.0 |         |

|           |  |   |       |       |       |      |       |         |
|-----------|--|---|-------|-------|-------|------|-------|---------|
| 10149-CAD | LTE-FDD (SC-FDMA, 50% RB, 20 MHz, 16-QAM)  | X | 3.20  | 70.28 | 17.80 | 0.00 | 150.0 | ± 9.6 % |
|           |  | Y | 3.08  | 69.42 | 17.19 |      | 150.0 |         |
|           |  | Z | 2.94  | 68.59 | 16.55 |      | 150.0 |         |
| 10150-CAD | LTE-FDD (SC-FDMA, 50% RB, 20 MHz, 64-QAM)  | X | 3.30  | 70.10 | 17.74 | 0.00 | 150.0 | ± 9.6 % |
|           |  | Y | 3.19  | 69.33 | 17.18 |      | 150.0 |         |
|           |  | Z | 3.06  | 68.56 | 16.57 |      | 150.0 |         |
| 10151-CAD | LTE-TDD (SC-FDMA, 50% RB, 20 MHz, QPSK)    | X | 12.94 | 90.52 | 26.60 | 3.98 | 65.0  | ± 9.6 % |
|           |  | Y | 11.63 | 87.44 | 25.23 |      | 65.0  |         |
|           |  | Z | 11.21 | 87.22 | 25.07 |      | 65.0  |         |
| 10152-CAD | LTE-TDD (SC-FDMA, 50% RB, 20 MHz, 16-QAM)  | X | 8.51  | 80.82 | 23.41 | 3.98 | 65.0  | ± 9.6 % |
|           |  | Y | 8.31  | 79.48 | 22.59 |      | 65.0  |         |
|           |  | Z | 8.01  | 79.28 | 22.44 |      | 65.0  |         |
| 10153-CAD | LTE-TDD (SC-FDMA, 50% RB, 20 MHz, 64-QAM)  | X | 9.02  | 81.90 | 24.19 | 3.98 | 65.0  | ± 9.6 % |
|           |  | Y | 8.86  | 80.67 | 23.43 |      | 65.0  |         |
|           |  | Z | 8.54  | 80.43 | 23.26 |      | 65.0  |         |
| 10154-CAE | LTE-FDD (SC-FDMA, 50% RB, 10 MHz, QPSK)    | X | 3.03  | 75.93 | 20.26 | 0.00 | 150.0 | ± 9.6 % |
|           |  | Y | 2.70  | 73.52 | 18.93 |      | 150.0 |         |
|           |  | Z | 2.40  | 71.40 | 17.66 |      | 150.0 |         |
| 10155-CAE | LTE-FDD (SC-FDMA, 50% RB, 10 MHz, 16-QAM)  | X | 3.14  | 72.90 | 18.83 | 0.00 | 150.0 | ± 9.6 % |
|           |  | Y | 2.95  | 71.60 | 18.01 |      | 150.0 |         |
|           |  | Z | 2.72  | 70.14 | 17.02 |      | 150.0 |         |
| 10156-CAE | LTE-FDD (SC-FDMA, 50% RB, 5 MHz, QPSK)     | X | 3.42  | 81.12 | 21.46 | 0.00 | 150.0 | ± 9.6 % |
|           |  | Y | 2.60  | 76.04 | 19.11 |      | 150.0 |         |
|           |  | Z | 2.06  | 72.15 | 17.02 |      | 150.0 |         |
| 10157-CAE | LTE-FDD (SC-FDMA, 50% RB, 5 MHz, 16-QAM)   | X | 3.03  | 74.63 | 17.79 | 0.00 | 150.0 | ± 9.6 % |
|           |  | Y | 2.53  | 71.54 | 16.20 |      | 150.0 |         |
|           |  | Z | 2.15  | 69.02 | 14.66 |      | 150.0 |         |
| 10158-CAE | LTE-FDD (SC-FDMA, 50% RB, 10 MHz, 64-QAM)  | X | 3.27  | 72.81 | 18.82 | 0.00 | 150.0 | ± 9.6 % |
|           |  | Y | 3.10  | 71.66 | 18.08 |      | 150.0 |         |
|           |  | Z | 2.87  | 70.26 | 17.13 |      | 150.0 |         |
| 10159-CAE | LTE-FDD (SC-FDMA, 50% RB, 5 MHz, 64-QAM)   | X | 3.21  | 75.21 | 18.07 | 0.00 | 150.0 | ± 9.6 % |
|           |  | Y | 2.69  | 72.18 | 16.53 |      | 150.0 |         |
|           |  | Z | 2.25  | 69.45 | 14.90 |      | 150.0 |         |
| 10160-CAD | LTE-FDD (SC-FDMA, 50% RB, 15 MHz, QPSK)    | X | 3.31  | 73.32 | 19.12 | 0.00 | 150.0 | ± 9.6 % |
|           |  | Y | 3.09  | 71.84 | 18.22 |      | 150.0 |         |
|           |  | Z | 2.86  | 70.49 | 17.35 |      | 150.0 |         |
| 10161-CAD | LTE-FDD (SC-FDMA, 50% RB, 15 MHz, 16-QAM)  | X | 3.21  | 70.26 | 17.75 | 0.00 | 150.0 | ± 9.6 % |
|           |  | Y | 3.10  | 69.43 | 17.16 |      | 150.0 |         |
|           |  | Z | 2.95  | 68.59 | 16.50 |      | 150.0 |         |
| 10162-CAD | LTE-FDD (SC-FDMA, 50% RB, 15 MHz, 64-QAM)  | X | 3.33  | 70.39 | 17.83 | 0.00 | 150.0 | ± 9.6 % |
|           |  | Y | 3.21  | 69.59 | 17.26 |      | 150.0 |         |
|           |  | Z | 3.06  | 68.78 | 16.62 |      | 150.0 |         |
| 10166-CAE | LTE-FDD (SC-FDMA, 50% RB, 1.4 MHz, QPSK)   | X | 3.94  | 73.38 | 21.77 | 3.01 | 150.0 | ± 9.6 % |
|           |  | Y | 3.79  | 72.11 | 20.84 |      | 150.0 |         |
|           |  | Z | 3.50  | 70.74 | 19.96 |      | 150.0 |         |
| 10167-CAE | LTE-FDD (SC-FDMA, 50% RB, 1.4 MHz, 16-QAM) | X | 5.65  | 79.78 | 23.51 | 3.01 | 150.0 | ± 9.6 % |
|           |  | Y | 5.10  | 77.08 | 22.03 |      | 150.0 |         |
|           |  | Z | 4.43  | 74.72 | 20.82 |      | 150.0 |         |

|           |  |   |        |        |       |      |       |         |
|-----------|--|---|--------|--------|-------|------|-------|---------|
| 10168-CAE | LTE-FDD (SC-FDMA, 50% RB, 1.4 MHz, 64-QAM) | X | 6.73   | 83.76  | 25.44 | 3.01 | 150.0 | ± 9.6 % |
|           |  | Y | 6.02   | 80.78  | 23.93 |      | 150.0 |         |
|           |  | Z | 5.04   | 77.58  | 22.39 |      | 150.0 |         |
| 10169-CAD | LTE-FDD (SC-FDMA, 1 RB, 20 MHz, QPSK)      | X | 3.37   | 73.36  | 21.96 | 3.01 | 150.0 | ± 9.6 % |
|           |  | Y | 3.23   | 71.75  | 20.78 |      | 150.0 |         |
|           |  | Z | 2.89   | 69.73  | 19.58 |      | 150.0 |         |
| 10170-CAD | LTE-FDD (SC-FDMA, 1 RB, 20 MHz, 16-QAM)    | X | 6.39   | 86.84  | 27.07 | 3.01 | 150.0 | ± 9.6 % |
|           |  | Y | 5.38   | 82.06  | 24.76 |      | 150.0 |         |
|           |  | Z | 4.13   | 77.19  | 22.57 |      | 150.0 |         |
| 10171-AAD | LTE-FDD (SC-FDMA, 1 RB, 20 MHz, 64-QAM)    | X | 4.69   | 79.68  | 23.25 | 3.01 | 150.0 | ± 9.6 % |
|           |  | Y | 4.06   | 75.75  | 21.17 |      | 150.0 |         |
|           |  | Z | 3.35   | 72.68  | 19.64 |      | 150.0 |         |
| 10172-CAD | LTE-TDD (SC-FDMA, 1 RB, 20 MHz, QPSK)      | X | 100.00 | 146.59 | 45.53 | 6.02 | 65.0  | ± 9.6 % |
|           |  | Y | 40.14  | 123.32 | 38.78 |      | 65.0  |         |
|           |  | Z | 46.23  | 127.51 | 39.93 |      | 65.0  |         |
| 10173-CAD | LTE-TDD (SC-FDMA, 1 RB, 20 MHz, 16-QAM)    | X | 100.00 | 136.26 | 40.09 | 6.02 | 65.0  | ± 9.6 % |
|           |  | Y | 100.00 | 132.71 | 38.54 |      | 65.0  |         |
|           |  | Z | 100.00 | 133.96 | 38.85 |      | 65.0  |         |
| 10174-CAD | LTE-TDD (SC-FDMA, 1 RB, 20 MHz, 64-QAM)    | X | 100.00 | 133.98 | 38.85 | 6.02 | 65.0  | ± 9.6 % |
|           |  | Y | 100.00 | 130.96 | 37.56 |      | 65.0  |         |
|           |  | Z | 100.00 | 131.78 | 37.67 |      | 65.0  |         |
| 10175-CAE | LTE-FDD (SC-FDMA, 1 RB, 10 MHz, QPSK)      | X | 3.32   | 73.00  | 21.69 | 3.01 | 150.0 | ± 9.6 % |
|           |  | Y | 3.19   | 71.38  | 20.50 |      | 150.0 |         |
|           |  | Z | 2.86   | 69.46  | 19.35 |      | 150.0 |         |
| 10176-CAE | LTE-FDD (SC-FDMA, 1 RB, 10 MHz, 16-QAM)    | X | 6.41   | 86.88  | 27.08 | 3.01 | 150.0 | ± 9.6 % |
|           |  | Y | 5.39   | 82.10  | 24.78 |      | 150.0 |         |
|           |  | Z | 4.14   | 77.22  | 22.58 |      | 150.0 |         |
| 10177-CAG | LTE-FDD (SC-FDMA, 1 RB, 5 MHz, QPSK)       | X | 3.35   | 73.17  | 21.78 | 3.01 | 150.0 | ± 9.6 % |
|           |  | Y | 3.21   | 71.55  | 20.60 |      | 150.0 |         |
|           |  | Z | 2.88   | 69.58  | 19.42 |      | 150.0 |         |
| 10178-CAE | LTE-FDD (SC-FDMA, 1 RB, 5 MHz, 16-QAM)     | X | 6.32   | 86.56  | 26.94 | 3.01 | 150.0 | ± 9.6 % |
|           |  | Y | 5.33   | 81.82  | 24.65 |      | 150.0 |         |
|           |  | Z | 4.11   | 77.04  | 22.49 |      | 150.0 |         |
| 10179-CAE | LTE-FDD (SC-FDMA, 1 RB, 10 MHz, 64-QAM)    | X | 5.51   | 83.28  | 25.09 | 3.01 | 150.0 | ± 9.6 % |
|           |  | Y | 4.67   | 78.80  | 22.85 |      | 150.0 |         |
|           |  | Z | 3.72   | 74.89  | 21.01 |      | 150.0 |         |
| 10180-CAE | LTE-FDD (SC-FDMA, 1 RB, 5 MHz, 64-QAM)     | X | 4.68   | 79.60  | 23.20 | 3.01 | 150.0 | ± 9.6 % |
|           |  | Y | 4.04   | 75.67  | 21.12 |      | 150.0 |         |
|           |  | Z | 3.35   | 72.63  | 19.61 |      | 150.0 |         |
| 10181-CAD | LTE-FDD (SC-FDMA, 1 RB, 15 MHz, QPSK)      | X | 3.35   | 73.15  | 21.78 | 3.01 | 150.0 | ± 9.6 % |
|           |  | Y | 3.21   | 71.53  | 20.59 |      | 150.0 |         |
|           |  | Z | 2.87   | 69.57  | 19.42 |      | 150.0 |         |
| 10182-CAD | LTE-FDD (SC-FDMA, 1 RB, 15 MHz, 16-QAM)    | X | 6.31   | 86.52  | 26.93 | 3.01 | 150.0 | ± 9.6 % |
|           |  | Y | 5.32   | 81.78  | 24.63 |      | 150.0 |         |
|           |  | Z | 4.10   | 77.02  | 22.48 |      | 150.0 |         |
| 10183-AAC | LTE-FDD (SC-FDMA, 1 RB, 15 MHz, 64-QAM)    | X | 4.66   | 79.56  | 23.19 | 3.01 | 150.0 | ± 9.6 % |
|           |  | Y | 4.04   | 75.64  | 21.10 |      | 150.0 |         |
|           |  | Z | 3.34   | 72.61  | 19.60 |      | 150.0 |         |

|           |   |   |      |       |       |      |       |         |
|-----------|---|---|------|-------|-------|------|-------|---------|
| 10184-CAD | LTE-FDD (SC-FDMA, 1 RB, 3 MHz, QPSK)          | X | 3.36 | 73.20 | 21.80 | 3.01 | 150.0 | ± 9.6 % |
|           |   | Y | 3.22 | 71.58 | 20.61 |      | 150.0 |         |
|           |   | Z | 2.88 | 69.61 | 19.44 |      | 150.0 |         |
| 10185-CAD | LTE-FDD (SC-FDMA, 1 RB, 3 MHz, 16-QAM)        | X | 6.35 | 86.64 | 26.98 | 3.01 | 150.0 | ± 9.6 % |
|           |   | Y | 5.35 | 81.89 | 24.68 |      | 150.0 |         |
|           |   | Z | 4.12 | 77.10 | 22.52 |      | 150.0 |         |
| 10186-AAD | LTE-FDD (SC-FDMA, 1 RB, 3 MHz, 64-QAM)        | X | 4.70 | 79.67 | 23.24 | 3.01 | 150.0 | ± 9.6 % |
|           |   | Y | 4.06 | 75.73 | 21.14 |      | 150.0 |         |
|           |   | Z | 3.36 | 72.68 | 19.63 |      | 150.0 |         |
| 10187-CAE | LTE-FDD (SC-FDMA, 1 RB, 1.4 MHz, QPSK)        | X | 3.37 | 73.27 | 21.88 | 3.01 | 150.0 | ± 9.6 % |
|           |   | Y | 3.23 | 71.66 | 20.69 |      | 150.0 |         |
|           |   | Z | 2.89 | 69.68 | 19.51 |      | 150.0 |         |
| 10188-CAE | LTE-FDD (SC-FDMA, 1 RB, 1.4 MHz, 16-QAM)      | X | 6.67 | 87.77 | 27.49 | 3.01 | 150.0 | ± 9.6 % |
|           |   | Y | 5.59 | 82.87 | 25.16 |      | 150.0 |         |
|           |   | Z | 4.25 | 77.76 | 22.89 |      | 150.0 |         |
| 10189-AAE | LTE-FDD (SC-FDMA, 1 RB, 1.4 MHz, 64-QAM)      | X | 4.86 | 80.38 | 23.61 | 3.01 | 150.0 | ± 9.6 % |
|           |   | Y | 4.18 | 76.34 | 21.49 |      | 150.0 |         |
|           |   | Z | 3.43 | 73.12 | 19.92 |      | 150.0 |         |
| 10193-CAB | IEEE 802.11n (HT Greenfield, 6.5 Mbps, BPSK)  | X | 4.60 | 67.78 | 17.00 | 0.00 | 150.0 | ± 9.6 % |
|           |   | Y | 4.56 | 67.53 | 16.75 |      | 150.0 |         |
|           |   | Z | 4.48 | 67.31 | 16.48 |      | 150.0 |         |
| 10194-CAB | IEEE 802.11n (HT Greenfield, 39 Mbps, 16-QAM) | X | 4.76 | 68.05 | 17.13 | 0.00 | 150.0 | ± 9.6 % |
|           |   | Y | 4.72 | 67.80 | 16.88 |      | 150.0 |         |
|           |   | Z | 4.63 | 67.57 | 16.61 |      | 150.0 |         |
| 10195-CAB | IEEE 802.11n (HT Greenfield, 65 Mbps, 64-QAM) | X | 4.80 | 68.07 | 17.14 | 0.00 | 150.0 | ± 9.6 % |
|           |   | Y | 4.75 | 67.82 | 16.90 |      | 150.0 |         |
|           |   | Z | 4.67 | 67.59 | 16.62 |      | 150.0 |         |
| 10196-CAB | IEEE 802.11n (HT Mixed, 6.5 Mbps, BPSK)       | X | 4.59 | 67.81 | 17.01 | 0.00 | 150.0 | ± 9.6 % |
|           |   | Y | 4.55 | 67.56 | 16.76 |      | 150.0 |         |
|           |   | Z | 4.47 | 67.33 | 16.48 |      | 150.0 |         |
| 10197-CAB | IEEE 802.11n (HT Mixed, 39 Mbps, 16-QAM)      | X | 4.77 | 68.06 | 17.13 | 0.00 | 150.0 | ± 9.6 % |
|           |   | Y | 4.73 | 67.81 | 16.89 |      | 150.0 |         |
|           |   | Z | 4.64 | 67.58 | 16.62 |      | 150.0 |         |
| 10198-CAB | IEEE 802.11n (HT Mixed, 65 Mbps, 64-QAM)      | X | 4.79 | 68.08 | 17.15 | 0.00 | 150.0 | ± 9.6 % |
|           |   | Y | 4.75 | 67.83 | 16.90 |      | 150.0 |         |
|           |   | Z | 4.66 | 67.60 | 16.63 |      | 150.0 |         |
| 10219-CAB | IEEE 802.11n (HT Mixed, 7.2 Mbps, BPSK)       | X | 4.55 | 67.87 | 16.99 | 0.00 | 150.0 | ± 9.6 % |
|           |   | Y | 4.51 | 67.61 | 16.74 |      | 150.0 |         |
|           |   | Z | 4.43 | 67.37 | 16.45 |      | 150.0 |         |
| 10220-CAB | IEEE 802.11n (HT Mixed, 43.3 Mbps, 16-QAM)    | X | 4.76 | 68.02 | 17.12 | 0.00 | 150.0 | ± 9.6 % |
|           |   | Y | 4.72 | 67.77 | 16.87 |      | 150.0 |         |
|           |   | Z | 4.63 | 67.54 | 16.60 |      | 150.0 |         |
| 10221-CAB | IEEE 802.11n (HT Mixed, 72.2 Mbps, 64-QAM)    | X | 4.80 | 67.99 | 17.12 | 0.00 | 150.0 | ± 9.6 % |
|           |   | Y | 4.76 | 67.75 | 16.88 |      | 150.0 |         |
|           |   | Z | 4.68 | 67.53 | 16.61 |      | 150.0 |         |
| 10222-CAB | IEEE 802.11n (HT Mixed, 15 Mbps, BPSK)        | X | 5.15 | 68.03 | 17.18 | 0.00 | 150.0 | ± 9.6 % |
|           |   | Y | 5.11 | 67.81 | 16.96 |      | 150.0 |         |
|           |   | Z | 5.04 | 67.60 | 16.72 |      | 150.0 |         |



|           |   |   |        |        |       |      |       |         |
|-----------|---|---|--------|--------|-------|------|-------|---------|
| 10223-CAB | IEEE 802.11n (HT Mixed, 90 Mbps, 16-QAM)  | X | 5.44   | 68.23  | 17.28 | 0.00 | 150.0 | ± 9.6 % |
|           |   | Y | 5.40   | 68.03  | 17.07 |      | 150.0 |         |
|           |   | Z | 5.32   | 67.81  | 16.83 |      | 150.0 |         |
| 10224-CAB | IEEE 802.11n (HT Mixed, 150 Mbps, 64-QAM) | X | 5.20   | 68.15  | 17.16 | 0.00 | 150.0 | ± 9.6 % |
|           |   | Y | 5.16   | 67.93  | 16.95 |      | 150.0 |         |
|           |   | Z | 5.08   | 67.72  | 16.70 |      | 150.0 |         |
| 10225-CAB | UMTS-FDD (HSPA+)                          | X | 3.00   | 68.59  | 16.83 | 0.00 | 150.0 | ± 9.6 % |
|           |   | Y | 2.92   | 67.92  | 16.31 |      | 150.0 |         |
|           |   | Z | 2.80   | 67.25  | 15.70 |      | 150.0 |         |
| 10226-CAA | LTE-TDD (SC-FDMA, 1 RB, 1.4 MHz, 16-QAM)  | X | 100.00 | 136.47 | 40.23 | 6.02 | 65.0  | ± 9.6 % |
|           |   | Y | 100.00 | 132.93 | 38.68 |      | 65.0  |         |
|           |   | Z | 100.00 | 134.18 | 38.99 |      | 65.0  |         |
| 10227-CAA | LTE-TDD (SC-FDMA, 1 RB, 1.4 MHz, 64-QAM)  | X | 100.00 | 133.67 | 38.75 | 6.02 | 65.0  | ± 9.6 % |
|           |   | Y | 100.00 | 130.47 | 37.37 |      | 65.0  |         |
|           |   | Z | 100.00 | 131.50 | 37.57 |      | 65.0  |         |
| 10228-CAA | LTE-TDD (SC-FDMA, 1 RB, 1.4 MHz, QPSK)    | X | 100.00 | 146.91 | 45.69 | 6.02 | 65.0  | ± 9.6 % |
|           |   | Y | 100.00 | 142.38 | 43.59 |      | 65.0  |         |
|           |   | Z | 62.29  | 133.89 | 41.59 |      | 65.0  |         |
| 10229-CAB | LTE-TDD (SC-FDMA, 1 RB, 3 MHz, 16-QAM)    | X | 100.00 | 136.23 | 40.09 | 6.02 | 65.0  | ± 9.6 % |
|           |   | Y | 100.00 | 132.70 | 38.54 |      | 65.0  |         |
|           |   | Z | 100.00 | 133.95 | 38.85 |      | 65.0  |         |
| 10230-CAB | LTE-TDD (SC-FDMA, 1 RB, 3 MHz, 64-QAM)    | X | 100.00 | 133.55 | 38.67 | 6.02 | 65.0  | ± 9.6 % |
|           |   | Y | 100.00 | 130.33 | 37.27 |      | 65.0  |         |
|           |   | Z | 100.00 | 131.37 | 37.48 |      | 65.0  |         |
| 10231-CAB | LTE-TDD (SC-FDMA, 1 RB, 3 MHz, QPSK)      | X | 100.00 | 146.76 | 45.58 | 6.02 | 65.0  | ± 9.6 % |
|           |   | Y | 98.12  | 141.81 | 43.38 |      | 65.0  |         |
|           |   | Z | 54.79  | 131.03 | 40.79 |      | 65.0  |         |
| 10232-CAD | LTE-TDD (SC-FDMA, 1 RB, 5 MHz, 16-QAM)    | X | 100.00 | 136.25 | 40.10 | 6.02 | 65.0  | ± 9.6 % |
|           |   | Y | 100.00 | 132.72 | 38.55 |      | 65.0  |         |
|           |   | Z | 100.00 | 133.96 | 38.86 |      | 65.0  |         |
| 10233-CAD | LTE-TDD (SC-FDMA, 1 RB, 5 MHz, 64-QAM)    | X | 100.00 | 133.57 | 38.68 | 6.02 | 65.0  | ± 9.6 % |
|           |   | Y | 100.00 | 130.35 | 37.28 |      | 65.0  |         |
|           |   | Z | 100.00 | 131.40 | 37.49 |      | 65.0  |         |
| 10234-CAD | LTE-TDD (SC-FDMA, 1 RB, 5 MHz, QPSK)      | X | 100.00 | 146.41 | 45.37 | 6.02 | 65.0  | ± 9.6 % |
|           |   | Y | 85.73  | 138.62 | 42.48 |      | 65.0  |         |
|           |   | Z | 49.48  | 128.58 | 40.03 |      | 65.0  |         |
| 10235-CAD | LTE-TDD (SC-FDMA, 1 RB, 10 MHz, 16-QAM)   | X | 100.00 | 136.27 | 40.10 | 6.02 | 65.0  | ± 9.6 % |
|           |   | Y | 100.00 | 132.73 | 38.55 |      | 65.0  |         |
|           |   | Z | 100.00 | 133.98 | 38.86 |      | 65.0  |         |
| 10236-CAD | LTE-TDD (SC-FDMA, 1 RB, 10 MHz, 64-QAM)   | X | 100.00 | 133.50 | 38.65 | 6.02 | 65.0  | ± 9.6 % |
|           |   | Y | 100.00 | 130.29 | 37.26 |      | 65.0  |         |
|           |   | Z | 100.00 | 131.33 | 37.46 |      | 65.0  |         |
| 10237-CAD | LTE-TDD (SC-FDMA, 1 RB, 10 MHz, QPSK)     | X | 100.00 | 146.81 | 45.60 | 6.02 | 65.0  | ± 9.6 % |
|           |   | Y | 99.93  | 142.23 | 43.48 |      | 65.0  |         |
|           |   | Z | 55.78  | 131.45 | 40.90 |      | 65.0  |         |
| 10238-CAD | LTE-TDD (SC-FDMA, 1 RB, 15 MHz, 16-QAM)   | X | 100.00 | 136.27 | 40.10 | 6.02 | 65.0  | ± 9.6 % |
|           |   | Y | 100.00 | 132.73 | 38.55 |      | 65.0  |         |
|           |   | Z | 100.00 | 133.98 | 38.86 |      | 65.0  |         |

|           |  |   |        |        |       |      |      |         |
|-----------|--|---|--------|--------|-------|------|------|---------|
| 10239-CAD | LTE-TDD (SC-FDMA, 1 RB, 15 MHz, 64-QAM)    | X | 100.00 | 133.60 | 38.69 | 6.02 | 65.0 | ± 9.6 % |
|           |  | Y | 100.00 | 130.37 | 37.29 |      | 65.0 |         |
|           |  | Z | 100.00 | 131.42 | 37.50 |      | 65.0 |         |
| 10240-CAD | LTE-TDD (SC-FDMA, 1 RB, 15 MHz, QPSK)      | X | 100.00 | 146.82 | 45.60 | 6.02 | 65.0 | ± 9.6 % |
|           |  | Y | 99.77  | 142.20 | 43.47 |      | 65.0 |         |
|           |  | Z | 55.59  | 131.39 | 40.89 |      | 65.0 |         |
| 10241-CAA | LTE-TDD (SC-FDMA, 50% RB, 1.4 MHz, 16-QAM) | X | 17.87  | 100.55 | 33.28 | 6.98 | 65.0 | ± 9.6 % |
|           |  | Y | 15.07  | 94.94  | 30.80 |      | 65.0 |         |
|           |  | Z | 13.77  | 93.88  | 30.45 |      | 65.0 |         |
| 10242-CAA | LTE-TDD (SC-FDMA, 50% RB, 1.4 MHz, 64-QAM) | X | 17.67  | 100.29 | 33.12 | 6.98 | 65.0 | ± 9.6 % |
|           |  | Y | 12.29  | 90.51  | 29.15 |      | 65.0 |         |
|           |  | Z | 12.81  | 92.35  | 29.83 |      | 65.0 |         |
| 10243-CAA | LTE-TDD (SC-FDMA, 50% RB, 1.4 MHz, QPSK)   | X | 11.06  | 91.58  | 31.22 | 6.98 | 65.0 | ± 9.6 % |
|           |  | Y | 8.79   | 84.63  | 27.92 |      | 65.0 |         |
|           |  | Z | 9.16   | 86.51  | 28.72 |      | 65.0 |         |
| 10244-CAB | LTE-TDD (SC-FDMA, 50% RB, 3 MHz, 16-QAM)   | X | 15.61  | 90.37  | 23.65 | 3.98 | 65.0 | ± 9.6 % |
|           |  | Y | 11.28  | 84.18  | 21.28 |      | 65.0 |         |
|           |  | Z | 8.72   | 80.34  | 19.49 |      | 65.0 |         |
| 10245-CAB | LTE-TDD (SC-FDMA, 50% RB, 3 MHz, 64-QAM)   | X | 13.68  | 88.02  | 22.81 | 3.98 | 65.0 | ± 9.6 % |
|           |  | Y | 10.35  | 82.60  | 20.65 |      | 65.0 |         |
|           |  | Z | 8.13   | 79.04  | 18.94 |      | 65.0 |         |
| 10246-CAB | LTE-TDD (SC-FDMA, 50% RB, 3 MHz, QPSK)     | X | 25.39  | 101.46 | 27.34 | 3.98 | 65.0 | ± 9.6 % |
|           |  | Y | 15.71  | 92.64  | 24.44 |      | 65.0 |         |
|           |  | Z | 12.87  | 89.62  | 23.18 |      | 65.0 |         |
| 10247-CAD | LTE-TDD (SC-FDMA, 50% RB, 5 MHz, 16-QAM)   | X | 9.04   | 82.99  | 22.10 | 3.98 | 65.0 | ± 9.6 % |
|           |  | Y | 8.34   | 80.70  | 21.02 |      | 65.0 |         |
|           |  | Z | 7.61   | 79.49  | 20.32 |      | 65.0 |         |
| 10248-CAD | LTE-TDD (SC-FDMA, 50% RB, 5 MHz, 64-QAM)   | X | 8.42   | 81.37  | 21.47 | 3.98 | 65.0 | ± 9.6 % |
|           |  | Y | 7.88   | 79.34  | 20.47 |      | 65.0 |         |
|           |  | Z | 7.23   | 78.25  | 19.81 |      | 65.0 |         |
| 10249-CAD | LTE-TDD (SC-FDMA, 50% RB, 5 MHz, QPSK)     | X | 33.71  | 108.55 | 30.66 | 3.98 | 65.0 | ± 9.6 % |
|           |  | Y | 20.64  | 98.74  | 27.50 |      | 65.0 |         |
|           |  | Z | 18.25  | 96.85  | 26.70 |      | 65.0 |         |
| 10250-CAD | LTE-TDD (SC-FDMA, 50% RB, 10 MHz, 16-QAM)  | X | 10.08  | 85.96  | 25.19 | 3.98 | 65.0 | ± 9.6 % |
|           |  | Y | 9.64   | 84.09  | 24.21 |      | 65.0 |         |
|           |  | Z | 9.09   | 83.41  | 23.82 |      | 65.0 |         |
| 10251-CAD | LTE-TDD (SC-FDMA, 50% RB, 10 MHz, 64-QAM)  | X | 8.74   | 81.98  | 23.31 | 3.98 | 65.0 | ± 9.6 % |
|           |  | Y | 8.42   | 80.36  | 22.40 |      | 65.0 |         |
|           |  | Z | 8.02   | 79.93  | 22.11 |      | 65.0 |         |
| 10252-CAD | LTE-TDD (SC-FDMA, 50% RB, 10 MHz, QPSK)    | X | 20.41  | 100.95 | 29.84 | 3.98 | 65.0 | ± 9.6 % |
|           |  | Y | 15.89  | 94.95  | 27.60 |      | 65.0 |         |
|           |  | Z | 15.09  | 94.44  | 27.31 |      | 65.0 |         |
| 10253-CAD | LTE-TDD (SC-FDMA, 50% RB, 15 MHz, 16-QAM)  | X | 8.27   | 80.12  | 23.07 | 3.98 | 65.0 | ± 9.6 % |
|           |  | Y | 8.11   | 78.88  | 22.29 |      | 65.0 |         |
|           |  | Z | 7.82   | 78.68  | 22.13 |      | 65.0 |         |
| 10254-CAD | LTE-TDD (SC-FDMA, 50% RB, 15 MHz, 64-QAM)  | X | 8.73   | 81.09  | 23.75 | 3.98 | 65.0 | ± 9.6 % |
|           |  | Y | 8.60   | 79.94  | 23.01 |      | 65.0 |         |
|           |  | Z | 8.29   | 79.69  | 22.83 |      | 65.0 |         |

|           |   |   |       |        |       |      |      |         |
|-----------|---|---|-------|--------|-------|------|------|---------|
| 10255-CAD | LTE-TDD (SC-FDMA, 50% RB, 15 MHz, QPSK)     | X | 12.08 | 89.56  | 26.46 | 3.98 | 65.0 | ± 9.6 % |
|           |   | Y | 11.00 | 86.69  | 25.13 |      | 65.0 |         |
|           |   | Z | 10.61 | 86.49  | 24.98 |      | 65.0 |         |
| 10256-CAA | LTE-TDD (SC-FDMA, 100% RB, 1.4 MHz, 16-QAM) | X | 9.73  | 81.73  | 19.44 | 3.98 | 65.0 | ± 9.6 % |
|           |   | Y | 7.42  | 76.93  | 17.43 |      | 65.0 |         |
|           |   | Z | 5.73  | 73.50  | 15.63 |      | 65.0 |         |
| 10257-CAA | LTE-TDD (SC-FDMA, 100% RB, 1.4 MHz, 64-QAM) | X | 8.33  | 79.13  | 18.36 | 3.98 | 65.0 | ± 9.6 % |
|           |   | Y | 6.73  | 75.21  | 16.63 |      | 65.0 |         |
|           |   | Z | 5.32  | 72.16  | 14.95 |      | 65.0 |         |
| 10258-CAA | LTE-TDD (SC-FDMA, 100% RB, 1.4 MHz, QPSK)   | X | 12.04 | 87.95  | 22.05 | 3.98 | 65.0 | ± 9.6 % |
|           |   | Y | 8.85  | 82.44  | 20.00 |      | 65.0 |         |
|           |   | Z | 7.11  | 79.43  | 18.57 |      | 65.0 |         |
| 10259-CAB | LTE-TDD (SC-FDMA, 100% RB, 3 MHz, 16-QAM)   | X | 9.53  | 84.22  | 23.26 | 3.98 | 65.0 | ± 9.6 % |
|           |   | Y | 8.90  | 82.06  | 22.20 |      | 65.0 |         |
|           |   | Z | 8.25  | 81.09  | 21.63 |      | 65.0 |         |
| 10260-CAB | LTE-TDD (SC-FDMA, 100% RB, 3 MHz, 64-QAM)   | X | 9.20  | 83.27  | 22.90 | 3.98 | 65.0 | ± 9.6 % |
|           |   | Y | 8.68  | 81.32  | 21.91 |      | 65.0 |         |
|           |   | Z | 8.06  | 80.39  | 21.35 |      | 65.0 |         |
| 10261-CAB | LTE-TDD (SC-FDMA, 100% RB, 3 MHz, QPSK)     | X | 23.02 | 102.54 | 29.52 | 3.98 | 65.0 | ± 9.6 % |
|           |   | Y | 16.54 | 95.31  | 26.97 |      | 65.0 |         |
|           |   | Z | 15.22 | 94.17  | 26.42 |      | 65.0 |         |
| 10262-CAD | LTE-TDD (SC-FDMA, 100% RB, 5 MHz, 16-QAM)   | X | 10.05 | 85.86  | 25.14 | 3.98 | 65.0 | ± 9.6 % |
|           |   | Y | 9.60  | 83.99  | 24.15 |      | 65.0 |         |
|           |   | Z | 9.05  | 83.31  | 23.76 |      | 65.0 |         |
| 10263-CAD | LTE-TDD (SC-FDMA, 100% RB, 5 MHz, 64-QAM)   | X | 8.72  | 81.95  | 23.30 | 3.98 | 65.0 | ± 9.6 % |
|           |   | Y | 8.40  | 80.33  | 22.40 |      | 65.0 |         |
|           |   | Z | 8.01  | 79.90  | 22.10 |      | 65.0 |         |
| 10264-CAD | LTE-TDD (SC-FDMA, 100% RB, 5 MHz, QPSK)     | X | 19.99 | 100.52 | 29.68 | 3.98 | 65.0 | ± 9.6 % |
|           |   | Y | 15.61 | 94.59  | 27.46 |      | 65.0 |         |
|           |   | Z | 14.84 | 94.09  | 27.18 |      | 65.0 |         |
| 10265-CAD | LTE-TDD (SC-FDMA, 100% RB, 10 MHz, 16-QAM)  | X | 8.51  | 80.83  | 23.42 | 3.98 | 65.0 | ± 9.6 % |
|           |   | Y | 8.31  | 79.48  | 22.60 |      | 65.0 |         |
|           |   | Z | 8.01  | 79.28  | 22.45 |      | 65.0 |         |
| 10266-CAD | LTE-TDD (SC-FDMA, 100% RB, 10 MHz, 64-QAM)  | X | 9.02  | 81.88  | 24.18 | 3.98 | 65.0 | ± 9.6 % |
|           |   | Y | 8.86  | 80.66  | 23.42 |      | 65.0 |         |
|           |   | Z | 8.53  | 80.41  | 23.25 |      | 65.0 |         |
| 10267-CAD | LTE-TDD (SC-FDMA, 100% RB, 10 MHz, QPSK)    | X | 12.89 | 90.43  | 26.57 | 3.98 | 65.0 | ± 9.6 % |
|           |   | Y | 11.59 | 87.37  | 25.20 |      | 65.0 |         |
|           |   | Z | 11.17 | 87.15  | 25.04 |      | 65.0 |         |
| 10268-CAD | LTE-TDD (SC-FDMA, 100% RB, 15 MHz, 16-QAM)  | X | 8.65  | 79.35  | 23.27 | 3.98 | 65.0 | ± 9.6 % |
|           |   | Y | 8.60  | 78.47  | 22.65 |      | 65.0 |         |
|           |   | Z | 8.34  | 78.33  | 22.54 |      | 65.0 |         |
| 10269-CAD | LTE-TDD (SC-FDMA, 100% RB, 15 MHz, 64-QAM)  | X | 8.50  | 78.69  | 23.04 | 3.98 | 65.0 | ± 9.6 % |
|           |   | Y | 8.49  | 77.91  | 22.46 |      | 65.0 |         |
|           |   | Z | 8.23  | 77.77  | 22.36 |      | 65.0 |         |
| 10270-CAD | LTE-TDD (SC-FDMA, 100% RB, 15 MHz, QPSK)    | X | 9.87  | 83.32  | 24.17 | 3.98 | 65.0 | ± 9.6 % |
|           |   | Y | 9.54  | 81.82  | 23.34 |      | 65.0 |         |
|           |   | Z | 9.23  | 81.64  | 23.20 |      | 65.0 |         |

|           |  |   |        |        |       |      |       |         |
|-----------|--|---|--------|--------|-------|------|-------|---------|
| 10274-CAB | UMTS-FDD (HSUPA, Subtest 5, 3GPP Rel8.10)                          | X | 2.93   | 69.92  | 17.28 | 0.00 | 150.0 | ± 9.6 % |
|           |  | Y | 2.80   | 68.92  | 16.59 |      | 150.0 |         |
|           |  | Z | 2.67   | 68.10  | 15.90 |      | 150.0 |         |
| 10275-CAB | UMTS-FDD (HSUPA, Subtest 5, 3GPP Rel8.4)                           | X | 2.65   | 78.26  | 21.12 | 0.00 | 150.0 | ± 9.6 % |
|           |  | Y | 2.15   | 74.09  | 18.99 |      | 150.0 |         |
|           |  | Z | 1.84   | 71.24  | 17.33 |      | 150.0 |         |
| 10277-CAA | PHS (QPSK)   | X | 3.36   | 65.20  | 9.94  | 9.03 | 50.0  | ± 9.6 % |
|           |  | Y | 3.89   | 66.16  | 10.82 |      | 50.0  |         |
|           |  | Z | 3.28   | 64.75  | 9.58  |      | 50.0  |         |
| 10278-CAA | PHS (QPSK, BW 884MHz, Rolloff 0.5)                                 | X | 9.68   | 82.05  | 19.91 | 9.03 | 50.0  | ± 9.6 % |
|           |  | Y | 8.39   | 79.03  | 18.95 |      | 50.0  |         |
|           |  | Z | 7.49   | 77.63  | 17.92 |      | 50.0  |         |
| 10279-CAA | PHS (QPSK, BW 884MHz, Rolloff 0.38)                                | X | 9.79   | 82.20  | 20.01 | 9.03 | 50.0  | ± 9.6 % |
|           |  | Y | 8.47   | 79.14  | 19.03 |      | 50.0  |         |
|           |  | Z | 7.60   | 77.79  | 18.03 |      | 50.0  |         |
| 10290-AAB | CDMA2000, RC1, SO55, Full Rate                                     | X | 100.00 | 128.73 | 31.86 | 0.00 | 150.0 | ± 9.6 % |
|           |  | Y | 5.46   | 88.02  | 21.05 |      | 150.0 |         |
|           |  | Z | 1.91   | 73.76  | 15.51 |      | 150.0 |         |
| 10291-AAB | CDMA2000, RC3, SO55, Full Rate                                     | X | 100.00 | 135.73 | 33.92 | 0.00 | 150.0 | ± 9.6 % |
|           |  | Y | 3.79   | 87.86  | 21.18 |      | 150.0 |         |
|           |  | Z | 1.18   | 71.73  | 14.72 |      | 150.0 |         |
| 10292-AAB | CDMA2000, RC3, SO32, Full Rate                                     | X | 100.00 | 142.87 | 36.94 | 0.00 | 150.0 | ± 9.6 % |
|           |  | Y | 100.00 | 136.51 | 34.18 |      | 150.0 |         |
|           |  | Z | 5.31   | 92.64  | 22.43 |      | 150.0 |         |
| 10293-AAB | CDMA2000, RC3, SO3, Full Rate                                      | X | 100.00 | 147.53 | 39.13 | 0.00 | 150.0 | ± 9.6 % |
|           |  | Y | 100.00 | 141.37 | 36.44 |      | 150.0 |         |
|           |  | Z | 100.00 | 134.56 | 33.36 |      | 150.0 |         |
| 10295-AAB | CDMA2000, RC1, SO3, 1/8th Rate 25 fr.                              | X | 51.26  | 114.86 | 33.17 | 9.03 | 50.0  | ± 9.6 % |
|           |  | Y | 27.72  | 102.36 | 29.45 |      | 50.0  |         |
|           |  | Z | 34.06  | 106.19 | 30.27 |      | 50.0  |         |
| 10297-AAC | LTE-FDD (SC-FDMA, 50% RB, 20 MHz, QPSK)                            | X | 3.44   | 75.06  | 19.80 | 0.00 | 150.0 | ± 9.6 % |
|           |  | Y | 3.15   | 73.19  | 18.73 |      | 150.0 |         |
|           |  | Z | 2.87   | 71.52  | 17.73 |      | 150.0 |         |
| 10298-AAC | LTE-FDD (SC-FDMA, 50% RB, 3 MHz, QPSK)                             | X | 4.53   | 85.32  | 21.43 | 0.00 | 150.0 | ± 9.6 % |
|           |  | Y | 2.49   | 75.98  | 17.66 |      | 150.0 |         |
|           |  | Z | 1.68   | 70.19  | 14.73 |      | 150.0 |         |
| 10299-AAC | LTE-FDD (SC-FDMA, 50% RB, 3 MHz, 16-QAM)                           | X | 35.97  | 105.52 | 25.86 | 0.00 | 150.0 | ± 9.6 % |
|           |  | Y | 5.66   | 80.41  | 18.09 |      | 150.0 |         |
|           |  | Z | 2.55   | 70.20  | 13.62 |      | 150.0 |         |
| 10300-AAC | LTE-FDD (SC-FDMA, 50% RB, 3 MHz, 64-QAM)                           | X | 3.08   | 71.93  | 14.32 | 0.00 | 150.0 | ± 9.6 % |
|           |  | Y | 2.13   | 67.03  | 11.85 |      | 150.0 |         |
|           |  | Z | 1.63   | 64.24  | 10.02 |      | 150.0 |         |
| 10301-AAA | IEEE 802.16e WiMAX (29:18, 5ms, 10MHz, QPSK, PUSC)                 | X | 5.45   | 69.13  | 19.39 | 4.17 | 80.0  | ± 9.6 % |
|           |  | Y | 5.47   | 68.97  | 19.13 |      | 80.0  |         |
|           |  | Z | 5.25   | 68.28  | 18.65 |      | 80.0  |         |
| 10302-AAA | IEEE 802.16e WiMAX (29:18, 5ms, 10MHz, QPSK, PUSC, 3 CTRL symbols) | X | 5.78   | 69.10  | 19.80 | 4.96 | 80.0  | ± 9.6 % |
|           |  | Y | 5.77   | 68.75  | 19.42 |      | 80.0  |         |
|           |  | Z | 5.66   | 68.63  | 19.27 |      | 80.0  |         |

|           |   |   |        |        |       |       |       |         |
|-----------|---|---|--------|--------|-------|-------|-------|---------|
| 10303-AAA | IEEE 802.16e WiMAX (31:15, 5ms, 10MHz, 64QAM, PUSC)                 | X | 5.58   | 68.98  | 19.73 | 4.96  | 80.0  | ± 9.6 % |
|           |   | Y | 5.58   | 68.66  | 19.35 |       | 80.0  |         |
|           |   | Z | 5.46   | 68.50  | 19.18 |       | 80.0  |         |
| 10304-AAA | IEEE 802.16e WiMAX (29:18, 5ms, 10MHz, 64QAM, PUSC)                 | X | 5.34   | 68.67  | 19.12 | 4.17  | 80.0  | ± 9.6 % |
|           |   | Y | 5.33   | 68.32  | 18.76 |       | 80.0  |         |
|           |   | Z | 5.21   | 68.15  | 18.55 |       | 80.0  |         |
| 10305-AAA | IEEE 802.16e WiMAX (31:15, 10ms, 10MHz, 64QAM, PUSC, 15 symbols)    | X | 6.61   | 77.30  | 24.10 | 6.02  | 50.0  | ± 9.6 % |
|           |   | Y | 7.10   | 78.07  | 24.03 |       | 50.0  |         |
|           |   | Z | 6.42   | 76.34  | 23.21 |       | 50.0  |         |
| 10306-AAA | IEEE 802.16e WiMAX (29:18, 10ms, 10MHz, 64QAM, PUSC, 18 symbols)    | X | 5.68   | 70.99  | 21.21 | 6.02  | 50.0  | ± 9.6 % |
|           |   | Y | 6.11   | 72.92  | 22.11 |       | 50.0  |         |
|           |   | Z | 5.54   | 70.33  | 20.52 |       | 50.0  |         |
| 10307-AAA | IEEE 802.16e WiMAX (29:18, 10ms, 10MHz, QPSK, PUSC, 18 symbols)     | X | 5.65   | 71.36  | 21.23 | 6.02  | 50.0  | ± 9.6 % |
|           |   | Y | 6.19   | 73.69  | 22.31 |       | 50.0  |         |
|           |   | Z | 5.79   | 72.63  | 21.74 |       | 50.0  |         |
| 10308-AAA | IEEE 802.16e WiMAX (29:18, 10ms, 10MHz, 16QAM, PUSC)                | X | 6.01   | 73.91  | 22.77 | 6.02  | 50.0  | ± 9.6 % |
|           |   | Y | 6.30   | 74.37  | 22.65 |       | 50.0  |         |
|           |   | Z | 5.88   | 73.25  | 22.07 |       | 50.0  |         |
| 10309-AAA | IEEE 802.16e WiMAX (29:18, 10ms, 10MHz, 16QAM, AMC 2x3, 18 symbols) | X | 5.73   | 71.20  | 21.36 | 6.02  | 50.0  | ± 9.6 % |
|           |   | Y | 6.16   | 73.11  | 22.25 |       | 50.0  |         |
|           |   | Z | 5.58   | 70.50  | 20.65 |       | 50.0  |         |
| 10310-AAA | IEEE 802.16e WiMAX (29:18, 10ms, 10MHz, QPSK, AMC 2x3, 18 symbols)  | X | 5.67   | 71.20  | 21.24 | 6.02  | 50.0  | ± 9.6 % |
|           |   | Y | 6.15   | 73.31  | 22.23 |       | 50.0  |         |
|           |   | Z | 5.52   | 70.51  | 20.54 |       | 50.0  |         |
| 10311-AAC | LTE-FDD (SC-FDMA, 100% RB, 15 MHz, QPSK)                            | X | 3.80   | 73.58  | 19.01 | 0.00  | 150.0 | ± 9.6 % |
|           |   | Y | 3.53   | 72.03  | 18.12 |       | 150.0 |         |
|           |   | Z | 3.24   | 70.56  | 17.24 |       | 150.0 |         |
| 10313-AAA | iDEN 1:3  | X | 59.05  | 112.13 | 29.07 | 6.99  | 70.0  | ± 9.6 % |
|           |   | Y | 21.12  | 95.82  | 24.56 |       | 70.0  |         |
|           |   | Z | 18.22  | 93.85  | 23.73 |       | 70.0  |         |
| 10314-AAA | iDEN 1:6  | X | 100.00 | 130.93 | 37.14 | 10.00 | 30.0  | ± 9.6 % |
|           |   | Y | 75.09  | 122.91 | 34.76 |       | 30.0  |         |
|           |   | Z | 51.44  | 117.42 | 33.31 |       | 30.0  |         |
| 10315-AAB | IEEE 802.11b WiFi 2.4 GHz (DSSS, 1 Mbps, 96pc duty cycle)           | X | 1.34   | 68.63  | 18.94 | 0.17  | 150.0 | ± 9.6 % |
|           |   | Y | 1.29   | 67.42  | 17.86 |       | 150.0 |         |
|           |   | Z | 1.21   | 66.04  | 16.71 |       | 150.0 |         |
| 10316-AAB | IEEE 802.11g WiFi 2.4 GHz (ERP-OFDM, 6 Mbps, 96pc duty cycle)       | X | 4.67   | 67.89  | 17.21 | 0.17  | 150.0 | ± 9.6 % |
|           |   | Y | 4.64   | 67.66  | 16.96 |       | 150.0 |         |
|           |   | Z | 4.56   | 67.44  | 16.70 |       | 150.0 |         |
| 10317-AAB | IEEE 802.11a WiFi 5 GHz (OFDM, 6 Mbps, 96pc duty cycle)             | X | 4.67   | 67.89  | 17.21 | 0.17  | 150.0 | ± 9.6 % |
|           |   | Y | 4.64   | 67.66  | 16.96 |       | 150.0 |         |
|           |   | Z | 4.56   | 67.44  | 16.70 |       | 150.0 |         |
| 10400-AAC | IEEE 802.11ac WiFi (20MHz, 64-QAM, 99pc duty cycle)                 | X | 4.74   | 68.13  | 17.15 | 0.00  | 150.0 | ± 9.6 % |
|           |   | Y | 4.69   | 67.85  | 16.88 |       | 150.0 |         |
|           |   | Z | 4.60   | 67.62  | 16.61 |       | 150.0 |         |
| 10401-AAC | IEEE 802.11ac WiFi (40MHz, 64-QAM, 99pc duty cycle)                 | X | 5.46   | 68.11  | 17.20 | 0.00  | 150.0 | ± 9.6 % |
|           |   | Y | 5.42   | 67.87  | 16.96 |       | 150.0 |         |
|           |   | Z | 5.29   | 67.51  | 16.65 |       | 150.0 |         |

|           |  |   |        |        |       |      |       |         |
|-----------|--|---|--------|--------|-------|------|-------|---------|
| 10402-AAC | IEEE 802.11ac WiFi (80MHz, 64-QAM, 99pc duty cycle)                            | X | 5.70   | 68.27  | 17.13 | 0.00 | 150.0 | ± 9.6 % |
|           |  | Y | 5.67   | 68.08  | 16.93 |      | 150.0 |         |
|           |  | Z | 5.59   | 67.90  | 16.71 |      | 150.0 |         |
| 10403-AAB | CDMA2000 (1xEV-DO, Rev. 0)   | X | 100.00 | 128.73 | 31.86 | 0.00 | 115.0 | ± 9.6 % |
|           |  | Y | 5.46   | 88.02  | 21.05 |      | 115.0 |         |
|           |  | Z | 1.91   | 73.76  | 15.51 |      | 115.0 |         |
| 10404-AAB | CDMA2000 (1xEV-DO, Rev. A)   | X | 100.00 | 128.73 | 31.86 | 0.00 | 115.0 | ± 9.6 % |
|           |  | Y | 5.46   | 88.02  | 21.05 |      | 115.0 |         |
|           |  | Z | 1.91   | 73.76  | 15.51 |      | 115.0 |         |
| 10406-AAB | CDMA2000, RC3, SO32, SCH0, Full Rate   | X | 100.00 | 125.52 | 31.82 | 0.00 | 100.0 | ± 9.6 % |
|           |  | Y | 100.00 | 122.74 | 30.63 |      | 100.0 |         |
|           |  | Z | 100.00 | 121.04 | 29.50 |      | 100.0 |         |
| 10410-AAC | LTE-TDD (SC-FDMA, 1 RB, 10 MHz, QPSK, UL Subframe=2,3,4,7,8,9)                 | X | 100.00 | 131.41 | 34.92 | 3.23 | 80.0  | ± 9.6 % |
|           |  | Y | 100.00 | 126.46 | 32.79 |      | 80.0  |         |
|           |  | Z | 100.00 | 125.69 | 32.11 |      | 80.0  |         |
| 10415-AAA | IEEE 802.11b WiFi 2.4 GHz (DSSS, 1 Mbps, 99pc duty cycle)                      | X | 1.18   | 66.83  | 17.95 | 0.00 | 150.0 | ± 9.6 % |
|           |  | Y | 1.13   | 65.66  | 16.89 |      | 150.0 |         |
|           |  | Z | 1.08   | 64.56  | 15.83 |      | 150.0 |         |
| 10416-AAA | IEEE 802.11g WiFi 2.4 GHz (ERP-OFDM, 6 Mbps, 99pc duty cycle)                  | X | 4.60   | 67.79  | 17.08 | 0.00 | 150.0 | ± 9.6 % |
|           |  | Y | 4.56   | 67.54  | 16.83 |      | 150.0 |         |
|           |  | Z | 4.48   | 67.32  | 16.55 |      | 150.0 |         |
| 10417-AAA | IEEE 802.11a/h WiFi 5 GHz (OFDM, 6 Mbps, 99pc duty cycle)                      | X | 4.60   | 67.79  | 17.08 | 0.00 | 150.0 | ± 9.6 % |
|           |  | Y | 4.56   | 67.54  | 16.83 |      | 150.0 |         |
|           |  | Z | 4.48   | 67.32  | 16.55 |      | 150.0 |         |
| 10418-AAA | IEEE 802.11g WiFi 2.4 GHz (DSSS-OFDM, 6 Mbps, 99pc duty cycle, Long preamble)  | X | 4.60   | 68.04  | 17.15 | 0.00 | 150.0 | ± 9.6 % |
|           |  | Y | 4.56   | 67.77  | 16.89 |      | 150.0 |         |
|           |  | Z | 4.48   | 67.54  | 16.61 |      | 150.0 |         |
| 10419-AAA | IEEE 802.11g WiFi 2.4 GHz (DSSS-OFDM, 6 Mbps, 99pc duty cycle, Short preamble) | X | 4.61   | 67.95  | 17.12 | 0.00 | 150.0 | ± 9.6 % |
|           |  | Y | 4.57   | 67.69  | 16.87 |      | 150.0 |         |
|           |  | Z | 4.49   | 67.46  | 16.60 |      | 150.0 |         |
| 10422-AAA | IEEE 802.11n (HT Greenfield, 7.2 Mbps, BPSK)                                   | X | 4.72   | 67.88  | 17.10 | 0.00 | 150.0 | ± 9.6 % |
|           |  | Y | 4.68   | 67.64  | 16.86 |      | 150.0 |         |
|           |  | Z | 4.60   | 67.42  | 16.59 |      | 150.0 |         |
| 10423-AAA | IEEE 802.11n (HT Greenfield, 43.3 Mbps, 16-QAM)                                | X | 4.86   | 68.17  | 17.20 | 0.00 | 150.0 | ± 9.6 % |
|           |  | Y | 4.82   | 67.92  | 16.96 |      | 150.0 |         |
|           |  | Z | 4.73   | 67.70  | 16.69 |      | 150.0 |         |
| 10424-AAA | IEEE 802.11n (HT Greenfield, 72.2 Mbps, 64-QAM)                                | X | 4.79   | 68.14  | 17.19 | 0.00 | 150.0 | ± 9.6 % |
|           |  | Y | 4.75   | 67.89  | 16.94 |      | 150.0 |         |
|           |  | Z | 4.66   | 67.66  | 16.67 |      | 150.0 |         |
| 10425-AAA | IEEE 802.11n (HT Greenfield, 15 Mbps, BPSK)                                    | X | 5.41   | 68.25  | 17.27 | 0.00 | 150.0 | ± 9.6 % |
|           |  | Y | 5.37   | 68.04  | 17.06 |      | 150.0 |         |
|           |  | Z | 5.28   | 67.83  | 16.82 |      | 150.0 |         |
| 10426-AAA | IEEE 802.11n (HT Greenfield, 90 Mbps, 16-QAM)                                  | X | 5.44   | 68.38  | 17.34 | 0.00 | 150.0 | ± 9.6 % |
|           |  | Y | 5.40   | 68.16  | 17.12 |      | 150.0 |         |
|           |  | Z | 5.31   | 67.93  | 16.86 |      | 150.0 |         |

|           |  |   |        |        |       |      |       |         |
|-----------|--|---|--------|--------|-------|------|-------|---------|
| 10427-AAA | IEEE 802.11n (HT Greenfield, 150 Mbps, 64-QAM)                 | X | 5.41   | 68.20  | 17.24 | 0.00 | 150.0 | ± 9.6 % |
|           |  | Y | 5.37   | 67.99  | 17.02 |      | 150.0 |         |
|           |  | Z | 5.27   | 67.73  | 16.76 |      | 150.0 |         |
| 10430-AAB | LTE-FDD (OFDMA, 5 MHz, E-TM 3.1)                               | X | 4.68   | 74.13  | 19.83 | 0.00 | 150.0 | ± 9.6 % |
|           |  | Y | 4.66   | 73.98  | 19.65 |      | 150.0 |         |
|           |  | Z | 4.33   | 72.57  | 18.70 |      | 150.0 |         |
| 10431-AAB | LTE-FDD (OFDMA, 10 MHz, E-TM 3.1)                              | X | 4.30   | 68.76  | 17.23 | 0.00 | 150.0 | ± 9.6 % |
|           |  | Y | 4.24   | 68.39  | 16.91 |      | 150.0 |         |
|           |  | Z | 4.13   | 68.04  | 16.54 |      | 150.0 |         |
| 10432-AAB | LTE-FDD (OFDMA, 15 MHz, E-TM 3.1)                              | X | 4.58   | 68.36  | 17.21 | 0.00 | 150.0 | ± 9.6 % |
|           |  | Y | 4.53   | 68.06  | 16.94 |      | 150.0 |         |
|           |  | Z | 4.43   | 67.79  | 16.63 |      | 150.0 |         |
| 10433-AAB | LTE-FDD (OFDMA, 20 MHz, E-TM 3.1)                              | X | 4.81   | 68.17  | 17.21 | 0.00 | 150.0 | ± 9.6 % |
|           |  | Y | 4.77   | 67.92  | 16.96 |      | 150.0 |         |
|           |  | Z | 4.68   | 67.69  | 16.69 |      | 150.0 |         |
| 10434-AAA | W-CDMA (BS Test Model 1, 64 DPCH)                              | X | 5.03   | 75.87  | 20.06 | 0.00 | 150.0 | ± 9.6 % |
|           |  | Y | 4.99   | 75.61  | 19.83 |      | 150.0 |         |
|           |  | Z | 4.49   | 73.69  | 18.66 |      | 150.0 |         |
| 10435-AAC | LTE-TDD (SC-FDMA, 1 RB, 20 MHz, QPSK, UL Subframe=2,3,4,7,8,9) | X | 100.00 | 131.13 | 34.80 | 3.23 | 80.0  | ± 9.6 % |
|           |  | Y | 100.00 | 126.21 | 32.67 |      | 80.0  |         |
|           |  | Z | 100.00 | 125.44 | 31.99 |      | 80.0  |         |
| 10447-AAB | LTE-FDD (OFDMA, 5 MHz, E-TM 3.1, Clipping 44%)                 | X | 3.69   | 69.53  | 16.77 | 0.00 | 150.0 | ± 9.6 % |
|           |  | Y | 3.58   | 68.87  | 16.29 |      | 150.0 |         |
|           |  | Z | 3.42   | 68.21  | 15.70 |      | 150.0 |         |
| 10448-AAB | LTE-FDD (OFDMA, 10 MHz, E-TM 3.1, Clipping 44%)                | X | 4.15   | 68.58  | 17.12 | 0.00 | 150.0 | ± 9.6 % |
|           |  | Y | 4.09   | 68.20  | 16.80 |      | 150.0 |         |
|           |  | Z | 3.99   | 67.84  | 16.42 |      | 150.0 |         |
| 10449-AAB | LTE-FDD (OFDMA, 15 MHz, E-TM 3.1, Clipping 44%)                | X | 4.41   | 68.22  | 17.14 | 0.00 | 150.0 | ± 9.6 % |
|           |  | Y | 4.36   | 67.92  | 16.86 |      | 150.0 |         |
|           |  | Z | 4.27   | 67.63  | 16.54 |      | 150.0 |         |
| 10450-AAB | LTE-FDD (OFDMA, 20 MHz, E-TM 3.1, Clipping 44%)                | X | 4.60   | 67.99  | 17.10 | 0.00 | 150.0 | ± 9.6 % |
|           |  | Y | 4.55   | 67.72  | 16.84 |      | 150.0 |         |
|           |  | Z | 4.47   | 67.48  | 16.56 |      | 150.0 |         |
| 10451-AAA | W-CDMA (BS Test Model 1, 64 DPCH, Clipping 44%)                | X | 3.62   | 69.93  | 16.40 | 0.00 | 150.0 | ± 9.6 % |
|           |  | Y | 3.47   | 69.09  | 15.83 |      | 150.0 |         |
|           |  | Z | 3.27   | 68.23  | 15.13 |      | 150.0 |         |
| 10456-AAA | IEEE 802.11ac WiFi (160MHz, 64-QAM, 99pc duty cycle)           | X | 6.36   | 68.84  | 17.42 | 0.00 | 150.0 | ± 9.6 % |
|           |  | Y | 6.32   | 68.67  | 17.24 |      | 150.0 |         |
|           |  | Z | 6.23   | 68.46  | 17.01 |      | 150.0 |         |
| 10457-AAA | UMTS-FDD (DC-HSDPA)  | X | 3.88   | 66.43  | 16.81 | 0.00 | 150.0 | ± 9.6 % |
|           |  | Y | 3.85   | 66.20  | 16.55 |      | 150.0 |         |
|           |  | Z | 3.80   | 66.01  | 16.28 |      | 150.0 |         |
| 10458-AAA | CDMA2000 (1xEV-DO, Rev. B, 2 carriers)                         | X | 4.65   | 75.19  | 19.34 | 0.00 | 150.0 | ± 9.6 % |
|           |  | Y | 4.52   | 74.56  | 18.92 |      | 150.0 |         |
|           |  | Z | 4.04   | 72.55  | 17.67 |      | 150.0 |         |
| 10459-AAA | CDMA2000 (1xEV-DO, Rev. B, 3 carriers)                         | X | 5.15   | 69.96  | 18.79 | 0.00 | 150.0 | ± 9.6 % |
|           |  | Y | 5.22   | 70.24  | 18.85 |      | 150.0 |         |
|           |  | Z | 4.92   | 69.20  | 18.07 |      | 150.0 |         |

|           |   |   |        |        |       |      |       |         |
|-----------|---|---|--------|--------|-------|------|-------|---------|
| 10460-AAA | UMTS-FDD (WCDMA, AMR)   | X | 3.37   | 95.81  | 29.07 | 0.00 | 150.0 | ± 9.6 % |
|           |   | Y | 1.74   | 81.67  | 23.23 |      | 150.0 |         |
|           |   | Z | 1.21   | 74.42  | 19.58 |      | 150.0 |         |
| 10461-AAA | LTE-TDD (SC-FDMA, 1 RB, 1.4 MHz, QPSK, UL Subframe=2,3,4,7,8,9)   | X | 100.00 | 143.01 | 40.15 | 3.29 | 80.0  | ± 9.6 % |
|           |   | Y | 100.00 | 134.90 | 36.63 |      | 80.0  |         |
|           |   | Z | 100.00 | 132.97 | 35.44 |      | 80.0  |         |
| 10462-AAA | LTE-TDD (SC-FDMA, 1 RB, 1.4 MHz, 16-QAM, UL Subframe=2,3,4,7,8,9) | X | 100.00 | 119.25 | 28.85 | 3.23 | 80.0  | ± 9.6 % |
|           |   | Y | 100.00 | 113.20 | 26.37 |      | 80.0  |         |
|           |   | Z | 100.00 | 110.00 | 24.63 |      | 80.0  |         |
| 10463-AAA | LTE-TDD (SC-FDMA, 1 RB, 1.4 MHz, 64-QAM, UL Subframe=2,3,4,7,8,9) | X | 100.00 | 113.75 | 26.28 | 3.23 | 80.0  | ± 9.6 % |
|           |   | Y | 100.00 | 108.57 | 24.18 |      | 80.0  |         |
|           |   | Z | 100.00 | 105.07 | 22.33 |      | 80.0  |         |
| 10464-AAA | LTE-TDD (SC-FDMA, 1 RB, 3 MHz, QPSK, UL Subframe=2,3,4,7,8,9)     | X | 100.00 | 141.23 | 39.11 | 3.23 | 80.0  | ± 9.6 % |
|           |   | Y | 100.00 | 132.81 | 35.48 |      | 80.0  |         |
|           |   | Z | 100.00 | 130.60 | 34.16 |      | 80.0  |         |
| 10465-AAA | LTE-TDD (SC-FDMA, 1 RB, 3 MHz, 16-QAM, UL Subframe=2,3,4,7,8,9)   | X | 100.00 | 118.41 | 28.46 | 3.23 | 80.0  | ± 9.6 % |
|           |   | Y | 100.00 | 112.48 | 26.02 |      | 80.0  |         |
|           |   | Z | 100.00 | 109.28 | 24.29 |      | 80.0  |         |
| 10466-AAA | LTE-TDD (SC-FDMA, 1 RB, 3 MHz, 64-QAM, UL Subframe=2,3,4,7,8,9)   | X | 100.00 | 112.90 | 25.90 | 3.23 | 80.0  | ± 9.6 % |
|           |   | Y | 100.00 | 107.89 | 23.87 |      | 80.0  |         |
|           |   | Z | 100.00 | 104.43 | 22.04 |      | 80.0  |         |
| 10467-AAC | LTE-TDD (SC-FDMA, 1 RB, 5 MHz, QPSK, UL Subframe=2,3,4,7,8,9)     | X | 100.00 | 141.61 | 39.28 | 3.23 | 80.0  | ± 9.6 % |
|           |   | Y | 100.00 | 133.15 | 35.63 |      | 80.0  |         |
|           |   | Z | 100.00 | 130.94 | 34.31 |      | 80.0  |         |
| 10468-AAC | LTE-TDD (SC-FDMA, 1 RB, 5 MHz, 16-QAM, UL Subframe=2,3,4,7,8,9)   | X | 100.00 | 118.75 | 28.61 | 3.23 | 80.0  | ± 9.6 % |
|           |   | Y | 100.00 | 112.75 | 26.15 |      | 80.0  |         |
|           |   | Z | 100.00 | 109.56 | 24.42 |      | 80.0  |         |
| 10469-AAC | LTE-TDD (SC-FDMA, 1 RB, 5 MHz, 64-QAM, UL Subframe=2,3,4,7,8,9)   | X | 100.00 | 112.98 | 25.93 | 3.23 | 80.0  | ± 9.6 % |
|           |   | Y | 100.00 | 107.94 | 23.89 |      | 80.0  |         |
|           |   | Z | 100.00 | 104.47 | 22.05 |      | 80.0  |         |
| 10470-AAC | LTE-TDD (SC-FDMA, 1 RB, 10 MHz, QPSK, UL Subframe=2,3,4,7,8,9)    | X | 100.00 | 141.70 | 39.31 | 3.23 | 80.0  | ± 9.6 % |
|           |   | Y | 100.00 | 133.21 | 35.65 |      | 80.0  |         |
|           |   | Z | 100.00 | 130.98 | 34.32 |      | 80.0  |         |
| 10471-AAC | LTE-TDD (SC-FDMA, 1 RB, 10 MHz, 16-QAM, UL Subframe=2,3,4,7,8,9)  | X | 100.00 | 118.69 | 28.58 | 3.23 | 80.0  | ± 9.6 % |
|           |   | Y | 100.00 | 112.69 | 26.12 |      | 80.0  |         |
|           |   | Z | 100.00 | 109.48 | 24.38 |      | 80.0  |         |
| 10472-AAC | LTE-TDD (SC-FDMA, 1 RB, 10 MHz, 64-QAM, UL Subframe=2,3,4,7,8,9)  | X | 100.00 | 112.90 | 25.89 | 3.23 | 80.0  | ± 9.6 % |
|           |   | Y | 100.00 | 107.86 | 23.85 |      | 80.0  |         |
|           |   | Z | 100.00 | 104.38 | 22.01 |      | 80.0  |         |
| 10473-AAC | LTE-TDD (SC-FDMA, 1 RB, 15 MHz, QPSK, UL Subframe=2,3,4,7,8,9)    | X | 100.00 | 141.67 | 39.29 | 3.23 | 80.0  | ± 9.6 % |
|           |   | Y | 100.00 | 133.18 | 35.63 |      | 80.0  |         |
|           |   | Z | 100.00 | 130.96 | 34.31 |      | 80.0  |         |
| 10474-AAC | LTE-TDD (SC-FDMA, 1 RB, 15 MHz, 16-QAM, UL Subframe=2,3,4,7,8,9)  | X | 100.00 | 118.71 | 28.58 | 3.23 | 80.0  | ± 9.6 % |
|           |   | Y | 100.00 | 112.70 | 26.12 |      | 80.0  |         |
|           |   | Z | 100.00 | 109.49 | 24.38 |      | 80.0  |         |
| 10475-AAC | LTE-TDD (SC-FDMA, 1 RB, 15 MHz, 64-QAM, UL Subframe=2,3,4,7,8,9)  | X | 100.00 | 112.93 | 25.90 | 3.23 | 80.0  | ± 9.6 % |
|           |   | Y | 100.00 | 107.88 | 23.85 |      | 80.0  |         |
|           |   | Z | 100.00 | 104.40 | 22.02 |      | 80.0  |         |



|           |   |   |        |        |       |      |      |         |
|-----------|---|---|--------|--------|-------|------|------|---------|
| 10477-AAC | LTE-TDD (SC-FDMA, 1 RB, 20 MHz, 16-QAM, UL Subframe=2,3,4,7,8,9)    | X | 100.00 | 118.43 | 28.45 | 3.23 | 80.0 | ± 9.6 % |
|           |   | Y | 100.00 | 112.46 | 26.00 |      | 80.0 |         |
|           |   | Z | 100.00 | 109.24 | 24.26 |      | 80.0 |         |
| 10478-AAC | LTE-TDD (SC-FDMA, 1 RB, 20 MHz, 64-QAM, UL Subframe=2,3,4,7,8,9)    | X | 100.00 | 112.82 | 25.85 | 3.23 | 80.0 | ± 9.6 % |
|           |   | Y | 100.00 | 107.79 | 23.82 |      | 80.0 |         |
|           |   | Z | 100.00 | 104.31 | 21.98 |      | 80.0 |         |
| 10479-AAA | LTE-TDD (SC-FDMA, 50% RB, 1.4 MHz, QPSK, UL Subframe=2,3,4,7,8,9)   | X | 100.00 | 132.85 | 37.00 | 3.23 | 80.0 | ± 9.6 % |
|           |   | Y | 100.00 | 128.47 | 35.00 |      | 80.0 |         |
|           |   | Z | 100.00 | 127.00 | 34.04 |      | 80.0 |         |
| 10480-AAA | LTE-TDD (SC-FDMA, 50% RB, 1.4 MHz, 16-QAM, UL Subframe=2,3,4,7,8,9) | X | 100.00 | 120.16 | 30.90 | 3.23 | 80.0 | ± 9.6 % |
|           |   | Y | 100.00 | 116.69 | 29.36 |      | 80.0 |         |
|           |   | Z | 100.00 | 114.91 | 28.26 |      | 80.0 |         |
| 10481-AAA | LTE-TDD (SC-FDMA, 50% RB, 1.4 MHz, 64-QAM, UL Subframe=2,3,4,7,8,9) | X | 100.00 | 117.70 | 29.67 | 3.23 | 80.0 | ± 9.6 % |
|           |   | Y | 100.00 | 114.39 | 28.21 |      | 80.0 |         |
|           |   | Z | 100.00 | 112.46 | 27.04 |      | 80.0 |         |
| 10482-AAA | LTE-TDD (SC-FDMA, 50% RB, 3 MHz, QPSK, UL Subframe=2,3,4,7,8,9)     | X | 100.00 | 122.13 | 31.51 | 2.23 | 80.0 | ± 9.6 % |
|           |   | Y | 54.92  | 111.25 | 28.42 |      | 80.0 |         |
|           |   | Z | 13.32  | 91.56  | 22.86 |      | 80.0 |         |
| 10483-AAA | LTE-TDD (SC-FDMA, 50% RB, 3 MHz, 16-QAM, UL Subframe=2,3,4,7,8,9)   | X | 100.00 | 116.38 | 29.36 | 2.23 | 80.0 | ± 9.6 % |
|           |   | Y | 100.00 | 113.46 | 28.01 |      | 80.0 |         |
|           |   | Z | 11.26  | 84.75  | 19.89 |      | 80.0 |         |
| 10484-AAA | LTE-TDD (SC-FDMA, 50% RB, 3 MHz, 64-QAM, UL Subframe=2,3,4,7,8,9)   | X | 100.00 | 115.90 | 29.19 | 2.23 | 80.0 | ± 9.6 % |
|           |   | Y | 50.77  | 104.49 | 25.86 |      | 80.0 |         |
|           |   | Z | 8.43   | 80.95  | 18.67 |      | 80.0 |         |
| 10485-AAC | LTE-TDD (SC-FDMA, 50% RB, 5 MHz, QPSK, UL Subframe=2,3,4,7,8,9)     | X | 65.25  | 120.82 | 33.02 | 2.23 | 80.0 | ± 9.6 % |
|           |   | Y | 24.29  | 103.39 | 28.10 |      | 80.0 |         |
|           |   | Z | 11.52  | 91.94  | 24.54 |      | 80.0 |         |
| 10486-AAC | LTE-TDD (SC-FDMA, 50% RB, 5 MHz, 16-QAM, UL Subframe=2,3,4,7,8,9)   | X | 10.69  | 87.70  | 22.97 | 2.23 | 80.0 | ± 9.6 % |
|           |   | Y | 8.09   | 82.63  | 21.00 |      | 80.0 |         |
|           |   | Z | 5.71   | 77.63  | 18.94 |      | 80.0 |         |
| 10487-AAC | LTE-TDD (SC-FDMA, 50% RB, 5 MHz, 64-QAM, UL Subframe=2,3,4,7,8,9)   | X | 9.28   | 85.21  | 22.13 | 2.23 | 80.0 | ± 9.6 % |
|           |   | Y | 7.33   | 80.85  | 20.36 |      | 80.0 |         |
|           |   | Z | 5.35   | 76.37  | 18.44 |      | 80.0 |         |
| 10488-AAC | LTE-TDD (SC-FDMA, 50% RB, 10 MHz, QPSK, UL Subframe=2,3,4,7,8,9)    | X | 11.48  | 93.02  | 26.74 | 2.23 | 80.0 | ± 9.6 % |
|           |   | Y | 9.12   | 87.88  | 24.67 |      | 80.0 |         |
|           |   | Z | 6.88   | 83.40  | 22.96 |      | 80.0 |         |
| 10489-AAC | LTE-TDD (SC-FDMA, 50% RB, 10 MHz, 16-QAM, UL Subframe=2,3,4,7,8,9)  | X | 6.05   | 78.94  | 21.72 | 2.23 | 80.0 | ± 9.6 % |
|           |   | Y | 5.74   | 77.30  | 20.79 |      | 80.0 |         |
|           |   | Z | 4.98   | 75.13  | 19.74 |      | 80.0 |         |
| 10490-AAC | LTE-TDD (SC-FDMA, 50% RB, 10 MHz, 64-QAM, UL Subframe=2,3,4,7,8,9)  | X | 5.92   | 78.02  | 21.35 | 2.23 | 80.0 | ± 9.6 % |
|           |   | Y | 5.66   | 76.55  | 20.49 |      | 80.0 |         |
|           |   | Z | 4.96   | 74.57  | 19.51 |      | 80.0 |         |
| 10491-AAC | LTE-TDD (SC-FDMA, 50% RB, 15 MHz, QPSK, UL Subframe=2,3,4,7,8,9)    | X | 7.36   | 83.03  | 23.55 | 2.23 | 80.0 | ± 9.6 % |
|           |   | Y | 6.73   | 80.60  | 22.34 |      | 80.0 |         |
|           |   | Z | 5.73   | 78.11  | 21.25 |      | 80.0 |         |
| 10492-AAC | LTE-TDD (SC-FDMA, 50% RB, 15 MHz, 16-QAM, UL Subframe=2,3,4,7,8,9)  | X | 5.42   | 74.92  | 20.52 | 2.23 | 80.0 | ± 9.6 % |
|           |   | Y | 5.33   | 74.03  | 19.90 |      | 80.0 |         |
|           |   | Z | 4.87   | 72.71  | 19.18 |      | 80.0 |         |

|           |  |   |        |        |       |      |      |         |
|-----------|--|---|--------|--------|-------|------|------|---------|
| 10493-AAC | LTE-TDD (SC-FDMA, 50% RB, 15 MHz, 64-QAM, UL Subframe=2,3,4,7,8,9)   | X | 5.40   | 74.45  | 20.32 | 2.23 | 80.0 | ± 9.6 % |
|           |  | Y | 5.32   | 73.63  | 19.73 |      | 80.0 |         |
|           |  | Z | 4.88   | 72.39  | 19.05 |      | 80.0 |         |
| 10494-AAC | LTE-TDD (SC-FDMA, 50% RB, 20 MHz, QPSK, UL Subframe=2,3,4,7,8,9)     | X | 9.17   | 86.80  | 24.72 | 2.23 | 80.0 | ± 9.6 % |
|           |  | Y | 8.03   | 83.58  | 23.27 |      | 80.0 |         |
|           |  | Z | 6.60   | 80.52  | 22.02 |      | 80.0 |         |
| 10495-AAC | LTE-TDD (SC-FDMA, 50% RB, 20 MHz, 16-QAM, UL Subframe=2,3,4,7,8,9)   | X | 5.52   | 75.46  | 20.81 | 2.23 | 80.0 | ± 9.6 % |
|           |  | Y | 5.42   | 74.52  | 20.17 |      | 80.0 |         |
|           |  | Z | 4.93   | 73.12  | 19.44 |      | 80.0 |         |
| 10496-AAC | LTE-TDD (SC-FDMA, 50% RB, 20 MHz, 64-QAM, UL Subframe=2,3,4,7,8,9)   | X | 5.45   | 74.64  | 20.50 | 2.23 | 80.0 | ± 9.6 % |
|           |  | Y | 5.38   | 73.84  | 19.92 |      | 80.0 |         |
|           |  | Z | 4.93   | 72.57  | 19.24 |      | 80.0 |         |
| 10497-AAA | LTE-TDD (SC-FDMA, 100% RB, 1.4 MHz, QPSK, UL Subframe=2,3,4,7,8,9)   | X | 100.00 | 115.27 | 27.88 | 2.23 | 80.0 | ± 9.6 % |
|           |  | Y | 25.28  | 96.48  | 22.93 |      | 80.0 |         |
|           |  | Z | 5.87   | 78.71  | 17.31 |      | 80.0 |         |
| 10498-AAA | LTE-TDD (SC-FDMA, 100% RB, 1.4 MHz, 16-QAM, UL Subframe=2,3,4,7,8,9) | X | 2.96   | 68.45  | 12.76 | 2.23 | 80.0 | ± 9.6 % |
|           |  | Y | 2.21   | 64.78  | 11.01 |      | 80.0 |         |
|           |  | Z | 1.67   | 62.18  | 9.40  |      | 80.0 |         |
| 10499-AAA | LTE-TDD (SC-FDMA, 100% RB, 1.4 MHz, 64-QAM, UL Subframe=2,3,4,7,8,9) | X | 2.39   | 65.91  | 11.50 | 2.23 | 80.0 | ± 9.6 % |
|           |  | Y | 1.96   | 63.35  | 10.16 |      | 80.0 |         |
|           |  | Z | 1.55   | 61.26  | 8.77  |      | 80.0 |         |
| 10500-AAA | LTE-TDD (SC-FDMA, 100% RB, 3 MHz, QPSK, UL Subframe=2,3,4,7,8,9)     | X | 21.96  | 103.85 | 29.24 | 2.23 | 80.0 | ± 9.6 % |
|           |  | Y | 13.48  | 94.40  | 26.05 |      | 80.0 |         |
|           |  | Z | 8.53   | 87.25  | 23.57 |      | 80.0 |         |
| 10501-AAA | LTE-TDD (SC-FDMA, 100% RB, 3 MHz, 16-QAM, UL Subframe=2,3,4,7,8,9)   | X | 8.02   | 83.54  | 22.29 | 2.23 | 80.0 | ± 9.6 % |
|           |  | Y | 6.90   | 80.32  | 20.86 |      | 80.0 |         |
|           |  | Z | 5.43   | 76.80  | 19.30 |      | 80.0 |         |
| 10502-AAA | LTE-TDD (SC-FDMA, 100% RB, 3 MHz, 64-QAM, UL Subframe=2,3,4,7,8,9)   | X | 7.77   | 82.58  | 21.87 | 2.23 | 80.0 | ± 9.6 % |
|           |  | Y | 6.74   | 79.56  | 20.50 |      | 80.0 |         |
|           |  | Z | 5.37   | 76.23  | 19.00 |      | 80.0 |         |
| 10503-AAC | LTE-TDD (SC-FDMA, 100% RB, 5 MHz, QPSK, UL Subframe=2,3,4,7,8,9)     | X | 11.17  | 92.54  | 26.57 | 2.23 | 80.0 | ± 9.6 % |
|           |  | Y | 8.90   | 87.45  | 24.51 |      | 80.0 |         |
|           |  | Z | 6.74   | 83.07  | 22.83 |      | 80.0 |         |
| 10504-AAC | LTE-TDD (SC-FDMA, 100% RB, 5 MHz, 16-QAM, UL Subframe=2,3,4,7,8,9)   | X | 6.00   | 78.78  | 21.64 | 2.23 | 80.0 | ± 9.6 % |
|           |  | Y | 5.69   | 77.13  | 20.71 |      | 80.0 |         |
|           |  | Z | 4.94   | 74.99  | 19.66 |      | 80.0 |         |
| 10505-AAC | LTE-TDD (SC-FDMA, 100% RB, 5 MHz, 64-QAM, UL Subframe=2,3,4,7,8,9)   | X | 5.88   | 77.87  | 21.28 | 2.23 | 80.0 | ± 9.6 % |
|           |  | Y | 5.62   | 76.40  | 20.42 |      | 80.0 |         |
|           |  | Z | 4.93   | 74.45  | 19.44 |      | 80.0 |         |
| 10506-AAC | LTE-TDD (SC-FDMA, 100% RB, 10 MHz, QPSK, UL Subframe=2,3,4,7,8,9)    | X | 9.03   | 86.51  | 24.60 | 2.23 | 80.0 | ± 9.6 % |
|           |  | Y | 7.91   | 83.32  | 23.16 |      | 80.0 |         |
|           |  | Z | 6.52   | 80.31  | 21.93 |      | 80.0 |         |
| 10507-AAC | LTE-TDD (SC-FDMA, 100% RB, 10 MHz, 16-QAM, UL Subframe=2,3,4,7,8,9)  | X | 5.50   | 75.38  | 20.77 | 2.23 | 80.0 | ± 9.6 % |
|           |  | Y | 5.39   | 74.44  | 20.13 |      | 80.0 |         |
|           |  | Z | 4.91   | 73.05  | 19.40 |      | 80.0 |         |

|           |   |   |        |        |       |      |       |         |
|-----------|---|---|--------|--------|-------|------|-------|---------|
| 10508-AAC | LTE-TDD (SC-FDMA, 100% RB, 10 MHz, 64-QAM, UL Subframe=2,3,4,7,8,9) | X | 5.43   | 74.55  | 20.45 | 2.23 | 80.0  | ± 9.6 % |
|           |   | Y | 5.35   | 73.74  | 19.86 |      | 80.0  |         |
|           |   | Z | 4.91   | 72.49  | 19.19 |      | 80.0  |         |
| 10509-AAC | LTE-TDD (SC-FDMA, 100% RB, 15 MHz, QPSK, UL Subframe=2,3,4,7,8,9)   | X | 7.27   | 80.16  | 22.31 | 2.23 | 80.0  | ± 9.6 % |
|           |   | Y | 6.86   | 78.46  | 21.40 |      | 80.0  |         |
|           |   | Z | 6.07   | 76.60  | 20.55 |      | 80.0  |         |
| 10510-AAC | LTE-TDD (SC-FDMA, 100% RB, 15 MHz, 16-QAM, UL Subframe=2,3,4,7,8,9) | X | 5.60   | 73.37  | 20.04 | 2.23 | 80.0  | ± 9.6 % |
|           |   | Y | 5.56   | 72.76  | 19.56 |      | 80.0  |         |
|           |   | Z | 5.19   | 71.77  | 19.01 |      | 80.0  |         |
| 10511-AAC | LTE-TDD (SC-FDMA, 100% RB, 15 MHz, 64-QAM, UL Subframe=2,3,4,7,8,9) | X | 5.57   | 72.82  | 19.83 | 2.23 | 80.0  | ± 9.6 % |
|           |   | Y | 5.55   | 72.29  | 19.39 |      | 80.0  |         |
|           |   | Z | 5.21   | 71.39  | 18.87 |      | 80.0  |         |
| 10512-AAC | LTE-TDD (SC-FDMA, 100% RB, 20 MHz, QPSK, UL Subframe=2,3,4,7,8,9)   | X | 8.90   | 84.26  | 23.64 | 2.23 | 80.0  | ± 9.6 % |
|           |   | Y | 8.02   | 81.72  | 22.45 |      | 80.0  |         |
|           |   | Z | 6.83   | 79.22  | 21.40 |      | 80.0  |         |
| 10513-AAC | LTE-TDD (SC-FDMA, 100% RB, 20 MHz, 16-QAM, UL Subframe=2,3,4,7,8,9) | X | 5.59   | 74.00  | 20.32 | 2.23 | 80.0  | ± 9.6 % |
|           |   | Y | 5.54   | 73.30  | 19.79 |      | 80.0  |         |
|           |   | Z | 5.13   | 72.20  | 19.19 |      | 80.0  |         |
| 10514-AAC | LTE-TDD (SC-FDMA, 100% RB, 20 MHz, 64-QAM, UL Subframe=2,3,4,7,8,9) | X | 5.48   | 73.14  | 20.00 | 2.23 | 80.0  | ± 9.6 % |
|           |   | Y | 5.45   | 72.55  | 19.53 |      | 80.0  |         |
|           |   | Z | 5.09   | 71.56  | 18.98 |      | 80.0  |         |
| 10515-AAA | IEEE 802.11b WiFi 2.4 GHz (DSSS, 2 Mbps, 99pc duty cycle)           | X | 1.15   | 67.44  | 18.30 | 0.00 | 150.0 | ± 9.6 % |
|           |   | Y | 1.10   | 66.10  | 17.12 |      | 150.0 |         |
|           |   | Z | 1.04   | 64.87  | 15.98 |      | 150.0 |         |
| 10516-AAA | IEEE 802.11b WiFi 2.4 GHz (DSSS, 5.5 Mbps, 99pc duty cycle)         | X | 100.00 | 185.02 | 53.92 | 0.00 | 150.0 | ± 9.6 % |
|           |   | Y | 4.08   | 110.19 | 34.01 |      | 150.0 |         |
|           |   | Z | 1.21   | 84.34  | 24.35 |      | 150.0 |         |
| 10517-AAA | IEEE 802.11b WiFi 2.4 GHz (DSSS, 11 Mbps, 99pc duty cycle)          | X | 1.23   | 74.63  | 21.82 | 0.00 | 150.0 | ± 9.6 % |
|           |   | Y | 1.06   | 70.88  | 19.41 |      | 150.0 |         |
|           |   | Z | 0.94   | 68.06  | 17.43 |      | 150.0 |         |
| 10518-AAA | IEEE 802.11a/h WiFi 5 GHz (OFDM, 9 Mbps, 99pc duty cycle)           | X | 4.59   | 67.92  | 17.08 | 0.00 | 150.0 | ± 9.6 % |
|           |   | Y | 4.55   | 67.66  | 16.83 |      | 150.0 |         |
|           |   | Z | 4.47   | 67.43  | 16.55 |      | 150.0 |         |
| 10519-AAA | IEEE 802.11a/h WiFi 5 GHz (OFDM, 12 Mbps, 99pc duty cycle)          | X | 4.75   | 68.08  | 17.16 | 0.00 | 150.0 | ± 9.6 % |
|           |   | Y | 4.71   | 67.83  | 16.91 |      | 150.0 |         |
|           |   | Z | 4.62   | 67.60  | 16.63 |      | 150.0 |         |
| 10520-AAA | IEEE 802.11a/h WiFi 5 GHz (OFDM, 18 Mbps, 99pc duty cycle)          | X | 4.61   | 68.08  | 17.11 | 0.00 | 150.0 | ± 9.6 % |
|           |   | Y | 4.57   | 67.81  | 16.85 |      | 150.0 |         |
|           |   | Z | 4.48   | 67.55  | 16.56 |      | 150.0 |         |
| 10521-AAA | IEEE 802.11a/h WiFi 5 GHz (OFDM, 24 Mbps, 99pc duty cycle)          | X | 4.55   | 68.08  | 17.11 | 0.00 | 150.0 | ± 9.6 % |
|           |   | Y | 4.50   | 67.80  | 16.85 |      | 150.0 |         |
|           |   | Z | 4.42   | 67.54  | 16.55 |      | 150.0 |         |
| 10522-AAA | IEEE 802.11a/h WiFi 5 GHz (OFDM, 36 Mbps, 99pc duty cycle)          | X | 4.61   | 68.22  | 17.21 | 0.00 | 150.0 | ± 9.6 % |
|           |   | Y | 4.56   | 67.94  | 16.95 |      | 150.0 |         |
|           |   | Z | 4.47   | 67.67  | 16.65 |      | 150.0 |         |

|           |  |   |      |       |       |      |       |         |
|-----------|--|---|------|-------|-------|------|-------|---------|
| 10523-AAA | IEEE 802.11a/h WiFi 5 GHz (OFDM, 48 Mbps, 99pc duty cycle) | X | 4.52 | 68.18 | 17.12 | 0.00 | 150.0 | ± 9.6 % |
|           |  | Y | 4.48 | 67.89 | 16.85 |      | 150.0 |         |
|           |  | Z | 4.39 | 67.64 | 16.56 |      | 150.0 |         |
| 10524-AAA | IEEE 802.11a/h WiFi 5 GHz (OFDM, 54 Mbps, 99pc duty cycle) | X | 4.56 | 68.16 | 17.20 | 0.00 | 150.0 | ± 9.6 % |
|           |  | Y | 4.51 | 67.87 | 16.93 |      | 150.0 |         |
|           |  | Z | 4.42 | 67.62 | 16.64 |      | 150.0 |         |
| 10525-AAA | IEEE 802.11ac WiFi (20MHz, MCS0, 99pc duty cycle)          | X | 4.58 | 67.22 | 16.79 | 0.00 | 150.0 | ± 9.6 % |
|           |  | Y | 4.53 | 66.96 | 16.53 |      | 150.0 |         |
|           |  | Z | 4.45 | 66.71 | 16.25 |      | 150.0 |         |
| 10526-AAA | IEEE 802.11ac WiFi (20MHz, MCS1, 99pc duty cycle)          | X | 4.73 | 67.55 | 16.92 | 0.00 | 150.0 | ± 9.6 % |
|           |  | Y | 4.68 | 67.28 | 16.66 |      | 150.0 |         |
|           |  | Z | 4.58 | 67.01 | 16.37 |      | 150.0 |         |
| 10527-AAA | IEEE 802.11ac WiFi (20MHz, MCS2, 99pc duty cycle)          | X | 4.66 | 67.55 | 16.87 | 0.00 | 150.0 | ± 9.6 % |
|           |  | Y | 4.61 | 67.26 | 16.61 |      | 150.0 |         |
|           |  | Z | 4.51 | 66.98 | 16.31 |      | 150.0 |         |
| 10528-AAA | IEEE 802.11ac WiFi (20MHz, MCS3, 99pc duty cycle)          | X | 4.67 | 67.56 | 16.90 | 0.00 | 150.0 | ± 9.6 % |
|           |  | Y | 4.62 | 67.27 | 16.64 |      | 150.0 |         |
|           |  | Z | 4.53 | 67.00 | 16.34 |      | 150.0 |         |
| 10529-AAA | IEEE 802.11ac WiFi (20MHz, MCS4, 99pc duty cycle)          | X | 4.67 | 67.56 | 16.90 | 0.00 | 150.0 | ± 9.6 % |
|           |  | Y | 4.62 | 67.27 | 16.64 |      | 150.0 |         |
|           |  | Z | 4.53 | 67.00 | 16.34 |      | 150.0 |         |
| 10531-AAA | IEEE 802.11ac WiFi (20MHz, MCS6, 99pc duty cycle)          | X | 4.65 | 67.64 | 16.91 | 0.00 | 150.0 | ± 9.6 % |
|           |  | Y | 4.60 | 67.34 | 16.64 |      | 150.0 |         |
|           |  | Z | 4.50 | 67.04 | 16.33 |      | 150.0 |         |
| 10532-AAA | IEEE 802.11ac WiFi (20MHz, MCS7, 99pc duty cycle)          | X | 4.52 | 67.51 | 16.86 | 0.00 | 150.0 | ± 9.6 % |
|           |  | Y | 4.47 | 67.22 | 16.59 |      | 150.0 |         |
|           |  | Z | 4.37 | 66.91 | 16.27 |      | 150.0 |         |
| 10533-AAA | IEEE 802.11ac WiFi (20MHz, MCS8, 99pc duty cycle)          | X | 4.68 | 67.65 | 16.91 | 0.00 | 150.0 | ± 9.6 % |
|           |  | Y | 4.63 | 67.36 | 16.65 |      | 150.0 |         |
|           |  | Z | 4.53 | 67.08 | 16.35 |      | 150.0 |         |
| 10534-AAA | IEEE 802.11ac WiFi (40MHz, MCS0, 99pc duty cycle)          | X | 5.20 | 67.39 | 16.83 | 0.00 | 150.0 | ± 9.6 % |
|           |  | Y | 5.16 | 67.18 | 16.61 |      | 150.0 |         |
|           |  | Z | 5.07 | 66.93 | 16.35 |      | 150.0 |         |
| 10535-AAA | IEEE 802.11ac WiFi (40MHz, MCS1, 99pc duty cycle)          | X | 5.27 | 67.58 | 16.92 | 0.00 | 150.0 | ± 9.6 % |
|           |  | Y | 5.22 | 67.35 | 16.70 |      | 150.0 |         |
|           |  | Z | 5.12 | 67.09 | 16.43 |      | 150.0 |         |
| 10536-AAA | IEEE 802.11ac WiFi (40MHz, MCS2, 99pc duty cycle)          | X | 5.15 | 67.59 | 16.91 | 0.00 | 150.0 | ± 9.6 % |
|           |  | Y | 5.11 | 67.36 | 16.68 |      | 150.0 |         |
|           |  | Z | 5.02 | 67.10 | 16.41 |      | 150.0 |         |
| 10537-AAA | IEEE 802.11ac WiFi (40MHz, MCS3, 99pc duty cycle)          | X | 5.20 | 67.53 | 16.88 | 0.00 | 150.0 | ± 9.6 % |
|           |  | Y | 5.16 | 67.30 | 16.66 |      | 150.0 |         |
|           |  | Z | 5.07 | 67.07 | 16.40 |      | 150.0 |         |
| 10538-AAA | IEEE 802.11ac WiFi (40MHz, MCS4, 99pc duty cycle)          | X | 5.27 | 67.48 | 16.89 | 0.00 | 150.0 | ± 9.6 % |
|           |  | Y | 5.23 | 67.27 | 16.67 |      | 150.0 |         |
|           |  | Z | 5.14 | 67.03 | 16.42 |      | 150.0 |         |
| 10540-AAA | IEEE 802.11ac WiFi (40MHz, MCS6, 99pc duty cycle)          | X | 5.20 | 67.48 | 16.91 | 0.00 | 150.0 | ± 9.6 % |
|           |  | Y | 5.16 | 67.26 | 16.69 |      | 150.0 |         |
|           |  | Z | 5.07 | 67.00 | 16.42 |      | 150.0 |         |

|           |  |   |      |       |       |      |       |         |
|-----------|--|---|------|-------|-------|------|-------|---------|
| 10541-AAA | IEEE 802.11ac WiFi (40MHz, MCS7, 99pc duty cycle)  | X | 5.18 | 67.34 | 16.82 | 0.00 | 150.0 | ± 9.6 % |
|           |  | Y | 5.14 | 67.12 | 16.61 |      | 150.0 |         |
|           |  | Z | 5.05 | 66.89 | 16.35 |      | 150.0 |         |
| 10542-AAA | IEEE 802.11ac WiFi (40MHz, MCS8, 99pc duty cycle)  | X | 5.33 | 67.42 | 16.87 | 0.00 | 150.0 | ± 9.6 % |
|           |  | Y | 5.29 | 67.21 | 16.66 |      | 150.0 |         |
|           |  | Z | 5.20 | 66.99 | 16.41 |      | 150.0 |         |
| 10543-AAA | IEEE 802.11ac WiFi (40MHz, MCS9, 99pc duty cycle)  | X | 5.40 | 67.44 | 16.90 | 0.00 | 150.0 | ± 9.6 % |
|           |  | Y | 5.36 | 67.24 | 16.70 |      | 150.0 |         |
|           |  | Z | 5.27 | 67.04 | 16.47 |      | 150.0 |         |
| 10544-AAA | IEEE 802.11ac WiFi (80MHz, MCS0, 99pc duty cycle)  | X | 5.53 | 67.39 | 16.75 | 0.00 | 150.0 | ± 9.6 % |
|           |  | Y | 5.49 | 67.20 | 16.56 |      | 150.0 |         |
|           |  | Z | 5.41 | 66.99 | 16.32 |      | 150.0 |         |
| 10545-AAA | IEEE 802.11ac WiFi (80MHz, MCS1, 99pc duty cycle)  | X | 5.74 | 67.91 | 16.97 | 0.00 | 150.0 | ± 9.6 % |
|           |  | Y | 5.70 | 67.70 | 16.77 |      | 150.0 |         |
|           |  | Z | 5.60 | 67.47 | 16.52 |      | 150.0 |         |
| 10546-AAA | IEEE 802.11ac WiFi (80MHz, MCS2, 99pc duty cycle)  | X | 5.57 | 67.55 | 16.80 | 0.00 | 150.0 | ± 9.6 % |
|           |  | Y | 5.53 | 67.35 | 16.60 |      | 150.0 |         |
|           |  | Z | 5.45 | 67.13 | 16.36 |      | 150.0 |         |
| 10547-AAA | IEEE 802.11ac WiFi (80MHz, MCS3, 99pc duty cycle)  | X | 5.66 | 67.65 | 16.84 | 0.00 | 150.0 | ± 9.6 % |
|           |  | Y | 5.62 | 67.45 | 16.64 |      | 150.0 |         |
|           |  | Z | 5.53 | 67.23 | 16.41 |      | 150.0 |         |
| 10548-AAA | IEEE 802.11ac WiFi (80MHz, MCS4, 99pc duty cycle)  | X | 5.90 | 68.59 | 17.29 | 0.00 | 150.0 | ± 9.6 % |
|           |  | Y | 5.84 | 68.33 | 17.06 |      | 150.0 |         |
|           |  | Z | 5.71 | 67.98 | 16.76 |      | 150.0 |         |
| 10550-AAA | IEEE 802.11ac WiFi (80MHz, MCS6, 99pc duty cycle)  | X | 5.64 | 67.75 | 16.92 | 0.00 | 150.0 | ± 9.6 % |
|           |  | Y | 5.60 | 67.54 | 16.71 |      | 150.0 |         |
|           |  | Z | 5.51 | 67.32 | 16.47 |      | 150.0 |         |
| 10551-AAA | IEEE 802.11ac WiFi (80MHz, MCS7, 99pc duty cycle)  | X | 5.59 | 67.58 | 16.79 | 0.00 | 150.0 | ± 9.6 % |
|           |  | Y | 5.55 | 67.38 | 16.59 |      | 150.0 |         |
|           |  | Z | 5.45 | 67.11 | 16.33 |      | 150.0 |         |
| 10552-AAA | IEEE 802.11ac WiFi (80MHz, MCS8, 99pc duty cycle)  | X | 5.54 | 67.49 | 16.75 | 0.00 | 150.0 | ± 9.6 % |
|           |  | Y | 5.50 | 67.29 | 16.55 |      | 150.0 |         |
|           |  | Z | 5.42 | 67.10 | 16.32 |      | 150.0 |         |
| 10553-AAA | IEEE 802.11ac WiFi (80MHz, MCS9, 99pc duty cycle)  | X | 5.60 | 67.45 | 16.75 | 0.00 | 150.0 | ± 9.6 % |
|           |  | Y | 5.56 | 67.25 | 16.56 |      | 150.0 |         |
|           |  | Z | 5.48 | 67.05 | 16.33 |      | 150.0 |         |
| 10554-AAB | IEEE 802.11ac WiFi (160MHz, MCS0, 99pc duty cycle) | X | 5.95 | 67.70 | 16.80 | 0.00 | 150.0 | ± 9.6 % |
|           |  | Y | 5.91 | 67.51 | 16.61 |      | 150.0 |         |
|           |  | Z | 5.83 | 67.32 | 16.39 |      | 150.0 |         |
| 10555-AAB | IEEE 802.11ac WiFi (160MHz, MCS1, 99pc duty cycle) | X | 6.07 | 68.00 | 16.93 | 0.00 | 150.0 | ± 9.6 % |
|           |  | Y | 6.03 | 67.81 | 16.74 |      | 150.0 |         |
|           |  | Z | 5.94 | 67.58 | 16.50 |      | 150.0 |         |
| 10556-AAB | IEEE 802.11ac WiFi (160MHz, MCS2, 99pc duty cycle) | X | 6.11 | 68.10 | 16.97 | 0.00 | 150.0 | ± 9.6 % |
|           |  | Y | 6.07 | 67.90 | 16.78 |      | 150.0 |         |
|           |  | Z | 5.98 | 67.68 | 16.55 |      | 150.0 |         |
| 10557-AAB | IEEE 802.11ac WiFi (160MHz, MCS3, 99pc duty cycle) | X | 6.05 | 67.93 | 16.91 | 0.00 | 150.0 | ± 9.6 % |
|           |  | Y | 6.01 | 67.74 | 16.72 |      | 150.0 |         |
|           |  | Z | 5.92 | 67.53 | 16.49 |      | 150.0 |         |

|           |   |   |        |        |       |      |       |         |
|-----------|---|---|--------|--------|-------|------|-------|---------|
| 10558-AAB | IEEE 802.11ac WiFi (160MHz, MCS4, 99pc duty cycle)              | X | 6.09   | 68.07  | 16.99 | 0.00 | 150.0 | ± 9.6 % |
|           |   | Y | 6.04   | 67.87  | 16.80 |      | 150.0 |         |
|           |   | Z | 5.95   | 67.63  | 16.56 |      | 150.0 |         |
| 10560-AAB | IEEE 802.11ac WiFi (160MHz, MCS6, 99pc duty cycle)              | X | 6.08   | 67.92  | 16.95 | 0.00 | 150.0 | ± 9.6 % |
|           |   | Y | 6.04   | 67.73  | 16.77 |      | 150.0 |         |
|           |   | Z | 5.95   | 67.52  | 16.54 |      | 150.0 |         |
| 10561-AAB | IEEE 802.11ac WiFi (160MHz, MCS7, 99pc duty cycle)              | X | 6.02   | 67.94  | 17.00 | 0.00 | 150.0 | ± 9.6 % |
|           |   | Y | 5.98   | 67.74  | 16.81 |      | 150.0 |         |
|           |   | Z | 5.89   | 67.52  | 16.58 |      | 150.0 |         |
| 10562-AAB | IEEE 802.11ac WiFi (160MHz, MCS8, 99pc duty cycle)              | X | 6.09   | 68.17  | 17.12 | 0.00 | 150.0 | ± 9.6 % |
|           |   | Y | 6.05   | 67.96  | 16.92 |      | 150.0 |         |
|           |   | Z | 5.95   | 67.72  | 16.67 |      | 150.0 |         |
| 10563-AAB | IEEE 802.11ac WiFi (160MHz, MCS9, 99pc duty cycle)              | X | 6.19   | 68.10  | 17.04 | 0.00 | 150.0 | ± 9.6 % |
|           |   | Y | 6.15   | 67.90  | 16.85 |      | 150.0 |         |
|           |   | Z | 6.04   | 67.65  | 16.60 |      | 150.0 |         |
| 10564-AAA | IEEE 802.11g WiFi 2.4 GHz (DSSS-OFDM, 9 Mbps, 99pc duty cycle)  | X | 4.91   | 67.89  | 17.17 | 0.46 | 150.0 | ± 9.6 % |
|           |   | Y | 4.87   | 67.64  | 16.93 |      | 150.0 |         |
|           |   | Z | 4.80   | 67.46  | 16.69 |      | 150.0 |         |
| 10565-AAA | IEEE 802.11g WiFi 2.4 GHz (DSSS-OFDM, 12 Mbps, 99pc duty cycle) | X | 5.11   | 68.27  | 17.46 | 0.46 | 150.0 | ± 9.6 % |
|           |   | Y | 5.08   | 68.05  | 17.23 |      | 150.0 |         |
|           |   | Z | 4.99   | 67.85  | 16.98 |      | 150.0 |         |
| 10566-AAA | IEEE 802.11g WiFi 2.4 GHz (DSSS-OFDM, 18 Mbps, 99pc duty cycle) | X | 4.96   | 68.15  | 17.30 | 0.46 | 150.0 | ± 9.6 % |
|           |   | Y | 4.92   | 67.91  | 17.06 |      | 150.0 |         |
|           |   | Z | 4.83   | 67.70  | 16.81 |      | 150.0 |         |
| 10567-AAA | IEEE 802.11g WiFi 2.4 GHz (DSSS-OFDM, 24 Mbps, 99pc duty cycle) | X | 4.99   | 68.55  | 17.66 | 0.46 | 150.0 | ± 9.6 % |
|           |   | Y | 4.96   | 68.34  | 17.45 |      | 150.0 |         |
|           |   | Z | 4.87   | 68.08  | 17.17 |      | 150.0 |         |
| 10568-AAA | IEEE 802.11g WiFi 2.4 GHz (DSSS-OFDM, 36 Mbps, 99pc duty cycle) | X | 4.88   | 67.99  | 17.11 | 0.46 | 150.0 | ± 9.6 % |
|           |   | Y | 4.83   | 67.70  | 16.84 |      | 150.0 |         |
|           |   | Z | 4.75   | 67.51  | 16.61 |      | 150.0 |         |
| 10569-AAA | IEEE 802.11g WiFi 2.4 GHz (DSSS-OFDM, 48 Mbps, 99pc duty cycle) | X | 4.98   | 68.78  | 17.81 | 0.46 | 150.0 | ± 9.6 % |
|           |   | Y | 4.95   | 68.58  | 17.60 |      | 150.0 |         |
|           |   | Z | 4.86   | 68.32  | 17.31 |      | 150.0 |         |
| 10570-AAA | IEEE 802.11g WiFi 2.4 GHz (DSSS-OFDM, 54 Mbps, 99pc duty cycle) | X | 4.98   | 68.56  | 17.69 | 0.46 | 150.0 | ± 9.6 % |
|           |   | Y | 4.95   | 68.33  | 17.47 |      | 150.0 |         |
|           |   | Z | 4.86   | 68.09  | 17.20 |      | 150.0 |         |
| 10571-AAA | IEEE 802.11b WiFi 2.4 GHz (DSSS, 1 Mbps, 90pc duty cycle)       | X | 1.53   | 70.26  | 19.68 | 0.46 | 130.0 | ± 9.6 % |
|           |   | Y | 1.48   | 68.95  | 18.55 |      | 130.0 |         |
|           |   | Z | 1.37   | 67.40  | 17.39 |      | 130.0 |         |
| 10572-AAA | IEEE 802.11b WiFi 2.4 GHz (DSSS, 2 Mbps, 90pc duty cycle)       | X | 1.59   | 71.46  | 20.33 | 0.46 | 130.0 | ± 9.6 % |
|           |   | Y | 1.53   | 70.00  | 19.13 |      | 130.0 |         |
|           |   | Z | 1.41   | 68.22  | 17.86 |      | 130.0 |         |
| 10573-AAA | IEEE 802.11b WiFi 2.4 GHz (DSSS, 5.5 Mbps, 90pc duty cycle)     | X | 100.00 | 167.17 | 47.85 | 0.46 | 130.0 | ± 9.6 % |
|           |   | Y | 100.00 | 157.87 | 43.89 |      | 130.0 |         |
|           |   | Z | 100.00 | 153.13 | 41.71 |      | 130.0 |         |
| 10574-AAA | IEEE 802.11b WiFi 2.4 GHz (DSSS, 11 Mbps, 90pc duty cycle)      | X | 3.10   | 89.83  | 28.24 | 0.46 | 130.0 | ± 9.6 % |
|           |   | Y | 2.51   | 83.93  | 25.32 |      | 130.0 |         |
|           |   | Z | 1.87   | 77.75  | 22.34 |      | 130.0 |         |

|           |   |   |      |       |       |      |       |         |
|-----------|---|---|------|-------|-------|------|-------|---------|
| 10575-AAA | IEEE 802.11g WiFi 2.4 GHz (DSSS-OFDM, 6 Mbps, 90pc duty cycle)  | X | 4.72 | 67.77 | 17.29 | 0.46 | 130.0 | ± 9.6 % |
|           |   | Y | 4.68 | 67.55 | 17.05 |      | 130.0 |         |
|           |   | Z | 4.61 | 67.35 | 16.79 |      | 130.0 |         |
| 10576-AAA | IEEE 802.11g WiFi 2.4 GHz (DSSS-OFDM, 9 Mbps, 90pc duty cycle)  | X | 4.75 | 67.98 | 17.37 | 0.46 | 130.0 | ± 9.6 % |
|           |   | Y | 4.72 | 67.76 | 17.14 |      | 130.0 |         |
|           |   | Z | 4.64 | 67.55 | 16.88 |      | 130.0 |         |
| 10577-AAA | IEEE 802.11g WiFi 2.4 GHz (DSSS-OFDM, 12 Mbps, 90pc duty cycle) | X | 4.92 | 68.19 | 17.49 | 0.46 | 130.0 | ± 9.6 % |
|           |   | Y | 4.89 | 67.98 | 17.27 |      | 130.0 |         |
|           |   | Z | 4.80 | 67.76 | 17.01 |      | 130.0 |         |
| 10578-AAA | IEEE 802.11g WiFi 2.4 GHz (DSSS-OFDM, 18 Mbps, 90pc duty cycle) | X | 4.83 | 68.39 | 17.63 | 0.46 | 130.0 | ± 9.6 % |
|           |   | Y | 4.80 | 68.19 | 17.41 |      | 130.0 |         |
|           |   | Z | 4.71 | 67.93 | 17.12 |      | 130.0 |         |
| 10579-AAA | IEEE 802.11g WiFi 2.4 GHz (DSSS-OFDM, 24 Mbps, 90pc duty cycle) | X | 4.60 | 67.68 | 16.96 | 0.46 | 130.0 | ± 9.6 % |
|           |   | Y | 4.56 | 67.40 | 16.68 |      | 130.0 |         |
|           |   | Z | 4.48 | 67.20 | 16.44 |      | 130.0 |         |
| 10580-AAA | IEEE 802.11g WiFi 2.4 GHz (DSSS-OFDM, 36 Mbps, 90pc duty cycle) | X | 4.64 | 67.76 | 17.00 | 0.46 | 130.0 | ± 9.6 % |
|           |   | Y | 4.60 | 67.47 | 16.71 |      | 130.0 |         |
|           |   | Z | 4.52 | 67.27 | 16.47 |      | 130.0 |         |
| 10581-AAA | IEEE 802.11g WiFi 2.4 GHz (DSSS-OFDM, 48 Mbps, 90pc duty cycle) | X | 4.75 | 68.54 | 17.65 | 0.46 | 130.0 | ± 9.6 % |
|           |   | Y | 4.72 | 68.32 | 17.42 |      | 130.0 |         |
|           |   | Z | 4.63 | 68.05 | 17.12 |      | 130.0 |         |
| 10582-AAA | IEEE 802.11g WiFi 2.4 GHz (DSSS-OFDM, 54 Mbps, 90pc duty cycle) | X | 4.53 | 67.47 | 16.77 | 0.46 | 130.0 | ± 9.6 % |
|           |   | Y | 4.49 | 67.15 | 16.46 |      | 130.0 |         |
|           |   | Z | 4.41 | 66.99 | 16.24 |      | 130.0 |         |
| 10583-AAA | IEEE 802.11a/h WiFi 5 GHz (OFDM, 6 Mbps, 90pc duty cycle)       | X | 4.72 | 67.77 | 17.29 | 0.46 | 130.0 | ± 9.6 % |
|           |   | Y | 4.68 | 67.55 | 17.05 |      | 130.0 |         |
|           |   | Z | 4.61 | 67.35 | 16.79 |      | 130.0 |         |
| 10584-AAA | IEEE 802.11a/h WiFi 5 GHz (OFDM, 9 Mbps, 90pc duty cycle)       | X | 4.75 | 67.98 | 17.37 | 0.46 | 130.0 | ± 9.6 % |
|           |   | Y | 4.72 | 67.76 | 17.14 |      | 130.0 |         |
|           |   | Z | 4.64 | 67.55 | 16.88 |      | 130.0 |         |
| 10585-AAA | IEEE 802.11a/h WiFi 5 GHz (OFDM, 12 Mbps, 90pc duty cycle)      | X | 4.92 | 68.19 | 17.49 | 0.46 | 130.0 | ± 9.6 % |
|           |   | Y | 4.89 | 67.98 | 17.27 |      | 130.0 |         |
|           |   | Z | 4.80 | 67.76 | 17.01 |      | 130.0 |         |
| 10586-AAA | IEEE 802.11a/h WiFi 5 GHz (OFDM, 18 Mbps, 90pc duty cycle)      | X | 4.83 | 68.39 | 17.63 | 0.46 | 130.0 | ± 9.6 % |
|           |   | Y | 4.80 | 68.19 | 17.41 |      | 130.0 |         |
|           |   | Z | 4.71 | 67.93 | 17.12 |      | 130.0 |         |
| 10587-AAA | IEEE 802.11a/h WiFi 5 GHz (OFDM, 24 Mbps, 90pc duty cycle)      | X | 4.60 | 67.68 | 16.96 | 0.46 | 130.0 | ± 9.6 % |
|           |   | Y | 4.56 | 67.40 | 16.68 |      | 130.0 |         |
|           |   | Z | 4.48 | 67.20 | 16.44 |      | 130.0 |         |
| 10588-AAA | IEEE 802.11a/h WiFi 5 GHz (OFDM, 36 Mbps, 90pc duty cycle)      | X | 4.64 | 67.76 | 17.00 | 0.46 | 130.0 | ± 9.6 % |
|           |   | Y | 4.60 | 67.47 | 16.71 |      | 130.0 |         |
|           |   | Z | 4.52 | 67.27 | 16.47 |      | 130.0 |         |
| 10589-AAA | IEEE 802.11a/h WiFi 5 GHz (OFDM, 48 Mbps, 90pc duty cycle)      | X | 4.75 | 68.54 | 17.65 | 0.46 | 130.0 | ± 9.6 % |
|           |   | Y | 4.72 | 68.32 | 17.42 |      | 130.0 |         |
|           |   | Z | 4.63 | 68.05 | 17.12 |      | 130.0 |         |
| 10590-AAA | IEEE 802.11a/h WiFi 5 GHz (OFDM, 54 Mbps, 90pc duty cycle)      | X | 4.53 | 67.47 | 16.77 | 0.46 | 130.0 | ± 9.6 % |
|           |   | Y | 4.49 | 67.15 | 16.46 |      | 130.0 |         |
|           |   | Z | 4.41 | 66.99 | 16.24 |      | 130.0 |         |

|           |   |   |      |       |       |      |       |         |
|-----------|---|---|------|-------|-------|------|-------|---------|
| 10591-AAA | IEEE 802.11n (HT Mixed, 20MHz, MCS0, 90pc duty cycle) | X | 4.86 | 67.77 | 17.35 | 0.46 | 130.0 | ± 9.6 % |
|           |   | Y | 4.83 | 67.57 | 17.13 |      | 130.0 |         |
|           |   | Z | 4.76 | 67.39 | 16.89 |      | 130.0 |         |
| 10592-AAA | IEEE 802.11n (HT Mixed, 20MHz, MCS1, 90pc duty cycle) | X | 5.00 | 68.10 | 17.48 | 0.46 | 130.0 | ± 9.6 % |
|           |   | Y | 4.97 | 67.89 | 17.26 |      | 130.0 |         |
|           |   | Z | 4.88 | 67.69 | 17.01 |      | 130.0 |         |
| 10593-AAA | IEEE 802.11n (HT Mixed, 20MHz, MCS2, 90pc duty cycle) | X | 4.92 | 68.01 | 17.36 | 0.46 | 130.0 | ± 9.6 % |
|           |   | Y | 4.89 | 67.79 | 17.13 |      | 130.0 |         |
|           |   | Z | 4.80 | 67.59 | 16.88 |      | 130.0 |         |
| 10594-AAA | IEEE 802.11n (HT Mixed, 20MHz, MCS3, 90pc duty cycle) | X | 4.97 | 68.18 | 17.52 | 0.46 | 130.0 | ± 9.6 % |
|           |   | Y | 4.94 | 67.97 | 17.30 |      | 130.0 |         |
|           |   | Z | 4.86 | 67.76 | 17.04 |      | 130.0 |         |
| 10595-AAA | IEEE 802.11n (HT Mixed, 20MHz, MCS4, 90pc duty cycle) | X | 4.95 | 68.18 | 17.45 | 0.46 | 130.0 | ± 9.6 % |
|           |   | Y | 4.91 | 67.96 | 17.21 |      | 130.0 |         |
|           |   | Z | 4.83 | 67.75 | 16.96 |      | 130.0 |         |
| 10596-AAA | IEEE 802.11n (HT Mixed, 20MHz, MCS5, 90pc duty cycle) | X | 4.88 | 68.19 | 17.46 | 0.46 | 130.0 | ± 9.6 % |
|           |   | Y | 4.85 | 67.95 | 17.22 |      | 130.0 |         |
|           |   | Z | 4.76 | 67.74 | 16.97 |      | 130.0 |         |
| 10597-AAA | IEEE 802.11n (HT Mixed, 20MHz, MCS6, 90pc duty cycle) | X | 4.83 | 68.07 | 17.33 | 0.46 | 130.0 | ± 9.6 % |
|           |   | Y | 4.80 | 67.83 | 17.08 |      | 130.0 |         |
|           |   | Z | 4.71 | 67.61 | 16.83 |      | 130.0 |         |
| 10598-AAA | IEEE 802.11n (HT Mixed, 20MHz, MCS7, 90pc duty cycle) | X | 4.82 | 68.29 | 17.59 | 0.46 | 130.0 | ± 9.6 % |
|           |   | Y | 4.79 | 68.08 | 17.36 |      | 130.0 |         |
|           |   | Z | 4.70 | 67.83 | 17.08 |      | 130.0 |         |
| 10599-AAA | IEEE 802.11n (HT Mixed, 40MHz, MCS0, 90pc duty cycle) | X | 5.54 | 68.17 | 17.50 | 0.46 | 130.0 | ± 9.6 % |
|           |   | Y | 5.51 | 67.99 | 17.30 |      | 130.0 |         |
|           |   | Z | 5.43 | 67.80 | 17.08 |      | 130.0 |         |
| 10600-AAA | IEEE 802.11n (HT Mixed, 40MHz, MCS1, 90pc duty cycle) | X | 5.69 | 68.70 | 17.74 | 0.46 | 130.0 | ± 9.6 % |
|           |   | Y | 5.65 | 68.47 | 17.52 |      | 130.0 |         |
|           |   | Z | 5.55 | 68.23 | 17.28 |      | 130.0 |         |
| 10601-AAA | IEEE 802.11n (HT Mixed, 40MHz, MCS2, 90pc duty cycle) | X | 5.56 | 68.37 | 17.60 | 0.46 | 130.0 | ± 9.6 % |
|           |   | Y | 5.53 | 68.17 | 17.39 |      | 130.0 |         |
|           |   | Z | 5.44 | 67.97 | 17.16 |      | 130.0 |         |
| 10602-AAA | IEEE 802.11n (HT Mixed, 40MHz, MCS3, 90pc duty cycle) | X | 5.70 | 68.54 | 17.60 | 0.46 | 130.0 | ± 9.6 % |
|           |   | Y | 5.66 | 68.33 | 17.38 |      | 130.0 |         |
|           |   | Z | 5.58 | 68.16 | 17.17 |      | 130.0 |         |
| 10603-AAA | IEEE 802.11n (HT Mixed, 40MHz, MCS4, 90pc duty cycle) | X | 5.78 | 68.87 | 17.89 | 0.46 | 130.0 | ± 9.6 % |
|           |   | Y | 5.75 | 68.67 | 17.69 |      | 130.0 |         |
|           |   | Z | 5.64 | 68.42 | 17.44 |      | 130.0 |         |
| 10604-AAA | IEEE 802.11n (HT Mixed, 40MHz, MCS5, 90pc duty cycle) | X | 5.65 | 68.51 | 17.70 | 0.46 | 130.0 | ± 9.6 % |
|           |   | Y | 5.62 | 68.31 | 17.49 |      | 130.0 |         |
|           |   | Z | 5.52 | 68.06 | 17.24 |      | 130.0 |         |
| 10605-AAA | IEEE 802.11n (HT Mixed, 40MHz, MCS6, 90pc duty cycle) | X | 5.67 | 68.56 | 17.73 | 0.46 | 130.0 | ± 9.6 % |
|           |   | Y | 5.64 | 68.34 | 17.50 |      | 130.0 |         |
|           |   | Z | 5.54 | 68.11 | 17.26 |      | 130.0 |         |
| 10606-AAA | IEEE 802.11n (HT Mixed, 40MHz, MCS7, 90pc duty cycle) | X | 5.41 | 67.85 | 17.23 | 0.46 | 130.0 | ± 9.6 % |
|           |   | Y | 5.38 | 67.63 | 17.01 |      | 130.0 |         |
|           |   | Z | 5.31 | 67.50 | 16.82 |      | 130.0 |         |



|           |   |   |      |       |       |      |       |         |
|-----------|---|---|------|-------|-------|------|-------|---------|
| 10607-AAA | IEEE 802.11ac WiFi (20MHz, MCS0, 90pc duty cycle) | X | 4.73 | 67.22 | 17.05 | 0.46 | 130.0 | ± 9.6 % |
|           |   | Y | 4.69 | 66.99 | 16.81 |      | 130.0 |         |
|           |   | Z | 4.61 | 66.77 | 16.55 |      | 130.0 |         |
| 10608-AAA | IEEE 802.11ac WiFi (20MHz, MCS1, 90pc duty cycle) | X | 4.89 | 67.59 | 17.21 | 0.46 | 130.0 | ± 9.6 % |
|           |   | Y | 4.85 | 67.36 | 16.97 |      | 130.0 |         |
|           |   | Z | 4.76 | 67.12 | 16.70 |      | 130.0 |         |
| 10609-AAA | IEEE 802.11ac WiFi (20MHz, MCS2, 90pc duty cycle) | X | 4.79 | 67.47 | 17.06 | 0.46 | 130.0 | ± 9.6 % |
|           |   | Y | 4.75 | 67.21 | 16.81 |      | 130.0 |         |
|           |   | Z | 4.66 | 66.98 | 16.54 |      | 130.0 |         |
| 10610-AAA | IEEE 802.11ac WiFi (20MHz, MCS3, 90pc duty cycle) | X | 4.84 | 67.62 | 17.21 | 0.46 | 130.0 | ± 9.6 % |
|           |   | Y | 4.80 | 67.38 | 16.98 |      | 130.0 |         |
|           |   | Z | 4.71 | 67.13 | 16.70 |      | 130.0 |         |
| 10611-AAA | IEEE 802.11ac WiFi (20MHz, MCS4, 90pc duty cycle) | X | 4.75 | 67.43 | 17.07 | 0.46 | 130.0 | ± 9.6 % |
|           |   | Y | 4.71 | 67.19 | 16.83 |      | 130.0 |         |
|           |   | Z | 4.62 | 66.94 | 16.55 |      | 130.0 |         |
| 10612-AAA | IEEE 802.11ac WiFi (20MHz, MCS5, 90pc duty cycle) | X | 4.76 | 67.63 | 17.15 | 0.46 | 130.0 | ± 9.6 % |
|           |   | Y | 4.72 | 67.36 | 16.89 |      | 130.0 |         |
|           |   | Z | 4.62 | 67.11 | 16.61 |      | 130.0 |         |
| 10613-AAA | IEEE 802.11ac WiFi (20MHz, MCS6, 90pc duty cycle) | X | 4.76 | 67.45 | 16.99 | 0.46 | 130.0 | ± 9.6 % |
|           |   | Y | 4.71 | 67.17 | 16.73 |      | 130.0 |         |
|           |   | Z | 4.62 | 66.92 | 16.46 |      | 130.0 |         |
| 10614-AAA | IEEE 802.11ac WiFi (20MHz, MCS7, 90pc duty cycle) | X | 4.71 | 67.65 | 17.23 | 0.46 | 130.0 | ± 9.6 % |
|           |   | Y | 4.68 | 67.41 | 16.99 |      | 130.0 |         |
|           |   | Z | 4.58 | 67.13 | 16.69 |      | 130.0 |         |
| 10615-AAA | IEEE 802.11ac WiFi (20MHz, MCS8, 90pc duty cycle) | X | 4.75 | 67.29 | 16.86 | 0.46 | 130.0 | ± 9.6 % |
|           |   | Y | 4.71 | 67.01 | 16.59 |      | 130.0 |         |
|           |   | Z | 4.62 | 66.80 | 16.34 |      | 130.0 |         |
| 10616-AAA | IEEE 802.11ac WiFi (40MHz, MCS0, 90pc duty cycle) | X | 5.36 | 67.41 | 17.11 | 0.46 | 130.0 | ± 9.6 % |
|           |   | Y | 5.32 | 67.22 | 16.91 |      | 130.0 |         |
|           |   | Z | 5.24 | 67.01 | 16.67 |      | 130.0 |         |
| 10617-AAA | IEEE 802.11ac WiFi (40MHz, MCS1, 90pc duty cycle) | X | 5.44 | 67.66 | 17.21 | 0.46 | 130.0 | ± 9.6 % |
|           |   | Y | 5.40 | 67.45 | 17.00 |      | 130.0 |         |
|           |   | Z | 5.30 | 67.20 | 16.74 |      | 130.0 |         |
| 10618-AAA | IEEE 802.11ac WiFi (40MHz, MCS2, 90pc duty cycle) | X | 5.34 | 67.71 | 17.26 | 0.46 | 130.0 | ± 9.6 % |
|           |   | Y | 5.30 | 67.51 | 17.04 |      | 130.0 |         |
|           |   | Z | 5.21 | 67.26 | 16.79 |      | 130.0 |         |
| 10619-AAA | IEEE 802.11ac WiFi (40MHz, MCS3, 90pc duty cycle) | X | 5.34 | 67.48 | 17.07 | 0.46 | 130.0 | ± 9.6 % |
|           |   | Y | 5.30 | 67.27 | 16.86 |      | 130.0 |         |
|           |   | Z | 5.22 | 67.06 | 16.62 |      | 130.0 |         |
| 10620-AAA | IEEE 802.11ac WiFi (40MHz, MCS4, 90pc duty cycle) | X | 5.41 | 67.47 | 17.11 | 0.46 | 130.0 | ± 9.6 % |
|           |   | Y | 5.38 | 67.26 | 16.90 |      | 130.0 |         |
|           |   | Z | 5.29 | 67.06 | 16.67 |      | 130.0 |         |
| 10621-AAA | IEEE 802.11ac WiFi (40MHz, MCS5, 90pc duty cycle) | X | 5.41 | 67.55 | 17.27 | 0.46 | 130.0 | ± 9.6 % |
|           |   | Y | 5.38 | 67.38 | 17.08 |      | 130.0 |         |
|           |   | Z | 5.29 | 67.14 | 16.82 |      | 130.0 |         |
| 10622-AAA | IEEE 802.11ac WiFi (40MHz, MCS6, 90pc duty cycle) | X | 5.42 | 67.70 | 17.34 | 0.46 | 130.0 | ± 9.6 % |
|           |   | Y | 5.38 | 67.50 | 17.14 |      | 130.0 |         |
|           |   | Z | 5.29 | 67.26 | 16.88 |      | 130.0 |         |

|           |  |   |      |       |       |      |       |         |
|-----------|--|---|------|-------|-------|------|-------|---------|
| 10623-AAA | IEEE 802.11ac WiFi (40MHz, MCS7, 90pc duty cycle)  | X | 5.29 | 67.21 | 16.97 | 0.46 | 130.0 | ± 9.6 % |
|           |  | Y | 5.26 | 67.01 | 16.75 |      | 130.0 |         |
|           |  | Z | 5.17 | 66.80 | 16.52 |      | 130.0 |         |
| 10624-AAA | IEEE 802.11ac WiFi (40MHz, MCS8, 90pc duty cycle)  | X | 5.49 | 67.44 | 17.13 | 0.46 | 130.0 | ± 9.6 % |
|           |  | Y | 5.46 | 67.25 | 16.93 |      | 130.0 |         |
|           |  | Z | 5.37 | 67.04 | 16.70 |      | 130.0 |         |
| 10625-AAA | IEEE 802.11ac WiFi (40MHz, MCS9, 90pc duty cycle)  | X | 5.67 | 67.85 | 17.40 | 0.46 | 130.0 | ± 9.6 % |
|           |  | Y | 5.63 | 67.64 | 17.18 |      | 130.0 |         |
|           |  | Z | 5.49 | 67.29 | 16.88 |      | 130.0 |         |
| 10626-AAA | IEEE 802.11ac WiFi (80MHz, MCS0, 90pc duty cycle)  | X | 5.67 | 67.37 | 17.01 | 0.46 | 130.0 | ± 9.6 % |
|           |  | Y | 5.64 | 67.20 | 16.82 |      | 130.0 |         |
|           |  | Z | 5.56 | 67.01 | 16.60 |      | 130.0 |         |
| 10627-AAA | IEEE 802.11ac WiFi (80MHz, MCS1, 90pc duty cycle)  | X | 5.95 | 68.11 | 17.34 | 0.46 | 130.0 | ± 9.6 % |
|           |  | Y | 5.91 | 67.91 | 17.14 |      | 130.0 |         |
|           |  | Z | 5.81 | 67.67 | 16.90 |      | 130.0 |         |
| 10628-AAA | IEEE 802.11ac WiFi (80MHz, MCS2, 90pc duty cycle)  | X | 5.68 | 67.42 | 16.93 | 0.46 | 130.0 | ± 9.6 % |
|           |  | Y | 5.65 | 67.22 | 16.73 |      | 130.0 |         |
|           |  | Z | 5.56 | 67.03 | 16.51 |      | 130.0 |         |
| 10629-AAA | IEEE 802.11ac WiFi (80MHz, MCS3, 90pc duty cycle)  | X | 5.78 | 67.58 | 17.01 | 0.46 | 130.0 | ± 9.6 % |
|           |  | Y | 5.75 | 67.38 | 16.80 |      | 130.0 |         |
|           |  | Z | 5.66 | 67.19 | 16.59 |      | 130.0 |         |
| 10630-AAA | IEEE 802.11ac WiFi (80MHz, MCS4, 90pc duty cycle)  | X | 6.18 | 69.00 | 17.72 | 0.46 | 130.0 | ± 9.6 % |
|           |  | Y | 6.12 | 68.72 | 17.47 |      | 130.0 |         |
|           |  | Z | 5.97 | 68.32 | 17.16 |      | 130.0 |         |
| 10631-AAA | IEEE 802.11ac WiFi (80MHz, MCS5, 90pc duty cycle)  | X | 6.05 | 68.69 | 17.74 | 0.46 | 130.0 | ± 9.6 % |
|           |  | Y | 6.02 | 68.51 | 17.56 |      | 130.0 |         |
|           |  | Z | 5.90 | 68.19 | 17.27 |      | 130.0 |         |
| 10632-AAA | IEEE 802.11ac WiFi (80MHz, MCS6, 90pc duty cycle)  | X | 5.92 | 68.20 | 17.52 | 0.46 | 130.0 | ± 9.6 % |
|           |  | Y | 5.89 | 68.03 | 17.34 |      | 130.0 |         |
|           |  | Z | 5.79 | 67.79 | 17.09 |      | 130.0 |         |
| 10633-AAA | IEEE 802.11ac WiFi (80MHz, MCS7, 90pc duty cycle)  | X | 5.75 | 67.61 | 17.06 | 0.46 | 130.0 | ± 9.6 % |
|           |  | Y | 5.71 | 67.43 | 16.87 |      | 130.0 |         |
|           |  | Z | 5.61 | 67.18 | 16.62 |      | 130.0 |         |
| 10634-AAA | IEEE 802.11ac WiFi (80MHz, MCS8, 90pc duty cycle)  | X | 5.73 | 67.62 | 17.12 | 0.46 | 130.0 | ± 9.6 % |
|           |  | Y | 5.70 | 67.45 | 16.93 |      | 130.0 |         |
|           |  | Z | 5.61 | 67.26 | 16.71 |      | 130.0 |         |
| 10635-AAA | IEEE 802.11ac WiFi (80MHz, MCS9, 90pc duty cycle)  | X | 5.59 | 66.93 | 16.52 | 0.46 | 130.0 | ± 9.6 % |
|           |  | Y | 5.55 | 66.70 | 16.29 |      | 130.0 |         |
|           |  | Z | 5.48 | 66.56 | 16.11 |      | 130.0 |         |
| 10636-AAB | IEEE 802.11ac WiFi (160MHz, MCS0, 90pc duty cycle) | X | 6.10 | 67.70 | 17.06 | 0.46 | 130.0 | ± 9.6 % |
|           |  | Y | 6.07 | 67.53 | 16.88 |      | 130.0 |         |
|           |  | Z | 5.99 | 67.35 | 16.67 |      | 130.0 |         |
| 10637-AAB | IEEE 802.11ac WiFi (160MHz, MCS1, 90pc duty cycle) | X | 6.26 | 68.11 | 17.25 | 0.46 | 130.0 | ± 9.6 % |
|           |  | Y | 6.22 | 67.93 | 17.06 |      | 130.0 |         |
|           |  | Z | 6.13 | 67.70 | 16.83 |      | 130.0 |         |
| 10638-AAB | IEEE 802.11ac WiFi (160MHz, MCS2, 90pc duty cycle) | X | 6.27 | 68.11 | 17.23 | 0.46 | 130.0 | ± 9.6 % |
|           |  | Y | 6.23 | 67.92 | 17.04 |      | 130.0 |         |
|           |  | Z | 6.14 | 67.72 | 16.82 |      | 130.0 |         |

|           |  |   |        |        |       |      |       |         |
|-----------|--|---|--------|--------|-------|------|-------|---------|
| 10639-AAB | IEEE 802.11ac WiFi (160MHz, MCS3, 90pc duty cycle)     | X | 6.22   | 67.97  | 17.20 | 0.46 | 130.0 | ± 9.6 % |
|           |  | Y | 6.18   | 67.80  | 17.02 |      | 130.0 |         |
|           |  | Z | 6.10   | 67.60  | 16.80 |      | 130.0 |         |
| 10640-AAB | IEEE 802.11ac WiFi (160MHz, MCS4, 90pc duty cycle)     | X | 6.21   | 67.98  | 17.15 | 0.46 | 130.0 | ± 9.6 % |
|           |  | Y | 6.17   | 67.78  | 16.95 |      | 130.0 |         |
|           |  | Z | 6.08   | 67.56  | 16.73 |      | 130.0 |         |
| 10641-AAB | IEEE 802.11ac WiFi (160MHz, MCS5, 90pc duty cycle)     | X | 6.30   | 68.00  | 17.18 | 0.46 | 130.0 | ± 9.6 % |
|           |  | Y | 6.26   | 67.81  | 16.98 |      | 130.0 |         |
|           |  | Z | 6.17   | 67.61  | 16.77 |      | 130.0 |         |
| 10642-AAB | IEEE 802.11ac WiFi (160MHz, MCS6, 90pc duty cycle)     | X | 6.30   | 68.13  | 17.40 | 0.46 | 130.0 | ± 9.6 % |
|           |  | Y | 6.27   | 67.97  | 17.23 |      | 130.0 |         |
|           |  | Z | 6.18   | 67.76  | 17.01 |      | 130.0 |         |
| 10643-AAB | IEEE 802.11ac WiFi (160MHz, MCS7, 90pc duty cycle)     | X | 6.16   | 67.91  | 17.20 | 0.46 | 130.0 | ± 9.6 % |
|           |  | Y | 6.12   | 67.71  | 17.00 |      | 130.0 |         |
|           |  | Z | 6.03   | 67.50  | 16.78 |      | 130.0 |         |
| 10644-AAB | IEEE 802.11ac WiFi (160MHz, MCS8, 90pc duty cycle)     | X | 6.24   | 68.16  | 17.34 | 0.46 | 130.0 | ± 9.6 % |
|           |  | Y | 6.20   | 67.95  | 17.14 |      | 130.0 |         |
|           |  | Z | 6.10   | 67.72  | 16.91 |      | 130.0 |         |
| 10645-AAB | IEEE 802.11ac WiFi (160MHz, MCS9, 90pc duty cycle)     | X | 6.44   | 68.39  | 17.42 | 0.46 | 130.0 | ± 9.6 % |
|           |  | Y | 6.39   | 68.17  | 17.21 |      | 130.0 |         |
|           |  | Z | 6.27   | 67.87  | 16.95 |      | 130.0 |         |
| 10646-AAD | LTE-TDD (SC-FDMA, 1 RB, 5 MHz, QPSK, UL Subframe=2,7)  | X | 100.00 | 154.07 | 50.96 | 9.30 | 60.0  | ± 9.6 % |
|           |  | Y | 100.00 | 149.19 | 48.64 |      | 60.0  |         |
|           |  | Z | 100.00 | 151.77 | 49.64 |      | 60.0  |         |
| 10647-AAC | LTE-TDD (SC-FDMA, 1 RB, 20 MHz, QPSK, UL Subframe=2,7) | X | 100.00 | 155.63 | 51.65 | 9.30 | 60.0  | ± 9.6 % |
|           |  | Y | 100.00 | 150.58 | 49.25 |      | 60.0  |         |
|           |  | Z | 100.00 | 153.26 | 50.29 |      | 60.0  |         |
| 10648-AAA | CDMA2000 (1x Advanced)                                 | X | 7.29   | 96.44  | 23.44 | 0.00 | 150.0 | ± 9.6 % |
|           |  | Y | 1.15   | 71.60  | 14.63 |      | 150.0 |         |
|           |  | Z | 0.73   | 65.79  | 11.39 |      | 150.0 |         |
| 10652-AAB | LTE-TDD (OFDMA, 5 MHz, E-TM 3.1, Clipping 44%)         | X | 4.70   | 71.99  | 19.13 | 2.23 | 80.0  | ± 9.6 % |
|           |  | Y | 4.65   | 71.36  | 18.64 |      | 80.0  |         |
|           |  | Z | 4.32   | 70.31  | 17.98 |      | 80.0  |         |
| 10653-AAB | LTE-TDD (OFDMA, 10 MHz, E-TM 3.1, Clipping 44%)        | X | 4.86   | 69.58  | 18.56 | 2.23 | 80.0  | ± 9.6 % |
|           |  | Y | 4.87   | 69.28  | 18.24 |      | 80.0  |         |
|           |  | Z | 4.66   | 68.67  | 17.81 |      | 80.0  |         |
| 10654-AAB | LTE-TDD (OFDMA, 15 MHz, E-TM 3.1, Clipping 44%)        | X | 4.78   | 68.93  | 18.47 | 2.23 | 80.0  | ± 9.6 % |
|           |  | Y | 4.81   | 68.69  | 18.18 |      | 80.0  |         |
|           |  | Z | 4.62   | 68.14  | 17.78 |      | 80.0  |         |
| 10655-AAB | LTE-TDD (OFDMA, 20 MHz, E-TM 3.1, Clipping 44%)        | X | 4.83   | 68.76  | 18.45 | 2.23 | 80.0  | ± 9.6 % |
|           |  | Y | 4.86   | 68.54  | 18.16 |      | 80.0  |         |
|           |  | Z | 4.67   | 68.01  | 17.79 |      | 80.0  |         |

<sup>E</sup> Uncertainty is determined using the max. deviation from linear response applying rectangular distribution and is expressed for the square of the field value.



Accredited by the Swiss Accreditation Service (SAS)  
The Swiss Accreditation Service is one of the signatories to the EA  
Multilateral Agreement for the recognition of calibration certificates

Accreditation No.: **SCS 0108**

Client **PC Test**

Certificate No: **EX3-7308\_Aug17**

**CALIBRATION CERTIFICATE**

Object: **EX3DV4 - SN:7308**

Calibration procedure(s): **QA CAL-01.v9, QA CAL-14.v4, QA CAL-23.v5, QA CAL-25.v6  
Calibration procedure for dosimetric E-field probes**

*PNV  
8/27/17*

Calibration date: **August 16, 2017**

This calibration certificate documents the traceability to national standards, which realize the physical units of measurements (SI).  
The measurements and the uncertainties with confidence probability are given on the following pages and are part of the certificate.

All calibrations have been conducted in the closed laboratory facility: environment temperature (22 ± 3)°C and humidity < 70%.

Calibration Equipment used (M&TE critical for calibration)

| Primary Standards          | ID               | Cal Date (Certificate No.)        | Scheduled Calibration  |
|----------------------------|------------------|-----------------------------------|------------------------|
| Power meter NRP            | SN: 104778       | 04-Apr-17 (No. 217-02521/02522)   | Apr-18                 |
| Power sensor NRP-Z91       | SN: 103244       | 04-Apr-17 (No. 217-02521)         | Apr-18                 |
| Power sensor NRP-Z91       | SN: 103245       | 04-Apr-17 (No. 217-02525)         | Apr-18                 |
| Reference 20 dB Attenuator | SN: S5277 (20x)  | 07-Apr-17 (No. 217-02528)         | Apr-18                 |
| Reference Probe ES3DV2     | SN: 3013         | 31-Dec-16 (No. ES3-3013_Dec16)    | Dec-17                 |
| DAE4                       | SN: 660          | 7-Dec-16 (No. DAE4-660_Dec16)     | Dec-17                 |
| Secondary Standards        | ID               | Check Date (in house)             | Scheduled Check        |
| Power meter E4419B         | SN: GB41293874   | 06-Apr-16 (in house check Jun-16) | In house check: Jun-18 |
| Power sensor E4412A        | SN: MY41498087   | 06-Apr-16 (in house check Jun-16) | In house check: Jun-18 |
| Power sensor E4412A        | SN: 000110210    | 06-Apr-16 (in house check Jun-16) | In house check: Jun-18 |
| RF generator HP 8648C      | SN: US3642U01700 | 04-Aug-99 (in house check Jun-16) | In house check: Jun-18 |
| Network Analyzer HP 8753E  | SN: US37390585   | 18-Oct-01 (in house check Oct-16) | In house check: Oct-17 |

|   |                              |  |                                   |
|---|------------------------------|--|-----------------------------------|
| Calibrated by:  | Name<br><b>Leif Klysnar</b>  | Function<br><b>Laboratory Technician</b> | Signature<br><i>Leif Klysnar</i>  |
| Approved by:  | Name<br><b>Katja Pokovic</b> | Function<br><b>Technical Manager</b>     | Signature<br><i>Katja Pokovic</i> |
|   |                              |  | Issued: August 16, 2017           |
| This calibration certificate shall not be reproduced except in full without written approval of the laboratory. |                              |  |                                   |



Accredited by the Swiss Accreditation Service (SAS)

Accreditation No.: **SCS 0108**

The Swiss Accreditation Service is one of the signatories to the EA Multilateral Agreement for the recognition of calibration certificates

**Glossary:**

|                          |  |
|--------------------------|--|
| TSL                      | tissue simulating liquid   |
| NORM <sub>x,y,z</sub>    | sensitivity in free space  |
| ConvF                    | sensitivity in TSL / NORM <sub>x,y,z</sub>   |
| DCP                      | diode compression point  |
| CF                       | crest factor (1/duty_cycle) of the RF signal   |
| A, B, C, D               | modulation dependent linearization parameters  |
| Polarization $\varphi$   | $\varphi$ rotation around probe axis   |
| Polarization $\vartheta$ | $\vartheta$ rotation around an axis that is in the plane normal to probe axis (at measurement center), i.e., $\vartheta = 0$ is normal to probe axis |
| Connector Angle          | information used in DASY system to align probe sensor X to the robot coordinate system   |

**Calibration is Performed According to the Following Standards:**

- a) IEEE Std 1528-2013, "IEEE Recommended Practice for Determining the Peak Spatial-Averaged Specific Absorption Rate (SAR) in the Human Head from Wireless Communications Devices: Measurement Techniques", June 2013
- b) IEC 62209-1, "Measurement procedure for the assessment of Specific Absorption Rate (SAR) from hand-held and body-mounted devices used next to the ear (frequency range of 300 MHz to 6 GHz)", July 2016
- c) IEC 62209-2, "Procedure to determine the Specific Absorption Rate (SAR) for wireless communication devices used in close proximity to the human body (frequency range of 30 MHz to 6 GHz)", March 2010
- d) KDB 865664, "SAR Measurement Requirements for 100 MHz to 6 GHz"

**Methods Applied and Interpretation of Parameters:**

- *NORM<sub>x,y,z</sub>*: Assessed for E-field polarization  $\vartheta = 0$  ( $f \leq 900$  MHz in TEM-cell;  $f > 1800$  MHz: R22 waveguide). *NORM<sub>x,y,z</sub>* are only intermediate values, i.e., the uncertainties of *NORM<sub>x,y,z</sub>* does not affect the  $E^2$ -field uncertainty inside TSL (see below *ConvF*).
- *NORM(f)<sub>x,y,z</sub> = NORM<sub>x,y,z</sub> \* frequency\_response* (see Frequency Response Chart). This linearization is implemented in DASY4 software versions later than 4.2. The uncertainty of the frequency response is included in the stated uncertainty of *ConvF*.
- *DCP<sub>x,y,z</sub>*: DCP are numerical linearization parameters assessed based on the data of power sweep with CW signal (no uncertainty required). DCP does not depend on frequency nor media.
- *PAR*: PAR is the Peak to Average Ratio that is not calibrated but determined based on the signal characteristics
- *A<sub>x,y,z</sub>; B<sub>x,y,z</sub>; C<sub>x,y,z</sub>; D<sub>x,y,z</sub>; VR<sub>x,y,z</sub>; A, B, C, D* are numerical linearization parameters assessed based on the data of power sweep for specific modulation signal. The parameters do not depend on frequency nor media. VR is the maximum calibration range expressed in RMS voltage across the diode.
- *ConvF and Boundary Effect Parameters*: Assessed in flat phantom using E-field (or Temperature Transfer Standard for  $f \leq 800$  MHz) and inside waveguide using analytical field distributions based on power measurements for  $f > 800$  MHz. The same setups are used for assessment of the parameters applied for boundary compensation (alpha, depth) of which typical uncertainty values are given. These parameters are used in DASY4 software to improve probe accuracy close to the boundary. The sensitivity in TSL corresponds to *NORM<sub>x,y,z</sub> \* ConvF* whereby the uncertainty corresponds to that given for *ConvF*. A frequency dependent *ConvF* is used in DASY version 4.4 and higher which allows extending the validity from  $\pm 50$  MHz to  $\pm 100$  MHz.
- *Spherical isotropy (3D deviation from isotropy)*: in a field of low gradients realized using a flat phantom exposed by a patch antenna.
- *Sensor Offset*: The sensor offset corresponds to the offset of virtual measurement center from the probe tip (on probe axis). No tolerance required.
- *Connector Angle*: The angle is assessed using the information gained by determining the *NORM<sub>x</sub>* (no uncertainty required).

# Probe EX3DV4

## SN:7308

Manufactured: March 11, 2014  
Calibrated: August 16, 2017

Calibrated for DASY/EASY Systems  
(Note: non-compatible with DASY2 system!)

## DASY/EASY - Parameters of Probe: EX3DV4 - SN:7308

### Basic Calibration Parameters

|   | Sensor X | Sensor Y | Sensor Z | Unc (k=2)     |
|---|----------|----------|----------|---------------|
| Norm ( $\mu\text{V}/(\text{V}/\text{m})^2$ ) <sup>A</sup> | 0.49     | 0.60     | 0.44     | $\pm 10.1 \%$ |
| DCP (mV) <sup>B</sup>                                     | 97.0     | 91.7     | 98.5     |               |

### Modulation Calibration Parameters

| UID | Communication System Name |   | A<br>dB | B<br>dB $\sqrt{\mu\text{V}}$ | C   | D<br>dB | VR<br>mV | Unc <sup>E</sup><br>(k=2) |
|-----|---------------------------|---|---------|------------------------------|-----|---------|----------|---------------------------|
| 0   | CW                        | X | 0.0     | 0.0                          | 1.0 | 0.00    | 134.5    | $\pm 3.3 \%$              |
|     |                           | Y | 0.0     | 0.0                          | 1.0 |         | 130.8    |                           |
|     |                           | Z | 0.0     | 0.0                          | 1.0 |         | 149.9    |                           |

Note: For details on UID parameters see Appendix.

### Sensor Model Parameters

|   | C1<br>fF | C2<br>fF | $\alpha$<br>V <sup>-1</sup> | T1<br>ms.V <sup>-2</sup> | T2<br>ms.V <sup>-1</sup> | T3<br>ms | T4<br>V <sup>-2</sup> | T5<br>V <sup>-1</sup> | T6    |
|---|----------|----------|-----------------------------|--------------------------|--------------------------|----------|-----------------------|-----------------------|-------|
| X | 46.65    | 351.1    | 36.16                       | 14.68                    | 0.000                    | 5.088    | 0.834                 | 0.399                 | 1.005 |
| Y | 52.88    | 402.1    | 36.74                       | 19.55                    | 0.309                    | 5.100    | 0.477                 | 0.605                 | 1.007 |
| Z | 36.70    | 273.3    | 35.48                       | 9.322                    | 0.000                    | 5.034    | 0.373                 | 0.314                 | 1.002 |

The reported uncertainty of measurement is stated as the standard uncertainty of measurement multiplied by the coverage factor k=2, which for a normal distribution corresponds to a coverage probability of approximately 95%.

<sup>A</sup> The uncertainties of Norm X,Y,Z do not affect the E<sup>2</sup>-field uncertainty inside TSL (see Pages 5 and 6).

<sup>B</sup> Numerical linearization parameter: uncertainty not required.

<sup>E</sup> Uncertainty is determined using the max. deviation from linear response applying rectangular distribution and is expressed for the square of the field value.

## DASY/EASY - Parameters of Probe: EX3DV4 - SN:7308

### Calibration Parameter Determined in Head Tissue Simulating Media

| f (MHz) <sup>C</sup> | Relative Permittivity <sup>F</sup> | Conductivity (S/m) <sup>F</sup> | ConvF X | ConvF Y | ConvF Z | Alpha <sup>G</sup> | Depth <sup>G</sup> (mm) | Unc (k=2) |
|----------------------|------------------------------------|---------------------------------|---------|---------|---------|--------------------|-------------------------|-----------|
| 5250                 | 35.9                               | 4.71                            | 5.25    | 5.25    | 5.25    | 0.35               | 1.80                    | ± 13.1 %  |
| 5600                 | 35.5                               | 5.07                            | 4.83    | 4.83    | 4.83    | 0.40               | 1.80                    | ± 13.1 %  |
| 5750                 | 35.4                               | 5.22                            | 5.11    | 5.11    | 5.11    | 0.40               | 1.80                    | ± 13.1 %  |

<sup>C</sup> Frequency validity above 300 MHz of  $\pm 100$  MHz only applies for DASY v4.4 and higher (see Page 2), else it is restricted to  $\pm 50$  MHz. The uncertainty is the RSS of the ConvF uncertainty at calibration frequency and the uncertainty for the indicated frequency band. Frequency validity below 300 MHz is  $\pm 10, 25, 40, 50$  and  $70$  MHz for ConvF assessments at 30, 64, 128, 150 and 220 MHz respectively. Above 5 GHz frequency validity can be extended to  $\pm 110$  MHz.

<sup>F</sup> At frequencies below 3 GHz, the validity of tissue parameters ( $\epsilon$  and  $\sigma$ ) can be relaxed to  $\pm 10\%$  if liquid compensation formula is applied to measured SAR values. At frequencies above 3 GHz, the validity of tissue parameters ( $\epsilon$  and  $\sigma$ ) is restricted to  $\pm 5\%$ . The uncertainty is the RSS of the ConvF uncertainty for indicated target tissue parameters.

<sup>G</sup> Alpha/Depth are determined during calibration. SPEAG warrants that the remaining deviation due to the boundary effect after compensation is always less than  $\pm 1\%$  for frequencies below 3 GHz and below  $\pm 2\%$  for frequencies between 3-6 GHz at any distance larger than half the probe tip diameter from the boundary.



## DASY/EASY - Parameters of Probe: EX3DV4 - SN:7308

### Calibration Parameter Determined in Body Tissue Simulating Media

| f (MHz) <sup>C</sup> | Relative Permittivity <sup>F</sup> | Conductivity (S/m) <sup>F</sup> | ConvF X | ConvF Y | ConvF Z | Alpha <sup>G</sup> | Depth <sup>G</sup> (mm) | Unc (k=2) |
|----------------------|------------------------------------|---------------------------------|---------|---------|---------|--------------------|-------------------------|-----------|
| 750                  | 55.5                               | 0.96                            | 10.39   | 10.39   | 10.39   | 0.54               | 0.85                    | ± 12.0 %  |
| 835                  | 55.2                               | 0.97                            | 10.21   | 10.21   | 10.21   | 0.47               | 0.84                    | ± 12.0 %  |
| 1750                 | 53.4                               | 1.49                            | 8.24    | 8.24    | 8.24    | 0.41               | 0.84                    | ± 12.0 %  |
| 1900                 | 53.3                               | 1.52                            | 7.96    | 7.96    | 7.96    | 0.37               | 0.80                    | ± 12.0 %  |
| 2300                 | 52.9                               | 1.81                            | 7.77    | 7.77    | 7.77    | 0.39               | 0.86                    | ± 12.0 %  |
| 2450                 | 52.7                               | 1.95                            | 7.66    | 7.66    | 7.66    | 0.35               | 0.85                    | ± 12.0 %  |
| 2600                 | 52.5                               | 2.16                            | 7.46    | 7.46    | 7.46    | 0.31               | 0.95                    | ± 12.0 %  |
| 5250                 | 48.9                               | 5.36                            | 4.84    | 4.84    | 4.84    | 0.35               | 1.90                    | ± 13.1 %  |
| 5600                 | 48.5                               | 5.77                            | 4.23    | 4.23    | 4.23    | 0.40               | 1.90                    | ± 13.1 %  |
| 5750                 | 48.3                               | 5.94                            | 4.50    | 4.50    | 4.50    | 0.40               | 1.90                    | ± 13.1 %  |

<sup>C</sup> Frequency validity above 300 MHz of ± 100 MHz only applies for DASY v4.4 and higher (see Page 2), else it is restricted to ± 50 MHz. The uncertainty is the RSS of the ConvF uncertainty at calibration frequency and the uncertainty for the indicated frequency band. Frequency validity below 300 MHz is ± 10, 25, 40, 50 and 70 MHz for ConvF assessments at 30, 64, 128, 150 and 220 MHz respectively. Above 5 GHz frequency validity can be extended to ± 110 MHz.

<sup>F</sup> At frequencies below 3 GHz, the validity of tissue parameters ( $\epsilon$  and  $\sigma$ ) can be relaxed to ± 10% if liquid compensation formula is applied to measured SAR values. At frequencies above 3 GHz, the validity of tissue parameters ( $\epsilon$  and  $\sigma$ ) is restricted to ± 5%. The uncertainty is the RSS of the ConvF uncertainty for indicated target tissue parameters.

<sup>G</sup> Alpha/Depth are determined during calibration. SPEAG warrants that the remaining deviation due to the boundary effect after compensation is always less than ± 1% for frequencies below 3 GHz and below ± 2% for frequencies between 3-6 GHz at any distance larger than half the probe tip diameter from the boundary.

### Frequency Response of E-Field (TEM-Cell:ifi110 EXX, Waveguide: R22)

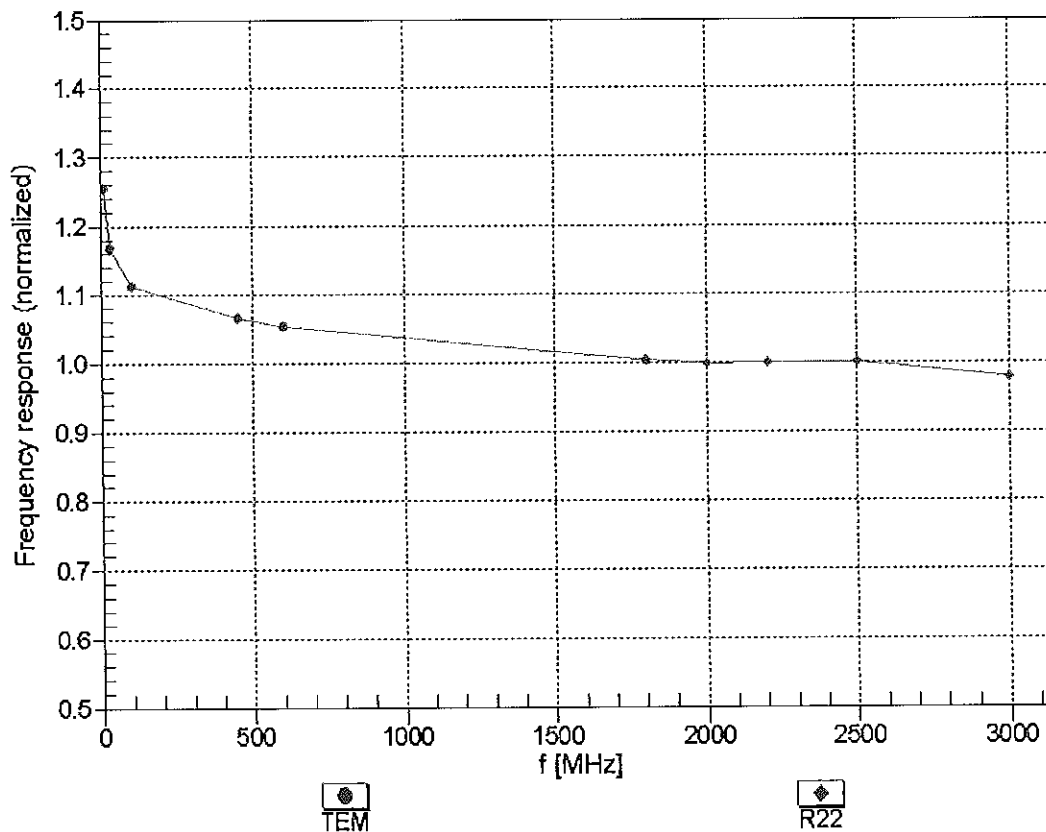

Uncertainty of Frequency Response of E-field:  $\pm 6.3\%$  (k=2)

### Receiving Pattern ( $\phi$ ), $\theta = 0^\circ$

f=600 MHz,TEM

f=1800 MHz,R22

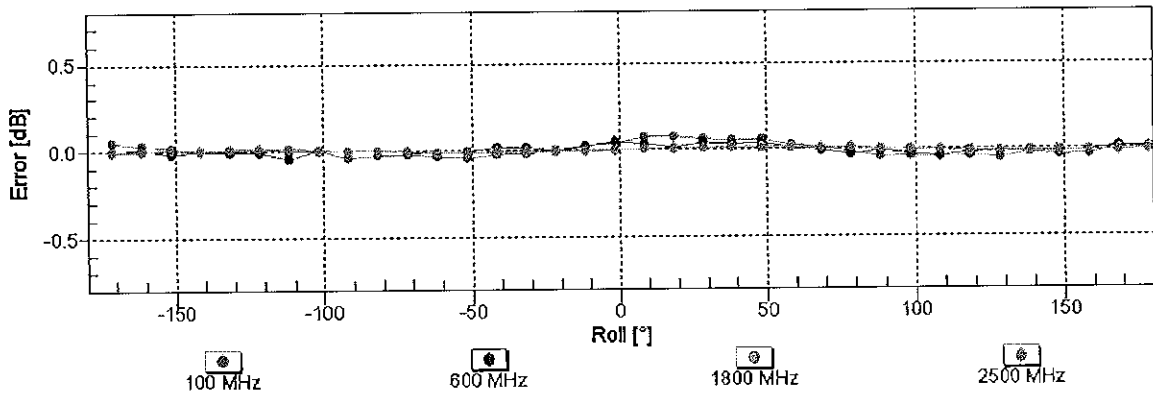
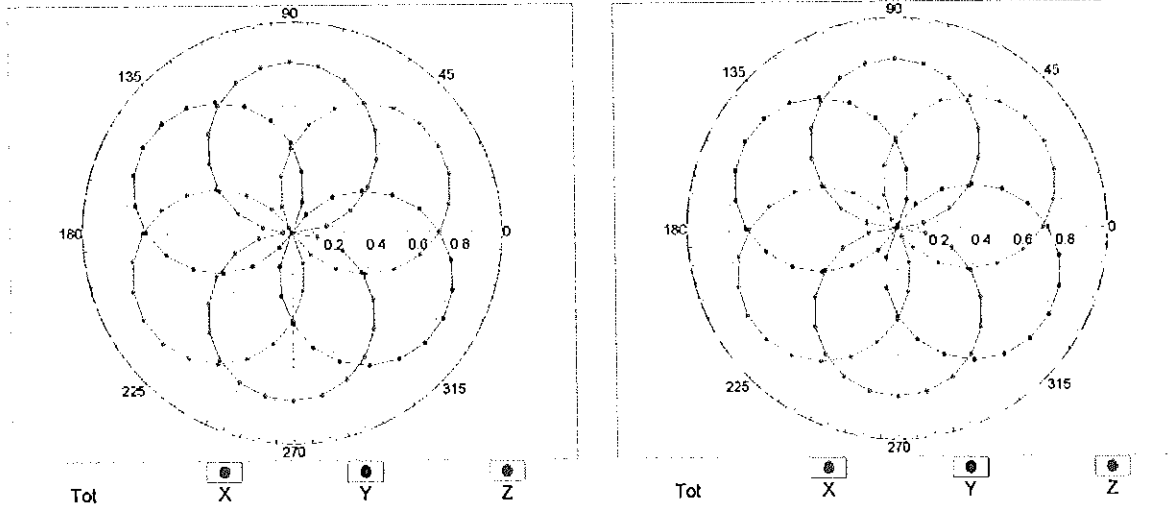

Uncertainty of Axial Isotropy Assessment:  $\pm 0.5\%$  (k=2)

### Dynamic Range $f(SAR_{head})$ (TEM cell , $f_{eval} = 1900$ MHz)

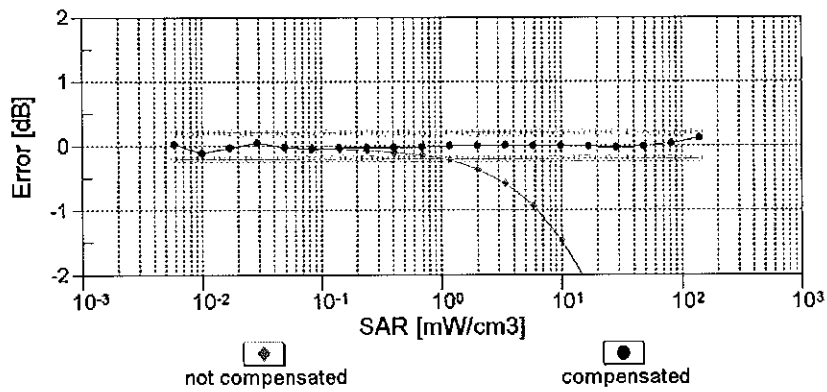
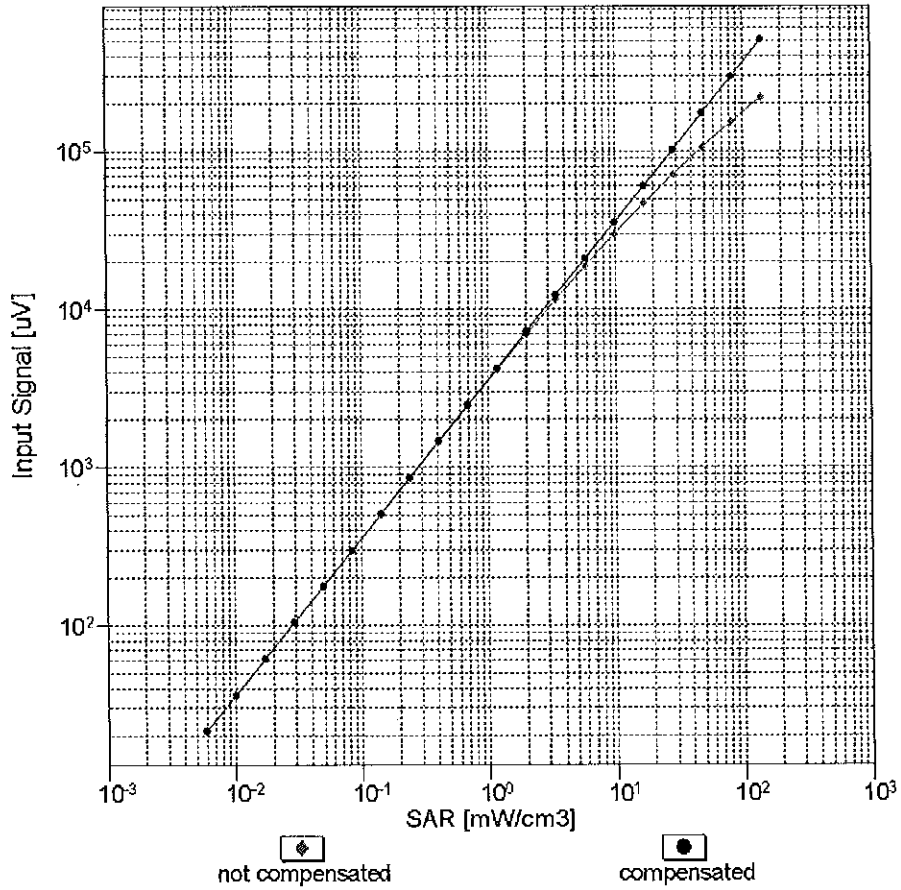

Uncertainty of Linearity Assessment:  $\pm 0.6\%$  (k=2)

# Conversion Factor Assessment

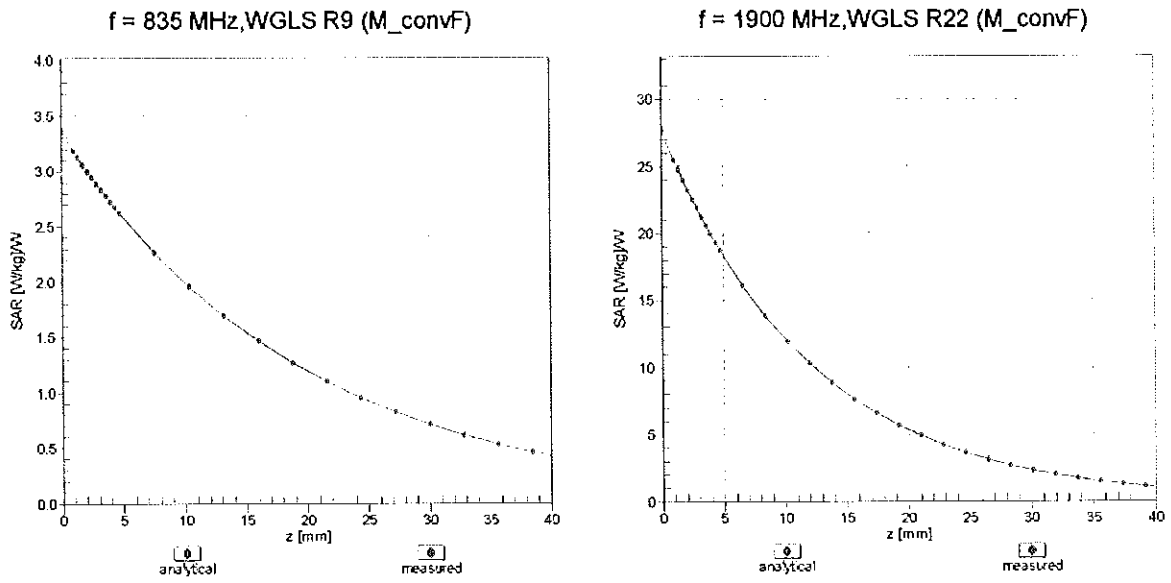

## Deviation from Isotropy in Liquid Error ( $\phi, \theta$ ), f = 900 MHz

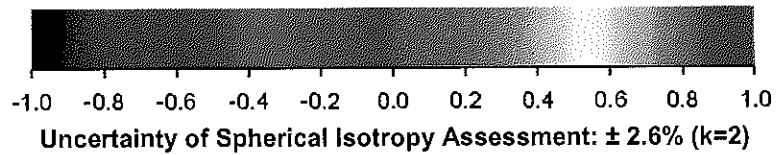
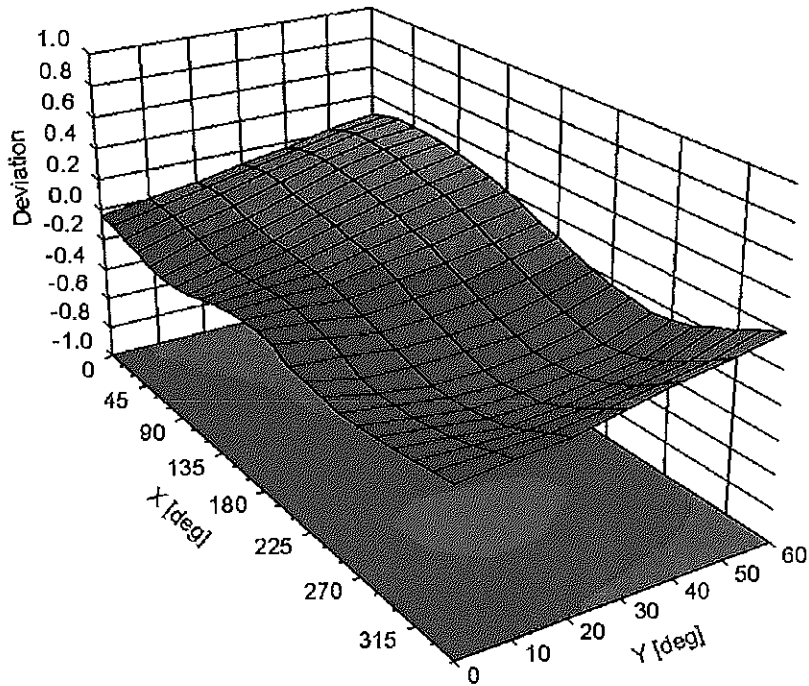

## DASY/EASY - Parameters of Probe: EX3DV4 - SN:7308

### Other Probe Parameters

|   |            |
|---|------------|
| Sensor Arrangement                            | Triangular |
| Connector Angle (°)                           | 108.4      |
| Mechanical Surface Detection Mode             | enabled    |
| Optical Surface Detection Mode                | disabled   |
| Probe Overall Length                          | 337 mm     |
| Probe Body Diameter                           | 10 mm      |
| Tip Length                                    | 9 mm       |
| Tip Diameter                                  | 2.5 mm     |
| Probe Tip to Sensor X Calibration Point       | 1 mm       |
| Probe Tip to Sensor Y Calibration Point       | 1 mm       |
| Probe Tip to Sensor Z Calibration Point       | 1 mm       |
| Recommended Measurement Distance from Surface | 1.4 mm     |

**Appendix: Modulation Calibration Parameters**

| UID           | Communication System Name                     |   | A<br>dB | B<br>dB $\sqrt{\mu V}$ | C     | D<br>dB | VR<br>mV | Max<br>Unc <sup>E</sup><br>(k=2) |
|---------------|---|---|---------|------------------------|-------|---------|----------|----------------------------------|
| 0             | CW  | X | 0.00    | 0.00                   | 1.00  | 0.00    | 134.5    | $\pm 3.3\%$                      |
|               |   | Y | 0.00    | 0.00                   | 1.00  |         | 130.8    |                                  |
|               |   | Z | 0.00    | 0.00                   | 1.00  |         | 149.9    |                                  |
| 10010-<br>CAA | SAR Validation (Square, 100ms, 10ms)          | X | 2.82    | 69.38                  | 11.47 | 10.00   | 20.0     | $\pm 9.6\%$                      |
|               |   | Y | 8.85    | 81.60                  | 16.75 |         | 20.0     |                                  |
|               |   | Z | 1.57    | 63.55                  | 8.34  |         | 20.0     |                                  |
| 10011-<br>CAB | UMTS-FDD (WCDMA)                              | X | 1.10    | 68.34                  | 15.94 | 0.00    | 150.0    | $\pm 9.6\%$                      |
|               |   | Y | 1.03    | 66.61                  | 14.91 |         | 150.0    |                                  |
|               |   | Z | 1.05    | 68.21                  | 15.74 |         | 150.0    |                                  |
| 10012-<br>CAB | IEEE 802.11b WiFi 2.4 GHz (DSSS, 1 Mbps)      | X | 1.19    | 64.20                  | 15.65 | 0.41    | 150.0    | $\pm 9.6\%$                      |
|               |   | Y | 1.20    | 63.83                  | 15.29 |         | 150.0    |                                  |
|               |   | Z | 1.16    | 63.91                  | 15.33 |         | 150.0    |                                  |
| 10013-<br>CAB | IEEE 802.11g WiFi 2.4 GHz (DSSS-OFDM, 6 Mbps) | X | 4.89    | 66.77                  | 17.26 | 1.46    | 150.0    | $\pm 9.6\%$                      |
|               |   | Y | 4.97    | 66.66                  | 17.21 |         | 150.0    |                                  |
|               |   | Z | 4.71    | 66.76                  | 17.06 |         | 150.0    |                                  |
| 10021-<br>DAC | GSM-FDD (TDMA, GMSK)                          | X | 100.00  | 115.21                 | 27.27 | 9.39    | 50.0     | $\pm 9.6\%$                      |
|               |   | Y | 100.00  | 118.99                 | 29.62 |         | 50.0     |                                  |
|               |   | Z | 100.00  | 108.16                 | 23.75 |         | 50.0     |                                  |
| 10023-<br>DAC | GPRS-FDD (TDMA, GMSK, TN 0)                   | X | 100.00  | 114.49                 | 26.98 | 9.57    | 50.0     | $\pm 9.6\%$                      |
|               |   | Y | 100.00  | 118.59                 | 29.46 |         | 50.0     |                                  |
|               |   | Z | 100.00  | 107.44                 | 23.48 |         | 50.0     |                                  |
| 10024-<br>DAC | GPRS-FDD (TDMA, GMSK, TN 0-1)                 | X | 100.00  | 117.36                 | 27.41 | 6.56    | 60.0     | $\pm 9.6\%$                      |
|               |   | Y | 100.00  | 118.20                 | 28.43 |         | 60.0     |                                  |
|               |   | Z | 100.00  | 109.72                 | 23.49 |         | 60.0     |                                  |
| 10025-<br>DAC | EDGE-FDD (TDMA, 8PSK, TN 0)                   | X | 9.43    | 102.43                 | 43.37 | 12.57   | 50.0     | $\pm 9.6\%$                      |
|               |   | Y | 5.76    | 81.81                  | 33.21 |         | 50.0     |                                  |
|               |   | Z | 6.64    | 89.92                  | 37.39 |         | 50.0     |                                  |
| 10026-<br>DAC | EDGE-FDD (TDMA, 8PSK, TN 0-1)                 | X | 12.23   | 103.58                 | 38.33 | 9.56    | 60.0     | $\pm 9.6\%$                      |
|               |   | Y | 13.89   | 103.56                 | 37.54 |         | 60.0     |                                  |
|               |   | Z | 6.87    | 89.09                  | 32.73 |         | 60.0     |                                  |
| 10027-<br>DAC | GPRS-FDD (TDMA, GMSK, TN 0-1-2)               | X | 100.00  | 121.12                 | 28.38 | 4.80    | 80.0     | $\pm 9.6\%$                      |
|               |   | Y | 100.00  | 119.35                 | 28.26 |         | 80.0     |                                  |
|               |   | Z | 100.00  | 113.58                 | 24.47 |         | 80.0     |                                  |
| 10028-<br>DAC | GPRS-FDD (TDMA, GMSK, TN 0-1-2-3)             | X | 100.00  | 126.40                 | 29.97 | 3.55    | 100.0    | $\pm 9.6\%$                      |
|               |   | Y | 100.00  | 121.68                 | 28.61 |         | 100.0    |                                  |
|               |   | Z | 100.00  | 119.83                 | 26.46 |         | 100.0    |                                  |
| 10029-<br>DAC | EDGE-FDD (TDMA, 8PSK, TN 0-1-2)               | X | 6.36    | 85.88                  | 30.18 | 7.80    | 80.0     | $\pm 9.6\%$                      |
|               |   | Y | 7.77    | 88.44                  | 30.64 |         | 80.0     |                                  |
|               |   | Z | 4.37    | 77.58                  | 26.51 |         | 80.0     |                                  |
| 10030-<br>CAA | IEEE 802.15.1 Bluetooth (GFSK, DH1)           | X | 100.00  | 116.71                 | 26.74 | 5.30    | 70.0     | $\pm 9.6\%$                      |
|               |   | Y | 100.00  | 116.86                 | 27.45 |         | 70.0     |                                  |
|               |   | Z | 100.00  | 108.46                 | 22.53 |         | 70.0     |                                  |
| 10031-<br>CAA | IEEE 802.15.1 Bluetooth (GFSK, DH3)           | X | 100.00  | 130.68                 | 30.26 | 1.88    | 100.0    | $\pm 9.6\%$                      |
|               |   | Y | 100.00  | 122.76                 | 27.68 |         | 100.0    |                                  |
|               |   | Z | 100.00  | 121.33                 | 25.72 |         | 100.0    |                                  |

|           |   |   |         |        |       |       |       |         |
|-----------|---|---|---------|--------|-------|-------|-------|---------|
| 10032-CAA | IEEE 802.15.1 Bluetooth (GFSK, DH5)                 | X | 100.00  | 146.47 | 35.43 | 1.17  | 100.0 | ± 9.6 % |
|           |   | Y | 100.00  | 130.05 | 29.64 |       | 100.0 |         |
|           |   | Z | 100.00  | 142.38 | 32.95 |       | 100.0 |         |
| 10033-CAA | IEEE 802.15.1 Bluetooth (PI/4-DQPSK, DH1)           | X | 100.00  | 133.81 | 36.67 | 5.30  | 70.0  | ± 9.6 % |
|           |   | Y | 100.00  | 132.56 | 36.57 |       | 70.0  |         |
|           |   | Z | 18.79   | 102.95 | 27.19 |       | 70.0  |         |
| 10034-CAA | IEEE 802.15.1 Bluetooth (PI/4-DQPSK, DH3)           | X | 7.76    | 92.37  | 23.91 | 1.88  | 100.0 | ± 9.6 % |
|           |   | Y | 6.00    | 87.65  | 22.68 |       | 100.0 |         |
|           |   | Z | 3.22    | 78.87  | 18.00 |       | 100.0 |         |
| 10035-CAA | IEEE 802.15.1 Bluetooth (PI/4-DQPSK, DH5)           | X | 3.37    | 81.04  | 19.87 | 1.17  | 100.0 | ± 9.6 % |
|           |   | Y | 2.89    | 77.85  | 18.94 |       | 100.0 |         |
|           |   | Z | 2.06    | 74.00  | 15.93 |       | 100.0 |         |
| 10036-CAA | IEEE 802.15.1 Bluetooth (8-DPSK, DH1)               | X | 100.00  | 134.35 | 36.91 | 5.30  | 70.0  | ± 9.6 % |
|           |   | Y | 100.00  | 133.01 | 36.79 |       | 70.0  |         |
|           |   | Z | 38.41   | 113.99 | 30.14 |       | 70.0  |         |
| 10037-CAA | IEEE 802.15.1 Bluetooth (8-DPSK, DH3)               | X | 6.72    | 90.40  | 23.29 | 1.88  | 100.0 | ± 9.6 % |
|           |   | Y | 5.52    | 86.51  | 22.28 |       | 100.0 |         |
|           |   | Z | 2.77    | 77.09  | 17.35 |       | 100.0 |         |
| 10038-CAA | IEEE 802.15.1 Bluetooth (8-DPSK, DH5)               | X | 3.40    | 81.53  | 20.18 | 1.17  | 100.0 | ± 9.6 % |
|           |   | Y | 2.93    | 78.34  | 19.24 |       | 100.0 |         |
|           |   | Z | 2.07    | 74.35  | 16.21 |       | 100.0 |         |
| 10039-CAB | CDMA2000 (1xRTT, RC1)                               | X | 2.05    | 73.74  | 16.48 | 0.00  | 150.0 | ± 9.6 % |
|           |   | Y | 1.78    | 70.97  | 15.59 |       | 150.0 |         |
|           |   | Z | 1.68    | 71.87  | 14.68 |       | 150.0 |         |
| 10042-CAB | IS-54 / IS-136 FDD (TDMA/FDM, PI/4-DQPSK, Halfrate) | X | 100.00  | 111.92 | 25.18 | 7.78  | 50.0  | ± 9.6 % |
|           |   | Y | 100.00  | 114.62 | 26.97 |       | 50.0  |         |
|           |   | Z | 100.00  | 105.38 | 21.87 |       | 50.0  |         |
| 10044-CAA | IS-91/EIA/TIA-553 FDD (FDMA, FM)                    | X | 0.00    | 97.13  | 0.41  | 0.00  | 150.0 | ± 9.6 % |
|           |   | Y | 0.00    | 93.19  | 1.28  |       | 150.0 |         |
|           |   | Z | 0.01    | 94.96  | 0.54  |       | 150.0 |         |
| 10048-CAA | DECT (TDD, TDMA/FDM, GFSK, Full Slot, 24)           | X | 100.00  | 111.98 | 26.96 | 13.80 | 25.0  | ± 9.6 % |
|           |   | Y | 100.00  | 121.05 | 31.60 |       | 25.0  |         |
|           |   | Z | 34.07   | 91.91  | 20.28 |       | 25.0  |         |
| 10049-CAA | DECT (TDD, TDMA/FDM, GFSK, Double Slot, 12)         | X | 1284.72 | 142.21 | 32.21 | 10.79 | 40.0  | ± 9.6 % |
|           |   | Y | 100.00  | 117.51 | 29.18 |       | 40.0  |         |
|           |   | Z | 145.96  | 109.32 | 23.74 |       | 40.0  |         |
| 10056-CAA | UMTS-TDD (TD-SCDMA, 1.28 Mcps)                      | X | 100.00  | 128.20 | 35.15 | 9.03  | 50.0  | ± 9.6 % |
|           |   | Y | 100.00  | 128.83 | 35.96 |       | 50.0  |         |
|           |   | Z | 100.00  | 122.10 | 31.77 |       | 50.0  |         |
| 10058-DAC | EDGE-FDD (TDMA, 8PSK, TN 0-1-2-3)                   | X | 4.71    | 78.88  | 26.31 | 6.55  | 100.0 | ± 9.6 % |
|           |   | Y | 5.67    | 81.33  | 26.92 |       | 100.0 |         |
|           |   | Z | 3.54    | 73.15  | 23.60 |       | 100.0 |         |
| 10059-CAB | IEEE 802.11b WiFi 2.4 GHz (DSSS, 2 Mbps)            | X | 1.24    | 65.47  | 16.42 | 0.61  | 110.0 | ± 9.6 % |
|           |   | Y | 1.27    | 65.23  | 16.10 |       | 110.0 |         |
|           |   | Z | 1.17    | 64.77  | 15.84 |       | 110.0 |         |
| 10060-CAB | IEEE 802.11b WiFi 2.4 GHz (DSSS, 5.5 Mbps)          | X | 100.00  | 144.38 | 38.50 | 1.30  | 110.0 | ± 9.6 % |
|           |   | Y | 100.00  | 138.88 | 36.40 |       | 110.0 |         |
|           |   | Z | 13.09   | 112.30 | 30.84 |       | 110.0 |         |



|           |  |   |      |       |       |      |       |         |
|-----------|--|---|------|-------|-------|------|-------|---------|
| 10061-CAB | IEEE 802.11b WiFi 2.4 GHz (DSSS, 11 Mbps)      | X | 4.05 | 88.33 | 25.97 | 2.04 | 110.0 | ± 9.6 % |
|           |  | Y | 4.75 | 88.86 | 25.68 |      | 110.0 |         |
|           |  | Z | 2.16 | 77.73 | 21.68 |      | 110.0 |         |
| 10062-CAB | IEEE 802.11a/h WiFi 5 GHz (OFDM, 6 Mbps)       | X | 4.69 | 66.76 | 16.65 | 0.49 | 100.0 | ± 9.6 % |
|           |  | Y | 4.76 | 66.60 | 16.58 |      | 100.0 |         |
|           |  | Z | 4.53 | 66.78 | 16.51 |      | 100.0 |         |
| 10063-CAB | IEEE 802.11a/h WiFi 5 GHz (OFDM, 9 Mbps)       | X | 4.71 | 66.86 | 16.76 | 0.72 | 100.0 | ± 9.6 % |
|           |  | Y | 4.78 | 66.72 | 16.70 |      | 100.0 |         |
|           |  | Z | 4.54 | 66.86 | 16.60 |      | 100.0 |         |
| 10064-CAB | IEEE 802.11a/h WiFi 5 GHz (OFDM, 12 Mbps)      | X | 4.99 | 67.12 | 16.99 | 0.86 | 100.0 | ± 9.6 % |
|           |  | Y | 5.09 | 67.02 | 16.95 |      | 100.0 |         |
|           |  | Z | 4.78 | 67.06 | 16.80 |      | 100.0 |         |
| 10065-CAB | IEEE 802.11a/h WiFi 5 GHz (OFDM, 18 Mbps)      | X | 4.86 | 67.02 | 17.11 | 1.21 | 100.0 | ± 9.6 % |
|           |  | Y | 4.96 | 66.95 | 17.08 |      | 100.0 |         |
|           |  | Z | 4.65 | 66.90 | 16.87 |      | 100.0 |         |
| 10066-CAB | IEEE 802.11a/h WiFi 5 GHz (OFDM, 24 Mbps)      | X | 4.88 | 67.05 | 17.29 | 1.46 | 100.0 | ± 9.6 % |
|           |  | Y | 4.99 | 66.99 | 17.27 |      | 100.0 |         |
|           |  | Z | 4.65 | 66.88 | 17.02 |      | 100.0 |         |
| 10067-CAB | IEEE 802.11a/h WiFi 5 GHz (OFDM, 36 Mbps)      | X | 5.16 | 67.22 | 17.75 | 2.04 | 100.0 | ± 9.6 % |
|           |  | Y | 5.27 | 67.12 | 17.71 |      | 100.0 |         |
|           |  | Z | 4.93 | 67.13 | 17.49 |      | 100.0 |         |
| 10068-CAB | IEEE 802.11a/h WiFi 5 GHz (OFDM, 48 Mbps)      | X | 5.20 | 67.26 | 17.98 | 2.55 | 100.0 | ± 9.6 % |
|           |  | Y | 5.34 | 67.28 | 18.00 |      | 100.0 |         |
|           |  | Z | 4.95 | 67.02 | 17.64 |      | 100.0 |         |
| 10069-CAB | IEEE 802.11a/h WiFi 5 GHz (OFDM, 54 Mbps)      | X | 5.28 | 67.26 | 18.18 | 2.67 | 100.0 | ± 9.6 % |
|           |  | Y | 5.42 | 67.23 | 18.17 |      | 100.0 |         |
|           |  | Z | 5.02 | 67.05 | 17.83 |      | 100.0 |         |
| 10071-CAB | IEEE 802.11g WiFi 2.4 GHz (DSSS/OFDM, 9 Mbps)  | X | 4.98 | 66.86 | 17.58 | 1.99 | 100.0 | ± 9.6 % |
|           |  | Y | 5.07 | 66.77 | 17.55 |      | 100.0 |         |
|           |  | Z | 4.79 | 66.80 | 17.35 |      | 100.0 |         |
| 10072-CAB | IEEE 802.11g WiFi 2.4 GHz (DSSS/OFDM, 12 Mbps) | X | 4.95 | 67.19 | 17.81 | 2.30 | 100.0 | ± 9.6 % |
|           |  | Y | 5.06 | 67.16 | 17.80 |      | 100.0 |         |
|           |  | Z | 4.74 | 67.03 | 17.53 |      | 100.0 |         |
| 10073-CAB | IEEE 802.11g WiFi 2.4 GHz (DSSS/OFDM, 18 Mbps) | X | 5.00 | 67.34 | 18.16 | 2.83 | 100.0 | ± 9.6 % |
|           |  | Y | 5.12 | 67.33 | 18.16 |      | 100.0 |         |
|           |  | Z | 4.79 | 67.17 | 17.85 |      | 100.0 |         |
| 10074-CAB | IEEE 802.11g WiFi 2.4 GHz (DSSS/OFDM, 24 Mbps) | X | 4.97 | 67.20 | 18.31 | 3.30 | 100.0 | ± 9.6 % |
|           |  | Y | 5.10 | 67.22 | 18.33 |      | 100.0 |         |
|           |  | Z | 4.78 | 67.07 | 17.99 |      | 100.0 |         |
| 10075-CAB | IEEE 802.11g WiFi 2.4 GHz (DSSS/OFDM, 36 Mbps) | X | 5.00 | 67.30 | 18.63 | 3.82 | 90.0  | ± 9.6 % |
|           |  | Y | 5.15 | 67.40 | 18.70 |      | 90.0  |         |
|           |  | Z | 4.78 | 67.05 | 18.23 |      | 90.0  |         |
| 10076-CAB | IEEE 802.11g WiFi 2.4 GHz (DSSS/OFDM, 48 Mbps) | X | 5.00 | 67.05 | 18.74 | 4.15 | 90.0  | ± 9.6 % |
|           |  | Y | 5.14 | 67.12 | 18.78 |      | 90.0  |         |
|           |  | Z | 4.81 | 66.90 | 18.39 |      | 90.0  |         |
| 10077-CAB | IEEE 802.11g WiFi 2.4 GHz (DSSS/OFDM, 54 Mbps) | X | 5.02 | 67.11 | 18.84 | 4.30 | 90.0  | ± 9.6 % |
|           |  | Y | 5.16 | 67.16 | 18.87 |      | 90.0  |         |
|           |  | Z | 4.84 | 66.97 | 18.50 |      | 90.0  |         |

|           |   |   |        |        |       |      |       |         |
|-----------|---|---|--------|--------|-------|------|-------|---------|
| 10081-CAB | CDMA2000 (1xRTT, RC3)                               | X | 0.91   | 67.10  | 13.23 | 0.00 | 150.0 | ± 9.6 % |
|           |   | Y | 0.87   | 65.55  | 12.69 |      | 150.0 |         |
|           |   | Z | 0.76   | 65.80  | 11.60 |      | 150.0 |         |
| 10082-CAB | IS-54 / IS-136 FDD (TDMA/FDM, PI/4-DQPSK, Fullrate) | X | 0.67   | 60.00  | 4.34  | 4.77 | 80.0  | ± 9.6 % |
|           |   | Y | 0.83   | 60.00  | 4.98  |      | 80.0  |         |
|           |   | Z | 1.32   | 62.68  | 4.53  |      | 80.0  |         |
| 10090-DAC | GPRS-FDD (TDMA, GMSK, TN 0-4)                       | X | 100.00 | 117.37 | 27.43 | 6.56 | 60.0  | ± 9.6 % |
|           |   | Y | 100.00 | 118.23 | 28.46 |      | 60.0  |         |
|           |   | Z | 100.00 | 109.70 | 23.50 |      | 60.0  |         |
| 10097-CAB | UMTS-FDD (HSDPA)                                    | X | 1.89   | 68.18  | 16.03 | 0.00 | 150.0 | ± 9.6 % |
|           |   | Y | 1.82   | 67.06  | 15.47 |      | 150.0 |         |
|           |   | Z | 1.87   | 68.73  | 15.97 |      | 150.0 |         |
| 10098-CAB | UMTS-FDD (HSUPA, Subtest 2)                         | X | 1.85   | 68.15  | 16.01 | 0.00 | 150.0 | ± 9.6 % |
|           |   | Y | 1.78   | 67.01  | 15.43 |      | 150.0 |         |
|           |   | Z | 1.83   | 68.68  | 15.95 |      | 150.0 |         |
| 10099-DAC | EDGE-FDD (TDMA, 8PSK, TN 0-4)                       | X | 12.41  | 103.93 | 38.44 | 9.56 | 60.0  | ± 9.6 % |
|           |   | Y | 14.05  | 103.81 | 37.62 |      | 60.0  |         |
|           |   | Z | 6.94   | 89.30  | 32.81 |      | 60.0  |         |
| 10100-CAD | LTE-FDD (SC-FDMA, 100% RB, 20 MHz, QPSK)            | X | 3.20   | 70.68  | 16.98 | 0.00 | 150.0 | ± 9.6 % |
|           |   | Y | 3.15   | 69.96  | 16.53 |      | 150.0 |         |
|           |   | Z | 3.05   | 70.44  | 16.91 |      | 150.0 |         |
| 10101-CAD | LTE-FDD (SC-FDMA, 100% RB, 20 MHz, 16-QAM)          | X | 3.27   | 67.67  | 16.10 | 0.00 | 150.0 | ± 9.6 % |
|           |   | Y | 3.29   | 67.34  | 15.87 |      | 150.0 |         |
|           |   | Z | 3.15   | 67.56  | 16.02 |      | 150.0 |         |
| 10102-CAD | LTE-FDD (SC-FDMA, 100% RB, 20 MHz, 64-QAM)          | X | 3.37   | 67.61  | 16.17 | 0.00 | 150.0 | ± 9.6 % |
|           |   | Y | 3.39   | 67.30  | 15.96 |      | 150.0 |         |
|           |   | Z | 3.26   | 67.54  | 16.10 |      | 150.0 |         |
| 10103-CAD | LTE-TDD (SC-FDMA, 100% RB, 20 MHz, QPSK)            | X | 6.70   | 77.76  | 21.71 | 3.98 | 65.0  | ± 9.6 % |
|           |   | Y | 7.25   | 78.01  | 21.66 |      | 65.0  |         |
|           |   | Z | 5.31   | 74.49  | 20.24 |      | 65.0  |         |
| 10104-CAD | LTE-TDD (SC-FDMA, 100% RB, 20 MHz, 16-QAM)          | X | 6.39   | 74.88  | 21.30 | 3.98 | 65.0  | ± 9.6 % |
|           |   | Y | 7.01   | 75.63  | 21.49 |      | 65.0  |         |
|           |   | Z | 5.41   | 72.53  | 20.08 |      | 65.0  |         |
| 10105-CAD | LTE-TDD (SC-FDMA, 100% RB, 20 MHz, 64-QAM)          | X | 5.93   | 73.22  | 20.87 | 3.98 | 65.0  | ± 9.6 % |
|           |   | Y | 6.37   | 73.62  | 20.93 |      | 65.0  |         |
|           |   | Z | 4.98   | 70.66  | 19.52 |      | 65.0  |         |
| 10108-CAE | LTE-FDD (SC-FDMA, 100% RB, 10 MHz, QPSK)            | X | 2.79   | 69.92  | 16.81 | 0.00 | 150.0 | ± 9.6 % |
|           |   | Y | 2.76   | 69.17  | 16.35 |      | 150.0 |         |
|           |   | Z | 2.63   | 69.76  | 16.75 |      | 150.0 |         |
| 10109-CAE | LTE-FDD (SC-FDMA, 100% RB, 10 MHz, 16-QAM)          | X | 2.93   | 67.55  | 16.01 | 0.00 | 150.0 | ± 9.6 % |
|           |   | Y | 2.94   | 67.14  | 15.76 |      | 150.0 |         |
|           |   | Z | 2.80   | 67.54  | 15.90 |      | 150.0 |         |
| 10110-CAE | LTE-FDD (SC-FDMA, 100% RB, 5 MHz, QPSK)             | X | 2.27   | 69.10  | 16.46 | 0.00 | 150.0 | ± 9.6 % |
|           |   | Y | 2.25   | 68.23  | 15.96 |      | 150.0 |         |
|           |   | Z | 2.13   | 69.06  | 16.32 |      | 150.0 |         |
| 10111-CAE | LTE-FDD (SC-FDMA, 100% RB, 5 MHz, 16-QAM)           | X | 2.65   | 68.45  | 16.32 | 0.00 | 150.0 | ± 9.6 % |
|           |   | Y | 2.64   | 67.76  | 16.00 |      | 150.0 |         |
|           |   | Z | 2.55   | 68.78  | 16.20 |      | 150.0 |         |

|           |  |   |      |       |       |      |       |         |
|-----------|--|---|------|-------|-------|------|-------|---------|
| 10112-CAE | LTE-FDD (SC-FDMA, 100% RB, 10 MHz, 64-QAM)     | X | 3.05 | 67.53 | 16.06 | 0.00 | 150.0 | ± 9.6 % |
|           |  | Y | 3.07 | 67.13 | 15.82 |      | 150.0 |         |
|           |  | Z | 2.92 | 67.58 | 15.97 |      | 150.0 |         |
| 10113-CAE | LTE-FDD (SC-FDMA, 100% RB, 5 MHz, 64-QAM)      | X | 2.80 | 68.56 | 16.43 | 0.00 | 150.0 | ± 9.6 % |
|           |  | Y | 2.80 | 67.90 | 16.13 |      | 150.0 |         |
|           |  | Z | 2.69 | 68.93 | 16.32 |      | 150.0 |         |
| 10114-CAB | IEEE 802.11n (HT Greenfield, 13.5 Mbps, BPSK)  | X | 5.15 | 67.26 | 16.54 | 0.00 | 150.0 | ± 9.6 % |
|           |  | Y | 5.19 | 67.08 | 16.42 |      | 150.0 |         |
|           |  | Z | 4.99 | 67.20 | 16.47 |      | 150.0 |         |
| 10115-CAB | IEEE 802.11n (HT Greenfield, 81 Mbps, 16-QAM)  | X | 5.43 | 67.37 | 16.60 | 0.00 | 150.0 | ± 9.6 % |
|           |  | Y | 5.52 | 67.34 | 16.56 |      | 150.0 |         |
|           |  | Z | 5.24 | 67.27 | 16.51 |      | 150.0 |         |
| 10116-CAB | IEEE 802.11n (HT Greenfield, 135 Mbps, 64-QAM) | X | 5.24 | 67.44 | 16.56 | 0.00 | 150.0 | ± 9.6 % |
|           |  | Y | 5.30 | 67.32 | 16.46 |      | 150.0 |         |
|           |  | Z | 5.08 | 67.39 | 16.50 |      | 150.0 |         |
| 10117-CAB | IEEE 802.11n (HT Mixed, 13.5 Mbps, BPSK)       | X | 5.11 | 67.11 | 16.48 | 0.00 | 150.0 | ± 9.6 % |
|           |  | Y | 5.16 | 66.99 | 16.39 |      | 150.0 |         |
|           |  | Z | 4.99 | 67.15 | 16.47 |      | 150.0 |         |
| 10118-CAB | IEEE 802.11n (HT Mixed, 81 Mbps, 16-QAM)       | X | 5.51 | 67.58 | 16.71 | 0.00 | 150.0 | ± 9.6 % |
|           |  | Y | 5.61 | 67.54 | 16.67 |      | 150.0 |         |
|           |  | Z | 5.31 | 67.44 | 16.61 |      | 150.0 |         |
| 10119-CAB | IEEE 802.11n (HT Mixed, 135 Mbps, 64-QAM)      | X | 5.22 | 67.40 | 16.54 | 0.00 | 150.0 | ± 9.6 % |
|           |  | Y | 5.27 | 67.25 | 16.44 |      | 150.0 |         |
|           |  | Z | 5.07 | 67.38 | 16.51 |      | 150.0 |         |
| 10140-CAD | LTE-FDD (SC-FDMA, 100% RB, 15 MHz, 16-QAM)     | X | 3.41 | 67.63 | 16.10 | 0.00 | 150.0 | ± 9.6 % |
|           |  | Y | 3.43 | 67.31 | 15.88 |      | 150.0 |         |
|           |  | Z | 3.28 | 67.57 | 16.02 |      | 150.0 |         |
| 10141-CAD | LTE-FDD (SC-FDMA, 100% RB, 15 MHz, 64-QAM)     | X | 3.53 | 67.71 | 16.25 | 0.00 | 150.0 | ± 9.6 % |
|           |  | Y | 3.55 | 67.40 | 16.05 |      | 150.0 |         |
|           |  | Z | 3.40 | 67.71 | 16.20 |      | 150.0 |         |
| 10142-CAD | LTE-FDD (SC-FDMA, 100% RB, 3 MHz, QPSK)        | X | 2.05 | 69.21 | 16.15 | 0.00 | 150.0 | ± 9.6 % |
|           |  | Y | 2.02 | 68.14 | 15.65 |      | 150.0 |         |
|           |  | Z | 1.90 | 69.18 | 15.79 |      | 150.0 |         |
| 10143-CAD | LTE-FDD (SC-FDMA, 100% RB, 3 MHz, 16-QAM)      | X | 2.53 | 69.32 | 16.06 | 0.00 | 150.0 | ± 9.6 % |
|           |  | Y | 2.50 | 68.40 | 15.76 |      | 150.0 |         |
|           |  | Z | 2.39 | 69.52 | 15.59 |      | 150.0 |         |
| 10144-CAD | LTE-FDD (SC-FDMA, 100% RB, 3 MHz, 64-QAM)      | X | 2.28 | 66.94 | 14.41 | 0.00 | 150.0 | ± 9.6 % |
|           |  | Y | 2.31 | 66.41 | 14.31 |      | 150.0 |         |
|           |  | Z | 2.06 | 66.49 | 13.57 |      | 150.0 |         |
| 10145-CAE | LTE-FDD (SC-FDMA, 100% RB, 1.4 MHz, QPSK)      | X | 1.26 | 65.57 | 12.06 | 0.00 | 150.0 | ± 9.6 % |
|           |  | Y | 1.33 | 65.51 | 12.47 |      | 150.0 |         |
|           |  | Z | 0.90 | 62.72 | 9.31  |      | 150.0 |         |
| 10146-CAE | LTE-FDD (SC-FDMA, 100% RB, 1.4 MHz, 16-QAM)    | X | 1.87 | 65.71 | 11.26 | 0.00 | 150.0 | ± 9.6 % |
|           |  | Y | 2.34 | 67.84 | 13.03 |      | 150.0 |         |
|           |  | Z | 1.05 | 60.97 | 7.27  |      | 150.0 |         |
| 10147-CAE | LTE-FDD (SC-FDMA, 100% RB, 1.4 MHz, 64-QAM)    | X | 2.17 | 67.47 | 12.23 | 0.00 | 150.0 | ± 9.6 % |
|           |  | Y | 2.79 | 70.16 | 14.23 |      | 150.0 |         |
|           |  | Z | 1.11 | 61.38 | 7.60  |      | 150.0 |         |

|           |  |   |      |       |       |      |       |         |
|-----------|--|---|------|-------|-------|------|-------|---------|
| 10149-CAD | LTE-FDD (SC-FDMA, 50% RB, 20 MHz, 16-QAM)  | X | 2.93 | 67.61 | 16.06 | 0.00 | 150.0 | ± 9.6 % |
|           |  | Y | 2.95 | 67.20 | 15.81 |      | 150.0 |         |
|           |  | Z | 2.81 | 67.60 | 15.95 |      | 150.0 |         |
| 10150-CAD | LTE-FDD (SC-FDMA, 50% RB, 20 MHz, 64-QAM)  | X | 3.06 | 67.58 | 16.10 | 0.00 | 150.0 | ± 9.6 % |
|           |  | Y | 3.08 | 67.18 | 15.86 |      | 150.0 |         |
|           |  | Z | 2.93 | 67.64 | 16.01 |      | 150.0 |         |
| 10151-CAD | LTE-TDD (SC-FDMA, 50% RB, 20 MHz, QPSK)    | X | 7.47 | 81.50 | 23.31 | 3.98 | 65.0  | ± 9.6 % |
|           |  | Y | 8.13 | 81.64 | 23.19 |      | 65.0  |         |
|           |  | Z | 5.82 | 78.02 | 21.74 |      | 65.0  |         |
| 10152-CAD | LTE-TDD (SC-FDMA, 50% RB, 20 MHz, 16-QAM)  | X | 5.96 | 75.09 | 21.13 | 3.98 | 65.0  | ± 9.6 % |
|           |  | Y | 6.59 | 75.82 | 21.34 |      | 65.0  |         |
|           |  | Z | 4.95 | 72.53 | 19.69 |      | 65.0  |         |
| 10153-CAD | LTE-TDD (SC-FDMA, 50% RB, 20 MHz, 64-QAM)  | X | 6.33 | 76.00 | 21.87 | 3.98 | 65.0  | ± 9.6 % |
|           |  | Y | 6.98 | 76.72 | 22.08 |      | 65.0  |         |
|           |  | Z | 5.31 | 73.57 | 20.52 |      | 65.0  |         |
| 10154-CAE | LTE-FDD (SC-FDMA, 50% RB, 10 MHz, QPSK)    | X | 2.32 | 69.50 | 16.70 | 0.00 | 150.0 | ± 9.6 % |
|           |  | Y | 2.30 | 68.63 | 16.21 |      | 150.0 |         |
|           |  | Z | 2.17 | 69.43 | 16.55 |      | 150.0 |         |
| 10155-CAE | LTE-FDD (SC-FDMA, 50% RB, 10 MHz, 16-QAM)  | X | 2.65 | 68.47 | 16.34 | 0.00 | 150.0 | ± 9.6 % |
|           |  | Y | 2.64 | 67.77 | 16.01 |      | 150.0 |         |
|           |  | Z | 2.55 | 68.82 | 16.23 |      | 150.0 |         |
| 10156-CAE | LTE-FDD (SC-FDMA, 50% RB, 5 MHz, QPSK)     | X | 1.90 | 69.38 | 15.98 | 0.00 | 150.0 | ± 9.6 % |
|           |  | Y | 1.87 | 68.22 | 15.49 |      | 150.0 |         |
|           |  | Z | 1.73 | 69.10 | 15.35 |      | 150.0 |         |
| 10157-CAE | LTE-FDD (SC-FDMA, 50% RB, 5 MHz, 16-QAM)   | X | 2.13 | 67.61 | 14.49 | 0.00 | 150.0 | ± 9.6 % |
|           |  | Y | 2.14 | 66.94 | 14.37 |      | 150.0 |         |
|           |  | Z | 1.88 | 66.88 | 13.39 |      | 150.0 |         |
| 10158-CAE | LTE-FDD (SC-FDMA, 50% RB, 10 MHz, 64-QAM)  | X | 2.80 | 68.62 | 16.48 | 0.00 | 150.0 | ± 9.6 % |
|           |  | Y | 2.80 | 67.95 | 16.18 |      | 150.0 |         |
|           |  | Z | 2.70 | 69.02 | 16.37 |      | 150.0 |         |
| 10159-CAE | LTE-FDD (SC-FDMA, 50% RB, 5 MHz, 64-QAM)   | X | 2.24 | 68.05 | 14.76 | 0.00 | 150.0 | ± 9.6 % |
|           |  | Y | 2.25 | 67.38 | 14.65 |      | 150.0 |         |
|           |  | Z | 1.97 | 67.26 | 13.62 |      | 150.0 |         |
| 10160-CAD | LTE-FDD (SC-FDMA, 50% RB, 15 MHz, QPSK)    | X | 2.79 | 68.96 | 16.56 | 0.00 | 150.0 | ± 9.6 % |
|           |  | Y | 2.78 | 68.29 | 16.16 |      | 150.0 |         |
|           |  | Z | 2.67 | 69.03 | 16.52 |      | 150.0 |         |
| 10161-CAD | LTE-FDD (SC-FDMA, 50% RB, 15 MHz, 16-QAM)  | X | 2.95 | 67.54 | 16.03 | 0.00 | 150.0 | ± 9.6 % |
|           |  | Y | 2.97 | 67.10 | 15.79 |      | 150.0 |         |
|           |  | Z | 2.82 | 67.63 | 15.91 |      | 150.0 |         |
| 10162-CAD | LTE-FDD (SC-FDMA, 50% RB, 15 MHz, 64-QAM)  | X | 3.06 | 67.69 | 16.14 | 0.00 | 150.0 | ± 9.6 % |
|           |  | Y | 3.08 | 67.22 | 15.89 |      | 150.0 |         |
|           |  | Z | 2.94 | 67.84 | 16.05 |      | 150.0 |         |
| 10166-CAE | LTE-FDD (SC-FDMA, 50% RB, 1.4 MHz, QPSK)   | X | 3.60 | 69.71 | 19.22 | 3.01 | 150.0 | ± 9.6 % |
|           |  | Y | 3.76 | 69.53 | 19.10 |      | 150.0 |         |
|           |  | Z | 3.14 | 68.43 | 18.52 |      | 150.0 |         |
| 10167-CAE | LTE-FDD (SC-FDMA, 50% RB, 1.4 MHz, 16-QAM) | X | 4.49 | 72.92 | 19.79 | 3.01 | 150.0 | ± 9.6 % |
|           |  | Y | 4.71 | 72.48 | 19.58 |      | 150.0 |         |
|           |  | Z | 3.64 | 70.88 | 18.81 |      | 150.0 |         |

|           |  |   |       |        |       |      |       |         |
|-----------|--|---|-------|--------|-------|------|-------|---------|
| 10168-CAE | LTE-FDD (SC-FDMA, 50% RB, 1.4 MHz, 64-QAM) | X | 4.99  | 75.19  | 21.10 | 3.01 | 150.0 | ± 9.6 % |
|           |  | Y | 5.19  | 74.57  | 20.82 |      | 150.0 |         |
|           |  | Z | 4.03  | 73.14  | 20.19 |      | 150.0 |         |
| 10169-CAD | LTE-FDD (SC-FDMA, 1 RB, 20 MHz, QPSK)      | X | 3.02  | 69.31  | 19.06 | 3.01 | 150.0 | ± 9.6 % |
|           |  | Y | 3.27  | 69.70  | 19.15 |      | 150.0 |         |
|           |  | Z | 2.51  | 66.78  | 17.76 |      | 150.0 |         |
| 10170-CAD | LTE-FDD (SC-FDMA, 1 RB, 20 MHz, 16-QAM)    | X | 4.24  | 75.66  | 21.52 | 3.01 | 150.0 | ± 9.6 % |
|           |  | Y | 4.60  | 75.59  | 21.37 |      | 150.0 |         |
|           |  | Z | 3.08  | 71.28  | 19.66 |      | 150.0 |         |
| 10171-AAD | LTE-FDD (SC-FDMA, 1 RB, 20 MHz, 64-QAM)    | X | 3.48  | 71.52  | 18.79 | 3.01 | 150.0 | ± 9.6 % |
|           |  | Y | 3.80  | 71.54  | 18.73 |      | 150.0 |         |
|           |  | Z | 2.62  | 68.04  | 17.18 |      | 150.0 |         |
| 10172-CAD | LTE-TDD (SC-FDMA, 1 RB, 20 MHz, QPSK)      | X | 9.86  | 97.03  | 31.31 | 6.02 | 65.0  | ± 9.6 % |
|           |  | Y | 11.94 | 97.60  | 31.03 |      | 65.0  |         |
|           |  | Z | 3.49  | 77.54  | 23.86 |      | 65.0  |         |
| 10173-CAD | LTE-TDD (SC-FDMA, 1 RB, 20 MHz, 16-QAM)    | X | 35.90 | 116.24 | 34.55 | 6.02 | 65.0  | ± 9.6 % |
|           |  | Y | 33.36 | 111.72 | 33.12 |      | 65.0  |         |
|           |  | Z | 6.56  | 87.15  | 25.45 |      | 65.0  |         |
| 10174-CAD | LTE-TDD (SC-FDMA, 1 RB, 20 MHz, 64-QAM)    | X | 21.48 | 105.16 | 30.85 | 6.02 | 65.0  | ± 9.6 % |
|           |  | Y | 20.65 | 101.59 | 29.68 |      | 65.0  |         |
|           |  | Z | 4.70  | 80.63  | 22.56 |      | 65.0  |         |
| 10175-CAE | LTE-FDD (SC-FDMA, 1 RB, 10 MHz, QPSK)      | X | 2.98  | 69.02  | 18.83 | 3.01 | 150.0 | ± 9.6 % |
|           |  | Y | 3.23  | 69.39  | 18.90 |      | 150.0 |         |
|           |  | Z | 2.49  | 66.55  | 17.55 |      | 150.0 |         |
| 10176-CAE | LTE-FDD (SC-FDMA, 1 RB, 10 MHz, 16-QAM)    | X | 4.24  | 75.68  | 21.53 | 3.01 | 150.0 | ± 9.6 % |
|           |  | Y | 4.61  | 75.61  | 21.38 |      | 150.0 |         |
|           |  | Z | 3.09  | 71.30  | 19.67 |      | 150.0 |         |
| 10177-CAG | LTE-FDD (SC-FDMA, 1 RB, 5 MHz, QPSK)       | X | 3.01  | 69.16  | 18.92 | 3.01 | 150.0 | ± 9.6 % |
|           |  | Y | 3.26  | 69.54  | 19.00 |      | 150.0 |         |
|           |  | Z | 2.50  | 66.65  | 17.62 |      | 150.0 |         |
| 10178-CAE | LTE-FDD (SC-FDMA, 1 RB, 5 MHz, 16-QAM)     | X | 4.21  | 75.48  | 21.42 | 3.01 | 150.0 | ± 9.6 % |
|           |  | Y | 4.56  | 75.38  | 21.26 |      | 150.0 |         |
|           |  | Z | 3.07  | 71.19  | 19.60 |      | 150.0 |         |
| 10179-CAE | LTE-FDD (SC-FDMA, 1 RB, 10 MHz, 64-QAM)    | X | 3.83  | 73.49  | 20.03 | 3.01 | 150.0 | ± 9.6 % |
|           |  | Y | 4.16  | 73.42  | 19.91 |      | 150.0 |         |
|           |  | Z | 2.83  | 69.59  | 18.31 |      | 150.0 |         |
| 10180-CAE | LTE-FDD (SC-FDMA, 1 RB, 5 MHz, 64-QAM)     | X | 3.47  | 71.46  | 18.75 | 3.01 | 150.0 | ± 9.6 % |
|           |  | Y | 3.79  | 71.47  | 18.68 |      | 150.0 |         |
|           |  | Z | 2.62  | 68.01  | 17.15 |      | 150.0 |         |
| 10181-CAD | LTE-FDD (SC-FDMA, 1 RB, 15 MHz, QPSK)      | X | 3.00  | 69.14  | 18.91 | 3.01 | 150.0 | ± 9.6 % |
|           |  | Y | 3.26  | 69.52  | 18.99 |      | 150.0 |         |
|           |  | Z | 2.50  | 66.64  | 17.62 |      | 150.0 |         |
| 10182-CAD | LTE-FDD (SC-FDMA, 1 RB, 15 MHz, 16-QAM)    | X | 4.20  | 75.46  | 21.41 | 3.01 | 150.0 | ± 9.6 % |
|           |  | Y | 4.55  | 75.36  | 21.25 |      | 150.0 |         |
|           |  | Z | 3.07  | 71.17  | 19.59 |      | 150.0 |         |
| 10183-AAC | LTE-FDD (SC-FDMA, 1 RB, 15 MHz, 64-QAM)    | X | 3.46  | 71.44  | 18.74 | 3.01 | 150.0 | ± 9.6 % |
|           |  | Y | 3.78  | 71.45  | 18.67 |      | 150.0 |         |
|           |  | Z | 2.62  | 68.00  | 17.14 |      | 150.0 |         |

|           |   |   |      |       |       |      |       |         |
|-----------|---|---|------|-------|-------|------|-------|---------|
| 10184-CAD | LTE-FDD (SC-FDMA, 1 RB, 3 MHz, QPSK)          | X | 3.01 | 69.18 | 18.93 | 3.01 | 150.0 | ± 9.6 % |
|           |   | Y | 3.27 | 69.56 | 19.01 |      | 150.0 |         |
|           |   | Z | 2.51 | 66.67 | 17.63 |      | 150.0 |         |
| 10185-CAD | LTE-FDD (SC-FDMA, 1 RB, 3 MHz, 16-QAM)        | X | 4.22 | 75.53 | 21.45 | 3.01 | 150.0 | ± 9.6 % |
|           |   | Y | 4.57 | 75.42 | 21.28 |      | 150.0 |         |
|           |   | Z | 3.08 | 71.23 | 19.63 |      | 150.0 |         |
| 10186-AAD | LTE-FDD (SC-FDMA, 1 RB, 3 MHz, 64-QAM)        | X | 3.48 | 71.51 | 18.77 | 3.01 | 150.0 | ± 9.6 % |
|           |   | Y | 3.80 | 71.51 | 18.70 |      | 150.0 |         |
|           |   | Z | 2.63 | 68.05 | 17.17 |      | 150.0 |         |
| 10187-CAE | LTE-FDD (SC-FDMA, 1 RB, 1.4 MHz, QPSK)        | X | 3.02 | 69.24 | 19.00 | 3.01 | 150.0 | ± 9.6 % |
|           |   | Y | 3.28 | 69.61 | 19.07 |      | 150.0 |         |
|           |   | Z | 2.52 | 66.73 | 17.71 |      | 150.0 |         |
| 10188-CAE | LTE-FDD (SC-FDMA, 1 RB, 1.4 MHz, 16-QAM)      | X | 4.35 | 76.17 | 21.80 | 3.01 | 150.0 | ± 9.6 % |
|           |   | Y | 4.72 | 76.08 | 21.65 |      | 150.0 |         |
|           |   | Z | 3.15 | 71.69 | 19.93 |      | 150.0 |         |
| 10189-AAE | LTE-FDD (SC-FDMA, 1 RB, 1.4 MHz, 64-QAM)      | X | 3.56 | 71.93 | 19.04 | 3.01 | 150.0 | ± 9.6 % |
|           |   | Y | 3.88 | 71.93 | 18.97 |      | 150.0 |         |
|           |   | Z | 2.67 | 68.37 | 17.41 |      | 150.0 |         |
| 10193-CAB | IEEE 802.11n (HT Greenfield, 6.5 Mbps, BPSK)  | X | 4.54 | 66.68 | 16.24 | 0.00 | 150.0 | ± 9.6 % |
|           |   | Y | 4.59 | 66.47 | 16.13 |      | 150.0 |         |
|           |   | Z | 4.40 | 66.85 | 16.19 |      | 150.0 |         |
| 10194-CAB | IEEE 802.11n (HT Greenfield, 39 Mbps, 16-QAM) | X | 4.70 | 66.99 | 16.36 | 0.00 | 150.0 | ± 9.6 % |
|           |   | Y | 4.77 | 66.80 | 16.26 |      | 150.0 |         |
|           |   | Z | 4.55 | 67.09 | 16.33 |      | 150.0 |         |
| 10195-CAB | IEEE 802.11n (HT Greenfield, 65 Mbps, 64-QAM) | X | 4.74 | 67.02 | 16.38 | 0.00 | 150.0 | ± 9.6 % |
|           |   | Y | 4.81 | 66.83 | 16.27 |      | 150.0 |         |
|           |   | Z | 4.58 | 67.11 | 16.34 |      | 150.0 |         |
| 10196-CAB | IEEE 802.11n (HT Mixed, 6.5 Mbps, BPSK)       | X | 4.54 | 66.74 | 16.25 | 0.00 | 150.0 | ± 9.6 % |
|           |   | Y | 4.60 | 66.55 | 16.16 |      | 150.0 |         |
|           |   | Z | 4.39 | 66.85 | 16.19 |      | 150.0 |         |
| 10197-CAB | IEEE 802.11n (HT Mixed, 39 Mbps, 16-QAM)      | X | 4.72 | 67.01 | 16.37 | 0.00 | 150.0 | ± 9.6 % |
|           |   | Y | 4.78 | 66.83 | 16.27 |      | 150.0 |         |
|           |   | Z | 4.56 | 67.10 | 16.33 |      | 150.0 |         |
| 10198-CAB | IEEE 802.11n (HT Mixed, 65 Mbps, 64-QAM)      | X | 4.75 | 67.04 | 16.39 | 0.00 | 150.0 | ± 9.6 % |
|           |   | Y | 4.81 | 66.85 | 16.28 |      | 150.0 |         |
|           |   | Z | 4.58 | 67.11 | 16.34 |      | 150.0 |         |
| 10219-CAB | IEEE 802.11n (HT Mixed, 7.2 Mbps, BPSK)       | X | 4.49 | 66.76 | 16.22 | 0.00 | 150.0 | ± 9.6 % |
|           |   | Y | 4.55 | 66.56 | 16.12 |      | 150.0 |         |
|           |   | Z | 4.34 | 66.89 | 16.16 |      | 150.0 |         |
| 10220-CAB | IEEE 802.11n (HT Mixed, 43.3 Mbps, 16-QAM)    | X | 4.71 | 66.98 | 16.36 | 0.00 | 150.0 | ± 9.6 % |
|           |   | Y | 4.78 | 66.81 | 16.26 |      | 150.0 |         |
|           |   | Z | 4.55 | 67.06 | 16.32 |      | 150.0 |         |
| 10221-CAB | IEEE 802.11n (HT Mixed, 72.2 Mbps, 64-QAM)    | X | 4.75 | 66.96 | 16.37 | 0.00 | 150.0 | ± 9.6 % |
|           |   | Y | 4.82 | 66.78 | 16.27 |      | 150.0 |         |
|           |   | Z | 4.59 | 67.05 | 16.33 |      | 150.0 |         |
| 10222-CAB | IEEE 802.11n (HT Mixed, 15 Mbps, BPSK)        | X | 5.08 | 67.12 | 16.48 | 0.00 | 150.0 | ± 9.6 % |
|           |   | Y | 5.14 | 67.00 | 16.39 |      | 150.0 |         |
|           |   | Z | 4.96 | 67.13 | 16.45 |      | 150.0 |         |

|           |   |   |       |        |       |      |       |         |
|-----------|---|---|-------|--------|-------|------|-------|---------|
| 10223-CAB | IEEE 802.11n (HT Mixed, 90 Mbps, 16-QAM)  | X | 5.38  | 67.33  | 16.60 | 0.00 | 150.0 | ± 9.6 % |
|           |   | Y | 5.45  | 67.20  | 16.51 |      | 150.0 |         |
|           |   | Z | 5.23  | 67.33  | 16.56 |      | 150.0 |         |
| 10224-CAB | IEEE 802.11n (HT Mixed, 150 Mbps, 64-QAM) | X | 5.13  | 67.23  | 16.46 | 0.00 | 150.0 | ± 9.6 % |
|           |   | Y | 5.19  | 67.11  | 16.37 |      | 150.0 |         |
|           |   | Z | 4.99  | 67.25  | 16.44 |      | 150.0 |         |
| 10225-CAB | UMTS-FDD (HSPA+)                          | X | 2.82  | 66.29  | 15.44 | 0.00 | 150.0 | ± 9.6 % |
|           |   | Y | 2.85  | 65.89  | 15.31 |      | 150.0 |         |
|           |   | Z | 2.69  | 66.42  | 15.13 |      | 150.0 |         |
| 10226-CAA | LTE-TDD (SC-FDMA, 1 RB, 1.4 MHz, 16-QAM)  | X | 40.58 | 118.73 | 35.31 | 6.02 | 65.0  | ± 9.6 % |
|           |   | Y | 36.88 | 113.76 | 33.77 |      | 65.0  |         |
|           |   | Z | 6.94  | 88.26  | 25.92 |      | 65.0  |         |
| 10227-CAA | LTE-TDD (SC-FDMA, 1 RB, 1.4 MHz, 64-QAM)  | X | 36.33 | 114.29 | 33.35 | 6.02 | 65.0  | ± 9.6 % |
|           |   | Y | 31.30 | 108.87 | 31.78 |      | 65.0  |         |
|           |   | Z | 6.95  | 87.06  | 24.80 |      | 65.0  |         |
| 10228-CAA | LTE-TDD (SC-FDMA, 1 RB, 1.4 MHz, QPSK)    | X | 13.65 | 104.05 | 33.59 | 6.02 | 65.0  | ± 9.6 % |
|           |   | Y | 18.81 | 107.23 | 34.08 |      | 65.0  |         |
|           |   | Z | 4.50  | 82.80  | 25.97 |      | 65.0  |         |
| 10229-CAB | LTE-TDD (SC-FDMA, 1 RB, 3 MHz, 16-QAM)    | X | 36.18 | 116.36 | 34.59 | 6.02 | 65.0  | ± 9.6 % |
|           |   | Y | 33.58 | 111.82 | 33.15 |      | 65.0  |         |
|           |   | Z | 6.61  | 87.25  | 25.49 |      | 65.0  |         |
| 10230-CAB | LTE-TDD (SC-FDMA, 1 RB, 3 MHz, 64-QAM)    | X | 32.38 | 112.10 | 32.69 | 6.02 | 65.0  | ± 9.6 % |
|           |   | Y | 28.70 | 107.19 | 31.24 |      | 65.0  |         |
|           |   | Z | 6.54  | 85.97  | 24.36 |      | 65.0  |         |
| 10231-CAB | LTE-TDD (SC-FDMA, 1 RB, 3 MHz, QPSK)      | X | 12.84 | 102.68 | 33.09 | 6.02 | 65.0  | ± 9.6 % |
|           |   | Y | 17.62 | 105.78 | 33.56 |      | 65.0  |         |
|           |   | Z | 4.35  | 82.09  | 25.62 |      | 65.0  |         |
| 10232-CAD | LTE-TDD (SC-FDMA, 1 RB, 5 MHz, 16-QAM)    | X | 36.15 | 116.36 | 34.59 | 6.02 | 65.0  | ± 9.6 % |
|           |   | Y | 33.55 | 111.82 | 33.15 |      | 65.0  |         |
|           |   | Z | 6.59  | 87.23  | 25.48 |      | 65.0  |         |
| 10233-CAD | LTE-TDD (SC-FDMA, 1 RB, 5 MHz, 64-QAM)    | X | 32.28 | 112.07 | 32.68 | 6.02 | 65.0  | ± 9.6 % |
|           |   | Y | 28.65 | 107.18 | 31.24 |      | 65.0  |         |
|           |   | Z | 6.52  | 85.93  | 24.35 |      | 65.0  |         |
| 10234-CAD | LTE-TDD (SC-FDMA, 1 RB, 5 MHz, QPSK)      | X | 12.22 | 101.47 | 32.58 | 6.02 | 65.0  | ± 9.6 % |
|           |   | Y | 16.65 | 104.42 | 33.04 |      | 65.0  |         |
|           |   | Z | 4.24  | 81.51  | 25.28 |      | 65.0  |         |
| 10235-CAD | LTE-TDD (SC-FDMA, 1 RB, 10 MHz, 16-QAM)   | X | 36.31 | 116.46 | 34.62 | 6.02 | 65.0  | ± 9.6 % |
|           |   | Y | 33.66 | 111.90 | 33.18 |      | 65.0  |         |
|           |   | Z | 6.60  | 87.26  | 25.49 |      | 65.0  |         |
| 10236-CAD | LTE-TDD (SC-FDMA, 1 RB, 10 MHz, 64-QAM)   | X | 33.06 | 112.44 | 32.77 | 6.02 | 65.0  | ± 9.6 % |
|           |   | Y | 29.12 | 107.43 | 31.30 |      | 65.0  |         |
|           |   | Z | 6.60  | 86.11  | 24.40 |      | 65.0  |         |
| 10237-CAD | LTE-TDD (SC-FDMA, 1 RB, 10 MHz, QPSK)     | X | 12.90 | 102.82 | 33.13 | 6.02 | 65.0  | ± 9.6 % |
|           |   | Y | 17.72 | 105.93 | 33.61 |      | 65.0  |         |
|           |   | Z | 4.35  | 82.12  | 25.64 |      | 65.0  |         |
| 10238-CAD | LTE-TDD (SC-FDMA, 1 RB, 15 MHz, 16-QAM)   | X | 36.09 | 116.34 | 34.59 | 6.02 | 65.0  | ± 9.6 % |
|           |   | Y | 33.52 | 111.82 | 33.15 |      | 65.0  |         |
|           |   | Z | 6.58  | 87.20  | 25.47 |      | 65.0  |         |

|           |  |   |       |        |       |      |      |         |
|-----------|--|---|-------|--------|-------|------|------|---------|
| 10239-CAD | LTE-TDD (SC-FDMA, 1 RB, 15 MHz, 64-QAM)    | X | 32.17 | 112.03 | 32.67 | 6.02 | 65.0 | ± 9.6 % |
|           |  | Y | 28.59 | 107.16 | 31.23 |      | 65.0 |         |
|           |  | Z | 6.49  | 85.89  | 24.34 |      | 65.0 |         |
| 10240-CAD | LTE-TDD (SC-FDMA, 1 RB, 15 MHz, QPSK)      | X | 12.85 | 102.75 | 33.11 | 6.02 | 65.0 | ± 9.6 % |
|           |  | Y | 17.65 | 105.86 | 33.59 |      | 65.0 |         |
|           |  | Z | 4.34  | 82.09  | 25.63 |      | 65.0 |         |
| 10241-CAA | LTE-TDD (SC-FDMA, 50% RB, 1.4 MHz, 16-QAM) | X | 8.52  | 83.40  | 26.72 | 6.98 | 65.0 | ± 9.6 % |
|           |  | Y | 9.34  | 83.46  | 26.63 |      | 65.0 |         |
|           |  | Z | 6.49  | 79.39  | 24.77 |      | 65.0 |         |
| 10242-CAA | LTE-TDD (SC-FDMA, 50% RB, 1.4 MHz, 64-QAM) | X | 7.72  | 81.29  | 25.79 | 6.98 | 65.0 | ± 9.6 % |
|           |  | Y | 8.22  | 80.66  | 25.42 |      | 65.0 |         |
|           |  | Z | 5.72  | 76.85  | 23.63 |      | 65.0 |         |
| 10243-CAA | LTE-TDD (SC-FDMA, 50% RB, 1.4 MHz, QPSK)   | X | 5.95  | 76.72  | 24.82 | 6.98 | 65.0 | ± 9.6 % |
|           |  | Y | 6.41  | 76.67  | 24.65 |      | 65.0 |         |
|           |  | Z | 4.75  | 73.34  | 22.98 |      | 65.0 |         |
| 10244-CAB | LTE-TDD (SC-FDMA, 50% RB, 3 MHz, 16-QAM)   | X | 6.67  | 78.45  | 19.67 | 3.98 | 65.0 | ± 9.6 % |
|           |  | Y | 8.20  | 80.91  | 21.14 |      | 65.0 |         |
|           |  | Z | 3.50  | 69.23  | 14.35 |      | 65.0 |         |
| 10245-CAB | LTE-TDD (SC-FDMA, 50% RB, 3 MHz, 64-QAM)   | X | 6.39  | 77.48  | 19.23 | 3.98 | 65.0 | ± 9.6 % |
|           |  | Y | 7.92  | 80.07  | 20.76 |      | 65.0 |         |
|           |  | Z | 3.42  | 68.65  | 14.03 |      | 65.0 |         |
| 10246-CAB | LTE-TDD (SC-FDMA, 50% RB, 3 MHz, QPSK)     | X | 8.15  | 85.97  | 22.95 | 3.98 | 65.0 | ± 9.6 % |
|           |  | Y | 9.24  | 86.80  | 23.49 |      | 65.0 |         |
|           |  | Z | 4.03  | 75.23  | 17.77 |      | 65.0 |         |
| 10247-CAD | LTE-TDD (SC-FDMA, 50% RB, 5 MHz, 16-QAM)   | X | 5.50  | 76.42  | 20.00 | 3.98 | 65.0 | ± 9.6 % |
|           |  | Y | 6.26  | 77.49  | 20.66 |      | 65.0 |         |
|           |  | Z | 3.95  | 71.61  | 16.94 |      | 65.0 |         |
| 10248-CAD | LTE-TDD (SC-FDMA, 50% RB, 5 MHz, 64-QAM)   | X | 5.40  | 75.54  | 19.60 | 3.98 | 65.0 | ± 9.6 % |
|           |  | Y | 6.16  | 76.66  | 20.28 |      | 65.0 |         |
|           |  | Z | 3.89  | 70.88  | 16.59 |      | 65.0 |         |
| 10249-CAD | LTE-TDD (SC-FDMA, 50% RB, 5 MHz, QPSK)     | X | 9.66  | 89.43  | 25.19 | 3.98 | 65.0 | ± 9.6 % |
|           |  | Y | 10.35 | 89.11  | 25.13 |      | 65.0 |         |
|           |  | Z | 5.64  | 80.91  | 21.33 |      | 65.0 |         |
| 10250-CAD | LTE-TDD (SC-FDMA, 50% RB, 10 MHz, 16-QAM)  | X | 6.21  | 78.20  | 22.44 | 3.98 | 65.0 | ± 9.6 % |
|           |  | Y | 6.93  | 79.00  | 22.73 |      | 65.0 |         |
|           |  | Z | 4.95  | 74.96  | 20.57 |      | 65.0 |         |
| 10251-CAD | LTE-TDD (SC-FDMA, 50% RB, 10 MHz, 64-QAM)  | X | 5.85  | 75.76  | 21.03 | 3.98 | 65.0 | ± 9.6 % |
|           |  | Y | 6.49  | 76.44  | 21.31 |      | 65.0 |         |
|           |  | Z | 4.69  | 72.73  | 19.17 |      | 65.0 |         |
| 10252-CAD | LTE-TDD (SC-FDMA, 50% RB, 10 MHz, QPSK)    | X | 8.41  | 86.24  | 25.10 | 3.98 | 65.0 | ± 9.6 % |
|           |  | Y | 9.13  | 86.11  | 24.91 |      | 65.0 |         |
|           |  | Z | 5.95  | 81.04  | 22.79 |      | 65.0 |         |
| 10253-CAD | LTE-TDD (SC-FDMA, 50% RB, 15 MHz, 16-QAM)  | X | 5.81  | 74.45  | 20.83 | 3.98 | 65.0 | ± 9.6 % |
|           |  | Y | 6.39  | 75.11  | 21.05 |      | 65.0 |         |
|           |  | Z | 4.88  | 72.13  | 19.42 |      | 65.0 |         |
| 10254-CAD | LTE-TDD (SC-FDMA, 50% RB, 15 MHz, 64-QAM)  | X | 6.16  | 75.32  | 21.51 | 3.98 | 65.0 | ± 9.6 % |
|           |  | Y | 6.77  | 75.99  | 21.73 |      | 65.0 |         |
|           |  | Z | 5.19  | 73.05  | 20.14 |      | 65.0 |         |



|           |   |   |      |       |       |      |      |         |
|-----------|---|---|------|-------|-------|------|------|---------|
| 10255-CAD | LTE-TDD (SC-FDMA, 50% RB, 15 MHz, QPSK)     | X | 6.96 | 80.42 | 23.12 | 3.98 | 65.0 | ± 9.6 % |
|           |   | Y | 7.59 | 80.64 | 23.06 |      | 65.0 |         |
|           |   | Z | 5.51 | 77.21 | 21.58 |      | 65.0 |         |
| 10256-CAA | LTE-TDD (SC-FDMA, 100% RB, 1.4 MHz, 16-QAM) | X | 4.89 | 73.41 | 16.49 | 3.98 | 65.0 | ± 9.6 % |
|           |   | Y | 6.68 | 77.30 | 18.76 |      | 65.0 |         |
|           |   | Z | 2.46 | 64.75 | 10.88 |      | 65.0 |         |
| 10257-CAA | LTE-TDD (SC-FDMA, 100% RB, 1.4 MHz, 64-QAM) | X | 4.63 | 72.26 | 15.89 | 3.98 | 65.0 | ± 9.6 % |
|           |   | Y | 6.35 | 76.13 | 18.19 |      | 65.0 |         |
|           |   | Z | 2.42 | 64.27 | 10.52 |      | 65.0 |         |
| 10258-CAA | LTE-TDD (SC-FDMA, 100% RB, 1.4 MHz, QPSK)   | X | 5.50 | 79.01 | 19.45 | 3.98 | 65.0 | ± 9.6 % |
|           |   | Y | 7.01 | 81.77 | 20.90 |      | 65.0 |         |
|           |   | Z | 2.56 | 68.30 | 13.54 |      | 65.0 |         |
| 10259-CAB | LTE-TDD (SC-FDMA, 100% RB, 3 MHz, 16-QAM)   | X | 5.80 | 77.14 | 20.90 | 3.98 | 65.0 | ± 9.6 % |
|           |   | Y | 6.53 | 78.01 | 21.38 |      | 65.0 |         |
|           |   | Z | 4.38 | 73.08 | 18.36 |      | 65.0 |         |
| 10260-CAB | LTE-TDD (SC-FDMA, 100% RB, 3 MHz, 64-QAM)   | X | 5.78 | 76.67 | 20.70 | 3.98 | 65.0 | ± 9.6 % |
|           |   | Y | 6.51 | 77.60 | 21.22 |      | 65.0 |         |
|           |   | Z | 4.39 | 72.73 | 18.19 |      | 65.0 |         |
| 10261-CAB | LTE-TDD (SC-FDMA, 100% RB, 3 MHz, QPSK)     | X | 8.27 | 86.47 | 24.62 | 3.98 | 65.0 | ± 9.6 % |
|           |   | Y | 9.00 | 86.40 | 24.57 |      | 65.0 |         |
|           |   | Z | 5.46 | 80.05 | 21.57 |      | 65.0 |         |
| 10262-CAD | LTE-TDD (SC-FDMA, 100% RB, 5 MHz, 16-QAM)   | X | 6.19 | 78.15 | 22.39 | 3.98 | 65.0 | ± 9.6 % |
|           |   | Y | 6.92 | 78.95 | 22.69 |      | 65.0 |         |
|           |   | Z | 4.94 | 74.88 | 20.51 |      | 65.0 |         |
| 10263-CAD | LTE-TDD (SC-FDMA, 100% RB, 5 MHz, 64-QAM)   | X | 5.84 | 75.72 | 21.02 | 3.98 | 65.0 | ± 9.6 % |
|           |   | Y | 6.48 | 76.42 | 21.31 |      | 65.0 |         |
|           |   | Z | 4.68 | 72.71 | 19.16 |      | 65.0 |         |
| 10264-CAD | LTE-TDD (SC-FDMA, 100% RB, 5 MHz, QPSK)     | X | 8.30 | 85.98 | 24.99 | 3.98 | 65.0 | ± 9.6 % |
|           |   | Y | 9.03 | 85.88 | 24.80 |      | 65.0 |         |
|           |   | Z | 5.88 | 80.81 | 22.67 |      | 65.0 |         |
| 10265-CAD | LTE-TDD (SC-FDMA, 100% RB, 10 MHz, 16-QAM)  | X | 5.96 | 75.09 | 21.13 | 3.98 | 65.0 | ± 9.6 % |
|           |   | Y | 6.59 | 75.82 | 21.35 |      | 65.0 |         |
|           |   | Z | 4.95 | 72.53 | 19.70 |      | 65.0 |         |
| 10266-CAD | LTE-TDD (SC-FDMA, 100% RB, 10 MHz, 64-QAM)  | X | 6.33 | 75.99 | 21.86 | 3.98 | 65.0 | ± 9.6 % |
|           |   | Y | 6.97 | 76.70 | 22.07 |      | 65.0 |         |
|           |   | Z | 5.31 | 73.56 | 20.51 |      | 65.0 |         |
| 10267-CAD | LTE-TDD (SC-FDMA, 100% RB, 10 MHz, QPSK)    | X | 7.45 | 81.44 | 23.28 | 3.98 | 65.0 | ± 9.6 % |
|           |   | Y | 8.11 | 81.58 | 23.17 |      | 65.0 |         |
|           |   | Z | 5.81 | 77.97 | 21.72 |      | 65.0 |         |
| 10268-CAD | LTE-TDD (SC-FDMA, 100% RB, 15 MHz, 16-QAM)  | X | 6.50 | 74.59 | 21.27 | 3.98 | 65.0 | ± 9.6 % |
|           |   | Y | 7.11 | 75.29 | 21.47 |      | 65.0 |         |
|           |   | Z | 5.58 | 72.49 | 20.14 |      | 65.0 |         |
| 10269-CAD | LTE-TDD (SC-FDMA, 100% RB, 15 MHz, 64-QAM)  | X | 6.45 | 74.07 | 21.10 | 3.98 | 65.0 | ± 9.6 % |
|           |   | Y | 7.04 | 74.76 | 21.30 |      | 65.0 |         |
|           |   | Z | 5.59 | 72.11 | 20.01 |      | 65.0 |         |
| 10270-CAD | LTE-TDD (SC-FDMA, 100% RB, 15 MHz, QPSK)    | X | 6.83 | 77.38 | 21.77 | 3.98 | 65.0 | ± 9.6 % |
|           |   | Y | 7.44 | 77.78 | 21.79 |      | 65.0 |         |
|           |   | Z | 5.71 | 75.01 | 20.64 |      | 65.0 |         |

|           |  |   |       |       |       |      |       |         |
|-----------|--|---|-------|-------|-------|------|-------|---------|
| 10274-CAB | UMTS-FDD (HSUPA, Subtest 5, 3GPP Rel8.10)                          | X | 2.62  | 66.75 | 15.42 | 0.00 | 150.0 | ± 9.6 % |
|           |  | Y | 2.61  | 66.15 | 15.17 |      | 150.0 |         |
|           |  | Z | 2.54  | 67.07 | 15.23 |      | 150.0 |         |
| 10275-CAB | UMTS-FDD (HSUPA, Subtest 5, 3GPP Rel8.4)                           | X | 1.67  | 68.55 | 15.99 | 0.00 | 150.0 | ± 9.6 % |
|           |  | Y | 1.61  | 67.31 | 15.31 |      | 150.0 |         |
|           |  | Z | 1.61  | 68.63 | 15.84 |      | 150.0 |         |
| 10277-CAA | PHS (QPSK)   | X | 1.74  | 60.91 | 6.37  | 9.03 | 50.0  | ± 9.6 % |
|           |  | Y | 2.31  | 62.75 | 8.24  |      | 50.0  |         |
|           |  | Z | 1.34  | 59.32 | 4.61  |      | 50.0  |         |
| 10278-CAA | PHS (QPSK, BW 884MHz, Rolloff 0.5)                                 | X | 9.23  | 83.71 | 19.86 | 9.03 | 50.0  | ± 9.6 % |
|           |  | Y | 16.13 | 92.59 | 23.80 |      | 50.0  |         |
|           |  | Z | 2.80  | 66.68 | 11.50 |      | 50.0  |         |
| 10279-CAA | PHS (QPSK, BW 884MHz, Rolloff 0.38)                                | X | 9.55  | 84.14 | 20.09 | 9.03 | 50.0  | ± 9.6 % |
|           |  | Y | 16.22 | 92.62 | 23.87 |      | 50.0  |         |
|           |  | Z | 2.90  | 67.01 | 11.74 |      | 50.0  |         |
| 10290-AAB | CDMA2000, RC1, SO55, Full Rate                                     | X | 1.55  | 69.78 | 14.51 | 0.00 | 150.0 | ± 9.6 % |
|           |  | Y | 1.48  | 68.23 | 14.09 |      | 150.0 |         |
|           |  | Z | 1.19  | 67.52 | 12.47 |      | 150.0 |         |
| 10291-AAB | CDMA2000, RC3, SO55, Full Rate                                     | X | 0.89  | 66.83 | 13.08 | 0.00 | 150.0 | ± 9.6 % |
|           |  | Y | 0.85  | 65.35 | 12.57 |      | 150.0 |         |
|           |  | Z | 0.74  | 65.55 | 11.46 |      | 150.0 |         |
| 10292-AAB | CDMA2000, RC3, SO32, Full Rate                                     | X | 1.27  | 72.61 | 16.13 | 0.00 | 150.0 | ± 9.6 % |
|           |  | Y | 1.03  | 68.80 | 14.67 |      | 150.0 |         |
|           |  | Z | 1.20  | 72.32 | 14.93 |      | 150.0 |         |
| 10293-AAB | CDMA2000, RC3, SO3, Full Rate                                      | X | 2.34  | 81.60 | 20.09 | 0.00 | 150.0 | ± 9.6 % |
|           |  | Y | 1.43  | 73.64 | 17.27 |      | 150.0 |         |
|           |  | Z | 3.93  | 87.90 | 20.92 |      | 150.0 |         |
| 10295-AAB | CDMA2000, RC1, SO3, 1/8th Rate 25 fr.                              | X | 16.32 | 98.49 | 29.02 | 9.03 | 50.0  | ± 9.6 % |
|           |  | Y | 11.98 | 92.39 | 27.58 |      | 50.0  |         |
|           |  | Z | 18.77 | 96.90 | 26.52 |      | 50.0  |         |
| 10297-AAC | LTE-FDD (SC-FDMA, 50% RB, 20 MHz, QPSK)                            | X | 2.80  | 70.02 | 16.88 | 0.00 | 150.0 | ± 9.6 % |
|           |  | Y | 2.77  | 69.27 | 16.41 |      | 150.0 |         |
|           |  | Z | 2.65  | 69.87 | 16.82 |      | 150.0 |         |
| 10298-AAC | LTE-FDD (SC-FDMA, 50% RB, 3 MHz, QPSK)                             | X | 1.62  | 68.28 | 14.44 | 0.00 | 150.0 | ± 9.6 % |
|           |  | Y | 1.62  | 67.40 | 14.26 |      | 150.0 |         |
|           |  | Z | 1.32  | 66.56 | 12.71 |      | 150.0 |         |
| 10299-AAC | LTE-FDD (SC-FDMA, 50% RB, 3 MHz, 16-QAM)                           | X | 2.59  | 69.34 | 14.00 | 0.00 | 150.0 | ± 9.6 % |
|           |  | Y | 2.92  | 70.30 | 15.01 |      | 150.0 |         |
|           |  | Z | 1.54  | 64.05 | 10.22 |      | 150.0 |         |
| 10300-AAC | LTE-FDD (SC-FDMA, 50% RB, 3 MHz, 64-QAM)                           | X | 1.92  | 64.86 | 11.14 | 0.00 | 150.0 | ± 9.6 % |
|           |  | Y | 2.24  | 65.95 | 12.27 |      | 150.0 |         |
|           |  | Z | 1.26  | 61.60 | 8.20  |      | 150.0 |         |
| 10301-AAA | IEEE 802.16e WiMAX (29:18, 5ms, 10MHz, QPSK, PUSC)                 | X | 4.85  | 66.06 | 17.86 | 4.17 | 50.0  | ± 9.6 % |
|           |  | Y | 4.97  | 65.84 | 17.76 |      | 50.0  |         |
|           |  | Z | 4.42  | 65.27 | 17.23 |      | 50.0  |         |
| 10302-AAA | IEEE 802.16e WiMAX (29:18, 5ms, 10MHz, QPSK, PUSC, 3 CTRL symbols) | X | 5.22  | 66.19 | 18.31 | 4.96 | 50.0  | ± 9.6 % |
|           |  | Y | 5.38  | 66.17 | 18.31 |      | 50.0  |         |
|           |  | Z | 4.86  | 65.76 | 17.88 |      | 50.0  |         |

|           |   |   |       |        |       |       |       |         |
|-----------|---|---|-------|--------|-------|-------|-------|---------|
| 10303-AAA | IEEE 802.16e WiMAX (31:15, 5ms, 10MHz, 64QAM, PUSC)                 | X | 4.96  | 65.79  | 18.13 | 4.96  | 50.0  | ± 9.6 % |
|           |   | Y | 5.14  | 65.84  | 18.17 |       | 50.0  |         |
|           |   | Z | 4.61  | 65.34  | 17.65 |       | 50.0  |         |
| 10304-AAA | IEEE 802.16e WiMAX (29:18, 5ms, 10MHz, 64QAM, PUSC)                 | X | 4.78  | 65.69  | 17.62 | 4.17  | 50.0  | ± 9.6 % |
|           |   | Y | 4.94  | 65.66  | 17.62 |       | 50.0  |         |
|           |   | Z | 4.45  | 65.35  | 17.22 |       | 50.0  |         |
| 10305-AAA | IEEE 802.16e WiMAX (31:15, 10ms, 10MHz, 64QAM, PUSC, 15 symbols)    | X | 4.24  | 66.91  | 19.40 | 6.02  | 35.0  | ± 9.6 % |
|           |   | Y | 4.54  | 67.57  | 19.86 |       | 35.0  |         |
|           |   | Z | 3.84  | 65.89  | 18.29 |       | 35.0  |         |
| 10306-AAA | IEEE 802.16e WiMAX (29:18, 10ms, 10MHz, 64QAM, PUSC, 18 symbols)    | X | 4.62  | 66.22  | 19.11 | 6.02  | 35.0  | ± 9.6 % |
|           |   | Y | 4.86  | 66.59  | 19.39 |       | 35.0  |         |
|           |   | Z | 4.26  | 65.53  | 18.31 |       | 35.0  |         |
| 10307-AAA | IEEE 802.16e WiMAX (29:18, 10ms, 10MHz, QPSK, PUSC, 18 symbols)     | X | 4.50  | 66.31  | 19.05 | 6.02  | 35.0  | ± 9.6 % |
|           |   | Y | 4.77  | 66.81  | 19.39 |       | 35.0  |         |
|           |   | Z | 4.12  | 65.47  | 18.17 |       | 35.0  |         |
| 10308-AAA | IEEE 802.16e WiMAX (29:18, 10ms, 10MHz, 16QAM, PUSC)                | X | 4.47  | 66.49  | 19.18 | 6.02  | 35.0  | ± 9.6 % |
|           |   | Y | 4.73  | 66.98  | 19.51 |       | 35.0  |         |
|           |   | Z | 4.09  | 65.63  | 18.30 |       | 35.0  |         |
| 10309-AAA | IEEE 802.16e WiMAX (29:18, 10ms, 10MHz, 16QAM, AMC 2x3, 18 symbols) | X | 4.68  | 66.45  | 19.27 | 6.02  | 35.0  | ± 9.6 % |
|           |   | Y | 4.93  | 66.86  | 19.56 |       | 35.0  |         |
|           |   | Z | 4.28  | 65.63  | 18.41 |       | 35.0  |         |
| 10310-AAA | IEEE 802.16e WiMAX (29:18, 10ms, 10MHz, QPSK, AMC 2x3, 18 symbols)  | X | 4.56  | 66.25  | 19.08 | 6.02  | 35.0  | ± 9.6 % |
|           |   | Y | 4.81  | 66.65  | 19.36 |       | 35.0  |         |
|           |   | Z | 4.20  | 65.54  | 18.28 |       | 35.0  |         |
| 10311-AAC | LTE-FDD (SC-FDMA, 100% RB, 15 MHz, QPSK)                            | X | 3.16  | 69.26  | 16.50 | 0.00  | 150.0 | ± 9.6 % |
|           |   | Y | 3.13  | 68.60  | 16.08 |       | 150.0 |         |
|           |   | Z | 3.01  | 69.09  | 16.45 |       | 150.0 |         |
| 10313-AAA | IDEN 1:3  | X | 8.00  | 86.23  | 21.34 | 6.99  | 70.0  | ± 9.6 % |
|           |   | Y | 8.53  | 85.21  | 20.95 |       | 70.0  |         |
|           |   | Z | 3.31  | 75.28  | 17.31 |       | 70.0  |         |
| 10314-AAA | IDEN 1:6  | X | 12.68 | 100.31 | 29.33 | 10.00 | 30.0  | ± 9.6 % |
|           |   | Y | 13.31 | 98.73  | 28.67 |       | 30.0  |         |
|           |   | Z | 5.19  | 85.23  | 24.17 |       | 30.0  |         |
| 10315-AAB | IEEE 802.11b WiFi 2.4 GHz (DSSS, 1 Mbps, 96pc duty cycle)           | X | 1.10  | 64.07  | 15.53 | 0.17  | 150.0 | ± 9.6 % |
|           |   | Y | 1.10  | 63.56  | 15.08 |       | 150.0 |         |
|           |   | Z | 1.08  | 63.95  | 15.31 |       | 150.0 |         |
| 10316-AAB | IEEE 802.11g WiFi 2.4 GHz (ERP-OFDM, 6 Mbps, 96pc duty cycle)       | X | 4.59  | 66.75  | 16.41 | 0.17  | 150.0 | ± 9.6 % |
|           |   | Y | 4.66  | 66.58  | 16.32 |       | 150.0 |         |
|           |   | Z | 4.43  | 66.78  | 16.29 |       | 150.0 |         |
| 10317-AAB | IEEE 802.11a WiFi 5 GHz (OFDM, 6 Mbps, 96pc duty cycle)             | X | 4.59  | 66.75  | 16.41 | 0.17  | 150.0 | ± 9.6 % |
|           |   | Y | 4.66  | 66.58  | 16.32 |       | 150.0 |         |
|           |   | Z | 4.43  | 66.78  | 16.29 |       | 150.0 |         |
| 10400-AAC | IEEE 802.11ac WiFi (20MHz, 64-QAM, 99pc duty cycle)                 | X | 4.69  | 67.06  | 16.37 | 0.00  | 150.0 | ± 9.6 % |
|           |   | Y | 4.77  | 66.86  | 16.25 |       | 150.0 |         |
|           |   | Z | 4.51  | 67.11  | 16.31 |       | 150.0 |         |
| 10401-AAC | IEEE 802.11ac WiFi (40MHz, 64-QAM, 99pc duty cycle)                 | X | 5.41  | 67.26  | 16.54 | 0.00  | 150.0 | ± 9.6 % |
|           |   | Y | 5.45  | 67.06  | 16.42 |       | 150.0 |         |
|           |   | Z | 5.18  | 66.94  | 16.33 |       | 150.0 |         |

|           |  |   |        |        |       |      |       |         |
|-----------|--|---|--------|--------|-------|------|-------|---------|
| 10402-AAC | IEEE 802.11ac WiFi (80MHz, 64-QAM, 99pc duty cycle)                            | X | 5.65   | 67.49  | 16.51 | 0.00 | 150.0 | ± 9.6 % |
|           |  | Y | 5.72   | 67.43  | 16.45 |      | 150.0 |         |
|           |  | Z | 5.51   | 67.47  | 16.48 |      | 150.0 |         |
| 10403-AAB | CDMA2000 (1xEV-DO, Rev. 0)   | X | 1.55   | 69.78  | 14.51 | 0.00 | 115.0 | ± 9.6 % |
|           |  | Y | 1.48   | 68.23  | 14.09 |      | 115.0 |         |
|           |  | Z | 1.19   | 67.52  | 12.47 |      | 115.0 |         |
| 10404-AAB | CDMA2000 (1xEV-DO, Rev. A)   | X | 1.55   | 69.78  | 14.51 | 0.00 | 115.0 | ± 9.6 % |
|           |  | Y | 1.48   | 68.23  | 14.09 |      | 115.0 |         |
|           |  | Z | 1.19   | 67.52  | 12.47 |      | 115.0 |         |
| 10406-AAB | CDMA2000, RC3, SO32, SCH0, Full Rate   | X | 100.00 | 120.41 | 29.76 | 0.00 | 100.0 | ± 9.6 % |
|           |  | Y | 19.72  | 99.25  | 25.38 |      | 100.0 |         |
|           |  | Z | 22.86  | 100.95 | 24.14 |      | 100.0 |         |
| 10410-AAC | LTE-TDD (SC-FDMA, 1 RB, 10 MHz, QPSK, UL Subframe=2,3,4,7,8,9)                 | X | 100.00 | 125.71 | 31.88 | 3.23 | 80.0  | ± 9.6 % |
|           |  | Y | 100.00 | 124.16 | 31.78 |      | 80.0  |         |
|           |  | Z | 8.15   | 91.76  | 22.46 |      | 80.0  |         |
| 10415-AAA | IEEE 802.11b WiFi 2.4 GHz (DSSS, 1 Mbps, 99pc duty cycle)                      | X | 1.03   | 63.26  | 14.92 | 0.00 | 150.0 | ± 9.6 % |
|           |  | Y | 1.02   | 62.63  | 14.41 |      | 150.0 |         |
|           |  | Z | 1.03   | 63.39  | 14.88 |      | 150.0 |         |
| 10416-AAA | IEEE 802.11g WiFi 2.4 GHz (ERP-OFDM, 6 Mbps, 99pc duty cycle)                  | X | 4.54   | 66.72  | 16.31 | 0.00 | 150.0 | ± 9.6 % |
|           |  | Y | 4.59   | 66.51  | 16.19 |      | 150.0 |         |
|           |  | Z | 4.40   | 66.84  | 16.26 |      | 150.0 |         |
| 10417-AAA | IEEE 802.11a/h WiFi 5 GHz (OFDM, 6 Mbps, 99pc duty cycle)                      | X | 4.54   | 66.72  | 16.31 | 0.00 | 150.0 | ± 9.6 % |
|           |  | Y | 4.59   | 66.51  | 16.19 |      | 150.0 |         |
|           |  | Z | 4.40   | 66.84  | 16.26 |      | 150.0 |         |
| 10418-AAA | IEEE 802.11g WiFi 2.4 GHz (DSSS-OFDM, 6 Mbps, 99pc duty cycle, Long preamble)  | X | 4.53   | 66.89  | 16.33 | 0.00 | 150.0 | ± 9.6 % |
|           |  | Y | 4.58   | 66.66  | 16.20 |      | 150.0 |         |
|           |  | Z | 4.40   | 67.05  | 16.32 |      | 150.0 |         |
| 10419-AAA | IEEE 802.11g WiFi 2.4 GHz (DSSS-OFDM, 6 Mbps, 99pc duty cycle, Short preamble) | X | 4.55   | 66.83  | 16.33 | 0.00 | 150.0 | ± 9.6 % |
|           |  | Y | 4.60   | 66.61  | 16.21 |      | 150.0 |         |
|           |  | Z | 4.41   | 66.98  | 16.30 |      | 150.0 |         |
| 10422-AAA | IEEE 802.11n (HT Greenfield, 7.2 Mbps, BPSK)                                   | X | 4.66   | 66.83  | 16.34 | 0.00 | 150.0 | ± 9.6 % |
|           |  | Y | 4.72   | 66.62  | 16.23 |      | 150.0 |         |
|           |  | Z | 4.52   | 66.95  | 16.31 |      | 150.0 |         |
| 10423-AAA | IEEE 802.11n (HT Greenfield, 43.3 Mbps, 16-QAM)                                | X | 4.82   | 67.13  | 16.45 | 0.00 | 150.0 | ± 9.6 % |
|           |  | Y | 4.90   | 66.96  | 16.35 |      | 150.0 |         |
|           |  | Z | 4.65   | 67.21  | 16.40 |      | 150.0 |         |
| 10424-AAA | IEEE 802.11n (HT Greenfield, 72.2 Mbps, 64-QAM)                                | X | 4.75   | 67.09  | 16.43 | 0.00 | 150.0 | ± 9.6 % |
|           |  | Y | 4.82   | 66.90  | 16.32 |      | 150.0 |         |
|           |  | Z | 4.58   | 67.17  | 16.38 |      | 150.0 |         |
| 10425-AAA | IEEE 802.11n (HT Greenfield, 15 Mbps, BPSK)                                    | X | 5.35   | 67.37  | 16.60 | 0.00 | 150.0 | ± 9.6 % |
|           |  | Y | 5.42   | 67.27  | 16.52 |      | 150.0 |         |
|           |  | Z | 5.19   | 67.35  | 16.55 |      | 150.0 |         |
| 10426-AAA | IEEE 802.11n (HT Greenfield, 90 Mbps, 16-QAM)                                  | X | 5.36   | 67.42  | 16.62 | 0.00 | 150.0 | ± 9.6 % |
|           |  | Y | 5.42   | 67.27  | 16.52 |      | 150.0 |         |
|           |  | Z | 5.21   | 67.42  | 16.58 |      | 150.0 |         |

|           |  |   |        |        |       |      |       |         |
|-----------|--|---|--------|--------|-------|------|-------|---------|
| 10427-AAA | IEEE 802.11n (HT Greenfield, 150 Mbps, 64-QAM)                 | X | 5.37   | 67.38  | 16.60 | 0.00 | 150.0 | ± 9.6 % |
|           |  | Y | 5.43   | 67.25  | 16.50 |      | 150.0 |         |
|           |  | Z | 5.18   | 67.23  | 16.48 |      | 150.0 |         |
| 10430-AAB | LTE-FDD (OFDMA, 5 MHz, E-TM 3.1)                               | X | 4.24   | 70.83  | 18.17 | 0.00 | 150.0 | ± 9.6 % |
|           |  | Y | 4.26   | 70.25  | 18.02 |      | 150.0 |         |
|           |  | Z | 4.20   | 71.89  | 18.27 |      | 150.0 |         |
| 10431-AAB | LTE-FDD (OFDMA, 10 MHz, E-TM 3.1)                              | X | 4.21   | 67.30  | 16.30 | 0.00 | 150.0 | ± 9.6 % |
|           |  | Y | 4.28   | 67.03  | 16.19 |      | 150.0 |         |
|           |  | Z | 4.03   | 67.45  | 16.18 |      | 150.0 |         |
| 10432-AAB | LTE-FDD (OFDMA, 15 MHz, E-TM 3.1)                              | X | 4.51   | 67.15  | 16.38 | 0.00 | 150.0 | ± 9.6 % |
|           |  | Y | 4.58   | 66.93  | 16.27 |      | 150.0 |         |
|           |  | Z | 4.34   | 67.27  | 16.32 |      | 150.0 |         |
| 10433-AAB | LTE-FDD (OFDMA, 20 MHz, E-TM 3.1)                              | X | 4.76   | 67.12  | 16.45 | 0.00 | 150.0 | ± 9.6 % |
|           |  | Y | 4.83   | 66.94  | 16.34 |      | 150.0 |         |
|           |  | Z | 4.59   | 67.20  | 16.40 |      | 150.0 |         |
| 10434-AAA | W-CDMA (BS Test Model 1, 64 DPCH)                              | X | 4.34   | 71.72  | 18.14 | 0.00 | 150.0 | ± 9.6 % |
|           |  | Y | 4.35   | 71.03  | 17.99 |      | 150.0 |         |
|           |  | Z | 4.31   | 72.81  | 18.12 |      | 150.0 |         |
| 10435-AAC | LTE-TDD (SC-FDMA, 1 RB, 20 MHz, QPSK, UL Subframe=2,3,4,7,8,9) | X | 100.00 | 125.48 | 31.77 | 3.23 | 80.0  | ± 9.6 % |
|           |  | Y | 100.00 | 123.97 | 31.69 |      | 80.0  |         |
|           |  | Z | 7.63   | 90.76  | 22.11 |      | 80.0  |         |
| 10447-AAB | LTE-FDD (OFDMA, 5 MHz, E-TM 3.1, Clipping 44%)                 | X | 3.51   | 67.35  | 15.60 | 0.00 | 150.0 | ± 9.6 % |
|           |  | Y | 3.58   | 66.99  | 15.55 |      | 150.0 |         |
|           |  | Z | 3.28   | 67.36  | 15.16 |      | 150.0 |         |
| 10448-AAB | LTE-FDD (OFDMA, 10 MHz, E-TM 3.1, Clipping 44%)                | X | 4.06   | 67.09  | 16.17 | 0.00 | 150.0 | ± 9.6 % |
|           |  | Y | 4.12   | 66.80  | 16.05 |      | 150.0 |         |
|           |  | Z | 3.89   | 67.25  | 16.05 |      | 150.0 |         |
| 10449-AAB | LTE-FDD (OFDMA, 15 MHz, E-TM 3.1, Clipping 44%)                | X | 4.33   | 66.98  | 16.28 | 0.00 | 150.0 | ± 9.6 % |
|           |  | Y | 4.39   | 66.75  | 16.16 |      | 150.0 |         |
|           |  | Z | 4.18   | 67.10  | 16.22 |      | 150.0 |         |
| 10450-AAB | LTE-FDD (OFDMA, 20 MHz, E-TM 3.1, Clipping 44%)                | X | 4.53   | 66.89  | 16.30 | 0.00 | 150.0 | ± 9.6 % |
|           |  | Y | 4.58   | 66.69  | 16.19 |      | 150.0 |         |
|           |  | Z | 4.39   | 66.98  | 16.26 |      | 150.0 |         |
| 10451-AAA | W-CDMA (BS Test Model 1, 64 DPCH, Clipping 44%)                | X | 3.39   | 67.51  | 15.20 | 0.00 | 150.0 | ± 9.6 % |
|           |  | Y | 3.48   | 67.19  | 15.21 |      | 150.0 |         |
|           |  | Z | 3.10   | 67.22  | 14.48 |      | 150.0 |         |
| 10456-AAA | IEEE 802.11ac WiFi (160MHz, 64-QAM, 99pc duty cycle)           | X | 6.22   | 67.91  | 16.74 | 0.00 | 150.0 | ± 9.6 % |
|           |  | Y | 6.28   | 67.83  | 16.68 |      | 150.0 |         |
|           |  | Z | 6.11   | 67.90  | 16.72 |      | 150.0 |         |
| 10457-AAA | UMTS-FDD (DC-HSDPA)  | X | 3.80   | 65.37  | 16.02 | 0.00 | 150.0 | ± 9.6 % |
|           |  | Y | 3.83   | 65.15  | 15.90 |      | 150.0 |         |
|           |  | Z | 3.74   | 65.57  | 15.99 |      | 150.0 |         |
| 10458-AAA | CDMA2000 (1xEV-DO, Rev. B, 2 carriers)                         | X | 3.21   | 66.83  | 14.57 | 0.00 | 150.0 | ± 9.6 % |
|           |  | Y | 3.31   | 66.55  | 14.68 |      | 150.0 |         |
|           |  | Z | 2.82   | 66.01  | 13.39 |      | 150.0 |         |
| 10459-AAA | CDMA2000 (1xEV-DO, Rev. B, 3 carriers)                         | X | 4.29   | 65.14  | 15.57 | 0.00 | 150.0 | ± 9.6 % |
|           |  | Y | 4.36   | 64.71  | 15.51 |      | 150.0 |         |
|           |  | Z | 4.04   | 65.27  | 15.07 |      | 150.0 |         |

|           |   |   |        |        |       |      |       |         |
|-----------|---|---|--------|--------|-------|------|-------|---------|
| 10460-AAA | UMTS-FDD (WCDMA, AMR)   | X | 0.96   | 69.26  | 16.86 | 0.00 | 150.0 | ± 9.6 % |
|           |   | Y | 0.88   | 67.02  | 15.53 |      | 150.0 |         |
|           |   | Z | 0.94   | 69.35  | 16.76 |      | 150.0 |         |
| 10461-AAA | LTE-TDD (SC-FDMA, 1 RB, 1.4 MHz, QPSK, UL Subframe=2,3,4,7,8,9)   | X | 100.00 | 131.25 | 34.47 | 3.29 | 80.0  | ± 9.6 % |
|           |   | Y | 100.00 | 128.59 | 33.89 |      | 80.0  |         |
|           |   | Z | 3.16   | 81.29  | 20.28 |      | 80.0  |         |
| 10462-AAA | LTE-TDD (SC-FDMA, 1 RB, 1.4 MHz, 16-QAM, UL Subframe=2,3,4,7,8,9) | X | 18.15  | 90.54  | 19.55 | 3.23 | 80.0  | ± 9.6 % |
|           |   | Y | 100.00 | 110.06 | 25.23 |      | 80.0  |         |
|           |   | Z | 0.71   | 60.00  | 7.72  |      | 80.0  |         |
| 10463-AAA | LTE-TDD (SC-FDMA, 1 RB, 1.4 MHz, 64-QAM, UL Subframe=2,3,4,7,8,9) | X | 2.32   | 68.92  | 12.27 | 3.23 | 80.0  | ± 9.6 % |
|           |   | Y | 12.78  | 85.50  | 18.46 |      | 80.0  |         |
|           |   | Z | 0.72   | 60.00  | 7.06  |      | 80.0  |         |
| 10464-AAA | LTE-TDD (SC-FDMA, 1 RB, 3 MHz, QPSK, UL Subframe=2,3,4,7,8,9)     | X | 100.00 | 128.50 | 33.02 | 3.23 | 80.0  | ± 9.6 % |
|           |   | Y | 100.00 | 126.31 | 32.66 |      | 80.0  |         |
|           |   | Z | 2.43   | 77.27  | 18.20 |      | 80.0  |         |
| 10465-AAA | LTE-TDD (SC-FDMA, 1 RB, 3 MHz, 16-QAM, UL Subframe=2,3,4,7,8,9)   | X | 7.48   | 81.44  | 16.98 | 3.23 | 80.0  | ± 9.6 % |
|           |   | Y | 53.06  | 102.63 | 23.42 |      | 80.0  |         |
|           |   | Z | 0.71   | 60.00  | 7.65  |      | 80.0  |         |
| 10466-AAA | LTE-TDD (SC-FDMA, 1 RB, 3 MHz, 64-QAM, UL Subframe=2,3,4,7,8,9)   | X | 1.86   | 66.75  | 11.37 | 3.23 | 80.0  | ± 9.6 % |
|           |   | Y | 7.10   | 79.26  | 16.56 |      | 80.0  |         |
|           |   | Z | 0.72   | 60.00  | 7.01  |      | 80.0  |         |
| 10467-AAC | LTE-TDD (SC-FDMA, 1 RB, 5 MHz, QPSK, UL Subframe=2,3,4,7,8,9)     | X | 100.00 | 128.82 | 33.16 | 3.23 | 80.0  | ± 9.6 % |
|           |   | Y | 100.00 | 126.57 | 32.78 |      | 80.0  |         |
|           |   | Z | 2.60   | 78.29  | 18.60 |      | 80.0  |         |
| 10468-AAC | LTE-TDD (SC-FDMA, 1 RB, 5 MHz, 16-QAM, UL Subframe=2,3,4,7,8,9)   | X | 9.21   | 83.60  | 17.62 | 3.23 | 80.0  | ± 9.6 % |
|           |   | Y | 76.07  | 106.68 | 24.37 |      | 80.0  |         |
|           |   | Z | 0.70   | 60.00  | 7.67  |      | 80.0  |         |
| 10469-AAC | LTE-TDD (SC-FDMA, 1 RB, 5 MHz, 64-QAM, UL Subframe=2,3,4,7,8,9)   | X | 1.87   | 66.82  | 11.40 | 3.23 | 80.0  | ± 9.6 % |
|           |   | Y | 7.22   | 79.45  | 16.62 |      | 80.0  |         |
|           |   | Z | 0.72   | 60.00  | 7.01  |      | 80.0  |         |
| 10470-AAC | LTE-TDD (SC-FDMA, 1 RB, 10 MHz, QPSK, UL Subframe=2,3,4,7,8,9)    | X | 100.00 | 128.87 | 33.17 | 3.23 | 80.0  | ± 9.6 % |
|           |   | Y | 100.00 | 126.61 | 32.79 |      | 80.0  |         |
|           |   | Z | 2.61   | 78.33  | 18.61 |      | 80.0  |         |
| 10471-AAC | LTE-TDD (SC-FDMA, 1 RB, 10 MHz, 16-QAM, UL Subframe=2,3,4,7,8,9)  | X | 9.03   | 83.37  | 17.54 | 3.23 | 80.0  | ± 9.6 % |
|           |   | Y | 75.72  | 106.57 | 24.32 |      | 80.0  |         |
|           |   | Z | 0.70   | 60.00  | 7.66  |      | 80.0  |         |
| 10472-AAC | LTE-TDD (SC-FDMA, 1 RB, 10 MHz, 64-QAM, UL Subframe=2,3,4,7,8,9)  | X | 1.85   | 66.72  | 11.34 | 3.23 | 80.0  | ± 9.6 % |
|           |   | Y | 7.17   | 79.36  | 16.58 |      | 80.0  |         |
|           |   | Z | 0.72   | 60.00  | 6.99  |      | 80.0  |         |
| 10473-AAC | LTE-TDD (SC-FDMA, 1 RB, 15 MHz, QPSK, UL Subframe=2,3,4,7,8,9)    | X | 100.00 | 128.83 | 33.15 | 3.23 | 80.0  | ± 9.6 % |
|           |   | Y | 100.00 | 126.57 | 32.77 |      | 80.0  |         |
|           |   | Z | 2.60   | 78.28  | 18.59 |      | 80.0  |         |
| 10474-AAC | LTE-TDD (SC-FDMA, 1 RB, 15 MHz, 16-QAM, UL Subframe=2,3,4,7,8,9)  | X | 8.86   | 83.19  | 17.49 | 3.23 | 80.0  | ± 9.6 % |
|           |   | Y | 73.20  | 106.22 | 24.25 |      | 80.0  |         |
|           |   | Z | 0.70   | 60.00  | 7.66  |      | 80.0  |         |
| 10475-AAC | LTE-TDD (SC-FDMA, 1 RB, 15 MHz, 64-QAM, UL Subframe=2,3,4,7,8,9)  | X | 1.84   | 66.67  | 11.33 | 3.23 | 80.0  | ± 9.6 % |
|           |   | Y | 7.07   | 79.22  | 16.54 |      | 80.0  |         |
|           |   | Z | 0.72   | 60.00  | 6.99  |      | 80.0  |         |

|           |   |   |       |        |       |      |      |         |
|-----------|---|---|-------|--------|-------|------|------|---------|
| 10477-AAC | LTE-TDD (SC-FDMA, 1 RB, 20 MHz, 16-QAM, UL Subframe=2,3,4,7,8,9)    | X | 7.55  | 81.52  | 16.98 | 3.23 | 80.0 | ± 9.6 % |
|           |   | Y | 56.45 | 103.26 | 23.54 |      | 80.0 |         |
|           |   | Z | 0.70  | 60.00  | 7.63  |      | 80.0 |         |
| 10478-AAC | LTE-TDD (SC-FDMA, 1 RB, 20 MHz, 64-QAM, UL Subframe=2,3,4,7,8,9)    | X | 1.82  | 66.56  | 11.27 | 3.23 | 80.0 | ± 9.6 % |
|           |   | Y | 6.95  | 79.03  | 16.47 |      | 80.0 |         |
|           |   | Z | 0.72  | 60.00  | 6.98  |      | 80.0 |         |
| 10479-AAA | LTE-TDD (SC-FDMA, 50% RB, 1.4 MHz, QPSK, UL Subframe=2,3,4,7,8,9)   | X | 10.99 | 93.23  | 25.61 | 3.23 | 80.0 | ± 9.6 % |
|           |   | Y | 9.79  | 90.18  | 24.96 |      | 80.0 |         |
|           |   | Z | 4.54  | 80.48  | 20.41 |      | 80.0 |         |
| 10480-AAA | LTE-TDD (SC-FDMA, 50% RB, 1.4 MHz, 16-QAM, UL Subframe=2,3,4,7,8,9) | X | 12.16 | 88.23  | 21.88 | 3.23 | 80.0 | ± 9.6 % |
|           |   | Y | 11.98 | 87.55  | 22.28 |      | 80.0 |         |
|           |   | Z | 2.88  | 70.37  | 14.48 |      | 80.0 |         |
| 10481-AAA | LTE-TDD (SC-FDMA, 50% RB, 1.4 MHz, 64-QAM, UL Subframe=2,3,4,7,8,9) | X | 8.71  | 82.91  | 19.80 | 3.23 | 80.0 | ± 9.6 % |
|           |   | Y | 9.82  | 84.02  | 20.80 |      | 80.0 |         |
|           |   | Z | 2.18  | 66.77  | 12.57 |      | 80.0 |         |
| 10482-AAA | LTE-TDD (SC-FDMA, 50% RB, 3 MHz, QPSK, UL Subframe=2,3,4,7,8,9)     | X | 4.05  | 77.33  | 19.19 | 2.23 | 80.0 | ± 9.6 % |
|           |   | Y | 4.17  | 76.68  | 19.19 |      | 80.0 |         |
|           |   | Z | 2.07  | 68.66  | 14.58 |      | 80.0 |         |
| 10483-AAA | LTE-TDD (SC-FDMA, 50% RB, 3 MHz, 16-QAM, UL Subframe=2,3,4,7,8,9)   | X | 4.93  | 75.57  | 17.70 | 2.23 | 80.0 | ± 9.6 % |
|           |   | Y | 6.34  | 78.50  | 19.36 |      | 80.0 |         |
|           |   | Z | 1.80  | 63.38  | 11.04 |      | 80.0 |         |
| 10484-AAA | LTE-TDD (SC-FDMA, 50% RB, 3 MHz, 64-QAM, UL Subframe=2,3,4,7,8,9)   | X | 4.47  | 74.01  | 17.11 | 2.23 | 80.0 | ± 9.6 % |
|           |   | Y | 5.79  | 76.98  | 18.82 |      | 80.0 |         |
|           |   | Z | 1.76  | 62.89  | 10.79 |      | 80.0 |         |
| 10485-AAC | LTE-TDD (SC-FDMA, 50% RB, 5 MHz, QPSK, UL Subframe=2,3,4,7,8,9)     | X | 4.05  | 77.49  | 20.34 | 2.23 | 80.0 | ± 9.6 % |
|           |   | Y | 4.20  | 76.76  | 20.09 |      | 80.0 |         |
|           |   | Z | 2.71  | 72.24  | 17.50 |      | 80.0 |         |
| 10486-AAC | LTE-TDD (SC-FDMA, 50% RB, 5 MHz, 16-QAM, UL Subframe=2,3,4,7,8,9)   | X | 3.54  | 71.63  | 17.34 | 2.23 | 80.0 | ± 9.6 % |
|           |   | Y | 3.76  | 71.58  | 17.54 |      | 80.0 |         |
|           |   | Z | 2.51  | 67.51  | 14.60 |      | 80.0 |         |
| 10487-AAC | LTE-TDD (SC-FDMA, 50% RB, 5 MHz, 64-QAM, UL Subframe=2,3,4,7,8,9)   | X | 3.49  | 71.03  | 17.07 | 2.23 | 80.0 | ± 9.6 % |
|           |   | Y | 3.74  | 71.08  | 17.31 |      | 80.0 |         |
|           |   | Z | 2.49  | 67.04  | 14.35 |      | 80.0 |         |
| 10488-AAC | LTE-TDD (SC-FDMA, 50% RB, 10 MHz, QPSK, UL Subframe=2,3,4,7,8,9)    | X | 3.92  | 74.84  | 20.03 | 2.23 | 80.0 | ± 9.6 % |
|           |   | Y | 4.21  | 74.77  | 19.87 |      | 80.0 |         |
|           |   | Z | 2.99  | 71.49  | 18.31 |      | 80.0 |         |
| 10489-AAC | LTE-TDD (SC-FDMA, 50% RB, 10 MHz, 16-QAM, UL Subframe=2,3,4,7,8,9)  | X | 3.58  | 70.14  | 18.01 | 2.23 | 80.0 | ± 9.6 % |
|           |   | Y | 3.82  | 70.22  | 18.04 |      | 80.0 |         |
|           |   | Z | 3.03  | 68.36  | 16.75 |      | 80.0 |         |
| 10490-AAC | LTE-TDD (SC-FDMA, 50% RB, 10 MHz, 64-QAM, UL Subframe=2,3,4,7,8,9)  | X | 3.66  | 69.89  | 17.90 | 2.23 | 80.0 | ± 9.6 % |
|           |   | Y | 3.90  | 69.97  | 17.95 |      | 80.0 |         |
|           |   | Z | 3.10  | 68.21  | 16.67 |      | 80.0 |         |
| 10491-AAC | LTE-TDD (SC-FDMA, 50% RB, 15 MHz, QPSK, UL Subframe=2,3,4,7,8,9)    | X | 4.00  | 72.50  | 19.16 | 2.23 | 80.0 | ± 9.6 % |
|           |   | Y | 4.28  | 72.62  | 19.08 |      | 80.0 |         |
|           |   | Z | 3.25  | 70.05  | 17.90 |      | 80.0 |         |
| 10492-AAC | LTE-TDD (SC-FDMA, 50% RB, 15 MHz, 16-QAM, UL Subframe=2,3,4,7,8,9)  | X | 3.86  | 68.99  | 17.79 | 2.23 | 80.0 | ± 9.6 % |
|           |   | Y | 4.11  | 69.18  | 17.85 |      | 80.0 |         |
|           |   | Z | 3.37  | 67.61  | 16.86 |      | 80.0 |         |

|           |  |   |      |       |       |      |      |         |
|-----------|--|---|------|-------|-------|------|------|---------|
| 10493-AAC | LTE-TDD (SC-FDMA, 50% RB, 15 MHz, 64-QAM, UL Subframe=2,3,4,7,8,9)   | X | 3.92 | 68.82 | 17.72 | 2.23 | 80.0 | ± 9.6 % |
|           |  | Y | 4.17 | 69.02 | 17.78 |      | 80.0 |         |
|           |  | Z | 3.43 | 67.50 | 16.80 |      | 80.0 |         |
| 10494-AAC | LTE-TDD (SC-FDMA, 50% RB, 20 MHz, QPSK, UL Subframe=2,3,4,7,8,9)     | X | 4.43 | 74.41 | 19.78 | 2.23 | 80.0 | ± 9.6 % |
|           |  | Y | 4.75 | 74.52 | 19.68 |      | 80.0 |         |
|           |  | Z | 3.49 | 71.39 | 18.37 |      | 80.0 |         |
| 10495-AAC | LTE-TDD (SC-FDMA, 50% RB, 20 MHz, 16-QAM, UL Subframe=2,3,4,7,8,9)   | X | 3.90 | 69.39 | 18.01 | 2.23 | 80.0 | ± 9.6 % |
|           |  | Y | 4.16 | 69.65 | 18.06 |      | 80.0 |         |
|           |  | Z | 3.39 | 67.86 | 17.06 |      | 80.0 |         |
| 10496-AAC | LTE-TDD (SC-FDMA, 50% RB, 20 MHz, 64-QAM, UL Subframe=2,3,4,7,8,9)   | X | 3.97 | 69.05 | 17.88 | 2.23 | 80.0 | ± 9.6 % |
|           |  | Y | 4.22 | 69.30 | 17.94 |      | 80.0 |         |
|           |  | Z | 3.47 | 67.65 | 16.99 |      | 80.0 |         |
| 10497-AAA | LTE-TDD (SC-FDMA, 100% RB, 1.4 MHz, QPSK, UL Subframe=2,3,4,7,8,9)   | X | 2.87 | 72.14 | 16.05 | 2.23 | 80.0 | ± 9.6 % |
|           |  | Y | 3.23 | 72.92 | 16.83 |      | 80.0 |         |
|           |  | Z | 1.19 | 62.14 | 10.12 |      | 80.0 |         |
| 10498-AAA | LTE-TDD (SC-FDMA, 100% RB, 1.4 MHz, 16-QAM, UL Subframe=2,3,4,7,8,9) | X | 1.73 | 63.11 | 10.85 | 2.23 | 80.0 | ± 9.6 % |
|           |  | Y | 2.27 | 65.45 | 12.56 |      | 80.0 |         |
|           |  | Z | 1.15 | 60.00 | 7.68  |      | 80.0 |         |
| 10499-AAA | LTE-TDD (SC-FDMA, 100% RB, 1.4 MHz, 64-QAM, UL Subframe=2,3,4,7,8,9) | X | 1.65 | 62.30 | 10.28 | 2.23 | 80.0 | ± 9.6 % |
|           |  | Y | 2.18 | 64.69 | 12.05 |      | 80.0 |         |
|           |  | Z | 1.17 | 60.00 | 7.51  |      | 80.0 |         |
| 10500-AAA | LTE-TDD (SC-FDMA, 100% RB, 3 MHz, QPSK, UL Subframe=2,3,4,7,8,9)     | X | 3.87 | 75.87 | 20.03 | 2.23 | 80.0 | ± 9.6 % |
|           |  | Y | 4.07 | 75.40 | 19.81 |      | 80.0 |         |
|           |  | Z | 2.80 | 71.83 | 17.80 |      | 80.0 |         |
| 10501-AAA | LTE-TDD (SC-FDMA, 100% RB, 3 MHz, 16-QAM, UL Subframe=2,3,4,7,8,9)   | X | 3.57 | 71.05 | 17.60 | 2.23 | 80.0 | ± 9.6 % |
|           |  | Y | 3.78 | 70.97 | 17.70 |      | 80.0 |         |
|           |  | Z | 2.79 | 68.23 | 15.59 |      | 80.0 |         |
| 10502-AAA | LTE-TDD (SC-FDMA, 100% RB, 3 MHz, 64-QAM, UL Subframe=2,3,4,7,8,9)   | X | 3.61 | 70.84 | 17.44 | 2.23 | 80.0 | ± 9.6 % |
|           |  | Y | 3.84 | 70.79 | 17.56 |      | 80.0 |         |
|           |  | Z | 2.82 | 68.03 | 15.41 |      | 80.0 |         |
| 10503-AAC | LTE-TDD (SC-FDMA, 100% RB, 5 MHz, QPSK, UL Subframe=2,3,4,7,8,9)     | X | 3.87 | 74.62 | 19.92 | 2.23 | 80.0 | ± 9.6 % |
|           |  | Y | 4.15 | 74.55 | 19.77 |      | 80.0 |         |
|           |  | Z | 2.95 | 71.29 | 18.21 |      | 80.0 |         |
| 10504-AAC | LTE-TDD (SC-FDMA, 100% RB, 5 MHz, 16-QAM, UL Subframe=2,3,4,7,8,9)   | X | 3.57 | 70.04 | 17.95 | 2.23 | 80.0 | ± 9.6 % |
|           |  | Y | 3.80 | 70.13 | 17.99 |      | 80.0 |         |
|           |  | Z | 3.01 | 68.26 | 16.69 |      | 80.0 |         |
| 10505-AAC | LTE-TDD (SC-FDMA, 100% RB, 5 MHz, 64-QAM, UL Subframe=2,3,4,7,8,9)   | X | 3.64 | 69.79 | 17.85 | 2.23 | 80.0 | ± 9.6 % |
|           |  | Y | 3.88 | 69.88 | 17.89 |      | 80.0 |         |
|           |  | Z | 3.09 | 68.12 | 16.62 |      | 80.0 |         |
| 10506-AAC | LTE-TDD (SC-FDMA, 100% RB, 10 MHz, QPSK, UL Subframe=2,3,4,7,8,9)    | X | 4.39 | 74.26 | 19.71 | 2.23 | 80.0 | ± 9.6 % |
|           |  | Y | 4.71 | 74.37 | 19.61 |      | 80.0 |         |
|           |  | Z | 3.46 | 71.26 | 18.30 |      | 80.0 |         |
| 10507-AAC | LTE-TDD (SC-FDMA, 100% RB, 10 MHz, 16-QAM, UL Subframe=2,3,4,7,8,9)  | X | 3.89 | 69.33 | 17.97 | 2.23 | 80.0 | ± 9.6 % |
|           |  | Y | 4.14 | 69.59 | 18.03 |      | 80.0 |         |
|           |  | Z | 3.38 | 67.80 | 17.02 |      | 80.0 |         |



|           |   |   |      |       |       |      |       |         |
|-----------|---|---|------|-------|-------|------|-------|---------|
| 10508-AAC | LTE-TDD (SC-FDMA, 100% RB, 10 MHz, 64-QAM, UL Subframe=2,3,4,7,8,9) | X | 3.95 | 68.98 | 17.84 | 2.23 | 80.0  | ± 9.6 % |
|           |   | Y | 4.21 | 69.23 | 17.90 |      | 80.0  |         |
|           |   | Z | 3.46 | 67.59 | 16.95 |      | 80.0  |         |
| 10509-AAC | LTE-TDD (SC-FDMA, 100% RB, 15 MHz, QPSK, UL Subframe=2,3,4,7,8,9)   | X | 4.62 | 72.40 | 18.91 | 2.23 | 80.0  | ± 9.6 % |
|           |   | Y | 4.92 | 72.59 | 18.86 |      | 80.0  |         |
|           |   | Z | 3.86 | 70.20 | 17.85 |      | 80.0  |         |
| 10510-AAC | LTE-TDD (SC-FDMA, 100% RB, 15 MHz, 16-QAM, UL Subframe=2,3,4,7,8,9) | X | 4.34 | 68.87 | 17.84 | 2.23 | 80.0  | ± 9.6 % |
|           |   | Y | 4.61 | 69.18 | 17.91 |      | 80.0  |         |
|           |   | Z | 3.85 | 67.53 | 17.06 |      | 80.0  |         |
| 10511-AAC | LTE-TDD (SC-FDMA, 100% RB, 15 MHz, 64-QAM, UL Subframe=2,3,4,7,8,9) | X | 4.39 | 68.57 | 17.74 | 2.23 | 80.0  | ± 9.6 % |
|           |   | Y | 4.65 | 68.86 | 17.81 |      | 80.0  |         |
|           |   | Z | 3.92 | 67.35 | 17.00 |      | 80.0  |         |
| 10512-AAC | LTE-TDD (SC-FDMA, 100% RB, 20 MHz, QPSK, UL Subframe=2,3,4,7,8,9)   | X | 4.95 | 74.43 | 19.59 | 2.23 | 80.0  | ± 9.6 % |
|           |   | Y | 5.29 | 74.60 | 19.52 |      | 80.0  |         |
|           |   | Z | 3.97 | 71.52 | 18.28 |      | 80.0  |         |
| 10513-AAC | LTE-TDD (SC-FDMA, 100% RB, 20 MHz, 16-QAM, UL Subframe=2,3,4,7,8,9) | X | 4.24 | 69.19 | 17.98 | 2.23 | 80.0  | ± 9.6 % |
|           |   | Y | 4.52 | 69.55 | 18.06 |      | 80.0  |         |
|           |   | Z | 3.73 | 67.67 | 17.13 |      | 80.0  |         |
| 10514-AAC | LTE-TDD (SC-FDMA, 100% RB, 20 MHz, 64-QAM, UL Subframe=2,3,4,7,8,9) | X | 4.25 | 68.69 | 17.82 | 2.23 | 80.0  | ± 9.6 % |
|           |   | Y | 4.51 | 69.03 | 17.90 |      | 80.0  |         |
|           |   | Z | 3.78 | 67.33 | 17.02 |      | 80.0  |         |
| 10515-AAA | IEEE 802.11b WiFi 2.4 GHz (DSSS, 2 Mbps, 99pc duty cycle)           | X | 0.99 | 63.46 | 15.00 | 0.00 | 150.0 | ± 9.6 % |
|           |   | Y | 0.98 | 62.78 | 14.45 |      | 150.0 |         |
|           |   | Z | 0.99 | 63.59 | 14.96 |      | 150.0 |         |
| 10516-AAA | IEEE 802.11b WiFi 2.4 GHz (DSSS, 5.5 Mbps, 99pc duty cycle)         | X | 0.69 | 72.54 | 18.63 | 0.00 | 150.0 | ± 9.6 % |
|           |   | Y | 0.56 | 68.11 | 16.08 |      | 150.0 |         |
|           |   | Z | 0.67 | 72.15 | 18.45 |      | 150.0 |         |
| 10517-AAA | IEEE 802.11b WiFi 2.4 GHz (DSSS, 11 Mbps, 99pc duty cycle)          | X | 0.85 | 65.62 | 15.80 | 0.00 | 150.0 | ± 9.6 % |
|           |   | Y | 0.82 | 64.42 | 14.91 |      | 150.0 |         |
|           |   | Z | 0.84 | 65.62 | 15.72 |      | 150.0 |         |
| 10518-AAA | IEEE 802.11a/h WiFi 5 GHz (OFDM, 9 Mbps, 99pc duty cycle)           | X | 4.53 | 66.80 | 16.29 | 0.00 | 150.0 | ± 9.6 % |
|           |   | Y | 4.59 | 66.58 | 16.17 |      | 150.0 |         |
|           |   | Z | 4.39 | 66.94 | 16.26 |      | 150.0 |         |
| 10519-AAA | IEEE 802.11a/h WiFi 5 GHz (OFDM, 12 Mbps, 99pc duty cycle)          | X | 4.71 | 67.02 | 16.40 | 0.00 | 150.0 | ± 9.6 % |
|           |   | Y | 4.78 | 66.84 | 16.30 |      | 150.0 |         |
|           |   | Z | 4.54 | 67.11 | 16.34 |      | 150.0 |         |
| 10520-AAA | IEEE 802.11a/h WiFi 5 GHz (OFDM, 18 Mbps, 99pc duty cycle)          | X | 4.56 | 66.98 | 16.32 | 0.00 | 150.0 | ± 9.6 % |
|           |   | Y | 4.63 | 66.80 | 16.22 |      | 150.0 |         |
|           |   | Z | 4.40 | 67.05 | 16.26 |      | 150.0 |         |
| 10521-AAA | IEEE 802.11a/h WiFi 5 GHz (OFDM, 24 Mbps, 99pc duty cycle)          | X | 4.49 | 66.97 | 16.31 | 0.00 | 150.0 | ± 9.6 % |
|           |   | Y | 4.56 | 66.79 | 16.20 |      | 150.0 |         |
|           |   | Z | 4.33 | 67.02 | 16.25 |      | 150.0 |         |
| 10522-AAA | IEEE 802.11a/h WiFi 5 GHz (OFDM, 36 Mbps, 99pc duty cycle)          | X | 4.56 | 67.08 | 16.40 | 0.00 | 150.0 | ± 9.6 % |
|           |   | Y | 4.62 | 66.86 | 16.28 |      | 150.0 |         |
|           |   | Z | 4.38 | 67.14 | 16.34 |      | 150.0 |         |

|           |  |   |      |       |       |      |       |         |
|-----------|--|---|------|-------|-------|------|-------|---------|
| 10523-AAA | IEEE 802.11a/h WiFi 5 GHz (OFDM, 48 Mbps, 99pc duty cycle) | X | 4.44 | 66.96 | 16.26 | 0.00 | 150.0 | ± 9.6 % |
|           |  | Y | 4.50 | 66.72 | 16.12 |      | 150.0 |         |
|           |  | Z | 4.31 | 67.14 | 16.26 |      | 150.0 |         |
| 10524-AAA | IEEE 802.11a/h WiFi 5 GHz (OFDM, 54 Mbps, 99pc duty cycle) | X | 4.50 | 67.00 | 16.37 | 0.00 | 150.0 | ± 9.6 % |
|           |  | Y | 4.57 | 66.78 | 16.25 |      | 150.0 |         |
|           |  | Z | 4.33 | 67.10 | 16.33 |      | 150.0 |         |
| 10525-AAA | IEEE 802.11ac WiFi (20MHz, MCS0, 99pc duty cycle)          | X | 4.49 | 66.06 | 15.96 | 0.00 | 150.0 | ± 9.6 % |
|           |  | Y | 4.54 | 65.82 | 15.83 |      | 150.0 |         |
|           |  | Z | 4.36 | 66.21 | 15.95 |      | 150.0 |         |
| 10526-AAA | IEEE 802.11ac WiFi (20MHz, MCS1, 99pc duty cycle)          | X | 4.65 | 66.41 | 16.10 | 0.00 | 150.0 | ± 9.6 % |
|           |  | Y | 4.72 | 66.20 | 15.98 |      | 150.0 |         |
|           |  | Z | 4.49 | 66.49 | 16.07 |      | 150.0 |         |
| 10527-AAA | IEEE 802.11ac WiFi (20MHz, MCS2, 99pc duty cycle)          | X | 4.58 | 66.37 | 16.05 | 0.00 | 150.0 | ± 9.6 % |
|           |  | Y | 4.64 | 66.16 | 15.92 |      | 150.0 |         |
|           |  | Z | 4.42 | 66.47 | 16.01 |      | 150.0 |         |
| 10528-AAA | IEEE 802.11ac WiFi (20MHz, MCS3, 99pc duty cycle)          | X | 4.59 | 66.39 | 16.08 | 0.00 | 150.0 | ± 9.6 % |
|           |  | Y | 4.65 | 66.18 | 15.96 |      | 150.0 |         |
|           |  | Z | 4.43 | 66.48 | 16.04 |      | 150.0 |         |
| 10529-AAA | IEEE 802.11ac WiFi (20MHz, MCS4, 99pc duty cycle)          | X | 4.59 | 66.39 | 16.08 | 0.00 | 150.0 | ± 9.6 % |
|           |  | Y | 4.65 | 66.18 | 15.96 |      | 150.0 |         |
|           |  | Z | 4.43 | 66.48 | 16.04 |      | 150.0 |         |
| 10531-AAA | IEEE 802.11ac WiFi (20MHz, MCS6, 99pc duty cycle)          | X | 4.58 | 66.48 | 16.09 | 0.00 | 150.0 | ± 9.6 % |
|           |  | Y | 4.65 | 66.29 | 15.97 |      | 150.0 |         |
|           |  | Z | 4.40 | 66.51 | 16.02 |      | 150.0 |         |
| 10532-AAA | IEEE 802.11ac WiFi (20MHz, MCS7, 99pc duty cycle)          | X | 4.44 | 66.34 | 16.02 | 0.00 | 150.0 | ± 9.6 % |
|           |  | Y | 4.51 | 66.14 | 15.90 |      | 150.0 |         |
|           |  | Z | 4.28 | 66.37 | 15.96 |      | 150.0 |         |
| 10533-AAA | IEEE 802.11ac WiFi (20MHz, MCS8, 99pc duty cycle)          | X | 4.60 | 66.44 | 16.07 | 0.00 | 150.0 | ± 9.6 % |
|           |  | Y | 4.66 | 66.22 | 15.94 |      | 150.0 |         |
|           |  | Z | 4.44 | 66.56 | 16.05 |      | 150.0 |         |
| 10534-AAA | IEEE 802.11ac WiFi (40MHz, MCS0, 99pc duty cycle)          | X | 5.13 | 66.46 | 16.12 | 0.00 | 150.0 | ± 9.6 % |
|           |  | Y | 5.19 | 66.32 | 16.03 |      | 150.0 |         |
|           |  | Z | 4.99 | 66.46 | 16.09 |      | 150.0 |         |
| 10535-AAA | IEEE 802.11ac WiFi (40MHz, MCS1, 99pc duty cycle)          | X | 5.20 | 66.64 | 16.21 | 0.00 | 150.0 | ± 9.6 % |
|           |  | Y | 5.25 | 66.49 | 16.10 |      | 150.0 |         |
|           |  | Z | 5.03 | 66.59 | 16.15 |      | 150.0 |         |
| 10536-AAA | IEEE 802.11ac WiFi (40MHz, MCS2, 99pc duty cycle)          | X | 5.07 | 66.60 | 16.17 | 0.00 | 150.0 | ± 9.6 % |
|           |  | Y | 5.12 | 66.44 | 16.06 |      | 150.0 |         |
|           |  | Z | 4.92 | 66.60 | 16.13 |      | 150.0 |         |
| 10537-AAA | IEEE 802.11ac WiFi (40MHz, MCS3, 99pc duty cycle)          | X | 5.12 | 66.56 | 16.15 | 0.00 | 150.0 | ± 9.6 % |
|           |  | Y | 5.18 | 66.41 | 16.05 |      | 150.0 |         |
|           |  | Z | 4.98 | 66.58 | 16.13 |      | 150.0 |         |
| 10538-AAA | IEEE 802.11ac WiFi (40MHz, MCS4, 99pc duty cycle)          | X | 5.21 | 66.56 | 16.19 | 0.00 | 150.0 | ± 9.6 % |
|           |  | Y | 5.28 | 66.45 | 16.11 |      | 150.0 |         |
|           |  | Z | 5.05 | 66.54 | 16.15 |      | 150.0 |         |
| 10540-AAA | IEEE 802.11ac WiFi (40MHz, MCS6, 99pc duty cycle)          | X | 5.14 | 66.58 | 16.22 | 0.00 | 150.0 | ± 9.6 % |
|           |  | Y | 5.20 | 66.45 | 16.12 |      | 150.0 |         |
|           |  | Z | 4.98 | 66.51 | 16.15 |      | 150.0 |         |

|           |  |   |      |       |       |      |       |         |
|-----------|--|---|------|-------|-------|------|-------|---------|
| 10541-AAA | IEEE 802.11ac WiFi (40MHz, MCS7, 99pc duty cycle)  | X | 5.12 | 66.46 | 16.14 | 0.00 | 150.0 | ± 9.6 % |
|           |  | Y | 5.18 | 66.32 | 16.05 |      | 150.0 |         |
|           |  | Z | 4.96 | 66.43 | 16.09 |      | 150.0 |         |
| 10542-AAA | IEEE 802.11ac WiFi (40MHz, MCS8, 99pc duty cycle)  | X | 5.27 | 66.53 | 16.19 | 0.00 | 150.0 | ± 9.6 % |
|           |  | Y | 5.33 | 66.40 | 16.10 |      | 150.0 |         |
|           |  | Z | 5.12 | 66.52 | 16.15 |      | 150.0 |         |
| 10543-AAA | IEEE 802.11ac WiFi (40MHz, MCS9, 99pc duty cycle)  | X | 5.34 | 66.55 | 16.23 | 0.00 | 150.0 | ± 9.6 % |
|           |  | Y | 5.41 | 66.44 | 16.14 |      | 150.0 |         |
|           |  | Z | 5.19 | 66.58 | 16.21 |      | 150.0 |         |
| 10544-AAA | IEEE 802.11ac WiFi (80MHz, MCS0, 99pc duty cycle)  | X | 5.45 | 66.57 | 16.12 | 0.00 | 150.0 | ± 9.6 % |
|           |  | Y | 5.49 | 66.44 | 16.03 |      | 150.0 |         |
|           |  | Z | 5.33 | 66.54 | 16.08 |      | 150.0 |         |
| 10545-AAA | IEEE 802.11ac WiFi (80MHz, MCS1, 99pc duty cycle)  | X | 5.64 | 66.98 | 16.28 | 0.00 | 150.0 | ± 9.6 % |
|           |  | Y | 5.69 | 66.86 | 16.18 |      | 150.0 |         |
|           |  | Z | 5.50 | 66.96 | 16.25 |      | 150.0 |         |
| 10546-AAA | IEEE 802.11ac WiFi (80MHz, MCS2, 99pc duty cycle)  | X | 5.50 | 66.75 | 16.18 | 0.00 | 150.0 | ± 9.6 % |
|           |  | Y | 5.56 | 66.68 | 16.11 |      | 150.0 |         |
|           |  | Z | 5.36 | 66.66 | 16.11 |      | 150.0 |         |
| 10547-AAA | IEEE 802.11ac WiFi (80MHz, MCS3, 99pc duty cycle)  | X | 5.57 | 66.80 | 16.19 | 0.00 | 150.0 | ± 9.6 % |
|           |  | Y | 5.64 | 66.72 | 16.12 |      | 150.0 |         |
|           |  | Z | 5.44 | 66.76 | 16.16 |      | 150.0 |         |
| 10548-AAA | IEEE 802.11ac WiFi (80MHz, MCS4, 99pc duty cycle)  | X | 5.80 | 67.67 | 16.61 | 0.00 | 150.0 | ± 9.6 % |
|           |  | Y | 5.91 | 67.72 | 16.59 |      | 150.0 |         |
|           |  | Z | 5.58 | 67.38 | 16.44 |      | 150.0 |         |
| 10550-AAA | IEEE 802.11ac WiFi (80MHz, MCS6, 99pc duty cycle)  | X | 5.54 | 66.80 | 16.21 | 0.00 | 150.0 | ± 9.6 % |
|           |  | Y | 5.59 | 66.67 | 16.11 |      | 150.0 |         |
|           |  | Z | 5.42 | 66.83 | 16.21 |      | 150.0 |         |
| 10551-AAA | IEEE 802.11ac WiFi (80MHz, MCS7, 99pc duty cycle)  | X | 5.54 | 66.82 | 16.18 | 0.00 | 150.0 | ± 9.6 % |
|           |  | Y | 5.59 | 66.72 | 16.10 |      | 150.0 |         |
|           |  | Z | 5.36 | 66.63 | 16.07 |      | 150.0 |         |
| 10552-AAA | IEEE 802.11ac WiFi (80MHz, MCS8, 99pc duty cycle)  | X | 5.46 | 66.64 | 16.10 | 0.00 | 150.0 | ± 9.6 % |
|           |  | Y | 5.51 | 66.51 | 16.00 |      | 150.0 |         |
|           |  | Z | 5.34 | 66.66 | 16.08 |      | 150.0 |         |
| 10553-AAA | IEEE 802.11ac WiFi (80MHz, MCS9, 99pc duty cycle)  | X | 5.54 | 66.66 | 16.14 | 0.00 | 150.0 | ± 9.6 % |
|           |  | Y | 5.59 | 66.56 | 16.06 |      | 150.0 |         |
|           |  | Z | 5.39 | 66.61 | 16.09 |      | 150.0 |         |
| 10554-AAB | IEEE 802.11ac WiFi (160MHz, MCS0, 99pc duty cycle) | X | 5.86 | 66.92 | 16.20 | 0.00 | 150.0 | ± 9.6 % |
|           |  | Y | 5.89 | 66.81 | 16.12 |      | 150.0 |         |
|           |  | Z | 5.75 | 66.87 | 16.15 |      | 150.0 |         |
| 10555-AAB | IEEE 802.11ac WiFi (160MHz, MCS1, 99pc duty cycle) | X | 5.98 | 67.22 | 16.33 | 0.00 | 150.0 | ± 9.6 % |
|           |  | Y | 6.03 | 67.12 | 16.25 |      | 150.0 |         |
|           |  | Z | 5.84 | 67.10 | 16.25 |      | 150.0 |         |
| 10556-AAB | IEEE 802.11ac WiFi (160MHz, MCS2, 99pc duty cycle) | X | 6.00 | 67.27 | 16.35 | 0.00 | 150.0 | ± 9.6 % |
|           |  | Y | 6.05 | 67.16 | 16.27 |      | 150.0 |         |
|           |  | Z | 5.88 | 67.20 | 16.30 |      | 150.0 |         |
| 10557-AAB | IEEE 802.11ac WiFi (160MHz, MCS3, 99pc duty cycle) | X | 5.96 | 67.16 | 16.31 | 0.00 | 150.0 | ± 9.6 % |
|           |  | Y | 6.02 | 67.08 | 16.25 |      | 150.0 |         |
|           |  | Z | 5.84 | 67.08 | 16.25 |      | 150.0 |         |

|           |   |   |      |       |       |      |       |         |
|-----------|---|---|------|-------|-------|------|-------|---------|
| 10558-AAB | IEEE 802.11ac WiFi (160MHz, MCS4, 99pc duty cycle)              | X | 6.01 | 67.32 | 16.41 | 0.00 | 150.0 | ± 9.6 % |
|           |   | Y | 6.07 | 67.25 | 16.34 |      | 150.0 |         |
|           |   | Z | 5.85 | 67.15 | 16.31 |      | 150.0 |         |
| 10560-AAB | IEEE 802.11ac WiFi (160MHz, MCS6, 99pc duty cycle)              | X | 6.01 | 67.17 | 16.37 | 0.00 | 150.0 | ± 9.6 % |
|           |   | Y | 6.06 | 67.10 | 16.31 |      | 150.0 |         |
|           |   | Z | 5.87 | 67.07 | 16.30 |      | 150.0 |         |
| 10561-AAB | IEEE 802.11ac WiFi (160MHz, MCS7, 99pc duty cycle)              | X | 5.93 | 67.15 | 16.40 | 0.00 | 150.0 | ± 9.6 % |
|           |   | Y | 5.98 | 67.06 | 16.32 |      | 150.0 |         |
|           |   | Z | 5.80 | 67.05 | 16.32 |      | 150.0 |         |
| 10562-AAB | IEEE 802.11ac WiFi (160MHz, MCS8, 99pc duty cycle)              | X | 6.04 | 67.49 | 16.57 | 0.00 | 150.0 | ± 9.6 % |
|           |   | Y | 6.12 | 67.48 | 16.53 |      | 150.0 |         |
|           |   | Z | 5.85 | 67.23 | 16.41 |      | 150.0 |         |
| 10563-AAB | IEEE 802.11ac WiFi (160MHz, MCS9, 99pc duty cycle)              | X | 6.18 | 67.55 | 16.56 | 0.00 | 150.0 | ± 9.6 % |
|           |   | Y | 6.43 | 68.00 | 16.75 |      | 150.0 |         |
|           |   | Z | 5.95 | 67.17 | 16.35 |      | 150.0 |         |
| 10564-AAA | IEEE 802.11g WiFi 2.4 GHz (DSSS-OFDM, 9 Mbps, 99pc duty cycle)  | X | 4.86 | 66.88 | 16.45 | 0.46 | 150.0 | ± 9.6 % |
|           |   | Y | 4.92 | 66.69 | 16.36 |      | 150.0 |         |
|           |   | Z | 4.71 | 66.96 | 16.39 |      | 150.0 |         |
| 10565-AAA | IEEE 802.11g WiFi 2.4 GHz (DSSS-OFDM, 12 Mbps, 99pc duty cycle) | X | 5.08 | 67.30 | 16.76 | 0.46 | 150.0 | ± 9.6 % |
|           |   | Y | 5.16 | 67.15 | 16.67 |      | 150.0 |         |
|           |   | Z | 4.90 | 67.36 | 16.69 |      | 150.0 |         |
| 10566-AAA | IEEE 802.11g WiFi 2.4 GHz (DSSS-OFDM, 18 Mbps, 99pc duty cycle) | X | 4.91 | 67.15 | 16.58 | 0.46 | 150.0 | ± 9.6 % |
|           |   | Y | 4.99 | 67.00 | 16.50 |      | 150.0 |         |
|           |   | Z | 4.74 | 67.18 | 16.50 |      | 150.0 |         |
| 10567-AAA | IEEE 802.11g WiFi 2.4 GHz (DSSS-OFDM, 24 Mbps, 99pc duty cycle) | X | 4.94 | 67.52 | 16.92 | 0.46 | 150.0 | ± 9.6 % |
|           |   | Y | 5.01 | 67.38 | 16.84 |      | 150.0 |         |
|           |   | Z | 4.77 | 67.57 | 16.87 |      | 150.0 |         |
| 10568-AAA | IEEE 802.11g WiFi 2.4 GHz (DSSS-OFDM, 36 Mbps, 99pc duty cycle) | X | 4.83 | 66.96 | 16.38 | 0.46 | 150.0 | ± 9.6 % |
|           |   | Y | 4.90 | 66.77 | 16.27 |      | 150.0 |         |
|           |   | Z | 4.63 | 66.92 | 16.25 |      | 150.0 |         |
| 10569-AAA | IEEE 802.11g WiFi 2.4 GHz (DSSS-OFDM, 48 Mbps, 99pc duty cycle) | X | 4.90 | 67.63 | 17.00 | 0.46 | 150.0 | ± 9.6 % |
|           |   | Y | 4.96 | 67.44 | 16.88 |      | 150.0 |         |
|           |   | Z | 4.75 | 67.78 | 17.00 |      | 150.0 |         |
| 10570-AAA | IEEE 802.11g WiFi 2.4 GHz (DSSS-OFDM, 54 Mbps, 99pc duty cycle) | X | 4.93 | 67.48 | 16.92 | 0.46 | 150.0 | ± 9.6 % |
|           |   | Y | 5.00 | 67.29 | 16.82 |      | 150.0 |         |
|           |   | Z | 4.76 | 67.58 | 16.89 |      | 150.0 |         |
| 10571-AAA | IEEE 802.11b WiFi 2.4 GHz (DSSS, 1 Mbps, 90pc duty cycle)       | X | 1.18 | 64.69 | 15.93 | 0.46 | 130.0 | ± 9.6 % |
|           |   | Y | 1.20 | 64.37 | 15.58 |      | 130.0 |         |
|           |   | Z | 1.13 | 64.22 | 15.49 |      | 130.0 |         |
| 10572-AAA | IEEE 802.11b WiFi 2.4 GHz (DSSS, 2 Mbps, 90pc duty cycle)       | X | 1.19 | 65.27 | 16.29 | 0.46 | 130.0 | ± 9.6 % |
|           |   | Y | 1.21 | 64.91 | 15.92 |      | 130.0 |         |
|           |   | Z | 1.14 | 64.74 | 15.83 |      | 130.0 |         |
| 10573-AAA | IEEE 802.11b WiFi 2.4 GHz (DSSS, 5.5 Mbps, 90pc duty cycle)     | X | 2.77 | 92.16 | 26.12 | 0.46 | 130.0 | ± 9.6 % |
|           |   | Y | 1.86 | 83.27 | 22.47 |      | 130.0 |         |
|           |   | Z | 1.57 | 83.20 | 23.00 |      | 130.0 |         |
| 10574-AAA | IEEE 802.11b WiFi 2.4 GHz (DSSS, 11 Mbps, 90pc duty cycle)      | X | 1.31 | 71.26 | 19.39 | 0.46 | 130.0 | ± 9.6 % |
|           |   | Y | 1.31 | 70.26 | 18.63 |      | 130.0 |         |
|           |   | Z | 1.20 | 70.00 | 18.67 |      | 130.0 |         |

|           |   |   |      |       |       |      |       |         |
|-----------|---|---|------|-------|-------|------|-------|---------|
| 10575-AAA | IEEE 802.11g WiFi 2.4 GHz (DSSS-OFDM, 6 Mbps, 90pc duty cycle)  | X | 4.64 | 66.67 | 16.51 | 0.46 | 130.0 | ± 9.6 % |
|           |   | Y | 4.71 | 66.50 | 16.43 |      | 130.0 |         |
|           |   | Z | 4.47 | 66.69 | 16.39 |      | 130.0 |         |
| 10576-AAA | IEEE 802.11g WiFi 2.4 GHz (DSSS-OFDM, 9 Mbps, 90pc duty cycle)  | X | 4.66 | 66.83 | 16.58 | 0.46 | 130.0 | ± 9.6 % |
|           |   | Y | 4.73 | 66.66 | 16.49 |      | 130.0 |         |
|           |   | Z | 4.50 | 66.89 | 16.47 |      | 130.0 |         |
| 10577-AAA | IEEE 802.11g WiFi 2.4 GHz (DSSS-OFDM, 12 Mbps, 90pc duty cycle) | X | 4.86 | 67.11 | 16.74 | 0.46 | 130.0 | ± 9.6 % |
|           |   | Y | 4.94 | 66.97 | 16.66 |      | 130.0 |         |
|           |   | Z | 4.67 | 67.12 | 16.61 |      | 130.0 |         |
| 10578-AAA | IEEE 802.11g WiFi 2.4 GHz (DSSS-OFDM, 18 Mbps, 90pc duty cycle) | X | 4.76 | 67.25 | 16.83 | 0.46 | 130.0 | ± 9.6 % |
|           |   | Y | 4.84 | 67.12 | 16.76 |      | 130.0 |         |
|           |   | Z | 4.57 | 67.26 | 16.72 |      | 130.0 |         |
| 10579-AAA | IEEE 802.11g WiFi 2.4 GHz (DSSS-OFDM, 24 Mbps, 90pc duty cycle) | X | 4.52 | 66.57 | 16.17 | 0.46 | 130.0 | ± 9.6 % |
|           |   | Y | 4.61 | 66.44 | 16.10 |      | 130.0 |         |
|           |   | Z | 4.33 | 66.48 | 15.99 |      | 130.0 |         |
| 10580-AAA | IEEE 802.11g WiFi 2.4 GHz (DSSS-OFDM, 36 Mbps, 90pc duty cycle) | X | 4.57 | 66.63 | 16.21 | 0.46 | 130.0 | ± 9.6 % |
|           |   | Y | 4.66 | 66.47 | 16.12 |      | 130.0 |         |
|           |   | Z | 4.36 | 66.53 | 16.01 |      | 130.0 |         |
| 10581-AAA | IEEE 802.11g WiFi 2.4 GHz (DSSS-OFDM, 48 Mbps, 90pc duty cycle) | X | 4.65 | 67.30 | 16.78 | 0.46 | 130.0 | ± 9.6 % |
|           |   | Y | 4.73 | 67.15 | 16.70 |      | 130.0 |         |
|           |   | Z | 4.48 | 67.34 | 16.69 |      | 130.0 |         |
| 10582-AAA | IEEE 802.11g WiFi 2.4 GHz (DSSS-OFDM, 54 Mbps, 90pc duty cycle) | X | 4.47 | 66.35 | 15.97 | 0.46 | 130.0 | ± 9.6 % |
|           |   | Y | 4.56 | 66.21 | 15.89 |      | 130.0 |         |
|           |   | Z | 4.26 | 66.25 | 15.78 |      | 130.0 |         |
| 10583-AAA | IEEE 802.11a/h WiFi 5 GHz (OFDM, 6 Mbps, 90pc duty cycle)       | X | 4.64 | 66.67 | 16.51 | 0.46 | 130.0 | ± 9.6 % |
|           |   | Y | 4.71 | 66.50 | 16.43 |      | 130.0 |         |
|           |   | Z | 4.47 | 66.69 | 16.39 |      | 130.0 |         |
| 10584-AAA | IEEE 802.11a/h WiFi 5 GHz (OFDM, 9 Mbps, 90pc duty cycle)       | X | 4.66 | 66.83 | 16.58 | 0.46 | 130.0 | ± 9.6 % |
|           |   | Y | 4.73 | 66.66 | 16.49 |      | 130.0 |         |
|           |   | Z | 4.50 | 66.89 | 16.47 |      | 130.0 |         |
| 10585-AAA | IEEE 802.11a/h WiFi 5 GHz (OFDM, 12 Mbps, 90pc duty cycle)      | X | 4.86 | 67.11 | 16.74 | 0.46 | 130.0 | ± 9.6 % |
|           |   | Y | 4.94 | 66.97 | 16.66 |      | 130.0 |         |
|           |   | Z | 4.67 | 67.12 | 16.61 |      | 130.0 |         |
| 10586-AAA | IEEE 802.11a/h WiFi 5 GHz (OFDM, 18 Mbps, 90pc duty cycle)      | X | 4.76 | 67.25 | 16.83 | 0.46 | 130.0 | ± 9.6 % |
|           |   | Y | 4.84 | 67.12 | 16.76 |      | 130.0 |         |
|           |   | Z | 4.57 | 67.26 | 16.72 |      | 130.0 |         |
| 10587-AAA | IEEE 802.11a/h WiFi 5 GHz (OFDM, 24 Mbps, 90pc duty cycle)      | X | 4.52 | 66.57 | 16.17 | 0.46 | 130.0 | ± 9.6 % |
|           |   | Y | 4.61 | 66.44 | 16.10 |      | 130.0 |         |
|           |   | Z | 4.33 | 66.48 | 15.99 |      | 130.0 |         |
| 10588-AAA | IEEE 802.11a/h WiFi 5 GHz (OFDM, 36 Mbps, 90pc duty cycle)      | X | 4.57 | 66.63 | 16.21 | 0.46 | 130.0 | ± 9.6 % |
|           |   | Y | 4.66 | 66.47 | 16.12 |      | 130.0 |         |
|           |   | Z | 4.36 | 66.53 | 16.01 |      | 130.0 |         |
| 10589-AAA | IEEE 802.11a/h WiFi 5 GHz (OFDM, 48 Mbps, 90pc duty cycle)      | X | 4.65 | 67.30 | 16.78 | 0.46 | 130.0 | ± 9.6 % |
|           |   | Y | 4.73 | 67.15 | 16.70 |      | 130.0 |         |
|           |   | Z | 4.48 | 67.34 | 16.69 |      | 130.0 |         |
| 10590-AAA | IEEE 802.11a/h WiFi 5 GHz (OFDM, 54 Mbps, 90pc duty cycle)      | X | 4.47 | 66.35 | 15.97 | 0.46 | 130.0 | ± 9.6 % |
|           |   | Y | 4.56 | 66.21 | 15.89 |      | 130.0 |         |
|           |   | Z | 4.26 | 66.25 | 15.78 |      | 130.0 |         |

|           |   |   |      |       |       |      |       |         |
|-----------|---|---|------|-------|-------|------|-------|---------|
| 10591-AAA | IEEE 802.11n (HT Mixed, 20MHz, MCS0, 90pc duty cycle) | X | 4.79 | 66.72 | 16.61 | 0.46 | 130.0 | ± 9.6 % |
|           |   | Y | 4.86 | 66.57 | 16.53 |      | 130.0 |         |
|           |   | Z | 4.63 | 66.78 | 16.50 |      | 130.0 |         |
| 10592-AAA | IEEE 802.11n (HT Mixed, 20MHz, MCS1, 90pc duty cycle) | X | 4.94 | 67.05 | 16.74 | 0.46 | 130.0 | ± 9.6 % |
|           |   | Y | 5.02 | 66.91 | 16.66 |      | 130.0 |         |
|           |   | Z | 4.75 | 67.07 | 16.63 |      | 130.0 |         |
| 10593-AAA | IEEE 802.11n (HT Mixed, 20MHz, MCS2, 90pc duty cycle) | X | 4.86 | 66.96 | 16.62 | 0.46 | 130.0 | ± 9.6 % |
|           |   | Y | 4.94 | 66.83 | 16.55 |      | 130.0 |         |
|           |   | Z | 4.67 | 66.95 | 16.49 |      | 130.0 |         |
| 10594-AAA | IEEE 802.11n (HT Mixed, 20MHz, MCS3, 90pc duty cycle) | X | 4.91 | 67.12 | 16.77 | 0.46 | 130.0 | ± 9.6 % |
|           |   | Y | 5.00 | 66.98 | 16.70 |      | 130.0 |         |
|           |   | Z | 4.72 | 67.12 | 16.65 |      | 130.0 |         |
| 10595-AAA | IEEE 802.11n (HT Mixed, 20MHz, MCS4, 90pc duty cycle) | X | 4.88 | 67.08 | 16.67 | 0.46 | 130.0 | ± 9.6 % |
|           |   | Y | 4.96 | 66.94 | 16.59 |      | 130.0 |         |
|           |   | Z | 4.69 | 67.10 | 16.56 |      | 130.0 |         |
| 10596-AAA | IEEE 802.11n (HT Mixed, 20MHz, MCS5, 90pc duty cycle) | X | 4.82 | 67.08 | 16.68 | 0.46 | 130.0 | ± 9.6 % |
|           |   | Y | 4.90 | 66.94 | 16.60 |      | 130.0 |         |
|           |   | Z | 4.62 | 67.07 | 16.55 |      | 130.0 |         |
| 10597-AAA | IEEE 802.11n (HT Mixed, 20MHz, MCS6, 90pc duty cycle) | X | 4.77 | 66.98 | 16.56 | 0.46 | 130.0 | ± 9.6 % |
|           |   | Y | 4.85 | 66.85 | 16.49 |      | 130.0 |         |
|           |   | Z | 4.57 | 66.94 | 16.41 |      | 130.0 |         |
| 10598-AAA | IEEE 802.11n (HT Mixed, 20MHz, MCS7, 90pc duty cycle) | X | 4.75 | 67.19 | 16.80 | 0.46 | 130.0 | ± 9.6 % |
|           |   | Y | 4.83 | 67.08 | 16.74 |      | 130.0 |         |
|           |   | Z | 4.56 | 67.16 | 16.67 |      | 130.0 |         |
| 10599-AAA | IEEE 802.11n (HT Mixed, 40MHz, MCS0, 90pc duty cycle) | X | 5.46 | 67.23 | 16.81 | 0.46 | 130.0 | ± 9.6 % |
|           |   | Y | 5.53 | 67.13 | 16.74 |      | 130.0 |         |
|           |   | Z | 5.31 | 67.22 | 16.74 |      | 130.0 |         |
| 10600-AAA | IEEE 802.11n (HT Mixed, 40MHz, MCS1, 90pc duty cycle) | X | 5.59 | 67.67 | 17.00 | 0.46 | 130.0 | ± 9.6 % |
|           |   | Y | 5.69 | 67.62 | 16.95 |      | 130.0 |         |
|           |   | Z | 5.40 | 67.56 | 16.88 |      | 130.0 |         |
| 10601-AAA | IEEE 802.11n (HT Mixed, 40MHz, MCS2, 90pc duty cycle) | X | 5.48 | 67.41 | 16.88 | 0.46 | 130.0 | ± 9.6 % |
|           |   | Y | 5.56 | 67.33 | 16.83 |      | 130.0 |         |
|           |   | Z | 5.31 | 67.36 | 16.79 |      | 130.0 |         |
| 10602-AAA | IEEE 802.11n (HT Mixed, 40MHz, MCS3, 90pc duty cycle) | X | 5.59 | 67.49 | 16.85 | 0.46 | 130.0 | ± 9.6 % |
|           |   | Y | 5.65 | 67.34 | 16.75 |      | 130.0 |         |
|           |   | Z | 5.41 | 67.42 | 16.75 |      | 130.0 |         |
| 10603-AAA | IEEE 802.11n (HT Mixed, 40MHz, MCS4, 90pc duty cycle) | X | 5.65 | 67.74 | 17.10 | 0.46 | 130.0 | ± 9.6 % |
|           |   | Y | 5.74 | 67.66 | 17.04 |      | 130.0 |         |
|           |   | Z | 5.48 | 67.71 | 17.02 |      | 130.0 |         |
| 10604-AAA | IEEE 802.11n (HT Mixed, 40MHz, MCS5, 90pc duty cycle) | X | 5.49 | 67.31 | 16.87 | 0.46 | 130.0 | ± 9.6 % |
|           |   | Y | 5.53 | 67.10 | 16.74 |      | 130.0 |         |
|           |   | Z | 5.37 | 67.37 | 16.83 |      | 130.0 |         |
| 10605-AAA | IEEE 802.11n (HT Mixed, 40MHz, MCS6, 90pc duty cycle) | X | 5.58 | 67.57 | 17.01 | 0.46 | 130.0 | ± 9.6 % |
|           |   | Y | 5.65 | 67.44 | 16.92 |      | 130.0 |         |
|           |   | Z | 5.40 | 67.46 | 16.88 |      | 130.0 |         |
| 10606-AAA | IEEE 802.11n (HT Mixed, 40MHz, MCS7, 90pc duty cycle) | X | 5.32 | 66.88 | 16.52 | 0.46 | 130.0 | ± 9.6 % |
|           |   | Y | 5.42 | 66.88 | 16.50 |      | 130.0 |         |
|           |   | Z | 5.18 | 66.90 | 16.45 |      | 130.0 |         |

|           |   |   |      |       |       |      |       |         |
|-----------|---|---|------|-------|-------|------|-------|---------|
| 10607-AAA | IEEE 802.11ac WiFi (20MHz, MCS0, 90pc duty cycle) | X | 4.63 | 66.06 | 16.24 | 0.46 | 130.0 | ± 9.6 % |
|           |   | Y | 4.69 | 65.87 | 16.14 |      | 130.0 |         |
|           |   | Z | 4.48 | 66.14 | 16.16 |      | 130.0 |         |
| 10608-AAA | IEEE 802.11ac WiFi (20MHz, MCS1, 90pc duty cycle) | X | 4.81 | 66.46 | 16.41 | 0.46 | 130.0 | ± 9.6 % |
|           |   | Y | 4.89 | 66.28 | 16.31 |      | 130.0 |         |
|           |   | Z | 4.62 | 66.47 | 16.30 |      | 130.0 |         |
| 10609-AAA | IEEE 802.11ac WiFi (20MHz, MCS2, 90pc duty cycle) | X | 4.70 | 66.31 | 16.25 | 0.46 | 130.0 | ± 9.6 % |
|           |   | Y | 4.78 | 66.14 | 16.15 |      | 130.0 |         |
|           |   | Z | 4.52 | 66.31 | 16.13 |      | 130.0 |         |
| 10610-AAA | IEEE 802.11ac WiFi (20MHz, MCS3, 90pc duty cycle) | X | 4.75 | 66.46 | 16.40 | 0.46 | 130.0 | ± 9.6 % |
|           |   | Y | 4.83 | 66.29 | 16.31 |      | 130.0 |         |
|           |   | Z | 4.57 | 66.47 | 16.29 |      | 130.0 |         |
| 10611-AAA | IEEE 802.11ac WiFi (20MHz, MCS4, 90pc duty cycle) | X | 4.67 | 66.27 | 16.25 | 0.46 | 130.0 | ± 9.6 % |
|           |   | Y | 4.74 | 66.11 | 16.17 |      | 130.0 |         |
|           |   | Z | 4.48 | 66.27 | 16.14 |      | 130.0 |         |
| 10612-AAA | IEEE 802.11ac WiFi (20MHz, MCS5, 90pc duty cycle) | X | 4.68 | 66.43 | 16.31 | 0.46 | 130.0 | ± 9.6 % |
|           |   | Y | 4.76 | 66.26 | 16.21 |      | 130.0 |         |
|           |   | Z | 4.47 | 66.40 | 16.18 |      | 130.0 |         |
| 10613-AAA | IEEE 802.11ac WiFi (20MHz, MCS6, 90pc duty cycle) | X | 4.68 | 66.30 | 16.19 | 0.46 | 130.0 | ± 9.6 % |
|           |   | Y | 4.76 | 66.16 | 16.10 |      | 130.0 |         |
|           |   | Z | 4.47 | 66.22 | 16.03 |      | 130.0 |         |
| 10614-AAA | IEEE 802.11ac WiFi (20MHz, MCS7, 90pc duty cycle) | X | 4.62 | 66.47 | 16.40 | 0.46 | 130.0 | ± 9.6 % |
|           |   | Y | 4.70 | 66.33 | 16.32 |      | 130.0 |         |
|           |   | Z | 4.44 | 66.44 | 16.27 |      | 130.0 |         |
| 10615-AAA | IEEE 802.11ac WiFi (20MHz, MCS8, 90pc duty cycle) | X | 4.67 | 66.12 | 16.05 | 0.46 | 130.0 | ± 9.6 % |
|           |   | Y | 4.75 | 65.95 | 15.95 |      | 130.0 |         |
|           |   | Z | 4.48 | 66.11 | 15.92 |      | 130.0 |         |
| 10616-AAA | IEEE 802.11ac WiFi (40MHz, MCS0, 90pc duty cycle) | X | 5.28 | 66.50 | 16.42 | 0.46 | 130.0 | ± 9.6 % |
|           |   | Y | 5.35 | 66.40 | 16.35 |      | 130.0 |         |
|           |   | Z | 5.12 | 66.44 | 16.33 |      | 130.0 |         |
| 10617-AAA | IEEE 802.11ac WiFi (40MHz, MCS1, 90pc duty cycle) | X | 5.35 | 66.70 | 16.50 | 0.46 | 130.0 | ± 9.6 % |
|           |   | Y | 5.42 | 66.55 | 16.40 |      | 130.0 |         |
|           |   | Z | 5.16 | 66.57 | 16.37 |      | 130.0 |         |
| 10618-AAA | IEEE 802.11ac WiFi (40MHz, MCS2, 90pc duty cycle) | X | 5.24 | 66.70 | 16.51 | 0.46 | 130.0 | ± 9.6 % |
|           |   | Y | 5.30 | 66.57 | 16.42 |      | 130.0 |         |
|           |   | Z | 5.08 | 66.64 | 16.42 |      | 130.0 |         |
| 10619-AAA | IEEE 802.11ac WiFi (40MHz, MCS3, 90pc duty cycle) | X | 5.25 | 66.50 | 16.35 | 0.46 | 130.0 | ± 9.6 % |
|           |   | Y | 5.33 | 66.41 | 16.28 |      | 130.0 |         |
|           |   | Z | 5.09 | 66.45 | 16.26 |      | 130.0 |         |
| 10620-AAA | IEEE 802.11ac WiFi (40MHz, MCS4, 90pc duty cycle) | X | 5.34 | 66.53 | 16.41 | 0.46 | 130.0 | ± 9.6 % |
|           |   | Y | 5.42 | 66.46 | 16.35 |      | 130.0 |         |
|           |   | Z | 5.16 | 66.45 | 16.31 |      | 130.0 |         |
| 10621-AAA | IEEE 802.11ac WiFi (40MHz, MCS5, 90pc duty cycle) | X | 5.34 | 66.65 | 16.59 | 0.46 | 130.0 | ± 9.6 % |
|           |   | Y | 5.41 | 66.55 | 16.51 |      | 130.0 |         |
|           |   | Z | 5.17 | 66.56 | 16.48 |      | 130.0 |         |
| 10622-AAA | IEEE 802.11ac WiFi (40MHz, MCS6, 90pc duty cycle) | X | 5.35 | 66.81 | 16.66 | 0.46 | 130.0 | ± 9.6 % |
|           |   | Y | 5.42 | 66.71 | 16.59 |      | 130.0 |         |
|           |   | Z | 5.16 | 66.65 | 16.52 |      | 130.0 |         |

|           |  |   |      |       |       |      |       |         |
|-----------|--|---|------|-------|-------|------|-------|---------|
| 10623-AAA | IEEE 802.11ac WiFi (40MHz, MCS7, 90pc duty cycle)  | X | 5.23 | 66.36 | 16.32 | 0.46 | 130.0 | ± 9.6 % |
|           |  | Y | 5.30 | 66.25 | 16.24 |      | 130.0 |         |
|           |  | Z | 5.05 | 66.22 | 16.17 |      | 130.0 |         |
| 10624-AAA | IEEE 802.11ac WiFi (40MHz, MCS8, 90pc duty cycle)  | X | 5.42 | 66.55 | 16.47 | 0.46 | 130.0 | ± 9.6 % |
|           |  | Y | 5.50 | 66.45 | 16.40 |      | 130.0 |         |
|           |  | Z | 5.25 | 66.47 | 16.36 |      | 130.0 |         |
| 10625-AAA | IEEE 802.11ac WiFi (40MHz, MCS9, 90pc duty cycle)  | X | 5.75 | 67.41 | 16.95 | 0.46 | 130.0 | ± 9.6 % |
|           |  | Y | 5.89 | 67.51 | 16.98 |      | 130.0 |         |
|           |  | Z | 5.34 | 66.63 | 16.50 |      | 130.0 |         |
| 10626-AAA | IEEE 802.11ac WiFi (80MHz, MCS0, 90pc duty cycle)  | X | 5.59 | 66.56 | 16.38 | 0.46 | 130.0 | ± 9.6 % |
|           |  | Y | 5.64 | 66.46 | 16.31 |      | 130.0 |         |
|           |  | Z | 5.45 | 66.47 | 16.28 |      | 130.0 |         |
| 10627-AAA | IEEE 802.11ac WiFi (80MHz, MCS1, 90pc duty cycle)  | X | 5.82 | 67.13 | 16.63 | 0.46 | 130.0 | ± 9.6 % |
|           |  | Y | 5.88 | 67.03 | 16.55 |      | 130.0 |         |
|           |  | Z | 5.67 | 67.05 | 16.54 |      | 130.0 |         |
| 10628-AAA | IEEE 802.11ac WiFi (80MHz, MCS2, 90pc duty cycle)  | X | 5.61 | 66.64 | 16.32 | 0.46 | 130.0 | ± 9.6 % |
|           |  | Y | 5.68 | 66.59 | 16.27 |      | 130.0 |         |
|           |  | Z | 5.44 | 66.46 | 16.18 |      | 130.0 |         |
| 10629-AAA | IEEE 802.11ac WiFi (80MHz, MCS3, 90pc duty cycle)  | X | 5.69 | 66.69 | 16.34 | 0.46 | 130.0 | ± 9.6 % |
|           |  | Y | 5.78 | 66.69 | 16.31 |      | 130.0 |         |
|           |  | Z | 5.54 | 66.62 | 16.26 |      | 130.0 |         |
| 10630-AAA | IEEE 802.11ac WiFi (80MHz, MCS4, 90pc duty cycle)  | X | 6.09 | 68.10 | 17.05 | 0.46 | 130.0 | ± 9.6 % |
|           |  | Y | 6.25 | 68.29 | 17.11 |      | 130.0 |         |
|           |  | Z | 5.78 | 67.54 | 16.72 |      | 130.0 |         |
| 10631-AAA | IEEE 802.11ac WiFi (80MHz, MCS5, 90pc duty cycle)  | X | 5.99 | 67.90 | 17.13 | 0.46 | 130.0 | ± 9.6 % |
|           |  | Y | 6.12 | 67.99 | 17.15 |      | 130.0 |         |
|           |  | Z | 5.75 | 67.56 | 16.92 |      | 130.0 |         |
| 10632-AAA | IEEE 802.11ac WiFi (80MHz, MCS6, 90pc duty cycle)  | X | 5.79 | 67.18 | 16.78 | 0.46 | 130.0 | ± 9.6 % |
|           |  | Y | 5.85 | 67.07 | 16.70 |      | 130.0 |         |
|           |  | Z | 5.67 | 67.21 | 16.76 |      | 130.0 |         |
| 10633-AAA | IEEE 802.11ac WiFi (80MHz, MCS7, 90pc duty cycle)  | X | 5.68 | 66.80 | 16.43 | 0.46 | 130.0 | ± 9.6 % |
|           |  | Y | 5.74 | 66.74 | 16.37 |      | 130.0 |         |
|           |  | Z | 5.48 | 66.57 | 16.27 |      | 130.0 |         |
| 10634-AAA | IEEE 802.11ac WiFi (80MHz, MCS8, 90pc duty cycle)  | X | 5.66 | 66.82 | 16.49 | 0.46 | 130.0 | ± 9.6 % |
|           |  | Y | 5.73 | 66.76 | 16.44 |      | 130.0 |         |
|           |  | Z | 5.50 | 66.72 | 16.40 |      | 130.0 |         |
| 10635-AAA | IEEE 802.11ac WiFi (80MHz, MCS9, 90pc duty cycle)  | X | 5.54 | 66.19 | 15.93 | 0.46 | 130.0 | ± 9.6 % |
|           |  | Y | 5.62 | 66.14 | 15.87 |      | 130.0 |         |
|           |  | Z | 5.36 | 66.00 | 15.77 |      | 130.0 |         |
| 10636-AAB | IEEE 802.11ac WiFi (160MHz, MCS0, 90pc duty cycle) | X | 6.00 | 66.92 | 16.46 | 0.46 | 130.0 | ± 9.6 % |
|           |  | Y | 6.05 | 66.85 | 16.41 |      | 130.0 |         |
|           |  | Z | 5.88 | 66.82 | 16.36 |      | 130.0 |         |
| 10637-AAB | IEEE 802.11ac WiFi (160MHz, MCS1, 90pc duty cycle) | X | 6.16 | 67.31 | 16.64 | 0.46 | 130.0 | ± 9.6 % |
|           |  | Y | 6.21 | 67.23 | 16.58 |      | 130.0 |         |
|           |  | Z | 6.00 | 67.12 | 16.50 |      | 130.0 |         |
| 10638-AAB | IEEE 802.11ac WiFi (160MHz, MCS2, 90pc duty cycle) | X | 6.16 | 67.28 | 16.60 | 0.46 | 130.0 | ± 9.6 % |
|           |  | Y | 6.21 | 67.20 | 16.54 |      | 130.0 |         |
|           |  | Z | 6.02 | 67.18 | 16.51 |      | 130.0 |         |



|           |  |   |       |        |       |      |       |         |
|-----------|--|---|-------|--------|-------|------|-------|---------|
| 10639-AAB | IEEE 802.11ac WiFi (160MHz, MCS3, 90pc duty cycle)     | X | 6.13  | 67.21  | 16.61 | 0.46 | 130.0 | ± 9.6 % |
|           |  | Y | 6.20  | 67.17  | 16.57 |      | 130.0 |         |
|           |  | Z | 5.98  | 67.06  | 16.49 |      | 130.0 |         |
| 10640-AAB | IEEE 802.11ac WiFi (160MHz, MCS4, 90pc duty cycle)     | X | 6.13  | 67.23  | 16.57 | 0.46 | 130.0 | ± 9.6 % |
|           |  | Y | 6.21  | 67.21  | 16.53 |      | 130.0 |         |
|           |  | Z | 5.95  | 66.98  | 16.40 |      | 130.0 |         |
| 10641-AAB | IEEE 802.11ac WiFi (160MHz, MCS5, 90pc duty cycle)     | X | 6.19  | 67.17  | 16.55 | 0.46 | 130.0 | ± 9.6 % |
|           |  | Y | 6.24  | 67.06  | 16.48 |      | 130.0 |         |
|           |  | Z | 6.04  | 67.04  | 16.44 |      | 130.0 |         |
| 10642-AAB | IEEE 802.11ac WiFi (160MHz, MCS6, 90pc duty cycle)     | X | 6.22  | 67.37  | 16.82 | 0.46 | 130.0 | ± 9.6 % |
|           |  | Y | 6.28  | 67.33  | 16.77 |      | 130.0 |         |
|           |  | Z | 6.06  | 67.23  | 16.70 |      | 130.0 |         |
| 10643-AAB | IEEE 802.11ac WiFi (160MHz, MCS7, 90pc duty cycle)     | X | 6.06  | 67.09  | 16.58 | 0.46 | 130.0 | ± 9.6 % |
|           |  | Y | 6.12  | 67.02  | 16.52 |      | 130.0 |         |
|           |  | Z | 5.91  | 66.93  | 16.45 |      | 130.0 |         |
| 10644-AAB | IEEE 802.11ac WiFi (160MHz, MCS8, 90pc duty cycle)     | X | 6.20  | 67.52  | 16.82 | 0.46 | 130.0 | ± 9.6 % |
|           |  | Y | 6.31  | 67.59  | 16.83 |      | 130.0 |         |
|           |  | Z | 5.97  | 67.13  | 16.57 |      | 130.0 |         |
| 10645-AAB | IEEE 802.11ac WiFi (160MHz, MCS9, 90pc duty cycle)     | X | 6.41  | 67.77  | 16.91 | 0.46 | 130.0 | ± 9.6 % |
|           |  | Y | 6.76  | 68.49  | 17.23 |      | 130.0 |         |
|           |  | Z | 6.10  | 67.18  | 16.56 |      | 130.0 |         |
| 10646-AAD | LTE-TDD (SC-FDMA, 1 RB, 5 MHz, QPSK, UL Subframe=2,7)  | X | 32.54 | 128.38 | 44.23 | 9.30 | 60.0  | ± 9.6 % |
|           |  | Y | 33.21 | 124.21 | 42.28 |      | 60.0  |         |
|           |  | Z | 8.58  | 97.27  | 34.21 |      | 60.0  |         |
| 10647-AAC | LTE-TDD (SC-FDMA, 1 RB, 20 MHz, QPSK, UL Subframe=2,7) | X | 24.86 | 122.50 | 42.74 | 9.30 | 60.0  | ± 9.6 % |
|           |  | Y | 27.83 | 120.75 | 41.46 |      | 60.0  |         |
|           |  | Z | 7.33  | 94.04  | 33.20 |      | 60.0  |         |
| 10648-AAA | CDMA2000 (1x Advanced)                                 | X | 0.71  | 63.99  | 11.07 | 0.00 | 150.0 | ± 9.6 % |
|           |  | Y | 0.72  | 63.38  | 11.01 |      | 150.0 |         |
|           |  | Z | 0.57  | 62.72  | 9.40  |      | 150.0 |         |
| 10652-AAB | LTE-TDD (OFDMA, 5 MHz, E-TM 3.1, Clipping 44%)         | X | 3.64  | 67.29  | 16.91 | 2.23 | 80.0  | ± 9.6 % |
|           |  | Y | 3.79  | 67.25  | 16.93 |      | 80.0  |         |
|           |  | Z | 3.31  | 66.63  | 16.20 |      | 80.0  |         |
| 10653-AAB | LTE-TDD (OFDMA, 10 MHz, E-TM 3.1, Clipping 44%)        | X | 4.13  | 66.44  | 16.95 | 2.23 | 80.0  | ± 9.6 % |
|           |  | Y | 4.30  | 66.53  | 16.99 |      | 80.0  |         |
|           |  | Z | 3.84  | 65.89  | 16.44 |      | 80.0  |         |
| 10654-AAB | LTE-TDD (OFDMA, 15 MHz, E-TM 3.1, Clipping 44%)        | X | 4.11  | 66.04  | 16.93 | 2.23 | 80.0  | ± 9.6 % |
|           |  | Y | 4.26  | 66.17  | 16.97 |      | 80.0  |         |
|           |  | Z | 3.86  | 65.50  | 16.46 |      | 80.0  |         |
| 10655-AAB | LTE-TDD (OFDMA, 20 MHz, E-TM 3.1, Clipping 44%)        | X | 4.17  | 66.02  | 16.96 | 2.23 | 80.0  | ± 9.6 % |
|           |  | Y | 4.32  | 66.18  | 17.01 |      | 80.0  |         |
|           |  | Z | 3.93  | 65.42  | 16.50 |      | 80.0  |         |

<sup>E</sup> Uncertainty is determined using the max. deviation from linear response applying rectangular distribution and is expressed for the square of the field value.