



Accredited by the Swiss Accreditation Service (SAS)
The Swiss Accreditation Service is one of the signatories to the EA
Multilateral Agreement for the recognition of calibration certificates

Accreditation No.: **SCS 108**

Client **PC Test**

Certificate No: **ES3-3213_Apr14**

CALIBRATION CERTIFICATE

Object	ES3DV3 - SN:3213
Calibration procedure(s)	QA CAL-01.v9, QA CAL-23.v5, QA CAL-25.v6 Calibration procedure for dosimetric E-field probes
Calibration date:	April 11, 2014

This calibration certificate documents the traceability to national standards, which realize the physical units of measurements (SI).
The measurements and the uncertainties with confidence probability are given on the following pages and are part of the certificate.

All calibrations have been conducted in the closed laboratory facility: environment temperature (22 ± 3)°C and humidity < 70%.

Calibration Equipment used (M&TE critical for calibration)

CC-V
5/7/14

Primary Standards	ID	Cal Date (Certificate No.)	Scheduled Calibration
Power meter E4419B	GB41293874	03-Apr-14 (No. 217-01911)	Apr-15
Power sensor E4412A	MY41498087	03-Apr-14 (No. 217-01911)	Apr-15
Reference 3 dB Attenuator	SN: S5054 (3c)	03-Apr-14 (No. 217-01915)	Apr-15
Reference 20 dB Attenuator	SN: S5277 (20x)	03-Apr-14 (No. 217-01919)	Apr-15
Reference 30 dB Attenuator	SN: S5129 (30b)	03-Apr-14 (No. 217-01920)	Apr-15
Reference Probe ES3DV2	SN: 3013	30-Dec-13 (No. ES3-3013_Dec13)	Dec-14
DAE4	SN: 660	13-Dec-13 (No. DAE4-660_Dec13)	Dec-14
Secondary Standards	ID	Check Date (in house)	Scheduled Check
RF generator HP 8648C	US3642U01700	4-Aug-99 (in house check Apr-13)	In house check: Apr-16
Network Analyzer HP 8753E	US37390585	18-Oct-01 (in house check Oct-13)	In house check: Oct-14

Calibrated by:	Name Leif Klysner	Function Laboratory Technician	Signature
Approved by:	Katja Pokovic	Technical Manager	

Issued: April 14, 2014

This calibration certificate shall not be reproduced except in full without written approval of the laboratory.



Accredited by the Swiss Accreditation Service (SAS)

Accreditation No.: **SCS 108**

The Swiss Accreditation Service is one of the signatories to the EA Multilateral Agreement for the recognition of calibration certificates

Glossary:

TSL	tissue simulating liquid
NORM _{x,y,z}	sensitivity in free space
ConvF	sensitivity in TSL / NORM _{x,y,z}
DCP	diode compression point
CF	crest factor (1/duty_cycle) of the RF signal
A, B, C, D	modulation dependent linearization parameters
Polarization φ	φ rotation around probe axis
Polarization ϑ	ϑ rotation around an axis that is in the plane normal to probe axis (at measurement center), i.e., $\vartheta = 0$ is normal to probe axis
Connector Angle	information used in DASY system to align probe sensor X to the robot coordinate system

Calibration is Performed According to the Following Standards:

- IEEE Std 1528-2013, "IEEE Recommended Practice for Determining the Peak Spatial-Averaged Specific Absorption Rate (SAR) in the Human Head from Wireless Communications Devices: Measurement Techniques", June 2013
- IEC 62209-1, "Procedure to measure the Specific Absorption Rate (SAR) for hand-held devices used in close proximity to the ear (frequency range of 300 MHz to 3 GHz)", February 2005

Methods Applied and Interpretation of Parameters:

- NORM_{x,y,z}**: Assessed for E-field polarization $\vartheta = 0$ ($f \leq 900$ MHz in TEM-cell; $f > 1800$ MHz: R22 waveguide). NORM_{x,y,z} are only intermediate values, i.e., the uncertainties of NORM_{x,y,z} does not affect the E²-field uncertainty inside TSL (see below ConvF).
- NORM(f)_{x,y,z}** = NORM_{x,y,z} * frequency_response (see Frequency Response Chart). This linearization is implemented in DASY4 software versions later than 4.2. The uncertainty of the frequency response is included in the stated uncertainty of ConvF.
- DCP_{x,y,z}**: DCP are numerical linearization parameters assessed based on the data of power sweep with CW signal (no uncertainty required). DCP does not depend on frequency nor media.
- PAR**: PAR is the Peak to Average Ratio that is not calibrated but determined based on the signal characteristics
- A_{x,y,z}; B_{x,y,z}; C_{x,y,z}; D_{x,y,z}; VR_{x,y,z}**: A, B, C, D are numerical linearization parameters assessed based on the data of power sweep for specific modulation signal. The parameters do not depend on frequency nor media. VR is the maximum calibration range expressed in RMS voltage across the diode.
- ConvF and Boundary Effect Parameters**: Assessed in flat phantom using E-field (or Temperature Transfer Standard for $f \leq 800$ MHz) and inside waveguide using analytical field distributions based on power measurements for $f > 800$ MHz. The same setups are used for assessment of the parameters applied for boundary compensation (alpha, depth) of which typical uncertainty values are given. These parameters are used in DASY4 software to improve probe accuracy close to the boundary. The sensitivity in TSL corresponds to NORM_{x,y,z} * ConvF whereby the uncertainty corresponds to that given for ConvF. A frequency dependent ConvF is used in DASY version 4.4 and higher which allows extending the validity from ± 50 MHz to ± 100 MHz.
- Spherical isotropy (3D deviation from isotropy)**: in a field of low gradients realized using a flat phantom exposed by a patch antenna.
- Sensor Offset**: The sensor offset corresponds to the offset of virtual measurement center from the probe tip (on probe axis). No tolerance required.
- Connector Angle**: The angle is assessed using the information gained by determining the NORM_x (no uncertainty required).

Probe ES3DV3

SN:3213

Manufactured: October 14, 2008
Calibrated: April 11, 2014

Calibrated for DASY/EASY Systems
(Note: non-compatible with DASY2 system!)

DASY/EASY - Parameters of Probe: ES3DV3 - SN:3213

Basic Calibration Parameters

	Sensor X	Sensor Y	Sensor Z	Unc (k=2)
Norm ($\mu\text{V}/(\text{V}/\text{m})^2$) ^A	1.47	1.36	1.32	$\pm 10.1\%$
DCP (mV) ^B	102.9	101.6	102.7	

Modulation Calibration Parameters

UID	Communication System Name		A dB	B dB $\sqrt{\mu\text{V}}$	C	D dB	VR mV	Unc ^E (k=2)
0	CW	X	0.0	0.0	1.0	0.00	197.4	$\pm 3.8\%$
		Y	0.0	0.0	1.0		219.1	
		Z	0.0	0.0	1.0		195.3	
10010- CAA	SAR Validation (Square, 100ms, 10ms)	X	5.05	68.5	14.4	10.00	41.4	$\pm 0.9\%$
		Y	9.83	75.4	16.6		39.8	
		Z	10.63	76.7	17.0		40.3	
10011- CAB	UMTS-FDD (WCDMA)	X	3.25	67.1	18.8	2.91	135.4	$\pm 0.5\%$
		Y	3.21	66.6	18.4		131.4	
		Z	3.43	68.3	19.4		133.5	
10012- CAA	IEEE 802.11b WiFi 2.4 GHz (DSSS, 1 Mbps)	X	3.39	71.8	20.4	1.87	137.8	$\pm 0.7\%$
		Y	2.98	69.1	19.1		133.1	
		Z	3.26	71.3	20.3		133.8	
10021- DAB	GSM-FDD (TDMA, GMSK)	X	22.08	99.1	27.6	9.39	143.1	$\pm 2.2\%$
		Y	21.57	99.6	28.2		141.4	
		Z	13.61	90.9	24.9		137.1	
10023- DAB	GPRS-FDD (TDMA, GMSK, TN 0)	X	16.13	94.0	26.2	9.57	133.8	$\pm 1.9\%$
		Y	22.39	99.7	28.1		137.8	
		Z	18.99	97.5	27.4		129.2	
10024- DAB	GPRS-FDD (TDMA, GMSK, TN 0-1)	X	21.23	93.4	23.4	6.56	148.9	$\pm 1.9\%$
		Y	33.62	99.9	25.4		148.5	
		Z	32.72	99.7	25.1		141.6	
10027- DAB	GPRS-FDD (TDMA, GMSK, TN 0-1-2)	X	49.20	99.7	23.0	4.80	138.6	$\pm 2.5\%$
		Y	40.22	99.8	23.9		134.7	
		Z	43.82	99.8	23.4		131.9	
10028- DAB	GPRS-FDD (TDMA, GMSK, TN 0-1-2-3)	X	50.05	99.8	22.4	3.55	146.5	$\pm 2.2\%$
		Y	51.41	99.6	22.3		144.4	
		Z	46.36	99.5	22.4		140.0	
10032- CAA	IEEE 802.15.1 Bluetooth (GFSK, DH5)	X	40.43	99.5	20.4	1.16	135.1	$\pm 1.7\%$
		Y	24.55	99.5	21.7		133.5	
		Z	32.87	99.9	21.0		131.0	
10039- CAB	CDMA2000 (1xRTT, RC1)	X	4.69	66.6	19.0	4.57	133.4	$\pm 0.9\%$
		Y	4.76	66.9	19.3		133.2	
		Z	4.71	66.8	19.2		130.1	

10081-CAB	CDMA2000 (1xRTT, RC3)	X	3.87	66.1	18.6	3.97	129.0	±0.7 %
		Y	3.89	66.1	18.7		129.6	
		Z	3.97	66.6	19.0		146.7	
10098-CAB	UMTS-FDD (HSUPA, Subtest 2)	X	4.59	66.8	18.8	3.98	141.1	±0.7 %
		Y	4.64	67.0	19.0		140.0	
		Z	4.67	67.2	19.1		138.5	
10100-CAB	LTE-FDD (SC-FDMA, 100% RB, 20 MHz, QPSK)	X	6.52	68.0	20.1	5.67	147.5	±1.4 %
		Y	6.61	68.3	20.4		148.5	
		Z	6.51	68.0	20.1		145.4	
10108-CAB	LTE-FDD (SC-FDMA, 100% RB, 10 MHz, QPSK)	X	6.39	67.5	19.9	5.80	145.2	±1.4 %
		Y	6.44	67.8	20.2		145.8	
		Z	6.41	67.7	20.1		145.5	
10110-CAB	LTE-FDD (SC-FDMA, 100% RB, 5 MHz, QPSK)	X	6.02	66.7	19.5	5.75	141.3	±1.4 %
		Y	6.10	67.2	20.0		141.0	
		Z	6.05	67.0	19.8		141.2	
10114-CAA	IEEE 802.11n (HT Greenfield, 13.5 Mbps, BPSK)	X	10.19	68.9	21.4	8.10	135.6	±2.2 %
		Y	10.43	69.6	21.9		135.7	
		Z	10.21	69.0	21.5		134.5	
10117-CAA	IEEE 802.11n (HT Mixed, 13.5 Mbps, BPSK)	X	10.17	68.9	21.3	8.07	137.7	±2.5 %
		Y	10.45	69.6	21.9		137.2	
		Z	10.22	69.1	21.5		136.9	
10151-CAB	LTE-TDD (SC-FDMA, 50% RB, 20 MHz, QPSK)	X	9.70	74.8	25.8	9.28	133.6	±3.0 %
		Y	9.81	75.7	26.7		130.1	
		Z	9.49	74.4	25.7		131.6	
10154-CAB	LTE-FDD (SC-FDMA, 50% RB, 10 MHz, QPSK)	X	6.07	67.0	19.7	5.75	142.9	±1.4 %
		Y	6.19	67.6	20.2		145.4	
		Z	6.06	67.0	19.8		141.7	
10160-CAB	LTE-FDD (SC-FDMA, 50% RB, 15 MHz, QPSK)	X	6.50	67.5	19.9	5.82	148.5	±1.4 %
		Y	6.35	67.0	19.7		127.0	
		Z	6.52	67.6	20.0		147.9	
10169-CAB	LTE-FDD (SC-FDMA, 1 RB, 20 MHz, QPSK)	X	5.00	66.8	19.8	5.73	145.4	±1.4 %
		Y	5.13	67.5	20.4		148.9	
		Z	5.06	67.3	20.2		144.8	
10172-CAB	LTE-TDD (SC-FDMA, 1 RB, 20 MHz, QPSK)	X	9.02	79.7	28.5	9.21	148.9	±3.0 %
		Y	8.14	77.1	27.6		125.0	
		Z	8.82	79.5	28.6		147.1	
10175-CAB	LTE-FDD (SC-FDMA, 1 RB, 10 MHz, QPSK)	X	5.05	67.2	20.0	5.72	146.2	±1.4 %
		Y	5.14	67.6	20.4		145.9	
		Z	5.00	67.1	20.1		140.8	
10181-CAB	LTE-FDD (SC-FDMA, 1 RB, 15 MHz, QPSK)	X	5.07	67.2	20.0	5.72	149.7	±1.4 %
		Y	5.15	67.6	20.4		146.0	
		Z	5.00	67.0	20.0		141.0	

10193-CAA	IEEE 802.11n (HT Greenfield, 6.5 Mbps, BPSK)	X	9.92	68.8	21.4	8.09	135.2	±2.2 %
		Y	10.06	69.3	21.8		130.6	
		Z	9.78	68.4	21.2		126.9	
10196-CAA	IEEE 802.11n (HT Mixed, 6.5 Mbps, BPSK)	X	9.93	68.9	21.4	8.10	136.4	±2.2 %
		Y	10.06	69.3	21.9		131.1	
		Z	9.84	68.7	21.4		128.8	
10219-CAA	IEEE 802.11n (HT Mixed, 7.2 Mbps, BPSK)	X	9.81	68.8	21.4	8.03	135.3	±2.2 %
		Y	9.95	69.3	21.8		130.1	
		Z	9.71	68.5	21.2		127.4	
10222-CAA	IEEE 802.11n (HT Mixed, 15 Mbps, BPSK)	X	10.24	69.1	21.5	8.06	141.2	±2.2 %
		Y	10.45	69.7	22.0		136.8	
		Z	10.13	68.9	21.4		133.6	
10225-CAB	UMTS-FDD (HSPA+)	X	6.95	66.9	19.5	5.97	137.9	±1.4 %
		Y	7.03	67.2	19.8		133.2	
		Z	6.92	66.9	19.5		130.6	
10237-CAB	LTE-TDD (SC-FDMA, 1 RB, 10 MHz, QPSK)	X	8.08	76.6	27.0	9.21	127.8	±3.0 %
		Y	10.15	84.0	31.2		149.6	
		Z	8.67	79.0	28.3		145.4	
10252-CAB	LTE-TDD (SC-FDMA, 50% RB, 10 MHz, QPSK)	X	8.92	73.6	25.3	9.24	126.0	±3.5 %
		Y	9.19	75.1	26.5		124.0	
		Z	9.66	76.2	26.8		149.1	
10267-CAB	LTE-TDD (SC-FDMA, 100% RB, 10 MHz, QPSK)	X	9.59	74.5	25.7	9.30	131.9	±3.0 %
		Y	9.87	75.8	26.8		130.6	
		Z	9.36	73.9	25.5		127.8	
10274-CAB	UMTS-FDD (HSUPA, Subtest 5, 3GPP Rel8.10)	X	5.84	66.6	18.8	4.87	128.6	±0.9 %
		Y	5.87	66.7	19.0		128.8	
		Z	6.08	67.6	19.4		149.9	
10275-CAB	UMTS-FDD (HSUPA, Subtest 5, 3GPP Rel8.4)	X	4.35	66.6	18.8	3.96	134.0	±0.9 %
		Y	4.46	67.0	19.1		138.5	
		Z	4.39	66.8	19.0		129.4	
10291-AAB	CDMA2000, RC3, SO55, Full Rate	X	3.72	67.5	19.2	3.46	149.2	±0.7 %
		Y	3.66	67.1	19.1		129.6	
		Z	3.72	67.6	19.3		143.2	
10292-AAB	CDMA2000, RC3, SO32, Full Rate	X	3.54	66.9	18.8	3.39	128.3	±0.5 %
		Y	3.61	67.2	19.1		130.4	
		Z	3.69	67.8	19.4		146.2	
10297-AAA	LTE-FDD (SC-FDMA, 50% RB, 20 MHz, QPSK)	X	6.38	67.4	19.9	5.81	145.8	±1.4 %
		Y	6.50	68.0	20.4		148.6	
		Z	6.35	67.4	19.9		140.8	
10311-AAA	LTE-FDD (SC-FDMA, 100% RB, 15 MHz, QPSK)	X	6.70	67.2	19.7	6.06	127.8	±1.4 %
		Y	6.85	67.7	20.3		130.2	
		Z	6.98	68.2	20.4		147.9	

10315-AAA	IEEE 802.11b WiFi 2.4 GHz (DSSS, 1 Mbps, 96pc duty cycle)	X	2.82	69.1	19.2	1.71	135.1	±0.7 %
		Y	2.92	69.5	19.6		136.9	
		Z	3.22	71.8	20.6		130.9	
10403-AAB	CDMA2000 (1xEV-DO, Rev. 0)	X	4.77	68.3	18.9	3.76	140.0	±0.5 %
		Y	4.80	68.4	19.1		141.4	
		Z	4.86	68.9	19.3		134.8	
10404-AAB	CDMA2000 (1xEV-DO, Rev. A)	X	4.61	68.0	18.8	3.77	138.2	±0.7 %
		Y	4.67	68.2	19.0		139.3	
		Z	4.69	68.5	19.1		133.9	

The reported uncertainty of measurement is stated as the standard uncertainty of measurement multiplied by the coverage factor k=2, which for a normal distribution corresponds to a coverage probability of approximately 95%.

^A The uncertainties of NormX,Y,Z do not affect the E²-field uncertainty inside TSL (see Pages 8 and 9).

^B Numerical linearization parameter: uncertainty not required.

^E Uncertainty is determined using the max. deviation from linear response applying rectangular distribution and is expressed for the square of the field value.

DASY/EASY - Parameters of Probe: ES3DV3 - SN:3213

Calibration Parameter Determined in Head Tissue Simulating Media

f (MHz) ^C	Relative Permittivity ^F	Conductivity (S/m) ^F	ConvF X	ConvF Y	ConvF Z	Alpha ^G	Depth ^G (mm)	Unct. (k=2)
750	41.9	0.89	6.58	6.58	6.58	0.34	1.79	± 12.0 %
835	41.5	0.90	6.37	6.37	6.37	0.29	1.94	± 12.0 %
1750	40.1	1.37	5.18	5.18	5.18	0.79	1.17	± 12.0 %
1900	40.0	1.40	4.99	4.99	4.99	0.57	1.36	± 12.0 %
2450	39.2	1.80	4.40	4.40	4.40	0.78	1.28	± 12.0 %
2600	39.0	1.96	4.25	4.25	4.25	0.77	1.23	± 12.0 %

^C Frequency validity of ± 100 MHz only applies for DASY v4.4 and higher (see Page 2), else it is restricted to ± 50 MHz. The uncertainty is the RSS of the ConvF uncertainty at calibration frequency and the uncertainty for the indicated frequency band.

^F At frequencies below 3 GHz, the validity of tissue parameters (ϵ and σ) can be relaxed to ± 10% if liquid compensation formula is applied to measured SAR values. At frequencies above 3 GHz, the validity of tissue parameters (ϵ and σ) is restricted to ± 5%. The uncertainty is the RSS of the ConvF uncertainty for indicated target tissue parameters.

^G Alpha/Depth are determined during calibration. SPEAG warrants that the remaining deviation due to the boundary effect after compensation is always less than ± 1% for frequencies below 3 GHz and below ± 2% for frequencies between 3-6 GHz at any distance larger than half the probe tip diameter from the boundary.

DASY/EASY - Parameters of Probe: ES3DV3 - SN:3213

Calibration Parameter Determined in Body Tissue Simulating Media

f (MHz) ^C	Relative Permittivity ^F	Conductivity (S/m) ^F	ConvF X	ConvF Y	ConvF Z	Alpha ^G	Depth ^G (mm)	Unct. (k=2)
750	55.5	0.96	6.21	6.21	6.21	0.77	1.19	± 12.0 %
835	55.2	0.97	6.18	6.18	6.18	0.54	1.37	± 12.0 %
1750	53.4	1.49	4.89	4.89	4.89	0.73	1.27	± 12.0 %
1900	53.3	1.52	4.68	4.68	4.68	0.47	1.70	± 12.0 %
2450	52.7	1.95	4.26	4.26	4.26	0.70	1.16	± 12.0 %
2600	52.5	2.16	4.05	4.05	4.05	0.67	1.00	± 12.0 %

^C Frequency validity of ± 100 MHz only applies for DASY v4.4 and higher (see Page 2), else it is restricted to ± 50 MHz. The uncertainty is the RSS of the ConvF uncertainty at calibration frequency and the uncertainty for the indicated frequency band.

^F At frequencies below 3 GHz, the validity of tissue parameters (ϵ and σ) can be relaxed to ± 10% if liquid compensation formula is applied to measured SAR values. At frequencies above 3 GHz, the validity of tissue parameters (ϵ and σ) is restricted to ± 5%. The uncertainty is the RSS of the ConvF uncertainty for indicated target tissue parameters.

^G Alpha/Depth are determined during calibration. SPEAG warrants that the remaining deviation due to the boundary effect after compensation is always less than ± 1% for frequencies below 3 GHz and below ± 2% for frequencies between 3-6 GHz at any distance larger than half the probe tip diameter from the boundary.

Frequency Response of E-Field (TEM-Cell:ifi110 EXX, Waveguide: R22)

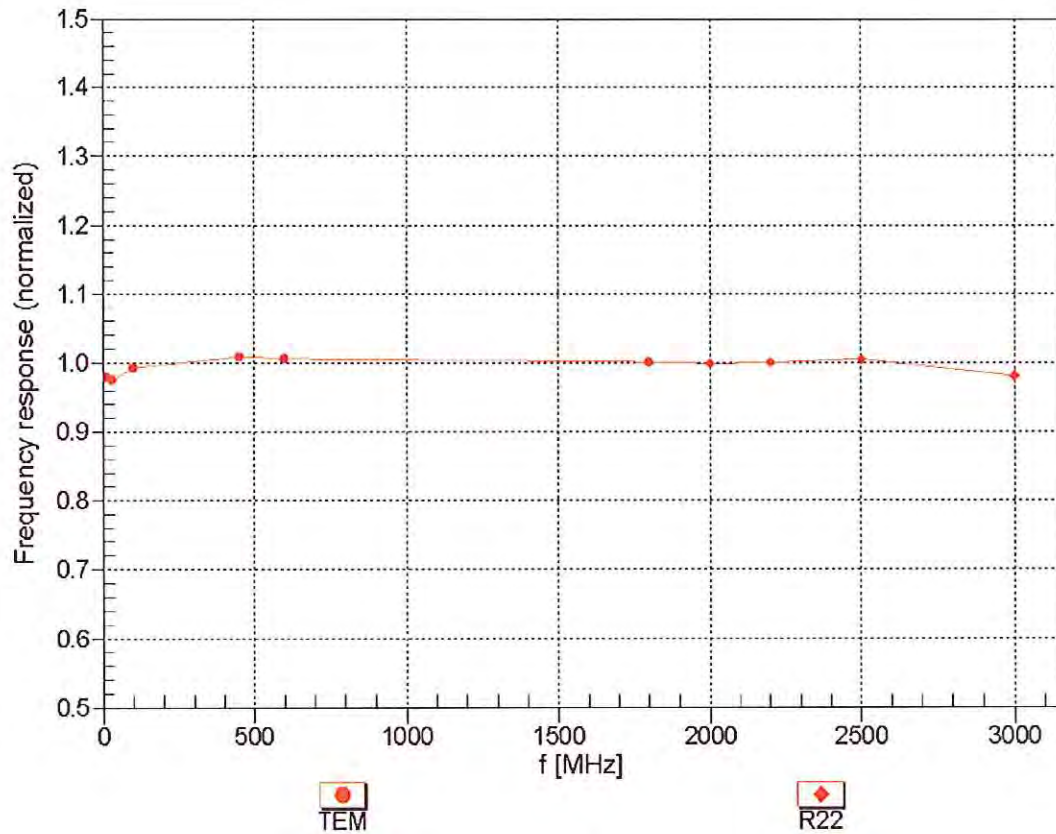

Uncertainty of Frequency Response of E-field: $\pm 6.3\%$ (k=2)

Receiving Pattern (ϕ), $\theta = 0^\circ$

f=600 MHz, TEM

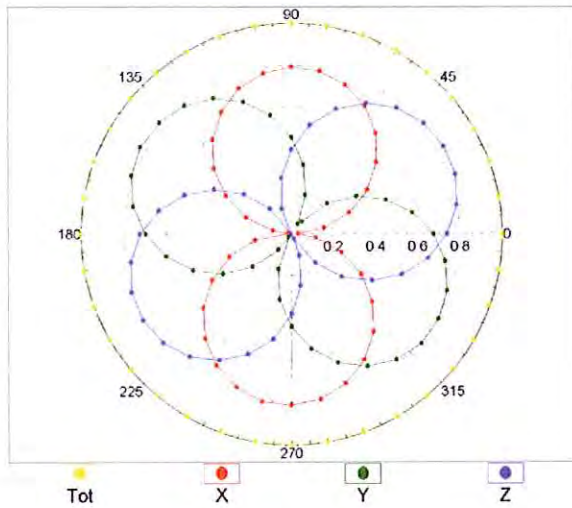

f=1800 MHz, R22

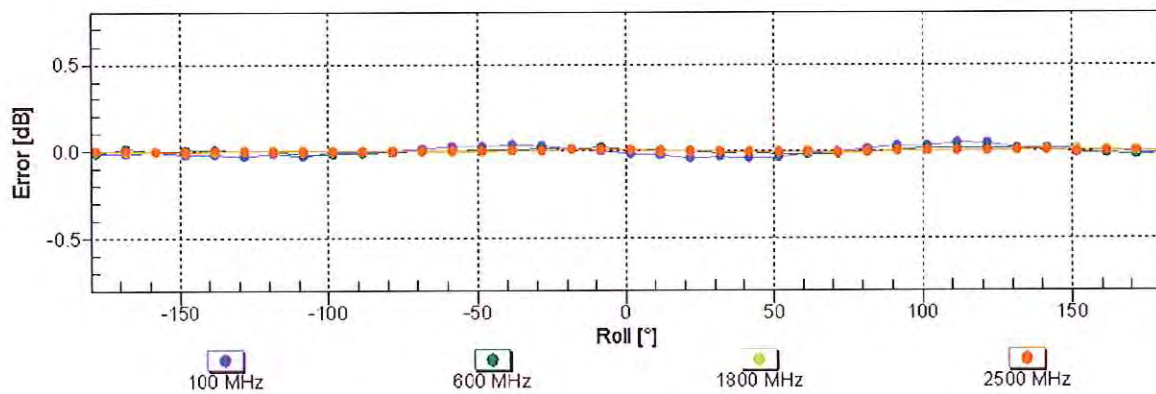
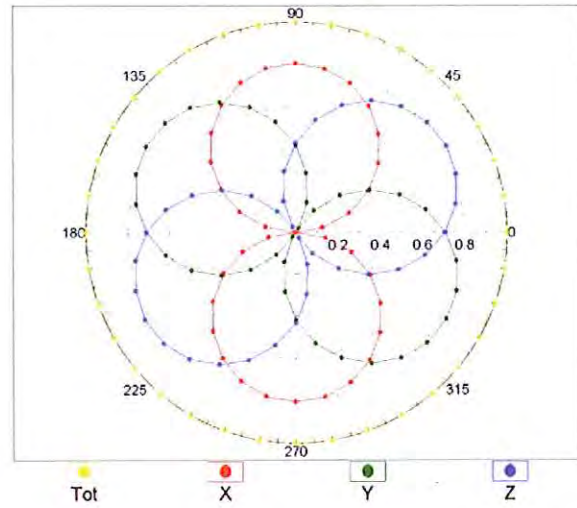

Uncertainty of Axial Isotropy Assessment: $\pm 0.5\%$ (k=2)

Dynamic Range f(SAR_{head}) (TEM cell , f_{eval}= 1900 MHz)

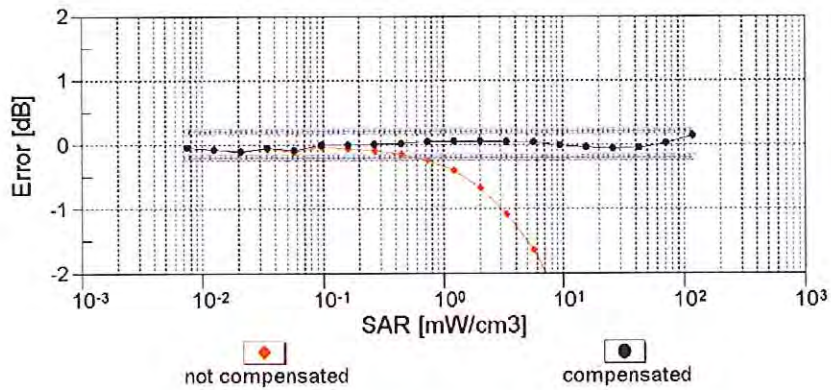
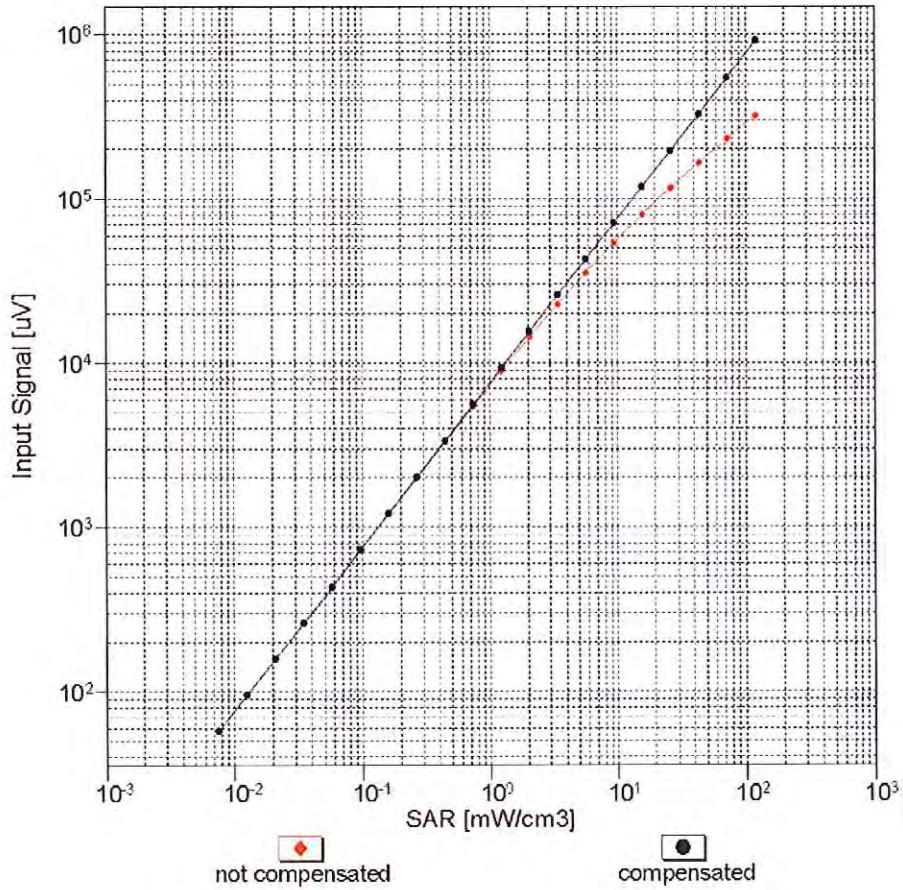

Uncertainty of Linearity Assessment: ± 0.6% (k=2)

Conversion Factor Assessment

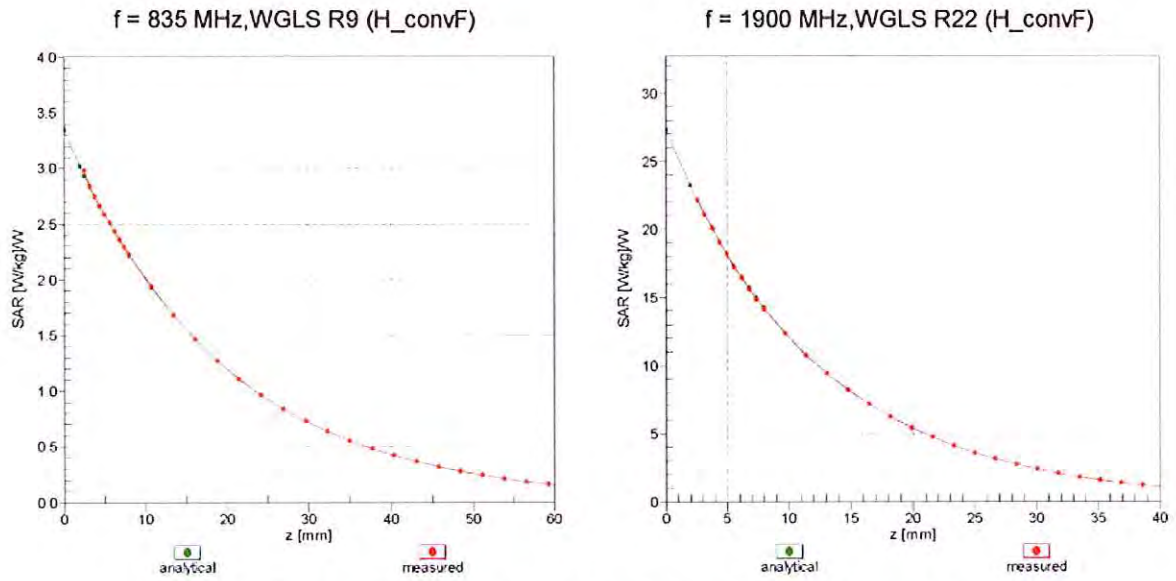

Deviation from Isotropy in Liquid Error (ϕ, θ), f = 900 MHz

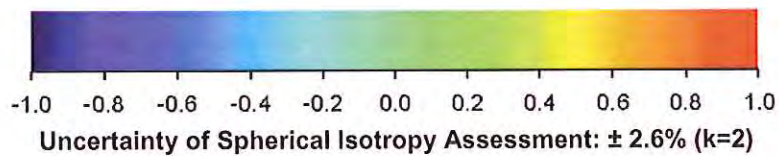
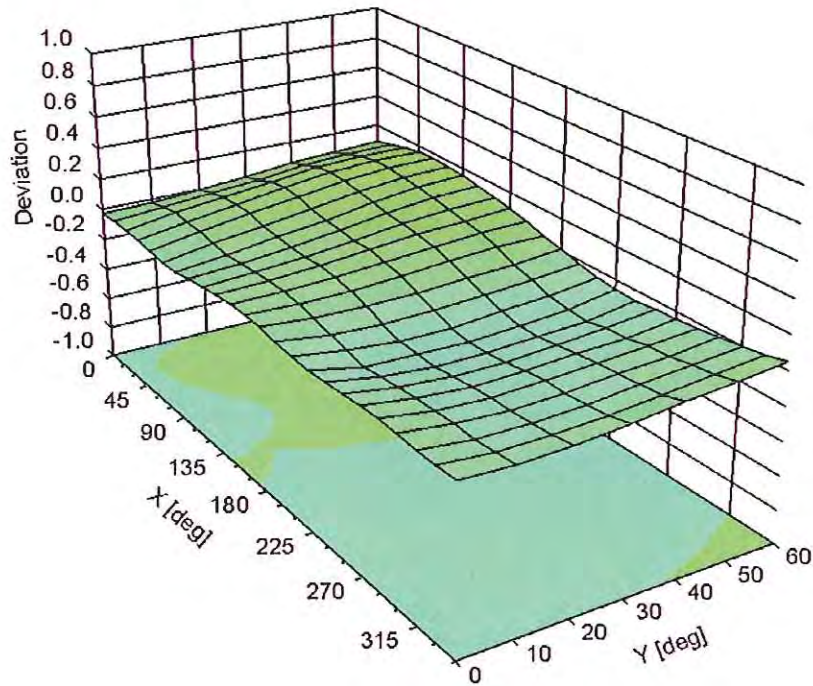

DASY/EASY - Parameters of Probe: ES3DV3 - SN:3213

Other Probe Parameters

Sensor Arrangement	Triangular
Connector Angle (°)	-68.3
Mechanical Surface Detection Mode	enabled
Optical Surface Detection Mode	disabled
Probe Overall Length	337 mm
Probe Body Diameter	10 mm
Tip Length	10 mm
Tip Diameter	4 mm
Probe Tip to Sensor X Calibration Point	2 mm
Probe Tip to Sensor Y Calibration Point	2 mm
Probe Tip to Sensor Z Calibration Point	2 mm
Recommended Measurement Distance from Surface	3 mm



Accredited by the Swiss Accreditation Service (SAS)
The Swiss Accreditation Service is one of the signatories to the EA
Multilateral Agreement for the recognition of calibration certificates

Accreditation No.: **SCS 108**

Client **PC Test**

Certificate No: **ES3-3263_May14**

CALIBRATION CERTIFICATE

Object **ES3DV3 - SN:3263**

Calibration procedure(s) **QA CAL-01.v9, QA CAL-23.v5, QA CAL-25.v6
Calibration procedure for dosimetric E-field probes**

OCV
7/17/14

Calibration date: **May 15, 2014**

This calibration certificate documents the traceability to national standards, which realize the physical units of measurements (SI).
The measurements and the uncertainties with confidence probability are given on the following pages and are part of the certificate.

All calibrations have been conducted in the closed laboratory facility: environment temperature (22 ± 3)°C and humidity < 70%.

Calibration Equipment used (M&TE critical for calibration)

Primary Standards	ID	Cal Date (Certificate No.)	Scheduled Calibration
Power meter E4419B	GB41293874	03-Apr-14 (No. 217-01911)	Apr-15
Power sensor E4412A	MY41498087	03-Apr-14 (No. 217-01911)	Apr-15
Reference 3 dB Attenuator	SN: S5054 (3c)	03-Apr-14 (No. 217-01915)	Apr-15
Reference 20 dB Attenuator	SN: S5277 (20x)	03-Apr-14 (No. 217-01919)	Apr-15
Reference 30 dB Attenuator	SN: S5129 (30b)	03-Apr-14 (No. 217-01920)	Apr-15
Reference Probe ES3DV2	SN: 3013	30-Dec-13 (No. ES3-3013_Dec13)	Dec-14
DAE4	SN: 660	13-Dec-13 (No. DAE4-660_Dec13)	Dec-14
Secondary Standards	ID	Check Date (in house)	Scheduled Check
RF generator HP 8648C	US3642U01700	4-Aug-99 (in house check Apr-13)	In house check: Apr-16
Network Analyzer HP 8753E	US37390585	18-Oct-01 (in house check Oct-13)	In house check: Oct-14

	Name	Function	Signature
Calibrated by:	Jeton Kastrati	Laboratory Technician	
Approved by:	Katja Pokovic	Technical Manager	
			Issued: May 15, 2014

This calibration certificate shall not be reproduced except in full without written approval of the laboratory.



Accredited by the Swiss Accreditation Service (SAS)
The Swiss Accreditation Service is one of the signatories to the EA
Multilateral Agreement for the recognition of calibration certificates

Accreditation No.: **SCS 108**

Glossary:

TSL	tissue simulating liquid
NORM _{x,y,z}	sensitivity in free space
ConvF	sensitivity in TSL / NORM _{x,y,z}
DCP	diode compression point
CF	crest factor (1/duty_cycle) of the RF signal
A, B, C, D	modulation dependent linearization parameters
Polarization φ	φ rotation around probe axis
Polarization ϑ	ϑ rotation around an axis that is in the plane normal to probe axis (at measurement center), i.e., $\vartheta = 0$ is normal to probe axis
Connector Angle	information used in DASY system to align probe sensor X to the robot coordinate system

Calibration is Performed According to the Following Standards:

- IEEE Std 1528-2013, "IEEE Recommended Practice for Determining the Peak Spatial-Averaged Specific Absorption Rate (SAR) in the Human Head from Wireless Communications Devices: Measurement Techniques", June 2013
- IEC 62209-1, "Procedure to measure the Specific Absorption Rate (SAR) for hand-held devices used in close proximity to the ear (frequency range of 300 MHz to 3 GHz)", February 2005

Methods Applied and Interpretation of Parameters:

- NORM_{x,y,z}**: Assessed for E-field polarization $\vartheta = 0$ ($f \leq 900$ MHz in TEM-cell; $f > 1800$ MHz: R22 waveguide). NORM_{x,y,z} are only intermediate values, i.e., the uncertainties of NORM_{x,y,z} does not affect the E²-field uncertainty inside TSL (see below ConvF).
- NORM(f)_{x,y,z}** = NORM_{x,y,z} * frequency_response (see Frequency Response Chart). This linearization is implemented in DASY4 software versions later than 4.2. The uncertainty of the frequency response is included in the stated uncertainty of ConvF.
- DCP_{x,y,z}**: DCP are numerical linearization parameters assessed based on the data of power sweep with CW signal (no uncertainty required). DCP does not depend on frequency nor media.
- PAR**: PAR is the Peak to Average Ratio that is not calibrated but determined based on the signal characteristics
- A_{x,y,z}; B_{x,y,z}; C_{x,y,z}; D_{x,y,z}; VR_{x,y,z}**: A, B, C, D are numerical linearization parameters assessed based on the data of power sweep for specific modulation signal. The parameters do not depend on frequency nor media. VR is the maximum calibration range expressed in RMS voltage across the diode.
- ConvF and Boundary Effect Parameters**: Assessed in flat phantom using E-field (or Temperature Transfer Standard for $f \leq 800$ MHz) and inside waveguide using analytical field distributions based on power measurements for $f > 800$ MHz. The same setups are used for assessment of the parameters applied for boundary compensation (alpha, depth) of which typical uncertainty values are given. These parameters are used in DASY4 software to improve probe accuracy close to the boundary. The sensitivity in TSL corresponds to NORM_{x,y,z} * ConvF whereby the uncertainty corresponds to that given for ConvF. A frequency dependent ConvF is used in DASY version 4.4 and higher which allows extending the validity from ± 50 MHz to ± 100 MHz.
- Spherical isotropy (3D deviation from isotropy)**: in a field of low gradients realized using a flat phantom exposed by a patch antenna.
- Sensor Offset**: The sensor offset corresponds to the offset of virtual measurement center from the probe tip (on probe axis). No tolerance required.
- Connector Angle**: The angle is assessed using the information gained by determining the NORM_x (no uncertainty required).

Probe ES3DV3

SN:3263

Manufactured: January 25, 2010
Calibrated: May 15, 2014

Calibrated for DASYS/EASY Systems
(Note: non-compatible with DASYS2 system!)

DASY/EASY - Parameters of Probe: ES3DV3 - SN:3263

Basic Calibration Parameters

	Sensor X	Sensor Y	Sensor Z	Unc (k=2)
Norm ($\mu\text{V}/(\text{V}/\text{m})^2$) ^A	1.21	1.24	1.13	$\pm 10.1\%$
DCP (mV) ^B	103.8	102.3	104.7	

Modulation Calibration Parameters

UID	Communication System Name		A dB	B dB $\sqrt{\mu\text{V}}$	C	D dB	VR mV	Unc ^E (k=2)
0	CW	X	0.0	0.0	1.0	0.00	156.3	$\pm 3.5\%$
		Y	0.0	0.0	1.0		203.1	
		Z	0.0	0.0	1.0		197.2	
10010- CAA	SAR Validation (Square, 100ms, 10ms)	X	2.33	59.4	10.8	10.00	46.4	$\pm 1.4\%$
		Y	4.39	63.4	13.6		50.8	
		Z	1.35	55.5	7.8		39.6	
10011- CAB	UMTS-FDD (WCDMA)	X	3.49	68.2	19.1	2.91	126.7	$\pm 0.7\%$
		Y	3.28	66.9	18.5		120.7	
		Z	2.74	63.1	15.1		113.5	
10012- CAA	IEEE 802.11b WiFi 2.4 GHz (DSSS, 1 Mbps)	X	3.51	72.0	20.3	1.87	127.9	$\pm 0.7\%$
		Y	3.21	69.4	18.8		124.1	
		Z	1.93	60.6	12.6		113.3	
10013- CAA	IEEE 802.11g WiFi 2.4 GHz (DSSS-OFDM, 6 Mbps)	X	11.30	70.8	23.3	9.46	125.2	$\pm 2.5\%$
		Y	12.42	72.7	24.4		129.4	
		Z	10.03	67.8	21.1		105.5	
10021- DAB	GSM-FDD (TDMA, GMSK)	X	24.45	99.1	27.6	9.39	141.4	$\pm 1.4\%$
		Y	29.93	99.5	29.0		124.5	
		Z	4.53	73.0	18.1		111.6	
10023- DAB	GPRS-FDD (TDMA, GMSK, TN 0)	X	25.10	99.7	27.9	9.57	134.2	$\pm 1.9\%$
		Y	24.85	96.1	28.0		120.2	
		Z	5.99	76.5	19.1		142.5	
10024- DAB	GPRS-FDD (TDMA, GMSK, TN 0-1)	X	24.34	93.0	23.0	6.56	117.1	$\pm 1.4\%$
		Y	26.49	92.6	24.2		148.7	
		Z	4.00	69.6	13.8		136.6	
10027- DAB	GPRS-FDD (TDMA, GMSK, TN 0-1-2)	X	51.24	99.9	23.5	4.80	131.1	$\pm 1.9\%$
		Y	56.83	99.5	24.3		101.8	
		Z	1.70	61.4	9.1		107.7	
10028- DAB	GPRS-FDD (TDMA, GMSK, TN 0-1-2-3)	X	60.12	99.6	22.2	3.55	138.7	$\pm 1.9\%$
		Y	64.73	99.9	23.4		105.5	
		Z	1.13	58.4	6.0		116.0	
10032- CAA	IEEE 802.15.1 Bluetooth (GFSK, DH5)	X	77.27	99.6	19.6	1.16	149.5	$\pm 2.5\%$
		Y	60.44	99.7	21.0		109.4	
		Z	0.34	55.9	2.9		131.4	
10039- CAB	CDMA2000 (1xRTT, RC1)	X	4.79	66.8	19.0	4.57	124.5	$\pm 0.9\%$
		Y	4.85	66.4	18.8		125.6	
		Z	4.06	63.4	16.1		108.1	

10081-CAB	CDMA2000 (1xRTT, RC3)	X	3.93	66.1	18.5	3.97	119.8	±0.7 %
		Y	3.90	65.5	18.2		120.1	
		Z	3.29	62.4	15.3		108.5	
10098-CAB	UMTS-FDD (HSUPA, Subtest 2)	X	4.68	66.9	18.7	3.98	131.2	±0.7 %
		Y	4.64	66.6	18.6		130.5	
		Z	4.15	64.5	16.5		118.8	
10100-CAB	LTE-FDD (SC-FDMA, 100% RB, 20 MHz, QPSK)	X	6.61	68.1	20.0	5.67	137.5	±1.7 %
		Y	6.70	68.4	20.2		137.7	
		Z	5.90	65.6	17.9		124.0	
10108-CAB	LTE-FDD (SC-FDMA, 100% RB, 10 MHz, QPSK)	X	6.44	67.5	19.8	5.80	135.1	±1.7 %
		Y	6.60	68.0	20.1		135.4	
		Z	5.75	64.9	17.6		121.8	
10110-CAB	LTE-FDD (SC-FDMA, 100% RB, 5 MHz, QPSK)	X	6.14	67.1	19.7	5.75	131.6	±1.2 %
		Y	6.28	67.4	19.9		132.7	
		Z	5.62	65.5	18.2		118.4	
10114-CAA	IEEE 802.11n (HT Greenfield, 13.5 Mbps, BPSK)	X	10.18	68.8	21.2	8.10	124.3	±1.9 %
		Y	10.60	69.7	21.8		126.2	
		Z	9.38	67.0	19.8		108.4	
10117-CAA	IEEE 802.11n (HT Mixed, 13.5 Mbps, BPSK)	X	10.23	68.9	21.3	8.07	125.0	±1.9 %
		Y	10.56	69.6	21.7		127.1	
		Z	9.37	67.1	19.8		109.1	
10151-CAB	LTE-TDD (SC-FDMA, 50% RB, 20 MHz, QPSK)	X	10.23	75.7	26.0	9.28	125.0	±2.7 %
		Y	14.60	83.3	29.5		147.3	
		Z	8.05	69.7	22.3		106.3	
10154-CAB	LTE-FDD (SC-FDMA, 50% RB, 10 MHz, QPSK)	X	6.12	67.0	19.6	5.75	131.6	±1.4 %
		Y	6.28	67.4	19.9		132.4	
		Z	5.49	64.7	17.4		117.9	
10160-CAB	LTE-FDD (SC-FDMA, 50% RB, 15 MHz, QPSK)	X	6.57	67.5	19.8	5.82	136.0	±1.4 %
		Y	6.71	67.9	20.1		137.1	
		Z	5.89	65.2	17.8		122.4	
10169-CAB	LTE-FDD (SC-FDMA, 1 RB, 20 MHz, QPSK)	X	4.82	66.0	19.3	5.73	113.5	±1.4 %
		Y	5.12	66.3	19.4		116.6	
		Z	4.75	65.9	18.3		142.7	
10172-CAB	LTE-TDD (SC-FDMA, 1 RB, 20 MHz, QPSK)	X	9.53	80.6	28.6	9.21	136.5	±2.2 %
		Y	11.32	81.6	28.8		109.2	
		Z	6.84	72.0	23.8		117.3	
10175-CAB	LTE-FDD (SC-FDMA, 1 RB, 10 MHz, QPSK)	X	4.86	66.2	19.4	5.72	112.9	±1.2 %
		Y	5.10	66.2	19.4		115.9	
		Z	4.55	64.9	17.8		137.7	
10181-CAB	LTE-FDD (SC-FDMA, 1 RB, 15 MHz, QPSK)	X	4.81	66.0	19.2	5.72	111.6	±1.2 %
		Y	5.13	66.4	19.5		116.1	
		Z	4.70	65.7	18.3		137.1	
10193-CAA	IEEE 802.11n (HT Greenfield, 6.5 Mbps, BPSK)	X	9.80	68.3	21.0	8.09	117.2	±2.2 %
		Y	10.23	69.1	21.6		121.5	
		Z	9.85	68.9	20.8		148.4	

10196-CAA	IEEE 802.11n (HT Mixed, 6.5 Mbps, BPSK)	X	9.81	68.4	21.1	8.10	117.7	±2.2 %
		Y	10.23	69.2	21.6		121.7	
		Z	9.87	69.0	20.9		149.9	
10219-CAA	IEEE 802.11n (HT Mixed, 7.2 Mbps, BPSK)	X	9.71	68.3	21.0	8.03	117.8	±2.2 %
		Y	10.12	69.1	21.6		121.0	
		Z	8.90	66.6	19.6		104.1	
10222-CAA	IEEE 802.11n (HT Mixed, 15 Mbps, BPSK)	X	10.14	68.7	21.2	8.06	122.3	±1.9 %
		Y	10.52	69.5	21.7		125.4	
		Z	9.28	66.8	19.6		108.5	
10225-CAB	UMTS-FDD (HSPA+)	X	7.25	67.8	19.9	5.97	146.3	±1.7 %
		Y	7.32	67.5	19.8		149.3	
		Z	6.52	65.7	18.0		130.7	
10237-CAB	LTE-TDD (SC-FDMA, 1 RB, 10 MHz, QPSK)	X	9.55	80.7	28.7	9.21	137.2	±2.5 %
		Y	11.34	81.7	28.9		109.9	
		Z	6.98	72.5	24.0		119.5	
10252-CAB	LTE-TDD (SC-FDMA, 50% RB, 10 MHz, QPSK)	X	9.26	74.1	25.3	9.24	115.6	±3.3 %
		Y	13.72	82.5	29.3		137.9	
		Z	8.83	73.3	24.4		144.1	
10267-CAB	LTE-TDD (SC-FDMA, 100% RB, 10 MHz, QPSK)	X	10.06	75.2	25.8	9.30	122.9	±2.7 %
		Y	14.69	83.4	29.6		147.6	
		Z	8.02	69.6	22.3		103.4	
10274-CAB	UMTS-FDD (HSUPA, Subtest 5, 3GPP Rel8.10)	X	6.08	67.2	19.0	4.87	140.2	±1.2 %
		Y	6.23	67.5	19.2		143.5	
		Z	5.52	65.4	17.4		125.1	
10275-CAB	UMTS-FDD (HSUPA, Subtest 5, 3GPP Rel8.4)	X	4.44	66.7	18.7	3.96	122.1	±0.7 %
		Y	4.39	66.3	18.5		124.4	
		Z	3.83	63.7	16.0		114.0	
10291-AAB	CDMA2000, RC3, SO55, Full Rate	X	3.64	66.7	18.6	3.46	115.7	±0.7 %
		Y	3.60	66.0	18.2		118.0	
		Z	3.17	64.2	16.3		108.4	
10292-AAB	CDMA2000, RC3, SO32, Full Rate	X	3.62	67.0	18.8	3.39	116.9	±0.9 %
		Y	3.54	66.1	18.2		119.1	
		Z	3.24	64.2	15.8		145.6	
10297-AAA	LTE-FDD (SC-FDMA, 50% RB, 20 MHz, QPSK)	X	6.43	67.5	19.8	5.81	132.0	±1.4 %
		Y	6.60	68.0	20.1		134.9	
		Z	5.81	65.4	18.0		115.0	
10311-AAA	LTE-FDD (SC-FDMA, 100% RB, 15 MHz, QPSK)	X	7.04	68.1	20.2	6.06	137.5	±1.4 %
		Y	7.19	68.6	20.5		140.3	
		Z	6.26	65.7	18.2		119.6	
10315-AAA	IEEE 802.11b WiFi 2.4 GHz (DSSS, 1 Mbps, 96pc duty cycle)	X	3.05	70.0	19.4	1.71	121.7	±0.7 %
		Y	2.91	68.7	18.7		123.4	
		Z	1.83	60.2	12.3		108.4	
10316-AAA	IEEE 802.11g WiFi 2.4 GHz (ERP-OFDM, 6 Mbps, 96pc duty cycle)	X	10.05	68.7	21.4	8.36	117.3	±1.9 %
		Y	10.57	69.7	22.0		122.8	
		Z	9.11	66.5	19.7		103.1	

10403-AAB	CDMA2000 (1xEV-DO, Rev. 0)	X	4.81	68.3	18.8	3.76	125.8	±0.7 %
		Y	4.65	66.5	18.1		130.8	
		Z	3.98	64.7	16.0		114.7	
10404-AAB	CDMA2000 (1xEV-DO, Rev. A)	X	4.91	69.1	19.2	3.77	123.3	±0.7 %
		Y	4.60	66.6	18.1		128.5	
		Z	3.73	64.0	15.4		112.0	
10415-AAA	IEEE 802.11b WiFi 2.4 GHz (DSSS, 1 Mbps, 99pc duty cycle)	X	2.78	69.0	19.0	1.54	121.9	±0.7 %
		Y	2.46	66.8	17.9		122.5	
		Z	1.83	60.9	13.0		112.4	
10416-AAA	IEEE 802.11g WiFi 2.4 GHz (ERP-OFDM, 6 Mbps, 99pc duty cycle)	X	9.88	68.4	21.2	8.23	116.6	±1.7 %
		Y	10.29	69.2	21.7		121.5	
		Z	9.25	67.3	20.2		103.4	

The reported uncertainty of measurement is stated as the standard uncertainty of measurement multiplied by the coverage factor $k=2$, which for a normal distribution corresponds to a coverage probability of approximately 95%.

^A The uncertainties of NormX,Y,Z do not affect the E^2 -field uncertainty inside TSL (see Pages 8 and 9).

^B Numerical linearization parameter: uncertainty not required.

^E Uncertainty is determined using the max. deviation from linear response applying rectangular distribution and is expressed for the square of the field value.

DASY/EASY - Parameters of Probe: ES3DV3 - SN:3263

Calibration Parameter Determined in Head Tissue Simulating Media

f (MHz) ^C	Relative Permittivity ^F	Conductivity (S/m) ^F	ConvF X	ConvF Y	ConvF Z	Alpha ^G	Depth ^G (mm)	Unct. (k=2)
750	41.9	0.89	6.42	6.42	6.42	0.72	1.18	± 12.0 %
835	41.5	0.90	6.23	6.23	6.23	0.27	2.02	± 12.0 %
1750	40.1	1.37	5.41	5.41	5.41	0.74	1.23	± 12.0 %
1900	40.0	1.40	5.08	5.08	5.08	0.80	1.16	± 12.0 %
2450	39.2	1.80	4.47	4.47	4.47	0.80	1.22	± 12.0 %
2600	39.0	1.96	4.33	4.33	4.33	0.66	1.41	± 12.0 %

^C Frequency validity of ± 100 MHz only applies for DASY v4.4 and higher (see Page 2), else it is restricted to ± 50 MHz. The uncertainty is the RSS of the ConvF uncertainty at calibration frequency and the uncertainty for the indicated frequency band.

^F At frequencies below 3 GHz, the validity of tissue parameters (ϵ and σ) can be relaxed to ± 10% if liquid compensation formula is applied to measured SAR values. At frequencies above 3 GHz, the validity of tissue parameters (ϵ and σ) is restricted to ± 5%. The uncertainty is the RSS of the ConvF uncertainty for indicated target tissue parameters.

^G Alpha/Depth are determined during calibration. SPEAG warrants that the remaining deviation due to the boundary effect after compensation is always less than ± 1% for frequencies below 3 GHz and below ± 2% for frequencies between 3-6 GHz at any distance larger than half the probe tip diameter from the boundary.

DASY/EASY - Parameters of Probe: ES3DV3 - SN:3263

Calibration Parameter Determined in Body Tissue Simulating Media

f (MHz) ^C	Relative Permittivity ^F	Conductivity (S/m) ^F	ConvF X	ConvF Y	ConvF Z	Alpha ^G	Depth (mm) ^G	Unct. (k=2)
750	55.5	0.96	6.19	6.19	6.19	0.52	1.41	± 12.0 %
835	55.2	0.97	6.16	6.16	6.16	0.68	1.28	± 12.0 %
1750	53.4	1.49	4.98	4.98	4.98	0.38	1.91	± 12.0 %
1900	53.3	1.52	4.78	4.78	4.78	0.66	1.35	± 12.0 %
2450	52.7	1.95	4.27	4.27	4.27	0.72	1.13	± 12.0 %
2600	52.5	2.16	4.11	4.11	4.11	0.74	1.07	± 12.0 %

^C Frequency validity of ± 100 MHz only applies for DASY v4.4 and higher (see Page 2), else it is restricted to ± 50 MHz. The uncertainty is the RSS of the ConvF uncertainty at calibration frequency and the uncertainty for the indicated frequency band.

^F At frequencies below 3 GHz, the validity of tissue parameters (ϵ and σ) can be relaxed to ± 10% if liquid compensation formula is applied to measured SAR values. At frequencies above 3 GHz, the validity of tissue parameters (ϵ and σ) is restricted to ± 5%. The uncertainty is the RSS of the ConvF uncertainty for indicated target tissue parameters.

^G Alpha/Depth are determined during calibration. SPEAG warrants that the remaining deviation due to the boundary effect after compensation is always less than ± 1% for frequencies below 3 GHz and below ± 2% for frequencies between 3-6 GHz at any distance larger than half the probe tip diameter from the boundary.

Frequency Response of E-Field (TEM-Cell:ifi110 EXX, Waveguide: R22)

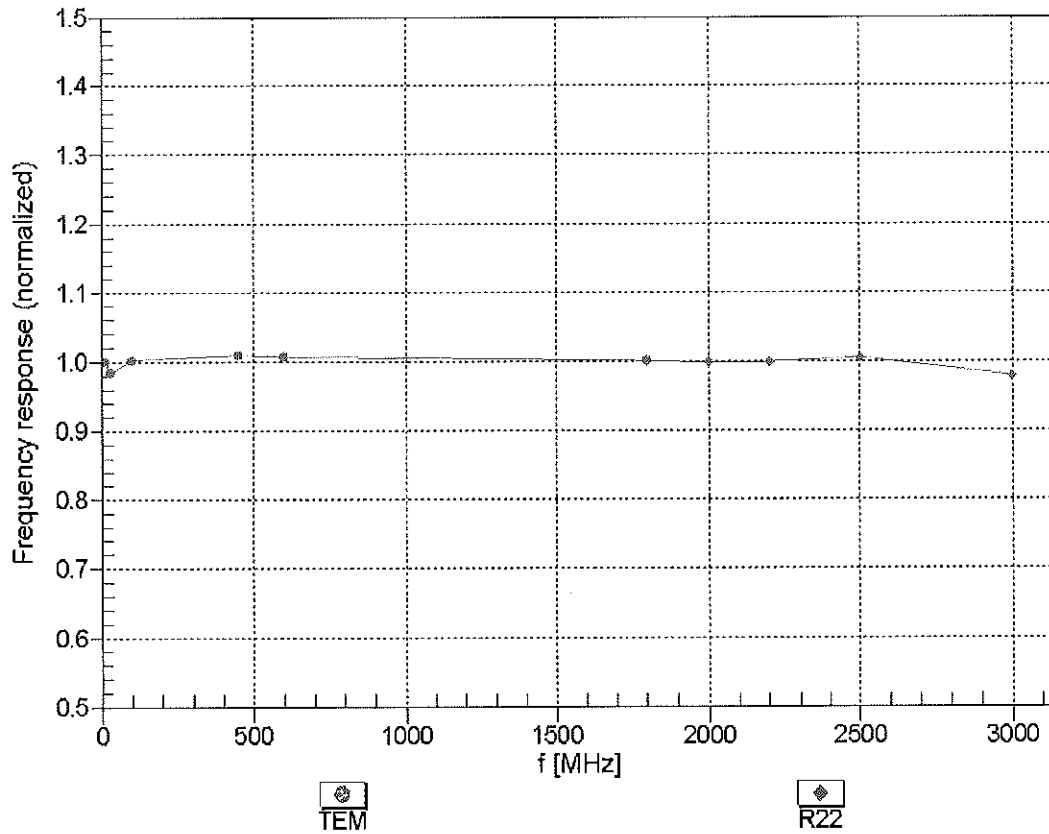

Uncertainty of Frequency Response of E-field: $\pm 6.3\%$ (k=2)

Receiving Pattern (ϕ), $\theta = 0^\circ$

f=600 MHz,TEM

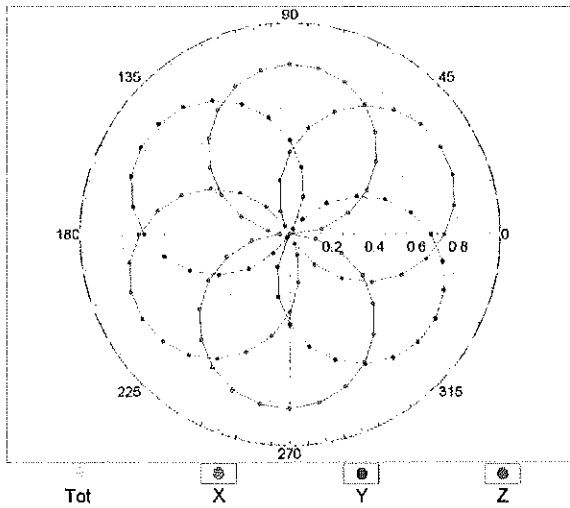

f=1800 MHz,R22

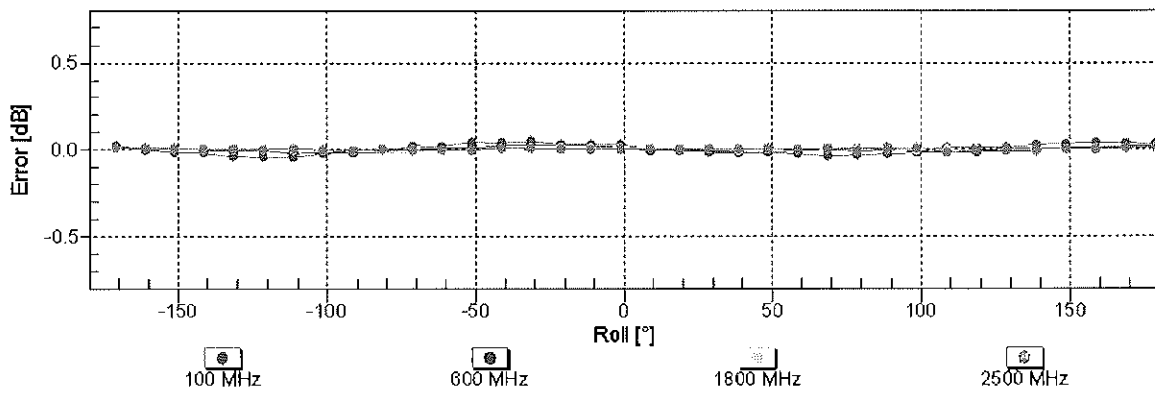
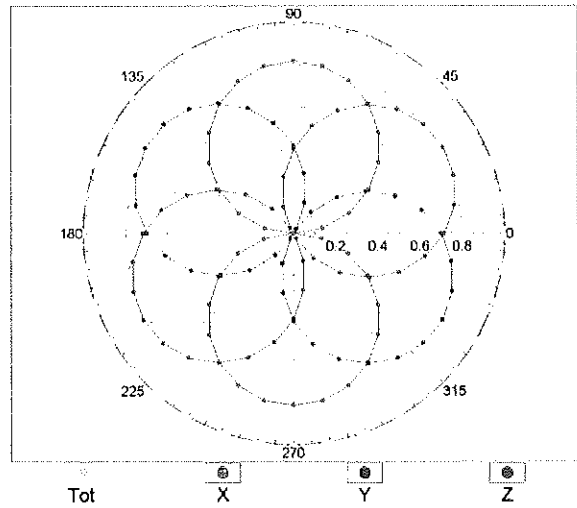

Uncertainty of Axial Isotropy Assessment: $\pm 0.5\%$ (k=2)

Dynamic Range $f(\text{SAR}_{\text{head}})$ (TEM cell , $f_{\text{eval}}=1900 \text{ MHz}$)

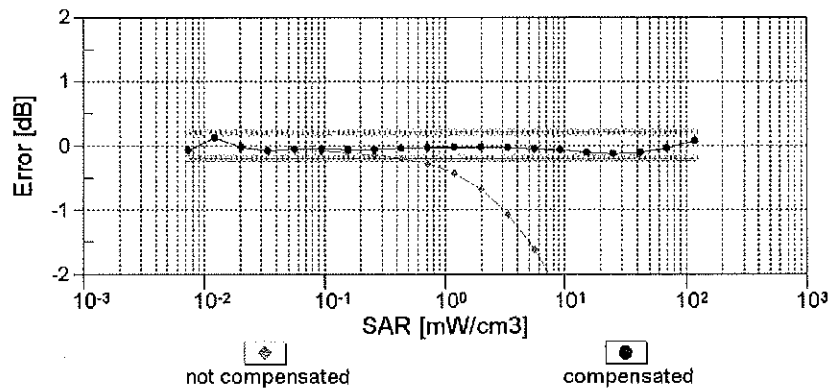
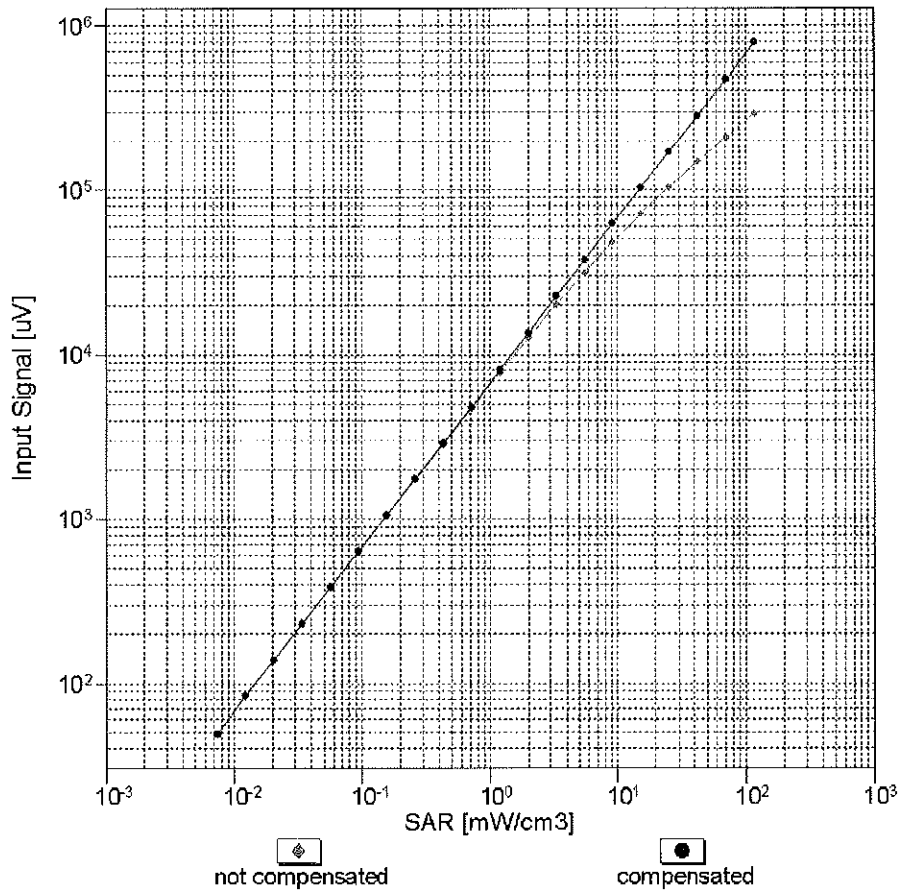

Uncertainty of Linearity Assessment: $\pm 0.6\%$ ($k=2$)

Conversion Factor Assessment

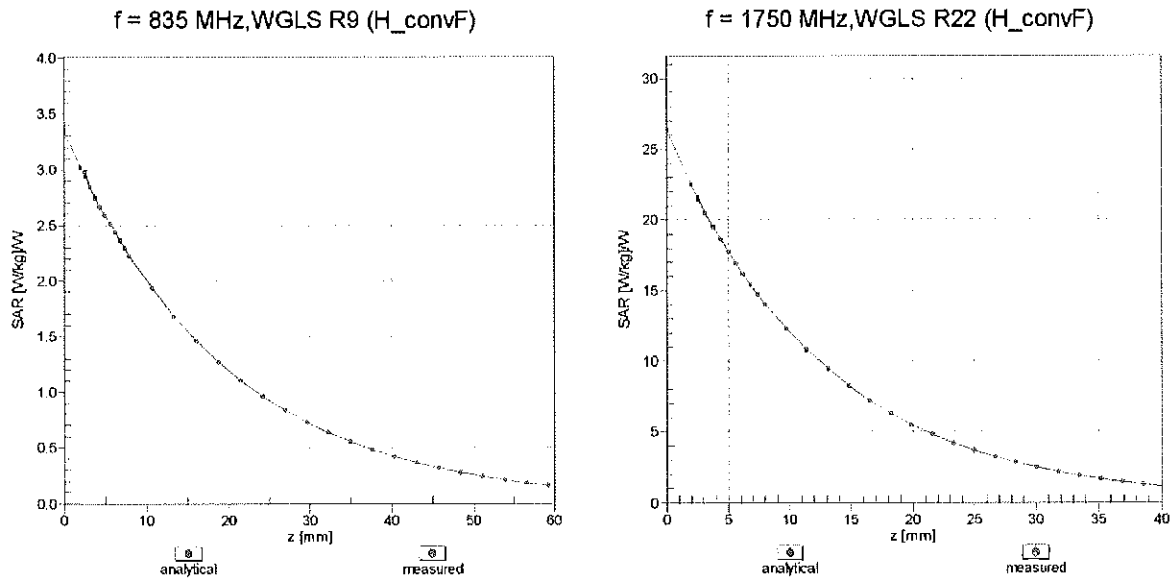

Deviation from Isotropy in Liquid Error (ϕ, ϑ), f = 900 MHz

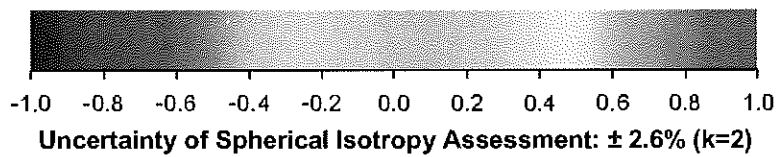
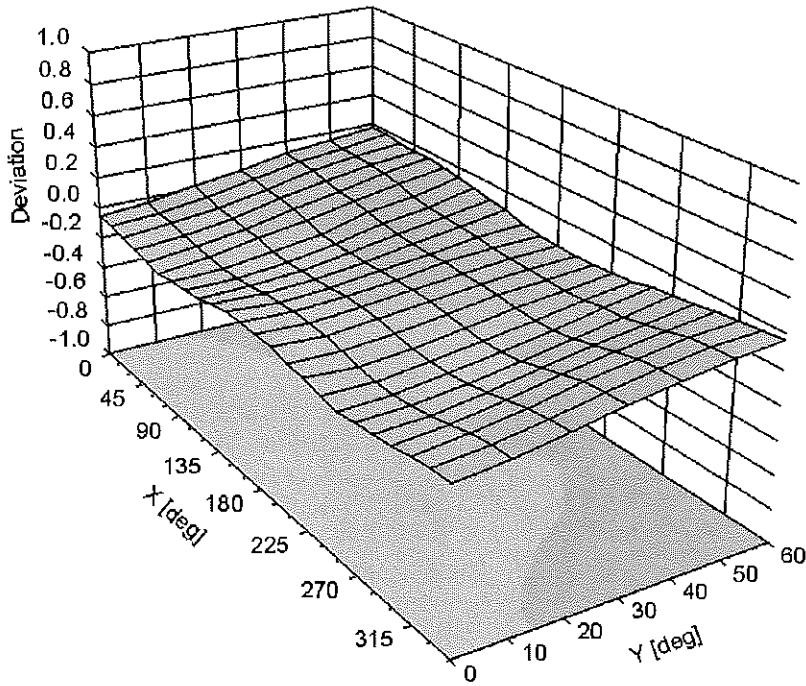

DASY/EASY - Parameters of Probe: ES3DV3 - SN:3263

Other Probe Parameters

Sensor Arrangement	Triangular
Connector Angle (°)	-111.2
Mechanical Surface Detection Mode	enabled
Optical Surface Detection Mode	disabled
Probe Overall Length	337 mm
Probe Body Diameter	10 mm
Tip Length	10 mm
Tip Diameter	4 mm
Probe Tip to Sensor X Calibration Point	2 mm
Probe Tip to Sensor Y Calibration Point	2 mm
Probe Tip to Sensor Z Calibration Point	2 mm
Recommended Measurement Distance from Surface	3 mm



Accredited by the Swiss Accreditation Service (SAS)
The Swiss Accreditation Service is one of the signatories to the EA
Multilateral Agreement for the recognition of calibration certificates

Accreditation No.: **SCS 108**

Client **PC Test**

Certificate No: **ES3-3288_Sep13/2**

CALIBRATION CERTIFICATE (Replacement of No: ES3-3288_Sep13)

Object **ES3DV3 - SN:3288** CCV
10/4/13

Calibration procedure(s) **QA CAL-01.v9, QA CAL-23.v5, QA CAL-25.v6
Calibration procedure for dosimetric E-field probes**

Calibration date: **September 23, 2013**

This calibration certificate documents the traceability to national standards, which realize the physical units of measurements (SI).
The measurements and the uncertainties with confidence probability are given on the following pages and are part of the certificate.

All calibrations have been conducted in the closed laboratory facility: environment temperature (22 ± 3)°C and humidity < 70%.

Calibration Equipment used (M&TE critical for calibration)

Primary Standards	ID	Cal Date (Certificate No.)	Scheduled Calibration
Power meter E4419B	GB41293874	04-Apr-13 (No. 217-01733)	Apr-14
Power sensor E4412A	MY41498087	04-Apr-13 (No. 217-01733)	Apr-14
Reference 3 dB Attenuator	SN: S5054 (3c)	04-Apr-13 (No. 217-01737)	Apr-14
Reference 20 dB Attenuator	SN: S5277 (20x)	04-Apr-13 (No. 217-01735)	Apr-14
Reference 30 dB Attenuator	SN: S5129 (30b)	04-Apr-13 (No. 217-01738)	Apr-14
Reference Probe ES3DV2	SN: 3013	28-Dec-12 (No. ES3-3013_Dec12)	Dec-13
DAE4	SN: 660	4-Sep-13 (No. DAE4-660_Sep13)	Apr-14
Secondary Standards	ID	Check Date (in house)	Scheduled Check
RF generator HP 8648C	US3642U01700	4-Aug-99 (in house check Apr-13)	In house check: Apr-15
Network Analyzer HP 8753E	US37390585	18-Oct-01 (in house check Oct-12)	In house check: Oct-13

Calibrated by:	Name Jeton Kastrati	Function Laboratory Technician	Signature
Approved by:	Name Katja Pokovic	Function Technical Manager	

Issued: October 4, 2013

This calibration certificate shall not be reproduced except in full without written approval of the laboratory.

PCT# 80828

Probe ES3DV3

SN:3288

Manufactured: July 6, 2010
Calibrated: September 23, 2013

Calibrated for DASY/EASY Systems
(Note: non-compatible with DASY2 system!)



Accredited by the Swiss Accreditation Service (SAS)

Accreditation No.: **SCS 108**

The Swiss Accreditation Service is one of the signatories to the EA
Multilateral Agreement for the recognition of calibration certificates

Glossary:

TSL	tissue simulating liquid
NORM _{x,y,z}	sensitivity in free space
ConvF	sensitivity in TSL / NORM _{x,y,z}
DCP	diode compression point
CF	crest factor (1/duty_cycle) of the RF signal
A, B, C, D	modulation dependent linearization parameters
Polarization φ	φ rotation around probe axis
Polarization ϑ	ϑ rotation around an axis that is in the plane normal to probe axis (at measurement center), i.e., $\vartheta = 0$ is normal to probe axis

Calibration is Performed According to the Following Standards:

- IEEE Std 1528-2013, "IEEE Recommended Practice for Determining the Peak Spatial-Averaged Specific Absorption Rate (SAR) in the Human Head from Wireless Communications Devices: Measurement Techniques", June 2013
- IEC 62209-1, "Procedure to measure the Specific Absorption Rate (SAR) for hand-held devices used in close proximity to the ear (frequency range of 300 MHz to 3 GHz)", February 2005

Methods Applied and Interpretation of Parameters:

- NORM_{x,y,z}**: Assessed for E-field polarization $\vartheta = 0$ ($f \leq 900$ MHz in TEM-cell; $f > 1800$ MHz: R22 waveguide). NORM_{x,y,z} are only intermediate values, i.e., the uncertainties of NORM_{x,y,z} does not affect the E²-field uncertainty inside TSL (see below ConvF).
- NORM(f)_{x,y,z}** = NORM_{x,y,z} * frequency_response (see Frequency Response Chart). This linearization is implemented in DASY4 software versions later than 4.2. The uncertainty of the frequency response is included in the stated uncertainty of ConvF.
- DCP_{x,y,z}**: DCP are numerical linearization parameters assessed based on the data of power sweep with CW signal (no uncertainty required). DCP does not depend on frequency nor media.
- PAR**: PAR is the Peak to Average Ratio that is not calibrated but determined based on the signal characteristics
- A_{x,y,z}; B_{x,y,z}; C_{x,y,z}; D_{x,y,z}; VR_{x,y,z}**: A, B, C, D are numerical linearization parameters assessed based on the data of power sweep for specific modulation signal. The parameters do not depend on frequency nor media. VR is the maximum calibration range expressed in RMS voltage across the diode.
- ConvF and Boundary Effect Parameters**: Assessed in flat phantom using E-field (or Temperature Transfer Standard for $f \leq 800$ MHz) and inside waveguide using analytical field distributions based on power measurements for $f > 800$ MHz. The same setups are used for assessment of the parameters applied for boundary compensation (alpha, depth) of which typical uncertainty values are given. These parameters are used in DASY4 software to improve probe accuracy close to the boundary. The sensitivity in TSL corresponds to NORM_{x,y,z} * ConvF whereby the uncertainty corresponds to that given for ConvF. A frequency dependent ConvF is used in DASY version 4.4 and higher which allows extending the validity from ± 50 MHz to ± 100 MHz.
- Spherical isotropy (3D deviation from isotropy)**: in a field of low gradients realized using a flat phantom exposed by a patch antenna.
- Sensor Offset**: The sensor offset corresponds to the offset of virtual measurement center from the probe tip (on probe axis). No tolerance required.

DASY/EASY - Parameters of Probe: ES3DV3 - SN:3288

Basic Calibration Parameters

	Sensor X	Sensor Y	Sensor Z	Unc (k=2)
Norm ($\mu V/(V/m)^2$) ^A	0.87	0.97	0.75	± 10.1 %
DCP (mV) ^B	103.3	103.2	100.2	

Modulation Calibration Parameters

UID	Communication System Name		A dB	B dB $\sqrt{\mu V}$	C	D dB	VR mV	Unc ^E (k=2)
0	CW	X	0.0	0.0	1.0	0.00	171.1	±3.5 %
		Y	0.0	0.0	1.0		135.0	
		Z	0.0	0.0	1.0		154.3	

The reported uncertainty of measurement is stated as the standard uncertainty of measurement multiplied by the coverage factor k=2, which for a normal distribution corresponds to a coverage probability of approximately 95%.

^A The uncertainties of NormX,Y,Z do not affect the E²-field uncertainty inside TSL (see Pages 5 and 6).

^B Numerical linearization parameter: uncertainty not required.

^E Uncertainty is determined using the max. deviation from linear response applying rectangular distribution and is expressed for the square of the field value.

DASY/EASY - Parameters of Probe: ES3DV3 - SN:3288

Calibration Parameter Determined in Head Tissue Simulating Media

f (MHz) ^C	Relative Permittivity ^F	Conductivity (S/m) ^F	ConvF X	ConvF Y	ConvF Z	Alpha	Depth (mm)	Unct. (k=2)
750	41.9	0.89	6.56	6.56	6.56	0.32	1.89	± 12.0 %
835	41.5	0.90	6.37	6.37	6.37	0.34	1.82	± 12.0 %
1750	40.1	1.37	5.67	5.67	5.67	0.56	1.51	± 12.0 %
1900	40.0	1.40	5.47	5.47	5.47	0.80	1.29	± 12.0 %
2450	39.2	1.80	4.63	4.63	4.63	0.80	1.34	± 12.0 %
2600	39.0	1.96	4.55	4.55	4.55	0.80	1.41	± 12.0 %

^C Frequency validity of ± 100 MHz only applies for DASY v4.4 and higher (see Page 2), else it is restricted to ± 50 MHz. The uncertainty is the RSS of the ConvF uncertainty at calibration frequency and the uncertainty for the indicated frequency band.

^F At frequencies below 3 GHz, the validity of tissue parameters (ϵ and σ) can be relaxed to ± 10% if liquid compensation formula is applied to measured SAR values. At frequencies above 3 GHz, the validity of tissue parameters (ϵ and σ) is restricted to ± 5%. The uncertainty is the RSS of the ConvF uncertainty for indicated target tissue parameters.

DASY/EASY - Parameters of Probe: ES3DV3 - SN:3288

Calibration Parameter Determined in Body Tissue Simulating Media

f (MHz) ^C	Relative Permittivity ^F	Conductivity (S/m) ^F	ConvF X	ConvF Y	ConvF Z	Alpha	Depth (mm)	Unct. (k=2)
750	55.5	0.96	6.25	6.25	6.25	0.70	1.27	± 12.0 %
835	55.2	0.97	6.27	6.27	6.27	0.75	1.22	± 12.0 %
1750	53.4	1.49	5.10	5.10	5.10	0.59	1.46	± 12.0 %
1900	53.3	1.52	4.82	4.82	4.82	0.53	1.54	± 12.0 %
2450	52.7	1.95	4.37	4.37	4.37	0.80	1.02	± 12.0 %
2600	52.5	2.16	4.14	4.14	4.14	0.64	0.94	± 12.0 %

^C Frequency validity of ± 100 MHz only applies for DASY v4.4 and higher (see Page 2), else it is restricted to ± 50 MHz. The uncertainty is the RSS of the ConvF uncertainty at calibration frequency and the uncertainty for the indicated frequency band.

^F At frequencies below 3 GHz, the validity of tissue parameters (ϵ and σ) can be relaxed to ± 10% if liquid compensation formula is applied to measured SAR values. At frequencies above 3 GHz, the validity of tissue parameters (ϵ and σ) is restricted to ± 5%. The uncertainty is the RSS of the ConvF uncertainty for indicated target tissue parameters.

Frequency Response of E-Field (TEM-Cell:ifi110 EXX, Waveguide: R22)

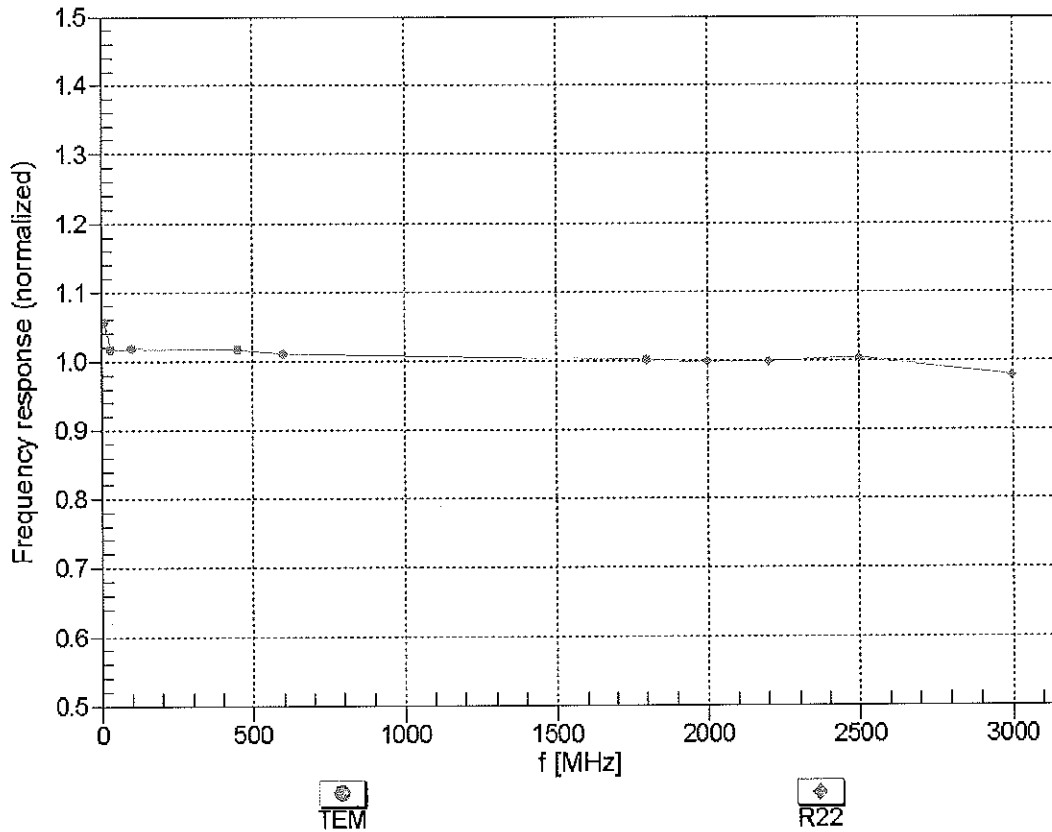

Uncertainty of Frequency Response of E-field: $\pm 6.3\%$ (k=2)

Receiving Pattern (ϕ), $\vartheta = 0^\circ$

f=600 MHz,TEM

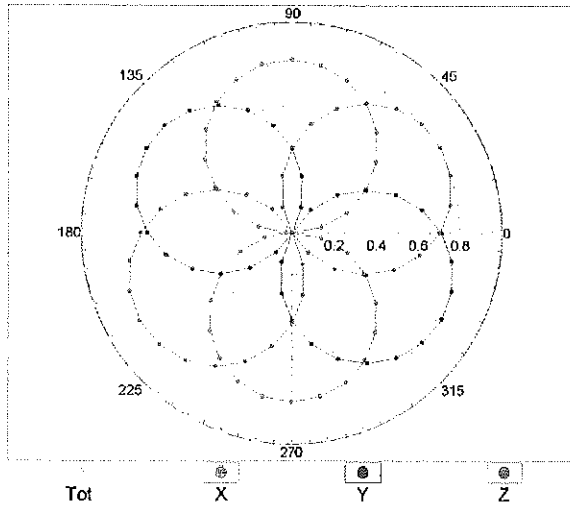

f=1800 MHz,R22

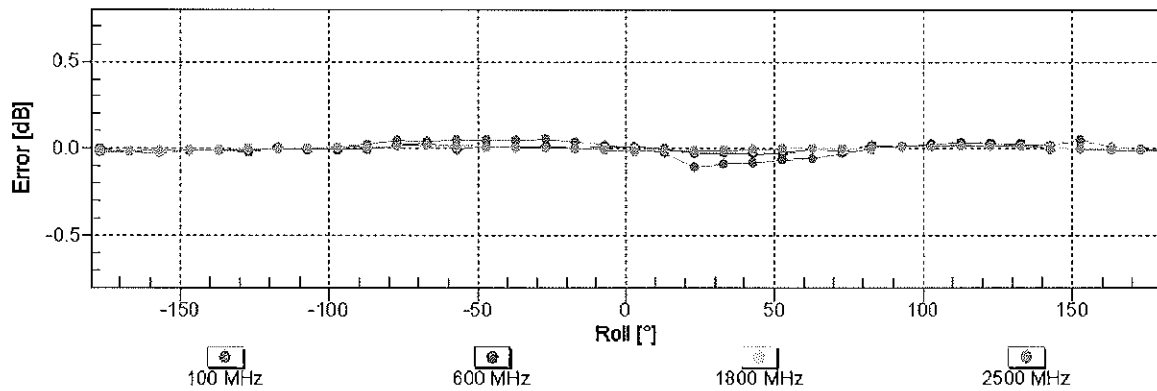
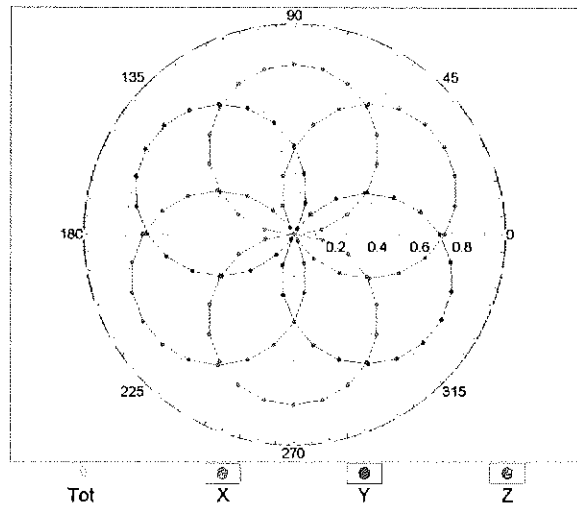

Uncertainty of Axial Isotropy Assessment: $\pm 0.5\%$ (k=2)

Dynamic Range $f(\text{SAR}_{\text{head}})$ (TEM cell , $f = 900 \text{ MHz}$)

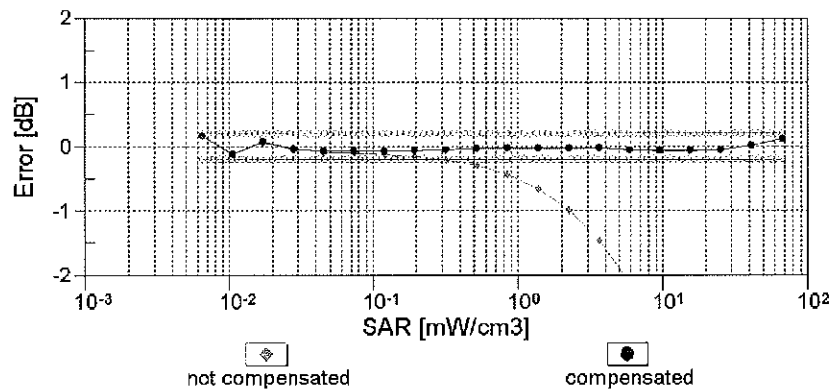
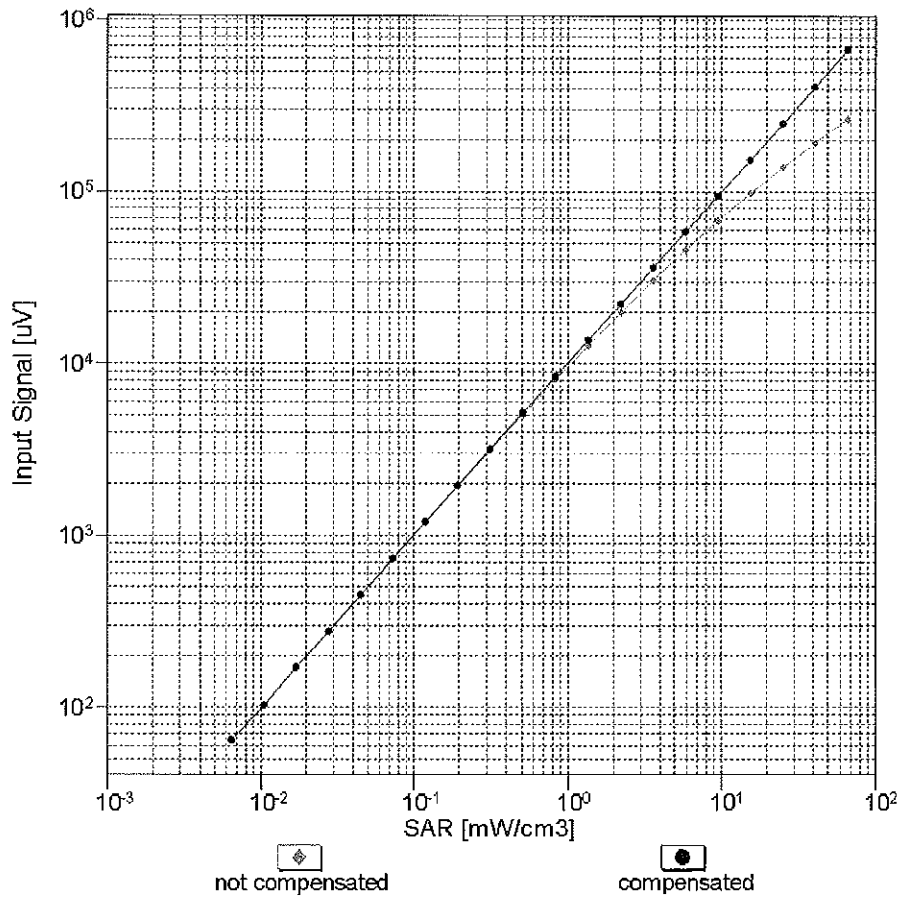

Uncertainty of Linearity Assessment: $\pm 0.6\%$ ($k=2$)

Conversion Factor Assessment

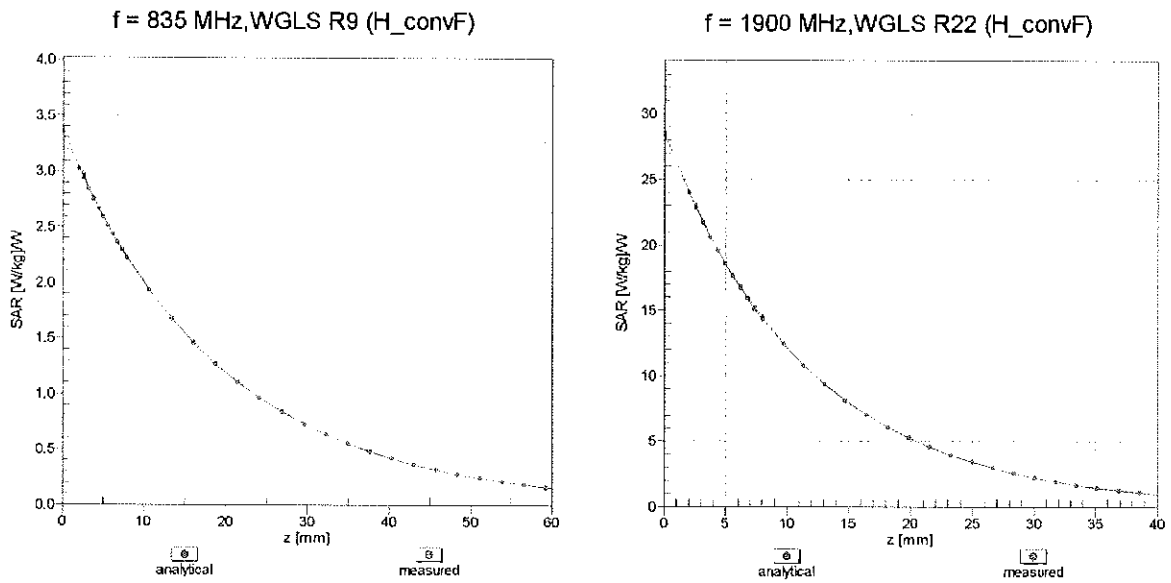

Deviation from Isotropy in Liquid Error (ϕ, θ), f = 900 MHz

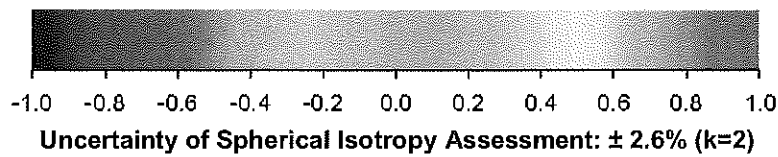
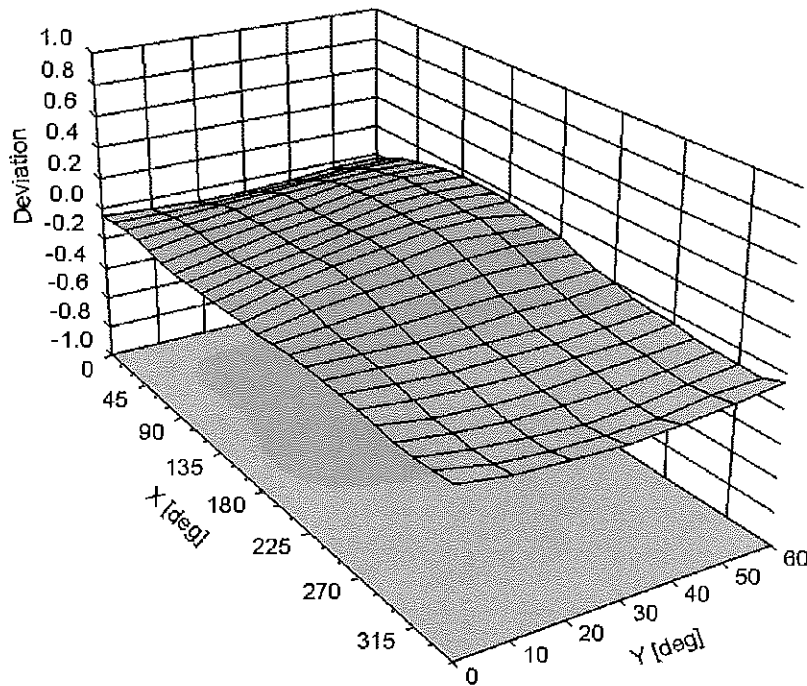

DASY/EASY - Parameters of Probe: ES3DV3 - SN:3288

Other Probe Parameters

Sensor Arrangement	Triangular
Connector Angle (°)	-127.1
Mechanical Surface Detection Mode	enabled
Optical Surface Detection Mode	disabled
Probe Overall Length	337 mm
Probe Body Diameter	10 mm
Tip Length	10 mm
Tip Diameter	4 mm
Probe Tip to Sensor X Calibration Point	2 mm
Probe Tip to Sensor Y Calibration Point	2 mm
Probe Tip to Sensor Z Calibration Point	2 mm
Recommended Measurement Distance from Surface	3 mm



Accredited by the Swiss Accreditation Service (SAS)
The Swiss Accreditation Service is one of the signatories to the EA
Multilateral Agreement for the recognition of calibration certificates

Accreditation No.: **SCS 108**

Client **PC Test**

Certificate No: **ES3-3319_Apr14**

CALIBRATION CERTIFICATE

Object **ES3DV3 - SN:3319**

Calibration procedure(s) **QA CAL-01.v9, QA CAL-23.v5, QA CAL-25.v6
Calibration procedure for dosimetric E-field probes**

Calibration date: **April 17, 2014**

*CCV
5/7/14*

This calibration certificate documents the traceability to national standards, which realize the physical units of measurements (SI).
The measurements and the uncertainties with confidence probability are given on the following pages and are part of the certificate.

All calibrations have been conducted in the closed laboratory facility: environment temperature (22 ± 3)°C and humidity < 70%.

Calibration Equipment used (M&TE critical for calibration)

Primary Standards	ID	Cal Date (Certificate No.)	Scheduled Calibration
Power meter E4419B	GB41293874	03-Apr-14 (No. 217-01911)	Apr-15
Power sensor E4412A	MY41498087	03-Apr-14 (No. 217-01911)	Apr-15
Reference 3 dB Attenuator	SN: S5054 (3c)	03-Apr-14 (No. 217-01915)	Apr-15
Reference 20 dB Attenuator	SN: S5277 (20x)	03-Apr-14 (No. 217-01919)	Apr-15
Reference 30 dB Attenuator	SN: S5129 (30b)	03-Apr-14 (No. 217-01920)	Apr-15
Reference Probe ES3DV2	SN: 3013	30-Dec-13 (No. ES3-3013_Dec13)	Dec-14
DAE4	SN: 660	13-Dec-13 (No. DAE4-660_Dec13)	Dec-14
Secondary Standards	ID	Check Date (in house)	Scheduled Check
RF generator HP 8648C	US3642U01700	4-Aug-99 (in house check Apr-13)	In house check: Apr-16
Network Analyzer HP 8753E	US37390585	18-Oct-01 (in house check Oct-13)	In house check: Oct-14

Calibrated by:	Name Claudio Leubler	Function Laboratory Technician	Signature
Approved by:	Name Katja Pokovic	Function Technical Manager	

Issued: April 21, 2014

This calibration certificate shall not be reproduced except in full without written approval of the laboratory.



Accredited by the Swiss Accreditation Service (SAS)
The Swiss Accreditation Service is one of the signatories to the EA
Multilateral Agreement for the recognition of calibration certificates

Accreditation No.: **SCS 108**

Glossary:

TSL	tissue simulating liquid
NORM _{x,y,z}	sensitivity in free space
ConvF	sensitivity in TSL / NORM _{x,y,z}
DCP	diode compression point
CF	crest factor (1/duty_cycle) of the RF signal
A, B, C, D	modulation dependent linearization parameters
Polarization φ	φ rotation around probe axis
Polarization ϑ	ϑ rotation around an axis that is in the plane normal to probe axis (at measurement center), i.e., ϑ = 0 is normal to probe axis
Connector Angle	information used in DASY system to align probe sensor X to the robot coordinate system

Calibration is Performed According to the Following Standards:

- IEEE Std 1528-2013, "IEEE Recommended Practice for Determining the Peak Spatial-Averaged Specific Absorption Rate (SAR) in the Human Head from Wireless Communications Devices: Measurement Techniques", June 2013
- IEC 62209-1, "Procedure to measure the Specific Absorption Rate (SAR) for hand-held devices used in close proximity to the ear (frequency range of 300 MHz to 3 GHz)", February 2005

Methods Applied and Interpretation of Parameters:

- NORM_{x,y,z}**: Assessed for E-field polarization ϑ = 0 (f ≤ 900 MHz in TEM-cell; f > 1800 MHz: R22 waveguide). NORM_{x,y,z} are only intermediate values, i.e., the uncertainties of NORM_{x,y,z} does not affect the E²-field uncertainty inside TSL (see below ConvF).
- NORM(f)_{x,y,z} = NORM_{x,y,z} * frequency_response** (see Frequency Response Chart). This linearization is implemented in DASY4 software versions later than 4.2. The uncertainty of the frequency response is included in the stated uncertainty of ConvF.
- DCP_{x,y,z}**: DCP are numerical linearization parameters assessed based on the data of power sweep with CW signal (no uncertainty required). DCP does not depend on frequency nor media.
- PAR**: PAR is the Peak to Average Ratio that is not calibrated but determined based on the signal characteristics
- A_{x,y,z}; B_{x,y,z}; C_{x,y,z}; D_{x,y,z}; VR_{x,y,z}; A, B, C, D** are numerical linearization parameters assessed based on the data of power sweep for specific modulation signal. The parameters do not depend on frequency nor media. VR is the maximum calibration range expressed in RMS voltage across the diode.
- ConvF and Boundary Effect Parameters**: Assessed in flat phantom using E-field (or Temperature Transfer Standard for f ≤ 800 MHz) and inside waveguide using analytical field distributions based on power measurements for f > 800 MHz. The same setups are used for assessment of the parameters applied for boundary compensation (alpha, depth) of which typical uncertainty values are given. These parameters are used in DASY4 software to improve probe accuracy close to the boundary. The sensitivity in TSL corresponds to NORM_{x,y,z} * ConvF whereby the uncertainty corresponds to that given for ConvF. A frequency dependent ConvF is used in DASY version 4.4 and higher which allows extending the validity from ± 50 MHz to ± 100 MHz.
- Spherical isotropy (3D deviation from isotropy)**: in a field of low gradients realized using a flat phantom exposed by a patch antenna.
- Sensor Offset**: The sensor offset corresponds to the offset of virtual measurement center from the probe tip (on probe axis). No tolerance required.
- Connector Angle**: The angle is assessed using the information gained by determining the NORM_x (no uncertainty required).

Probe ES3DV3

SN:3319

Manufactured:	January 10, 2012
Repaired:	April 11, 2014
Calibrated:	April 17, 2014

Calibrated for DASY/EASY Systems
(Note: non-compatible with DASY2 system!)

DASY/EASY - Parameters of Probe: ES3DV3 - SN:3319

Basic Calibration Parameters

	Sensor X	Sensor Y	Sensor Z	Unc (k=2)
Norm ($\mu\text{V}/(\text{V}/\text{m})^2$) ^A	1.11	1.08	1.15	$\pm 10.1\%$
DCP (mV) ^B	102.6	104.2	103.7	

Modulation Calibration Parameters

UID	Communication System Name		A dB	B dB $\sqrt{\mu\text{V}}$	C	D dB	VR mV	Unc ^E (k=2)
0	CW	X	0.0	0.0	1.0	0.00	199.6	$\pm 3.5\%$
		Y	0.0	0.0	1.0		188.8	
		Z	0.0	0.0	1.0		178.5	
10010- CAA	SAR Validation (Square, 100ms, 10ms)	X	3.31	63.3	12.9	10.00	42.6	$\pm 2.2\%$
		Y	5.10	68.0	14.1		38.8	
		Z	2.84	61.7	12.1		44.3	
10011- CAB	UMTS-FDD (WCDMA)	X	3.30	66.9	18.4	2.91	136.7	$\pm 0.5\%$
		Y	3.32	67.1	18.4		127.0	
		Z	3.45	68.0	19.1		145.1	
10012- CAA	IEEE 802.11b WiFi 2.4 GHz (DSSS, 1 Mbps)	X	3.12	69.3	19.0	1.87	138.7	$\pm 0.7\%$
		Y	3.22	70.2	19.3		127.0	
		Z	3.40	71.3	19.9		146.4	
10021- DAB	GSM-FDD (TDMA, GMSK)	X	25.66	99.7	28.3	9.39	139.0	$\pm 1.4\%$
		Y	16.30	92.5	25.7		141.7	
		Z	25.20	99.5	28.1		144.9	
10023- DAB	GPRS-FDD (TDMA, GMSK, TN 0)	X	25.81	100.0	28.5	9.57	128.3	$\pm 2.2\%$
		Y	13.99	89.5	24.6		129.0	
		Z	25.39	99.7	28.3		141.2	
10024- DAB	GPRS-FDD (TDMA, GMSK, TN 0-1)	X	37.04	99.8	25.7	6.56	131.4	$\pm 2.2\%$
		Y	37.62	99.7	25.0		139.6	
		Z	38.36	99.8	25.3		145.5	
10027- DAB	GPRS-FDD (TDMA, GMSK, TN 0-1-2)	X	48.04	99.6	23.8	4.80	144.6	$\pm 1.9\%$
		Y	29.62	94.2	22.1		129.3	
		Z	43.87	99.7	24.0		129.9	
10028- DAB	GPRS-FDD (TDMA, GMSK, TN 0-1-2-3)	X	54.95	99.9	22.9	3.55	149.6	$\pm 1.7\%$
		Y	57.76	99.6	22.2		138.2	
		Z	54.27	99.8	22.7		137.3	
10032- CAA	IEEE 802.15.1 Bluetooth (GFSK, DH5)	X	44.58	99.9	21.1	1.16	134.6	$\pm 1.7\%$
		Y	96.74	98.9	18.8		149.0	
		Z	59.46	99.9	20.4		149.1	
10039- CAB	CDMA2000 (1xRTT, RC1)	X	4.70	66.3	18.7	4.57	130.9	$\pm 0.9\%$
		Y	4.85	67.1	19.0		147.5	
		Z	4.88	67.3	19.3		147.2	

10081-CAB	CDMA2000 (1xRTT, RC3)	X	3.90	65.8	18.4	3.97	130.0	±0.7 %
		Y	4.00	66.5	18.6		140.8	
		Z	3.99	66.5	18.7		142.5	
10098-CAB	UMTS-FDD (HSUPA, Subtest 2)	X	4.64	66.7	18.6	3.98	143.1	±0.9 %
		Y	4.58	66.5	18.4		132.8	
		Z	4.60	66.7	18.6		131.9	
10100-CAB	LTE-FDD (SC-FDMA, 100% RB, 20 MHz, QPSK)	X	6.32	67.1	19.5	5.67	125.8	±1.4 %
		Y	6.41	67.4	19.5		138.4	
		Z	6.51	67.9	19.9		143.6	
10108-CAB	LTE-FDD (SC-FDMA, 100% RB, 10 MHz, QPSK)	X	6.48	67.7	20.0	5.80	148.0	±1.4 %
		Y	6.28	66.9	19.4		135.8	
		Z	6.39	67.4	19.8		141.0	
10110-CAB	LTE-FDD (SC-FDMA, 100% RB, 5 MHz, QPSK)	X	6.17	67.2	19.8	5.75	141.0	±1.4 %
		Y	5.94	66.3	19.1		132.2	
		Z	6.08	67.0	19.6		137.9	
10114-CAA	IEEE 802.11n (HT Greenfield, 13.5 Mbps, BPSK)	X	10.35	69.2	21.5	8.10	133.6	±2.2 %
		Y	9.93	68.1	20.7		124.5	
		Z	10.29	69.2	21.5		131.9	
10117-CAA	IEEE 802.11n (HT Mixed, 13.5 Mbps, BPSK)	X	10.42	69.4	21.6	8.07	140.6	±2.2 %
		Y	9.93	68.1	20.7		125.5	
		Z	10.28	69.1	21.5		132.6	
10151-CAB	LTE-TDD (SC-FDMA, 50% RB, 20 MHz, QPSK)	X	11.18	78.2	27.5	9.28	143.6	±3.3 %
		Y	9.33	73.0	24.5		124.3	
		Z	10.45	76.4	26.6		132.7	
10154-CAB	LTE-FDD (SC-FDMA, 50% RB, 10 MHz, QPSK)	X	6.16	67.2	19.8	5.75	145.7	±1.4 %
		Y	5.96	66.4	19.1		133.0	
		Z	6.08	66.9	19.6		138.6	
10160-CAB	LTE-FDD (SC-FDMA, 50% RB, 15 MHz, QPSK)	X	6.32	66.6	19.4	5.82	126.2	±1.4 %
		Y	6.40	66.9	19.4		137.3	
		Z	6.51	67.4	19.8		143.8	
10169-CAB	LTE-FDD (SC-FDMA, 1 RB, 20 MHz, QPSK)	X	5.12	67.3	20.0	5.73	147.9	±1.2 %
		Y	4.90	66.4	19.4		134.4	
		Z	5.07	67.2	20.0		141.5	
10172-CAB	LTE-TDD (SC-FDMA, 1 RB, 20 MHz, QPSK)	X	9.44	80.0	28.6	9.21	128.7	±3.3 %
		Y	8.63	77.8	27.1		143.9	
		Z	10.62	83.7	30.3		148.2	
10175-CAB	LTE-FDD (SC-FDMA, 1 RB, 10 MHz, QPSK)	X	5.04	66.9	19.8	5.72	140.4	±1.4 %
		Y	4.92	66.6	19.5		133.7	
		Z	5.01	66.9	19.8		134.9	
10181-CAB	LTE-FDD (SC-FDMA, 1 RB, 15 MHz, QPSK)	X	5.05	67.0	19.9	5.72	140.6	±1.4 %
		Y	4.90	66.5	19.4		132.4	
		Z	4.97	66.7	19.7		134.1	

10193-CAA	IEEE 802.11n (HT Greenfield, 6.5 Mbps, BPSK)	X	9.98	68.8	21.4	8.09	131.1	±2.5 %
		Y	10.00	68.8	21.2		145.5	
		Z	10.14	69.4	21.7		144.7	
10196-CAA	IEEE 802.11n (HT Mixed, 6.5 Mbps, BPSK)	X	9.99	68.9	21.5	8.10	132.0	±2.7 %
		Y	10.05	69.0	21.3		148.1	
		Z	10.16	69.5	21.8		145.8	
10219-CAA	IEEE 802.11n (HT Mixed, 7.2 Mbps, BPSK)	X	9.88	68.8	21.4	8.03	131.3	±2.5 %
		Y	9.96	69.0	21.3		147.8	
		Z	10.03	69.3	21.6		144.7	
10222-CAA	IEEE 802.11n (HT Mixed, 15 Mbps, BPSK)	X	10.34	69.3	21.6	8.06	137.1	±2.2 %
		Y	9.93	68.2	20.8		127.8	
		Z	10.07	68.6	21.2		125.1	
10225-CAB	UMTS-FDD (HSPA+)	X	6.97	66.8	19.4	5.97	133.6	±1.4 %
		Y	6.90	66.7	19.2		129.7	
		Z	7.14	67.5	19.8		147.4	
10237-CAB	LTE-TDD (SC-FDMA, 1 RB, 10 MHz, QPSK)	X	9.18	79.3	28.2	9.21	128.1	±3.5 %
		Y	8.54	77.6	27.0		144.1	
		Z	9.99	81.9	29.4		141.7	
10252-CAB	LTE-TDD (SC-FDMA, 50% RB, 10 MHz, QPSK)	X	9.65	75.1	26.1	9.24	126.1	±3.5 %
		Y	9.34	74.2	25.3		141.3	
		Z	10.46	77.6	27.3		144.1	
10267-CAB	LTE-TDD (SC-FDMA, 100% RB, 10 MHz, QPSK)	X	10.46	76.2	26.5	9.30	133.6	±3.5 %
		Y	9.23	72.7	24.4		122.8	
		Z	9.90	74.8	25.7		123.8	
10274-CAB	UMTS-FDD (HSUPA, Subtest 5, 3GPP Rel8.10)	X	6.04	67.1	19.0	4.87	149.9	±1.2 %
		Y	6.02	67.1	18.9		142.8	
		Z	6.00	67.1	19.0		141.0	
10275-CAB	UMTS-FDD (HSUPA, Subtest 5, 3GPP Rel8.4)	X	4.22	65.6	18.1	3.96	131.0	±0.9 %
		Y	4.49	66.9	18.6		144.3	
		Z	4.55	67.3	19.1		147.0	
10291-AAB	CDMA2000, RC3, SO55, Full Rate	X	3.74	67.2	18.9	3.46	145.6	±0.5 %
		Y	3.66	66.8	18.5		136.7	
		Z	3.71	67.2	18.9		136.5	
10292-AAB	CDMA2000, RC3, SO32, Full Rate	X	3.65	67.0	18.7	3.39	147.2	±0.7 %
		Y	3.61	66.8	18.4		139.6	
		Z	3.64	67.1	18.8		139.6	
10297-AAA	LTE-FDD (SC-FDMA, 50% RB, 20 MHz, QPSK)	X	6.37	67.3	19.8	5.81	140.5	±1.4 %
		Y	6.24	66.8	19.3		134.0	
		Z	6.33	67.2	19.8		134.8	
10311-AAA	LTE-FDD (SC-FDMA, 100% RB, 15 MHz, QPSK)	X	7.00	68.0	20.2	6.06	146.8	±1.7 %
		Y	6.82	67.4	19.7		140.3	
		Z	6.90	67.8	20.1		141.4	

10315-AAA	IEEE 802.11b WiFi 2.4 GHz (DSSS, 1 Mbps, 96pc duty cycle)	X	2.85	68.5	18.8	1.71	129.5	±0.5 %
		Y	3.09	70.0	19.2		146.1	
		Z	3.15	70.6	19.8		146.8	
10403-AAB	CDMA2000 (1xEV-DO, Rev. 0)	X	4.73	67.9	18.7	3.76	137.5	±0.5 %
		Y	4.77	68.3	18.7		126.5	
		Z	4.77	68.1	18.8		128.1	
10404-AAB	CDMA2000 (1xEV-DO, Rev. A)	X	4.55	67.6	18.6	3.77	132.0	±0.7 %
		Y	4.89	69.1	19.1		148.8	
		Z	4.90	69.1	19.3		148.0	

The reported uncertainty of measurement is stated as the standard uncertainty of measurement multiplied by the coverage factor k=2, which for a normal distribution corresponds to a coverage probability of approximately 95%.

^A The uncertainties of NormX,Y,Z do not affect the E²-field uncertainty inside TSL (see Pages 8 and 9).
^B Numerical linearization parameter: uncertainty not required.
^E Uncertainty is determined using the max. deviation from linear response applying rectangular distribution and is expressed for the square of the field value.

DASY/EASY - Parameters of Probe: ES3DV3 - SN:3319

Calibration Parameter Determined in Head Tissue Simulating Media

f (MHz) ^C	Relative Permittivity ^F	Conductivity (S/m) ^F	ConvF X	ConvF Y	ConvF Z	Alpha ^G	Depth ^G (mm)	Unct. (k=2)
750	41.9	0.89	6.48	6.48	6.48	0.28	2.09	± 12.0 %
835	41.5	0.90	6.27	6.27	6.27	0.34	1.72	± 12.0 %
1750	40.1	1.37	5.24	5.24	5.24	0.80	1.14	± 12.0 %
1900	40.0	1.40	5.05	5.05	5.05	0.72	1.24	± 12.0 %
2450	39.2	1.80	4.45	4.45	4.45	0.77	1.23	± 12.0 %
2600	39.0	1.96	4.29	4.29	4.29	0.80	1.27	± 12.0 %

^C Frequency validity of ± 100 MHz only applies for DASY v4.4 and higher (see Page 2), else it is restricted to ± 50 MHz. The uncertainty is the RSS of the ConvF uncertainty at calibration frequency and the uncertainty for the indicated frequency band.

^F At frequencies below 3 GHz, the validity of tissue parameters (ϵ and σ) can be relaxed to ± 10% if liquid compensation formula is applied to measured SAR values. At frequencies above 3 GHz, the validity of tissue parameters (ϵ and σ) is restricted to ± 5%. The uncertainty is the RSS of the ConvF uncertainty for indicated target tissue parameters.

^G Alpha/Depth are determined during calibration. SPEAG warrants that the remaining deviation due to the boundary effect after compensation is always less than ± 1% for frequencies below 3 GHz and below ± 2% for frequencies between 3-6 GHz at any distance larger than half the probe tip diameter from the boundary.

DASY/EASY - Parameters of Probe: ES3DV3 - SN:3319

Calibration Parameter Determined in Body Tissue Simulating Media

f (MHz) ^c	Relative Permittivity ^F	Conductivity (S/m) ^F	ConvF X	ConvF Y	ConvF Z	Alpha ^G	Depth ^G (mm)	Unct. (k=2)
750	55.5	0.96	6.25	6.25	6.25	0.39	1.65	± 12.0 %
835	55.2	0.97	6.18	6.18	6.18	0.56	1.37	± 12.0 %
1750	53.4	1.49	4.85	4.85	4.85	0.57	1.46	± 12.0 %
1900	53.3	1.52	4.67	4.67	4.67	0.53	1.58	± 12.0 %
2450	52.7	1.95	4.24	4.24	4.24	0.74	1.10	± 12.0 %
2600	52.5	2.16	4.05	4.05	4.05	0.80	1.02	± 12.0 %

^c Frequency validity of ± 100 MHz only applies for DASY v4.4 and higher (see Page 2), else it is restricted to ± 50 MHz. The uncertainty is the RSS of the ConvF uncertainty at calibration frequency and the uncertainty for the indicated frequency band.

^F At frequencies below 3 GHz, the validity of tissue parameters (ϵ and σ) can be relaxed to ± 10% if liquid compensation formula is applied to measured SAR values. At frequencies above 3 GHz, the validity of tissue parameters (ϵ and σ) is restricted to ± 5%. The uncertainty is the RSS of the ConvF uncertainty for indicated target tissue parameters.

^G Alpha/Depth are determined during calibration. SPEAG warrants that the remaining deviation due to the boundary effect after compensation is always less than ± 1% for frequencies below 3 GHz and below ± 2% for frequencies between 3-6 GHz at any distance larger than half the probe tip diameter from the boundary.

Frequency Response of E-Field (TEM-Cell:ifi110 EXX, Waveguide: R22)

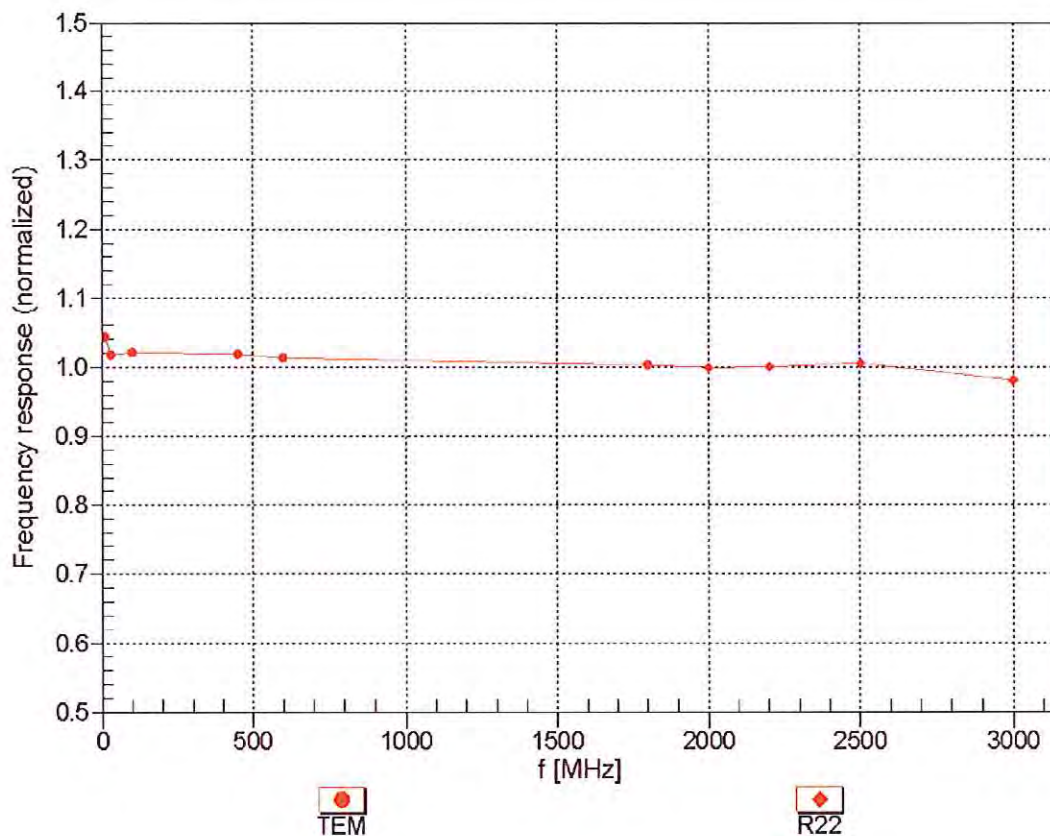

Uncertainty of Frequency Response of E-field: $\pm 6.3\%$ (k=2)

Receiving Pattern (ϕ), $\vartheta = 0^\circ$

f=600 MHz,TEM

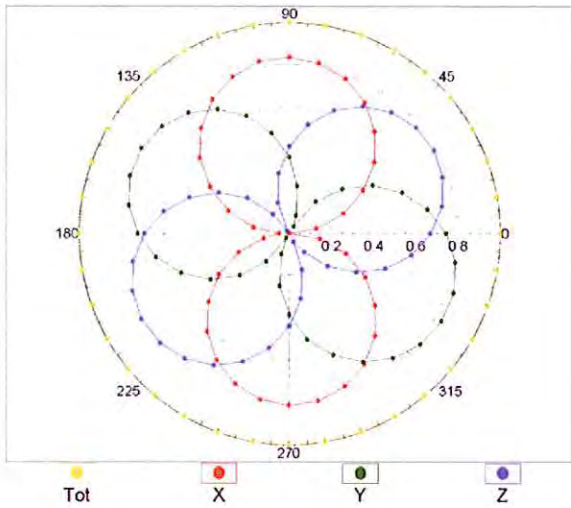

f=1800 MHz,R22

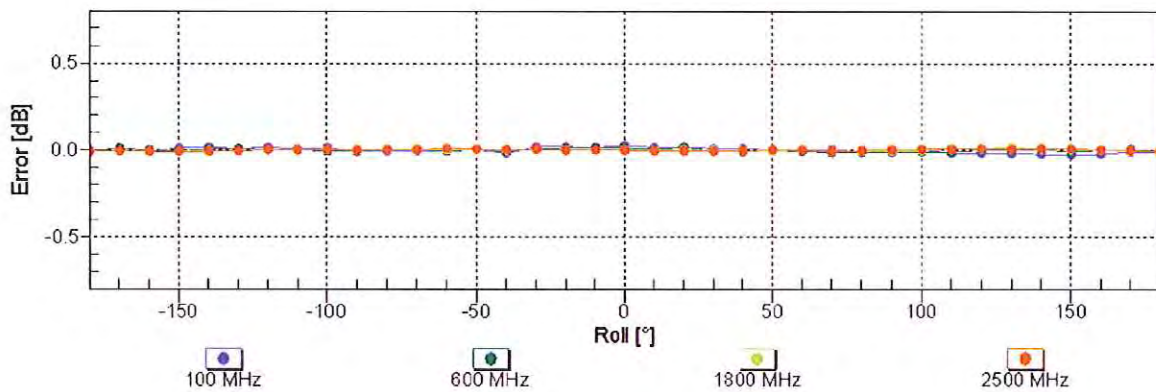
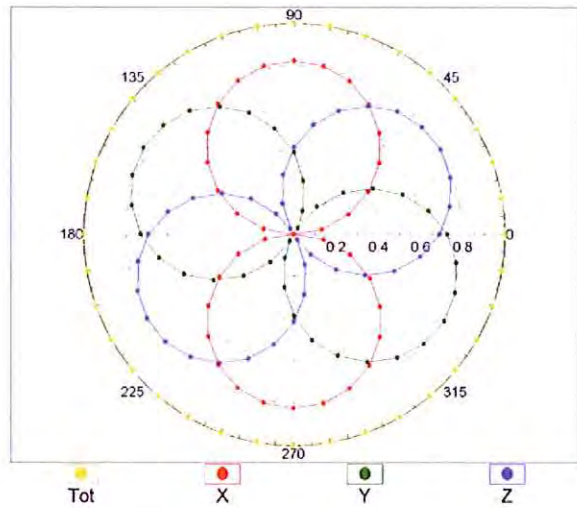

Uncertainty of Axial Isotropy Assessment: $\pm 0.5\%$ (k=2)

Dynamic Range $f(SAR_{head})$ (TEM cell , $f_{eval}= 1900$ MHz)

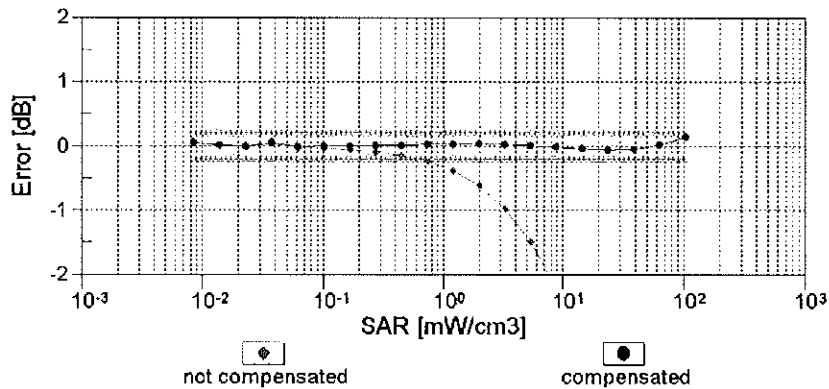
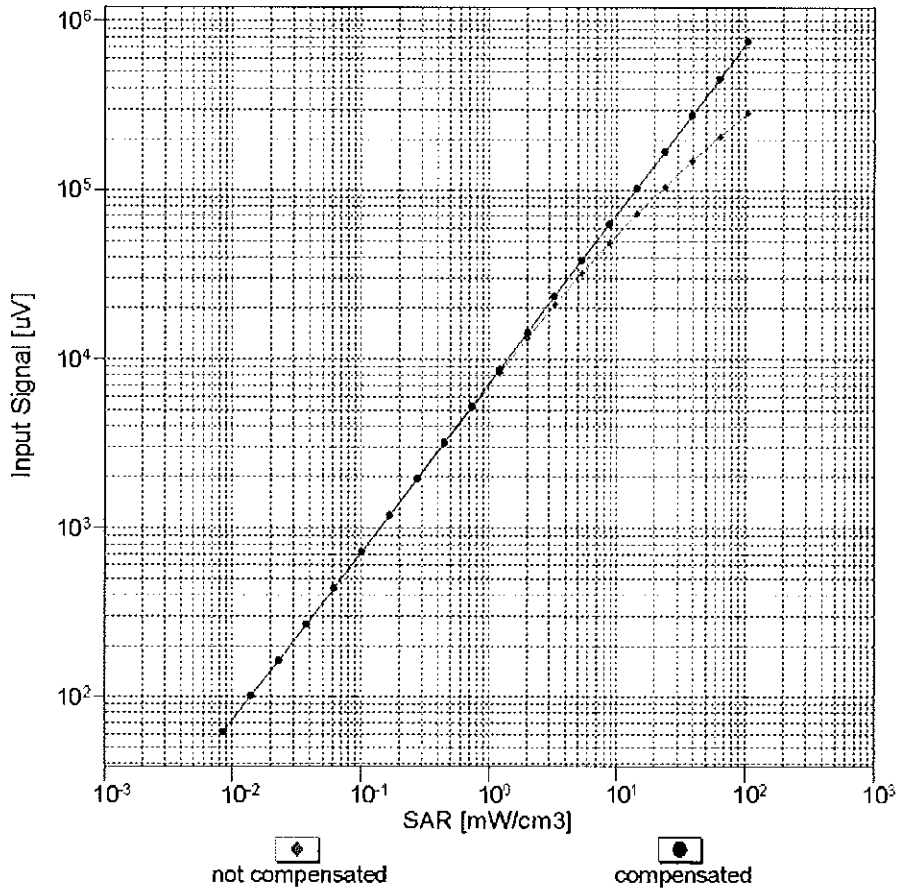

Uncertainty of Linearity Assessment: $\pm 0.6\%$ (k=2)

Conversion Factor Assessment

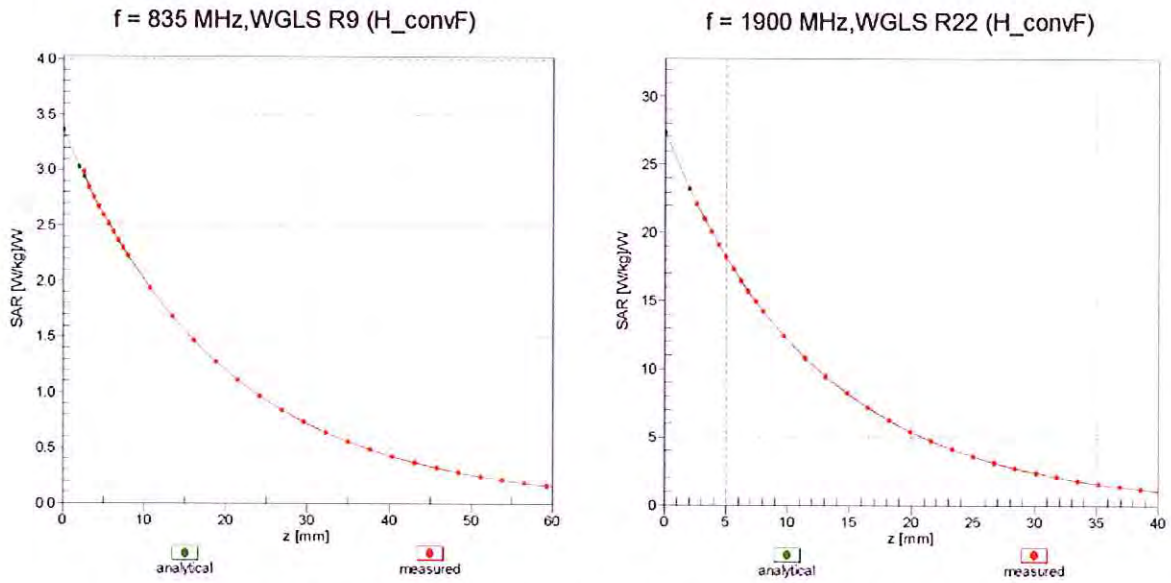

Deviation from Isotropy in Liquid Error (ϕ, ϑ), f = 900 MHz

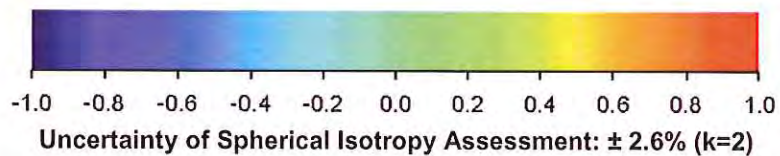
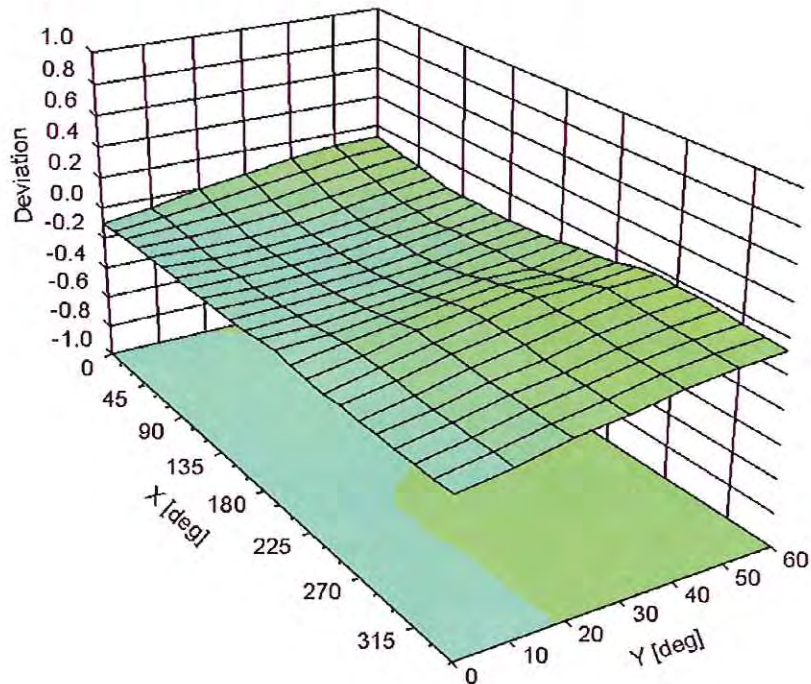

DASY/EASY - Parameters of Probe: ES3DV3 - SN:3319**Other Probe Parameters**

Sensor Arrangement	Triangular
Connector Angle (°)	-119.8
Mechanical Surface Detection Mode	enabled
Optical Surface Detection Mode	disabled
Probe Overall Length	337 mm
Probe Body Diameter	10 mm
Tip Length	10 mm
Tip Diameter	4 mm
Probe Tip to Sensor X Calibration Point	2 mm
Probe Tip to Sensor Y Calibration Point	2 mm
Probe Tip to Sensor Z Calibration Point	2 mm
Recommended Measurement Distance from Surface	3 mm



Accredited by the Swiss Accreditation Service (SAS)
The Swiss Accreditation Service is one of the signatories to the EA
Multilateral Agreement for the recognition of calibration certificates

Accreditation No.: **SCS 108**

Client **PC Test**

Certificate No: **EX3-3589_Jan14**

CALIBRATION CERTIFICATE

Object **EX3DV4 - SN:3589**

Calibration procedure(s) **QA CAL-01.v9, QA CAL-14.v4, QA CAL-23.v5, QA CAL-25.v6
Calibration procedure for dosimetric E-field probes**

Calibration date: **January 29, 2014**

This calibration certificate documents the traceability to national standards, which realize the physical units of measurements (SI).
The measurements and the uncertainties with confidence probability are given on the following pages and are part of the certificate.

All calibrations have been conducted in the closed laboratory facility: environment temperature (22 ± 3)°C and humidity < 70%.

Calibration Equipment used (M&TE critical for calibration)

CC ✓
25/14

Primary Standards	ID	Cal Date (Certificate No.)	Scheduled Calibration
Power meter E4419B	GB41293874	04-Apr-13 (No. 217-01733)	Apr-14
Power sensor E4412A	MY41498087	04-Apr-13 (No. 217-01733)	Apr-14
Reference 3 dB Attenuator	SN: S5054 (3c)	04-Apr-13 (No. 217-01737)	Apr-14
Reference 20 dB Attenuator	SN: S5277 (20x)	04-Apr-13 (No. 217-01735)	Apr-14
Reference 30 dB Attenuator	SN: S5129 (30b)	04-Apr-13 (No. 217-01738)	Apr-14
Reference Probe ES3DV2	SN: 3013	30-Dec-13 (No. ES3-3013_Dec13)	Dec-14
DAE4	SN: 660	13-Dec-13 (No. DAE4-660_Dec13)	Dec-14
Secondary Standards	ID	Check Date (in house)	Scheduled Check
RF generator HP 8648C	US3642U01700	4-Aug-99 (in house check Apr-13)	In house check: Apr-16
Network Analyzer HP 8753E	US37390585	18-Oct-01 (in house check Oct-13)	In house check: Oct-14

Calibrated by:	Name Claudio Leubler	Function Laboratory Technician	Signature
Approved by:	Name Katja Pokovic	Function Technical Manager	Signature
			Issued: January 30, 2014

This calibration certificate shall not be reproduced except in full without written approval of the laboratory.

PC-T-783



Accredited by the Swiss Accreditation Service (SAS)
The Swiss Accreditation Service is one of the signatories to the EA
Multilateral Agreement for the recognition of calibration certificates

Accreditation No.: **SCS 108**

Glossary:

TSL	tissue simulating liquid
NORM _{x,y,z}	sensitivity in free space
ConvF	sensitivity in TSL / NORM _{x,y,z}
DCP	diode compression point
CF	crest factor (1/duty_cycle) of the RF signal
A, B, C, D	modulation dependent linearization parameters
Polarization φ	φ rotation around probe axis
Polarization ϑ	ϑ rotation around an axis that is in the plane normal to probe axis (at measurement center), i.e., $\vartheta = 0$ is normal to probe axis
Connector Angle	information used in DASY system to align probe sensor X to the robot coordinate system

Calibration is Performed According to the Following Standards:

- a) IEEE Std 1528-2013, "IEEE Recommended Practice for Determining the Peak Spatial-Averaged Specific Absorption Rate (SAR) in the Human Head from Wireless Communications Devices: Measurement Techniques", June 2013
- b) IEC 62209-1, "Procedure to measure the Specific Absorption Rate (SAR) for hand-held devices used in close proximity to the ear (frequency range of 300 MHz to 3 GHz)", February 2005

Methods Applied and Interpretation of Parameters:

- **NORM_{x,y,z}**: Assessed for E-field polarization $\vartheta = 0$ ($f \leq 900$ MHz in TEM-cell; $f > 1800$ MHz: R22 waveguide). NORM_{x,y,z} are only intermediate values, i.e., the uncertainties of NORM_{x,y,z} does not affect the E²-field uncertainty inside TSL (see below ConvF).
- **NORM(f)_{x,y,z}** = NORM_{x,y,z} * frequency_response (see Frequency Response Chart). This linearization is implemented in DASY4 software versions later than 4.2. The uncertainty of the frequency response is included in the stated uncertainty of ConvF.
- **DCP_{x,y,z}**: DCP are numerical linearization parameters assessed based on the data of power sweep with CW signal (no uncertainty required). DCP does not depend on frequency nor media.
- **PAR**: PAR is the Peak to Average Ratio that is not calibrated but determined based on the signal characteristics
- **A_{x,y,z}; B_{x,y,z}; C_{x,y,z}; D_{x,y,z}; VR_{x,y,z}**: A, B, C, D are numerical linearization parameters assessed based on the data of power sweep for specific modulation signal. The parameters do not depend on frequency nor media. VR is the maximum calibration range expressed in RMS voltage across the diode.
- **ConvF and Boundary Effect Parameters**: Assessed in flat phantom using E-field (or Temperature Transfer Standard for $f \leq 800$ MHz) and inside waveguide using analytical field distributions based on power measurements for $f > 800$ MHz. The same setups are used for assessment of the parameters applied for boundary compensation (alpha, depth) of which typical uncertainty values are given. These parameters are used in DASY4 software to improve probe accuracy close to the boundary. The sensitivity in TSL corresponds to NORM_{x,y,z} * ConvF whereby the uncertainty corresponds to that given for ConvF. A frequency dependent ConvF is used in DASY version 4.4 and higher which allows extending the validity from ± 50 MHz to ± 100 MHz.
- **Spherical isotropy (3D deviation from isotropy)**: in a field of low gradients realized using a flat phantom exposed by a patch antenna.
- **Sensor Offset**: The sensor offset corresponds to the offset of virtual measurement center from the probe tip (on probe axis). No tolerance required.
- **Connector Angle**: The angle is assessed using the information gained by determining the NORM_x (no uncertainty required).

Probe EX3DV4

SN:3589

Manufactured: March 30, 2006
Calibrated: January 29, 2014

Calibrated for DASY/EASY Systems
(Note: non-compatible with DASY2 system!)

DASY/EASY - Parameters of Probe: EX3DV4 - SN:3589

Basic Calibration Parameters

	Sensor X	Sensor Y	Sensor Z	Unc (k=2)
Norm ($\mu\text{V}/(\text{V}/\text{m})^2$) ^A	0.46	0.40	0.40	$\pm 10.1 \%$
DCP (mV) ^B	101.2	100.8	98.0	

Modulation Calibration Parameters

UID	Communication System Name		A dB	B dB $\sqrt{\mu\text{V}}$	C	D dB	VR mV	Unc ^E (k=2)
0	CW	X	0.0	0.0	1.0	0.00	150.4	$\pm 3.8 \%$
		Y	0.0	0.0	1.0		142.3	
		Z	0.0	0.0	1.0		171.7	
10010- CAA	SAR Validation (Square, 100ms, 10ms)	X	6.00	69.5	14.2	10.00	42.1	$\pm 0.9 \%$
		Y	7.03	71.8	15.0		40.3	
		Z	3.33	64.6	12.1		44.6	
10011- CAA	UMTS-FDD (WCDMA)	X	3.26	66.2	17.8	2.91	117.6	$\pm 0.9 \%$
		Y	3.38	66.8	18.2		113.0	
		Z	2.79	62.4	14.7		133.2	
10012- CAA	IEEE 802.11b WiFi 2.4 GHz (DSSS, 1 Mbps)	X	2.77	66.8	17.4	1.87	117.4	$\pm 0.7 \%$
		Y	3.22	69.6	18.8		113.5	
		Z	2.22	62.0	13.8		135.2	
10021- DAA	GSM-FDD (TDMA, GMSK)	X	3.61	69.7	16.6	9.39	91.2	$\pm 1.7 \%$
		Y	5.48	77.1	19.6		125.1	
		Z	2.18	62.5	12.6		75.3	
10023- DAA	GPRS-FDD (TDMA, GMSK, TN 0)	X	3.01	66.4	14.9	9.57	86.1	$\pm 2.7 \%$
		Y	7.02	82.0	22.0		120.5	
		Z	2.13	62.9	12.7		71.4	
10024- DAA	GPRS-FDD (TDMA, GMSK, TN 0-1)	X	18.01	91.8	22.6	6.56	132.3	$\pm 1.7 \%$
		Y	8.55	83.0	19.9		134.3	
		Z	4.04	72.4	15.7		139.6	
10027- DAA	GPRS-FDD (TDMA, GMSK, TN 0-1-2)	X	4.70	74.7	15.9	4.80	107.5	$\pm 1.7 \%$
		Y	4.94	76.1	16.4		107.8	
		Z	2.97	68.7	12.8		127.1	
10028- DAA	GPRS-FDD (TDMA, GMSK, TN 0-1-2-3)	X	67.89	99.9	21.4	3.55	114.7	$\pm 2.7 \%$
		Y	48.02	99.7	21.9		116.6	
		Z	1.36	61.4	7.8		134.4	
10032- CAA	IEEE 802.15.1 Bluetooth (GFSK, DH5)	X	97.41	97.0	17.7	1.16	129.2	$\pm 3.0 \%$
		Y	71.47	99.8	19.3		130.9	
		Z	0.29	53.5	0.9		109.2	
10039- CAA	CDMA2000 (1xRTT, RC1)	X	4.62	65.4	18.0	4.57	113.0	$\pm 1.7 \%$
		Y	4.74	66.1	18.4		111.5	
		Z	4.22	63.3	15.9		133.6	
10062- CAA	IEEE 802.11a/h WiFi 5 GHz (OFDM, 6 Mbps)	X	10.10	67.8	20.8	8.68	108.0	$\pm 2.7 \%$
		Y	10.07	68.1	21.1		108.1	
		Z	10.03	67.6	20.2		130.3	

10098-CAA	UMTS-FDD (HSUPA, Subtest 2)	X	4.53	65.7	17.8	3.98	122.5	±0.9 %
		Y	4.72	66.6	18.4		123.1	
		Z	4.38	64.5	16.7		147.3	
10100-CAB	LTE-FDD (SC-FDMA, 100% RB, 20 MHz, QPSK)	X	6.32	66.5	18.8	5.67	126.9	±1.2 %
		Y	6.50	67.2	19.4		128.9	
		Z	5.80	64.3	17.3		107.2	
10108-CAB	LTE-FDD (SC-FDMA, 100% RB, 10 MHz, QPSK)	X	6.22	66.1	18.8	5.80	124.2	±1.7 %
		Y	6.39	66.9	19.4		126.7	
		Z	6.10	65.2	17.7		149.4	
10110-CAB	LTE-FDD (SC-FDMA, 100% RB, 5 MHz, QPSK)	X	5.94	65.8	18.7	5.75	121.3	±1.7 %
		Y	6.05	66.3	19.1		123.1	
		Z	5.80	65.0	17.7		144.5	
10114-CAA	IEEE 802.11n (HT Greenfield, 13.5 Mbps, BPSK)	X	10.01	67.7	20.3	8.10	113.9	±2.5 %
		Y	10.16	68.3	20.8		117.0	
		Z	9.96	67.5	19.8		135.3	
10117-CAA	IEEE 802.11n (HT Mixed, 13.5 Mbps, BPSK)	X	10.07	67.9	20.4	8.07	115.2	±2.5 %
		Y	10.16	68.2	20.7		118.4	
		Z	10.02	67.7	19.9		138.0	
10151-CAB	LTE-TDD (SC-FDMA, 50% RB, 20 MHz, QPSK)	X	7.89	68.4	21.8	9.28	108.1	±1.9 %
		Y	8.15	69.7	22.8		109.4	
		Z	7.38	66.5	20.4		123.2	
10154-CAB	LTE-FDD (SC-FDMA, 50% RB, 10 MHz, QPSK)	X	5.94	65.7	18.6	5.75	122.1	±1.7 %
		Y	6.03	66.3	19.0		122.5	
		Z	5.79	65.0	17.7		144.0	
10160-CAB	LTE-FDD (SC-FDMA, 50% RB, 15 MHz, QPSK)	X	6.38	66.3	18.9	5.82	126.0	±1.7 %
		Y	6.54	67.0	19.4		128.2	
		Z	6.16	65.3	17.8		146.9	
10169-CAB	LTE-FDD (SC-FDMA, 1 RB, 20 MHz, QPSK)	X	5.17	66.5	19.2	5.73	149.7	±1.2 %
		Y	4.95	65.8	19.0		108.3	
		Z	4.64	63.9	17.1		125.3	
10172-CAB	LTE-TDD (SC-FDMA, 1 RB, 20 MHz, QPSK)	X	6.79	70.4	23.0	9.21	120.6	±3.0 %
		Y	6.96	72.0	24.2		122.8	
		Z	6.43	69.3	22.0		136.7	
10175-CAB	LTE-FDD (SC-FDMA, 1 RB, 10 MHz, QPSK)	X	5.15	66.4	19.1	5.72	143.0	±1.4 %
		Y	5.23	67.1	19.6		145.8	
		Z	4.60	63.7	17.0		121.1	
10181-CAB	LTE-FDD (SC-FDMA, 1 RB, 15 MHz, QPSK)	X	5.11	66.2	19.0	5.72	141.0	±1.4 %
		Y	5.27	67.3	19.7		144.9	
		Z	4.54	63.4	16.8		119.2	
10193-CAA	IEEE 802.11n (HT Greenfield, 6.5 Mbps, BPSK)	X	9.57	67.1	20.1	8.09	102.2	±2.2 %
		Y	9.59	67.4	20.4		105.3	
		Z	9.73	67.6	20.0		129.6	
10196-CAA	IEEE 802.11n (HT Mixed, 6.5 Mbps, BPSK)	X	9.61	67.3	20.2	8.10	104.6	±2.5 %
		Y	9.63	67.6	20.5		107.8	
		Z	9.63	67.3	19.8		130.9	

10219-CAA	IEEE 802.11n (HT Mixed, 7.2 Mbps, BPSK)	X	9.61	67.5	20.3	8.03	109.2	±2.7 %
		Y	9.54	67.5	20.4		107.4	
		Z	9.53	67.2	19.7		130.7	
10222-CAA	IEEE 802.11n (HT Mixed, 15 Mbps, BPSK)	X	10.00	67.8	20.4	8.06	114.1	±2.7 %
		Y	10.01	68.0	20.6		112.3	
		Z	9.96	67.6	19.9		137.1	
10225-CAA	UMTS-FDD (HSPA+)	X	7.18	66.9	19.2	5.97	137.5	±1.4 %
		Y	7.25	67.4	19.5		134.4	
		Z	6.48	64.4	17.3		114.6	
10237-CAB	LTE-TDD (SC-FDMA, 1 RB, 10 MHz, QPSK)	X	6.93	71.0	23.5	9.21	123.5	±3.0 %
		Y	6.88	71.6	24.0		119.3	
		Z	6.63	70.1	22.4		141.3	
10252-CAB	LTE-TDD (SC-FDMA, 50% RB, 10 MHz, QPSK)	X	8.19	70.5	23.1	9.24	142.9	±2.5 %
		Y	8.46	72.0	24.2		143.3	
		Z	7.10	67.0	20.8		119.9	
10267-CAB	LTE-TDD (SC-FDMA, 100% RB, 10 MHz, QPSK)	X	7.83	68.1	21.6	9.30	104.2	±2.2 %
		Y	8.07	69.4	22.7		103.0	
		Z	7.49	67.2	20.9		125.2	
10274-CAA	UMTS-FDD (HSUPA, Subtest 5, 3GPP Rel8.10)	X	5.96	66.2	18.3	4.87	128.1	±1.7 %
		Y	6.12	67.0	18.8		126.0	
		Z	5.31	63.8	16.4		110.2	
10275-CAA	UMTS-FDD (HSUPA, Subtest 5, 3GPP Rel8.4)	X	4.30	65.5	17.8	3.96	110.5	±1.2 %
		Y	4.47	66.4	18.4		110.3	
		Z	3.92	63.1	15.6		135.7	
10291-AAA	CDMA2000, RC3, SO55, Full Rate	X	3.59	65.7	17.7	3.46	138.1	±1.2 %
		Y	3.85	67.2	18.6		146.7	
		Z	3.08	61.7	14.7		123.3	
10292-AAA	CDMA2000, RC3, SO32, Full Rate	X	3.59	66.0	17.8	3.39	144.2	±0.9 %
		Y	3.83	67.5	18.7		148.4	
		Z	3.18	63.1	15.7		128.6	
10297-AAA	LTE-FDD (SC-FDMA, 50% RB, 20 MHz, QPSK)	X	6.13	65.8	18.7	5.81	116.5	±1.7 %
		Y	6.30	66.6	19.2		119.4	
		Z	6.20	65.9	18.4		145.6	
10311-AAA	LTE-FDD (SC-FDMA, 100% RB, 15 MHz, QPSK)	X	6.70	66.4	19.0	6.06	122.5	±1.4 %
		Y	6.92	67.3	19.6		124.5	
		Z	6.28	65.0	17.9		103.7	
10315-AAA	IEEE 802.11b WiFi 2.4 GHz (DSSS, 1 Mbps, 96pc duty cycle)	X	2.66	66.7	17.4	1.71	109.5	±0.7 %
		Y	3.18	70.0	19.2		111.5	
		Z	2.08	61.6	13.4		134.4	
10317-AAA	IEEE 802.11a WiFi 5 GHz (OFDM, 6 Mbps, 96pc duty cycle)	X	9.78	67.4	20.4	8.36	103.5	±2.5 %
		Y	9.81	67.7	20.7		107.1	
		Z	9.86	67.6	20.3		129.5	
10400-AAA	IEEE 802.11ac WiFi (20MHz, 64-QAM, 99pc duty cycle)	X	9.86	67.5	20.4	8.37	104.9	±2.7 %
		Y	9.93	67.9	20.8		107.9	
		Z	9.97	67.7	20.2		134.3	

10402-AAA	IEEE 802.11ac WiFi (80MHz, 64-QAM, 99pc duty cycle)	X	10.47	67.9	20.5	8.53	109.9	±3.0 %
		Y	10.86	68.8	21.1		116.0	
		Z	10.68	68.2	20.4		142.5	
10403-AAA	CDMA2000 (1xEV-DO, Rev. 0)	X	4.74	67.0	17.9	3.76	114.9	±0.9 %
		Y	5.02	68.5	18.7		116.6	
		Z	4.23	64.4	15.8		145.1	
10404-AAA	CDMA2000 (1xEV-DO, Rev. A)	X	4.71	67.1	17.9	3.77	112.3	±1.4 %
		Y	4.95	68.5	18.7		115.0	
		Z	4.01	63.4	15.1		138.9	

The reported uncertainty of measurement is stated as the standard uncertainty of measurement multiplied by the coverage factor $k=2$, which for a normal distribution corresponds to a coverage probability of approximately 95%.

^A The uncertainties of NormX,Y,Z do not affect the E^2 -field uncertainty inside TSL (see Pages 8 and 9).

^B Numerical linearization parameter: uncertainty not required.

^E Uncertainty is determined using the max. deviation from linear response applying rectangular distribution and is expressed for the square of the field value.

DASY/EASY - Parameters of Probe: EX3DV4 - SN:3589

Calibration Parameter Determined in Head Tissue Simulating Media

f (MHz) ^C	Relative Permittivity ^F	Conductivity (S/m) ^F	ConvF X	ConvF Y	ConvF Z	Alpha ^G	Depth ^G (mm)	Unct. (k=2)
750	41.9	0.89	8.86	8.86	8.86	0.80	0.62	± 12.0 %
835	41.5	0.90	8.49	8.49	8.49	0.45	0.82	± 12.0 %
1750	40.1	1.37	7.31	7.31	7.31	0.80	0.60	± 12.0 %
1900	40.0	1.40	7.05	7.05	7.05	0.52	0.73	± 12.0 %
2450	39.2	1.80	6.45	6.45	6.45	0.29	1.08	± 12.0 %
2600	39.0	1.96	6.24	6.24	6.24	0.76	0.62	± 12.0 %
5200	36.0	4.66	4.78	4.78	4.78	0.30	1.80	± 13.1 %
5300	35.9	4.76	4.58	4.58	4.58	0.30	1.80	± 13.1 %
5500	35.6	4.96	4.44	4.44	4.44	0.31	1.80	± 13.1 %
5600	35.5	5.07	4.20	4.20	4.20	0.35	1.80	± 13.1 %
5800	35.3	5.27	4.39	4.39	4.39	0.32	1.80	± 13.1 %

^C Frequency validity of ± 100 MHz only applies for DASY v4.4 and higher (see Page 2), else it is restricted to ± 50 MHz. The uncertainty is the RSS of the ConvF uncertainty at calibration frequency and the uncertainty for the indicated frequency band.

^F At frequencies below 3 GHz, the validity of tissue parameters (ϵ and σ) can be relaxed to ± 10% if liquid compensation formula is applied to measured SAR values. At frequencies above 3 GHz, the validity of tissue parameters (ϵ and σ) is restricted to ± 5%. The uncertainty is the RSS of the ConvF uncertainty for indicated target tissue parameters.

^G Alpha/Depth are determined during calibration. SPEAG warrants that the remaining deviation due to the boundary effect after compensation is always less than ± 1% for frequencies below 3 GHz and below ± 2% for frequencies between 3-6 GHz at any distance larger than half the probe tip diameter from the boundary.

DASY/EASY - Parameters of Probe: EX3DV4 - SN:3589

Calibration Parameter Determined in Body Tissue Simulating Media

f (MHz) ^C	Relative Permittivity ^F	Conductivity (S/m) ^F	ConvF X	ConvF Y	ConvF Z	Alpha ^G	Depth (mm) ^G	Unct. (k=2)
750	55.5	0.96	8.34	8.34	8.34	0.66	0.72	± 12.0 %
835	55.2	0.97	8.29	8.29	8.29	0.31	1.11	± 12.0 %
1750	53.4	1.49	6.68	6.68	6.68	0.80	0.61	± 12.0 %
1900	53.3	1.52	6.54	6.54	6.54	0.72	0.64	± 12.0 %
2450	52.7	1.95	6.26	6.26	6.26	0.80	0.57	± 12.0 %
2600	52.5	2.16	6.08	6.08	6.08	0.68	0.50	± 12.0 %
5200	49.0	5.30	4.19	4.19	4.19	0.38	1.90	± 13.1 %
5300	48.9	5.42	3.98	3.98	3.98	0.38	1.90	± 13.1 %
5500	48.6	5.65	3.76	3.76	3.76	0.42	1.90	± 13.1 %
5600	48.5	5.77	3.81	3.81	3.81	0.30	1.90	± 13.1 %
5800	48.2	6.00	3.97	3.97	3.97	0.43	1.90	± 13.1 %

^C Frequency validity of ± 100 MHz only applies for DASY v4.4 and higher (see Page 2), else it is restricted to ± 50 MHz. The uncertainty is the RSS of the ConvF uncertainty at calibration frequency and the uncertainty for the indicated frequency band.

^F At frequencies below 3 GHz, the validity of tissue parameters (ϵ and σ) can be relaxed to ± 10% if liquid compensation formula is applied to measured SAR values. At frequencies above 3 GHz, the validity of tissue parameters (ϵ and σ) is restricted to ± 5%. The uncertainty is the RSS of the ConvF uncertainty for indicated target tissue parameters.

^G Alpha/Depth are determined during calibration. SPEAG warrants that the remaining deviation due to the boundary effect after compensation is always less than ± 1% for frequencies below 3 GHz and below ± 2% for frequencies between 3-6 GHz at any distance larger than half the probe tip diameter from the boundary.

Frequency Response of E-Field (TEM-Cell:ifi110 EXX, Waveguide: R22)

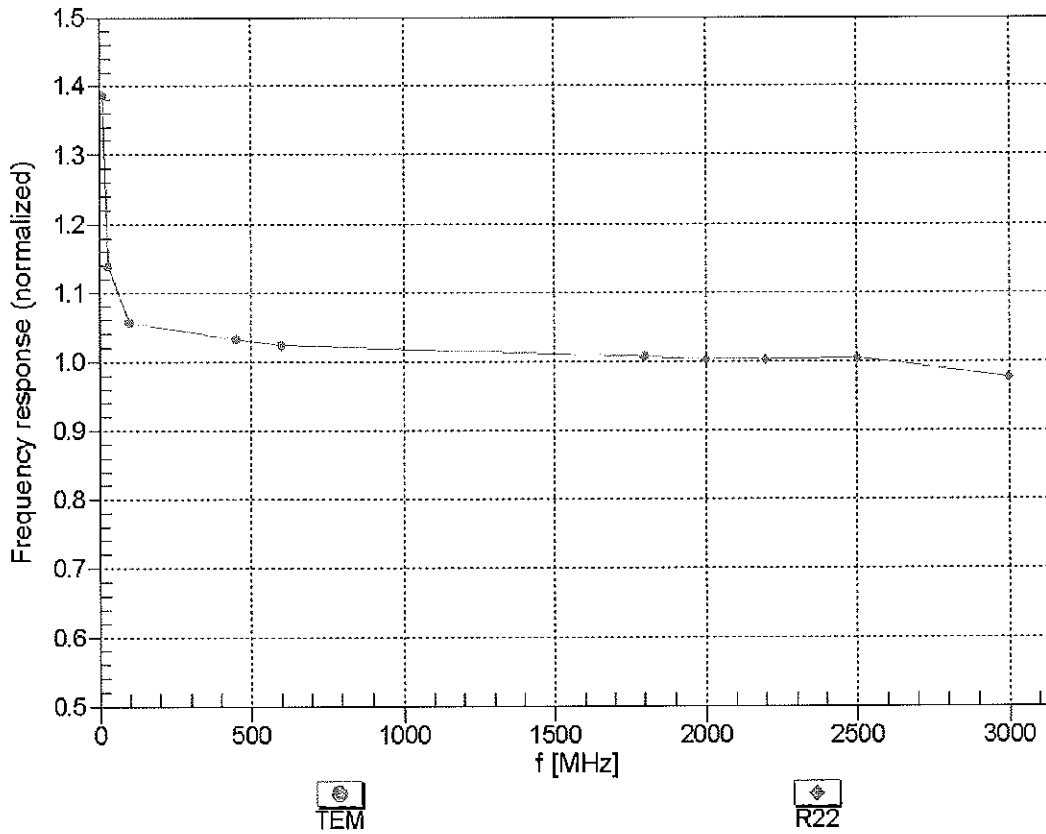

Uncertainty of Frequency Response of E-field: $\pm 6.3\%$ (k=2)

Receiving Pattern (ϕ), $\vartheta = 0^\circ$

f=600 MHz, TEM

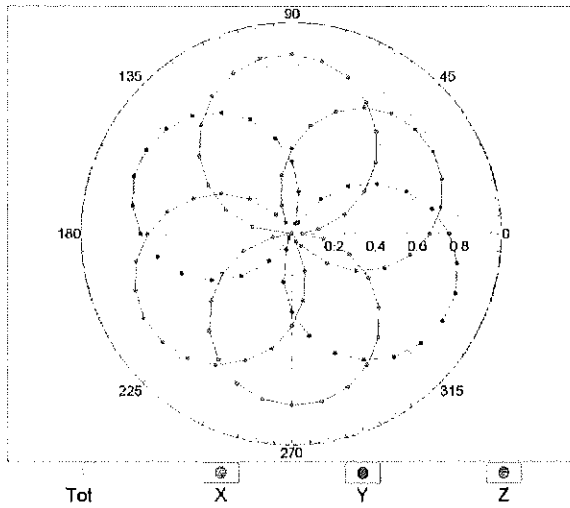

f=1800 MHz, R22

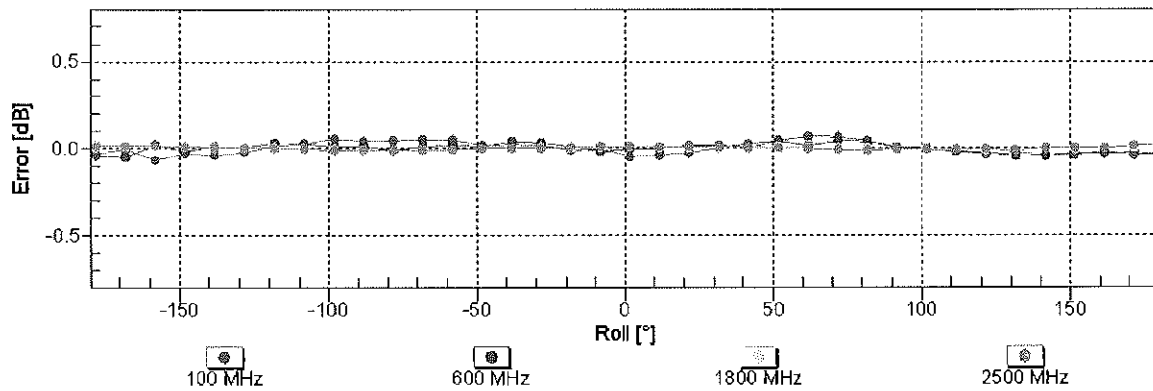
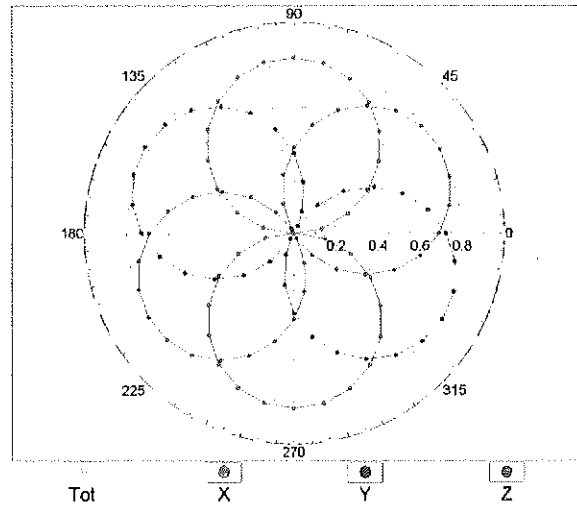

Uncertainty of Axial Isotropy Assessment: $\pm 0.5\%$ (k=2)

Dynamic Range $f(\text{SAR}_{\text{head}})$ (TEM cell , $f = 900 \text{ MHz}$)

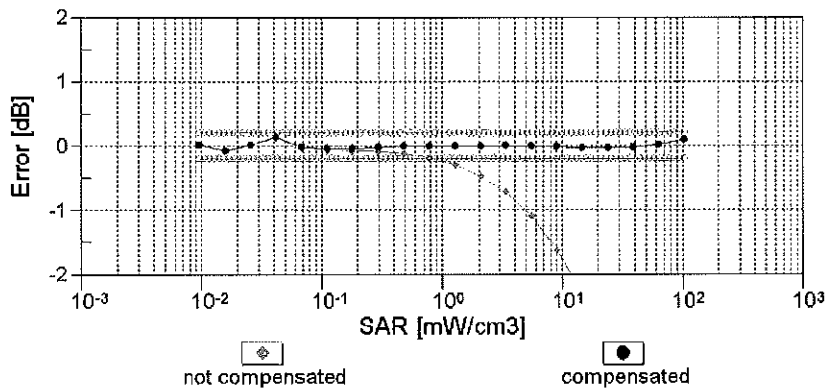
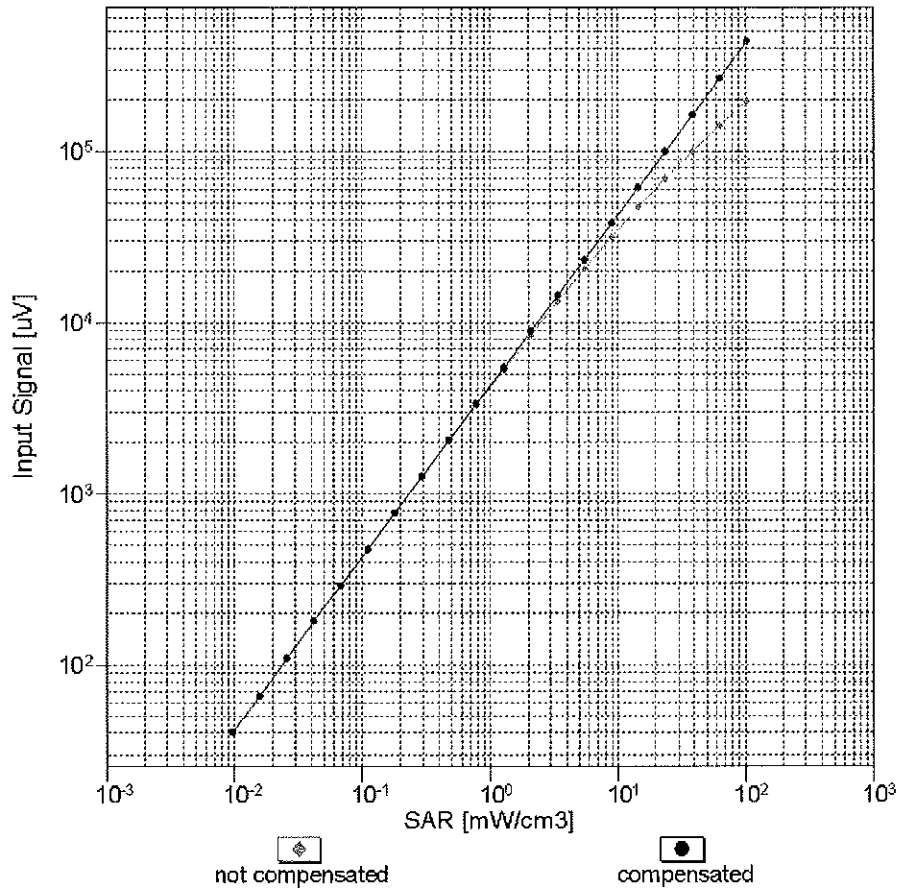

Uncertainty of Linearity Assessment: $\pm 0.6\%$ ($k=2$)

Conversion Factor Assessment

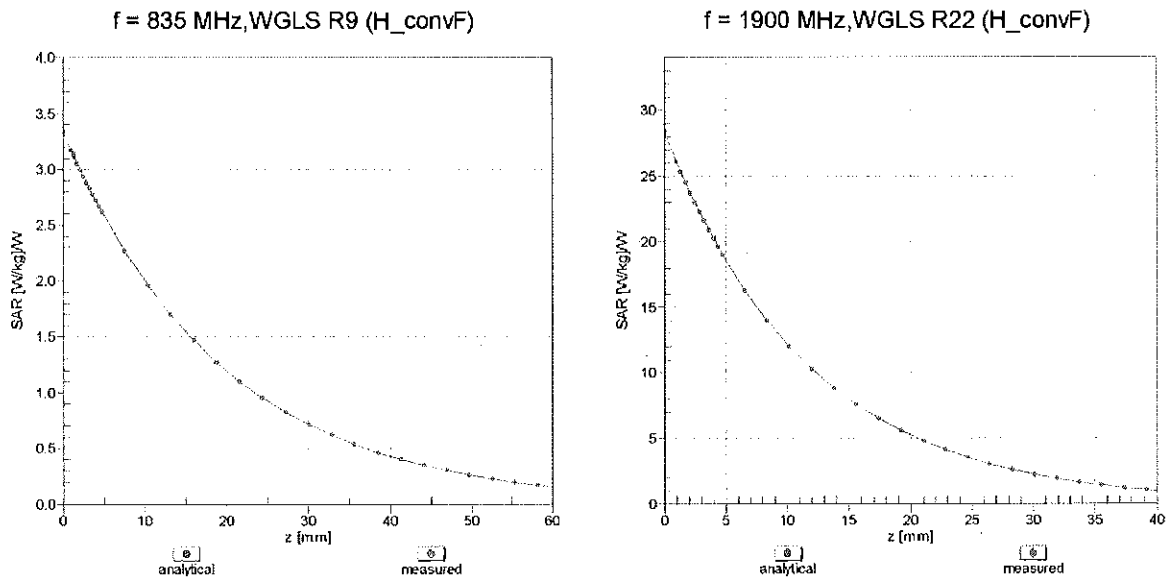

Deviation from Isotropy in Liquid Error (ϕ, ϑ), f = 900 MHz

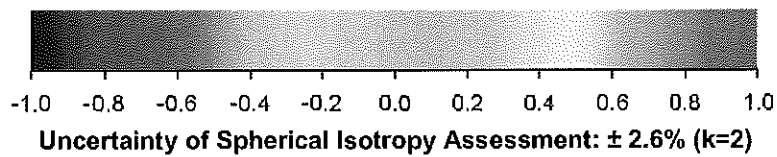
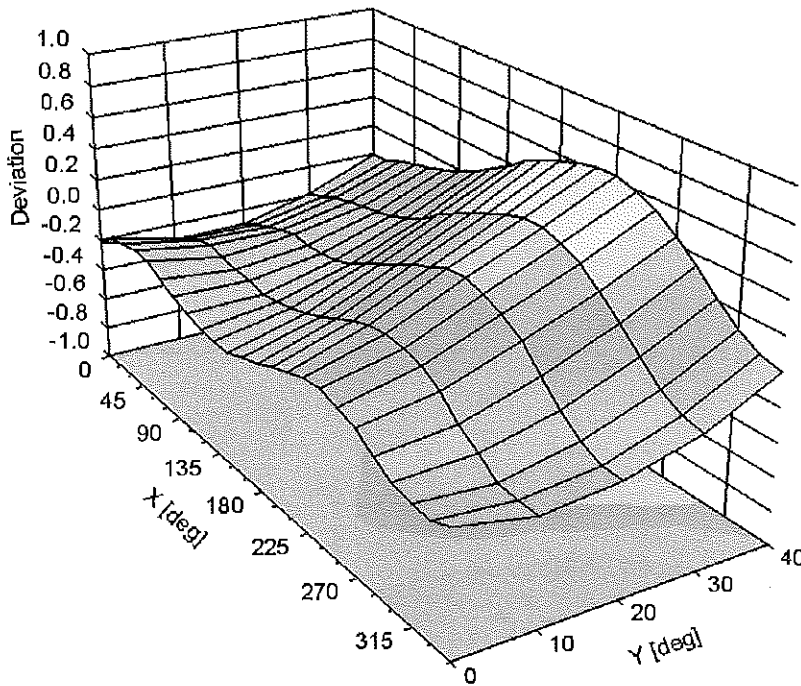

DASY/EASY - Parameters of Probe: EX3DV4 - SN:3589

Other Probe Parameters

Sensor Arrangement	Triangular
Connector Angle (°)	-38.2
Mechanical Surface Detection Mode	enabled
Optical Surface Detection Mode	disabled
Probe Overall Length	337 mm
Probe Body Diameter	10 mm
Tip Length	9 mm
Tip Diameter	2.5 mm
Probe Tip to Sensor X Calibration Point	1 mm
Probe Tip to Sensor Y Calibration Point	1 mm
Probe Tip to Sensor Z Calibration Point	1 mm
Recommended Measurement Distance from Surface	2 mm

Calibration Laboratory of
Schmid & Partner
Engineering AG
Zeughausstrasse 43, 8004 Zurich, Switzerland



SCS Schweizerischer Kalibrierdienst
Service suisse d'étalonnage
Servizio svizzero di taratura
Swiss Calibration Service

Accredited by the Swiss Accreditation Service (SAS)
The Swiss Accreditation Service is one of the signatories to the EA
Multilateral Agreement for the recognition of calibration certificates

Accreditation No.: **SCS 108**

Client **PC Test**

Certificate No: **EX3-3914_Oct13**

CALIBRATION CERTIFICATE

Object **EX3DV4 - SN:3914**

Calibration procedure(s) **DIA CAL-01 v3, GA CAL-14 v4, GA CAL-23 v5, DIA CAL-25 v6
Calibration procedure for dielectric E-field probes**

Calibration date: **October 23, 2013** VCC
11/20/2013

This calibration certificate documents the traceability to national standards, which realize the physical units of measurements (SI).
The measurements and the uncertainties with confidence probability are given on the following pages and are part of the certificate.

All calibrations have been conducted in the closed laboratory facility: environment temperature (22 ± 3)°C and humidity < 70%.

Calibration Equipment used (M&TE critical for calibration)

Primary Standards	ID	Cal Date (Certificate No.)	Scheduled Calibration
Power meter E4419B	GB41293874	04-Apr-13 (No. 217-01733)	Apr-14
Power sensor E4412A	MY41498087	04-Apr-13 (No. 217-01733)	Apr-14
Reference 3 dB Attenuator	SN: S5054 (3c)	04-Apr-13 (No. 217-01737)	Apr-14
Reference 20 dB Attenuator	SN: S5277 (20x)	04-Apr-13 (No. 217-01735)	Apr-14
Reference 30 dB Attenuator	SN: S5129 (30b)	04-Apr-13 (No. 217-01738)	Apr-14
Reference Probe ES3DV2	SN: 3013	28-Dec-12 (No. ES3-3013_Dec12)	Dec-13
DAE4	SN: 660	4-Sep-13 (No. DAE4-660_Sep13)	Sep-14
Secondary Standards	ID	Check Date (in house)	Scheduled Check
RF generator HP 8648C	US3642U01700	4-Aug-99 (in house check Apr-13)	In house check: Apr-15
Network Analyzer HP 8753E	US37390585	18-Oct-01 (in house check Oct-13)	In house check: Oct-14

Calibrated by:	Name Leif Klysner	Function Laboratory Technician	Signature
Approved by:	Name Katja Pokovic	Function Technical Manager	

Issued: October 25, 2013

This calibration certificate shall not be reproduced except in full without written approval of the laboratory.

PCT # 81072



Accredited by the Swiss Accreditation Service (SAS)
 The Swiss Accreditation Service is one of the signatories to the EA
 Multilateral Agreement for the recognition of calibration certificates

Accreditation No.: **SCS 108**

Glossary:

TSL	tissue simulating liquid
NORM _{x,y,z}	sensitivity in free space
ConvF	sensitivity in TSL / NORM _{x,y,z}
DCP	diode compression point
CF	crest factor (1/duty_cycle) of the RF signal
A, B, C, D	modulation dependent linearization parameters
Polarization φ	φ rotation around probe axis
Polarization ϑ	ϑ rotation around an axis that is in the plane normal to probe axis (at measurement center), i.e., $\vartheta = 0$ is normal to probe axis
Connector Angle	information used in DASY system to align probe sensor X to the robot coordinate system

Calibration is Performed According to the Following Standards:

- a) IEEE Std 1528-2013, "IEEE Recommended Practice for Determining the Peak Spatial-Averaged Specific Absorption Rate (SAR) in the Human Head from Wireless Communications Devices: Measurement Techniques", June 2013
- b) IEC 62209-1, "Procedure to measure the Specific Absorption Rate (SAR) for hand-held devices used in close proximity to the ear (frequency range of 300 MHz to 3 GHz)", February 2005

Methods Applied and Interpretation of Parameters:

- *NORM_{x,y,z}*: Assessed for E-field polarization $\vartheta = 0$ ($f \leq 900$ MHz in TEM-cell; $f > 1800$ MHz: R22 waveguide). *NORM_{x,y,z}* are only intermediate values, i.e., the uncertainties of *NORM_{x,y,z}* does not affect the E^2 -field uncertainty inside TSL (see below *ConvF*).
- *NORM(f)_{x,y,z}* = *NORM_{x,y,z}* * *frequency_response* (see Frequency Response Chart). This linearization is implemented in DASY4 software versions later than 4.2. The uncertainty of the frequency response is included in the stated uncertainty of *ConvF*.
- *DCP_{x,y,z}*: DCP are numerical linearization parameters assessed based on the data of power sweep with CW signal (no uncertainty required). DCP does not depend on frequency nor media.
- *PAR*: PAR is the Peak to Average Ratio that is not calibrated but determined based on the signal characteristics
- *A_{x,y,z}*; *B_{x,y,z}*; *C_{x,y,z}*; *D_{x,y,z}*; *VR_{x,y,z}*; *A, B, C, D* are numerical linearization parameters assessed based on the data of power sweep for specific modulation signal. The parameters do not depend on frequency nor media. *VR* is the maximum calibration range expressed in RMS voltage across the diode.
- *ConvF* and *Boundary Effect Parameters*: Assessed in flat phantom using E-field (or Temperature Transfer Standard for $f \leq 800$ MHz) and inside waveguide using analytical field distributions based on power measurements for $f > 800$ MHz. The same setups are used for assessment of the parameters applied for boundary compensation (alpha, depth) of which typical uncertainty values are given. These parameters are used in DASY4 software to improve probe accuracy close to the boundary. The sensitivity in TSL corresponds to *NORM_{x,y,z}* * *ConvF* whereby the uncertainty corresponds to that given for *ConvF*. A frequency dependent *ConvF* is used in DASY version 4.4 and higher which allows extending the validity from ± 50 MHz to ± 100 MHz.
- *Spherical isotropy (3D deviation from isotropy)*: in a field of low gradients realized using a flat phantom exposed by a patch antenna.
- *Sensor Offset*: The sensor offset corresponds to the offset of virtual measurement center from the probe tip (on probe axis). No tolerance required.
- *Connector Angle*: The angle is assessed using the information gained by determining the *NORM_x* (no uncertainty required).

Probe EX3DV4

SN:3914

Manufactured: December 18, 2012
Calibrated: October 23, 2013

Calibrated for DASY/EASY Systems
(Note: non-compatible with DASY2 system!)

DASY/EASY - Parameters of Probe: EX3DV4 - SN:3914

Basic Calibration Parameters

	Sensor X	Sensor Y	Sensor Z	Unc (k=2)
Norm ($\mu\text{V}/(\text{V}/\text{m})^2$) ^A	0.47	0.49	0.51	$\pm 10.1 \%$
DCP (mV) ^B	99.2	98.9	98.2	

Modulation Calibration Parameters

UID	Communication System Name		A dB	B dB $\sqrt{\mu\text{V}}$	C	D dB	VR mV	Unc ^E (k=2)
0	CW	X	0.0	0.0	1.0	0.00	158.3	$\pm 3.0 \%$
		Y	0.0	0.0	1.0		154.6	
		Z	0.0	0.0	1.0		170.8	
10010- CAA	SAR Validation (Square, 100ms, 10ms)	X	0.71	53.3	6.1	10.00	48.4	$\pm 2.5 \%$
		Y	2.43	67.0	13.8		39.9	
		Z	4.18	68.7	13.8		45.7	
10011- CAA	UMTS-FDD (WCDMA)	X	3.05	64.4	16.5	2.91	122.4	$\pm 0.5 \%$
		Y	3.31	66.5	18.2		123.5	
		Z	3.34	66.3	17.8		136.6	
10012- CAA	IEEE 802.11b WiFi 2.4 GHz (DSSS, 1 Mbps)	X	2.49	64.8	16.1	1.87	120.6	$\pm 0.5 \%$
		Y	2.94	68.6	18.7		123.6	
		Z	2.63	65.9	17.0		135.4	
10021- DAA	GSM-FDD (TDMA, GMSK)	X	1.52	61.5	10.9	9.39	83.6	$\pm 1.2 \%$
		Y	2.22	67.4	15.0		116.0	
		Z	2.47	66.8	14.7		95.9	
10023- DAA	GPRS-FDD (TDMA, GMSK, TN 0)	X	1.73	63.3	11.9	9.57	81.5	$\pm 1.7 \%$
		Y	2.11	66.2	14.2		111.8	
		Z	2.76	69.0	16.0		93.6	
10024- DAA	GPRS-FDD (TDMA, GMSK, TN 0-1)	X	1.34	62.1	9.4	6.56	121.0	$\pm 1.2 \%$
		Y	4.24	78.6	17.9		130.0	
		Z	2.91	70.7	14.9		141.4	
10027- DAA	GPRS-FDD (TDMA, GMSK, TN 0-1-2)	X	1.25	63.5	9.7	4.80	143.5	$\pm 1.4 \%$
		Y	1.59	66.9	12.2		149.7	
		Z	2.98	71.5	14.0		123.3	
10028- DAA	GPRS-FDD (TDMA, GMSK, TN 0-1-2-3)	X	0.51	58.3	7.4	3.55	113.4	$\pm 1.2 \%$
		Y	25.43	100.0	22.6		121.3	
		Z	38.67	97.5	20.6		133.3	
10032- CAA	IEEE 802.15.1 Bluetooth (GFSK, DH5)	X	0.28	58.6	5.3	1.16	134.7	$\pm 0.9 \%$
		Y	65.75	99.6	18.6		141.3	
		Z	0.20	55.6	4.1		112.1	
10039- CAA	CDMA2000 (1xRTT, RC1)	X	4.33	64.6	17.4	4.57	113.8	$\pm 0.7 \%$
		Y	4.55	66.0	18.6		120.8	
		Z	4.85	66.2	18.4		135.9	
10062- CAA	IEEE 802.11a/h WiFi 5 GHz (OFDM, 6 Mbps)	X	9.83	67.6	20.7	8.68	109.0	$\pm 2.5 \%$
		Y	10.06	68.4	21.5		118.2	
		Z	10.66	69.2	21.7		134.0	

10081-CAA	CDMA2000 (1xRTT, RC3)	X	3.59	63.9	16.9	3.97	113.6	±0.7 %
		Y	3.84	65.6	18.2		119.6	
		Z	3.95	65.4	17.8		134.5	
10098-CAA	UMTS-FDD (HSUPA, Subtest 2)	X	4.41	65.2	17.3	3.98	126.0	±0.7 %
		Y	4.73	66.9	18.6		132.5	
		Z	4.51	65.5	17.7		105.6	
10100-CAB	LTE-FDD (SC-FDMA, 100% RB, 20 MHz, QPSK)	X	6.26	66.2	18.6	5.67	130.5	±1.2 %
		Y	6.61	67.7	19.8		139.3	
		Z	6.21	66.0	18.7		107.7	
10108-CAB	LTE-FDD (SC-FDMA, 100% RB, 10 MHz, QPSK)	X	6.13	65.8	18.6	5.80	126.3	±1.2 %
		Y	6.40	67.1	19.6		135.6	
		Z	6.10	65.5	18.5		107.4	
10110-CAB	LTE-FDD (SC-FDMA, 100% RB, 5 MHz, QPSK)	X	5.78	65.3	18.3	5.75	123.1	±1.2 %
		Y	5.97	66.3	19.2		131.5	
		Z	5.86	65.3	18.4		104.9	
10114-CAA	IEEE 802.11n (HT Greenfield, 13.5 Mbps, BPSK)	X	9.92	67.7	20.3	8.10	115.7	±2.5 %
		Y	10.25	68.7	21.2		126.8	
		Z	10.71	69.4	21.3		146.0	
10117-CAA	IEEE 802.11n (HT Mixed, 13.5 Mbps, BPSK)	X	9.95	67.8	20.3	8.07	116.6	±2.5 %
		Y	10.26	68.7	21.1		128.3	
		Z	10.70	69.4	21.3		146.9	
10151-CAB	LTE-TDD (SC-FDMA, 50% RB, 20 MHz, QPSK)	X	7.19	67.3	21.5	9.28	145.0	±2.2 %
		Y	7.40	68.3	22.4		110.8	
		Z	7.79	68.4	22.0		128.0	
10154-CAB	LTE-FDD (SC-FDMA, 50% RB, 10 MHz, QPSK)	X	5.79	65.3	18.3	5.75	124.2	±1.2 %
		Y	6.03	66.5	19.4		131.9	
		Z	6.29	66.9	19.3		149.7	
10160-CAB	LTE-FDD (SC-FDMA, 50% RB, 15 MHz, QPSK)	X	6.23	65.9	18.6	5.82	128.3	±1.2 %
		Y	6.51	67.2	19.7		136.9	
		Z	6.24	65.7	18.6		107.3	
10169-CAB	LTE-FDD (SC-FDMA, 1 RB, 20 MHz, QPSK)	X	4.83	66.0	18.9	5.73	147.5	±1.2 %
		Y	4.72	65.8	19.2		113.8	
		Z	5.03	66.1	19.1		129.7	
10172-CAB	LTE-TDD (SC-FDMA, 1 RB, 20 MHz, QPSK)	X	5.83	69.2	22.8	9.21	149.9	±1.9 %
		Y	5.81	69.4	23.4		120.3	
		Z	6.38	70.0	23.2		137.2	
10175-CAB	LTE-FDD (SC-FDMA, 1 RB, 10 MHz, QPSK)	X	4.86	66.1	18.9	5.72	149.8	±1.2 %
		Y	4.72	65.8	19.2		113.3	
		Z	5.09	66.4	19.1		126.0	
10181-CAB	LTE-FDD (SC-FDMA, 1 RB, 15 MHz, QPSK)	X	4.83	66.0	18.9	5.72	146.3	±1.2 %
		Y	4.69	65.6	19.1		112.2	
		Z	5.02	66.1	19.0		125.1	
10193-CAA	IEEE 802.11n (HT Greenfield, 6.5 Mbps, BPSK)	X	9.51	67.4	20.2	8.09	108.6	±2.5 %
		Y	9.72	68.1	20.9		118.2	
		Z	10.30	68.9	21.1		135.0	

10196-CAA	IEEE 802.11n (HT Mixed, 6.5 Mbps, BPSK)	X	9.52	67.4	20.2	8.10	111.6	±2.5 %
		Y	9.79	68.3	21.1		121.3	
		Z	10.30	68.9	21.2		139.2	
10219-CAA	IEEE 802.11n (HT Mixed, 7.2 Mbps, BPSK)	X	9.47	67.4	20.2	8.03	111.8	±2.2 %
		Y	9.67	68.3	21.0		120.0	
		Z	10.20	68.9	21.1		138.0	
10222-CAA	IEEE 802.11n (HT Mixed, 15 Mbps, BPSK)	X	9.96	67.9	20.4	8.06	118.4	±2.5 %
		Y	10.25	68.8	21.2		128.2	
		Z	10.65	69.3	21.3		144.5	
10225-CAA	UMTS-FDD (HSPA+)	X	6.96	66.7	18.9	5.97	140.0	±1.4 %
		Y	7.23	67.9	20.0		148.9	
		Z	7.03	66.4	18.9		115.6	
10237-CAB	LTE-TDD (SC-FDMA, 1 RB, 10 MHz, QPSK)	X	5.51	67.5	21.8	9.21	114.2	±1.9 %
		Y	5.82	69.4	23.4		123.0	
		Z	6.49	70.6	23.6		140.2	
10252-CAB	LTE-TDD (SC-FDMA, 50% RB, 10 MHz, QPSK)	X	6.83	67.1	21.4	9.24	136.6	±1.9 %
		Y	7.30	69.4	23.2		147.3	
		Z	7.36	68.1	22.0		117.5	
10267-CAB	LTE-TDD (SC-FDMA, 100% RB, 10 MHz, QPSK)	X	7.26	67.5	21.6	9.30	142.7	±1.9 %
		Y	7.44	68.4	22.4		110.5	
		Z	7.84	68.7	22.2		122.6	
10274-CAA	UMTS-FDD (HSUPA, Subtest 5, 3GPP Rel8.10)	X	5.86	66.2	18.2	4.87	135.4	±0.9 %
		Y	6.12	67.5	19.2		142.3	
		Z	5.91	65.9	18.2		107.6	
10275-CAA	UMTS-FDD (HSUPA, Subtest 5, 3GPP Rel8.4)	X	4.17	64.8	17.3	3.96	115.6	±0.7 %
		Y	4.42	66.4	18.5		124.6	
		Z	4.47	66.0	18.0		132.6	
10291-AAA	CDMA2000, RC3, SO55, Full Rate	X	3.36	64.7	17.1	3.46	109.4	±0.5 %
		Y	3.55	66.2	18.3		118.2	
		Z	3.60	65.6	17.7		120.9	
10292-AAA	CDMA2000, RC3, SO32, Full Rate	X	3.34	64.9	17.2	3.39	110.1	±0.5 %
		Y	3.57	66.7	18.5		121.0	
		Z	3.54	65.6	17.7		123.9	
10297-AAA	LTE-FDD (SC-FDMA, 50% RB, 20 MHz, QPSK)	X	6.14	65.8	18.6	5.81	125.1	±1.2 %
		Y	6.44	67.2	19.7		135.7	
		Z	6.52	67.0	19.3		142.2	
10311-AAA	LTE-FDD (SC-FDMA, 100% RB, 15 MHz, QPSK)	X	6.76	66.6	19.1	6.06	131.8	±1.4 %
		Y	7.03	67.8	20.0		142.5	
		Z	7.15	67.7	19.7		148.6	
10315-AAA	IEEE 802.11b WiFi 2.4 GHz (DSSS, 1 Mbps, 96pc duty cycle)	X	2.42	64.6	16.1	1.71	116.8	±0.5 %
		Y	3.00	69.3	19.0		126.9	
		Z	2.61	66.3	17.2		128.2	
10317-AAA	IEEE 802.11a WiFi 5 GHz (OFDM, 6 Mbps, 96pc duty cycle)	X	9.71	67.6	20.5	8.36	111.7	±2.5 %
		Y	9.99	68.6	21.4		122.2	
		Z	10.38	68.9	21.3		129.5	

10400-AAA	IEEE 802.11ac WiFi (20MHz, 64-QAM, 99pc duty cycle)	X	9.83	67.8	20.6	8.37	112.9	±2.5 %
		Y	10.09	68.7	21.4		123.9	
		Z	10.48	68.9	21.3		130.5	
10402-AAA	IEEE 802.11ac WiFi (80MHz, 64-QAM, 99pc duty cycle)	X	10.61	68.3	20.7	8.53	121.1	±2.5 %
		Y	11.25	70.0	21.9		135.4	
		Z	11.15	69.4	21.4		137.4	
10403-AAA	CDMA2000 (1xEV-DO, Rev. 0)	X	4.51	67.4	17.8	3.76	119.2	±0.5 %
		Y	4.91	69.5	19.3		128.3	
		Z	4.84	67.5	18.1		135.4	
10404-AAA	CDMA2000 (1xEV-DO, Rev. A)	X	4.51	67.7	18.0	3.77	117.4	±0.5 %
		Y	4.92	69.8	19.5		125.4	
		Z	4.71	67.3	18.0		131.9	

The reported uncertainty of measurement is stated as the standard uncertainty of measurement multiplied by the coverage factor $k=2$, which for a normal distribution corresponds to a coverage probability of approximately 95%.

^A The uncertainties of NormX,Y,Z do not affect the E^2 -field uncertainty inside TSL (see Pages 8 and 9).

^B Numerical linearization parameter: uncertainty not required.

^E Uncertainty is determined using the max. deviation from linear response applying rectangular distribution and is expressed for the square of the field value.

DASY/EASY - Parameters of Probe: EX3DV4 - SN:3914

Calibration Parameter Determined in Head Tissue Simulating Media

f (MHz) ^C	Relative Permittivity ^F	Conductivity (S/m) ^F	ConvF X	ConvF Y	ConvF Z	Alpha ^G	Depth ^G (mm)	Unct. (k=2)
750	41.9	0.89	9.70	9.70	9.70	0.34	1.01	± 12.0 %
835	41.5	0.90	9.34	9.34	9.34	0.67	0.67	± 12.0 %
1750	40.1	1.37	7.99	7.99	7.99	0.79	0.56	± 12.0 %
1900	40.0	1.40	7.69	7.69	7.69	0.80	0.58	± 12.0 %
2450	39.2	1.80	6.95	6.95	6.95	0.41	0.77	± 12.0 %
2600	39.0	1.96	6.79	6.79	6.79	0.40	0.82	± 12.0 %
5200	36.0	4.66	4.99	4.99	4.99	0.30	1.80	± 13.1 %
5300	35.9	4.76	4.82	4.82	4.82	0.30	1.80	± 13.1 %
5500	35.6	4.96	4.55	4.55	4.55	0.35	1.80	± 13.1 %
5600	35.5	5.07	4.37	4.37	4.37	0.35	1.80	± 13.1 %
5800	35.3	5.27	4.52	4.52	4.52	0.35	1.80	± 13.1 %

^C Frequency validity of ± 100 MHz only applies for DASY v4.4 and higher (see Page 2), else it is restricted to ± 50 MHz. The uncertainty is the RSS of the ConvF uncertainty at calibration frequency and the uncertainty for the indicated frequency band.

^F At frequencies below 3 GHz, the validity of tissue parameters (ϵ and σ) can be relaxed to ± 10% if liquid compensation formula is applied to measured SAR values. At frequencies above 3 GHz, the validity of tissue parameters (ϵ and σ) is restricted to ± 5%. The uncertainty is the RSS of the ConvF uncertainty for indicated target tissue parameters.

^G Alpha/Depth are determined during calibration. SPEAG warrants that the remaining deviation due to the boundary effect after compensation is always less than ± 1% for frequencies below 3 GHz and below ± 2% for frequencies between 3-6 GHz at any distance larger than half the probe tip diameter from the boundary.

DASY/EASY - Parameters of Probe: EX3DV4 - SN:3914

Calibration Parameter Determined in Body Tissue Simulating Media

f (MHz) ^C	Relative Permittivity ^F	Conductivity (S/m) ^F	ConvF X	ConvF Y	ConvF Z	Alpha ^G	Depth ^G (mm)	Unct. (k=2)
750	55.5	0.96	9.39	9.39	9.39	0.63	0.74	± 12.0 %
835	55.2	0.97	9.31	9.31	9.31	0.56	0.76	± 12.0 %
1750	53.4	1.49	7.89	7.89	7.89	0.32	1.03	± 12.0 %
1900	53.3	1.52	7.51	7.51	7.51	0.51	0.76	± 12.0 %
2450	52.7	1.95	7.02	7.02	7.02	0.80	0.50	± 12.0 %
2600	52.5	2.16	6.81	6.81	6.81	0.80	0.50	± 12.0 %
5200	49.0	5.30	4.52	4.52	4.52	0.35	1.90	± 13.1 %
5300	48.9	5.42	4.32	4.32	4.32	0.35	1.90	± 13.1 %
5500	48.6	5.65	4.07	4.07	4.07	0.35	1.90	± 13.1 %
5600	48.5	5.77	3.97	3.97	3.97	0.35	1.90	± 13.1 %
5800	48.2	6.00	4.14	4.14	4.14	0.40	1.90	± 13.1 %

^C Frequency validity of ± 100 MHz only applies for DASY v4.4 and higher (see Page 2), else it is restricted to ± 50 MHz. The uncertainty is the RSS of the ConvF uncertainty at calibration frequency and the uncertainty for the indicated frequency band.

^F At frequencies below 3 GHz, the validity of tissue parameters (ϵ and σ) can be relaxed to ± 10% if liquid compensation formula is applied to measured SAR values. At frequencies above 3 GHz, the validity of tissue parameters (ϵ and σ) is restricted to ± 5%. The uncertainty is the RSS of the ConvF uncertainty for indicated target tissue parameters.

^G Alpha/Depth are determined during calibration. SPEAG warrants that the remaining deviation due to the boundary effect after compensation is always less than ± 1% for frequencies below 3 GHz and below ± 2% for frequencies between 3-6 GHz at any distance larger than half the probe tip diameter from the boundary.

Frequency Response of E-Field

(TEM-Cell:ifi110 EXX, Waveguide: R22)

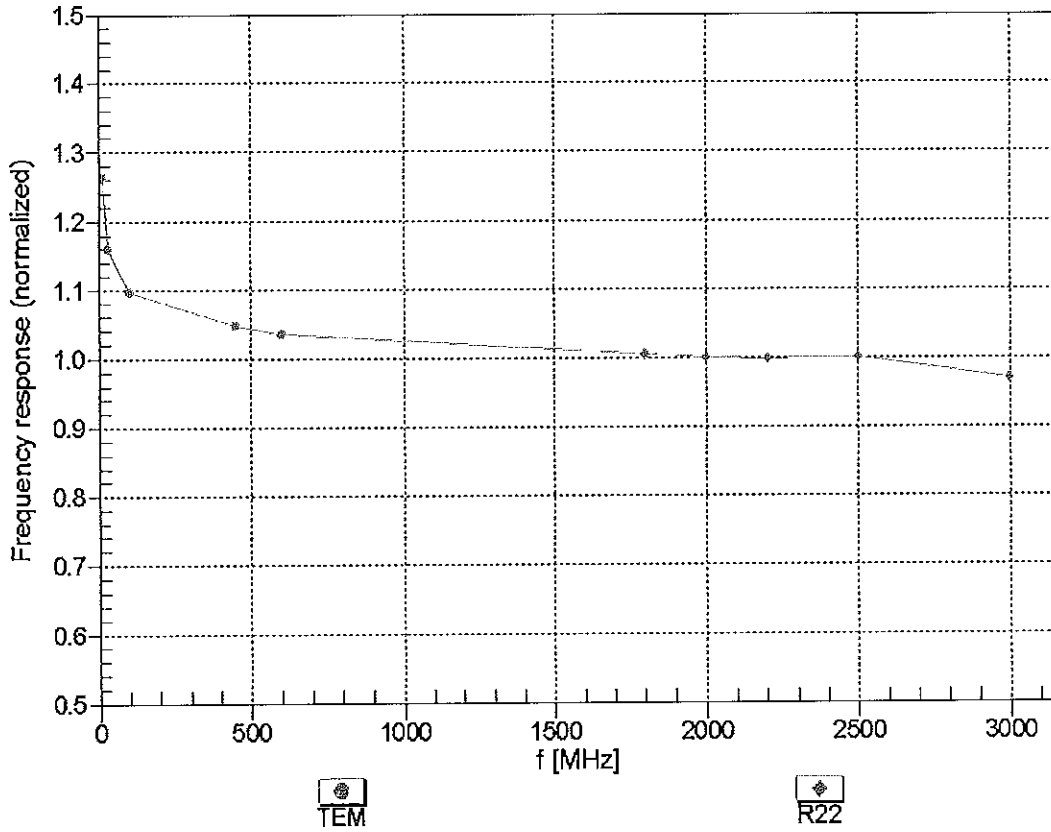

Uncertainty of Frequency Response of E-field: $\pm 6.3\%$ (k=2)

Receiving Pattern (ϕ), $\theta = 0^\circ$

f=600 MHz,TEM

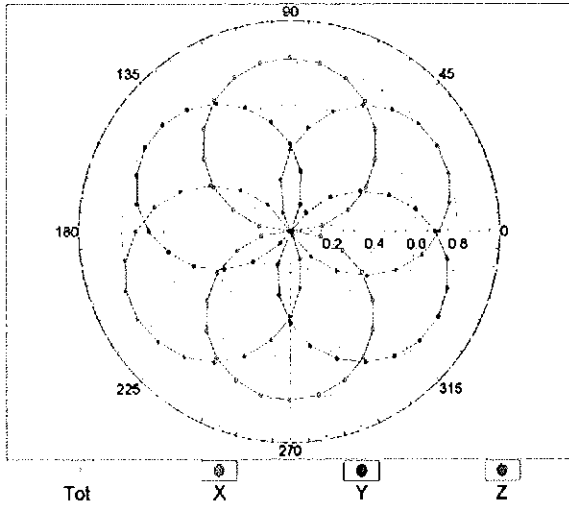

f=1800 MHz,R22

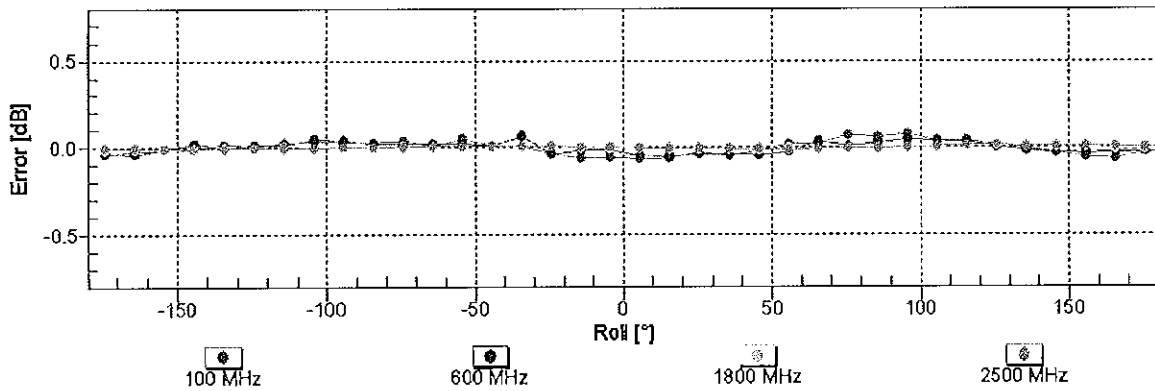
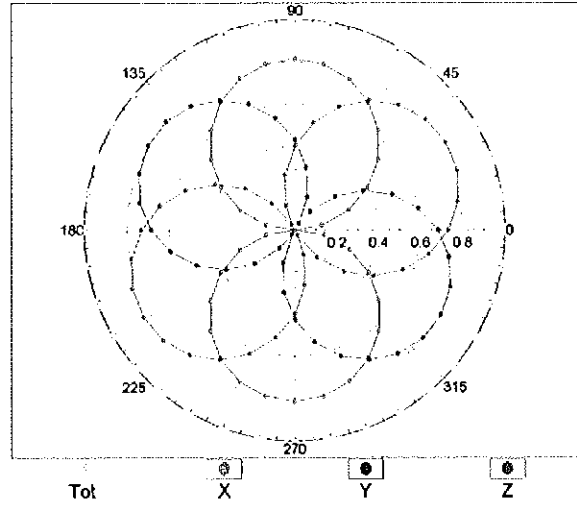

Uncertainty of Axial Isotropy Assessment: $\pm 0.5\%$ ($k=2$)

Dynamic Range $f(SAR_{head})$ (TEM cell , $f = 900$ MHz)

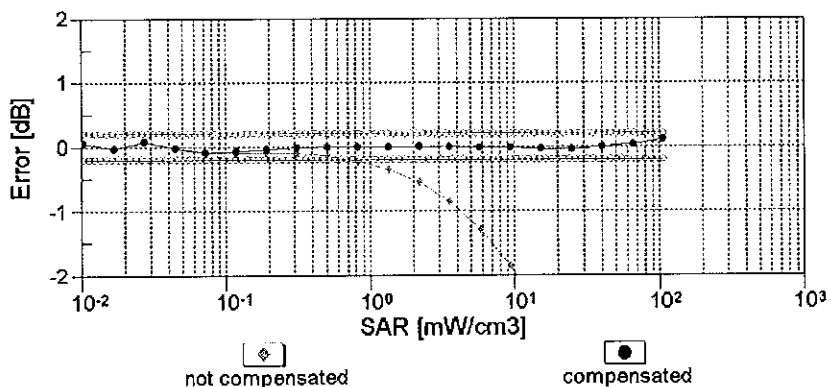
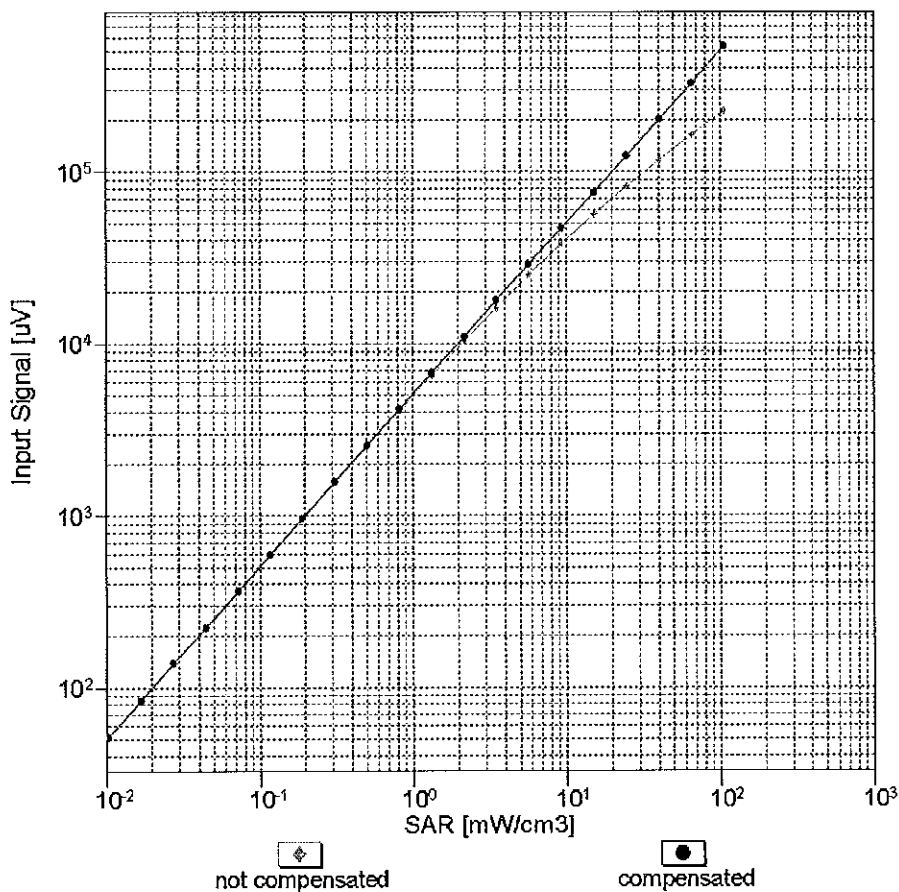

Uncertainty of Linearity Assessment: $\pm 0.6\%$ ($k=2$)

Conversion Factor Assessment

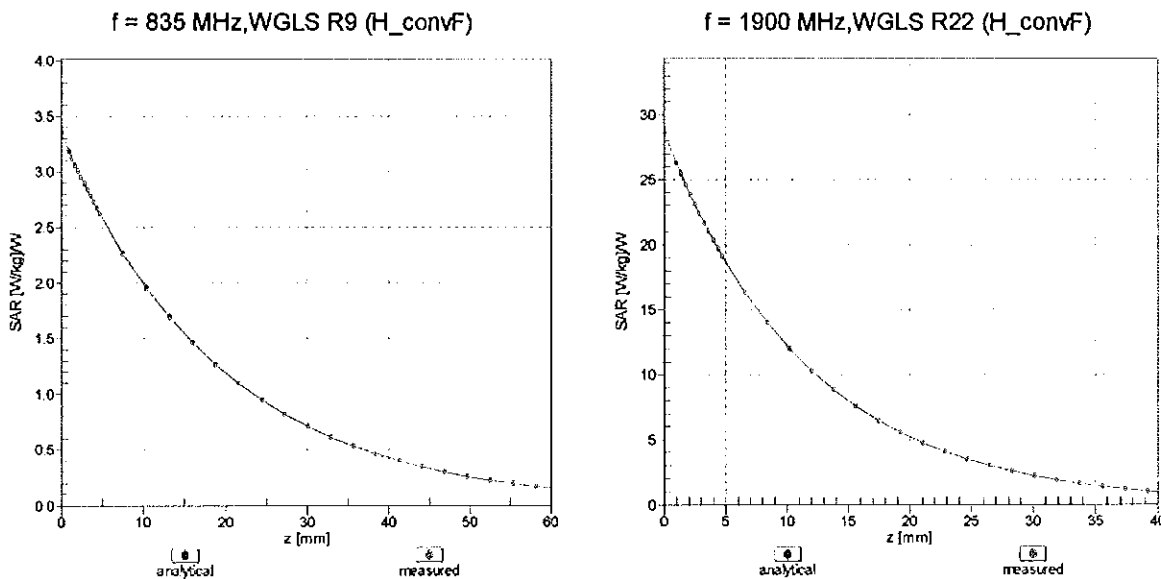

Deviation from Isotropy in Liquid

Error (ϕ, θ), f = 900 MHz

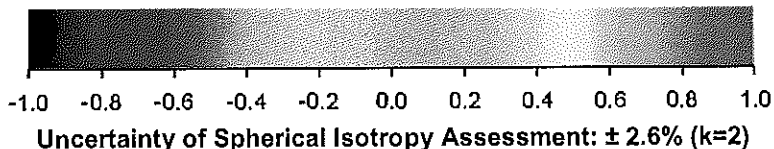
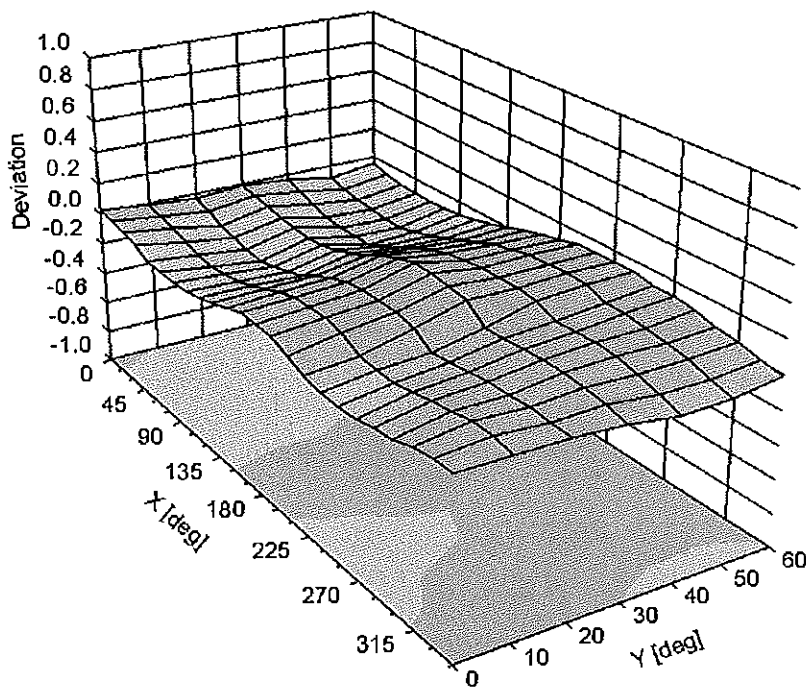

DASY/EASY - Parameters of Probe: EX3DV4 - SN:3914**Other Probe Parameters**

Sensor Arrangement	Triangular
Connector Angle (°)	-24.3
Mechanical Surface Detection Mode	enabled
Optical Surface Detection Mode	disabled
Probe Overall Length	337 mm
Probe Body Diameter	10 mm
Tip Length	9 mm
Tip Diameter	2.5 mm
Probe Tip to Sensor X Calibration Point	1 mm
Probe Tip to Sensor Y Calibration Point	1 mm
Probe Tip to Sensor Z Calibration Point	1 mm
Recommended Measurement Distance from Surface	2 mm



Accredited by the Swiss Accreditation Service (SAS)
The Swiss Accreditation Service is one of the signatories to the EA
Multilateral Agreement for the recognition of calibration certificates

Accreditation No.: **SCS 108**

Client **PC Test**

Certificate No: **EX3-3920_Dec13**

CALIBRATION CERTIFICATE

Object **EX3DV4 - SN:3920**

Calibration procedure(s) **QA CAL-01.v9, QA CAL-14.v4, QA CAL-23.v5, QA CAL-25.v6
Calibration procedure for dosimetric E-field probes**

Calibration date: **December 18, 2013**

*VCC
1/12/14*

This calibration certificate documents the traceability to national standards, which realize the physical units of measurements (SI).
The measurements and the uncertainties with confidence probability are given on the following pages and are part of the certificate.

All calibrations have been conducted in the closed laboratory facility: environment temperature (22 ± 3)°C and humidity < 70%.

Calibration Equipment used (M&TE critical for calibration)

Primary Standards	ID	Cal Date (Certificate No.)	Scheduled Calibration
Power meter E4419B	GB41293874	04-Apr-13 (No. 217-01733)	Apr-14
Power sensor E4412A	MY41498087	04-Apr-13 (No. 217-01733)	Apr-14
Reference 3 dB Attenuator	SN: S5054 (3c)	04-Apr-13 (No. 217-01737)	Apr-14
Reference 20 dB Attenuator	SN: S5277 (20x)	04-Apr-13 (No. 217-01735)	Apr-14
Reference 30 dB Attenuator	SN: S5129 (30b)	04-Apr-13 (No. 217-01738)	Apr-14
Reference Probe ES3DV2	SN: 3013	28-Dec-12 (No. ES3-3013_Dec12)	Dec-13
DAE4	SN: 660	13-Dec-13 (No. DAE4-660_Dec13)	Dec-14
Secondary Standards	ID	Check Date (in house)	Scheduled Check
RF generator HP 8648C	US3642U01700	4-Aug-99 (in house check Apr-13)	In house check: Apr-15
Network Analyzer HP 8753E	US37390585	18-Oct-01 (in house check Oct-13)	In house check: Oct-14

	Name	Function	Signature
Calibrated by:	Leif Klysner	Laboratory Technician	<i>Leif Klysner</i>
Approved by:	Katja Pokovic	Technical Manager	<i>Katja Pokovic</i>

Issued: December 19, 2013

This calibration certificate shall not be reproduced except in full without written approval of the laboratory.



Accredited by the Swiss Accreditation Service (SAS)

Accreditation No.: **SCS 108**

The Swiss Accreditation Service is one of the signatories to the EA
Multilateral Agreement for the recognition of calibration certificates

Glossary:

TSL	tissue simulating liquid
NORM _{x,y,z}	sensitivity in free space
ConvF	sensitivity in TSL / NORM _{x,y,z}
DCP	diode compression point
CF	crest factor (1/duty_cycle) of the RF signal
A, B, C, D	modulation dependent linearization parameters
Polarization φ	φ rotation around probe axis
Polarization ϑ	ϑ rotation around an axis that is in the plane normal to probe axis (at measurement center), i.e., $\vartheta = 0$ is normal to probe axis
Connector Angle	information used in DASY system to align probe sensor X to the robot coordinate system

Calibration is Performed According to the Following Standards:

- IEEE Std 1528-2013, "IEEE Recommended Practice for Determining the Peak Spatial-Averaged Specific Absorption Rate (SAR) in the Human Head from Wireless Communications Devices: Measurement Techniques", June 2013
- IEC 62209-1, "Procedure to measure the Specific Absorption Rate (SAR) for hand-held devices used in close proximity to the ear (frequency range of 300 MHz to 3 GHz)", February 2005

Methods Applied and Interpretation of Parameters:

- NORM_{x,y,z}**: Assessed for E-field polarization $\vartheta = 0$ ($f \leq 900$ MHz in TEM-cell; $f > 1800$ MHz: R22 waveguide). NORM_{x,y,z} are only intermediate values, i.e., the uncertainties of NORM_{x,y,z} does not affect the E^2 -field uncertainty inside TSL (see below ConvF).
- NORM(f)_{x,y,z}** = NORM_{x,y,z} * frequency_response (see Frequency Response Chart). This linearization is implemented in DASY4 software versions later than 4.2. The uncertainty of the frequency response is included in the stated uncertainty of ConvF.
- DCP_{x,y,z}**: DCP are numerical linearization parameters assessed based on the data of power sweep with CW signal (no uncertainty required). DCP does not depend on frequency nor media.
- PAR**: PAR is the Peak to Average Ratio that is not calibrated but determined based on the signal characteristics
- A_{x,y,z}; B_{x,y,z}; C_{x,y,z}; D_{x,y,z}; VR_{x,y,z}; A, B, C, D** are numerical linearization parameters assessed based on the data of power sweep for specific modulation signal. The parameters do not depend on frequency nor media. VR is the maximum calibration range expressed in RMS voltage across the diode.
- ConvF and Boundary Effect Parameters**: Assessed in flat phantom using E-field (or Temperature Transfer Standard for $f \leq 800$ MHz) and inside waveguide using analytical field distributions based on power measurements for $f > 800$ MHz. The same setups are used for assessment of the parameters applied for boundary compensation (alpha, depth) of which typical uncertainty values are given. These parameters are used in DASY4 software to improve probe accuracy close to the boundary. The sensitivity in TSL corresponds to NORM_{x,y,z} * ConvF whereby the uncertainty corresponds to that given for ConvF. A frequency dependent ConvF is used in DASY version 4.4 and higher which allows extending the validity from ± 50 MHz to ± 100 MHz.
- Spherical isotropy (3D deviation from isotropy)**: in a field of low gradients realized using a flat phantom exposed by a patch antenna.
- Sensor Offset**: The sensor offset corresponds to the offset of virtual measurement center from the probe tip (on probe axis). No tolerance required.
- Connector Angle**: The angle is assessed using the information gained by determining the NORM_x (no uncertainty required).

Probe EX3DV4

SN:3920

Manufactured: December 18, 2012
Calibrated: December 18, 2013

Calibrated for DASY/EASY Systems
(Note: non-compatible with DASY2 system!)

DASY/EASY - Parameters of Probe: EX3DV4 - SN:3920

Basic Calibration Parameters

	Sensor X	Sensor Y	Sensor Z	Unc (k=2)
Norm ($\mu\text{V}/(\text{V}/\text{m})^2$) ^A	0.34	0.50	0.49	$\pm 10.1\%$
DCP (mV) ^B	102.9	99.5	98.3	

Modulation Calibration Parameters

UID	Communication System Name		A dB	B dB $\sqrt{\mu\text{V}}$	C	D dB	VR mV	Unc ^E (k=2)
0	CW	X	0.0	0.0	1.0	0.00	182.5	$\pm 2.7\%$
		Y	0.0	0.0	1.0		164.9	
		Z	0.0	0.0	1.0		153.0	
10010- CAA	SAR Validation (Square, 100ms, 10ms)	X	0.76	53.8	6.5	10.00	44.1	$\pm 2.2\%$
		Y	2.33	62.8	11.4		43.7	
		Z	1.15	55.6	7.5		53.0	
10011- CAA	UMTS-FDD (WCDMA)	X	3.36	66.5	17.5	2.91	142.4	$\pm 0.5\%$
		Y	3.15	65.0	16.7		131.4	
		Z	3.26	66.0	17.7		121.6	
10012- CAA	IEEE 802.11b WiFi 2.4 GHz (DSSS, 1 Mbps)	X	2.69	66.4	16.9	1.87	138.1	$\pm 0.5\%$
		Y	2.56	65.1	16.2		130.7	
		Z	2.72	66.6	17.2		121.4	
10021- DAA	GSM-FDD (TDMA, GMSK)	X	2.06	63.4	11.7	9.39	99.7	$\pm 1.9\%$
		Y	2.43	66.1	14.1		94.7	
		Z	2.90	69.9	16.1		121.8	
10023- DAA	GPRS-FDD (TDMA, GMSK, TN 0)	X	1.94	62.4	11.3	9.57	95.1	$\pm 1.9\%$
		Y	2.31	64.8	13.1		90.1	
		Z	2.98	70.4	16.4		117.0	
10024- DAA	GPRS-FDD (TDMA, GMSK, TN 0-1)	X	2.19	67.1	12.2	6.56	140.1	$\pm 1.4\%$
		Y	2.35	67.0	12.9		134.0	
		Z	3.45	73.5	16.1		131.4	
10027- DAA	GPRS-FDD (TDMA, GMSK, TN 0-1-2)	X	1.18	61.7	8.5	4.80	121.6	$\pm 1.2\%$
		Y	1.57	63.4	10.0		116.0	
		Z	1.57	65.5	11.9		109.2	
10028- DAA	GPRS-FDD (TDMA, GMSK, TN 0-1-2-3)	X	3.80	74.5	13.3	3.55	130.3	$\pm 0.9\%$
		Y	1.00	60.5	8.0		123.9	
		Z	1.58	66.1	11.1		119.0	
10032- CAA	IEEE 802.15.1 Bluetooth (GFSK, DH5)	X	0.18	55.2	3.4	1.16	111.6	$\pm 0.7\%$
		Y	0.34	57.4	4.4		143.6	
		Z	0.40	59.2	5.7		136.6	
10039- CAA	CDMA2000 (1xRTT, RC1)	X	4.49	65.9	18.1	4.57	131.8	$\pm 0.9\%$
		Y	4.57	65.1	17.5		123.0	
		Z	4.66	65.9	18.3		118.6	
10062- CAA	IEEE 802.11a/h WiFi 5 GHz (OFDM, 6 Mbps)	X	10.09	68.6	21.3	8.68	126.5	$\pm 2.5\%$
		Y	10.31	68.5	21.1		121.9	
		Z	10.12	68.3	21.3		115.8	

10098-CAA	UMTS-FDD (HSUPA, Subtest 2)	X	4.64	66.6	18.1	3.98	144.6	±0.7 %
		Y	4.54	65.4	17.4		133.9	
		Z	4.60	66.1	18.0		128.0	
10100-CAB	LTE-FDD (SC-FDMA, 100% RB, 20 MHz, QPSK)	X	6.00	65.5	18.3	5.67	104.2	±1.4 %
		Y	6.44	66.7	18.8		138.2	
		Z	6.54	67.4	19.4		134.7	
10108-CAB	LTE-FDD (SC-FDMA, 100% RB, 10 MHz, QPSK)	X	6.37	67.0	19.2	5.80	149.0	±1.4 %
		Y	6.40	66.6	18.9		141.2	
		Z	6.40	66.9	19.4		132.1	
10110-CAB	LTE-FDD (SC-FDMA, 100% RB, 5 MHz, QPSK)	X	5.96	66.3	18.9	5.75	142.3	±1.4 %
		Y	6.05	66.1	18.7		136.6	
		Z	6.03	66.3	19.1		128.2	
10114-CAA	IEEE 802.11n (HT Greenfield, 13.5 Mbps, BPSK)	X	10.28	68.7	20.9	8.10	137.3	±2.5 %
		Y	10.32	68.5	20.7		131.3	
		Z	10.24	68.5	20.9		124.5	
10117-CAA	IEEE 802.11n (HT Mixed, 13.5 Mbps, BPSK)	X	10.29	68.8	20.9	8.07	138.5	±2.5 %
		Y	10.34	68.6	20.8		131.9	
		Z	10.26	68.5	20.9		125.5	
10151-CAB	LTE-TDD (SC-FDMA, 50% RB, 20 MHz, QPSK)	X	7.20	67.5	21.6	9.28	118.6	±2.2 %
		Y	7.59	67.9	21.6		116.7	
		Z	7.78	69.2	22.7		110.7	
10154-CAB	LTE-FDD (SC-FDMA, 50% RB, 10 MHz, QPSK)	X	5.98	66.4	18.9	5.75	142.7	±1.2 %
		Y	5.97	65.7	18.4		132.7	
		Z	6.06	66.4	19.1		128.6	
10160-CAB	LTE-FDD (SC-FDMA, 50% RB, 15 MHz, QPSK)	X	6.41	66.8	19.1	5.82	147.7	±1.4 %
		Y	6.48	66.5	18.8		137.3	
		Z	6.53	67.0	19.4		134.9	
10169-CAB	LTE-FDD (SC-FDMA, 1 RB, 20 MHz, QPSK)	X	4.59	65.5	18.6	5.73	120.3	±1.2 %
		Y	4.76	65.0	18.2		113.9	
		Z	4.82	65.6	18.9		112.0	
10172-CAB	LTE-TDD (SC-FDMA, 1 RB, 20 MHz, QPSK)	X	5.77	69.3	22.7	9.21	128.1	±1.9 %
		Y	6.15	69.3	22.6		123.8	
		Z	6.22	70.3	23.6		120.8	
10175-CAB	LTE-FDD (SC-FDMA, 1 RB, 10 MHz, QPSK)	X	4.62	65.6	18.7	5.72	120.2	±0.9 %
		Y	4.75	65.0	18.2		113.5	
		Z	4.80	65.6	18.8		110.7	
10181-CAB	LTE-FDD (SC-FDMA, 1 RB, 15 MHz, QPSK)	X	4.57	65.4	18.6	5.72	118.9	±0.9 %
		Y	4.72	64.8	18.1		113.1	
		Z	4.81	65.6	18.8		110.4	
10193-CAA	IEEE 802.11n (HT Greenfield, 6.5 Mbps, BPSK)	X	9.77	68.3	20.8	8.09	128.1	±2.5 %
		Y	9.84	67.9	20.5		117.1	
		Z	9.80	68.1	20.8		116.6	
10196-CAA	IEEE 802.11n (HT Mixed, 6.5 Mbps, BPSK)	X	9.78	68.4	20.8	8.10	128.4	±2.5 %
		Y	9.86	68.0	20.5		120.3	
		Z	9.82	68.1	20.9		119.1	

10219-CAA	IEEE 802.11n (HT Mixed, 7.2 Mbps, BPSK)	X	9.70	68.4	20.8	8.03	128.0	±2.5 %
		Y	9.79	68.0	20.5		119.6	
		Z	9.72	68.1	20.8		118.7	
10222-CAA	IEEE 802.11n (HT Mixed, 15 Mbps, BPSK)	X	10.27	68.8	20.9	8.06	137.0	±2.5 %
		Y	10.18	68.3	20.6		125.2	
		Z	10.20	68.5	20.9		124.8	
10225-CAA	UMTS-FDD (HSPA+)	X	6.64	66.1	18.7	5.97	108.8	±1.4 %
		Y	7.23	67.1	19.1		148.9	
		Z	7.31	67.7	19.7		146.5	
10237-CAB	LTE-TDD (SC-FDMA, 1 RB, 10 MHz, QPSK)	X	5.82	69.6	23.0	9.21	130.2	±1.9 %
		Y	6.14	69.2	22.6		123.9	
		Z	6.25	70.4	23.7		122.2	
10252-CAB	LTE-TDD (SC-FDMA, 50% RB, 10 MHz, QPSK)	X	6.85	67.5	21.7	9.24	112.9	±2.2 %
		Y	7.54	69.0	22.4		149.2	
		Z	7.80	70.6	23.7		147.3	
10267-CAB	LTE-TDD (SC-FDMA, 100% RB, 10 MHz, QPSK)	X	7.23	67.6	21.6	9.30	118.3	±2.2 %
		Y	7.55	67.7	21.5		111.5	
		Z	7.79	69.2	22.7		109.6	
10274-CAA	UMTS-FDD (HSUPA, Subtest 5, 3GPP Rel8.10)	X	5.64	65.9	18.1	4.87	105.5	±1.2 %
		Y	6.04	66.4	18.2		142.6	
		Z	6.09	66.9	18.7		138.4	
10275-CAA	UMTS-FDD (HSUPA, Subtest 5, 3GPP Rel8.4)	X	4.42	66.3	18.1	3.96	135.8	±0.7 %
		Y	4.26	65.0	17.3		119.3	
		Z	4.40	65.9	18.0		120.4	
10291-AAA	CDMA2000, RC3, SO55, Full Rate	X	3.62	66.7	18.1	3.46	123.6	±0.7 %
		Y	3.38	64.3	16.7		112.5	
		Z	3.59	66.0	17.9		114.3	
10292-AAA	CDMA2000, RC3, SO32, Full Rate	X	3.46	66.0	17.7	3.39	127.3	±0.5 %
		Y	3.35	64.5	16.8		113.7	
		Z	3.50	65.7	17.7		115.4	
10297-AAA	LTE-FDD (SC-FDMA, 50% RB, 20 MHz, QPSK)	X	6.35	66.9	19.2	5.81	145.7	±1.2 %
		Y	6.26	66.1	18.7		129.2	
		Z	6.42	67.0	19.4		131.3	
10311-AAA	LTE-FDD (SC-FDMA, 100% RB, 15 MHz, QPSK)	X	6.45	65.9	18.7	6.06	103.7	±1.7 %
		Y	6.90	66.9	19.1		137.2	
		Z	7.04	67.7	19.8		137.5	
10315-AAA	IEEE 802.11b WiFi 2.4 GHz (DSSS, 1 Mbps, 96pc duty cycle)	X	2.85	67.8	17.7	1.71	135.6	±0.5 %
		Y	2.45	64.7	16.0		121.4	
		Z	2.75	67.3	17.6		122.1	
10317-AAA	IEEE 802.11a WiFi 5 GHz (OFDM, 6 Mbps, 96pc duty cycle)	X	9.93	68.5	21.0	8.36	128.1	±2.7 %
		Y	10.02	68.1	20.7		117.9	
		Z	10.01	68.3	21.1		119.4	
10400-AAA	IEEE 802.11ac WiFi (20MHz, 64-QAM, 99pc duty cycle)	X	10.09	68.8	21.2	8.37	134.9	±2.5 %
		Y	10.16	68.3	20.8		119.8	
		Z	10.14	68.5	21.2		121.0	

10402-AAA	IEEE 802.11ac WiFi (80MHz, 64-QAM, 99pc duty cycle)	X	11.18	69.8	21.5	8.53	147.1	±2.7 %
		Y	10.79	68.6	20.8		126.5	
		Z	11.17	69.6	21.6		131.4	
10403-AAA	CDMA2000 (1xEV-DO, Rev. 0)	X	4.83	69.6	18.9	3.76	139.6	±0.5 %
		Y	4.70	67.1	17.6		128.1	
		Z	4.90	68.4	18.6		127.8	
10404-AAA	CDMA2000 (1xEV-DO, Rev. A)	X	4.73	69.5	18.9	3.77	134.8	±0.5 %
		Y	4.62	67.1	17.7		124.9	
		Z	4.67	67.7	18.1		125.9	

The reported uncertainty of measurement is stated as the standard uncertainty of measurement multiplied by the coverage factor $k=2$, which for a normal distribution corresponds to a coverage probability of approximately 95%.

^A The uncertainties of NormX,Y,Z do not affect the E^2 -field uncertainty inside TSL (see Pages 8 and 9).

^B Numerical linearization parameter: uncertainty not required.

^E Uncertainty is determined using the max. deviation from linear response applying rectangular distribution and is expressed for the square of the field value.

DASY/EASY - Parameters of Probe: EX3DV4 - SN:3920

Calibration Parameter Determined in Head Tissue Simulating Media

f (MHz) ^C	Relative Permittivity ^F	Conductivity (S/m) ^F	ConvF X	ConvF Y	ConvF Z	Alpha ^G	Depth ^G (mm)	Unct. (k=2)
750	41.9	0.89	10.05	10.05	10.05	0.27	1.13	± 12.0 %
835	41.5	0.90	9.69	9.69	9.69	0.50	0.76	± 12.0 %
1750	40.1	1.37	7.91	7.91	7.91	0.72	0.62	± 12.0 %
1900	40.0	1.40	7.70	7.70	7.70	0.77	0.61	± 12.0 %
2450	39.2	1.80	6.98	6.98	6.98	0.37	0.86	± 12.0 %
2600	39.0	1.96	6.74	6.74	6.74	0.34	0.97	± 12.0 %
5200	36.0	4.66	4.87	4.87	4.87	0.40	1.80	± 13.1 %
5300	35.9	4.76	4.66	4.66	4.66	0.40	1.80	± 13.1 %
5500	35.6	4.96	4.54	4.54	4.54	0.40	1.80	± 13.1 %
5600	35.5	5.07	4.37	4.37	4.37	0.40	1.80	± 13.1 %
5800	35.3	5.27	4.11	4.11	4.11	0.50	1.80	± 13.1 %

^C Frequency validity of ± 100 MHz only applies for DASY v4.4 and higher (see Page 2), else it is restricted to ± 50 MHz. The uncertainty is the RSS of the ConvF uncertainty at calibration frequency and the uncertainty for the indicated frequency band.

^F At frequencies below 3 GHz, the validity of tissue parameters (ϵ and σ) can be relaxed to ± 10% if liquid compensation formula is applied to measured SAR values. At frequencies above 3 GHz, the validity of tissue parameters (ϵ and σ) is restricted to ± 5%. The uncertainty is the RSS of the ConvF uncertainty for indicated target tissue parameters.

^G Alpha/Depth are determined during calibration. SPEAG warrants that the remaining deviation due to the boundary effect after compensation is always less than ± 1% for frequencies below 3 GHz and below ± 2% for frequencies between 3-6 GHz at any distance larger than half the probe tip diameter from the boundary.

DASY/EASY - Parameters of Probe: EX3DV4 - SN:3920

Calibration Parameter Determined in Body Tissue Simulating Media

f (MHz) ^C	Relative Permittivity ^F	Conductivity (S/m) ^F	ConvF X	ConvF Y	ConvF Z	Alpha ^G	Depth ^G (mm)	Unct. (k=2)
750	55.5	0.96	9.54	9.54	9.54	0.32	1.07	± 12.0 %
835	55.2	0.97	9.47	9.47	9.47	0.45	0.85	± 12.0 %
1750	53.4	1.49	7.77	7.77	7.77	0.59	0.74	± 12.0 %
1900	53.3	1.52	7.50	7.50	7.50	0.37	0.91	± 12.0 %
2450	52.7	1.95	7.18	7.18	7.18	0.80	0.56	± 12.0 %
2600	52.5	2.16	6.91	6.91	6.91	0.80	0.57	± 12.0 %
5200	49.0	5.30	4.23	4.23	4.23	0.50	1.90	± 13.1 %
5300	48.9	5.42	4.11	4.11	4.11	0.50	1.90	± 13.1 %
5500	48.6	5.65	3.80	3.80	3.80	0.50	1.90	± 13.1 %
5600	48.5	5.77	3.62	3.62	3.62	0.50	1.90	± 13.1 %
5800	48.2	6.00	4.00	4.00	4.00	0.50	1.90	± 13.1 %

^C Frequency validity of ± 100 MHz only applies for DASY v4.4 and higher (see Page 2), else it is restricted to ± 50 MHz. The uncertainty is the RSS of the ConvF uncertainty at calibration frequency and the uncertainty for the indicated frequency band.

^F At frequencies below 3 GHz, the validity of tissue parameters (ϵ and σ) can be relaxed to ± 10% if liquid compensation formula is applied to measured SAR values. At frequencies above 3 GHz, the validity of tissue parameters (ϵ and σ) is restricted to ± 5%. The uncertainty is the RSS of the ConvF uncertainty for indicated target tissue parameters.

^G Alpha/Depth are determined during calibration. SPEAG warrants that the remaining deviation due to the boundary effect after compensation is always less than ± 1% for frequencies below 3 GHz and below ± 2% for frequencies between 3-6 GHz at any distance larger than half the probe tip diameter from the boundary.

Frequency Response of E-Field (TEM-Cell:ifi110 EXX, Waveguide: R22)

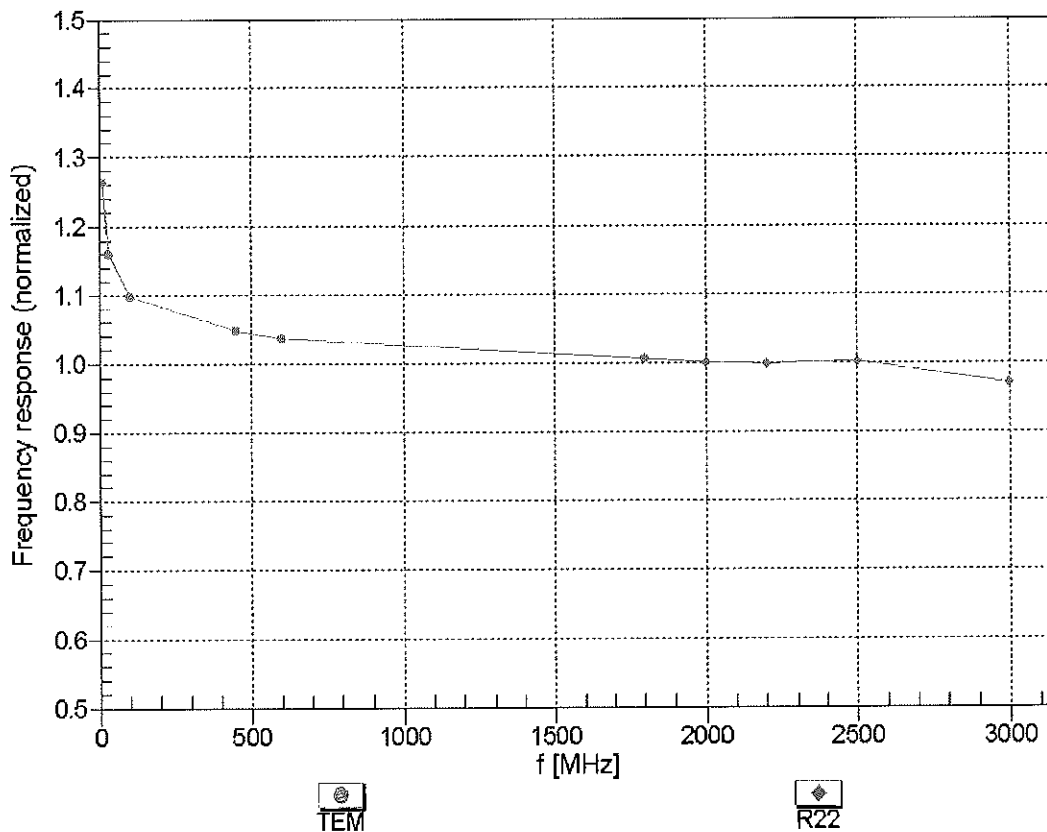

Uncertainty of Frequency Response of E-field: $\pm 6.3\%$ (k=2)

Receiving Pattern (ϕ), $\theta = 0^\circ$

f=600 MHz,TEM

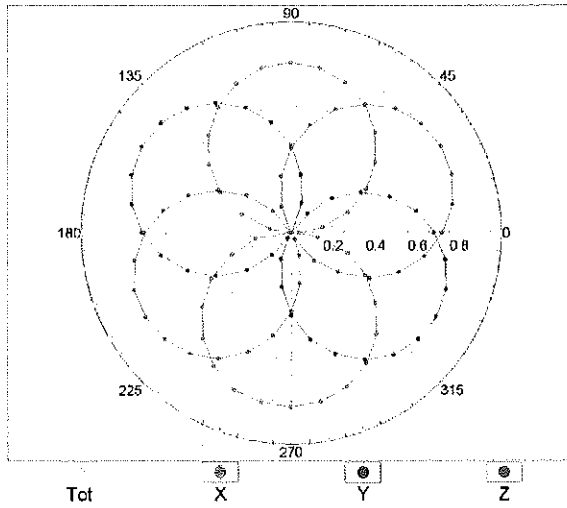

f=1800 MHz,R22

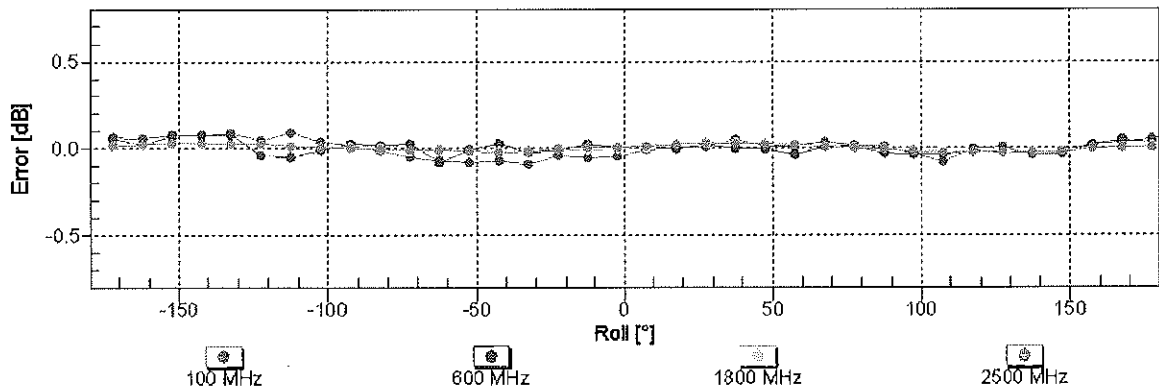
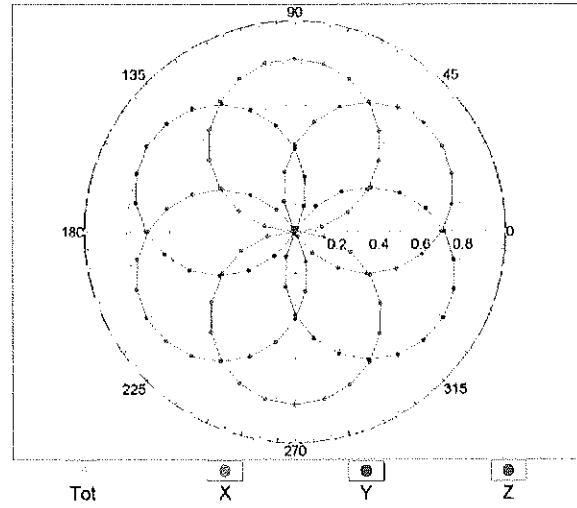

Uncertainty of Axial Isotropy Assessment: $\pm 0.5\%$ ($k=2$)

Dynamic Range $f(SAR_{head})$ (TEM cell , $f = 900$ MHz)

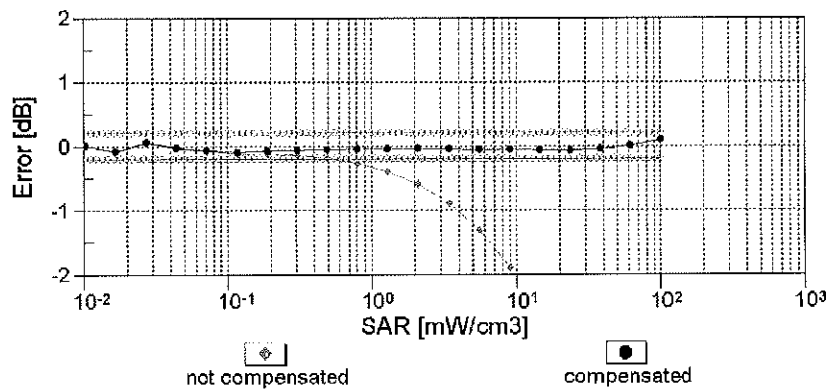
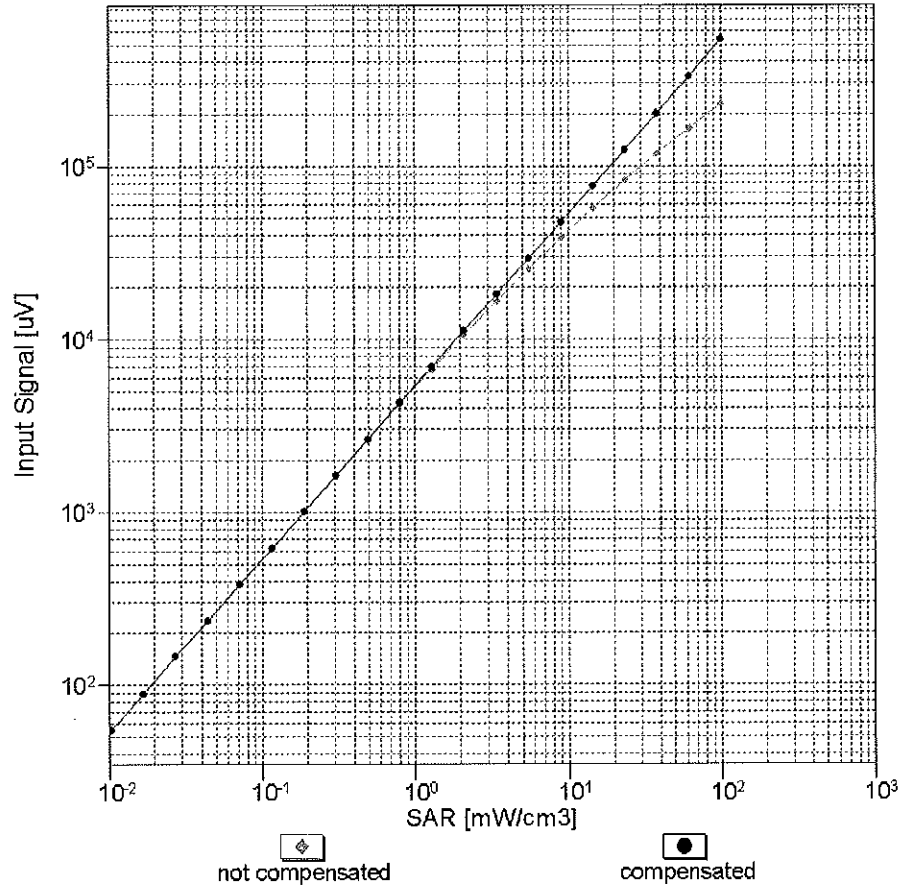

Uncertainty of Linearity Assessment: $\pm 0.6\%$ (k=2)

Conversion Factor Assessment

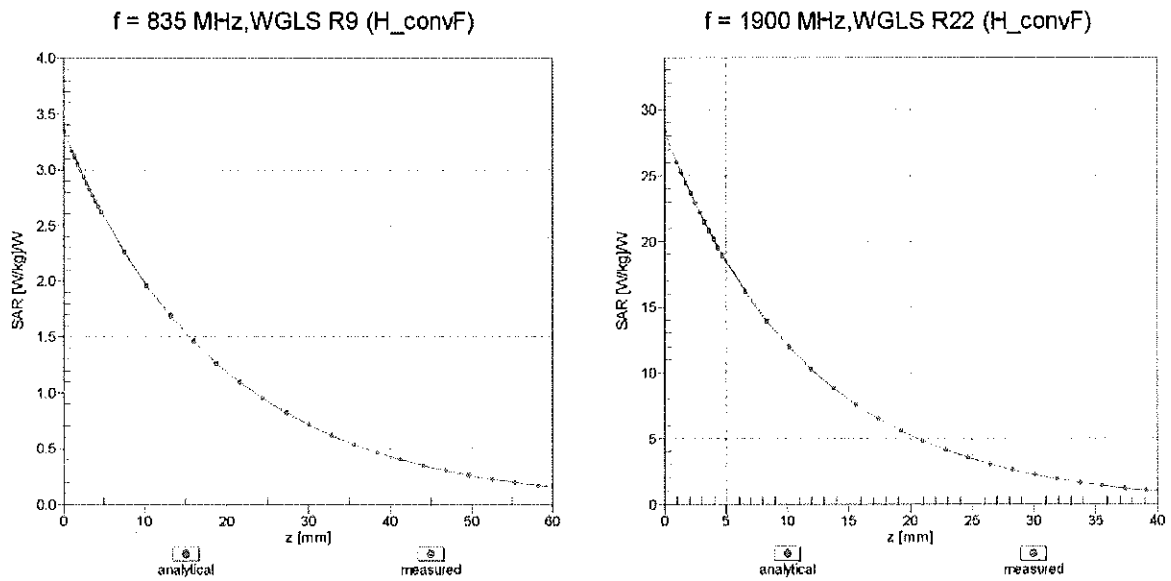

Deviation from Isotropy in Liquid Error (ϕ, θ), f = 900 MHz

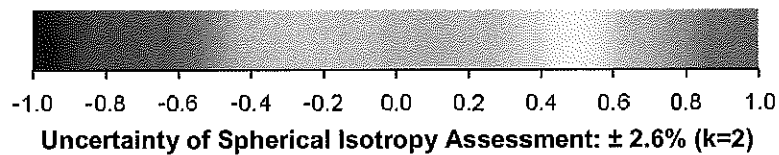
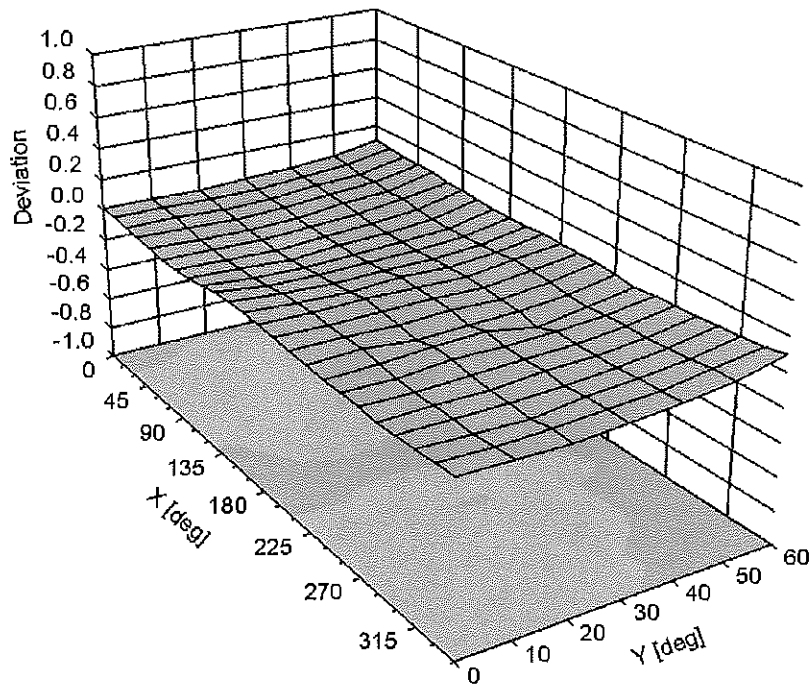

DASY/EASY - Parameters of Probe: EX3DV4 - SN:3920

Other Probe Parameters

Sensor Arrangement	Triangular
Connector Angle (°)	-22.4
Mechanical Surface Detection Mode	enabled
Optical Surface Detection Mode	disabled
Probe Overall Length	337 mm
Probe Body Diameter	10 mm
Tip Length	9 mm
Tip Diameter	2.5 mm
Probe Tip to Sensor X Calibration Point	1 mm
Probe Tip to Sensor Y Calibration Point	1 mm
Probe Tip to Sensor Z Calibration Point	1 mm
Recommended Measurement Distance from Surface	2 mm

APPENDIX D: SAR TISSUE SPECIFICATIONS

Measurement Procedure for Tissue verification:



- 1) The network analyzer and probe system was configured and calibrated.
- 2) The probe was immersed in the tissue. The tissue was placed in a nonmetallic container. Trapped air bubbles beneath the flange were minimized by placing the probe at a slight angle.
- 3) The complex admittance with respect to the probe aperture was measured
- 4) The complex relative permittivity ϵ can be calculated from the below equation (Pournaropoulos and Misra):

$$Y = \frac{j2\omega\epsilon_r\epsilon_0}{[\ln(b/a)]^2} \int_a^b \int_a^b \int_0^\pi \cos\phi' \frac{\exp[-j\omega r(\mu_0\epsilon_r'\epsilon_0)^{1/2}]}{r} d\phi' d\rho' d\rho$$

where Y is the admittance of the probe in contact with the sample, the primed and unprimed coordinates refer to source and observation points, respectively, $r^2 = \rho^2 + \rho'^2 - 2\rho\rho' \cos\phi'$, ω is the angular frequency, and $j = \sqrt{-1}$.

**Table D-I
Composition of the Tissue Equivalent Matter**

Frequency (MHz)	835	835	1900	1900	2450	2450	5200-5800	5200-5800
Tissue	Head	Body	Head	Body	Head	Body	Head	Body
Ingredients (% by weight)								
Bactericide	0.1	0.1			See page 2		See page 3	
DGBE			44.92	29.44		26.7		
HEC	1	1						
NaCl	1.45	0.94	0.18	0.39		0.1		
Sucrose	57	44.9						
Polysorbate (Tween) 80								20
Water	40.45	53.06	54.9	70.17		73.2		80

FCC ID: A3LSMN9109W		SAR EVALUATION REPORT		Reviewed by: Quality Manager
Test Dates: 08/11/14 - 08/20/14	DUT Type: Portable Handset			APPENDIX D: Page 1 of 3

2 Composition / Information on ingredients

The Item is composed of the following ingredients:

H2O	Water, 52 – 75%
C8H18O3	Diethylene glycol monobutyl ether (DGBE), 25 – 48% (CAS-No. 112-34-5, EC-No. 203-961-6, EC-index-No. 603-096-00-8) Relevant for safety; Refer to the respective Safety Data Sheet*.
NaCl	Sodium Chloride, <1.0%

**Figure D-1
Composition of 2.4 GHz Head Tissue Equivalent Matter**

Note: 2.4 GHz head liquid recipes are proprietary SPEAG. Since the composition is approximate to the actual liquids utilized, the manufacturer tissue-equivalent liquid data sheets are provided below.

Measurement Certificate / Material Test

Item Name	Head Tissue Simulating Liquid (HSL2450V2)
Product No.	SL AAH 245 BA (Charge: 130212-2)
Manufacturer	SPEAG

Measurement Method

TSL dielectric parameters measured using calibrated OCP probe.

Setup Validation

Validation results were within $\pm 2.5\%$ towards the target values of Methanol.

Target Parameters

Target parameters as defined in the IEEE 1528 and IEC 62209 compliance standards.

Test Condition

Ambient	Environment temperatur (22 ± 3)°C and humidity < 70%.
TSL Temperature	23°C
Test Date	13-Feb-13
Operator	DI



Additional Information

TSL Density 0.988 g/cm³
TSL Heat-capacity 3.680 kJ/(kg*K)

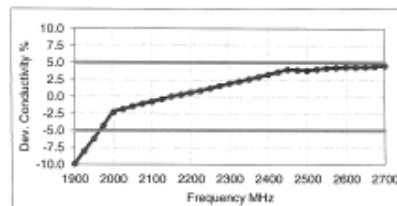
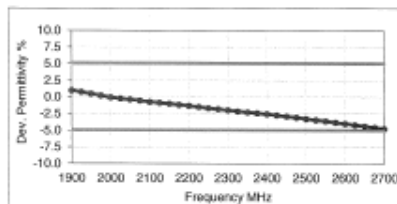
f (MHz)	Measured			Target			Diff. to Target [%]	
	HP-e'	HP-e''	sigma	eps	sigma	delta-eps	delta-sigma	
1900	40.4	11.94	1.26	40.0	1.40	1.0	-0.9	
1925	40.3	12.02	1.29	40.0	1.40	0.7	-8.0	
1950	40.2	12.11	1.31	40.0	1.40	0.5	-8.2	
1975	40.1	12.20	1.34	40.0	1.40	0.2	-4.2	
2000	40.0	12.29	1.37	40.0	1.40	-0.1	-2.3	
2025	39.9	12.39	1.40	40.0	1.42	-0.2	-1.9	
2050	39.8	12.49	1.42	39.9	1.44	-0.4	-1.4	
2075	39.6	12.57	1.45	39.9	1.47	-0.6	-1.1	
2100	39.5	12.65	1.48	39.8	1.49	-0.7	-0.7	
2125	39.4	12.74	1.51	39.8	1.51	-0.9	-0.4	
2150	39.3	12.82	1.53	39.7	1.53	-1.0	0.0	
2175	39.2	12.89	1.56	39.7	1.56	-1.2	0.3	
2200	39.1	12.97	1.59	39.6	1.58	-1.3	0.6	
2225	39.0	13.04	1.61	39.6	1.60	-1.5	0.9	
2250	38.9	13.11	1.64	39.6	1.62	-1.7	1.2	
2275	38.8	13.20	1.67	39.5	1.64	-1.8	1.6	
2300	38.7	13.28	1.70	39.5	1.67	-2.0	2.0	
2325	38.6	13.35	1.73	39.4	1.69	-2.1	2.3	
2350	38.5	13.42	1.75	39.4	1.71	-2.3	2.6	
2375	38.4	13.50	1.78	39.3	1.73	-2.4	2.9	
2400	38.3	13.58	1.81	39.3	1.76	-2.6	3.3	
2425	38.2	13.65	1.84	39.2	1.78	-2.7	3.6	
2450	38.1	13.73	1.87	39.2	1.80	-2.9	4.0	
2475	38.0	13.79	1.90	39.2	1.83	-3.1	3.9	
2500	37.9	13.85	1.93	39.1	1.85	-3.3	3.9	
2525	37.8	13.94	1.96	39.1	1.88	-3.4	4.0	
2550	37.7	14.02	1.99	39.1	1.91	-3.6	4.2	
2575	37.6	14.09	2.02	39.0	1.94	-3.8	4.3	
2600	37.5	14.17	2.05	39.0	1.96	-4.0	4.4	
2625	37.4	14.23	2.08	39.0	1.99	-4.2	4.4	
2650	37.3	14.29	2.11	38.9	2.02	-4.3	4.4	
2675	37.1	14.36	2.14	38.9	2.05	-4.5	4.5	
2700	37.0	14.43	2.17	38.9	2.07	-4.8	4.6	



**Figure D-2
2.4 GHz Head Tissue Equivalent Matter**

FCC ID: A3LSMN9109W		SAR EVALUATION REPORT		Reviewed by: Quality Manager
Test Dates: 08/11/14 - 08/20/14	DUT Type: Portable Handset			APPENDIX D: Page 2 of 3

2 Composition / Information on ingredients

The Item is composed of the following ingredients:

Water	50 – 65%
Mineral oil	10 – 30%
Emulsifiers	8 – 25%
Sodium salt	0 – 1.5%

Figure D-3
Composition of 5 GHz Head Tissue Equivalent Matter

Note: 5GHz head liquid recipes are proprietary SPEAG. Since the composition is approximate to the actual liquids utilized, the manufacturer tissue-equivalent liquid data sheets are provided below.

Measurement Certificate / Material Test

Item Name	Head Tissue Simulating Liquid (HBBL3500-5800V5)
Product No.	SL AAH 502 AC (Charge: 130903-1)
Manufacturer	SPEAG

Measurement Method

TSL dielectric parameters measured using calibrated OCP probe.

Setup Validation

Validation results were within $\pm 2.5\%$ towards the target values of Methanol.

Target Parameters

Target parameters as defined in the IEEE 1528 and IEC 62209 compliance standards.

Test Condition

Ambient Environment temperatur (22 ± 3)°C and humidity < 70%.
 TSL Temperature 22°C
 Test Date 4-Sep-13
 Operator IEN

Additional Information

TSL Density 0.985 g/cm³
 TSL Heat-capacity 3.383 kJ/(kg*K)

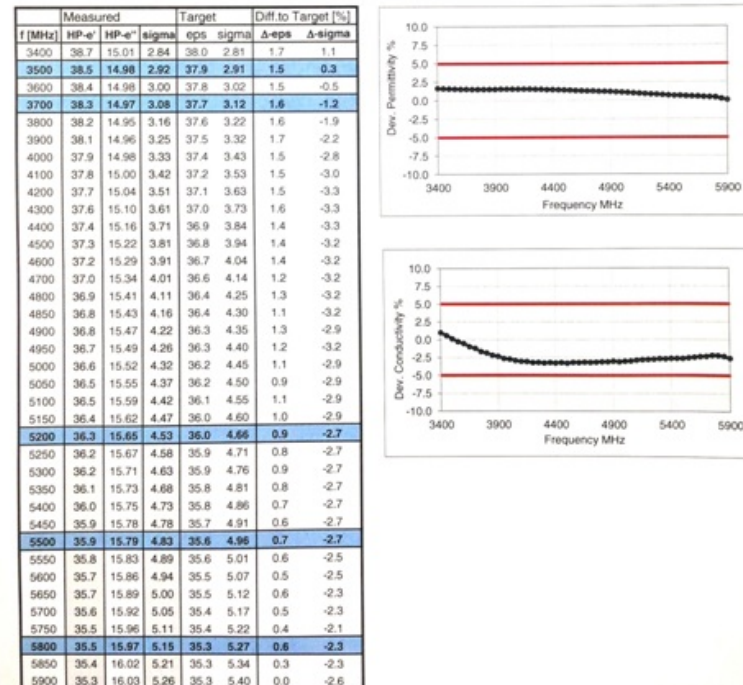

Figure D-4
5GHz Head Tissue Equivalent Matter

FCC ID: A3LSMN9109W		SAR EVALUATION REPORT		Reviewed by: Quality Manager
Test Dates: 08/11/14 - 08/20/14	DUT Type: Portable Handset			APPENDIX D: Page 3 of 3

APPENDIX E: SAR SYSTEM VALIDATION

Per FCC KDB 865664 D02v01, SAR system validation status should be documented to confirm measurement accuracy. The SAR systems (including SAR probes, system components and software versions) used for this device were validated against its performance specifications prior to the SAR measurements. Reference dipoles were used with the required tissue- equivalent media for system validation, according to the procedures outlined in FCC KDB 865664 D01 v01 and IEEE 1528-2013. Since SAR probe calibrations are frequency dependent, each probe calibration point was validated at a frequency within the valid frequency range of the probe calibration point, using the system that normally operates with the probe for routine SAR measurements and according to the required tissue-equivalent media.

A tabulated summary of the system validation status including the validation date(s), measurement frequencies, SAR probes and tissue dielectric parameters has been included.



**Table E-I
SAR System 1g Validation Summary**

SAR SYSTEM #	FREQ. [MHz]	DATE	PROBE SN	PROBE TYPE	PROBE CAL. POINT		COND.	PERM.	CW VALIDATION			MOD. VALIDATION		
							(σ)	(ε _r)	SENSI- TIVITY	PROBE LINEARITY	PROBE ISOTROPY	MOD. TYPE	DUTY FACTOR	PAR
C	835	6/10/2014	3213	ES3DV3	835	Head	0.925	42.76	PASS	PASS	PASS	GMSK	PASS	N/A
C	1900	6/23/2014	3213	ES3DV3	1900	Head	1.407	39.80	PASS	PASS	PASS	GMSK	PASS	N/A
H	2450	6/19/2014	3319	ES3DV3	2450	Head	1.788	39.78	PASS	PASS	PASS	OFDM	N/A	PASS
E	5200	12/3/2013	3914	EX3DV4	5200	Head	4.482	34.70	PASS	PASS	PASS	OFDM	N/A	PASS
E	5300	12/3/2013	3914	EX3DV4	5300	Head	4.604	34.60	PASS	PASS	PASS	OFDM	N/A	PASS
E	5500	12/3/2013	3914	EX3DV4	5500	Head	4.821	34.28	PASS	PASS	PASS	OFDM	N/A	PASS
E	5600	12/3/2013	3914	EX3DV4	5600	Head	4.907	34.13	PASS	PASS	PASS	OFDM	N/A	PASS
E	5800	12/3/2013	3914	EX3DV4	5800	Head	5.133	33.89	PASS	PASS	PASS	OFDM	N/A	PASS
D	835	8/11/2014	3263	ES3DV3	835	Body	1.000	53.26	PASS	PASS	PASS	GMSK	PASS	N/A
B	1900	6/28/2014	3288	ES3DV3	1900	Body	1.565	52.71	PASS	PASS	PASS	GMSK	PASS	N/A
H	2450	6/12/2014	3319	ES3DV3	2450	Body	1.981	51.57	PASS	PASS	PASS	OFDM	N/A	PASS
A	5200	1/13/2014	3920	EX3DV4	5200	Body	5.344	47.27	PASS	PASS	PASS	OFDM	N/A	PASS
A	5300	1/13/2014	3920	EX3DV4	5300	Body	5.500	46.91	PASS	PASS	PASS	OFDM	N/A	PASS
A	5500	1/13/2014	3920	EX3DV4	5500	Body	5.826	46.38	PASS	PASS	PASS	OFDM	N/A	PASS
A	5600	1/13/2014	3920	EX3DV4	5600	Body	5.991	46.16	PASS	PASS	PASS	OFDM	N/A	PASS
A	5800	1/13/2014	3920	EX3DV4	5800	Body	6.282	46.05	PASS	PASS	PASS	OFDM	N/A	PASS

**Table E-II
SAR System 10g Validation Summary**

SAR SYSTEM #	FREQ. [MHz]	DATE	PROBE SN	PROBE TYPE	PROBE CAL. POINT		COND.	PERM.	CW VALIDATION			MOD. VALIDATION		
							(σ)	(ε _r)	SENSI- TIVITY	PROBE LINEARITY	PROBE ISOTROPY	MOD. TYPE	DUTY FACTOR	PAR
I	5200	7/17/2014	3589	EX3DV4	5200	Body	5.183	48.21	PASS	PASS	PASS	OFDM	N/A	PASS
I	5300	7/17/2014	3589	EX3DV4	5300	Body	5.350	48.02	PASS	PASS	PASS	OFDM	N/A	PASS
I	5500	7/17/2014	3589	EX3DV4	5500	Body	5.662	47.59	PASS	PASS	PASS	OFDM	N/A	PASS
I	5600	7/17/2014	3589	EX3DV4	5600	Body	5.789	47.28	PASS	PASS	PASS	OFDM	N/A	PASS
I	5800	7/17/2014	3589	EX3DV4	5800	Body	6.098	46.89	PASS	PASS	PASS	OFDM	N/A	PASS

NOTE: While the probes have been calibrated for both CW and modulated signals, all measurements were performed using communication systems calibrated for CW signals only. Modulations in the table above represent test configurations for which the measurement system has been validated per FCC KDB Publication 865664 D01v01 for scenarios when CW probe calibrations are used with other signal types. SAR systems were validated for modulated signals with a periodic duty cycle, such as GMSK, or with a high peak to average ratio (>5 dB), such as OFDM according to KDB 865664.

FCC ID: A3LSMN9109W		SAR EVALUATION REPORT		Reviewed by: Quality Manager
Test Dates: 08/11/14 - 08/20/14	DUT Type: Portable Handset	APPENDIX E: Page 1 of 1		