

EMI TEST REPORT

FCC CERTIFICATION

Applicant:

SAMSUNG Electronics Co., Ltd.
129, Samsung-ro, Yeongtong-gu, Suwon-si,
Gyeonggi-do, 16677, Korea

Date of Issue: January 10, 2023

Test Report No. HCT-EM-2301-FC001

Test Site: HCT CO., LTD.

FCC ID :

A3LSMM546B

Rule Part(s) / Standard(s) : 47 CFR PART 15 Subpart B Class B
ANSI C63.4-2014

Product Name : Mobile phone

Model Name : SM-M546B/DS

Date of Test : November 29, 2022 to January 04, 2023

The device bearing the trade name and model specified above, has been shown to comply with the applicable technical standards as indicated in the measurement report and was tested in accordance with the measurement procedures specified in ANSI C63.4-2014. (See Test Report if any modifications were made for compliance)
I attest to the accuracy of data. All measurements reported herein were performed by me or were made under my supervision and are correct to the best of my knowledge and belief. I assume full responsibility for the completeness of these measurements and vouch for the qualifications of all persons taking them.

Tested By



Wook Yi
Test Engineer
EMC Team
Certification Division

Reviewed



Jeong-Hyun Choi
Technical Manager
EMC Team
Certification Division

This report only responds to the tested sample and may not be reproduced, except in full, without written approval of the HCT Co., Ltd.



REVISION HISTORY

The revision history for this document is shown in table.

Rev No.	Issue Date	Information About Changes
0	January 10, 2023	Initial Release

The above Test Report is not related to the accredited test result by (KS Q) ISO/IEC 17025 and KOLAS (Korea Laboratory Accreditation Scheme), which signed the ILAC-MRA.

If this report is required to confirmation of authenticity, please contact to www.hct.co.kr



TABLE OF CONTENTS

	PAGE
1. GENERAL INFORMATION	4
1.1 Description of EUT	4
1.2 Tested System Details	4
1.3 Cable Description	5
1.4 Noise Suppression Parts on Cable. (I/O Cable).....	5
1.5 Test Facility	6
1.6 Calibration of Measuring Instrument	6
1.7 Measurement Uncertainty	6
2. LIST OF TEST EQUIPMENT.....	7
3. DESCRIPTION OF TEST	8
3.1 Measurement of Conducted Emission.....	8
3.2 Measurement of Radiated Emission.....	9
3.3 Configuration of Tested System	10
4. OPERATION OF THE EUT.....	10
4.1 Conducted Emission (Not Applicable).....	11
4.2 Radiated Emission.....	11
5. EMI TEST SUMMARY	12
5.1 Conducted Emission (Not Applicable).....	12
5.1.1 Test Condition.....	12
5.1.2 Measuring Data.....	12
5.2 Radiated Emission Below 1 GHz	12
5.2.1 Test Condition.....	13
5.2.2 Measuring Data.....	14
5.3 Radiated Emission Above 1 GHz	17
5.3.1 Test Condition.....	18
5.3.2 Measuring Data.....	19
6 APPENDIX A. TEST SETUP PHOTO.....	23



1. GENERAL INFORMATION

1.1 Description of EUT

FCC ID	A3LSMM546B
Model Name	SM-M546B/DS
Product Name	Mobile phone
Frequency Band	GSM 850/1900, WCDMA B2/4/5, LTE (FDD) B2/4/5/12/17/26/66 (TDD) B41, NR (FDD) n5/66, BT, BT LE, WLAN a/b/g/n/ac/ax, NFC
Power Supply	Travel adapter: Input: 100~240 V, 50~60 Hz, 0.7 A Output: (PDO)5.0 V, 3.0 A or 9.0 V, 2.77 A (PPS)3.3~5.9 V, 3.0 A or 3.3~11.0 V, 2.25 A

1.2 Tested System Details

All equipment descriptions used in the tested system (including inserted cards) are:

Device Type	Model Name	Serial Number	Manufacturer
Mobile phone	SM-M546B/DS	-	SAMSUNG
TA	EP-TA800	-	SOLUM
Data Cable	EP-DN980	-	RFTECH
Earphone	YBD-19HS	-	CRESYN



1.3 Cable Description

Product Name	Port	Power Cord Shielded (Y/N)	I/O Cable Shielded (Y/N)	Length (m)
EUT	Data Cable (USB Type C)	Y	N/A	(P) 1.0
	Earphone (USB Type C)	N/A	N	(D) 1.3

"(D)" Data Cable and "(P)" Power Cable.

1.4 Noise Suppression Parts on Cable. (I/O Cable)

Product Name	Port	Ferrite Bead (Y/N)	Location	Metal Hood (Y/N)	Location
EUT	Data Cable (USB Type C)	N	N/A	Y	Both End
	Earphone (USB Type C)	N	N/A	Y	EUT End



1.5 Test Facility

Test site is located at 74, Seoicheon-ro 578beon-gil, Majang-myeon, Icheon-si, Gyeonggi-do, Korea. Those measurement facilities are constructed in conformance with the requirements of ANSI C63.4-2014. The Normalized site attenuations (30 MHz to 1 GHz) and Site validation (1 GHz to 18 GHz) were performed in accordance with the standard in ANSI C63.4-2014 and ANSI C63.4a-2017. Our laboratories are accredited and designated in accordance with the provisions of Radio Waves ACT and International Standard ISO/IEC 17025:2017. (National Radio Research Agency, CABID No. KR0032)

1.6 Calibration of Measuring Instrument

The measuring equipment, which was utilized in performing the tests documented herein, has been calibrated in accordance with the manufacturers recommendations for utilizing calibration equipment, which is traceable to recognized national standards.

Especially, all antenna for measurement is calibrated in accordance with the requirements of C63.5:2017.

1.7 Measurement Uncertainty

The measurement uncertainties shown below were calculated in accordance with the requirements of ANSI C63.4-2014.

All measurement uncertainty values are shown with a coverage factor of $k = 2$ to indicate a 95 % level of confidence. The measurement data shown herein meets or exceeds the U_{CISPR} measurement uncertainty values specified in CISPR 16-4-2 and, thus, can be compared directly to specified limits to determine compliance.

Test Item	Test Site (Chamber)	Expanded Uncertainty
Radiated Emission (30 MHz to 1 GHz)	3 m Semi Anechoic Chamber #1	5.9 dB
Radiated Emission (1 GHz to 18 GHz)	3 m Semi Anechoic Chamber #1	4.8 dB
Radiated Emission (18 GHz to 40 GHz)	3 m Semi Anechoic Chamber #1	5.8 dB



2. LIST OF TEST EQUIPMENT

<u>Type</u>	<u>Model Name</u>	<u>Manufacturer</u>	<u>Serial Number</u>	<u>Calibration Cycle</u>	<u>Next Calibration Date</u>
<u>Conducted Emission</u>					
<input type="checkbox"/> EMI Test Receiver	ESR7	Rohde & Schwarz	101910	1 year	06.07.2023
<input type="checkbox"/> LISN	ENV216	Rohde & Schwarz	102245	1 year	08.22.2023
<input type="checkbox"/> Antenna (for Communication)	HyperLOG7060	Aaronia	66450	-	-
<input type="checkbox"/> Antenna (for Communication)	HyperLOG7060	Aaronia	66451	-	-
<input type="checkbox"/> Software	EMC32	Rohde & Schwarz	-	-	-
<u>Radiated Emission</u>					
-For measurement below 1 GHz					
<input checked="" type="checkbox"/> EMI Test Receiver	ESU40	Rohde & Schwarz	100524	1 year	05.10.2023
<input checked="" type="checkbox"/> Bi-Log Antenna	VULB9168	Schwarzbeck	255	2 year	03.15.2023
<input checked="" type="checkbox"/> Antenna master	MA4640-XP-ET	INNCO SYSTEM	-	N/A	-
<input checked="" type="checkbox"/> Antenna master controller	CO3000	INNCO SYSTEM	CO3000/870/ 35990515/L	N/A	-
<input checked="" type="checkbox"/> Turn Table	1060	INNCO SYSTEM	-	N/A	-
<input checked="" type="checkbox"/> Turn Table controller	CO2000	INNCO SYSTEM	CO2000/095/ 7590304/L	N/A	-
<input type="checkbox"/> UNIVERSAL RADIO COMMUNICATION TESTER	CMU200	Rohde & Schwarz	107488	1 year	09.13.2023
<input checked="" type="checkbox"/> MOBILE COMMUNICATION TEST SET	CMW500	Rohde & Schwarz	103246	1 year	08.24.2023
<input checked="" type="checkbox"/> Radio communication analyzer	MT8821C	ANRITSU	6262192376	1 year	10.20.2023
<input checked="" type="checkbox"/> Antenna (for Communication)	HyperLOG7060	Aaronia	66450	-	-
<input checked="" type="checkbox"/> Radio communication analyzer	MT8000A	ANRITSU	6262208294	1 year	10.20.2023
<input checked="" type="checkbox"/> Antenna (for Communication)	HyperLOG7060	Aaronia	66451	-	-
<input checked="" type="checkbox"/> Software	EMC32	Rohde & Schwarz	-	-	-
-For measurement above 1 GHz					
<input checked="" type="checkbox"/> EMI Test Receiver	ESU40	Rohde & Schwarz	100524	1 year	05.10.2023
<input checked="" type="checkbox"/> Antenna master	MA4640-XP-ET	INNCO SYSTEM	-	N/A	-
<input checked="" type="checkbox"/> Antenna master controller	CO3000	INNCO SYSTEM	CO3000/870/ 35990515/L	N/A	-
<input checked="" type="checkbox"/> Turn Table	1060	INNCO SYSTEM	-	N/A	-
<input checked="" type="checkbox"/> Turn Table controller	CO2000	INNCO SYSTEM	CO2000/095/ 7590304/L	N/A	-
<input checked="" type="checkbox"/> Low Noise Amplifier	TK-PA1840H	TESTEK	170030-L	1 year	02.24.2023
<input checked="" type="checkbox"/> Low Noise Amplifier	TK-PA18H	TESTEK	170034-L	1 year	11.04.2023
<input checked="" type="checkbox"/> Horn Antenna	BBHA 9120D	Schwarzbeck	01836	1 year	07.21.2023
<input checked="" type="checkbox"/> Horn Antenna	BBHA 9170	Schwarzbeck	BBHA 9170 #786	1 year	11.17.2023
<input checked="" type="checkbox"/> Radio communication analyzer	MT8821C	ANRITSU	6262192376	1 year	10.20.2023
<input checked="" type="checkbox"/> MOBILE COMMUNICATION TEST SET	CMW500	Rohde & Schwarz	103246	1 year	08.24.2023
<input checked="" type="checkbox"/> Antenna (for Communication)	HyperLOG7060	Aaronia	66450	-	-
<input checked="" type="checkbox"/> Radio communication analyzer	MT8000A	ANRITSU	6262208294	1 year	10.20.2023
<input checked="" type="checkbox"/> Antenna (for Communication)	HyperLOG7060	Aaronia	66451	-	-
<input checked="" type="checkbox"/> Software	EMC32	Rohde & Schwarz	-	-	-



3. DESCRIPTION OF TEST

3.1 Measurement of Conducted Emission

The test procedure was in accordance with ANSI C63.4-2014, Clause 7.3

- a. The EUT was placed 0.4 meters from the conducting wall of the shielded room with EUT being connected to the power mains through a line impedance stabilization network (LISN).
If the EUT is connected to the PC through USB, the AC power-line adapter of the PC is directly connected to a line impedance stabilization network (LISN).
Other support units were connected to the power mains through another LISN. The two LISNs provide 50 Ohm/50uH of coupling impedance for the measuring instrument.
- b. Both conducted lines are measured in Quasi-Peak and Average mode, including the worst-case data points for each tested configuration.
- c. The frequency ranges from 150 kHz to 30 MHz was searched.

[Conducted Emission Limits]

Frequency (MHz)	Resolution Bandwidth (kHz)	Quasi-Peak (dB(μ V))	Average (dB(μ V))
0.15 to 0.5	9	66 to 56*	56 to 46*
0.5 to 5	9	56	46
5 to 30	9	60	50

**Decreases with the logarithm of the frequency.*



3.2 Measurement of Radiated Emission

The test procedure was in accordance with ANSI C63.4-2014, Clause 8.3

- The EUT was placed on the top of a turn table 0.8 meters above the ground at a semi-anechoic chamber. The table was rotated 360 degrees to determine the position of the highest radiation.
- The EUT was set 3 m away from the interference-receiving antenna, which was mounted on the top of a variable-height antenna tower.
- The antenna height is varied from 1 m to 4 m above the ground to determine the maximum value of the field strength. Both horizontal and vertical polarizations of the antenna are set to make the measurement.
- For each suspected emission, the EUT was arranged to its worst case and then the antenna was tuned to heights from 1 m to 4 m and the turn table was turned from 0 degrees to 360 degrees to find the maximum reading.
- The test-receiver system was set to Quasi-Peak detect function and specified bandwidth with maximum hold mode when the test frequency is below 1 GHz.
- The test-receiver system was set to Peak and Average detect function and specified bandwidth with maximum hold mode when the test frequency is above 1 GHz.
- Place the measurement antenna away from each area of the EUT determined to be a source of emissions at the specified measurement distance, while keeping the measurement antenna aimed at the source of emissions at each frequency of significant emissions, with polarization oriented for maximum response. (1 GHz to 40 GHz)

[Radiated Emission Limits]

Frequency (MHz)	Antenna Distance (m)	Field Strength ($\mu\text{V}/\text{m}$)	Quasi-Peak (dB $\mu\text{V}/\text{m}$)
30 to 88	3	100	40.0
88 to 216	3	150	43.5
216 to 960	3	200	46.0
Above 960	3	500	54.0

Frequency (MHz)	Antenna Distance (m)	Peak (dB $\mu\text{V}/\text{m}$)	Average (dB $\mu\text{V}/\text{m}$)
Above 1 000	3	74	54



3.2.1 Frequency Range of Radiated Measurements

An unintentional radiator, including a digital device, the spectrum shall be investigated from the lowest radio frequency signal generated or used in the device, without going below the lowest frequency for which a Radiated Emission limit is specified, up to the frequency shown in the following table.

Highest frequency generated or used in the device or on which the device operates or tunes (MHz)	Upper frequency of measurement range (MHz)
Below 1.705	30
1.705 to 108	1 000
108 to 500	2 000
500 to 1 000	5 000
Above 1 000	5 th harmonic of the highest frequency or 40 GHz, whichever is lower

3.3 Configuration of Tested System

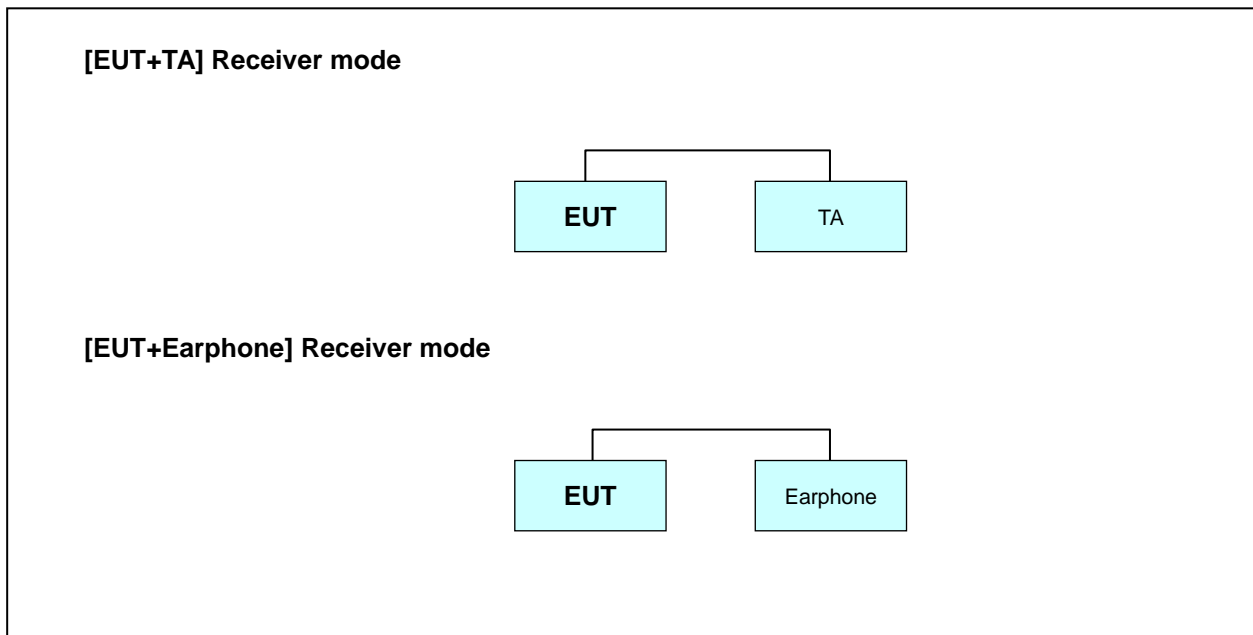

Non-Conductive Table



4. OPERATION OF THE EUT

During preliminary tests, the following operating mode was investigated.

- Receiver mode(GSM 850 Low/Middle/High ch Idle)
- Receiver mode(WCDMA B5 Low/Middle/High ch Idle)
- Receiver mode(LTE B5_Low/Middle/High ch)
- Receiver mode(LTE B12_Low/Middle/High ch)
- Receiver mode(LTE B17_Low/Middle/High ch)
- Receiver mode(LTE B26_Low/Middle/High ch)
- Receiver mode(5G NR n5_Low/Middle/High ch)
- Receiver mode(Earphone)

NOTE. The worst case is tested.

4.1 Conducted Emission (Not Applicable)

Operating Mode: Not applicable

4.2 Radiated Emission

It was final tested the following operating mode, after connecting all peripheral devices.

Operating Mode:

Radiated Emission below 1 GHz:

- [EUT+TA]**
 - LTE B5+5G NR n5 Low ch Idle
 - LTE B5+5G NR n5 Middle ch Idle
 - LTE B5+5G NR n5 High ch Idle*
 - LTE B12(B17) Low ch Idle
 - LTE B12(B17) Middle ch Idle*
 - LTE B12(B17) High ch Idle
 - LTE B26 Low ch Idle
 - LTE B26 Middle ch Idle
 - LTE B26 High ch Idle*

[EUT+Earphone] LTE B12(B17) Middle ch Idle

Radiated Emission above 1 GHz:

- [EUT+TA]**
 - LTE B5+5G NR n5 High ch Idle
 - LTE B12(B17) Middle ch Idle*
 - LTE B26 High ch Idle

[EUT+Earphone] LTE B12(B17) Middle ch Idle

NOTE.

1. Three orientations have been investigated and the worst case orientation (x-axis: The display of EUT placed on the table is facing upwards) is reported.
2. The worst case of operating mode is reported. [*].



5. EMI TEST SUMMARY

5.1 Conducted Emission

5.1.1 Test Condition

The test results of conducted emission at mains ports provide the following information:

Used Test Standard	47 CFR PART 15 Subpart B Class B ANSI C63.4-2014
Frequency Range	150 kHz to 30 MHz
Detector	Quasi-Peak, CISPR-Average
Bandwidth	9 kHz (6 dB)
Operating Mode	-
Test Site	EMI Shield Room
Temperature	min. - °C, max. - °C
Humidity	min. - % R.H., max. - % R.H.
Test Date	-

Calculation Formula:

1. Conductor L1 = Hot, Conductor N = Neutral
2. Corr. = LISN Factor+Cable Loss
3. QuasiPeak or CAverage= Receiver Reading+Corr.
4. Margin = Limit – QuasiPeak or CAverage

5.1.2 Measuring Data

Not applicable



5.2 Radiated Emission Below 1 GHz

5.2.1 Test Condition

The test results of radiated emission provide the following information:

Used Test Standard	47 CFR PART 15 Subpart B Class B ANSI C63.4-2014
Frequency Range	30 MHz to 1 000 MHz
Detector / Bandwidth	Quasi-Peak / Bandwidth: 120 kHz (6 dB)
Operating Mode of Worst case	[EUT+TA] LTE B5+5G NR n5 High ch Idle LTE B12(B17) Middle ch Idle LTE B26 High ch Idle [EUT+Earphone] LTE B12(B17) Middle ch Idle
Measurement Distance	3 m
Antenna Measurement Height	1 m to 4 m
Test Site	3 m Semi Anechoic Chamber #1
Temperature	min. 21.5 °C, max. 23.5 °C
Humidity	min. 36.8 % R.H., max. 39.2 % R.H.
Test Date	November 29, 2022 – December 01, 2022

Calculation Formula:

1. POL. H = Horizontal, POL. V = Vertical
2. QuasiPeak = Reading (Receiver Reading)+Corr.
3. Corr. (Correction Factor) = Antenna Factor+Cable Loss
4. Margin = Limit - QuasiPeak



5.2.2 Measuring Data

Figure 1: Radiated Emission (30 to 1 000) MHz, [EUT+TA] LTE B5+5G NR n5 High ch Idle

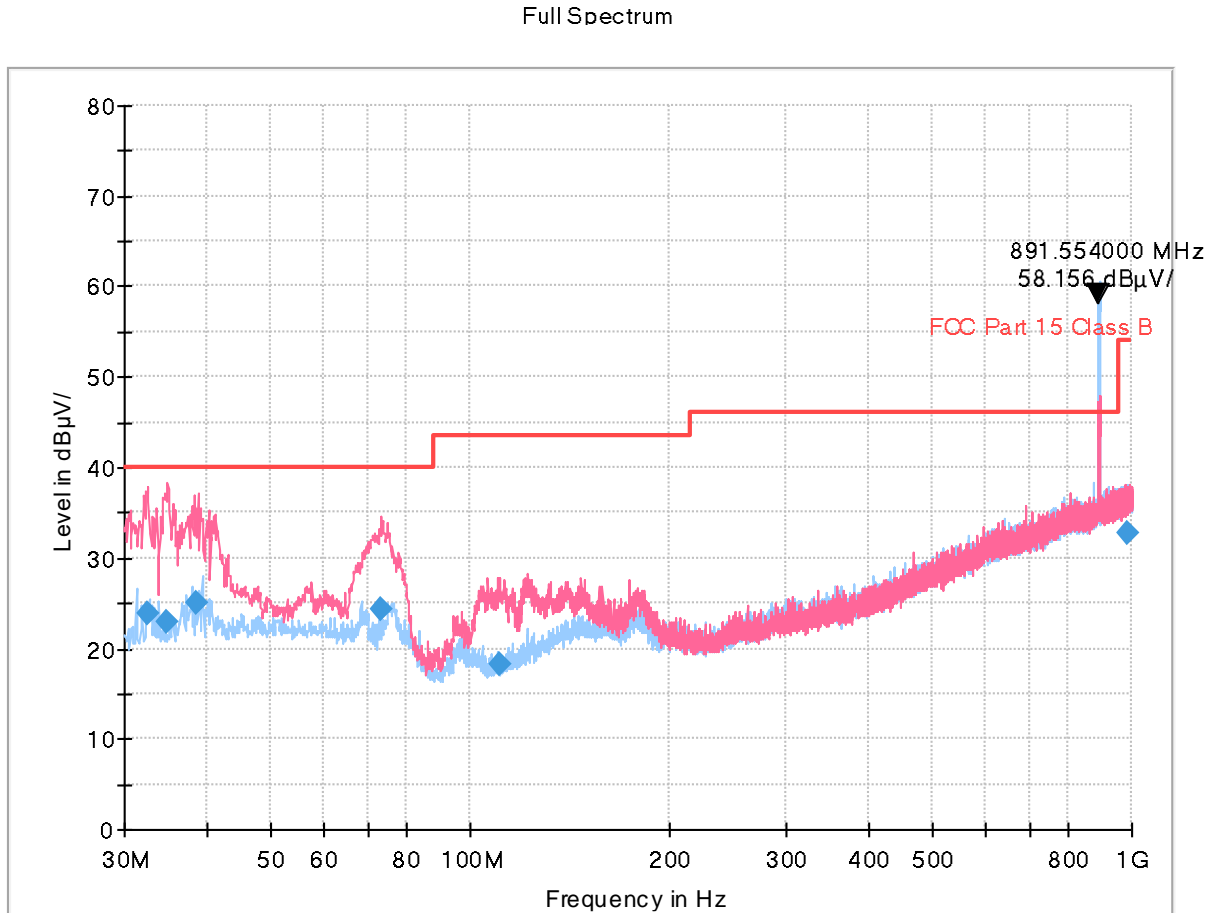

NOTE. 1. Carrier Frequency: Rx 891.554 MHz
 2. These are signals for fundamental frequency from the base station

Frequency (MHz)	Quasi Peak (dBµV/m)	Limit (dBµV/m)	Margin (dB)	Antenna Height (cm)	POL. (H/V)	Azimuth (deg)	Corr. (dB)
32.5172	23.89	40.00	16.11	105.5	V	330.0	18.7
34.8600	23.03	40.00	16.97	104.9	V	107.0	18.9
38.6967	24.93	40.00	15.07	104.7	V	82.0	19.2
73.2122	24.40	40.00	15.60	100.0	V	303.0	17.4
110.7166	18.23	43.50	25.27	125.1	V	125.0	16.2
982.7357	32.74	54.00	21.26	274.7	H	66.0	32.4



Figure 2: Radiated Emission (30 to 1 000) MHz, [EUT+TA] LTE B12(B17) Middle ch Idle

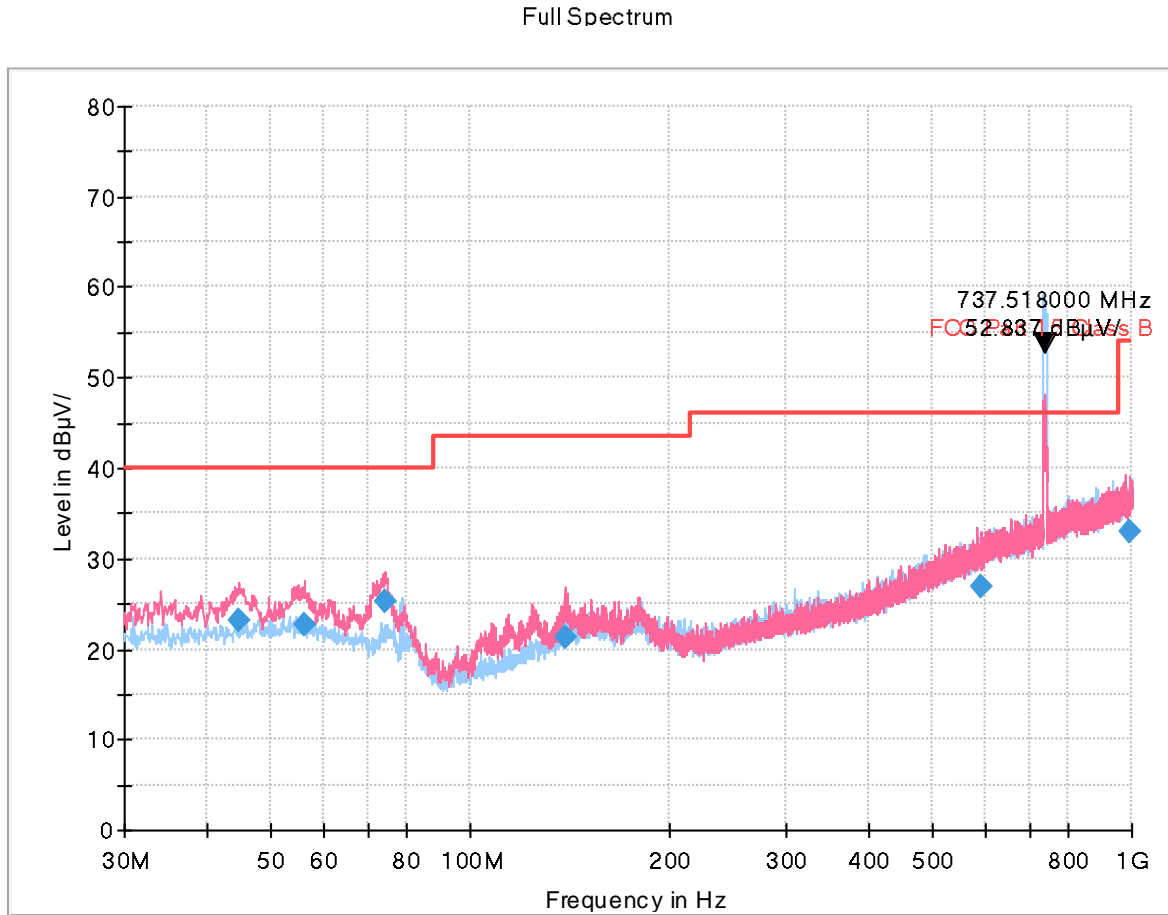

NOTE. 1. Carrier Frequency: Rx 737.518 MHz
 2. These are signals for fundamental frequency from the base station

Frequency (MHz)	Quasi Peak (dBµV/m)	Limit (dBµV/m)	Margin (dB)	Antenna Height (cm)	POL. (H/V)	Azimuth (deg)	Corr. (dB)
44.6114	23.05	40.00	16.95	104.8	V	30.0	19.7
56.2198	22.77	40.00	17.23	125.3	V	94.0	19.8
74.4933	25.16	40.00	14.84	100.0	V	75.0	17.1
138.8177	21.26	43.50	22.24	100.0	V	90.0	19.1
591.3102	26.91	46.00	19.09	125.0	V	292.0	27.3
996.1308	32.91	54.00	21.09	325.0	V	241.0	32.6



Figure 3: Radiated Emission (30 to 1 000) MHz, [EUT+TA] LTE B26 High ch Idle

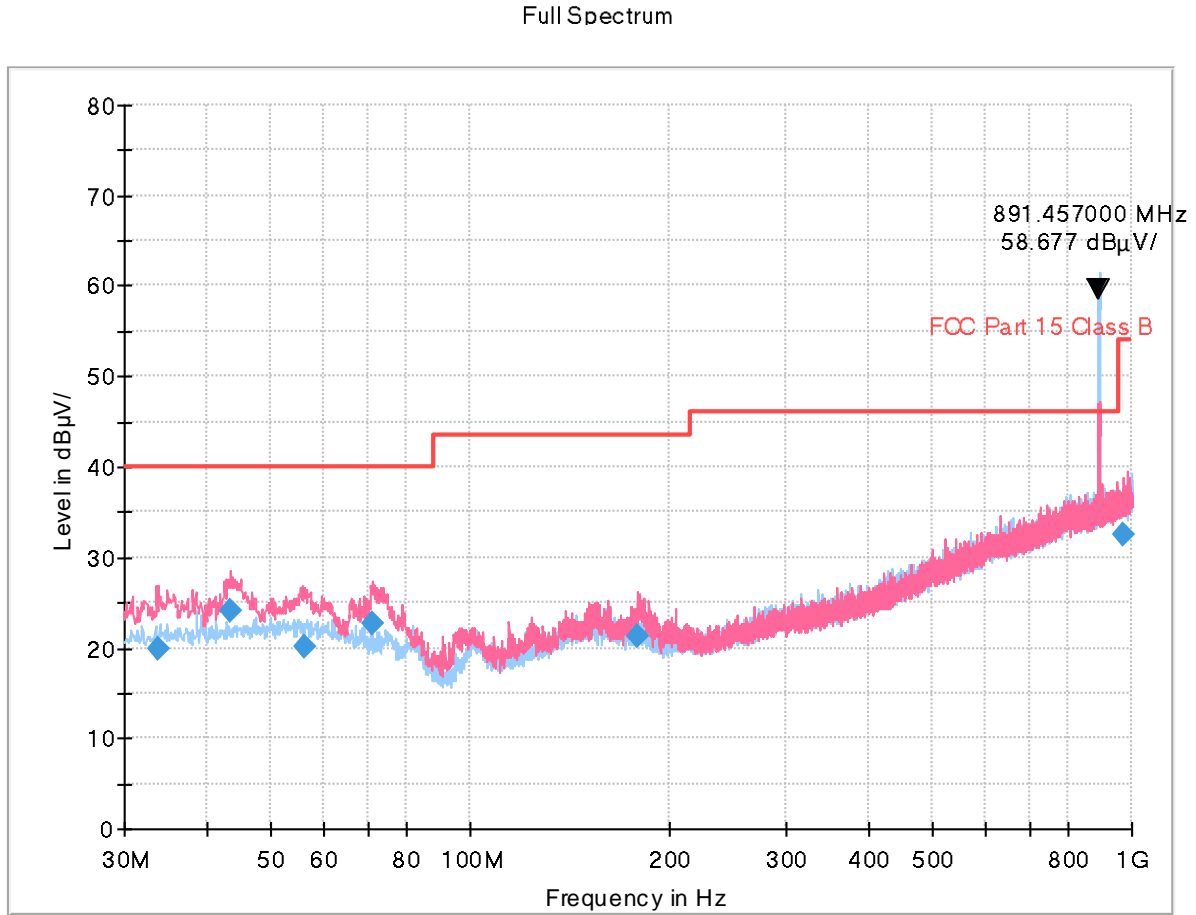

NOTE. 1. Carrier Frequency: Rx 891.457 MHz
 2. These are signals for fundamental frequency from the base station

Frequency (MHz)	Quasi Peak (dBµV/m)	Limit (dBµV/m)	Margin (dB)	Antenna Height (cm)	POL. (H/V)	Azimuth (deg)	Corr. (dB)
33.7445	19.83	40.00	20.17	179.7	V	0.0	18.8
43.3949	24.06	40.00	15.94	104.3	V	204.0	19.6
56.3447	20.04	40.00	19.96	118.3	V	230.0	19.8
71.3689	22.70	40.00	17.30	100.0	V	31.0	17.9
179.0152	21.20	43.50	22.30	100.0	V	185.0	18.4
967.8830	32.50	54.00	21.50	394.8	V	115.0	32.3



Figure 4: Radiated Emission (30 to 1 000) MHz, [EUT+Earphone] LTE B12(B17) Middle ch Idle

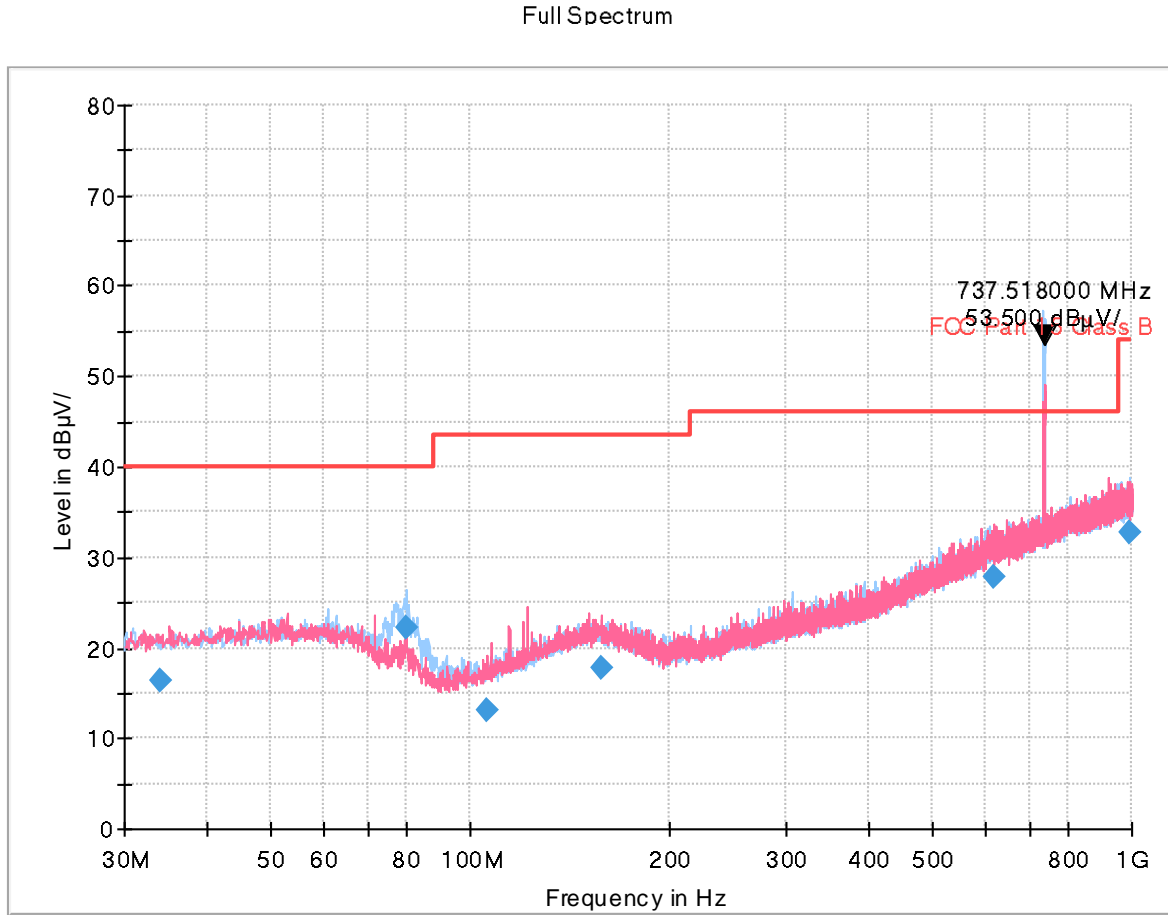

NOTE. 1. Carrier Frequency: Rx 737.518 MHz
 2. These are signals for fundamental frequency from the base station

Frequency (MHz)	Quasi Peak (dBµV/m)	Limit (dBµV/m)	Margin (dB)	Antenna Height (cm)	POL. (H/V)	Azimuth (deg)	Corr. (dB)
33.980269	16.39	40.00	23.61	285.7	V	0.0	18.8
80.066731	22.18	40.00	17.82	274.8	H	122.0	15.6
105.932346	13.12	43.50	30.38	100.0	V	42.0	15.7
158.337808	17.83	43.50	25.67	100.0	V	72.0	19.7
619.786192	27.74	46.00	18.26	100.0	V	38.0	27.8
993.187769	32.71	54.00	21.29	325.1	H	49.0	32.5



5.3 Radiated Emission Above 1 GHz

5.3.1 Test Condition

The test results of radiated emission provide the following information:

Used Test Standard	47 CFR PART 15 Subpart B Class B ANSI C63.4-2014
Detector	Peak, CISPR-Average
Bandwidth	1 MHz
Highest Frequency	5 825 MHz
Tested Frequency Range	1 GHz to 40 GHz
Operating Mode of Worst case	[EUT+TA] LTE B12(B17) Middle ch Idle [EUT+Earphone] LTE B12(B17) Middle ch Idle
Measurement Distance	3 m
Antenna Measurement Height	1 m to 4 m
Test Site	3 m Semi Anechoic Chamber #1
Temperature	min. 19.6 °C, max. 24.0 °C
Humidity	min. 37.1 % R.H., max. 44.0 % R.H.
Test Date	January 02, 2023 - January 04, 2023

Calculation Formula:

1. POL. H = Horizontal, POL. V = Vertical
2. Peak or CAverage = Reading (Receiver Reading)+Corr.
3. Corr. (Correction Factor) = Antenna Factor+ Cable Loss –Amplifier Gain
4. Margin = Limit - Peak or CAverage



5.3.2 Measuring Data

Figure 5: Radiated Emission (1 to 40) GHz, [EUT+TA] LTE B12(B17) Middle ch Idle

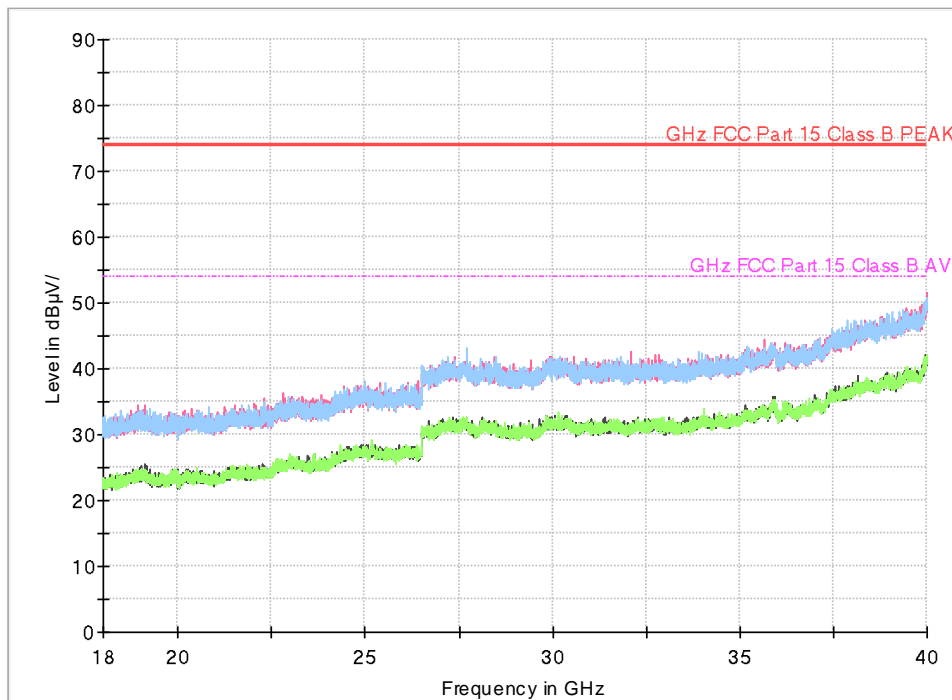
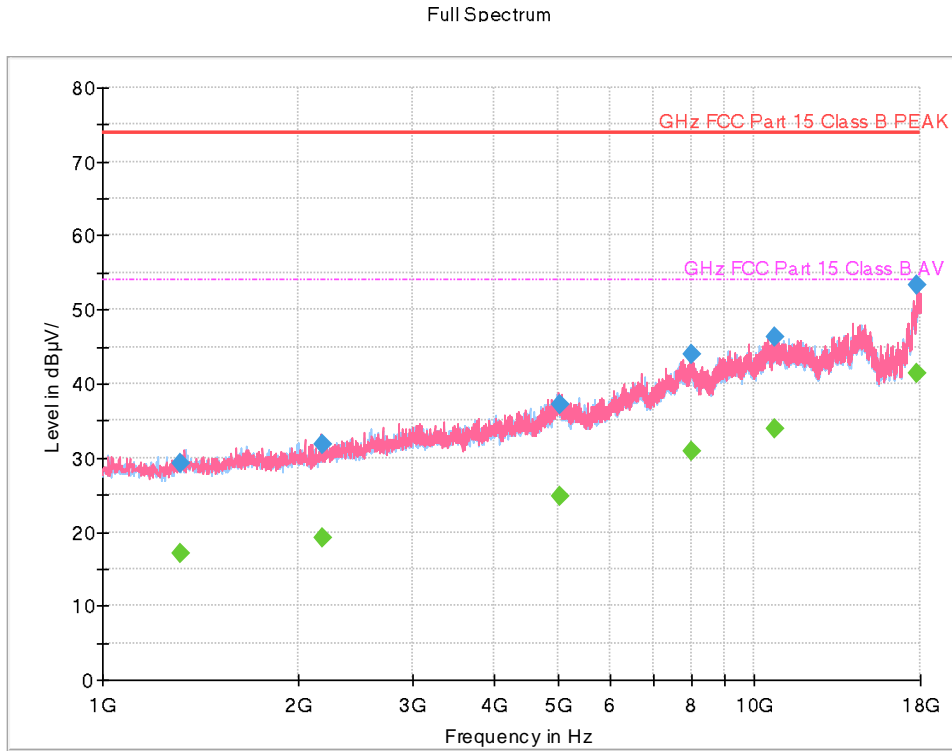



Frequency (MHz)	Peak (dB μ V/m)	Limit (dB μ V/m)	Margin (dB)	Antenna Height (cm)	POL. (H/V)	Azimuth (deg)	Corr. (dB)
1318.2050	29.18	74.00	44.82	150.1	V	230.0	-30.2
2181.2850	31.77	74.00	42.23	132.8	V	195.0	-27.3
5045.1400	37.13	74.00	36.87	150.1	V	1.0	-17.7
8019.4250	44.04	74.00	29.96	175.6	V	312.0	-9.5
10765.9200	46.31	74.00	27.69	218.7	V	184.0	-4.2
17794.3000	53.39	74.00	20.61	150.1	V	180.0	8.4

Frequency (MHz)	CAverage (dB μ V/m)	Limit (dB μ V/m)	Margin (dB)	Antenna Height (cm)	POL. (H/V)	Azimuth (deg)	Corr. (dB)
1318.2050	16.97	54.00	37.03	150.1	V	230.0	-30.2
2181.2850	19.22	54.00	34.78	132.8	V	195.0	-27.3
5045.1400	24.75	54.00	29.25	150.1	V	1.0	-17.7
8019.4250	30.81	54.00	23.19	175.6	V	312.0	-9.5
10765.9200	33.81	54.00	20.19	218.7	V	184.0	-4.2
17794.3000	41.31	54.00	12.69	150.1	V	180.0	8.4



Figure 6: Radiated Emission (1 to 40) GHz, [EUT+Earphone] LTE B12(B17) Middle ch Idle

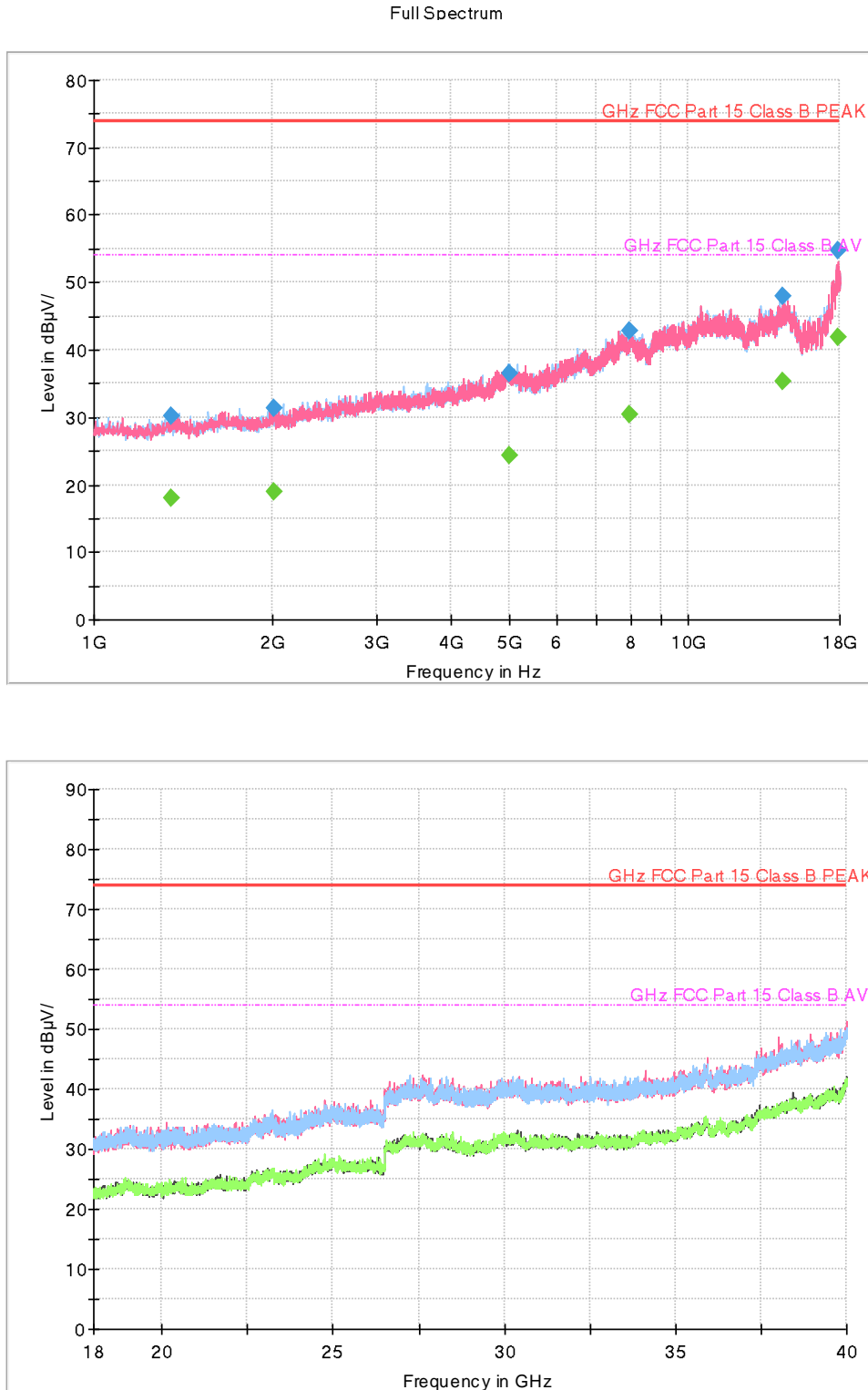



Frequency (MHz)	Peak (dB μ V/m)	Limit (dB μ V/m)	Margin (dB)	Antenna Height (cm)	POL. (H/V)	Azimuth (deg)	Corr. (dB)
1351.7200	30.19	74.00	43.81	150.1	V	25.0	-30.1
2012.4050	31.28	74.00	42.72	127.7	V	100.0	-28.1
4992.4700	36.41	74.00	37.59	209.7	H	191.0	-17.8
7977.3350	42.91	74.00	31.09	350.0	V	132.0	-9.5
14449.0850	48.07	74.00	25.93	107.7	V	293.0	-0.4
17840.2050	54.73	74.00	19.27	149.9	V	0.0	9.0

Frequency (MHz)	CAverage (dB μ V/m)	Limit (dB μ V/m)	Margin (dB)	Antenna Height (cm)	POL. (H/V)	Azimuth (deg)	Corr. (dB)
1351.7200	17.93	54.00	36.07	150.1	V	25.0	-30.1
2012.4050	18.92	54.00	35.08	127.7	V	100.0	-28.1
4992.4700	24.36	54.00	29.64	209.7	H	191.0	-17.8
7977.3350	30.38	54.00	23.62	350.0	V	132.0	-9.5
14449.0850	35.34	54.00	18.66	107.7	V	293.0	-0.4
17840.2050	41.92	54.00	12.08	149.9	V	0.0	9.0



6. APPENDIX A. TEST SETUP PHOTO

Please refer to EMI Test Setup Photo and test setup photo file no. as follows;

Rev. No.	Issue Date	File No.
0	January 10, 2023	HCT-EM-2301-FC001-P

End of report