

HEARING AID COMPATIBILITY

Applicant Name:
Samsung Electronics Co., Ltd.
129, Samsung-ro, Maetan dong,
Yeongtong-gu, Suwon-si
Gyeonggi-do 16677, Korea

Date of Testing:
04/12/2018 - 04/23/2018
Test Site/Location:
PCTEST Lab, Columbia, MD, USA
Test Report Serial No.:
1M1803150042-12.A3L

FCC ID: A3LSMJ737T

APPLICANT: SAMSUNG ELECTRONICS CO., LTD.

Scope of Test: Audio Band Magnetic Testing (T-Coil)
Application Type: Certification
FCC Rule Part(s): CFR §20.19(b)
HAC Standard: ANSI C63.19-2011
285076 D01 HAC Guidance v05
285076 D02 T-Coil testing for CMRS IP v03
DUT Type: Portable Handset
Model: SM-J737T
Test Device Serial No.: Pre-Production Sample [S/N: 22003]

C63.19-2011 HAC Category: T3 (SIGNAL TO NOISE CATEGORY)

This wireless portable device has been shown to be hearing-aid compatible under the above rated category, specified in ANSI/IEEE Std. C63.19-2011 and has been tested in accordance with the specified measurement procedures. Test results reported herein relate only to the item(s) tested. Hearing-Aid Compatibility is based on the assumption that all production units will be designed electrically identical to the device tested in this report. North American Bands only.

I attest to the accuracy of data. All measurements reported herein were performed by me or were made under my supervision and are correct to the best of my knowledge and belief. I assume full responsibility for the completeness of these measurements and vouch for the qualifications of all persons taking them.

Randy Ortanez
President







FCC ID: A3LSMJ737T		HAC (T-COIL) TEST REPORT		Approved by: Quality Manager
Filename: 1M1803150042-12.A3L	Test Dates: 04/12/2018 - 04/23/2018	DUT Type: Portable Handset	Page 1 of 74	

TABLE OF CONTENTS

1.	INTRODUCTION	3
2.	DUT DESCRIPTION.....	4
3.	ANSI C63.19-2011 PERFORMANCE CATEGORIES	6
4.	METHOD OF MEASUREMENT	8
5.	VOLTE TEST SYSTEM SETUP AND DUT CONFIGURATION	20
6.	VOWIFI TEST SYSTEM SETUP AND DUT CONFIGURATION	22
7.	OTT VOIP TEST SYSTEM AND DUT CONFIGURATION	25
8.	FCC 3G MEASUREMENTS	27
9.	T-COIL TEST SUMMARY	28
10.	MEASUREMENT UNCERTAINTY	38
11.	EQUIPMENT LIST	39
12.	TEST DATA	40
13.	CALIBRATION CERTIFICATES.....	62
14.	CONCLUSION.....	69
15.	REFERENCES	70
16.	TEST SETUP PHOTOGRAPHS	72

FCC ID: A3LSMJ737T		HAC (T-COIL) TEST REPORT		Approved by: Quality Manager
Filename: 1M1803150042-12.A3L	Test Dates: 04/12/2018 - 04/23/2018	DUT Type: Portable Handset		Page 2 of 74

© 2018 PCTEST Engineering Laboratory, Inc.

REV 3.2.M
04/17/2018

© 2018 PCTEST Engineering Laboratory, Inc. All rights reserved. Unless otherwise specified, no part of this report may be reproduced or utilized in any part, form or by any means, electronic or mechanical, including photocopying and microfilm, without permission in writing from PCTEST Engineering Laboratory, Inc. If you have any questions about this international copyright or have an enquiry about obtaining additional rights to this report or assembly of contents thereof, please contact INFO@PCTEST.COM.

1. INTRODUCTION

On July 10, 2003, the Federal Communications Commission (FCC) adopted new rules requiring wireless manufacturers and service providers to provide digital wireless phones that are compatible with hearing aids. The FCC has modified the exemption for wireless phones under the Hearing Aid Compatibility Act of 1998 (HAC Act) in WT Docket 01-309 RM-8658¹ to extend the benefits of wireless telecommunications to individuals with hearing disabilities. These benefits encompass business, social and emergency communications, which increase the value of the wireless network for everyone. An estimated more than 10% of the population in the United States show signs of hearing impairment and of that fraction, almost 80% use hearing aids. Approximately 500 million people worldwide and 30 million people in the United States suffer from hearing loss.

Compatibility Tests Involved:

The standard calls for wireless communications devices to be measured for:

- RF Electric-field emissions
- T-coil mode, magnetic-signal strength in the audio band
- T-coil mode, magnetic-signal frequency response through the audio band
- T-coil mode, magnetic-signal and noise articulation index

The hearing aid must be measured for:

- RF immunity in microphone mode
- RF immunity in T-coil mode

In the following tests and results, this report includes the evaluation for a wireless communications device.

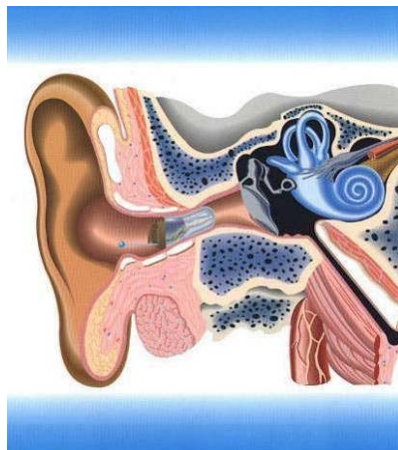



Figure 1-1 Hearing Aid *in-vitu*

¹ FCC Rule & Order, WT Docket 01-309 RM-8658

FCC ID: A3LSMJ737T		HAC (T-COIL) TEST REPORT		Approved by: Quality Manager
Filename: 1M1803150042-12.A3L	Test Dates: 04/12/2018 - 04/23/2018	DUT Type: Portable Handset		Page 3 of 74

2. DUT DESCRIPTION



FCC ID: A3LSMJ737T
Applicant: Samsung Electronics Co., Ltd.
129, Samsung-ro, Maetan dong,
Yeongtong-gu, Suwon-si
Gyeonggi-do 16677, Korea
Model: SM-J737T
Serial Number: 22003
HW Version: REV1.0
SW Version: J737TUVU0ARC9
Antenna: Internal Antenna
DUT Type: Portable Handset

I. LTE Band Selection

This device supports the following pair of LTE bands with similar frequencies: LTE B4 & B66. This pair of LTE bands has the same target power and shares the same transmission path. Since the supported frequency span for the smaller LTE band is completely covered by the larger LTE band, only the larger LTE band (LTE B66) was evaluated for hearing-aid compliance.

FCC ID: A3LSMJ737T	PCTEST ENGINEERING LABORATORY, INC.	HAC (T-COIL) TEST REPORT		Approved by: Quality Manager
Filename: 1M1803150042-12.A3L	Test Dates: 04/12/2018 - 04/23/2018	DUT Type: Portable Handset		Page 4 of 74



© 2018 PCTEST Engineering Laboratory, Inc.

REV 3.2.M
04/17/2018

© 2018 PCTEST Engineering Laboratory, Inc. All rights reserved. Unless otherwise specified, no part of this report may be reproduced or utilized in any part, form or by any means, electronic or mechanical, including photocopying and microfilm, without permission in writing from PCTEST Engineering Laboratory, Inc. If you have any questions about this international copyright or have an enquiry about obtaining additional rights to this report or assembly of contents thereof, please contact INFO@PCTEST.COM.

**Table 2-1
A3LSMJ737T HAC Air Interfaces**

Air-Interface	Band (MHz)	Type Transport	HAC Tested	Simultaneous But Not Tested	Name of Voice Service
GSM	850	VO	Yes	Yes: WIFI or BT	CMRS Voice*
	1900				
	GPRS/EDGE	VD	Yes	Yes: WIFI or BT	Google Duo**
UMTS	850	VD	Yes	Yes: WIFI or BT	CMRS Voice*
	1700				
	1900	VD	Yes	Yes: WIFI or BT	Google Duo**
LTE (FDD)	680 (B71)	VD	Yes ¹	Yes: WIFI or BT	VoLTE*, Google Duo**
	700 (B12)		Yes		
	850 (B5)				
	1700 (B4)				
	1700 (B66)				
	1900 (B2)				
2500 (B7)					
WIFI	2450	VD	Yes	Yes: GSM, UMTS, or LTE	VoWIFI**, Google Duo**
	5200 (U-NII 1)				
	5300 (U-NII 2A)				
	5500 (U-NII 2C)				
	5800 (U-NII 3)				
BT	2450	DT	No	Yes: GSM, UMTS, or LTE	N/A
Type Transport VO = Voice Only DT = Digital Data - Not intended for CMRS Service VD = CMRS and IP Voice over Data Transport			Notes: * Reference level in accordance with 7.4.2.1 of ANSI C63.19-2011 and July 2012 C63 VoLTE Interpretation. ** Reference level is -20dBm0 in accordance with FCC KDB 285076 D02 1. LTE B71, while outside the scope of ANSI C63.19 and FCC HAC regulations, was tested according to the existing HAC procedures.		

FCC ID: A3LSMJ737T		HAC (T-COIL) TEST REPORT		Approved by: Quality Manager
Filename: 1M1803150042-12.A3L	Test Dates: 04/12/2018 - 04/23/2018	DUT Type: Portable Handset	Page 5 of 74	

3. ANSI C63.19-2011 PERFORMANCE CATEGORIES

I. MAGNETIC COUPLING

Axial and Radial Field Intensity

All orientations of the magnetic field, in the axial and radial position along the measurement plane shall be ≥ -18 dB(A/m) at 1 kHz in a 1/3 octave band filter per §8.3.1.

Frequency Response

The frequency response of the axial component of the magnetic field shall follow the response curve specified in EIA RS-504-1983, over the frequency range 300 Hz – 3000 Hz per §8.3.2.

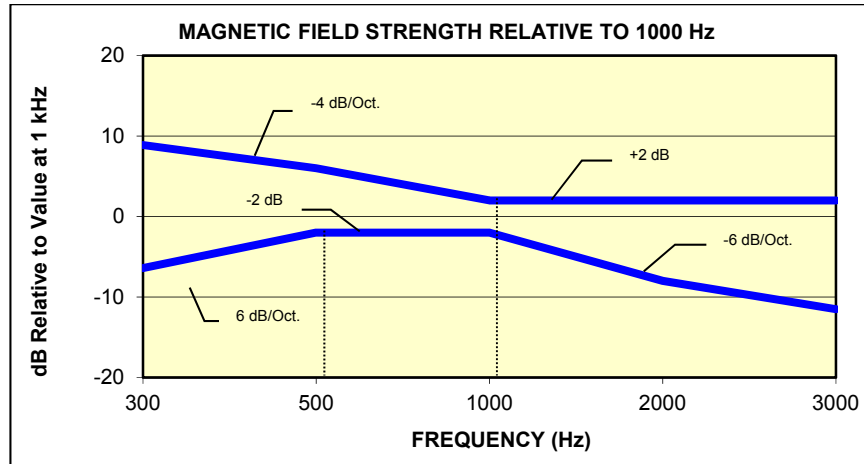

Figure 3-1
Magnetic field frequency response for Wireless Devices with an axial field ≤ -15 dB(A/m) at 1 kHz

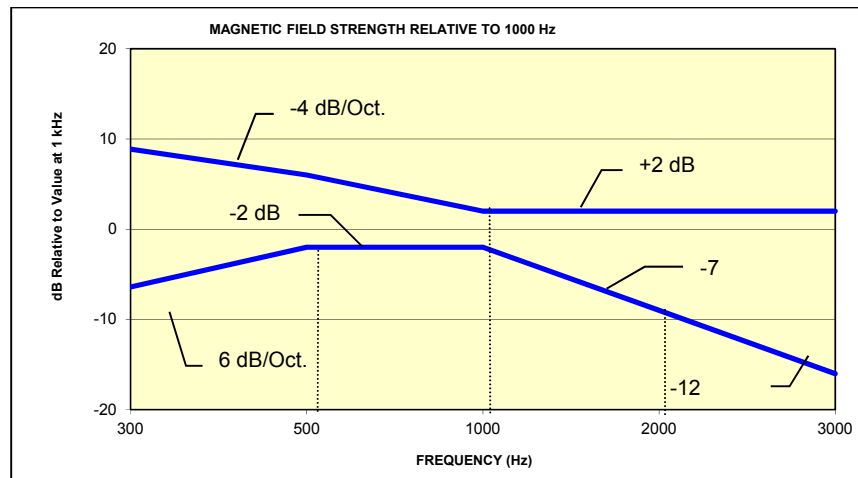



Figure 3-2
Magnetic Field frequency response for wireless devices with an axial field that exceeds -15 dB(A/m) at 1 kHz

FCC ID: A3LSMJ737T		HAC (T-COIL) TEST REPORT		Approved by: Quality Manager
Filename: 1M1803150042-12.A3L	Test Dates: 04/12/2018 - 04/23/2018	DUT Type: Portable Handset		Page 6 of 74

Signal Quality



The table below provides the signal quality requirement for the intended audio magnetic signal from a wireless device. Only the RF immunity of the hearing aid is measured in T-coil mode. It is assumed that a hearing aid can have no immunity to an interference signal in the audio band, which is the intended reception band for this mode. The only criterion that can be measured is the RF immunity in T-coil mode. This is measured using the same procedure as the audio coupling mode at the same levels.

The signal quality of the axial and radial components of the magnetic field was used to determine the T-coil mode category.

Category	Telephone RF Parameters
	Wireless Device Signal Quality [(Signal + Noise)-to-noise ratio in dB]
T1	0 to 10 dB
T2	10 to 20 dB
T3	20 to 30 dB
T4	> 30 dB

Table 3-1
Magnetic Coupling Parameters

Note: The FCC limit for SNNR is 20dB and the test data margins will indicate a margin from the FCC limit for compliance.

FCC ID: A3LSMJ737T	 PCTEST ENGINEERING LABORATORY, INC.	HAC (T-COIL) TEST REPORT		Approved by: Quality Manager
Filename: 1M1803150042-12.A3L	Test Dates: 04/12/2018 - 04/23/2018	DUT Type: Portable Handset		Page 7 of 74

© 2018 PCTEST Engineering Laboratory, Inc.

REV 3.2.M
04/17/2018

© 2018 PCTEST Engineering Laboratory, Inc. All rights reserved. Unless otherwise specified, no part of this report may be reproduced or utilized in any part, form or by any means, electronic or mechanical, including photocopying and microfilm, without permission in writing from PCTEST Engineering Laboratory, Inc. If you have any questions about this international copyright or have an enquiry about obtaining additional rights to this report or assembly of contents thereof, please contact INFO@PCTEST.COM.

4. METHOD OF MEASUREMENT

I. Test Setup

The equipment was connected as shown in an acoustic/RF hemi-anechoic chamber:

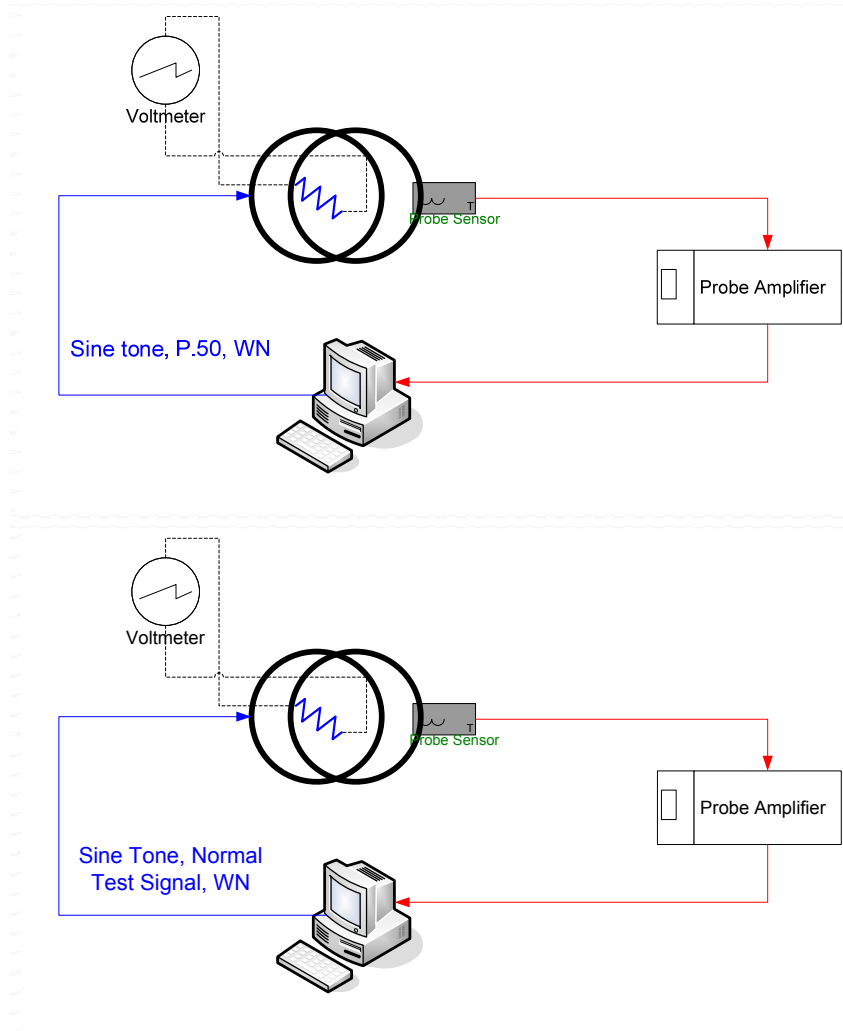



Figure 4-1
Validation Setup with Helmholtz Coil

FCC ID: A3LSMJ737T		HAC (T-COIL) TEST REPORT		Approved by: Quality Manager
Filename: 1M1803150042-12.A3L	Test Dates: 04/12/2018 - 04/23/2018	DUT Type: Portable Handset		Page 8 of 74

© 2018 PCTEST Engineering Laboratory, Inc.

REV 3.2.M

04/17/2018

© 2018 PCTEST Engineering Laboratory, Inc. All rights reserved. Unless otherwise specified, no part of this report may be reproduced or utilized in any part, form or by any means, electronic or mechanical, including photocopying and microfilm, without permission in writing from PCTEST Engineering Laboratory, Inc. If you have any questions about this international copyright or have an enquiry about obtaining additional rights to this report or assembly of contents thereof, please contact INFO@PCTEST.COM.

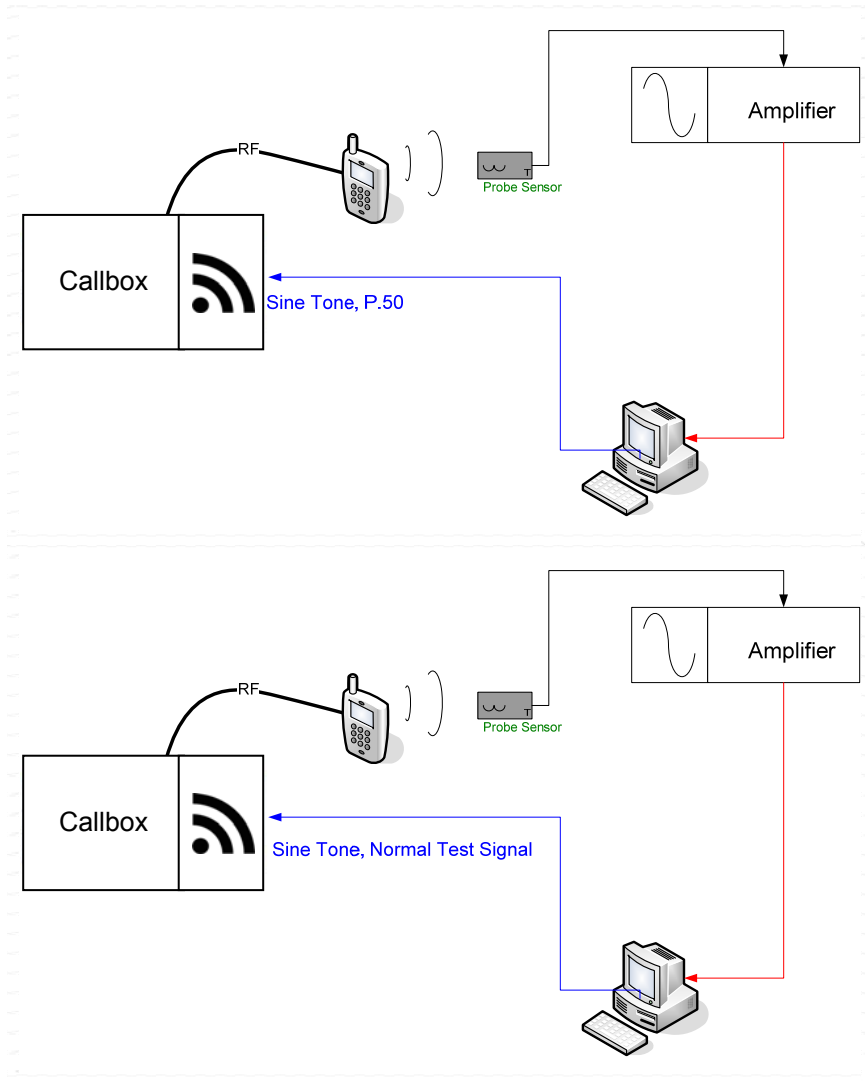



Figure 4-2
T-Coil Test Setup

FCC ID: A3LSMJ737T		HAC (T-COIL) TEST REPORT		Approved by: Quality Manager
Filename: 1M1803150042-12.A3L	Test Dates: 04/12/2018 - 04/23/2018	DUT Type: Portable Handset		Page 9 of 74

© 2018 PCTEST Engineering Laboratory, Inc.

REV 3.2.M
04/17/2018

© 2018 PCTEST Engineering Laboratory, Inc. All rights reserved. Unless otherwise specified, no part of this report may be reproduced or utilized in any part, form or by any means, electronic or mechanical, including photocopying and microfilm, without permission in writing from PCTEST Engineering Laboratory, Inc. If you have any questions about this international copyright or have an enquiry about obtaining additional rights to this report or assembly of contents thereof, please contact INFO@PCTEST.COM.

II. Scanning Mechanism

Manufacturer: TEM
 Accuracy: ± 0.83 cm/meter
 Minimum Step Size: 0.1 mm
 Maximum speed: 6.1 cm/sec
 Line Voltage: 115 VAC
 Line Frequency: 60 Hz
 Material Composite: Delrin (Acetal)
 Data Control: Parallel Port
 Dynamic Range (X-Y-Z): 45 x 31.75 x 47 cm
 Dimensions: 36" x 25" x 38"
 Operating Area: 36" x 49" x 55"
 Reflections: < -20 dB (in anechoic chamber)

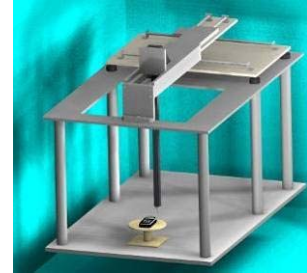

Figure 4-3
RF Near-Field Scanner

III. ITU-T P.50 Artificial Voice

Manufacturer: ITU-T
 Active Frequency Range: 100 Hz – 8 kHz
 Stimulus Type: Male and Female, no spaces
 Single Sample Duration: 20.96 seconds
 Activity Level: 100%

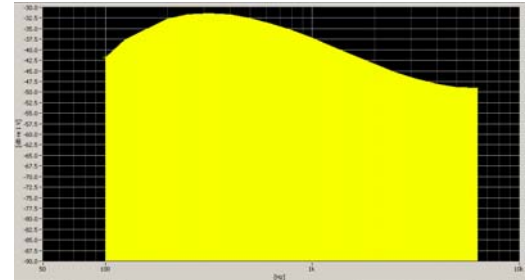

Figure 4-4
Spectral Characteristic of full P.50

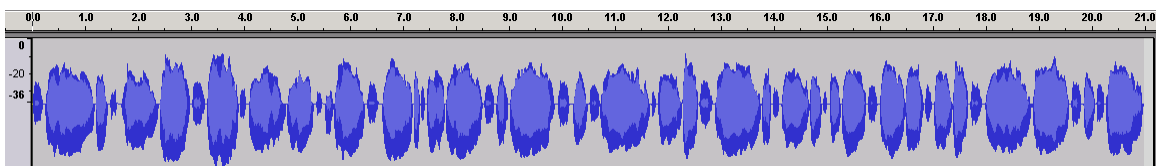



Figure 4-5
Temporal Characteristic of full P.50

FCC ID: A3LSMJ737T		HAC (T-COIL) TEST REPORT		Approved by: Quality Manager
Filename: 1M1803150042-12.A3L	Test Dates: 04/12/2018 - 04/23/2018	DUT Type: Portable Handset		Page 10 of 74

© 2018 PCTEST Engineering Laboratory, Inc.

REV 3.2.M
04/17/2018

© 2018 PCTEST Engineering Laboratory, Inc. All rights reserved. Unless otherwise specified, no part of this report may be reproduced or utilized in any part, form or by any means, electronic or mechanical, including photocopying and microfilm, without permission in writing from PCTEST Engineering Laboratory, Inc. If you have any questions about this international copyright or have an enquiry about obtaining additional rights to this report or assembly of contents thereof, please contact INFO@PCTEST.COM.

IV. 3GPP2 Normal Test Signal (Speech)

Manufacturer: 3GPP2 (TIA 1042 §3.3.1)
 Stimulus Type: Modified-IRS weighted, multi-talker speech signal, 4 Male and 4 Female speakers (alternating)
 Single Sample Duration: 51.62 seconds
 Activity Level: 77.4%

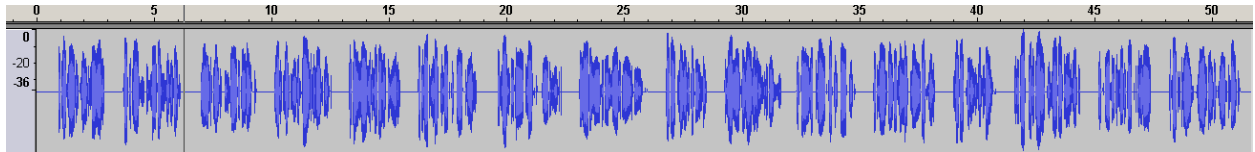
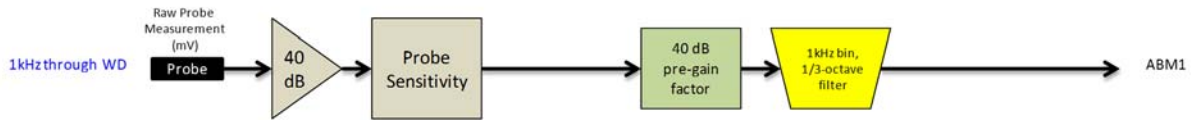

Figure 4-6
Temporal Characteristic of Normal Test Signal

ABM1 Measurement Block Diagram:



ABM2 Measurement Block Diagram:

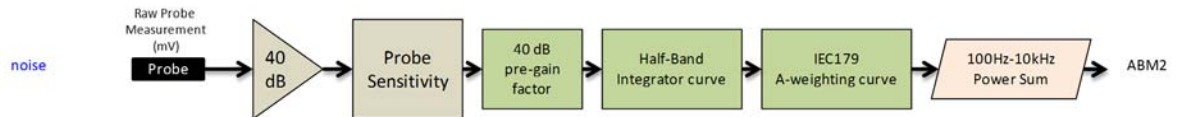

Figure 4-7 Magnetic Measurement Processing Steps

FCC ID: A3LSMJ737T		HAC (T-COIL) TEST REPORT		Approved by: Quality Manager
Filename: 1M1803150042-12.A3L	Test Dates: 04/12/2018 - 04/23/2018	DUT Type: Portable Handset		Page 11 of 74

© 2018 PCTEST Engineering Laboratory, Inc.

REV 3.2.M

04/17/2018

© 2018 PCTEST Engineering Laboratory, Inc. All rights reserved. Unless otherwise specified, no part of this report may be reproduced or utilized in any part, form or by any means, electronic or mechanical, including photocopying and microfilm, without permission in writing from PCTEST Engineering Laboratory, Inc. If you have any questions about this international copyright or have an enquiry about obtaining additional rights to this report or assembly of contents thereof, please contact INFO@PCTEST.COM.

V. Test Procedure

1. Ambient Noise Check per C63.19 §7.3.1
 - a. Ambient interference was monitored using a Real-Time Analyzer between 100-10,000 Hz with 1/3 octave filtering.
 - b. “A-weighting” and Half-Band Integration was applied to the measurements.
 - c. Since this measurement was measured in the same method as ABM2 measurements, this level was verified to be more than 10 dB below the lowest measurement signal (which is the highest ABM2 measurement for a T4 WD). Therefore the maximum noise level for a T4 WD with an ABM1 = -18 dBA/m is:

$$-18 - 30 - 10 = -58 \text{ dBA/m}$$

2. Measurement System Validation(See Figure 4-1)
 - a. The measurement system including the probe, pre-amplifier and acquisition system were validated as an entire system to ensure the reliability of test measurements.
 - b. ABM1 Validation
The magnetic field at the center of the Helmholtz coil is given by the equation (per C63.19 Annex D.10.1):

$$H_c = \frac{NI}{r\sqrt{1.25^3}} = \frac{N\left(\frac{V}{R}\right)}{r\sqrt{1.25^3}}$$

Where H_c = magnetic field strength in amperes per meter

N = number of turns per coil

For the Helmholtz Coil, N=20; r=0.08m; R=10.2Ω and using V=18mV:

$$H_c = \frac{20 \cdot \left(\frac{0.018}{10.2}\right)}{0.08 \cdot \sqrt{1.25^3}} = 0.316 \text{ A/m} \approx -10 \text{ dB(A/m)}$$

Therefore a pure tone of 1kHz was applied into the coils such that 18mV was observed across the resistor. The voltmeter used for measurement was verified to be capable of measurements in the audio band range. This theoretically generates an expected field of -10 dB(A/m) in the center of the Helmholtz coil which was used to validate the probe measurement at -10dB(A/m). This was verified to be within ± 0.5 dB of the -10dB(A/m) value (see Page 36).

- c. Frequency Response Validation
The frequency response through the Helmholtz Coil was verified to be within 0.5 dB relative to 1kHz, between 300 – 3000 Hz using the P.50 and Normal signal as shown below:

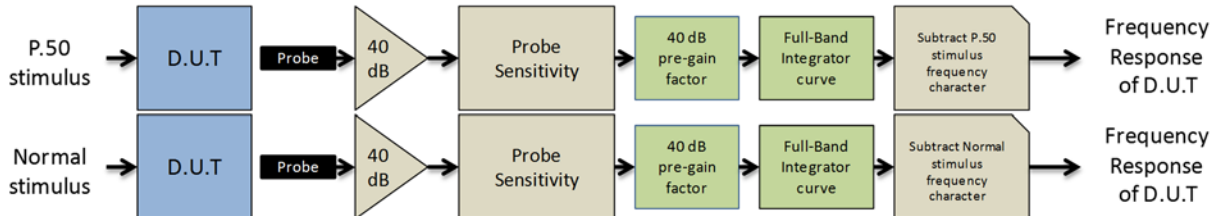



Figure 4-8 Frequency Response Validation

FCC ID: A3LSMJ737T		HAC (T-COIL) TEST REPORT		Approved by: Quality Manager
Filename: 1M1803150042-12.A3L	Test Dates: 04/12/2018 - 04/23/2018	DUT Type: Portable Handset		Page 12 of 74

© 2018 PCTEST Engineering Laboratory, Inc.

REV 3.2.M

04/17/2018



© 2018 PCTEST Engineering Laboratory, Inc. All rights reserved. Unless otherwise specified, no part of this report may be reproduced or utilized in any part, form or by any means, electronic or mechanical, including photocopying and microfilm, without permission in writing from PCTEST Engineering Laboratory, Inc. If you have any questions about this international copyright or have an enquiry about obtaining additional rights to this report or assembly of contents thereof, please contact INFO@PCTEST.COM.

d. ABM2 Measurement Validation

WD noise measurements are filtered with A-weighting and Half-Band Integration over a frequency range of 100Hz – 10kHz to process ABM2 measurements. Below is the verification of the system processing A-weighting and Half-Band integration between system input to output within 0.5 dB of the theoretical result:

**Table 4-1
ABM2 Frequency Response Validation**

f (Hz)	HBI, A - Measured (dB re 1kHz)	HBI, A - Theoretical (dB re 1kHz)	dB Var.
100	-16.180	-16.170	-0.010
125	-13.257	-13.250	-0.007
160	-10.347	-10.340	-0.007
200	-8.017	-8.010	-0.007
250	-5.925	-5.920	-0.005
315	-4.045	-4.040	-0.005
400	-2.405	-2.400	-0.005
500	-1.212	-1.210	-0.002
630	-0.349	-0.350	0.001
800	0.071	0.070	0.001
1000	0.000	0.000	0.000
1250	-0.503	-0.500	-0.003
1600	-1.513	-1.510	-0.003
2000	-2.778	-2.780	0.002
2500	-4.316	-4.320	0.004
3150	-6.166	-6.170	0.004
4000	-8.322	-8.330	0.008
5000	-10.573	-10.590	0.017
6300	-13.178	-13.200	0.022
8000	-16.241	-16.270	0.029
10000	-19.495	-19.520	0.025

FCC ID: A3LSMJ737T		HAC (T-COIL) TEST REPORT		Approved by: Quality Manager
Filename: 1M1803150042-12.A3L	Test Dates: 04/12/2018 - 04/23/2018	DUT Type: Portable Handset	Page 13 of 74	

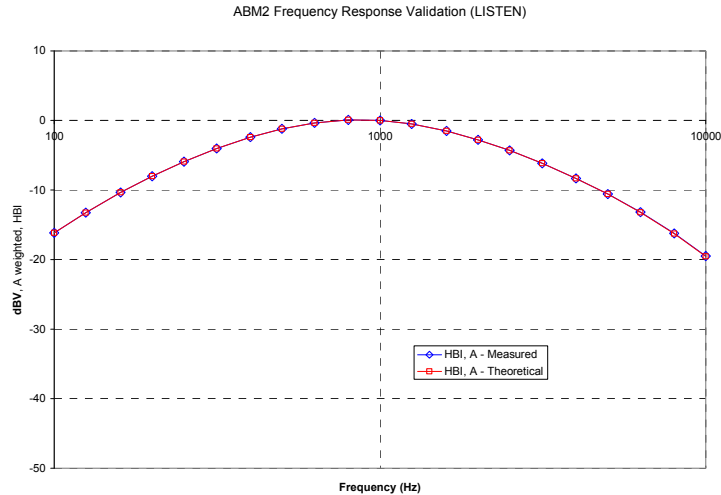

Figure 4-9
ABM2 Frequency Response Validation

The ABM2 result is a power sum from 100Hz to 10kHz with half-band integration and A-weighting. To verify the power sum measurement, a power sum over the full band was measured and verified to track with the source level (See Figure 4-10). Therefore the setup in this step was used to verify the power sum post-processing for ABM2 measurements. See below block diagram:

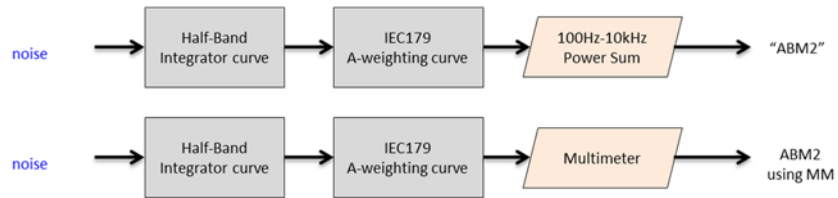

Figure 4-10
ABM2 Validation Block Diagram

The power summed output results for a known input were compared to the multi-meter results to verify any deviation in the post-processing implemented with the power-sum.

Table 4-2
ABM2 Power Sum Validation

WN Input (dBV)	Power Sum (dBV)	Multimeter-Full (dBV)	Dev (dB)
-60	-60.36	-60.2	0.16
-50	-50.19	-50.13	0.06
-40	-40.14	-40.03	0.11
-30	-30.13	-30.01	0.12
-20	-20.12	-20	0.12
-10	-10.14	-10	0.14

FCC ID: A3LSMJ737T		HAC (T-COIL) TEST REPORT		Approved by: Quality Manager
Filename: 1M1803150042-12.A3L	Test Dates: 04/12/2018 - 04/23/2018	DUT Type: Portable Handset		Page 14 of 74

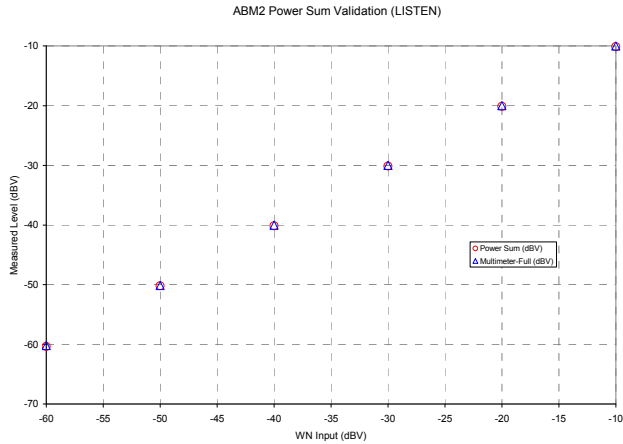

Figure 4-11
ABM2 Power Sum Validation

3. Measurement Test Setup

a. Fine scan above the WD (TEM)

- i. A multitone signal was applied to the handset such that the phone acoustic output was stable within 1dB over the probe settling time and with the acoustic output level at the C63.19 specified levels (below). The measurement step size was in 2 mm increments at a distance of 10 mm between the surface of the wireless device as shown below (note that in Figure 4-13, the grid is not to scale but merely a graphical representation of the coordinate system in use):

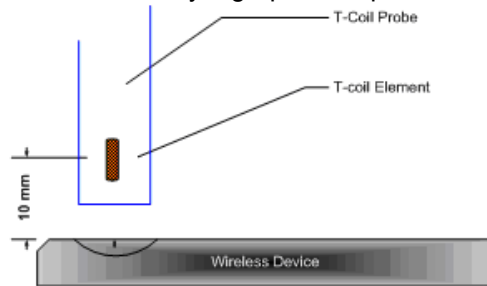

Figure 4-12
Measurement Distance

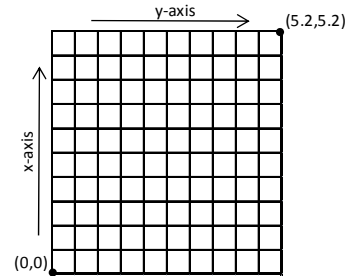

Figure 4-13
Measurement Grid

- ii. After scanning, the planar field maximum point was determined. The position of the probe was moved to this location to setup the test using the SoundCheck system.
 - iii. These steps were repeated for all T-coil orientations (axial and radial) per Figure 4-16 after a T-coil orientation was fully measured with the SoundCheck system.
- b. Speech Signal Setup to Base Station Simulator
- i. C63.19 Table 7-1 states audio reference input levels for various technologies:

Standard	Technology	Input Level (dBm0)
TIA/EIA/IS-2000	CDMA	-18
J-STD-007	GSM (217)	-16
T1/T1P1/3GPP	UMTS (WCDMA)	-16
iDEN™	TDMA (22 and 11 Hz)	-18

FCC ID: A3LSMJ737T	PCTEST ENGINEERING LABORATORY, INC.	HAC (T-COIL) TEST REPORT		Approved by: Quality Manager
Filename: 1M1803150042-12.A3L	Test Dates: 04/12/2018 - 04/23/2018	DUT Type: Portable Handset		Page 15 of 74

- ii. See Section 5 and 6 for more information regarding CMW500 audio level settings for Voice Over LTE (VoLTE), and Voice Over WIFI (VoWIFI) testing.
 - iii. See Section 7 for more information regarding audio level settings for Over-The-Top (OTT) Voice Over IP (VoIP) Testing.
- c. Real-Time Analyzer (RTA)
- i. The Real-Time Analyzer was configured to analyze measurements using 1/3 Octave band weighted filtering.
- d. WD Radio Configuration Selection
- i. The device was chosen to be tested in the worst-case ABM2 condition (see below for GSM, see Section 8 for more information regarding worst-case configurations for UMTS. LTE configuration information can be found in Section 5. WIFI configuration information can be found in Section 6 and 7.):

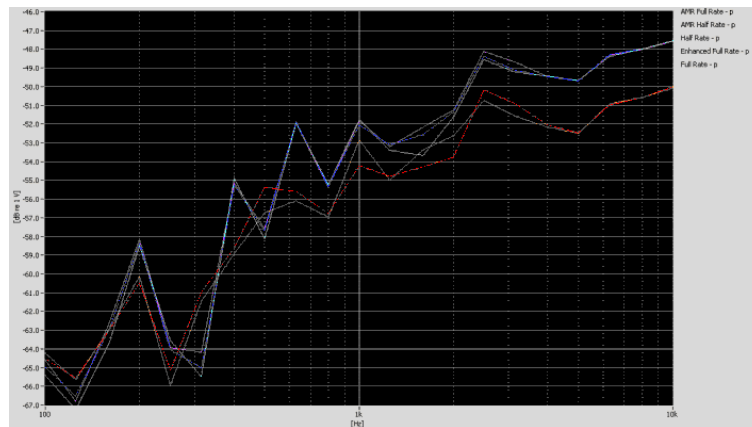



Figure 4-14
Vocoder Analysis for ABM Noise for GSM

4. Signal Quality Data Analysis
- a. Narrow-band Magnetic Intensity
 - i. The standard specifies a 1kHz 1/3 octave band minimum field intensity for a sine tone. The ABM1 measurements were evaluated at 1kHz with 1/3 octave band filtering over an averaged period of 10 seconds.
 - b. Frequency Response
 - i. The appropriate frequency response curve was measured to curves in Figure 3-1 or Figure 3-2 between 300 – 3000 Hz using digital linear averaging (limit lines chosen according to measurement found in step 4a). A linear average over 3x the length of the artificial voice signal (3x sampling) was performed. A 10 second delay was configured in the measurement process of the stimulus to ensure handset vocoder latency effects and echo cancellation devices (if any) were appropriately stabilized during measurements.
 - ii. The appropriate post-processing was applied according to the system processing chain illustrated in Figure 4-8. All R10 frequencies were plotted with respect to 0dB at 1kHz value and aligned with respect to the EIA-504 mask.
 - iii. The margin is represented by the closest measured data point on the curve to the EIA-504 limit lines, in dB.

FCC ID: A3LSMJ737T		HAC (T-COIL) TEST REPORT		Approved by: Quality Manager
Filename: 1M1803150042-12.A3L	Test Dates: 04/12/2018 - 04/23/2018	DUT Type: Portable Handset	Page 16 of 74	

c. Signal Quality Index

- i. Ensuring the WD was at maximum RF power, maximum volume, backlight off, display on, maximum contrast setting, keypad lights on (when possible) with no audio signal through the vocoder, the WD was measured over at least 100 Hz – 10,000 Hz, maximized over 5 seconds with a 50ms sample time for the ABM2 measurement (5 second time period is used in noise measurements under standards such as IEEE 269, etc.).
- ii. After applying half-band integration and A-weighting to the result, a power sum was applied over each 1/3 octave bandwidth frequency for an ABM2 value.
- iii. This result was subtracted from the ABM1 result in step a, to obtain the Signal Quality.

VI. Test Setup

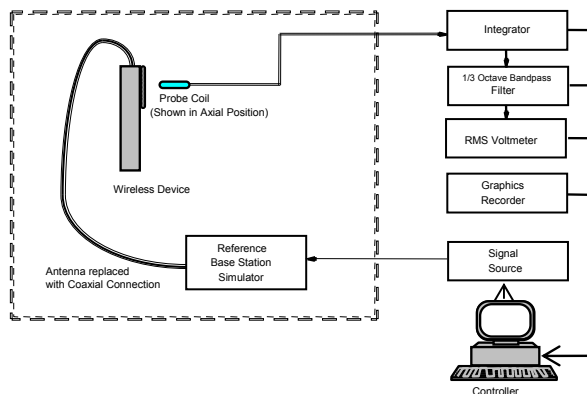



**Figure 4-15
Audio Magnetic Field Test Setup**

VII. Deviation from C63.19 Test Procedure

Non-conducted RF connection due to inaccessible RF ports.

VIII. Air Interface Technologies Tested

All air interfaces which support voice capabilities over a managed CMRS or pre-installed OTT VoIP applications were tested for T-coil unless otherwise noted. See Table 2-1 for more details regarding which modes were tested.

FCC ID: A3LSMJ737T		HAC (T-COIL) TEST REPORT		Approved by: Quality Manager
Filename: 1M1803150042-12.A3L	Test Dates: 04/12/2018 - 04/23/2018	DUT Type: Portable Handset		Page 17 of 74

IX. Wireless Device Channels and Frequencies

1. 2G/3G Modes

The frequencies listed in the table below are those that lie in the center of the bands used for cellular telephony. Low, middle and high channels were tested in each band for FCC compliance evaluation to ensure the maximum emission is captured across the entire band. Only middle channels were evaluated for data modes since circuit-switched voice modes were worst-case.

**Table 4-3
Center Channels and Frequencies**



Test frequencies & associated channels	
Channel	Frequency (MHz)
Cellular 850	
190 (GSM)	836.60
4183 (UMTS)	836.60
AWS 1750	
1412 (UMTS)	1730.40
PCS 1900	
661 (GSM)	1880
9400 (UMTS)	1880

2. 4G (LTE) Modes

The middle channel for every band and bandwidth combination was tested for each probe orientation. The band and bandwidth combination from each probe orientation resulting in the worst-case SNNR was additionally tested using low and high channels for that band and bandwidth combination. The middle channel and supported bandwidths from the worst-case band according to Table 7-5 was additionally evaluated with OTT VoIP for each probe orientation. See Tables 9-4 to 9-9 as well as Table 9-16 for LTE bandwidths and channels.

3. WIFI

The middle channel for each 802.11 standard was tested for each probe orientation. The 2.4GHz 802.11 standard from each probe orientation resulting in the worst-case SNNR was additionally tested using low and high channels. The 5GHz 802.11 standard from each probe orientation resulting in the worst-case SNNR was additionally tested on higher U-NII bands as well as applicable low and high channels. See Tables 9-10 to 9-13 and Tables 9-17 to 9-20 for WIFI standards and channels.

FCC ID: A3LSMJ737T		HAC (T-COIL) TEST REPORT		Approved by: Quality Manager
Filename: 1M1803150042-12.A3L	Test Dates: 04/12/2018 - 04/23/2018	DUT Type: Portable Handset	Page 18 of 74	

X. Test Flow

The flow diagram below was followed (From C63.19):

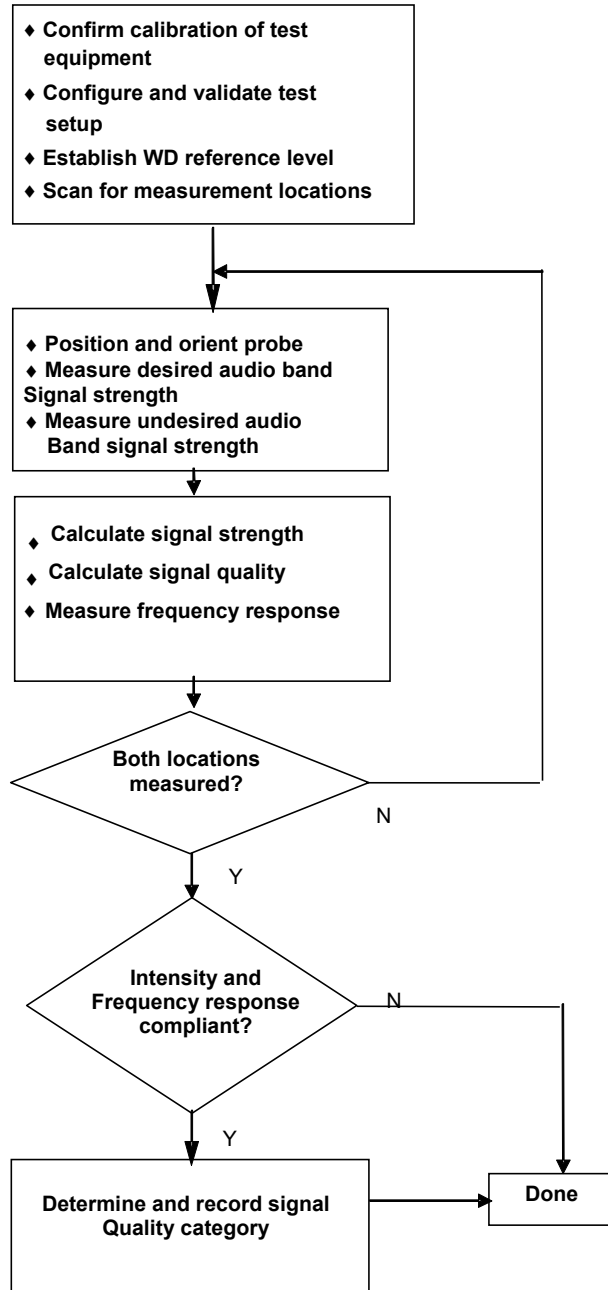



Figure 4-16
C63.19 T-Coil Signal Test Process

FCC ID: A3LSMJ737T		HAC (T-COIL) TEST REPORT		Approved by: Quality Manager
Filename: 1M1803150042-12.A3L	Test Dates: 04/12/2018 - 04/23/2018	DUT Type: Portable Handset		Page 19 of 74

© 2018 PCTEST Engineering Laboratory, Inc.

REV 3.2.M

04/17/2018

© 2018 PCTEST Engineering Laboratory, Inc. All rights reserved. Unless otherwise specified, no part of this report may be reproduced or utilized in any part, form or by any means, electronic or mechanical, including photocopying and microfilm, without permission in writing from PCTEST Engineering Laboratory, Inc. If you have any questions about this international copyright or have an enquiry about obtaining additional rights to this report or assembly of contents thereof, please contact INFO@PCTEST.COM.

5. VOLTE TEST SYSTEM SETUP AND DUT CONFIGURATION

I. Test System Setup for VoLTE over IMS T-coil Testing

1. Equipment Setup

The general test setup used for VoLTE over IMS is shown below. The callbox used when performing VoLTE over IMS T-coil measurements is a CMW500. The Data Application Unit (DAU) of the CMW500 was used to simulate the IP Multimedia Subsystem (IMS) server.

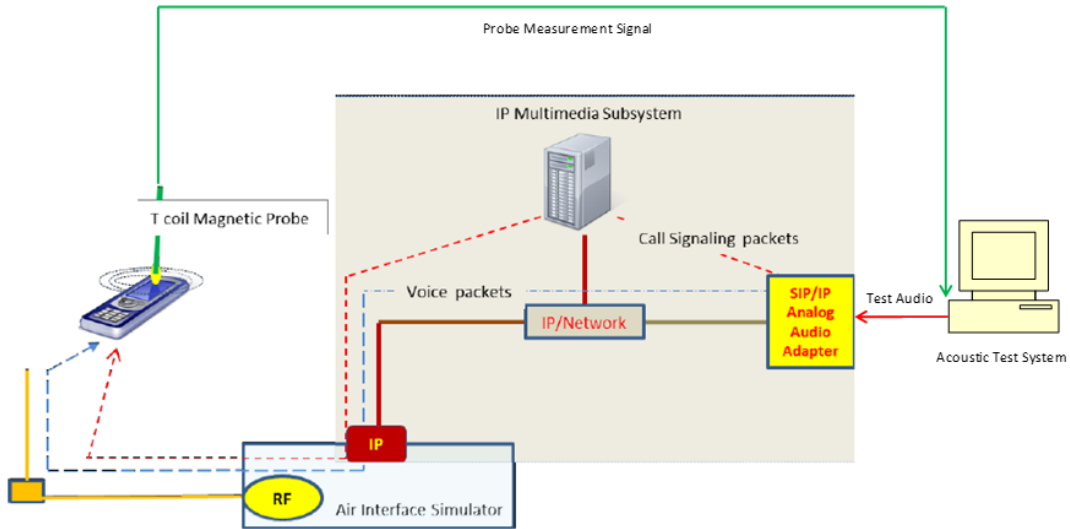



Figure 5-1
Test Setup for VoLTE over IMS T-Coil Measurements

2. Audio Level Settings

According to the July 2012 interpretations by the C63 Committee regarding the appropriate audio levels to be used for VoLTE over IMS T-coil testing, -16dBm0 shall be used for the normal speech input level*. The CMW500 base station simulator was manually configured to ensure that the settings for speech input and full scale levels resulted in the -16dBm0 speech input level to the DUT for the VoLTE over IMS connection.

* http://c63.org/documents/misc/posting/new_interpretations.htm

FCC ID: A3LSMJ737T		HAC (T-COIL) TEST REPORT		Approved by: Quality Manager
Filename: 1M1803150042-12.A3L	Test Dates: 04/12/2018 - 04/23/2018	DUT Type: Portable Handset		Page 20 of 74

© 2018 PCTEST Engineering Laboratory, Inc.

REV 3.2.M

04/17/2018

© 2018 PCTEST Engineering Laboratory, Inc. All rights reserved. Unless otherwise specified, no part of this report may be reproduced or utilized in any part, form or by any means, electronic or mechanical, including photocopying and microfilm, without permission in writing from PCTEST Engineering Laboratory, Inc. If you have any questions about this international copyright or have an enquiry about obtaining additional rights to this report or assembly of contents thereof, please contact INFO@PCTEST.COM.

II. DUT Configuration for VoLTE over IMS T-coil Testing

1. Radio Configuration

An investigation was performed to determine the modulation and RB configuration to be used for testing. 16QAM, 1RB, 0RB offset was used for the testing as the worst-case configuration for the handset. See below table for SNNR comparison between different radio configurations:

Table 5-1
VoLTE over IMS SNNR by Radio Configuration

Frequency [MHz]	Channel	Bandwidth [MHz]	Modulation	RB Size	RB Offset	ABM1 [dB(A/m)]	ABM2 [dB(A/m)]	SNNR [dB]
1880.0	18900	20	QPSK	1	0	-0.19	-36.50	36.31
1880.0	18900	20	QPSK	1	50	-0.43	-36.07	35.64
1880.0	18900	20	QPSK	1	99	-0.11	-36.64	36.53
1880.0	18900	20	QPSK	50	0	0.00	-35.53	35.53
1880.0	18900	20	QPSK	50	25	0.29	-35.40	35.69
1880.0	18900	20	QPSK	50	50	0.26	-35.57	35.83
1880.0	18900	20	QPSK	100	0	0.22	-35.59	35.81
1880.0	18900	20	16QAM	1	0	0.08	-34.51	34.59
1880.0	18900	20	16QAM	1	50	0.03	-34.72	34.75
1880.0	18900	20	16QAM	1	99	0.17	-35.02	35.19
1880.0	18900	20	16QAM	50	0	0.47	-35.76	36.23
1880.0	18900	20	16QAM	50	25	0.21	-35.74	35.95
1880.0	18900	20	16QAM	50	50	0.06	-35.72	35.78
1880.0	18900	20	16QAM	100	0	0.10	-35.72	35.82

2. Codec Configuration

An investigation was performed to determine the audio codec configuration to be used for testing. The WB AMR 6.60kbps setting was used for the audio codec on the CMW500 for VoLTE over IMS T-coil testing. See below table for comparisons between different codecs and codec data rates:

Table 5-2
AMR Codec Investigation – VoLTE over IMS

Codec Setting:	WB AMR 23.85kbps	WB AMR 6.60kbps	NB AMR 12.2kbps	NB AMR 4.75kbps	Orientation	Band / BW	Channel
ABM1 (dBA/m)	1.88	0.64	5.00	4.68	Axial	Band 2 20MHz	18900
ABM2 (dBA/m)	-35.34	-35.12	-35.51	-35.75			
Frequency Response	Pass	Pass	Pass	Pass			
S+N/N (dB)	37.22	35.76	40.51	40.43			

- Mute on; Backlight off; Max Volume; Max Contrast
- TPC = “Max Power”

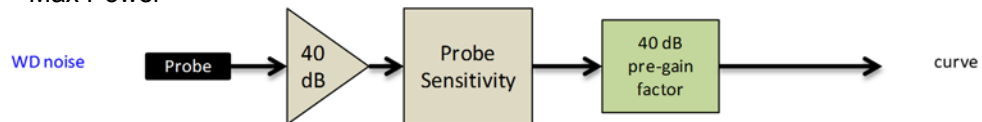

Figure 5-2
Audio Band Magnetic Curve Measurement Block Diagram

FCC ID: A3LSMJ737T		HAC (T-COIL) TEST REPORT		Approved by: Quality Manager
Filename: 1M1803150042-12.A3L	Test Dates: 04/12/2018 - 04/23/2018	DUT Type: Portable Handset		Page 21 of 74

6. VOWIFI TEST SYSTEM SETUP AND DUT CONFIGURATION

I. Test System Setup for VoWIFI over IMS T-coil Testing

1. Equipment Setup

The general test setup used for VoWIFI over IMS, or CMRS WIFI Calling, is shown below. The callbox used when performing VoWIFI over IMS T-coil measurements is a CMW500. The Data Application Unit (DAU) of the CMW500 was used to simulate the IP Multimedia Subsystem (IMS) server.

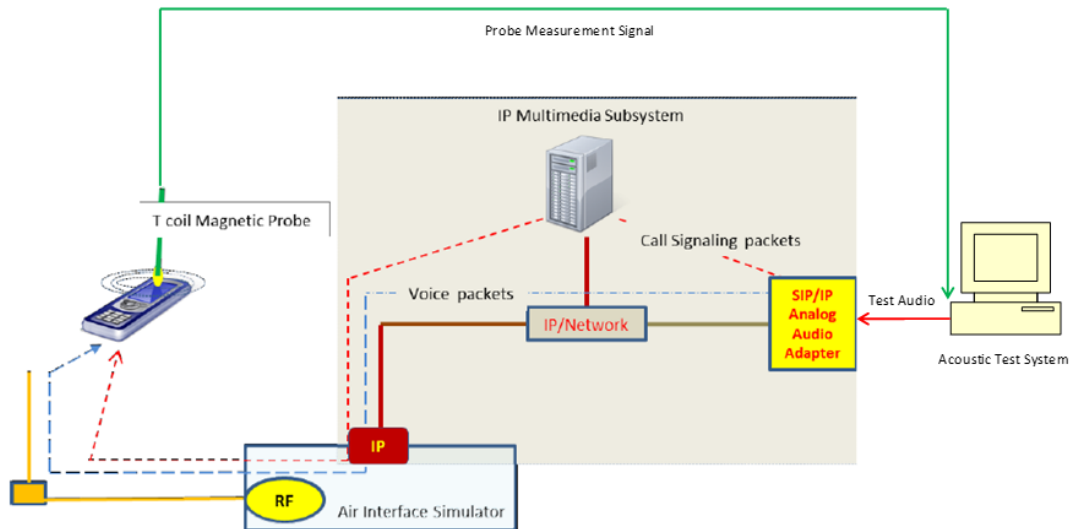



Figure 6-1
Test Setup for VoWIFI over IMS T-Coil Measurements

2. Audio Level Settings

According to KDB 285076 D02 released by the FCC OET regarding the appropriate audio levels to be used for VoWIFI over IMS T-Coil testing, -20dBm_0 shall be used for the normal speech input level². The CMW500 base station simulator was manually configured to ensure that the settings for speech input and full scale levels resulted in the -20dBm_0 speech input level to the DUT for the VoWIFI over IMS connection.

² FCC Office of Engineering and Technology KDB, "285076 D02 T-Coil Testing for CMRS IP v03," September 13, 2017

FCC ID: A3LSMJ737T		HAC (T-COIL) TEST REPORT		Approved by: Quality Manager
Filename: 1M1803150042-12.A3L	Test Dates: 04/12/2018 - 04/23/2018	DUT Type: Portable Handset		Page 22 of 74

II. DUT Configuration for VoWiFi over IMS T-coil Testing

1. Radio Configuration

An investigation was performed on all applicable data rates and modulations to determine the radio configuration to be used for testing. See tables below for SNNR comparison between radio configurations in each 802.11 standard:

Table 6-1
802.11b SNNR by Radio Configuration

Mode	Channel	Modulation	Data Rate [Mbps]	ABM1 [dB(A/m)]	ABM2 [dB(A/m)]	SNNR [dB]
802.11b	6	DSSS	1	-0.63	-36.04	35.41
802.11b	6	DSSS	2	-1.06	-35.98	34.92
802.11b	6	CCK	5.5	-0.51	-35.78	35.27
802.11b	6	CCK	11	-0.99	-35.74	34.75

Table 6-2
802.11g/a SNNR by Radio Configuration

Mode	Channel	Modulation	Data Rate [Mbps]	ABM1 [dB(A/m)]	ABM2 [dB(A/m)]	SNNR [dB]
802.11g	6	BPSK	6	-0.93	-35.85	34.92
802.11g	6	BPSK	9	-0.98	-35.87	34.89
802.11g	6	QPSK	12	-0.88	-35.95	35.07
802.11g	6	QPSK	18	-0.99	-35.96	34.97
802.11g	6	16-QAM	24	-1.02	-36.00	34.98
802.11g	6	16-QAM	36	-1.04	-35.74	34.70
802.11g	6	64-QAM	48	-1.04	-35.99	34.95
802.11g	6	64-QAM	54	-1.02	-35.98	34.96

Table 6-3
802.11n/ac 20MHz BW SNNR by Radio Configuration

Mode	Bandwidth [MHz]	Channel	Modulation	Data Rate [Mbps]	ABM1 [dB(A/m)]	ABM2 [dB(A/m)]	SNNR [dB]
802.11n	20	40	BPSK	6.5	-0.98	-35.96	34.98
802.11n	20	40	QPSK	13	-0.44	-35.97	35.53
802.11n	20	40	QPSK	19.5	-1.10	-35.94	34.84
802.11n	20	40	16-QAM	26	-1.01	-35.95	34.94
802.11n	20	40	16-QAM	39	-0.45	-35.96	35.51
802.11n	20	40	64-QAM	52	-0.48	-35.93	35.45
802.11n	20	40	64-QAM	58.5	-0.89	-35.88	34.99
802.11n	20	40	64-QAM	65	-0.84	-35.85	35.01
802.11ac	20	40	256-QAM	78	-0.91	-35.92	35.01



FCC ID: A3LSMJ737T		HAC (T-COIL) TEST REPORT		Approved by: Quality Manager
Filename: 1M1803150042-12.A3L	Test Dates: 04/12/2018 - 04/23/2018	DUT Type: Portable Handset		Page 23 of 74

Table 6-4
802.11n/ac 40MHz BW SNNR by Radio Configuration

Mode	Bandwidth [MHz]	Channel	Modulation	Data Rate [Mbps]	ABM1 [dB(A/m)]	ABM2 [dB(A/m)]	SNNR [dB]
802.11n	40	38	BPSK	13.5	-0.49	-35.84	35.35
802.11n	40	38	QPSK	27	-0.48	-35.86	35.38
802.11n	40	38	QPSK	40.5	-0.96	-35.13	34.17
802.11n	40	38	16-QAM	54	-0.50	-35.72	35.22
802.11n	40	38	16-QAM	81	-0.38	-35.64	35.26
802.11n	40	38	64-QAM	108	-0.93	-35.71	34.78
802.11n	40	38	64-QAM	121.5	-0.50	-35.70	35.20
802.11n	40	38	64-QAM	135	-0.54	-35.85	35.31
802.11ac	40	38	256-QAM	162	-0.98	-35.80	34.82
802.11ac	40	38	256-QAM	180	-0.56	-35.81	35.25

2. Codec Configuration

An investigation was performed to determine the audio codec configuration to be used for testing. The WB AMR 6.60kbps setting was used for the audio codec on the CMW500 for VoWiFi over IMS T-coil testing. See below table for comparisons between different codecs and codec data rates:

Table 6-5
AMR Codec Investigation – VoWiFi over IMS

Codec Setting:	WB AMR 23.85kbps	WB AMR 6.60kbps	NB AMR 12.2kbps	NB AMR 4.75kbps	Orientation	Band	Standard	Channel
ABM1 (dBA/m)	0.67	-0.55	4.51	4.24	Axial	2.4GHz	IEEE 802.11b	6
ABM2 (dBA/m)	-36.19	-35.98	-35.29	-35.19				
Frequency Response	Pass	Pass	Pass	Pass				
S+N/N (dB)	36.86	35.43	39.80	39.43				

- Mute on; Backlight off; Max Volume; Max Contrast

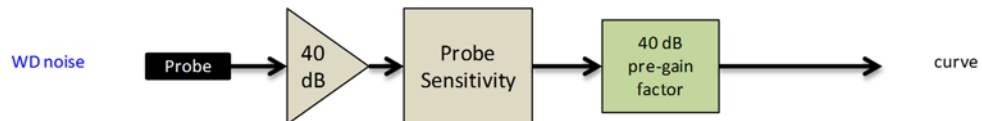

Figure 6-2
Audio Band Magnetic Curve Measurement Block Diagram

FCC ID: A3LSMJ737T		HAC (T-COIL) TEST REPORT		Approved by: Quality Manager
Filename: 1M1803150042-12.A3L	Test Dates: 04/12/2018 - 04/23/2018	DUT Type: Portable Handset		Page 24 of 74

7. OTT VOIP TEST SYSTEM AND DUT CONFIGURATION

I. Test System Setup for OTT VoIP T-Coil Testing

1. OTT VoIP Application

Google Duo is a pre-installed application on the DUT which allows for VoIP calls in a held-to-ear scenario. Duo uses the OPUS audio codec and supports a bitrate range of 6kb/s to 64kb/s. All air interfaces capable of a data connection were evaluated with Google Duo.

2. Equipment Setup

A CMW500 callbox was used to perform OTT VoIP T-coil measurements. The Data Application Unit (DAU) of the CMW500 was connected to the internet and allowed for an IP data connection on the DUT. An auxiliary VoIP unit was used to initiate an OTT VoIP call to the DUT. The auxiliary VoIP unit allowed for the configuration and monitoring of the OTT VoIP codec bitrate during a call. Both high and low bitrate settings were evaluated in to determine the worst-case configuration.

3. Audio Level Settings

According to KDB 285076 D02, the average speech level of -20dBm0 shall be used for protocols not specifically listed in Table 7.1 of ANSI C63.19-2011 or the ANSI C63.19-2011 VoLTE interpretation³. The auxiliary VoIP unit allowed for monitoring the signal input level to ensure that the settings for speech input and full scale levels resulted in the -20dBm0 speech input level to the DUT for the OTT VoIP call.

II. DUT Configuration for OTT VoIP T-Coil Testing



1. Codec Configuration

An investigation was performed for each applicable data mode to determine the audio codec configuration to be used for testing. The 6kbps codec setting was used for the audio codec on the auxiliary VoIP unit for OTT VoIP T-Coil testing. See below tables for comparisons between codec data rates on all applicable data modes:

**Table 7-1
Codec Investigation – OTT VoIP (EDGE)**

Codec Setting:	64kbps	6kbps	Orientation	Channel
ABM1 (dBA/m)	9.72	9.17	Axial	661
ABM2 (dBA/m)	-28.81	-29.12		
Frequency Response	Pass	Pass		
S+N/N (dB)	38.53	38.29		

³ FCC Office of Engineering and Technology KDB, "285076 D02 T-Coil Testing for CMRS IP v03," September 13, 2017

FCC ID: A3LSMJ737T		HAC (T-COIL) TEST REPORT		Approved by: Quality Manager
Filename: 1M1803150042-12.A3L	Test Dates: 04/12/2018 - 04/23/2018	DUT Type: Portable Handset	Page 25 of 74	

**Table 7-2
Codec Investigation – OTT VoIP (HSPA)**

Codec Setting:	64kbps	6kbps	Orientation	Channel
ABM1 (dBA/m)	11.33	10.44	Axial	9400
ABM2 (dBA/m)	-35.89	-35.95		
Frequency Response	Pass	Pass		
S+N/N (dB)	47.22	46.39		

**Table 7-3
Codec Investigation – OTT VoIP (LTE)**

Codec Setting:	64kbps	6kbps	Orientation	Band / BW	Channel
ABM1 (dBA/m)	11.31	11.23	Axial	Band 12 10MHz	23095
ABM2 (dBA/m)	-35.39	-35.09			
Frequency Response	Pass	Pass			
S+N/N (dB)	46.70	46.32			

**Table 7-4
Codec Investigation – OTT VoIP (WIFI)**

Codec Setting:	64kbps	6kbps	Orientation	Band	Standard	Channel
ABM1 (dBA/m)	11.27	11.22	Axial	2.4GHz	IEEE 802.11b	6
ABM2 (dBA/m)	-34.39	-34.33				
Frequency Response	Pass	Pass				
S+N/N (dB)	45.66	45.55				

- Mute on; Backlight off; Max Volume; Max Contrast
- Radio Configurations can be found in Section 9.II.F

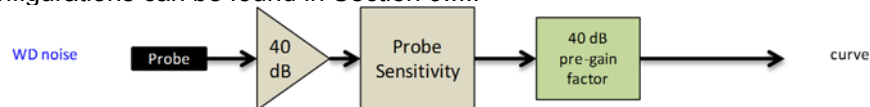

**Figure 7-1
Audio Band Magnetic Curve Measurement Block Diagram**

2. Radio Configuration for OTT VoIP (LTE)

An investigation was performed to determine the worst-case LTE band to be used for OTT VoIP testing. LTE Band 12 was used for the testing as the worst-case configuration for the handset. See below table for SNNR comparison between different LTE bands:

**Table 7-5
OTT VoIP (LTE) SNNR by LTE Band**

Band	Frequency [MHz]	Channel	Bandwidth [MHz]	Modulation	RB Size	RB Offset	ABM1 [dB(A/m)]	ABM2 [dB(A/m)]	SNNR [dB]
2	1880.0	18900	20	16QAM	1	0	1.49	-43.33	44.82
5	836.5	20525	10	16QAM	1	0	1.49	-43.66	45.15
7	2535.0	21100	20	16QAM	1	0	1.44	-43.97	45.41
12	707.5	23095	10	16QAM	1	0	1.35	-43.37	44.72
66	1745.0	132322	20	16QAM	1	0	1.58	-43.53	45.11
71	680.5	133297	20	16QAM	1	0	1.60	-43.22	44.82

FCC ID: A3LSMJ737T		HAC (T-COIL) TEST REPORT		Approved by: Quality Manager
Filename: 1M1803150042-12.A3L	Test Dates: 04/12/2018 - 04/23/2018	DUT Type: Portable Handset		Page 26 of 74

8. FCC 3G MEASUREMENTS

I. UMTS Test Configurations

AMR at 12.2kbps, 13.6kbps SRB was used for the testing as the worst-case configuration for the handset. See below plot for ABM noise comparison between vocoder rates:

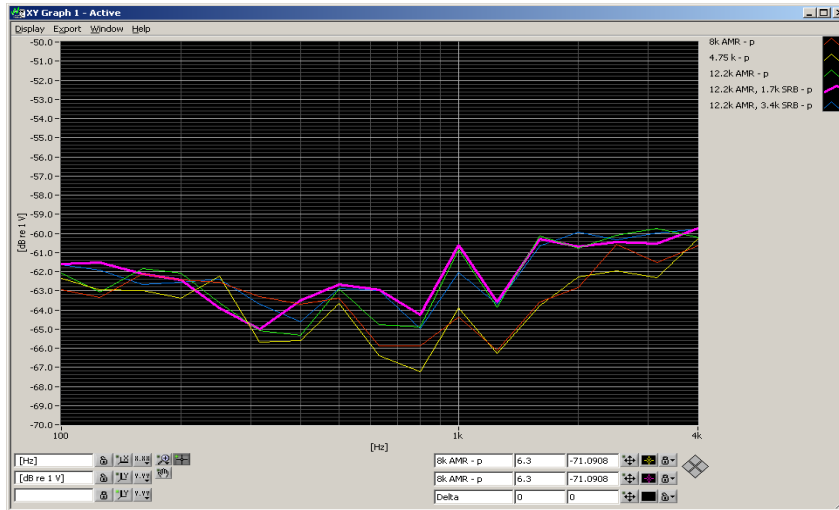

Figure 8-1
UMTS Audio Band Magnetic Noise

Table 8-1
Codec Investigation - UMTS

Codec Setting:	AMR 12.2kbps	AMR 7.95kbps	AMR 4.75kbps	Orientation	Channel
ABM1 (dBA/m)	6.46	6.59	6.50	Axial	9400
ABM2 (dBA/m)	-34.50	-34.43	-35.06		
Frequency Response	Pass	Pass	Pass		
S+N/N (dB)	40.96	41.02	41.56		

- Mute on; Backlight off; Max Volume; Max Contrast
- TPC="All 1s"

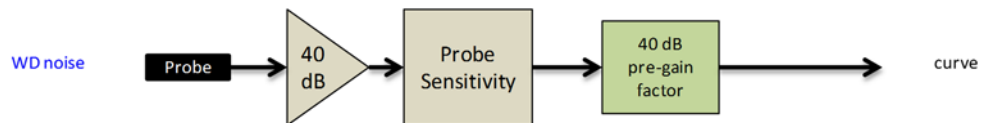

Figure 8-2
Audio Band Magnetic Curve Measurement Block Diagram

FCC ID: A3LSMJ737T	PCTEST ENGINEERING LABORATORY, INC.	HAC (T-COIL) TEST REPORT	SAMSUNG	Approved by: Quality Manager
Filename: 1M1803150042-12.A3L	Test Dates: 04/12/2018 - 04/23/2018	DUT Type: Portable Handset		Page 27 of 74

© 2018 PCTEST Engineering Laboratory, Inc.

REV 3.2.M

04/17/2018

© 2018 PCTEST Engineering Laboratory, Inc. All rights reserved. Unless otherwise specified, no part of this report may be reproduced or utilized in any part, form or by any means, electronic or mechanical, including photocopying and microfilm, without permission in writing from PCTEST Engineering Laboratory, Inc. If you have any questions about this international copyright or have an enquiry about obtaining additional rights to this report or assembly of contents thereof, please contact INFO@PCTEST.COM.

9. T-COIL TEST SUMMARY

**Table 9-1
Consolidated Tabled Results**

		Freq. Response Margin		Magnetic Intensity Verdict		FCC SNNR Verdict		Margin from FCC Limit (dB)	C63.19-2011 Rating
		8.3.2		8.3.1		8.3.4			
		Axial	Radial	Axial	Radial	Axial	Radial		
GSM	Cellular	PASS	NA	PASS	PASS	PASS	PASS	-3.53	T3
	PCS	PASS	NA	PASS	PASS	PASS	PASS		
EDGE (OTT VoIP)	Cellular	PASS	NA	PASS	PASS	PASS	PASS	-14.39	T4
	PCS	PASS	NA	PASS	PASS	PASS	PASS		
UMTS	Cellular	PASS	NA	PASS	PASS	PASS	PASS	-19.92	T4
	AWS	PASS	NA	PASS	PASS	PASS	PASS		
	PCS	PASS	NA	PASS	PASS	PASS	PASS		
HSPA (OTT VoIP)	Cellular	PASS	NA	PASS	PASS	PASS	PASS	-25.87	T4
	AWS	PASS	NA	PASS	PASS	PASS	PASS		
	PCS	PASS	NA	PASS	PASS	PASS	PASS		
LTE FDD	B71	PASS	NA	PASS	PASS	PASS	PASS	-13.44	T4
	B12	PASS	NA	PASS	PASS	PASS	PASS		
	B5	PASS	NA	PASS	PASS	PASS	PASS		
	B66	PASS	NA	PASS	PASS	PASS	PASS		
	B2	PASS	NA	PASS	PASS	PASS	PASS		
	B7	PASS	NA	PASS	PASS	PASS	PASS		
LTE FDD (OTT VoIP)	B12	PASS	NA	PASS	PASS	PASS	PASS	-24.57	T4
WLAN	802.11b	PASS	NA	PASS	PASS	PASS	PASS	-13.80	T4
	802.11g	PASS	NA	PASS	PASS	PASS	PASS		
	802.11n	PASS	NA	PASS	PASS	PASS	PASS		
WLAN (OTT VoIP)	802.11b	PASS	NA	PASS	PASS	PASS	PASS	-23.86	T4
	802.11g	PASS	NA	PASS	PASS	PASS	PASS		
	802.11n	PASS	NA	PASS	PASS	PASS	PASS		
U-NII	802.11a	PASS	NA	PASS	PASS	PASS	PASS	-14.49	T4
	802.11n	PASS	NA	PASS	PASS	PASS	PASS		
	802.11ac	PASS	NA	PASS	PASS	PASS	PASS		
U-NII (OTT VoIP)	802.11a	PASS	NA	PASS	PASS	PASS	PASS	-25.70	T4
	802.11n	PASS	NA	PASS	PASS	PASS	PASS		
	802.11ac	PASS	NA	PASS	PASS	PASS	PASS		

FCC ID: A3LSMJ737T		HAC (T-COIL) TEST REPORT		Approved by: Quality Manager
Filename: 1M1803150042-12.A3L	Test Dates: 04/12/2018 - 04/23/2018	DUT Type: Portable Handset	Page 28 of 74	

© 2018 PCTEST Engineering Laboratory, Inc.

REV 3.2.M
04/17/2018

© 2018 PCTEST Engineering Laboratory, Inc. All rights reserved. Unless otherwise specified, no part of this report may be reproduced or utilized in any part, form or by any means, electronic or mechanical, including photocopying and microfilm, without permission in writing from PCTEST Engineering Laboratory, Inc. If you have any questions about this international copyright or have an enquiry about obtaining additional rights to this report or assembly of contents thereof, please contact INFO@PCTEST.COM.

I. Raw Handset Data

Table 9-2
Raw Data Results for GSM



Mode	Orientation	Channel	ABM1 [dB(A/m)]	ABM2 [dB(A/m)]	Ambient Noise [dB(A/m)]	Frequency Response Margin (dB)	S+N/N (dB)	FCC Limit (dB)	Margin from FCC Limit (dB)	C63.19-2011 Rating	Test Coordinates
GSM850	Axial	128	4.97	-21.34	-58.23	1.73	26.31	20.00	-6.31	T3	2.6, 2.4
		190	4.94	-21.66		1.79	26.60	20.00	-6.60	T3	
		251	4.98	-21.45		1.82	26.43	20.00	-6.43	T3	
	Radial	128	-4.91	-28.67	-59.88	N/A	23.76	20.00	-3.76	T3	2.6, 1.4
		190	-5.01	-28.93			23.92	20.00	-3.92	T3	
		251	-5.15	-28.68			23.53	20.00	-3.53	T3	
GSM1900	Axial	512	4.96	-25.11	-58.23	1.74	30.07	20.00	-10.07	T4	2.6, 2.4
		661	5.07	-24.60		1.77	29.67	20.00	-9.67	T3	
		810	4.81	-24.66		2.00	29.47	20.00	-9.47	T3	
	Radial	512	-5.43	-32.47	-59.88	N/A	27.04	20.00	-7.04	T3	2.6, 1.4
		661	-5.36	-31.89			26.53	20.00	-6.53	T3	
		810	-5.22	-31.90			26.68	20.00	-6.68	T3	

Table 9-3
Raw Data Results for UMTS

Mode	Orientation	Channel	ABM1 [dB(A/m)]	ABM2 [dB(A/m)]	Ambient Noise [dB(A/m)]	Frequency Response Margin (dB)	S+N/N (dB)	FCC Limit (dB)	Margin from FCC Limit (dB)	C63.19-2011 Rating	Test Coordinates
UMTS V	Axial	4132	6.88	-34.11	-59.93	1.72	40.99	20.00	-20.99	T4	2.6, 2.4
		4183	6.87	-34.07		1.70	40.94	20.00	-20.94	T4	
		4233	6.92	-34.09		1.73	41.01	20.00	-21.01	T4	
	Radial	4132	-4.67	-44.92	-59.88	N/A	40.25	20.00	-20.25	T4	2.6, 1.4
		4183	-4.66	-45.01			40.35	20.00	-20.35	T4	
		4233	-4.65	-44.97			40.32	20.00	-20.32	T4	
UMTS IV	Axial	1312	6.88	-33.62	-59.93	1.69	40.50	20.00	-20.50	T4	2.6, 2.4
		1412	6.89	-34.06		1.73	40.95	20.00	-20.95	T4	
		1513	6.83	-34.12		1.68	40.95	20.00	-20.95	T4	
	Radial	1312	-4.71	-44.94	-59.88	N/A	40.23	20.00	-20.23	T4	2.6, 1.4
		1412	-4.67	-44.95			40.28	20.00	-20.28	T4	
		1513	-4.66	-44.95			40.29	20.00	-20.29	T4	
UMTS II	Axial	9262	6.78	-34.21	-59.93	1.70	40.99	20.00	-20.99	T4	2.6, 2.4
		9400	6.71	-34.24		1.66	40.95	20.00	-20.95	T4	
		9538	6.84	-34.17		1.72	41.01	20.00	-21.01	T4	
	Radial	9262	-4.71	-45.05	-59.88	N/A	40.34	20.00	-20.34	T4	2.6, 1.4
		9400	-4.71	-44.63			39.92	20.00	-19.92	T4	
		9538	-4.69	-45.02			40.33	20.00	-20.33	T4	

Table 9-4
Raw Data Results for LTE B71

Mode	Orientation	Bandwidth	Channel	ABM1 [dB(A/m)]	ABM2 [dB(A/m)]	Ambient Noise [dB(A/m)]	Frequency Response Margin (dB)	S+N/N (dB)	FCC Limit (dB)	Margin from FCC Limit (dB)	C63.19-2011 Rating	Test Coordinates
LTE Band 71	Axial	20MHz	133297	-0.10	-34.97	-59.93	1.68	34.87	20.00	-14.87	T4	2.6, 2.4
		15MHz	133297	0.02	-34.71		1.64	34.73	20.00	-14.73	T4	
		10MHz	133297	-0.03	-34.82		1.60	34.79	20.00	-14.79	T4	
		5MHz	133297	-0.35	-35.13		1.66	34.78	20.00	-14.78	T4	
	Radial	20MHz	133297	-9.03	-43.23	-59.88	N/A	34.20	20.00	-14.20	T4	2.6, 1.4
		15MHz	133297	-9.16	-43.39			34.23	20.00	-14.23	T4	
		10MHz	133297	-9.28	-43.56			34.28	20.00	-14.28	T4	
		5MHz	133297	-9.35	-43.65			34.30	20.00	-14.30	T4	

FCC ID: A3LSMJ737T		HAC (T-COIL) TEST REPORT		Approved by: Quality Manager
Filename: 1M1803150042-12.A3L	Test Dates: 04/12/2018 - 04/23/2018	DUT Type: Portable Handset	Page 29 of 74	

© 2018 PCTEST Engineering Laboratory, Inc.

REV 3.2.M
04/17/2018

© 2018 PCTEST Engineering Laboratory, Inc. All rights reserved. Unless otherwise specified, no part of this report may be reproduced or utilized in any part, form or by any means, electronic or mechanical, including photocopying and microfilm, without permission in writing from PCTEST Engineering Laboratory, Inc. If you have any questions about this international copyright or have an enquiry about obtaining additional rights to this report or assembly of contents thereof, please contact INFO@PCTEST.COM.

**Table 9-5
Raw Data Results for LTE B12**

Mode	Orientation	Bandwidth	Channel	ABM1 [dB(A/m)]	ABM2 [dB(A/m)]	Ambient Noise [dB(A/m)]	Frequency Response Margin (dB)	S+N/N (dB)	FCC Limit (dB)	Margin from FCC Limit (dB)	C63.19-2011 Rating	Test Coordinates
LTE Band 12	Axial	10MHz	23095	-0.30	-35.22	-59.93	1.59	34.92	20.00	-14.92	T4	2.6, 2.4
		5MHz	23095	0.00	-35.04		1.58	35.04	20.00	-15.04	T4	
		3MHz	23095	-0.32	-34.93		1.57	34.61	20.00	-14.61	T4	
		1.4MHz	23095	-0.34	-35.03		1.63	34.69	20.00	-14.69	T4	
	Radial	10MHz	23095	-9.09	-43.60	-59.88	N/A	34.51	20.00	-14.51	T4	2.6, 1.4
		5MHz	23095	-9.03	-43.19			34.16	20.00	-14.16	T4	
		3MHz	23095	-9.18	-43.22			34.04	20.00	-14.04	T4	
		1.4MHz	23095	-8.98	-44.05			35.07	20.00	-15.07	T4	

**Table 9-6
Raw Data Results for LTE B5**



Mode	Orientation	Bandwidth	Channel	ABM1 [dB(A/m)]	ABM2 [dB(A/m)]	Ambient Noise [dB(A/m)]	Frequency Response Margin (dB)	S+N/N (dB)	FCC Limit (dB)	Margin from FCC Limit (dB)	C63.19-2011 Rating	Test Coordinates
LTE Band 5	Axial	10MHz	20525	-0.22	-35.16	-59.93	1.61	34.94	20.00	-14.94	T4	2.6, 2.4
		5MHz	20525	-0.38	-34.98		1.64	34.60	20.00	-14.60	T4	
		3MHz	20525	-0.30	-35.06		1.67	34.76	20.00	-14.76	T4	
		1.4MHz	20643	0.00	-34.49		1.59	34.49	20.00	-14.49	T4	
		1.4MHz	20525	-0.33	-34.91		1.61	34.58	20.00	-14.58	T4	
		1.4MHz	20407	0.11	-34.71		1.60	34.82	20.00	-14.82	T4	
	Radial	10MHz	20525	-9.39	-43.52	-59.88	N/A	34.13	20.00	-14.13	T4	2.6, 1.4
		5MHz	20525	-9.04	-43.27			34.23	20.00	-14.23	T4	
		3MHz	20525	-9.06	-43.36			34.30	20.00	-14.30	T4	
		1.4MHz	20643	-9.14	-42.58			33.44	20.00	-13.44	T4	
		1.4MHz	20525	-9.00	-42.99			33.99	20.00	-13.99	T4	
		1.4MHz	20407	-9.23	-42.87			33.64	20.00	-13.64	T4	

**Table 9-7
Raw Data Results for LTE B66**

Mode	Orientation	Bandwidth	Channel	ABM1 [dB(A/m)]	ABM2 [dB(A/m)]	Ambient Noise [dB(A/m)]	Frequency Response Margin (dB)	S+N/N (dB)	FCC Limit (dB)	Margin from FCC Limit (dB)	C63.19-2011 Rating	Test Coordinates
LTE Band 66	Axial	20MHz	132322	-0.06	-35.16	-59.93	1.64	35.10	20.00	-15.10	T4	2.6, 2.4
		15MHz	132322	-0.34	-35.27		1.54	34.93	20.00	-14.93	T4	
		10MHz	132322	-0.22	-35.19		1.58	34.97	20.00	-14.97	T4	
		5MHz	132322	-0.30	-34.89		1.69	34.59	20.00	-14.59	T4	
		3MHz	132322	-0.38	-35.05		1.63	34.67	20.00	-14.67	T4	
		1.4MHz	132322	0.07	-35.09		1.68	35.16	20.00	-15.16	T4	
	Radial	20MHz	132322	-9.26	-43.58	-59.88	N/A	34.32	20.00	-14.32	T4	2.6, 1.4
		15MHz	132322	-9.02	-43.67			34.65	20.00	-14.65	T4	
		10MHz	132322	-8.98	-43.48			34.50	20.00	-14.50	T4	
		5MHz	132322	-8.99	-43.56			34.57	20.00	-14.57	T4	
		3MHz	132322	-8.89	-43.73			34.84	20.00	-14.84	T4	
		1.4MHz	132322	-9.36	-43.51			34.15	20.00	-14.15	T4	

**Table 9-8
Raw Data Results for LTE B2**

Mode	Orientation	Bandwidth	Channel	ABM1 [dB(A/m)]	ABM2 [dB(A/m)]	Ambient Noise [dB(A/m)]	Frequency Response Margin (dB)	S+N/N (dB)	FCC Limit (dB)	Margin from FCC Limit (dB)	C63.19-2011 Rating	Test Coordinates
LTE Band 2	Axial	20MHz	18900	-0.24	-35.47	-59.93	1.60	35.23	20.00	-15.23	T4	2.6, 2.4
		15MHz	18900	0.07	-35.53		1.56	35.60	20.00	-15.60	T4	
		10MHz	18900	-0.06	-35.30		1.60	35.24	20.00	-15.24	T4	
		5MHz	18900	-0.38	-35.35		1.73	34.97	20.00	-14.97	T4	
		3MHz	18900	0.05	-35.24		1.60	35.29	20.00	-15.29	T4	
		1.4MHz	18900	-0.18	-35.20		1.57	35.02	20.00	-15.02	T4	
	Radial	20MHz	18900	-9.11	-43.43	-59.88	N/A	34.32	20.00	-14.32	T4	2.6, 1.4
		15MHz	18900	-9.44	-43.81			34.37	20.00	-14.37	T4	
		10MHz	18900	-9.18	-43.65			34.47	20.00	-14.47	T4	
		5MHz	18900	-9.37	-43.52			34.15	20.00	-14.15	T4	
		3MHz	18900	-9.37	-43.69			34.32	20.00	-14.32	T4	
		1.4MHz	18900	-9.11	-43.63			34.52	20.00	-14.52	T4	

FCC ID: A3LSMJ737T	 PCTEST ENGINEERING LABORATORY, INC.	HAC (T-COIL) TEST REPORT		Approved by: Quality Manager
Filename: 1M1803150042-12.A3L	Test Dates: 04/12/2018 - 04/23/2018	DUT Type: Portable Handset		Page 30 of 74

**Table 9-9
Raw Data Results for LTE B7**

Mode	Orientation	Bandwidth	Channel	ABM1 [dB(A/m)]	ABM2 [dB(A/m)]	Ambient Noise [dB(A/m)]	Frequency Response Margin (dB)	S+N/N (dB)	FCC Limit (dB)	Margin from FCC Limit (dB)	C63.19-2011 Rating	Test Coordinates
LTE Band 7	Axial	20MHz	21100	-0.28	-35.36	-59.93	1.62	35.08	20.00	-15.08	T4	2.6, 2.4
		15MHz	21100	-0.32	-35.31		1.68	34.99	20.00	-14.99	T4	
		10MHz	21100	-0.38	-35.10		1.61	34.72	20.00	-14.72	T4	
		5MHz	21100	-0.07	-35.20		1.62	35.13	20.00	-15.13	T4	
	Radial	20MHz	21100	-9.51	-43.94	-59.88	N/A	34.43	20.00	-14.43	T4	2.6, 1.4
		15MHz	21100	-9.22	-43.88			34.66	20.00	-14.66	T4	
		10MHz	21100	-9.27	-43.95			34.68	20.00	-14.68	T4	
		5MHz	21100	-9.30	-43.71			34.41	20.00	-14.41	T4	

**Table 9-10
Raw Data Results for 2.4GHz WIFI**

Mode	Orientation	Channel	ABM1 [dB(A/m)]	ABM2 [dB(A/m)]	Ambient Noise [dB(A/m)]	Frequency Response Margin (dB)	S+N/N (dB)	FCC Limit (dB)	Margin from FCC Limit (dB)	C63.19-2011 Rating	Test Coordinates
WLAN 802.11b	Axial	1	-0.41	-35.72	-59.93	1.41	35.31	20.00	-15.31	T4	2.6, 2.4
		6	-0.32	-35.80		1.39	35.48	20.00	-15.48	T4	
		11	-0.13	-35.63		1.45	35.50	20.00	-15.50	T4	
	Radial	1	-9.77	-44.07	-59.88	N/A	34.30	20.00	-14.30	T4	2.6, 1.4
		6	-9.58	-44.00			34.42	20.00	-14.42	T4	
		11	-9.89	-43.69			33.80	20.00	-13.80	T4	
WLAN 802.11g	Axial	6	-0.16	-35.79	-59.93	1.50	35.63	20.00	-15.63	T4	2.6, 2.4
	Radial	6	-9.55	-44.67	-59.88	N/A	35.12	20.00	-15.12	T4	2.6, 1.4
WLAN 802.11n	Axial	6	-0.50	-36.01	-59.93	1.39	35.51	20.00	-15.51	T4	2.6, 2.4
	Radial	6	-9.99	-44.68	-59.88	N/A	34.69	20.00	-14.69	T4	2.6, 1.4

**Table 9-11
Raw Data Results for 5GHz WIFI 802.11a**

Mode	Orientation	Bandwidth	U-NII	Channel	ABM1 [dB(A/m)]	ABM2 [dB(A/m)]	Ambient Noise [dB(A/m)]	Frequency Response Margin (dB)	S+N/N (dB)	FCC Limit (dB)	Margin from FCC Limit (dB)	C63.19-2011 Rating	Test Coordinates
802.11a	Axial	20MHz	1	40	-0.32	-35.23	-59.93	1.64	34.91	20.00	-14.91	T4	2.6, 2.4
		20MHz	2A	56	-0.61	-35.81		1.45	35.20	20.00	-15.20	T4	
		20MHz	2C	120	-0.14	-35.40		1.59	35.26	20.00	-15.26	T4	
		20MHz	3	149	-0.34	-35.44		1.47	35.10	20.00	-15.10	T4	
		20MHz	3	157	-0.70	-35.55		1.44	34.85	20.00	-14.85	T4	
		20MHz	3	165	-0.68	-35.76		1.58	35.08	20.00	-15.08	T4	
	Radial	20MHz	1	40	-9.55	-44.39	-59.88	N/A	34.84	20.00	-14.84	T4	2.6, 1.4
		20MHz	2A	56	-9.55	-44.46			34.91	20.00	-14.91	T4	
		20MHz	2C	120	-9.75	-44.66			34.91	20.00	-14.91	T4	
		20MHz	3	149	-9.61	-44.35			34.74	20.00	-14.74	T4	
		20MHz	3	157	-9.55	-44.10			34.55	20.00	-14.55	T4	
		20MHz	3	165	-9.87	-44.36			34.49	20.00	-14.49	T4	

**Table 9-12
Raw Data Results for 5GHz WIFI 802.11n**

Mode	Orientation	Bandwidth	U-NII	Channel	ABM1 [dB(A/m)]	ABM2 [dB(A/m)]	Ambient Noise [dB(A/m)]	Frequency Response Margin (dB)	S+N/N (dB)	FCC Limit (dB)	Margin from FCC Limit (dB)	C63.19-2011 Rating	Test Coordinates
802.11n	Axial	40MHz	1	38	-0.20	-35.83	-59.93	1.38	35.63	20.00	-15.63	T4	2.6, 2.4
		20MHz	1	40	-0.50	-35.84		1.41	35.34	20.00	-15.34	T4	
	Radial	40MHz	1	38	-9.72	-44.92	-59.88	N/A	35.20	20.00	-15.20	T4	2.6, 1.4
		20MHz	1	40	-9.69	-44.70			35.01	20.00	-15.01	T4	



FCC ID: A3LSMJ737T	 PCTEST ENGINEERING LABORATORY, INC.	HAC (T-COIL) TEST REPORT		Approved by: Quality Manager
Filename: 1M1803150042-12.A3L	Test Dates: 04/12/2018 - 04/23/2018	DUT Type: Portable Handset		Page 31 of 74

Table 9-13
Raw Data Results for 5GHz WIFI 802.11ac

Mode	Orientation	Bandwidth	U-NII	Channel	ABM1 [dB(A/m)]	ABM2 [dB(A/m)]	Ambient Noise [dB(A/m)]	Frequency Response Margin (dB)	S+N/N (dB)	FCC Limit (dB)	Margin from FCC Limit (dB)	C63.19-2011 Rating	Test Coordinates
802.11ac	Axial	40MHz	1	38	-0.32	-35.81	-59.93	1.40	35.49	20.00	-15.49	T4	2.6, 2.4
		20MHz	1	40	-0.14	-35.61		1.46	35.47	20.00	-15.47	T4	
	Radial	40MHz	1	38	-9.68	-44.88	-59.88	N/A	35.20	20.00	-15.20	T4	2.6, 1.4
		20MHz	1	40	-9.61	-44.54			34.93	20.00	-14.93	T4	

Table 9-14
Raw Data Results for EDGE (OTT VoIP)

Mode	Orientation	Channel	ABM1 [dB(A/m)]	ABM2 [dB(A/m)]	Ambient Noise [dB(A/m)]	Frequency Response Margin (dB)	S+N/N (dB)	FCC Limit (dB)	Margin from FCC Limit (dB)	C63.19-2011 Rating	Test Coordinates
EDGE850	Axial	190	9.18	-26.44	-59.93	1.58	35.62	20.00	-15.62	T4	2.6, 2.4
	Radial	190	0.60	-33.79	-59.88	N/A	34.39	20.00	-14.39	T4	2.6, 1.4
EDGE1900	Axial	661	9.44	-28.40	-59.93	1.54	37.84	20.00	-17.84	T4	2.6, 2.4
	Radial	661	0.39	-35.62	-59.88	N/A	36.01	20.00	-16.01	T4	2.6, 1.4

Table 9-15
Raw Data Results for HSPA (OTT VoIP)

Mode	Orientation	Channel	ABM1 [dB(A/m)]	ABM2 [dB(A/m)]	Ambient Noise [dB(A/m)]	Frequency Response Margin (dB)	S+N/N (dB)	FCC Limit (dB)	Margin from FCC Limit (dB)	C63.19-2011 Rating	Test Coordinates
HSPA V	Axial	4183	10.85	-35.99	-59.93	1.40	46.84	20.00	-26.84	T4	2.6, 2.4
	Radial	4183	1.17	-44.70	-59.88	N/A	45.87	20.00	-25.87	T4	2.6, 1.4
HSPA IV	Axial	1412	10.14	-35.97	-59.93	1.45	46.11	20.00	-26.11	T4	2.6, 2.4
	Radial	1412	1.39	-44.58	-59.88	N/A	45.97	20.00	-25.97	T4	2.6, 1.4
HSPA II	Axial	9400	10.39	-36.00	-59.93	1.46	46.39	20.00	-26.39	T4	2.6, 2.4
	Radial	9400	1.36	-44.53	-59.88	N/A	45.89	20.00	-25.89	T4	2.6, 1.4

Table 9-16
Raw Data Results for LTE B12 (OTT VoIP)

Mode	Orientation	Bandwidth	Channel	ABM1 [dB(A/m)]	ABM2 [dB(A/m)]	Ambient Noise [dB(A/m)]	Frequency Response Margin (dB)	S+N/N (dB)	FCC Limit (dB)	Margin from FCC Limit (dB)	C63.19-2011 Rating	Test Coordinates
LTE Band 12	Axial	10MHz	23095	11.37	-34.83	-59.93	1.40	46.20	20.00	-26.20	T4	2.6, 2.4
		5MHz	23155	11.24	-35.34		1.39	46.58	20.00	-26.58	T4	
		5MHz	23095	11.23	-34.39		1.47	45.62	20.00	-25.62	T4	
		5MHz	23035	11.05	-35.21		1.43	46.26	20.00	-26.26	T4	
		3MHz	23095	11.18	-34.88		1.53	46.06	20.00	-26.06	T4	
		1.4MHz	23095	11.46	-34.58		1.63	46.04	20.00	-26.04	T4	
	Radial	10MHz	23095	1.48	-43.20	-59.88	N/A	44.68	20.00	-24.68	T4	2.6, 1.4
		5MHz	23095	1.53	-43.22			44.75	20.00	-24.75	T4	
		3MHz	23095	1.51	-43.16			44.67	20.00	-24.67	T4	
		1.4MHz	23173	1.49	-43.52			45.01	20.00	-25.01	T4	
		1.4MHz	23095	1.47	-43.10			44.57	20.00	-24.57	T4	
		1.4MHz	23017	1.49	-43.53			45.02	20.00	-25.02	T4	



FCC ID: A3LSMJ737T		HAC (T-COIL) TEST REPORT		Approved by: Quality Manager
Filename: 1M1803150042-12.A3L	Test Dates: 04/12/2018 - 04/23/2018	DUT Type: Portable Handset		Page 32 of 74

Table 9-17
Raw Data Results for 2.4GHz WIFI (OTT VoIP)

Mode	Orientation	Channel	ABM1 [dB(A/m)]	ABM2 [dB(A/m)]	Ambient Noise [dB(A/m)]	Frequency Response Margin (dB)	S+N/N (dB)	FCC Limit (dB)	Margin from FCC Limit (dB)	C63.19-2011 Rating	Test Coordinates
WLAN 802.11b	Axial	1	11.31	-35.55	-59.93	1.58	46.86	20.00	-26.86	T4	2.6, 2.4
		6	10.98	-35.36		1.43	46.34	20.00	-26.34	T4	
		11	11.36	-35.53		1.47	46.89	20.00	-26.89	T4	
	Radial	1	1.45	-42.72	-59.88	N/A	44.17	20.00	-24.17	T4	2.6, 1.4
		6	1.45	-42.41			43.86	20.00	-23.86	T4	
		11	1.44	-43.27			44.71	20.00	-24.71	T4	
WLAN 802.11g	Axial	6	11.07	-35.34	-59.93	1.53	46.41	20.00	-26.41	T4	2.6, 2.4
	Radial	6	1.36	-43.48	-59.88	N/A	44.84	20.00	-24.84	T4	2.6, 1.4
WLAN 802.11n	Axial	6	11.36	-35.75	-59.93	1.36	47.11	20.00	-27.11	T4	2.6, 2.4
	Radial	6	1.44	-43.86	-59.88	N/A	45.30	20.00	-25.30	T4	2.6, 1.4

Table 9-18
Raw Data Results for 5GHz WIFI 802.11a (OTT VoIP)



Mode	Orientation	Bandwidth	U-NII	Channel	ABM1 [dB(A/m)]	ABM2 [dB(A/m)]	Ambient Noise [dB(A/m)]	Frequency Response Margin (dB)	S+N/N (dB)	FCC Limit (dB)	Margin from FCC Limit (dB)	C63.19-2011 Rating	Test Coordinates
802.11a	Axial	20MHz	1	40	11.31	-35.78	-59.93	1.34	47.09	20.00	-27.09	T4	2.6, 2.4
		20MHz	2A	56	11.18	-35.83		1.45	47.01	20.00	-27.01	T4	
		20MHz	2C	100	11.10	-35.81		1.41	46.91	20.00	-26.91	T4	
		20MHz	2C	120	10.94	-35.81		1.50	46.75	20.00	-26.75	T4	
		20MHz	2C	144	11.12	-35.41		1.53	46.53	20.00	-26.53	T4	
		20MHz	3	157	11.39	-35.66		1.49	47.05	20.00	-27.05	T4	
	Radial	20MHz	1	40	1.55	-44.56	-59.88	N/A	46.11	20.00	-26.11	T4	2.6, 1.4
		20MHz	2A	52	1.40	-44.60			46.00	20.00	-26.00	T4	
		20MHz	2A	56	1.61	-44.09			45.70	20.00	-25.70	T4	
		20MHz	2A	64	1.40	-44.52			45.92	20.00	-25.92	T4	
		20MHz	2C	120	1.51	-44.62			46.13	20.00	-26.13	T4	
		20MHz	3	157	1.36	-44.49			45.85	20.00	-25.85	T4	

Table 9-19
Raw Data Results for 5GHz WIFI 802.11n (OTT VoIP)

Mode	Orientation	Bandwidth	U-NII	Channel	ABM1 [dB(A/m)]	ABM2 [dB(A/m)]	Ambient Noise [dB(A/m)]	Frequency Response Margin (dB)	S+N/N (dB)	FCC Limit (dB)	Margin from FCC Limit (dB)	C63.19-2011 Rating	Test Coordinates
802.11n	Axial	40MHz	1	38	11.42	-35.78	-59.93	1.55	47.20	20.00	-27.20	T4	2.6, 2.4
		20MHz	1	40	11.50	-35.77		1.37	47.27	20.00	-27.27	T4	
	Radial	40MHz	1	38	1.50	-44.66	-59.88	N/A	46.16	20.00	-26.16	T4	2.6, 1.4
		20MHz	1	40	1.42	-45.12			46.54	20.00	-26.54	T4	

Table 9-20
Raw Data Results for 5GHz WIFI 802.11ac (OTT VoIP)

Mode	Orientation	Bandwidth	U-NII	Channel	ABM1 [dB(A/m)]	ABM2 [dB(A/m)]	Ambient Noise [dB(A/m)]	Frequency Response Margin (dB)	S+N/N (dB)	FCC Limit (dB)	Margin from FCC Limit (dB)	C63.19-2011 Rating	Test Coordinates
802.11ac	Axial	40MHz	1	38	11.47	-35.98	-59.93	1.33	47.45	20.00	-27.45	T4	2.6, 2.4
		20MHz	1	40	11.36	-35.76		1.43	47.12	20.00	-27.12	T4	
	Radial	40MHz	1	38	1.45	-45.04	-59.88	N/A	46.49	20.00	-26.49	T4	2.6, 1.4
		20MHz	1	40	1.48	-45.18			46.66	20.00	-26.66	T4	

FCC ID: A3LSMJ737T	 PCTEST ENGINEERING LABORATORY, INC.	HAC (T-COIL) TEST REPORT		Approved by: Quality Manager
Filename: 1M1803150042-12.A3L	Test Dates: 04/12/2018 - 04/23/2018	DUT Type: Portable Handset		Page 33 of 74

II. Test Notes

A. General

1. Phone Condition: Mute on; Backlight off; Max Volume; Max Contrast
2. 'Radial' orientation refers to radial transverse.
3. Hearing Aid Mode (**Phone→Call Settings→More Settings→Hearing aids**) was set to ON for Frequency Response compliance
4. Bluetooth and WIFI were disabled for 2G/3G/4G modes while testing.
5. Licensed data modes and Bluetooth were disabled for WIFI modes while testing.
6. The Margin from FCC limit column indicates a margin from the FCC limit for compliance (T3).

B. GSM

1. Power Configuration: GSM850: PCL=5, GSM1900: PCL=0;
2. Vocoder Configuration: EFR (GSM);
3. Speech Signal: 3GPP2 Normal Test Signal

C. UMTS



1. Power Configuration: TPC= "All 1s";
2. Vocoder Configuration: AMR 12.2 kbps (UMTS);
3. Speech Signal: 3GPP2 Normal Test Signal

D. LTE FDD

1. Power Configuration: TPC = "Max Power"
2. Radio Configuration: 16QAM, 1RB, 0RB offset
3. Vocoder Configuration: WB AMR 6.60kbps
4. Speech Signal: 3GPP2 Normal Test Signal
5. The worst-case band and bandwidth combination for each probe orientation is additionally tested on the low and high channels for those combinations. LTE Band 5 at 1.4MHz is the worst-case for both Axial and Radial probe orientations.

E. WIFI

1. Radio Configuration
 - a. 802.11b: CCK, 11Mbps
 - b. 802.11g/a: 16-QAM, 36Mbps
 - c. 802.11n/ac 20MHz: QPSK, 19.5Mbps
 - d. 802.11n/ac 40MHz: QPSK, 40.5Mbps
2. Vocoder Configuration: WB AMR 6.60kbps
3. Speech Signal: 3GPP2 Normal Test Signal
4. The worst-case standard for 2.4GHz WIFI in each probe orientation is additionally tested on the low and high channels. 802.11b is the worst-case for both Axial and Radial probe orientations.
5. The worst-case standard for 5GHz WIFI in each probe orientation is additionally tested on higher U-NII bands as well as applicable low and high channels. 802.11a (U-NII 3) is the worst-case for both Axial and Radial probe orientations.

FCC ID: A3LSMJ737T		HAC (T-COIL) TEST REPORT		Approved by: Quality Manager
Filename: 1M1803150042-12.A3L	Test Dates: 04/12/2018 - 04/23/2018	DUT Type: Portable Handset	Page 34 of 74	

© 2018 PCTEST Engineering Laboratory, Inc.

REV 3.2.M
04/17/2018

© 2018 PCTEST Engineering Laboratory, Inc. All rights reserved. Unless otherwise specified, no part of this report may be reproduced or utilized in any part, form or by any means, electronic or mechanical, including photocopying and microfilm, without permission in writing from PCTEST Engineering Laboratory, Inc. If you have any questions about this international copyright or have an enquiry about obtaining additional rights to this report or assembly of contents thereof, please contact INFO@PCTEST.COM.



F. OTT VoIP

1. Vocoder Configuration: 6kbps
2. Speech Signal: ITU-T P.50 Artificial Voice
3. EDGE Configuration
 - a. MCS Index: 7
 - b. Number of TX slots: 2
4. HSPA Configuration:
 - a. Release: 6
 - b. 3GPP 34.121 Subtest 1
5. LTE FDD Configuration:
 - a. Power Configuration: TPC = "Max Power"
 - b. Radio Configuration: 16QAM, 1RB, 0RB offset
 - c. LTE Band 12 was the worst-case band from Table 7-5 and was used to test both Axial and Radial probe orientations.
 - d. The worst-case band and bandwidth combination for each probe orientation is additionally tested on the low and high channels for those combinations. LTE Band 12 at 5MHz is the worst-case for the Axial probe orientation. LTE Band 12 at 1.4MHz bandwidth is the worst-case for the Radial probe orientation.
6. WIFI Configuration:
 - a. Radio Configuration
 - i. 802.11b: CCK, 11Mbps
 - ii. 802.11g/a: 16-QAM, 36Mbps
 - iii. 802.11n/ac 20MHz: QPSK, 19.5Mbps
 - iv. 802.11n/ac 40MHz: QPSK, 40.5Mbps
 - b. The worst-case standard for 2.4GHz WIFI in each probe orientation is additionally tested on the low and high channels. 802.11b is the worst-case for both Axial and Radial probe orientations.
 - c. The worst-case standard for 5GHz WIFI in each probe orientation is additionally tested on higher U-NII bands as well as applicable low and high channels. 802.11a (U-NII 2C) is the worst-case for the Axial probe orientation. 802.11a (U-NII 2A) is the worst-case for the Radial probe orientation.

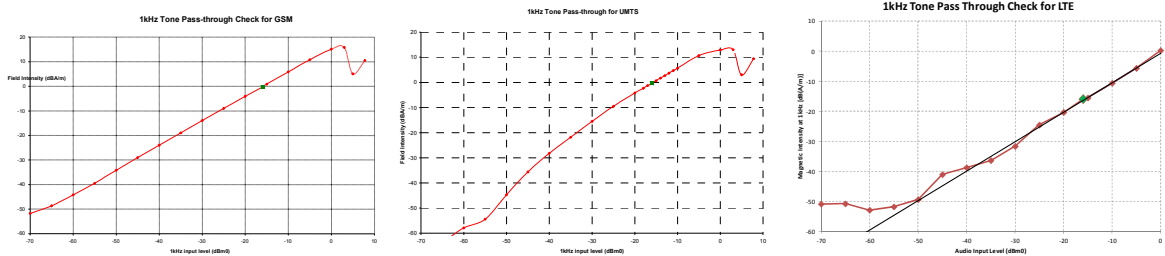
III. 1 kHz Vocoder Application Check



This model was verified to be within the linear region for ABM1 measurements at -16 dBm0 for GSM, UMTS, and VoLTE over IMS. This measurement was taken in the axial configuration above the maximum location.

FCC ID: A3LSMJ737T	 PCTEST ENGINEERING LABORATORY, INC.	HAC (T-COIL) TEST REPORT		Approved by: Quality Manager
Filename: 1M1803150042-12.A3L	Test Dates: 04/12/2018 - 04/23/2018	DUT Type: Portable Handset		Page 35 of 74

© 2018 PCTEST Engineering Laboratory, Inc.

REV 3.2.M

04/17/2018

© 2018 PCTEST Engineering Laboratory, Inc. All rights reserved. Unless otherwise specified, no part of this report may be reproduced or utilized in any part, form or by any means, electronic or mechanical, including photocopying and microfilm, without permission in writing from PCTEST Engineering Laboratory, Inc. If you have any questions about this international copyright or have an enquiry about obtaining additional rights to this report or assembly of contents thereof, please contact INFO@PCTEST.COM.

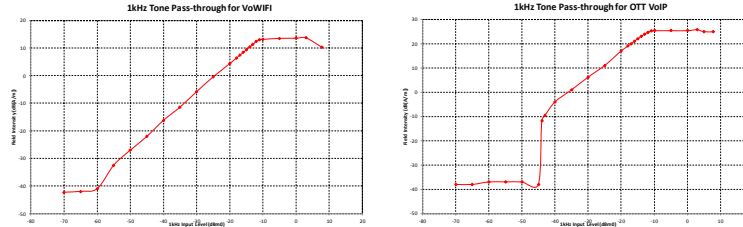

This model was verified to be within the linear region for ABM1 measurements at -20 dBm0 for VoWiFi over IMS and OTT VoIP. This measurement was taken in the axial configuration above the maximum location.



IV. T-Coil Validation Test Results

Table 9-21
Helmholtz Coil Validation Table of Results – 4/12/2018

Item	Target	Result	Verdict
Axial			
Magnetic Intensity, -10 dBA/m	$-10 \pm 0.5 \text{ dB}$	-10.177	PASS
Environmental Noise	< -58 dBA/m	-58.23	PASS
Frequency Response, from limits	> 0 dB	0.80	PASS

Table 9-22
Helmholtz Coil Validation Table of Results – 4/21/2018

Item	Target	Result	Verdict
Axial			
Magnetic Intensity, -10 dBA/m	$-10 \pm 0.5 \text{ dB}$	-10.167	PASS
Environmental Noise	< -58 dBA/m	-59.93	PASS
Frequency Response, from limits	> 0 dB	0.70	PASS
Radial			
Magnetic Intensity, -10 dBA/m	$-10 \pm 0.5 \text{ dB}$	-10.269	PASS
Environmental Noise	< -58 dBA/m	-59.88	PASS
Frequency Response, from limits	> 0 dB	0.70	PASS

FCC ID: A3LSMJ737T		HAC (T-COIL) TEST REPORT		Approved by: Quality Manager
Filename: 1M1803150042-12.A3L	Test Dates: 04/12/2018 - 04/23/2018	DUT Type: Portable Handset		Page 36 of 74

© 2018 PCTEST Engineering Laboratory, Inc.

REV 3.2.M

04/17/2018

© 2018 PCTEST Engineering Laboratory, Inc. All rights reserved. Unless otherwise specified, no part of this report may be reproduced or utilized in any part, form or by any means, electronic or mechanical, including photocopying and microfilm, without permission in writing from PCTEST Engineering Laboratory, Inc. If you have any questions about this international copyright or have an enquiry about obtaining additional rights to this report or assembly of contents thereof, please contact INFO@PCTEST.COM.

V. ABM1 Magnetic Field Distribution Scan Overlays

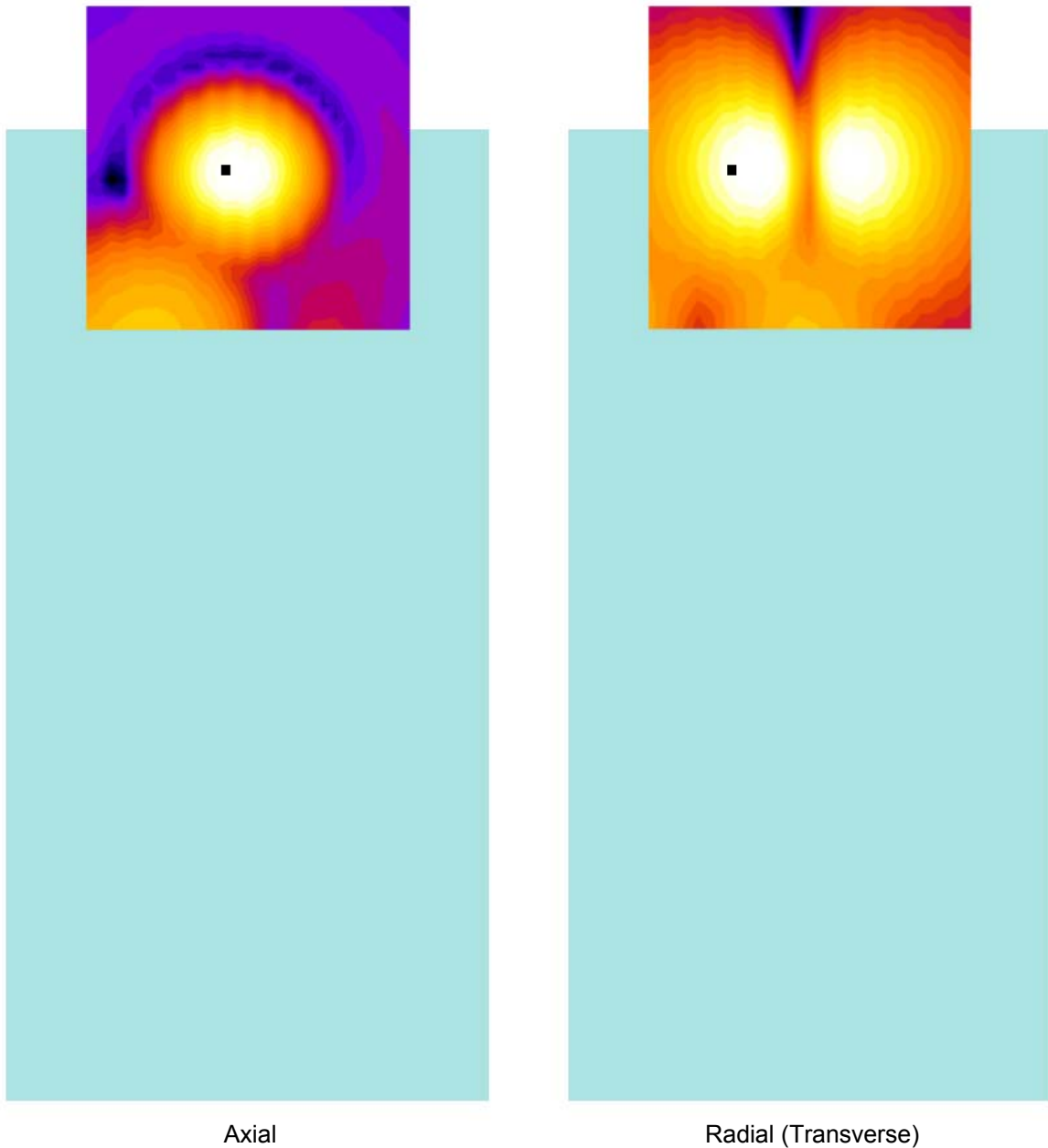



Axial

Radial (Transverse)

Figure 9-1
T-Coil Scan Overlay Magnetic Field Distributions

Notes:

1. Final measurement locations are indicated by a cursor on the contour plots.
2. See Test Setup Photographs for actual WD overlay.

FCC ID: A3LSMJ737T		HAC (T-COIL) TEST REPORT		Approved by: Quality Manager
Filename: 1M1803150042-12.A3L	Test Dates: 04/12/2018 - 04/23/2018	DUT Type: Portable Handset	Page 37 of 74	

© 2018 PCTEST Engineering Laboratory, Inc.

REV 3.2.M
04/17/2018

© 2018 PCTEST Engineering Laboratory, Inc. All rights reserved. Unless otherwise specified, no part of this report may be reproduced or utilized in any part, form or by any means, electronic or mechanical, including photocopying and microfilm, without permission in writing from PCTEST Engineering Laboratory, Inc. If you have any questions about this international copyright or have an enquiry about obtaining additional rights to this report or assembly of contents thereof, please contact INFO@PCTEST.COM.

10. MEASUREMENT UNCERTAINTY



**Table 10-1
Uncertainty Estimation Table**

Contribution	Data +/- %	Data +/- dB	Data Type	Probability distribution	Divisor	Standard uncertainty	Standard Uncertainty (dB)
ABM Noise	7.0%	0.29	Std. Dev.	Normal k=1	1.00	7.0%	
RF Reflections	4.7%	0.20	Specification	Rectangular	1.73	2.7%	
Reference Signal Level	12.2%	0.50	Specification	Rectangular	1.73	7.0%	
Positioning Accuracy	10.0%	0.41	Uncertainty	Rectangular	1.73	5.8%	
Probe Coil Sensitivity	12.2%	0.50	Specification	Rectangular	1.73	7.0%	
Probe Linearity	2.4%	0.10	Std. Dev.	Normal k=1	1.00	2.4%	
Cable Loss	2.8%	0.12	Specification	Rectangular	1.73	1.6%	
Frequency Analyzer	5.0%	0.21	Specification	Rectangular	1.73	2.9%	
System Repeatability	5.0%	0.21	Std. Dev.	Normal k=1	1.00	5.0%	
WD Repeatability	9.0%	0.37	Std. Dev.	Normal k=1	1.00	9.0%	
Positioner Accuracy	1.0%	0.04	Specification	Rectangular	1.73	0.6%	
Combined standard uncertainty, u_c (k=1)						17.7%	0.71
Expanded uncertainty (k=2), 95% confidence level						35.3%	1.31

Notes:

1. Test equipments are calibrated according to techniques outlined in NIS81, NIS3003 and NIST Tech Note 1297.
2. All equipments have traceability according to NIST. Measurement Uncertainties are defined in further detail in NIS 81 and NIST Tech Note 1297 and UKAS M3003.



Measurement uncertainty reflects the quality and accuracy of a measured result as compared to the true value. Such statements are generally required when stating results of measurements so that it is clear to the intended audience that the results may differ when reproduced by different facilities. Measurement results vary due to the measurement uncertainty of the instrumentation, measurement technique, and test engineer. Most uncertainties are calculated using the tolerances of the instrumentation used in the measurement, the measurement setup variability, and the technique used in performing the test. While not generally included, the variability of the equipment under test also figures into the overall measurement uncertainty. Another component of the overall uncertainty is based on the variability of repeated measurements (so-called Type A uncertainty). This may mean that the Hearing Aid compatibility tests may have to be repeated by taking down the test setup and resetting it up so that there are a statistically significant number of repeat measurements to identify the measurement uncertainty. By combining the repeat measurement results with that of the instrumentation chain using the technique contained in NIS 81 and NIS 3003, the overall measurement uncertainty was estimated.

FCC ID: A3LSMJ737T	 PCTEST ENGINEERING LABORATORY, INC.	HAC (T-COIL) TEST REPORT		Approved by: Quality Manager
Filename: 1M1803150042-12.A3L	Test Dates: 04/12/2018 - 04/23/2018	DUT Type: Portable Handset		Page 38 of 74

11. EQUIPMENT LIST

**Table 11-1
Equipment List**

Model	Description	Cal Date	Cal Interval	Cal Due	Serial Number
Latitude E6540	SoundCheck Acoustic Analyzer Laptop	4/11/2017	Biennial	4/11/2019	7BFNM32
SoundConnect	Microphone Power Supply	N/A		N/A	0899-PS150
SoundConnect	Microphone Power Supply	12/2/2016	Biennial	12/2/2018	PS2612
Fireface UC	Soundcheck Acoustic Analyzer External Audio Interface	4/11/2017	Biennial	4/11/2019	23528889
CMW500	Wideband Radio Communication Tester	1/19/2018	Annual	1/19/2019	162125
CMW500	Wideband Radio Communication Tester	7/14/2017	Annual	7/14/2018	140144
NC-100	Torque Wrench (8" lb)	9/1/2016	Biennial	9/1/2018	21053
C63.19	Helmholtz Coil	12/7/2016	Biennial	12/7/2018	925
Radial T-Coil Probe	Radial T-Coil Probe	12/7/2016	Biennial	12/7/2018	TEM-1130
Axial T-Coil Probe	Axial T-Coil Probe	12/7/2016	Biennial	12/7/2018	TEM-1124
	HAC System Controller with Software	N/A		N/A	N/A
	HAC Positioner	N/A		N/A	N/A



FCC ID: A3LSMJ737T	 PCTEST ENGINEERING LABORATORY, INC.	HAC (T-COIL) TEST REPORT		Approved by: Quality Manager
Filename: 1M1803150042-12.A3L	Test Dates: 04/12/2018 - 04/23/2018	DUT Type: Portable Handset	Page 39 of 74	

© 2018 PCTEST Engineering Laboratory, Inc.

REV 3.2.M
04/17/2018

© 2018 PCTEST Engineering Laboratory, Inc. All rights reserved. Unless otherwise specified, no part of this report may be reproduced or utilized in any part, form or by any means, electronic or mechanical, including photocopying and microfilm, without permission in writing from PCTEST Engineering Laboratory, Inc. If you have any questions about this international copyright or have an enquiry about obtaining additional rights to this report or assembly of contents thereof, please contact INFO@PCTEST.COM.

12. TEST DATA

FCC ID: A3LSMJ737T		HAC (T-COIL) TEST REPORT		Approved by: Quality Manager
Filename: 1M1803150042-12.A3L	Test Dates: 04/12/2018 - 04/23/2018	DUT Type: Portable Handset	Page 40 of 74	

© 2018 PCTEST Engineering Laboratory, Inc.

REV 3.2.M
04/17/2018

© 2018 PCTEST Engineering Laboratory, Inc. All rights reserved. Unless otherwise specified, no part of this report may be reproduced or utilized in any part, form or by any means, electronic or mechanical, including photocopying and microfilm, without permission in writing from PCTEST Engineering Laboratory, Inc. If you have any questions about this international copyright or have an enquiry about obtaining additional rights to this report or assembly of contents thereof, please contact INFO@PCTEST.COM.



PCTEST Hearing-Aid Compatibility Facility

DUT: HH Coil – SN: 925

Type: HH Coil
Serial: 925

Measurement Standard: ANSI C63.19-2011

Equipment:

- Probe: Axial T-Coil Probe – SN: TEM-1124; Calibrated: 12/07/2016
- Helmholtz Coil – SN: 925; Calibrated: 12/07/2016

Noise Spectrum

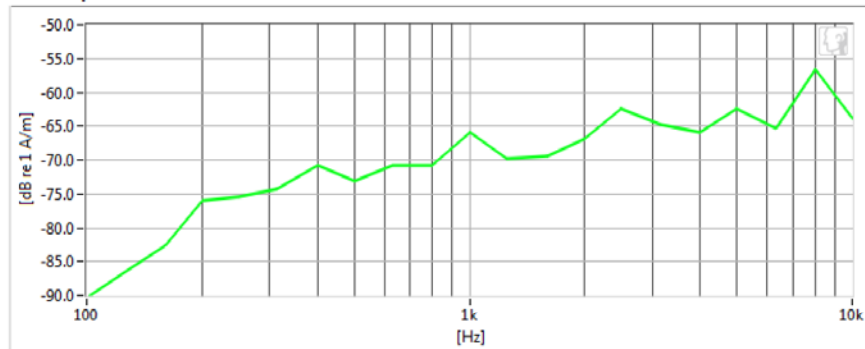

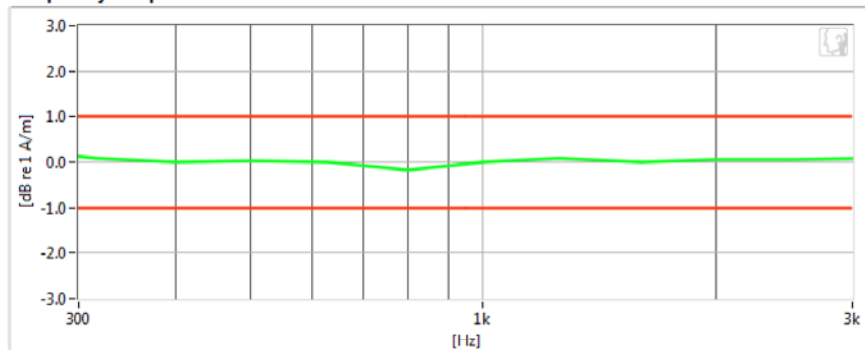

Frequency Response



Results

Verification 1kHz Intensity	-10.177 dB	✓	Max/Min	-9.5/-10.5
Verification ABM2	-58.23 dB	✓	Maximum	-58.0
Frequency Response Margin	800m dB	✓	Tolerance curves	Aligned Data

PCTEST 2018

FCC ID: A3LSMJ737T		HAC (T-COIL) TEST REPORT		Approved by: Quality Manager
Filename: 1M1803150042-12.A3L	Test Dates: 04/12/2018 - 04/23/2018	DUT Type: Portable Handset		Page 41 of 74

© 2018 PCTEST Engineering Laboratory, Inc.

REV 3.2.M
04/17/2018

© 2018 PCTEST Engineering Laboratory, Inc. All rights reserved. Unless otherwise specified, no part of this report may be reproduced or utilized in any part, form or by any means, electronic or mechanical, including photocopying and microfilm, without permission in writing from PCTEST Engineering Laboratory, Inc. If you have any questions about this international copyright or have an enquiry about obtaining additional rights to this report or assembly of contents thereof, please contact INFO@PCTEST.COM.



PCTEST Hearing-Aid Compatibility Facility

DUT: HH Coil – SN: 925

Type: HH Coil
Serial: 925

Measurement Standard: ANSI C63.19-2011

Equipment:

- Probe: Axial T-Coil Probe – SN: TEM-1124; Calibrated: 12/07/2016
- Helmholtz Coil – SN: 925; Calibrated: 12/07/2016

Noise Spectrum

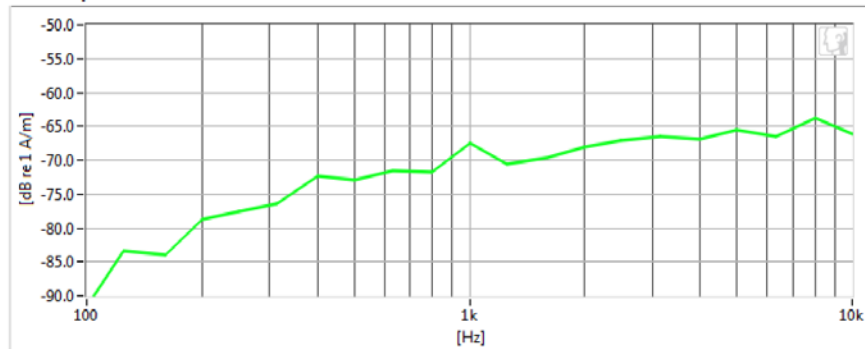

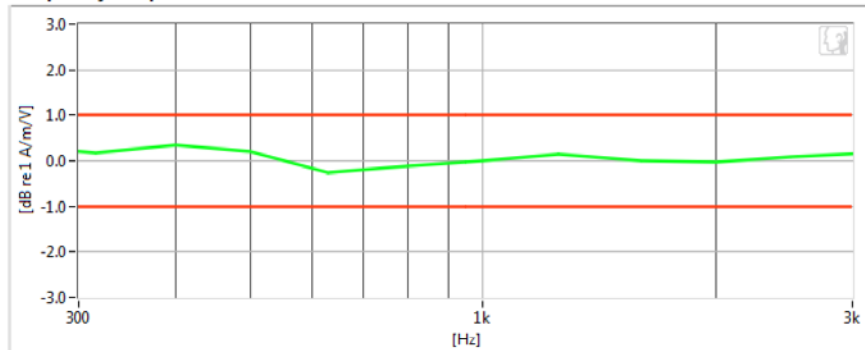

Frequency Response



Results

Verification 1kHz Intensity	-10.167 dB	✓	Max/Min	-9.5/-10.5
Verification ABM2	-59.93 dB	✓	Maximum	-58.0
Frequency Response Margin	700m dB	✓	Tolerance curves	Aligned Data

PCTEST 2018

FCC ID: A3LSMJ737T		HAC (T-COIL) TEST REPORT		Approved by: Quality Manager
Filename: 1M1803150042-12.A3L	Test Dates: 04/12/2018 - 04/23/2018	DUT Type: Portable Handset		Page 42 of 74

© 2018 PCTEST Engineering Laboratory, Inc.

REV 3.2.M
04/17/2018

© 2018 PCTEST Engineering Laboratory, Inc. All rights reserved. Unless otherwise specified, no part of this report may be reproduced or utilized in any part, form or by any means, electronic or mechanical, including photocopying and microfilm, without permission in writing from PCTEST Engineering Laboratory, Inc. If you have any questions about this international copyright or have an enquiry about obtaining additional rights to this report or assembly of contents thereof, please contact INFO@PCTEST.COM.



PCTEST Hearing-Aid Compatibility Facility

DUT: HH Coil – SN: 925

Type: HH Coil
Serial: 925

Measurement Standard: ANSI C63.19-2011

Equipment:

- Probe: Radial T-Coil Probe – SN: TEM-1130; Calibrated: 12/07/2016
- Helmholtz Coil – SN: 925; Calibrated: 12/07/2016

Noise Spectrum

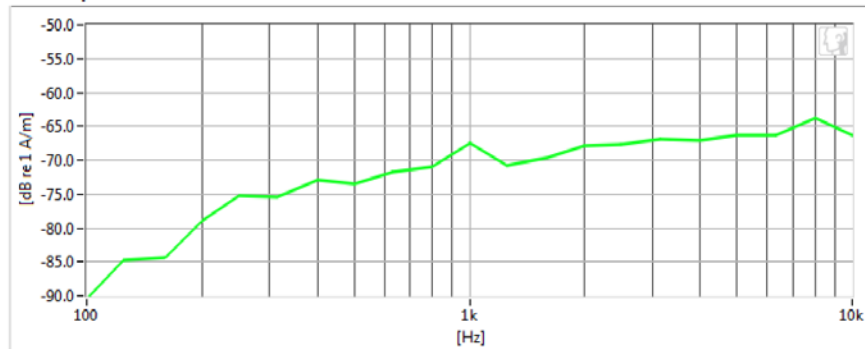

Frequency Response

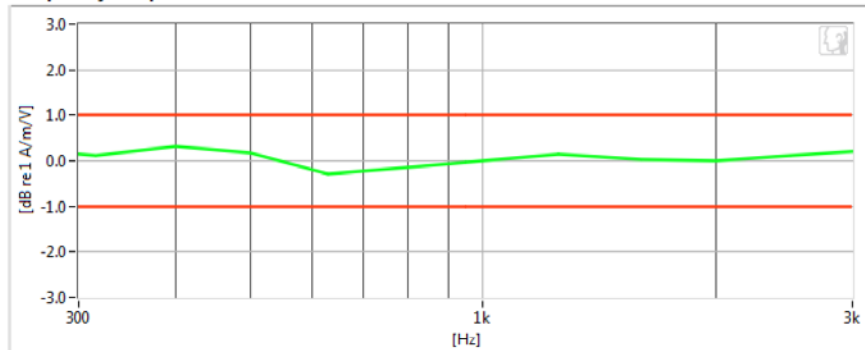

Results

Verification 1kHz Intensity	-10.269 dB	✓	Max/Min	-9.5/-10.5
Verification ABM2	-59.88 dB	✓	Maximum	-58.0
Frequency Response Margin	700m dB	✓	Tolerance curves	Aligned Data

PCTEST 2018

FCC ID: A3LSMJ737T		HAC (T-COIL) TEST REPORT		Approved by: Quality Manager
Filename: 1M1803150042-12.A3L	Test Dates: 04/12/2018 - 04/23/2018	DUT Type: Portable Handset		Page 43 of 74

© 2018 PCTEST Engineering Laboratory, Inc.

REV 3.2.M
04/17/2018

© 2018 PCTEST Engineering Laboratory, Inc. All rights reserved. Unless otherwise specified, no part of this report may be reproduced or utilized in any part, form or by any means, electronic or mechanical, including photocopying and microfilm, without permission in writing from PCTEST Engineering Laboratory, Inc. If you have any questions about this international copyright or have an enquiry about obtaining additional rights to this report or assembly of contents thereof, please contact INFO@PCTEST.COM.



PCTEST Hearing-Aid Compatibility Facility

DUT: A3LSMJ737T

Type: Portable Handset
Serial: 22003

Measurement Standard: ANSI C63.19-2011

Equipment:

- Probe: Axial T-Coil Probe – SN: TEM-1124; Calibrated: 12/07/2016

Test Configuration:

- Mode: GSM850
- Channel: 128
- Speech Signal: 3GPP2 Normal Test Signal

Noise Spectrum

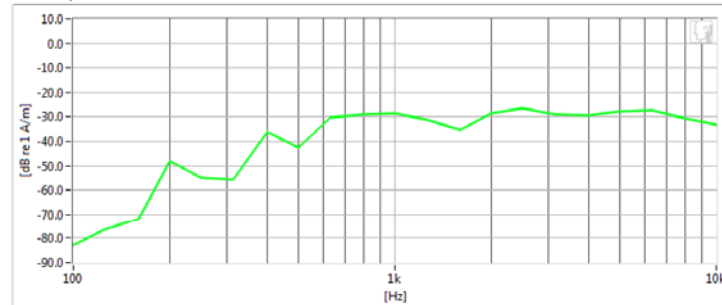

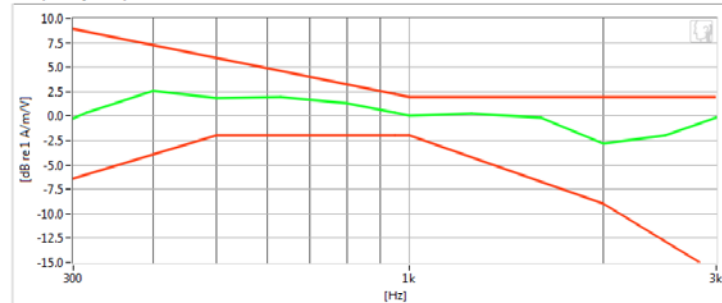

Frequency Response



Results

ABM1	4.97 dB	✓	Minimum	-18.0
ABM2	-21.34 dB	✓	Maximum	0.0
SNNR	26.31 dB	✓	Minimum	20.0
Aligned Response - Normal	1.73 dB	✓	Tolerance curves	Aligned Data

PCTEST 2018

FCC ID: A3LSMJ737T		HAC (T-COIL) TEST REPORT		Approved by: Quality Manager
Filename: 1M1803150042-12.A3L	Test Dates: 04/12/2018 - 04/23/2018	DUT Type: Portable Handset	Page 44 of 74	

© 2018 PCTEST Engineering Laboratory, Inc.

REV 3.2.M
04/17/2018

© 2018 PCTEST Engineering Laboratory, Inc. All rights reserved. Unless otherwise specified, no part of this report may be reproduced or utilized in any part, form or by any means, electronic or mechanical, including photocopying and microfilm, without permission in writing from PCTEST Engineering Laboratory, Inc. If you have any questions about this international copyright or have an enquiry about obtaining additional rights to this report or assembly of contents thereof, please contact INFO@PCTEST.COM.

PCTEST Hearing-Aid Compatibility Facility

DUT: A3LSMJ737T

Type: Portable Handset
Serial: 22003

Measurement Standard: ANSI C63.19-2011

Equipment:

- Probe: Axial T-Coil Probe – SN: TEM-1124; Calibrated: 12/07/2016

Test Configuration:

- Mode: GSM1900
- Channel: 810
- Speech Signal: 3GPP2 Normal Test Signal

Noise Spectrum

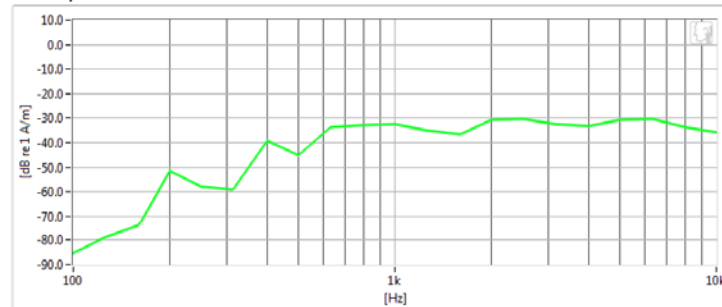

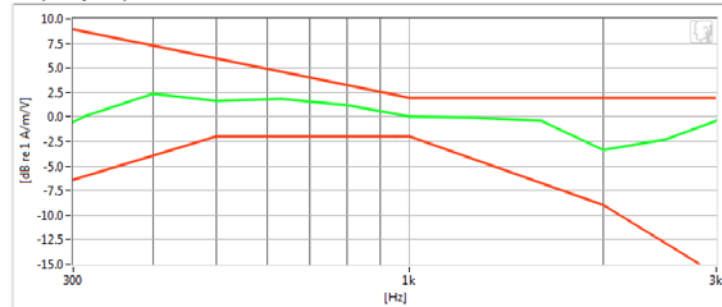

Frequency Response



Results

ABM1	4.81 dB	✓	Minimum	-18.0
ABM2	-24.66 dB	✓	Maximum	0.0
SNNR	29.47 dB	✓	Minimum	20.0
Aligned Response - Normal	2 dB	✓	Tolerance curves	Aligned Data

PCTEST 2018

FCC ID: A3LSMJ737T		HAC (T-COIL) TEST REPORT		Approved by: Quality Manager
Filename: 1M1803150042-12.A3L	Test Dates: 04/12/2018 - 04/23/2018	DUT Type: Portable Handset		Page 45 of 74

© 2018 PCTEST Engineering Laboratory, Inc.

REV 3.2.M

04/17/2018

© 2018 PCTEST Engineering Laboratory, Inc. All rights reserved. Unless otherwise specified, no part of this report may be reproduced or utilized in any part, form or by any means, electronic or mechanical, including photocopying and microfilm, without permission in writing from PCTEST Engineering Laboratory, Inc. If you have any questions about this international copyright or have an enquiry about obtaining additional rights to this report or assembly of contents thereof, please contact INFO@PCTEST.COM.

PCTEST Hearing-Aid Compatibility Facility

DUT: A3LSMJ737T

Type: Portable Handset
Serial: 22003

Measurement Standard: ANSI C63.19-2011

Equipment:

- Probe: Axial T-Coil Probe – SN: TEM-1124; Calibrated: 12/07/2016

Test Configuration:

- Mode: UMTS V
- Channel: 4183
- Speech Signal: 3GPP2 Normal Test Signal

Noise Spectrum

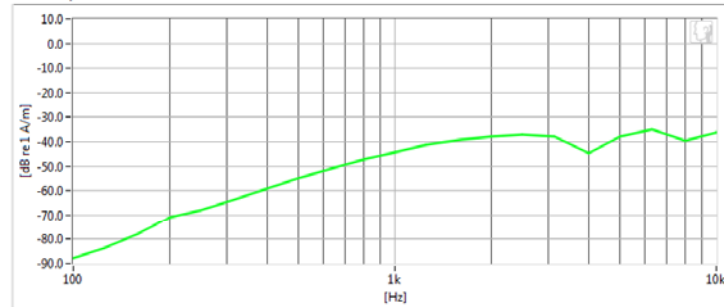

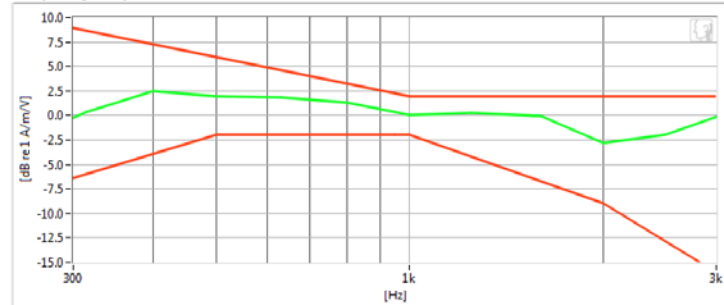

Frequency Response



Results

ABM1	6.87 dB	✓	Minimum	-18.0
ABM2	-34.07 dB	✓	Maximum	0.0
SNNR	40.94 dB	✓	Minimum	20.0
Aligned Response - Normal	1.7 dB	✓	Tolerance curves	Aligned Data

PCTEST 2018

FCC ID: A3LSMJ737T		HAC (T-COIL) TEST REPORT		Approved by: Quality Manager
Filename: 1M1803150042-12.A3L	Test Dates: 04/12/2018 - 04/23/2018	DUT Type: Portable Handset	Page 46 of 74	

© 2018 PCTEST Engineering Laboratory, Inc.

REV 3.2.M
04/17/2018

© 2018 PCTEST Engineering Laboratory, Inc. All rights reserved. Unless otherwise specified, no part of this report may be reproduced or utilized in any part, form or by any means, electronic or mechanical, including photocopying and microfilm, without permission in writing from PCTEST Engineering Laboratory, Inc. If you have any questions about this international copyright or have an enquiry about obtaining additional rights to this report or assembly of contents thereof, please contact INFO@PCTEST.COM.

PCTEST Hearing-Aid Compatibility Facility

DUT: A3LSMJ737T

Type: Portable Handset
Serial: 22003

Measurement Standard: ANSI C63.19-2011

Equipment:

- Probe: Axial T-Coil Probe – SN: TEM-1124; Calibrated: 12/07/2016

Test Configuration:

- Mode: UMTS IV
- Channel: 1312
- Speech Signal: 3GPP2 Normal Test Signal

Noise Spectrum

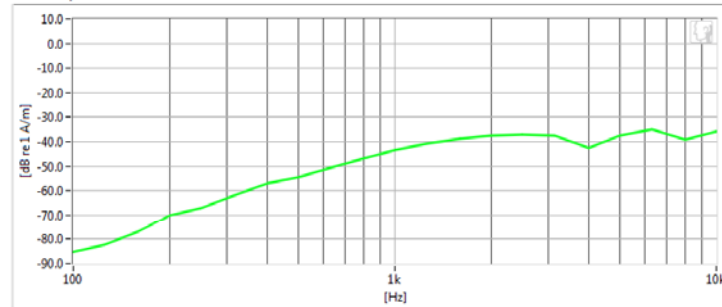

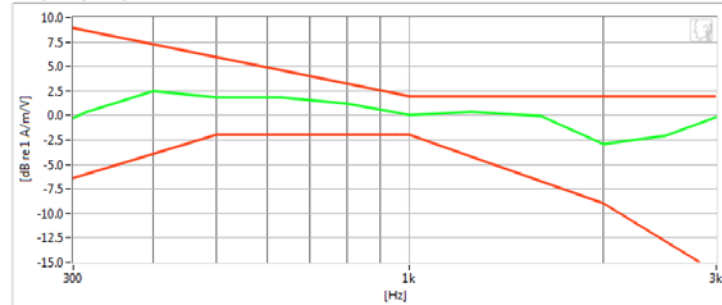

Frequency Response



Results

ABM1	6.88 dB	✓	Minimum	-18.0
ABM2	-33.62 dB	✓	Maximum	0.0
SNNR	40.5 dB	✓	Minimum	20.0
Aligned Response - Normal	1.69 dB	✓	Tolerance curves	Aligned Data

PCTEST 2018

FCC ID: A3LSMJ737T		HAC (T-COIL) TEST REPORT		Approved by: Quality Manager
Filename: 1M1803150042-12.A3L	Test Dates: 04/12/2018 - 04/23/2018	DUT Type: Portable Handset	Page 47 of 74	

© 2018 PCTEST Engineering Laboratory, Inc.

REV 3.2.M

04/17/2018

© 2018 PCTEST Engineering Laboratory, Inc. All rights reserved. Unless otherwise specified, no part of this report may be reproduced or utilized in any part, form or by any means, electronic or mechanical, including photocopying and microfilm, without permission in writing from PCTEST Engineering Laboratory, Inc. If you have any questions about this international copyright or have an enquiry about obtaining additional rights to this report or assembly of contents thereof, please contact INFO@PCTEST.COM.



PCTEST Hearing-Aid Compatibility Facility

DUT: A3LSMJ737T

Type: Portable Handset
Serial: 22003

Measurement Standard: ANSI C63.19-2011

Equipment:

- Probe: Axial T-Coil Probe – SN: TEM-1124; Calibrated: 12/07/2016

Test Configuration:

- Mode: UMTS II
- Channel: 9400
- Speech Signal: 3GPP2 Normal Test Signal

Noise Spectrum

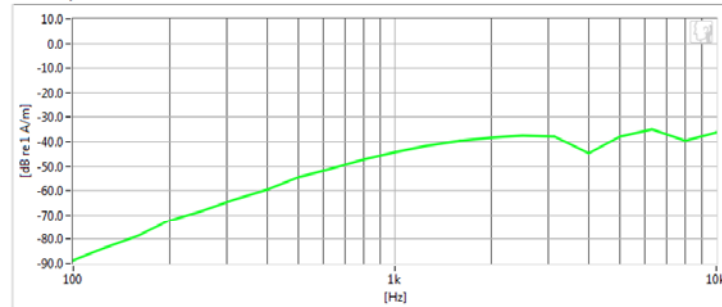

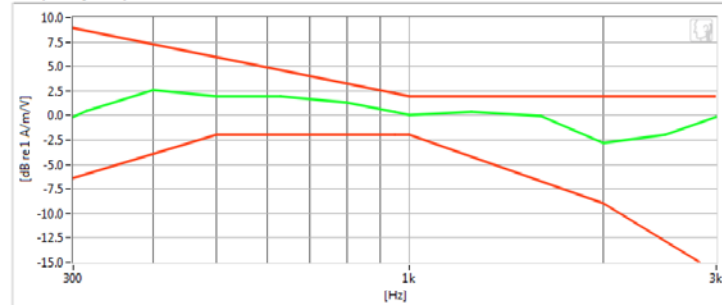

Frequency Response



Results

ABM1	6.71 dB	✓	Minimum	-18.0
ABM2	-34.24 dB	✓	Maximum	0.0
SNNR	40.95 dB	✓	Minimum	20.0
Aligned Response - Normal	1.66 dB	✓	Tolerance curves	Aligned Data

PCTEST 2018

FCC ID: A3LSMJ737T		HAC (T-COIL) TEST REPORT		Approved by: Quality Manager
Filename: 1M1803150042-12.A3L	Test Dates: 04/12/2018 - 04/23/2018	DUT Type: Portable Handset	Page 48 of 74	

© 2018 PCTEST Engineering Laboratory, Inc.

REV 3.2.M

04/17/2018

© 2018 PCTEST Engineering Laboratory, Inc. All rights reserved. Unless otherwise specified, no part of this report may be reproduced or utilized in any part, form or by any means, electronic or mechanical, including photocopying and microfilm, without permission in writing from PCTEST Engineering Laboratory, Inc. If you have any questions about this international copyright or have an enquiry about obtaining additional rights to this report or assembly of contents thereof, please contact INFO@PCTEST.COM.

PCTEST Hearing-Aid Compatibility Facility

DUT: A3LSMJ737T

Type: Portable Handset
Serial: 22003

Measurement Standard: ANSI C63.19-2011

Equipment:

- Probe: Axial T-Coil Probe – SN: TEM-1124; Calibrated: 12/07/2016

Test Configuration:

- Mode: LTE FDD Band 5
- Bandwidth: 1.4MHz
- Channel: 20643
- Speech Signal: 3GPP2 Normal Test Signal

Noise Spectrum

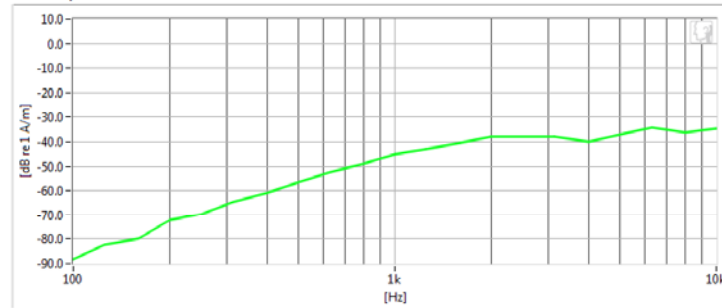

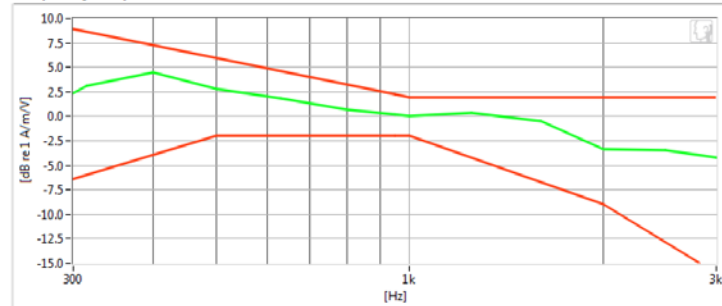

Frequency Response



Results

ABM1	0 dB	✓	Minimum	-18.0
ABM2	-34.49 dB	✓	Maximum	0.0
SNNR	34.49 dB	✓	Minimum	20.0
Aligned Response - Normal	1.59 dB	✓	Tolerance curves	Aligned Data

PCTEST 2018

FCC ID: A3LSMJ737T		HAC (T-COIL) TEST REPORT		Approved by: Quality Manager
Filename: 1M1803150042-12.A3L	Test Dates: 04/12/2018 - 04/23/2018	DUT Type: Portable Handset	Page 49 of 74	

© 2018 PCTEST Engineering Laboratory, Inc.

REV 3.2.M
04/17/2018

© 2018 PCTEST Engineering Laboratory, Inc. All rights reserved. Unless otherwise specified, no part of this report may be reproduced or utilized in any part, form or by any means, electronic or mechanical, including photocopying and microfilm, without permission in writing from PCTEST Engineering Laboratory, Inc. If you have any questions about this international copyright or have an enquiry about obtaining additional rights to this report or assembly of contents thereof, please contact INFO@PCTEST.COM.



PCTEST Hearing-Aid Compatibility Facility

DUT: A3LSMJ737T

Type: Portable Handset
Serial: 22003

Measurement Standard: ANSI C63.19-2011

Equipment:

- Probe: Axial T-Coil Probe – SN: TEM-1124; Calibrated: 12/07/2016

Test Configuration:

- Mode: 2.4GHz WIFI
- Standard: IEEE 802.11b
- Channel: 1
- Speech Signal: 3GPP2 Normal Test Signal

Noise Spectrum

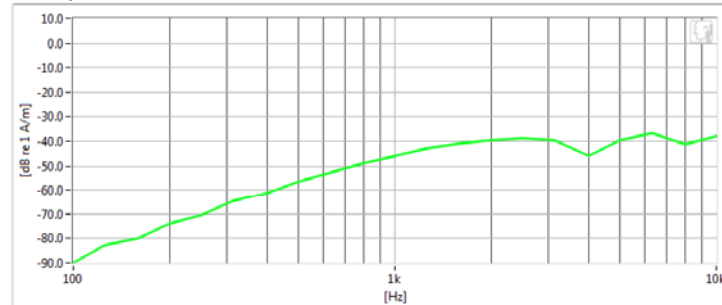

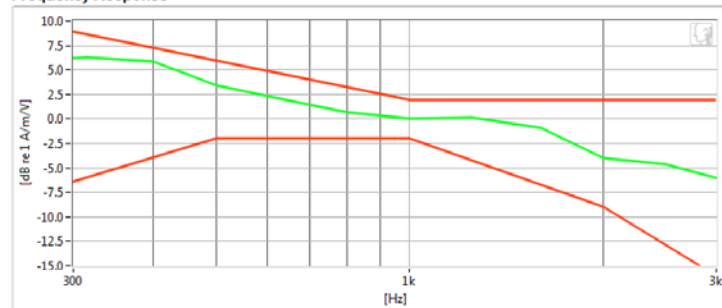

Frequency Response



Results

ABM1	-410m dB	✓	Minimum	-18.0
ABM2	-35.71 dB	✓	Maximum	0.0
SNNR	35.31 dB	✓	Minimum	20.0
Aligned Response - Normal	1.41 dB	✓	Tolerance curves	Aligned Data

PCTEST 2018

FCC ID: A3LSMJ737T		HAC (T-COIL) TEST REPORT		Approved by: Quality Manager
Filename: 1M1803150042-12.A3L	Test Dates: 04/12/2018 - 04/23/2018	DUT Type: Portable Handset	Page 50 of 74	

© 2018 PCTEST Engineering Laboratory, Inc.

REV 3.2.M

04/17/2018

© 2018 PCTEST Engineering Laboratory, Inc. All rights reserved. Unless otherwise specified, no part of this report may be reproduced or utilized in any part, form or by any means, electronic or mechanical, including photocopying and microfilm, without permission in writing from PCTEST Engineering Laboratory, Inc. If you have any questions about this international copyright or have an enquiry about obtaining additional rights to this report or assembly of contents thereof, please contact INFO@PCTEST.COM.



PCTEST Hearing-Aid Compatibility Facility

DUT: A3LSMJ737T

Type: Portable Handset
Serial: 22003

Measurement Standard: ANSI C63.19-2011

Equipment:

- Probe: Axial T-Coil Probe – SN: TEM-1124; Calibrated: 12/07/2016

Test Configuration:

- Mode: 5GHz WIFI (U-NII 3)
- Standard: IEEE 802.11a
- Bandwidth: 20MHz
- Channel: 157
- Speech Signal: 3GPP2 Normal Test Signal

Noise Spectrum

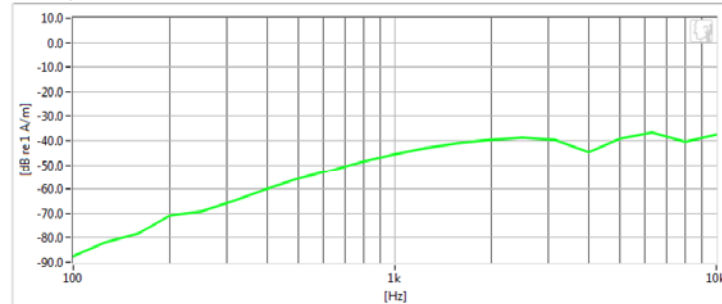

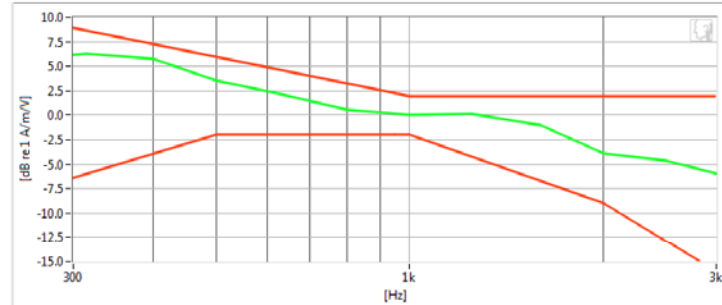

Frequency Response



Results

ABM1	-700m dB	✓	Minimum	-18.0
ABM2	-35.55 dB	✓	Maximum	0.0
SNNR	34.85 dB	✓	Minimum	20.0
Aligned Response - Normal	1.44 dB	✓	Tolerance curves	Aligned Data

PCTEST 2018

FCC ID: A3LSMJ737T		HAC (T-COIL) TEST REPORT		Approved by: Quality Manager
Filename: 1M1803150042-12.A3L	Test Dates: 04/12/2018 - 04/23/2018	DUT Type: Portable Handset		Page 51 of 74

© 2018 PCTEST Engineering Laboratory, Inc.

REV 3.2.M
04/17/2018

© 2018 PCTEST Engineering Laboratory, Inc. All rights reserved. Unless otherwise specified, no part of this report may be reproduced or utilized in any part, form or by any means, electronic or mechanical, including photocopying and microfilm, without permission in writing from PCTEST Engineering Laboratory, Inc. If you have any questions about this international copyright or have an enquiry about obtaining additional rights to this report or assembly of contents thereof, please contact INFO@PCTEST.COM.



PCTEST Hearing-Aid Compatibility Facility

DUT: A3LSMJ737T

Type: Portable Handset
Serial: 22003

Measurement Standard: ANSI C63.19-2011

Equipment:

- Probe: Axial T-Coil Probe – SN: TEM-1124; Calibrated: 12/07/2016

Test Configuration:

- VoIP Application: Google Duo
- Mode: EDGE850
- Channel: 190
- Speech Signal: ITU-T P.50 Artificial Voice

Noise Spectrum

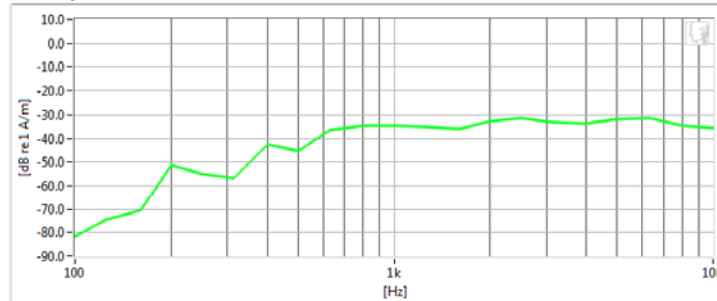

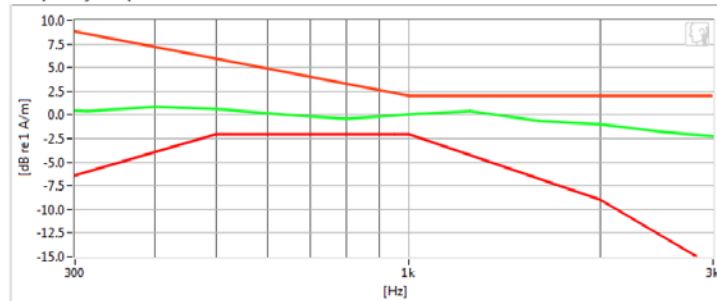

Frequency Response



Results

ABM1	9.18 dB	✓	Minimum	-18.0
ABM2	-26.45 dB	✓	Maximum	0
SNNR	35.62 dB	✓	Minimum	20
Aligned Response - P.50	1.58 dB	✓	Tolerance curves	Aligned Data

PCTEST 2018

FCC ID: A3LSMJ737T		HAC (T-COIL) TEST REPORT		Approved by: Quality Manager
Filename: 1M1803150042-12.A3L	Test Dates: 04/12/2018 - 04/23/2018	DUT Type: Portable Handset	Page 52 of 74	

© 2018 PCTEST Engineering Laboratory, Inc.

REV 3.2.M
04/17/2018

© 2018 PCTEST Engineering Laboratory, Inc. All rights reserved. Unless otherwise specified, no part of this report may be reproduced or utilized in any part, form or by any means, electronic or mechanical, including photocopying and microfilm, without permission in writing from PCTEST Engineering Laboratory, Inc. If you have any questions about this international copyright or have an enquiry about obtaining additional rights to this report or assembly of contents thereof, please contact INFO@PCTEST.COM.



PCTEST Hearing-Aid Compatibility Facility

DUT: A3LSMJ737T

Type: Portable Handset
Serial: 22003

Measurement Standard: ANSI C63.19-2011

Equipment:

- Probe: Radial T-Coil Probe – SN: TEM-1130; Calibrated: 12/07/2016

Test Configuration:

- Mode: GSM850
- Channel: 251

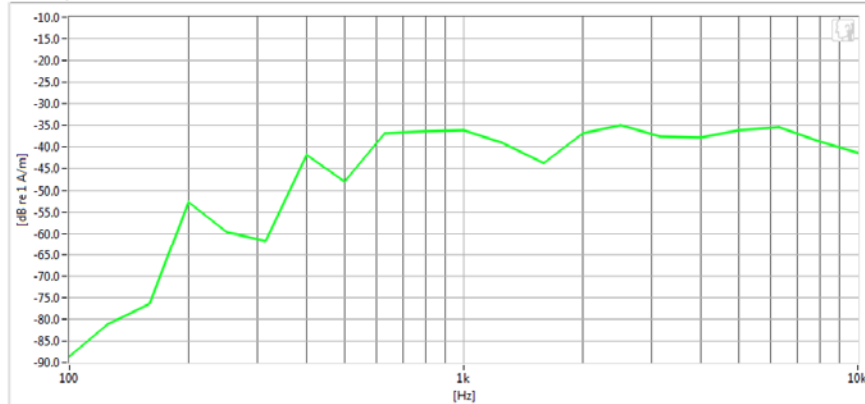

Noise Spectrum



Results

ABM1	-5.15 dB	✓	Minimum	-18.0
ABM2	-28.68 dB	✓	Maximum	0.0
SNNR	23.53 dB	✓	Minimum	20.0

PCTEST 2018

FCC ID: A3LSMJ737T		HAC (T-COIL) TEST REPORT		Approved by: Quality Manager
Filename: 1M1803150042-12.A3L	Test Dates: 04/12/2018 - 04/23/2018	DUT Type: Portable Handset	Page 53 of 74	

© 2018 PCTEST Engineering Laboratory, Inc.

REV 3.2.M
04/17/2018

© 2018 PCTEST Engineering Laboratory, Inc. All rights reserved. Unless otherwise specified, no part of this report may be reproduced or utilized in any part, form or by any means, electronic or mechanical, including photocopying and microfilm, without permission in writing from PCTEST Engineering Laboratory, Inc. If you have any questions about this international copyright or have an enquiry about obtaining additional rights to this report or assembly of contents thereof, please contact INFO@PCTEST.COM.



PCTEST Hearing-Aid Compatibility Facility

DUT: A3LSMJ737T

Type: Portable Handset
Serial: 22003

Measurement Standard: ANSI C63.19-2011

Equipment:

- Probe: Radial T-Coil Probe – SN: TEM-1130; Calibrated: 12/07/2016

Test Configuration:

- Mode: GSM1900
- Channel: 661

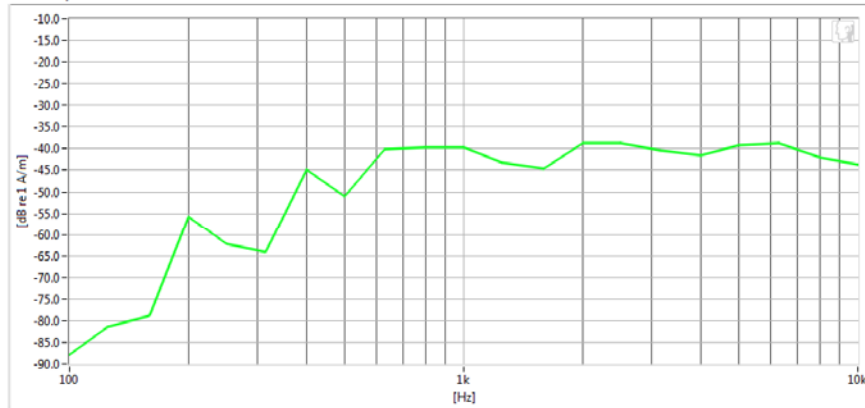

Noise Spectrum



Results

ABM1	-5.36 dB	✓	Minimum	-18.0
ABM2	-31.9 dB	✓	Maximum	0
SNNR	26.53 dB	✓	Minimum	20

PCTEST 2018

FCC ID: A3LSMJ737T		HAC (T-COIL) TEST REPORT		Approved by: Quality Manager
Filename: 1M1803150042-12.A3L	Test Dates: 04/12/2018 - 04/23/2018	DUT Type: Portable Handset	Page 54 of 74	

© 2018 PCTEST Engineering Laboratory, Inc.

REV 3.2.M
04/17/2018

© 2018 PCTEST Engineering Laboratory, Inc. All rights reserved. Unless otherwise specified, no part of this report may be reproduced or utilized in any part, form or by any means, electronic or mechanical, including photocopying and microfilm, without permission in writing from PCTEST Engineering Laboratory, Inc. If you have any questions about this international copyright or have an enquiry about obtaining additional rights to this report or assembly of contents thereof, please contact INFO@PCTEST.COM.



PCTEST Hearing-Aid Compatibility Facility

DUT: A3LSMJ737T

Type: Portable Handset
Serial: 22003

Measurement Standard: ANSI C63.19-2011

Equipment:

- Probe: Radial T-Coil Probe – SN: TEM-1130; Calibrated: 12/07/2016

Test Configuration:

- Mode: UMTS V
- Channel: 4132

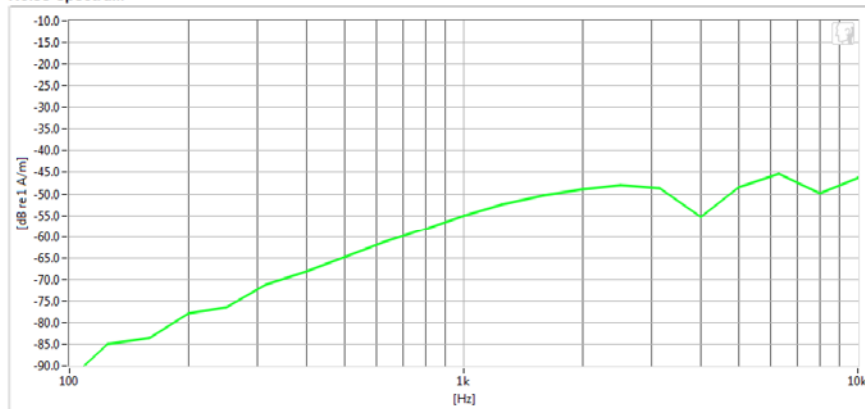

Noise Spectrum



Results

ABM1	-4.67 dB	✓	Minimum	-18.0
ABM2	-44.93 dB	✓	Maximum	0.0
SNNR	40.25 dB	✓	Minimum	20.0

PCTEST 2018

FCC ID: A3LSMJ737T		HAC (T-COIL) TEST REPORT		Approved by: Quality Manager
Filename: 1M1803150042-12.A3L	Test Dates: 04/12/2018 - 04/23/2018	DUT Type: Portable Handset	Page 55 of 74	

© 2018 PCTEST Engineering Laboratory, Inc.

REV 3.2.M
04/17/2018

© 2018 PCTEST Engineering Laboratory, Inc. All rights reserved. Unless otherwise specified, no part of this report may be reproduced or utilized in any part, form or by any means, electronic or mechanical, including photocopying and microfilm, without permission in writing from PCTEST Engineering Laboratory, Inc. If you have any questions about this international copyright or have an enquiry about obtaining additional rights to this report or assembly of contents thereof, please contact INFO@PCTEST.COM.



PCTEST Hearing-Aid Compatibility Facility

DUT: A3LSMJ737T

Type: Portable Handset
Serial: 22003

Measurement Standard: ANSI C63.19-2011

Equipment:

- Probe: Radial T-Coil Probe – SN: TEM-1130; Calibrated: 12/07/2016

Test Configuration:

- Mode: UMTS IV
- Channel: 1312

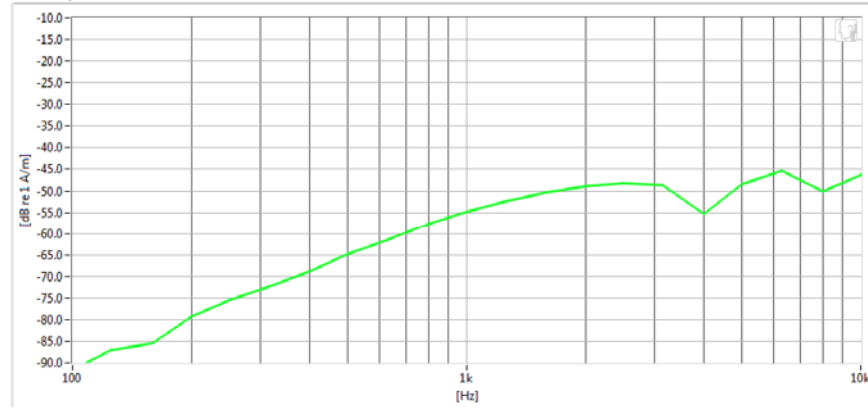

Noise Spectrum



Results

ABM1	-4.71 dB	✓	Minimum	-18.0
ABM2	-44.94 dB	✓	Maximum	0.0
SNNR	40.23 dB	✓	Minimum	20.0

PCTEST 2018

FCC ID: A3LSMJ737T		HAC (T-COIL) TEST REPORT		Approved by: Quality Manager
Filename: 1M1803150042-12.A3L	Test Dates: 04/12/2018 - 04/23/2018	DUT Type: Portable Handset	Page 56 of 74	

© 2018 PCTEST Engineering Laboratory, Inc.

REV 3.2.M
04/17/2018

© 2018 PCTEST Engineering Laboratory, Inc. All rights reserved. Unless otherwise specified, no part of this report may be reproduced or utilized in any part, form or by any means, electronic or mechanical, including photocopying and microfilm, without permission in writing from PCTEST Engineering Laboratory, Inc. If you have any questions about this international copyright or have an enquiry about obtaining additional rights to this report or assembly of contents thereof, please contact INFO@PCTEST.COM.

PCTEST Hearing-Aid Compatibility Facility

DUT: A3LSMJ737T

Type: Portable Handset
Serial: 22003

Measurement Standard: ANSI C63.19-2011

Equipment:

- Probe: Radial T-Coil Probe – SN: TEM-1130; Calibrated: 12/07/2016

Test Configuration:

- Mode: UMTS II
- Channel: 9400

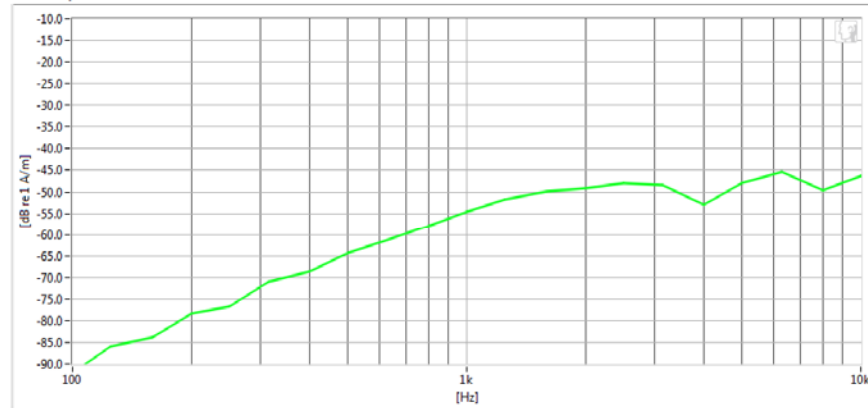

Noise Spectrum



Results

ABM1	-4.71 dB	✓	Minimum	-18.0
ABM2	-44.63 dB	✓	Maximum	0.0
SNNR	39.92 dB	✓	Minimum	20.0

PCTEST 2018

FCC ID: A3LSMJ737T		HAC (T-COIL) TEST REPORT		Approved by: Quality Manager
Filename: 1M1803150042-12.A3L	Test Dates: 04/12/2018 - 04/23/2018	DUT Type: Portable Handset	Page 57 of 74	

© 2018 PCTEST Engineering Laboratory, Inc.

REV 3.2.M
04/17/2018

© 2018 PCTEST Engineering Laboratory, Inc. All rights reserved. Unless otherwise specified, no part of this report may be reproduced or utilized in any part, form or by any means, electronic or mechanical, including photocopying and microfilm, without permission in writing from PCTEST Engineering Laboratory, Inc. If you have any questions about this international copyright or have an enquiry about obtaining additional rights to this report or assembly of contents thereof, please contact INFO@PCTEST.COM.



PCTEST Hearing-Aid Compatibility Facility

DUT: A3LSMJ737T

Type: Portable Handset
Serial: 22003

Measurement Standard: ANSI C63.19-2011

Equipment:

- Probe: Radial T-Coil Probe – SN: TEM-1130; Calibrated: 12/07/2016

Test Configuration:

- Mode: LTE FDD Band 5
- Bandwidth: 1.4MHz
- Channel: 20643

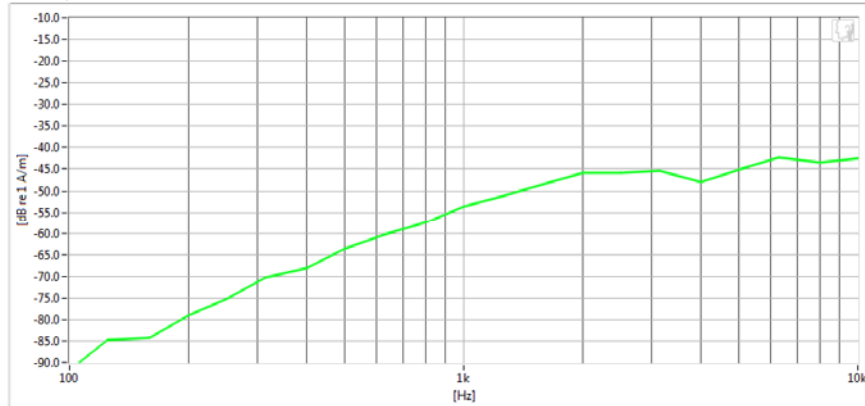

Noise Spectrum



Results

ABM1	-9.14 dB	✓	Minimum	-18.0
ABM2	-42.58 dB	✓	Maximum	0.0
SNNR	33.44 dB	✓	Minimum	20.0

PCTEST 2018

FCC ID: A3LSMJ737T		HAC (T-COIL) TEST REPORT		Approved by: Quality Manager
Filename: 1M1803150042-12.A3L	Test Dates: 04/12/2018 - 04/23/2018	DUT Type: Portable Handset	Page 58 of 74	

© 2018 PCTEST Engineering Laboratory, Inc.

REV 3.2.M
04/17/2018

© 2018 PCTEST Engineering Laboratory, Inc. All rights reserved. Unless otherwise specified, no part of this report may be reproduced or utilized in any part, form or by any means, electronic or mechanical, including photocopying and microfilm, without permission in writing from PCTEST Engineering Laboratory, Inc. If you have any questions about this international copyright or have an enquiry about obtaining additional rights to this report or assembly of contents thereof, please contact INFO@PCTEST.COM.



PCTEST Hearing-Aid Compatibility Facility

DUT: A3LSMJ737T

Type: Portable Handset
Serial: 22003

Measurement Standard: ANSI C63.19-2011

Equipment:

- Probe: Radial T-Coil Probe – SN: TEM-1130; Calibrated: 12/07/2016

Test Configuration:

- Mode: 2.4GHz WIFI
- Standard: IEEE 802.11b
- Channel: 11

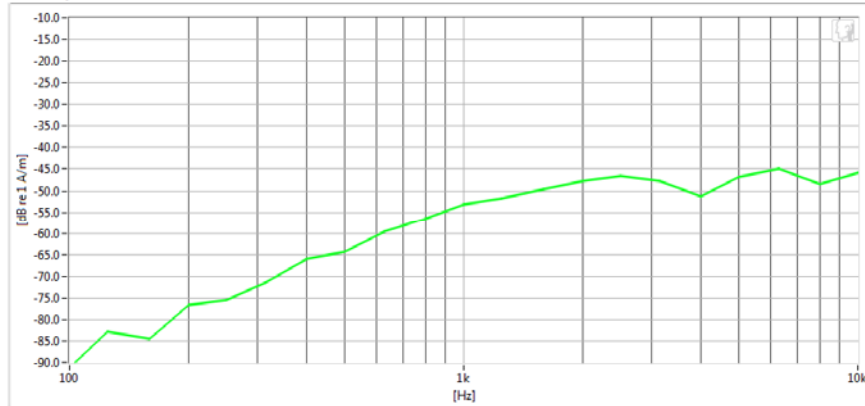

Noise Spectrum



Results

ABM1	-9.89 dB	✓	Minimum	-18.0
ABM2	-43.69 dB	✓	Maximum	0.0
SNNR	33.8 dB	✓	Minimum	20.0

PCTEST 2018

FCC ID: A3LSMJ737T		HAC (T-COIL) TEST REPORT		Approved by: Quality Manager
Filename: 1M1803150042-12.A3L	Test Dates: 04/12/2018 - 04/23/2018	DUT Type: Portable Handset	Page 59 of 74	

© 2018 PCTEST Engineering Laboratory, Inc.

REV 3.2.M
04/17/2018

© 2018 PCTEST Engineering Laboratory, Inc. All rights reserved. Unless otherwise specified, no part of this report may be reproduced or utilized in any part, form or by any means, electronic or mechanical, including photocopying and microfilm, without permission in writing from PCTEST Engineering Laboratory, Inc. If you have any questions about this international copyright or have an enquiry about obtaining additional rights to this report or assembly of contents thereof, please contact INFO@PCTEST.COM.



PCTEST Hearing-Aid Compatibility Facility

DUT: A3LSMJ737T

Type: Portable Handset
Serial: 22003

Measurement Standard: ANSI C63.19-2011

Equipment:

- Probe: Radial T-Coil Probe – SN: TEM-1130; Calibrated: 12/07/2016

Test Configuration:

- Mode: 5GHz WIFI (U-NII 3)
- Standard: IEEE 802.11a
- Bandwidth: 20MHz
- Channel: 165

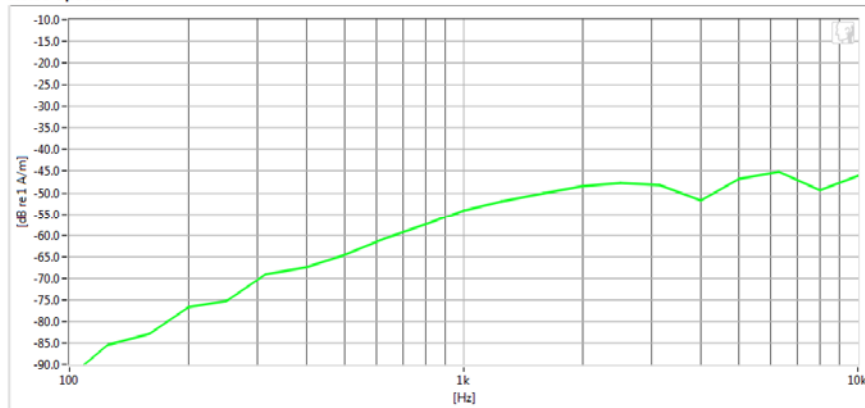

Noise Spectrum



Results

ABM1	-9.87 dB	✓	Minimum	-18.0
ABM2	-44.36 dB	✓	Maximum	0.0
SNNR	34.49 dB	✓	Minimum	20.0

PCTEST 2018

FCC ID: A3LSMJ737T		HAC (T-COIL) TEST REPORT		Approved by: Quality Manager
Filename: 1M1803150042-12.A3L	Test Dates: 04/12/2018 - 04/23/2018	DUT Type: Portable Handset	Page 60 of 74	

© 2018 PCTEST Engineering Laboratory, Inc.

REV 3.2.M
04/17/2018

© 2018 PCTEST Engineering Laboratory, Inc. All rights reserved. Unless otherwise specified, no part of this report may be reproduced or utilized in any part, form or by any means, electronic or mechanical, including photocopying and microfilm, without permission in writing from PCTEST Engineering Laboratory, Inc. If you have any questions about this international copyright or have an enquiry about obtaining additional rights to this report or assembly of contents thereof, please contact INFO@PCTEST.COM.



PCTEST Hearing-Aid Compatibility Facility

DUT: A3LSMJ737T

Type: Portable Handset
Serial: 22003

Measurement Standard: ANSI C63.19-2011

Equipment:

- Probe: Radial T-Coil Probe – SN: TEM-1130; Calibrated: 12/07/2016

Test Configuration:

- VoIP Application: Google Duo
- Mode: EDGE850
- Channel: 190

Noise Spectrum

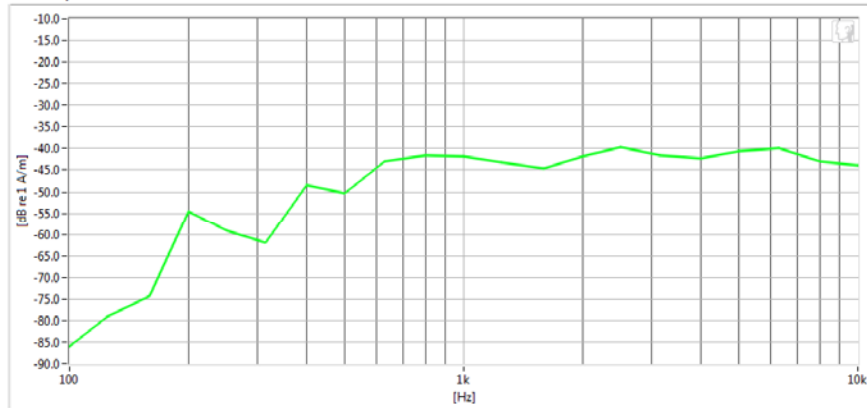

Results

ABM1	600m dB	✓	Minimum	-18.0
ABM2	-33.79 dB	✓	Maximum	0.0
SNR	34.39 dB	✓	Minimum	20.0

PCTEST 2018



FCC ID: A3LSMJ737T		HAC (T-COIL) TEST REPORT		Approved by: Quality Manager
Filename: 1M1803150042-12.A3L	Test Dates: 04/12/2018 - 04/23/2018	DUT Type: Portable Handset	Page 61 of 74	

© 2018 PCTEST Engineering Laboratory, Inc.

REV 3.2.M
04/17/2018

© 2018 PCTEST Engineering Laboratory, Inc. All rights reserved. Unless otherwise specified, no part of this report may be reproduced or utilized in any part, form or by any means, electronic or mechanical, including photocopying and microfilm, without permission in writing from PCTEST Engineering Laboratory, Inc. If you have any questions about this international copyright or have an enquiry about obtaining additional rights to this report or assembly of contents thereof, please contact INFO@PCTEST.COM.

13. CALIBRATION CERTIFICATES

FCC ID: A3LSMJ737T		HAC (T-COIL) TEST REPORT		Approved by: Quality Manager
Filename: 1M1803150042-12.A3L	Test Dates: 04/12/2018 - 04/23/2018	DUT Type: Portable Handset	Page 62 of 74	

© 2018 PCTEST Engineering Laboratory, Inc.

REV 3.2.M
04/17/2018

© 2018 PCTEST Engineering Laboratory, Inc. All rights reserved. Unless otherwise specified, no part of this report may be reproduced or utilized in any part, form or by any means, electronic or mechanical, including photocopying and microfilm, without permission in writing from PCTEST Engineering Laboratory, Inc. If you have any questions about this international copyright or have an enquiry about obtaining additional rights to this report or assembly of contents thereof, please contact INFO@PCTEST.COM.

West Caldwell Calibration Laboratories Inc.

Certificate of Calibration

for

AXIAL T COIL PROBE

Manufactured by: TEM CONSULTING
Model No: AXIAL T COIL PROBE
Serial No: TEM-1124
Calibration Recall No: 27068

Submitted By:

Customer: ANDREW HARWELL
Company: PCTEST ENGINEERING LAB
Address: 6660-B DOBBIN ROAD COLUMBIA MD 21045

The subject instrument was calibrated to the indicated specification using standards traceable to the National Institute of Standards and Technology or to accepted values of natural physical constants. This document certifies that the instrument met the following specification upon its return to the submitter.

West Caldwell Calibration Laboratories Procedure No. AXIAL T C TEM C

Upon receipt for Calibration, the instrument was found to be:

Within (X)

tolerance of the indicated specification. See attached Report of Calibration.

West Caldwell Calibration Laboratories' calibration control system meets the following requirements, ISO 10012-1 MIL STD 45662A, ANSI/NCSL Z540-1, IEC Guide 25, ISO 9001:2008 and ISO 17025

Note: With this Certificate, Report of Calibration is Included.

Approved by:

Calibration Date: 07-Dec-16

Certificate No: 27068 - 3

QA Doc. #1051 Rev. 2.0 10/1/01

Certificate Page 1 of 1

FC
Felix Christopher (QA Mgr.)
ISO/IEC 17025:2005

West Caldwell Calibration Laboratories, Inc.
uncompromised calibration
1575 State Route 96, Victor, NY 14564, U.S.A.



Calibration Lab. Cert. # 1533.01

FCC ID: A3LSMJ737T		HAC (T-COIL) TEST REPORT		Approved by: Quality Manager
Filename: 1M1803150042-12.A3L	Test Dates: 04/12/2018 - 04/23/2018	DUT Type: Portable Handset		Page 63 of 74

© 2018 PCTEST Engineering Laboratory, Inc.

REV 3.2.M
04/17/2018

© 2018 PCTEST Engineering Laboratory, Inc. All rights reserved. Unless otherwise specified, no part of this report may be reproduced or utilized in any part, form or by any means, electronic or mechanical, including photocopying and microfilm, without permission in writing from PCTEST Engineering Laboratory, Inc. If you have any questions about this international copyright or have an enquiry about obtaining additional rights to this report or assembly of contents thereof, please contact INFO@PCTEST.COM.



1575 State Route 96, Victor NY 14564

ISO/IEC 17025: 2005



Calibration Lab. Cert. # 1533.01

REPORT OF CALIBRATION

TEM Consulting LP Axial T Coil Probe

for
Model No.: Axial T Coil Probe

Serial No.: TEM 1124

Company : PCTEST Engineering Lab.

I. D. No: 80578

Calibration results:			
Probe Sensitivity measured with Helmholtz Coil			
Helmholtz Coil;			
the number of turns on each coil;	10	No.	Before & after data same: ... X.....
the radius of each coil, in meters;	0.204	m	
the current in the coils, in amperes.;	0.09	A	
Helmholtz Coil Constant;	7.09	A/m/V	Laboratory Environment:
Helmholtz Coil magnetic field;	5.98	A/m	Ambient Temperature: 20.2 °C
			Ambient Humidity: 31.4 % RH
			Ambient Pressure: 99.1 kPa
			Calibration Date: 7-Dec-16
Probe Sensitivity at	1000	Hz.	Report Number: 27068 -3
was	-60.23	dBV/A/m	Control Number: 27068
	0.974	mV/A/m	
Probe resistance	904	Ohms	

The above listed instrument meets or exceeds the tested manufacturer's specifications.

This Calibration is traceable through NIST test numbers: 683/284413-14

The expanded uncertainty of calibration: 0.30dB at 95% confidence level with a coverage factor of k=2.

Graph represents Probes Frequency Response.

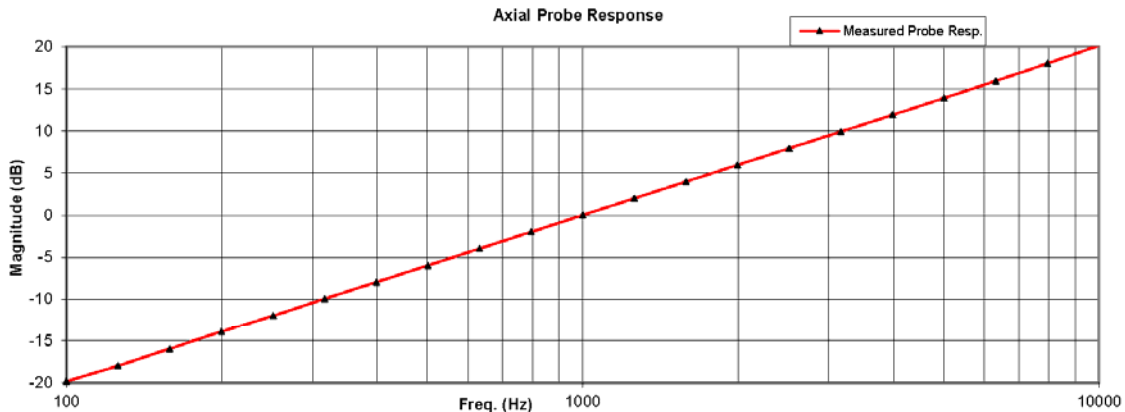

The above listed instrument was checked using calibration procedure documented in West Caldwell Calibration Laboratories Inc. procedure :

Rev. 7.0 Jan. 24, 2014 Doc. # 1038 HCATEMC

Calibration was performed by West Caldwell Calibration Laboratories Inc. under Operating Procedures

intended to implement the requirements of ISO10012-1, IEC Guide 25, ANSI/NCCL Z540-1, (MIL-STD-45662A) and ISO 9001:2008, ISO 17025

Cal. Date: 7-Dec-2016

Measurements performed by: FC

Calibrated on WCCL system type 9700

Felix Christopher

This document shall not be reproduced, except in full, without the written approval from West Caldwell Cal. Labs, Inc.

Rev. 7.0 Jan. 24, 2014 Doc # 1038 HCATEMC

FCC ID: A3LSMJ737T		HAC (T-COIL) TEST REPORT		Approved by: Quality Manager
Filename: 1M1803150042-12.A3L	Test Dates: 04/12/2018 - 04/23/2018	DUT Type: Portable Handset		Page 64 of 74

West Caldwell Calibration Laboratories Inc.

1575 State Route 96, Victor NY 14564
 Tel. (585) 586-3900 FAX (585) 586-4327

Calibration Data Record

TEM Consulting LP Axial T Coil Probe

Model No.: Axial T Coil Probe

Serial No.: TEM 1124

Company : PCTEST Engineering Lab.

Test	Function	Tolerance	Measured values			
			Before	Out	Remarks	
1.0	Probe Sensitivity at	1000 Hz. μ BV/A/m	-60.23			
2.0	Probe Level Linearity	μ B				
		6	6.03			
		Ref. (0 μ B)	0	0.00		
		-6	-6.03			
		-12	-12.05			
3.0	Probe Frequency Response	Hz				
		100	-19.8			
		126	-18.0			
		158	-16.0			
		200	-13.9			
		251	-12.0			
		316	-9.9			
		398	-8.0			
		501	-6.0			
		631	-4.0			
		794	-2.0			
		Ref. (0 μ B)	1000	0.0		
		1259	2.0			
		1585	4.0			
		1995	6.0			
		2512	7.9			
		3162	9.9			
3981	11.9					
5012	13.9					
6310	15.9					
7943	18.0					
10000	20.2					

Instruments used for calibration:				Date or Cal.	Traceability No.	Due Date
HP	34401A	S/N	36064102	1-Oct-2016	,287708	1-Oct-2017
HP	34401A	S/N	36102471	1-Oct-2016	,287708	1-Oct-2017
HP	33120A	S/N	36043716	1-Oct-2016	,287708	1-Oct-2017
B&K	2133	S/N	1583254	1-Oct-2016	683/284413-14	1-Oct-2017



Cal. Date: 7-Dec-2016

Tested by: Felix Christopher

Calibrated on WCCL system type 9700

This document shall not be reproduced, except in full, without the written approval from West Caldwell Cal. Labs, Inc.

Rev. 7.0 Jan. 24, 2014 Doc. # 1038 HCATEMC

FCC ID: A3LSMJ737T		HAC (T-COIL) TEST REPORT		Approved by: Quality Manager
Filename: 1M1803150042-12.A3L	Test Dates: 04/12/2018 - 04/23/2018	DUT Type: Portable Handset		Page 65 of 74

© 2018 PCTEST Engineering Laboratory, Inc.

REV 3.2.M
04/17/2018

© 2018 PCTEST Engineering Laboratory, Inc. All rights reserved. Unless otherwise specified, no part of this report may be reproduced or utilized in any part, form or by any means, electronic or mechanical, including photocopying and microfilm, without permission in writing from PCTEST Engineering Laboratory, Inc. If you have any questions about this international copyright or have an enquiry about obtaining additional rights to this report or assembly of contents thereof, please contact INFO@PCTEST.COM.

West Caldwell Calibration Laboratories Inc.

Certificate of Calibration

for

RADIAL T COIL PROBE

Manufactured by: TEM CONSULTING
Model No: RADIAL T COIL PROBE
Serial No: TEM-1130
Calibration Recall No: 27068

Submitted By:

Customer: ANDREW HARWELL
Company: PCTEST ENGINEERING LAB
Address: 6660-B DOBBIN ROAD
COLUMBIA MD 21045

The subject instrument was calibrated to the indicated specification using standards traceable to the National Institute of Standards and Technology or to accepted values of natural physical constants. This document certifies that the instrument met the following specification upon its return to the submitter.

West Caldwell Calibration Laboratories Procedure No. RADIAL T TEM C

Upon receipt for Calibration, the instrument was found to be:

Within (X)

tolerance of the indicated specification. See attached Report of Calibration.

West Caldwell Calibration Laboratories' calibration control system meets the following requirements, ISO 10012-1 MIL STD 45662A, ANSI/NCSL Z540-1, IEC Guide 25, ISO 9001:2008 and ISO 17025

Note: With this Certificate, Report of Calibration is included.

Approved by:

Calibration Date: 07-Dec-16

Certificate No: 27068 -2

QA Doc. #1061 Rev. 2.0 10/1/01

Certificate Page 1 of 1

FC
Felix Christopher (QA Mgr.)
ISO/IEC 17025:2005

West Caldwell Calibration Laboratories, Inc.
uncompromised calibration
1575 State Route 96, Victor, NY 14564, U.S.A.



Calibration Lab. Cert. # 1533.01

FCC ID: A3LSMJ737T		HAC (T-COIL) TEST REPORT		Approved by: Quality Manager
Filename: 1M1803150042-12.A3L	Test Dates: 04/12/2018 - 04/23/2018	DUT Type: Portable Handset		Page 66 of 74

© 2018 PCTEST Engineering Laboratory, Inc.

REV 3.2.M

04/17/2018

© 2018 PCTEST Engineering Laboratory, Inc. All rights reserved. Unless otherwise specified, no part of this report may be reproduced or utilized in any part, form or by any means, electronic or mechanical, including photocopying and microfilm, without permission in writing from PCTEST Engineering Laboratory, Inc. If you have any questions about this international copyright or have an enquiry about obtaining additional rights to this report or assembly of contents thereof, please contact INFO@PCTEST.COM.



1575 State Route 96, Victor NY 14564

ISO/IEC 17025: 2005



Calibration Lab. Cert. # 1533.01

REPORT OF CALIBRATION

TEM Consulting LP Radial T Coil Probe

for Model No.: Radial T Coil Probe

Serial No.: TEM-1130

Company : PCTEST Engineering Lab.

I. D. No: 80579

Calibration results:			
Probe Sensitivity measured with Helmholtz Coil			
Helmholtz Coil;			
the number of turns on each coil;	10	No.	Before & after data same: ...X.....
the radius of each coil, in meters;	0.204	m	
the current in the coils, in amperes.;	0.09	A	
Helmholtz Coil Constant;	7.09	A/m/V	Laboratory Environment:
Helmholtz Coil magnetic field;	5.98	A/m	Ambient Temperature: 20.2 °C
			Ambient Humidity: 31.4 % RH
			Ambient Pressure: 99.1 kPa
			Calibration Date: 7-Dec-16
Probe Sensitivity at	1000	Hz.	Report Number: 27068 -2
was	-60.27	dBV/A/m	Control Number: 27068
	0.969	mV/A/m	
Probe resistance	902	Ohms	

The above listed instrument meets or exceeds the tested manufacturer's specifications.

This Calibration is traceable through NIST test numbers: 683/284413-14
 The expanded uncertainty of calibration: 0.30dB at 95% confidence level with a coverage factor of k=2.

Graph represents Probes Frequency Response.

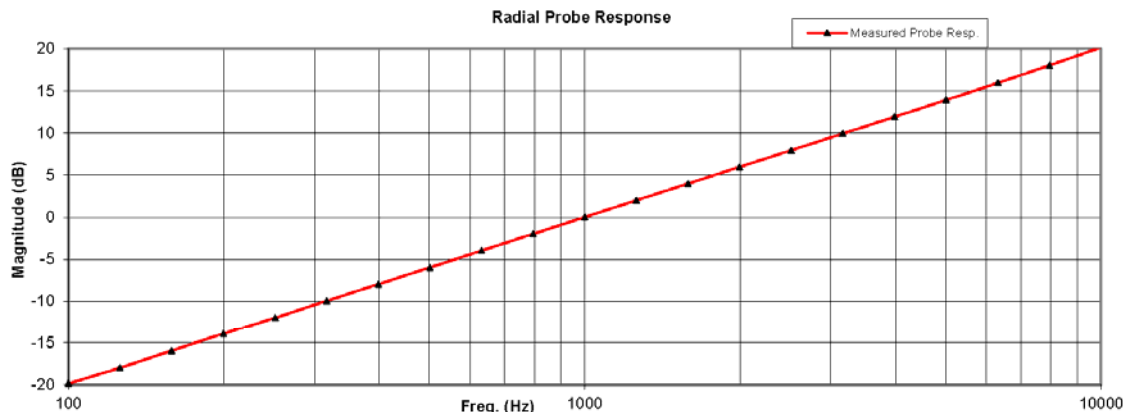

The above listed instrument was checked using calibration procedure documented in West Caldwell Calibration Laboratories Inc. procedure : **Rev. 7.0 Jan. 24, 2014 Doc. # 1038 HCRTEMC**

Calibration was performed by West Caldwell Calibration Laboratories Inc. under Operating Procedures intended to implement the requirements of ISO10012-1, IEC Guide 25, ANSI/NCCL Z540-1, (MIL-STD-45662A) and ISO 9001:2008, ISO 17025

Cal. Date: 7-Dec-2016
 Calibrated on WCCL system type 9700

Measurements performed by: FC
Felix Christopher

This document shall not be reproduced, except in full, without the written approval from West Caldwell Cal. Labs. Inc.

Rev. 7.0 Jan. 24, 2014 Doc # 1038 HCRTEMC

FCC ID: A3LSMJ737T		HAC (T-COIL) TEST REPORT		Approved by: Quality Manager
Filename: 1M1803150042-12.A3L	Test Dates: 04/12/2018 - 04/23/2018	DUT Type: Portable Handset		Page 67 of 74

West Caldwell Calibration Laboratories Inc.

1575 State Route 96, Victor NY 14564
 Tel. (585) 586-3900 FAX (585) 586-4327

Calibration Data Record

TEM Consulting LP Radial T Coil Probe

Model No.: Radial T Coil Probe

Serial No.: TEM-1130

Company : PCTEST Engineering Lab.

Test	Function	Tolerance	Measured values		
			Before	Out	Remarks
1.0	Probe Sensitivity at	1000 Hz. μ BV/A/m	-60.27		
2.0	Probe Level Linearity	Ref. (0 μ B)	μ B		
			6	6.03	
			0	0.00	
			-6	-6.03	
			-12	-12.06	
3.0	Probe Frequency Response	Ref. (0 μ B)	Hz		
			100	-19.9	
			126	-18.0	
			158	-16.0	
			200	-13.9	
			251	-12.0	
			316	-10.0	
			398	-8.0	
			501	-6.0	
			631	-4.0	
			794	-2.0	
			1000	0.0	
			1259	2.0	
			1585	4.0	
			1995	6.0	
			2512	7.9	
			3162	9.9	
3981	11.9				
5012	13.9				
6310	15.9				
7943	18.0				
10000	20.2				

Instruments used for calibration:			Date or Cal.	Traceability No.	Due Date
HP	34401A	S/N 36064102	1-Oct-2016	,287708	1-Oct-2017
HP	34401A	S/N 36102471	1-Oct-2016	,287708	1-Oct-2017
HP	33120A	S/N 36043716	1-Oct-2016	,287708	1-Oct-2017
B&K	2133	S/N 1583254	1-Oct-2016	683/284413-14	1-Oct-2017



Cal. Date: 7-Dec-2016

Tested by: Felix Christopher

Calibrated on WCCL system type 9700

This document shall not be reproduced, except in full, without the written approval from West Caldwell Cal. Labs, Inc.

Rev. 7.0 Jan. 24, 2014 Doc. # 1038 HCRTEMC

FCC ID: A3LSMJ737T		HAC (T-COIL) TEST REPORT		Approved by: Quality Manager
Filename: 1M1803150042-12.A3L	Test Dates: 04/12/2018 - 04/23/2018	DUT Type: Portable Handset		Page 68 of 74

© 2018 PCTEST Engineering Laboratory, Inc.



REV 3.2.M
04/17/2018

© 2018 PCTEST Engineering Laboratory, Inc. All rights reserved. Unless otherwise specified, no part of this report may be reproduced or utilized in any part, form or by any means, electronic or mechanical, including photocopying and microfilm, without permission in writing from PCTEST Engineering Laboratory, Inc. If you have any questions about this international copyright or have an enquiry about obtaining additional rights to this report or assembly of contents thereof, please contact INFO@PCTEST.COM.

14. CONCLUSION

The measurements indicate that the wireless communications device complies with the HAC limits specified in accordance with the ANSI C63.19 Standard and FCC WT Docket No. 01-309 RM-8658. Precise laboratory measures were taken to assure repeatability of the tests. The tested device complies with the requirements in respect to all parameters specific to the test. The test results and statements relate only to the item(s) tested.

The measurement system and techniques presented in this evaluation are proposed in the ANSI standard as a means of best approximating wireless device compatibility with a hearing-aid. The literature is under continual re-construction.

FCC ID: A3LSMJ737T		HAC (T-COIL) TEST REPORT		Approved by: Quality Manager
Filename: 1M1803150042-12.A3L	Test Dates: 04/12/2018 - 04/23/2018	DUT Type: Portable Handset	Page 69 of 74	



© 2018 PCTEST Engineering Laboratory, Inc.

REV 3.2.M
04/17/2018

© 2018 PCTEST Engineering Laboratory, Inc. All rights reserved. Unless otherwise specified, no part of this report may be reproduced or utilized in any part, form or by any means, electronic or mechanical, including photocopying and microfilm, without permission in writing from PCTEST Engineering Laboratory, Inc. If you have any questions about this international copyright or have an enquiry about obtaining additional rights to this report or assembly of contents thereof, please contact INFO@PCTEST.COM.

15. REFERENCES

1. ANSI C63.19-2011, American National Standard for Methods of Measurement of Compatibility between Wireless communication devices and Hearing Aids., New York, NY, IEEE, May 2011
2. FCC Office of Engineering and Technology KDB, "285076 D01 HAC Guidance v05," September 13, 2017
3. FCC Office of Engineering and Technology KDB, "285076 D02 T-Coil Testing for CMRS IP v03," September 13, 2017
4. FCC Public Notice DA 06-1215, *Wireless Telecommunications Bureau and Office of Engineering and Technology Clarify Use of Revised Wireless Phone Hearing Aid Compatibility Standard*, June 6, 2006
5. FCC 3G Review Guidance, Laboratory Division OET FCC, May/June 2006
6. Berger, H. S., "Compatibility Between Hearing Aids and Wireless Devices," Electronic Industries Forum, Boston, MA, May, 1997
7. Berger, H. S., "Hearing Aid and Cellular Phone Compatibility: Working Toward Solutions," *Wireless Telephones and Hearing Aids: New Challenges for Audiology*, Gallaudet University, Washington, D.C., May, 1997 (To be reprinted in the American Journal of Audiology).
8. Berger, H. S., "Hearing Aid Compatibility with Wireless Communications Devices," IEEE International Symposium on Electromagnetic Compatibility, Austin, TX, August, 1997.
9. Bronaugh, E. L., "Simplifying EMI Immunity (Susceptibility) Tests in TEM Cells," in the 1990 IEEE International Symposium on Electromagnetic Compatibility Symposium Record, Washington, D.C., August 1990, pp. 488-491
10. Byrne, D. and Dillon, H., The National Acoustics Laboratory (NAL) New Procedure for Selecting the Gain and Frequency Response of a Hearing Aid, *Ear and Hearing* 7:257-265, 1986.
11. Crawford, M. L., "Measurement of Electromagnetic Radiation from Electronic Equipment using TEM Transmission Cells," U.S. Department of Commerce, National Bureau of Standards, NBSIR 73-306, Feb. 1973.
12. Crawford, M. L., and Workman, J. L., "Using a TEM Cell for EMC Measurements of Electronic Equipment," U.S. Department of Commerce, National Bureau of Standards. Technical Note 1013, July 1981.
13. EHIMA GSM Project, Development phase, Project Report (1st part) Revision A. Technical-Audiological Laboratory and Telecom Denmark, October 1993.
14. EHIMA GSM Project, Development phase, Part II Project Report. Technical-Audiological Laboratory and Telecom Denmark, June 1994.
15. EHIMA GSM Project Final Report, Hearing Aids and GSM Mobile Telephones: Interference Problems, Methods of Measurement and Levels of Immunity. Technical-Audiological Laboratory and Telecom Denmark, 1995.
16. HAMPIS Report, Comparison of Mobile phone electromagnetic near field with an upscaled electromagnetic far field, using hearing aid as reference, 21 October 1999.



FCC ID: A3LSMJ737T		HAC (T-COIL) TEST REPORT		Approved by: Quality Manager
Filename: 1M1803150042-12.A3L	Test Dates: 04/12/2018 - 04/23/2018	DUT Type: Portable Handset		Page 70 of 74

© 2018 PCTEST Engineering Laboratory, Inc.

REV 3.2.M
04/17/2018

© 2018 PCTEST Engineering Laboratory, Inc. All rights reserved. Unless otherwise specified, no part of this report may be reproduced or utilized in any part, form or by any means, electronic or mechanical, including photocopying and microfilm, without permission in writing from PCTEST Engineering Laboratory, Inc. If you have any questions about this international copyright or have an enquiry about obtaining additional rights to this report or assembly of contents thereof, please contact INFO@PCTEST.COM.

17. Hearing Aids/GSM, Report from OTWIDAM, Technical-Audiological Laboratory and Telecom Denmark, April 1993.
18. IEEE 100, The Authoritative Dictionary of IEEE Standards Terms, Seventh Edition.
19. Joyner, K. H., et. al., Interference to Hearing Aids by the New Digital Mobile Telephone System, Global System for Mobile (GSM) Communication Standard, National Acoustic Laboratory, Australian Hearing Series, Sydney 1993.
20. Joyner, K. H., et. al., Interference to Hearing Aids by the Digital Mobile Telephone System, Global System for Mobile Communications (GSM), NAL Report #131, National Acoustic Laboratory, Australian Hearing Series, Sydney, 1995.
21. Kecker, W. T., Crawford, M. L., and Wilson, W. A., "Construction of a Transverse Electromagnetic Cell", U.S. Department of Commerce, National Bureau of Standards, Technical Note 1011, Nov. 1978.
22. Konigstein, D., and Hansen, D., "A New Family of TEM Cells with enlarged bandwidth and Optimized working Volume," in the Proceedings of the 7th International Symposium on EMC, Zurich, Switzerland, March 1987; 50:9, pp. 127-132.
23. Kuk, F., and Hjorstgaard, N. K., "Factors affecting interference from digital cellular telephones," Hearing Journal, 1997; 50:9, pp 32-34.
24. Ma, M. A., and Kanda, M., "Electromagnetic Compatibility and Interference Metrology," U.S. Department of Commerce, National Bureau of Standards, Technical Note 1099, July 1986, pp. 17-43.
25. Ma, M. A., Sreenivashiah, I. , and Chang, D. C., "A Method of Determining the Emission and Susceptibility Levels of Electrically Small Objects Using a TEM Cell," U.S. Department of Commerce, National Bureau of Standards, Technial Note 1040, July 1981.
26. McCandless, G. A., and Lyregaard, P. E., Prescription of Gain/Output (POGO) for Hearing Aids, Hearing Instruments 1:16-21, 1983
27. Skopec, M., "Hearing Aid Electromagnetic Interference from Digital Wireless Telephones," IEEE Transactions on Rehabilitation Engineering, vol. 6, no. 2, pp. 235-239, June 1998.
28. Technical Report, GSM 05.90, GSM EMC Considerations, European Telecommunications Standards Institute, January 1993.
29. Victorian, T. A., "Digital Cellular Telephone Interference and Hearing Aid Compatibility—an Update," Hearing Journal 1998; 51:10, pp. 53-60
30. Wong, G. S. K., and Embleton, T. F. W., eds., AIP Handbook of Condenser Microphones: Theory, Calibration and Measurements, AIP Press.

FCC ID: A3LSMJ737T		HAC (T-COIL) TEST REPORT		Approved by: Quality Manager
Filename: 1M1803150042-12.A3L	Test Dates: 04/12/2018 - 04/23/2018	DUT Type: Portable Handset	Page 71 of 74	

© 2018 PCTEST Engineering Laboratory, Inc.

REV 3.2.M

04/17/2018

© 2018 PCTEST Engineering Laboratory, Inc. All rights reserved. Unless otherwise specified, no part of this report may be reproduced or utilized in any part, form or by any means, electronic or mechanical, including photocopying and microfilm, without permission in writing from PCTEST Engineering Laboratory, Inc. If you have any questions about this international copyright or have an enquiry about obtaining additional rights to this report or assembly of contents thereof, please contact INFO@PCTEST.COM.