



HEARING AID COMPATIBILITY

Applicant Name:
 Samsung Electronics Co., Ltd.
 129, Samsung-ro, Maetan dong,
 Yeongtong-gu, Suwon-si
 Gyeonggi-do 16677, Korea

Date of Testing:
 3/12/2018 - 3/13/2018
Test Site/Location:
 PCTEST Lab, Columbia, MD, USA
Test Report Serial No.:
 1M1803080036-11-R1.A3L

FCC ID: **A3LSMJ737A**

APPLICANT: **SAMSUNG ELECTRONICS CO., LTD.**

Scope of Test: RF Emissions Testing
Application Type: Certification
FCC Rule Part(s): CFR §20.19(b)
HAC Standard: ANSI C63.19-2011
 285076 D01 HAC Guidance v05
 285076 D02 T-Coil testing for CMRS IP v03
DUT Type: Portable Handset
Model: SM-J737A
Test Device Serial No.: *Pre-Production Sample [S/N: 17914]*

C63.19-2011 HAC Category: **M3 (RF EMISSIONS CATEGORY)**

Note: This revised Test Report (S/N: 1M1803080036-11-R1.A3L) supersedes and replaces the previously issued test report on the same subject device for the same type of testing as indicated. Please discard or destroy the previously issued test report(s) and dispose of it accordingly.

This wireless portable device has been shown to be hearing-aid compatible under the above rated category, specified in ANSI/IEEE Std. C63.19-2011 and has been tested in accordance with the specified measurement procedures. Hearing-Aid Compatibility is based on the assumption that all production units will be designed electrically identical to the device tested in this report. Test results reported herein relate only to the item(s) tested. North America bands only.

I attest to the accuracy of data. All measurements reported herein were performed by me or were made under my supervision and are correct to the best of my knowledge and belief. I assume full responsibility for the completeness of these measurements and vouch for the qualifications of all persons taking them.

 Randy Ortanez
 President







FCC ID: A3LSMJ737A		HAC (RF EMISSIONS) TEST REPORT		Approved by: Quality Manager
Filename: 1M1803080036-11-R1.A3L	Test Dates: 3/12/2018 - 3/13/2018	DUT Type: Portable Handset	Page 1 of 71	

TABLE OF CONTENTS

1.	INTRODUCTION	3
2.	DUT DESCRIPTION.....	4
3.	ANSI/IEEE C63.19 PERFORMANCE CATEGORIES	6
4.	SYSTEM SPECIFICATIONS.....	7
5.	TEST PROCEDURE	12
6.	SYSTEM CHECK	14
7.	MODULATION INTERFERENCE FACTOR.....	17
8.	RF CONDUCTED POWER MEASUREMENTS.....	21
9.	JUSTIFICATION OF HELD TO EAR MODES TESTED	33
10.	OVERALL MEASUREMENT SUMMARY	34
11.	EQUIPMENT LIST.....	36
12.	MEASUREMENT UNCERTAINTY	37
13.	TEST DATA.....	38
14.	CALIBRATION CERTIFICATES.....	43
15.	CONCLUSION.....	66
16.	REFERENCES	67
17.	TEST PHOTOGRAPHS	69

FCC ID: A3LSMJ737A	 PCTEST <small>ENGINEERING LABORATORY, INC.</small>	HAC (RF EMISSIONS) TEST REPORT		Approved by: Quality Manager
Filename: 1M1803080036-11-R1.A3L	Test Dates: 3/12/2018 - 3/13/2018	DUT Type: Portable Handset		Page 2 of 71

1. INTRODUCTION

On July 10, 2003, the Federal Communications Commission (FCC) adopted new rules requiring wireless manufacturers and service providers to provide digital wireless phones that are compatible with hearing aids. The FCC has modified the exemption for wireless phones under the Hearing Aid Compatibility Act of 1998 (HAC Act) in WT Docket 01-309 RM-8658¹ to extend the benefits of wireless telecommunications to individuals with hearing disabilities. These benefits encompass business, social and emergency communications, which increase the value of the wireless network for everyone. An estimated more than 10% of the population in the United States show signs of hearing impairment and of that fraction, almost 80% use hearing aids. Approximately 500 million people worldwide suffer from hearing loss.

Compatibility Tests Involved:

The standard calls for wireless communications devices to be measured for:

- RF Electric-field emissions
- T-coil mode, magnetic-signal strength in the audio band
- T-coil mode, magnetic-signal frequency response through the audio band
- T-coil mode, magnetic-signal and noise articulation index

The hearing aid must be measured for:

- RF immunity in microphone mode
- RF immunity in T-coil mode

In the following tests and results, this report includes the evaluation for a wireless communications device.

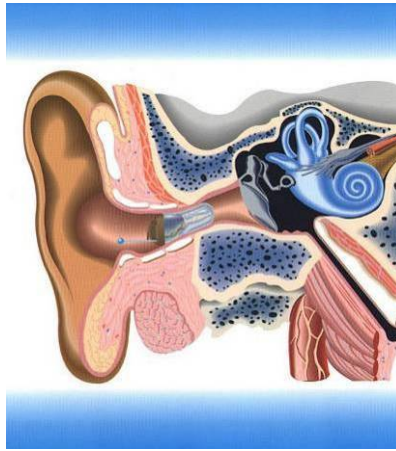



Figure 1-1 Hearing Aid *in-vitu*

¹ FCC Rule & Order, WT Docket 01-309 RM-8658

FCC ID: A3LSMJ737A	 PCTEST ENGINEERING LABORATORY, INC.	HAC (RF EMISSIONS) TEST REPORT		Approved by: Quality Manager
Filename: 1M1803080036-11-R1.A3L	Test Dates: 3/12/2018 - 3/13/2018	DUT Type: Portable Handset	Page 3 of 71	

2. DUT DESCRIPTION



FCC ID: A3LSMJ737A
Manufacturer: Samsung Electronics Co., Ltd.
129, Samsung-ro, Maetan dong,
Yeongtong-gu, Suwon-si
Gyeonggi-do 16677, Korea
Model: SM-J737A
Serial Number: 17914
Antenna Configurations: Internal Antenna
DUT Type: Portable Handset



I. Power Reduction for WIFI

This device uses an independent fixed level power reduction mechanism for all WIFI operations during voice or VoIP held to ear scenarios. Reduced powers were used to evaluate for low-power exemption in Section 9.II for WIFI. Detailed descriptions of the power reduction mechanism are included in the operational description.

FCC ID: A3LSMJ737A	PCTEST ENGINEERING LABORATORY, INC.	HAC (RF EMISSIONS) TEST REPORT	SAMSUNG	Approved by: Quality Manager
Filename: 1M1803080036-11-R1.A3L	Test Dates: 3/12/2018 - 3/13/2018	DUT Type: Portable Handset	Page 4 of 71	

Table 2-1
A3LSMJ737A HAC Air Interfaces

Air-Interface	Band (MHz)	Type Transport	HAC Tested	Simultaneous But Not Tested	Name of Voice Service
GSM	850	VO	Yes	Yes: WIFI or BT	CMRS Voice
	1900				
	GPRS/EDGE	VD	No ¹	Yes: WIFI or BT	Google Duo
UMTS	850	VD	No ¹	Yes: WIFI or BT	CMRS Voice
	1700				
	1900	VD	No ¹	Yes: WIFI or BT	Google Duo
LTE (FDD)	700 (B12)	VD	No ¹	Yes: WIFI or BT	VoLTE, Google Duo
	790 (B14)				
	850 (B5)				
	1700 (B4)				
	1900 (B2)				
2500 (B7)					
WIFI	2450	VD	No ¹	Yes: GSM, UMTS, or LTE	VoWIFI, Google Duo
	5200 (U-NII 1)				
	5300 (U-NII 2A)				
	5500 (U-NII 2C)				
	5800 (U-NII 3)				
BT	2450	DT	No	Yes: GSM, UMTS, or LTE	N/A
Type Transport VO = Voice Only DT = Digital Data - Not intended for CMRS Service VD = CMRS and IP Voice over Data Transport			Notes: 1. Evaluated for MIF and low-power exemption.		



FCC ID: A3LSMJ737A	 PCTEST ENGINEERING LABORATORY, INC.	HAC (RF EMISSIONS) TEST REPORT		Approved by: Quality Manager
Filename: 1M1803080036-11-R1.A3L	Test Dates: 3/12/2018 - 3/13/2018	DUT Type: Portable Handset	Page 5 of 71	

3. ANSI/IEEE C63.19 PERFORMANCE CATEGORIES

I. RF EMISSIONS

The ANSI Standard presents performance requirements for acceptable interoperability of hearing aids with wireless communications devices. When these parameters are met, a hearing aid operates acceptably in close proximity to a wireless communications device.

Category	Telephone RF Parameters
Near field Category	E-field emissions CW dB(V/m)
f < 960 MHz	
M1	50 to 55
M2	45 to 50
M3	40 to 45
M4	< 40
f > 960 MHz	
M1	40 to 45
M2	35 to 40
M3	30 to 35
M4	< 30
Table 3-1 WD near-field categories as defined in ANSI C63.19-2011	

FCC ID: A3LSMJ737A	 PCTEST ENGINEERING LABORATORY, INC.	HAC (RF EMISSIONS) TEST REPORT		Approved by: Quality Manager
Filename: 1M1803080036-11-R1.A3L	Test Dates: 3/12/2018 - 3/13/2018	DUT Type: Portable Handset	Page 6 of 71	

4. SYSTEM SPECIFICATIONS

ER3DV6 E-Field Probe Description

Construction:	One dipole parallel, two dipoles normal to probe axis Built-in shielding against static charges
Calibration:	In air from 100 MHz to 3.0 GHz (absolute accuracy $\pm 6.0\%$, $k=2$)
Frequency:	100 MHz to > 6 GHz; Linearity: ± 0.2 dB (100 MHz to 3 GHz)
Directivity	± 0.2 dB in air (rotation around probe axis) ± 0.4 dB in air (rotation normal to probe axis)
Dynamic Range	2 V/m to > 1000 V/m (M3 or better device readings fall well below diode compression point)
Linearity:	± 0.2 dB
Dimensions	Overall length: 330 mm (Tip: 16 mm) Tip diameter: 8 mm (Body: 12 mm) Distance from probe tip to dipole centers: 2.5 mm

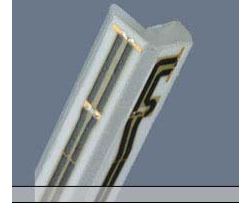
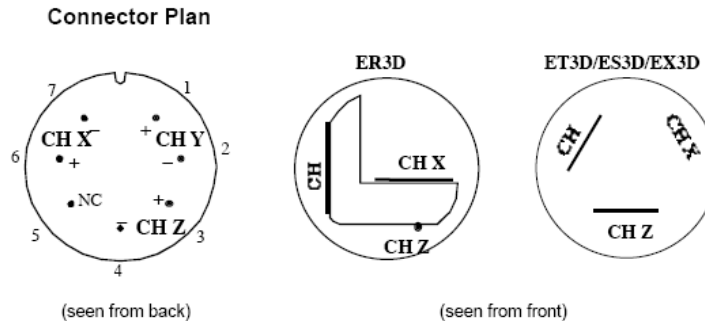

Figure 4-1
E-field Free-space Probe

Probe Tip Description

HAC field measurements take place in the close near field with high gradients. Increasing the measuring distance from the source will generally decrease the measured field values (in case of the validation dipole approx. 10% per mm).

The electric field probes have an irregular internal geometry because it is physically not possible to have the 3 orthogonal sensors situated with the same center. The effect of the different sensor centers is accounted for in the HAC uncertainty budget ("sensor displacement"). Their geometric center is at 2.5mm from the tip, and the element ends are 1.1mm closer to the tip.



The antistatic shielding inside the probe is connected to the probe connector case.

FCC ID: A3LSMJ737A	PCTEST ENGINEERING LABORATORY, INC.	HAC (RF EMISSIONS) TEST REPORT	SAMSUNG	Approved by: Quality Manager
Filename: 1M1803080036-11-R1.A3L	Test Dates: 3/12/2018 - 3/13/2018	DUT Type: Portable Handset	Page 7 of 71	

Instrumentation Chain

Equation 1

Conversion of Connector Voltage u_i to E-Field E_i

$$E_i = \sqrt{\frac{u_i + (u_i^2 \cdot CF)/(DCP)}{Norm_i \cdot ConvF}}$$

whereby

E_i : electric field in V/m
 u_i : voltage of channel i at the connector in μV
 $Norm_i$: sensitivity of channel i in $\mu\text{V}/(\text{V/m})^2$
 $ConvF$: enhancement factor in liquid ($ConvF=1$ for Air)
 DCP : diode compression point in μV
 CF : signal crest factor (peak power/average power)

Conditions of Calibration



Please note:

- a lower input impedance of the amplifier will result in different sensitivity factors $Norm_i$ and DCP
- larger bias currents will cause higher offset

Probe Response to Frequency

The E-field sensors have inherently a very flat frequency response. They are calibrated with a number of frequencies resulting in a common calibration factor, with the frequency behavior documented in the calibration certificate (See also below).

Frequency Response of E-Field

(TEM-Cell:if110 EXX, Waveguide R22)

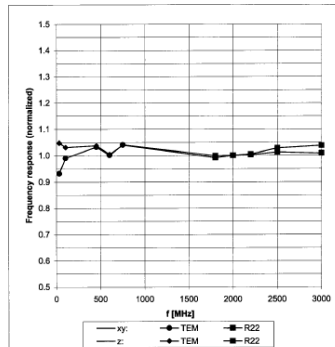

Uncertainty of Frequency Response of E-field: $\pm 6.3\%$ ($k=2$)

Figure 4-2 E-Field Probe Frequency Response

FCC ID: A3LSMJ737A	PCTEST ENGINEERING LABORATORY, INC.	HAC (RF EMISSIONS) TEST REPORT	SAMSUNG	Approved by: Quality Manager
Filename: 1M1803080036-11-R1.A3L	Test Dates: 3/12/2018 - 3/13/2018	DUT Type: Portable Handset		Page 8 of 71

© 2018 PCTEST Engineering Laboratory, Inc.

REV 3.2.M

01/12/2018

© 2018 PCTEST Engineering Laboratory, Inc. All rights reserved. Unless otherwise specified, no part of this report may be reproduced or utilized in any part, form or by any means, electronic or mechanical, including photocopying and microfilm, without permission in writing from PCTEST Engineering Laboratory, Inc. If you have any questions about this international copyright or have an enquiry about obtaining additional rights to this report or assembly of contents thereof, please contact INFO@PCTEST.COM.

SPEAG Robotic System



E-field measurements are performed using the DASY5 automated dosimetric assessment system. The DASY5 is made by Schmid & Partner Engineering AG (SPEAG) in Zurich, Switzerland and consists of high precision robotics system (Staubli), robot controller, Intel CORE i7 computer, near-field probe, probe alignment sensor, and the HAC phantom. The robot is a six-axis industrial robot performing precise movements to position the probe to the location (points) of maximum electromagnetic field (EMF).



Figure 4-3
SPEAG Robotic System

System Hardware

A cell controller system contains the power supply, robot controller, teach pendant (Joystick), and a remote control used to drive the robot motors. The PC consists of the computer with operating system and RF Measurement Software DASY5 v52.8 (with HAC Extension), A/D interface card, monitor, mouse, and keyboard. The Staubli Robot is connected to the cell controller to allow software manipulation of the robot. A data acquisition electronic (DAE) circuit that performs the signal amplification, signal multiplexing, AD-conversion, offset measurements, mechanical surface detection, collision detection, etc. is connected to the Electro-optical coupler (EOC). The EOC performs the conversion from the optical into digital electric signal of the DAE and transfers data to the PC plug-in card.

FCC ID: A3LSMJ737A	 PCTEST ENGINEERING LABORATORY, INC.	HAC (RF EMISSIONS) TEST REPORT		Approved by: Quality Manager
Filename: 1M1803080036-11-R1.A3L	Test Dates: 3/12/2018 - 3/13/2018	DUT Type: Portable Handset	Page 9 of 71	

System Electronics

The DAE consists of a highly sensitive electrometer-grade preamplifier with auto-zeroing, a channel and gain-switching multiplexer, a fast 16 bit AD-converter and a command decoder and control logic unit. Transmission to the PC-card is accomplished through an optical downlink for data and status information and an optical uplink for commands and clock lines. The mechanical probe mounting device includes two different sensor systems for frontal and sidewise probe contacts. They are also used for mechanical surface detection and probe collision detection. The robot uses its own controller with a built in VME-bus computer.





Figure 4-4
SPEAG Robotic System Diagram

DASY5 Instrumentation Chain

The first step of the evaluation is a linearization of the filtered input signal to account for the compression characteristics of the detector diode. The compensation depends on the input signal, the diode type and the DC-transmission factor from the diode to the evaluation electronics. If the exciting field is pulsed, the crest factor of the signal must be known to correctly compensate for peak power. The formula for each channel can be given as:

$$V_i = U_i + U_i^2 \cdot \frac{cf}{dcp_i}$$

with V_i	= compensated signal of channel i	(i = x, y, z)
U_i	= input signal of channel i	(i = x, y, z)
cf	= crest factor of exciting field	(DASY parameter)
dcp_i	= diode compression point	(DASY parameter)

FCC ID: A3LSMJ737A	 PCTEST ENGINEERING LABORATORY, INC.	HAC (RF EMISSIONS) TEST REPORT		Approved by: Quality Manager
Filename: 1M1803080036-11-R1.A3L	Test Dates: 3/12/2018 - 3/13/2018	DUT Type: Portable Handset		Page 10 of 71

From the compensated input signals the primary field data for each channel can be evaluated:

$$E - \text{fieldprobes} : \quad E_i = \sqrt{\frac{V_i}{Norm_i \cdot ConvF}}$$

with V_i = compensated signal of channel i (i = x, y, z)
 $Norm_i$ = sensor sensitivity of channel i (i = x, y, z)
 $\mu\text{V}/(\text{V}/\text{m})^2$ for E-field Probes
 $ConvF$ = sensitivity enhancement in solution
 E_i = electric field strength of channel i in V/m

The RSS value of the field components gives the total field strength (Hermitian magnitude):



$$E_{tot} = \sqrt{E_x^2 + E_y^2 + E_z^2}$$

The primary field data are used to calculate the derived field units.

The measurement/integration time per point, as specified by the system manufacturer is >500ms.

The signal response time is evaluated as the time required by the system to reach 90% of the expected final value after an on/off switch of the power source with an integration time of 500ms and a probe response time of <5 ms. In the current implementation, DASY5 waits longer than 100ms after having reached the grid point before starting a measurement, i.e., the response time uncertainty is negligible.

If the device under test does not emit a CW signal, the integration time applied to measure the electric field at a specific point may introduce additional uncertainties due to the discretization. The tolerances for the different systems had the worst-case of 2.6%.

FCC ID: A3LSMJ737A	 PCTEST ENGINEERING LABORATORY, INC.	HAC (RF EMISSIONS) TEST REPORT		Approved by: Quality Manager
Filename: 1M1803080036-11-R1.A3L	Test Dates: 3/12/2018 - 3/13/2018	DUT Type: Portable Handset	Page 11 of 71	

5. TEST PROCEDURE

I. RF EMISSIONS

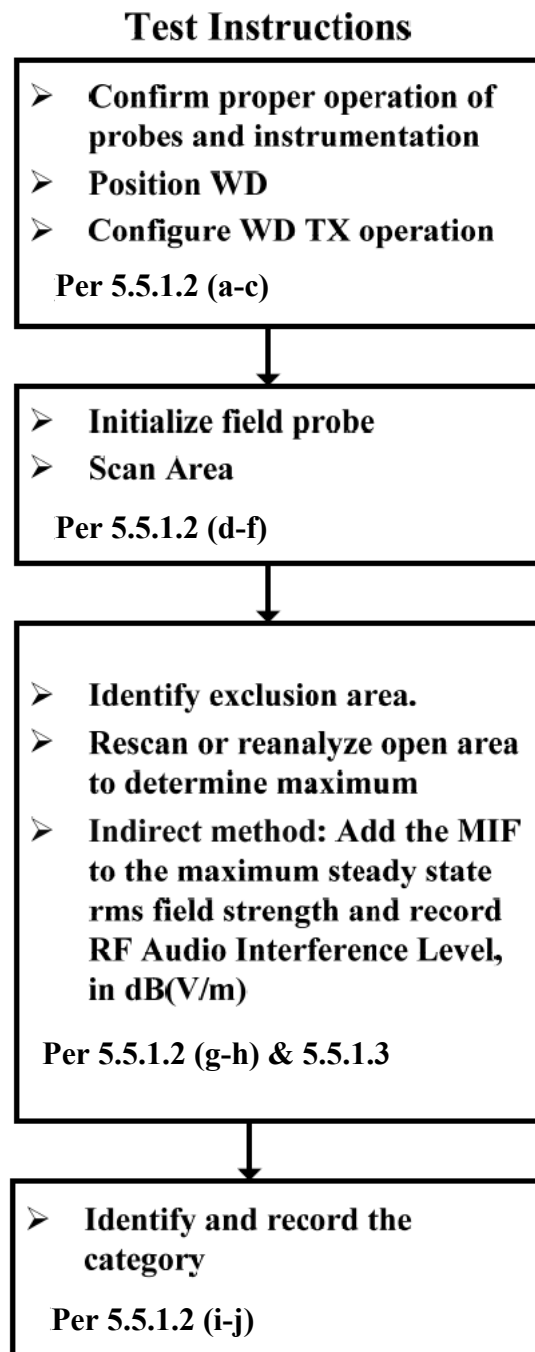



Figure 5-1 RF Emissions Flow Chart

FCC ID: A3LSMJ737A	 PCTEST ENGINEERING LABORATORY, INC.	HAC (RF EMISSIONS) TEST REPORT		Approved by: Quality Manager
Filename: 1M1803080036-11-R1.A3L	Test Dates: 3/12/2018 - 3/13/2018	DUT Type: Portable Handset		Page 12 of 71

Test Setup

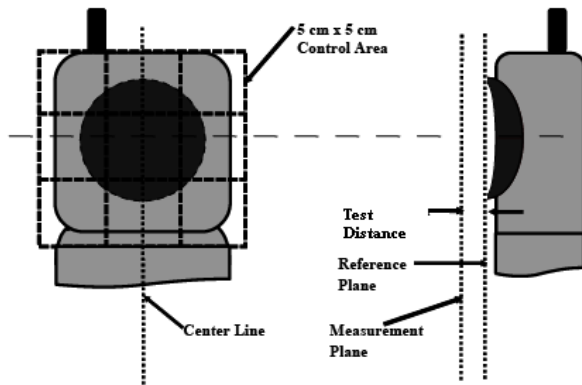

Figure 5-2

E-Field Emissions Test Setup Diagram (See Test Photographs for actual WD scan grid overlay)

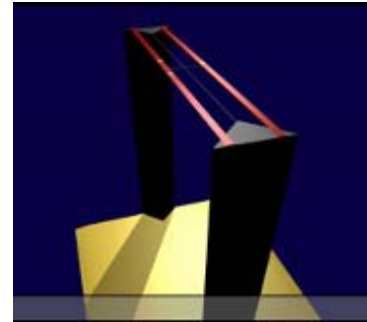



Figure 5-3
HAC Phantom

RF Emissions Test Procedure:

The following illustrate a typical RF emissions test scan over a wireless communications device:

1. Proper operation of the field probe, probe measurement system, other instrumentation, and the positioning system was confirmed.
2. WD is positioned in its intended test position, acoustic output point of the device perpendicular to the field probe.
3. The WD operation for maximum rated RF output power was configured and confirmed with the base station simulator, at the test channel and other normal operating parameters as intended for the test. The battery was ensured to be fully charged before each test.
4. The center sub-grid was centered over the center of the acoustic output (also audio band magnetic output, if applicable). The WD audio output was positioned tangent (as physically possible) to the measurement plane.
5. A surface calibration was performed before each setup change to ensure repeatable spacing and proper maintenance of the measurement plane using the HAC Phantom.
6. The measurement system measured the field strength at the reference location.
7. Measurements at 2mm or 5mm increments in the 5 x 5 cm region were performed at a distance 15 mm from the center point of the probe measurement element to the WD. A 360° rotation about the azimuth axis at the maximum interpolated position was measured. For the worst-case condition, the peak reading from this rotation was used in re-evaluating the HAC category.
8. The system performed a drift evaluation by measuring the field at the reference location. If the power drift deviated by more than 5%, the HAC test and drift measurements were repeated.

FCC ID: A3LSMJ737A	 PCTEST ENGINEERING LABORATORY, INC.	HAC (RF EMISSIONS) TEST REPORT	 SAMSUNG	Approved by: Quality Manager
Filename: 1M1803080036-11-R1.A3L	Test Dates: 3/12/2018 - 3/13/2018	DUT Type: Portable Handset		Page 13 of 71

6. SYSTEM CHECK

I. System Check Parameters

The input signal was an un-modulated continuous wave. The following points were taken into consideration in performing this check:

- Average Input Power $P = 100\text{mW RMS}$ (20dBm RMS) after adjustment for return loss
- The test fixture must meet the 2 wavelength separation criterion
- The proper measurement of the 15 mm probe to dipole separation, which is measured from top surface of the dipole to the calibration reference point of the sensor, defined by the probe manufacturer is shown in the following diagram:

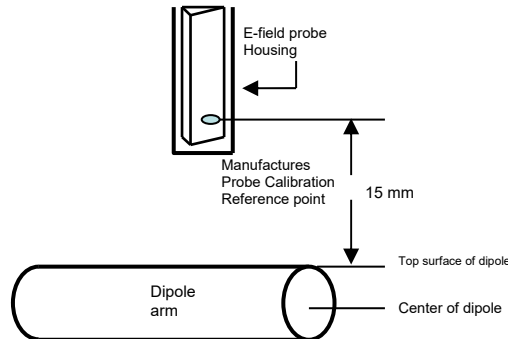

Figure 6-1
Separation Distance from Dipole to Field Probe

RF power was recorded using both an average reading meter and a peak reading meter. Readings of the probe are provided by the measurement system.

To assure proper operation of the near-field measurement probe the input power to the dipole shall be commensurate with the full rated output power of the wireless device [e.g. - for a cellular phone wireless device the average peak antenna input power will be on the order of 100mW (20dBm) RMS] after adjustment for any mismatch.



II. Validation Procedure

A dipole antenna meeting the requirements given in C63.19 was placed in the position normally occupied by the WD.

The length of the dipole was scanned, and the average peak value was recorded.

Measurement of CW

Using the near-field measurement system, scan the antenna over the radiating dipole and record the greatest field reading observed. Due to the nature of E-fields about free-space dipoles, the two E-field peaks measured over the dipole are averaged to compensate for non-parallelity of the setup (see manufacturer method on dipole calibration certificates, page 2). Field strength measurements shall be made only when the probe is stationary.

FCC ID: A3LSMJ737A	 PCTEST ENGINEERING LABORATORY, INC.	HAC (RF EMISSIONS) TEST REPORT		Approved by: Quality Manager
Filename: 1M1803080036-11-R1.A3L	Test Dates: 3/12/2018 - 3/13/2018	DUT Type: Portable Handset		Page 14 of 71

RF power was recorded using both an average and a peak power reading meter.

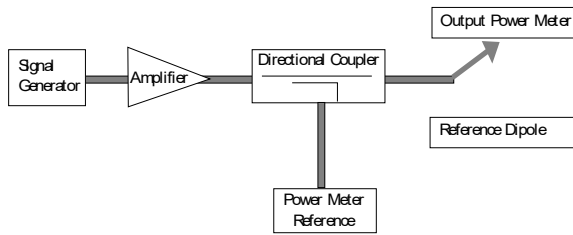

Figure 6-2

Setup for Desired Output Power to Dipole

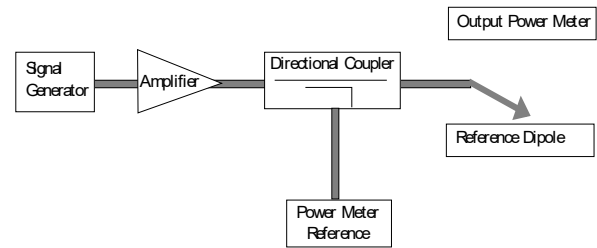

Figure 6-3

Setup to Dipole

Using this setup configuration, the signal generator was adjusted for the desired output power (100mW) at a specified frequency. The reference power from the coupled port of the directional coupler is recorded. Next, the output cable is connected to the reference dipole, as shown in Figure 6-3.

The input signal level was adjusted until the reference power from the coupled port of the directional coupler was the same as previously recorded, to compensate for the impedance mismatch between the output cable and the reference dipole. To assure proper operation of the near-field measurement probe the input power to the reference dipole was verified to the full rated output power of the wireless device. The dipole was secured in a holder in a manner to meet the 20 dB reflection. The near-field measurement probe was positioned over the dipole. The antenna was scanned over the appropriate sized area to cover the dipole from end to end. SPEAG uses 2D interpolation algorithms between the measured points. Please see below two dimensional plots showing that the interpolated values interpolate smoothly between 5mm steps for a free-space RF dipole:



Figure 6-4

2-D Raw Data from scan along dipole axis

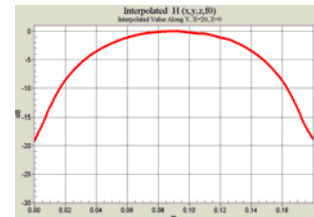

Figure 6-5

2-D Interpolated points from scan along dipole axis

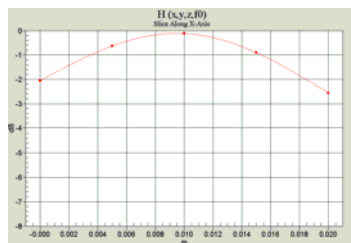

Figure 6-6

2-D Raw Data from scan along transverse axis

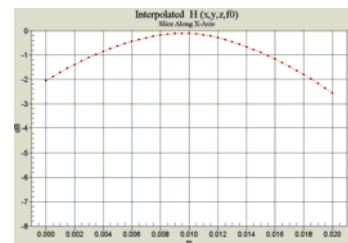

Figure 6-7

2-D Interpolated points from scan along transverse axis

FCC ID: A3LSMJ737A	PCTEST ENGINEERING LABORATORY, INC.	HAC (RF EMISSIONS) TEST REPORT	SAMSUNG	Approved by: Quality Manager
Filename: 1M1803080036-11-R1.A3L	Test Dates: 3/12/2018 - 3/13/2018	DUT Type: Portable Handset		Page 15 of 71

III. System Check Results

Validation Results

Date	Frequency (MHz)	Probe S/N	DAE S/N	Dipole S/N	Input Power (dBm)	E-field Result (V/m)	Target Field (V/m)	% Deviation
3/12/2018	835	2335	859	1082	20.0	103.0	106.8	-3.6%
	1880	2335	859	1064	20.0	95.8	89.6	6.9%

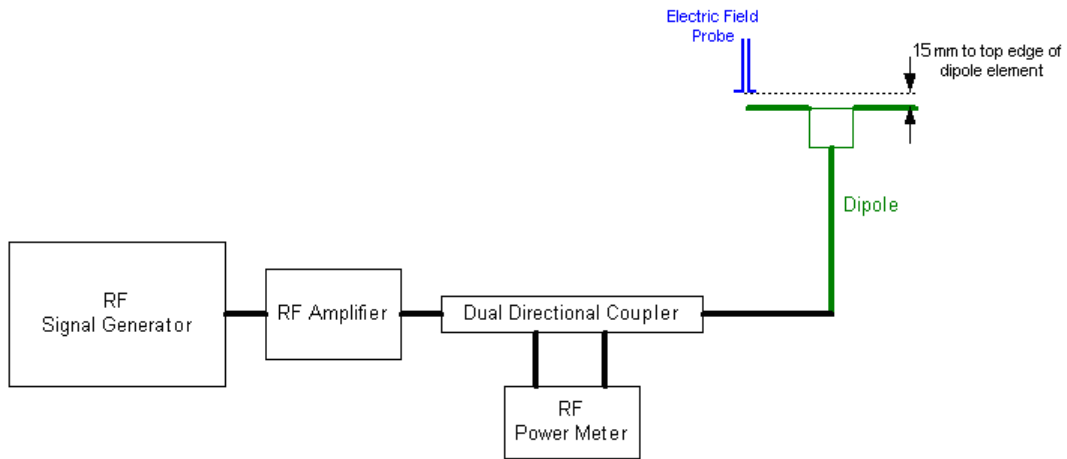



Figure 6-8
System Check Setup

FCC ID: A3LSMJ737A	 PCTEST ENGINEERING LABORATORY, INC.	HAC (RF EMISSIONS) TEST REPORT	 SAMSUNG	Approved by: Quality Manager
Filename: 1M1803080036-11-R1.A3L	Test Dates: 3/12/2018 - 3/13/2018	DUT Type: Portable Handset	Page 16 of 71	

7. MODULATION INTERFERENCE FACTOR

I. Measuring Modulation Interference Factors

For any specific fixed and repeatable modulated signal, a modulation interference factor (MIF, expressed in dB) may be determined that relates its interference potential to its steady-state RMS signal level or average power level. This factor is a function only of the audio-frequency amplitude modulation characteristics of the signal and is the same for field-strength and conducted power measurements. The MIF is valid only for a specific repeatable audio-frequency amplitude modulation characteristic; any change in modulation characteristic requires determination and application of a new MIF.

The MIF may be determined using a radiated RF field or a conducted RF signal:

- a. Using RF illumination or conducted coupling, apply the specific modulated signal in question to the measurement system at a level within its confirmed operating dynamic range.
- b. Measure the steady-state RMS level at the output of the fast probe or sensor.
- c. Measure the steady-state average level at the weighting output.
- d. Without changing the square-law detector or weighting system, and using RF illumination or conducted coupling, substitute for the specific modulated signal a 1 kHz, 80% amplitude modulated carrier at the same frequency and adjust its strength until the level at the weighting output equals the step c) measurement.
- e. Without changing the carrier level from step d), remove the 1 kHz modulation and again measure the steady-state RMS level indicated at the output of the fast probe or sensor.
- f. The MIF for the specific modulation characteristic is provided by the ratio of the step e) measurement to the step b) measurement, expressed in dB ($20 \times \log[(\text{step e})/(\text{step b})]$).



The following procedure was used to measure the MIF using the SPEAG Audio Interference Analyzer (AIA), Type No: SE UMS 170 CB, Serial No.: 1010:

1. The device was placed into a simulated call using a base station simulator or set to transmit using test software for a given mode.
2. The device was then set to continuously transmit at maximum power.
3. Using a coupler if needed, the device output signal was connected to the RF In port of the AIA, which was connected to a desktop computer. Alternatively, a radiated RF signal may be used with the AIA's built-in antenna.
4. The MIF measurement procedure in the DASY software was run, and the resulting MIF value was recorded.
5. Steps 1-4 were repeated for all CMRS air interfaces, frequency bands, and modulations.

The modulation interference factors obtained were applied to readings taken of the actual wireless device in order to obtain an accurate audio interference level reading using the formula:

$$\text{Audio Interference Level [dB(V/m)]} = 20 * \log[\text{Raw Field Value (V/m)}] + \text{MIF (dB)}$$

Because the MIF value is output power independent, MIF values for a given mode should be constant across all devices; however, per C63.19-2011 §D.7, MIF values should be measured for each device being evaluated. The voice modes for this device have been investigated in this section of the report.

FCC ID: A3LSMJ737A	 PCTEST ENGINEERING LABORATORY, INC.	HAC (RF EMISSIONS) TEST REPORT		Approved by: Quality Manager
Filename: 1M1803080036-11-R1.A3L	Test Dates: 3/12/2018 - 3/13/2018	DUT Type: Portable Handset		Page 17 of 71

II. MIF Measurement Block Diagrams

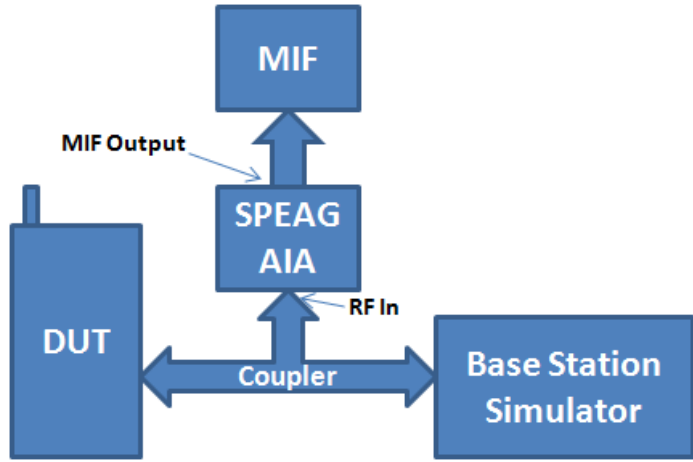

Figure 7-1
MIF Measurement Setup
for licensed modes

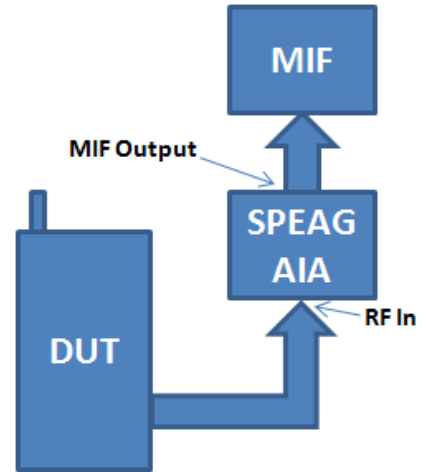

Figure 7-2
MIF Measurement Setup
for unlicensed modes

III. Measured Modulation Interference Factors:

Table 7-1
GSM Modulation Interference Factors¹

Mode		GSM850			GSM1900		
		128	190	251	512	661	810
GSM	Voice	3.52	3.52	3.53	3.56	3.56	3.56
	EDGE	4.24	4.22	4.25	3.93	3.86	3.86

Table 7-2
UMTS Modulation Interference Factors¹

Mode		UMTS V			UMTS IV			UMTS II		
		4132	4183	4233	1312	1412	1513	9262	9400	9538
UMTS	12.2 kbps RMC	-21.09	-21.34	-21.53	-21.95	-22.59	-22.85	-21.24	-21.08	-20.70
	12.2 kbps AMR	-12.94	-13.08	-12.97	-13.15	-13.53	-13.63	-13.50	-13.51	-13.61
	HSUPA Subtest1	-19.18	-19.36	-19.33	-20.37	-20.31	-21.34	-21.25	-20.92	-20.75

¹ Note: Measured MIF values may be lower than sample MIF values provided in ANSI C63.19-2011 Annex D.7 Table D.5 due to manufacturing variations for each device, however per Annex D.7, the sample MIF values of Table D.5 are not intended to substitute for measurements of actual devices under test and their respective operating modes.

FCC ID: A3LSMJ737A	PCTEST ENGINEERING LABORATORY, INC.	HAC (RF EMISSIONS) TEST REPORT		Approved by: Quality Manager
Filename: 1M1803080036-11-R1.A3L	Test Dates: 3/12/2018 - 3/13/2018	DUT Type: Portable Handset		Page 18 of 71

Table 7-3
LTE FDD Modulation Interference Factors^{1,3}

LTE Band	Frequency [MHz]	Channel	Bandwidth [MHz]	Modulation	RB Size	RB Offset	MIF [dB]
2	1880.0	18900	20	16QAM	1	0	-9.80
4	1732.5	20175	20	16QAM	1	0	-10.43
5	836.5	20525	10	16QAM	1	0	-9.98
7	2535.0	21100	20	16QAM	1	0	-10.34
12	707.5	23095	10	16QAM	1	0	-9.87
14	793.0	23330	10	16QAM	1	0	-10.49
2	1880.0	18900	20	QPSK	1	0	-14.36
2	1880.0	18900	20	16QAM	1	50	-9.81
2	1880.0	18900	20	16QAM	1	99	-9.95
2	1880.0	18900	20	16QAM	50	0	-16.44
2	1880.0	18900	20	16QAM	100	0	-17.51
2	1880.0	18900	15	16QAM	1	0	-9.95
2	1880.0	18900	10	16QAM	1	0	-10.17
2	1880.0	18900	5	16QAM	1	0	-10.37
2	1880.0	18900	3	16QAM	1	0	-10.48
2	1880.0	18900	1.4	16QAM	1	0	-10.08
2	1860.0	18700	20	16QAM	1	0	-10.19
2	1900.0	19100	20	16QAM	1	0	-9.85

Table 7-4
802.11b (2.4GHz, SISO) Modulation Interference Factors^{1,2}

Mode	802.11b MIF Measurements [dB]			
	Data Rate [Mbps]			
	1	2	5.5	11
802.11b	-10.18	-9.46	-7.39	-6.37

Table 7-5
802.11g (2.4GHz, SISO) Modulation Interference Factors^{1,2}

Mode	802.11g MIF Measurements [dB]							
	Data Rate [Mbps]							
	6	9	12	18	24	36	48	54
802.11g	-13.04	-12.39	-11.97	-10.93	-11.08	-11.15	-11.68	-12.61

Table 7-6
802.11n (2.4GHz, SISO) Modulation Interference Factors^{1,2}

Mode	802.11n (2.4GHz) MIF Measurements [dB]							
	Data Rate [Mbps]							
	6.5	13	19.5	26	39	52	58.5	65
802.11n	-13.37	-12.19	-11.66	-11.42	-11.59	-11.95	-12.40	-12.59

¹ Note: Measured MIF values may be lower than sample MIF values provided in ANSI C63.19-2011 Annex D.7 Table D.5 due to manufacturing variations for each device, however per Annex D.7, the sample MIF values of Table D.5 are not intended to substitute for measurements of actual devices under test and their respective operating modes.

² Note: WIFI MIF values were found to be independent of the transmit channel.

³ Note: All FDD LTE bands were found to have substantially similar MIF values given similar RB, BW, and modulation configurations.



FCC ID: A3LSMJ737A	 PCTEST TECHNOLOGICAL CORPORATION, INC.	HAC (RF EMISSIONS) TEST REPORT		Approved by: Quality Manager
Filename: 1M1803080036-11-R1.A3L	Test Dates: 3/12/2018 - 3/13/2018	DUT Type: Portable Handset	Page 19 of 71	

Table 7-7
802.11a (5GHz, 20MHz BW, SISO) Modulation Interference Factors^{1,2}

Mode	802.11a MIF Measurements [dB]							
	Data Rate [Mbps]							
	6	9	12	18	24	36	48	54
802.11a	-13.34	-12.65	-12.17	-11.10	-11.27	-11.35	-11.86	-12.91

Table 7-8
802.11n (5GHz, 20MHz BW, SISO) Modulation Interference Factors^{1,2}

Mode	20MHz BW 802.11n (5GHz) MIF Measurements [dB]							
	Data Rate [Mbps]							
	6.5	13	19.5	26	39	52	58.5	65
802.11n	-13.45	-12.25	-11.74	-11.52	-11.69	-12.04	-12.57	-12.74

Table 7-9
802.11ac (5GHz, 20MHz BW, SISO) Modulation Interference Factors^{1,2}

Mode	20MHz BW 802.11ac (5GHz) MIF Measurements [dB]								
	Data Rate [Mbps]								
	6.5	13	19.5	26	39	52	58.5	65	78
802.11ac	-13.52	-12.42	-11.76	-11.45	-11.58	-12.03	-12.45	-12.60	-12.96

Table 7-10
802.11n (5GHz, 40MHz BW, SISO) Modulation Interference Factors^{1,2}

Mode	40MHz BW 802.11n (5GHz) MIF Measurements [dB]							
	Data Rate [Mbps]							
	13.5	27	40.5	54	81	108	121.5	135
802.11n	-11.54	-11.51	-11.21	-11.71	-12.98	-13.77	-14.20	-14.67

Table 7-11
802.11ac (5GHz, 40MHz BW, SISO) Modulation Interference Factors^{1,2}



Mode	40MHz BW 802.11ac (5GHz) MIF Measurements [dB]								
	Data Rate [Mbps]								
	13.5	27	40.5	54	81	108	121.5	135	180
802.11ac	-11.28	-10.47	-10.88	-11.50	-12.78	-13.70	-13.95	-14.19	-15.25

Table 7-12
802.11ac (5GHz, 80MHz BW, SISO) Modulation Interference Factors^{1,2}

Mode	80MHz BW 802.11ac (5GHz) MIF Measurements [dB]									
	Data Rate [Mbps]									
	29.3	58.5	87.8	117	175.5	234	263.3	292.5	351	390
802.11ac	-10.96	-12.01	-13.08	-13.86	-15.03	-16.28	-16.39	-16.24	-16.45	-16.84

¹ Note: Measured MIF values may be lower than sample MIF values provided in ANSI C63.19-2011 Annex D.7 Table D.5 due to manufacturing variations for each device, however per Annex D.7, the sample MIF values of Table D.5 are not intended to substitute for measurements of actual devices under test and their respective operating modes.

² Note: WIFI MIF values were found to be independent of the transmit channel.

FCC ID: A3LSMJ737A	 PCTEST ENGINEERING LABORATORY, INC.	HAC (RF EMISSIONS) TEST REPORT		Approved by: Quality Manager
Filename: 1M1803080036-11-R1.A3L	Test Dates: 3/12/2018 - 3/13/2018	DUT Type: Portable Handset	Page 20 of 71	

8. RF CONDUCTED POWER MEASUREMENTS

I. Procedures Used to Establish RF Signal for HAC Testing

The handset was placed into a simulated call using a base station simulator in a shielded chamber. Such test signals offer a consistent means for testing HAC and are recommended for evaluating HAC. Measurements were taken with a fully charged battery. In order to verify that the device was tested and maintained at full power, this was configured with the base station simulator.

II. HAC Measurement Conditions

Output Power Verification

Maximum output power is verified on the High, Middle and Low channels for all applicable air interfaces. See Table 8-1 for air interface specific settings of transmit power parameters.

**Table 8-1
Power Control Parameters and Settings by Air Interface**

Air Interface:	Parameter Name:	Parameter Set To:
GSM	PCL	GSM850: "5"; GSM1900: "0"
UMTS	TPC	"All 1's"
LTE	TPC	"Max Power"
WIFI	PLS	Mfr Specified

III. Setup Used to Measure RF Conducted Powers

Power measurements for licensed modes were performed using a base station simulator under digital average power. Power measurements for unlicensed modes were performed using a power meter and power sensor.

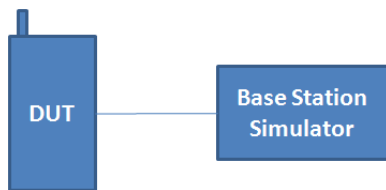

Figure 8-1
Power Measurement Setup for licensed modes

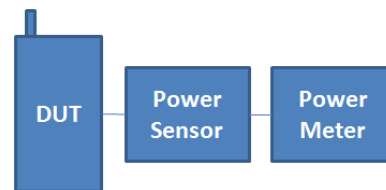



Figure 8-2
Power Measurement Setup for unlicensed modes

IV. GSM Conducted Powers

Band	Channel	GSM [dBm] CS (1 Slot)	EDGE [dBm] 1 Tx Slot
GSM 850	128	32.36	27.46
	190	32.44	27.54
	251	32.43	27.51
GSM 1900	512	29.57	26.54
	661	29.64	26.72
	810	29.65	26.71

FCC ID: A3LSMJ737A	 PCTEST ENGINEERING LABORATORY, INC.	HAC (RF EMISSIONS) TEST REPORT		Approved by: Quality Manager
Filename: 1M1803080036-11-R1.A3L	Test Dates: 3/12/2018 - 3/13/2018	DUT Type: Portable Handset		Page 21 of 71

V. UMTS Conducted Powers

Mode	3GPP 34.121 Subtest	Cellular Band [dBm]			AWS Band [dBm]			PCS Band [dBm]		
		4132	4183	4233	1312	1412	1513	9262	9400	9538
WCDMA	12.2 kbps RMC	24.10	24.04	24.35	23.44	23.47	23.50	22.70	22.68	22.91
	12.2 kbps AMR	24.06	24.04	24.34	23.45	23.45	23.49	22.83	22.69	22.90
HSUPA	Subtest 1	21.75	21.66	21.70	21.95	21.94	22.04	21.66	21.69	21.85

VI. LTE Conducted Powers

a. LTE Band 12

Table 8-2
LTE Band 12 (707.5MHz) Conducted Powers – 10MHz Bandwidth

LTE Band 12 10 MHz Bandwidth					
Modulation	RB Size	RB Offset	Mid Channel	MPR Allowed per 3GPP [dB]	MPR [dB]
			23095 (707.5 MHz) Conducted Power [dBm]		
QPSK	1	0	24.07	0	0
	1	25	23.98		0
	1	49	23.92		0
	25	0	23.02	0-1	1
	25	12	22.96		1
	25	25	23.00		1
16QAM	50	0	23.01	0-1	1
	1	0	22.94		1
	1	25	22.86		1
	1	49	22.80	0-2	1
	25	0	21.89		2
	25	12	21.92		2
	25	25	21.90	2	
	50	0	21.89	2	

Note: Since LTE Band 12 at 10MHz bandwidth does not support 3 non-overlapping channels, conducted power measurements were made only on the middle channel.

Table 8-3
LTE Band 12 (707.5MHz) Conducted Powers – 5MHz Bandwidth

LTE Band 12 5 MHz Bandwidth							
Modulation	RB Size	RB Offset	Low Channel	Mid Channel	High Channel	MPR Allowed per 3GPP [dB]	MPR [dB]
			23035 (701.5 MHz) Conducted Power [dBm]	23095 (707.5 MHz) Conducted Power [dBm]	23155 (713.5 MHz) Conducted Power [dBm]		
QPSK	1	0	24.07	24.02	24.02	0	0
	1	12	24.10	23.98	24.03		0
	1	24	24.03	23.95	24.01		0
	12	0	23.06	23.06	23.03	0-1	1
	12	6	23.02	23.01	23.06		1
	12	13	23.00	23.02	23.05		1
	25	0	23.06	23.05	23.00		1
16QAM	1	0	22.93	22.89	22.97	0-1	1
	1	12	22.90	22.87	22.95		1
	1	24	22.91	22.82	22.83		1
	12	0	21.95	21.94	21.97	0-2	2
	12	6	21.92	21.92	21.93		2
	12	13	21.87	21.85	21.92		2
	25	0	21.97	21.92	21.93		2



FCC ID: A3LSMJ737A	 PCTEST ENGINEERING LABORATORY, INC.	HAC (RF EMISSIONS) TEST REPORT		Approved by: Quality Manager
Filename: 1M1803080036-11-R1.A3L	Test Dates: 3/12/2018 - 3/13/2018	DUT Type: Portable Handset		Page 22 of 71

Table 8-4
LTE Band 12 (707.5MHz) Conducted Powers – 3MHz Bandwidth

LTE Band 12 3 MHz Bandwidth							
Modulation	RB Size	RB Offset	Low Channel	Mid Channel	High Channel	MPR Allowed per 3GPP [dB]	MPR [dB]
			23025 (700.5 MHz)	23095 (707.5 MHz)	23165 (714.5 MHz)		
Conducted Power [dBm]							
QPSK	1	0	24.02	24.00	24.01	0	0
	1	7	23.94	23.98	24.02		0
	1	14	23.95	23.94	24.00		0
	8	0	23.05	23.02	23.08	0-1	1
	8	4	23.03	23.03	23.10		1
	8	7	23.03	23.02	23.02		1
	15	0	23.02	23.05	23.12		1
16QAM	1	0	23.05	23.00	22.81	0-1	1
	1	7	22.95	22.98	22.85		1
	1	14	22.96	22.99	22.80		1
	8	0	22.04	22.04	22.00	0-2	2
	8	4	22.05	22.02	22.01		2
	8	7	22.02	22.03	21.98		2
	15	0	22.00	22.01	21.97		2

Table 8-5
LTE Band 12 (707.5MHz) Conducted Powers – 1.4MHz Bandwidth

LTE Band 12 1.4 MHz Bandwidth							
Modulation	RB Size	RB Offset	Low Channel	Mid Channel	High Channel	MPR Allowed per 3GPP [dB]	MPR [dB]
			23017 (699.7 MHz)	23095 (707.5 MHz)	23173 (715.3 MHz)		
Conducted Power [dBm]							
QPSK	1	0	23.92	23.90	24.03	0	0
	1	2	23.90	23.95	24.05		0
	1	5	23.89	23.91	24.02		0
	3	0	24.05	24.02	24.11	0-1	0
	3	2	24.03	23.98	24.10		0
	3	3	24.00	23.97	24.08		0
	6	0	23.04	23.03	23.12		1
16QAM	1	0	22.91	22.97	23.00	0-1	1
	1	2	22.90	22.95	23.02		1
	1	5	22.89	22.98	23.05		1
	3	0	22.89	23.04	22.98	0-1	1
	3	2	22.89	23.00	22.99		1
	3	3	22.88	22.96	22.97		1
	6	0	21.91	22.03	22.09		0-2

b. LTE Band 14

Table 8-6
LTE Band 14 (793.0MHz) Conducted Powers – 10MHz Bandwidth

LTE Band 14 10 MHz Bandwidth					
Modulation	RB Size	RB Offset	Mid Channel	MPR Allowed per 3GPP [dB]	MPR [dB]
			23330 (793.0 MHz)		
Conducted Power [dBm]					
QPSK	1	0	23.06	0	0
	1	25	23.01		0
	1	49	22.96		0
	25	0	21.90	0-1	1
	25	12	21.86		1
	25	25	21.84		1
	50	0	21.86		1
16QAM	1	0	21.76	0-1	1
	1	25	21.70		1
	1	49	21.65		1
	25	0	20.82	0-2	2
	25	12	20.78		2
	25	25	20.77		2
	50	0	20.78		2



FCC ID: A3LSMJ737A	 PCTEST ENGINEERING LABORATORY, INC.	HAC (RF EMISSIONS) TEST REPORT		Approved by: Quality Manager
Filename: 1M1803080036-11-R1.A3L	Test Dates: 3/12/2018 - 3/13/2018	DUT Type: Portable Handset	Page 23 of 71	

Table 8-7
LTE Band 14 (793.0MHz) Conducted Powers – 5MHz Bandwidth

LTE Band 14 5 MHz Bandwidth					
Modulation	RB Size	RB Offset	Mid Channel	MPR Allowed per 3GPP [dB]	MPR [dB]
			2330 (793.0 MHz)		
			Conducted Power [dBm]		
QPSK	1	0	22.90	0	0
	1	12	22.88		0
	1	24	22.84		0
	12	0	21.93	0-1	1
	12	6	21.95		1
	12	13	21.96		1
16QAM	25	0	21.89	0-1	1
	1	0	21.82		1
	1	12	21.85		1
	1	24	21.76	0-2	1
	12	0	20.91		2
	12	6	20.90		2
	12	13	20.89		2
	25	0	20.91	2	

Note: Since LTE Band 14 at 5MHz bandwidth does not support 3 non-overlapping channels, conducted power measurements were made only on the middle channel.

c. LTE Band 5

Table 8-8
LTE Band 5 (836.5MHz) Conducted Powers – 10MHz Bandwidth

LTE Band 5 (Cell) 10 MHz Bandwidth					
Modulation	RB Size	RB Offset	Mid Channel	MPR Allowed per 3GPP [dB]	MPR [dB]
			20525 (836.5 MHz)		
			Conducted Power [dBm]		
QPSK	1	0	24.05	0	0
	1	25	24.02		0
	1	49	23.99		0
	25	0	23.07	0-1	1
	25	12	23.05		1
	25	25	23.02		1
	50	0	23.06		1
16QAM	1	0	22.95	0-1	1
	1	25	22.86		1
	1	49	22.88		1
	25	0	22.06	0-2	2
	25	12	22.01		2
	25	25	22.02		2
	50	0	22.04		2

Note: Since LTE Band 5 at 10MHz bandwidth does not support 3 non-overlapping channels, conducted power measurements were made only on the middle channel.

Table 8-9
LTE Band 5 (836.5MHz) Conducted Powers – 5MHz Bandwidth

LTE Band 5 (Cell) 5 MHz Bandwidth							
Modulation	RB Size	RB Offset	Low Channel	Mid Channel	High Channel	MPR Allowed per 3GPP [dB]	MPR [dB]
			20425 (826.5 MHz)	20525 (836.5 MHz)	20625 (846.5 MHz)		
			Conducted Power [dBm]				
QPSK	1	0	24.14	24.16	24.10	0	0
	1	12	24.15	24.13	24.12		0
	1	24	24.12	24.11	24.05		0
	12	0	23.18	23.16	23.11	0-1	1
	12	6	23.16	23.15	23.12		1
	12	13	23.09	23.13	23.08		1
	25	0	23.14	23.13	23.07		1
16QAM	1	0	23.09	23.11	23.08	0-1	1
	1	12	23.08	23.08	23.01		1
	1	24	23.04	23.07	22.98		1
	12	0	22.08	22.10	22.19	0-2	2
	12	6	22.07	22.13	22.12		2
	12	13	22.10	22.11	22.10		2
	25	0	22.11	22.15	22.06		2



FCC ID: A3LSMJ737A	 PCTEST ENGINEERING LABORATORY, INC.	HAC (RF EMISSIONS) TEST REPORT		Approved by: Quality Manager
Filename: 1M1803080036-11-R1.A3L	Test Dates: 3/12/2018 - 3/13/2018	DUT Type: Portable Handset		Page 24 of 71

Table 8-10
LTE Band 5 (836.5MHz) Conducted Powers – 3MHz Bandwidth

LTE Band 5 (Cell) 3 MHz Bandwidth							
Modulation	RB Size	RB Offset	Low Channel	Mid Channel	High Channel	MPR Allowed per 3GPP [dB]	MPR [dB]
			20415 (825.5 MHz)	20525 (836.5 MHz)	20635 (847.5 MHz)		
Conducted Power [dBm]							
QPSK	1	0	24.26	24.25	24.24	0	0
	1	7	24.24	24.22	24.23		0
	1	14	24.18	24.23	24.19		0
	8	0	23.16	23.04	23.12	0-1	1
	8	4	23.14	23.07	23.13		1
	8	7	23.13	23.01	23.11		1
16QAM	15	0	23.15	23.08	23.17	0-1	1
	1	0	23.05	22.98	23.02		1
	1	7	23.03	23.05	23.03		1
	1	14	23.00	23.03	23.00	0-2	1
	8	0	22.09	22.12	22.14		2
	8	4	22.12	22.09	22.11		2
	8	7	22.13	22.11	22.08	2	
	15	0	22.15	22.10	22.06	2	

Table 8-11
LTE Band 5 (836.5MHz) Conducted Powers – 1.4MHz Bandwidth

LTE Band 5 (Cell) 1.4 MHz Bandwidth							
Modulation	RB Size	RB Offset	Low Channel	Mid Channel	High Channel	MPR Allowed per 3GPP [dB]	MPR [dB]
			20407 (824.7 MHz)	20525 (836.5 MHz)	20643 (848.3 MHz)		
Conducted Power [dBm]							
QPSK	1	0	24.00	24.05	24.08	0	0
	1	2	23.98	24.04	24.09		0
	1	5	23.96	24.01	24.06		0
	3	0	24.09	24.17	24.16	0-1	0
	3	2	24.13	24.14	24.15		0
	3	3	24.05	24.12	24.09		0
16QAM	6	0	23.09	23.11	23.11	0-1	1
	1	0	22.97	22.96	22.97		1
	1	2	22.96	22.98	22.92		1
	1	5	22.98	23.01	22.89	0-1	1
	3	0	22.94	22.99	22.99		1
	3	2	22.97	23.07	23.02		1
	3	3	22.90	23.01	23.04	0-2	1
	6	0	22.12	22.09	22.12		2

d. LTE Band 4

Table 8-12
LTE Band 4 (1732.5MHz) Conducted Powers – 20MHz Bandwidth

LTE Band 4 (AWS) 20 MHz Bandwidth					
Modulation	RB Size	RB Offset	Mid Channel	MPR Allowed per 3GPP [dB]	MPR [dB]
			20175 (1732.5 MHz)		
Conducted Power [dBm]					
QPSK	1	0	23.83	0	0
	1	50	23.79		0
	1	99	23.81		0
	50	0	22.86	0-1	1
	50	25	22.82		1
	50	50	22.83		1
16QAM	100	0	22.84	0-1	1
	1	0	22.63		1
	1	50	22.60		1
	1	99	22.51	0-2	1
	50	0	21.83		2
	50	25	21.80		2
	50	50	21.81	0-2	2
	100	0	21.77		2

Note: Since LTE Band 4 at 20MHz bandwidth does not support 3 non-overlapping channels, conducted power measurements were made only on the middle channel.



FCC ID: A3LSMJ737A	 PCTEST ENGINEERING LABORATORY, INC.	HAC (RF EMISSIONS) TEST REPORT		Approved by: Quality Manager
Filename: 1M1803080036-11-R1.A3L	Test Dates: 3/12/2018 - 3/13/2018	DUT Type: Portable Handset	Page 25 of 71	

Table 8-13
LTE Band 4 (1732.5MHz) Conducted Powers – 15MHz Bandwidth

LTE Band 4 (AWS) 15 MHz Bandwidth							
Modulation	RB Size	RB Offset	Low Channel	Mid Channel	High Channel	MPR Allowed per 3GPP [dB]	MPR [dB]
			20025 (1717.5 MHz)	20175 (1732.5 MHz)	20325 (1747.5 MHz)		
Conducted Power [dBm]							
QPSK	1	0	23.82	23.88	23.96	0	0
	1	36	23.81	23.84	23.92		0
	1	74	23.73	23.74	23.88		0
	36	0	22.82	22.82	22.89	0-1	1
	36	18	22.78	22.80	22.87		1
	36	37	22.76	22.77	22.85		1
16QAM	75	0	22.76	22.77	22.89	0-1	1
	1	0	22.66	22.74	22.83		1
	1	36	22.61	22.67	22.80		1
	1	74	22.57	22.55	22.73	0-2	1
	36	0	21.83	21.80	21.91		2
	36	18	21.79	21.78	21.89		2
	36	37	21.77	21.77	21.86		2
75	0	21.79	21.81	21.86	2		

Table 8-14
LTE Band 4 (1732.5MHz) Conducted Powers – 10MHz Bandwidth

LTE Band 4 (AWS) 10 MHz Bandwidth							
Modulation	RB Size	RB Offset	Low Channel	Mid Channel	High Channel	MPR Allowed per 3GPP [dB]	MPR [dB]
			20000 (1715.0 MHz)	20175 (1732.5 MHz)	20350 (1750.0 MHz)		
Conducted Power [dBm]							
QPSK	1	0	23.85	23.86	23.97	0	0
	1	25	23.85	23.81	23.92		0
	1	49	23.80	23.75	23.89		0
	25	0	22.81	22.82	22.93	0-1	1
	25	12	22.80	22.80	22.90		1
	25	25	22.78	22.78	22.89		1
16QAM	50	0	22.80	22.82	22.91	0-1	1
	1	0	22.75	22.82	22.84		1
	1	25	22.67	22.68	22.80		1
	1	49	22.62	22.70	22.76	0-2	1
	25	0	21.82	21.83	21.89		2
	25	12	21.81	21.80	21.89		2
	25	25	21.79	21.77	21.88		2
50	0	21.85	21.85	21.90	2		

Table 8-15
LTE Band 4 (1732.5MHz) Conducted Powers – 5MHz Bandwidth

LTE Band 4 (AWS) 5 MHz Bandwidth							
Modulation	RB Size	RB Offset	Low Channel	Mid Channel	High Channel	MPR Allowed per 3GPP [dB]	MPR [dB]
			19975 (1712.5 MHz)	20175 (1732.5 MHz)	20375 (1752.5 MHz)		
Conducted Power [dBm]							
QPSK	1	0	23.83	23.81	23.85	0	0
	1	12	23.82	23.80	23.85		0
	1	24	23.77	23.73	23.90		0
	12	0	22.76	22.78	22.87	0-1	1
	12	6	22.76	22.77	22.88		1
	12	13	22.74	22.77	22.85		1
16QAM	25	0	22.75	22.79	22.86	0-1	1
	1	0	22.64	22.69	22.78		1
	1	12	22.68	22.73	22.75		1
	1	24	22.70	22.70	22.75	0-2	1
	12	0	21.76	21.80	21.87		2
	12	6	21.77	21.78	21.89		2
	12	13	21.73	21.76	21.87		2
25	0	21.79	21.77	21.84	2		



FCC ID: A3LSMJ737A	 PCTEST ENGINEERING LABORATORY, INC.	HAC (RF EMISSIONS) TEST REPORT		Approved by: Quality Manager
Filename: 1M1803080036-11-R1.A3L	Test Dates: 3/12/2018 - 3/13/2018	DUT Type: Portable Handset		Page 26 of 71

Table 8-16
LTE Band 4 (1732.5MHz) Conducted Powers – 3MHz Bandwidth

LTE Band 4 (AWS) 3 MHz Bandwidth							
Modulation	RB Size	RB Offset	Low Channel	Mid Channel	High Channel	MPR Allowed per 3GPP [dB]	MPR [dB]
			19965 (1711.5 MHz)	20175 (1732.5 MHz)	20385 (1753.5 MHz)		
Conducted Power [dBm]							
QPSK	1	0	23.67	23.73	23.79	0	0
	1	7	23.68	23.72	23.81		0
	1	14	23.66	23.68	23.78		0
	8	0	22.73	22.78	22.82	0-1	1
	8	4	22.73	22.78	22.82		1
	8	7	22.71	22.75	22.83		1
	15	0	22.73	22.75	22.85		1
16QAM	1	0	22.67	22.71	22.82	0-1	1
	1	7	22.74	22.69	22.81		1
	1	14	22.70	22.69	22.76		1
	8	0	21.70	21.74	21.80	0-2	2
	8	4	21.71	21.71	21.79		2
	8	7	21.69	21.73	21.81		2
	15	0	21.74	21.76	21.84		2

Table 8-17
LTE Band 4 (1732.5MHz) Conducted Powers – 1.4MHz Bandwidth

LTE Band 4 (AWS) 1.4 MHz Bandwidth							
Modulation	RB Size	RB Offset	Low Channel	Mid Channel	High Channel	MPR Allowed per 3GPP [dB]	MPR [dB]
			19957 (1710.7 MHz)	20175 (1732.5 MHz)	20393 (1754.3 MHz)		
Conducted Power [dBm]							
QPSK	1	0	23.70	23.76	23.83	0	0
	1	2	23.72	23.73	23.81		0
	1	5	23.67	23.75	23.78		0
	3	0	23.80	23.85	23.91	0-1	0
	3	2	23.77	23.82	23.88		0
	3	3	23.76	23.82	23.89		0
	6	0	22.75	22.82	22.89		1
16QAM	1	0	22.48	22.67	22.56	0-1	1
	1	2	22.45	22.59	22.58		1
	1	5	22.47	22.63	22.54		1
	3	0	22.62	22.71	22.79	0-2	1
	3	2	22.61	22.67	22.79		1
	3	3	22.65	22.68	22.79		1
	6	0	21.74	21.82	21.87		2

e. LTE Band 2

Table 8-18
LTE Band 2 (1880.0MHz) Conducted Powers – 20MHz Bandwidth

LTE Band 2 (PCS) 20 MHz Bandwidth							
Modulation	RB Size	RB Offset	Low Channel	Mid Channel	High Channel	MPR Allowed per 3GPP [dB]	MPR [dB]
			18700 (1860.0 MHz)	18900 (1880.0 MHz)	19100 (1900.0 MHz)		
Conducted Power [dBm]							
QPSK	1	0	23.18	23.15	23.12	0	0
	1	50	23.11	23.20	23.29		0
	1	99	23.04	23.36	23.16		0
	50	0	21.95	22.00	22.07	0-1	1
	50	25	21.89	22.03	22.10		1
	50	50	21.90	22.09	22.08		1
	100	0	21.91	22.07	22.07		1
16QAM	1	0	21.78	21.86	21.60	0-1	1
	1	50	21.67	21.92	21.74		1
	1	99	21.56	22.04	21.69		1
	50	0	20.94	20.93	21.05	0-2	2
	50	25	20.88	20.99	21.08		2
	50	50	20.85	21.04	21.09		2
	100	0	20.88	21.00	20.99		2



FCC ID: A3LSMJ737A	 PCTEST ENGINEERING LABORATORY, INC.	HAC (RF EMISSIONS) TEST REPORT		Approved by: Quality Manager
Filename: 1M1803080036-11-R1.A3L	Test Dates: 3/12/2018 - 3/13/2018	DUT Type: Portable Handset		Page 27 of 71

Table 8-19
LTE Band 2 (1880.0MHz) Conducted Powers – 15MHz Bandwidth

LTE Band 2 (PCS) 15 MHz Bandwidth							
Modulation	RB Size	RB Offset	Low Channel	Mid Channel	High Channel	MPR Allowed per 3GPP [dB]	MPR [dB]
			18675 (1857.5 MHz)	18900 (1880.0 MHz)	19125 (1902.5 MHz)		
			Conducted Power [dBm]				
QPSK	1	0	23.17	23.13	23.19	0	0
	1	36	23.08	23.18	23.22		0
	1	74	23.00	23.23	23.11		0
	36	0	22.00	22.02	22.09	0-1	1
	36	18	21.96	22.03	22.08		1
	36	37	21.90	22.05	22.04		1
16QAM	75	0	21.92	22.03	22.10	0-1	1
	1	0	21.93	21.92	21.95		1
	1	36	21.86	21.96	22.01		1
	1	74	21.82	22.03	21.92	0-2	1
	36	0	20.92	20.98	21.05		2
	36	18	20.90	20.97	21.06		2
	36	37	20.85	21.03	21.07		2
75	0	20.88	20.98	21.03	2		

Table 8-20
LTE Band 2 (1880.0MHz) Conducted Powers – 10MHz Bandwidth

LTE Band 2 (PCS) 10 MHz Bandwidth							
Modulation	RB Size	RB Offset	Low Channel	Mid Channel	High Channel	MPR Allowed per 3GPP [dB]	MPR [dB]
			18650 (1855.0 MHz)	18900 (1880.0 MHz)	19150 (1905.0 MHz)		
			Conducted Power [dBm]				
QPSK	1	0	23.00	23.00	23.19	0	0
	1	25	22.97	23.01	23.16		0
	1	49	22.89	23.05	23.06		0
	25	0	22.00	22.01	22.17	0-1	1
	25	12	21.95	22.04	22.14		1
	25	25	21.90	22.05	22.09		1
	50	0	21.94	21.99	22.14		1
16QAM	1	0	21.84	21.91	22.04	0-1	1
	1	25	21.80	21.88	21.98		1
	1	49	21.71	21.93	21.91		1
	25	0	20.88	20.93	21.07	0-2	2
	25	12	20.87	20.93	21.07		2
	25	25	20.84	20.96	21.04		2
50	0	20.91	20.95	21.10	2		

Table 8-21
LTE Band 2 (1880.0MHz) Conducted Powers – 5MHz Bandwidth

LTE Band 2 (PCS) 5 MHz Bandwidth							
Modulation	RB Size	RB Offset	Low Channel	Mid Channel	High Channel	MPR Allowed per 3GPP [dB]	MPR [dB]
			18625 (1852.5 MHz)	18900 (1880.0 MHz)	19175 (1907.5 MHz)		
			Conducted Power [dBm]				
QPSK	1	0	23.05	22.96	23.22	0	0
	1	12	23.03	22.97	23.18		0
	1	24	23.00	22.96	23.08		0
	12	0	21.93	21.98	22.15	0-1	1
	12	6	21.94	21.99	22.12		1
	12	13	21.90	22.01	22.08		1
	25	0	21.91	22.00	22.14		1
16QAM	1	0	21.75	21.77	22.09	0-1	1
	1	12	21.74	21.85	22.04		1
	1	24	21.77	21.90	21.95		1
	12	0	20.87	20.93	21.13	0-2	2
	12	6	20.86	20.94	21.11		2
	12	13	20.83	20.94	21.08		2
	25	0	20.88	20.91	21.08		2



FCC ID: A3LSMJ737A	 PCTEST ENGINEERING LABORATORY, INC.	HAC (RF EMISSIONS) TEST REPORT		Approved by: Quality Manager
Filename: 1M1803080036-11-R1.A3L	Test Dates: 3/12/2018 - 3/13/2018	DUT Type: Portable Handset	Page 28 of 71	

Table 8-22
LTE Band 2 (1880.0MHz) Conducted Powers – 3MHz Bandwidth

LTE Band 2 (PCS) 3 MHz Bandwidth								
Modulation	RB Size	RB Offset	Low Channel	Mid Channel	High Channel	MPR Allowed per 3GPP [dB]	MPR [dB]	
			18615 (1851.5 MHz)	18900 (1880.0 MHz)	19185 (1908.5 MHz)			
Conducted Power [dBm]								
QPSK	1	0	22.83	22.91	23.14	0	0	
	1	7	22.84	22.94	23.09		0	
	1	14	22.82	22.94	23.00		0	
	QPSK	8	0	21.88	21.99	22.09	0-1	1
		8	4	21.86	21.99	22.10		1
		8	7	21.85	21.99	22.08		1
		15	0	21.84	21.99	22.12		1
15		0	21.69	21.83	22.03	1		
16QAM	1	7	21.75	21.88	22.02	0-1	1	
	1	14	21.71	21.84	21.97		1	
	8	0	20.79	20.86	21.09		2	
	16QAM	8	4	20.82	20.89	21.07	0-2	2
		8	7	20.80	20.91	21.07		2
		15	0	20.85	20.91	21.08		2

Table 8-23
LTE Band 2 (1880.0MHz) Conducted Powers – 1.4MHz Bandwidth

LTE Band 2 (PCS) 1.4 MHz Bandwidth							
Modulation	RB Size	RB Offset	Low Channel	Mid Channel	High Channel	MPR Allowed per 3GPP [dB]	MPR [dB]
			18607 (1850.7 MHz)	18900 (1880.0 MHz)	19193 (1909.3 MHz)		
Conducted Power [dBm]							
QPSK	1	0	22.70	22.94	23.12	0	0
	1	2	22.72	22.95	23.11		0
	1	5	22.70	22.93	23.04		0
	3	0	22.91	23.05	23.21		0
	3	2	22.91	23.03	23.17		0
	3	3	22.91	23.01	23.16		0
	6	0	21.86	22.03	22.18	0-1	1
16QAM	1	0	21.67	21.78	21.99	0-1	1
	1	2	21.64	21.76	21.97		1
	1	5	21.63	21.78	22.01		1
	3	0	21.72	21.87	22.03		1
	3	2	21.73	21.85	21.99		1
	3	3	21.75	21.85	22.01		1
	6	0	20.75	20.88	21.11	0-2	2

f. LTE Band 7

Table 8-24
LTE Band 7 (2535.0MHz) Conducted Powers – 20MHz Bandwidth

LTE Band 7 20 MHz Bandwidth								
Modulation	RB Size	RB Offset	Low Channel	Mid Channel	High Channel	MPR Allowed per 3GPP [dB]	MPR [dB]	
			20850 (2510.0 MHz)	21100 (2535.0 MHz)	21350 (2560.0 MHz)			
Conducted Power [dBm]								
QPSK	1	0	22.48	22.74	22.57	0	0	
	1	50	22.56	22.73	22.46		0	
	1	99	22.60	22.70	22.33		0	
	QPSK	50	0	21.40	21.58	21.39	0-1	1
		50	25	21.43	21.60	21.33		1
		50	50	21.49	21.57	21.27		1
		100	0	21.43	21.58	21.32		1
16QAM	1	0	21.20	21.55	21.28	0-1	1	
	1	50	21.27	21.48	21.15		1	
	1	99	21.35	21.46	20.95		1	
	16QAM	50	0	20.44	20.63	20.48	0-2	2
		50	25	20.43	20.62	20.41		2
		50	50	20.50	20.59	20.27		2
		100	0	20.46	20.59	20.34		2



FCC ID: A3LSMJ737A		HAC (RF EMISSIONS) TEST REPORT		Approved by: Quality Manager
Filename: 1M1803080036-11-R1.A3L	Test Dates: 3/12/2018 - 3/13/2018	DUT Type: Portable Handset		Page 29 of 71

Table 8-25
LTE Band 7 (2535.0MHz) Conducted Powers – 15MHz Bandwidth



LTE Band 7 15 MHz Bandwidth							
Modulation	RB Size	RB Offset	Low Channel	Mid Channel	High Channel	MPR Allowed per 3GPP [dB]	MPR [dB]
			20825 (2507.5 MHz)	21100 (2535.0 MHz)	21375 (2562.5 MHz)		
Conducted Power [dBm]							
QPSK	1	0	22.46	22.45	22.39	0	0
	1	36	22.48	22.48	22.44		0
	1	74	22.46	22.54	22.42		0
	36	0	21.28	21.30	21.26	0-1	1
	36	18	21.22	21.36	21.27		1
	36	37	21.20	21.36	21.28		1
	75	0	21.20	21.34	21.21		1
16QAM	1	0	21.07	21.11	21.05	0-1	1
	1	36	21.12	21.16	21.11		1
	1	74	21.10	21.24	21.07		1
	36	0	20.19	20.31	20.24	0-2	2
	36	18	20.20	20.36	20.26		2
	36	37	20.21	20.39	20.28		2
	75	0	20.16	20.30	20.24		2

Table 8-26
LTE Band 7 (2535.0MHz) Conducted Powers – 10MHz Bandwidth

LTE Band 7 10 MHz Bandwidth							
Modulation	RB Size	RB Offset	Low Channel	Mid Channel	High Channel	MPR Allowed per 3GPP [dB]	MPR [dB]
			20800 (2505.0 MHz)	21100 (2535.0 MHz)	21400 (2565.0 MHz)		
Conducted Power [dBm]							
QPSK	1	0	22.31	22.45	22.36	0	0
	1	25	22.31	22.50	22.37		0
	1	49	22.27	22.51	22.33		0
	25	0	21.15	21.31	21.21	0-1	1
	25	12	21.18	21.34	21.21		1
	25	25	21.16	21.38	21.22		1
	50	0	21.16	21.32	21.24		1
16QAM	1	0	21.09	21.13	21.16	0-1	1
	1	25	21.09	21.19	21.21		1
	1	49	21.09	21.21	21.22		1
	25	0	20.15	20.28	20.25	0-2	2
	25	12	20.15	20.32	20.24		2
	25	25	20.13	20.34	20.24		2
	50	0	20.22	20.36	20.26		2

Table 8-27
LTE Band 7 (2535.0MHz) Conducted Powers – 5MHz Bandwidth

LTE Band 7 5 MHz Bandwidth							
Modulation	RB Size	RB Offset	Low Channel	Mid Channel	High Channel	MPR Allowed per 3GPP [dB]	MPR [dB]
			20775 (2502.5 MHz)	21100 (2535.0 MHz)	21425 (2567.5 MHz)		
Conducted Power [dBm]							
QPSK	1	0	22.36	22.46	22.33	0	0
	1	12	22.37	22.50	22.34		0
	1	24	22.33	22.48	22.32		0
	12	0	21.21	21.30	21.22	0-1	1
	12	6	21.21	21.32	21.20		1
	12	13	21.19	21.34	21.21		1
	25	0	21.16	21.32	21.22		1
16QAM	1	0	21.29	21.44	21.27	0-1	1
	1	12	21.26	21.34	21.21		1
	1	24	21.17	21.35	21.21		1
	12	0	20.20	20.34	20.22	0-2	2
	12	6	20.22	20.36	20.25		2
	12	13	20.15	20.36	20.22		2
	25	0	20.23	20.36	20.31		2

FCC ID: A3LSMJ737A	 PCTEST ENGINEERING LABORATORY, INC.	HAC (RF EMISSIONS) TEST REPORT		Approved by: Quality Manager
Filename: 1M1803080036-11-R1.A3L	Test Dates: 3/12/2018 - 3/13/2018	DUT Type: Portable Handset	Page 30 of 71	

VII. WIFI Conducted Powers (SISO)

Table 8-28
IEEE 802.11b/g/n (2.4GHz, SISO) Reduced Average RF Power¹

2.4GHz Conducted Power [dBm]				
Freq [MHz]	Channel	IEEE Transmission Mode		
		802.11b	802.11g	802.11n
2412	1	13.92	14.15	14.84
2437	6	14.11	14.31	14.83
2462	11	13.99	14.33	14.77

Table 8-29
IEEE 802.11a/n/ac (5GHz, 20MHz BW, SISO) Reduced Average RF Power¹

5GHz (20MHz) Conducted Power [dBm]				
Freq [MHz]	Channel	IEEE Transmission Mode		
		802.11a	802.11n	802.11ac
5180	36	10.18	9.69	9.66
5200	40	9.98	9.65	9.60
5220	44	9.81	9.52	9.51
5240	48	9.77	9.48	9.38
5260	52	10.10	9.59	9.64
5280	56	9.83	9.57	9.53
5300	60	9.79	9.43	9.39
5320	64	9.80	9.36	9.26
5500	100	9.82	9.45	9.43
5600	120	9.55	9.23	9.20
5620	124	9.51	9.10	9.10
5720	144	9.39	10.42	9.01
5745	149	9.80	9.35	9.40
5785	157	9.70	9.34	9.52
5825	165	9.95	9.43	9.44

¹ Note: This device utilizes independent power reduction mechanisms for the WIFI transmitter in all WIFI modes for held-to-ear scenarios.



FCC ID: A3LSMJ737A	 PCTEST ENGINEERING LABORATORY, INC.	HAC (RF EMISSIONS) TEST REPORT		Approved by: Quality Manager
Filename: 1M1803080036-11-R1.A3L	Test Dates: 3/12/2018 - 3/13/2018	DUT Type: Portable Handset	Page 31 of 71	



Table 8-30
IEEE 802.11n/ac (5GHz, 40MHz BW, SISO) Reduced Average RF Power¹

5GHz (40MHz) Conducted Power [dBm]			
Freq [MHz]	Channel	IEEE Transmission Mode	
		802.11n	802.11ac
5190	38	10.22	10.99
5230	46	10.95	10.80
5270	54	10.25	10.26
5310	62	8.83	8.89
5510	102	10.99	10.81
5590	118	10.52	10.71
5630	126	10.74	10.72
5710	142	10.65	10.60
5755	151	10.99	10.99
5795	159	10.98	10.96

Table 8-31
IEEE 802.11ac (5GHz, 80MHz BW, SISO) Reduced Average RF Power¹

5GHz (80MHz) Conducted Power [dBm]		
Freq [MHz]	Channel	IEEE Transmission Mode
		802.11ac
5210	42	8.65
5290	58	8.65
5530	106	8.05
5610	122	10.35
5690	138	10.51
5775	155	10.99

¹ Note: This device utilizes independent power reduction mechanisms for the WIFI transmitter in all WIFI modes for held-to-ear scenarios.

FCC ID: A3LSMJ737A	 PCTEST TECHNOLOGICAL LABORATORY, INC.	HAC (RF EMISSIONS) TEST REPORT		Approved by: Quality Manager
Filename: 1M1803080036-11-R1.A3L	Test Dates: 3/12/2018 - 3/13/2018	DUT Type: Portable Handset	Page 32 of 71	

9. JUSTIFICATION OF HELD TO EAR MODES TESTED

I. Analysis of RF Air Interface Technologies

An analysis was performed, following the guidance of §4.3 and §4.4 of the ANSI standard, of the RF air interface technologies being evaluated. The factors that will affect the RF interference potential were evaluated, and the worst-case operating modes were identified and used in the evaluation. A WD's interference potential is a function both of the WD's average near-field field strength and of the signal's audio-frequency amplitude modulation characteristics. Per §4.4, RF air interface technologies that have low power have been found to produce sufficiently low RF interference potential, so it is possible to exempt them from the product testing specified in Clause 5 of the ANSI standard. An RF air interface technology of a device is exempt from testing when its average antenna input power plus its MIF is $\leq 17\text{dBm}$ for all of its operating modes. RF air interface technologies exempted from testing in this manner are automatically assigned an M4 rating to be used in determining the overall rating for the WD.

The worst-case MIF plus the worst-case average antenna input power for all modes are investigated below to determine the testing requirements for this device.

II. Individual Mode Evaluations

Table 9-1
Max Power + MIF calculations for Low Power Exemptions



Air Interface	Maximum Average Power (dBm)	Worst Case MIF (dB)	Total (Power + MIF, dB)	C63.19 Testing Required
GSM850	23.41*	3.53	26.94	Yes
GSM1900	20.62*	3.56	24.18	Yes
EDGE850	18.51*	4.25	22.76	Yes**
EDGE1900	17.69*	3.93	21.62	Yes**
UMTS - RMC	24.35	-20.70	3.65	No
UMTS - AMR	24.34	-12.94	11.40	No
HSPA	22.04	-19.18	2.86	No
LTE - FDD	24.26	-9.80	14.46	No
2.4GHz WIFI	14.84	-6.37	8.47	No
5GHz WIFI	10.99	-10.47	0.52	No

* Note: ANSI C63.19-2011 Sec. 4.4 Footnote 20 indicates the use of a long averaging time for measuring the antenna input power when using this method of exclusion. Therefore, the frame averaged power was calculated for these modes in this investigation.

** Note: EDGE data modes were considered but not tested as GSM voice modes were found to be the worst-case modes for the GSM air interface.

III. Low-Power Exemption Conclusions

Per ANSI C63.19-2011, RF Emissions testing for this device is required only for GSM Voice Modes. All other air interfaces are exempt.

FCC ID: A3LSMJ737A	 PCTEST ENGINEERING LABORATORY, INC.	HAC (RF EMISSIONS) TEST REPORT		Approved by: Quality Manager
Filename: 1M1803080036-11-R1.A3L	Test Dates: 3/12/2018 - 3/13/2018	DUT Type: Portable Handset		Page 33 of 71

10. OVERALL MEASUREMENT SUMMARY

FCC ID:	A3LSMJ737A
S/N:	17914



I. E-FIELD EMISSIONS:

**Table 10-1
HAC Data Summary for E-field**

Mode	Channel	Scan Center	Conducted Power at BS (dBm)	Time Avg. Field (V/m)	Time Avg. Field [dB(V/m)]	MIF (dB)	Audio Interference Level [dB(V/m)]	FCC Limit (dBV/m)	FCC Margin (dB)	Result	Excl Blocks per 5.5
E-Field Emissions											
GSM850	128	Acoustic	32.36	47.46	33.53	3.52	37.05	45.00	-7.95	M4	none
	190	Acoustic	32.44	54.18	34.68	3.52	38.20	45.00	-6.80	M4	none
	251	Acoustic	32.43	55.79	34.93	3.53	38.46	45.00	-6.54	M4	none
GSM1900	512	Acoustic	29.57	31.23	29.89	3.56	33.45	35.00	-1.55	M3	none
	661	Acoustic	29.64	29.50	29.40	3.56	32.96	35.00	-2.04	M3	none
	810	Acoustic	29.65	27.58	28.81	3.56	32.37	35.00	-2.63	M3	none
	512	T-Coil	29.57	31.23	29.89	3.56	33.45	35.00	-1.55	M3	none



Figure 10-1
Sample E-field Scan Overlay
(See Test Setup Photographs for actual WD overlay)

FCC ID: A3LSMJ737A	 PCTEST <small>ENGINEERING LABORATORY, INC.</small>	HAC (RF EMISSIONS) TEST REPORT	
Filename: 1M1803080036-11-R1.A3L	Test Dates: 3/12/2018 - 3/13/2018	DUT Type: Portable Handset	Approved by: Quality Manager
			Page 34 of 71

FCC ID:	A3LSMJ737A
S/N:	17914

II. Worst-case Configuration Evaluation

Table 10-2
Peak Reading 360° Probe Rotation at Azimuth axis

Mode	Channel	Scan Center	Time Avg. Field (V/m)	Time Avg. Field [dB(V/m)]	MIF (dB)	Audio Interference Level [dB(V/m)]	FCC Limit (dBV/m)	FCC Margin (dB)	Result	Excl Blocks per 5.5
Probe Rotation at Worst-Case										
GSM1900	512	Acoustic	31.23	29.89	3.56	33.45	35.00	-1.55	M3	none

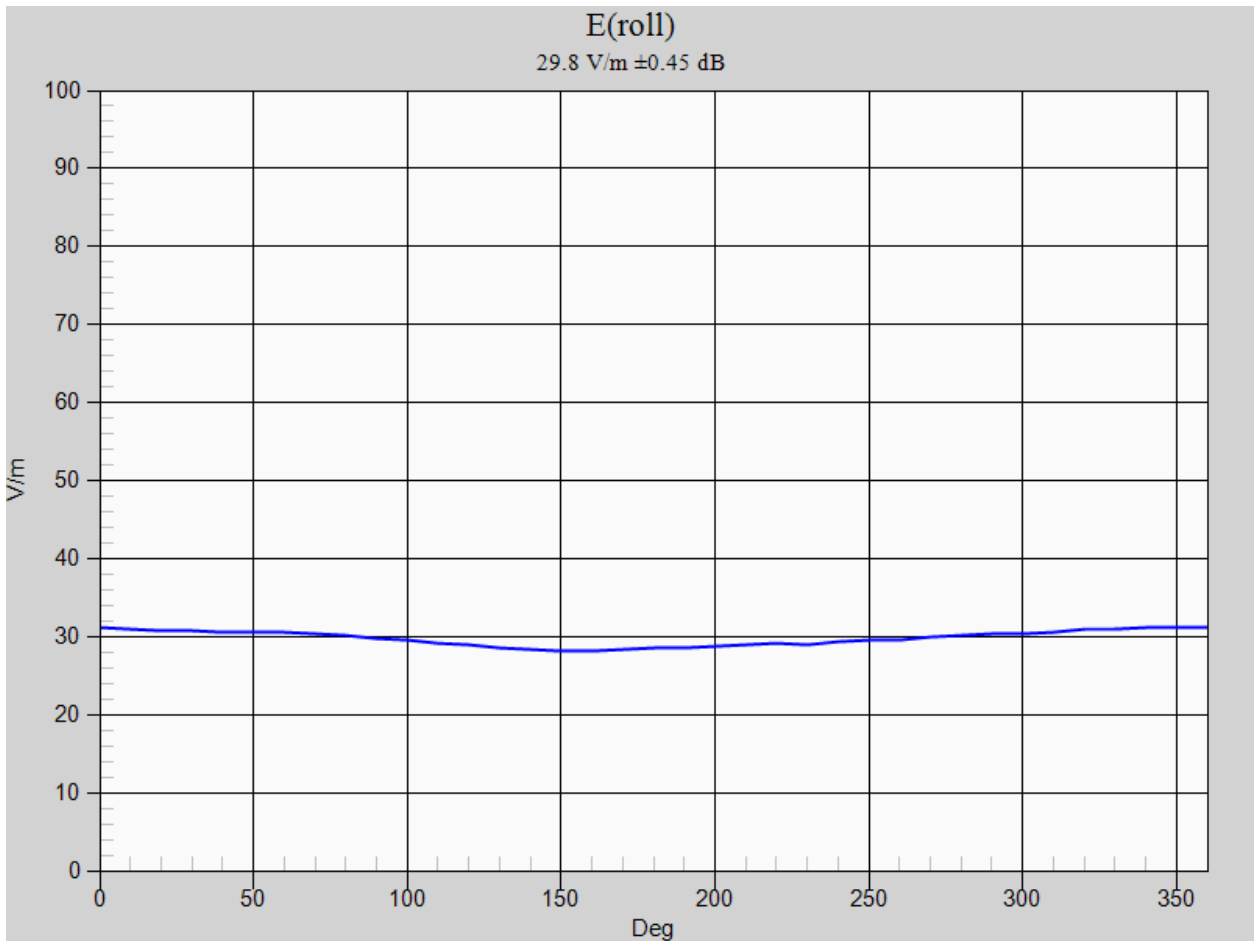



Figure 10-2
Worst-Case Probe Rotation about Azimuth axis

* Note: Locations of probe rotation (with and without exclusions) are shown in Figure 10-1 denoted by the green square markers.

FCC ID: A3LSMJ737A	 PCTEST ENGINEERING LABORATORY, INC.	HAC (RF EMISSIONS) TEST REPORT		Approved by: Quality Manager
Filename: 1M1803080036-11-R1.A3L	Test Dates: 3/12/2018 - 3/13/2018	DUT Type: Portable Handset	Page 35 of 71	

© 2018 PCTEST Engineering Laboratory, Inc.

REV 3.2.M
01/12/2018

© 2018 PCTEST Engineering Laboratory, Inc. All rights reserved. Unless otherwise specified, no part of this report may be reproduced or utilized in any part, form or by any means, electronic or mechanical, including photocopying and microfilm, without permission in writing from PCTEST Engineering Laboratory, Inc. If you have any questions about this international copyright or have an enquiry about obtaining additional rights to this report or assembly of contents thereof, please contact INFO@PCTEST.COM.



11. EQUIPMENT LIST

Table 11-1
Equipment List

Manufacturer	Model	Description	Cal Date	Cal Interval	Cal Due	Serial Number
Agilent	E4438C	ESG Vector Signal Generator	3/24/2017	Biennial	3/24/2019	MY42082385
Agilent	E4432B	ESG-D Series Signal Generator	3/24/2017	Annual	3/24/2018	US40053896
Agilent	N5182A	MXG Vector Signal Generator	11/1/2017	Annual	11/1/2018	MY47420603
Amplifier Research	15S1G6	Amplifier	N/A	CBT*	N/A	433978
Anritsu	ML2496A	Power Meter	4/20/2017	Annual	4/20/2018	1306009
Anritsu	MA2411B	Pulse Power Sensor	10/22/2017	Annual	10/22/2018	846215
Anritsu	MA2411B	Pulse Power Sensor	11/28/2017	Annual	11/28/2018	1027293
Anritsu	MA24106A	USB Power Sensor	6/7/2017	Annual	6/7/2018	1244512
Anritsu	MA24106A	USB Power Sensor	6/7/2017	Annual	6/7/2018	1248508
Mini-Circuits	NLP-1200+	Low Pass Filter DC to 1000 MHz	N/A	CBT*	N/A	N/A
Mini-Circuits	NLP-2950+	Low Pass Filter DC to 2700 MHz	N/A	CBT*	N/A	N/A
Mini-Circuits	BW-N20W5	Power Attenuator	N/A	CBT*	N/A	1226
Pasternack	PE2237-20	Bidirectional Coupler	N/A	CBT*	N/A	N/A
Rohde & Schwarz	CMW500	Wideband Radio Communication Tester	7/14/2017	Annual	7/14/2018	140144
Seekonk	NC-100	Torque Wrench (8" lb)	9/1/2016	Biennial	9/1/2018	21053
SPEAG	AIA	Audio Interference Analyzer	N/A	CBT*	N/A	1010
SPEAG	DAE4	Dasy Data Acquisition Electronics	5/17/2017	Annual	5/17/2018	859
SPEAG	CD1880V3	Freespace 1880 MHz Dipole	5/12/2016	Biennial	5/12/2018	1064
SPEAG	CD835V3	Freespace 835 MHz Dipole	5/10/2016	Biennial	5/10/2018	1082
SPEAG	ER3DV6	Freespace E-field Probe	8/11/2017	Annual	8/11/2018	2335

Calibration traceable to the National Institute of Standards and Technology (NIST).

***Note: CBT (Calibrated Before Testing).** Prior to testing, the measurement paths containing a cable, attenuator, coupler or filter were connected to a calibrated source (i.e. a signal generator) to determine the losses of the measurement path. The power meter offset was then adjusted to compensate for the measurement system losses. This level offset is stored within the power meter before measurements are made. This calibration verification procedure applies to the system verification and output power measurements. The calibrated reading is then taken directly from the power meter after compensation of the losses for all final power measurements.

FCC ID: A3LSMJ737A	 PCTEST TECHNOLOGICAL LABORATORY, INC.	HAC (RF EMISSIONS) TEST REPORT		Approved by: Quality Manager
Filename: 1M1803080036-11-R1.A3L	Test Dates: 3/12/2018 - 3/13/2018	DUT Type: Portable Handset	Page 36 of 71	

© 2018 PCTEST Engineering Laboratory, Inc.

REV 3.2.M

01/12/2018

© 2018 PCTEST Engineering Laboratory, Inc. All rights reserved. Unless otherwise specified, no part of this report may be reproduced or utilized in any part, form or by any means, electronic or mechanical, including photocopying and microfilm, without permission in writing from PCTEST Engineering Laboratory, Inc. If you have any questions about this international copyright or have an enquiry about obtaining additional rights to this report or assembly of contents thereof, please contact INFO@PCTEST.COM.

12. MEASUREMENT UNCERTAINTY



Table 12-1
Uncertainty Estimation Table

Wireless Communications Device Near-Field Measurement Uncertainty Estimation							
Uncertainty Component	Data (dB)	Data Type	Prob. Dist.	Divisor	Ci (E)	Unc. (dB)	Notes/Comments
Measurement System							
RF System Reflections	0.50	Tolerance	N	1.00	1	0.50	* Refl. < -20 dB
Field Probe Calibration	0.21	Tolerance	N	1.00	1	0.21	
Field Probe Isotropy	0.01	Tolerance	N	1.00	1	0.01	
Field Probe Frequency Response	0.135	Tolerance	N	1.00	1	0.14	
Field Probe Linearity	0.013	Tolerance	N	1.00	1	0.01	
Modulation Interference Factor	0.20	Tolerance	R	1.73	1	0.12	Applicable for M-rating testing
Boundary Effects	0.105	Accuracy	R	1.73	1	0.06	*
Probe Positioning Accuracy	0.20	Accuracy	R	1.73	1	0.12	*
Probe Positioner	0.050	Accuracy	R	1.73	1	0.03	*
Extrapolation/Interpolation	0.045	Tolerance	R	1.73	1	0.03	*
Resolution to 2mm error	0.21	Tolerance	N	1.00	1	0.21	
System Detection Limit	0.05	Tolerance	R	1.73	1	0.03	*
Readout Electronics	0.015	Tolerance	N	1.00	1	0.02	*
Integration Time	0.11	Tolerance	R	1.73	1	0.06	*
Response Time	0.033	Tolerance	R	1.73	1	0.02	*
Phantom Thickness	0.10	Tolerance	R	1.73	1	0.06	*
System Repeatability (Field x 2=power)	0.17	Tolerance	N	1.00	1	0.17	*
Test Sample Related							
Device Positioning Vertical	0.2	Tolerance	R	1.73	1	0.12	*
Device Positioning Lateral	0.045	Tolerance	R	1.73	1	0.03	*
Device Holder and Phantom	0.1	Tolerance	R	1.73	1	0.06	*
Power Drift	0.21	Tolerance	R	1.73	1	0.12	
Combined Standard Uncertainty (k=1)						0.66	16.3%
Expanded Uncertainty [95% confidence]						1.31	32.6%
Expanded Uncertainty [95% confidence] on Field						0.66	16.3%

Notes:



1. Test equipments are calibrated according to techniques outlined in NIS81, NIS3003 and NIST Tech Note 1297. All equipments have traceability according to NIST. Measurement Uncertainties are defined in further detail in NIS 81 and NIST Tech Note 1297 and UKAS M3003.
2. * Uncertainty specifications from Schmidt & Partner Engineering AG (not site specific)

Measurement uncertainty reflects the quality and accuracy of a measured result as compared to the true value. Such statements are generally required when stating results of measurements so that it is clear to the intended audience that the results may differ when reproduced by different facilities. Measurement results vary due to the measurement uncertainty of the instrumentation, measurement technique, and test engineer. Most uncertainties are calculated using the tolerances of the instrumentation used in the measurement, the measurement setup variability, and the technique used in performing the test. While not generally included, the variability of the equipment under test also figures into the overall measurement uncertainty. Another component of the overall uncertainty is based on the variability of repeated measurements (so-called Type A uncertainty). This may mean that the Hearing Aid immunity tests may have to be repeated by taking down the test setup and resetting it up so that there are a statistically significant number of repeat measurements to identify the measurement uncertainty. By combining the repeat measurement results with that of the instrumentation chain using the technique contained in NIS 81 and NIS 3003, the overall measurement uncertainty was estimated.

FCC ID: A3LSMJ737A	 PCTEST <small>TECHNOLOGICAL LABORATORY, INC.</small>	HAC (RF EMISSIONS) TEST REPORT	
Filename: 1M1803080036-11-R1.A3L	Test Dates: 3/12/2018 - 3/13/2018	DUT Type: Portable Handset	Approved by: Quality Manager Page 37 of 71

13. TEST DATA

See following Attached Pages for Test Data.

FCC ID: A3LSMJ737A		HAC (RF EMISSIONS) TEST REPORT		Approved by: Quality Manager
Filename: 1M1803080036-11-R1.A3L	Test Dates: 3/12/2018 - 3/13/2018	DUT Type: Portable Handset	Page 38 of 71	

© 2018 PCTEST Engineering Laboratory, Inc.

REV 3.2.M

01/12/2018

© 2018 PCTEST Engineering Laboratory, Inc. All rights reserved. Unless otherwise specified, no part of this report may be reproduced or utilized in any part, form or by any means, electronic or mechanical, including photocopying and microfilm, without permission in writing from PCTEST Engineering Laboratory, Inc. If you have any questions about this international copyright or have an enquiry about obtaining additional rights to this report or assembly of contents thereof, please contact INFO@PCTEST.COM.

PCTEST Hearing-Aid Compatibility Facility

DUT: CD835V3 - SN1082

Type: CD835V3
Serial: 1082

Communication System: CW; Frequency: 835 MHz;

Measurement Standard: DASYS (IEEE/IEC/ANSI C63.19-2011)

DASY5 Configuration:



- Probe: ER3DV6 - SN2335; Calibrated: 8/11/2017;
- Sensor-Surface: 0mm (Fix Surface)
- Electronics: DAE4 Sn859; Calibrated: 5/17/2017
- Phantom: HAC Test Arch with AMCC; Type: SD HAC P01 BA;
- Measurement SW: DASY52, Version 52.10 (0);

835 MHz / 100mW HAC Dipole Validation at 15mm / Hearing Aid Compatibility Test (41x361x1):

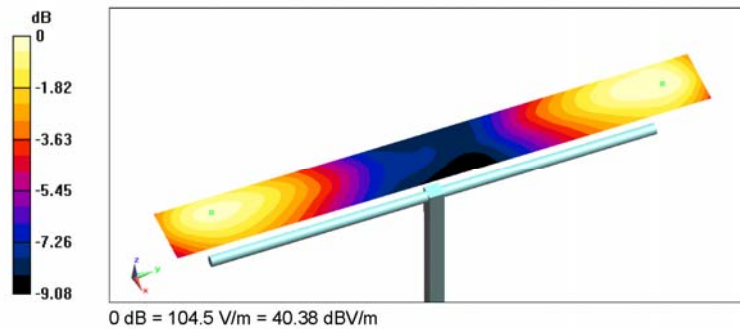
Interpolated grid: dx=0.5000 mm, dy=0.5000 mm
 Device Reference Point: 0, 0, -6.3 mm
 Reference Value = 108.5 V/m; Power Drift = 0.16 dB
 Applied MIF = 0.00 dB
 Average Value of Peak (interpolated) = 103.0 V/m



PCTEST 2018

FCC ID: A3LSMJ737A		HAC (RF EMISSIONS) TEST REPORT		Approved by: Quality Manager
Filename: 1M1803080036-11-R1.A3L	Test Dates: 3/12/2018 - 3/13/2018	DUT Type: Portable Handset	Page 39 of 71	

© 2018 PCTEST Engineering Laboratory, Inc.

REV 3.2.M

01/12/2018

© 2018 PCTEST Engineering Laboratory, Inc. All rights reserved. Unless otherwise specified, no part of this report may be reproduced or utilized in any part, form or by any means, electronic or mechanical, including photocopying and microfilm, without permission in writing from PCTEST Engineering Laboratory, Inc. If you have any questions about this international copyright or have an enquiry about obtaining additional rights to this report or assembly of contents thereof, please contact INFO@PCTEST.COM.

PCTEST
 ENGINEERING LABORATORY, INC.
PCTEST Hearing-Aid Compatibility Facility

DUT: CD1880V3 - SN1064

Type: CD1880V3
Serial: 1064

Communication System: CW; Frequency: 1880 MHz;

Measurement Standard: DASYS (IEEE/IEC/ANSI C63.19-2011)

DASYS Configuration:



- Probe: ER3DV6 - SN2335; Calibrated: 8/11/2017;
- Sensor-Surface: 0mm (Fix Surface)
- Electronics: DAE4 Sn859; Calibrated: 5/17/2017
- Phantom: HAC Test Arch with AMCC; Type: SD HAC P01 BA;
- Measurement SW: DASYS2, Version 52.10 (0);

1880 MHz / 100mW HAC Dipole Validation at 15mm/Hearing Aid Compatibility Test (41x181x1):

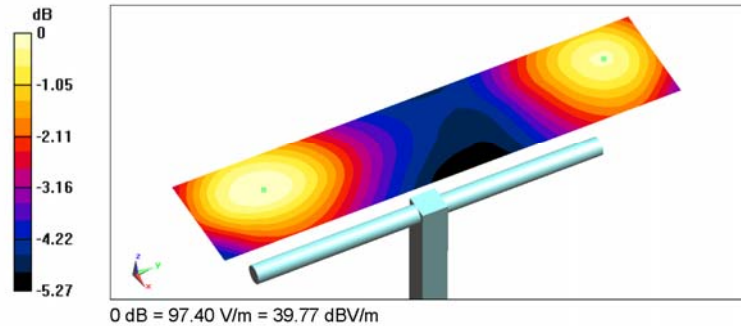
Interpolated grid: dx=0.5000 mm, dy=0.5000 mm
 Device Reference Point: 0, 0, -6.3 mm
 Reference Value = 168.2 V/m; Power Drift = 0.07 dB
 Applied MIF = 0.00 dB
 Average Value of Peak (interpolated) = 95.8 V/m



PCTEST 2018

FCC ID: A3LSMJ737A		HAC (RF EMISSIONS) TEST REPORT		Approved by: Quality Manager
Filename: 1M1803080036-11-R1.A3L	Test Dates: 3/12/2018 - 3/13/2018	DUT Type: Portable Handset	Page 40 of 71	

© 2018 PCTEST Engineering Laboratory, Inc.

REV 3.2.M

01/12/2018

© 2018 PCTEST Engineering Laboratory, Inc. All rights reserved. Unless otherwise specified, no part of this report may be reproduced or utilized in any part, form or by any means, electronic or mechanical, including photocopying and microfilm, without permission in writing from PCTEST Engineering Laboratory, Inc. If you have any questions about this international copyright or have an enquiry about obtaining additional rights to this report or assembly of contents thereof, please contact INFO@PCTEST.COM.



PCTEST Hearing-Aid Compatibility Facility

DUT: A3LSMJ737A

Type: Portable Handset
 Serial: 17914
 Backlight off
 Duty Cycle: 1:8.3

Communication System: GSM; Frequency: 848.8 MHz;

Measurement Standard: DASYS (IEEE/IEC/ANSI C63.19-2011)

DASYS Configuration:

- Probe: ER3DV6 - SN2335; Calibrated: 8/11/2017;
- Sensor-Surface: (Fix Surface)
- Electronics: DAE4 Sn859; Calibrated: 5/17/2017
- Phantom: HAC Test Arch with AMCC; Type: SD HAC P01 BA;
- Measurement SW: DASYS2, Version 52.10 (0);

GSM850 High Channel/Hearing Aid Compatibility Test (101x101x1):

Interpolated grid: dx=0.5000 mm, dy=0.5000 mm
 Device Reference Point: 0, 0, -6.3 mm
 Reference Value = 69.56 V/m; Power Drift = 0.16 dB
 Applied MIF = 3.53 dB
 RF audio interference level = 38.46 dBV/m
Emission category: M4

MIF scaled E-field

Grid 1 M4 37.72 dBV/m	Grid 2 M4 38.34 dBV/m	Grid 3 M4 38.04 dBV/m
Grid 4 M4 37.92 dBV/m	Grid 5 M4 38.46 dBV/m	Grid 6 M4 38.15 dBV/m
Grid 7 M4 37.78 dBV/m	Grid 8 M4 38.34 dBV/m	Grid 9 M4 37.99 dBV/m



PCTEST 2018

FCC ID: A3LSMJ737A	PCTEST ENGINEERING LABORATORY, INC.	HAC (RF EMISSIONS) TEST REPORT		Approved by: Quality Manager
Filename: 1M1803080036-11-R1.A3L	Test Dates: 3/12/2018 - 3/13/2018	DUT Type: Portable Handset		Page 41 of 71

© 2018 PCTEST Engineering Laboratory, Inc.

REV 3.2.M
01/12/2018

© 2018 PCTEST Engineering Laboratory, Inc. All rights reserved. Unless otherwise specified, no part of this report may be reproduced or utilized in any part, form or by any means, electronic or mechanical, including photocopying and microfilm, without permission in writing from PCTEST Engineering Laboratory, Inc. If you have any questions about this international copyright or have an enquiry about obtaining additional rights to this report or assembly of contents thereof, please contact INFO@PCTEST.COM.



PCTEST Hearing-Aid Compatibility Facility

DUT: A3LSMJ737A

Type: Portable Handset
 Serial: 17914
 Backlight off
 Duty Cycle: 1:8.3

Communication System: GSM; Frequency: 1850.2 MHz;

Measurement Standard: DASYS (IEEE/IEC/ANSI C63.19-2011)

DASYS Configuration:

- Probe: ER3DV6 - SN2335; Calibrated: 8/11/2017;
- Sensor-Surface: (Fix Surface)
- Electronics: DAE4 Sn859; Calibrated: 5/17/2017
- Phantom: HAC Test Arch with AMCC; Type: SD HAC P01 BA;
- Measurement SW: DASYS2, Version 52.10 (0);

GSM1900 Low Channel/Hearing Aid Compatibility Test (101x101x1):

Interpolated grid: dx=0.5000 mm, dy=0.5000 mm
 Device Reference Point: 0, 0, -6.3 mm
 Reference Value = 23.90 V/m; Power Drift = 0.12 dB
 Applied MIF = 3.56 dB
 RF audio interference level = 33.45 dBV/m
Emission category: M3

MIF scaled E-field

Grid 1 M3 32.73 dBV/m	Grid 2 M3 32.89 dBV/m	Grid 3 M3 32.3 dBV/m
Grid 4 M4 29.07 dBV/m	Grid 5 M3 31.93 dBV/m	Grid 6 M3 31.97 dBV/m
Grid 7 M3 30.45 dBV/m	Grid 8 M3 33.45 dBV/m	Grid 9 M3 33.43 dBV/m



PCTEST 2018

FCC ID: A3LSMJ737A	PCTEST ENGINEERING LABORATORY, INC.	HAC (RF EMISSIONS) TEST REPORT	Approved by: Quality Manager
Filename: 1M1803080036-11-R1.A3L	Test Dates: 3/12/2018 - 3/13/2018	DUT Type: Portable Handset	Page 42 of 71



© 2018 PCTEST Engineering Laboratory, Inc.

REV 3.2.M
01/12/2018

© 2018 PCTEST Engineering Laboratory, Inc. All rights reserved. Unless otherwise specified, no part of this report may be reproduced or utilized in any part, form or by any means, electronic or mechanical, including photocopying and microfilm, without permission in writing from PCTEST Engineering Laboratory, Inc. If you have any questions about this international copyright or have an enquiry about obtaining additional rights to this report or assembly of contents thereof, please contact INFO@PCTEST.COM.

14. CALIBRATION CERTIFICATES

The following pages include the probe calibration used to evaluate HAC for the DUT.

FCC ID: A3LSMJ737A	 PCTEST ENGINEERING LABORATORY, INC.	HAC (RF EMISSIONS) TEST REPORT		Approved by: Quality Manager
Filename: 1M1803080036-11-R1.A3L	Test Dates: 3/12/2018 - 3/13/2018	DUT Type: Portable Handset	Page 43 of 71	

© 2018 PCTEST Engineering Laboratory, Inc.

REV 3.2.M

01/12/2018

© 2018 PCTEST Engineering Laboratory, Inc. All rights reserved. Unless otherwise specified, no part of this report may be reproduced or utilized in any part, form or by any means, electronic or mechanical, including photocopying and microfilm, without permission in writing from PCTEST Engineering Laboratory, Inc. If you have any questions about this international copyright or have an enquiry about obtaining additional rights to this report or assembly of contents thereof, please contact INFO@PCTEST.COM.

**Calibration Laboratory of
Schmid & Partner
Engineering AG**
Zeughausstrasse 43, 8004 Zurich, Switzerland



S Schweizerischer Kalibrierdienst
C Service suisse d'étalonnage
S Servizio svizzero di taratura
S Swiss Calibration Service

Accredited by the Swiss Accreditation Service (SAS)
The Swiss Accreditation Service is one of the signatories to the EA
Multilateral Agreement for the recognition of calibration certificates

Accreditation No.: **SCS 0108**

Client **PC Test**

Certificate No: **ER3-2335_Aug17**

CALIBRATION CERTIFICATE

Object: **ER3DV6 - SN:2335**

Calibration procedure(s): **QA CAL-02.v8, QA CAL-25.v6**
Calibration procedure for E-field probes optimized for close near field evaluations in air

Calibration date: **August 11, 2017**

This calibration certificate documents the traceability to national standards, which realize the physical units of measurements (SI).
The measurements and the uncertainties with confidence probability are given on the following pages and are part of the certificate.

All calibrations have been conducted in the closed laboratory facility: environment temperature (22 ± 3)°C and humidity < 70%.

Calibration Equipment used (M&TF critical for calibration)

[Signature]
03/30/2017

Primary Standards	ID	Cal Date (Certificate No.)	Scheduled Calibration
Power meter NRP	SN: 104778	04-Apr-17 (No. 217-02521/02522)	Apr-18
Power sensor NRP-Z91	SN: 103244	04-Apr-17 (No. 217-02521)	Apr-18
Power sensor NRP-Z91	SN: 103245	04-Apr-17 (No. 217-02525)	Apr-18
Reference 20 dB Attenuator	SN: S5277 (20x)	07-Apr-17 (No. 217-02528)	Apr-18
Reference Probe ER3DV6	SN: 2328	14-Oct-16 (No. ER3-2328_Oct16)	Oct-17
DAE4	SN: 789	2-Aug-17 (No. DAE4-789_Aug17)	Aug-18
Secondary Standards	ID	Check Date (in house)	Scheduled Check
Power meter E4419B	SN: GB41293874	06-Apr-16 (in house check Jun-16)	In house check: Jun-18
Power sensor E4412A	SN: MY41498087	06-Apr-16 (in house check Jun-16)	In house check: Jun-18
Power sensor E4412A	SN: 000110210	06-Apr-16 (in house check Jun-16)	In house check: Jun-18
RF generator HP 8648C	SN: US3642U01700	04-Aug-99 (in house check Jun-16)	In house check: Jun-18
Network Analyzer HP 8753E	SN: US37390585	18-Oct-01 (in house check Oct-16)	In house check: Oct-17

	Name	Function	Signature
Calibrated by:	Leif Klynsner	Laboratory Technician	<i>[Signature]</i>
Approved by:	Katja Pokovic	Technical Manager	<i>[Signature]</i>

Issued: August 12, 2017

This calibration certificate shall not be reproduced except in full without written approval of the laboratory.

Certificate No: ER3-2335_Aug17

Page 1 of 10

FCC ID: A3LSMJ737A	PCTEST TECHNICAL LABORATORY, INC.	HAC (RF EMISSIONS) TEST REPORT		Approved by: Quality Manager
Filename: 1M1803080036-11-R1.A3L	Test Dates: 3/12/2018 - 3/13/2018	DUT Type: Portable Handset	Page 44 of 71	

© 2018 PCTEST Engineering Laboratory, Inc.

REV 3.2.M
01/12/2018

© 2018 PCTEST Engineering Laboratory, Inc. All rights reserved. Unless otherwise specified, no part of this report may be reproduced or utilized in any part, form or by any means, electronic or mechanical, including photocopying and microfilm, without permission in writing from PCTEST Engineering Laboratory, Inc. If you have any questions about this international copyright or have an enquiry about obtaining additional rights to this report or assembly of contents thereof, please contact INFO@PCTEST.COM.



Accredited by the Swiss Accreditation Service (SAS)
The Swiss Accreditation Service is one of the signatories to the EA
Multilateral Agreement for the recognition of calibration certificates

Accreditation No.: **SCS 0108**

Glossary:

NORM_{x,y,z} sensitivity in free space
DCP diode compression point
CF crest factor (1/duty_cycle) of the RF signal
A, B, C, D modulation dependent linearization parameters
Polarization ϕ ϕ rotation around probe axis
Polarization ϑ ϑ rotation around an axis that is in the plane normal to probe axis (at measurement center),
i.e., $\vartheta = 0$ is normal to probe axis
Connector Angle information used in DASY system to align probe sensor X to the robot coordinate system

Calibration is Performed According to the Following Standards:

- a) IEEE Std 1309-2005, "IEEE Standard for calibration of electromagnetic field sensors and probes, excluding antennas, from 9 kHz to 40 GHz", December 2005
- b) CTIA Test Plan for Hearing Aid Compatibility, Rev 3.0, November 2013

Methods Applied and Interpretation of Parameters:

- **NORM_{x,y,z}**: Assessed for E-field polarization $\vartheta = 0$ for XY sensors and $\vartheta = 90$ for Z sensor ($f \leq 900$ MHz in TEM-cell; $f > 1800$ MHz: R22 waveguide).
- **NORM(f)_{x,y,z} = NORM_{x,y,z} * frequency_response** (see Frequency Response Chart).
- **DCP_{x,y,z}**: DCP are numerical linearization parameters assessed based on the data of power sweep with CW signal (no uncertainty required). DCP does not depend on frequency nor media.
- **PAR**: PAR is the Peak to Average Ratio that is not calibrated but determined based on the signal characteristics
- **A_{x,y,z}; B_{x,y,z}; C_{x,y,z}; D_{x,y,z}; VR_{x,y,z}**: A, B, C, D are numerical linearization parameters assessed based on the data of power sweep for specific modulation signal. The parameters do not depend on frequency nor media. VR is the maximum calibration range expressed in RMS voltage across the diode.
- **Spherical isotropy (3D deviation from isotropy)**: in a locally homogeneous field realized using an open waveguide setup.
- **Sensor Offset**: The sensor offset corresponds to the offset of virtual measurement center from the probe tip (on probe axis). No tolerance required.
- **Connector Angle**: The angle is assessed using the information gained by determining the NORM_x (no uncertainty required).



FCC ID: A3LSMJ737A	PCTEST TECHNOLOGICAL LABORATORY, INC.	HAC (RF EMISSIONS) TEST REPORT		Approved by: Quality Manager
Filename: 1M1803080036-11-R1.A3L	Test Dates: 3/12/2018 - 3/13/2018	DUT Type: Portable Handset	Page 45 of 71	

Probe ER3DV6

SN:2335

Manufactured: September 9, 2003
Calibrated: August 11, 2017

Calibrated for DASY/EASY Systems
(Note: non-compatible with DASY2 system!)

FCC ID: A3LSMJ737A	 PCTEST <small>ENGINEERING LABORATORY, INC.</small>	HAC (RF EMISSIONS) TEST REPORT	 Approved by: Quality Manager
Filename: 1M1803080036-11-R1.A3L	Test Dates: 3/12/2018 - 3/13/2018	DUT Type: Portable Handset	Page 46 of 71

DASY/EASY - Parameters of Probe: ER3DV6 - SN:2335

Basic Calibration Parameters

	Sensor X	Sensor Y	Sensor Z	Unc (k=2)
Norm ($\mu\text{V}/(\text{V}/\text{m})^2$)	1.61	1.64	1.83	$\pm 10.1\%$
DCP (mV) ^b	99.3	98.5	100.0	



Modulation Calibration Parameters

UID	Communication System Name		A dB	B dB $\sqrt{\mu\text{V}}$	C	D dB	VR mV	Unc ^E (k=2)
0	CW	X	0.0	0.0	1.0	0.00	194.5	$\pm 3.8\%$
		Y	0.0	0.0	1.0		207.3	
		Z	0.0	0.0	1.0		191.6	

The reported uncertainty of measurement is stated as the standard uncertainty of measurement multiplied by the coverage factor k=2, which for a normal distribution corresponds to a coverage probability of approximately 95%.

^B Numerical linearization parameter: uncertainty not required.



^E Uncertainty is determined using the max. deviation from linear response applying rectangular distribution and is expressed for the square of the field value.

FCC ID: A3LSMJ737A	 PCTEST ENGINEERING LABORATORY, INC.	HAC (RF EMISSIONS) TEST REPORT		Approved by: Quality Manager
Filename: 1M1803080036-11-R1.A3L	Test Dates: 3/12/2018 - 3/13/2018	DUT Type: Portable Handset		Page 47 of 71

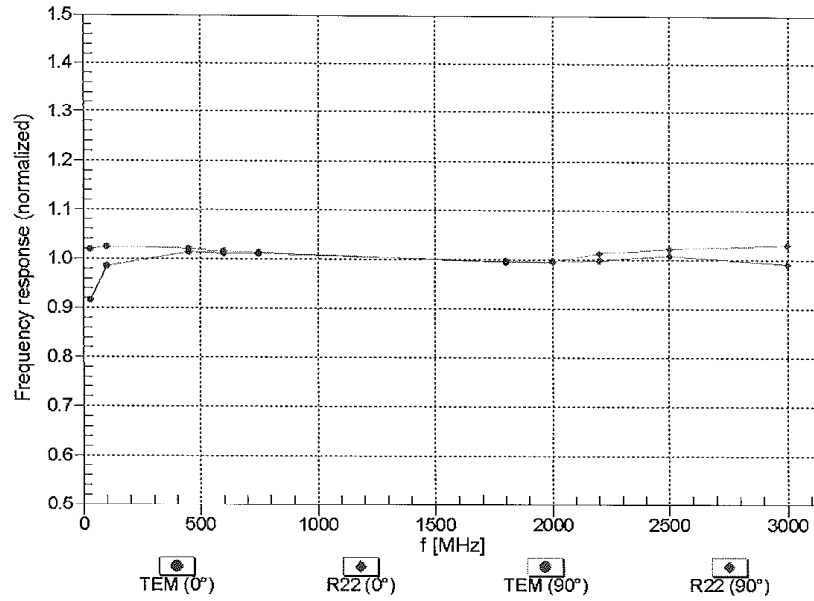
Frequency Response of E-Field (TEM-Cell: ifi110 EXX, Waveguide: R22)



Uncertainty of Frequency Response of E-field: ± 6.3% (k=2)

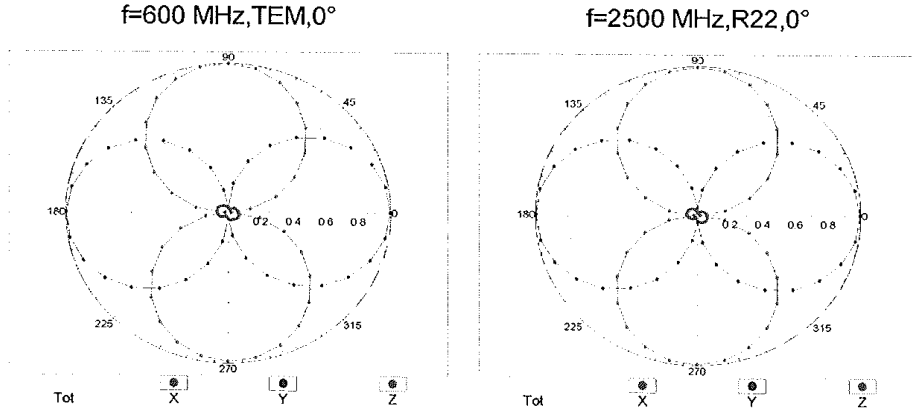

FCC ID: A3LSMJ737A	 PCTEST <small>TECHNOLOGICAL LABORATORY, INC.</small>	HAC (RF EMISSIONS) TEST REPORT	 Approved by: Quality Manager
Filename: 1M1803080036-11-R1.A3L	Test Dates: 3/12/2018 - 3/13/2018	DUT Type: Portable Handset	Page 48 of 71

Receiving Pattern (ϕ), $\theta = 0^\circ$

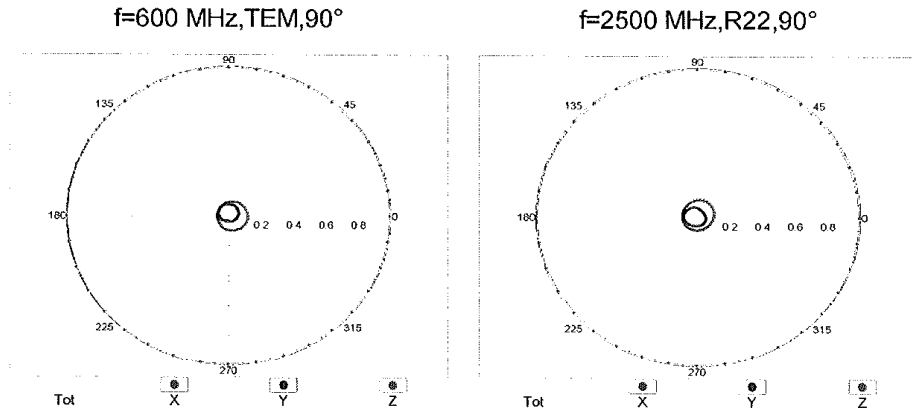

Receiving Pattern (ϕ), $\theta = 90^\circ$



FCC ID: A3LSMJ737A	 PCTEST ENGINEERING LABORATORY, INC.	HAC (RF EMISSIONS) TEST REPORT	 SAMSUNG	Approved by: Quality Manager
Filename: 1M1803080036-11-R1.A3L	Test Dates: 3/12/2018 - 3/13/2018	DUT Type: Portable Handset		Page 49 of 71

Receiving Pattern (ϕ), $\vartheta = 0^\circ$

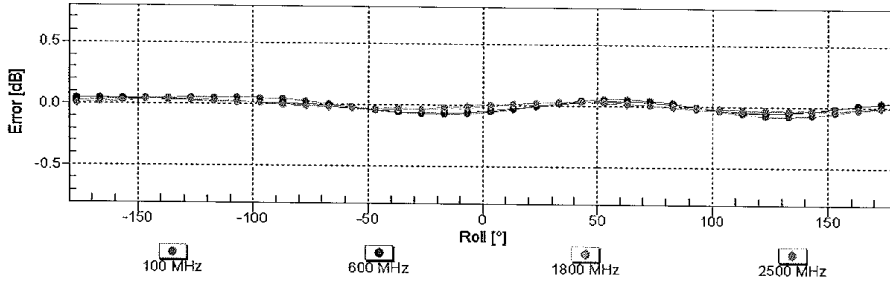

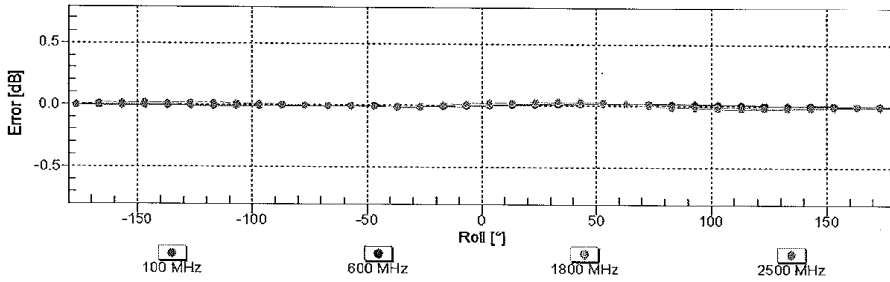

Uncertainty of Axial Isotropy Assessment: $\pm 0.5\%$ ($k=2$)

Receiving Pattern (ϕ), $\vartheta = 90^\circ$





Uncertainty of Axial Isotropy Assessment: $\pm 0.5\%$ ($k=2$)

<p>FCC ID: A3LSMJ737A</p>		<p>HAC (RF EMISSIONS) TEST REPORT</p>	 <p>Approved by: Quality Manager</p>
<p>Filename: 1M1803080036-11-R1.A3L</p>	<p>Test Dates: 3/12/2018 - 3/13/2018</p>	<p>DUT Type: Portable Handset</p>	<p>Page 50 of 71</p>

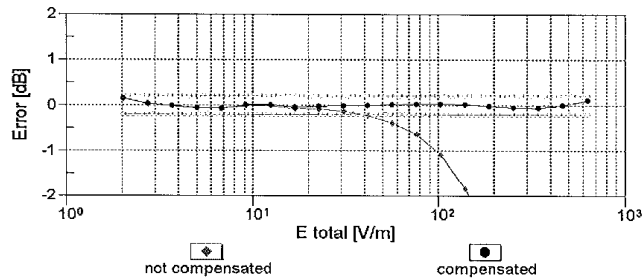
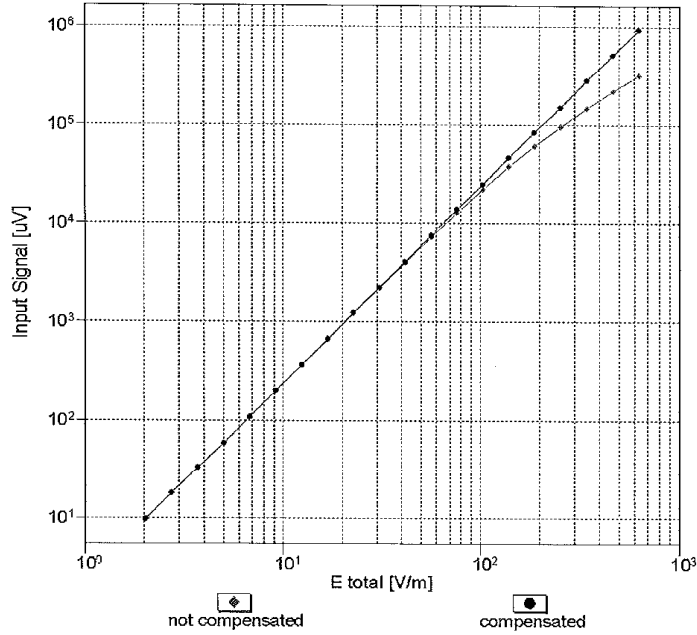
Dynamic Range f(E-field) (TEM cell , f = 900 MHz)





Uncertainty of Linearity Assessment: ± 0.6% (k=2)

<p>FCC ID: A3LSMJ737A</p>		<p>HAC (RF EMISSIONS) TEST REPORT</p> 	<p>Approved by: Quality Manager</p>
<p>Filename: 1M1803080036-11-R1.A3L</p>	<p>Test Dates: 3/12/2018 - 3/13/2018</p>	<p>DUT Type: Portable Handset</p>	<p>Page 51 of 71</p>

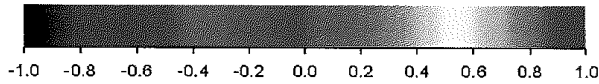
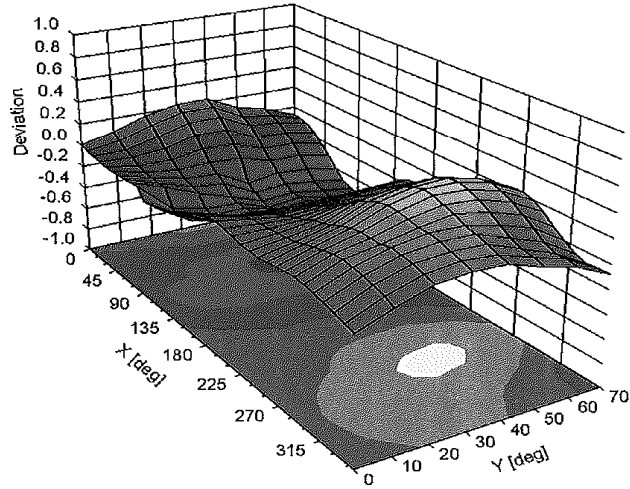
Deviation from Isotropy in Air Error (ϕ , ϑ), $f = 900$ MHz





Uncertainty of Spherical Isotropy Assessment: $\pm 2.6\%$ ($k=2$)

FCC ID: A3LSMJ737A		HAC (RF EMISSIONS) TEST REPORT	 Approved by: Quality Manager
Filename: 1M1803080036-11-R1.A3L	Test Dates: 3/12/2018 - 3/13/2018	DUT Type: Portable Handset	Page 52 of 71

DASY/EASY - Parameters of Probe: ER3DV6 - SN:2335**Other Probe Parameters**

Sensor Arrangement	Rectangular
Connector Angle (°)	83.1
Mechanical Surface Detection Mode	enabled
Optical Surface Detection Mode	disabled
Probe Overall Length	337 mm
Probe Body Diameter	10 mm
Tip Length	10 mm
Tip Diameter	8 mm
Probe Tip to Sensor X Calibration Point	2.5 mm
Probe Tip to Sensor Y Calibration Point	2.5 mm
Probe Tip to Sensor Z Calibration Point	2.5 mm

FCC ID: A3LSMJ737A	 PCTEST ENGINEERING LABORATORY, INC.	HAC (RF EMISSIONS) TEST REPORT		Approved by: Quality Manager
Filename: 1M1803080036-11-R1.A3L	Test Dates: 3/12/2018 - 3/13/2018	DUT Type: Portable Handset	Page 53 of 71	

**Calibration Laboratory of
Schmid & Partner
Engineering AG**
Zeughausstrasse 43, 8004 Zurich, Switzerland



S Schweizerischer Kalibrierdienst
C Service suisse d'étalonnage
S Servizio svizzero di taratura
S Swiss Calibration Service

Accredited by the Swiss Accreditation Service (SAS)
The Swiss Accreditation Service is one of the signatories to the EA
Multilateral Agreement for the recognition of calibration certificates

Accreditation No.: **SCS 0108**

Client **PC Test**

Certificate No: **CD835V3-1082_May16**

CALIBRATION CERTIFICATE			
Object	CD835V3 - SN: 1082		
Calibration procedure(s)	QA CAL-20.v6 Calibration procedure for dipoles in air		
Calibration date:	May 10, 2016		
<p>This calibration certificate documents the traceability to national standards, which realize the physical units of measurements (SI). The measurements and the uncertainties with confidence probability are given on the following pages and are part of the certificate.</p> <p>All calibrations have been conducted in the closed laboratory facility: environment temperature (22 ± 3)°C and humidity < 70%.</p>			
Calibration Equipment used (M&TE critical for calibration)			
Primary Standards	ID #	Cal Date (Certificate No.)	Scheduled Calibration
Power meter NRP	SN: 104778	06-Apr-16 (No. 217-02288/02289)	Apr-17
Power sensor NRP-Z91	SN: 103244	06-Apr-16 (No. 217-02288)	Apr-17
Power sensor NRP-Z91	SN: 103245	06-Apr-16 (No. 217-02289)	Apr-17
Reference 20 dB Attenuator	SN: 5058 (20k)	05-Apr-16 (No. 217-02292)	Apr-17
Type-N mismatch combination	SN: 5047.2 / 06327	05-Apr-16 (No. 217-02295)	Apr-17
Probe ER3DV6	SN: 2336	31-Dec-15 (No. ER3-2336_Dec15)	Dec-16
Probe H3DV6	SN: 6065	31-Dec-15 (No. H3-6065_Dec15)	Dec-16
DAE4	SN: 781	04-Sep-15 (No. DAE4-781_Sep15)	Sep-16
Secondary Standards	ID #	Check Date (in house)	Scheduled Check
Power meter Agilent 4419B	SN: GB42420191	09-Oct-09 (in house check Sep-14)	In house check: Oct-17
Power sensor HP E4412A	SN: US38485102	05-Jan-10 (in house check Sep-14)	In house check: Oct-17
Power sensor HP 8482A	SN: US37295597	09-Oct-09 (in house check Sep-14)	In house check: Oct-17
RF generator R&S SMT-06	SN: 832283/011	27-Aug-12 (in house check Oct-15)	In house check: Oct-17
Network Analyzer HP 8753E	SN: US37390585	18-Oct-01 (in house check Oct-15)	In house check: Oct-16
Calibrated by:	Name Jeton Kastrati	Function Laboratory Technician	Signature
Approved by:	Name Katja Pokovic	Technical Manager	Signature
			Issued: May 12, 2016
This calibration certificate shall not be reproduced except in full without written approval of the laboratory.			

Certificate No: CD835V3-1082_May16

Page 1 of 5

FCC ID: A3LSMJ737A	PCTEST ENGINEERING LABORATORY, INC.	HAC (RF EMISSIONS) TEST REPORT		Approved by: Quality Manager
Filename: 1M1803080036-11-R1.A3L	Test Dates: 3/12/2018 - 3/13/2018	DUT Type: Portable Handset	Page 54 of 71	

© 2018 PCTEST Engineering Laboratory, Inc.

REV 3.2.M

01/12/2018

© 2018 PCTEST Engineering Laboratory, Inc. All rights reserved. Unless otherwise specified, no part of this report may be reproduced or utilized in any part, form or by any means, electronic or mechanical, including photocopying and microfilm, without permission in writing from PCTEST Engineering Laboratory, Inc. If you have any questions about this international copyright or have an enquiry about obtaining additional rights to this report or assembly of contents thereof, please contact INFO@PCTEST.COM.

**Calibration Laboratory of
Schmid & Partner
Engineering AG**
Zeughausstrasse 43, 8004 Zurich, Switzerland



S Schweizerischer Kalibrierdienst
C Service suisse d'étalonnage
S Servizio svizzero di taratura
S Swiss Calibration Service

Accredited by the Swiss Accreditation Service (SAS)
The Swiss Accreditation Service is one of the signatories to the EA
Multilateral Agreement for the recognition of calibration certificates

Accreditation No.: **SCS 0108**

References

- [1] ANSI-C63.19-2011
American National Standard, Methods of Measurement of Compatibility between Wireless Communications Devices and Hearing Aids.

Methods Applied and Interpretation of Parameters:

- **Coordinate System:** y-axis is in the direction of the dipole arms. z-axis is from the basis of the antenna (mounted on the table) towards its feed point between the two dipole arms. x-axis is normal to the other axes. In coincidence with the standards [1], the measurement planes (probe sensor center) are selected to be at a distance of 15 mm above the top metal edge of the dipole arms.
- **Measurement Conditions:** Further details are available from the hardcopies at the end of the certificate. All figures stated in the certificate are valid at the frequency indicated. The forward power to the dipole connector is set with a calibrated power meter connected and monitored with an auxiliary power meter connected to a directional coupler. While the dipole under test is connected, the forward power is adjusted to the same level.
- **Antenna Positioning:** The dipole is mounted on a HAC Test Arch phantom using the matching dipole positioner with the arms horizontal and the feeding cable coming from the floor. The measurements are performed in a shielded room with absorbers around the setup to reduce the reflections. It is verified before the mounting of the dipole under the Test Arch phantom, that its arms are perfectly in a line. It is installed on the HAC dipole positioner with its arms parallel below the dielectric reference wire and able to move elastically in vertical direction without changing its relative position to the top center of the Test Arch phantom. The vertical distance to the probe is adjusted after dipole mounting with a DASY5 Surface Check job. Before the measurement, the distance between phantom surface and probe tip is verified. The proper measurement distance is selected by choosing the matching section of the HAC Test Arch phantom with the proper device reference point (upper surface of the dipole) and the matching grid reference point (tip of the probe) considering the probe sensor offset. The vertical distance to the probe is essential for the accuracy.
- **Feed Point Impedance and Return Loss:** These parameters are measured using a HP 8753E Vector Network Analyzer. The impedance is specified at the SMA connector of the dipole. The influence of reflections was eliminated by applying the averaging function while moving the dipole in the air, at least 70cm away from any obstacles.
- **E-field distribution:** E field is measured in the x-y-plane with an isotropic ER3D-field probe with 100 mW forward power to the antenna feed point. In accordance with [1], the scan area is 20mm wide, its length exceeds the dipole arm length (180 or 90mm). The sensor center is 15 mm (in z) above the metal top of the dipole arms. Two 3D maxima are available near the end of the dipole arms. Assuming the dipole arms are perfectly in one line, the average of these two maxima (in subgrid 2 and subgrid 8) is determined to compensate for any non-parallelity to the measurement plane as well as the sensor displacement. The E-field value stated as calibration value represents the maximum of the interpolated 3D-E-field, in the plane above the dipole surface.

The reported uncertainty of measurement is stated as the standard uncertainty of measurement multiplied by the coverage factor k=2, which for a normal distribution corresponds to a coverage probability of approximately 95%.

FCC ID: A3LSMJ737A	PCTEST ENGINEERING LABORATORY, INC.	HAC (RF EMISSIONS) TEST REPORT		Approved by: Quality Manager
Filename: 1M1803080036-11-R1.A3L	Test Dates: 3/12/2018 - 3/13/2018	DUT Type: Portable Handset	Page 55 of 71	

Measurement Conditions

DASY system configuration, as far as not given on page 1.

DASY Version	DASY5	V52.8.8
Phantom	HAC Test Arch	
Distance Dipole Top - Probe Center	15 mm	
Scan resolution	dx, dy = 5 mm	
Frequency	835 MHz ± 1 MHz	
Input power drift	< 0.05 dB	

Maximum Field values at 835 MHz

E-field 15 mm above dipole surface	condition	Interpolated maximum
Maximum measured above high end	100 mW input power	107.5 V/m = 40.63 dBV/m
Maximum measured above low end	100 mW input power	106.1 V/m = 40.51 dBV/m
Averaged maximum above arm	100 mW input power	106.8 V/m ± 12.8 % (k=2)

Appendix (Additional assessments outside the scope of SCS 0108)

Antenna Parameters

Frequency	Return Loss	Impedance
800 MHz	16.4 dB	44.5 Ω - 13.4 jΩ
835 MHz	26.3 dB	50.0 Ω + 4.9 jΩ
900 MHz	16.4 dB	57.4 Ω - 14.7 jΩ
950 MHz	21.9 dB	43.6 Ω + 4.0 jΩ
960 MHz	17.2 dB	47.9 Ω + 13.5 jΩ



3.2 Antenna Design and Handling

The calibration dipole has a symmetric geometry with a built-in two stub matching network, which leads to the enhanced bandwidth.

The dipole is built of standard semirigid coaxial cable. The internal matching line is open ended. The antenna is therefore open for DC signals.

Do not apply force to dipole arms, as they are liable to bend. The soldered connections near the feedpoint may be damaged. After excessive mechanical stress or overheating, check the impedance characteristics to ensure that the internal matching network is not affected.

After long term use with 40W radiated power, only a slight warming of the dipole near the feedpoint can be measured.

FCC ID: A3LSMJ737A	 PCTEST ENGINEERING LABORATORY, INC.	HAC (RF EMISSIONS) TEST REPORT		Approved by: Quality Manager
Filename: 1M1803080036-11-R1.A3L	Test Dates: 3/12/2018 - 3/13/2018	DUT Type: Portable Handset		Page 56 of 71

Impedance Measurement Plot

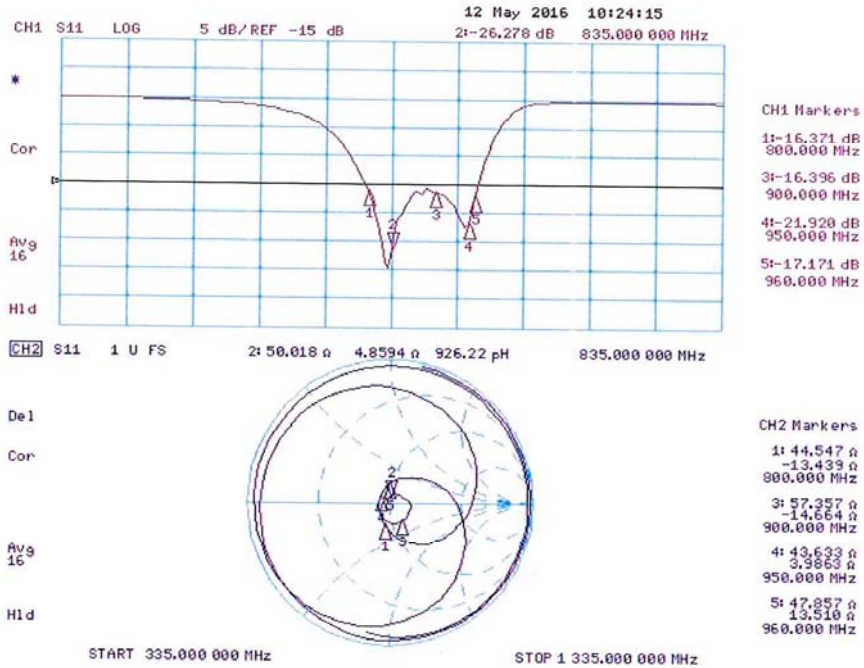

FCC ID: A3LSMJ737A	PCTEST ENGINEERING LABORATORY, INC.	HAC (RF EMISSIONS) TEST REPORT	SAMSUNG	Approved by: Quality Manager
Filename: 1M1803080036-11-R1.A3L	Test Dates: 3/12/2018 - 3/13/2018	DUT Type: Portable Handset		Page 57 of 71

DASY5 E-field Result

Date: 10.05.2016

Test Laboratory: SPEAG Lab2

DUT: HAC-Dipole 835 MHz; Type: CD835V3; Serial: CD835V3 - SN: 1082

Communication System: UID 0 - CW ; Frequency: 835 MHz
 Medium parameters used: $\sigma = 0$ S/m, $\epsilon_r = 1$; $\rho = 1000$ kg/m³
 Phantom section: RF Section
 Measurement Standard: DASY5 (IEEE/IEC/ANSI C63.19-2011)

DASY52 Configuration:

- Probe: ER3DV6 - SN2336; ConvF(1, 1, 1); Calibrated: 31.12.2015;
- Sensor-Surface: (Fix Surface)
- Electronics: DAE4 Sn781; Calibrated: 04.09.2015
- Phantom: HAC Test Arch with AMCC; Type: SD HAC P01 BA; Serial: 1070
- DASY52 52.8.8(1258); SEMCAD X 14.6.10(7372)

Dipole E-Field measurement @ 835MHz/E-Scan - 835MHz d=15mm/Hearing Aid Compatibility Test (41x361x1):

Interpolated grid: dx=0.5000 mm, dy=0.5000 mm
 Device Reference Point: 0, 0, -6.3 mm
 Reference Value = 109.8 V/m; Power Drift = 0.02 dB
 Applied MIF = 0.00 dB
 RF audio interference level = 40.63 dBV/m
Emission category: M3

MIF scaled E-field

Grid 1 M3 40.52 dBV/m	Grid 2 M3 40.63 dBV/m	Grid 3 M3 40.46 dBV/m
Grid 4 M4 35.69 dBV/m	Grid 5 M4 35.78 dBV/m	Grid 6 M4 35.62 dBV/m
Grid 7 M3 40.38 dBV/m	Grid 8 M3 40.51 dBV/m	Grid 9 M3 40.37 dBV/m

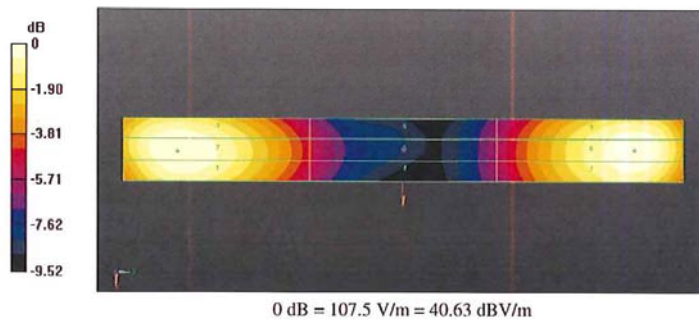

FCC ID: A3LSMJ737A	PCTEST ENGINEERING LABORATORY, INC.	HAC (RF EMISSIONS) TEST REPORT	SAMSUNG	Approved by: Quality Manager
Filename: 1M1803080036-11-R1.A3L	Test Dates: 3/12/2018 - 3/13/2018	DUT Type: Portable Handset		Page 58 of 71

**Calibration Laboratory of
Schmid & Partner
Engineering AG**
Zeughausstrasse 43, 8004 Zurich, Switzerland



S Schweizerischer Kalibrierdienst
C Service suisse d'étalonnage
S Servizio svizzero di taratura
S Swiss Calibration Service

Accredited by the Swiss Accreditation Service (SAS)
The Swiss Accreditation Service is one of the signatories to the EA
Multilateral Agreement for the recognition of calibration certificates

Accreditation No.: **SCS 0108**

Client **PC Test**

Certificate No: **CD1880V3-1064_May16**

CALIBRATION CERTIFICATE			
Object	CD1880V3 - SN: 1064		
Calibration procedure(s)	QA CAL-20.v6 Calibration procedure for dipoles in air		
Calibration date:	May 12, 2016		
<p>This calibration certificate documents the traceability to national standards, which realize the physical units of measurements (SI). The measurements and the uncertainties with confidence probability are given on the following pages and are part of the certificate.</p> <p>All calibrations have been conducted in the closed laboratory facility: environment temperature (22 ± 3)°C and humidity < 70%.</p>			
Calibration Equipment used (M&TE critical for calibration)			
Primary Standards	ID #	Cal Date (Certificate No.)	Scheduled Calibration
Power meter NRP	SN: 104778	06-Apr-16 (No. 217-02288/02289)	Apr-17
Power sensor NRP-Z91	SN: 103244	06-Apr-16 (No. 217-02288)	Apr-17
Power sensor NRP-Z91	SN: 103245	06-Apr-16 (No. 217-02289)	Apr-17
Reference 20 dB Attenuator	SN: 5058 (20k)	05-Apr-16 (No. 217-02292)	Apr-17
Type-N mismatch combination	SN: 5047.2 / 06327	05-Apr-16 (No. 217-02295)	Apr-17
Probe ER3DV6	SN: 2336	31-Dec-15 (No. ER3-2336_Dec15)	Dec-16
Probe H3DV6	SN: 6065	31-Dec-15 (No. H3-6065_Dec15)	Dec-16
DAE4	SN: 781	04-Sep-15 (No. DAE4-781_Sep15)	Sep-16
Secondary Standards	ID #	Check Date (in house)	Scheduled Check
Power meter Agilent 4419B	SN: GB42420191	09-Oct-09 (in house check Sep-14)	In house check: Oct-17
Power sensor HP E4412A	SN: US38485102	05-Jan-10 (in house check Sep-14)	In house check: Oct-17
Power sensor HP 8482A	SN: US37295597	09-Oct-09 (in house check Sep-14)	In house check: Oct-17
RF generator R&S SMT-06	SN: 832283/011	27-Aug-12 (in house check Oct-15)	In house check: Oct-17
Network Analyzer HP 8753E	SN: US37390585	18-Oct-01 (in house check Oct-15)	In house check: Oct-16
Calibrated by:	Name Jeton Kastrati	Function Laboratory Technician	Signature
Approved by:	Name Katja Pokovic	Function Technical Manager	Signature
			Issued: May 12, 2016
This calibration certificate shall not be reproduced except in full without written approval of the laboratory.			

Certificate No: CD1880V3-1064_May16

Page 1 of 7

FCC ID: A3LSMJ737A	PCTEST TECHNICAL LABORATORY, INC.	HAC (RF EMISSIONS) TEST REPORT		Approved by: Quality Manager
Filename: 1M1803080036-11-R1.A3L	Test Dates: 3/12/2018 - 3/13/2018	DUT Type: Portable Handset	Page 59 of 71	

© 2018 PCTEST Engineering Laboratory, Inc.

REV 3.2.M
01/12/2018

© 2018 PCTEST Engineering Laboratory, Inc. All rights reserved. Unless otherwise specified, no part of this report may be reproduced or utilized in any part, form or by any means, electronic or mechanical, including photocopying and microfilm, without permission in writing from PCTEST Engineering Laboratory, Inc. If you have any questions about this international copyright or have an enquiry about obtaining additional rights to this report or assembly of contents thereof, please contact INFO@PCTEST.COM.

**Calibration Laboratory of
Schmid & Partner
Engineering AG**
Zeughausstrasse 43, 8004 Zurich, Switzerland



S Schweizerischer Kalibrierdienst
C Service suisse d'étalonnage
S Servizio svizzero di taratura
S Swiss Calibration Service

Accredited by the Swiss Accreditation Service (SAS)
The Swiss Accreditation Service is one of the signatories to the EA
Multilateral Agreement for the recognition of calibration certificates

Accreditation No.: **SCS 0108**

References

- [1] ANSI-C63.19-2011
American National Standard, Methods of Measurement of Compatibility between Wireless Communications Devices and Hearing Aids.

Methods Applied and Interpretation of Parameters:

- *Coordinate System:* y-axis is in the direction of the dipole arms. z-axis is from the basis of the antenna (mounted on the table) towards its feed point between the two dipole arms. x-axis is normal to the other axes. In coincidence with the standards [1], the measurement planes (probe sensor center) are selected to be at a distance of 15 mm above the top metal edge of the dipole arms.
- *Measurement Conditions:* Further details are available from the hardcopies at the end of the certificate. All figures stated in the certificate are valid at the frequency indicated. The forward power to the dipole connector is set with a calibrated power meter connected and monitored with an auxiliary power meter connected to a directional coupler. While the dipole under test is connected, the forward power is adjusted to the same level.
- *Antenna Positioning:* The dipole is mounted on a HAC Test Arch phantom using the matching dipole positioner with the arms horizontal and the feeding cable coming from the floor. The measurements are performed in a shielded room with absorbers around the setup to reduce the reflections. It is verified before the mounting of the dipole under the Test Arch phantom, that its arms are perfectly in a line. It is installed on the HAC dipole positioner with its arms parallel below the dielectric reference wire and able to move elastically in vertical direction without changing its relative position to the top center of the Test Arch phantom. The vertical distance to the probe is adjusted after dipole mounting with a DASY5 Surface Check job. Before the measurement, the distance between phantom surface and probe tip is verified. The proper measurement distance is selected by choosing the matching section of the HAC Test Arch phantom with the proper device reference point (upper surface of the dipole) and the matching grid reference point (tip of the probe) considering the probe sensor offset. The vertical distance to the probe is essential for the accuracy.
- *Feed Point Impedance and Return Loss:* These parameters are measured using a HP 8753E Vector Network Analyzer. The impedance is specified at the SMA connector of the dipole. The influence of reflections was eliminating by applying the averaging function while moving the dipole in the air, at least 70cm away from any obstacles.
- *E-field distribution:* E field is measured in the x-y-plane with an isotropic ER3D-field probe with 100 mW forward power to the antenna feed point. In accordance with [1], the scan area is 20mm wide, its length exceeds the dipole arm length (180 or 90mm). The sensor center is 15 mm (in z) above the metal top of the dipole arms. Two 3D maxima are available near the end of the dipole arms. Assuming the dipole arms are perfectly in one line, the average of these two maxima (in subgrid 2 and subgrid 8) is determined to compensate for any non-parallelity to the measurement plane as well as the sensor displacement. The E-field value stated as calibration value represents the maximum of the interpolated 3D-E-field, in the plane above the dipole surface.

The reported uncertainty of measurement is stated as the standard uncertainty of measurement multiplied by the coverage factor k=2, which for a normal distribution corresponds to a coverage probability of approximately 95%.

FCC ID: A3LSMJ737A	PCTEST ENGINEERING LABORATORY, INC.	HAC (RF EMISSIONS) TEST REPORT		Approved by: Quality Manager
Filename: 1M1803080036-11-R1.A3L	Test Dates: 3/12/2018 - 3/13/2018	DUT Type: Portable Handset	Page 60 of 71	

Measurement Conditions

DASY system configuration, as far as not given on page 1.



DASY Version	DASY5	V52.8.8
Phantom	HAC Test Arch	
Distance Dipole Top - Probe Center	15 mm	
Scan resolution	dx, dy = 5 mm	
Frequency	1730 MHz ± 1 MHz 1880 MHz ± 1 MHz	
Input power drift	< 0.05 dB	

Maximum Field values at 1730 MHz

E-field 15 mm above dipole surface	condition	Interpolated maximum
Maximum measured above high end	100 mW input power	96.1 V/m = 39.66 dBV/m
Maximum measured above low end	100 mW input power	95.3 V/m = 39.58 dBV/m
Averaged maximum above arm	100 mW input power	95.7 V/m ± 12.8 % (k=2)

Maximum Field values at 1880 MHz

E-field 15 mm above dipole surface	condition	Interpolated maximum
Maximum measured above high end	100 mW input power	91.2 V/m = 39.20 dBV/m
Maximum measured above low end	100 mW input power	88.0 V/m = 38.89 dBV/m
Averaged maximum above arm	100 mW input power	89.6 V/m ± 12.8 % (k=2)

FCC ID: A3LSMJ737A	 PCTEST ENGINEERING LABORATORY, INC.	HAC (RF EMISSIONS) TEST REPORT		Approved by: Quality Manager
Filename: 1M1803080036-11-R1.A3L	Test Dates: 3/12/2018 - 3/13/2018	DUT Type: Portable Handset	Page 61 of 71	

Appendix (Additional assessments outside the scope of SCS 0108)

Antenna Parameters

Nominal Frequencies

Frequency	Return Loss	Impedance
1730 MHz	24.0 dB	49.6 Ω + 6.3 j Ω
1880 MHz	19.8 dB	49.5 Ω + 10.2 j Ω
1900 MHz	20.4 dB	52.9 Ω + 9.4 j Ω
1950 MHz	26.8 dB	54.4 Ω + 1.8 j Ω
2000 MHz	22.7 dB	43.2 Ω + 0.8 j Ω



3.2 Antenna Design and Handling

The calibration dipole has a symmetric geometry with a built-in two stub matching network, which leads to the enhanced bandwidth.

The dipole is built of standard semirigid coaxial cable. The internal matching line is open ended. The antenna is therefore open for DC signals.

Do not apply force to dipole arms, as they are liable to bend. The soldered connections near the feedpoint may be damaged. After excessive mechanical stress or overheating, check the impedance characteristics to ensure that the internal matching network is not affected.

After long term use with 40W radiated power, only a slight warming of the dipole near the feedpoint can be measured.

FCC ID: A3LSMJ737A	 PCTEST ENGINEERING LABORATORY, INC.	HAC (RF EMISSIONS) TEST REPORT		Approved by: Quality Manager
Filename: 1M1803080036-11-R1.A3L	Test Dates: 3/12/2018 - 3/13/2018	DUT Type: Portable Handset	Page 62 of 71	

Impedance Measurement Plot

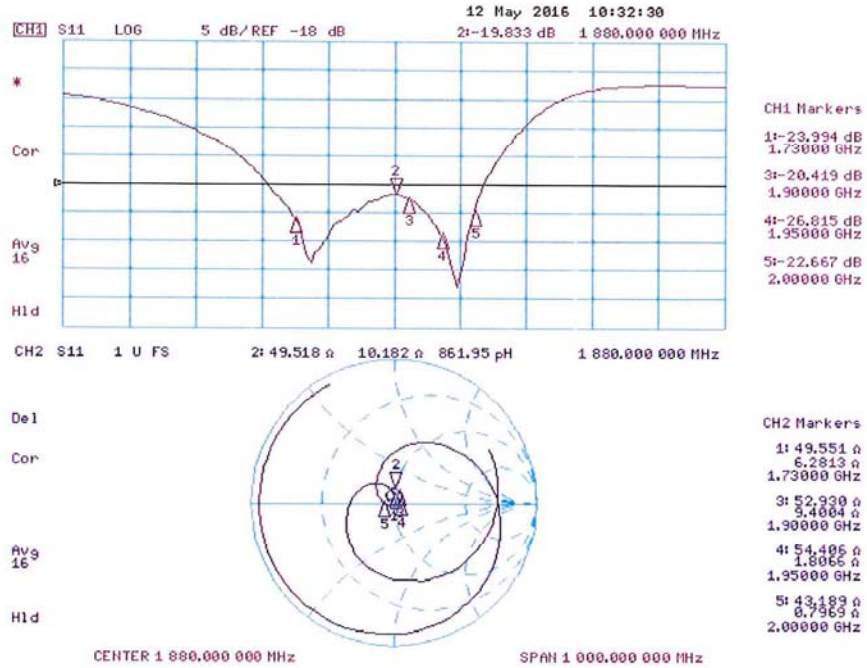

FCC ID: A3LSMJ737A	PCTEST ENGINEERING LABORATORY, INC.	HAC (RF EMISSIONS) TEST REPORT	SAMSUNG	Approved by: Quality Manager
Filename: 1M1803080036-11-R1.A3L	Test Dates: 3/12/2018 - 3/13/2018	DUT Type: Portable Handset		Page 63 of 71

DASY5 E-field Result

Date: 10.05.2016

Test Laboratory: SPEAG Lab2

DUT: HAC Dipole 1880 MHz; Type: CD1880V3; Serial: CD1880V3 - SN: 1064

Communication System: UID 0 - CW ; Frequency: 1880 MHz, Frequency: 1730 MHz

Medium parameters used: $\sigma = 0$ S/m, $\epsilon_r = 1$; $\rho = 1000$ kg/m³

Phantom section: RF Section

Measurement Standard: DASY5 (IEEE/IEC/ANSI C63.19-2011)

DASY52 Configuration:

- Probe: ER3DV6 - SN2336; ConvF(1, 1, 1); Calibrated: 31.12.2015;
- Sensor-Surface: (Fix Surface)
- Electronics: DAE4 Sn781; Calibrated: 04.09.2015
- Phantom: HAC Test Arch with AMCC; Type: SD HAC P01 BA; Serial: 1070
- DASY52 52.8.8(1258); SEMCAD X 14.6.10(7372)

Dipole E-Field measurement @ 1880MHz/E-Scan - 1880MHz d=15mm/Hearing Aid Compatibility Test (41x181x1):

Interpolated grid: dx=0.5000 mm, dy=0.5000 mm

Device Reference Point: 0, 0, -6.3 mm

Reference Value = 151.7 V/m; Power Drift = -0.01 dB



Applied MIF = 0.00 dB

RF audio interference level = 39.20 dBV/m

Emission category: M2

MIF scaled E-field

Grid 1 M2 39.04 dBV/m	Grid 2 M2 39.2 dBV/m	Grid 3 M2 39.08 dBV/m
Grid 4 M2 36.76 dBV/m	Grid 5 M2 36.86 dBV/m	Grid 6 M2 36.75 dBV/m
Grid 7 M2 38.68 dBV/m	Grid 8 M2 38.89 dBV/m	Grid 9 M2 38.8 dBV/m

FCC ID: A3LSMJ737A	 PCTEST ENGINEERING LABORATORY, INC.	HAC (RF EMISSIONS) TEST REPORT		Approved by: Quality Manager
Filename: 1M1803080036-11-R1.A3L	Test Dates: 3/12/2018 - 3/13/2018	DUT Type: Portable Handset		Page 64 of 71



Dipole E-Field measurement @ 1880MHz/E-Scan - 1730MHz d=15mm/Hearing Aid Compatibility Test (41x181x1):
 Interpolated grid: dx=0.5000 mm, dy=0.5000 mm
 Device Reference Point: 0, 0, -6.3 mm
 Reference Value = 168.3 V/m; Power Drift = 0.00 dB
 Applied MIF = 0.00 dB
 RF audio interference level = 39.66 dBV/m
Emission category: M2

MIF scaled E-field

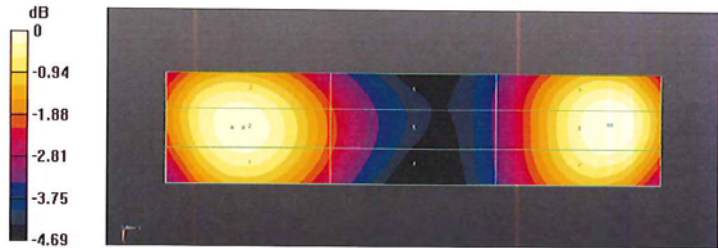
Grid 1 M2	Grid 2 M2	Grid 3 M2
39.43 dBV/m	39.58 dBV/m	39.44 dBV/m
Grid 4 M2	Grid 5 M2	Grid 6 M2
37.46 dBV/m	37.56 dBV/m	37.42 dBV/m
Grid 7 M2	Grid 8 M2	Grid 9 M2
39.44 dBV/m	39.66 dBV/m	39.57 dBV/m





0 dB = 91.23 V/m = 39.20 dBV/m

FCC ID: A3LSMJ737A	 PCTEST ENGINEERING LABORATORY, INC.	HAC (RF EMISSIONS) TEST REPORT		Approved by: Quality Manager
Filename: 1M1803080036-11-R1.A3L	Test Dates: 3/12/2018 - 3/13/2018	DUT Type: Portable Handset	Page 65 of 71	

15. CONCLUSION

The measurements indicate that the wireless communications device complies with the HAC limits specified in accordance with the ANSI C63.19 Standard and FCC WT Docket No. 01-309 RM-8658. Precise laboratory measures were taken to assure repeatability of the tests. The tested device complies with the requirements in respect to all parameters specific to the test. The test results and statements relate only to the item(s) tested.

Please note that the M-rating for this equipment only represents the field interference possible against a hypothetical and typical hearing aid. The measurement system and techniques presented in this evaluation are proposed in the ANSI standard as a means of best approximating wireless device compatibility with a hearing-aid. The literature is under continual re-construction.

FCC ID: A3LSMJ737A	 PCTEST ENGINEERING LABORATORY, INC.	HAC (RF EMISSIONS) TEST REPORT		Approved by: Quality Manager
Filename: 1M1803080036-11-R1.A3L	Test Dates: 3/12/2018 - 3/13/2018	DUT Type: Portable Handset	Page 66 of 71	

© 2018 PCTEST Engineering Laboratory, Inc.



REV 3.2.M

01/12/2018



© 2018 PCTEST Engineering Laboratory, Inc. All rights reserved. Unless otherwise specified, no part of this report may be reproduced or utilized in any part, form or by any means, electronic or mechanical, including photocopying and microfilm, without permission in writing from PCTEST Engineering Laboratory, Inc. If you have any questions about this international copyright or have an enquiry about obtaining additional rights to this report or assembly of contents thereof, please contact INFO@PCTEST.COM.

16. REFERENCES

1. ANSI/IEEE C63.19-2011, "American National Standard for Methods of Measurement of Compatibility between Wireless Communication Devices and Hearing Aids.", New York, NY, IEEE, May 2011
2. FCC Office of Engineering and Technology KDB, "285076 D01 HAC Guidance v05," September 13, 2017
3. FCC Office of Engineering and Technology KDB, "285076 D02 T-Coil Testing for CMRS IP v03," September 13, 2017
4. FCC Public Notice DA 06-1215, *Wireless Telecommunications Bureau and Office of Engineering and Technology Clarify Use of Revised Wireless Phone Hearing Aid Compatibility Standard*, June 6, 2006
5. FCC 3G Review Guidance, Laboratory Division OET FCC, May/June 2006
6. Berger, H. S., "Compatibility Between Hearing Aids and Wireless Devices," Electronic Industries Forum, Boston, MA, May, 1997
7. Berger, H. S., "Hearing Aid and Cellular Phone Compatibility: Working Toward Solutions," *Wireless Telephones and Hearing Aids: New Challenges for Audiology*, Gallaudet University, Washington, D.C., May, 1997 (To be reprinted in the American Journal of Audiology).
8. Berger, H. S., "Hearing Aid Compatibility with Wireless Communications Devices," IEEE International Symposium on Electromagnetic Compatibility, Austin, TX, August, 1997.
9. Bronaugh, E. L., "Simplifying EMI Immunity (Susceptibility) Tests in TEM Cells," in the 1990 IEEE International Symposium on Electromagnetic Compatibility Symposium Record, Washington, D.C., August 1990, pp. 488-491
10. Byrne, D. and Dillon, H., The National Acoustics Laboratory (NAL) New Procedure for Selecting the Gain and Frequency Response of a Hearing Aid, *Ear and Hearing* 7:257-265, 1986.
11. Crawford, M. L., "Measurement of Electromagnetic Radiation from Electronic Equipment using TEM Transmission Cells," U.S. Department of Commerce, National Bureau of Standards, NBSIR 73-306, Feb. 1973.
12. Crawford, M. L., and Workman, J. L., "Using a TEM Cell for EMC Measurements of Electronic Equipment," U.S. Department of Commerce, National Bureau of Standards. Technical Note 1013, July 1981.
13. Decker, W. F., Crawford, M. L., and Wilson, W. A., "Construction of a Large Transverse Electromagnetic Cell", U.S. Department of Commerce, National Bureau of Standards, Technical Note 1011, Feb. 1979.
14. EHIMA GSM Project, Development phase, Project Report (1st part) Revision A. Technical-Audiological Laboratory and Telecom Denmark, October 1993.

FCC ID: A3LSMJ737A	 PCTEST ENGINEERING LABORATORY, INC.	HAC (RF EMISSIONS) TEST REPORT		Approved by: Quality Manager
Filename: 1M1803080036-11-R1.A3L	Test Dates: 3/12/2018 - 3/13/2018	DUT Type: Portable Handset	Page 67 of 71	

15. EHIMA GSM Project, Development phase, Part II Project Report. Technical-Audiological Laboratory and Telecom Denmark, June 1994.
16. EHIMA GSM Project Final Report, Hearing Aids and GSM Mobile Telephones: Interference Problems, Methods of Measurement and Levels of Immunity. Technical-Audiological Laboratory and Telecom Denmark, 1995.
17. HAMPIS Report, Comparison of Mobile phone electromagnetic near field with an upscaled electromagnetic far field, using hearing aid as reference, 21 October 1999.
18. Hearing Aids/GSM, Report from OTWIDAM, Technical-Audiological Laboratory and Telecom Denmark, April 1993.
19. IEEE 100, The Authoritative Dictionary of IEEE Standards Terms, Seventh Edition.
20. Joyner, K. H, et. al., Interference to Hearing Aids by the New Digital Mobile Telephone System, Global System for Mobile (GSM) Communication Standard, National Acoustic Laboratory, Australian Hearing Series, Sydney 1993.
21. Joyner, K. H., et. al., Interference to Hearing Aids by the Digital Mobile Telephone System, Global System for Mobile Communications (GSM), NAL Report #131, National Acoustic Laboratory, Australian Hearing Series, Sydney, 1995.
22. Konigstein, D., and Hansen, D., "A New Family of TEM Cells with enlarged bandwidth and Optimized working Volume," in the Proceedings of the 7th International Symposium on EMC, Zurich, Switzerland, March 1987; 50:9, pp. 127-132.
23. Kuk, F., and Hjorstgaard, N. K., "Factors affecting interference from digital cellular telephones," Hearing Journal, 1997; 50:9, pp 32-34.
24. Ma, M. A., and Kanda, M., "Electromagnetic Compatibility and Interference Metrology," U.S. Department of Commerce, National Bureau of Standards, Technical Note 1099, July 1986, pp. 17-43.
25. Ma, M. A., Sreenivashiah, I. , and Chang, D. C., "A Method of Determining the Emission and Susceptibility Levels of Electrically Small Objects Using a TEM Cell," U.S. Department of Commerce, National Bureau of Standards, Technial Note 1040, July 1981.
26. McCandless, G. A., and Lyregaard, P. E., Prescription of Gain/Output (POGO) for Hearing Aids, Hearing Instruments 1:16-21, 1983
27. Skopec, M., "Hearing Aid Electromagnetic Interference from Digital Wireless Telephones, "IEEE Transactions on Rehabilitation Engineering, vol. 6, no. 2, pp. 235-239, June 1998.
28. Technical Report, GSM 05.90, GSM EMC Considerations, European Telecommunications Standards Institute, January 1993.
29. Victorian, T. A., "Digital Cellular Telephone Interference and Hearing Aid Compatibility—an Update," Hearing Journal 1998; 51:10, pp. 53-60
30. Wong, G. S. K., and Embleton, T. F. W., eds., AIP Handbook of Condenser Microphones: Theory, Calibration and Measurements, AIP Press.

FCC ID: A3LSMJ737A	 PCTEST TECHNICAL LABORATORY, INC.	HAC (RF EMISSIONS) TEST REPORT		Approved by: Quality Manager
Filename: 1M1803080036-11-R1.A3L	Test Dates: 3/12/2018 - 3/13/2018	DUT Type: Portable Handset	Page 68 of 71	