



FCC CFR47 PART 15 SUBPART C

Bluetooth Low Energy

CERTIFICATION TEST REPORT

FOR

GSM/WCDMA/LTE Phone + BT/BLE and DTS b/g/n

MODEL NUMBER : SM-J600F/DS, SM-J600F

FCC ID: A3LSMJ600F

REPORT NUMBER: 4788397760-E2V2

ISSUE DATE: APR 11, 2018

Prepared for
SAMSUNG ELECTRONICS CO., LTD.
129 SAMSUNG-RO, YEONGTONG-GU, SUWON-SI,
GYEONGGI-DO, 16677, KOREA

Prepared by
UL Korea, Ltd.
26th floor, 152, Teheran-ro, Gangnam-gu Seoul, 06236, Korea

Suwon Test Site: UL Korea, Ltd. Suwon Laboratory
218 Maeyeong-ro, Yeongtong-gu,
Suwon-si, Gyeonggi-do, 16675, Korea
TEL: (031) 337-9902
FAX: (031) 213-5433



Testing
Laboratory

TL-637

Revision History

<u>Rev.</u>	<u>Issue Date</u>	<u>Revisions</u>	<u>Revised By</u>
V1	04/09/18	Initial issue	Hoonpyo Lee
V2	04/11/18	Updated to address TCB's question	Hoonpyo Lee

TABLE OF CONTENTS

1. ATTESTATION OF TEST RESULTS	5
2. TEST METHODOLOGY	6
3. FACILITIES AND ACCREDITATION	6
4. CALIBRATION AND UNCERTAINTY	6
4.1. <i>MEASURING INSTRUMENT CALIBRATION.....</i>	6
4.2. <i>SAMPLE CALCULATION.....</i>	6
4.3. <i>MEASUREMENT UNCERTAINTY</i>	7
5. EQUIPMENT UNDER TEST	8
5.1. <i>DESCRIPTION OF EUT.....</i>	8
5.2. <i>MAXIMUM OUTPUT POWER.....</i>	8
5.3. <i>DESCRIPTION OF AVAILABLE ANTENNAS</i>	8
5.4. <i>WORST-CASE CONFIGURATION AND MODE</i>	8
5.5. <i>DESCRIPTION OF TEST SETUP</i>	9
6. TEST AND MEASUREMENT EQUIPMENT	11
7. REFERENCE MEASUREMENT RESULTS.....	12
7.1. <i>ON TIME AND DUTY CYCLE RESULTS.....</i>	12
7.2. <i>99% BANDWIDTH</i>	13
8. MEASUREMENT METHODS	15
9. SUMMARY TABLE	16
10. ANTENNA PORT TEST RESULTS	17
10.1. <i>6 dB BANDWIDTH.....</i>	17
10.2. <i>OUTPUT POWER.....</i>	19
10.3. <i>AVERAGE POWER.....</i>	21
10.4. <i>PSD.....</i>	22
10.5. <i>OUT-OF-BAND EMISSIONS</i>	24
11. RADIATED TEST RESULTS	28
11.1. <i>LIMITS AND PROCEDURE</i>	28
11.2. <i>TRANSMITTER ABOVE 1 GHz</i>	30

11.3. WORST-CASE BELOW 1 GHz.....	40
12. AC POWER LINE CONDUCTED EMISSIONS	42
13. SETUP PHOTOS	47

1. ATTESTATION OF TEST RESULTS

COMPANY NAME: SAMSUNG ELECTRONICS CO., LTD.
EUT DESCRIPTION: GSM/WCDMA/LTE Phone + BT/BLE and DTS b/g/n
MODEL NUMBER: SM-J600F/DS, SM-J600F
SERIAL NUMBER: R38K20GLBNH (RADIATED);
R38K20GLBPP (CONDUCTED)
DATE TESTED: MAR 17, 2018 - MAR 30, 2018

APPLICABLE STANDARDS	
STANDARD	TEST RESULTS
CFR 47 Part 15 Subpart C	Pass

UL Korea, Ltd. tested the above equipment in accordance with the requirements set forth in the above standards. All indications of Pass/Fail in this report are opinions expressed by UL Korea, Ltd. based on interpretations and/or observations of test results. Measurement Uncertainties were not taken into account and are published for informational purposes only. The test results show that the equipment tested is capable of demonstrating compliance with the requirements as documented in this report.

Note: The results documented in this report apply only to the tested sample, under the conditions and modes of operation as described herein. This document may not be altered or revised in any way unless done so by UL Korea, Ltd. and all revisions are duly noted in the revisions section. Any alteration of this document not carried out by UL Korea, Ltd. will constitute fraud and shall nullify the document. This report must not be used by the client to claim product certification, approval, or endorsement by IAS, any agency of the Federal Government, or any agency of any government.

Approved & Released For
UL Korea, Ltd. By:



SungGil Park
Suwon Lab Engineer
UL Korea, Ltd.

Tested By:



Hoonpyo Lee
Suwon Lab Engineer
UL Korea, Ltd.

2. TEST METHODOLOGY

The tests documented in this report were performed in accordance with following methods.

1. FCC CFR 47 Part 2.
2. FCC CFR 47 Part 15.
3. KDB 558074 D01 DTS Meas Guidance v04.
4. ANSI C63.10-2013.

3. FACILITIES AND ACCREDITATION

The test sites and measurement facilities used to collect data are located at 218 Maeyeong-ro, Yeongtong-gu, Suwon-si, Gyeonggi-do, 16675, Korea. Line conducted emissions are measured only at the 218 address. The following table identifies which facilities were utilized for radiated emission measurements documented in this report. Specific facilities are also identified in the test results sections.

218 Maeyeong-ro	
<input checked="" type="checkbox"/>	Chamber 1
<input type="checkbox"/>	Chamber 2
<input type="checkbox"/>	Chamber 3

UL Korea, Ltd. is accredited by IAS, Laboratory Code TL-637. The full scope of accreditation can be viewed at <http://www.iasonline.org/PDF/TL/TL-637.pdf>.

4. CALIBRATION AND UNCERTAINTY

4.1. MEASURING INSTRUMENT CALIBRATION

The measuring equipment utilized to perform the tests documented in this report has been calibrated in accordance with the manufacturer's recommendations, and is traceable to recognized national standards.

4.2. SAMPLE CALCULATION

Where relevant, the following sample calculation is provided:

$$\begin{aligned} \text{Field Strength (dBuV/m)} &= \text{Measured Voltage (dBuV)} + \text{Antenna Factor (dB/m)} + \\ &\text{Cable Loss (dB)} - \text{Preamp Gain (dB)} \\ 36.5 \text{ dBuV} + 18.7 \text{ dB/m} + 0.6 \text{ dB} - 26.9 \text{ dB} &= 28.9 \text{ dBuV/m} \end{aligned}$$

4.3. MEASUREMENT UNCERTAINTY

Where relevant, the following measurement uncertainty levels have been estimated for tests performed on the apparatus:

PARAMETER	UNCERTAINTY
Conducted Disturbance, 0.15 to 30 MHz	2.32 dB
Radiated Disturbance, Below 1GHz	3.86 dB
Radiated Disturbance, Above 1 GHz	5.97 dB

Uncertainty figures are valid to a confidence level of 95%.

5. EQUIPMENT UNDER TEST

5.1. DESCRIPTION OF EUT

The EUT is a GSM/WCDMA/LTE Phone + BT/BLE and DTS b/g/n.
 This test report addresses the DTS (BLE) operational mode.

5.2. MAXIMUM OUTPUT POWER

The transmitter has a maximum total conducted output power as follows:

Frequency Range [MHz]	Mode	Power Mode	Output Power [dBm]	Output Power [mW]
2402 - 2480	BLE	Peak	8.268	6.71
		Average	7.982	6.28

5.3. DESCRIPTION OF AVAILABLE ANTENNAS

The radio utilizes an internal antenna, with a maximum gain of -2.0 dBi.

5.4. WORST-CASE CONFIGURATION AND MODE

Radiated emission below 1GHz and power line conducted emission were performed with the EUT set to transmit at the channel with highest output power as worst-case scenario.

Radiated emission above 1GHz was performed with the EUT set to transmit low/mid/high channels.

The fundamental of the EUT was investigated in three orthogonal orientations X, Y and Z it was determined that X orientation was worst-case orientation; therefore, all final radiated testing was performed with the EUT in X orientation.

Note : All radiated and power line conducted tests were performed connected with earphone and charger for evaluation of worst case mode.

5.5. DESCRIPTION OF TEST SETUP

SUPPORT EQUIPMENT

Support Equipment List				
Description	Manufacturer	Model	Serial Number	FCC ID
Charger	SAMSUNG	ETA0U83EWE	RT2K117oS/A-E	N/A
Data Cable	SAMSUNG	ECB-DU68WE	N/A	N/A
Earphone	SAMSUNG	EHS61ASFWE	N/A	N/A

I/O CABLES

I/O Cable List						
Cable No	Port	# of identical ports	Connector Type	Cable Type	Cable Length (m)	Remarks
1	DC Power	1	Mini-USB	Shielded	1.2m	N/A
2	Audio	2	Mini-Jack	Unshielded	1.2m	N/A

TEST SETUP

The EUT is a stand-alone unit during the tests.
 Test software in hidden menu exercised the EUT to enable BLE mode.

SETUP DIAGRAM FOR TESTS (CONDUCTED TEST SETUP)

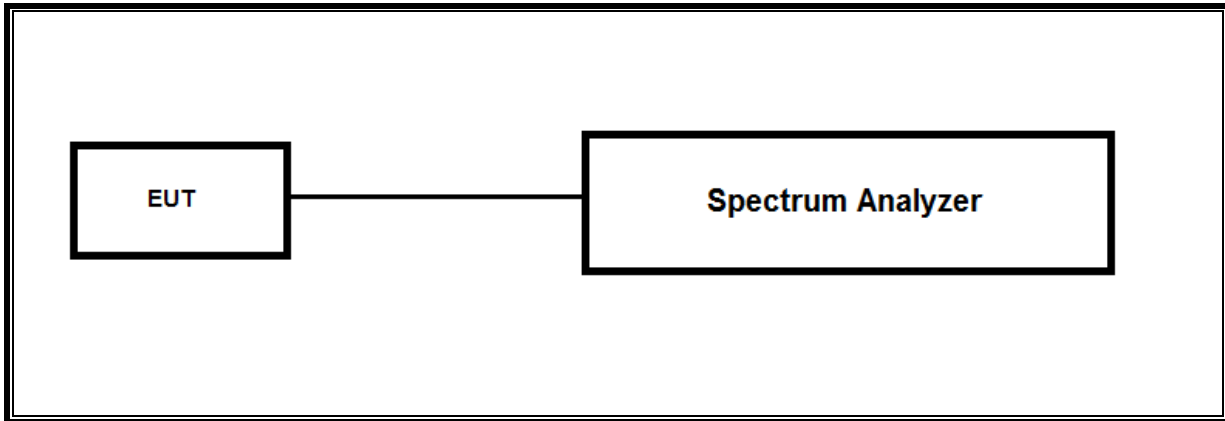

SETUP DIAGRAM FOR TESTS (RADIATED TEST SETUP)

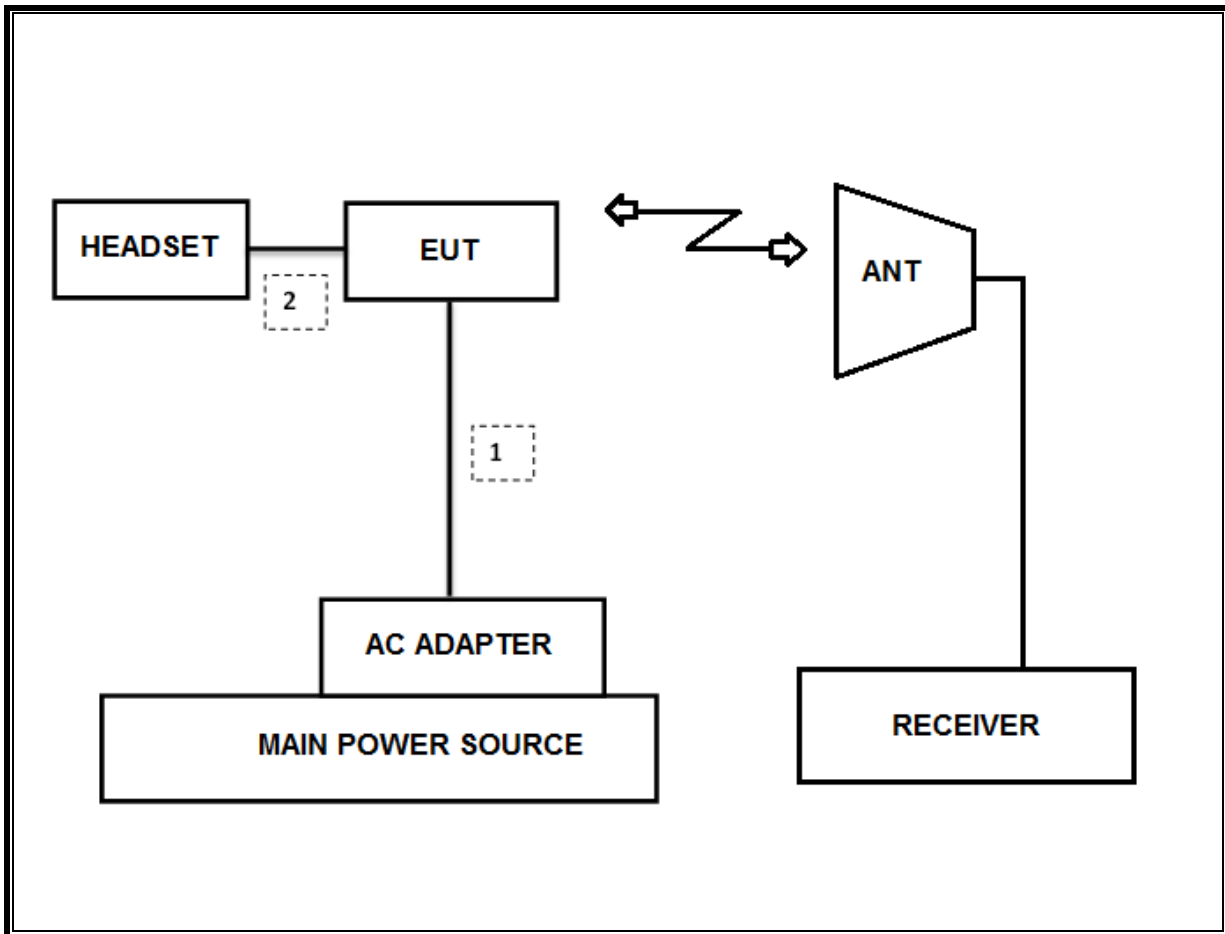

6. TEST AND MEASUREMENT EQUIPMENT

The following test and measurement equipment was utilized for the tests documented in this report:

Test Equipment List				
Description	Manufacturer	Model	S/N	Cal Due
Antenna, Bilog, 30MHz-1GHz	SCHWARZBECK	VULB9163	750	08-31-19
Antenna, Bilog, 30MHz-1GHz	SCHWARZBECK	VULB9163	749	09-14-19
Antenna, Bilog, 30MHz-1GHz	SCHWARZBECK	VULB9163	845	08-31-19
Antenna, Loop, 9kHz-30MHz	R&S	HFH2-Z2	100418	10-26-19
Antenna, Horn, 18 GHz	ETS	3115	00167211	10-14-18
Antenna, Horn, 18 GHz	ETS	3115	00161451	03-10-19
Antenna, Horn, 18 GHz	ETS	3117	00168724	05-31-19
Antenna, Horn, 18 GHz	ETS	3117	00168717	05-31-19
Antenna, Horn, 18 GHz	ETS	3117	00205959	11-29-18
Antenna, Horn, 40 GHz	ETS	3116C	00166155	12-04-19
Antenna, Horn, 40 GHz	ETS	3116C	00168645	12-04-19
Antenna, Horn, 40 GHz	ETS	3116C-PA	00168841	11-13-19
Preamplifier, 1000 MHz	Sonoma	310N	341282	08-09-18
Preamplifier, 1000 MHz	Sonoma	310N	351741	08-07-18
Preamplifier, 1000 MHz	Sonoma	310N	370599	08-10-18
Preamplifier, 18 GHz	Miteq	AFS42-00101800-25-S-42	1876511	08-08-18
Preamplifier, 18 GHz	Miteq	AFS42-00101800-25-S-42	1896138	08-08-18
Preamplifier, 18 GHz	Miteq	AFS42-00101800-25-S-42	2029169	08-11-18
Spectrum Analyzer, 44 GHz	Agilent / HP	N9030A	MY54170614	08-08-18
Spectrum Analyzer, 44 GHz	Agilent / HP	N9030A	MY54490312	08-08-18
Spectrum Analyzer, 43.5 GHz	R&S	FSW43	104089	08-11-18
Average Power Sensor	Agilent / HP	U2000	MY54270007	08-08-18
Attenuator	PASTERNAK	PE7087-10	A001	08-08-18
Attenuator	PASTERNAK	PE7087-10	A008	08-08-18
Attenuator	PASTERNAK	PE7087-10	2	08-10-18
EMI Test Receive, 40 GHz	R&S	ESU40	100439	08-08-18
EMI Test Receive, 40 GHz	R&S	ESU40	100457	08-08-18
EMI Test Receive, 44 GHz	R&S	ESW44	101590	08-09-18
EMI Test Receive, 3 GHz	R&S	ESR3	101832	08-07-18
Low Pass Filter 5GHz	Micro-Tronics	LPS17541	009	08-08-18
Low Pass Filter 5GHz	Micro-Tronics	LPS17541	015	08-08-18
Low Pass Filter 5GHz	Micro-Tronics	LPS17541	020	08-11-18
High Pass Filter 3GHz	Micro-Tronics	HPM17543	010	08-08-18
High Pass Filter 3GHz	Micro-Tronics	HPM17543	015	08-08-18
High Pass Filter 3GHz	Micro-Tronics	HPM17543	020	08-11-18
High Pass Filter 6GHz	Micro-Tronics	HPS17542	009	08-08-18
High Pass Filter 6GHz	Micro-Tronics	HPS17542	016	08-08-18
High Pass Filter 6GHz	Micro-Tronics	HPS17542	021	08-11-18
LISN	R&S	ENV-216	101837	08-09-18
UL Software				
Description	Manufacturer	Model	Version	
Radiated software	UL	UL EMC	Ver 9.5	
AC Line Conducted software	UL	UL EMC	Ver 9.5	

7. REFERENCE MEASUREMENT RESULTS

7.1. ON TIME AND DUTY CYCLE RESULTS

LIMITS

None: for reporting purposes only.

Mode	ON Time B [msec]	Period [msec]	Duty Cycle x [linear]	Duty Cycle [%]	Duty Cycle Correction Factor [dB]	1/T Minimum VBW [kHz]
2400MHz Bands						
BLE	0.389	0.625	0.623	62.3%	2.06	2.569

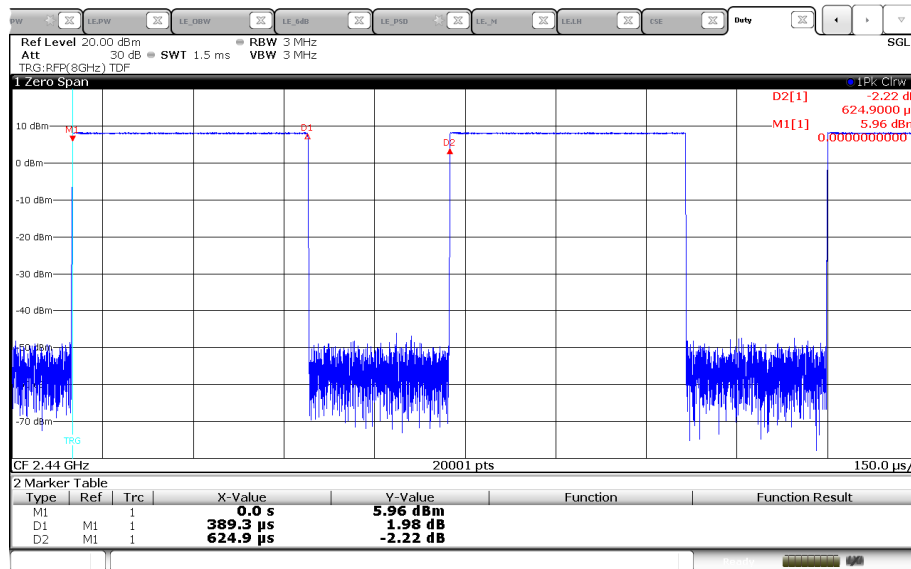

14:23:51 19.03.2018

7.2. 99% BANDWIDTH

LIMITS

None; for reporting purposes only.

TEST PROCEDURE

The transmitter output is connected to the spectrum analyzer. The RBW is set to 1% to 3% of the 99 % bandwidth and to 1% of the span. The VBW is set to ≥ 3 times the RBW. The spectrum analyzer internal 99% bandwidth function is utilized.

RESULTS

Channel	Frequency [MHz]	99% Bandwidth [MHz]
Low	2402	1.060
Mid	2440	1.060
High	2480	1.053
Worst		1.060

99% BANDWIDTH PLOTS

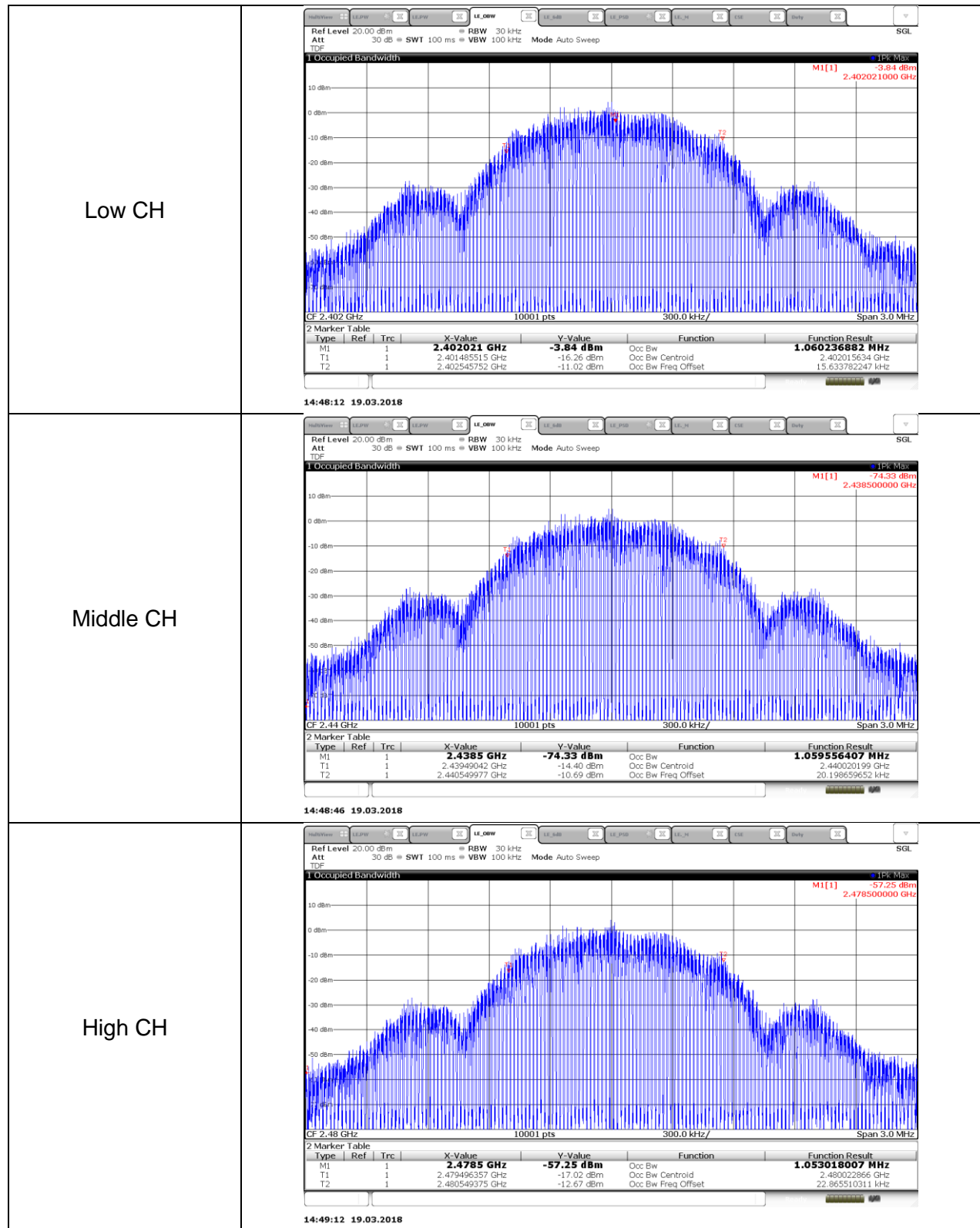

8. MEASUREMENT METHODS

6 dB BW : KDB 558074 D01 v04, Section 8.1.

OUTPUT POWER : KDB 558074 D01 v04, Section 9.1.1.(Peak) / 9.2.3.1 (Average)

POWER SPECTRAL DENSITY : KDB 558074 D01 v04, Section 10.2.

Out-of-band EMISSIONS (Conducted) : KDB 558074 D01 v04, Section 11.1, 11.2.

Out-of-band EMISSIONS IN NON-RESTRICTED BANDS: KDB 558074 D01 v04, Section 11.0.

Out-of-band EMISSIONS IN RESTRICTED BANDS : KDB 558074 D01 v04, Section 12.1.

AC Power Line Conducted Emission : ANSI C63.10-2013, Section 6.2.

9. SUMMARY TABLE

FCC Part Section	Test Description	Test Limit	Test Condition	Test Result
15.247 (a)(2)	Occupied Band width (6dB)	>500KHz	Conducted	Pass
2.1051, 15.247 (d)	Band Edge / Conducted Spurious Emission	-20dBc		Pass
15.247 (b)(3)	TX conducted output power	<30dBm		Pass
15.247 (e)	PSD	<8dBm		Pass
15.207 (a)	AC Power Line conducted emissions	Section 10	Power Line conducted	Pass
15.205, 15.209	Radiated Spurious Emission	< 54dBuV/m(Av)	Radiated	Pass

10. ANTENNA PORT TEST RESULTS

10.1. 6 dB BANDWIDTH

LIMITS

FCC §15.247 (a) (2)

The minimum 6 dB bandwidth shall be at least 500 kHz.

TEST PROCEDURE

Reference to KDB 558074 D01 DTS Meas Guidance v04: The transmitter output is connected to a spectrum analyzer with the RBW set to 100kHz, the VBW $\geq 3 \times$ RBW, peak detector and max hold.

RESULTS

Channel	Frequency [MHz]	6 dB Bandwidth [kHz]	Minimum Limit [kHz]
Low	2402	678.79	500.0
Mid	2440	676.99	500.0
High	2480	684.42	500.0
Worst		676.99	500.0

6 dB BANDWIDTH PLOTS

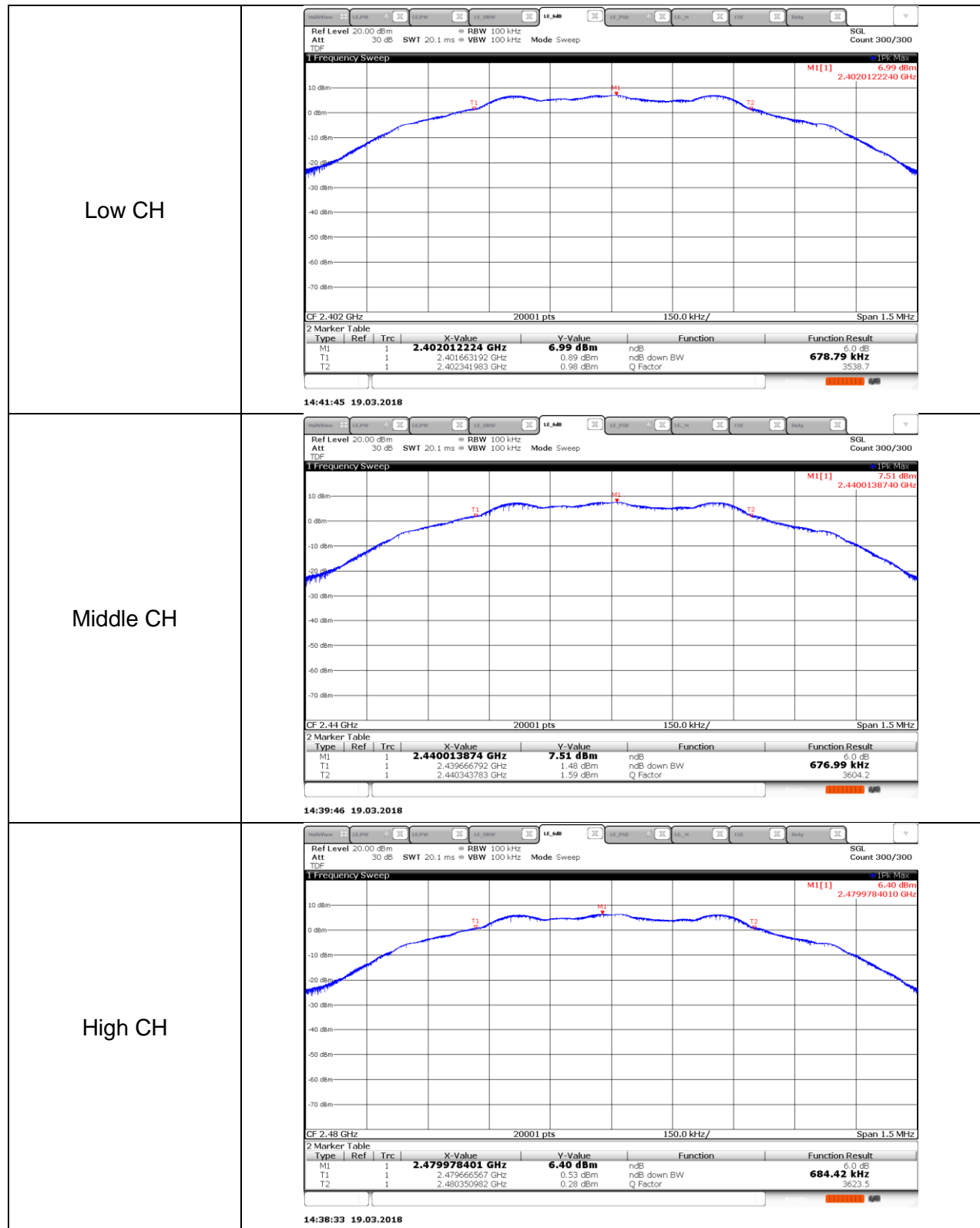

10.2. OUTPUT POWER

LIMITS

FCC §15.247 (b)

The maximum antenna gain is less than or equal to 6 dBi, therefore the limit is 30 dBm.

TEST PROCEDURE

Peak power is measured using KDB558074 D01 DTS Meas Guidance v04 under section 9.1.1 utilizing spectrum analyzer.

RESULTS

Channel	Frequency [MHz]	Peak Power Reading [dBm]	Limit [dBm]	Margin [dB]
Low	2402	7.447	30.000	-22.553
Mid	2440	8.268	30.000	-21.732
High	2480	7.736	30.000	-22.264
Worst		8.268		-21.732

OUTPUT POWER PLOTS

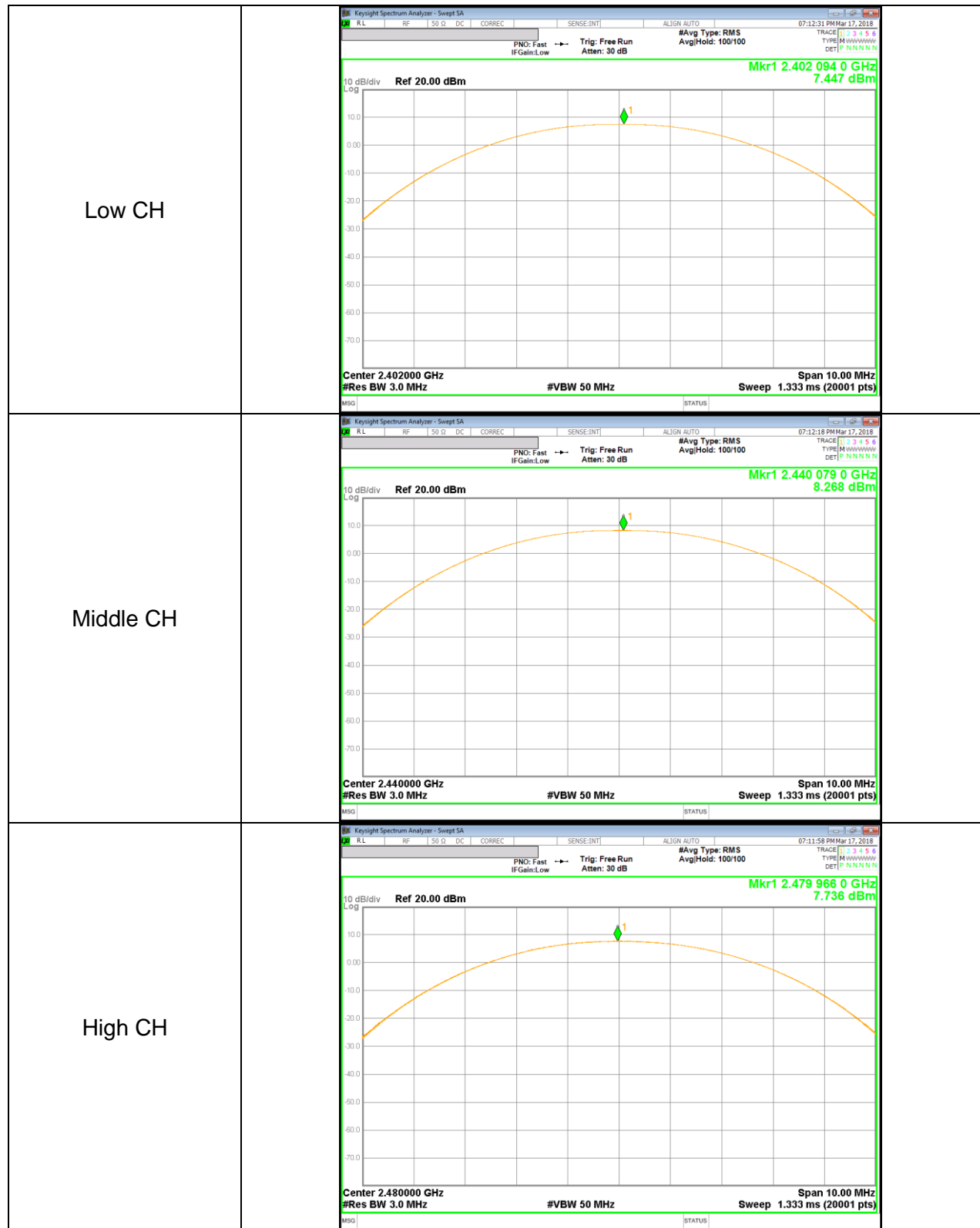

10.3. AVERAGE POWER

LIMITS

None; for reporting purposes only.

TEST PROCEDURE

Average power is measured using KDB558074 D01 DTS Meas Guidance v04 under 9.2.3.1 utilizing a power meter.

RESULTS

The cable assembly insertion loss was entered as an offset in the power meter to allow for direct reading of power.

And duty cycle correction factor is already added to the average output power results.

Channel	Frequency [MHz]	AV power [dBm]	AV power [mW]
Low	2402	7.167	5.209
Middle	2440	7.982	6.283
High	2480	7.257	5.317

10.4. PSD

LIMITS

FCC §15.247

The power spectral density conducted from the transmitter to the antenna shall not be greater than 8 dBm in any 3 kHz band during any time interval of continuous transmission.

TEST PROCEDURE

Power Spectral Density was performed utilizing the “§10.2 Method PKPSD (Peak PSD)” under KDB558074 D01 DTS Meas Guidance v04

RESULTS

Channel	Frequency [MHz]	PSD [dBm/3kHz]	Limit [dBm/3kHz]	Margin [dB]
Low	2402	-6.47	8.00	-14.47
Mid	2440	-5.96	8.00	-13.96
High	2480	-7.01	8.00	-15.01

POWER SPECTRAL DENSITY PLOTS

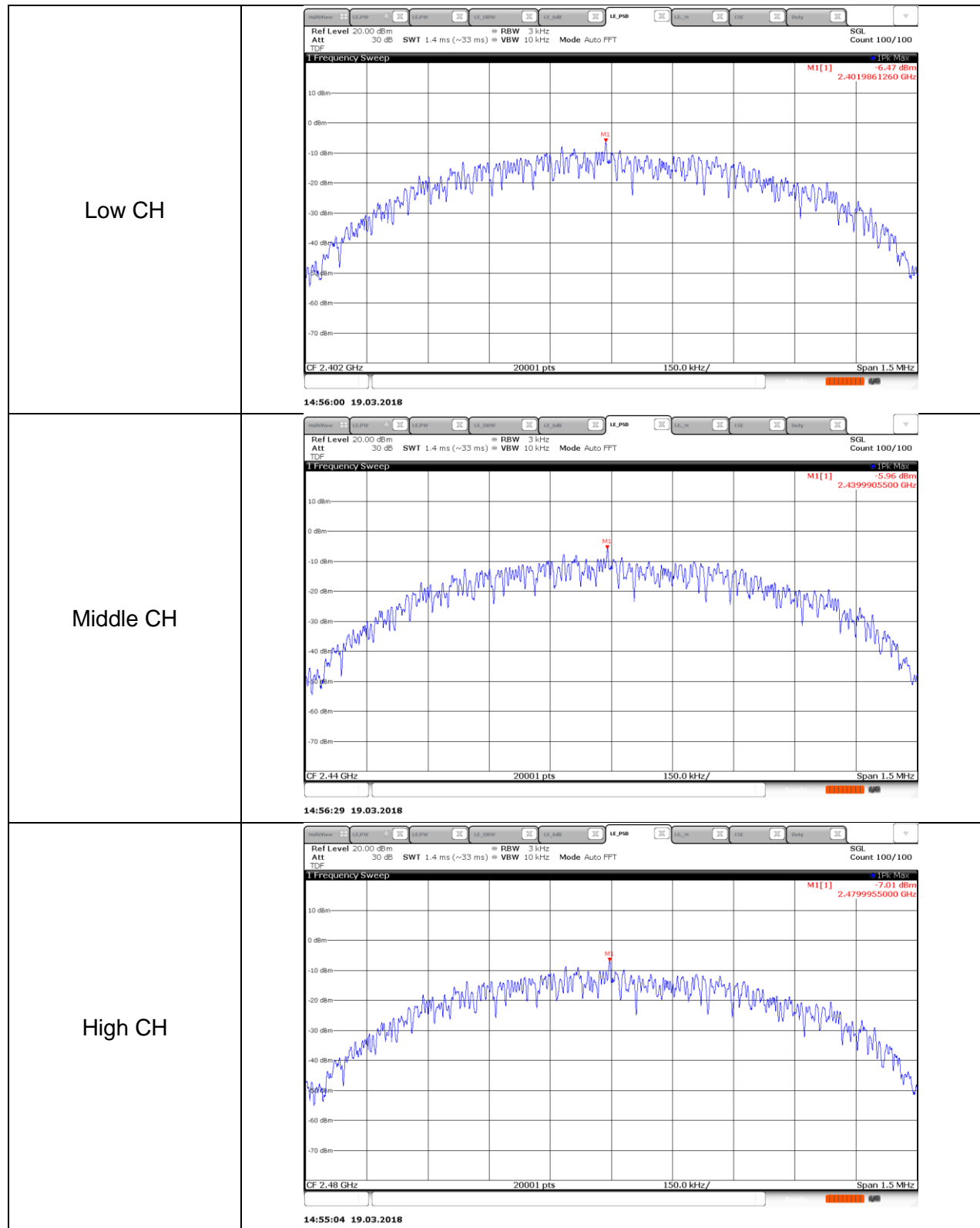

10.5. OUT-OF-BAND EMISSIONS

LIMITS

FCC §15.247 (d)

In any 100 kHz bandwidth outside the frequency band in which the spread spectrum or digitally modulated intentional radiator is operating, the radio frequency power that is produced by the intentional radiator shall be at least 20 dB below that in the 100 kHz bandwidth within the band that contains the highest level of the desired power, based on either an RF conducted or a radiated measurement, provided the transmitter demonstrates compliance with the peak conducted power limits. If the transmitter complies with the conducted power limits based on the use of RMS averaging over a time interval, as permitted under paragraph (b)(3) of this section, the attenuation required under this paragraph shall be 30 dB instead of 20 dB. Attenuation below the general limits specified in §15.209(a) is not required.

TEST PROCEDURE

The transmitter output is connected to a spectrum analyzer with RBW = 100 kHz, VBW = 300 kHz, peak detector, and max hold. Measurements utilizing these settings are made of the in-band reference level, bandedge (where measurements to the general radiated limits will not be made).

For out-of-band emissions, it was tested with RBW = 1 MHz, VBW = 3 MHz, peak detector, and max hold.

If the emission level with above setting was close to the limit (ie, less than 3 dB margin) then re-test is required using RBW = 100 kHz, VBW = 300 kHz, peak detector, and max hold to get accurate emission level within 100 kHz BW.

RESULTS

BANDEDGE & SPURIOUS EMISSIONS, LOW CHANNEL

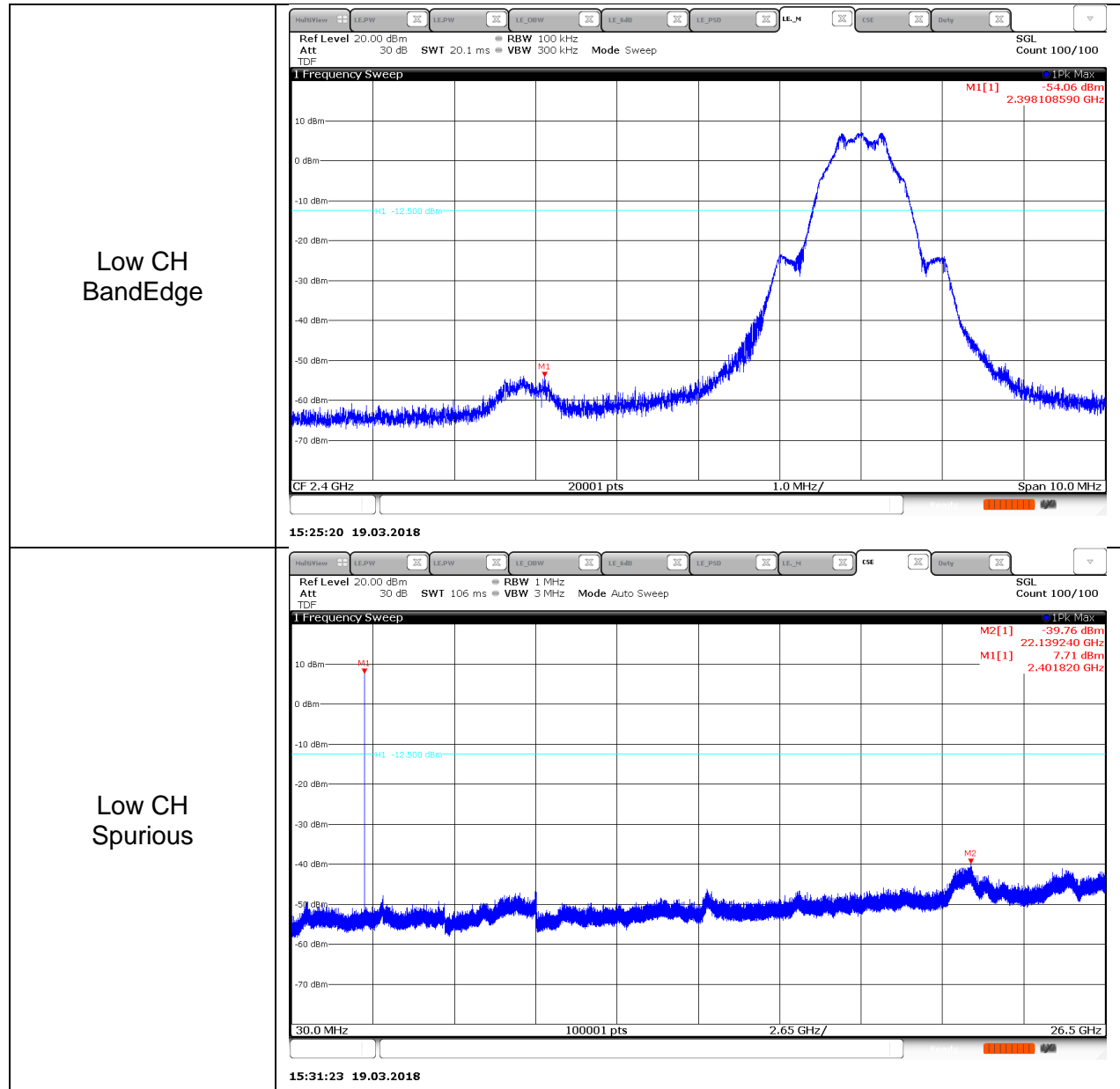

SPURIOUS EMISSIONS, MID CHANNEL

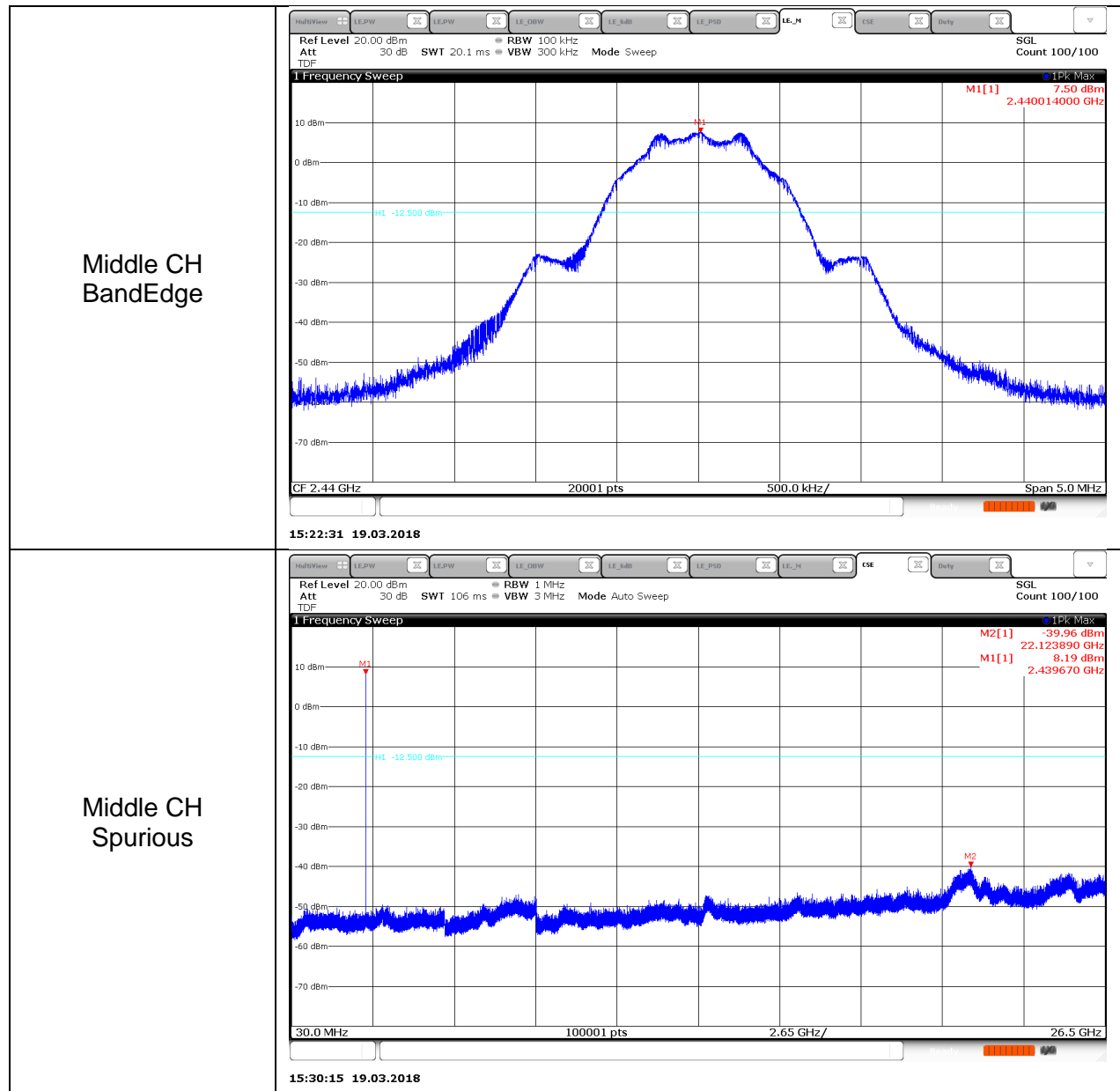

SPURIOUS EMISSIONS, HIGH CHANNEL

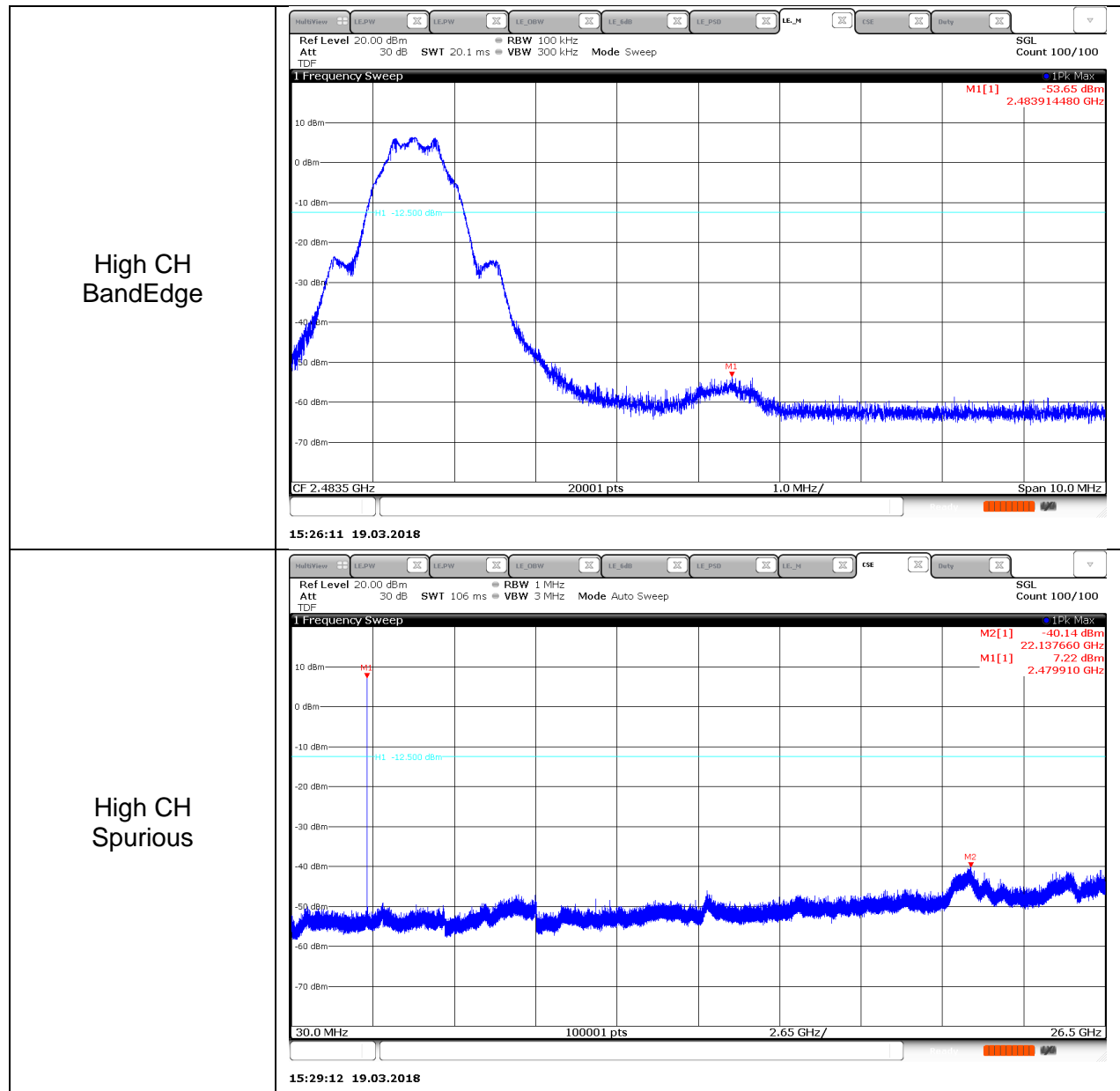

11. RADIATED TEST RESULTS

11.1. LIMITS AND PROCEDURE

LIMITS

FCC §15.205 and §15.209

Limits for radiated disturbance of an intentional radiator		
Frequency range (MHz)	Limits (µV/m)	Measurement Distance (m)
0.009 – 0.490	2400 / F (kHz)	300
0.490 – 1.705	24000 / F (kHz)	30
1.705 – 30.0	30	30
30 – 88	100**	3
88 - 216	150**	3
216 – 960	200**	3
Above 960	500	3

** Except as provided in paragraph (g), fundamental emissions from intentional radiators operating under this section shall not be located in the frequency bands 54-72 MHz, 76-88 MHz, 174-216 MHz or 470-806 MHz. However, operation within these frequency bands is permitted under other sections of this part, e.g. §§ 15.231 and 15.241.

TEST PROCEDURE

The EUT is placed on a non-conducting table 80 cm above the ground plane for below 1GHz and 150 cm for above 1GHz. The antenna to EUT distance is 3 meters. The EUT is configured in accordance with ANSI C63.10. The EUT is set to transmit in a continuous mode.

For measurements below 1 GHz the resolution bandwidth is set to 100 kHz for peak detection measurements or 120 kHz for quasi-peak detection measurements. Peak detection is used unless otherwise noted as quasi-peak.

For measurements above 1 GHz the resolution bandwidth is set to 1 MHz, then the video bandwidth is set to 3 MHz for peak measurements and add duty cycle factor for average measurements. (Restricted bandedge, Final detection of spurious harmonic emissions) Duty cycle factor = $10 \log(1/x)$. For this sample: DCF = $10 \log(1/0.623) = 2.06 \text{dB}$ (Spectrum Analyzer round it up to 2.06dB)

Pre-scans to detect harmonic and spurious emissions, the resolution bandwidth is set to 1 MHz; the video bandwidth is set to 30 KHz for peak measurements.

The spectrum from 1 GHz to 26 GHz is investigated with the transmitter set to the lowest, middle, and highest channels in the 2.4 GHz band.
(From 30MHz to 1GHz, test was performed with the EUT set to transmit at the channel with highest output power)

The frequency range of interest is monitored at a fixed antenna height and EUT azimuth. The EUT is rotated through 360 degrees to maximize emissions received. The antenna is scanned from 1 to 4 meters above the ground plane to further maximize the emission. Measurements are made with the antenna polarized in both the vertical and the horizontal positions.

Note : Emission was pre-scanned from 9KHz to 30MHz; No emissions were detected which was at least 20dB below the specification limit (consider distance correction factor).
Per FCC part 15.31(o), test results were not reported.

Although these tests were performed other than open area test site, adequate comparison measurements were confirmed against 30 m open area test site.
Therefore sufficient tests were made to demonstrate that the alternative site produces results that correlate with the one of tests made in an open field based on KDB 414788.

11.2. TRANSMITTER ABOVE 1 GHz RESTRICTED BANDEDGE (LOW CHANNEL)

HORIZONTAL PEAK AND AVERAGE PLOT

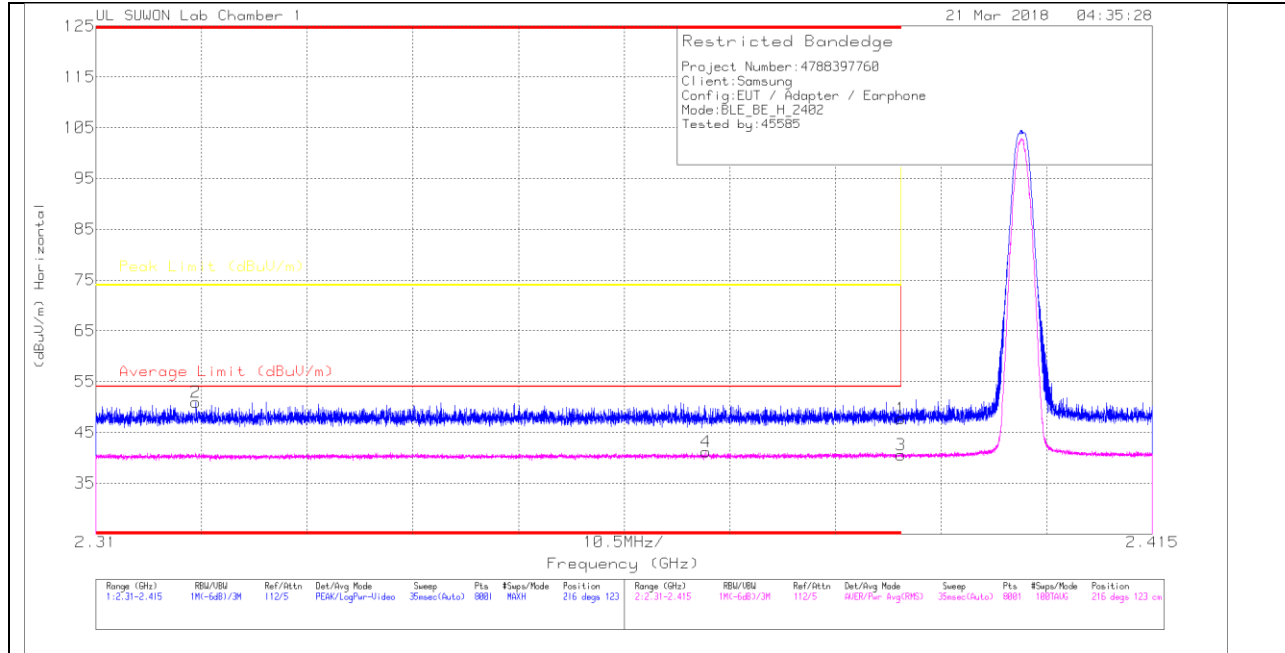

HORIZONTAL DATA

Trace Markers

Marker	Frequency (GHz)	Meter Reading (dBu/m)	Det	20170531_3117_00168 717	10dB_ATT(dB)_170809	DC Corr (dB)	Corrected Reading (dBu/m)	Average Limit (dBu/m)	Margin (dB)	Peak Limit (dBu/m)	PK Margin (dB)	Azimuth (Degs)	Height (cm)	Polarity
1	* 2.39	42.16	Pk	31.3	-25.7	0	47.76	-	-	74	-26.24	216	123	H
2	* 2.32	45.54	Pk	31.2	-25.8	0	50.94	-	-	74	-23.06	216	123	H
3	* 2.39	32.88	RMS	31.3	-25.7	2.06	40.54	54	-13.46	-	-	216	123	H
4	* 2.371	33.72	RMS	31.2	-25.8	2.06	41.18	54	-12.82	-	-	216	123	H

* - indicates frequency in CFR47 Pt 15 / IC RSS-Restricted Band

Pk - Peak detector

RMS - RMS detection

VERTICAL PEAK AND AVERAGE PLOT

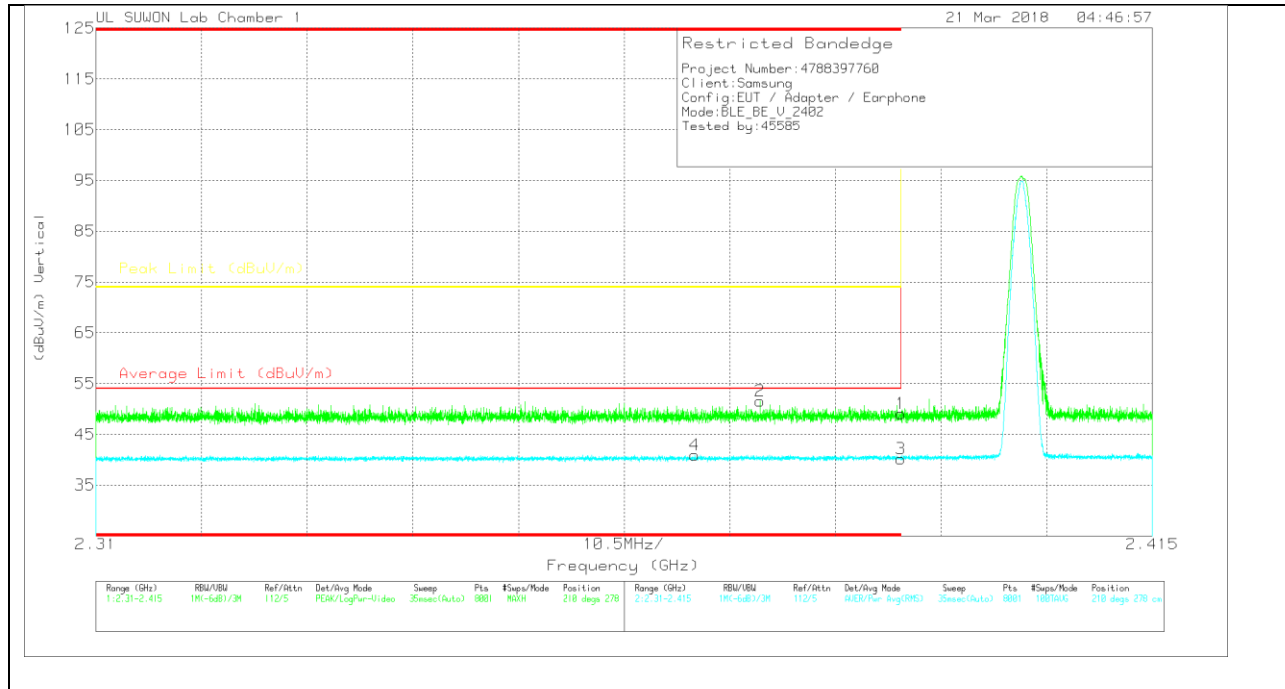

VERTICAL DATA

Trace Markers

Marker	Frequency (GHz)	Meter Reading (dBu)	Det	20170531_3117_00168 717	10dB_ATT(dB)_170809	DC Corr (dB)	Corrected Reading (dBu/m)	Average Limit (dBu/m)	Margin (dB)	Peak Limit (dBu/m)	PK Margin (dB)	Azimuth (Degs)	Height (cm)	Polarity
1	* 2.39	43.54	Pk	31.3	-25.7	0	49.14	-	-	74	-24.86	210	278	V
2	* 2.376	46.01	Pk	31.3	-25.7	0	51.61	-	-	74	-22.39	210	278	V
3	* 2.39	32.48	RMS	31.3	-25.7	2.06	40.14	54	-13.86	-	-	210	278	V
4	* 2.37	33.51	RMS	31.2	-25.8	2.06	40.97	54	-13.03	-	-	210	278	V

* - indicates frequency in CFR47 Pt 15 / IC RSS-Restricted Band

Pk - Peak detector

RMS - RMS detection

AUTHORIZED BANDEDGE (HIGH CHANNEL)

HORIZONTAL PEAK AND AVERAGE PLOT

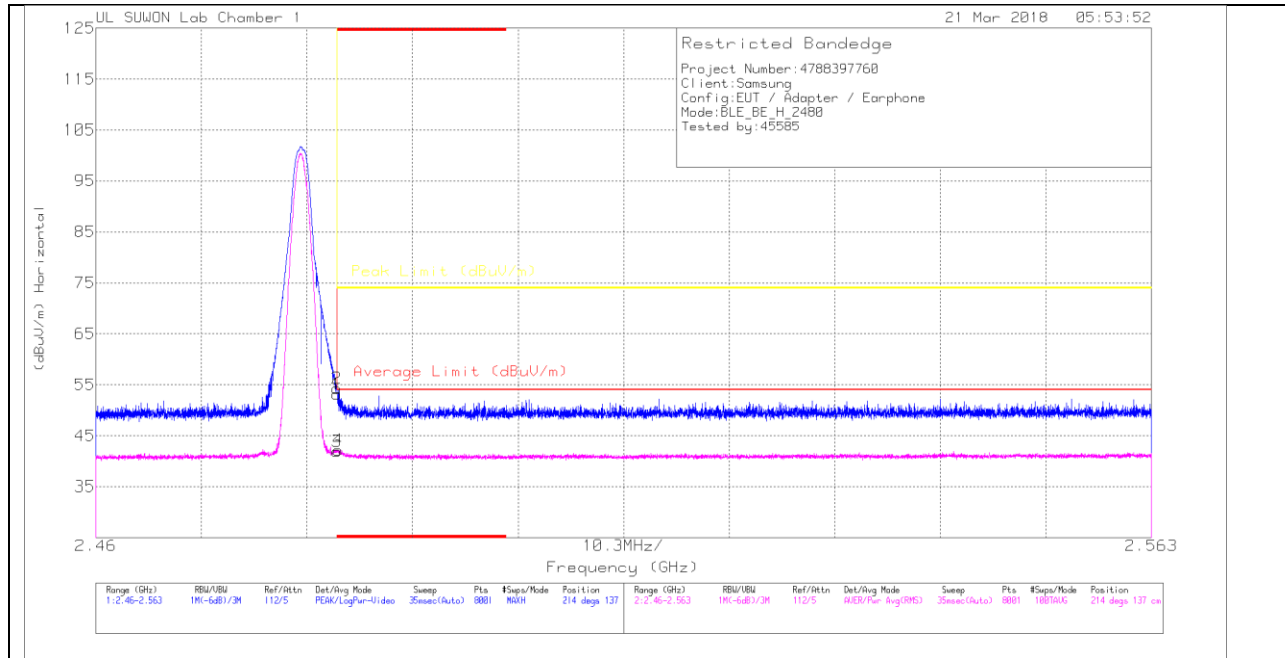

HORIZONTAL DATA

Trace Markers

Marker	Frequency (GHz)	Meter Reading (dBuV)	Det	20170531_3117_00168 717	10dB_ATT(dB)_170809	DC Corr (dB)	Corrected Reading (dBuV/m)	Average Limit (dBuV/m)	Margin (dB)	Peak Limit (dBuV/m)	PK Margin (dB)	Azimuth (Degs)	Height (cm)	Polarity
1	* 2.484	47.08	Pk	31.6	-25.5	0	53.18	-	-	74	-20.82	214	137	H
2	* 2.484	48.16	Pk	31.6	-25.5	0	54.26	-	-	74	-19.74	214	137	H
3	* 2.484	33.81	RMS	31.6	-25.5	2.06	41.97	54	-12.03	-	-	214	137	H
4	* 2.484	34.05	RMS	31.6	-25.5	2.06	42.21	54	-11.79	-	-	214	137	H

* - indicates frequency in CFR47 Pt 15 / IC RSS-Restricted Band

Pk - Peak detector

RMS - RMS detection

VERTICAL PEAK AND AVERAGE PLOT

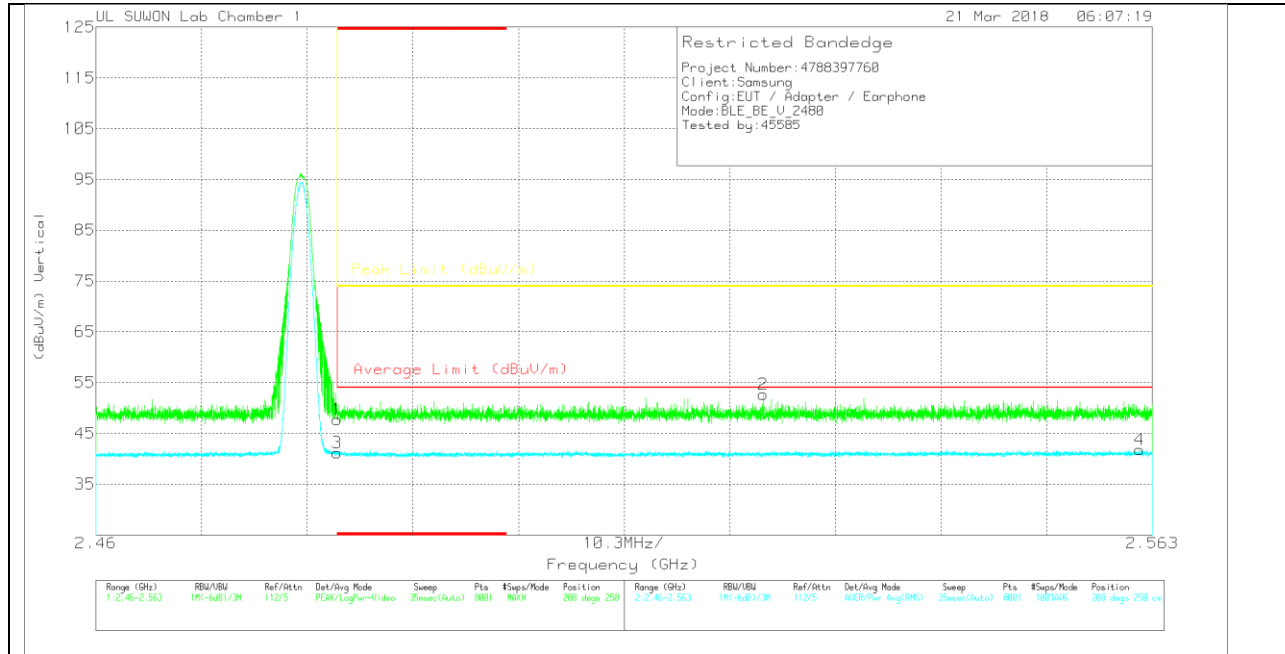

VERTICAL DATA

Trace Markers

Marker	Frequency (GHz)	Meter Reading (dBuV)	Det	20170531_3117_00168 717	10dB_ATT(dB)_170809	DC Corr (dB)	Corrected Reading (dBuV/m)	Average Limit (dBuV/m)	Margin (dB)	Peak Limit (dBuV/m)	PK Margin (dB)	Azimuth (Degs)	Height (cm)	Polarity
1	* 2.484	41.67	Pk	31.6	-25.5	0	47.77	-	-	74	-26.23	208	250	V
2	2.525	46.42	Pk	31.7	-25.4	0	52.72	-	-	74	-21.28	208	250	V
3	* 2.484	33.07	RMS	31.6	-25.5	2.06	41.23	54	-12.77	-	-	208	250	V
4	2.562	33.36	RMS	31.7	-25.3	2.06	41.82	54	-12.18	-	-	208	250	V

* - indicates frequency in CFR47 Pt 15 / IC RSS-Restricted Band

Pk - Peak detector

RMS - RMS detection

HARMONICS AND SPURIOUS EMISSIONS

LOW CHANNEL HORIZONTAL

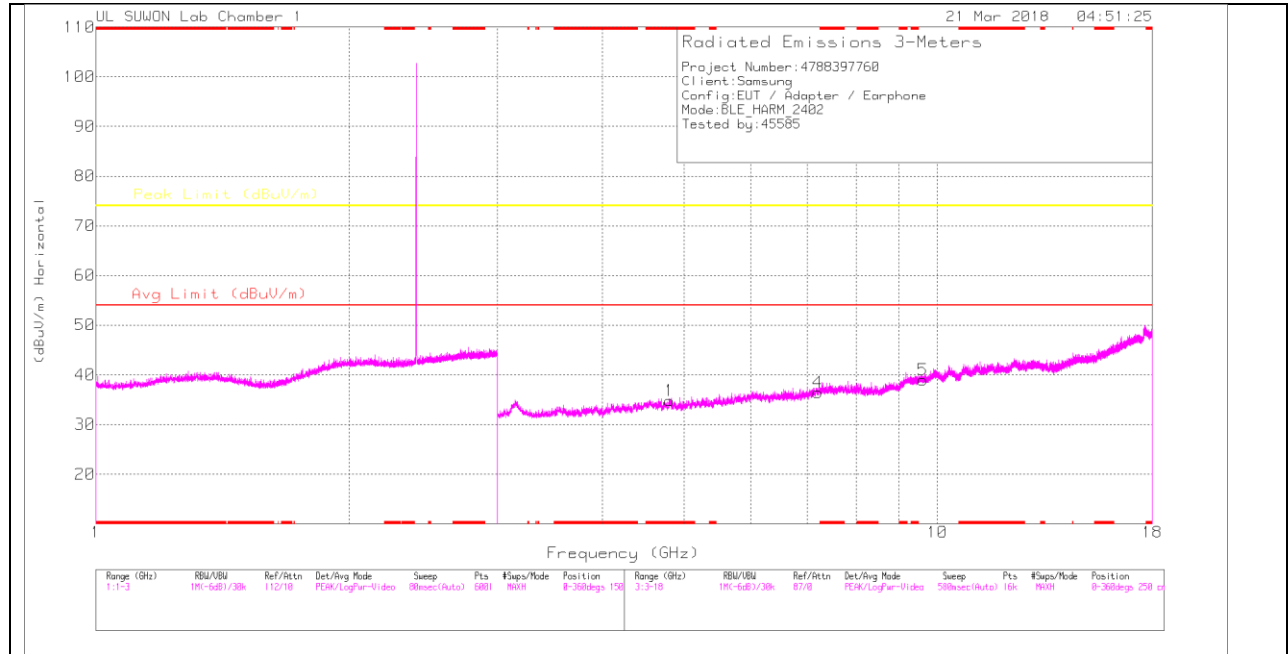

LOW CHANNEL VERTICAL

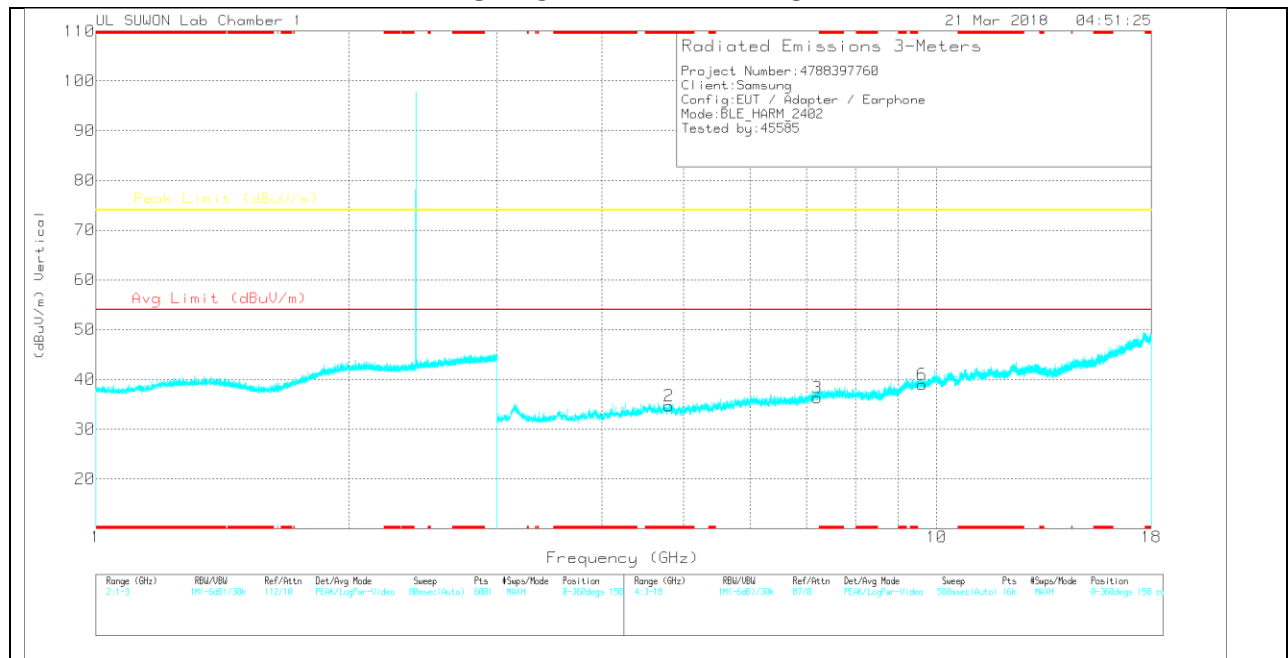

Note: Emission was scanned up to 26GHz; No emissions were detected above the noise floor which was at least 20dB below the specification limit.

LOW CHANNEL DATA

Trace Markers

Marker	Frequency (GHz)	Meter Reading (dBuV)	Det	20170531_3117_001687 17	3GHz_HP(dB)_170809	DC Corr (dB)	Corrected Reading (dBuV/m)	Avg Limit (dBuV/m)	Margin (dB)	Peak Limit (dBuV/m)	Margin (dB)	Azimuth (Degs)	Height (cm)	Polarity
1	* 4.805	32.61	PK	33.8	-31.6	0	34.81	-	-	74	-39.19	0-360	150	H
4	7.206	28.6	PK	35.9	-28.1	0	36.4	-	-	74	-37.6	0-360	250	H
5	9.608	25.72	PK	36.7	-23.5	0	38.92	-	-	74	-35.08	0-360	250	H
2	* 4.805	32.49	PK	33.8	-31.6	0	34.69	-	-	74	-39.31	0-360	150	V
3	7.206	28.53	PK	35.9	-28.1	0	36.33	-	-	74	-37.67	0-360	250	V
6	9.608	25.75	PK	36.7	-23.5	0	38.95	-	-	74	-35.05	0-360	150	V

* - indicates frequency in CFR47 Pt 15 / IC RSS-Restricted Band
 PK – Peak Detector

Note: Only peak measurement was performed. Because peak measurement result of unwanted emission is less than average limit (54dBuV/m).

MID CHANNEL HORIZONTAL

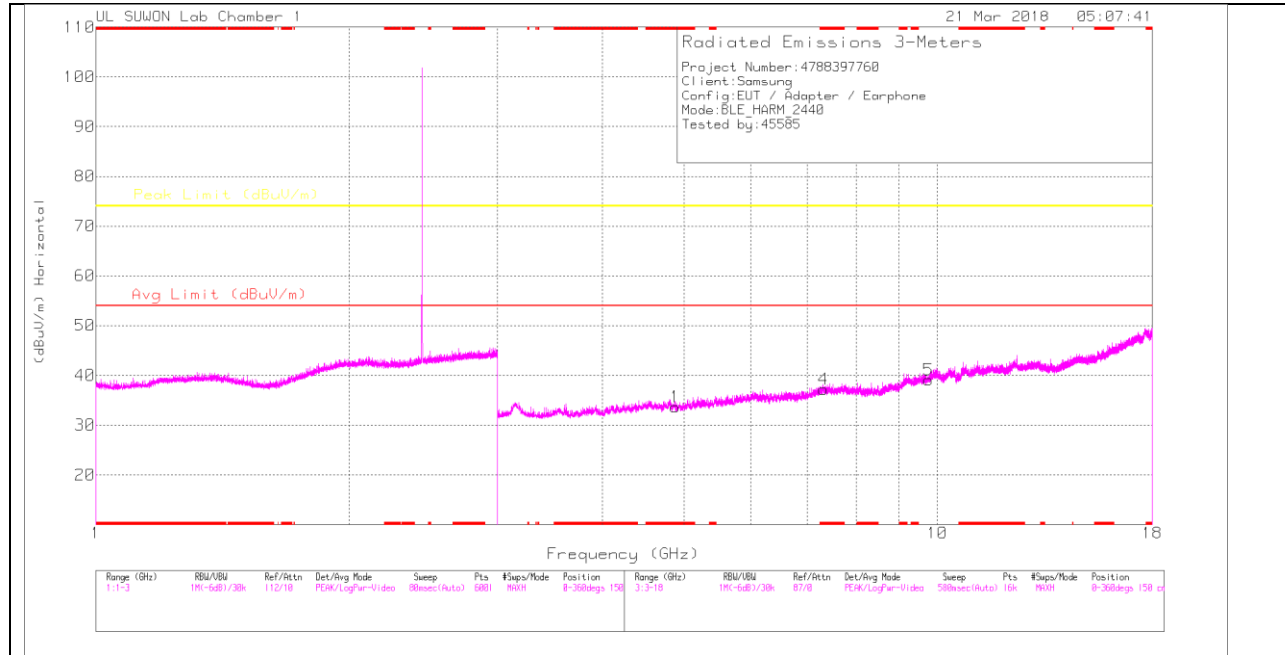

MID CHANNEL VERTICAL

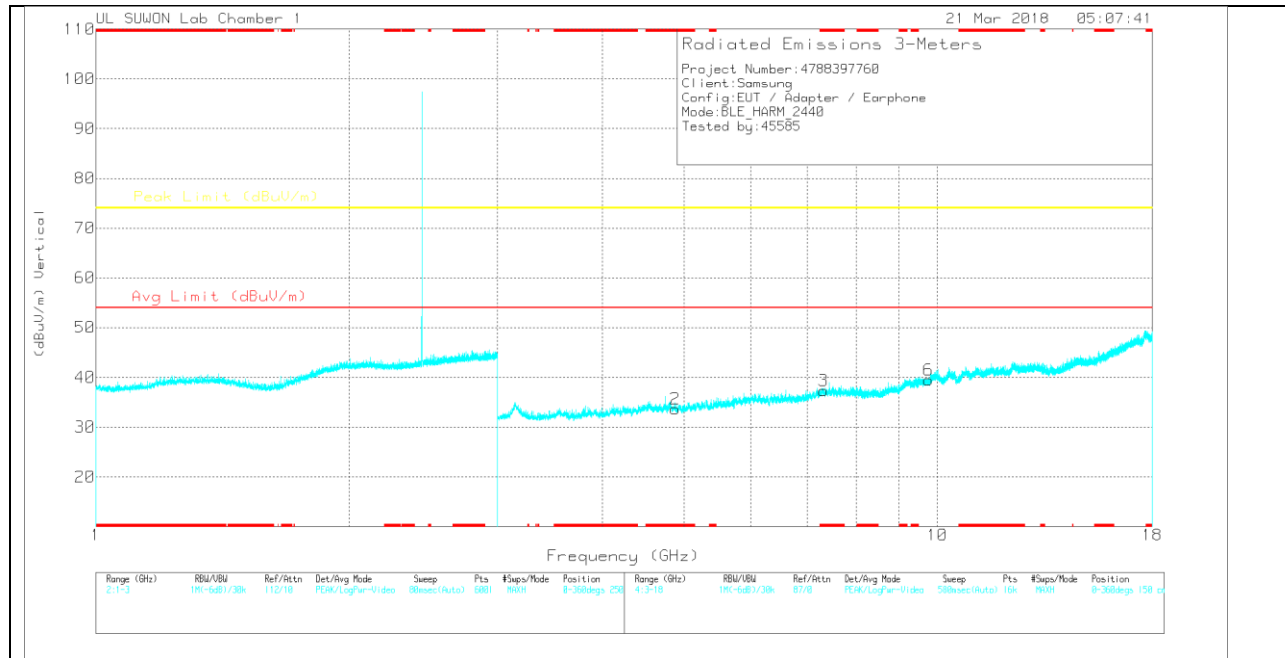

Note: Emission was scanned up to 26GHz; No emissions were detected above the noise floor which was at least 20dB below the specification limit.

MID CHANNEL DATA

Trace Markers

Marker	Frequency (GHz)	Meter Reading (dBuV)	Det	20170531_3117_001687 17	3GHz_HPI(dB)_170809	DC Corr (dB)	Corrected Reading (dBuV/m)	Avg Limit (dBuV/m)	Margin (dB)	Peak Limit (dBuV/m)	Margin (dB)	Azimuth (Degs)	Height (cm)	Polarity
1	* 4.881	31.6	PK	33.8	-31.7	0	33.7	-	-	74	-40.3	0-360	250	H
4	* 7.32	28.92	PK	35.9	-27.6	0	37.22	-	-	74	-36.78	0-360	250	H
5	9.761	26.45	PK	36.9	-24.2	0	39.15	-	-	74	-34.85	0-360	250	H
2	* 4.881	31.53	PK	33.8	-31.7	0	33.63	-	-	74	-40.37	0-360	150	V
3	* 7.32	29.06	PK	35.9	-27.6	0	37.36	-	-	74	-36.64	0-360	250	V
6	9.761	26.79	PK	36.9	-24.2	0	39.49	-	-	74	-34.51	0-360	150	V

* - indicates frequency in CFR47 Pt 15 / IC RSS-Restricted Band

PK – Peak Detector

Note: Only peak measurement was performed. Because peak measurement result of unwanted emission is less than average limit (54dBuV/m).

HIGH CHANNEL HORIZONTAL

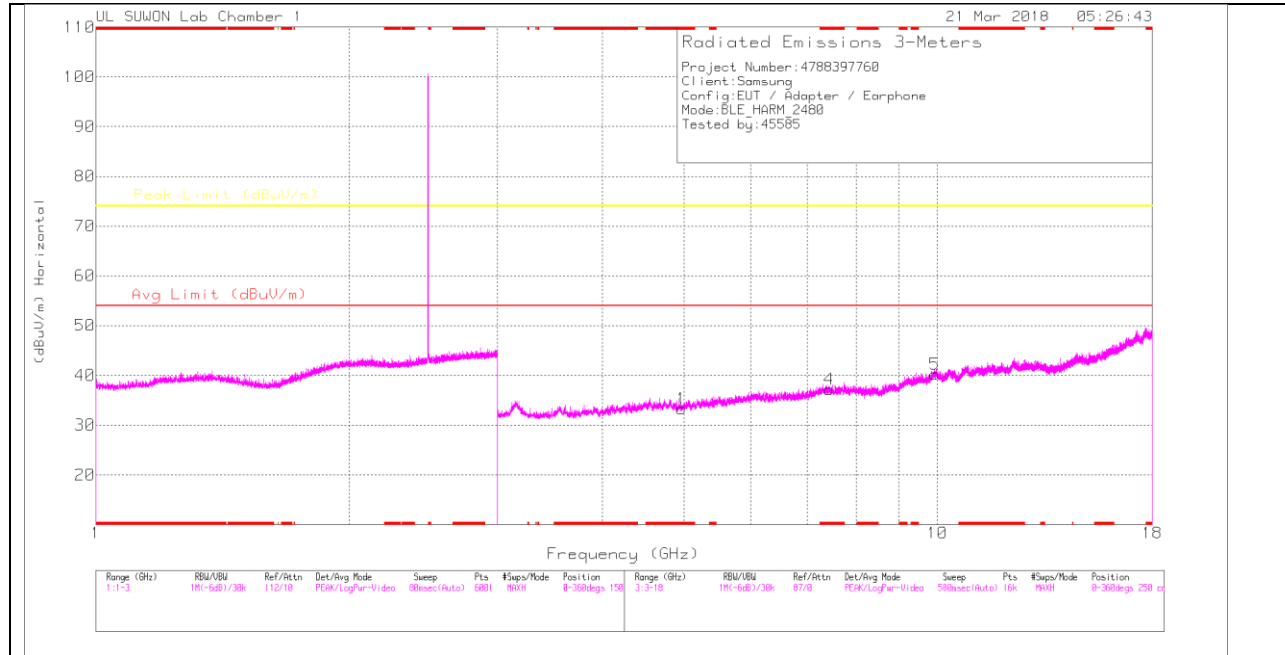

HIGH CHANNEL VERTICAL

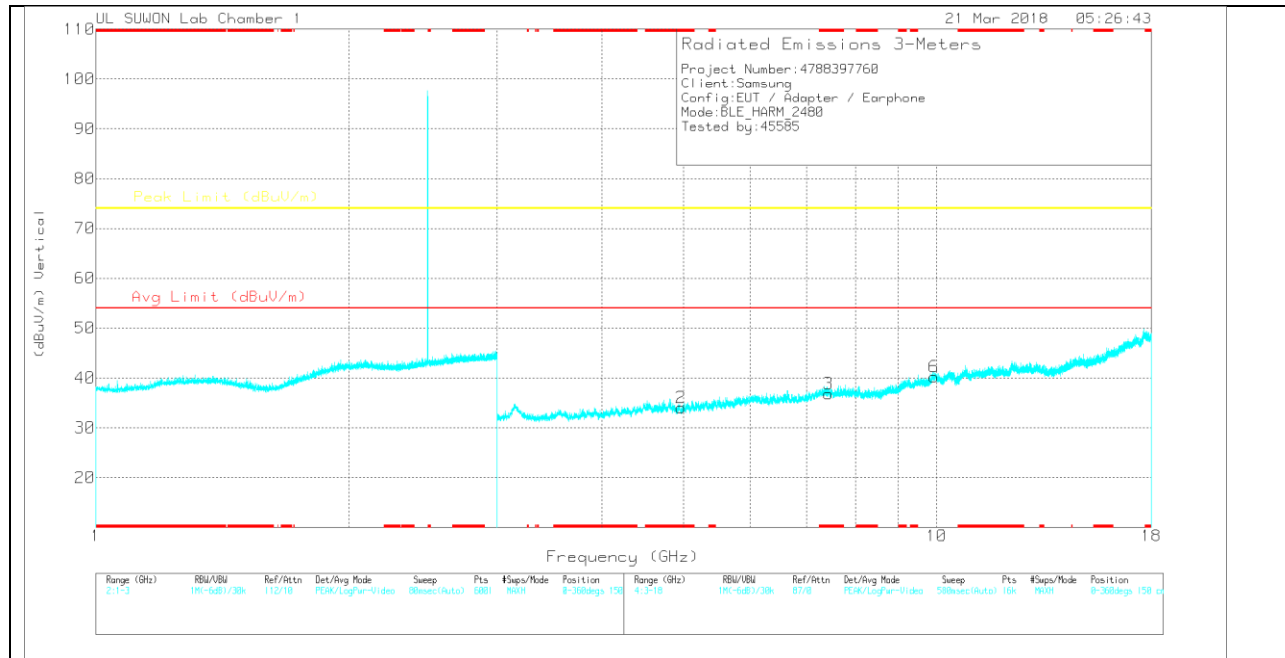

Note: Emission was scanned up to 26GHz; No emissions were detected above the noise floor which was at least 20dB below the specification limit.

HIGH CHANNEL DATA

Trace Markers

Marker	Frequency (GHz)	Meter Reading (dBuV)	Det	20170531_3117_001687 17	3GHz_HP(dB)_170809	DC Corr (dB)	Corrected Reading (dBuV/m)	Avg Limit (dBuV/m)	Margin (dB)	Peak Limit (dBuV/m)	Margin (dB)	Azimuth (Degs)	Height (cm)	Polarity
1	* 4.96	31.04	PK	33.8	-31.6	0	33.24	-	-	74	-40.76	0-360	150	H
4	* 7.441	28.56	PK	35.9	-27.2	0	37.26	-	-	74	-36.74	0-360	250	H
5	9.92	25.41	PK	37.1	-22.3	0	40.21	-	-	74	-33.79	0-360	250	H
2	* 4.96	31.82	PK	33.8	-31.6	0	34.02	-	-	74	-39.98	0-360	250	V
3	* 7.441	28.09	PK	35.9	-27.2	0	36.79	-	-	74	-37.21	0-360	150	V
6	9.92	25.42	PK	37.1	-22.3	0	40.22	-	-	74	-33.78	0-360	250	V

* - indicates frequency in CFR47 Pt 15 / IC RSS-Restricted Band
 PK – Peak Detector

Note: Only peak measurement was performed. Because peak measurement result of unwanted emission is less than average limit (54dBuV/m).

11.3. WORST-CASE BELOW 1 GHz

SPURIOUS EMISSIONS 30 TO 1000 MHz (WORST-CASE CONFIGURATION)

HORIZONTAL PLOT

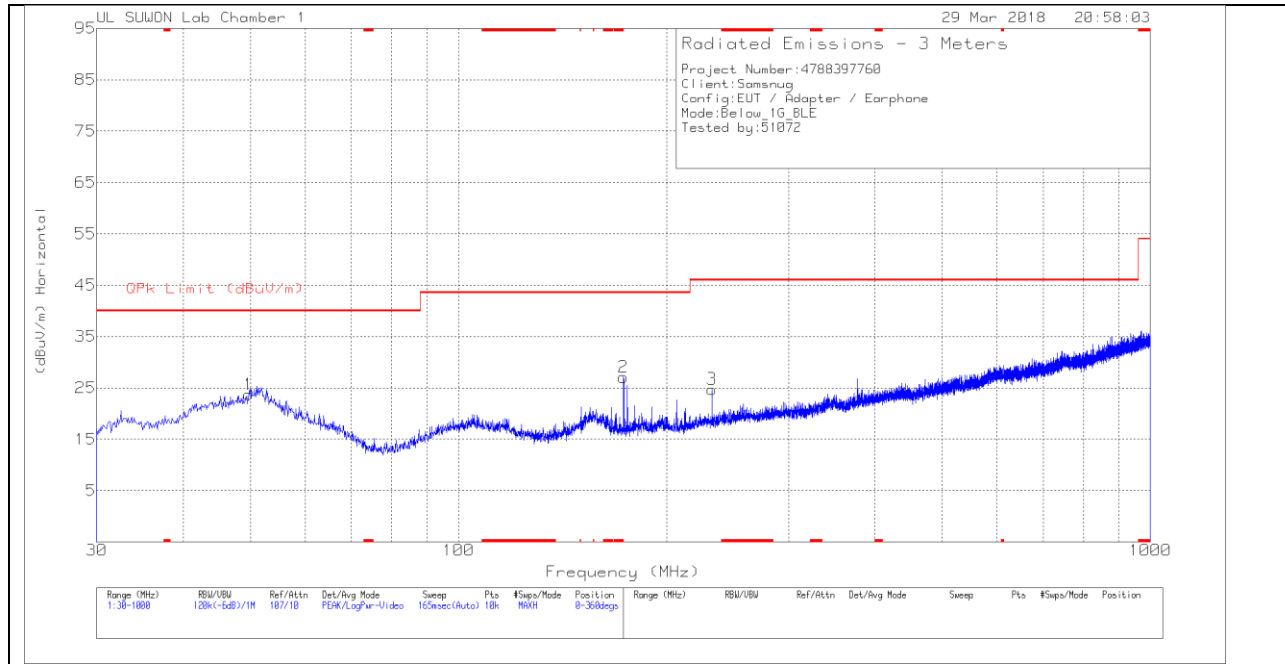

VERTICAL PLOT

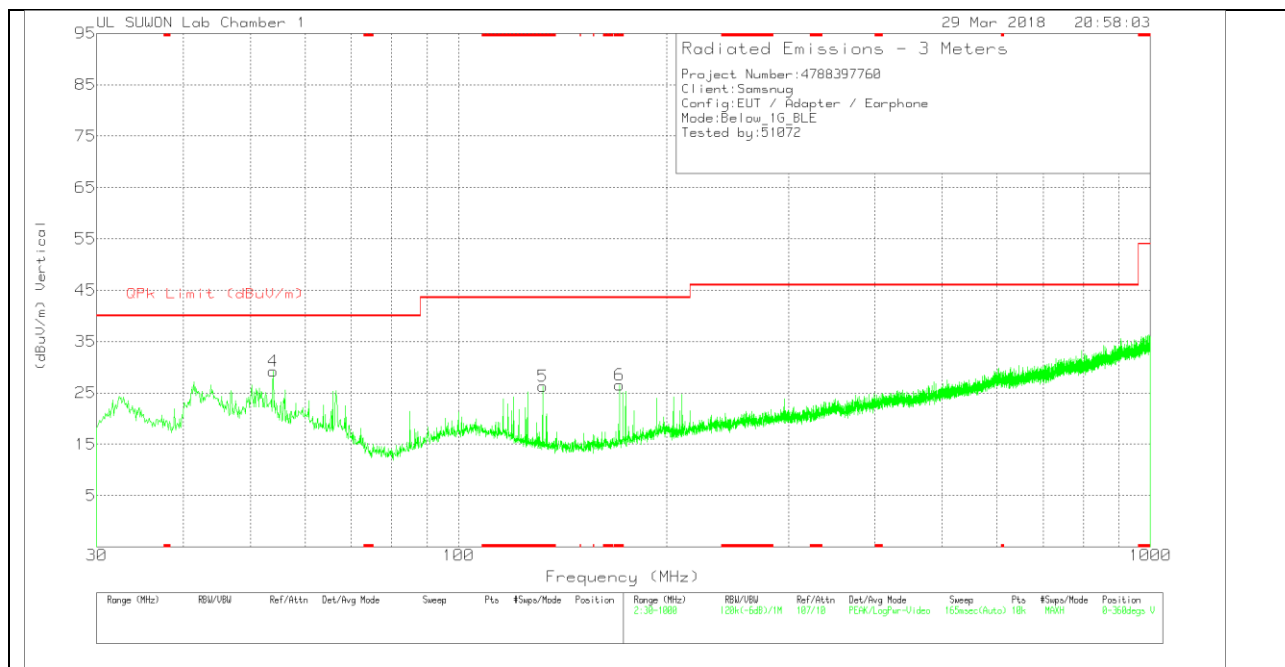

BELOW 1 GHz TABLE

Trace Markers

Marker	Frequency (MHz)	Meter Reading (dBuV)	Det	750_20170831	30-1000MHz[dB]	DC Corr (dB)	Corrected Reading (dBuV/m)	QPk Limit (dBuV/m)	Margin (dB)	Azimuth (Degs)	Height (cm)	Polarity
1	49.691	33.2	Pk	19.9	-29.4	0	23.7	40	-16.3	0-360	300	H
2	* 172.978	39.79	Pk	14.9	-27.6	0	27.09	43.52	-16.43	0-360	100	H
3	232.439	34.54	Pk	17.8	-27.6	0	24.74	46.02	-21.28	0-360	300	H
4	53.959	38.89	Pk	19.5	-29.2	0	29.19	40	-10.81	0-360	200	V
5	* 132.335	40.16	Pk	14.2	-28.1	0	26.26	43.52	-17.26	0-360	100	V
6	* 170.844	39.43	Pk	14.8	-27.7	0	26.53	43.52	-16.99	0-360	200	V

* - indicates frequency in CFR47 Pt 15 / IC RSS-Restricted Band
 Pk - Peak detector

12. AC POWER LINE CONDUCTED EMISSIONS

LIMITS

FCC §15.207 (a)

Frequency of Emission (MHz)	Conducted Limit (dBuV)	
	Quasi-peak	Average
0.15-0.5	66 to 56	56 to 46
0.5-5	56	46
5-30	60	50

*Decreases with the logarithm of the frequency.

TEST PROCEDURE

The EUT is placed on a non-conducting table 40 cm from the vertical ground plane and 80 cm above the horizontal ground plane. The EUT is configured in accordance with ANSI C63.10.

The receiver is set to a resolution bandwidth of 9 kHz. Peak detection is used unless otherwise noted as quasi-peak or average.

Line conducted data is recorded for both NEUTRAL and HOT lines.

RESULTS

WORST EMISSIONS

LINE 1 PLOT

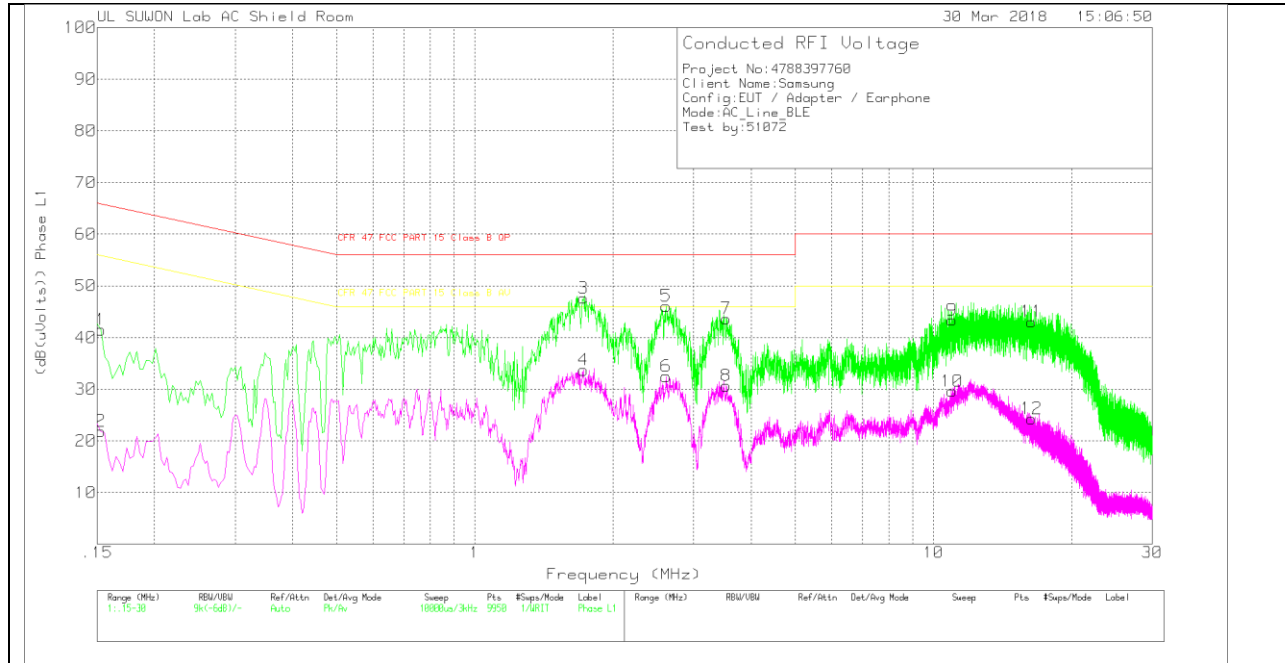

LINE 1 RESULTS

Trace Markers

Range 1: Phase L1 .15 - 30MHz

Marker	Frequency (MHz)	Meter Reading (dBuV)	Det	101837_L1_with extension	CABLELOSS(dB)	Corrected Reading (dB(uVolts))	CFR 47 FCC PART 15 Class B QP	Margin (dB)	CFR 47 FCC PART 15 Class B AV	Margin (dB)
1	.153	31.41	Pk	10	.1	41.51	65.84	-24.33	-	-
2	.153	11.78	Av	10	.1	21.88	-	-	55.84	-33.96
3	1.725	37.43	Pk	9.9	.3	47.63	56	-8.37	-	-
4	1.725	23.51	Av	9.9	.3	33.71	-	-	46	-12.29
5	2.613	36	Pk	9.8	.3	46.1	56	-9.9	-	-
6	2.613	22.39	Av	9.8	.3	32.49	-	-	46	-13.51
7	3.531	33.57	Pk	9.8	.3	43.67	56	-12.33	-	-
8	3.531	20.58	Av	9.8	.3	30.68	-	-	46	-15.32
9	10.98	33.25	Pk	9.8	.3	43.35	60	-16.65	-	-
10	10.98	19.53	Av	9.8	.3	29.63	-	-	50	-20.37
11	16.356	32.77	Pk	9.9	.4	43.07	60	-16.93	-	-
12	16.374	14	Av	9.9	.4	24.3	-	-	50	-25.7

Pk - Peak detector

Av - Average detection

Quasi-Peak Emissions

Range 1: Phase L1 .15 - 30MHz

Frequency (MHz)	Meter Reading (dBuV)	Det	101837_L1_with extension	CABLELOSS(dB)	Corrected Reading (dB(uVolts))	CFR 47 FCC PART 15 Class B QP	Margin (dB)	CFR 47 FCC PART 15 Class B AV	Margin (dB)
.15225	28.57	Qp	10	.1	38.67	65.88	-27.21	-	-
1.72575	35.54	Qp	9.9	.3	45.74	56	-10.26	-	-
2.61315	31.74	Qp	9.8	.3	41.84	56	-14.16	-	-
3.53115	28.72	Qp	9.8	.3	38.82	56	-17.18	-	-
10.9808	28.54	Qp	9.8	.3	38.64	60	-21.36	-	-
16.3562	28.65	Qp	9.9	.4	38.95	60	-21.05	-	-
16.3733	27.78	Qp	9.9	.4	38.08	60	-21.92	-	-

Qp - Quasi-Peak detector

LINE 2 PLOT

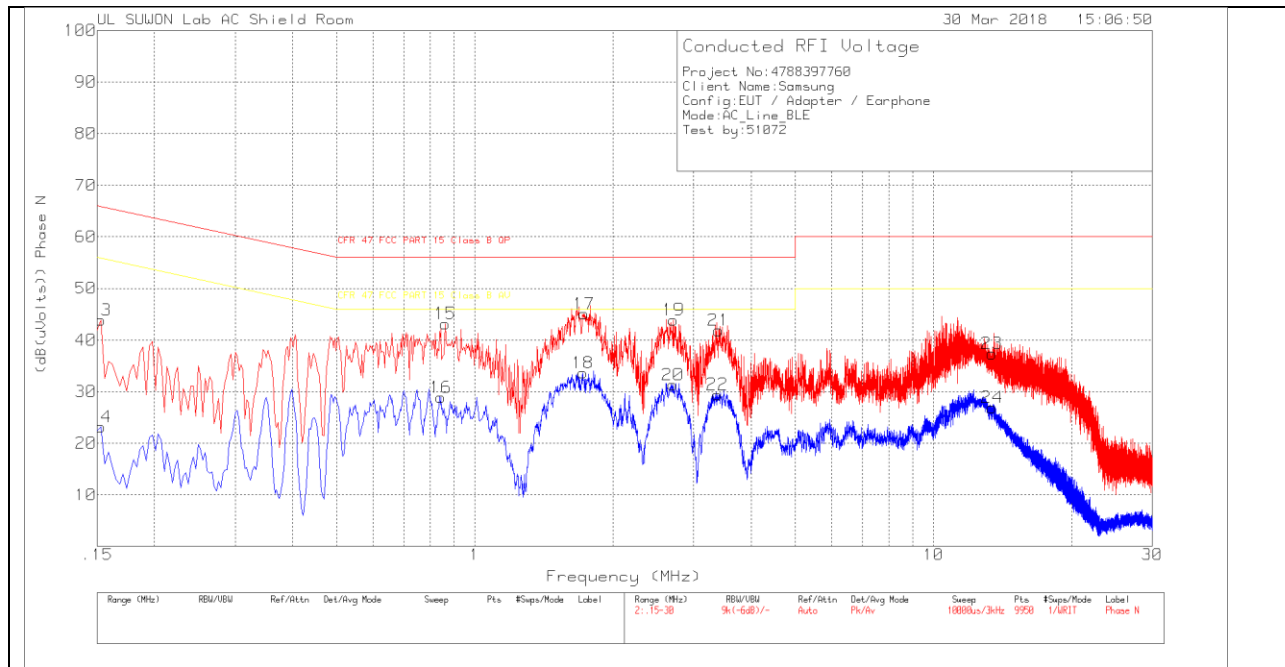

LINE 2 RESULTS

Trace Markers

Range 2: Phase N .15 - 30MHz

Marker	Frequency (MHz)	Meter Reading (dBuV)	Det	101837_N_with extension	CABLELOSS(dB)	Corrected Reading (dB(uVolts))	CFR 47 FCC PART 15 Class B QP	Margin (dB)	CFR 47 FCC PART 15 Class B AV	Margin (dB)
13	.153	33.74	Pk	10	.1	43.84	65.84	-22	-	-
14	.153	13.08	Av	10	.1	23.18	-	-	55.84	-32.66
15	.861	33.15	Pk	9.7	.3	43.15	56	-12.85	-	-
16	.843	18.9	Av	9.7	.3	28.9	-	-	46	-17.1
17	1.731	34.86	Pk	9.9	.3	45.06	56	-10.94	-	-
18	1.719	23.41	Av	9.9	.3	33.61	-	-	46	-12.39
19	2.712	33.68	Pk	9.9	.3	43.88	56	-12.12	-	-
20	2.703	21.11	Av	9.9	.3	31.31	-	-	46	-14.69
21	3.399	31.77	Pk	9.8	.3	41.87	56	-14.13	-	-
22	3.378	19.32	Av	9.8	.3	29.42	-	-	46	-16.58
23	13.413	27.16	Pk	9.8	.4	37.36	60	-22.64	-	-
24	13.428	16.7	Av	9.8	.4	26.9	-	-	50	-23.1

Pk - Peak detector

Av - Average detection

Quasi-Peak Emissions

Range 2: Phase N .15 - 30MHz

Frequency (MHz)	Meter Reading (dBuV)	Det	101837_N_with extension	CABLELOSS(dB)	Corrected Reading (dB(uVolts))	CFR 47 FCC PART 15 Class B QP	Margin (dB)	CFR 47 FCC PART 15 Class B AV	Margin (dB)
.15225	29.65	Qp	10	.1	39.75	65.88	-26.13	-	-
.86175	29.24	Qp	9.7	.3	39.24	56	-16.76	-	-
.84225	29.31	Qp	9.7	.3	39.31	56	-16.69	-	-
1.73175	32.84	Qp	9.9	.3	43.04	56	-12.96	-	-
1.71975	31.75	Qp	9.9	.3	41.95	56	-14.05	-	-
2.71215	28.09	Qp	9.9	.3	38.29	56	-17.71	-	-
2.70375	28.98	Qp	9.9	.3	39.18	56	-16.82	-	-
3.39975	27.34	Qp	9.8	.3	37.44	56	-18.56	-	-
3.37725	26.78	Qp	9.8	.3	36.88	56	-19.12	-	-
13.4123	22.78	Qp	9.8	.4	32.98	60	-27.02	-	-
13.4288	22.39	Qp	9.8	.4	32.59	60	-27.41	-	-

Qp - Quasi-Peak detector