



**FCC CFR47 PART 15 SUBPART C**

**Bluetooth**

**CERTIFICATION TEST REPORT**

**FOR**

**GSM/WCDMA/LTE Phone + BT/BLE and DTS b/g/n**

**MODEL NUMBER : SM-J600F/DS, SM-J600F**

**FCC ID: A3LSMJ600F**

**REPORT NUMBER: 4788397760-E3V2**

**ISSUE DATE: APR 11, 2018**

*Prepared for*  
**SAMSUNG ELECTRONICS CO., LTD.**  
**129 SAMSUNG-RO, YEONGTONG-GU, SUWON-SI,**  
**GYEONGGI-DO, 16677, KOREA**

*Prepared by*  
**UL Korea, Ltd.**  
**26th floor, 152, Teheran-ro, Gangnam-gu Seoul, 06236, Korea**

**Suwon Test Site: UL Korea, Ltd. Suwon Laboratory**  
**218 Maeyeong-ro, Yeongtong-gu,**  
**Suwon-si, Gyeonggi-do, 16675, Korea**  
**TEL: (031) 337-9902**  
**FAX: (031) 213-5433**



**ACCREDITED\***

Testing  
Laboratory

**TL-637**

Revision History

<u>Rev.</u>	<u>Issue Date</u>	<u>Revisions</u>	<u>Revised By</u>
V1	04/09/18	Initial issue	Hoonpyo Lee
V2	04/11/18	Updated to address TCB's question	Hoonpyo Lee

## TABLE OF CONTENTS

<b>1. ATTESTATION OF TEST RESULTS .....</b>	<b>5</b>
<b>2. TEST METHODOLOGY .....</b>	<b>6</b>
<b>3. FACILITIES AND ACCREDITATION .....</b>	<b>6</b>
<b>4. CALIBRATION AND UNCERTAINTY .....</b>	<b>6</b>
4.1. MEASURING INSTRUMENT CALIBRATION.....	6
4.2. SAMPLE CALCULATION.....	6
4.3. MEASUREMENT UNCERTAINTY .....	7
<b>5. EQUIPMENT UNDER TEST .....</b>	<b>8</b>
5.1. DESCRIPTION OF EUT.....	8
5.1. MAXIMUM OUTPUT POWER.....	8
5.2. DESCRIPTION OF AVAILABLE ANTENNAS .....	8
5.3. WORST-CASE CONFIGURATION AND MODE .....	8
5.4. DESCRIPTION OF TEST SETUP .....	9
<b>6. MEASUREMENT METHODS .....</b>	<b>11</b>
<b>7. TEST AND MEASUREMENT EQUIPMENT .....</b>	<b>12</b>
<b>8. REFERENCE MEASUREMENT RESULTS.....</b>	<b>13</b>
8.1. ON TIME AND DUTY CYCLE RESULTS.....	13
8.2. 20 dB AND 99% BANDWIDTH.....	14
8.2.1. BASIC DATA RATE GFSK MODULATION.....	14
8.2.2. ENHANCED DATA RATE Pi/4-DQPSK MODULATION.....	14
8.2.3. ENHANCED DATA RATE 8PSK MODULATION .....	14
8.2.4. 20 dB AND 99% BANDWIDTH PLOTS.....	15
<b>9. SUMMARY TABLE .....</b>	<b>18</b>
<b>10. ANTENNA PORT TEST RESULTS .....</b>	<b>19</b>
10.1. HOPPING FREQUENCY SEPARATION .....	19
10.2. NUMBER OF HOPPING CHANNELS.....	20
10.3. AVERAGE TIME OF OCCUPANCY.....	22
10.4. OUTPUT POWER.....	26
10.4.1. BASIC DATA RATE GFSK MODULATION.....	26
10.4.2. ENHANCED DATA RATE Pi/4-DPSK MODULATION .....	26
10.4.3. ENHANCED DATA RATE 8PSK MODULATION .....	26
10.4.4. OUTPUT POWER PLOTS.....	27
10.5. AVERAGE POWER.....	30

---

10.5.1.	BASIC DATA RATE GFSK MODULATION.....	30
10.5.2.	DATA RATE PI/4-DQPSK MODULATION .....	30
10.5.3.	ENHANCED DATA RATE 8PSK MODULATION .....	30
10.6.	CONDUCTED SPURIOUS EMISSIONS.....	31
10.6.1.	BASIC DATA RATE GFSK MODULATION.....	32
<b>11.</b>	<b>RADIATED TEST RESULTS .....</b>	<b>44</b>
11.1.	LIMITS AND PROCEDURE .....	44
11.2.	TRANSMITTER ABOVE 1 GHz .....	46
11.2.1.	BASIC DATA RATE GFSK MODULATION.....	46
11.2.2.	ENHANCED DATA RATE 8PSK MODULATION .....	56
11.3.	WORST-CASE BELOW 1 GHz.....	66
<b>12.</b>	<b>AC POWER LINE CONDUCTED EMISSIONS .....</b>	<b>68</b>
<b>13.</b>	<b>SETUP PHOTOS .....</b>	<b>73</b>

# 1. ATTESTATION OF TEST RESULTS

**COMPANY NAME:** SAMSUNG ELECTRONICS CO., LTD.  
**EUT DESCRIPTION:** GSM/WCDMA/LTE Phone + BT/BLE and DTS b/g/n  
**MODEL NUMBER:** SM-J600F/DS, SM-J600F  
**SERIAL NUMBER:** R38K20GLBNH (RADIATED);  
R38K20GLBPP (CONDUCTED)  
**DATE TESTED:** MAR 17, 2018 - MAR 30, 2018

APPLICABLE STANDARDS	
STANDARD	TEST RESULTS
CFR 47 Part 15 Subpart C	Pass

UL Korea, Ltd. tested the above equipment in accordance with the requirements set forth in the above standards. All indications of Pass/Fail in this report are opinions expressed by UL Korea, Ltd. based on interpretations and/or observations of test results. Measurement Uncertainties were not taken into account and are published for informational purposes only. The test results show that the equipment tested is capable of demonstrating compliance with the requirements as documented in this report.

**Note:** The results documented in this report apply only to the tested sample, under the conditions and modes of operation as described herein. This document may not be altered or revised in any way unless done so by UL Korea, Ltd. and all revisions are duly noted in the revisions section. Any alteration of this document not carried out by UL Korea, Ltd. will constitute fraud and shall nullify the document. This report must not be used by the client to claim product certification, approval, or endorsement by IAS, any agency of the Federal Government, or any agency of any government.

Approved & Released For  
UL Korea, Ltd. By:



SungGil Park  
Suwon Lab Engineer  
UL Korea, Ltd.

Tested By:



Hoonpyo Lee  
Suwon Lab Engineer  
UL Korea, Ltd.

## 2. TEST METHODOLOGY

The tests documented in this report were performed in accordance with following methods.

1. FCC CFR 47 Part 2.
2. FCC CFR 47 Part 15.
3. FCC DA 00-705 Filling and measurement guidelines for FHSS systems
4. ANSI C63.10-2013.

## 3. FACILITIES AND ACCREDITATION

The test sites and measurement facilities used to collect data are located at 218 Maeyeong-ro, Yeongtong-gu, Suwon-si, Gyeonggi-do, 16675, Korea. Line conducted emissions are measured only at the 218 address. The following table identifies which facilities were utilized for radiated emission measurements documented in this report. Specific facilities are also identified in the test results sections.

218 Maeyeong-ro	
<input checked="" type="checkbox"/>	Chamber 1
<input checked="" type="checkbox"/>	Chamber 2
<input type="checkbox"/>	Chamber 3

UL Korea, Ltd. is accredited by IAS, Laboratory Code TL-637. The full scope of accreditation can be viewed at <http://www.iasonline.org/PDF/TL/TL-637.pdf>.

## 4. CALIBRATION AND UNCERTAINTY

### 4.1. MEASURING INSTRUMENT CALIBRATION

The measuring equipment utilized to perform the tests documented in this report has been calibrated in accordance with the manufacturer's recommendations, and is traceable to recognized national standards.

### 4.2. SAMPLE CALCULATION

Where relevant, the following sample calculation is provided:

$$\begin{aligned} \text{Field Strength (dBuV/m)} &= \text{Measured Voltage (dBuV)} + \text{Antenna Factor (dB/m)} + \\ &\text{Cable Loss (dB)} - \text{Preamp Gain (dB)} \\ 36.5 \text{ dBuV} + 18.7 \text{ dB/m} + 0.6 \text{ dB} - 26.9 \text{ dB} &= 28.9 \text{ dBuV/m} \end{aligned}$$

### 4.3. MEASUREMENT UNCERTAINTY

Where relevant, the following measurement uncertainty levels have been estimated for tests performed on the apparatus:

PARAMETER	UNCERTAINTY
Conducted Disturbance, 0.15 to 30 MHz	2.32 dB
Radiated Disturbance, Below 1GHz	3.86 dB
Radiated Disturbance, Above 1 GHz	5.97 dB

Uncertainty figures are valid to a confidence level of 95%.

## 5. EQUIPMENT UNDER TEST

### 5.1. DESCRIPTION OF EUT

The EUT is a GSM/WCDMA/LTE Phone + BT/BLE and DTS b/g/n.  
 This test report addresses the DSS (BT) operational mode.

### 5.1. MAXIMUM OUTPUT POWER

The transmitter has a maximum conducted output power as follows:

Frequency Range [MHz]	Mode	Power Mode	Output Power [dBm]	Output Power [mW]
2402 - 2480	Basic GFSK	Average	9.701	9.334
		Peak	10.940	12.417
	Enhanced Pi/4-DPSK	Average	4.663	2.926
		Peak	8.480	7.047
	Enhanced 8PSK	Average	4.664	2.927
		Peak	8.890	7.745

### 5.2. DESCRIPTION OF AVAILABLE ANTENNAS

The radio utilizes an internal antenna, with a maximum gain of -2.0 dBi.

### 5.3. WORST-CASE CONFIGURATION AND MODE

Radiated emission below 1GHz and power line conducted emission were performed with the EUT set to transmit at the channel with highest output power as worst-case scenario.

Radiated emission above 1GHz was performed with the EUT set to transmit low/mid/high channels.

The fundamental of the EUT was investigated in three orthogonal orientations X, Y and Z it was determined that X orientation was worst-case orientation; therefore, all final radiated testing was performed with the EUT in X orientation.

Note: GFSK, Pi/4-DQPSK, 8PSK average Power are all investigated, The GFSK & 8PSK Power are the worst case. Testing is based on this mode to showing compliance. For average power data please refer to section 9.5. All radiated and power line conducted tests were performed connected with earphone and charger for evaluation of worst case mode.



## 5.4. DESCRIPTION OF TEST SETUP

### SUPPORT EQUIPMENT

Support Equipment List				
Description	Manufacturer	Model	Serial Number	FCC ID
Charger	SAMSUNG	ETA0U83EWE	RT2K117oS/A-E	N/A
Data Cable	SAMSUNG	ECB-DU68WE	N/A	N/A
Earphone	SAMSUNG	EHS61ASFWE	N/A	N/A

### I/O CABLES

I/O Cable List						
Cable No	Port	# of identical ports	Connector Type	Cable Type	Cable Length (m)	Remarks
1	DC Power	1	Mini-USB	Shielded	1.2m	N/A
2	Audio	2	Mini-Jack	Unshielded	1.2m	N/A

### TEST SETUP

The EUT is continuously communicating to the Bluetooth tester during the tests.  
 Test software enable BT communications.

**SETUP DIAGRAM FOR TESTS (CONDUCTED TEST SETUP)**

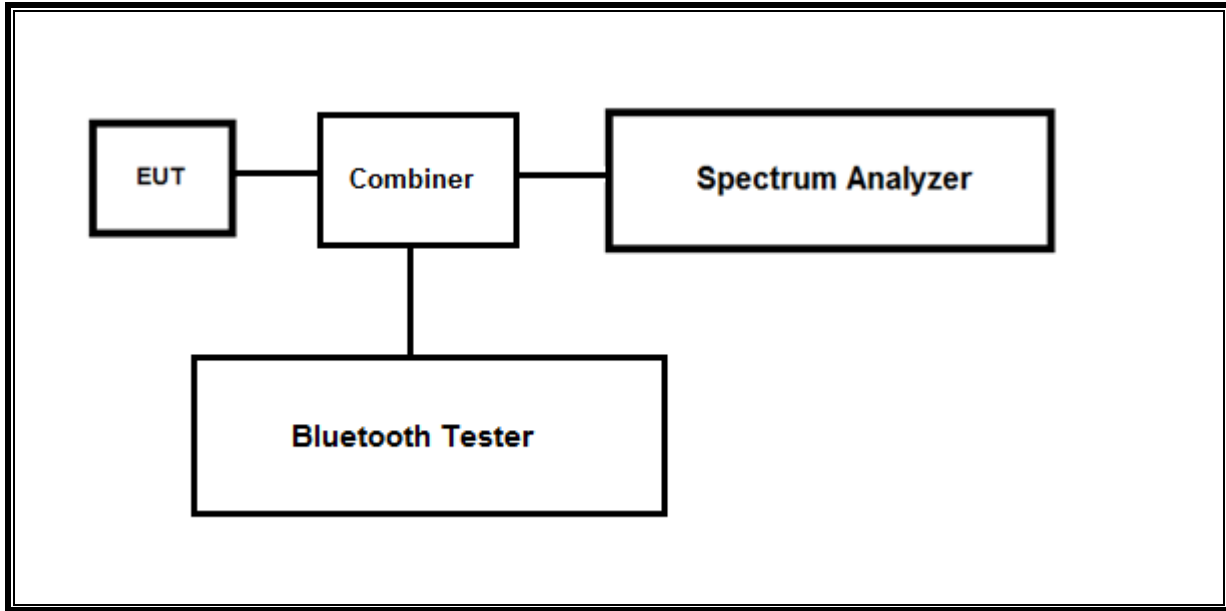

**SETUP DIAGRAM FOR TESTS (RADIATED TEST SETUP)**

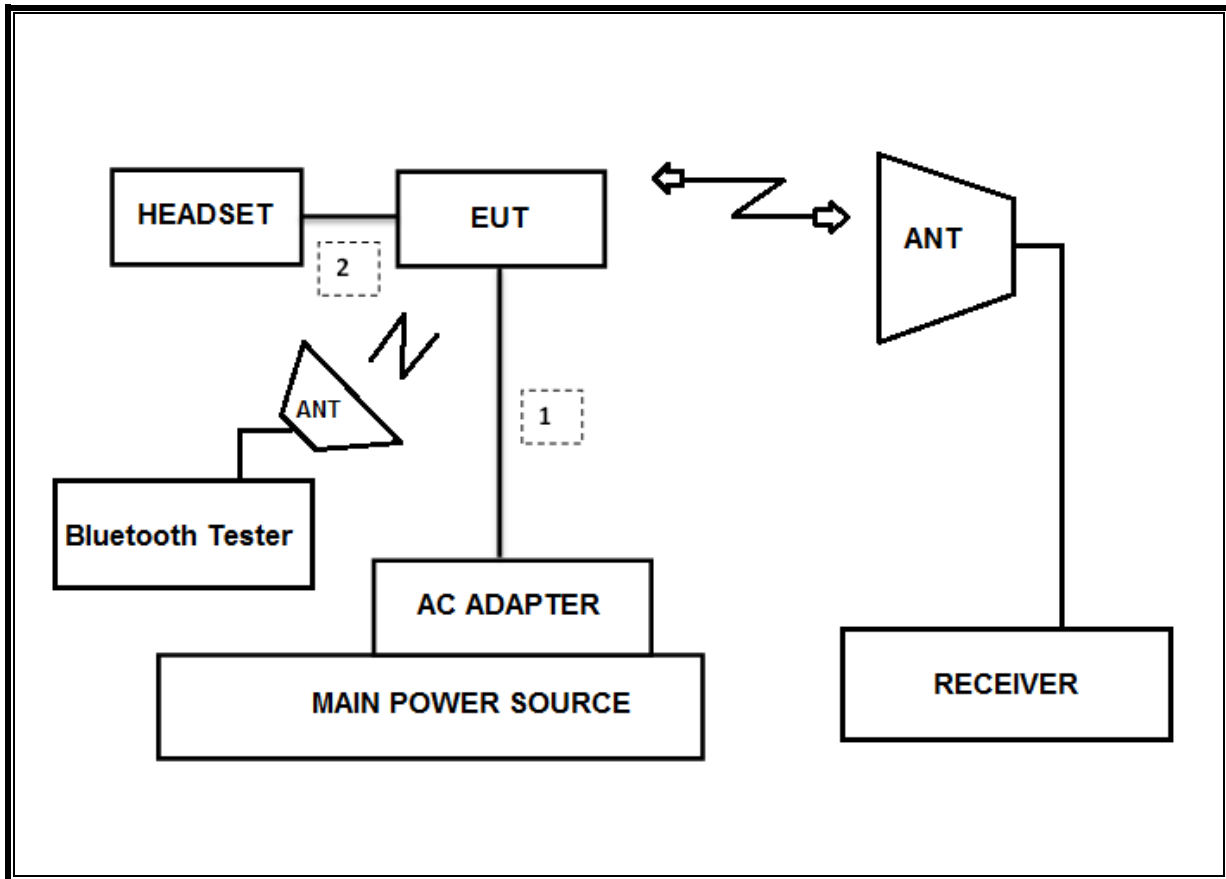

## 6. MEASUREMENT METHODS

20dB BW : ANSI C63.10, Section 6.9.2

99% BW : ANSI C63.10, Section 6.9.3

HOPPING FREQUENCY SEPARATION : ANSI C63.10, Section 7.8.2

NUMBER OF HOPPING CHANNELS : ANSI C63.10, Section 7.8.3

AVERAGE TIME OF OCCUPANCY : ANSI C63.10, Section 7.8.4

OUTPUT POWER : ANSI C63.10, Section 7.8.5.

Out-of-band EMISSIONS (Conducted) : ANSI C63.10, Section 7.8.6, 7.8.8

Out-of-band EMISSIONS IN NON-RESTRICTED BANDS: ANSI C63.10, Section 6.

Out-of-band EMISSIONS IN RESTRICTED BANDS : ANSI C63.10, Section 6.

AC Power Line Conducted Emission : ANSI C63.10-2013, Section 6.2.

## 7. TEST AND MEASUREMENT EQUIPMENT

The following test and measurement equipment was utilized for the tests documented in this report:

Test Equipment List				
Description	Manufacturer	Model	S/N	Cal Due
Antenna, Bilog, 30MHz-1GHz	SCHWARZBECK	VULB9163	750	08-31-19
Antenna, Bilog, 30MHz-1GHz	SCHWARZBECK	VULB9163	749	09-14-19
Antenna, Bilog, 30MHz-1GHz	SCHWARZBECK	VULB9163	845	08-31-19
Antenna, Loop, 9kHz-30MHz	R&S	HFH2-Z2	100418	10-26-19
Antenna, Horn, 18 GHz	ETS	3115	00167211	10-14-18
Antenna, Horn, 18 GHz	ETS	3115	00161451	03-10-19
Antenna, Horn, 18 GHz	ETS	3117	00168724	05-31-19
Antenna, Horn, 18 GHz	ETS	3117	00168717	05-31-19
Antenna, Horn, 18 GHz	ETS	3117	00205959	11-29-18
Antenna, Horn, 40 GHz	ETS	3116C	00166155	12-04-19
Antenna, Horn, 40 GHz	ETS	3116C	00168645	12-04-19
Antenna, Horn, 40 GHz	ETS	3116C-PA	00168841	11-13-19
Preamplifier, 1000 MHz	Sonoma	310N	341282	08-09-18
Preamplifier, 1000 MHz	Sonoma	310N	351741	08-07-18
Preamplifier, 1000 MHz	Sonoma	310N	370599	08-10-18
Preamplifier, 18 GHz	Miteq	AFS42-00101800-25-S-42	1876511	08-08-18
Preamplifier, 18 GHz	Miteq	AFS42-00101800-25-S-42	1896138	08-08-18
Preamplifier, 18 GHz	Miteq	AFS42-00101800-25-S-42	2029169	08-11-18
Spectrum Analyzer, 44 GHz	Agilent / HP	N9030A	MY54170614	08-08-18
Spectrum Analyzer, 44 GHz	Agilent / HP	N9030A	MY54490312	08-08-18
Spectrum Analyzer, 43.5 GHz	R&S	FSW43	104089	08-11-18
Average Power Sensor	Agilent / HP	U2000	MY54270007	08-08-18
Bluetooth Tester	TESCOM	TC-3000C	3000C000546	08-08-18
Combiner	WEINCHEL	1575	2152	08-08-18
Attenuator	PASTERNAK	PE7087-10	A001	08-08-18
Attenuator	PASTERNAK	PE7087-10	A008	08-08-18
Attenuator	PASTERNAK	PE7087-10	2	08-10-18
EMI Test Receive, 40 GHz	R&S	ESU40	100439	08-08-18
EMI Test Receive, 40 GHz	R&S	ESU40	100457	08-08-18
EMI Test Receive, 44 GHz	R&S	ESW44	101590	08-09-18
EMI Test Receive, 3 GHz	R&S	ESR3	101832	08-07-18
Low Pass Filter 5GHz	Micro-Tronics	LPS17541	009	08-08-18
Low Pass Filter 5GHz	Micro-Tronics	LPS17541	015	08-08-18
Low Pass Filter 5GHz	Micro-Tronics	LPS17541	020	08-11-18
High Pass Filter 3GHz	Micro-Tronics	HPM17543	010	08-08-18
High Pass Filter 3GHz	Micro-Tronics	HPM17543	015	08-08-18
High Pass Filter 3GHz	Micro-Tronics	HPM17543	020	08-11-18
High Pass Filter 6GHz	Micro-Tronics	HPS17542	009	08-08-18
High Pass Filter 6GHz	Micro-Tronics	HPS17542	016	08-08-18
High Pass Filter 6GHz	Micro-Tronics	HPS17542	021	08-11-18
LISN	R&S	ENV-216	101837	08-09-18
UL Software				
Description	Manufacturer	Model	Version	
Radiated software	UL	UL EMC	Ver 9.5	

## 8. REFERENCE MEASUREMENT RESULTS

### 8.1. ON TIME AND DUTY CYCLE RESULTS

#### LIMITS

None: for reporting purposes only.

Mode	ON Time B [msec]	Period [msec]	Duty Cycle x [linear]	Duty Cycle [%]	Duty Cycle Correction Factor [dB]	1/T Minimum VBW [kHz]
<b>2400MHz Bands</b>						
BT	2.887	3.750	0.770	77.0%	1.14	0.346

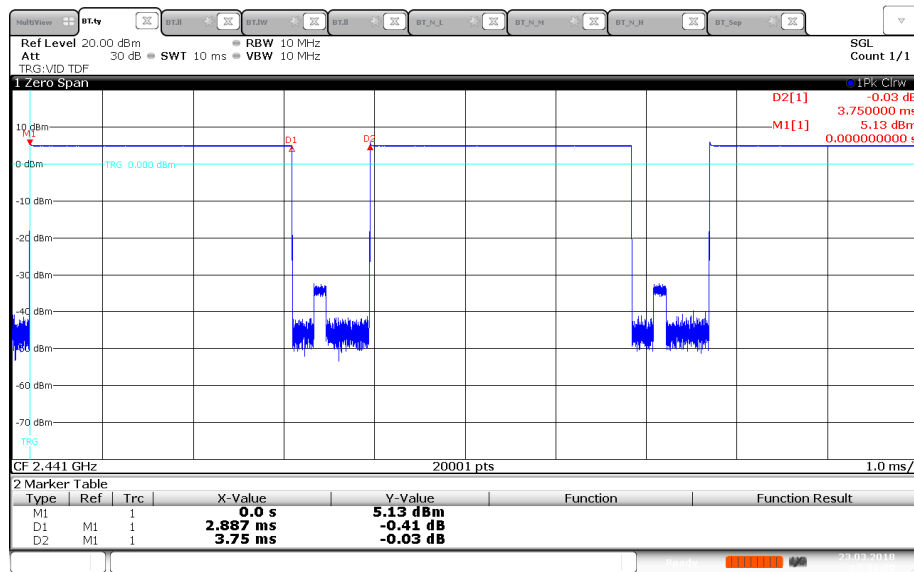

15:39:10 23.03.2018

## 8.2. 20 dB AND 99% BANDWIDTH

### LIMITS

None; for reporting purposes only.

### TEST PROCEDURE

The transmitter output is connected to a spectrum analyzer. The RBW is set to  $\geq 1\%$  of the 20 dB bandwidth. The VBW is set to  $\geq$  RBW. The sweep time is coupled.

### RESULTS

#### 8.2.1. BASIC DATA RATE GFSK MODULATION

Channel	Frequency [MHz]	20 dB Bandwidth [MHz]	99% Bandwidth [kHz]
Low	2402	1.052	895.877
Mid	2441	1.052	900.036
High	2480	1.051	899.247
Worst		1.052	900.036

#### 8.2.2. ENHANCED DATA RATE Pi/4-DQPSK MODULATION

Channel	Frequency [MHz]	20 dB Bandwidth [MHz]	99% Bandwidth [MHz]
Low	2402	1.347	1.165
Mid	2441	1.348	1.166
High	2480	1.349	1.165
Worst		1.349	1.166

#### 8.2.3. ENHANCED DATA RATE 8PSK MODULATION

Channel	Frequency [MHz]	20 dB Bandwidth [MHz]	99% Bandwidth [MHz]
Low	2402	1.312	1.165
Mid	2441	1.308	1.164
High	2480	1.308	1.165
Worst		1.312	1.165

### 8.2.4. 20 dB AND 99% BANDWIDTH PLOTS

#### GFSK BANDWIDTH

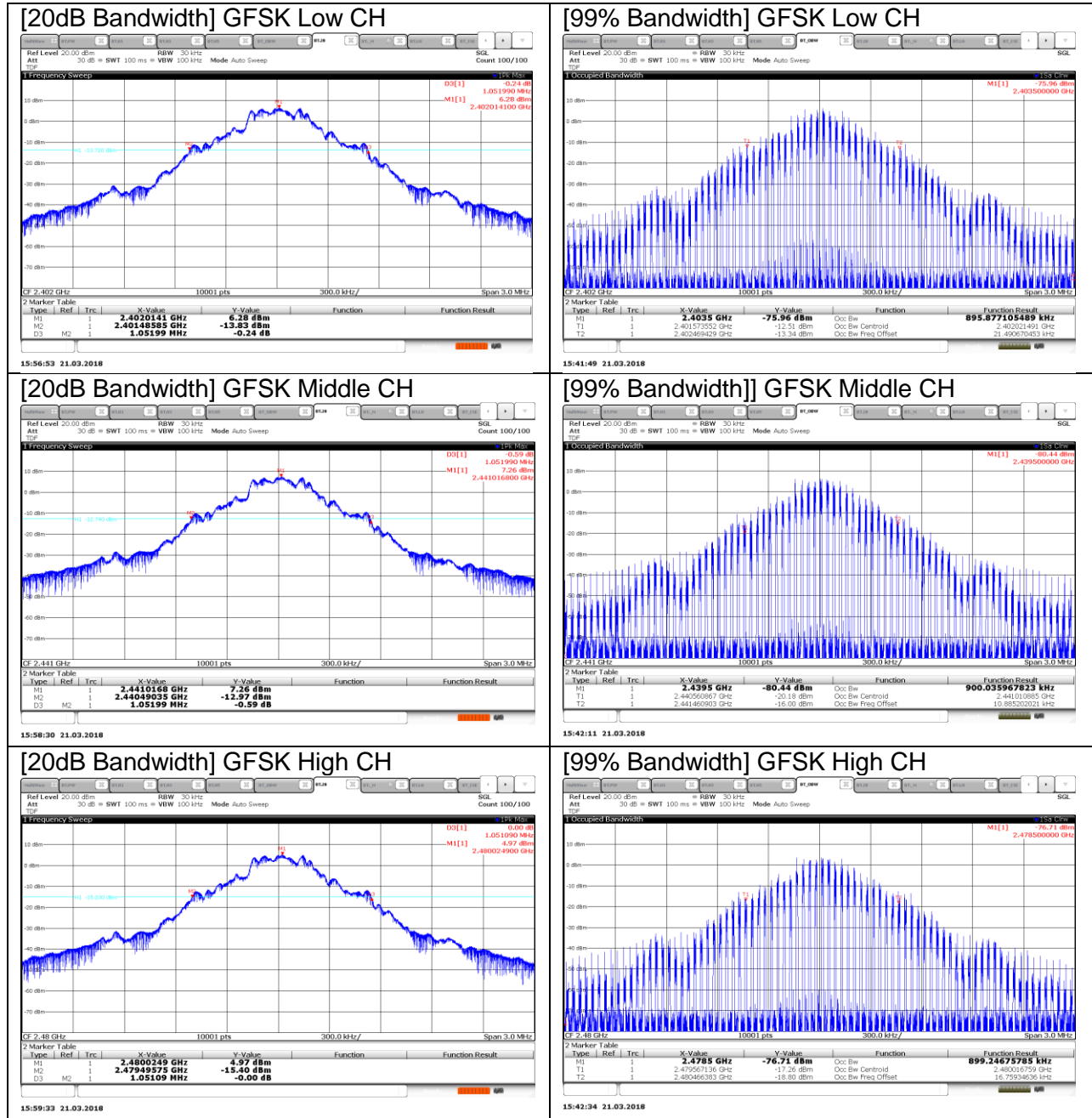

**Pi/4-DQPSK BANDWIDTH**

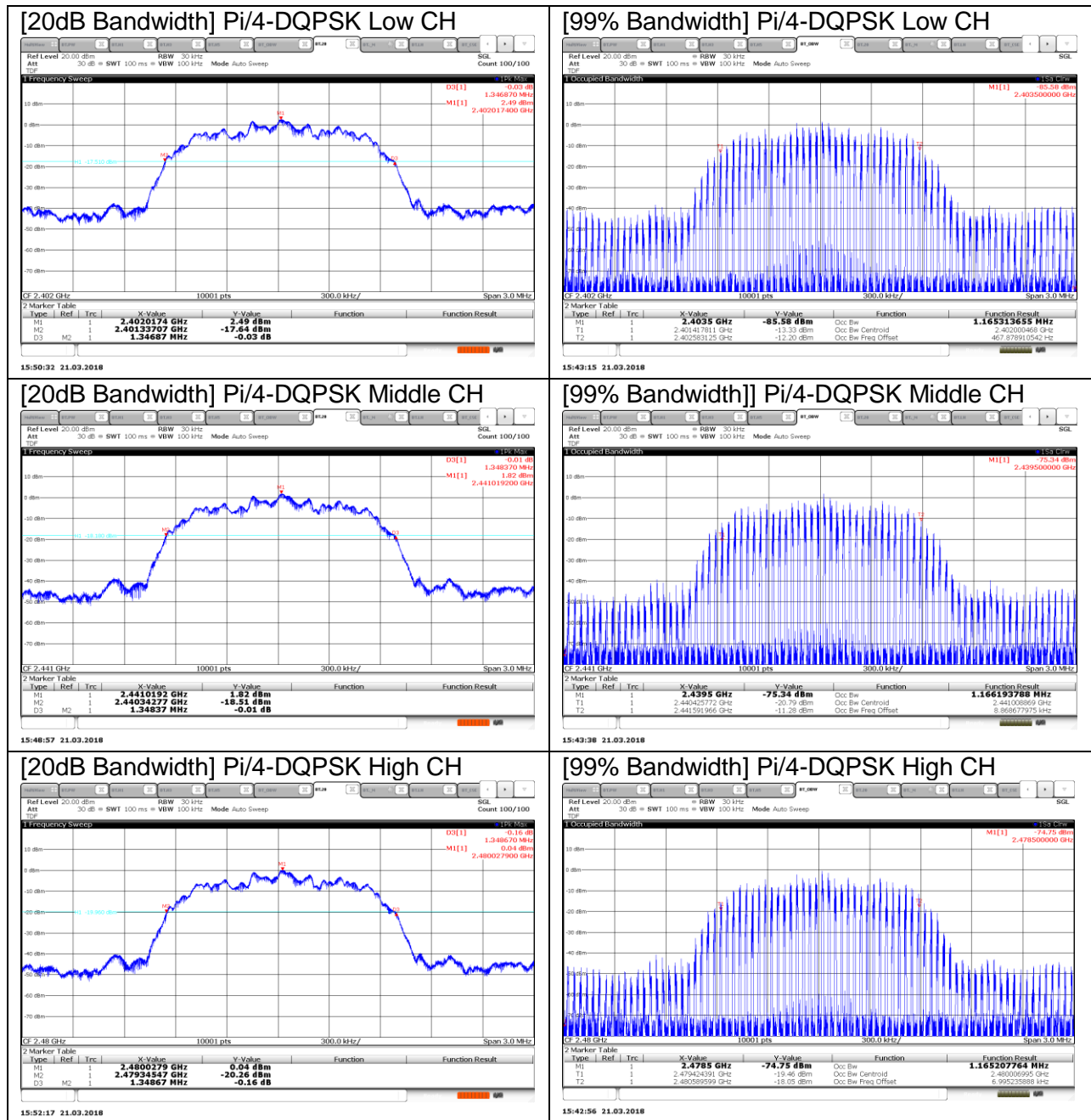



**8PSK BANDWIDTH**

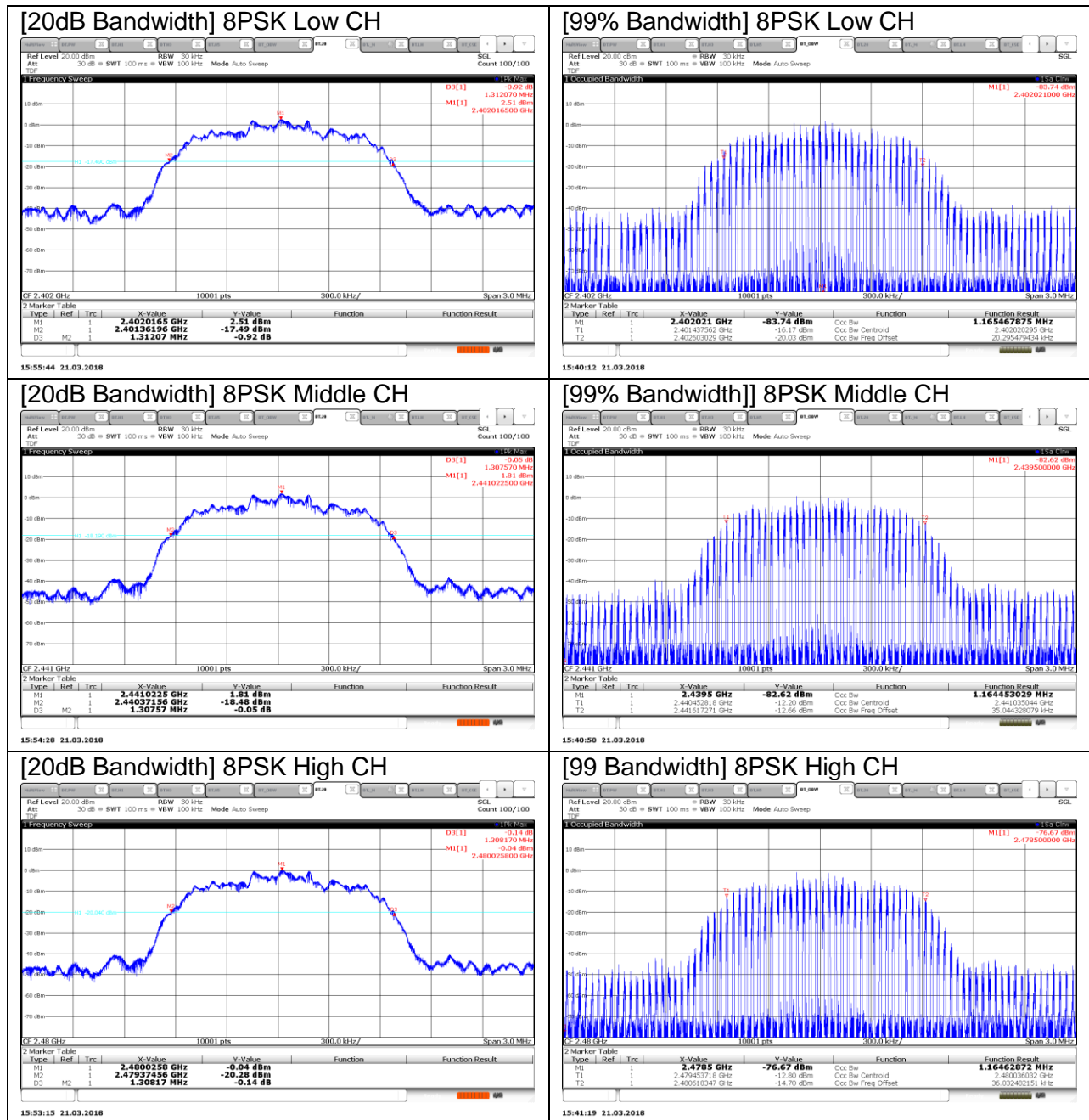

## 9. SUMMARY TABLE

FCC Part Section	Test Description	Test Limit	Test Condition	Test Result
2.1051, 15.247 (d)	Band Edge / Conducted Spurious Emission	-20dBc		Pass
15.247 (b)(1)	TX conducted output power	<30dBm		Pass
15.247 (a)(1)	Hopping frequency separation	> two-thirds of the 20 dB bandwidth		Pass
15.247 (a)(1)(iii)	Number of Hopping channels	More than 15 non-overlapping channels		Pass
15.247 (a)(1)(iii)	Avg Time of Occupancy	< 0.4sec		Pass
15.207 (a)	AC Power Line conducted emissions	Section 10	Power Line conducted	Pass
15.205, 15.209	Radiated Spurious Emission	< 54dBuV/m	Radiated	Pass

## 10. ANTENNA PORT TEST RESULTS

### 10.1. HOPPING FREQUENCY SEPARATION

#### LIMIT

FCC §15.247 (a) (1)

Frequency hopping systems shall have hopping channel carrier frequencies separated by a minimum of 25 kHz or the 20 dB bandwidth of the hopping channel, whichever is greater.

Alternatively, frequency hopping systems operating in the 2400-2483.5 MHz band may have hopping channel carrier frequencies that are separated by 25 kHz or two-thirds of the 20 dB bandwidth of the hopping channel, whichever is greater, provided the systems operate with an output power no greater than 125 mW.

#### TEST PROCEDURE

The transmitter output is connected to a spectrum analyzer. The RBW is set to 300 kHz and the VBW is set to 300 kHz. The sweep time is coupled.

#### RESULTS

##### HOPPING FREQUENCY SEPARATION PLOT

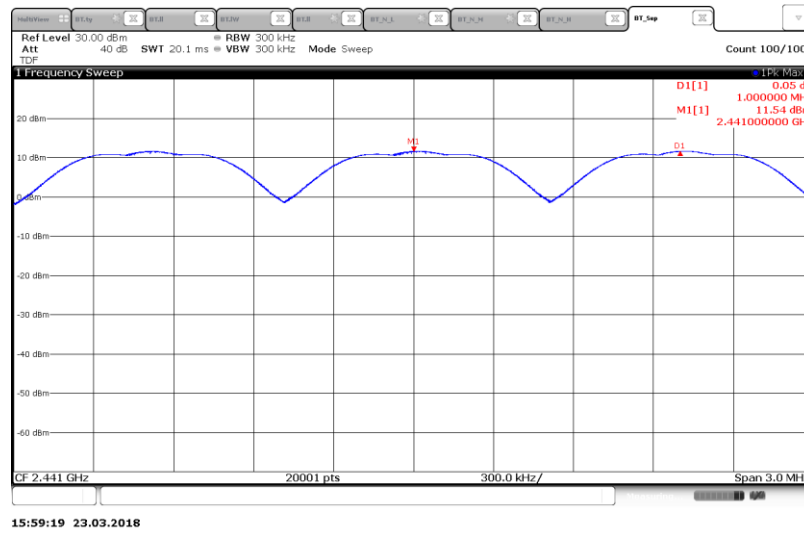

## 10.2. NUMBER OF HOPPING CHANNELS

### LIMIT

FCC §15.247 (a) (1) (iii)

Frequency hopping systems in the 2400 – 2483.5 MHz band shall use at least 15 non-overlapping channels.

### TEST PROCEDURE

The transmitter output is connected to a spectrum analyzer. The span is set to cover the entire authorized band, in either a single sweep or in multiple contiguous sweeps. The RBW is set to a maximum of 1 % of the span. The analyzer is set to Max Hold.

### RESULTS

Normal Mode: 79 Channels observed.

### NUMBER OF HOPPING CHANNELS PLOTS

#### NUMBER OF HOPPING CHANNELS (100 MHz SPAN)

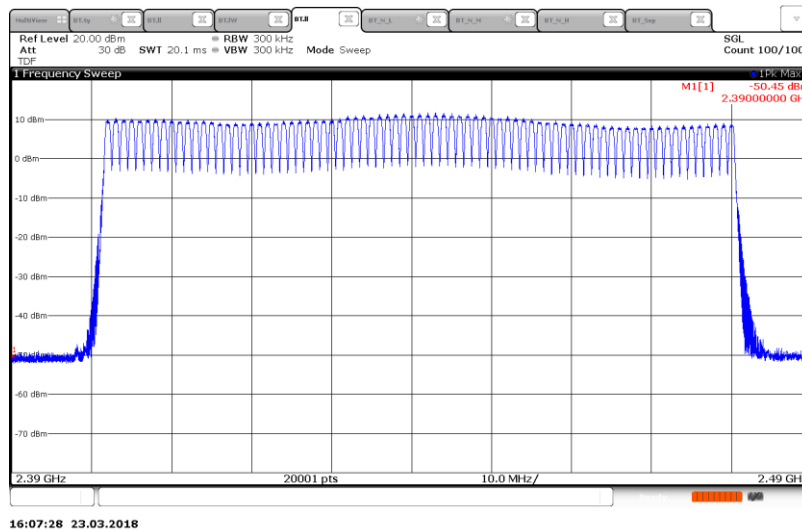

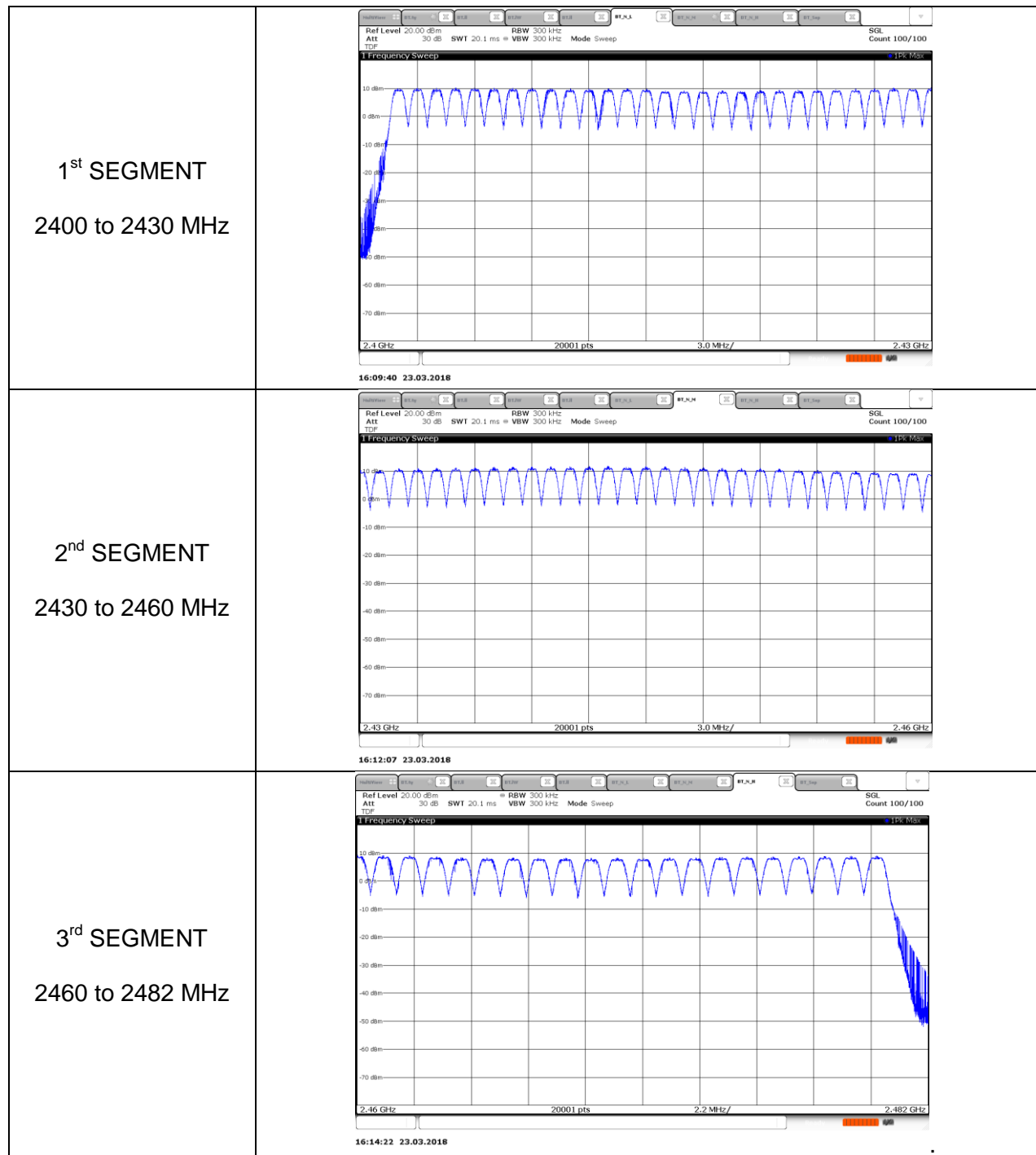

### 10.3. AVERAGE TIME OF OCCUPANCY

#### LIMIT

FCC §15.247 (a) (1) (iii)

The average time of occupancy on any channel shall not be greater than 0.4 seconds within a period of 0.4 seconds multiplied by the number of hopping channels employed.

#### TEST PROCEDURE

The transmitter output is connected to a spectrum analyzer. The span is set to 0 Hz, centered on a single, selected hopping channel. The width of a single pulse is measured in a fast scan. The number of pulses is measured in a 3.16 second scan, to enable resolution of each occurrence.

The average time of occupancy in the specified 31.6 second period (79 channels \* 0.4 s) is equal to 10 \* (# of pulses in 3.16 s) \* pulse width.

For AFH mode, the average time of occupancy in the specified 8 second period (20 channels \* 0.4 seconds) is equal to 10 \* (# of pulses in 0.8 s) \* pulse width.

#### RESULTS[GFSK]

DH Packet	Pulse Width [msec]	Number of Pulses in 3.16 seconds	Average Time of Occupancy [sec]	Limit [sec]	Margin [sec]
GFSK Normal					
DH1	0.383	32	0.122464	0.4	-0.2775
DH3	1.639	16	0.262240	0.4	-0.1378
DH5	2.887	12	0.346440	0.4	-0.0536
GFSK AFH					
DH Packet	Pulse Width [msec]	Number of Pulses in 0.8 seconds	Average Time of Occupancy [sec]	Limit [sec]	Margin [sec]
DH1	0.383	8	0.030616	0.4	-0.3694
DH3	1.639	4	0.065560	0.4	-0.3344
DH5	2.887	3	0.086610	0.4	-0.3134

**DH1**

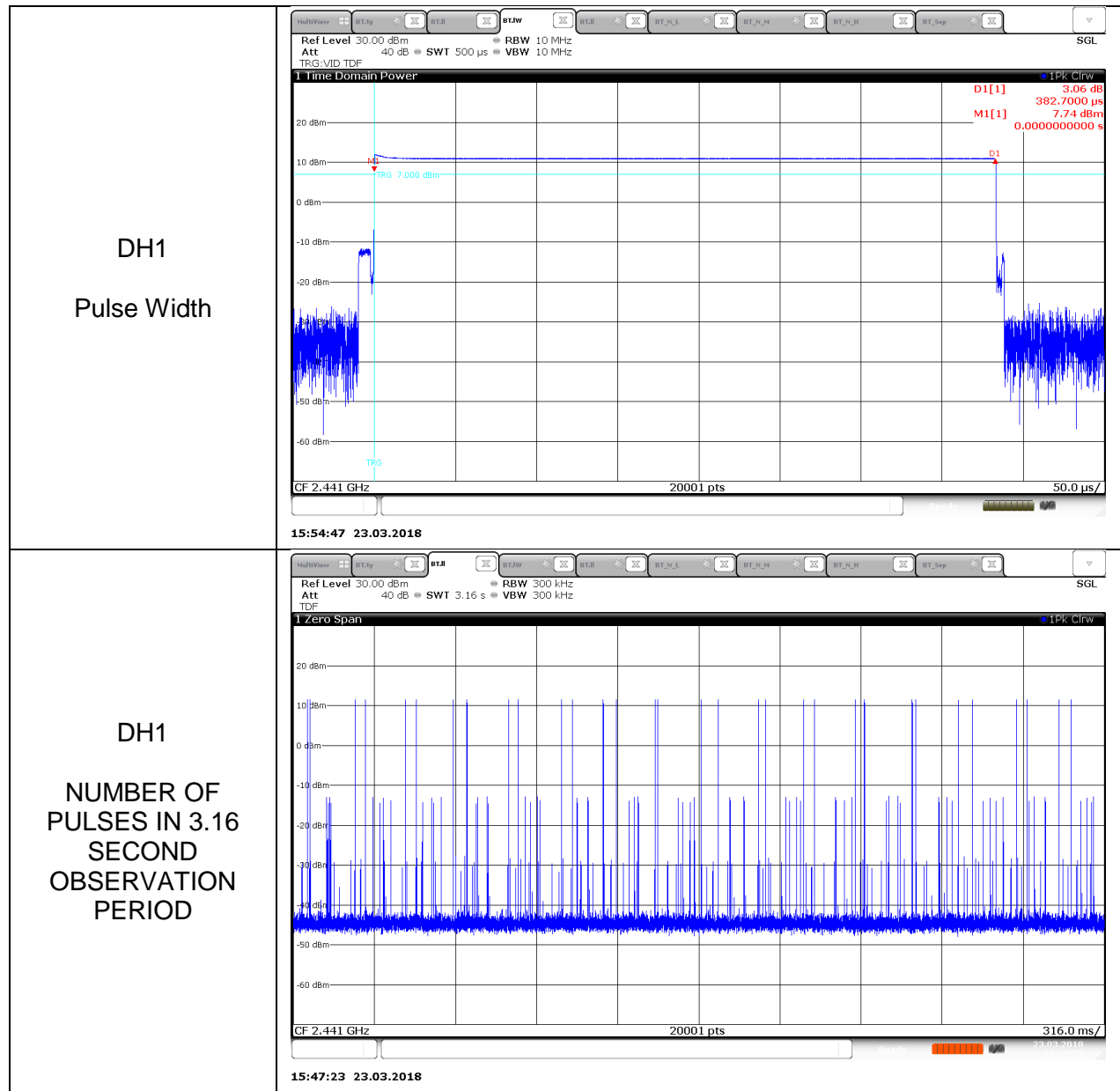

**DH3**

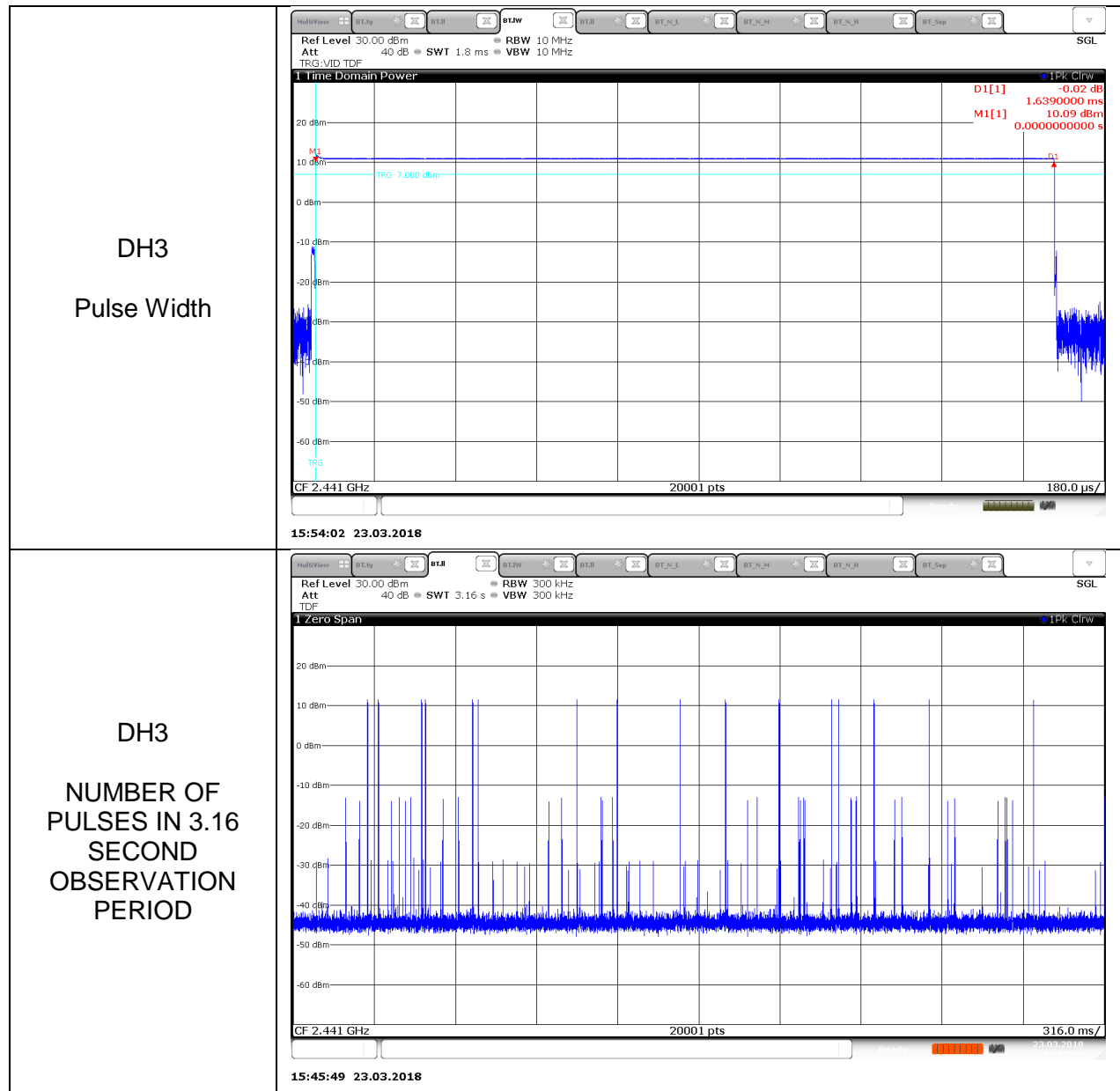



**DH5**

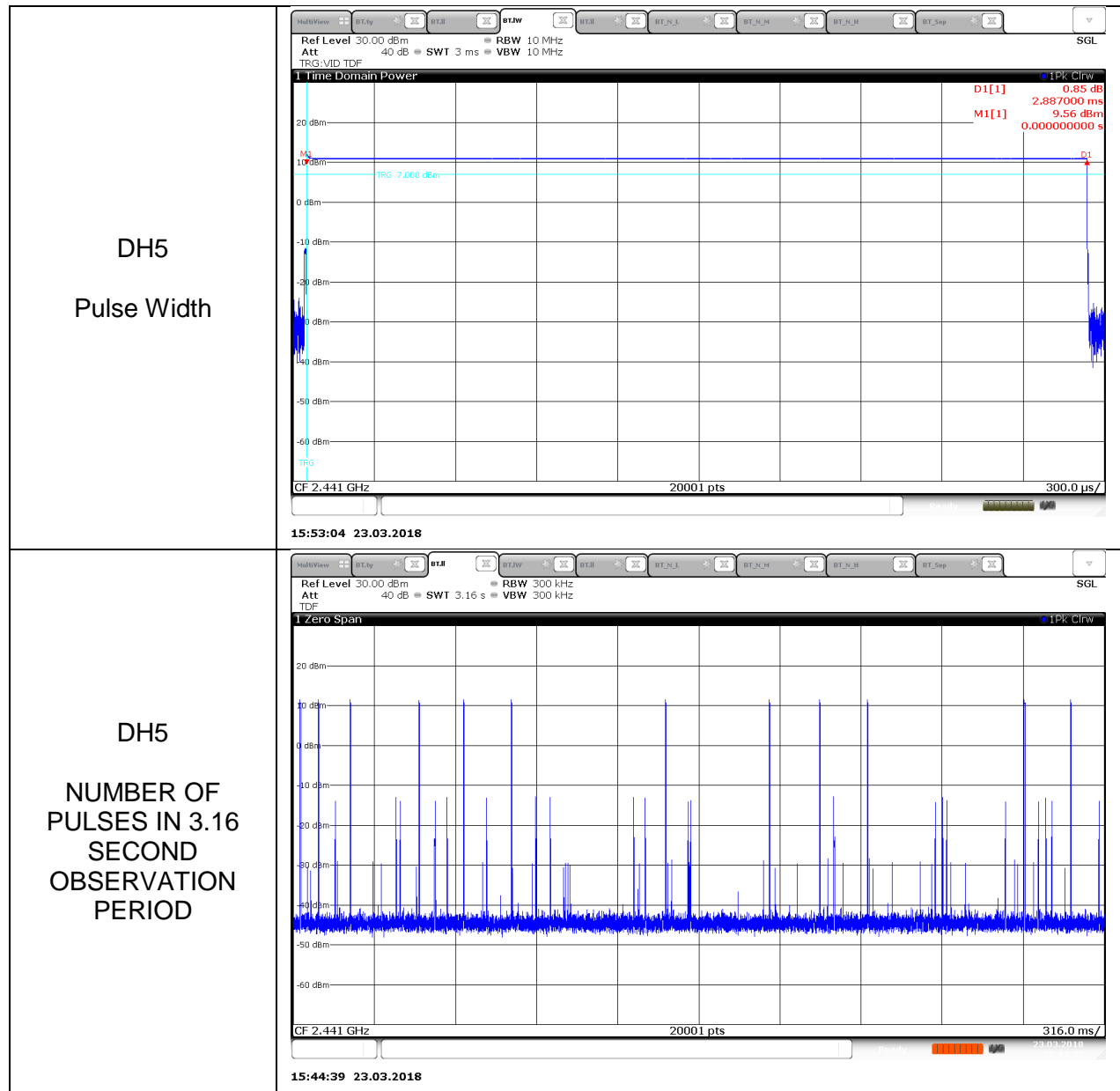

## 10.4. OUTPUT POWER

### LIMIT

§15.247 (b) (1)

The maximum antenna gain is less than 6 dBi, therefore the limit is 21 dBm.

### TEST PROCEDURE

The transmitter output is connected to a spectrum analyzer the analyzer bandwidth is set to a value greater than the 20 dB bandwidth of the EUT.

### RESULTS

#### 10.4.1. BASIC DATA RATE GFSK MODULATION

Channel	Frequency [MHz]	Output Power [dBm]	Limit [dBm]	Margin [dB]
Low	2402	10.560	21	-10.44
Middle	2441	10.940	21	-10.06
High	2480	9.330	21	-11.67
Worst		10.940	21	-10.06

#### 10.4.2. ENHANCED DATA RATE Pi/4-DPSK MODULATION

Channel	Frequency [MHz]	Output Power [dBm]	Limit [dBm]	Margin [dB]
Low	2402	8.480	21	-12.520
Middle	2441	7.700	21	-13.300
High	2480	6.070	21	-14.930
Worst		8.480	21	-12.520

#### 10.4.3. ENHANCED DATA RATE 8PSK MODULATION

Channel	Frequency [MHz]	Output Power [dBm]	Limit [dBm]	Margin [dB]
Low	2402	8.890	21	-12.110
Middle	2441	8.240	21	-12.760
High	2480	6.630	21	-14.370
Worst		8.890	21	-12.110

### 10.4.4. OUTPUT POWER PLOTS

#### GFSK OUTPUT POWER

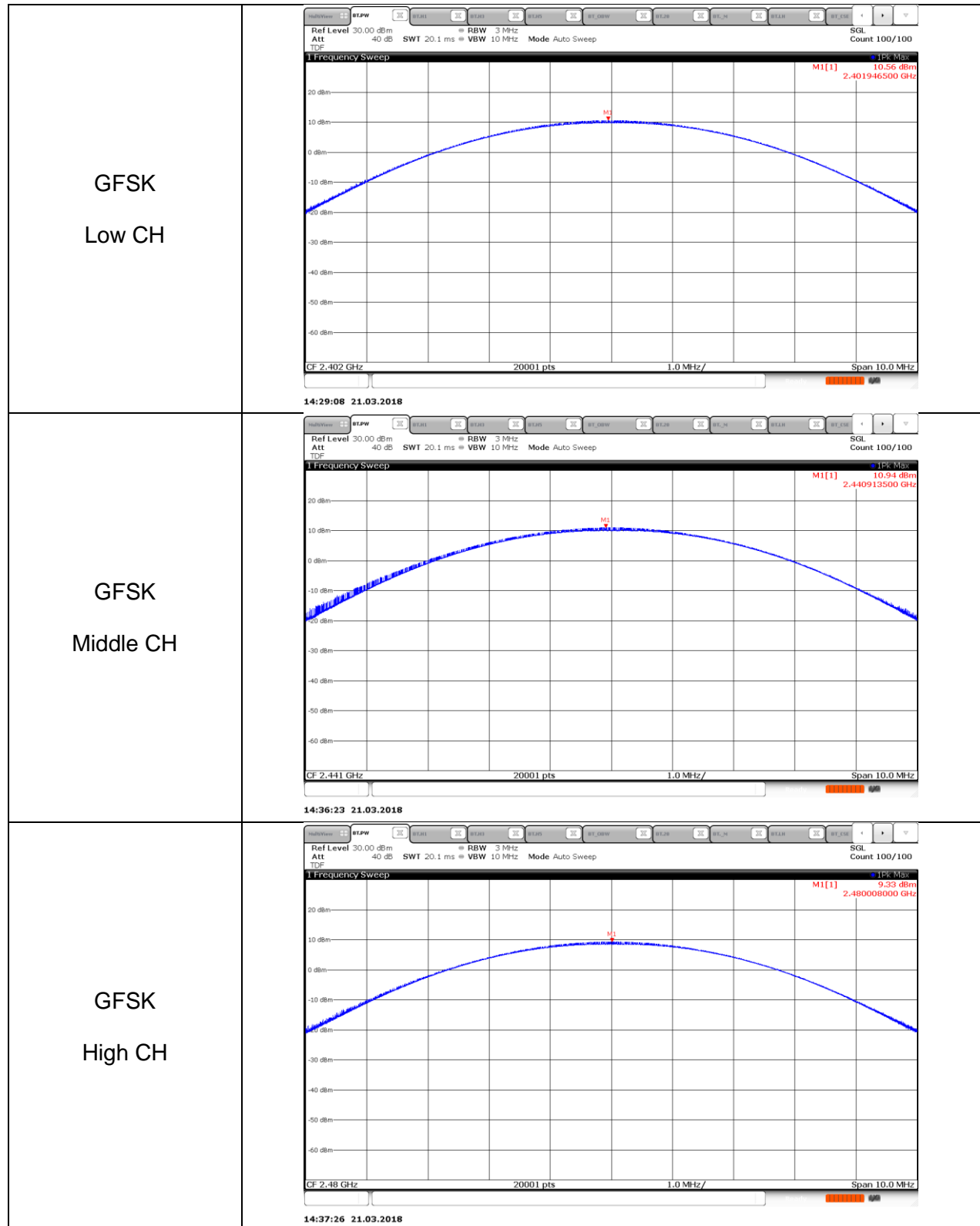

**Pi/4-DPSK OUTPUT POWER**

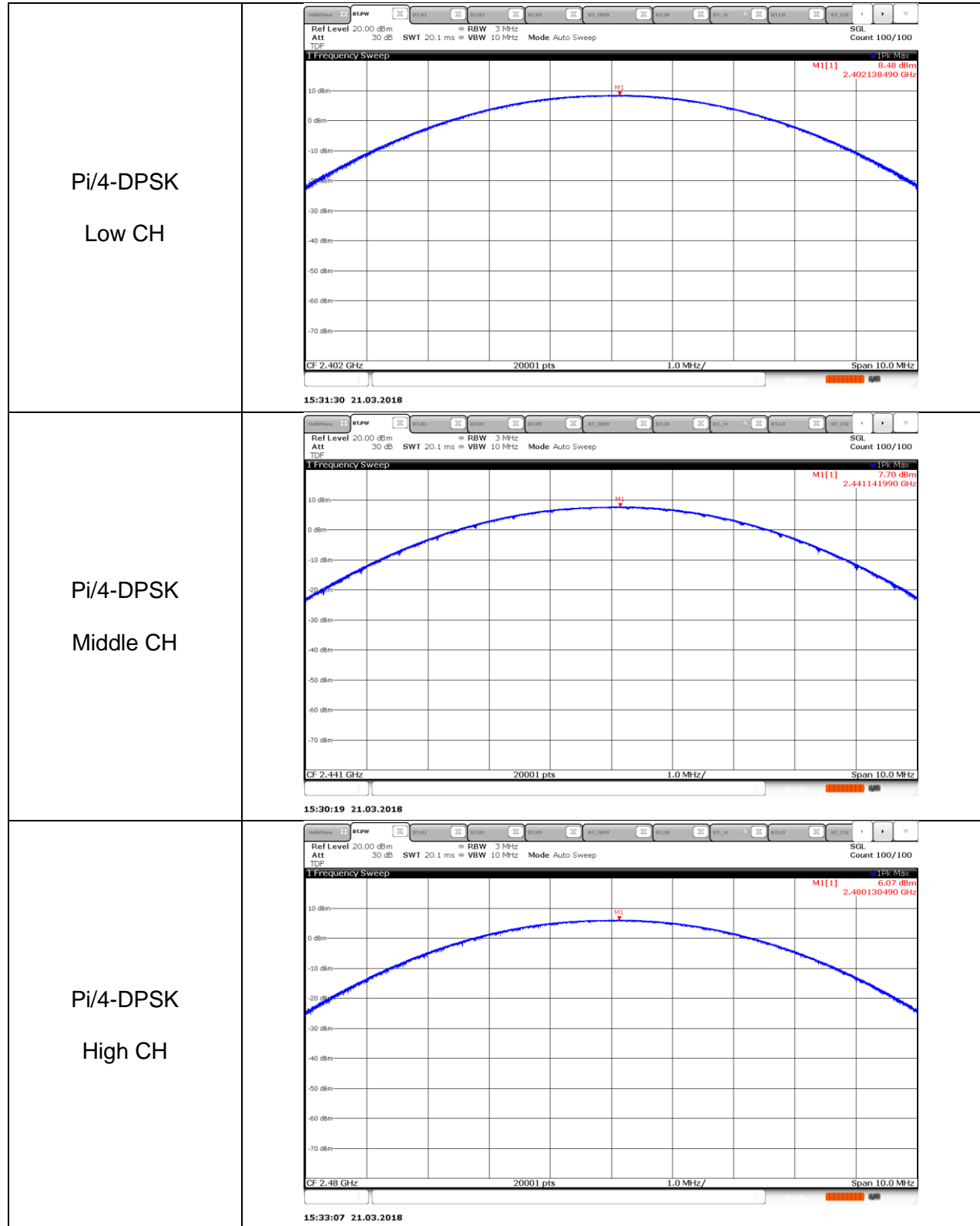

**8PSK OUTPUT POWER**

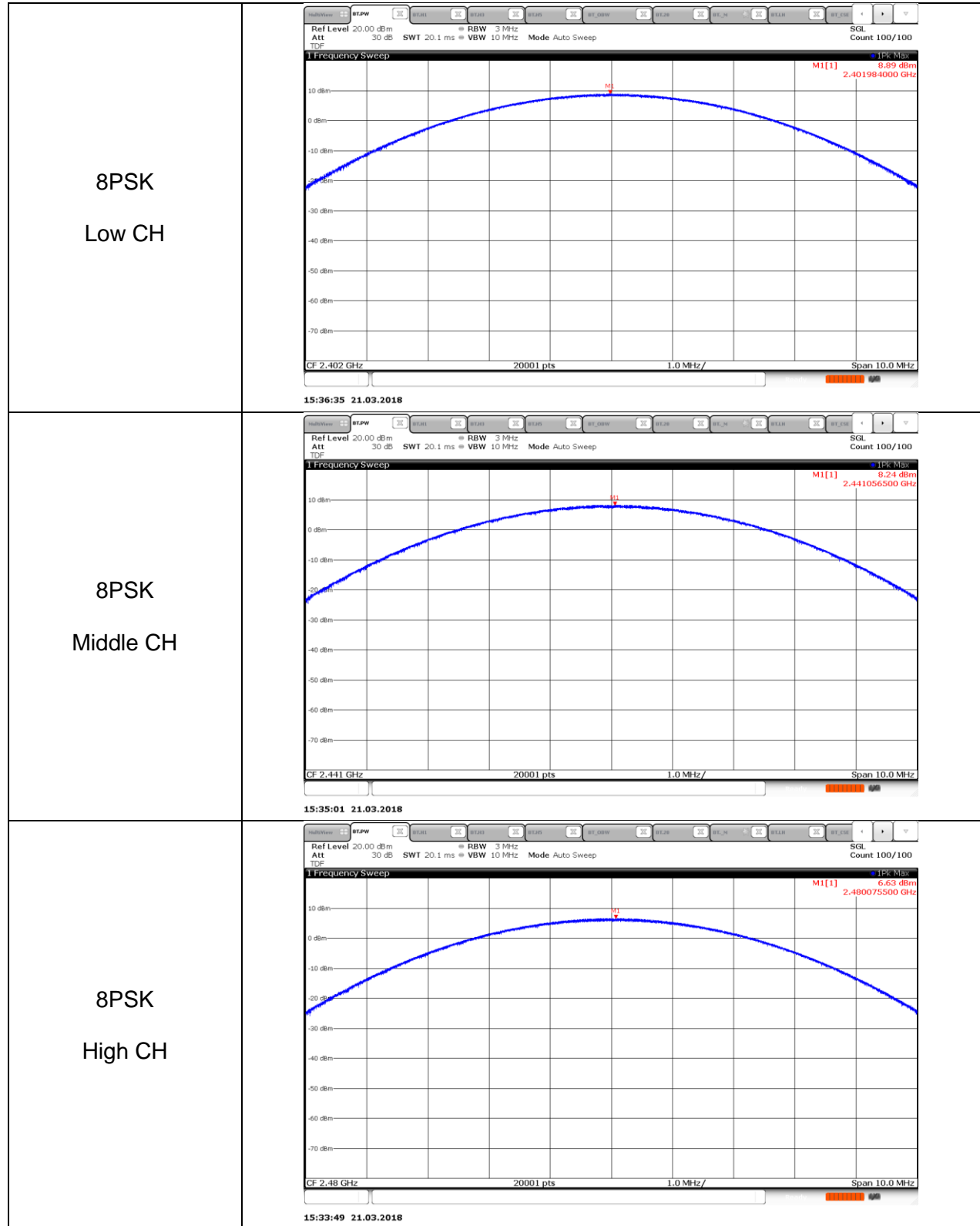

## 10.5. AVERAGE POWER

### LIMIT

None; for reporting purposes only.

### TEST PROCEDURE

The transmitter output is connected to a power meter.

### RESULTS

The cable assembly insertion loss was entered as an offset in the power meter to allow for direct reading of power.

#### 10.5.1. BASIC DATA RATE GFSK MODULATION

Channel	Frequency [MHz]	AV power [dBm]	AV power [mW]
Low	2402	9.701	9.33
Middle	2441	9.549	9.01
High	2480	8.100	6.46

#### 10.5.2. DATA RATE PI/4-DQPSK MODULATION

Channel	Frequency [MHz]	AV power [dBm]	AV power [mW]
Low	2402	4.663	2.93
Middle	2441	4.659	2.92
High	2480	4.368	2.73

#### 10.5.3. ENHANCED DATA RATE 8PSK MODULATION

Channel	Frequency [MHz]	AV power [dBm]	AV power [mW]
Low	2402	4.664	2.93
Middle	2441	4.663	2.93
High	2480	4.392	2.75

## 10.6. CONDUCTED SPURIOUS EMISSIONS

### LIMITS

FCC §15.247 (d)

Limit = -20 dBc

### TEST PROCEDURE

The transmitter output is connected to a spectrum analyzer. The resolution bandwidth is set to 100 kHz. The video bandwidth is set to 300 kHz.

For out-of-band emissions, it was tested with RBW = 1 MHz, VBW = 3 MHz, peak detector, and max hold.

If the emission level with above setting was close to the limit (ie, less than 3 dB margin) then re-test is required using RBW = 100 kHz, VBW = 300 kHz, peak detector, and max hold to get accurate emission level within 100 kHz BW.

The spectrum from 30 MHz to 26 GHz is investigated with the transmitter set to the lowest, middle, and highest channels.

The bandedges at 2.4 and 2.4835 GHz are investigated with the transmitter set to the normal hopping mode.

### RESULTS

### 10.6.1. BASIC DATA RATE GFSK MODULATION

#### GFSK Mode

[GFSK] Low Channel BandEdge

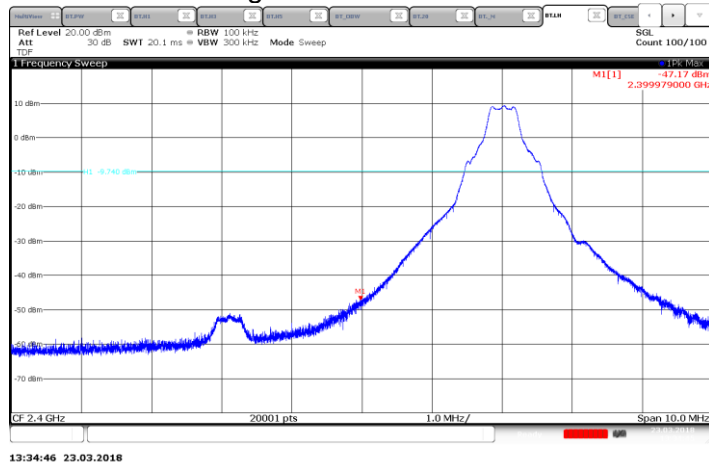

[GFSK] Low Channel Spurious

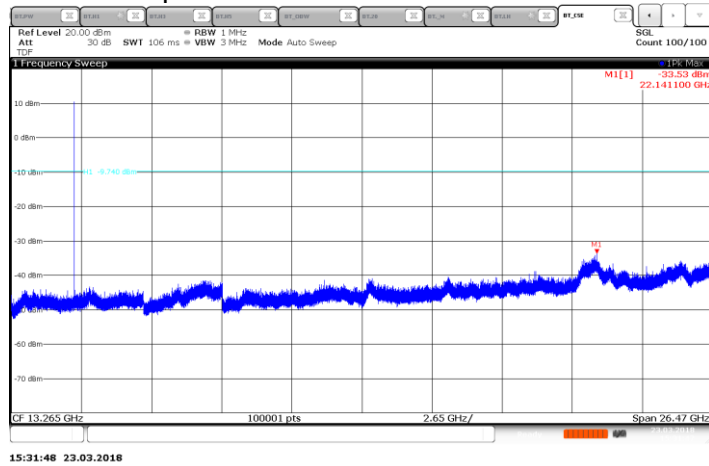



### [GFSK] Mid Channel BandEdge

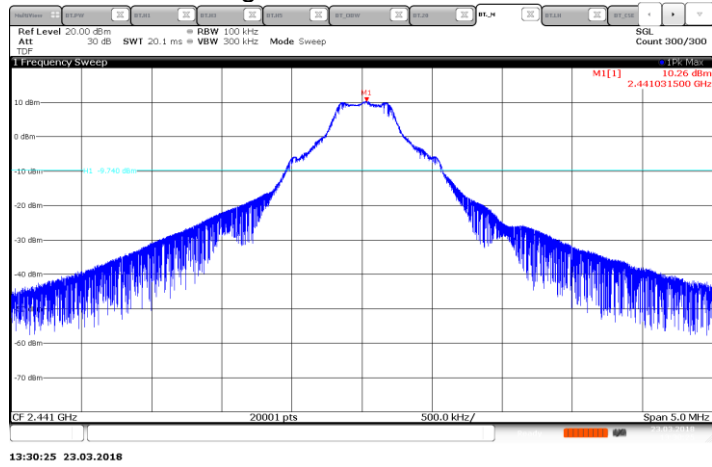

### [GFSK] Mid Channel Spurious

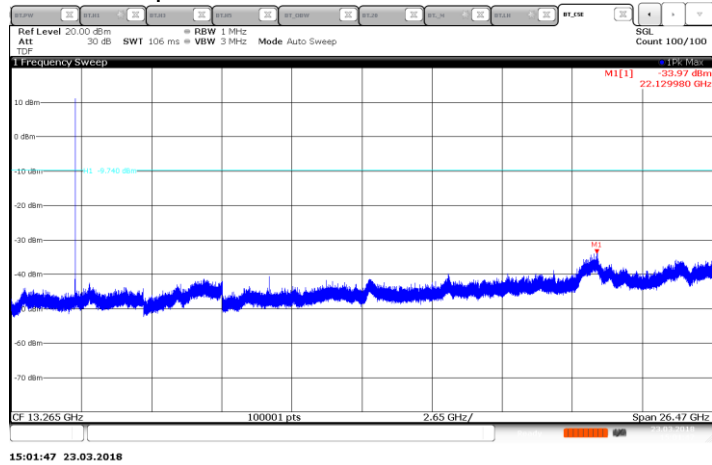

### [GFSK] High Channel BandEdge

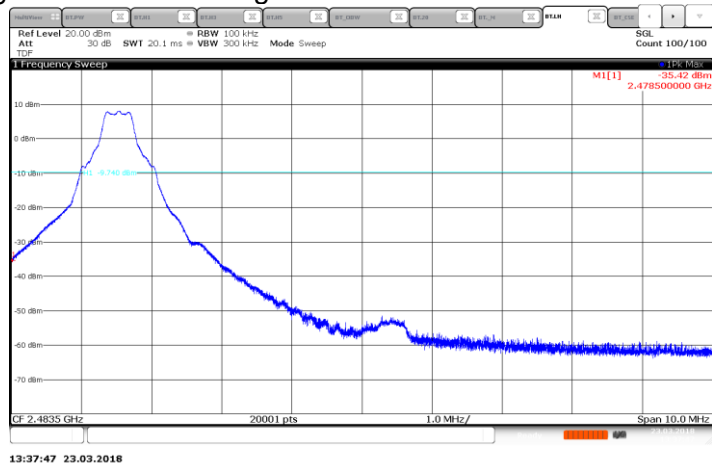

### [GFSK] High Channel Spurious

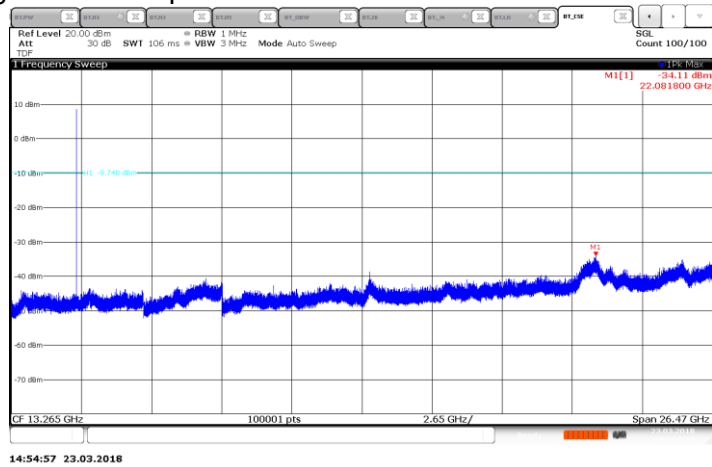

**BandEdge Emission at GFSK Hopping Mode**

[GFSK Hopping Mode] Low Channel BandEdge

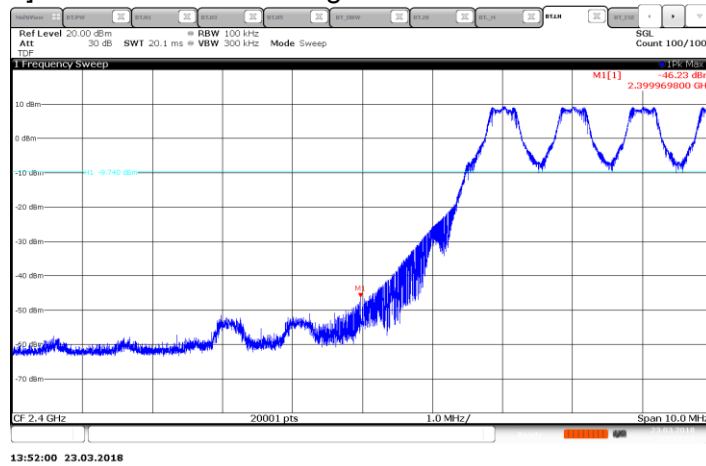

[GFSK Hopping Mode] High Channel BandEdge

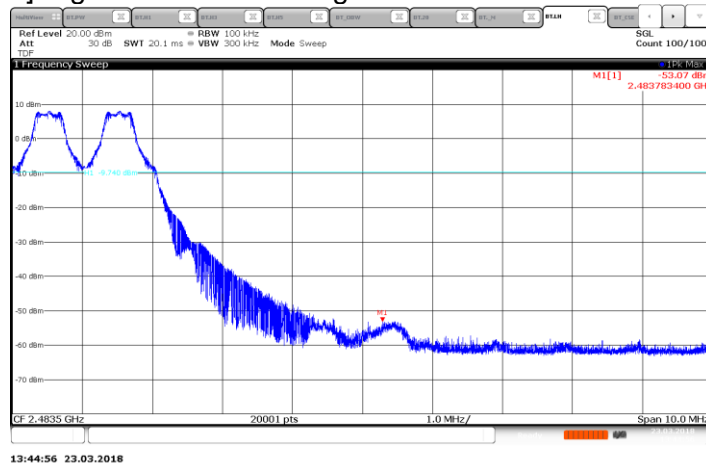

**PI/4-DQPSK Mode**

**[PI/4-DQPSK] Low Channel BandEdge**

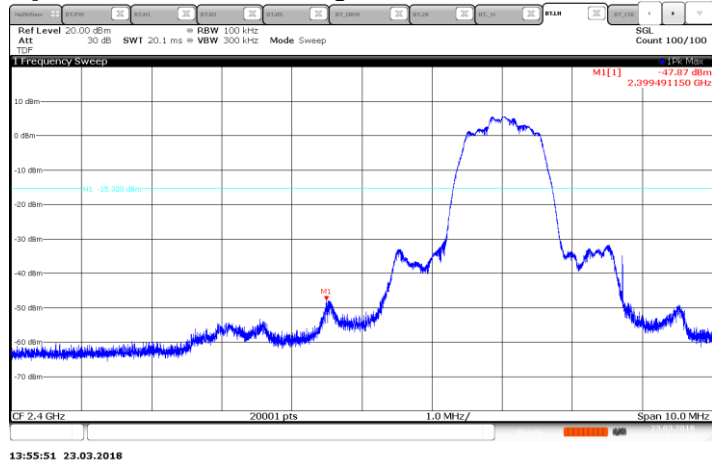

**[PI/4-DQPSK] Low Channel Spurious**

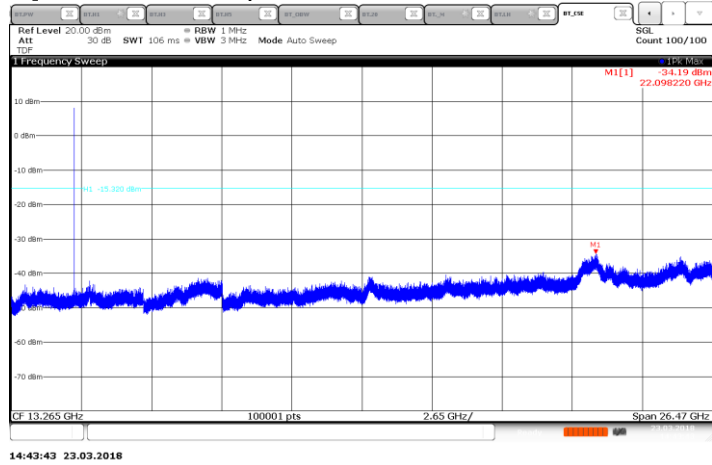

### [PI/4-DQPSK] Mid Channel BandEdge

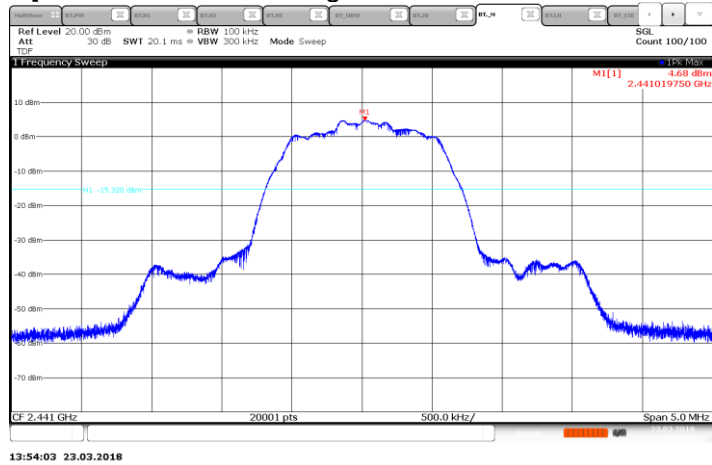

### [PI/4-DQPSK] Mid Channel Spurious

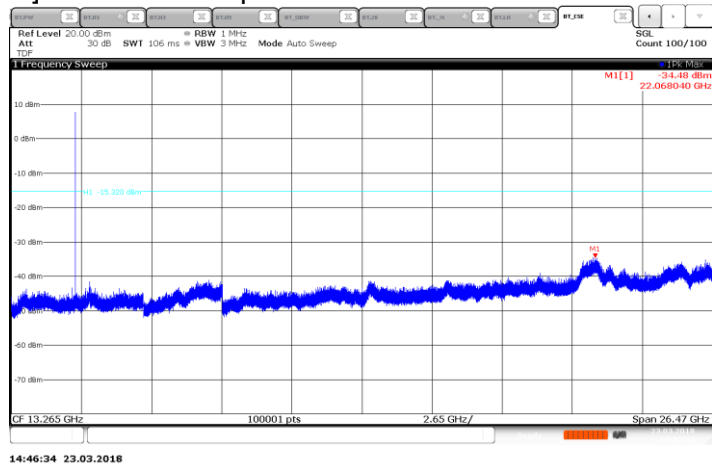

### [PI/4-DQPSK] High Channel BandEdge

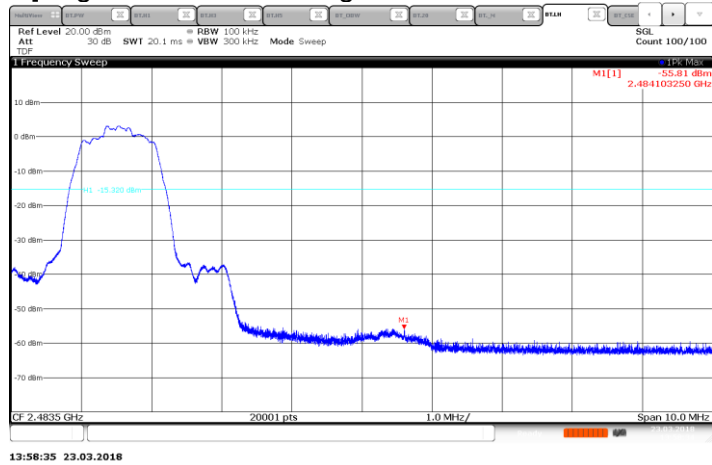

### [PI/4-DQPSK] High Channel Spurious

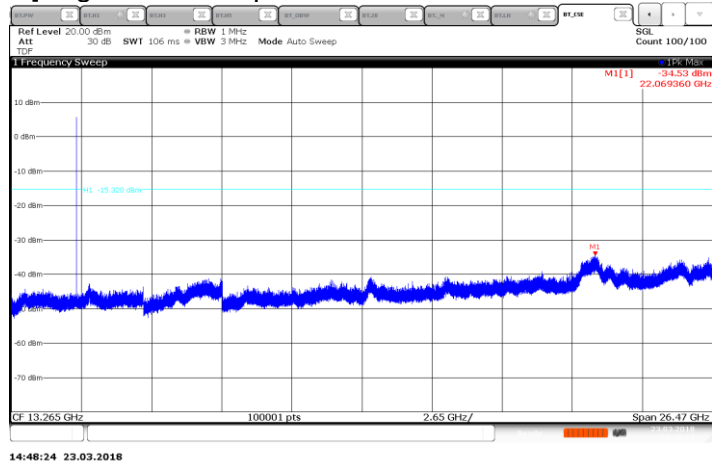

**BandEdge Emission at PI/4-DQPSK Hopping Mode**

[PI/4-DQPSK Hopping Mode] Low Channel BandEdge

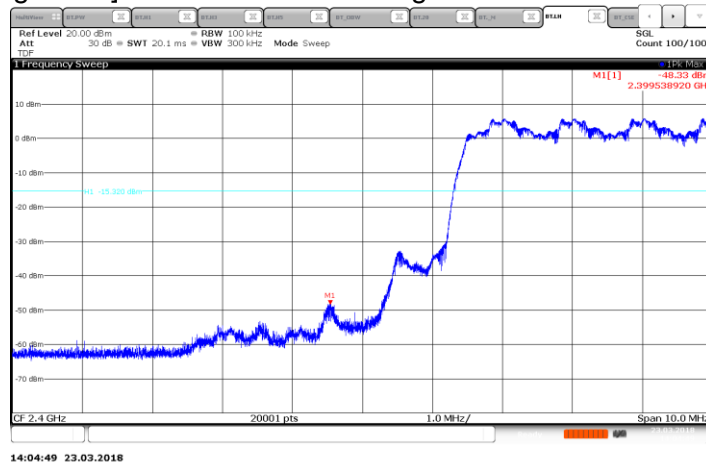

[PI/4-DQPSK Hopping Mode] High Channel BandEdge

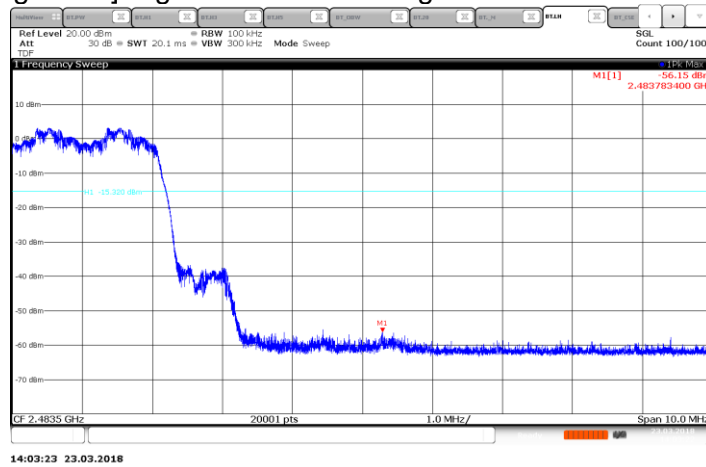

**8PSK Mode**

**[8PSK] Low Channel BandEdge**

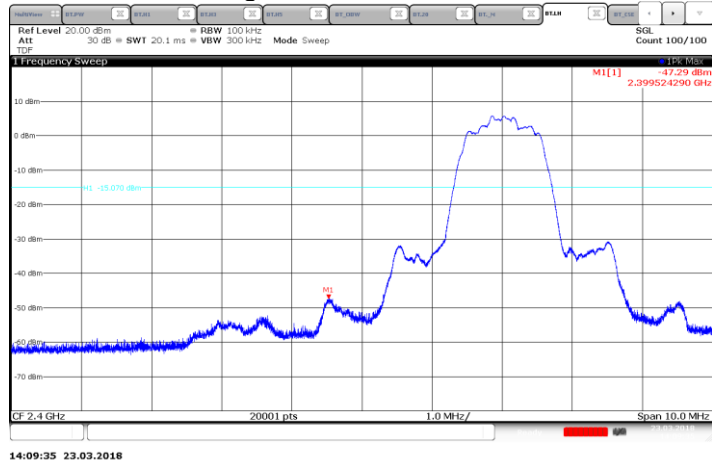

**[8PSK] Low Channel Spurious**

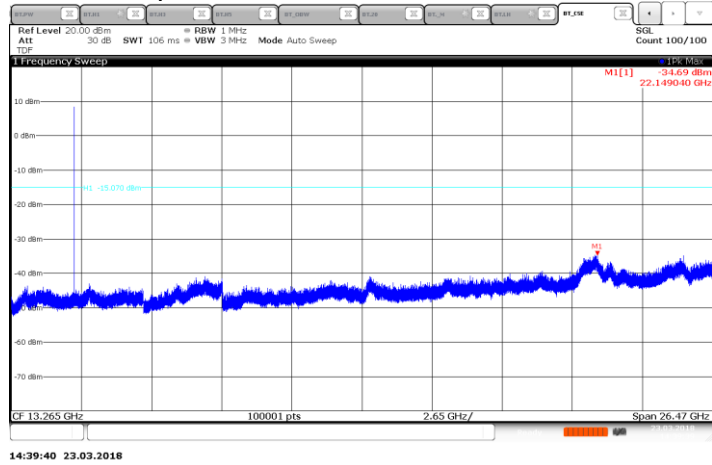



### [8PSK] Mid Channel BandEdge

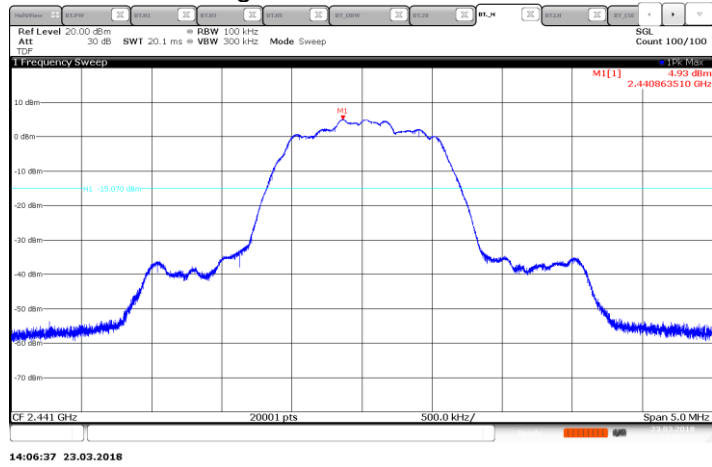

### [8PSK] Mid Channel Spurious

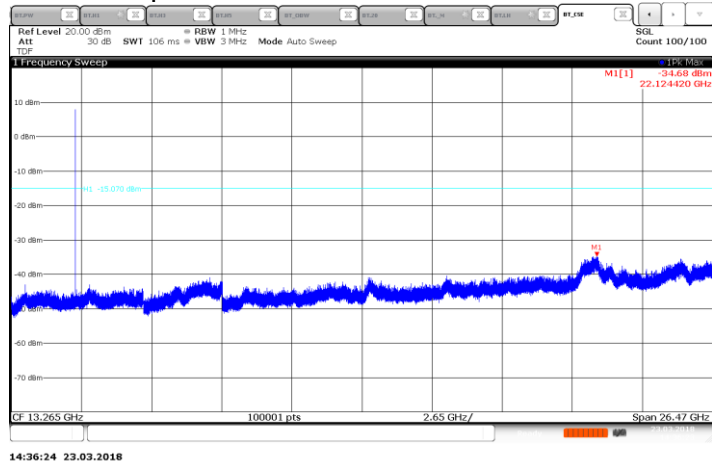

### [8PSK] High Channel BandEdge

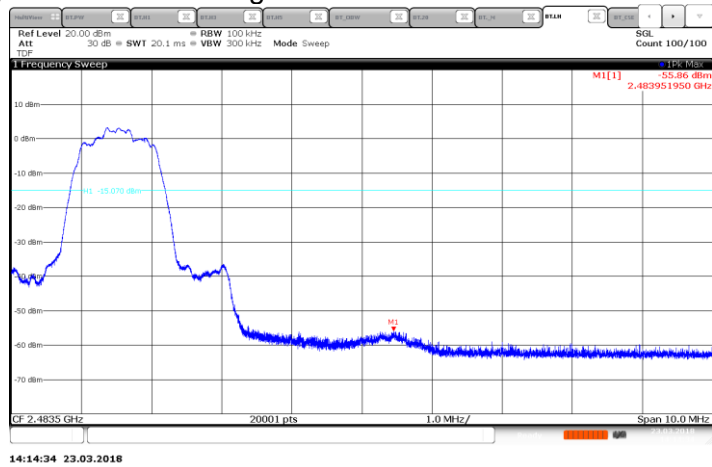

### [8PSK] High Channel Spurious

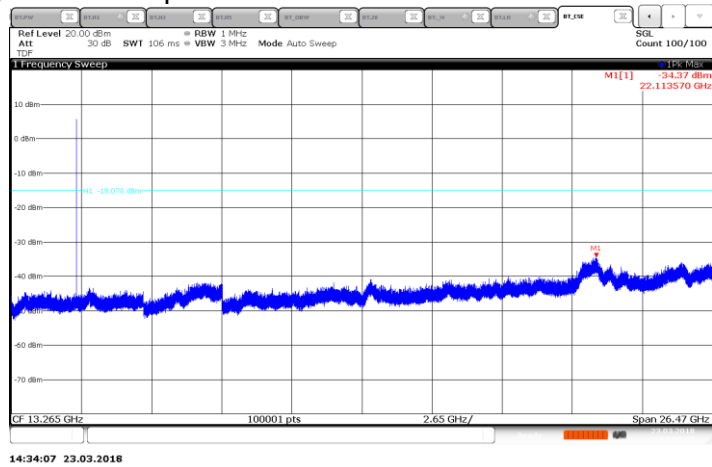

**BandEdge Emission at 8PSK Hopping Mode**

[8PSK Hopping Mode] Low Channel BandEdge

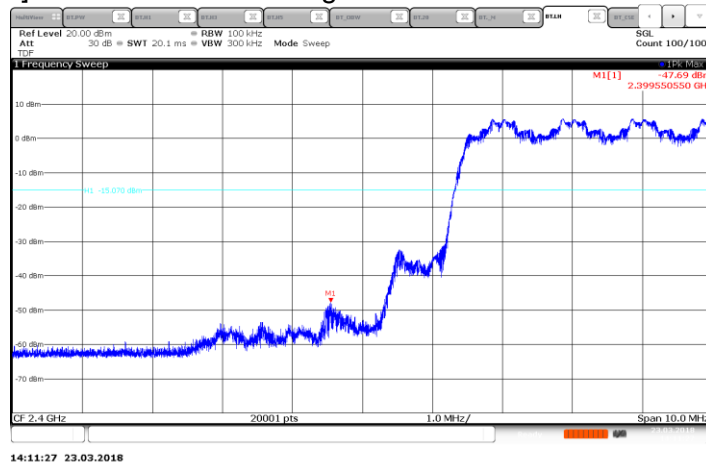

[8PSK Hopping Mode] High Channel BandEdge

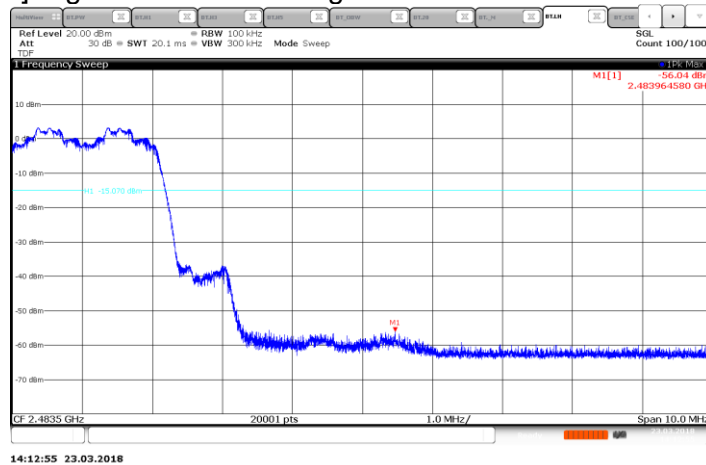

## 11. RADIATED TEST RESULTS

### 11.1. LIMITS AND PROCEDURE

#### LIMITS

FCC §15.205 and §15.209

Limits for radiated disturbance of an intentional radiator		
Frequency range (MHz)	Limits (µV/m)	Measurement Distance (m)
0.009 – 0.490	2400 / F (kHz)	300
0.490 – 1.705	24000 / F (kHz)	30
1.705 – 30.0	30	30
30 – 88	100**	3
88 - 216	150**	3
216 – 960	200**	3
Above 960	500	3

\*\* Except as provided in paragraph (g), fundamental emissions from intentional radiators operating under this section shall not be located in the frequency bands 54-72 MHz, 76-88 MHz, 174-216 MHz or 470-806 MHz. However, operation within these frequency bands is permitted under other sections of this part, e.g. §§ 15.231 and 15.241.

## **TEST PROCEDURE**

The EUT is placed on a non-conducting table 80 cm above the ground plane for below 1GHz and 150 cm for above 1GHz. The EUT is configured in accordance with ANSI C63.10. The EUT is set to transmit in a continuous mode.

For measurements below 1 GHz the resolution bandwidth is set to 100 kHz for peak detection measurements or 120 kHz for quasi-peak detection measurements. Peak detection is used unless otherwise noted as quasi-peak.

For measurements above 1 GHz the resolution bandwidth is set to 1 MHz; the video bandwidth is set to 3 MHz for peak measurements.(Pre-scans to detect harmonic and spurious emissions, the resolution bandwidth is set to 1 MHz; the video bandwidth is set to 30 KHz for peak measurements.)

For band edge measurements above 1 GHz the resolution bandwidth is set to 1 MHz, then the video bandwidth is set to 3 MHz for peak measurements and 1/T (on time) for average measurement.

$$\text{GFSK} = 1/T = 1 / 0.002887\text{S} = 346\text{Hz}.$$

The minimum VBW was 350Hz, but test receiver(ESU40) couldn't set value 350Hz. Due to this reason, testing VBW was set to 500Hz(Worst cases).

The spectrum from 1GHz to 26 GHz is investigated with the transmitter set to the lowest, middle, and highest channels in the 2.4 GHz band.  
(From 30MHz to 1GHz, test was performed with the EUT set to transmit at the channel with highest output power)

The frequency range of interest is monitored at a fixed antenna height and EUT azimuth. The EUT is rotated through 360 degrees to maximize emissions received. The antenna is scanned from 1 to 4 meters above the ground plane to further maximize the emission. Measurements are made with the antenna polarized in both the vertical and the horizontal positions.

Note : Emission was pre-scanned from 9KHz to 30MHz; No emissions were detected which was at least 20dB below the specification limit (consider distance correction factor).  
Per FCC part 15.31(o), test results were not reported.

Although these tests were performed other than open area test site, adequate comparison measurements were confirmed against 30 m open are test site.  
Therefore sufficient tests were made to demonstrate that the alternative site produces results that correlate with the one of tests made in an open field based on KDB 414788.

## 11.2. TRANSMITTER ABOVE 1 GHz

### 11.2.1. BASIC DATA RATE GFSK MODULATION

#### RESTRICTED BANDEDGE (LOW CHANNEL)

##### HORIZONTAL PEAK AND AVERAGE PLOT

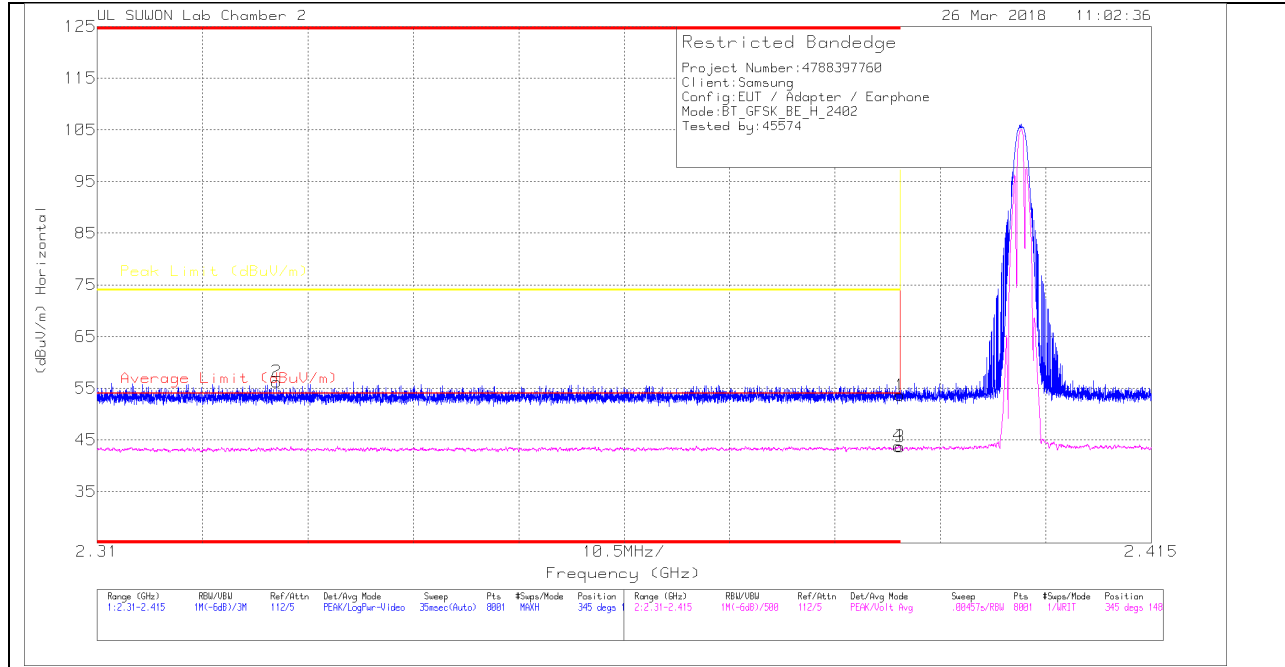

##### HORIZONTAL DATA

##### Trace Markers

Marker	Frequency (GHz)	Meter Reading (dBuV)	Det	170531_3117[0016 8724]	10dB(dB)	Corrected Reading (dBuV/m)	Average Limit (dBuV/m)	Margin (dB)	Peak Limit (dBuV/m)	PK Margin (dB)	Azimuth (Degs)	Height (cm)	Polarity
1	* 2.39	40.53	Pk	31.3	-18.2	53.63	-	-	74	-20.37	345	148	H
2	* 2.328	43.46	Pk	31.2	-18.4	56.26	-	-	74	-17.74	345	148	H
3	* 2.39	30.59	VA1T	31.3	-18.2	43.69	54	-10.31	-	-	345	148	H
4	* 2.39	30.75	VA1T	31.3	-18.2	43.85	54	-10.15	-	-	345	148	H

\* - indicates frequency in CFR47 Pt 15 / IC RSS-Restricted Band

Pk - Peak detector

VA1T - FHSS: Linear Voltage Average VB=1/Ton where: Ton is transmit duration

**VERTICAL PEAK AND AVERAGE PLOT**

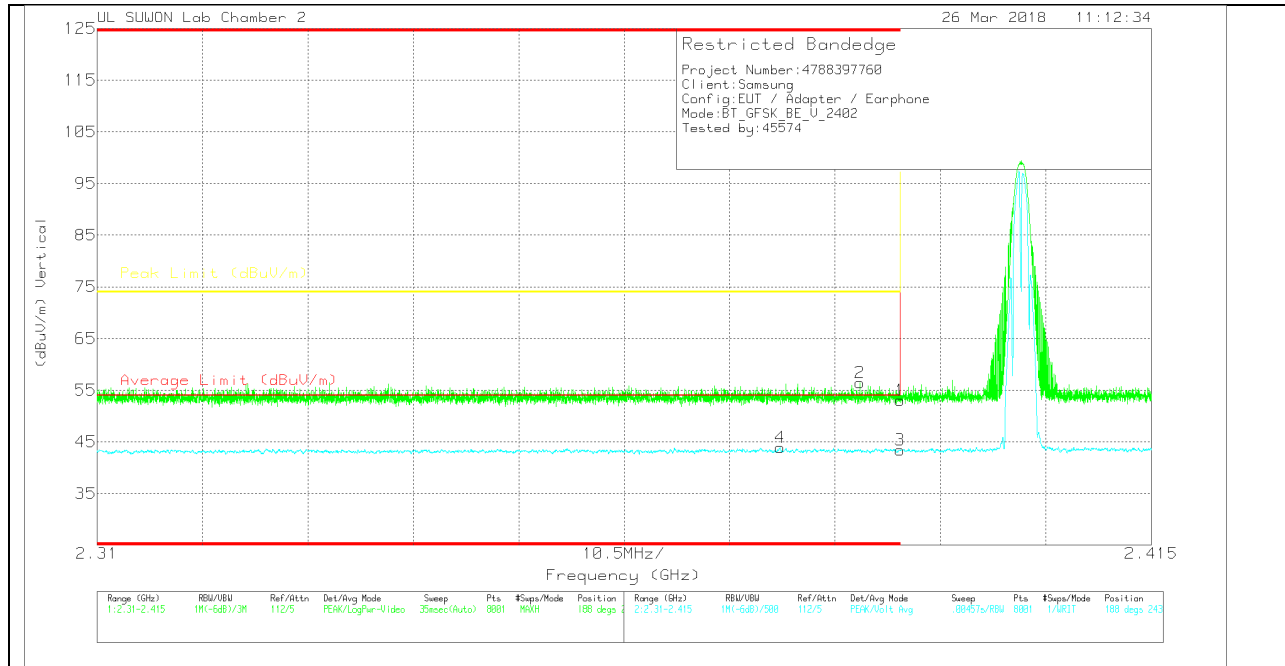

**VERTICAL DATA**

**Trace Markers**

Marker	Frequency (GHz)	Meter Reading (dBuV)	Det	170531_3117[0016 8724]	10dB(dB)	Corrected Reading (dBuV/m)	Average Limit (dBuV/m)	Margin (dB)	Peak Limit (dBuV/m)	PK Margin (dB)	Azimuth (Degs)	Height (cm)	Polarity
1	* 2.39	39.95	Pk	31.3	-18.2	53.05	-	-	74	-20.95	188	243	V
2	* 2.386	43.35	Pk	31.3	-18.2	56.45	-	-	74	-17.55	188	243	V
3	* 2.39	30.3	VA1T	31.3	-18.2	43.4	54	-10.6	-	-	188	243	V
4	* 2.378	30.89	VA1T	31.3	-18.3	43.89	54	-10.11	-	-	188	243	V

\* - indicates frequency in CFR47 Pt 15 / IC RSS-Restricted Band

Pk - Peak detector

VA1T - FHSS: Linear Voltage Average VB=1/Ton where: Ton is transmit duration

### AUTHORIZED BANDEDGE (HIGH CHANNEL)

#### HORIZONTAL PEAK AND AVERAGE PLOT

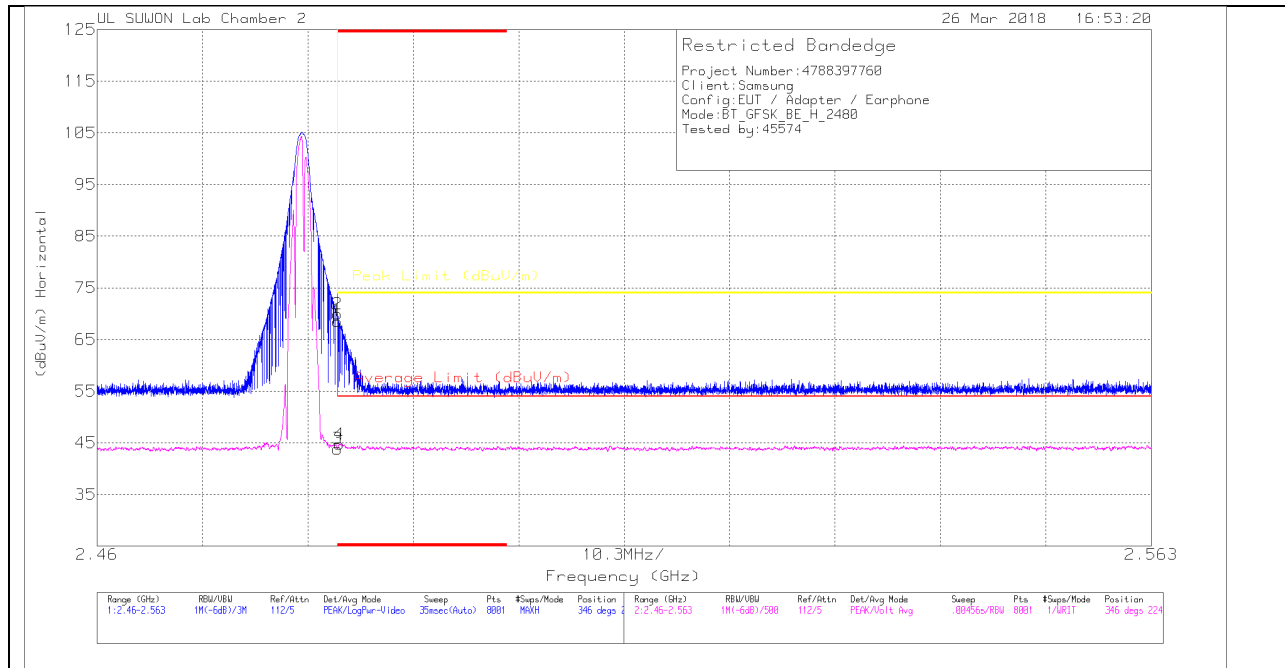

#### HORIZONTAL DATA

##### Trace Markers

Marker	Frequency (GHz)	Meter Reading (dBuV)	Det	170531_3117[0016 8724]	10dB[dB]	Corrected Reading (dBuV/m)	Average Limit (dBuV/m)	Margin (dB)	Peak Limit (dBuV/m)	PK Margin (dB)	Azimuth (Degs)	Height (cm)	Polarity
1	* 2.484	54.96	Pk		-18	68.56	-	-	74	-5.44	346	224	H
2	* 2.484	56.34	Pk		-18	69.94	-	-	74	-4.06	346	224	H
3	* 2.484	30.26	VA1T		-18	43.86	54	-10.14	-	-	346	224	H
4	* 2.484	31.14	VA1T		-18	44.74	54	-9.26	-	-	346	224	H

\* - indicates frequency in CFR47 Pt 15 / IC RSS-Restricted Band

Pk - Peak detector

VA1T - FHSS: Linear Voltage Average VB=1/Ton where: Ton is transmit duration



**VERTICAL PEAK AND AVERAGE PLOT**

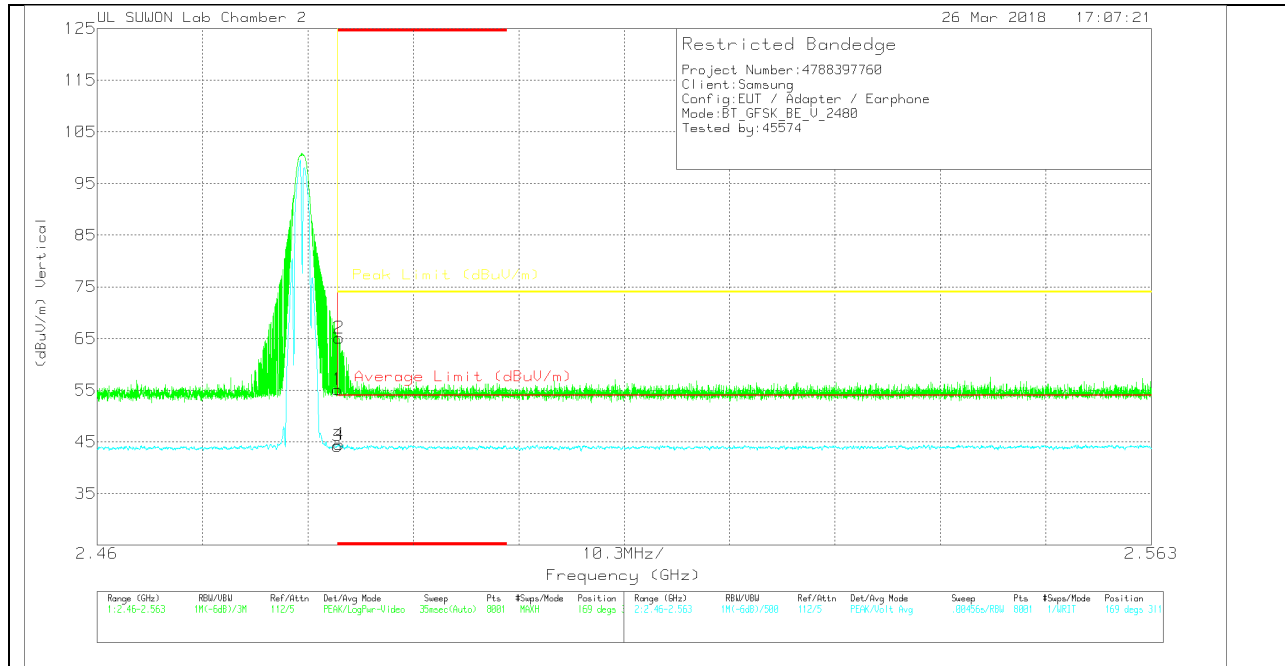

**VERTICAL DATA**

Trace Markers

Marker	Frequency (GHz)	Meter Reading (dBuV)	Det	170531_3117[0016 8724]	10dB[dB]	Corrected Reading (dBuV/m)	Average Limit (dBuV/m)	Margin (dB)	Peak Limit (dBuV/m)	PK Margin (dB)	Azimuth (Degs)	Height (cm)	Polarity
1	* 2.484	41.53	Pk		-18	55.13	-	-	74	-18.87	169	311	V
2	* 2.484	51.52	Pk		-18	65.12	-	-	74	-8.88	169	311	V
3	* 2.484	30.63	VA1T		-18	44.23	54	-9.77	-	-	169	311	V
4	* 2.484	30.94	VA1T		-18	44.54	54	-9.46	-	-	169	311	V

\* - indicates frequency in CFR47 Pt 15 / IC RSS-Restricted Band

Pk - Peak detector

VA1T - FHSS: Linear Voltage Average  $V_B=1/T_{on}$  where:  $T_{on}$  is transmit duration

## HARMONICS AND SPURIOUS EMISSIONS

### LOW CHANNEL HORIZONTAL

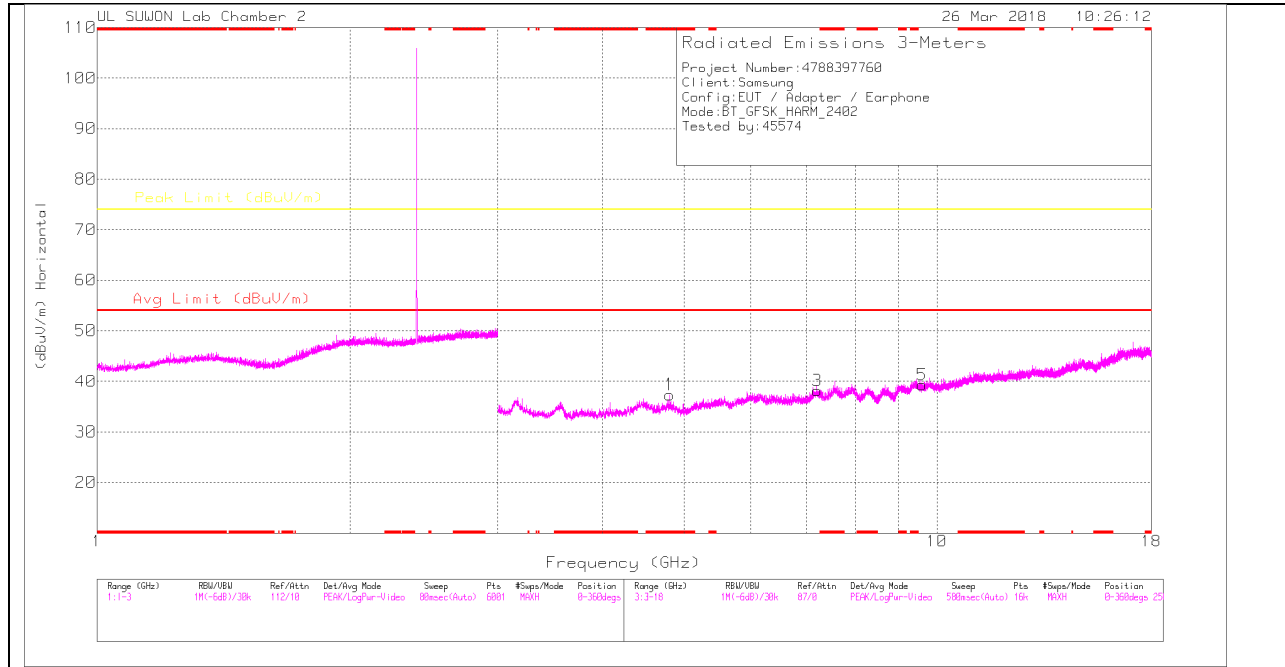

### LOW CHANNEL VERTICAL

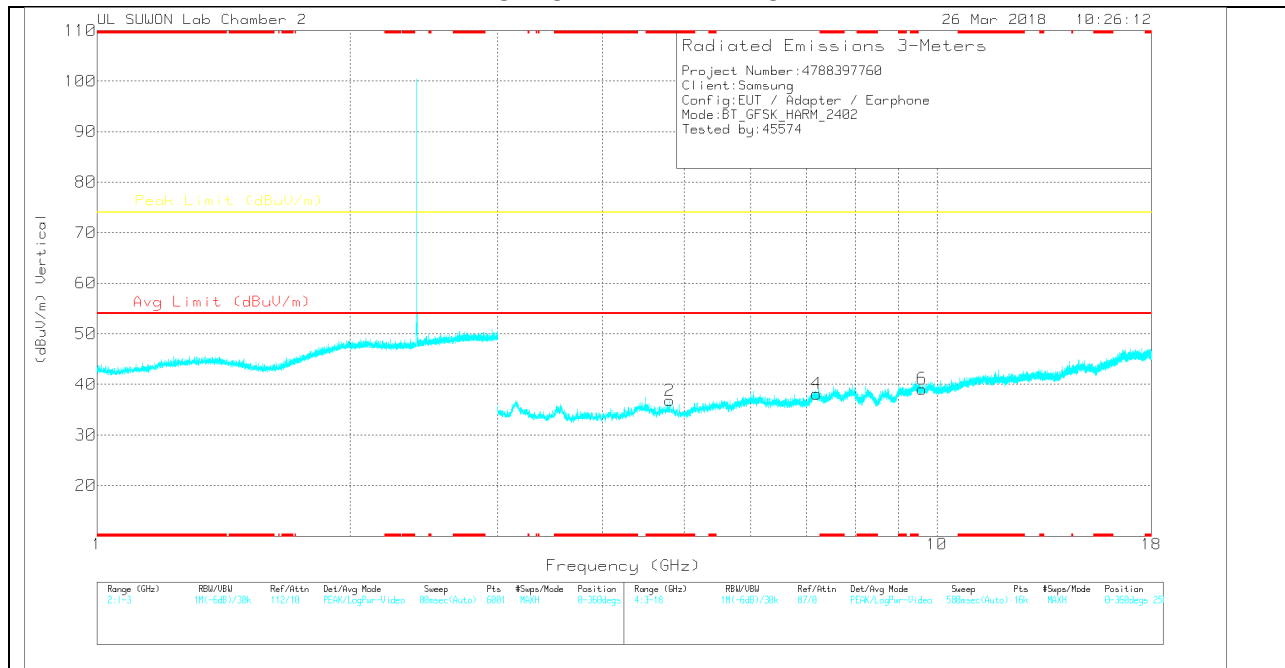

Note: Emission was scanned up to 26GHz; No emissions were detected above the noise floor which was at least 20dB below the specification limit.

**LOW CHANNEL DATA**

Trace Markers

Marker	Frequency (GHz)	Meter Reading (dBuV)	Det	170531_3117[0016 8724]	3GHz_HP[dB]	Corrected Reading (dBuV/m)	Avg Limit (dBuV/m)	Margin (dB)	Peak Limit (dBuV/m)	Margin (dB)	Azimuth (Degs)	Height (cm)	Polarity
1	* 4.804	27.85	PK	33.8	-24.3	37.35	-	-	74	-36.65	0-360	150	H
3	7.2	23.89	PK	35.9	-21.6	38.19	-	-	74	-35.81	0-360	150	H
5	9.603	20.97	PK	36.7	-18.4	39.27	-	-	74	-34.73	0-360	150	H
2	* 4.804	27.32	PK	33.8	-24.3	36.82	-	-	74	-37.18	0-360	250	V
4	7.195	23.73	PK	35.9	-21.5	38.13	-	-	74	-35.87	0-360	150	V
6	9.603	20.8	PK	36.7	-18.4	39.1	-	-	74	-34.9	0-360	250	V

\* - indicates frequency in CFR47 Pt 15 / IC RSS-Restricted Band  
 PK – Peak Detector

Note: Only peak measurement was performed. Because peak measurement result of unwanted emission is less than average limit (54dBuV/m).

**MID CHANNEL HORIZONTAL**

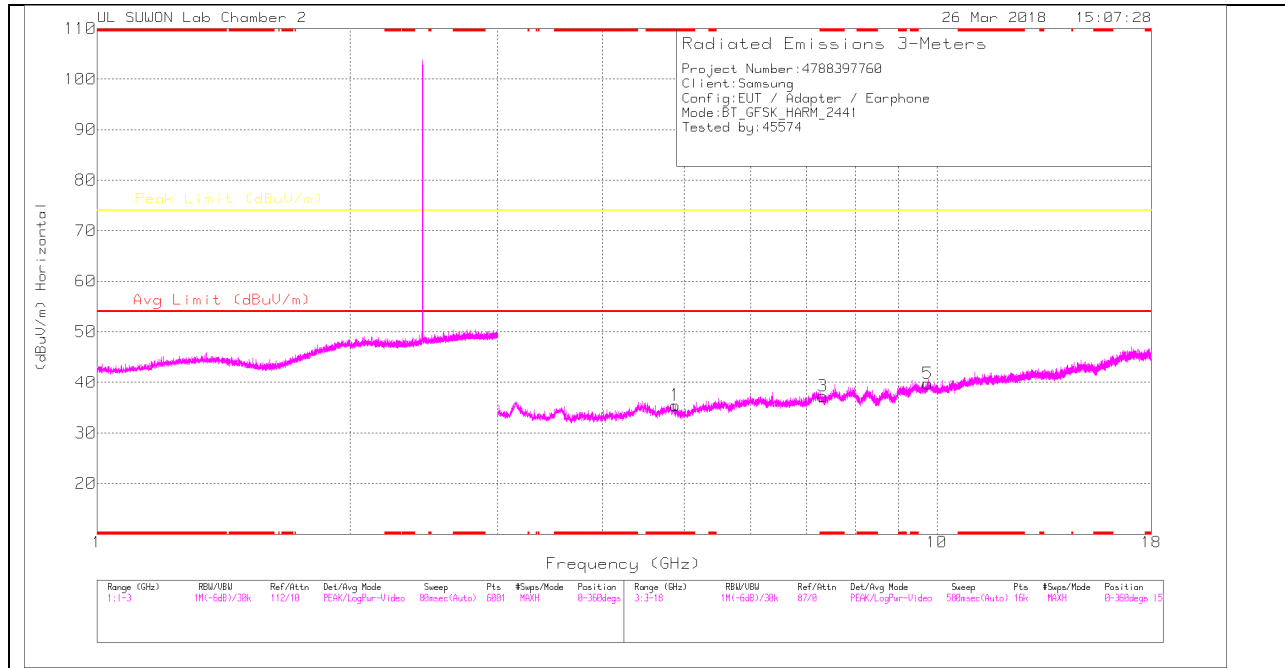

**MID CHANNEL VERTICAL**

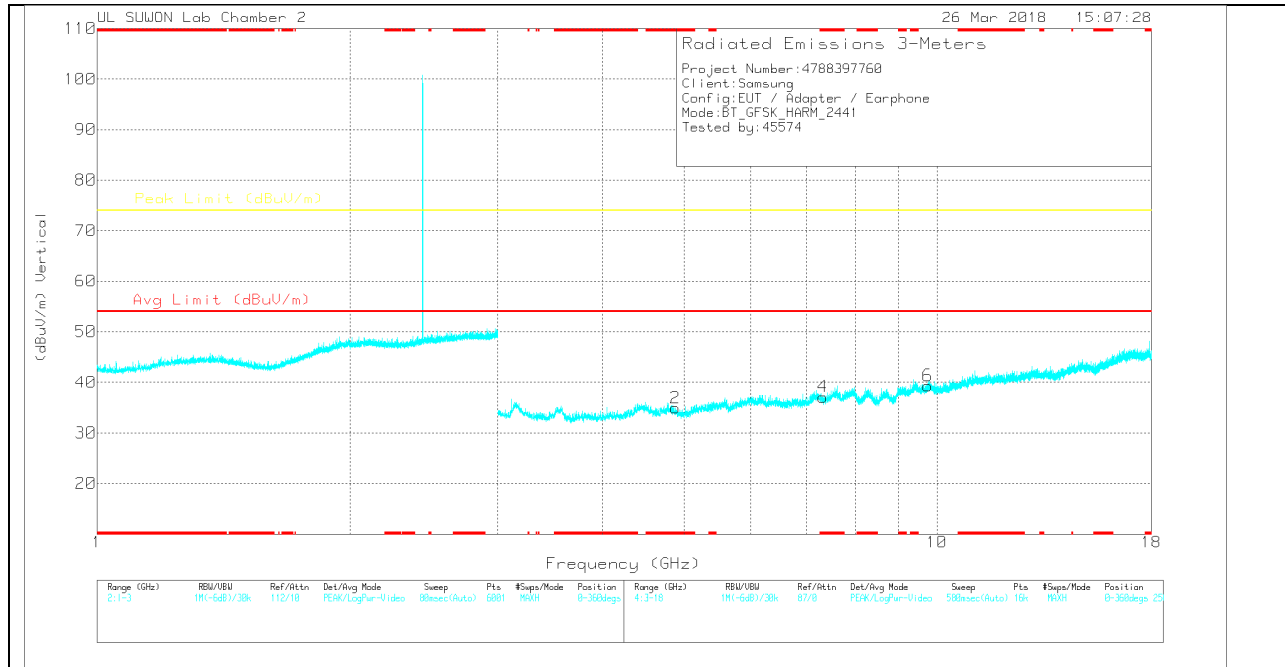

Note: Emission was scanned up to 26GHz; No emissions were detected above the noise floor which was at least 20dB below the specification limit.

**MID CHANNEL DATA**

Trace Markers

Marker	Frequency (GHz)	Meter Reading (dBuV)	Det	170531_3117[0016 8724]	3GHz_HP[dB]	Corrected Reading (dBuV/m)	Avg Limit (dBuV/m)	Margin (dB)	Peak Limit (dBuV/m)	Margin (dB)	Azimuth (Degs)	Height (cm)	Polarity
1	* 4.881	26.28	PK	33.8	-24.6	35.48	-	-	74	-38.52	0-360	150	H
3	* 7.319	23.35	PK	35.9	-22	37.25	-	-	74	-36.75	0-360	250	H
5	9.757	20.85	PK	36.9	-18	39.75	-	-	74	-34.25	0-360	250	H
2	* 4.881	25.72	PK	33.8	-24.6	34.92	-	-	74	-39.08	0-360	250	V
4	* 7.316	23.22	PK	35.9	-22	37.12	-	-	74	-36.88	0-360	250	V
6	9.755	20.42	PK	36.9	-18	39.32	-	-	74	-34.68	0-360	150	V

\* - indicates frequency in CFR47 Pt 15 / IC RSS-Restricted Band

PK – Peak Detector

Note: Only peak measurement was performed. Because peak measurement result of unwanted emission is less than average limit (54dBuV/m).

**HIGH CHANNEL HORIZONTAL**

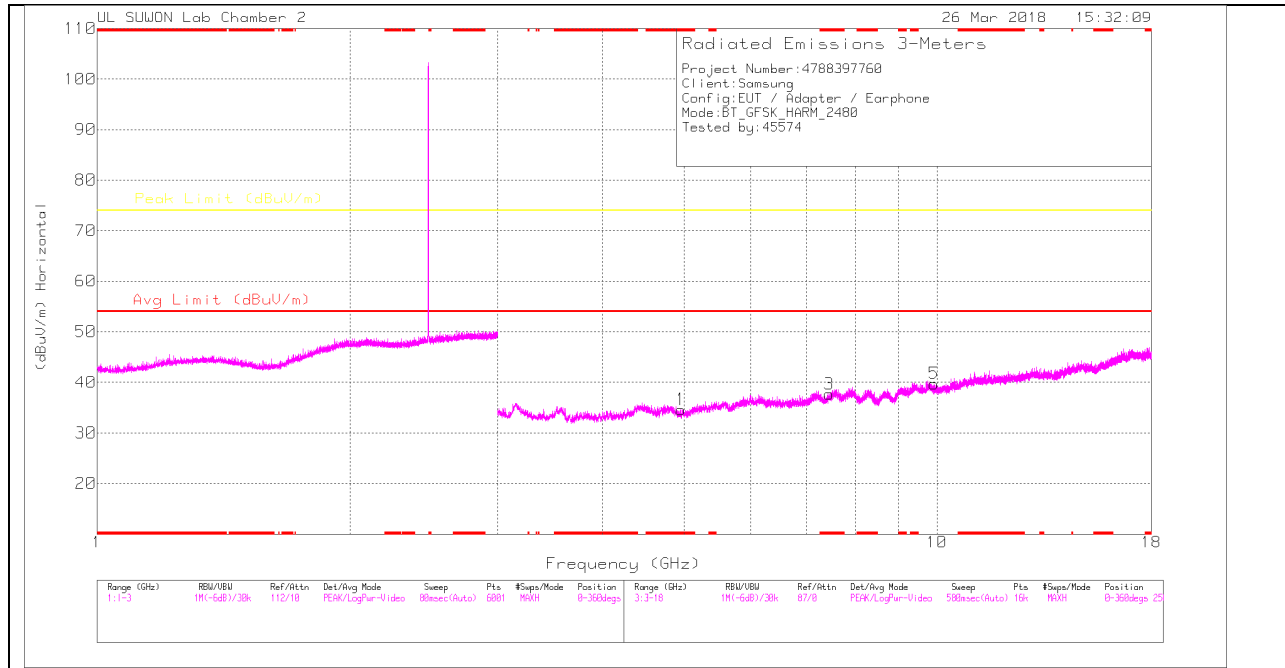

**HIGH CHANNEL VERTICAL**

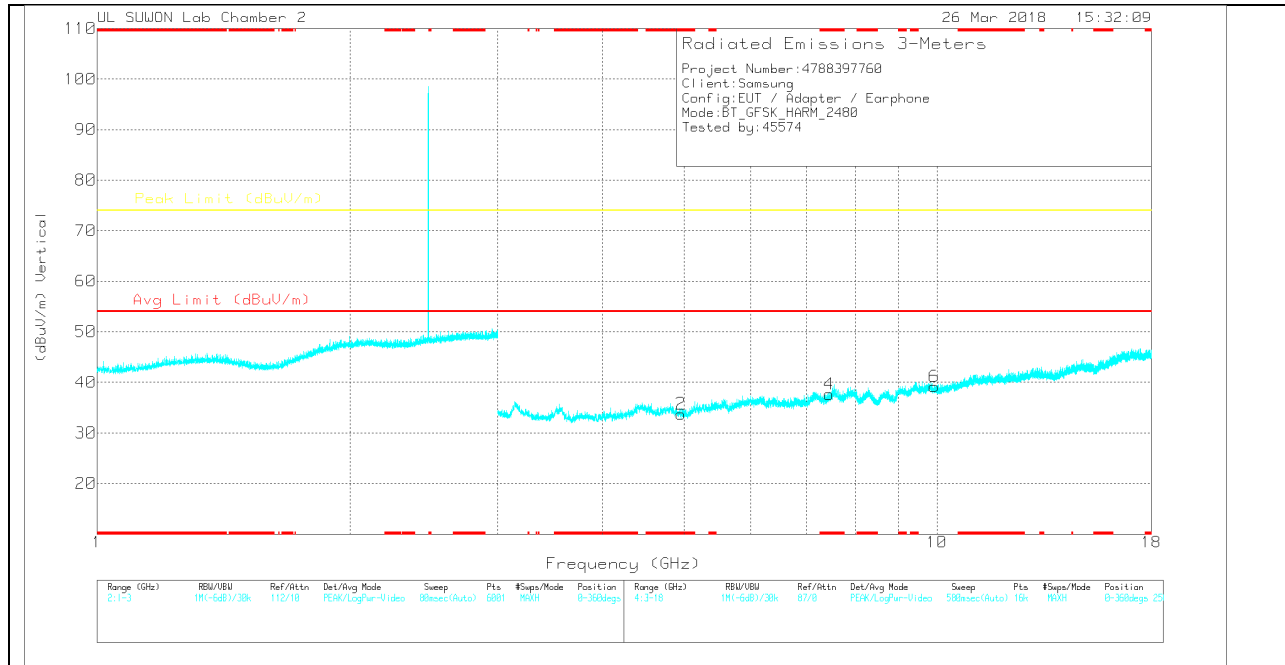

Note: Emission was scanned up to 26GHz; No emissions were detected above the noise floor which was at least 20dB below the specification limit.

**HIGH CHANNEL DATA**

Trace Markers

Marker	Frequency (GHz)	Meter Reading (dBuV)	Det	170531_3117[0016 8724]	3GHz_HP[dB]	Corrected Reading (dBuV/m)	Avg Limit (dBuV/m)	Margin (dB)	Peak Limit (dBuV/m)	Margin (dB)	Azimuth (Degs)	Height (cm)	Polarity
1	* 4.958	25.52	PK	33.8	-24.7	34.62	-	-	74	-39.38	0-360	150	H
3	* 7.443	22.76	PK	35.9	-21	37.66	-	-	74	-36.34	0-360	150	H
5	9.924	20.63	PK	37.1	-18	39.73	-	-	74	-34.27	0-360	250	H
2	* 4.959	24.64	PK	33.8	-24.7	33.74	-	-	74	-40.26	0-360	250	V
4	* 7.442	22.73	PK	35.9	-21	37.63	-	-	74	-36.37	0-360	250	V
6	9.928	20.07	PK	37.1	-18	39.17	-	-	74	-34.83	0-360	150	V

\* - indicates frequency in CFR47 Pt 15 / IC RSS-Restricted Band

PK – Peak detector

Note: Only peak measurement was performed. Because peak measurement result of unwanted emission is less than average limit (54dBuV/m).

## 11.2.2. ENHANCED DATA RATE 8PSK MODULATION RESTRICTED BANDEDGE (LOW CHANNEL)

### HORIZONTAL PEAK AND AVERAGE PLOT

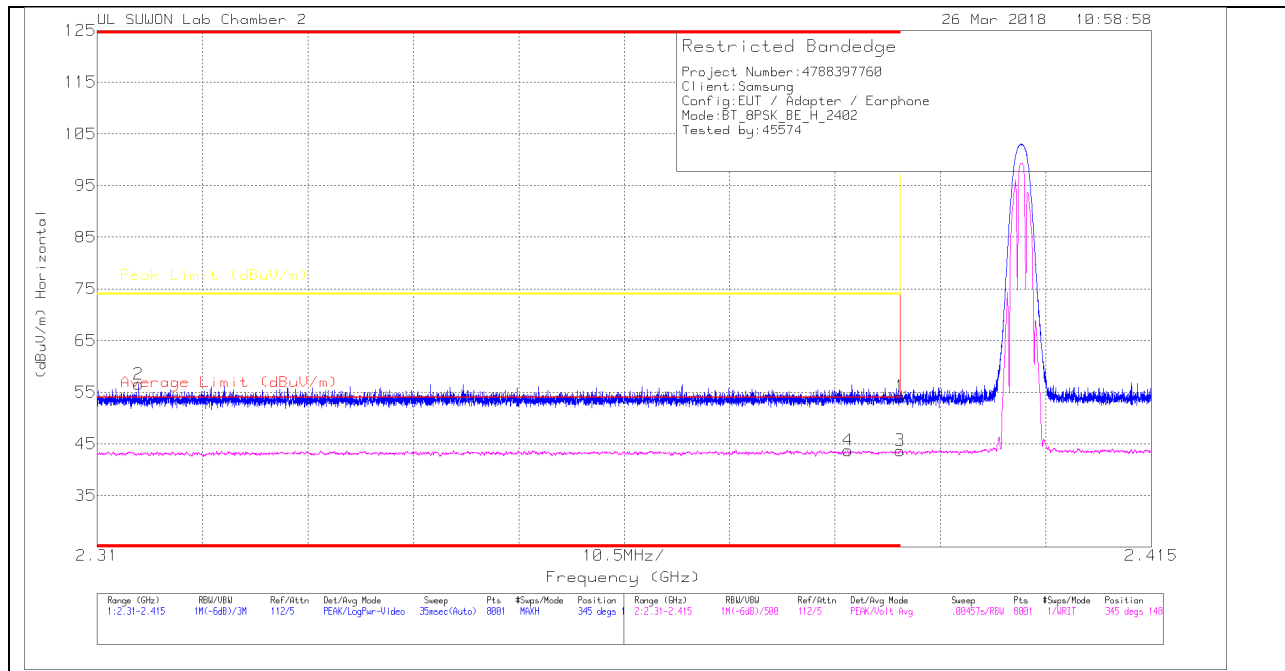

### HORIZONTAL DATA

#### Trace Markers

Marker	Frequency (GHz)	Meter Reading (dBuV)	Det	170531_3117[0016 8724]	10dB(dB)	Corrected Reading (dBuV/m)	Average Limit (dBuV/m)	Margin (dB)	Peak Limit (dBuV/m)	PK Margin (dB)	Azimuth (Degs)	Height (cm)	Polarity
1	* 2.39	41.07	Pk	31.3	-18.2	54.17	-	-	74	-19.83	345	148	H
2	* 2.314	43.78	Pk	31.2	-18.4	56.58	-	-	74	-17.42	345	148	H
3	* 2.39	30.6	VA1T	31.3	-18.2	43.7	54	-10.3	-	-	345	148	H
4	* 2.385	30.65	VA1T	31.3	-18.2	43.75	54	-10.25	-	-	345	148	H

\* - indicates frequency in CFR47 Pt 15 / IC RSS-Restricted Band

Pk - Peak detector

VA1T - FHSS: Linear Voltage Average VB=1/Ton where: Ton is transmit duration



**VERTICAL PEAK AND AVERAGE PLOT**

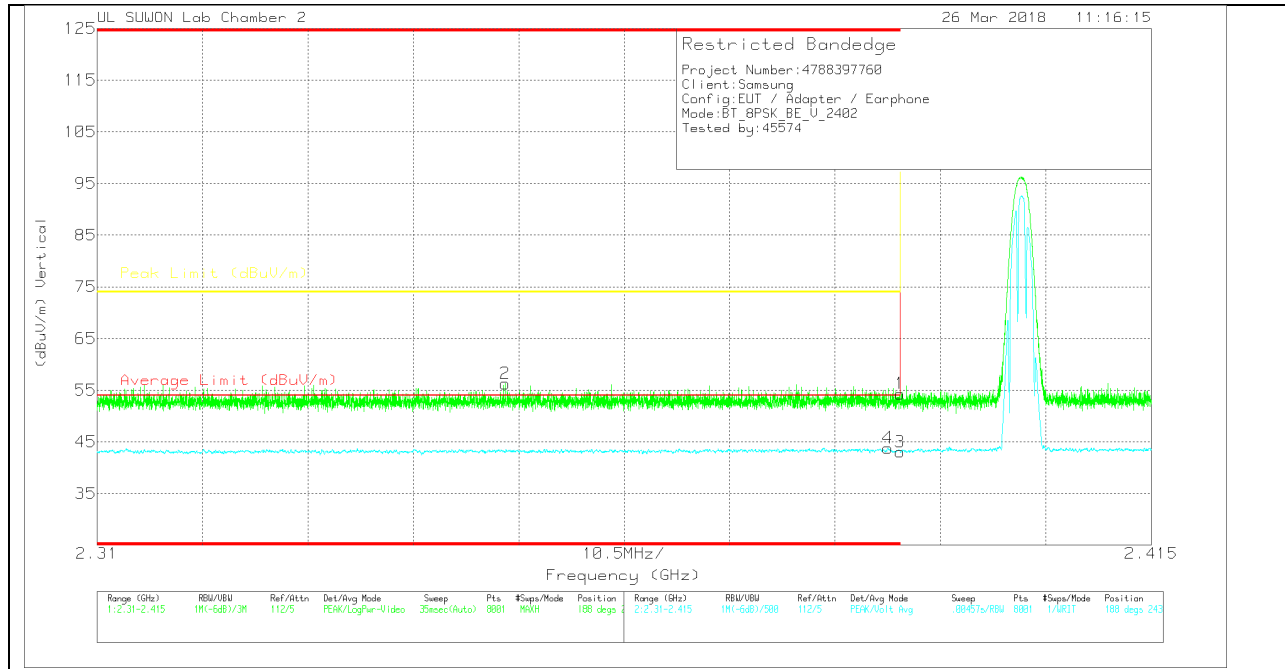

**VERTICAL DATA**

**Trace Markers**

Marker	Frequency (GHz)	Meter Reading (dBuV)	Det	170531_3117[0016 8724]	10dB[dB]	Corrected Reading (dBuV/m)	Average Limit (dBuV/m)	Margin (dB)	Peak Limit (dBuV/m)	PK Margin (dB)	Azimuth (Degs)	Height (cm)	Polarity
1	* 2.39	41.21	Pk		-18.2	54.31	-	-	74	-19.69	188	243	V
2	* 2.351	43.38	Pk		-18.3	56.28	-	-	74	-17.72	188	243	V
3	* 2.39	29.93	VA1T		-18.2	43.03	54	-10.97	-	-	188	243	V
4	* 2.389	30.71	VA1T		-18.2	43.81	54	-10.19	-	-	188	243	V

\* - indicates frequency in CFR47 Pt 15 / IC RSS-Restricted Band

Pk - Peak detector

VA1T - FHSS: Linear Voltage Average VB=1/Ton where: Ton is transmit duration

### AUTHORIZED BANDEDGE (HIGH CHANNEL)

#### HORIZONTAL PEAK AND AVERAGE PLOT

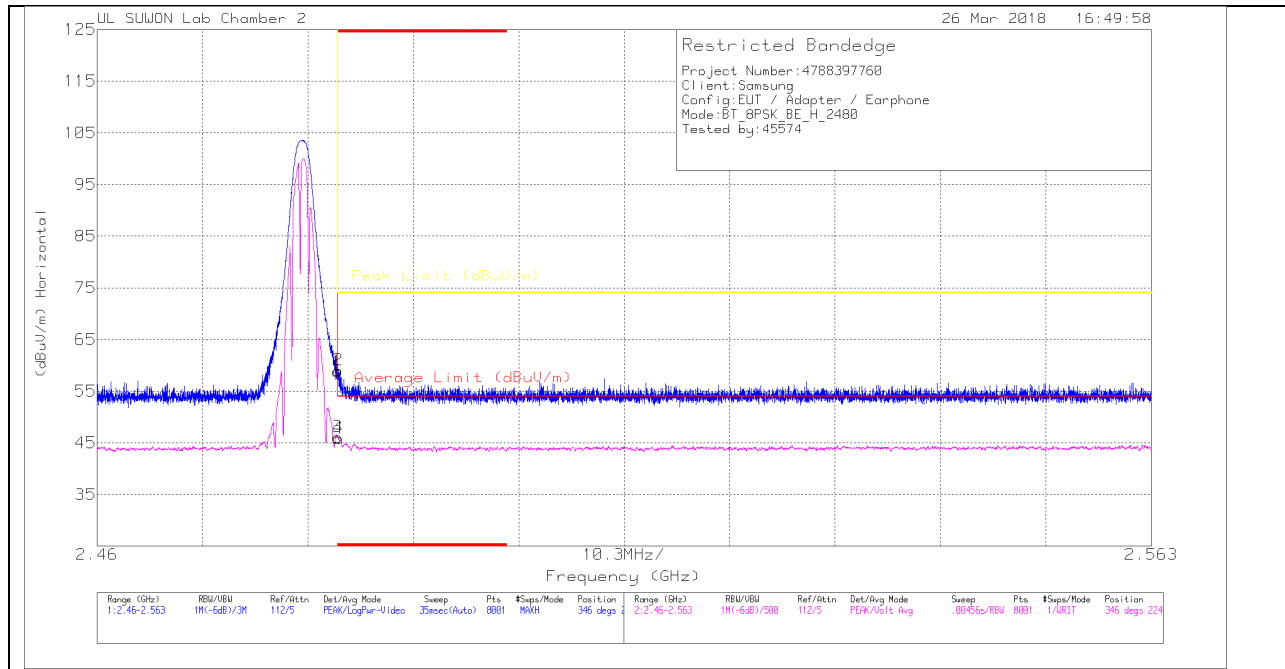

#### HORIZONTAL DATA

##### Trace Markers

Marker	Frequency (GHz)	Meter Reading (dBuV)	Det	170531_3117[0016 8724]	10dB[dB]	Corrected Reading (dBuV/m)	Average Limit (dBuV/m)	Margin (dB)	Peak Limit (dBuV/m)	PK Margin (dB)	Azimuth (Degs)	Height (cm)	Polarity
1	* 2.484	45.28	Pk		-18	58.88	-	-	74	-15.12	346	224	H
2	* 2.484	45.46	Pk		-18	59.06	-	-	74	-14.94	346	224	H
3	* 2.484	32.56	VA1T		-18	46.16	54	-7.84	-	-	346	224	H
4	* 2.484	32.3	VA1T		-18	45.9	54	-8.1	-	-	346	224	H

\* - indicates frequency in CFR47 Pt 15 / IC RSS-Restricted Band

Pk - Peak detector

VA1T - FHSS: Linear Voltage Average  $V_B=1/T_{on}$  where:  $T_{on}$  is transmit duration

**VERTICAL PEAK AND AVERAGE PLOT**

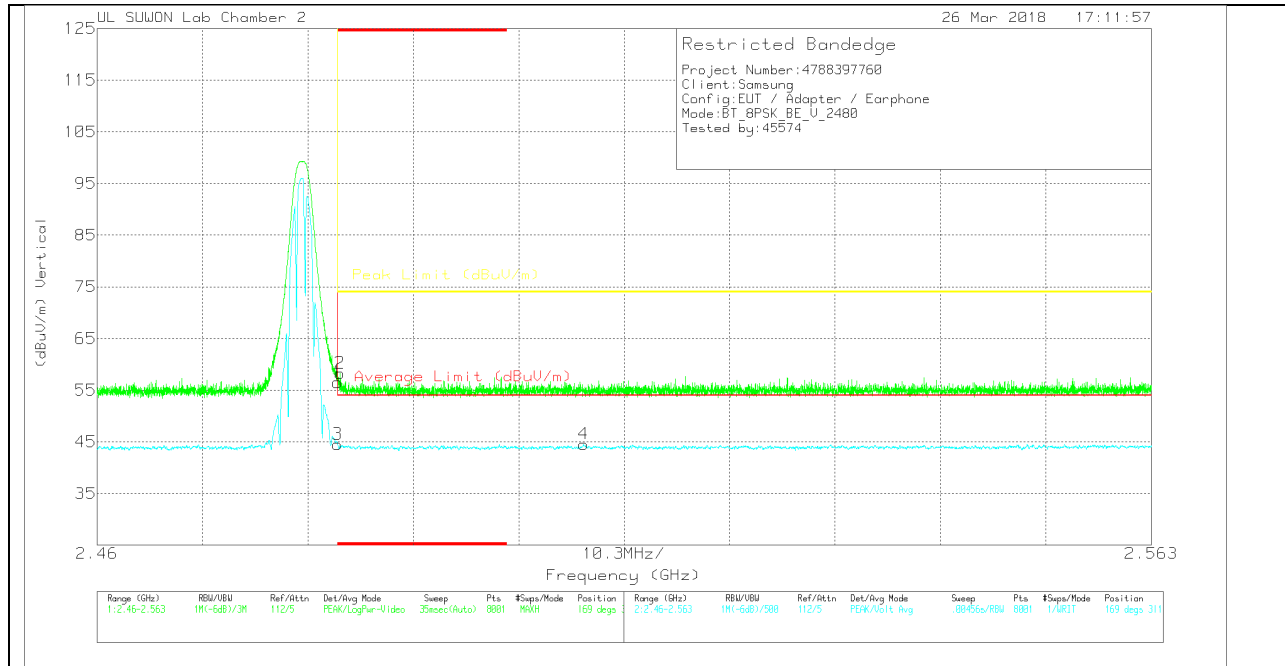

**VERTICAL DATA**

**Trace Markers**

Marker	Frequency (GHz)	Meter Reading (dBuV)	Det	170531_3117[0016 8724]	10dB(dB)	Corrected Reading (dBuV/m)	Average Limit (dBuV/m)	Margin (dB)	Peak Limit (dBuV/m)	PK Margin (dB)	Azimuth (Degs)	Height (cm)	Polarity
1	* 2.484	42.92	Pk	31.6	-18	56.52	-	-	74	-17.48	169	311	V
2	* 2.484	44.7	Pk	31.6	-18	58.3	-	-	74	-15.7	169	311	V
3	* 2.484	30.96	VA1T	31.6	-18	44.56	54	-9.44	-	-	169	311	V
4	2.508	30.98	VA1T	31.6	-18	44.58	54	-9.42	-	-	169	311	V

\* - indicates frequency in CFR47 Pt 15 / IC RSS-Restricted Band

Pk - Peak detector

VA1T - FHSS: Linear Voltage Average VB=1/Ton where: Ton is transmit duration

## HARMONICS AND SPURIOUS EMISSIONS

### LOW CHANNEL HORIZONTAL

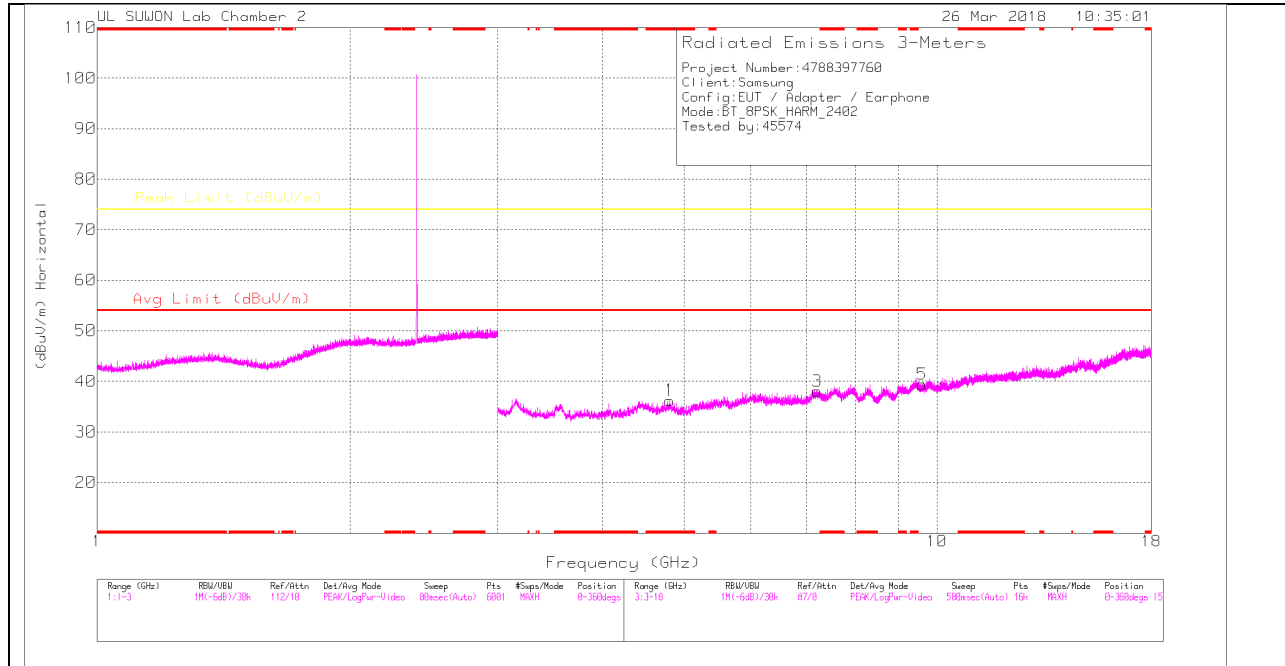

### LOW CHANNEL VERTICAL

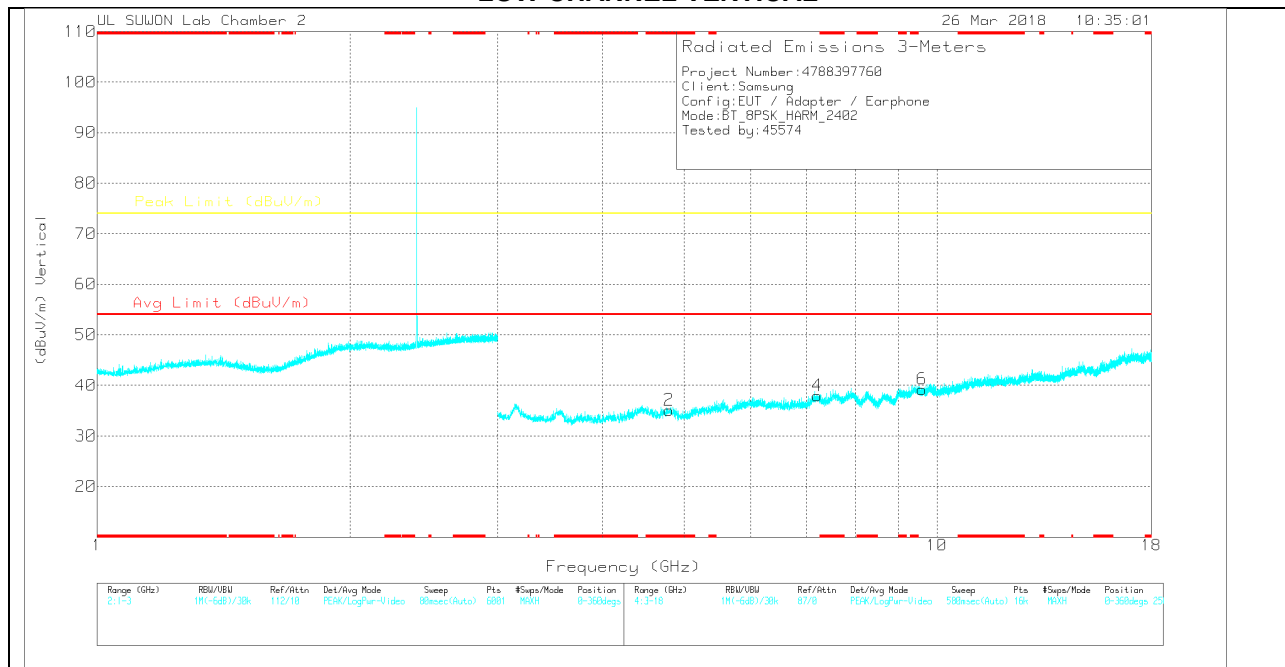

Note: Emission was scanned up to 26GHz; No emissions were detected above the noise floor which was at least 20dB below the specification limit.

**LOW CHANNEL DATA**

Trace Markers

Marker	Frequency (GHz)	Meter Reading (dBuV)	Det	170531_3117[0016 8724]	3GHz_HP[dB]	Corrected Reading (dBuV/m)	Avg Limit (dBuV/m)	Margin (dB)	Peak Limit (dBuV/m)	Margin (dB)	Azimuth (Degs)	Height (cm)	Polarity
1	* 4.805	26.72	PK	33.8	-24.3	36.22	-	-	74	-37.78	0-360	250	H
3	7.205	23.83	PK	35.9	-21.7	38.03	-	-	74	-35.97	0-360	250	H
5	9.601	21.11	PK	36.7	-18.4	39.41	-	-	74	-34.59	0-360	250	H
2	* 4.801	25.61	PK	33.8	-24.3	35.11	-	-	74	-38.89	0-360	150	V
4	7.201	23.65	PK	35.9	-21.6	37.95	-	-	74	-36.05	0-360	250	V
6	9.606	20.94	PK	36.7	-18.4	39.24	-	-	74	-34.76	0-360	150	V

\* - indicates frequency in CFR47 Pt 15 / IC RSS-Restricted Band

PK - Peak Detector

Note: Only peak measurement was performed. Because peak measurement result of unwanted emission is less than average limit (54dBuV/m).

**MID CHANNEL HORIZONTAL**

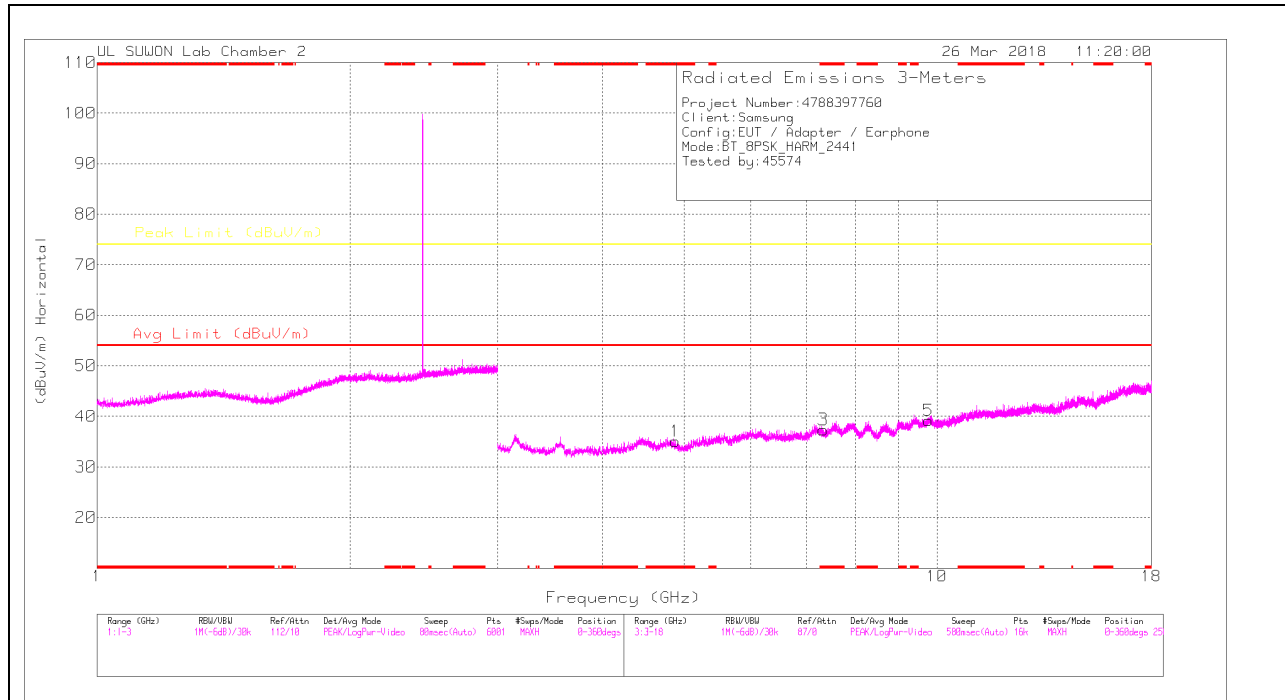

**MID CHANNEL VERTICAL**

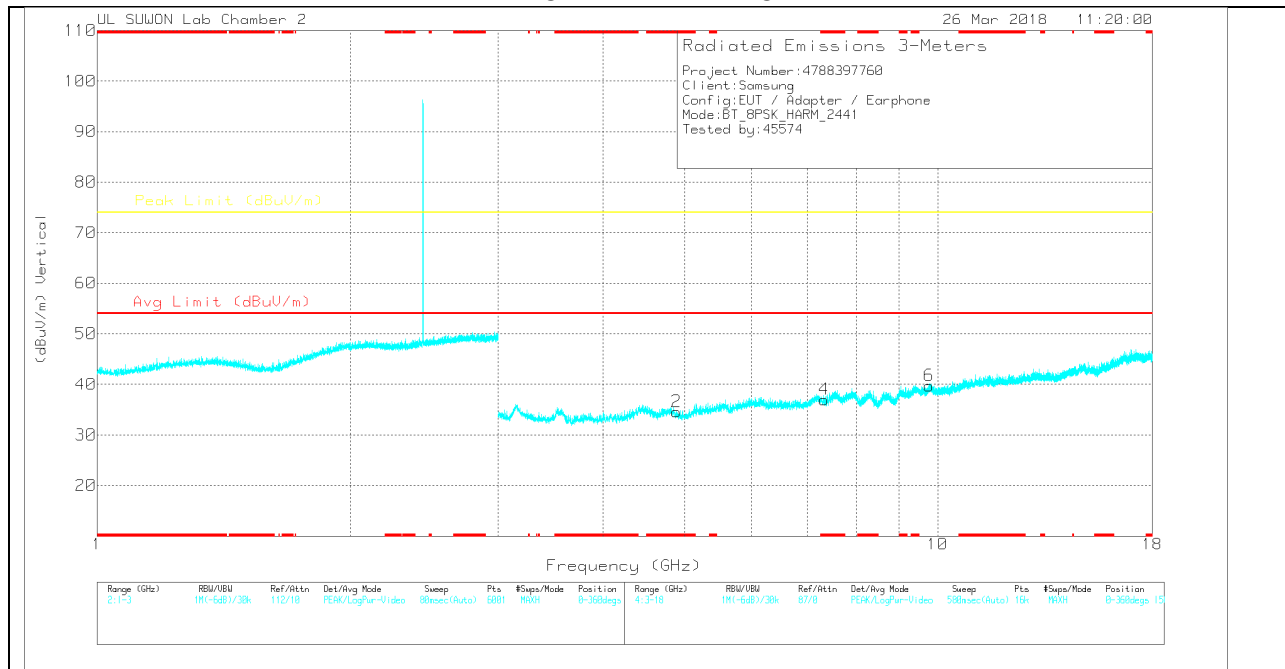

Note: Emission was scanned up to 26GHz; No emissions were detected above the noise floor which was at least 20dB below the specification limit.

**MID CHANNEL DATA**

Trace Markers

Marker	Frequency (GHz)	Meter Reading (dBuV)	Det	170531_3117[0016 8724]	3GHz_HP[dB]	Corrected Reading (dBuV/m)	Avg Limit (dBuV/m)	Margin (dB)	Peak Limit (dBuV/m)	Margin (dB)	Azimuth (Degs)	Height (cm)	Polarity
1	* 4.881	25.88	PK	33.8	-24.6	35.08	-	-	74	-38.92	0-360	150	H
3	* 7.322	23.34	PK	35.9	-21.9	37.34	-	-	74	-36.66	0-360	150	H
5	9.767	20.26	PK	36.9	-18	39.16	-	-	74	-34.84	0-360	150	H
2	* 4.887	25.4	PK	33.8	-24.6	34.6	-	-	74	-39.4	0-360	150	V
4	* 7.326	23	PK	35.9	-21.9	37	-	-	74	-37	0-360	150	V
6	9.766	20.83	PK	36.9	-18	39.73	-	-	74	-34.27	0-360	150	V

\* - indicates frequency in CFR47 Pt 15 / IC RSS-Restricted Band

PK – Peak Detector

Note: Only peak measurement was performed. Because peak measurement result of unwanted emission is less than average limit (54dBuV/m).

### HIGH CHANNEL HORIZONTAL

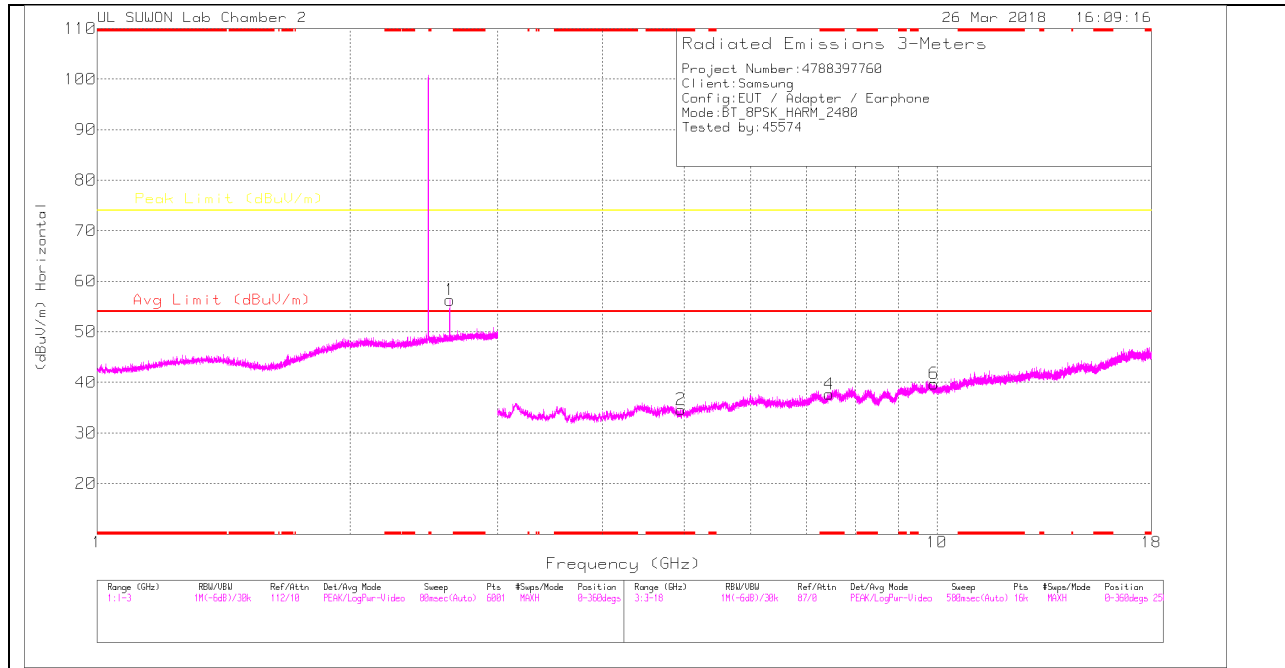

### HIGH CHANNEL VERTICAL

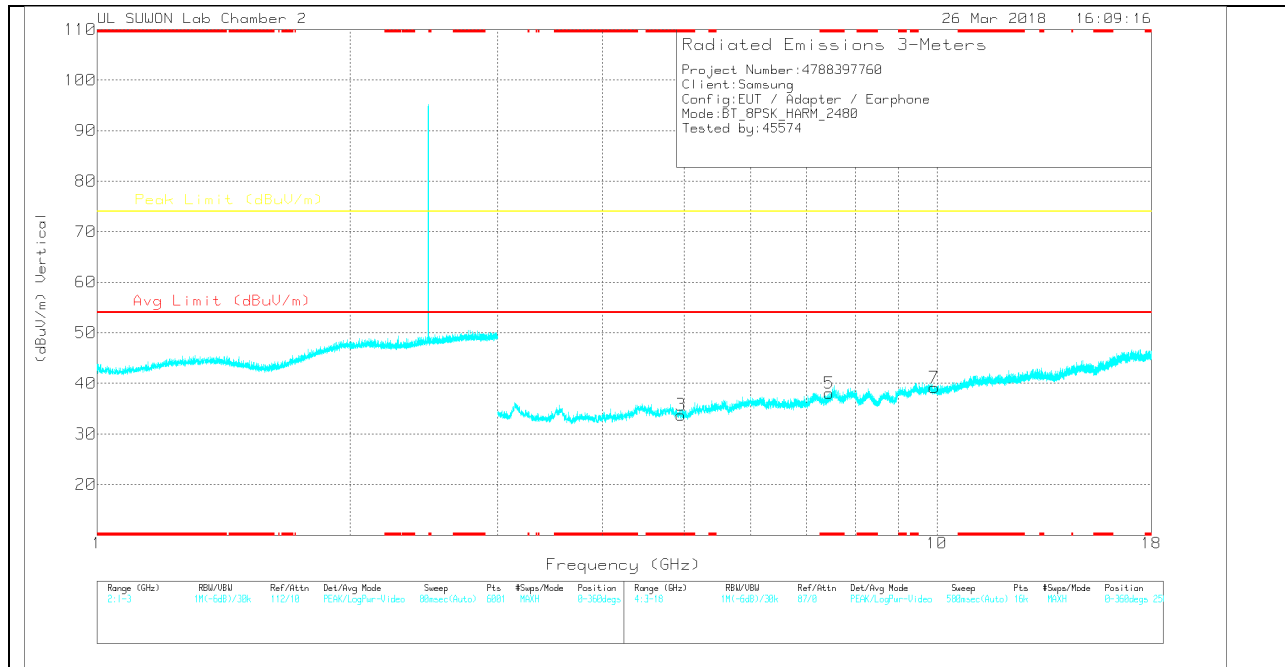

Note: Emission was scanned up to 26GHz; No emissions were detected above the noise floor which was at least 20dB below the specification limit.



**HIGH CHANNEL DATA**

Trace Markers

Marker	Frequency (GHz)	Meter Reading (dBuV)	Det	170531_3117[00168 724]	10dB[dB]	Corrected Reading (dBuV/m)	Avg Limit (dBuV/m)	Margin (dB)	Peak Limit (dBuV/m)	Margin (dB)	Azimuth (Degs)	Height (cm)	Polarity
1	2.63	42.3	PK	31.9	-17.9	56.3	-	-	74	-17.7	0-360	250	H
2	* 4.958	25.52	PK	33.8	-24.7	34.62	-	-	74	-39.38	0-360	150	H
4	* 7.443	22.76	PK	35.9	-21	37.66	-	-	74	-36.34	0-360	150	H
6	9.924	20.63	PK	37.1	-18	39.73	-	-	74	-34.27	0-360	250	H
3	* 4.959	24.64	PK	33.8	-24.7	33.74	-	-	74	-40.26	0-360	250	V
5	* 7.438	23.13	PK	35.9	-21	38.03	-	-	74	-35.97	0-360	250	V
7	9.928	20.07	PK	37.1	-18	39.17	-	-	74	-34.83	0-360	150	V

\* - indicates frequency in CFR47 Pt 15 / IC RSS-Restricted Band  
 PK – Peak Detector

Radiated Emissions

Frequency (GHz)	Meter Reading (dBuV)	Det	170531_3117[0016 8724]	10dB[dB]	Corrected Reading (dBuV/m)	Avg Limit (dBuV/m)	Margin (dB)	Peak Limit (dBuV/m)	Margin (dB)	Azimuth (Degs)	Height (cm)	Polarity
2.631	48.66	PK	31.9	-17.9	62.66	-	-	74	-11.34	332	103	H

\* - indicates frequency in CFR47 Pt 15 / IC RSS-Restricted Band  
 PK – Peak Detector

Note: Only peak measurement was performed. Because peak measurement result of unwanted emission is less than average limit (54dBuV/m).

### 11.3. WORST-CASE BELOW 1 GHz

#### GFSK SPURIOUS EMISSIONS 30 TO 1000 MHz (WORST-CASE CONFIGURATION, HORIZONTAL)

#### HORIZONTAL PLOT

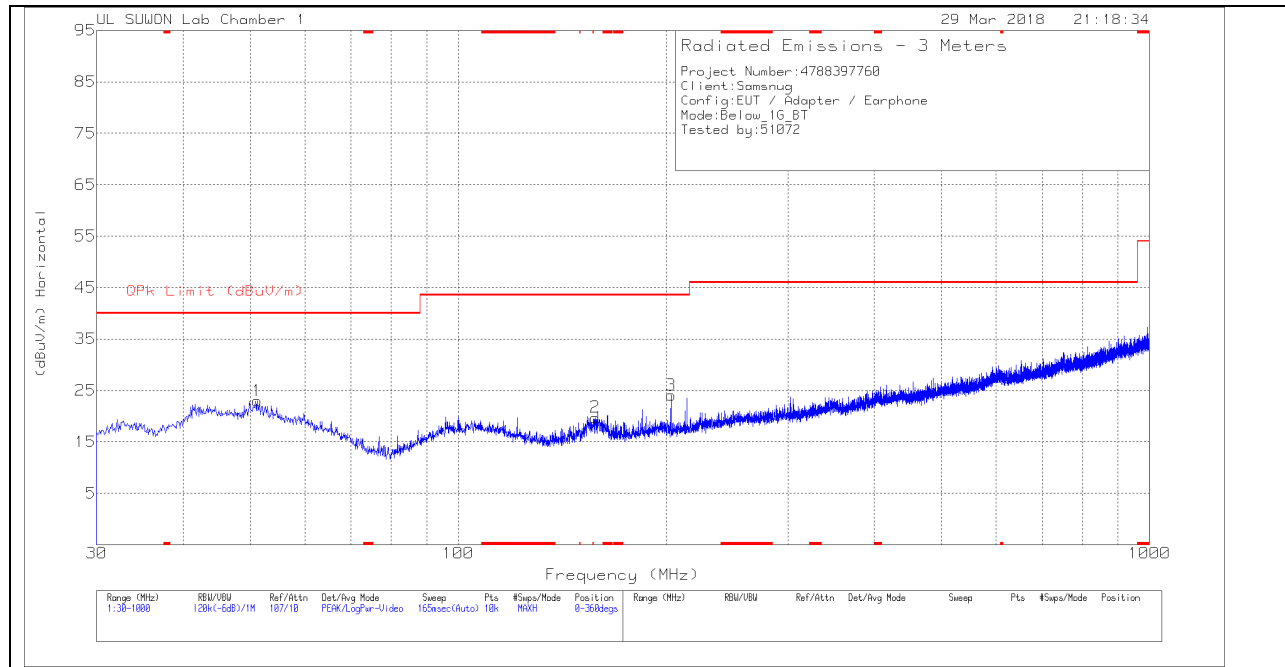

#### VERTICAL PLOT

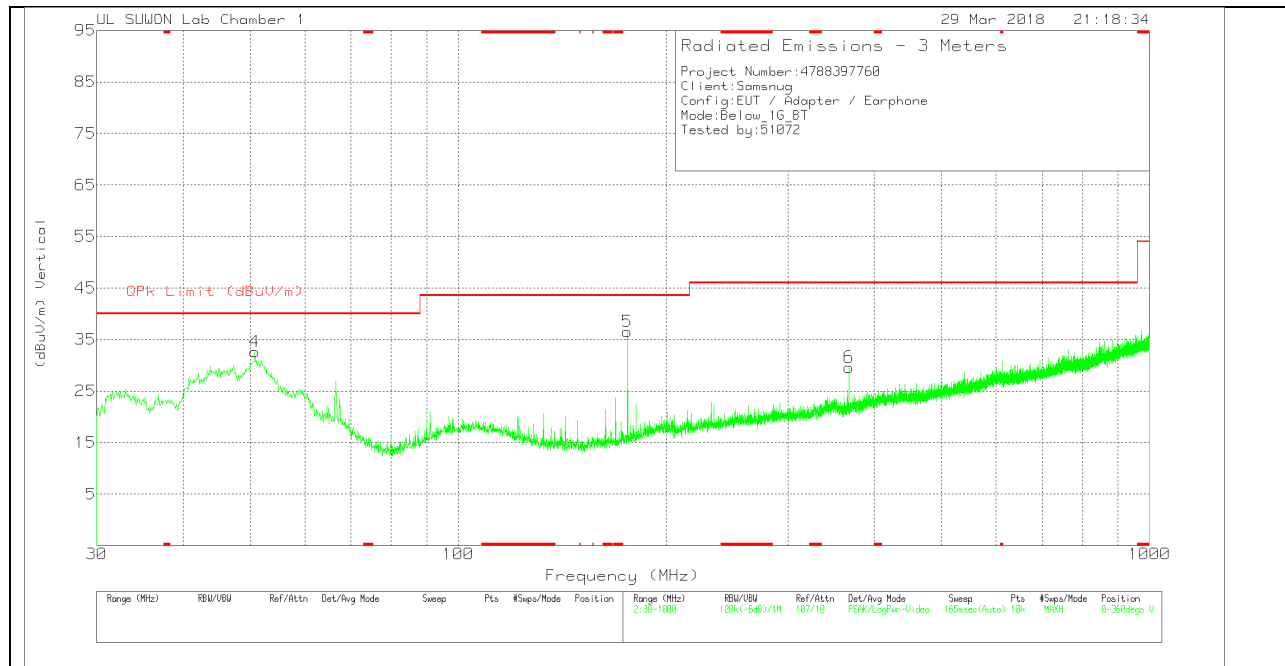

**BELOW 1 GHz TABLE**

Trace Markers

Marker	Frequency (MHz)	Meter Reading (dBuV)	Det	750_20170831	30-1000MHz[dB]	DC Corr (dB)	Corrected Reading (dBuV/m)	QPk Limit (dBuV/m)	Margin (dB)	Azimuth (Degs)	Height (cm)	Polarity
1	51.243	32.29	Pk	19.8	-29.1	0	22.99	40	-17.01	0-360	200	H
2	157.943	33.34	Pk	14.2	-27.8	0	19.74	43.52	-23.78	0-360	100	H
3	203.145	34.97	Pk	16.7	-27.6	0	24.07	43.52	-19.45	0-360	100	H
4	50.758	42	Pk	19.8	-29.2	0	32.6	40	-7.4	0-360	100	V
5	175.597	49.13	Pk	15	-27.6	0	36.53	43.52	-6.99	0-360	100	V
6	367.657	35.53	Pk	20.5	-26.4	0	29.63	46.02	-16.39	0-360	100	V

Pk - Peak detector

## 12. AC POWER LINE CONDUCTED EMISSIONS

### LIMITS

FCC §15.207 (a)

Frequency of Emission (MHz)	Conducted Limit (dBuV)	
	Quasi-peak	Average
0.15-0.5	66 to 56	56 to 46
0.5-5	56	46
5-30	60	50

\*Decreases with the logarithm of the frequency.

### TEST PROCEDURE

The EUT is placed on a non-conducting table 40 cm from the vertical ground plane and 80 cm above the horizontal ground plane. The EUT is configured in accordance with ANSI C63.10.

The receiver is set to a resolution bandwidth of 9 kHz. Peak detection is used unless otherwise noted as quasi-peak or average.

Line conducted data is recorded for both NEUTRAL and HOT lines.

**RESULTS**

**WORST EMISSIONS**

**LINE 1 PLOT**

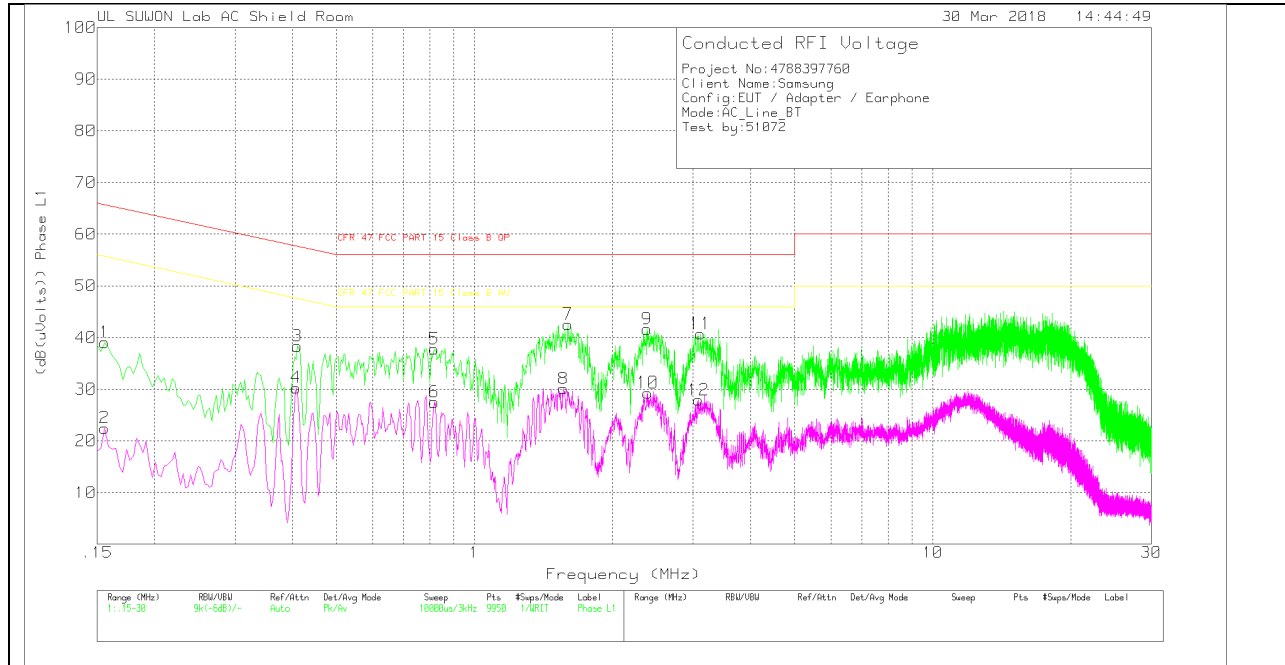

## LINE 1 RESULTS

### Trace Markers

#### Range 1: Phase L1 .15 - 30MHz

Marker	Frequency (MHz)	Meter Reading (dBuV)	Det	101837_L1_with extension	CABLELOSS(dB)	Corrected Reading (dB(uVolts))	CFR 47 FCC PART 15 Class B QP	Margin (dB)	CFR 47 FCC PART 15 Class B AV	Margin (dB)
1	.156	28.96	Pk	10	.1	39.06	65.67	-26.61	-	-
2	.156	12.4	Av	10	.1	22.5	-	-	55.67	-33.17
3	.411	28.35	Pk	9.8	.2	38.35	57.63	-19.28	-	-
4	.408	20.29	Av	9.8	.2	30.29	-	-	47.69	-17.4
5	.816	27.96	Pk	9.6	.2	37.76	56	-18.24	-	-
6	.816	17.71	Av	9.6	.2	27.51	-	-	46	-18.49
7	1.599	32.36	Pk	9.9	.3	42.56	56	-13.44	-	-
8	1.566	19.9	Av	9.9	.3	30.1	-	-	46	-15.9
9	2.379	31.53	Pk	9.8	.3	41.63	56	-14.37	-	-
10	2.388	19.2	Av	9.8	.3	29.3	-	-	46	-16.7
11	3.114	30.62	Pk	9.8	.3	40.72	56	-15.28	-	-
12	3.084	17.79	Av	9.8	.3	27.89	-	-	46	-18.11

Pk - Peak detector

Av - Average detection

### Quasi-Peak Emissions

#### Range 1: Phase L1 .15 - 30MHz

Frequency (MHz)	Meter Reading (dBuV)	Det	101837_L1_with extension	CABLELOSS(dB)	Corrected Reading (dB(uVolts))	CFR 47 FCC PART 15 Class B QP	Margin (dB)	CFR 47 FCC PART 15 Class B AV	Margin (dB)
.15525	27.73	Qp	10	.1	37.83	65.71	-27.88	-	-
.41025	22.33	Qp	9.8	.2	32.33	57.64	-25.31	-	-
.40725	25.89	Qp	9.8	.2	35.89	57.7	-21.81	-	-
.81525	27.26	Qp	9.6	.2	37.06	56	-18.94	-	-
1.59825	31.6	Qp	9.9	.3	41.8	56	-14.2	-	-
1.56615	31.48	Qp	9.9	.3	41.68	56	-14.32	-	-
2.37975	21.9	Qp	9.8	.3	32	56	-24	-	-
2.38875	24.22	Qp	9.8	.3	34.32	56	-21.68	-	-
3.11325	18.92	Qp	9.8	.3	29.02	56	-26.98	-	-
3.08475	21.39	Qp	9.8	.3	31.49	56	-24.51	-	-

**LINE 2 PLOT**

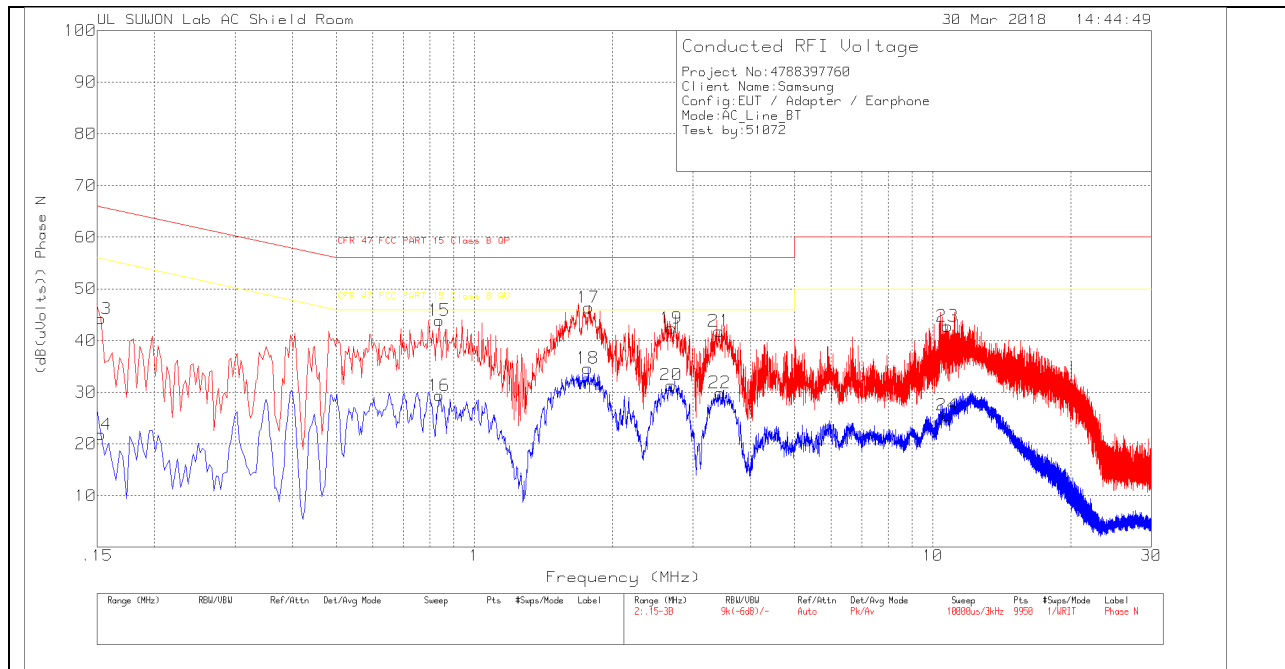

## LINE 2 RESULTS

### Trace Markers

#### Range 2: Phase N .15 - 30MHz

Marker	Frequency (MHz)	Meter Reading (dBuV)	Det	101837_N_with extension	CABLELOSS(dB)	Corrected Reading (dB(uVolts))	CFR 47 FCC PART 15 Class B QP	Margin (dB)	CFR 47 FCC PART 15 Class B AV	Margin (dB)
13	.153	34.11	Pk	10	.1	44.21	65.84	-21.63	-	-
14	.153	11.71	Av	10	.1	21.81	-	-	55.84	-34.03
15	.837	33.88	Pk	9.7	.3	43.88	56	-12.12	-	-
16	.837	19.36	Av	9.7	.3	29.36	-	-	46	-16.64
17	1.773	36.18	Pk	9.9	.3	46.38	56	-9.62	-	-
18	1.767	24.44	Av	9.9	.3	34.64	-	-	46	-11.36
19	2.688	32.17	Pk	9.9	.3	42.37	56	-13.63	-	-
20	2.688	21.19	Av	9.9	.3	31.39	-	-	46	-14.61
21	3.417	31.72	Pk	9.8	.3	41.82	56	-14.18	-	-
22	3.429	19.79	Av	9.8	.3	29.89	-	-	46	-16.11
23	10.77	32.68	Pk	9.8	.3	42.78	60	-17.22	-	-
24	10.749	15.46	Av	9.8	.3	25.56	-	-	50	-24.44

Pk - Peak detector

Av - Average detection

### Quasi-Peak Emissions

#### Range 2: Phase N .15 - 30MHz

Frequency (MHz)	Meter Reading (dBuV)	Det	101837_N_with extension	CABLELOSS(dB)	Corrected Reading (dB(uVolts))	CFR 47 FCC PART 15 Class B QP	Margin (dB)	CFR 47 FCC PART 15 Class B AV	Margin (dB)
.15225	30.29	Qp	10	.1	40.39	65.88	-25.49	-	-
.83775	28.19	Qp	9.7	.3	38.19	56	-17.81	-	-
1.77375	32.86	Qp	9.9	.3	43.06	56	-12.94	-	-
1.76775	31.52	Qp	9.9	.3	41.72	56	-14.28	-	-
2.68725	29.58	Qp	9.9	.3	39.78	56	-16.22	-	-
3.41715	28.3	Qp	9.8	.3	38.4	56	-17.6	-	-
3.42915	27.34	Qp	9.8	.3	37.44	56	-18.56	-	-
10.7708	23.41	Qp	9.8	.3	33.51	60	-26.49	-	-
10.7483	23.16	Qp	9.8	.3	33.26	60	-26.74	-	-

Qp - Quasi-Peak detector