

**MEASUREMENT REPORT
FCC PART 15.407 DFS**

Applicant Name:
Samsung Electronics Co., Ltd.
129, Samsung-ro,
Yeongtong-gu, Suwon-si
Gyeonggi-do, 16677, Korea

Date of Testing:
3/9 - 4/25/2018
Test Site/Location:
PCTEST Lab. Columbia, MD, USA
Test Report Serial No.:
1M1803090037-07.A3L

FCC ID:	A3LSMJ337P
APPLICANT:	Samsung Electronics Co., Ltd.

Application Type: Certification
Model: SM-J337P
EUT Type: Client Only Device, No Radar Detection Capability
Max. RF Output Power: 31.550 mW (14.99 dBm) Conducted (802.11n UNII Band 2A)
 32.434 mW (15.11 dBm) Conducted (802.11a UNII Band 2C)
Frequency Range: 5260 – 5320 MHz (UNII-2A Band)
 5500 – 5720 MHz (UNII-2C Band)
FCC Classification: Unlicensed National Information Infrastructure (UNII)
FCC Rule Part(s): Part 15.247(UNII)
Test Procedure(s): KDB 905462 D02 v02

This equipment has been shown to be capable of compliance with the applicable technical standards as indicated in the measurement report and was tested in accordance with the measurement procedures specified in KDB 905462 D02 v02 Compliance Measurement Procedures for Unlicensed-National Information Infrastructure Devices Operating in the 5.25 – 5.35 GHz and 5.47 – 5.725 GHz Bands Incorporating Dynamic Frequency Selection. Test results reported herein relate only to the item(s) tested.

I attest to the accuracy of data. All measurements reported herein were performed by me or were made under my supervision and are correct to the best of my knowledge and belief. I assume full responsibility for the completeness of these measurements and vouch for the qualifications of all persons taking them.

Randy Ortanez
President



FCC ID: A3LSMJ337P	 MEASUREMENT REPORT (CERTIFICATION)		Approved by: Quality Manager
Test Report S/N: 1M1803090037-07.A3L	Test Dates: 3/9 - 4/25/2018	EUT Type: Portable Handset	Page 1 of 16

TABLE OF CONTENTS

1.0	INTRODUCTION	3
	1.1 Scope	3
	1.2 Evaluation Procedure	3
	1.3 Summary of Test Results	3
2.0	PRODUCT INFORMATION.....	4
	2.1 Equipment Description	4
	2.2 EUT Capabilities.....	4
	2.3 Modifications	4
3.0	DESCRIPTION OF DYNAMIC FREQUENCY SELECTION TEST.....	5
	3.1 Applicability	5
	3.2 Requirements	5
	3.3 DFS Detection Threshold Values	7
	3.4 Parameters of DFS Test Signals	7
	3.5 Procedure.....	8
4.0	TEST EQUIPMENT	9
	4.1 Additional Equipment.....	9
5.0	TEST RESULTS	10
6.0	CONCLUSION.....	16

FCC ID: A3LSMJ337P		MEASUREMENT REPORT (CERTIFICATION)		Approved by: Quality Manager
Test Report S/N: 1M1803090037-07.A3L	Test Dates: 3/9 - 4/25/2018	EUT Type: Portable Handset	Page 2 of 16	

1.0 INTRODUCTION

1.1 Scope

This report has been prepared to demonstrate compliance with the requirements for Dynamic Frequency Selection (DFS) as stated in KDB 905462 D02 v02. Testing was performed on the **Samsung Portable Handset FCC ID: A3LSMJ337P**. As of July 20, 2007 all devices operating in the 5250 – 5350 MHz and/or the 5470 – 5725 MHz bands must comply with the DFS requirements. As the EUT does not have radar detection capability it was evaluated as a Client Only Device. All test results reported herein are applicable to the sample selected for testing. The unit used for testing was supplied by Samsung Electronics Co., Ltd..

1.2 Evaluation Procedure

Conducted test methodology was used for the DFS evaluation procedure of the EUT. No deviations to the test procedure and test methods occurred during the evaluation of the EUT.

1.3 Summary of Test Results

The EUT was found to be compliant with the requirements for DFS as required for a Client Device per Part 15.407(h), RSS-247 and KDB 905462 D02 v02. The following table lists the measured parameters. The actual data and plots can be found in Section 5 and 6 of this report.

	Parameter	Measured	Limit	Result
5260 – 5320 MHz UNII – 2A Band	Channel Move Time	3.51 s	10 seconds	Pass
	Channel Closing Transmission Time	< 200ms + 43.87 ms (aggregate)	200ms + aggregate of 60ms over remaining 10 second period	Pass
	Client beacon test	Monitored for 10 minutes with no client transmission	No client transmission occurred	Pass
5470 – 5725 MHz UNII – 2C Band	Channel Move Time	3.23 s	10 seconds	Pass
	Channel Closing Transmission Time	< 200ms + 27.42 ms (aggregate)	200ms + aggregate of 60ms over remaining 10 second period	Pass
	Client beacon test	Monitored for 10 minutes with no client transmission	No client transmission occurred	Pass

Table 1-1. DFS Test Results Summary

FCC ID: A3LSMJ337P		MEASUREMENT REPORT (CERTIFICATION)		Approved by: Quality Manager
Test Report S/N: 1M1803090037-07.A3L	Test Dates: 3/9 - 4/25/2018	EUT Type: Portable Handset	Page 3 of 16	

2.0 PRODUCT INFORMATION

2.1 Equipment Description

The Equipment Under Test (EUT) is the **Samsung Portable Handset FCC ID: A3LSMJ337P**.

Mode of Operation:

Master Device	<input type="checkbox"/>
Client Device (No radar detection)	<input checked="" type="checkbox"/>
Client Device with Radar Detection	<input type="checkbox"/>

Parameters of EUT:	
Frequency	5260 – 5320 MHz 5500 – 5720 MHz
Output Power:	31.550 mW (14.99 dBm) Conducted (802.11n UNII Band 2A) 32.434 mW (15.11 dBm) Conducted (802.11a UNII Band 2C)
Modulation:	OFDM
Channel Bandwidth:	20, 40 MHz

Table 2-1. Parameters of EUT

Test Device Serial No.: 05808,

2.2 EUT Capabilities

This device contains the following capabilities:

850/1900 CDMA/EVDO, 850/1900 GSM/GPRS/EDGE, 850/1700/1900 WCDMA/HSPA, Multi-band LTE, 802.11b/g/n WLAN, 802.11a/n UNII, Bluetooth (1x, EDR, LE)

2.3 Modifications

No modifications to the EUT were required in order to comply with the DFS specifications.

FCC ID: A3LSMJ337P		MEASUREMENT REPORT (CERTIFICATION)		Approved by: Quality Manager
Test Report S/N: 1M1803090037-07.A3L	Test Dates: 3/9 - 4/25/2018	EUT Type: Portable Handset	Page 4 of 16	

3.0 DESCRIPTION OF DYNAMIC FREQUENCY SELECTION TEST

3.1 Applicability

The following table from KDB 905462 D02 v02 lists the applicable requirements for the DFS testing. The device evaluated in this report is considered a client device without radar detection capability.

Requirement	Operational Mode		
	Master	Client Without Radar Detection	Client With Radar Detection
Non-Occupancy Period	Yes	Not required	Yes
DFS Detection Threshold	Yes	Not required	Yes
Channel Availability Check Time	Yes	Not required	Not required
Uniform Spreading	Yes	Not required	Not required
U-NII Detection Bandwidth	Yes	Not required	Yes

Table 3-1. DFS Applicability

Requirement	Operational Mode		
	Master	Client Without Radar Detection	Client With Radar Detection
DFS Detection Threshold	Yes	Not required	Yes
Channel Closing Transmission Time	Yes	Yes	Yes
Channel Move Time	Yes	Yes	Yes
U-NII Detection Bandwidth	Yes	Not required	Yes
Client Beacon Test	N/A	Yes	Yes

Table 3-2. DFS Applicability During Normal Operation

3.2 Requirements

Per KDB 905462 D02 v02 the following are the requirements for Client Devices:

- a) A Client Device will not transmit before having received appropriate control signals from a Master Device.
- b) A Client Device will stop all its transmissions whenever instructed by a Master Device to which it is associated and will meet the Channel Move Time and Channel Closing Transmission Time requirements.

FCC ID: A3LSMJ337P	 MEASUREMENT REPORT (CERTIFICATION) 		Approved by: Quality Manager
Test Report S/N: 1M1803090037-07.A3L	Test Dates: 3/9 - 4/25/2018	EUT Type: Portable Handset	Page 5 of 16

The Client Device will not resume any transmissions until it has again received control signals from a Master Device.

- c) If a Client Device is performing In-Service Monitoring and detects a Radar Waveform above the DFS Detection Threshold, it will inform the Master Device. This is equivalent to the Master Device detecting the Radar Waveform and d) through f) of section 5.1.1 apply.
- d) Irrespective of Client Device or Master Device detection the Channel Move Time and Channel Closing Transmission Time requirements remain the same.

Channel Move Time and Channel Closing Transmission Time requirements are listed in the following table.

Parameter	Value
Non-occupancy period	Minimum 30 minutes
Channel Availability Check Time	60 seconds
Channel Move Time	10 seconds See Note 1.
Channel Closing Transmission Time	200 milliseconds + an aggregate of 60 milliseconds over remaining 10 second period. See Notes 1 and 2.
U-NII Detection Bandwidth	Minimum 80% of the U-NII 99% transmission power bandwidth. See Note 3.
<p>Note 1: The instant that the Channel Move Time and the Channel Closing Transmission Time begins is as follows:</p> <ul style="list-style-type: none"> • For the Short Pulse Radar Test Signals this instant is the end of the Burst. • For the Frequency Hopping radar Test Signal, this instant is the end of the last radar Burst generated. • For the Long Pulse Radar Test Signal this instant is the end of the 12 second period defining the Radar Waveform. <p>Note 2: The Channel Closing Transmission Time is comprised of 200 milliseconds starting at the beginning of the Channel Move Time plus any additional intermittent control signals required to facilitate a Channel move (an aggregate of 60 milliseconds) during the remainder of the 10 second period. The aggregate duration of control signals will not count quiet periods in between transmissions.</p> <p>Note 3: During the U-NII Detection Bandwidth detection test, radar type 1 is used and for each frequency step the minimum percentage of detection is 90 percent. Measurements are performed with no data traffic.</p>	

Table 3-3: DFS Response Requirements

FCC ID: A3LSMJ337P			MEASUREMENT REPORT (CERTIFICATION)		Approved by: Quality Manager
Test Report S/N: 1M1803090037-07.A3L	Test Dates: 3/9 - 4/25/2018	EUT Type: Portable Handset		Page 6 of 16	

3.3 DFS Detection Threshold Values

The DFS detection thresholds are defined for Master devices and Client Devices with In-service monitoring. These detection thresholds are listed in the following table.

Maximum Transmit Power	Value (See Notes 1 and 2)
≥ 200 milliwatt	-64 dBm
< 200 milliwatt	-62 dBm
Note 1: This is the level at the input of the receiver assuming a 0 dBi receive antenna. Note 2: Throughout these test procedures an additional 1 dB has been added to the amplitude of the test transmission waveforms to account for variations in measurement equipment. This will ensure that the test signal is at or above the detection threshold level to trigger a DFS response.	

Table 3-4: Detection Thresholds for Master Devices and Client Devices with Radar Detection

3.4 Parameters of DFS Test Signals

As the EUT is a Client Device with no Radar Detection only one type radar pulse is required for the testing. Radar Pulse type 1 was used in the evaluation of the Client device for the purpose of measuring the Channel Move Time and the Channel Closing Transmission Time. Table 3-5 lists the parameters for the Short Pulse Radar Waveforms. A plot of the Radar Pulse Type 1 used for testing is included in Section 5.0 of this report.

Radar Type	Pulse Width (µsec)	PRI (µsec)	Number of Pulses	Minimum Percentage of Successful Detection	Minimum Number of Trials
1	1	1428	18	60%	30
2	1-5	150-230	23-29	60%	30
3	6-10	200-500	16-18	60%	30
4	11-20	200-500	12-16	60%	30
Aggregate (Radar Types 1-4)				80%	120

Table 3-5: Parameters for Short Pulse Radar Waveforms

Radar Type	Pulse Width (µsec)	Chirp Width (MHz)	PRI (µsec)	Number of Pulses per Burst	Number of Bursts	Minimum Percentage of Successful Detection	Minimum Number of Trials
5	50 - 100	5 - 20	5 - 20	1 - 3	8 - 20	60%	30

Table 3-6. Parameters for Long Pulse Radar Waveforms

FCC ID: A3LSMJ337P			MEASUREMENT REPORT (CERTIFICATION)		Approved by: Quality Manager
Test Report S/N: 1M1803090037-07.A3L	Test Dates: 3/9 - 4/25/2018	EUT Type: Portable Handset			Page 7 of 16

Radar Type	Pulse Width (µsec)	PRI (µsec)	Pulses per Hop	Hopping Rate (kHz)	Hopping Sequence Length (msec)	Minimum Percentage of Successful Detection	Minimum Number of Trials
6	1	333	9	0.333	300	70%	30

Table 3-7. Parameters for Frequency Hopping Radar Waveforms

3.5 Procedure

KDB 905462 D02 v02 describes a radiated test setup and a conducted test setup. The conducted test setup was used for this testing. Figure 3-1 shows the typical test setup. In Band 2A, one channel selected between 5260 and 5350 MHz is chosen for the testing. In Band 2C, one channel selected between 5500 and 5720 MHz was chosen for testing.

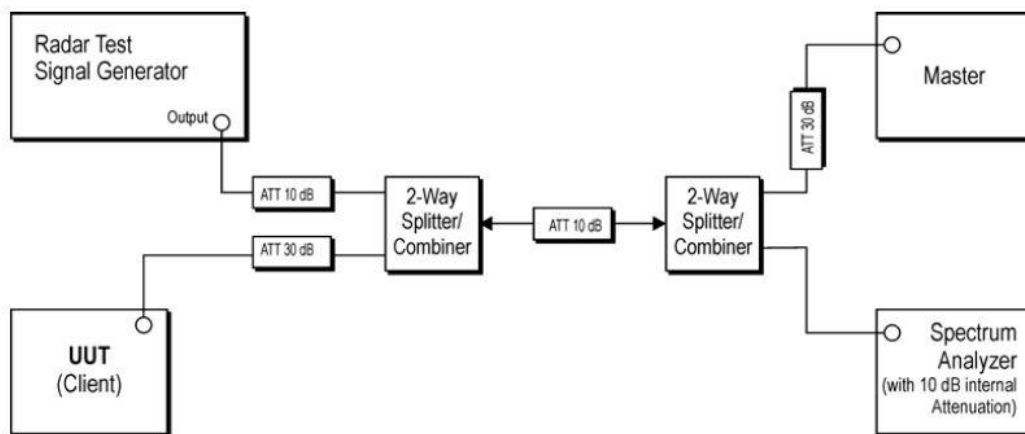

Figure 3-1. Conducted Test Setup for DFS

1. The “Aeroflex PXI DFS Radar Simulator and Analyzer Test Suite” is setup to provide a simulated radar pulse at the frequency that the Master and Client are operating. A Type 0 radar pulse was used.
2. The Client Device (EUT) is set up per the diagram in Figure 3-1 and communications between the Master device and the Client is established.
3. An MPEG or data file that is typical for the device is streamed from the Master to the Client to properly load the network.
4. The “Aeroflex PXI DFS Radar Simulator and Analyzer Test Suite” is set to record and display 12 seconds of time, starting from where the simulated radar is generated. This time domain plot captures any transmissions occurring up to and after 10sec. Aggregate time is computed to ensure compliance. (Note: the channel may be different since the Master and Client have changed channels due to the detection of the initial radar pulse.)
5. After the initial radar burst the channel is monitored for 10 minutes to ensure no transmissions or beacons occur. A second monitoring setup is used to verify that the Master and Client have both moved to different channels.

FCC ID: A3LSMJ337P		MEASUREMENT REPORT (CERTIFICATION)		Approved by: Quality Manager
Test Report S/N: 1M1803090037-07.A3L	Test Dates: 3/9 - 4/25/2018	EUT Type: Portable Handset	Page 8 of 16	

4.0 TEST EQUIPMENT

Test Equipment Calibration is traceable to the National Institute of Standards and Technology (NIST). Measurements antennas used during testing were calibrated in accordance to the requirements of ANSI C63.5-2006.

Manufacturer	Model	Description	Cal Date	Cal Interval	Cal Due	Serial Number
Aeroflex	PXI 82531	PXI RF Synthesizer	9/22/2016	Biennial	9/22/2018	1082329
Agilent	N9038A	MXE EMI Receiver	4/26/2017	Annual	4/26/2018	MY51210133
Agilent	E4448A	PSA (3Hz-50GHz) Spectrum Analyzer	5/5/2017	Annual	5/5/2018	US42510244
Seekonk	NC-100	Torque Wrench 5/16", 8" lbs	1/22/2018	Annual	1/22/2019	N/A

Table 4-1. Annual Test Equipment Calibration Schedule

Note:

For equipment listed above that has a calibration date or calibration due date that falls within the test date range, care was taken to ensure that this equipment was used after the calibration date and before the calibration due date.

4.1 Additional Equipment

The following equipment was used in support of the DFS testing.

Device	Manufacturer	Model/Description	Description	S/N:
Master	Cisco Systems	AIR-CAP2702E-A-K9	Access Point	FTX1834S05B
		AIR-CT2504-K9 V03	Controller	PSZ18381P6K

Table 4-2. Support Equipment

FCC ID: A3LSMJ337P		MEASUREMENT REPORT (CERTIFICATION)			Approved by: Quality Manager
Test Report S/N: 1M1803090037-07.A3L	Test Dates: 3/9 - 4/25/2018	EUT Type: Portable Handset		Page 9 of 16	

5.0 TEST RESULTS

Channel Loading Notes:

Per KDB 905462 D02 v02, timing plots are required with calculations demonstrating a minimum channel loading of approximately 17% or greater. For example, you can zero span the spectrum analyzer and approximate the transmission time.

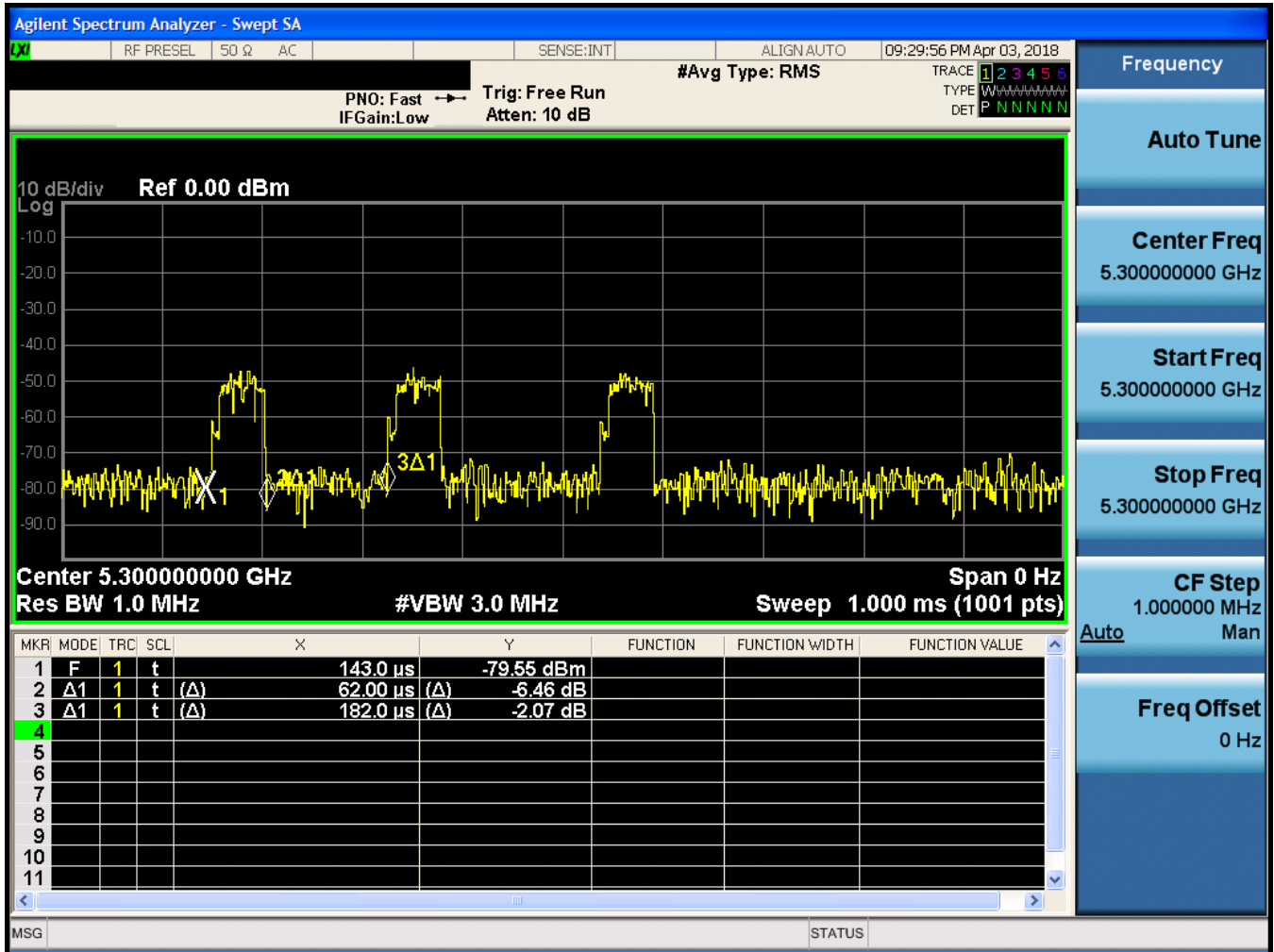

Figure 5-1. Band 2A Pulse Width and Period

$$\text{Channel Loading} = \text{Pulse Width} / \text{Period} = 62 \mu\text{s} / 182 \mu\text{s} = 34.07 \%$$

FCC ID: A3LSMJ337P	MEASUREMENT REPORT (CERTIFICATION)		Approved by: Quality Manager
Test Report S/N: 1M1803090037-07.A3L	Test Dates: 3/9 - 4/25/2018	EUT Type: Portable Handset	Page 10 of 16

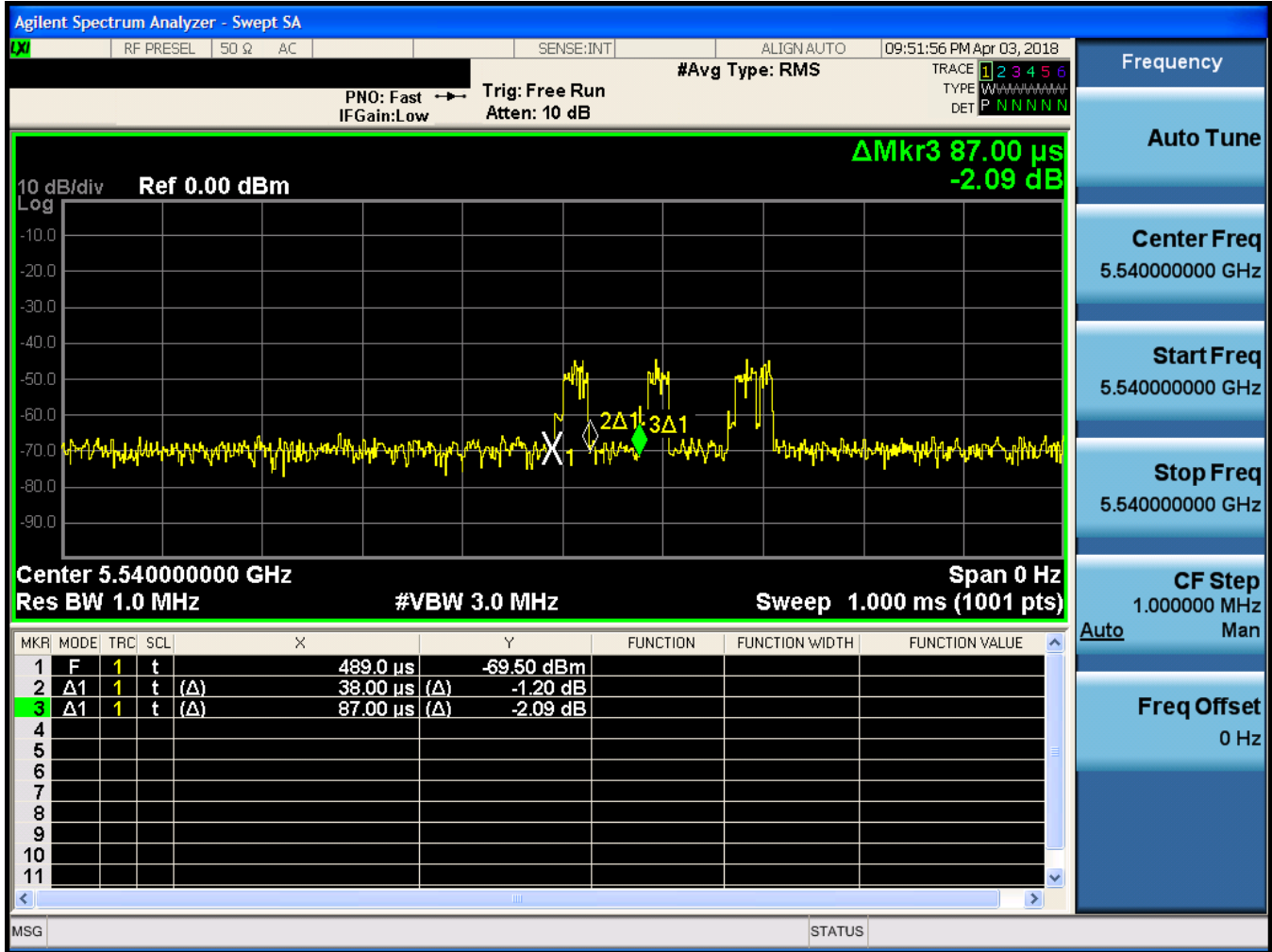

Figure 5-2. Band 2C Pulse Width and Period

Channel Loading = Pulse Width / Period = 38 μ s / 87 μ s = 39.08 %

FCC ID: A3LSMJ337P		MEASUREMENT REPORT (CERTIFICATION)		Approved by: Quality Manager
Test Report S/N: 1M1803090037-07.A3L	Test Dates: 3/9 - 4/25/2018	EUT Type: Portable Handset		Page 11 of 16

Move Time and Aggregate Time Notes:

1. Trigger Threshold was configured to only capture client pulses. The pulses shown in the plots below have been determined to be from the Master AP.
2. Marker Info and Aggregate time results are shown on the right side of the plots below.

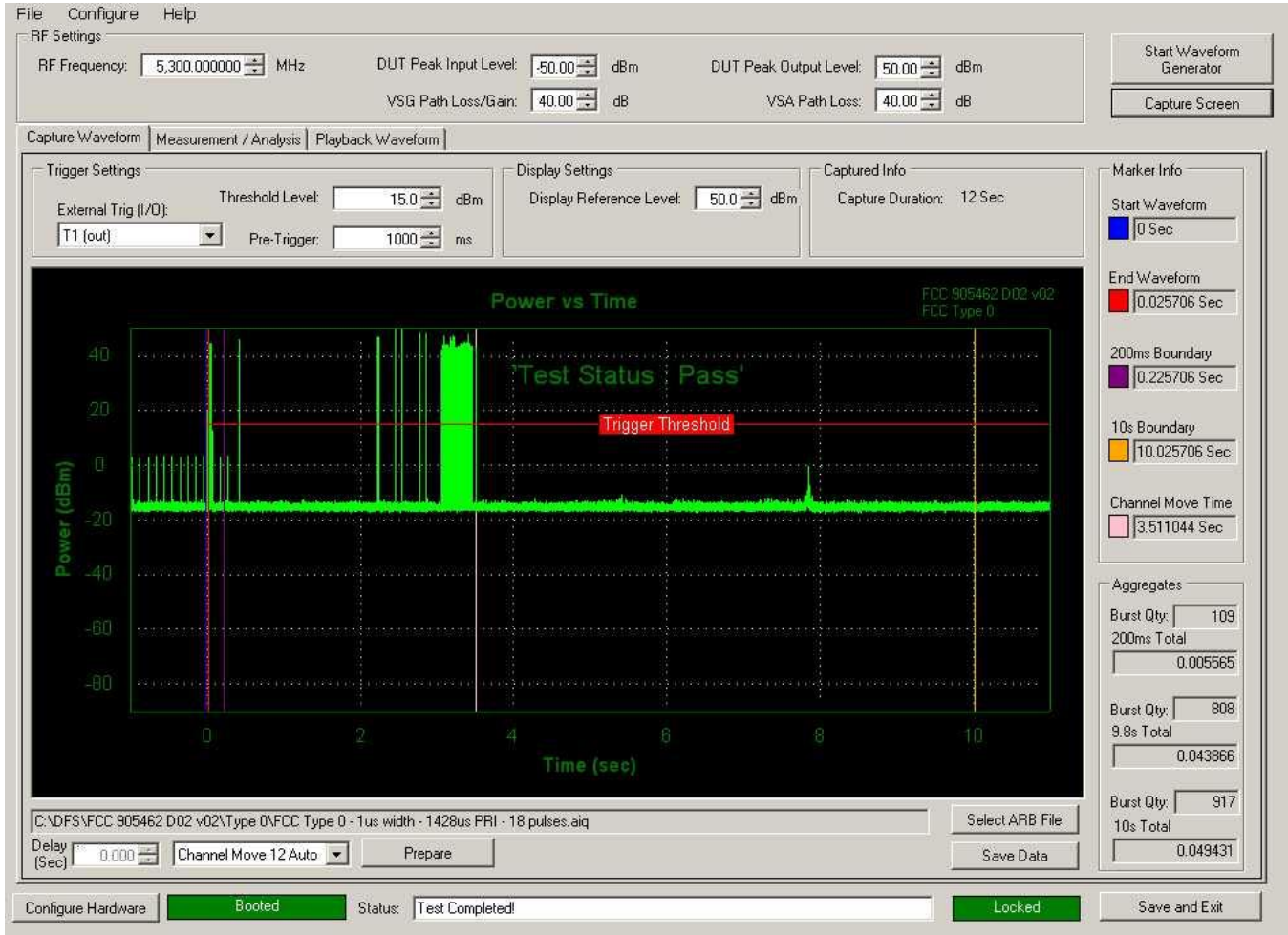

Figure 5-3. Band 2A Move Time and Aggregate Time

FCC ID: A3LSMJ337P	MEASUREMENT REPORT (CERTIFICATION)		Approved by: Quality Manager
Test Report S/N: 1M1803090037-07.A3L	Test Dates: 3/9 - 4/25/2018	EUT Type: Portable Handset	Page 12 of 16

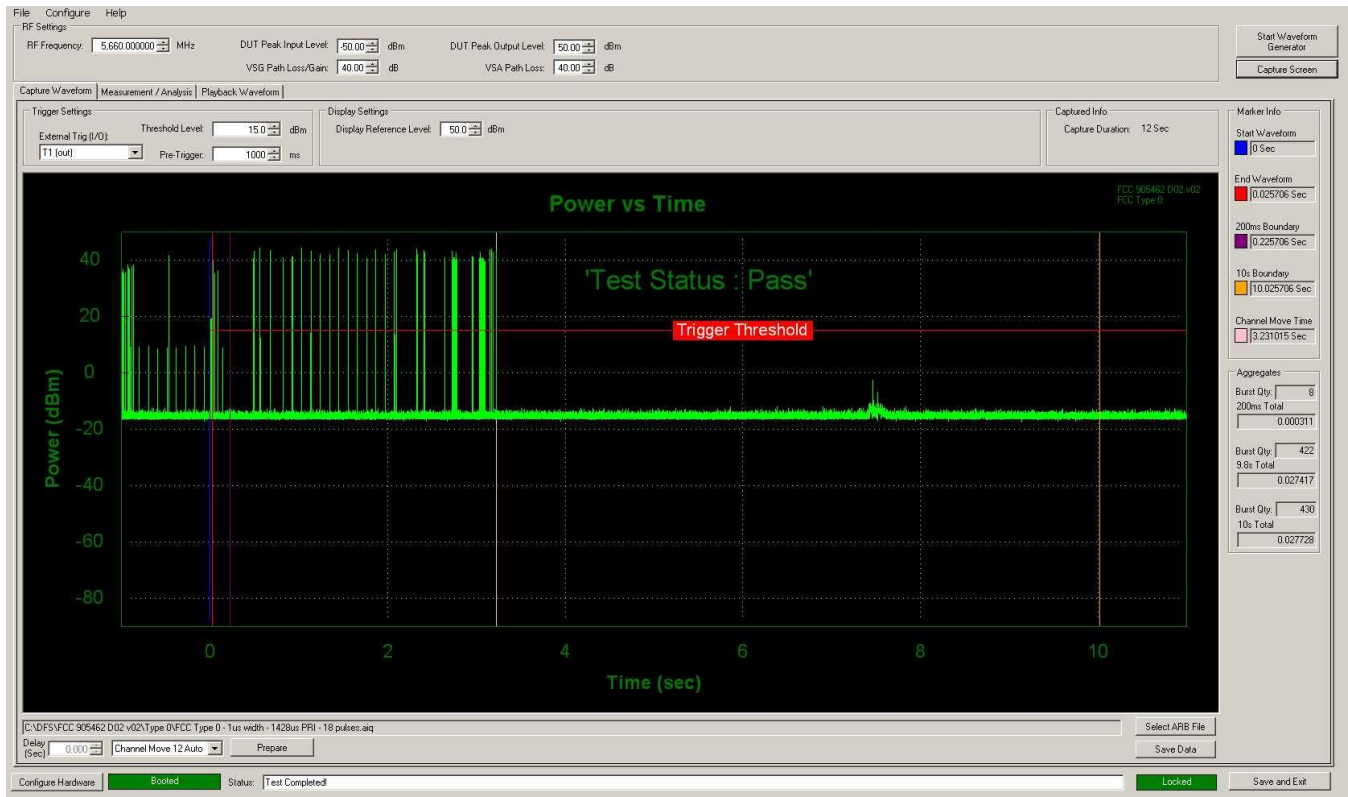

Figure 5-4. Band 2C Move Time and Aggregate Time

FCC ID: A3LSMJ337P	 MEASUREMENT REPORT (CERTIFICATION) 		Approved by: Quality Manager
Test Report S/N: 1M1803090037-07.A3L	Test Dates: 3/9 - 4/25/2018	EUT Type: Portable Handset	Page 13 of 16

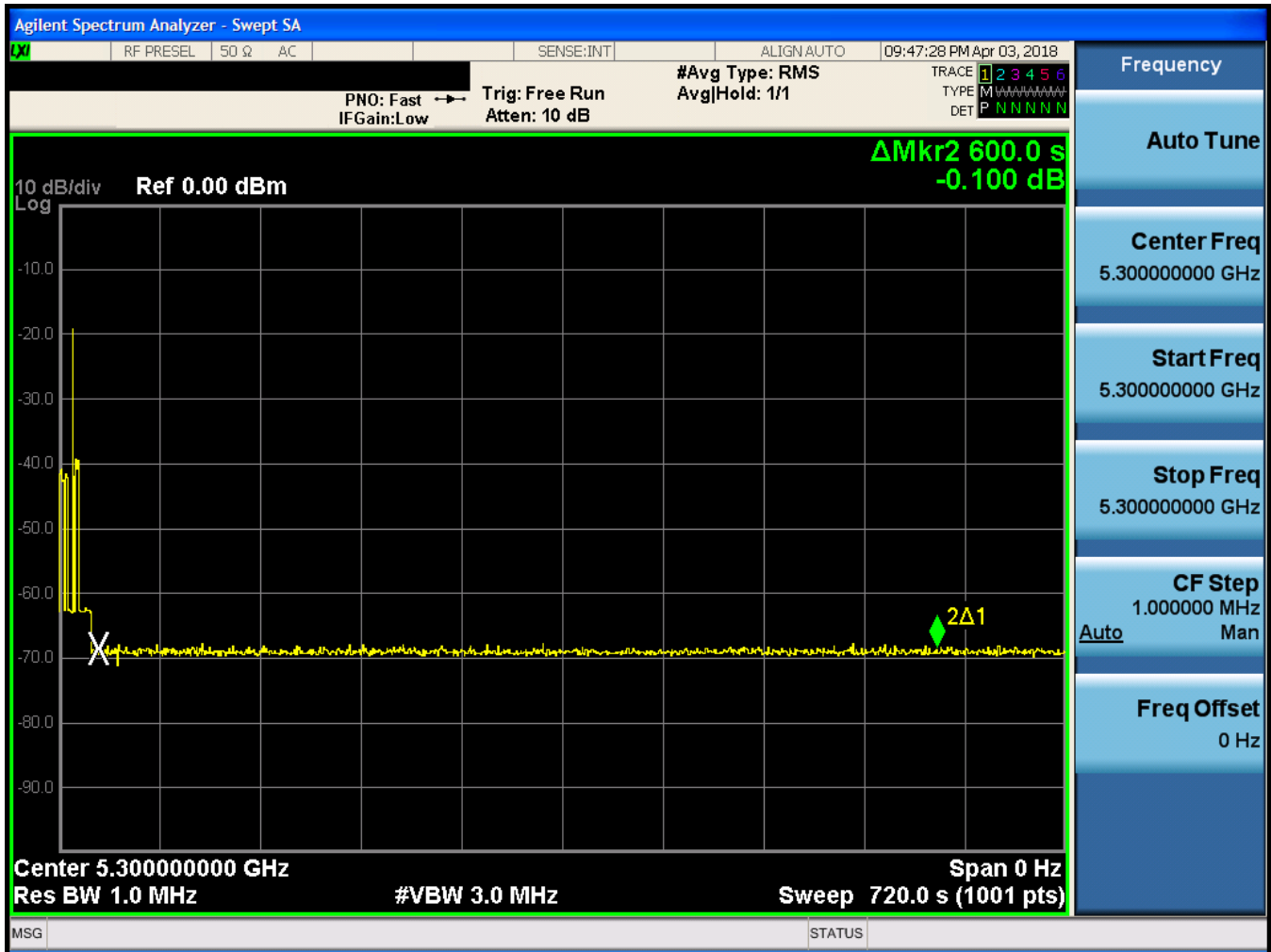

Figure 5-5. Band 2A Client Beacon Test – Monitoring live spectrum – Elapse time 10 minutes

FCC ID: A3LSMJ337P	PCTEST ENGINEERING LABORATORY, INC.		MEASUREMENT REPORT (CERTIFICATION)		Approved by: Quality Manager
Test Report S/N: 1M1803090037-07.A3L	Test Dates: 3/9 - 4/25/2018	EUT Type: Portable Handset			Page 14 of 16

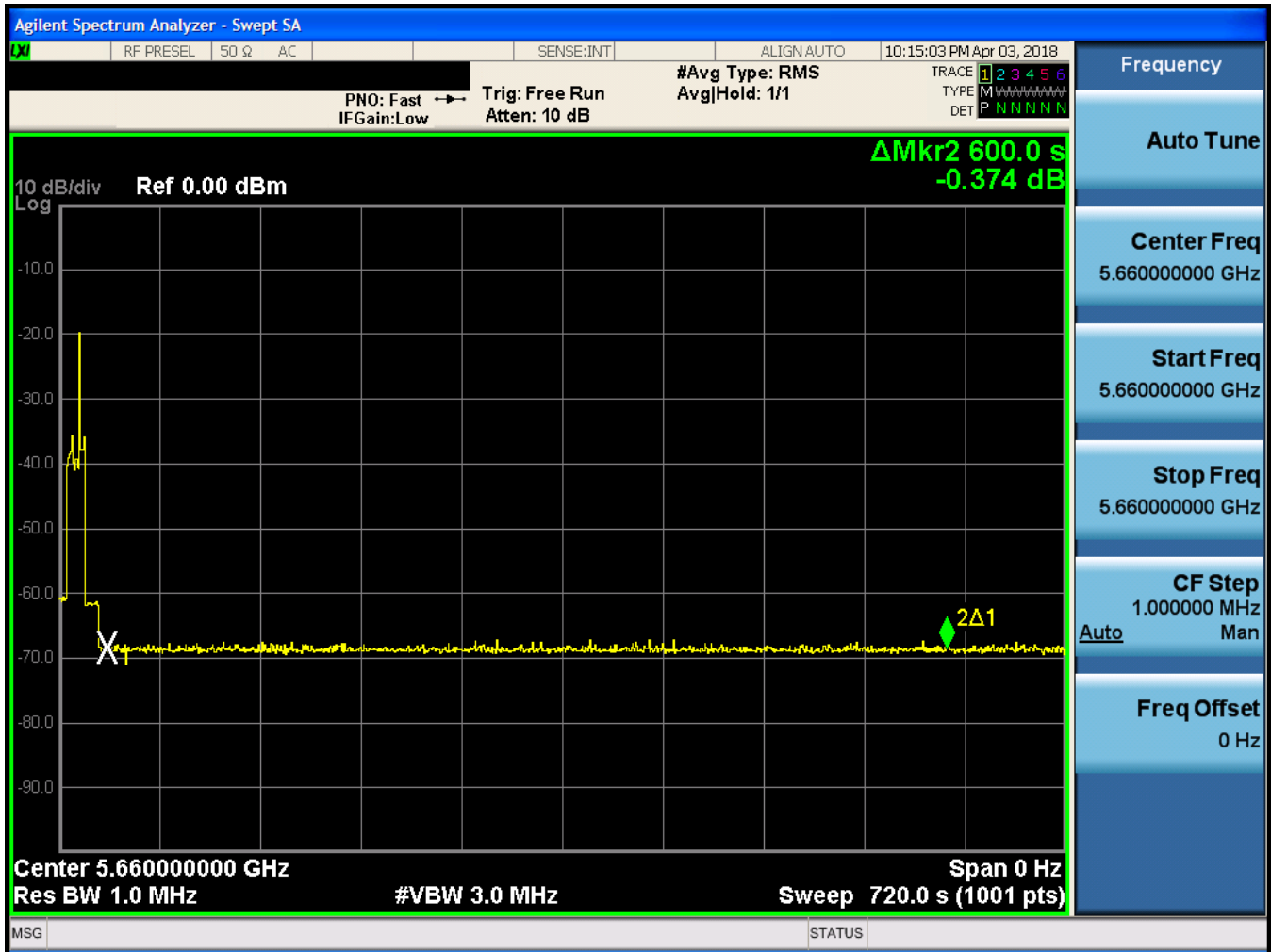

Figure 5-6. Band 2C Client Beacon Test – Monitoring live spectrum – Elapse time 10 minutes

FCC ID: A3LSMJ337P		MEASUREMENT REPORT (CERTIFICATION)		Approved by: Quality Manager
Test Report S/N: 1M1803090037-07.A3L	Test Dates: 3/9 - 4/25/2018	EUT Type: Portable Handset		Page 15 of 16

6.0 CONCLUSION

The data collected relate only to the item(s) tested and show that the **Samsung Portable Handset FCC ID: A3LSMJ337P** is in compliance with the DFS requirements for a Client Device without radar detection in accordance with Part 15.407 of the FCC Rules.

FCC ID: A3LSMJ337P		MEASUREMENT REPORT (CERTIFICATION)		Approved by: Quality Manager
Test Report S/N: 1M1803090037-07.A3L	Test Dates: 3/9 - 4/25/2018	EUT Type: Portable Handset	Page 16 of 16	