



Issue Date:

129 Samsung-ro,
Yeongtong-gu, Suwon-Si,
Gyeonggi-Do, 16677
Korea
Tel: 82-31-8062-4341
Fax: 82-31-279-9985

FCC TEST REPORT

Manufacturer: SAMSUNG Electronics Co., Ltd.

Model: SM-J320F/DS, SM-J320F, SM-J320G/DS

FCC ID: A3LSMJ320F

Application Type: Certification

EUT Type: Portable Handset

All measurements reported here are in accordance with FCC Rules,
47CFR Part2 and Part22.

Prepared By Date
DH Ju
T est Engineer

Checked By Date
Jooha Bek
Deputy Technical Manager

Authorized By Date
YG Choi
Technical Manager



Revision History

| Rev. # | Issue Date | Revisions | Revised By |
|--------|------------|--|------------|
| 1 | 2015.12.29 | <ul style="list-style-type: none">▪ Initial issue | DH Ju |
| 1/2 | | <ul style="list-style-type: none">▪ Revised model name▪ Revised device capabilities on page 5 | DH Ju |

– End of this page –



Table of Contents

| | |
|---|-----------|
| §2.1033 General Information | 4 |
| 1. INTRODUCTION | 5 |
| 1.1. General..... | 5 |
| 2. PRODUCT INFORMATION | 5 |
| 2.1. Equipment Description..... | 5 |
| 2.2. Device Capabilities..... | 5 |
| 3. DESCRIPTION OF TESTS | 6 |
| 3.1. Evaluation Procedure..... | 6 |
| 3.2. Measurement Procedure for Radiated Power and Radiated Spurious Emissions . | 6 |
| 3.3. EMI Suppression Device(s)/Modifications..... | 6 |
| 4. TEST EQUIPMENT LIST | 7 |
| 5. SAMPLE CALCULATIONS | 8 |
| 6. TEST RESULTS | 9 |
| 6.1. Summary..... | 9 |
| 6.2. Occupied Bandwidth..... | 10 |
| 6.3. Spurious and Harmonic Emissions at Antenna Terminal..... | 15 |
| 6.4. Band Edge Emissions at Antenna Terminal..... | 23 |
| 6.5. Frequency Stability / Temperature Variation..... | 33 |
| 6.6. Radiated Power (ERP)..... | 36 |
| 6.7. Radiated Spurious Emissions Measurements..... | 39 |
| 7. CONCLUSION | 43 |



Issue Date:

§2.1033 General Information

APPLICANT: Samsung Electronics Co., Ltd.

APPLICANT ADDRESS: 129 Samsung-ro,
Yeongtong-gu, Suwon-si, Gyeonggi-do, 16677, Korea

TEST SITE: Samsung Electronics Co., Ltd.

TEST SITE ADDRESS: 129 Samsung-ro,
Yeongtong-gu, Suwon-si, Gyeonggi-do, 16677, Korea

FCC RULE PART(S): §2, §22

TEST PROCEDURE(S): ANSI/TIA-603-D-2010, KDB971168 v02r02

BASE MODEL: SM-J320F/DS

MULTI MODEL: SM-J320F, SM-J320G/DS

FCC ID: A3LSMJ320F

FCC CLASSIFICATION: PCS Licensed Transmitter Held to Ear (PCE)

MODE: LTE

EMISSION DESIGNATOR: See Table 0-1

TX FREQUENCY BLOCK 824 – 849MHz (LTE Band 5)

RX FREQUENCY BLOCK 869 – 894MHz (LTE Band 5)

MAX POWER RATING: 0.099 W ERP LTE Band 5 (19.96 dBm)

TEST DEVICE SERIAL NO.: FCM-044-A , FCM-044-B

DATE(S) OF TEST: December 07 – 18 , 2015

| Mode | Tx Frequency (MHz) | Emission Designator | Modulation | ERP | |
|------------|--------------------|---------------------|------------|-------------------|------------------|
| | | | | Max. Power (Watt) | Max. Power (dBm) |
| LTE Band 5 | 824.7 – 848.3 | 1M10G7D | QPSK | 0.095 | 19.79 |
| LTE Band 5 | 824.7 – 848.3 | 1M09W7D | 16QAM | 0.081 | 19.08 |
| LTE Band 5 | 825.5 – 847.5 | 2M69G7D | QPSK | 0.099 | 19.96 |
| LTE Band 5 | 825.5 – 847.5 | 2M69W7D | 16QAM | 0.087 | 19.38 |
| LTE Band 5 | 826.5 – 846.5 | 4M51G7D | QPSK | 0.096 | 19.84 |
| LTE Band 5 | 826.5 – 846.5 | 4M50W7D | 16QAM | 0.082 | 19.16 |
| LTE Band 5 | 829 - 844 | 8M97G7D | QPSK | 0.088 | 19.43 |
| LTE Band 5 | 829 - 844 | 8M97W7D | 16QAM | 0.087 | 19.37 |

Table 0-1. Emission Designator



1. INTRODUCTION

1.1. General

These measurement tests were conducted at SAMSUNG ELECTRONICS CO., LTD. (SUWON). The site address is 129 Samsung-ro, Yeongtong-gu, Suwon-si, Gyeonggi-do, 16677, Korea.

2. PRODUCT INFORMATION

2.1. Equipment Description

The Equipment Under Test (EUT) is the Samsung Portable Handset FCC ID: A3LSMJ320F. The test data contained in this report pertains only to the emissions due to the EUT's LTE function.

2.2. Device Capabilities

This device contains the following capabilities:

850/1900 GSM/GPRS/EDGE, 850/1900 WCDMA/HSPA, LTE Band 5, 802.11 b/g/n WLAN, Bluetooth (1x, EDR, LE).

– End of this page –



3. DESCRIPTION OF TESTS

3.1. Evaluation Procedure

The measurement procedures described in the document titled "Land Mobile FM or PM - Communications Equipment- Measurements and Performance Standards" (ANSI/TIA-603-D-2010) and "Procedures for Compliance Measurement of the Fundamental Emission Power of Licensed Wideband (> 1MHz) Digital Transmission System" (KDB 971168) were used in the measurement of the Samsung Portable Handset FCC ID: A3LSMJ320F.

3.2. Measurement Procedure for Radiated Power and Radiated Spurious Emissions

The radiated and spurious measurements were made at the full anechoic chamber. The equipment under test was placed on the Turn Device at the same height and a distance of 3-meters from the measuring antenna.

The turn device is designed for mobile device measurements. Different sized devices can be mounted on the mounting bracket made of Rohacell.

The turn device is mounted onto a turn table to have both 360° vertical and horizontal rotation. The measurement was made for each horizontal/vertical position in combination with horizontally and vertically polarized measuring antenna at Fully-anechoic chamber, it is equivalent to test in 3-orthogonal planes.

The substitution antenna will replace the EUT antenna at the same position. The frequency of the signal generator shall be set to the frequencies that were measured on the EUT. The output level of the signal generator shall be adjusted until an equal or a known related level that was measured from the EUT. This level was recorded. For emissions above 1 GHz, the above procedure is repeated by using horn antennas and dBi gain is taken into consideration.

The power of the emission is calculated using the following formula:

$$P_{d[\text{dBm}]} = P_{g[\text{dBm}]} - \text{cable loss}_{[\text{dB}]} + \text{antenna gain}_{[\text{dBd,dBi}]}$$

Where P_d is the dipole equivalent power, P_g is the generator output into the substitution antenna, and the antenna gain is the gain of the substitute antenna used relative to either a half-wave dipole(dBd) or an isotropic source(dBi). The cable connects the generator to the substitute antenna.

Radiated power levels and radiated spurious emissions levels are investigated per ANSI/TIA-603-D-2010.

3.3. EMI Suppression Device(s)/Modifications

No EMI suppression device(s) were added and no modifications were made during testing.



4. TEST EQUIPMENT LIST

The measuring equipment, which was utilized in performing the tests documented herein, has been calibrated in accordance with the manufacturer's recommendations for utilizing calibration equipment, which is traceable to recognized national standards.

| Description | Model | Serial No. | Manufacturer | Cal. Date | Cal. Due |
|---------------------------------------|------------------|------------|--------------|------------|------------|
| Wideband Radio Communication Tester | CMW500 | 140748 | R&S | 2015-10-28 | 2016-10-28 |
| Wideband Radio Communication Tester | CMW500 | 140697 | R&S | 2015-11-04 | 2016-11-04 |
| Signal & Spectrum Analyzer | FSW | 103775 | R&S | 2015-12-16 | 2016-12-16 |
| PXA Signal Analyzer | N9030A | MY52350977 | Agilent | 2015-10-20 | 2016-10-20 |
| PSG Analog Signal Generator | E8257D | MY51501209 | Agilent | 2015-11-04 | 2016-11-04 |
| EPM Series Power Meter | E4419B | GB41293846 | Agilent | 2015-09-22 | 2016-09-22 |
| POWER SENSOR | E9300H | MY41495838 | Agilent | 2015-09-18 | 2016-09-18 |
| DC Power Supply | E3642A | MY40022438 | Agilent | 2015-02-23 | 2016-02-23 |
| Temperature Humidity Chamber | SH-641 | 92009178 | Espec | 2015-03-19 | 2016-03-19 |
| Loop Antenna | HFH2-Z2 | 100276 | R&S | 2014-05-19 | 2016-05-19 |
| DIPOLE ANTENNA | UHA 9105 | 9105-2412 | Schwarzbeck | 2015-09-08 | 2017-09-08 |
| LOG PERIODIC DIPOLE ANTENNA | HL040 | 353255/020 | R&S | 2014-10-15 | 2016-10-15 |
| HORN Antenna | 3115 | 00156307 | ETS LINDGREN | 2015-05-07 | 2017-05-07 |
| HORN Antenna | 3115 | 00156245 | ETS LINDGREN | 2015-05-07 | 2017-05-07 |
| HORN Antenna & Pre-amplifier assembly | HAP18-26N | 216250 | Flann | 2014-01-09 | 2016-01-09 |
| HORN Antenna & Pre-amplifier assembly | HAP18-26N | 216251 | Flann | 2015-04-30 | 2017-04-30 |
| PRE-AMPLIFIER | 8449B | 3008A00691 | Agilent | 2015-11-25 | 2016-11-25 |
| RF Power Amplifier | 5S1G4 | 304866 | AR | 2015-02-09 | 2016-02-09 |
| Hygrothermograph Data Logger | SK-L200TH2a | 5077 | SATO | 2015-11-06 | 2016-11-06 |
| Hygrothermograph Data Logger | SK-L200TH2a | 5095 | SATO | 2015-10-26 | 2016-10-26 |
| Hygrothermograph Data Logger | SK-L200TH2a | 5110 | SATO | 2015-10-26 | 2016-10-26 |
| Power Divider | 11636B | 58456 | Agilent | 2015-04-27 | 2016-04-27 |
| Highpass Filter | WHVX1.0/15G-10SS | 39 | Wainwright | 2015-01-07 | 2016-01-07 |

Table 4-1. Test Equipment

Note

1. For equipment listed above that has calibration dates that falls within the test date range, care was taken to ensure that this equipment was used after the calibration date and before the calibration due date.



5. SAMPLE CALCULATIONS

5.1. QPSK Modulation

Emission Designator = 8M62G7D

LTE BW = 8.62 MHz

G = Phase Modulation

7 = Quantized/Digital Info

D = Data transmission

5.2. 16QAM Modulation

Emission Designator = 8M45W7D

LTE BW = 8.45 MHz

W = Amplitude/Angle Modulation

7 = Quantized/Digital Info

D = Data transmission

5.3. Spurious Radiated Emission

Example: Spurious emission at 3700.40MHz

The receive spectrum analyzer reading at 3 meters with the EUT on the turn device was -81.0dBm. The gain of the substituted antenna is 8.1dBi. The signal generator connected to the substituted antenna terminals is adjusted to produce a reading of -81.0dBm on the spectrum analyzer. The loss of the cable between the signal generator and the terminals of the substituted antenna is 2.0dB at 3700.40MHz. So 6.1dB is added to the signal generator reading of -30.9dBm yielding -24.80dBm. The fundamental EIRP was 25.50dBm so this harmonic was $25.50\text{dBm} - (-24.80) = 50.3\text{dBc}$.



6. TEST RESULTS

6.1. Summary

| FCC Part Section(s) | Test Description | Test Limit | Test Condition | Test Result | Reference |
|-----------------------|--|---|----------------|-------------|-------------------|
| TRANSMITTER MODE (TX) | | | | | |
| 2.1049 | Occupied Bandwidth | N/A | CONDUCTED | PASS | Section 6.2 |
| 2.1051 22.917(a) | Conducted Band Edge / Spurious Emissions | $> 43 + 10 \log_{10}(P[\text{Watts}])$ at Band Edge and for all out-of-band emissions | | PASS | Sections 6.3, 6.4 |
| 2.1046 | Transmitter Conducted Output Power | N/A | | PASS | See SAR Report |
| 2.1055 22.355 | Frequency Stability | < 2.5 ppm | | PASS | Section 6.5 |
| 22.913(a.2) | Effective Radiated Power | < 7 Watts max. ERP | RADIATED | PASS | Section 6.6 |
| 2.1053 22.917(a) | Radiated Spurious Emissions | $> 43 + 10 \log_{10}(P[\text{Watts}])$ for all out-of-band emissions | | PASS | Section 6.7 |

Table 6-1. Summary of Test Results

Notes

1. All modes of operation and data rates were investigated. The test results shown in the following sections represent the worst case emissions.
2. The analyzer plots shown in this section were all taken with a correction value loaded into the analyzer. The correction value was used to account for the losses of the cables, couplers, and attenuators used as part of the system to connect the EUT to the analyzer at all frequencies of interest.
3. All antenna port conducted emissions testing was performed on a test bench with the antenna port of the EUT connected to the spectrum analyzer through calibrated cables and couplers.
4. For conducted spurious emissions, automated test software was used to measure emissions and capture the corresponding plots necessary to show compliance. The measurement software utilized is Rohde & Schwarz and SAMSUNG Electronics "CMWrun", Version 1.8.1.

6.2. Occupied Bandwidth §2.1049

Test Overview

The Occupied bandwidth, that is the frequency bandwidth such that, below its lower and above its upper frequency limits, the mean powers radiated are each equal to 0.5 percent of the total mean power radiated by a given emission shall be measured. All modes of operation were investigated and the worst case configuration results are reported in this section.

Test Procedure Used

KDB 971168 v02r02 – Section 4.2

Test Settings

1. The signal analyzer's automatic bandwidth measurement capability was used to perform the 99% Occupied bandwidth. The bandwidth measurement was not influenced by any intermediate power nulls in the fundamental emission.
2. RBW = 1~5% of the expected OBW
3. VBW $\geq 3 \times$ RBW
4. Detector = Peak
5. Trace mode = max hold
6. Sweep = auto couple
7. The trace was allowed to stabilize
8. If necessary, steps 2~7 were repeated after changing the RBW such that it would be within 1~5% of the 99% occupied bandwidth observed in Step 7

Test Setup

The EUT and measurement equipment were set up as shown in the diagram below.

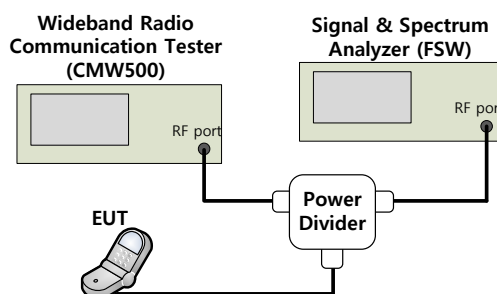
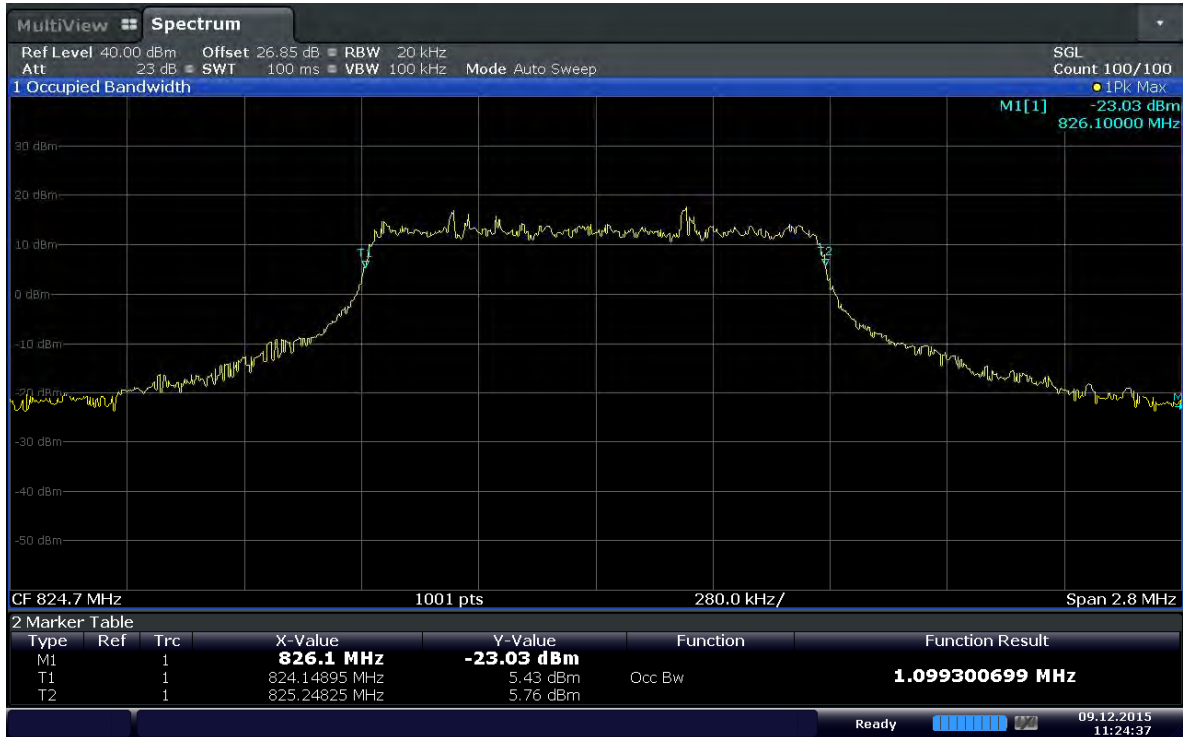

Figure 6-1. Test Instruments & Measurement Setup



Test Plots



Date: 9.DEC.2015 11:24:37

Plot 6-1. Occupied Bandwidth Plot (Band 5 – 1.4MHz QPSK - RB Size 6)

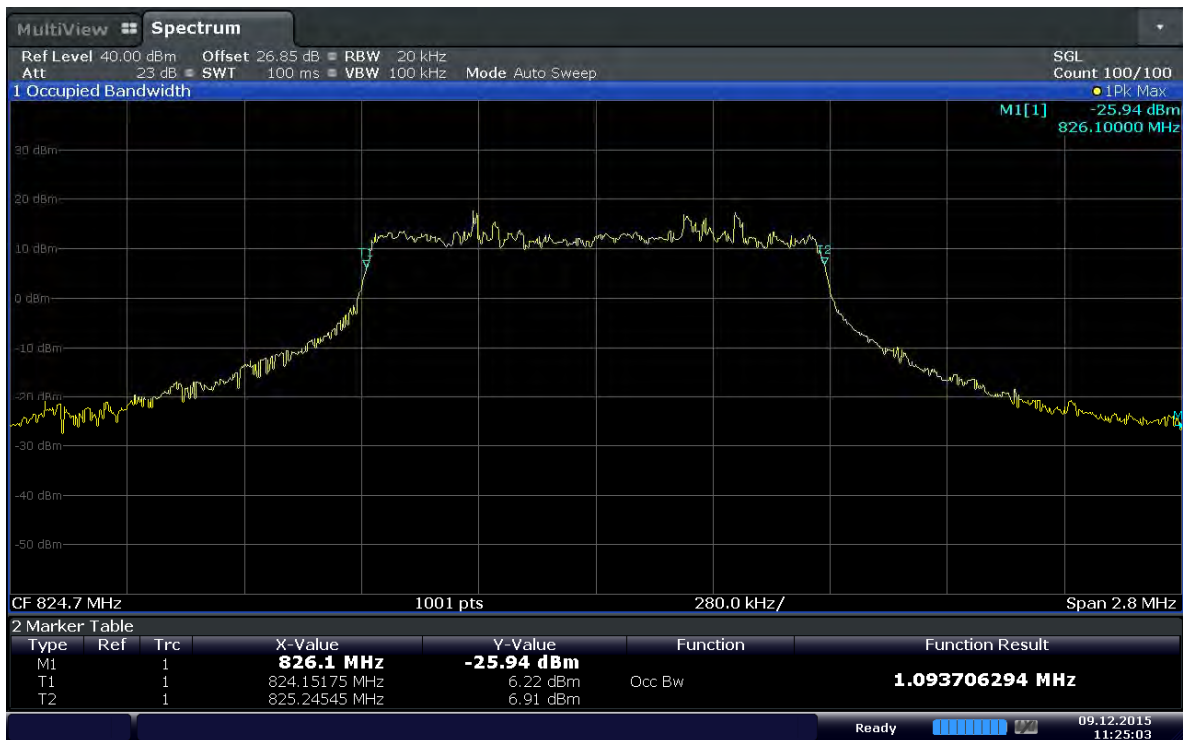

Date: 9.DEC.2015 11:25:04

Plot 6-2. Occupied Bandwidth Plot (Band 5 – 1.4MHz 16QAM - RB Size 6)

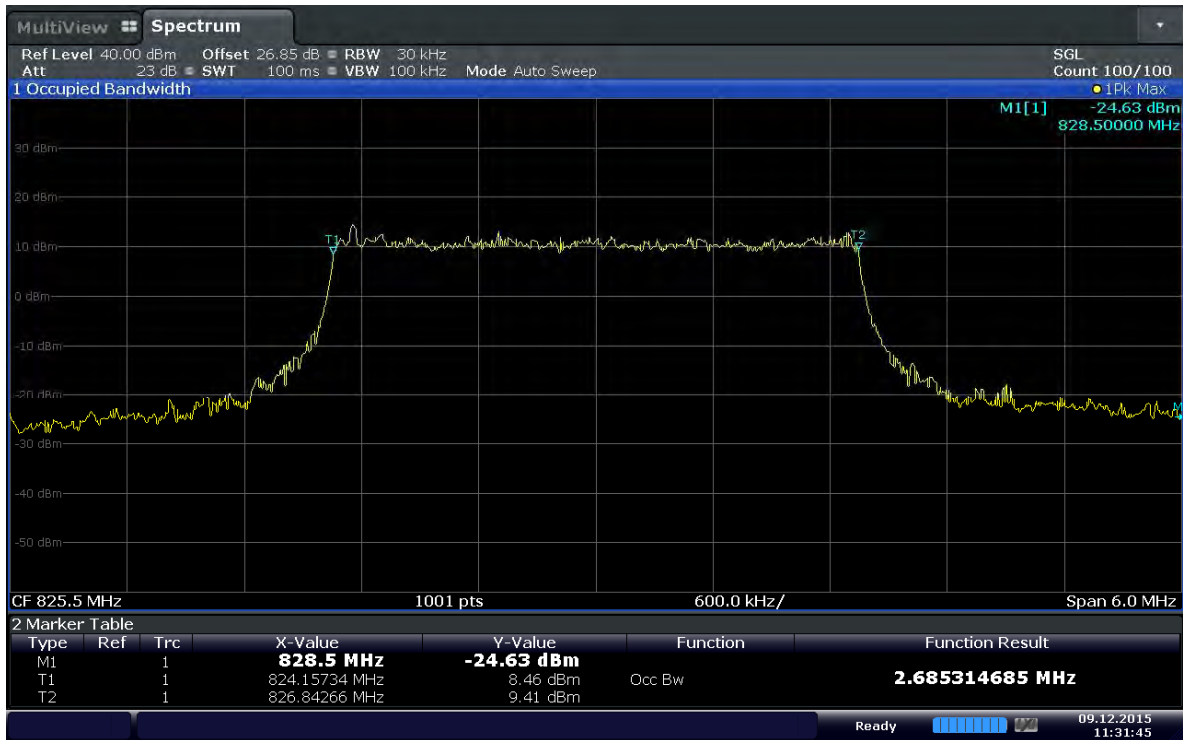

Date: 9.DEC.2015 11:31:45

Plot 6-3. Occupied Bandwidth Plot (Band 5 - 3.0MHz QPSK - RB Size 15)

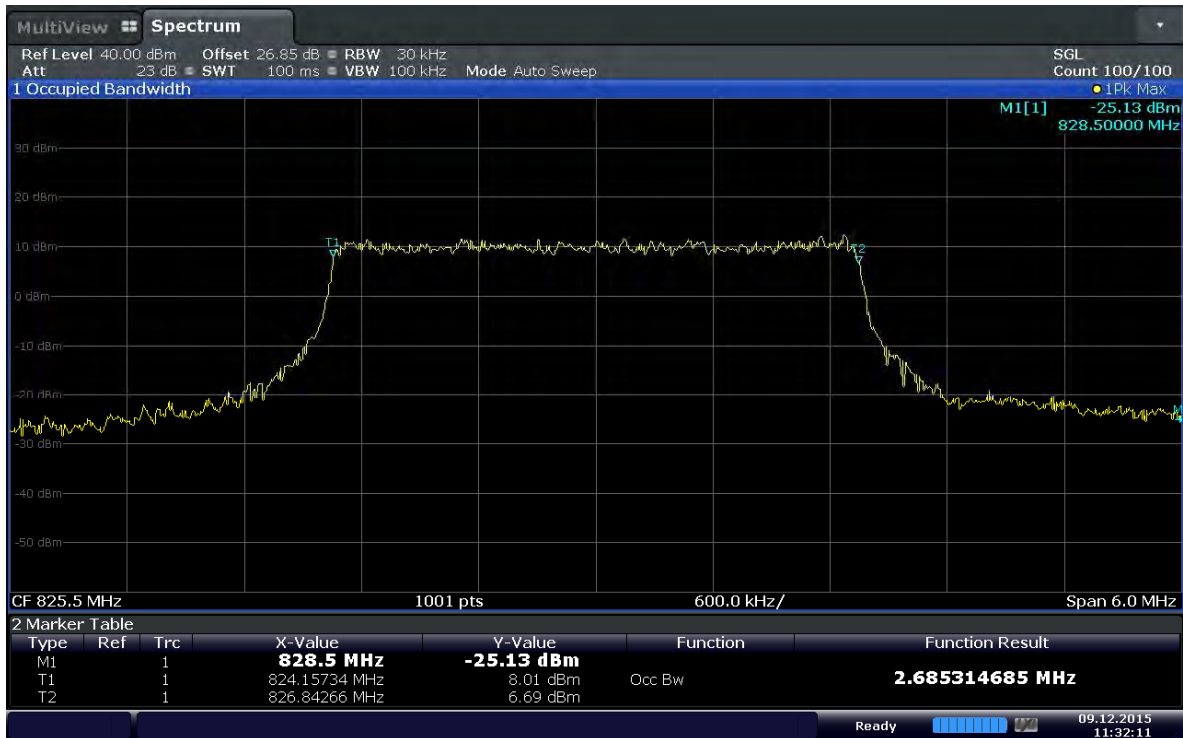

Date: 9.DEC.2015 11:32:12

Plot 6-4. Occupied Bandwidth Plot (Band 5 - 3.0MHz 16QAM - RB Size 15)



Issue Date:

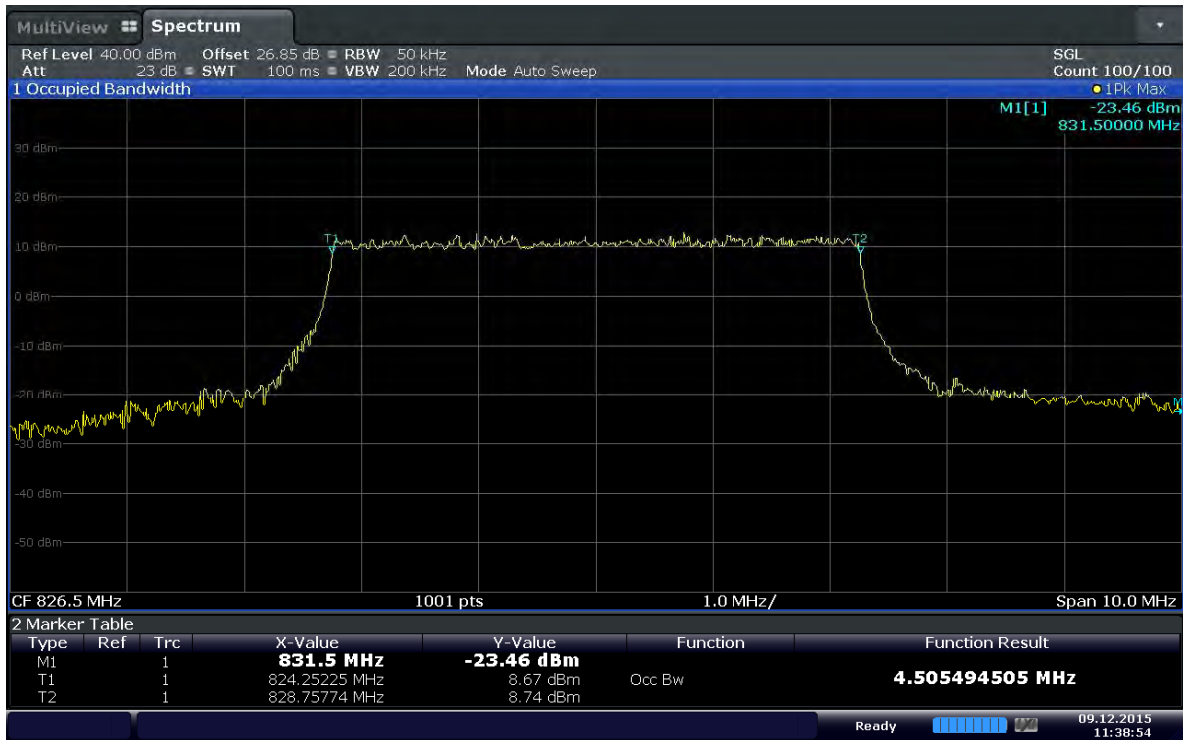

Date: 9.DEC.2015 11:38:54

Plot 6-5. Occupied Bandwidth Plot (Band 5 - 5.0MHz QPSK - RB Size 25)

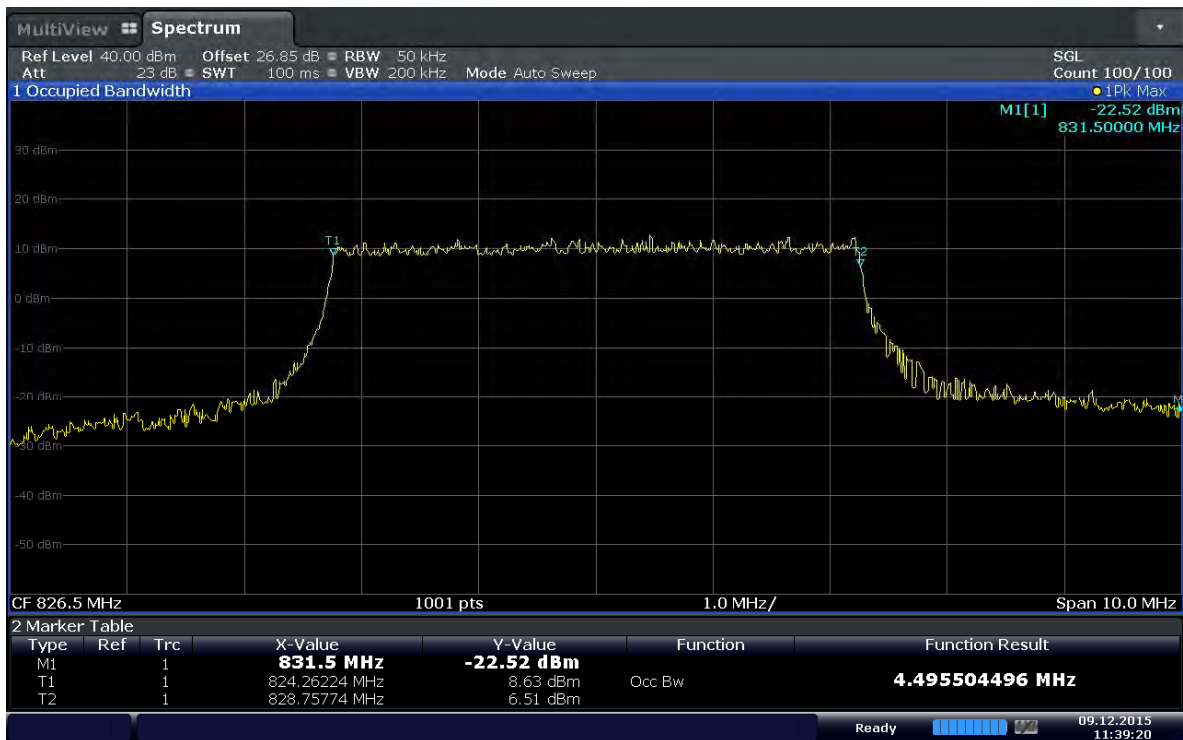

Date: 9.DEC.2015 11:39:20

Plot 6-6. Occupied Bandwidth Plot (Band 5 - 5.0MHz 16QAM - RB Size 25)



Issue Date:

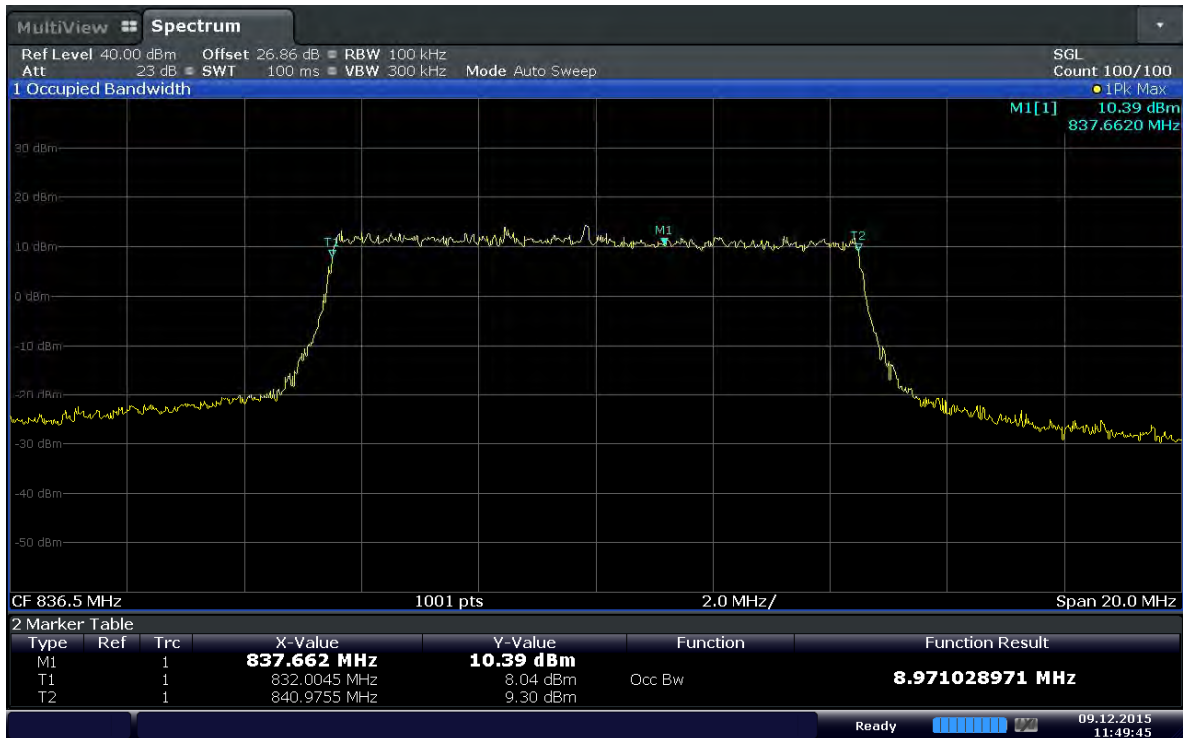

Date: 9.DEC.2015 11:49:45

Plot 6-7. Occupied Bandwidth Plot (Band 5 - 10.0MHz QPSK - RB Size 50)



Date: 9.DEC.2015 11:52:38

Plot 6-8. Occupied Bandwidth Plot (Band 5 - 10.0MHz 16QAM - RB Size 50)



6.3. Spurious and Harmonic Emissions at Antenna Terminal §2.1051 §22.917(a)

Test Overview

The level of the carrier and the various conducted spurious and harmonic frequencies is measured by means of a calibrated spectrum analyzer. The spectrum is scanned from the lowest frequency generated in the equipment up to a frequency including its 10th harmonic. All out of band emissions are measured with a spectrum analyzer connected to the antenna terminal of the EUT while the EUT is operating at maximum power, and at the appropriate frequencies. All data rates were investigated to determine the worst case configuration. All modes of operation were investigated and the worst case configuration results are reported in this section.

The minimum permissible attenuation level of any spurious emission is $43 + 10\log_{10}(P_{\text{Watts}})$, where P is the transmitter power in Watts. Limit equivalent to -13dBm, calculation shown below.

$$\begin{aligned}43 + 10\log_{10}(1.567\text{W}) &= 44.95 \text{ dB} \\1.567\text{W} &= 31.95 \text{ dBm} \\31.95 \text{ dBm} - 44.95 \text{ dB} &= -13 \text{ dBm}\end{aligned}$$

Test Procedure Used

KDB 971168 v02r02 – Section 6.0

Test Settings

1. Start frequency was set to 30MHz and stop frequency was set to 10GHz (separated into at least two plots per channel)
2. RBW \geq 100kHz
3. VBW \geq 3 x RBW
4. Detector = RMS
5. Trace mode = max hold
6. Sweep time = auto couple
7. The trace was allowed to stabilize

Test Setup

The EUT and measurement equipment were set up as shown in the diagram below.

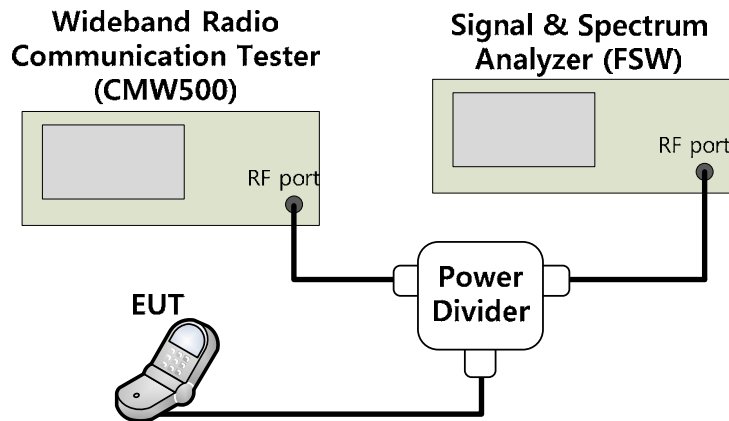

Figure 6-2. Test Instruments & Measurement Setup

Test Note

1. Compliance with the applicable limits is based on the use of measurement instrumentation employing a resolution bandwidth of 100kHz or greater for cellular equipment whose frequencies are less than 1GHz. However, in the 1MHz bands immediately outside and adjacent to the frequency block a resolution bandwidth of at least one percent of the emission bandwidth of the fundamental emission of the transmitter may be employed. The emission bandwidth is defined as the width of the signal between two points, one below the carrier center frequency and one above the carrier center frequency, outside of which all emissions are attenuated at least 26dB below the transmitter power.



Test Plots

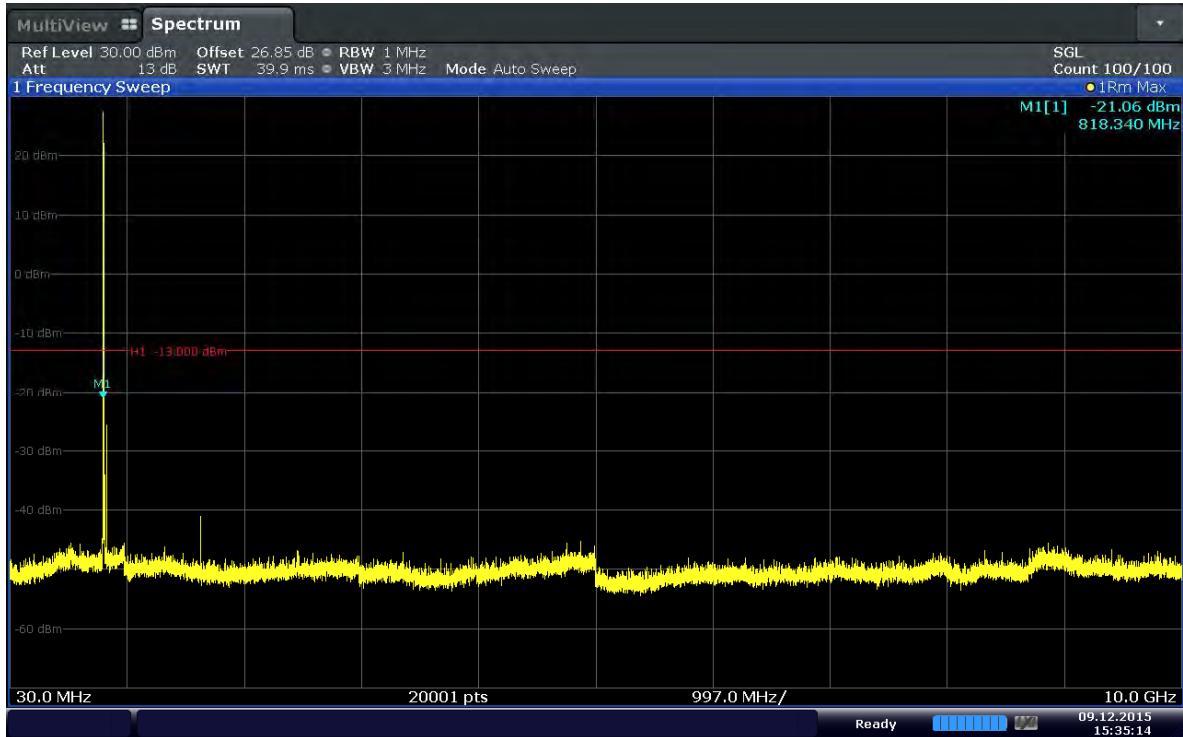

Date: 9.DEC.2015 15:35:14

Plot 6-9. Conducted Spurious Plot (Band 5–1.4MHz–QPSK–RB Size 1–RB Offset 2–Ch.20407)

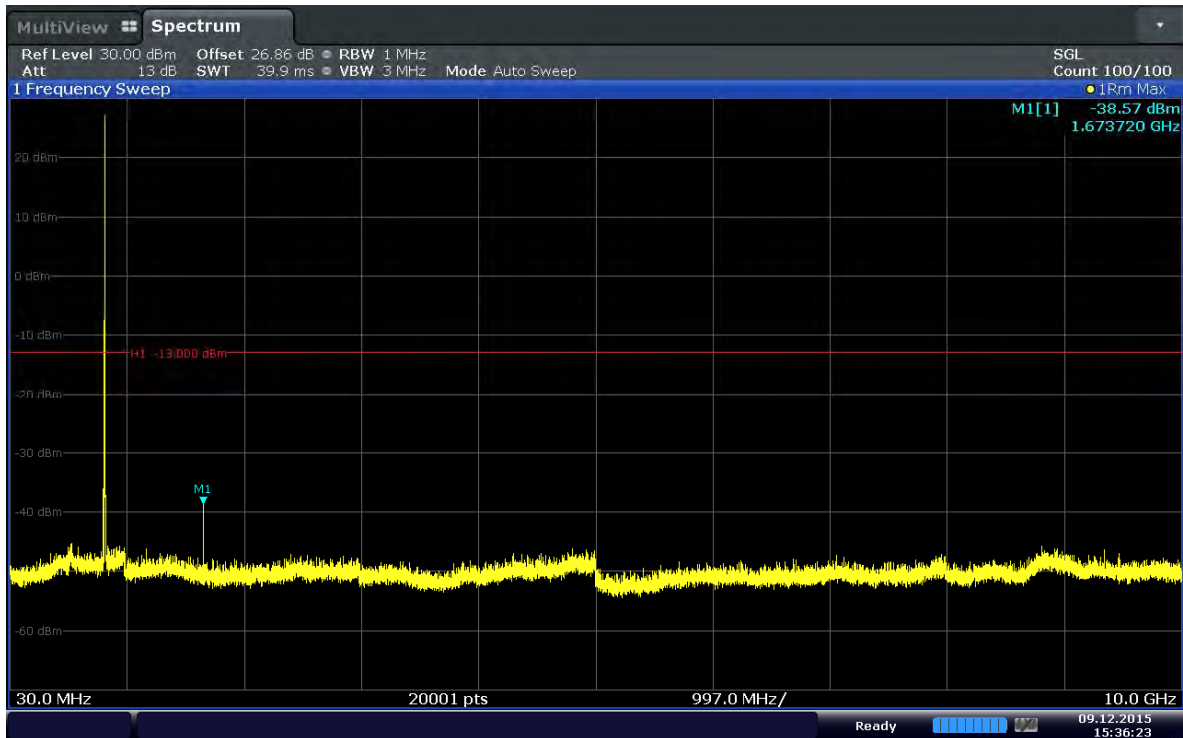

Date: 9.DEC.2015 15:36:23

Plot 6-10. Conducted Spurious Plot (Band 5–1.4MHz–QPSK–RB Size 1–RB Offset 5–Ch.20525)

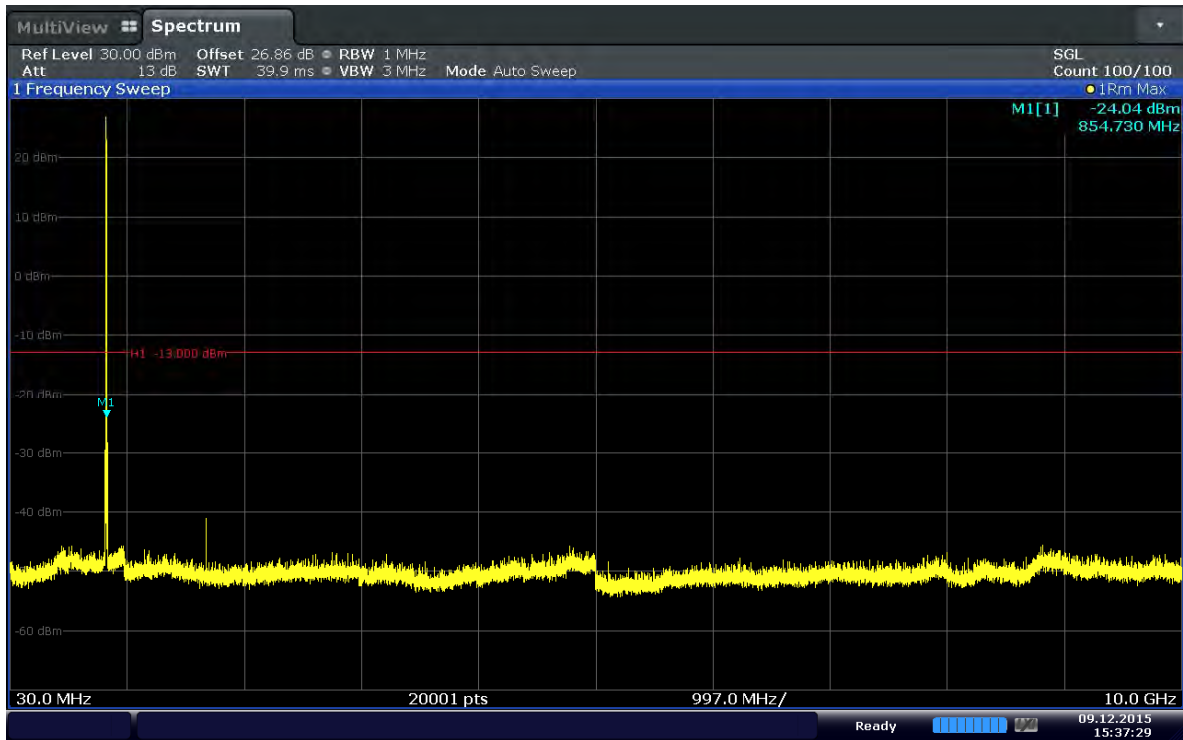

Date: 9.DEC.2015 15:37:29

Plot 6-11. Conducted Spurious Plot (Band 5-1.4MHz-QPSK-RB Size 1-RB Offset 2- Ch.20643)

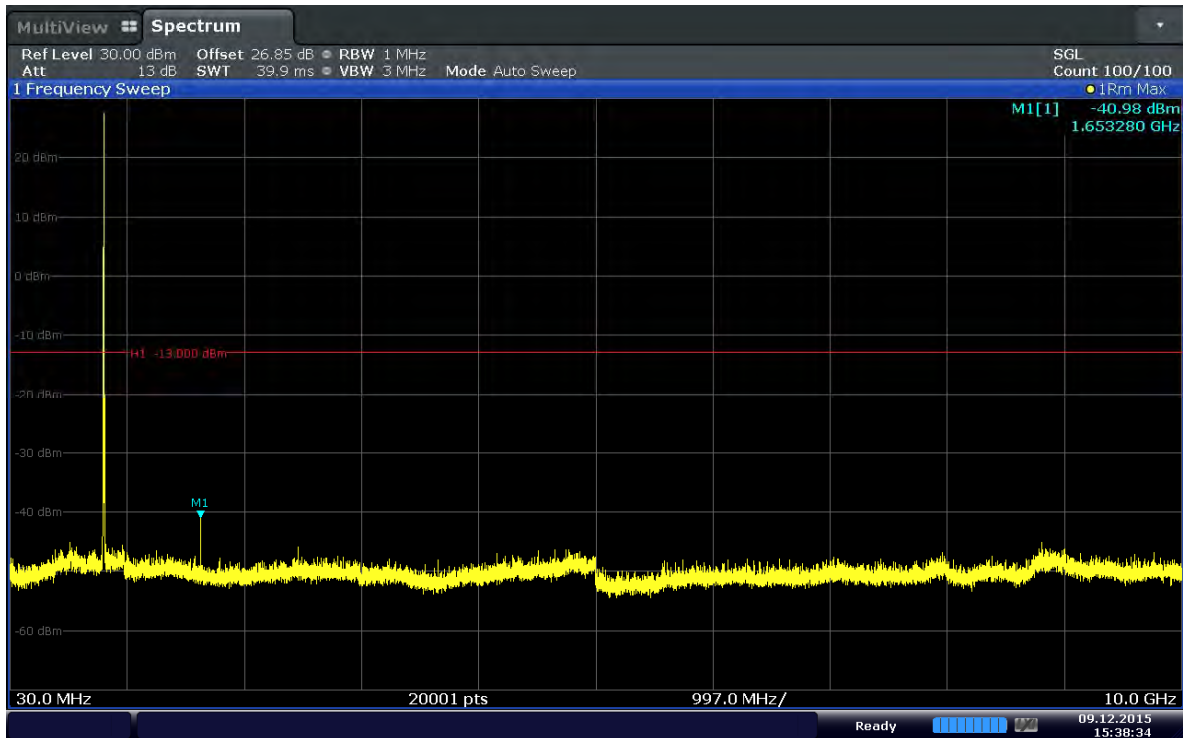

Date: 9.DEC.2015 15:38:34

Plot 6-12. Conducted Spurious Plot (Band 5-3.0MHz-QPSK-RB Size 1-RB Offset 14- Ch.20415)

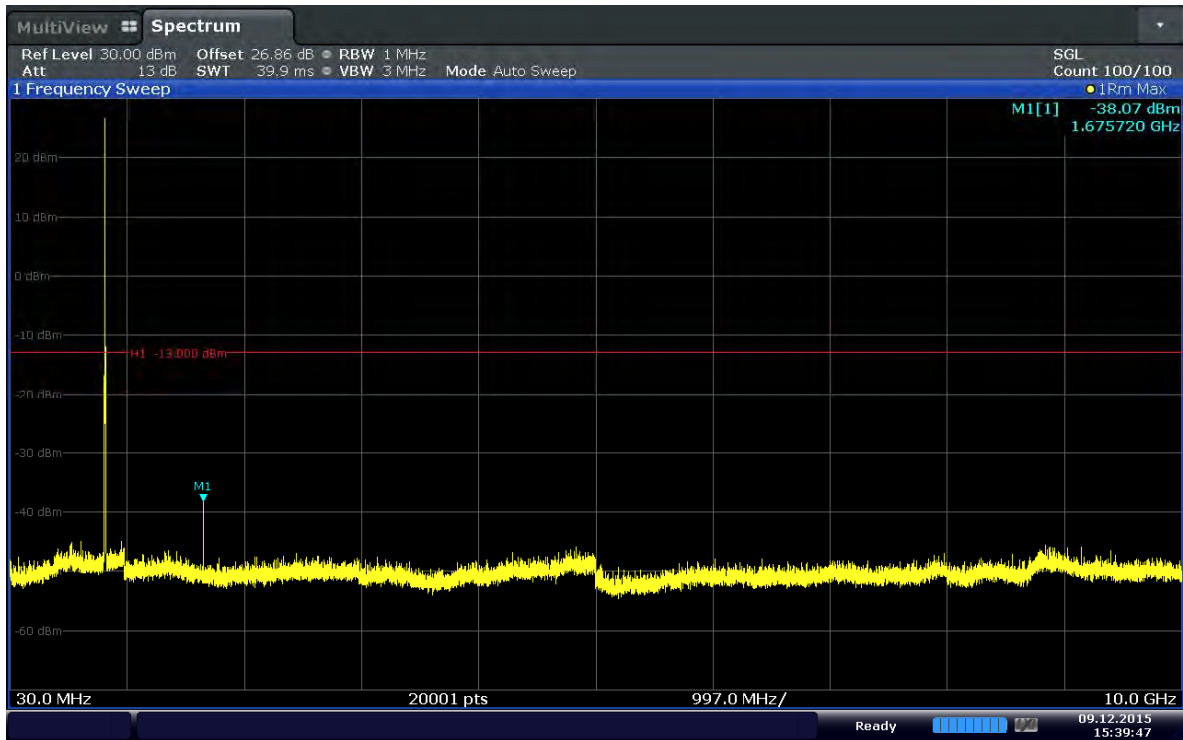

Date: 9.DEC.2015 15:39:47

Plot 6-13. Conducted Spurious Plot (Band 5–3.0MHz–QPSK–RB Size 1–RB Offset 14– Ch.20525)

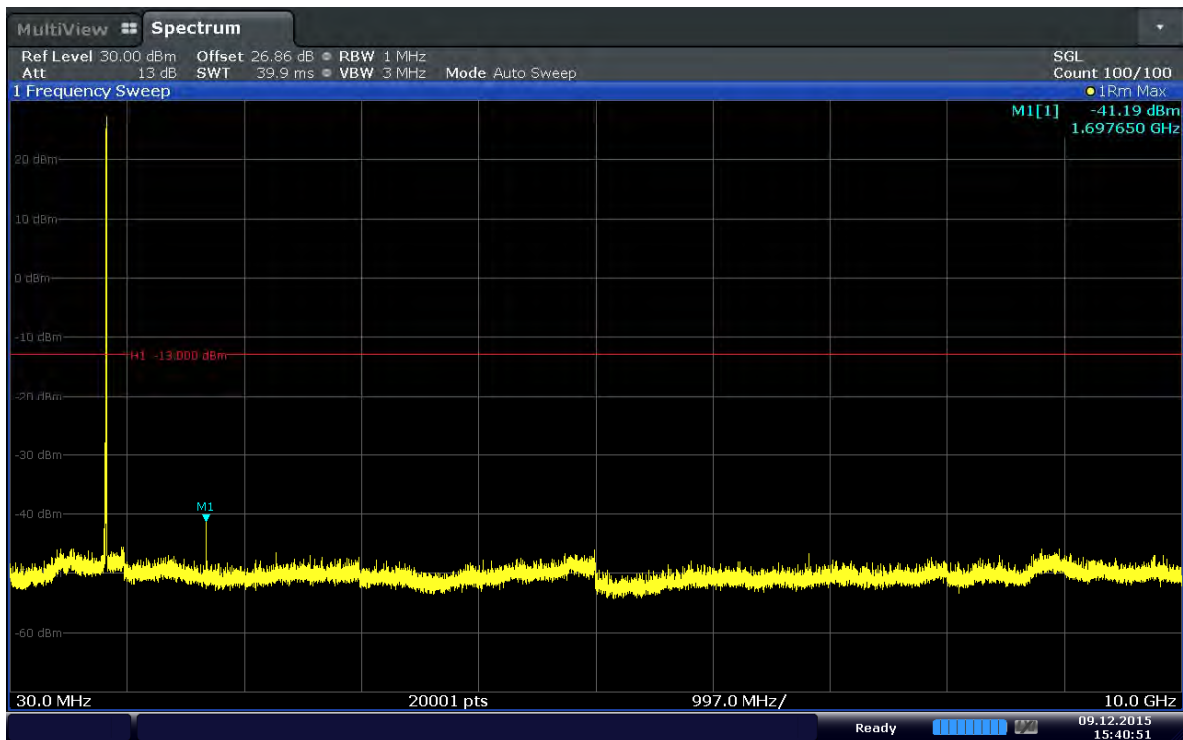

Date: 9.DEC.2015 15:40:51

Plot 6-14. Conducted Spurious Plot (Band 5–3.0MHz–QPSK–RB Size 1–RB Offset 14– Ch.20635)

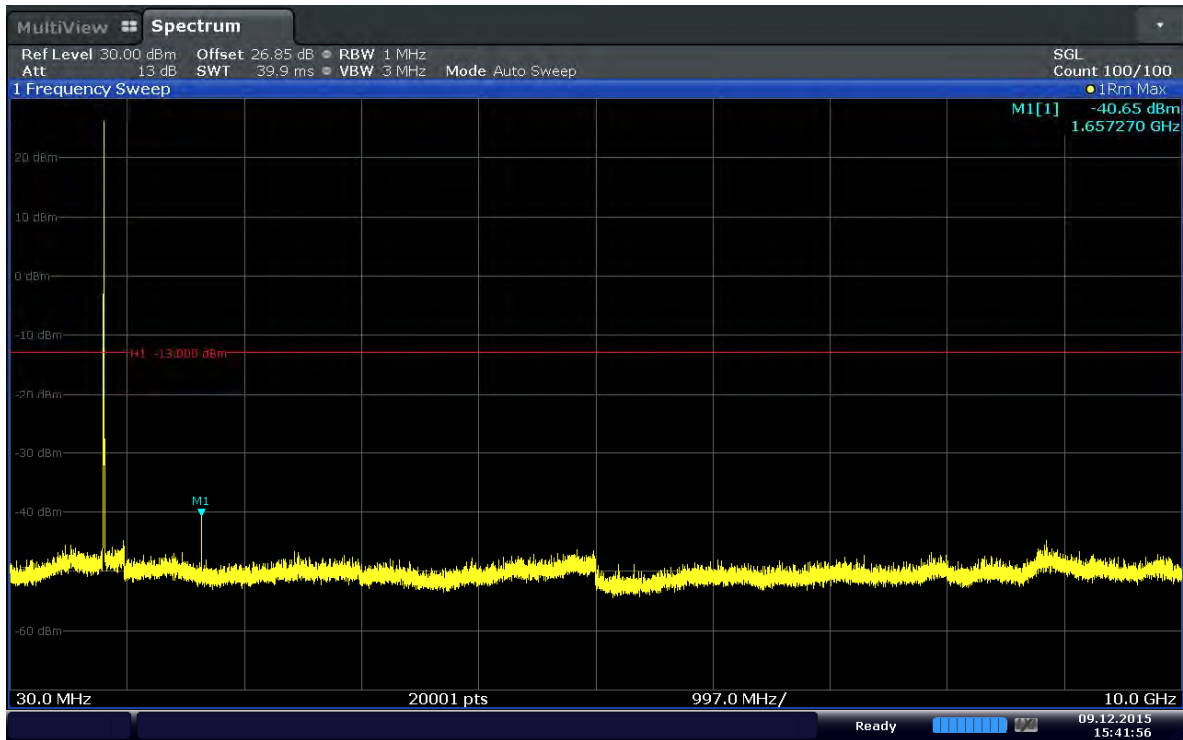

Date: 9.DEC.2015 15:41:56

Plot 6-15. Conducted Spurious Plot (Band 5–5.0MHz–QPSK–RB Size 1–RB Offset 24– Ch.20425)

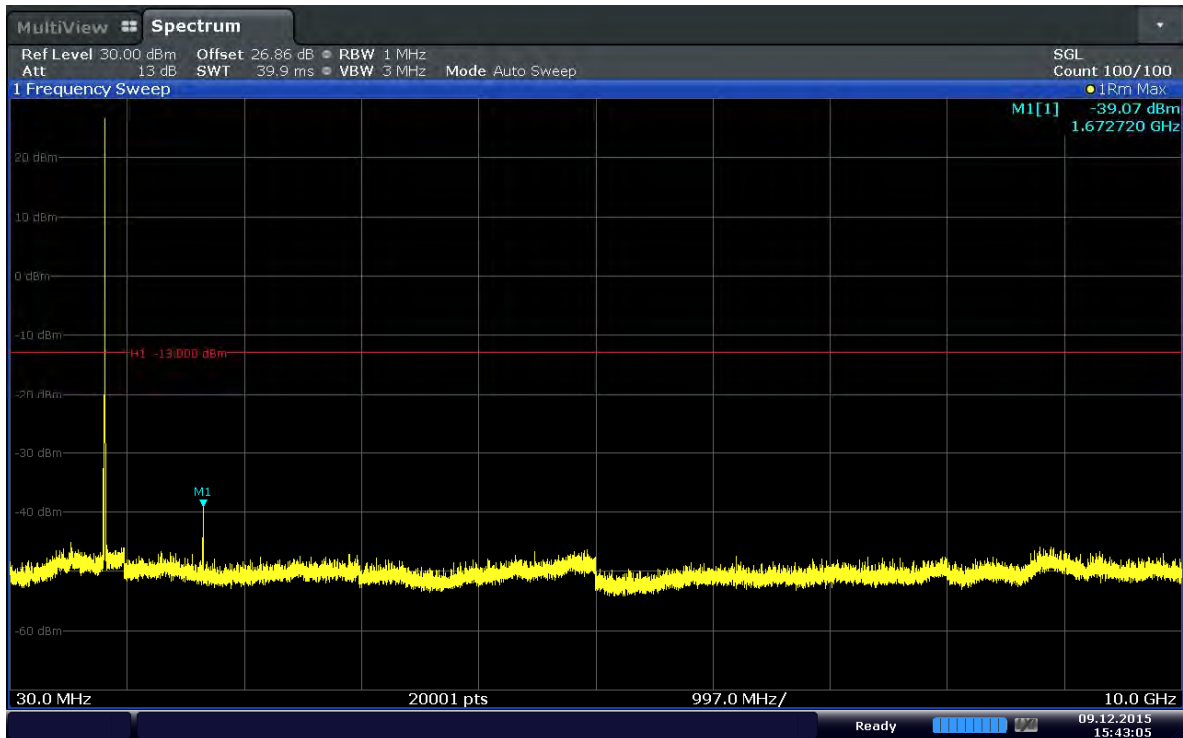

Date: 9.DEC.2015 15:43:05

Plot 6-16. Conducted Spurious Plot (Band 5–5.0MHz–QPSK–RB Size 1–RB Offset 12– Ch.20525)

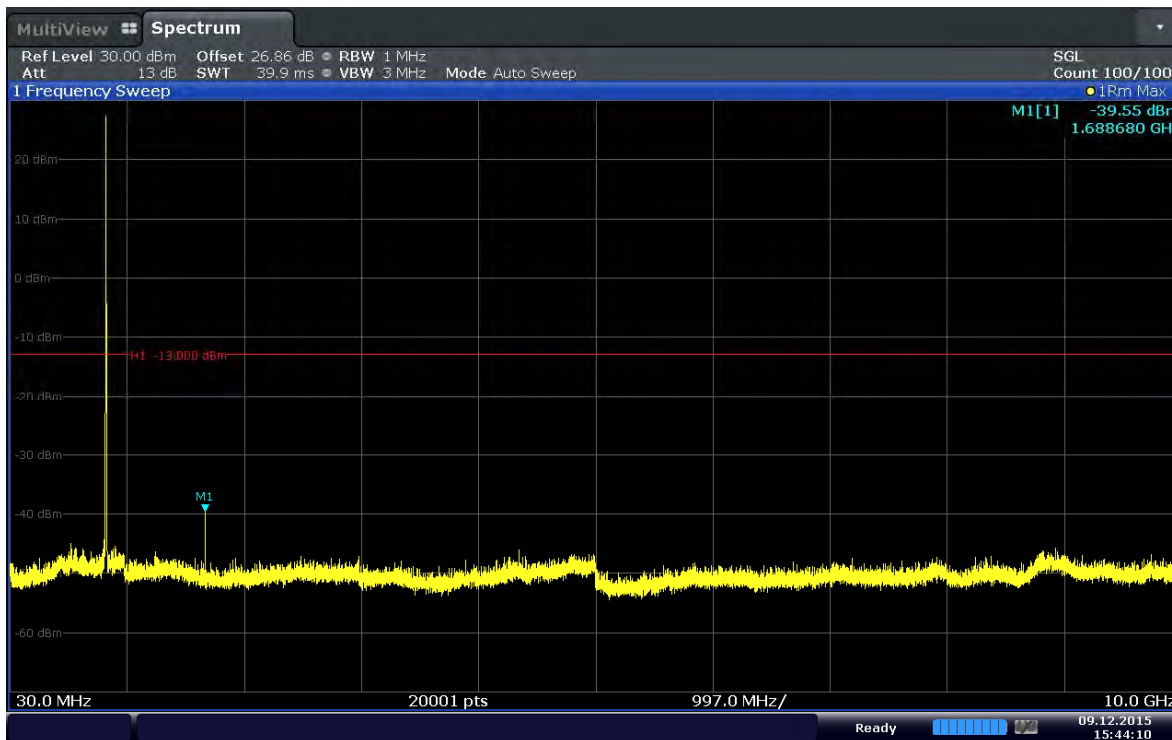

Date: 9.DEC.2015 15:44:11

Plot 6-17. Conducted Spurious Plot (Band 5–5.0MHz–QPSK–RB Size 1–RB Offset0– Ch.20625)

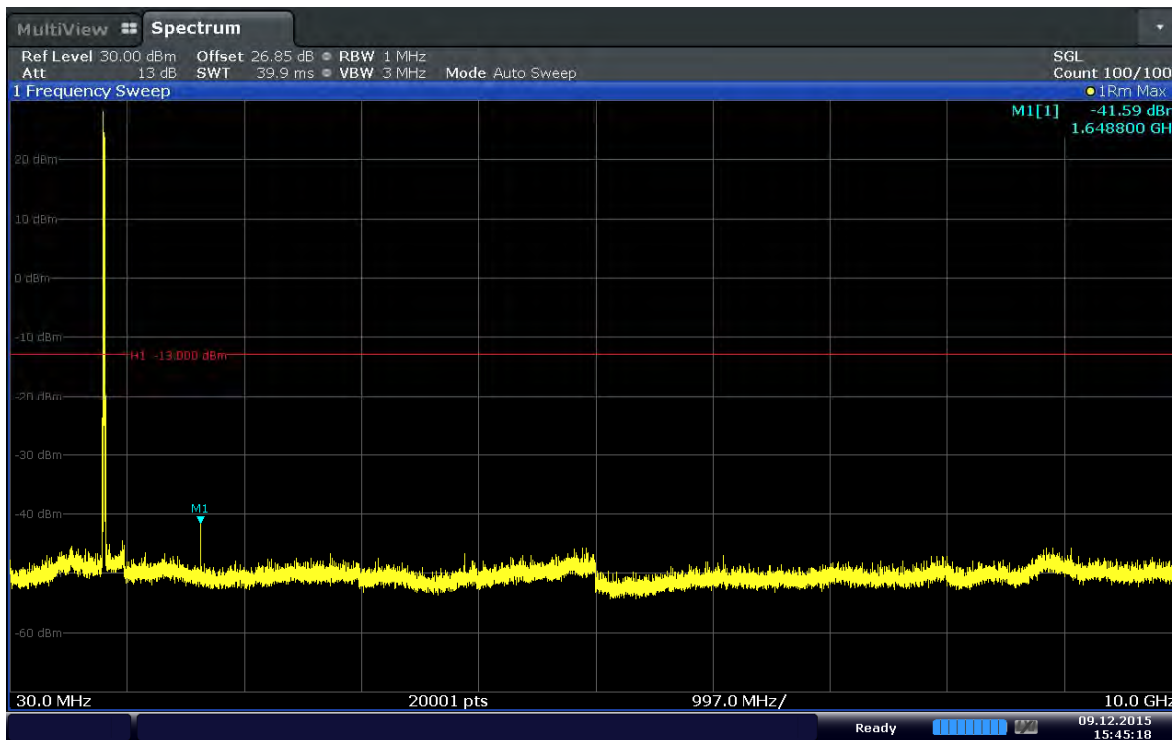

Date: 9.DEC.2015 15:45:18

Plot 6-18. Conducted Spurious Plot (Band 5–10.0MHz–QPSK–RB Size 1–RB Offset 0– Ch.20450)

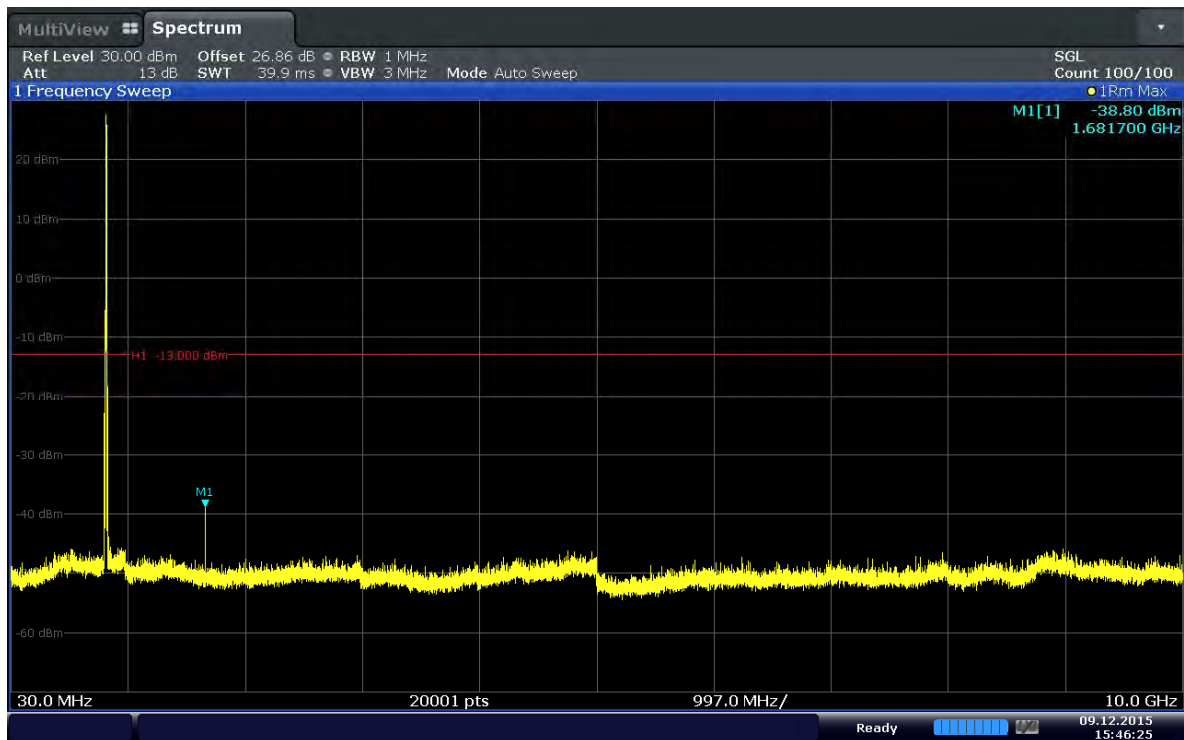

Date: 9.DEC.2015 15:46:26

Plot 6-19. Conducted Spurious Plot (Band 5–10.0MHz–QPSK–RB Size 1–RB Offset 49– Ch.20525)

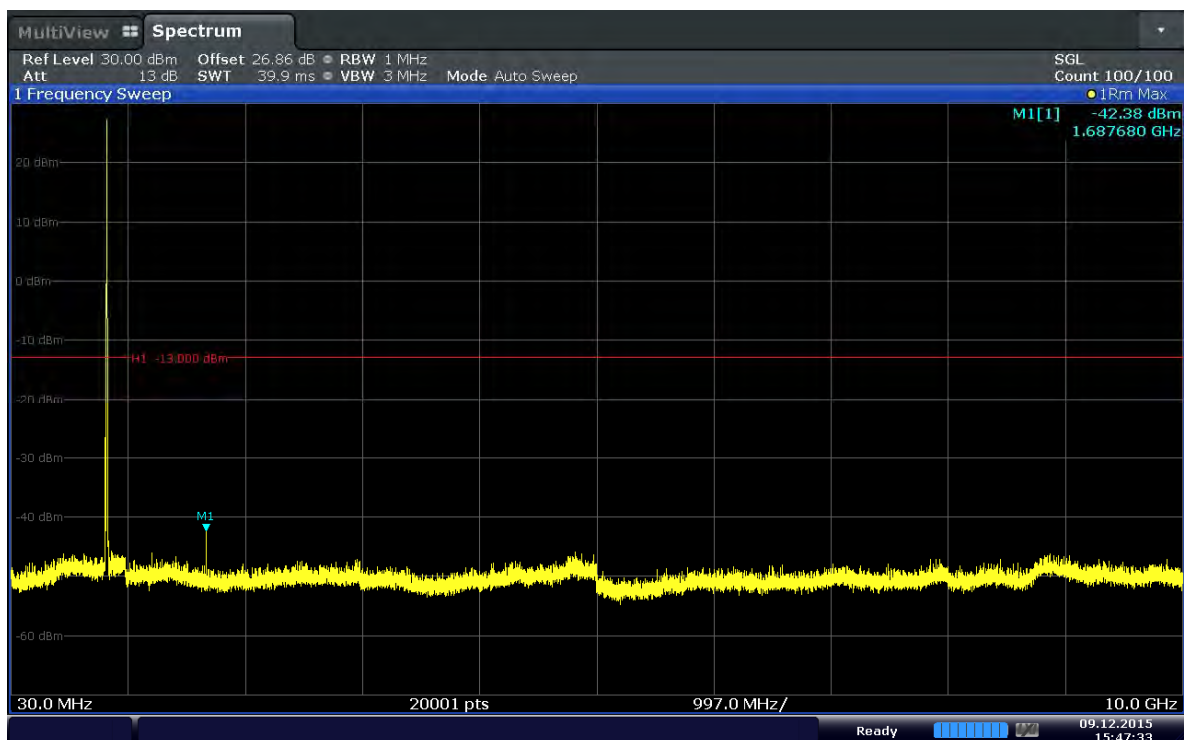

Date: 9.DEC.2015 15:47:33

Plot 6-20. Conducted Spurious Plot (Band 5–10.0MHz–QPSK–RB Size 1–RB Offset 25– Ch.20600)



6.4. Band Edge Emissions at Antenna Terminal §2.1051 §22.917(a)

Test Overview

All out of band emissions are measured with a spectrum analyzer connected to the antenna terminal of the EUT while the EUT is operating at its maximum duty cycle, at maximum power, and at the appropriate frequencies. All data rates were investigated to determine the worst case configuration. All modes of operation were investigated and the worst case configuration results are reported in this section.

The minimum permissible attenuation level of any spurious emission is $43 + 10 \log_{10}(P_{\text{Watts}})$, where P is the transmitter power in Watts. Limit equivalent to -13dBm, calculation shown below.

$$43 + 10 \log_{10}(1.567\text{W}) = 44.95 \text{ dB}$$

$$1.567\text{W} = 31.95 \text{ dBm}$$

$$31.95 \text{ dBm} - 44.95 \text{ dB} = -13 \text{ dBm}$$

Test Procedure Used

KDB 971168 v02r02 – Section 6.0

Test Settings

1. Start and stop frequency were set such that the band edge would be placed in the center of the plot.
2. Span was set large enough so as to capture all out of band emissions near the band edge
3. RBW \geq 1% of the emission bandwidth
4. VBW \geq 3 x RBW
5. Detector = RMS
6. Number of sweep points \geq 2 x Span/RBW
7. Trace mode = average
8. Sweep time = auto couple
9. The trace was allowed to stabilize

Test Setup

The EUT and measurement equipment were set up as shown in the diagram below.

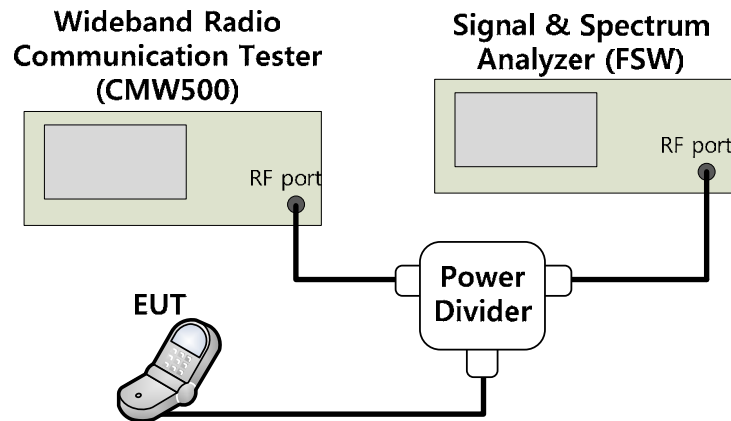

Figure 6-3. Test Instruments & Measurement Setup

Test Notes

1. Per 22.917(b), in the 1 MHz bands immediately outside and adjacent to the frequency block, a resolution bandwidth of at least one percent of the emission bandwidth of the fundamental emission of the transmitter may be employed to demonstrate compliance with the out-of-band emissions limit.



Test Plots

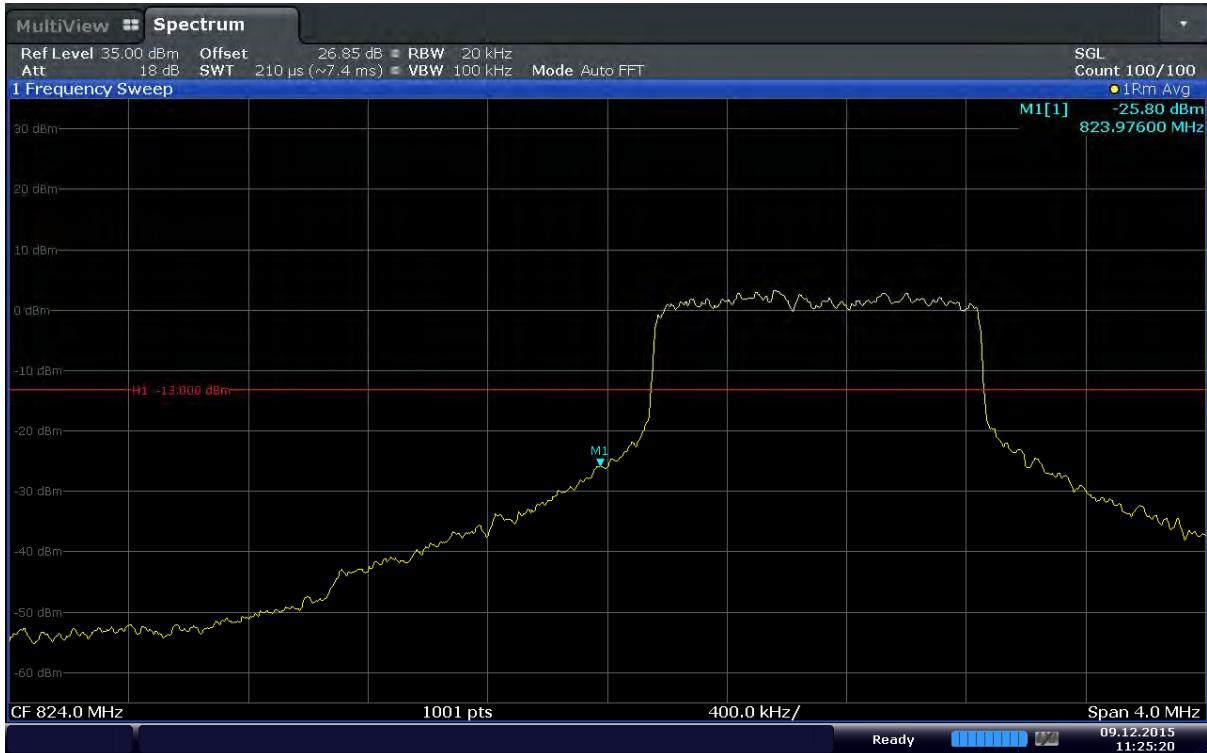

Date: 9.DEC.2015 11:25:20

Plot 6-21. Lower Band Edge Plot (Band5 – 1.4MHz – QPSK – RB Size 6)



Date: 9.DEC.2015 11:25:26

Plot 6-22. Extended Lower Band Edge Plot (Band5 – 1.4MHz – QPSK – RB Size 6)

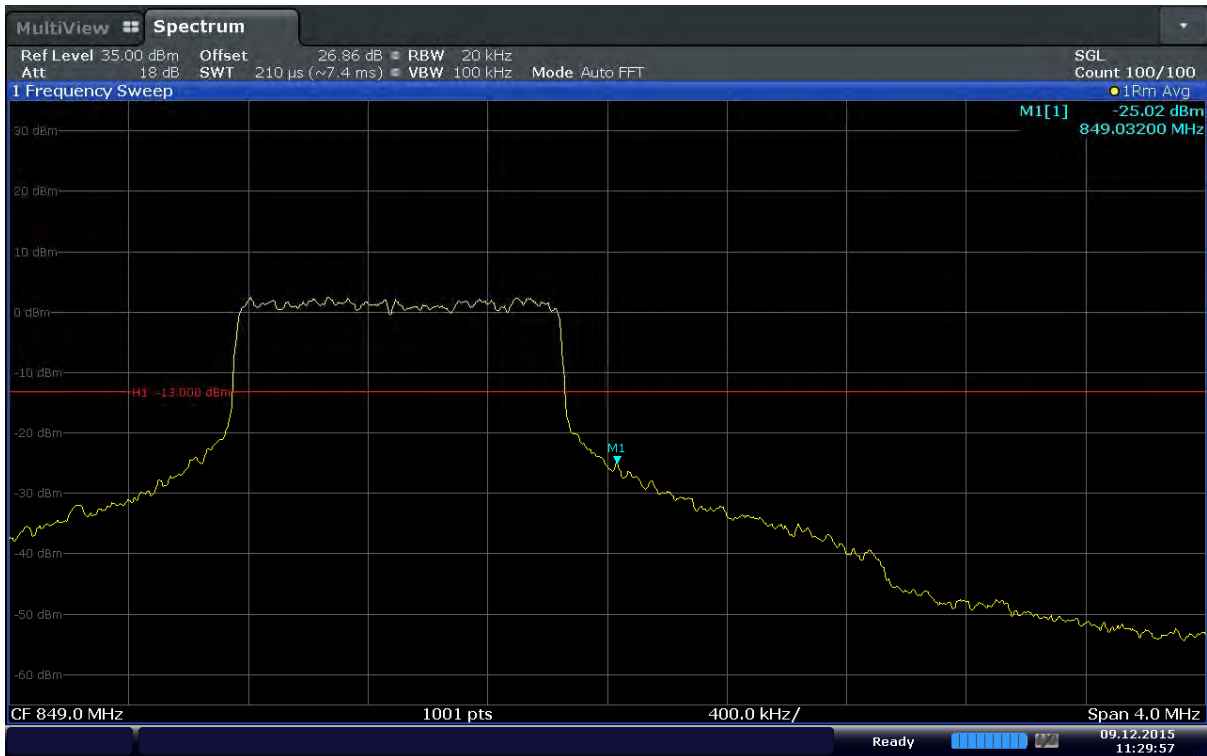

Date: 9.DEC.2015 11:29:57

Plot 6-23. Upper Band Edge Plot (Band5 – 1.4MHz – QPSK – RB Size 6)



Date: 9.DEC.2015 11:30:03

Plot 6-24. Extended Upper Band Edge Plot (Band5 – 1.4MHz – QPSK – RB Size 6)

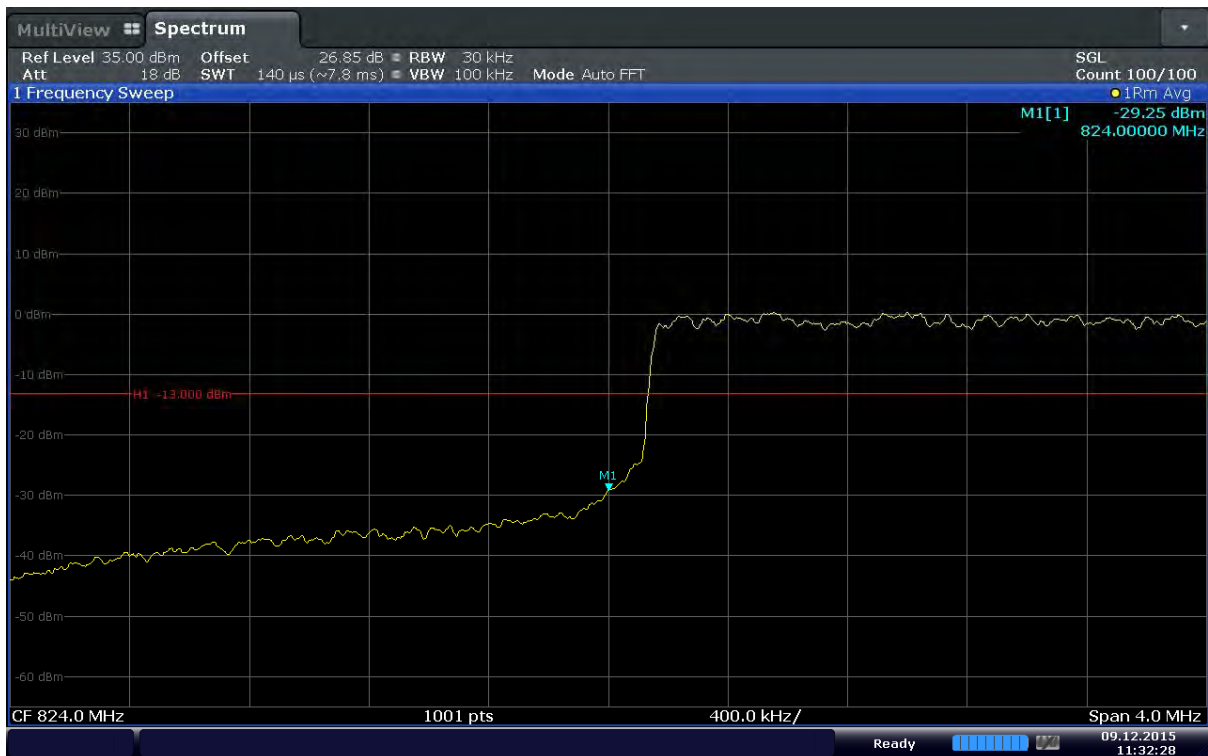

Date: 9.DEC.2015 11:32:28

Plot 6-25. Lower Band Edge Plot (Band 5 – 3.0MHz – QPSK – RB Size 15)



Date: 9.DEC.2015 11:32:34

Plot 6-26. Extended Lower Band Edge Plot (Band 5 – 3.0MHz – QPSK – RB Size 15)



Date: 9.DEC.2015 11:37:05

Plot 6-27. Upper Band Edge Plot (Band 5 – 3.0MHz – QPSK – RB Size 15)



Date: 9.DEC.2015 11:37:12

Plot 6-28. Extended Upper Band Edge Plot (Band 5 – 3.0MHz – QPSK – RB Size 15)

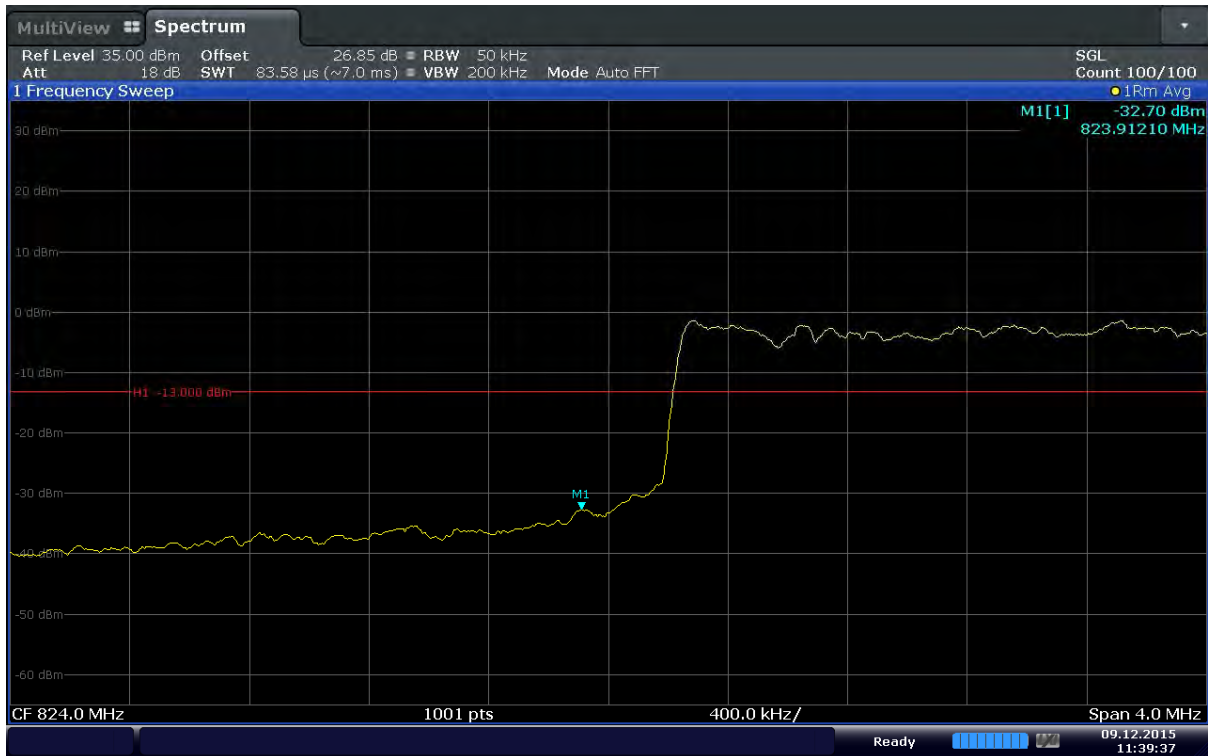

Date: 9.DEC.2015 11:39:37

Plot 6-29. Lower Band Edge Plot (Band 5 – 5.0MHz – QPSK – RB Size 25)



Date: 9.DEC.2015 11:39:43

Plot 6-30. Extended Lower Band Edge Plot (Band 5 – 5.0MHz – QPSK – RB Size 25)

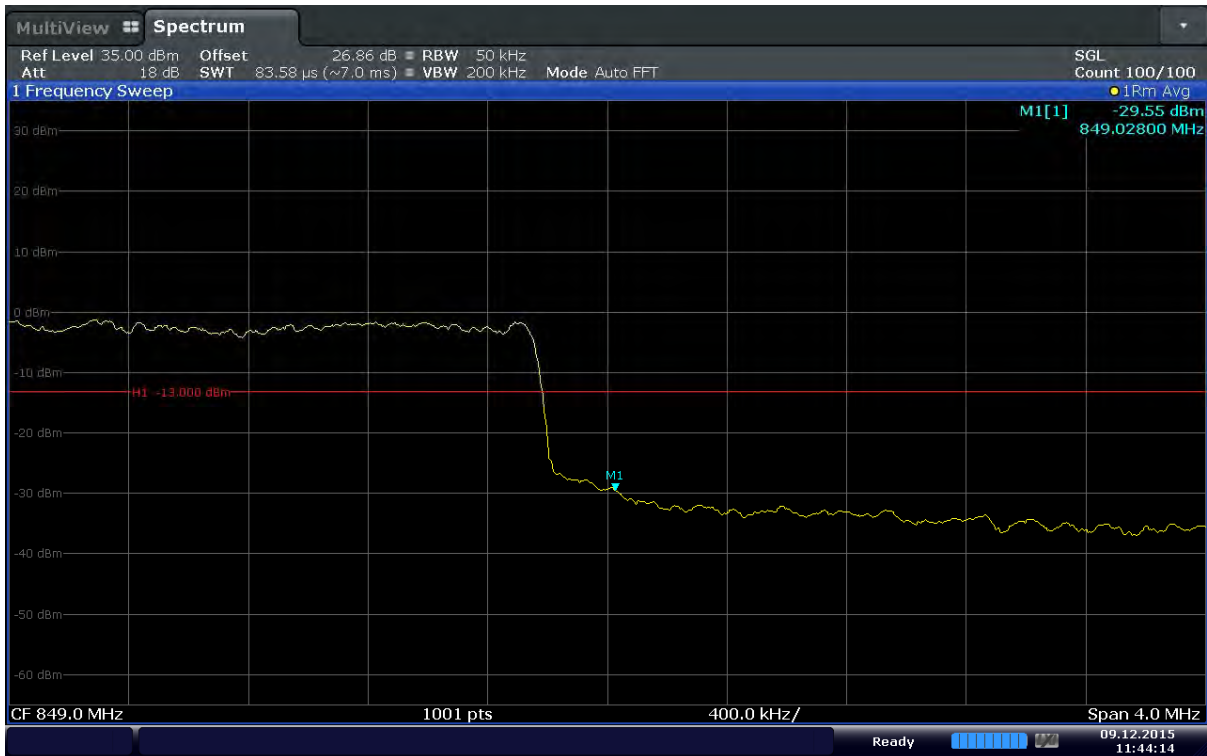

Date: 9.DEC.2015 11:44:15

Plot 6-31. Upper Band Edge Plot (Band 5 – 5.0MHz – QPSK – RB Size 25)



Date: 9.DEC.2015 11:44:21

Plot 6-32. Extended Upper Band Edge Plot (Band 5 – 5.0MHz – QPSK – RB Size 25)

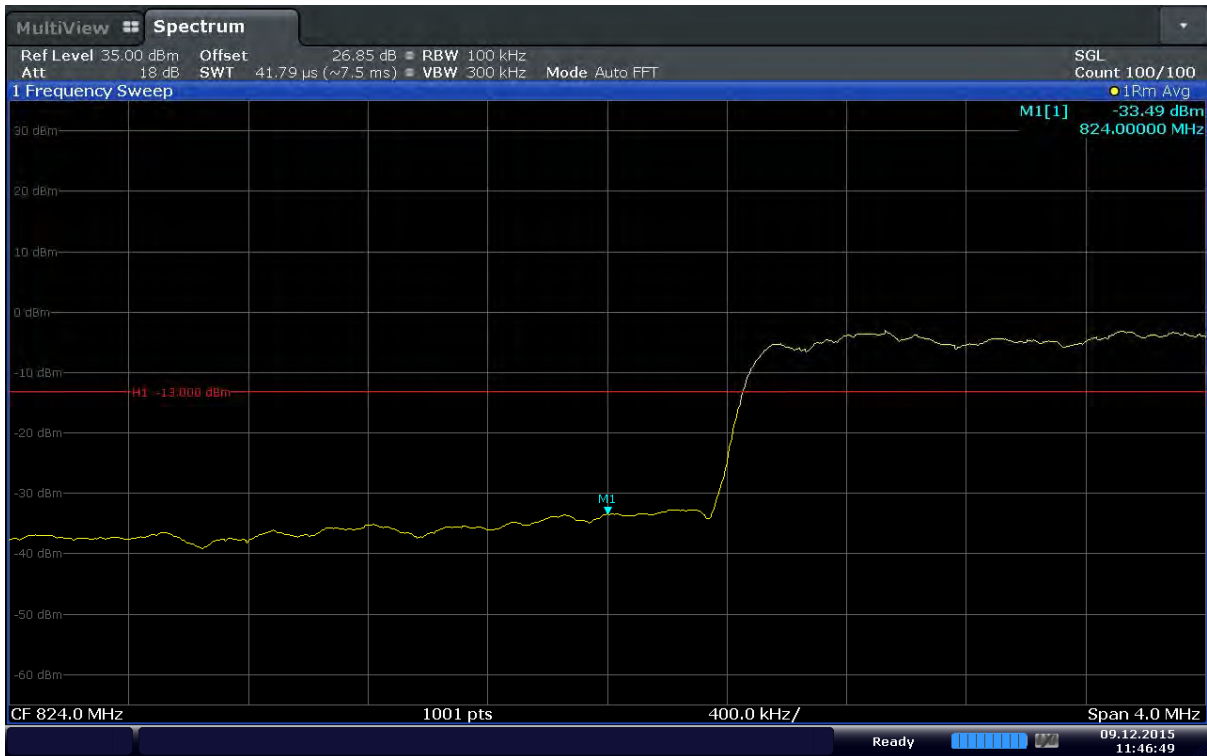

Date: 9.DEC.2015 11:46:48

Plot 6-33. Lower Band Edge Plot (Band 5 – 10.0MHz – QPSK – RB Size 50)

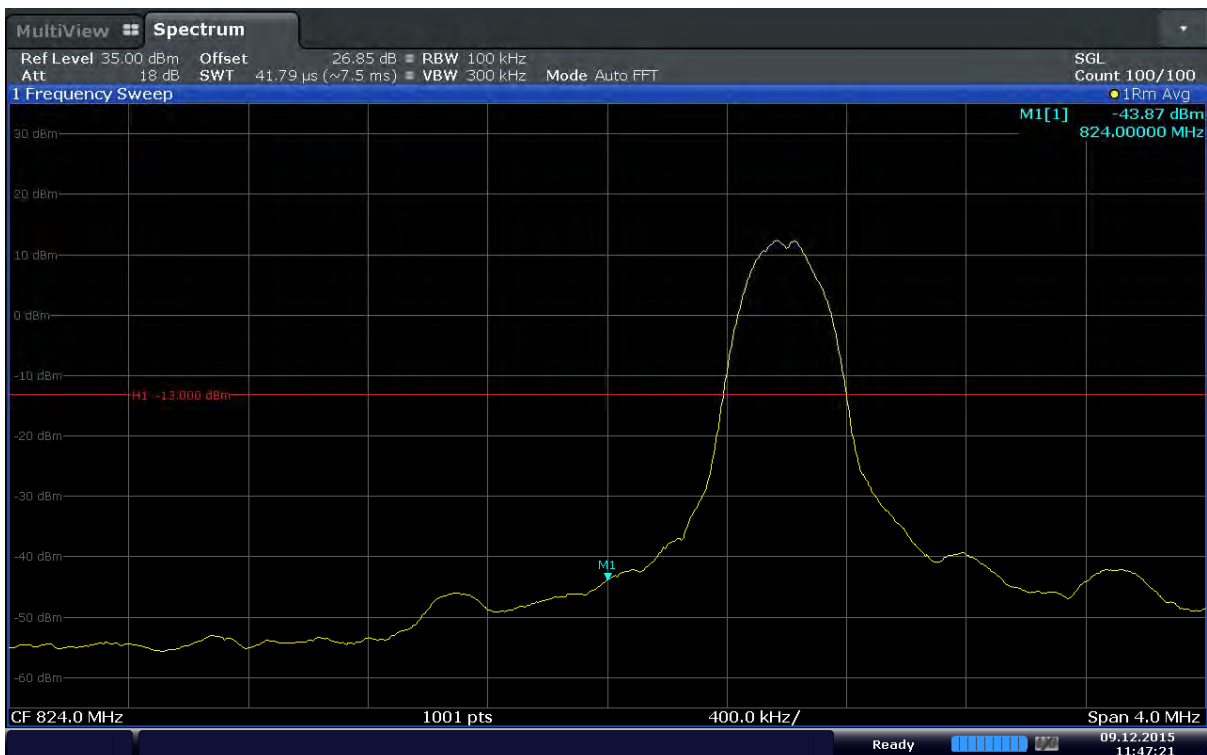

Date: 9.DEC.2015 11:47:21

Plot 6-34. Lower Band Edge Plot (Band 5 – 10.0MHz – QPSK – RB Size 1 – RB Offset 0)

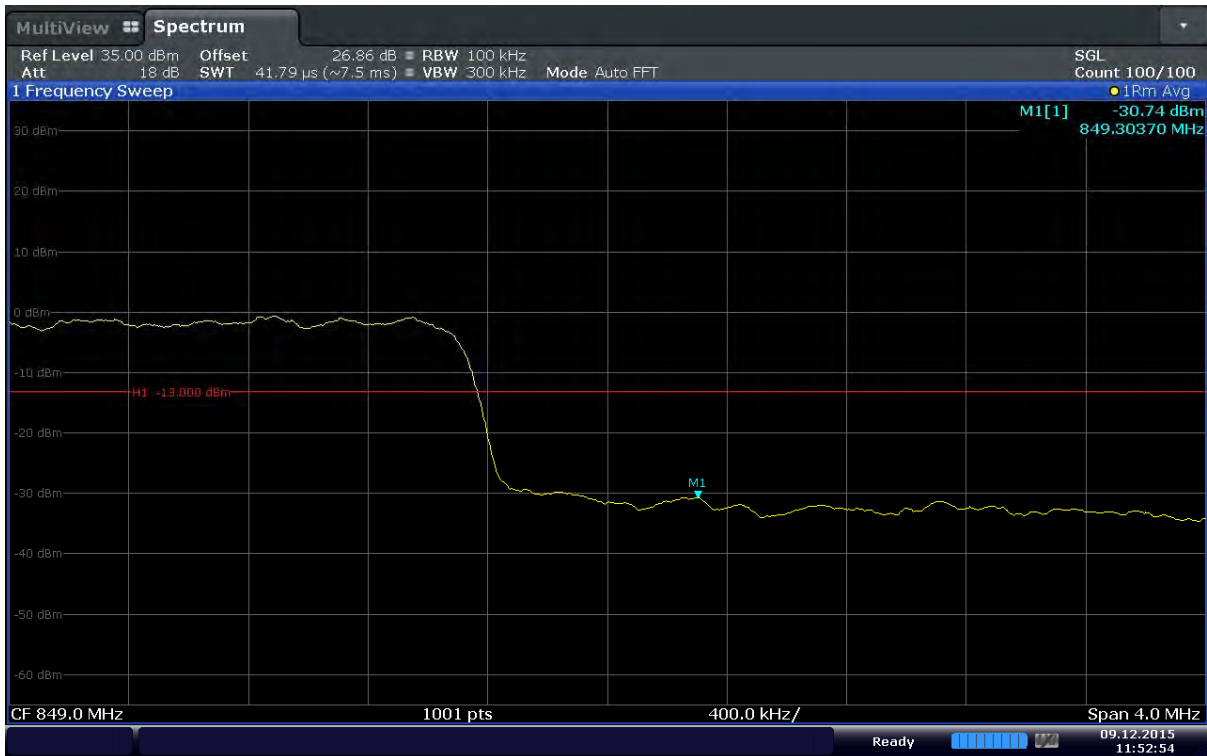

Date: 9.DEC.2015 11:52:54

Plot 6-35. Upper Band Edge Plot (Band 5 – 10.0MHz – QPSK – RB Size 50)

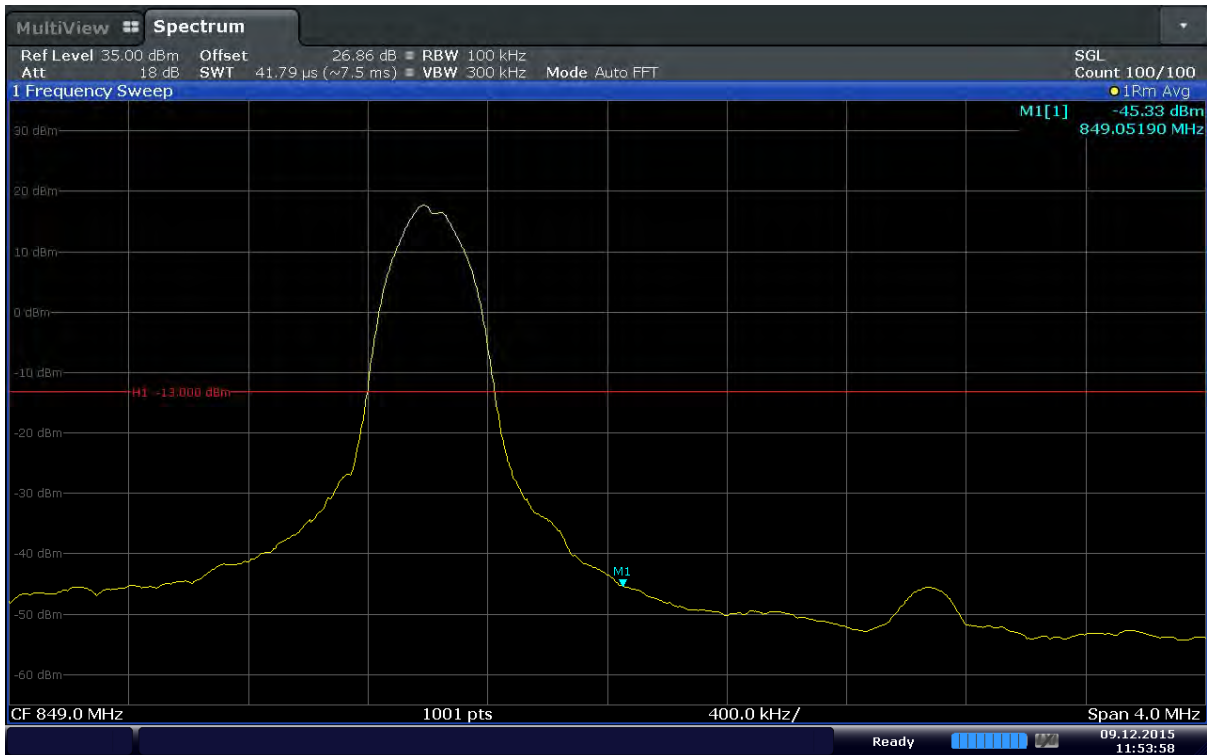

Date: 9.DEC.2015 11:53:59

Plot 6-36. Upper Band Edge Plot (Band 5 – 10.0MHz – QPSK – RB Size 1 – RB Offset 49)



6.5. Frequency Stability / Temperature Variation
§2.1055 §22.355

Test Overview and Limit

Frequency stability testing is performed in accordance with the guidelines of ANSI/TIA-603-D-2010. The frequency stability of the transmitter is measured by:

1. Temperature: The temperature is varied from -30°C to $+50^{\circ}\text{C}$ in 10°C increments using an environmental chamber.
2. Primary Supply Voltage: The primary supply voltage is varied from 85% to 115% of the nominal value for other than hand carried battery equipment. For hand-carried, battery-powered equipment, primary supply voltage is reduced to the battery operating end point(=Batt.End) which shall be specified by the manufacturer.

The frequency stability of the transmitter shall be maintained within $\pm 0.00025\%$ (± 2.5 ppm) of the center frequency.

Test Procedure Used

ANSI/TIA-603-D-2010

Test Settings

1. The equipment is turned on in a "standby" condition for fifteen minutes before applying power to the transmitter. Measurement of the carrier frequency of the transmitter is made within one minute after applying power to the transmitter.
2. Frequency measurements are made at 10°C intervals ranging from -30°C to $+50^{\circ}\text{C}$. A period of time sufficient to stabilize EUT at each temperature level shall be allowed prior to frequency measurement.

Test Setup

The EUT and measurement equipment were set up as shown in the diagram below.

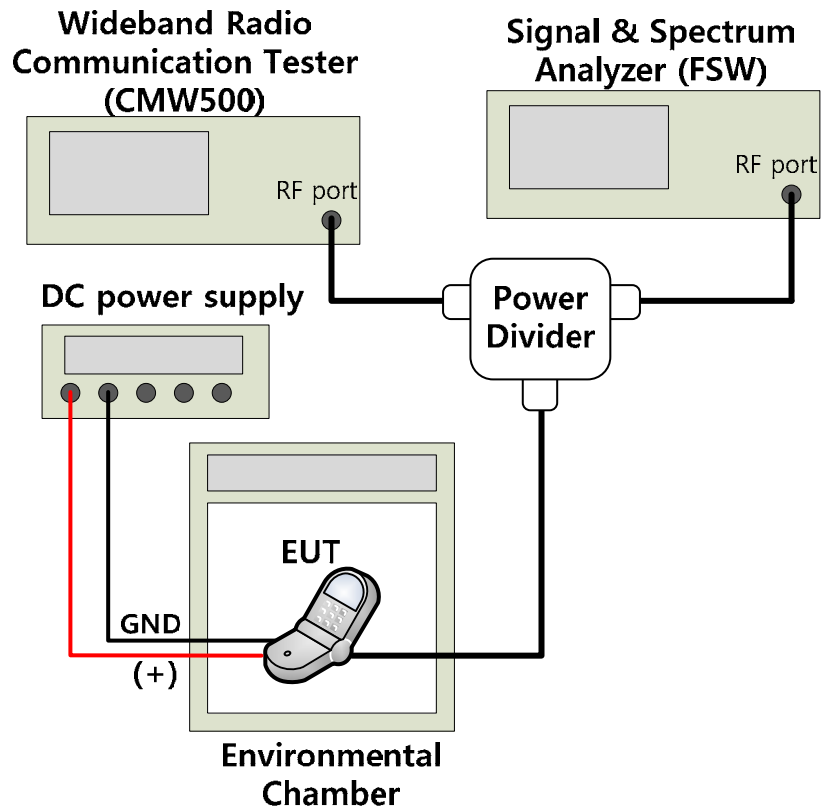

Figure 6-4. Test Instruments & Measurement Setup

Test Notes

1. MCF is the Measured Carrier Frequency
ACF is the Assigned Carrier Frequency
2. Calculate the ppm frequency error by the following:

$$\text{ppm error} = \left(\frac{\text{MCF}_{[\text{MHz}]} - \text{ACF}_{[\text{MHz}]}}{\text{ACF}_{[\text{MHz}]}} \right) \times 10^6$$



Issue Date:

Mode : LTE Band 5
 Channel : 20415
 Operating Frequency : 825.5 MHz
 Reference Voltage : 3.80 VDC

| Voltage [%] | Power [VDC] | Temp [°C] | ACF [MHz] | MCF [MHz] | Freq. Dev. [Hz] | ppm error | Limit [ppm] |
|-------------|-------------|-----------|-----------|------------|-----------------|-----------|-------------|
| 100 % | 3.80 | -30 | 825.5 | 825.499990 | -10.03 | -0.012 | ±2.5 |
| | | -20 | 825.5 | 825.499990 | -10.20 | -0.012 | |
| | | -10 | 825.5 | 825.499988 | -11.60 | -0.014 | |
| | | 0 | 825.5 | 825.499990 | -9.63 | -0.012 | |
| | | +10 | 825.5 | 825.499990 | -10.49 | -0.013 | |
| | | +20 | 825.5 | 825.499989 | -10.53 | -0.013 | |
| | | +30 | 825.5 | 825.499988 | -12.29 | -0.015 | |
| | | +40 | 825.5 | 825.499988 | -11.54 | -0.014 | |
| | | +50 | 825.5 | 825.499989 | -11.47 | -0.014 | |
| Batt.End | 3.40 | +20 | 825.5 | 825.499989 | -10.69 | -0.013 | |

Table 6-2. Frequency Stability Data

- End of this page -



6.6. Radiated Power (ERP)
§22.913(a.2)

Test Overview

Effective Radiated Power (ERP) measurements are performed using the substitution method described in ANSI/TIA-603-D-2010 with the EUT transmitting into an integral antenna. Measurements on signals operating below 1GHz are performed using dipole antennas. All measurements are performed as RMS average measurements while the EUT is operating at its maximum duty cycle, at maximum power, and at the appropriate frequencies.

Test Procedure Used

KDB 971168 v02r02 – Section 5.2.1

ANSI/TIA-603-D-2010 – Section 2.2.17

Test Settings

1. Radiated power measurements are performed using the signal analyzer's "channel power" measurement capability for signals with continuous operation.
2. RBW = 1 – 5% of the expected OBW, not to exceed 1MHz
3. VBW $\geq 3 \times$ RBW
4. Span = 1.5 times the OBW
5. No. of sweep points $\geq 2 \times$ span / RBW
6. Detector = RMS
7. Trigger is set to "free run" for signals with continuous operation with the sweep times set to "auto"
8. The integration bandwidth was roughly set equal to the measured OBW of the signal for signals with continuous operation.
9. Trace mode = trace averaging (RMS) over 100 sweeps
10. The trace was allowed to stabilize

Test Setup

The EUT and measurement equipment were set up as shown in the diagram below.

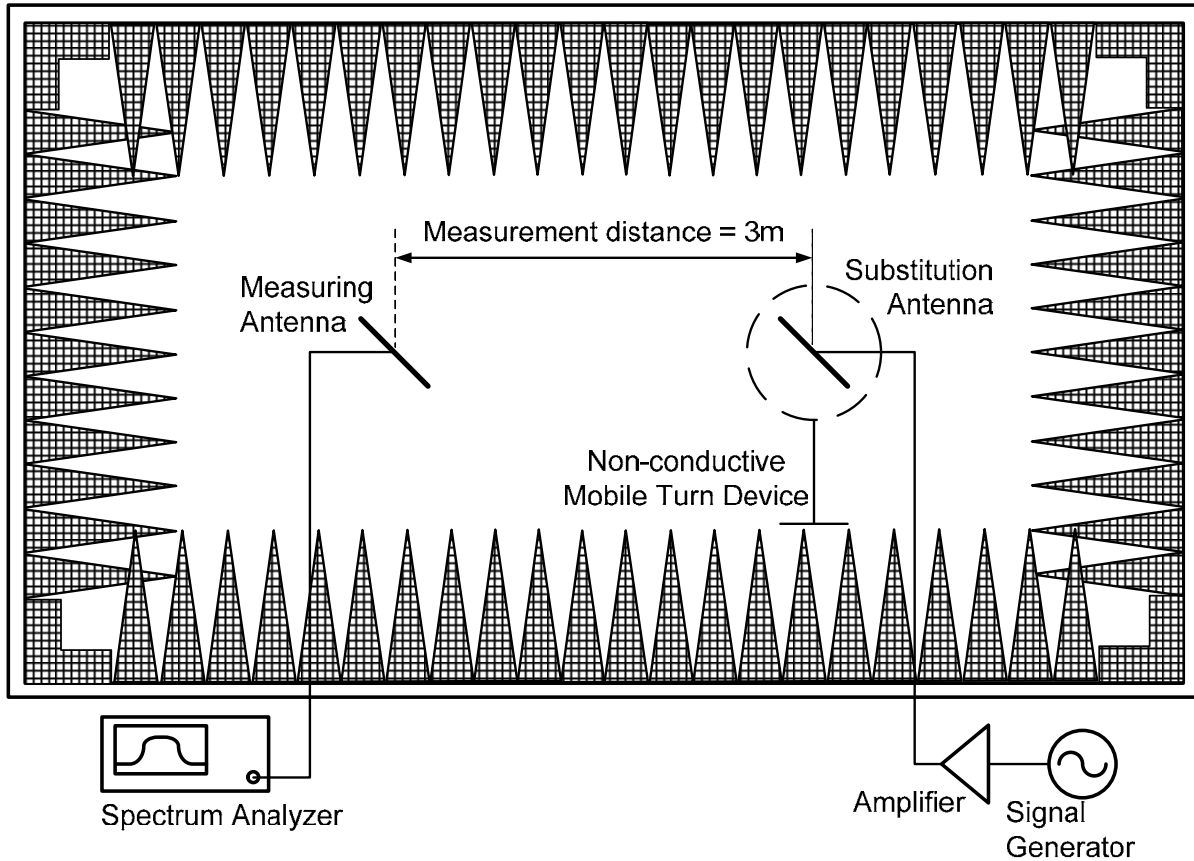

Figure 6-7. Test Instruments & Measurement Setup

Test Notes

1. The EUT was tested with Turn Device and the worst case emissions are reported with the EUT positioning, modulations, RB sizes and offsets, and channel bandwidth configurations shown in the tables below.
2. This unit was tested with its standard battery. The battery for this model EB-BG530CBB.



Test Results

| Channel | Channel BW [MHz] | Mod. | RB Size /Offset | Ant Pol (H/V) | EUT POL [degree] | | S/A Reading [dBm] | S/G Level [dBm] | Tx C/L [dB] | Ant. Gain [dBd] | ERP [dBm] | Limit [dBm] | Margin [dB] |
|---------|------------------|-------|-----------------|---------------|------------------|-----------|-------------------|-----------------|-------------|-----------------|-----------|-------------|-------------|
| | | | | | Azimuth | Elevation | | | | | | | |
| 20407 | 1.4 | QPSK | 1/2 | H | 77 | 360 | -15.50 | 23.73 | 3.35 | -0.75 | 19.63 | 38.45 | 18.82 |
| 20407 | 1.4 | 16QAM | 3/3 | H | 77 | 360 | -16.05 | 23.18 | 3.35 | -0.75 | 19.08 | 38.45 | 19.37 |
| 20525 | 1.4 | QPSK | 1/5 | H | 91 | 360 | -15.26 | 23.93 | 3.37 | -0.77 | 19.79 | 38.45 | 18.66 |
| 20525 | 1.4 | 16QAM | 3/2 | H | 91 | 360 | -16.02 | 23.17 | 3.37 | -0.77 | 19.03 | 38.45 | 19.42 |
| 20643 | 1.4 | QPSK | 1/2 | H | 92 | 360 | -15.83 | 23.32 | 3.39 | -0.80 | 19.13 | 38.45 | 19.32 |
| 20643 | 1.4 | 16QAM | 3/2 | H | 92 | 360 | -16.81 | 22.34 | 3.39 | -0.80 | 18.15 | 38.45 | 20.30 |
| 20415 | 3 | QPSK | 1/14 | H | 86 | 360 | -15.37 | 23.85 | 3.35 | -0.75 | 19.76 | 38.45 | 18.69 |
| 20415 | 3 | 16QAM | 1/7 | H | 86 | 360 | -15.75 | 23.47 | 3.35 | -0.75 | 19.38 | 38.45 | 19.07 |
| 20525 | 3 | QPSK | 1/14 | H | 86 | 360 | -15.09 | 24.10 | 3.37 | -0.77 | 19.96 | 38.45 | 18.49 |
| 20525 | 3 | 16QAM | 1/7 | H | 86 | 360 | -16.76 | 22.43 | 3.37 | -0.77 | 18.29 | 38.45 | 20.16 |
| 20635 | 3 | QPSK | 1/14 | H | 92 | 360 | -15.63 | 23.53 | 3.39 | -0.80 | 19.34 | 38.45 | 19.11 |
| 20635 | 3 | 16QAM | 1/14 | H | 92 | 360 | -16.55 | 22.61 | 3.39 | -0.80 | 18.42 | 38.45 | 20.03 |
| 20425 | 5 | QPSK | 1/24 | H | 82 | 360 | -15.28 | 23.94 | 3.35 | -0.75 | 19.84 | 38.45 | 18.61 |
| 20425 | 5 | 16QAM | 1/24 | H | 82 | 360 | -16.05 | 23.17 | 3.35 | -0.75 | 19.07 | 38.45 | 19.38 |
| 20525 | 5 | QPSK | 1/12 | H | 102 | 360 | -15.25 | 23.94 | 3.37 | -0.77 | 19.80 | 38.45 | 18.65 |
| 20525 | 5 | 16QAM | 1/0 | H | 102 | 360 | -15.89 | 23.30 | 3.37 | -0.77 | 19.16 | 38.45 | 19.29 |
| 20625 | 5 | QPSK | 1/0 | H | 90 | 360 | -16.07 | 23.09 | 3.39 | -0.80 | 18.90 | 38.45 | 19.55 |
| 20625 | 5 | 16QAM | 1/0 | H | 90 | 360 | -17.79 | 21.37 | 3.39 | -0.80 | 17.18 | 38.45 | 21.27 |
| 20450 | 10 | QPSK | 1/0 | H | 79 | 360 | -15.67 | 23.54 | 3.36 | -0.76 | 19.43 | 38.45 | 19.02 |
| 20450 | 10 | 16QAM | 1/49 | H | 79 | 360 | -15.73 | 23.48 | 3.36 | -0.76 | 19.37 | 38.45 | 19.08 |
| 20525 | 10 | QPSK | 1/49 | H | 96 | 360 | -15.98 | 23.21 | 3.37 | -0.77 | 19.07 | 38.45 | 19.38 |
| 20525 | 10 | 16QAM | 1/25 | H | 96 | 360 | -17.58 | 21.61 | 3.37 | -0.77 | 17.47 | 38.45 | 20.98 |
| 20600 | 10 | QPSK | 1/25 | H | 82 | 360 | -16.58 | 22.59 | 3.38 | -0.79 | 18.41 | 38.45 | 20.04 |
| 20600 | 10 | 16QAM | 1/0 | H | 82 | 360 | -17.55 | 21.62 | 3.38 | -0.79 | 17.44 | 38.45 | 21.01 |

Table 6-3. ERP



6.7. Radiated Spurious Emissions Measurements §2.1053 §22.917(a)

Test Overview

Radiated spurious emissions measurements are performed using the substitution method described in ANSI/TIA-603-D-2010 with the EUT transmitting into an integral antenna. Measurements on signals operating below 1GHz are performed using dipole antennas. Measurements on signals operating above 1GHz are performed using broadband horn antennas. All measurements are performed as peak measurements while the EUT is operating at its maximum duty cycle, at maximum power, and at the appropriate frequencies.

Test Procedure Used

KDB 971168 v02r02 – Section 5.8

ANSI/TIA-603-D-2010 – Section 2.2.12

Test Settings

1. RBW = 100kHz for emissions below 1GHz and 1MHz for emissions above 1GHz
2. VBW $\geq 3 \times$ RBW
3. No. of sweep points \geq Span / RBW
4. Detector = Max Peak
5. Trace mode = max hold
6. The trace was allowed to stabilize

– End of this page –

Test Setup

The EUT and measurement equipment were set up as shown in the diagram below.

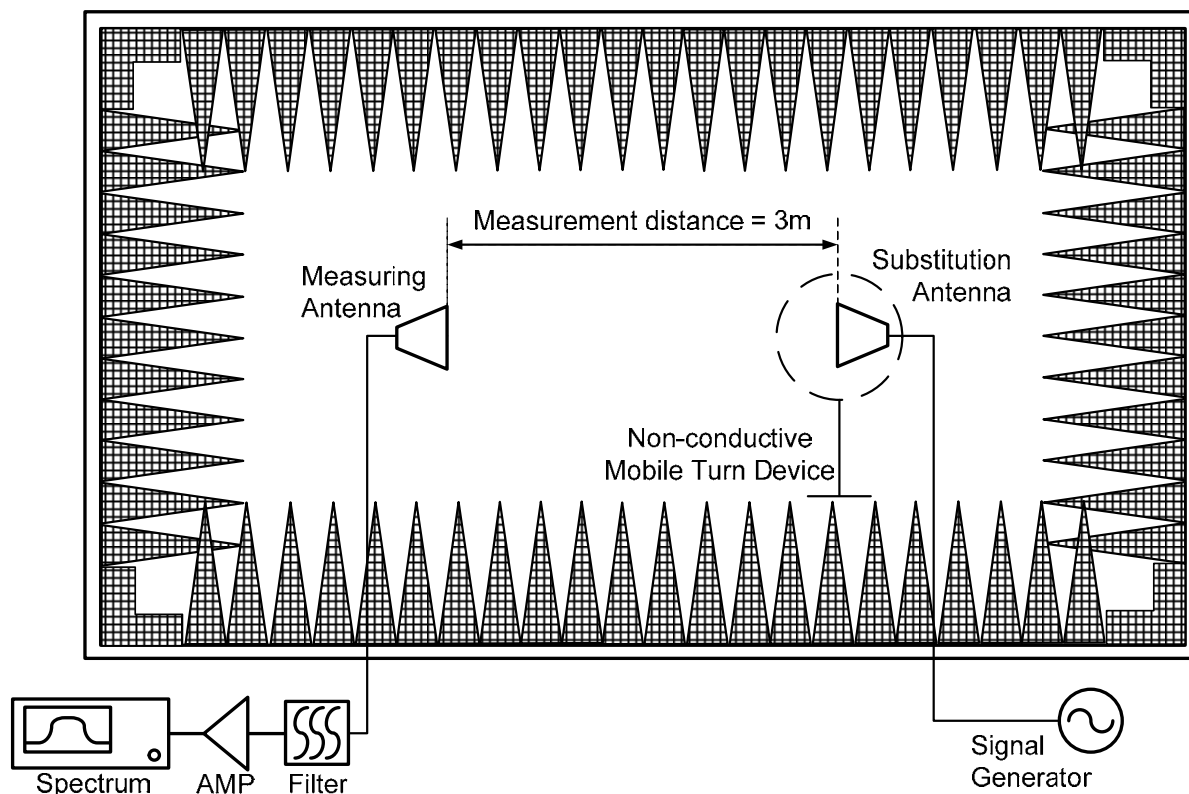

Figure 6-8. Test Instruments & Measurement Setup

Test Notes

1. The EUT was tested with Turn Device and the worst case emissions are reported with the EUT positioning, modulations, RB sizes and offsets, and channel bandwidth configurations shown in the tables below.
2. This unit was tested with its standard battery. The battery for this model EB-BG530CBB.
3. The spectrum is measured from 9kHz to the 10th harmonic of the fundamental frequency of the transmitter. The worst-case emissions are reported.



Issue Date:

Test Results

Operating Frequency : 826.5 MHz
 Channel : 20425
 Measured Output Power : 19.84 dBm = 0.096 Watt
 Modulation Signal : QPSK
 Band Width : 5 MHz
 RB Size / Offset : 1 / 24
 Distance : 3 Meters
 Limit : $43 + 10 \log_{10}(W)$ = 32.84 dBc
 RSE Limit : -13 dBm

| Freq. [MHz] | Ant Pol (H/V) | EUT Pol [degree] | | S/A reading [dBm] | S/G Lev. [dBm] | Tx C/L [dB] | Ant. Gain [dBd] | RSE Level [dBm] |
|-------------|---------------|------------------|-----------|-------------------|----------------|-------------|-----------------|-----------------|
| | | Azimuth | Elevation | | | | | |
| 1653.0 | V | 58 | 290 | -48.49 | -48.91 | 4.77 | 7.19 | -46.49 |
| 2479.5 | H | 113 | 322 | -59.35 | -56.21 | 5.80 | 8.37 | -53.64 |
| 3306.0 | H | 129 | 300 | -58.69 | -50.54 | 6.78 | 8.19 | -49.14 |
| 4132.5 | H | Noise floor | | -62.84 | -50.70 | 7.58 | 8.28 | -50.00 |

Table 6-4. Radiated Spurious Data – Low Channel

Operating Frequency : 836.5 MHz
 Channel : 20525
 Measured Output Power : 19.96 dBm = 0.099 Watt
 Modulation Signal : QPSK
 Band Width : 3 MHz
 RB Size / Offset : 1 / 14
 Distance : 3 meters
 Limit : $43 + 10 \log_{10}(W)$ = 32.96 dBc
 RSE Limit : -13 dBm

| Freq. [MHz] | Ant Pol (H/V) | EUT Pol [degree] | | S/A reading [dBm] | S/G Lev. [dBm] | Tx C/L [dB] | Ant. Gain [dBd] | RSE Level [dBm] |
|-------------|---------------|------------------|-----------|-------------------|----------------|-------------|-----------------|-----------------|
| | | Azimuth | Elevation | | | | | |
| 1673.0 | V | 76 | 286 | -48.28 | -48.76 | 4.79 | 7.29 | -46.26 |
| 2509.5 | H | 110 | 303 | -58.84 | -55.39 | 5.83 | 8.35 | -52.87 |
| 3346.0 | V | 52 | 215 | -59.71 | -51.17 | 6.82 | 8.25 | -49.74 |

Table 6-5. Radiated Spurious Data – Mid Channel

– End of this page –



Issue Date:

Operating Frequency : 847.5 MHz
Channel : 20643
Measured Output Power : 19.34 dBm = 0.086 Watt
Modulation Signal : QPSK
Band Width : 3 MHz
RB Size / Offset : 1 / 14
Distance : 3 meters
Limit : $43 + 10 \log_{10}(W)$ = 32.34 dBc
RSE Limit : -13 dBm

| Freq. [MHz] | Ant Pol (H/V) | EUT Pol [degree] | | S/A reading [dBm] | S/G Lev. [dBm] | Tx C/L [dB] | Ant. Gain [dBd] | RSE Level [dBm] |
|-------------|---------------|------------------|-----------|-------------------|----------------|-------------|-----------------|-----------------|
| | | Azimuth | Elevation | | | | | |
| 1695.0 | V | 94 | 306 | -48.47 | -49.03 | 4.82 | 7.41 | -46.44 |
| 2542.5 | V | 28 | 278 | -59.50 | -55.39 | 5.88 | 8.23 | -53.03 |
| 3390.0 | V | 52 | 213 | -59.16 | -50.31 | 6.85 | 8.31 | -48.85 |

Table 6-6. Radiated Spurious Data – High Channel

– End of this page –



7. CONCLUSION

The data collected relate only the item(s) tested and show that the Samsung Portable Handset FCC ID: A3LSMJ320F compliance with all the requirements of Parts 2, 22 of the FCC rules.

– End of this report –