



Issue Date:

129 Samsung-ro,
Yeongtong-gu, Suwon-Si,
Gyeonggi-Do, 16677
Korea
Tel: 82-31-8062-4278
Fax: 82-31-279-9985

FCC TEST REPORT

Manufacturer: SAMSUNG Electronics Co., Ltd.

Model: SM-J3109

FCC ID: A3LSMJ3109

Application Type: Certification

EUT Type: Portable Handset

All measurements reported here are in accordance with FCC Rules,
47CFR Part2 and Part27.

Prepared By Date
IH Park
Test Engineer

Checked By Date
Jooha Bek
Deputy Technical Manager

Authorized By Date
JD Jang
Technical Manager



Revision History

Rev. #	Issue Date	Revisions	Revised By
1	2015.10.19	▪ Initial issue	IH Park
1/2		▪ Revised Tx Frequency on Table 0-1	IH Park

– End of this page –



Table of Contents

§2.1033 General Information	4
1. INTRODUCTION	5
1.1. General.....	5
2. PRODUCT INFORMATION	5
2.1. Equipment Description	5
2.2. Device Capabilities	5
3. DESCRIPTION OF TESTS	6
3.1. Evaluation Procedure	6
3.2. Measurement Procedure for Radiated Power and Radiated Spurious Emissions .	6
3.3. EMI Suppression Device(s)/Modifications	6
4. TEST EQUIPMENT LIST	7
5. SAMPLE CALCULATIONS	8
6. TEST RESULTS	9
6.1. Summary	9
6.2. Occupied Bandwidth.....	10
6.3. Spurious and Harmonic Emissions at Antenna Terminal	15
6.4. Band Edge Emissions at Antenna Terminal	35
6.5. Frequency Stability / Temperature Variation	42
6.6. Radiated Power (EIRP)	45
6.7. Radiated Spurious Emissions Measurements	48
7. CONCLUSION	52



Issue Date:

§2.1033 General Information

APPLICANT: Samsung Electronics Co., Ltd.

APPLICANT ADDRESS: 129 Samsung-ro,
Yeongtong-gu, Suwon-si, Gyeonggi-do, 16677, Korea

TEST SITE: Samsung Electronics Co., Ltd.

TEST SITE ADDRESS: 129 Samsung-ro,
Yeongtong-gu, Suwon-si, Gyeonggi-do, 16677, Korea

FCC RULE PART(S): §2, §27

TEST PROCEDURE(S): ANSI/TIA603-D-2010, KDB971168 v02r02

BASE MODEL: SM-J3109

FCC ID: A3LSMJ3109

FCC CLASSIFICATION: PCS Licensed Transmitter Held to Ear (PCE)

MODE: LTE

EMISSION DESIGNATOR: See Table 0-1

TX FREQUENCY BLOCK 2555 – 2655MHz (LTE Band 41)

RX FREQUENCY BLOCK 2555 – 2655MHz (LTE Band 41)

MAX POWER RATING: 0.161 W ERP LTE Band 41 (22.07 dBm)

TEST DEVICE SERIAL NO.: FCM-034-A , FCM-034-B

DATE(S) OF TEST: September 22 – October 16, 2015

Mode	Tx Frequency (MHz)	Emission Designator	Modulation	EIRP	
				Max. Power (Watt)	Max. Power (dBm)
LTE Band 41	2557.5 – 2652.5	4M46G7D	QPSK	0.145	21.61
LTE Band 41	2557.5 – 2652.5	4M48W7D	16QAM	0.102	20.09
LTE Band 41	2560.0 – 2650.0	8M95G7D	QPSK	0.161	22.07
LTE Band 41	2560.0 – 2650.0	8M95W7D	16QAM	0.113	20.55
LTE Band 41	2562.5 – 2647.5	13M4G7D	QPSK	0.157	21.97
LTE Band 41	2562.5 – 2647.5	13M4W7D	16QAM	0.118	20.72
LTE Band 41	2565.0 – 2645.0	17M8G7D	QPSK	0.158	21.99
LTE Band 41	2565.0 – 2645.0	17M8W7D	16QAM	0.118	20.71

Table 0-1. Emission Designator



1. INTRODUCTION

1.1. General

These measurement tests were conducted at SAMSUNG ELECTRONICS CO., LTD. (SUWON). The site address is 129 Samsung-ro, Yeongtong-gu, Suwon-si, Gyeonggi-do, 16677, Korea.

2. PRODUCT INFORMATION

2.1. Equipment Description

The Equipment Under Test (EUT) is the Samsung Portable Handset FCC ID: A3LSMJ3109. The test data contained in this report pertains only to the emissions due to the EUT's LTE function.

2.2. Device Capabilities

This device contains the following capabilities:

1900 GSM/GPRS/EDGE, 850/1900 WCDMA, Multi-band LTE, 802.11b/g/n WLAN, Bluetooth (1x, EDR, LE, HS), NFC.



3. DESCRIPTION OF TESTS

3.1. Evaluation Procedure

The measurement procedures described in the document titled "Land Mobile FM or PM - Communications Equipment- Measurements and Performance Standards" (ANSI/TIA-603-D-2010) and "Procedures for Compliance Measurement of the Fundamental Emission Power of Licensed Wideband (> 1MHz) Digital Transmission System" (KDB 971168) were used in the measurement of the Samsung Portable Handset FCC ID: A3LSMJ3109.

3.2. Measurement Procedure for Radiated Power and Radiated Spurious Emissions

The radiated and spurious measurements were made at the full anechoic chamber. The equipment under test was placed on the Turn Device at the same height and a distance of 3-meters from the measuring antenna.

The turn device is designed for mobile device measurements. Different sized devices can be mounted on the mounting bracket made of Rohacell.

The turn device is mounted onto a turntable to have both 360° vertical and horizontal rotation. The measurement was made for each horizontal/vertical position in combination with horizontally and vertically polarized measuring antenna.

The substitution antenna will replace the EUT antenna at the same position. The frequency of the signal generator shall be set to the frequencies that were measured on the EUT. The output level of the signal generator shall be adjusted until an equal or a known related level that was measured from the EUT. This level was recorded. For emissions above 1 GHz, the above procedure is repeated by using horn antennas and dBi gain is taken into consideration.

The power of the emission is calculated using the following formula:

$$P_{d[\text{dBm}]} = P_{g[\text{dBm}]} - \text{cable loss}_{[\text{dB}]} + \text{antenna gain}_{[\text{dBd,dBi}]}$$

Where P_d is the dipole equivalent power, P_g is the generator output into the substitution antenna, and the antenna gain is the gain of the substitute antenna used relative to either a half-wave dipole(dBd) or an isotropic source(dBi). The cable connects the generator to the substitute antenna.

Radiated power levels and radiated spurious emissions levels are investigated per ANSI/TIA-603-D-2010.

3.3. EMI Suppression Device(s)/Modifications

No EMI suppression device(s) were added and no modifications were made during testing.



4. TEST EQUIPMENT LIST

The measuring equipment, which was utilized in performing the tests documented herein, has been calibrated in accordance with the manufacturer's recommendations for utilizing calibration equipment, which is traceable to recognized national standards.

Description	Model	Serial No.	Manufacturer	Cal. Date	Cal. Due
Wideband Radio Communication Tester	CMW500	140748	R&S	2014-10-28	2015-10-28
Wideband Radio Communication Tester	CMW500	100697	R&S	2014-11-03	2015-11-03
Signal & Spectrum Analyzer	FSW	103775	R&S	2014-12-17	2015-12-17
PXA Signal Analyzer	N9030A	MY52350977	Agilent	2014-10-24	2015-10-24
PSG Analog Signal Generator	E8257D	MY51501209	Agilent	2014-11-07	2015-11-07
EPM Series Power Meter	E4419B	GB41293846	Agilent	2015-09-22	2016-09-22
POWER SENSOR	E9300H	MY41495838	Agilent	2015-09-18	2016-09-18
DC Power Supply	E3642A	MY40022438	Agilent	2015-02-23	2016-02-23
Temperature Humidity Chamber	SH-641	92009178	Espec	2015-03-19	2016-03-19
Loop Antenna	HFH2-Z2	100276	R&S	2014-05-19	2016-05-19
DIPOLE ANTENNA	UHA 9105	9105-2412	Schwarzbeck	2015-09-08	2017-09-08
LOG PERIODIC DIPOLE ANTENNA	HL040	353255/020	R&S	2014-10-15	2016-10-15
HORN Antenna	3115	00156307	ETS LINDGREN	2015-05-07	2017-05-07
HORN Antenna	3115	00156245	ETS LINDGREN	2015-05-07	2017-05-07
HORN Antenna & Pre-amplifier assembly	HAP18-26N	216250	Flann	2014-01-09	2016-01-09
HORN Antenna & Pre-amplifier assembly	HAP18-26N	216251	Flann	2015-04-30	2017-04-30
PRE-AMPLIFIER	8449B	3008A00691	Agilent	2014-11-25	2015-11-25
RF Power Amplifier	5S1G4	304866	AR	2015-02-09	2016-02-09
Hygrothermograph Data Logger	SK-L200TH2a	5077	SATO	2014-10-31	2015-10-31
Hygrothermograph Data Logger	SK-L200TH2a	5078	SATO	2014-10-31	2015-10-31
Hygrothermograph Data Logger	SK-L200TH2a	5110	SATO	2014-10-31	2015-10-31
Power Divider	11636B	58456	Agilent	2015-04-27	2016-04-27
Highpass Filter	WHVX1.0/15G-10SS	39	Wainwright	2015-01-07	2016-01-07
Highpass Filter	WHKX3.0/18G-10SS	206	Wainwright	2015-01-07	2016-01-07
Attenuator 10dB	8491B	MY39264180	Agilent	2015-06-23	2016-06-23
Attenuator 20dB	8493C	74158	Agilent	2015-08-20	2016-08-20

Table 4-1. Test Equipment

Notes:

1. For equipment listed above that has calibration dates that falls within the test date range, care was taken to ensure that this equipment was used after the calibration date and before the calibration due date.



5. SAMPLE CALCULATIONS

5.1. QPSK Modulation

Emission Designator = 8M62G7D

LTE BW = 8.62 MHz

G = Phase Modulation

7 = Quantized/Digital Info

D = Data transmission

5.2. 16QAM Modulation

Emission Designator = 8M45W7D

LTE BW = 8.45 MHz

W = Amplitude/Angle Modulation

7 = Quantized/Digital Info

D = Data transmission

5.3. Spurious Radiated Emission

Example: Spurious emission at 3700.40MHz

The receive spectrum analyzer reading at 3 meters with the EUT on the turn device was -81.0dBm. The gain of the substituted antenna is 8.1dBi. The signal generator connected to the substituted antenna terminals is adjusted to produce a reading of -81.0dBm on the spectrum analyzer. The loss of the cable between the signal generator and the terminals of the substituted antenna is 2.0dB at 3700.40MHz. So 6.1dB is added to the signal generator reading of -30.9dBm yielding -24.80dBm. The fundamental EIRP was 25.50dBm so this harmonic was 25.50dBm - (-24.80) = 50.3dBc.

– End of this page –



6. TEST RESULTS

6.1. Summary

FCC Part Section(s)	Test Description	Test Limit	Test Condition	Test Result	Reference
TRANSMITTER MODE (TX)					
2.1049	Occupied Bandwidth	N/A	CONDUCTED	PASS	Section 6.2
2.1051 27.53(m)	Conducted Band Edge / Spurious Emissions	> 40+10log ₁₀ (P[Watts]) between channel edge and 5 MHz from the channel edge, > 43+10log ₁₀ (P[Watts]) between 5 MHz and X MHz from the channel edge, or between 2490.5 MHz and 2496 MHz, > 55+10log ₁₀ (P[Watts]) more than X MHz from the channel edge, or below 2490.5 MHz, where X is the grater of 6 MHz or the actual emission bandwidth.		PASS	Sections 6.3, 6.4
2.1046	Transmitter Conducted Output Power	N/A		PASS	See SAR Report
2.1055 27.54	Frequency Stability	Fundamental emissions stay within authorized frequency block		PASS	Section 6.5
27.50(h.2)	Equivalent Isotropic Radiated Power	< 2 Watts max. EIRP		PASS	Section 6.6
2.1053 27.53(m)	Radiated Spurious Emissions	> 40+10log ₁₀ (P[Watts]) between channel edge and 5 MHz from the channel edge, > 43+10log ₁₀ (P[Watts]) between 5 MHz and X MHz from the channel edge, or between 2490.5 MHz and 2496 MHz, > 55+10log ₁₀ (P[Watts]) more than X MHz from the channel edge, or below 2490.5 MHz, where X is the grater of 6 MHz or the actual emission bandwidth.	RADIATED	PASS	Section 6.7

Table 6-1. Summary of Test Results

Notes:

1. All modes of operation and data rates were investigated. The test results shown in the following sections represent the worst case emissions.
2. The analyzer plots shown in this section were all taken with a correction table loaded into the analyzer. The correction table was used to account for the losses of the cables, couplers, and attenuators used as part of the system to connect the EUT to the analyzer at all frequencies of interest.
3. All antenna port conducted emissions testing was performed on a test bench with the antenna port of the EUT connected to the spectrum analyzer through calibrated cables and couplers.
4. For conducted spurious emissions, automated test software was used to measure emissions and capture the corresponding plots necessary to show compliance. The measurement software utilized is Rohde & Schwarz and SAMSUNG Electronics "CMWrun", Version 1.8.1.

6.2. Occupied Bandwidth

§2.1049

Test Overview

The Occupied bandwidth, that is the frequency bandwidth such that, below its lower and above its upper frequency limits, the mean powers radiated are each equal to 0.5 percent of the total mean power radiated by a given emission shall be measured. All modes of operation were investigated and the worst case configuration results are reported in this section.

Test Procedure Used

KDB 971168 v02r02 – Section 4.2

Test Settings

1. The signal analyzer's automatic bandwidth measurement capability was used to perform the 99% Occupied bandwidth. The bandwidth measurement was not influenced by any intermediate power nulls in the fundamental emission.
2. RBW = 1 – 5% of the expected OBW
3. VBW \geq 3 x RBW
4. Detector = Peak
5. Trace mode = max hold
6. Sweep = auto couple
7. The trace was allowed to stabilize
8. If necessary, steps 2 – 7 were repeated after changing the RBW such that it would be within 1 – 5% of the 99% occupied bandwidth observed in Step 7

Test Setup

The EUT and measurement equipment were set up as shown in the diagram below.

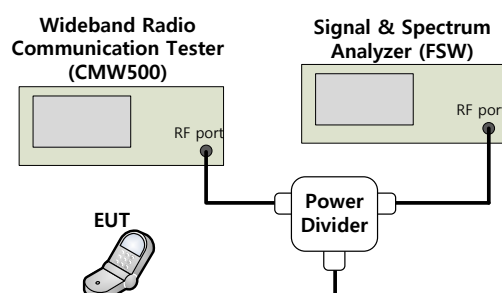
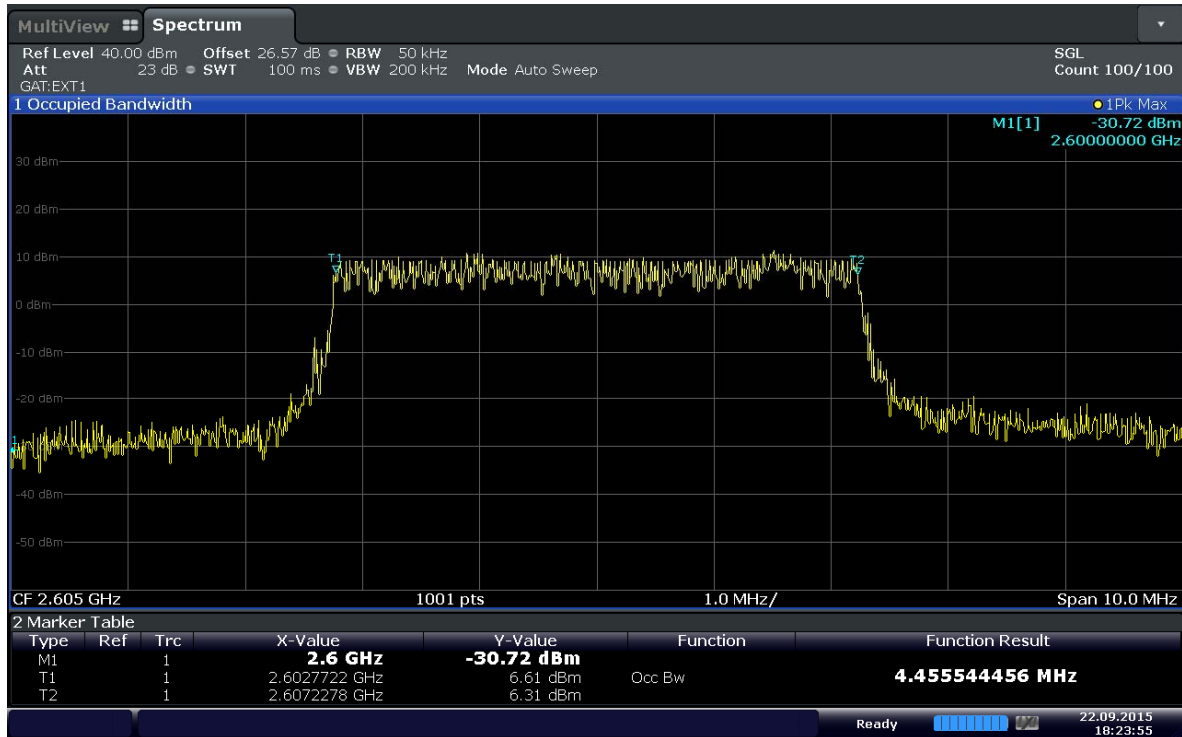

Figure 6-1. Test Instruments & Measurement Setup



Test Plots



Date: 22.SEP.2015 18:23:56

Plot 6-1. Occupied Bandwidth Plot (Band 41 – 5MHz QPSK - RB Size 25)

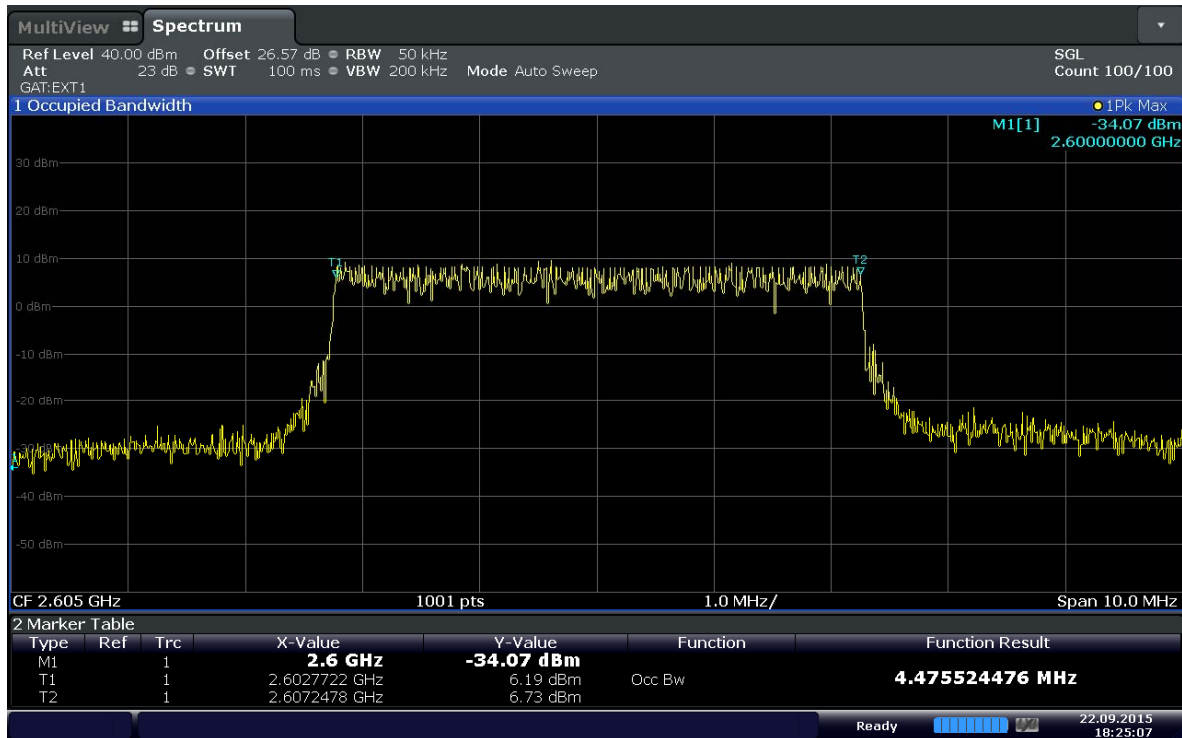

Date: 22.SEP.2015 18:25:08

Plot 6-2. Occupied Bandwidth Plot (Band 41 – 5MHz 16QAM - RB Size 25)

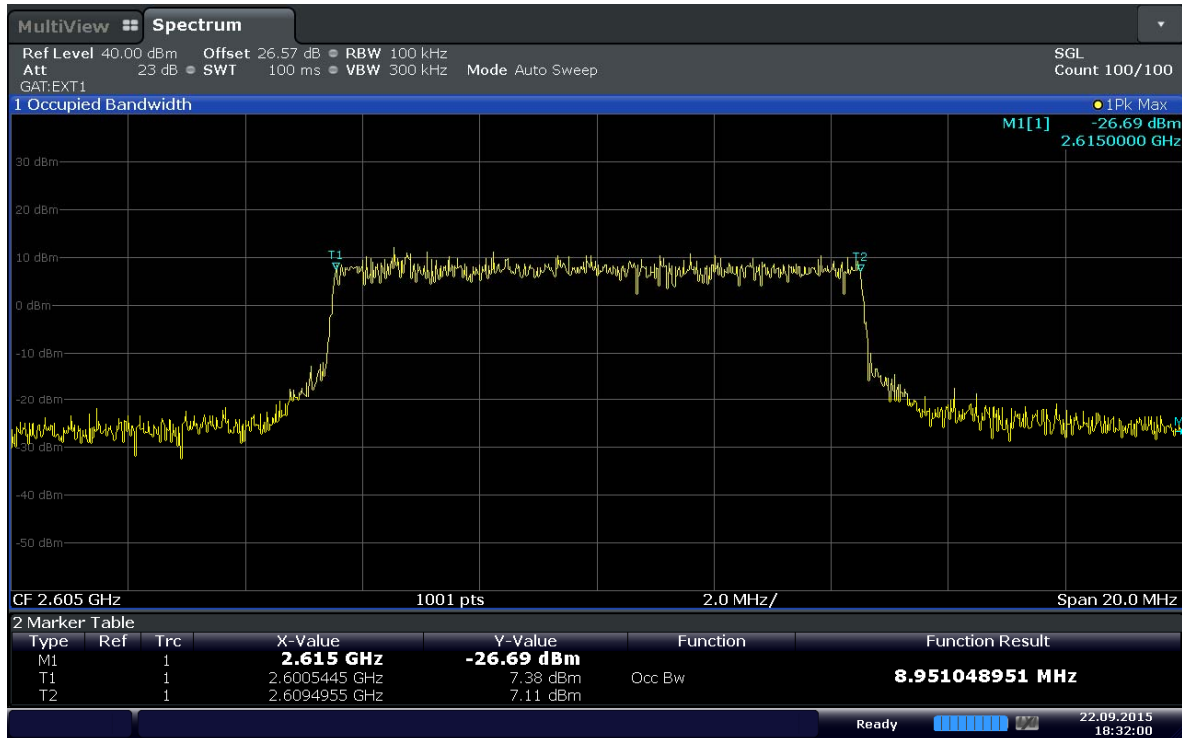

Date: 22.SEP.2015 18:32:00

Plot 6-3. Occupied Bandwidth Plot (Band 41 – 10MHz QPSK - RB Size 50)

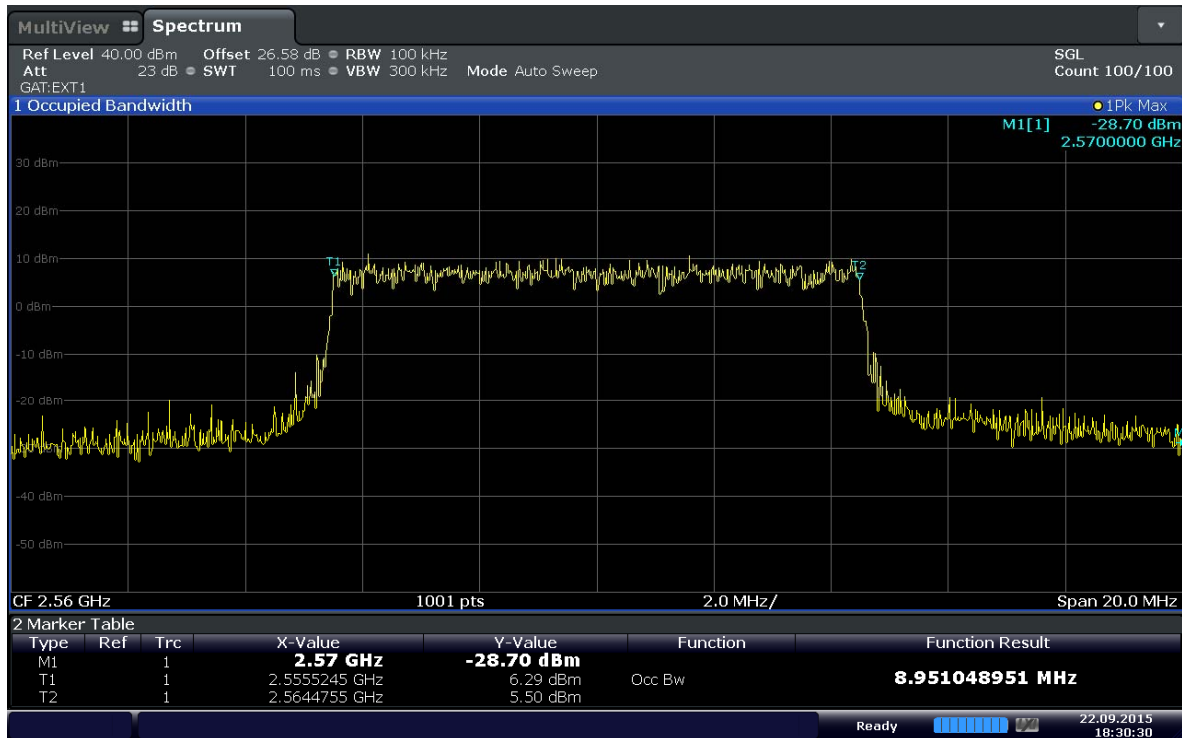

Date: 22.SEP.2015 18:30:30

Plot 6-4. Occupied Bandwidth Plot (Band 41 – 10MHz 16QAM - RB Size 50)

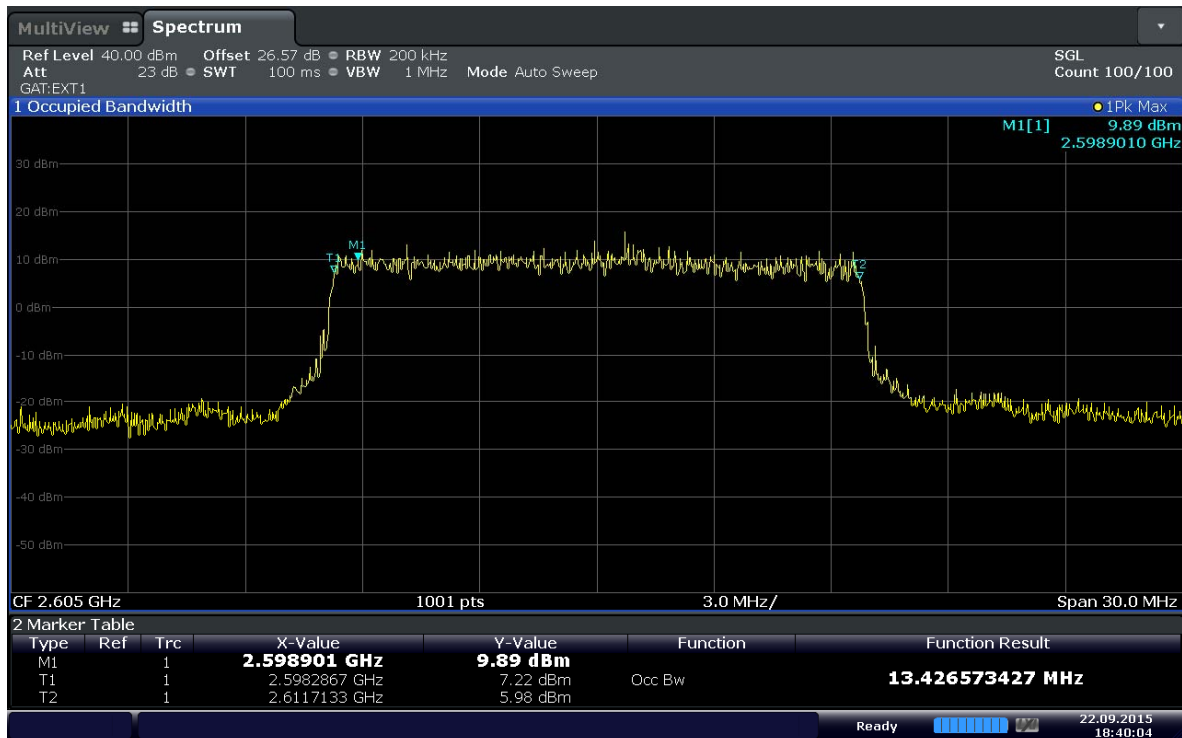

Date: 22.SEP.2015 18:40:04

Plot 6-5. Occupied Bandwidth Plot (Band 41 - 15MHz QPSK - RB Size 75)

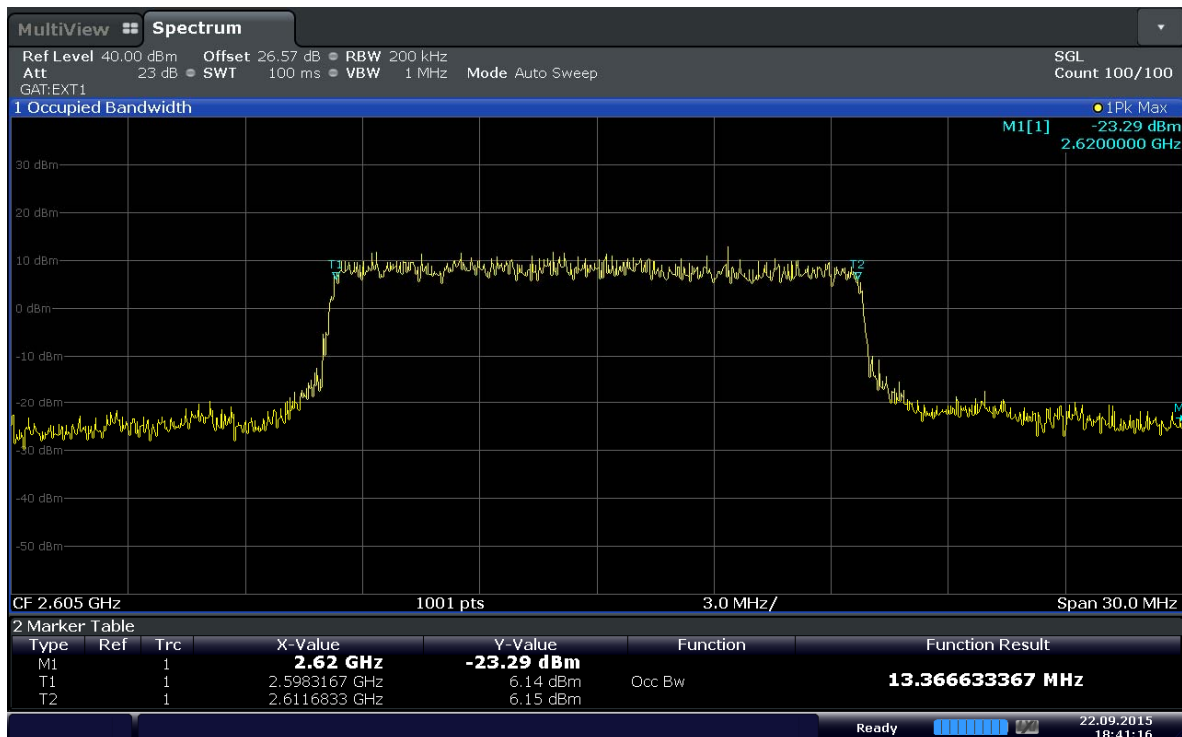

Date: 22.SEP.2015 18:41:16

Plot 6-6. Occupied Bandwidth Plot (Band 41 - 15MHz 16QAM - RB Size 75)



Issue Date:

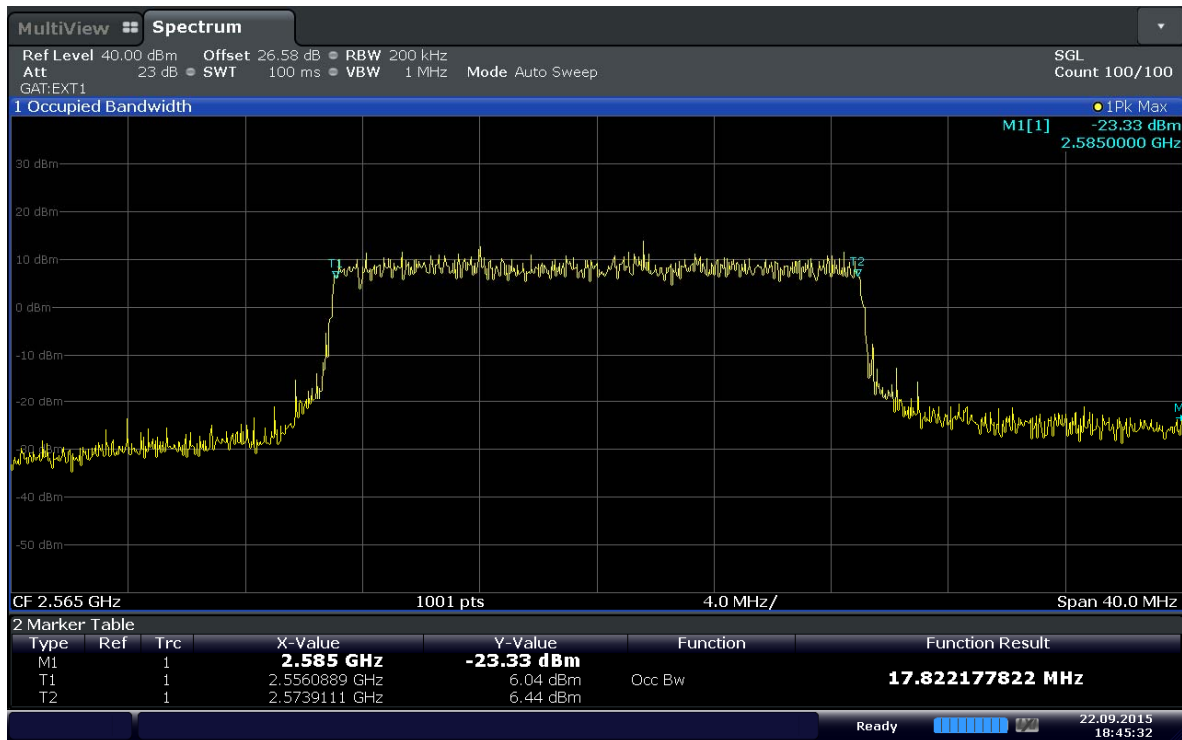

Date: 22.SEP.2015 18:45:33

Plot 6-7. Occupied Bandwidth Plot (Band 41 - 20MHz QPSK - RB Size 100)

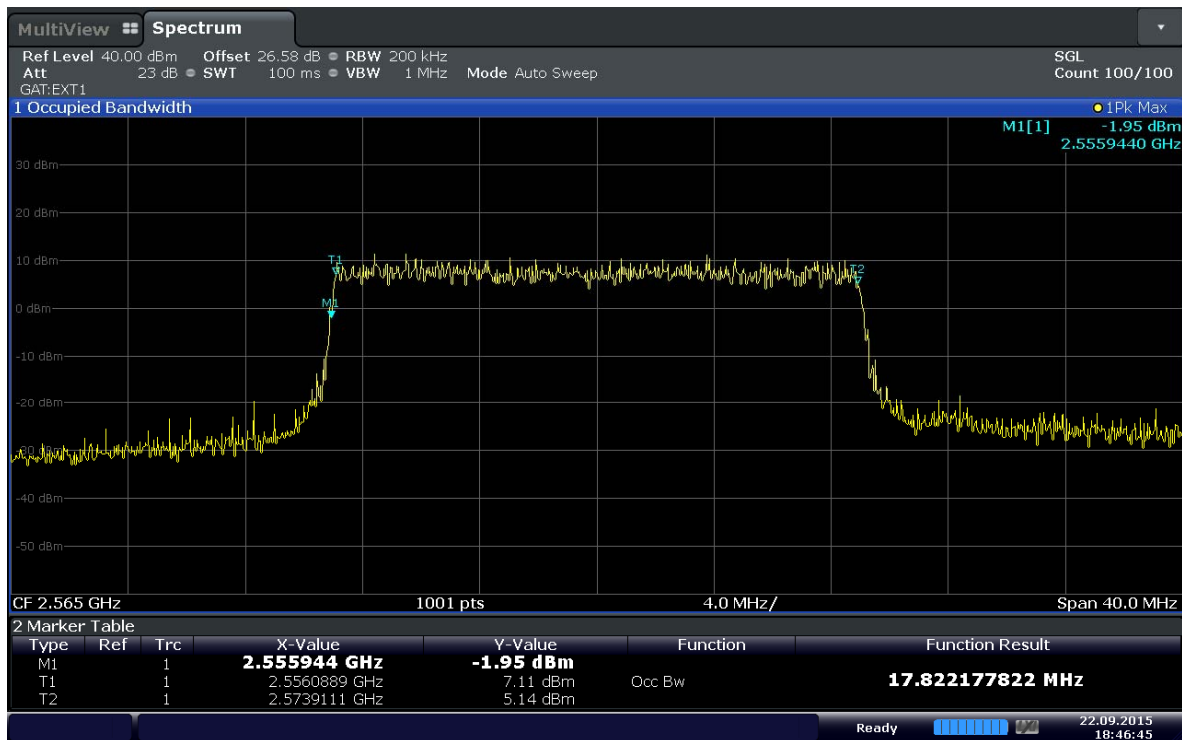

Date: 22.SEP.2015 18:46:46

Plot 6-8. Occupied Bandwidth Plot (Band 41 - 20MHz 16QAM - RB Size 100)



6.3. Spurious and Harmonic Emissions at Antenna Terminal §2.1051 §27.53(m)

Test Overview

The level of the carrier and the various conducted spurious and harmonic frequencies is measured by means of a calibrated spectrum analyzer. The spectrum is scanned from the lowest frequency generated in the equipment up to a frequency including its 10th harmonic. All out of band emissions are measured with a spectrum analyzer connected to the antenna terminal of the EUT while the EUT is operating at maximum power, and at the appropriate frequencies. All data rates were investigated to determine the worst case configuration. All modes of operation were investigated and the worst case configuration results are reported in this section.

The minimum permissible attenuation level of any spurious emission is $55 + 10 \log_{10}(P_{[\text{Watts}]})$, where P is the transmitter power in Watts. Limit equivalent to -25dBm, calculation shown below.

$$\begin{aligned}55 + 10 \log_{10}(1.567\text{W}) &= 56.95 \text{ dB} \\1.567\text{W} &= 31.95 \text{ dBm} \\31.95 \text{ dBm} - 56.95 \text{ dB} &= -25 \text{ dBm}\end{aligned}$$

Test Procedure Used

KDB 971168 v02r02 – Section 6.0

Test Settings

1. Start frequency was set to 30MHz and stop frequency was set to 26GHz (separated into four plots per channel)
2. RBW \geq 1 MHz
3. VBW \geq 3 x RBW
4. Detector = RMS
5. Trace mode = max hold
6. Sweep time = auto couple
7. The trace was allowed to stabilize

Test Setup

The EUT and measurement equipment were set up as shown in the diagram below.

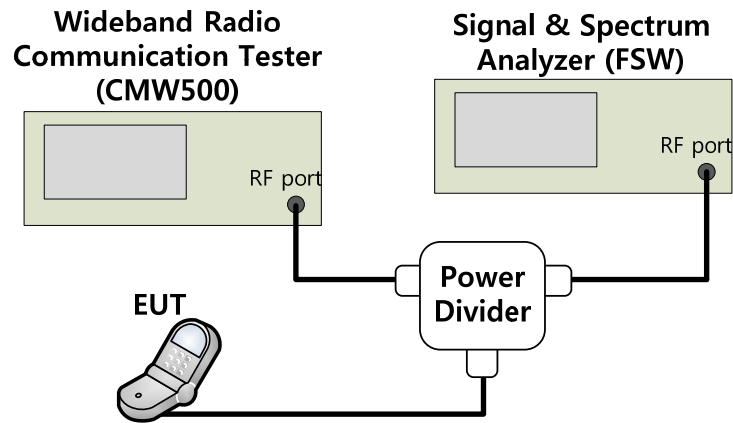
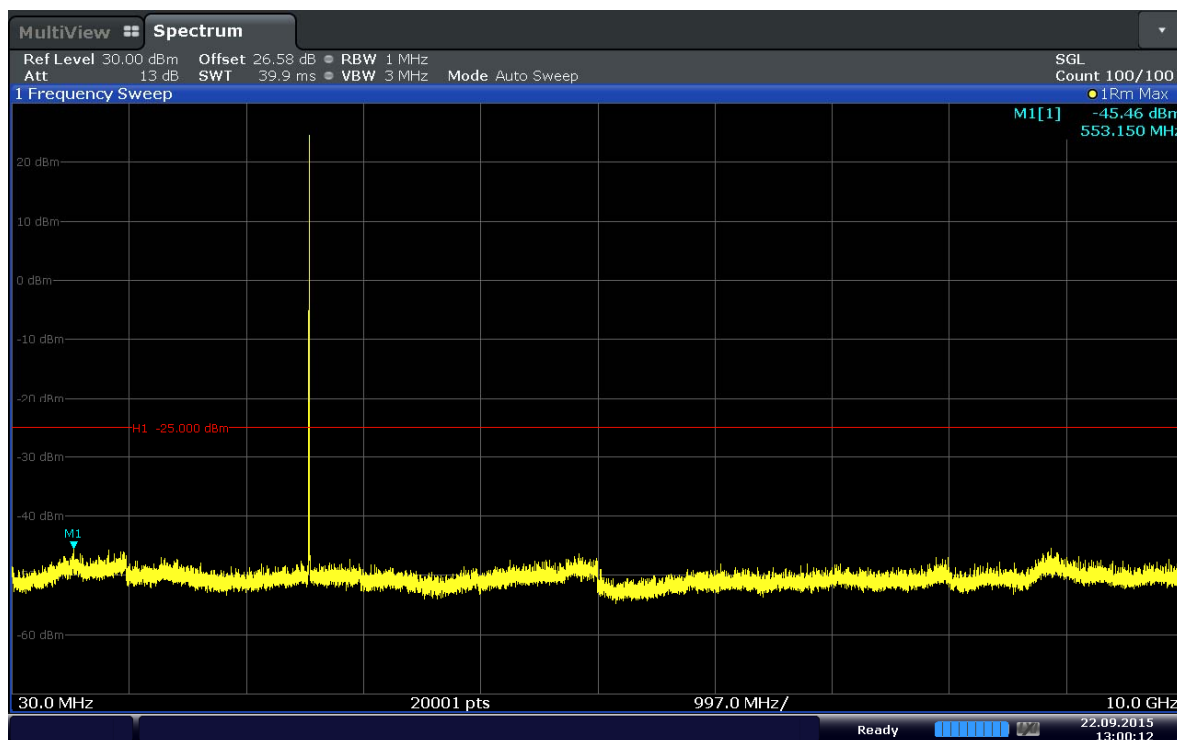

Figure 6-2. Test Instruments & Measurement Setup



Test Plots



Date: 22.SEP.2015 13:00:12

Plot 6-9. Conducted Spurious Plot (Band 41-5MHz-QPSK-RB Size 1-RB Offset 12-Ch.40265)

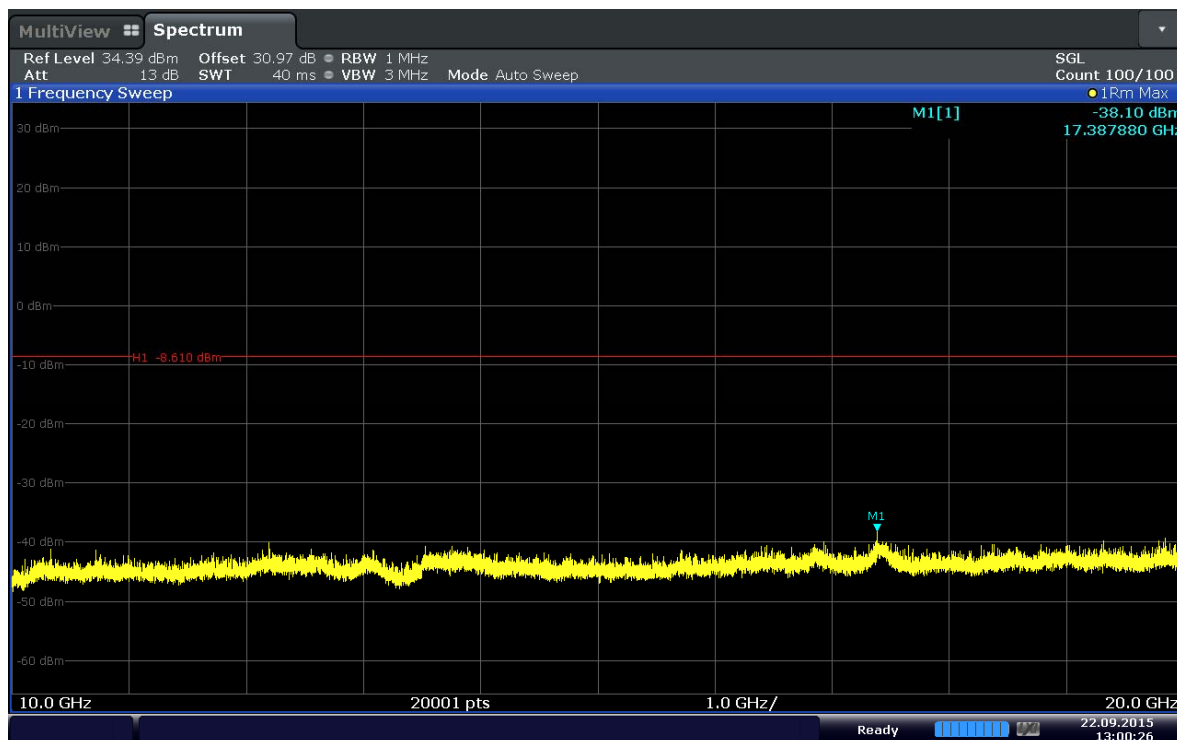

Date: 22.SEP.2015 13:00:27

Plot 6-10. Conducted Spurious Plot (Band 41-5MHz-QPSK-RB Size 1-RB Offset 12-Ch. 40265)



Issue Date:

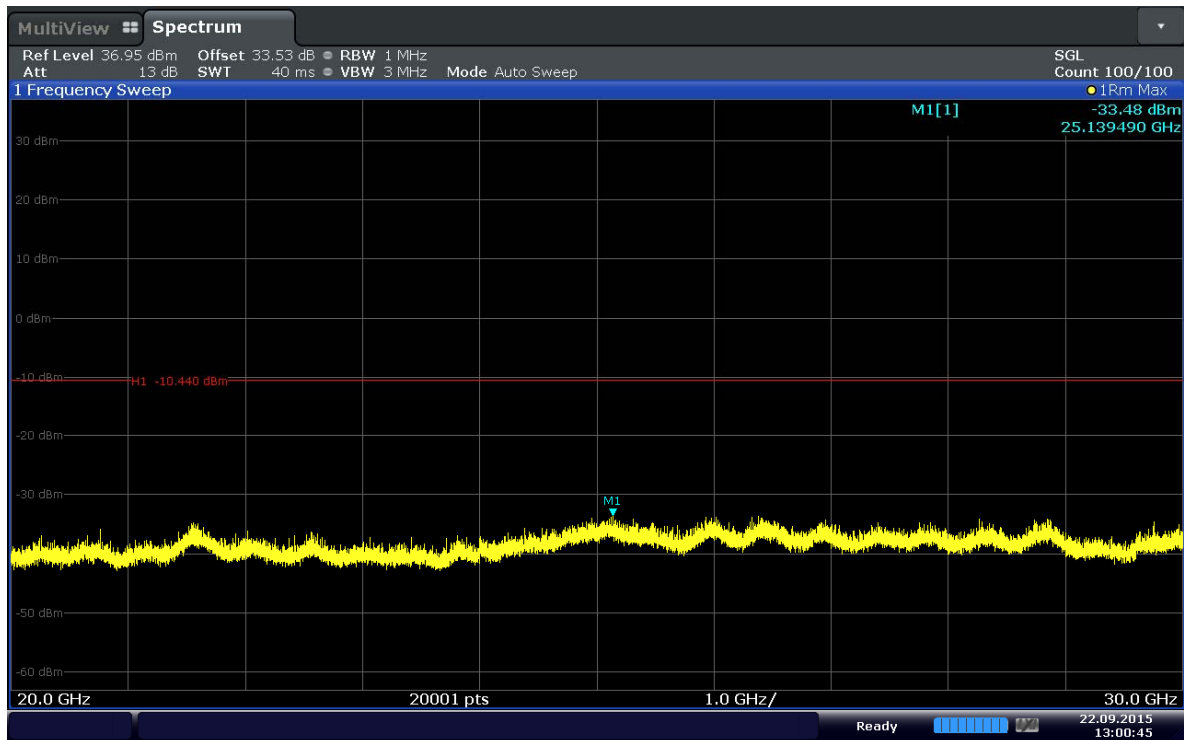

Date: 22.SEP.2015 13:00:45

Plot 6-11. Conducted Spurious Plot (Band 41–5MHz–QPSK–RB Size 1–RB Offset 12–Ch. 40265)

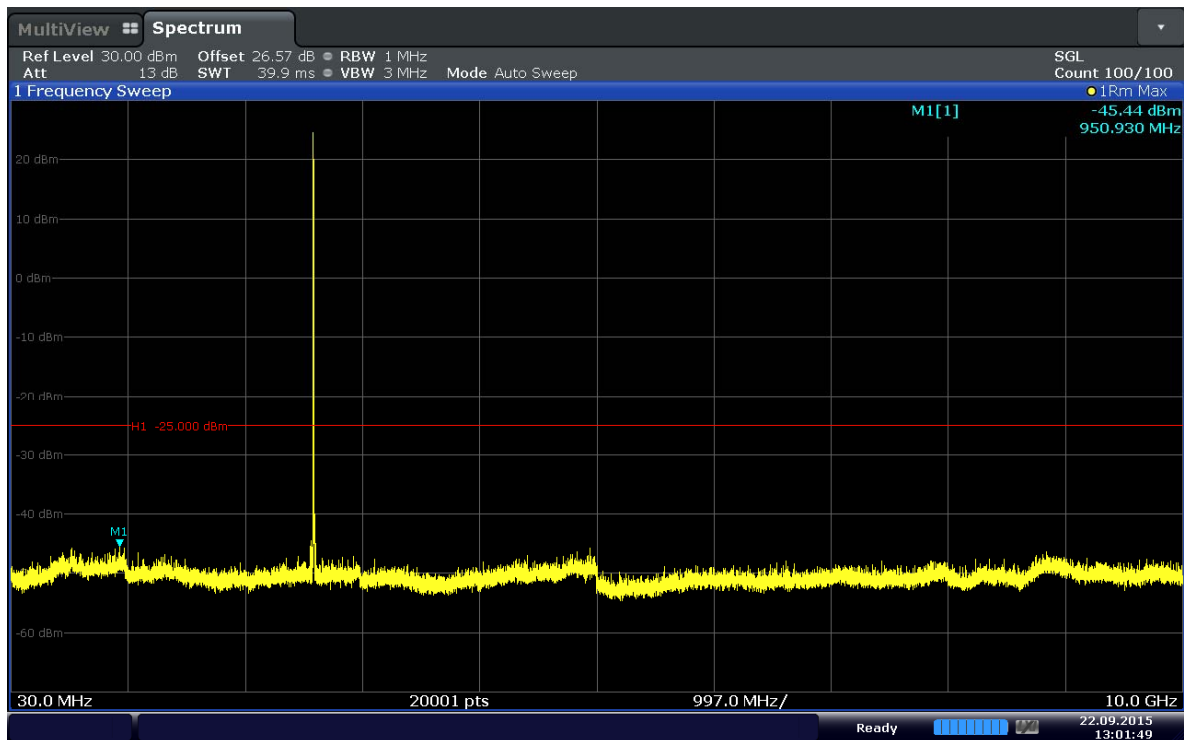

Date: 22.SEP.2015 13:01:50

Plot 6-12. Conducted Spurious Plot (Band 41–5MHz–QPSK–RB Size 1–RB Offset 0–Ch.40740)



Issue Date:

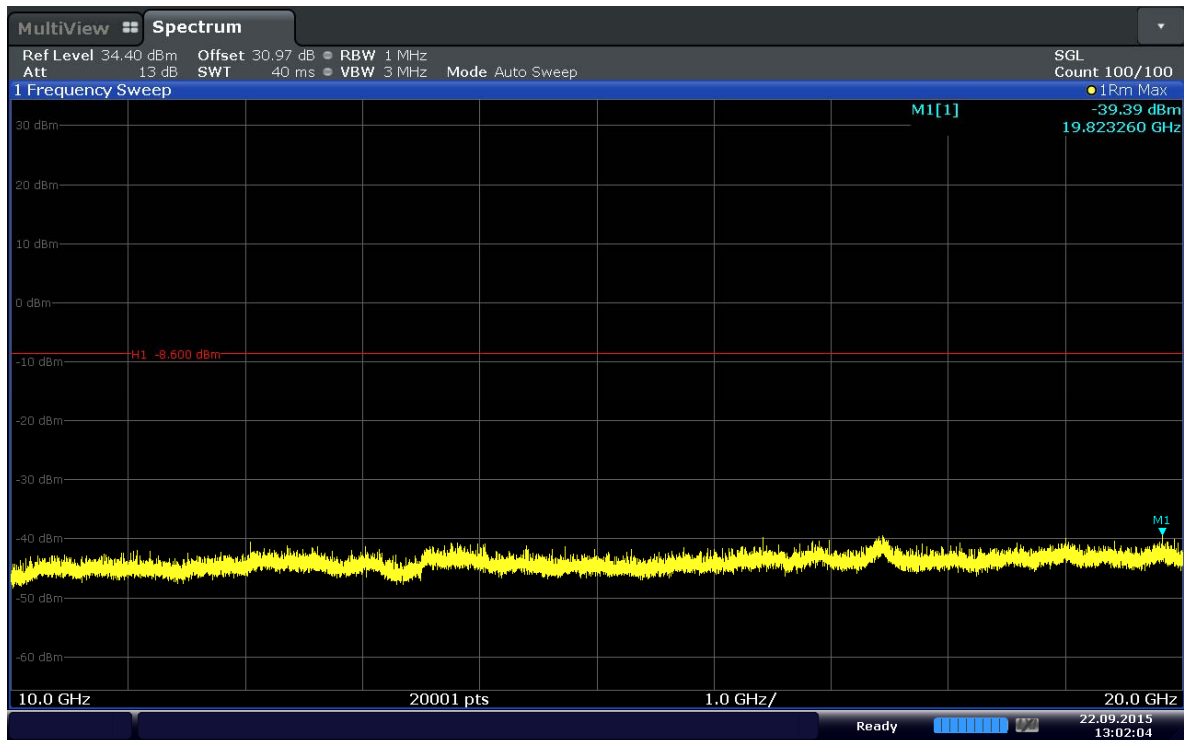

Date: 22.SEP.2015 13:02:04

Plot 6-13. Conducted Spurious Plot (Band 41–5MHz–QPSK–RB Size 1–RB Offset 0–Ch.40740)

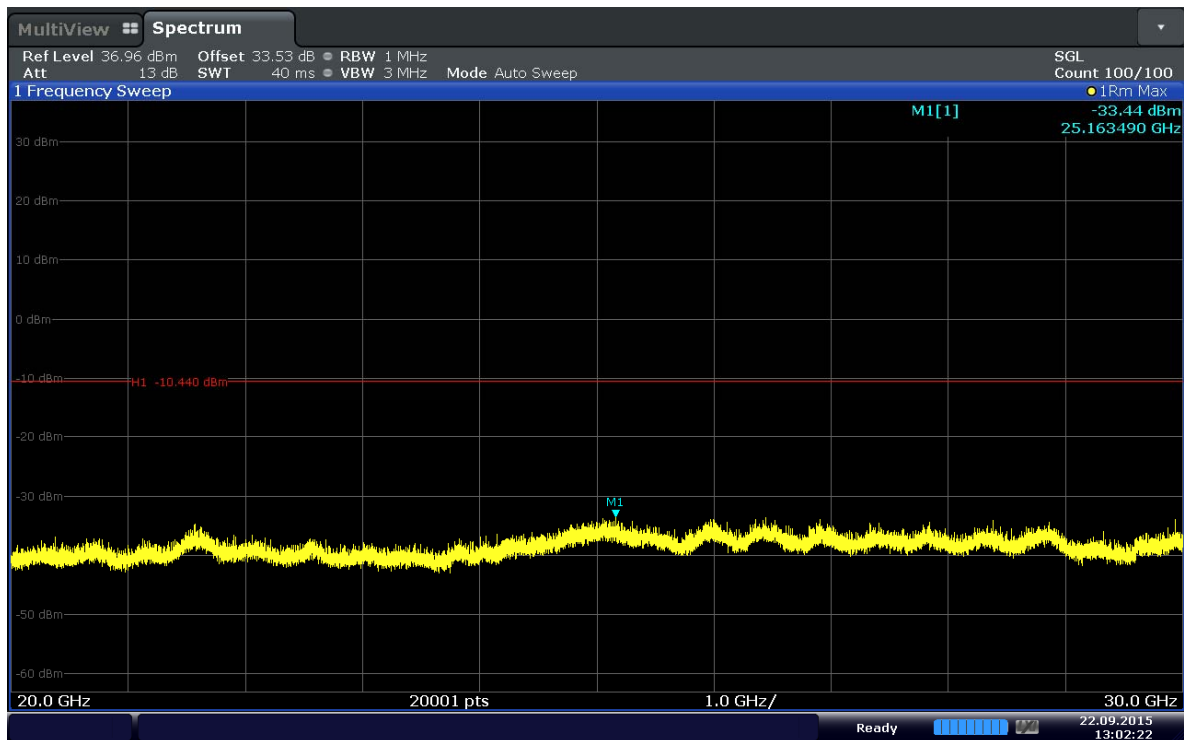

Date: 22.SEP.2015 13:02:22

Plot 6-14. Conducted Spurious Plot (Band 41–5MHz–QPSK–RB Size 1–RB Offset 0–Ch.40740)

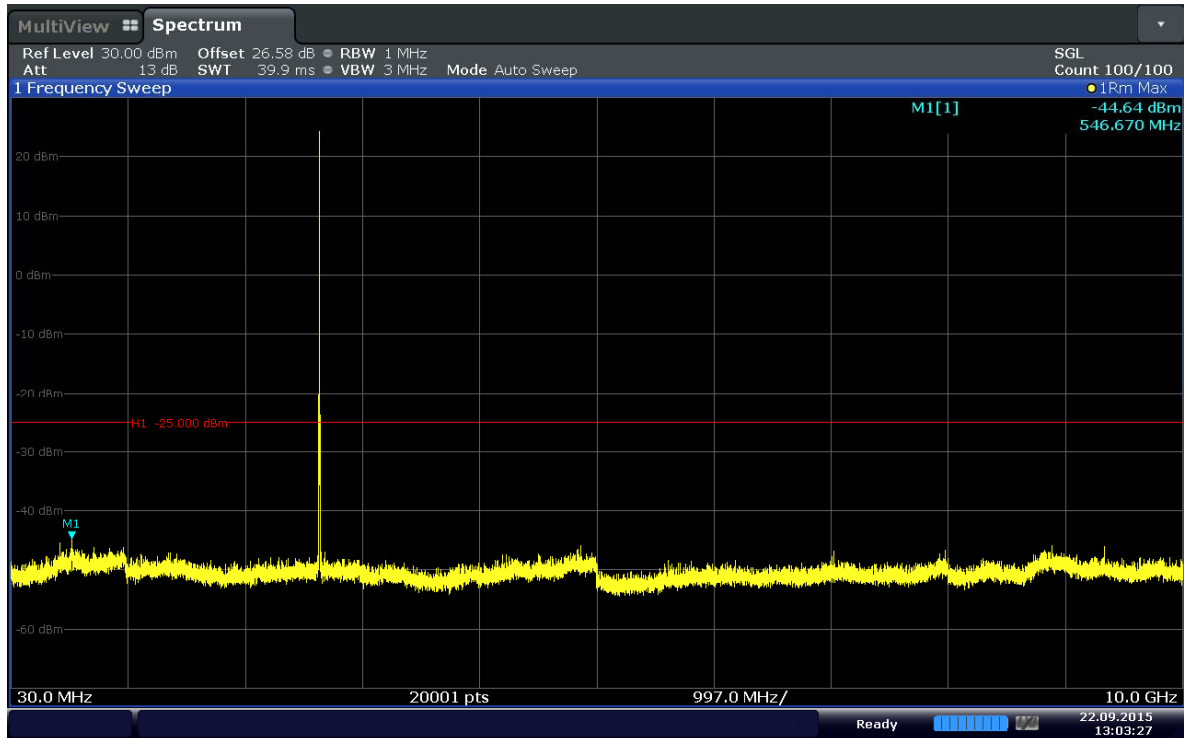

Date: 22.SEP.2015 13:03:27

Plot 6-15. Conducted Spurious Plot (Band 41–5MHz–QPSK–RB Size 1–RB Offset 12–Ch.41215)

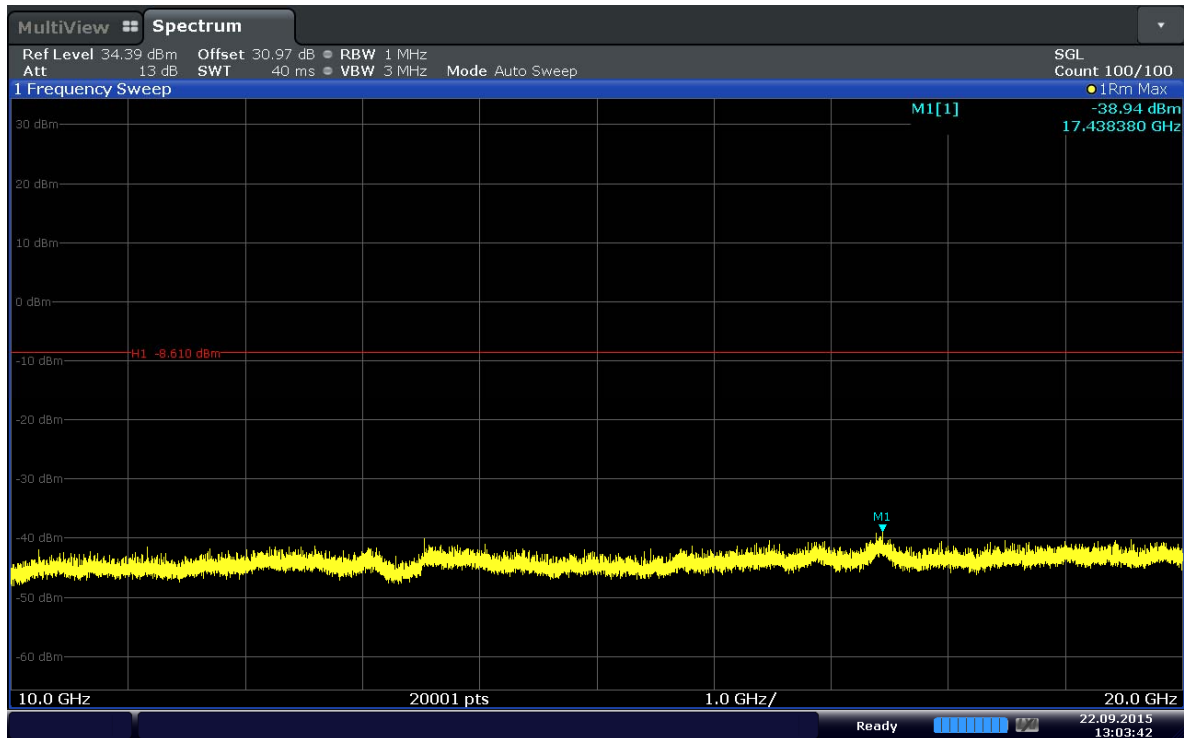

Date: 22.SEP.2015 13:03:42

Plot 6-16. Conducted Spurious Plot (Band 41–5MHz–QPSK–RB Size 1–RB Offset 12–Ch.41215)

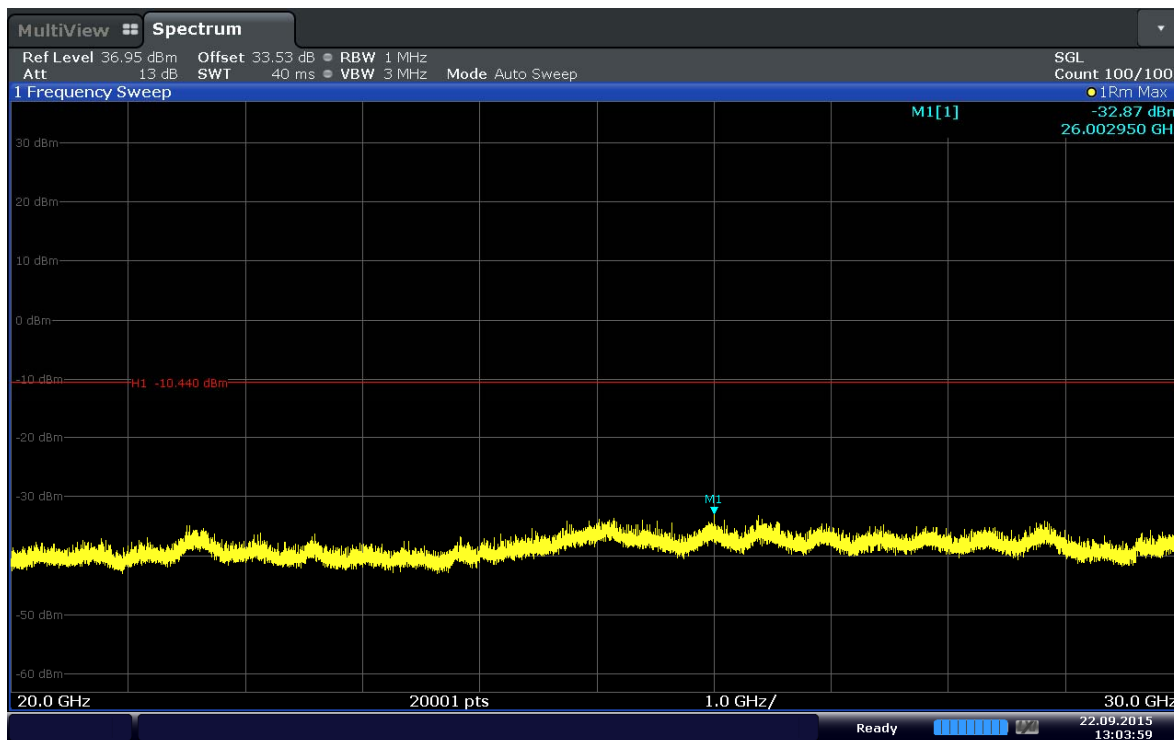

Date: 22.SEP.2015 13:04:00

Plot 6-17. Conducted Spurious Plot (Band 41–5MHz–QPSK–RB Size 1–RB Offset 12–Ch.41215)

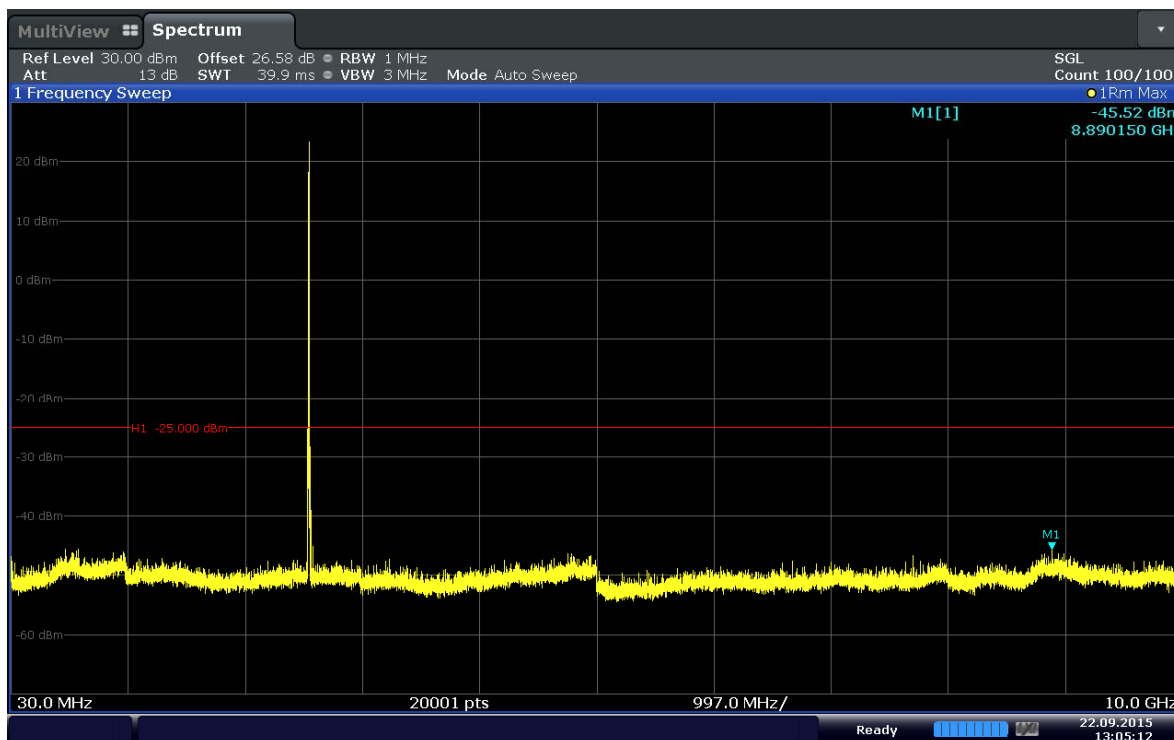

Date: 22.SEP.2015 13:05:13

Plot 6-18. Conducted Spurious Plot (Band 41–10MHz–QPSK–RB Size 1–RB Offset 49–Ch.40290)



Issue Date:

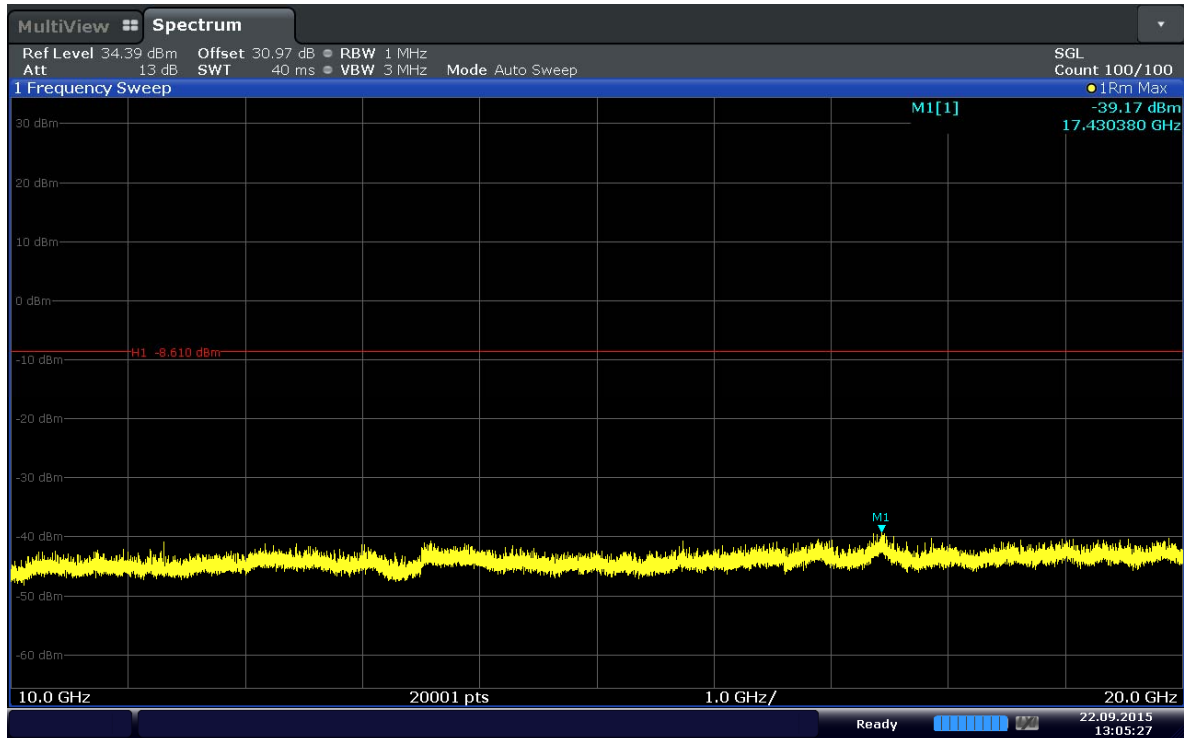

Date: 22.SEP.2015 13:05:27

Plot 6-19. Conducted Spurious Plot (Band 41–10MHz–QPSK–RB Size 1–RB Offset 49–Ch.40290)

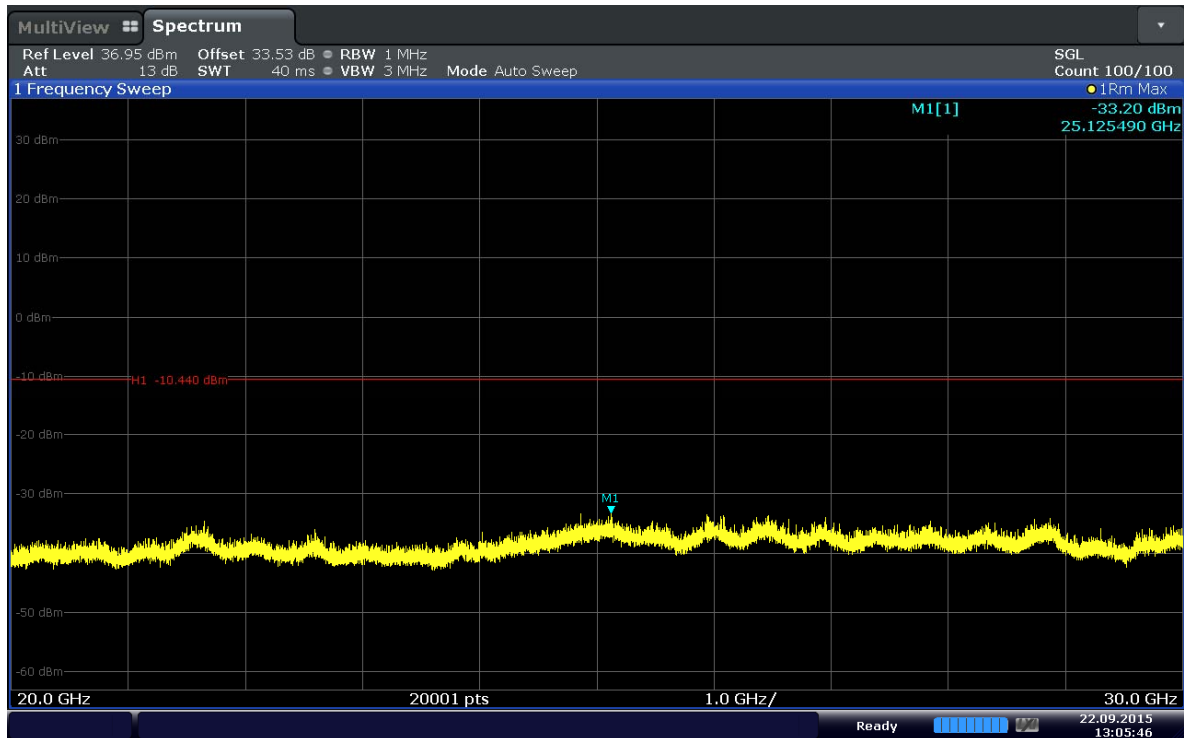

Date: 22.SEP.2015 13:05:46

Plot 6-20. Conducted Spurious Plot (Band 41–10MHz–QPSK–RB Size 1–RB Offset 49–Ch.40290)

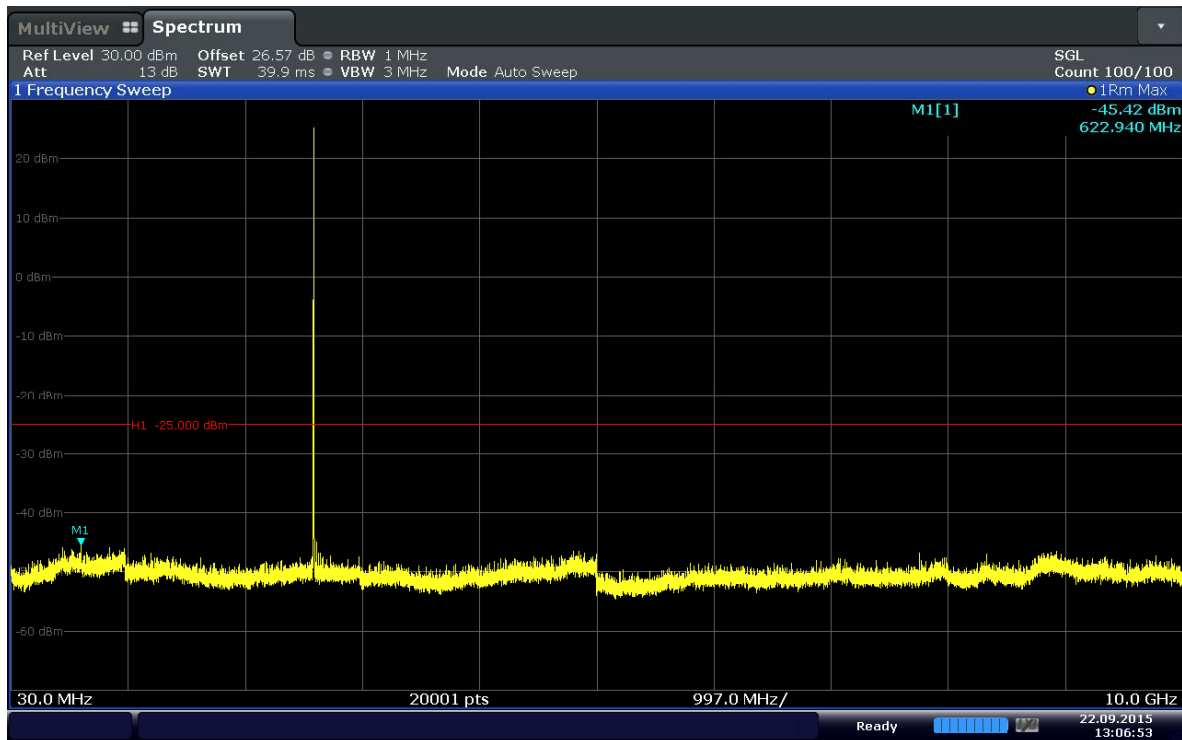

Date: 22.SEP.2015 13:06:53

Plot 6-21. Conducted Spurious Plot (Band 41–10MHz–QPSK–RB Size 1–RB Offset 24–Ch.40740)

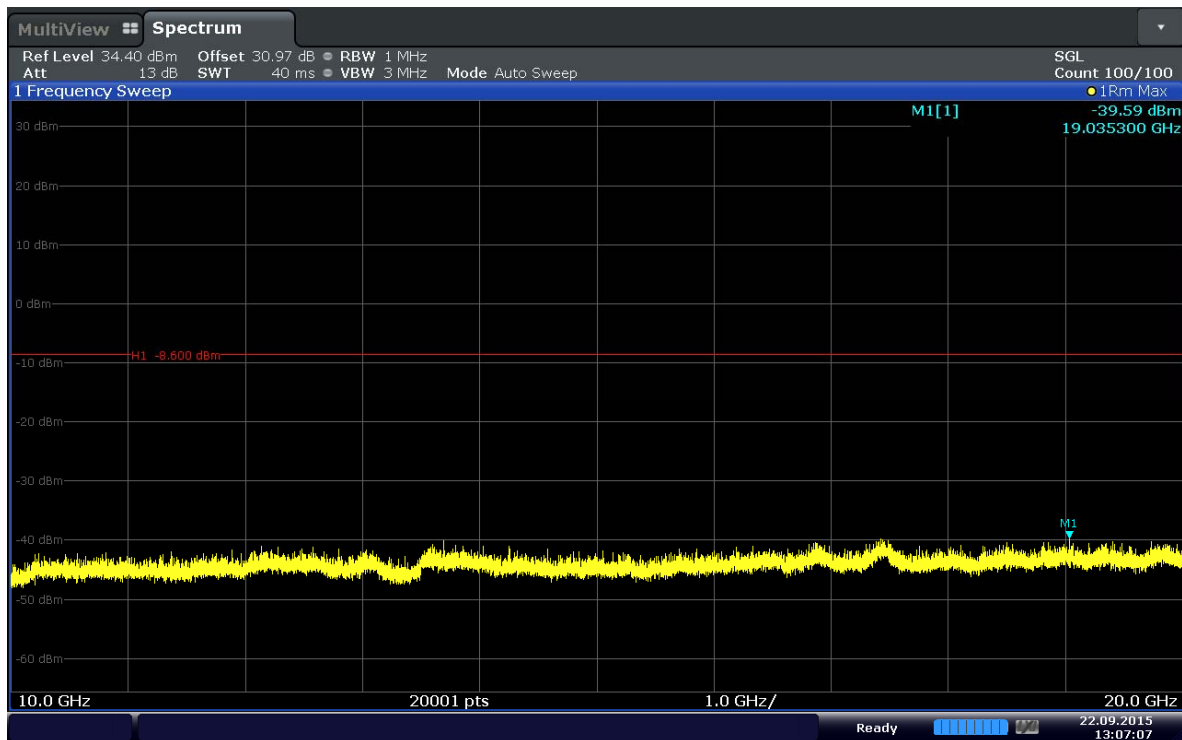

Date: 22.SEP.2015 13:07:07

Plot 6-22. Conducted Spurious Plot (Band 41–10MHz–QPSK–RB Size 1–RB Offset 24–Ch.40740)

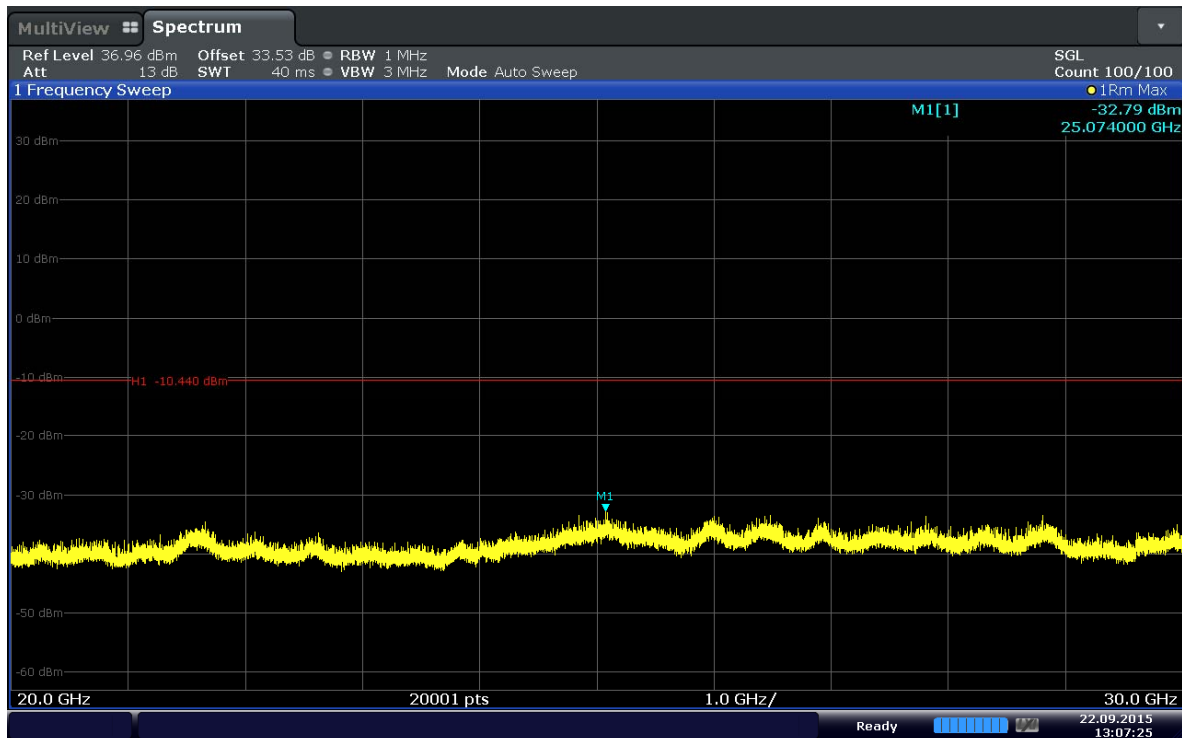

Date: 22.SEP.2015 13:07:25

Plot 6-23. Conducted Spurious Plot (Band 41–10MHz–QPSK–RB Size 1–RB Offset 24–Ch.40740)

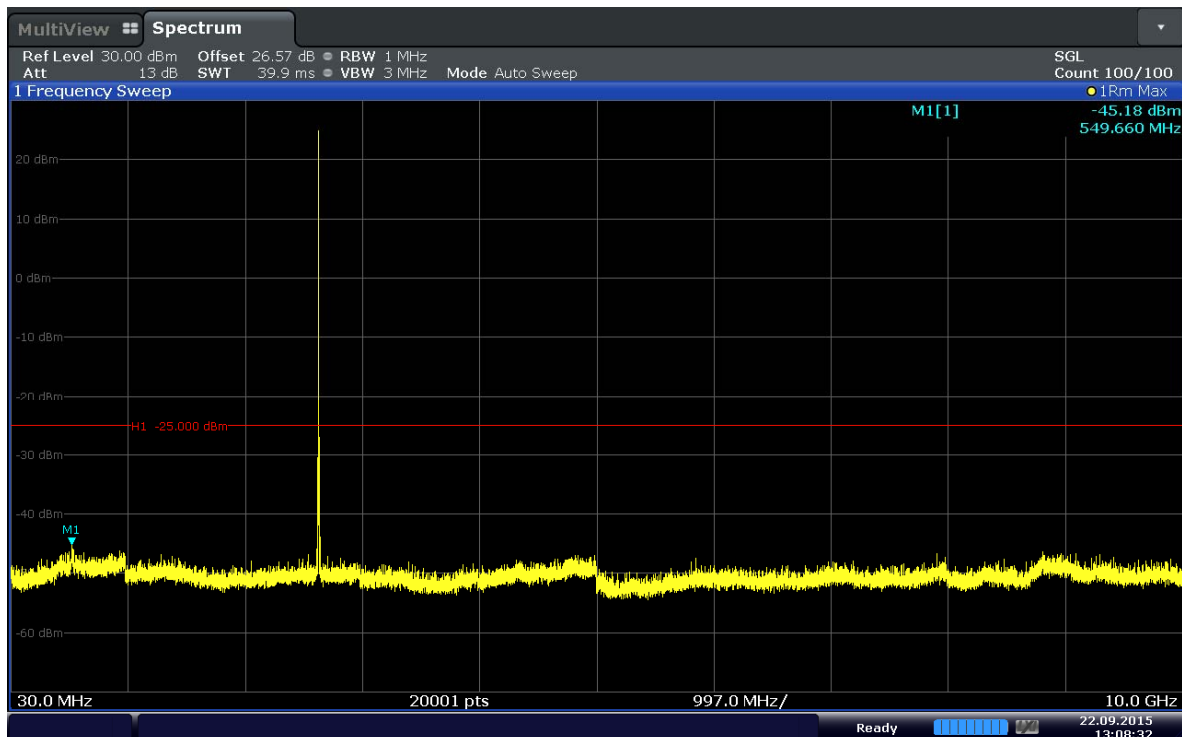

Date: 22.SEP.2015 13:08:33

Plot 6-24. Conducted Spurious Plot (Band 41–10MHz–QPSK–RB Size 1–RB Offset 0–Ch.41190)



Issue Date:

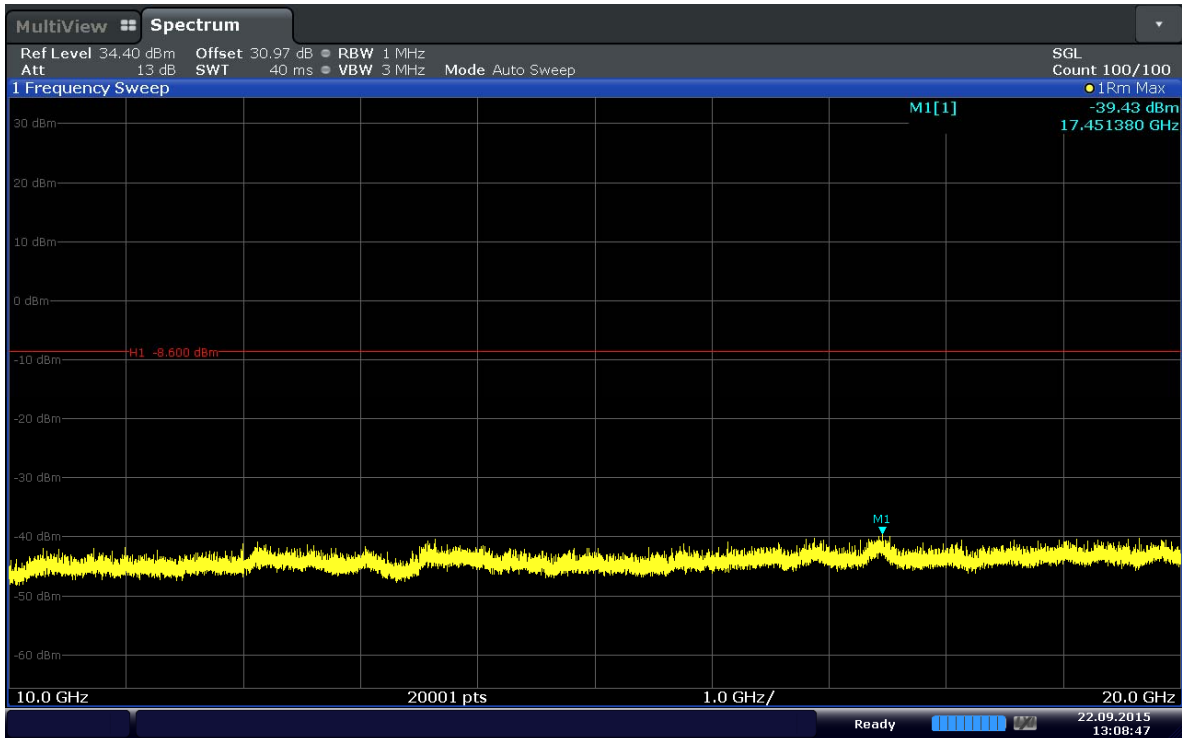

Date: 22.SEP.2015 13:08:47

Plot 6-25. Conducted Spurious Plot (Band 41-10MHz-QPSK-RB Size 1-RB Offset 0-Ch.41190)

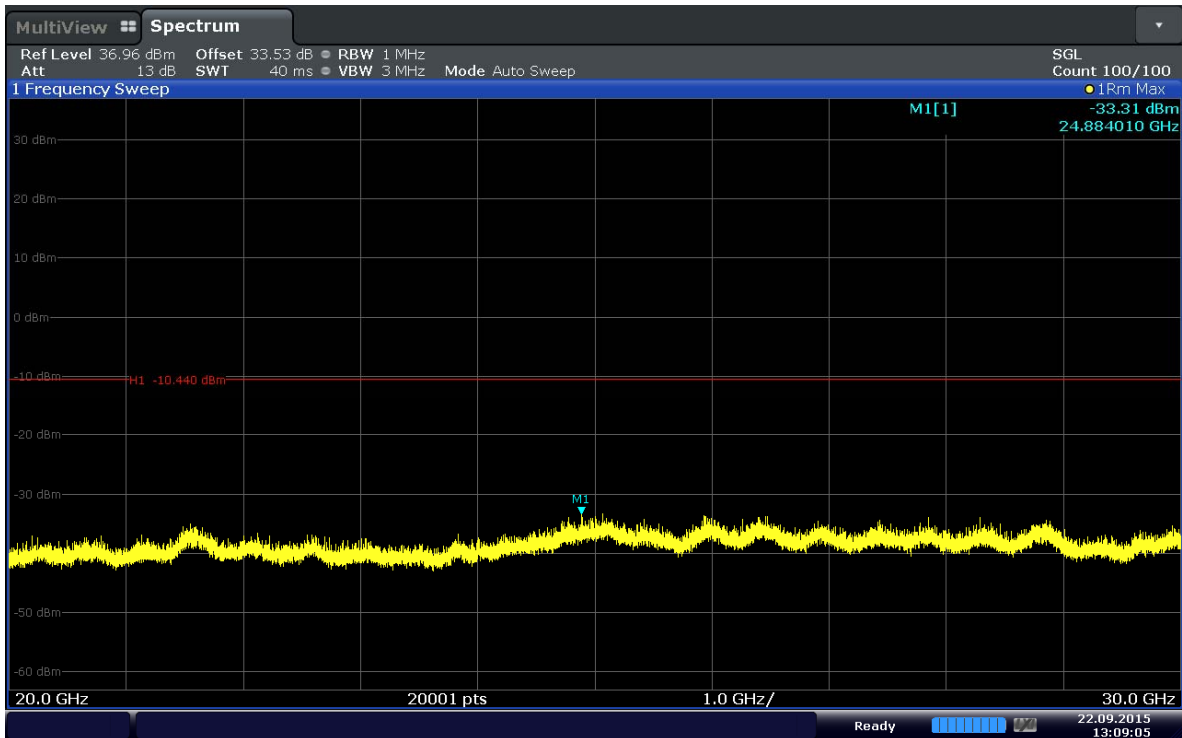

Date: 22.SEP.2015 13:09:05

Plot 6-26. Conducted Spurious Plot (Band 41-10MHz-QPSK-RB Size 1-RB Offset 0-Ch.41190)

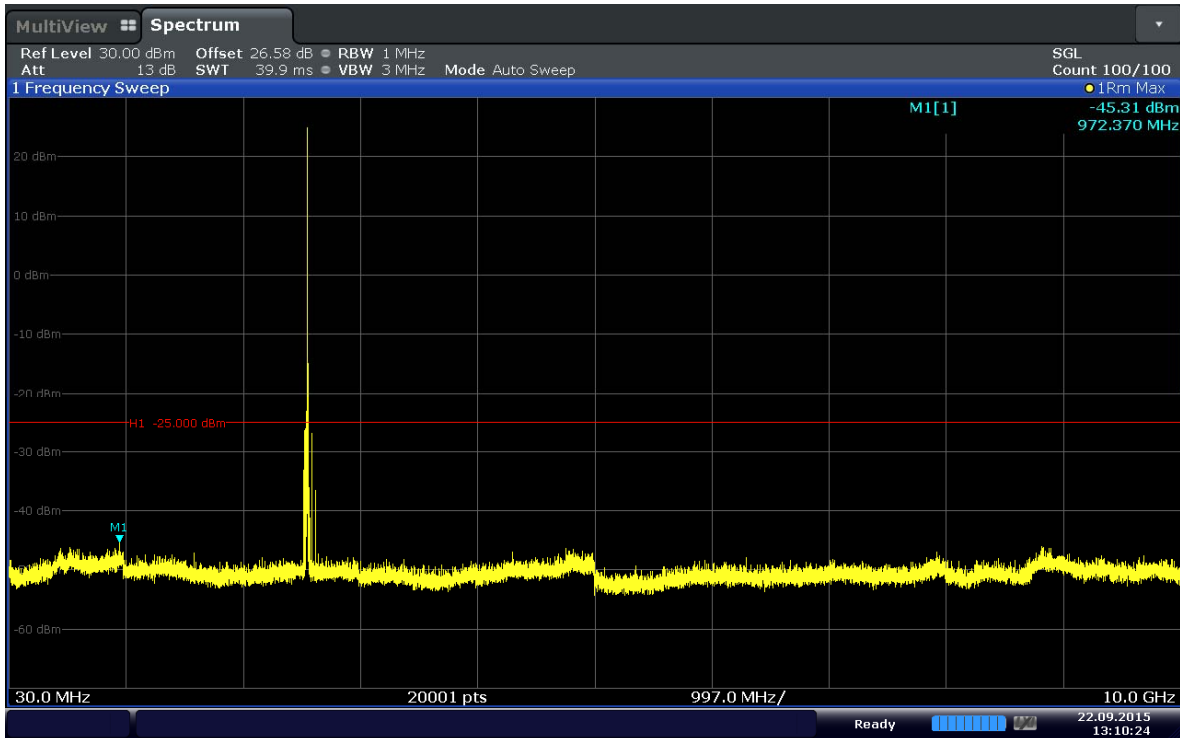

Date: 22.SEP.2015 13:10:24

Plot 6-27. Conducted Spurious Plot (Band 41–15MHz–QPSK–RB Size 1–RB Offset 74–Ch.40315)

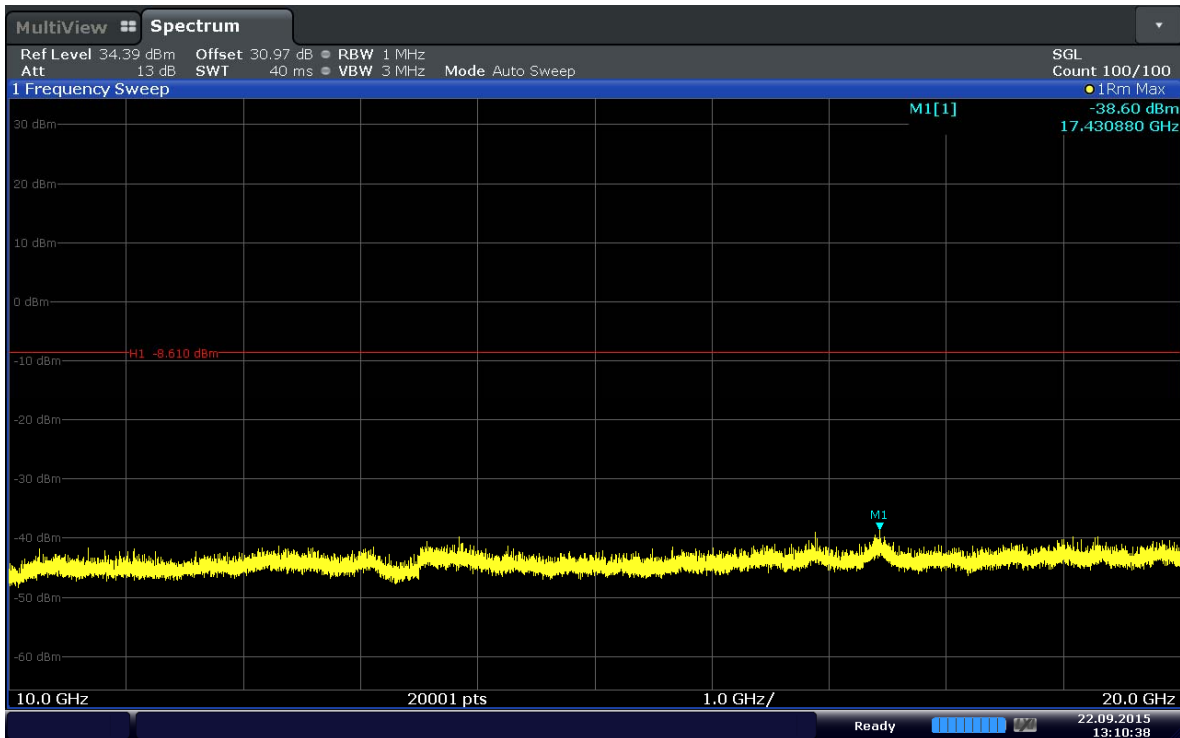

Date: 22.SEP.2015 13:10:38

Plot 6-28. Conducted Spurious Plot (Band 41–15MHz–QPSK–RB Size 1–RB Offset 74–Ch.40315)

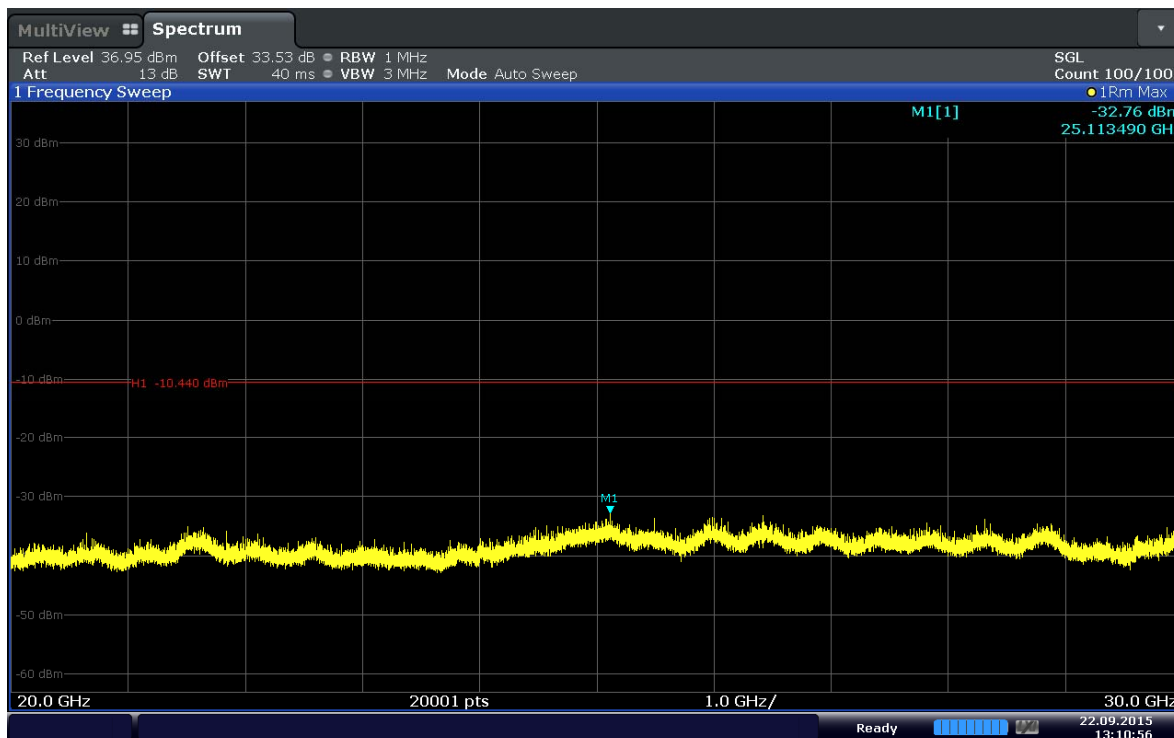

Date: 22.SEP.2015 13:10:56

Plot 6-29. Conducted Spurious Plot (Band 41-15MHz-QPSK-RB Size 1-RB Offset 74-Ch.40315)

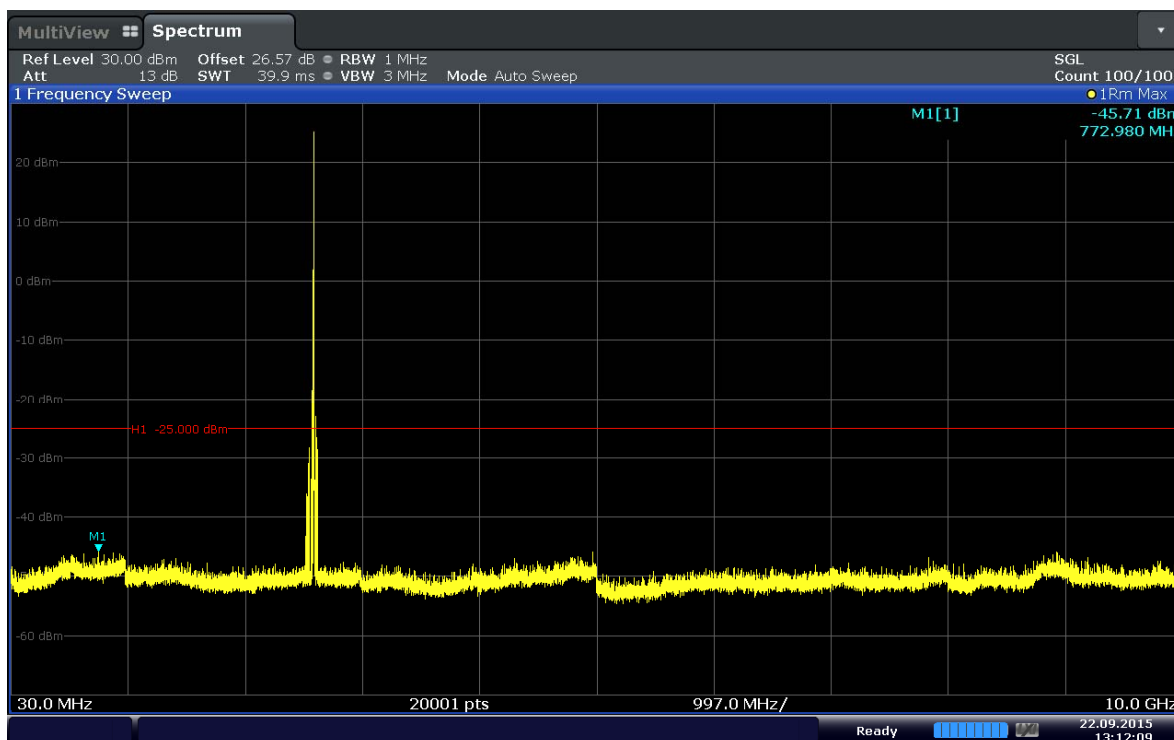

Date: 22.SEP.2015 13:12:09

Plot 6-30. Conducted Spurious Plot (Band 41-15MHz-QPSK-RB Size 1-RB Offset 36-Ch.40740)



Issue Date:

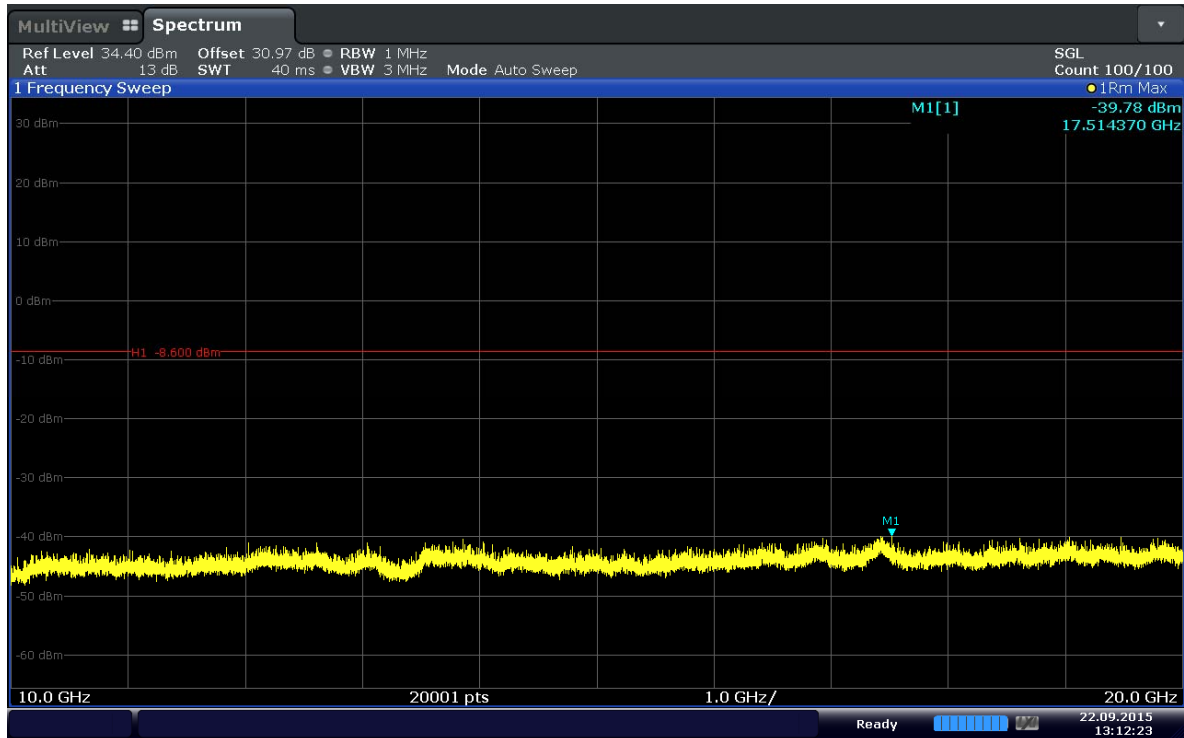

Date: 22.SEP.2015 13:12:23

Plot 6-31. Conducted Spurious Plot (Band 41–15MHz–QPSK–RB Size 1–RB Offset 36–Ch.40740)

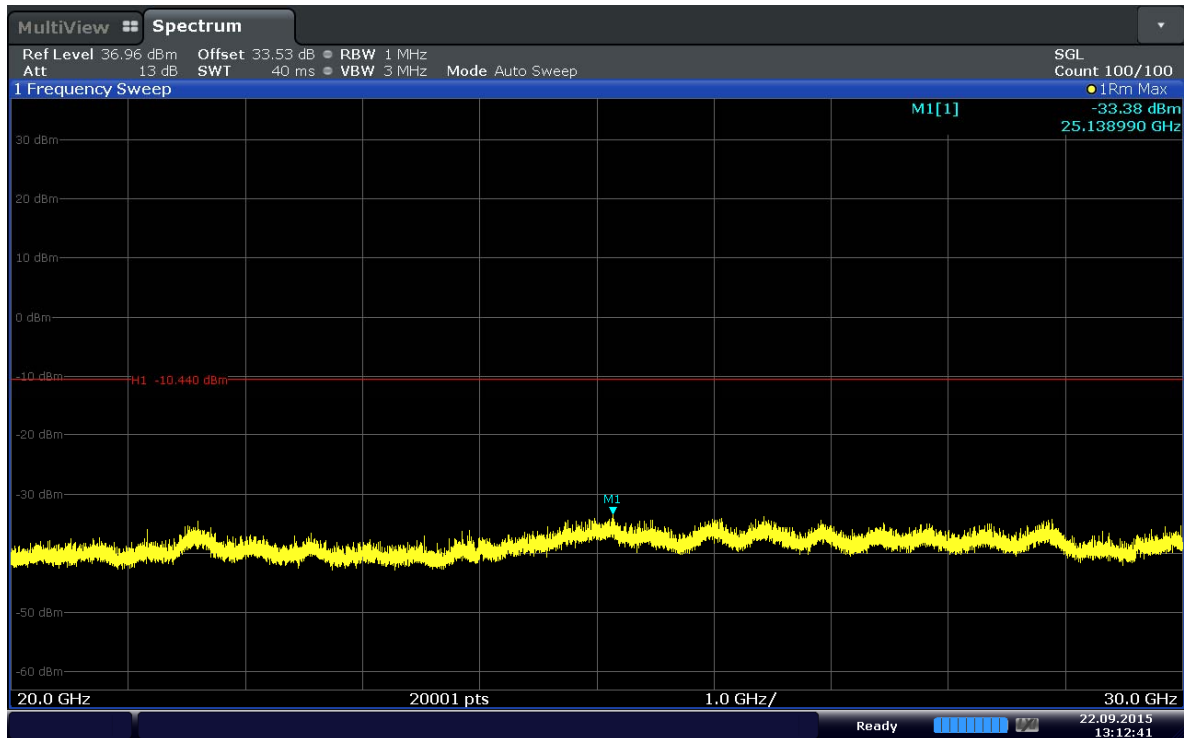

Date: 22.SEP.2015 13:12:41

Plot 6-32. Conducted Spurious Plot (Band 41–15MHz–QPSK–RB Size 1–RB Offset 36–Ch.40740)

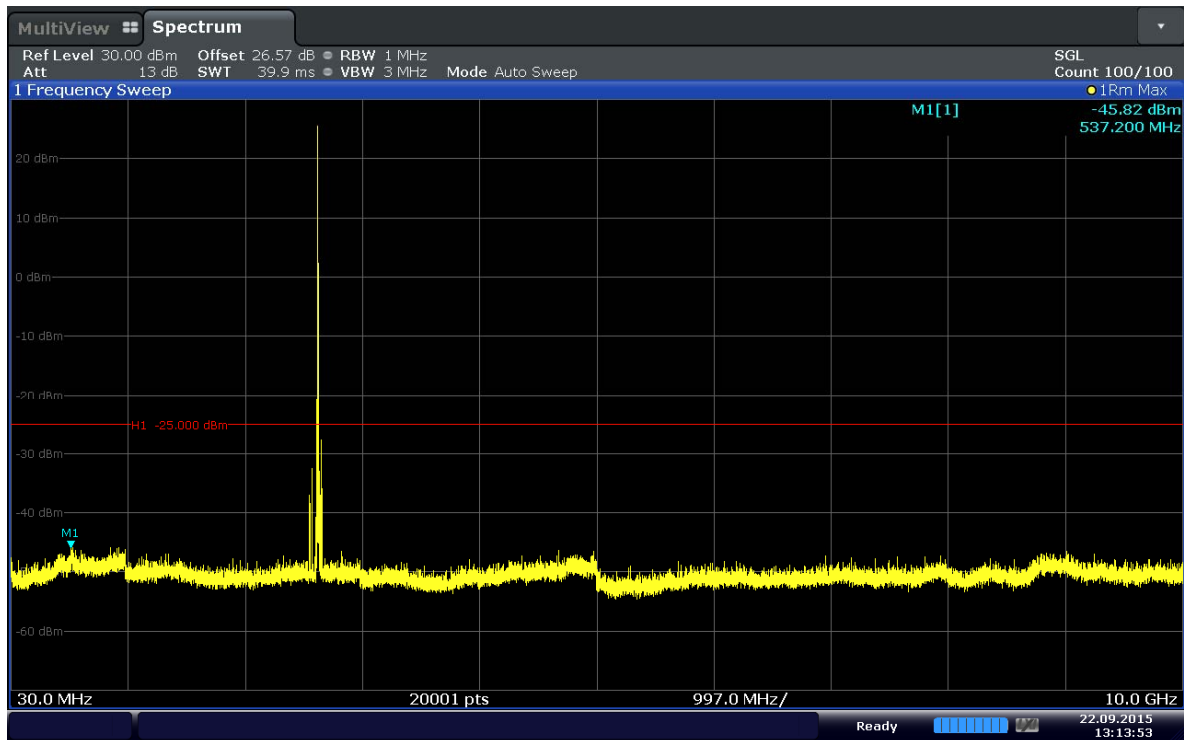

Date: 22.SEP.2015 13:13:54

Plot 6-33. Conducted Spurious Plot (Band 41-15MHz-QPSK-RB Size 1-RB Offset 0-Ch.41165)

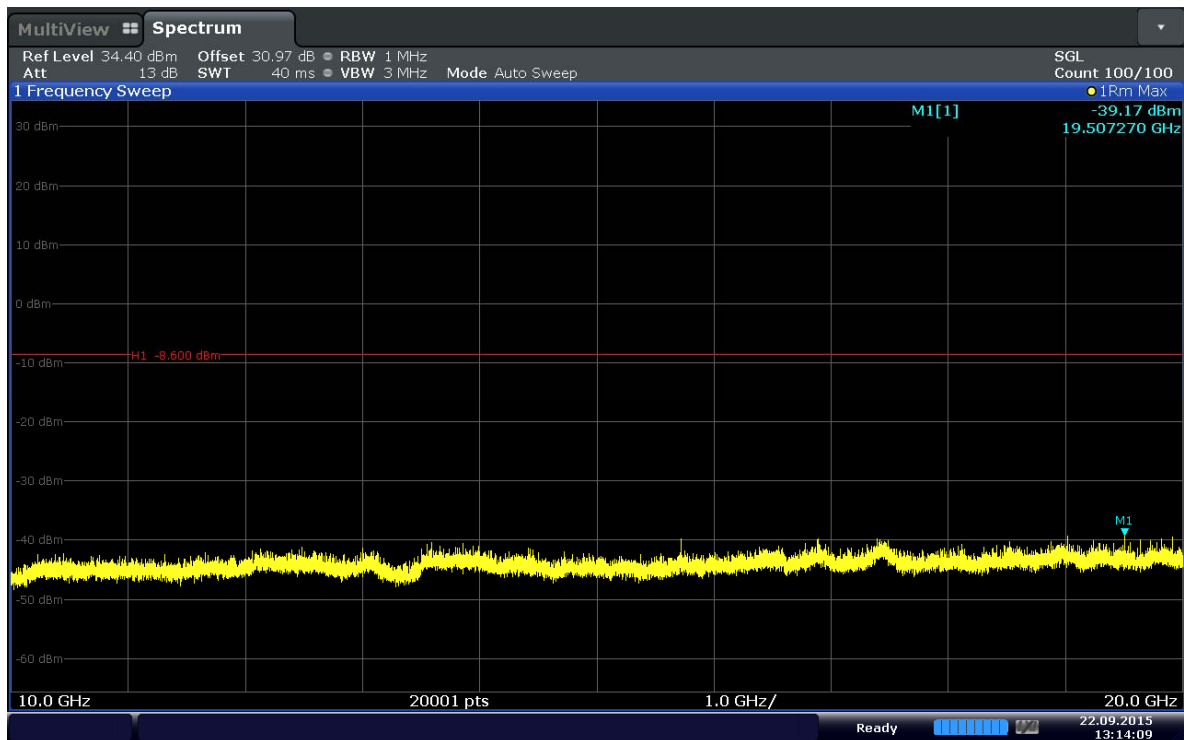

Date: 22.SEP.2015 13:14:09

Plot 6-34. Conducted Spurious Plot (Band 41-15MHz-QPSK-RB Size 1-RB Offset 0-Ch.41165)

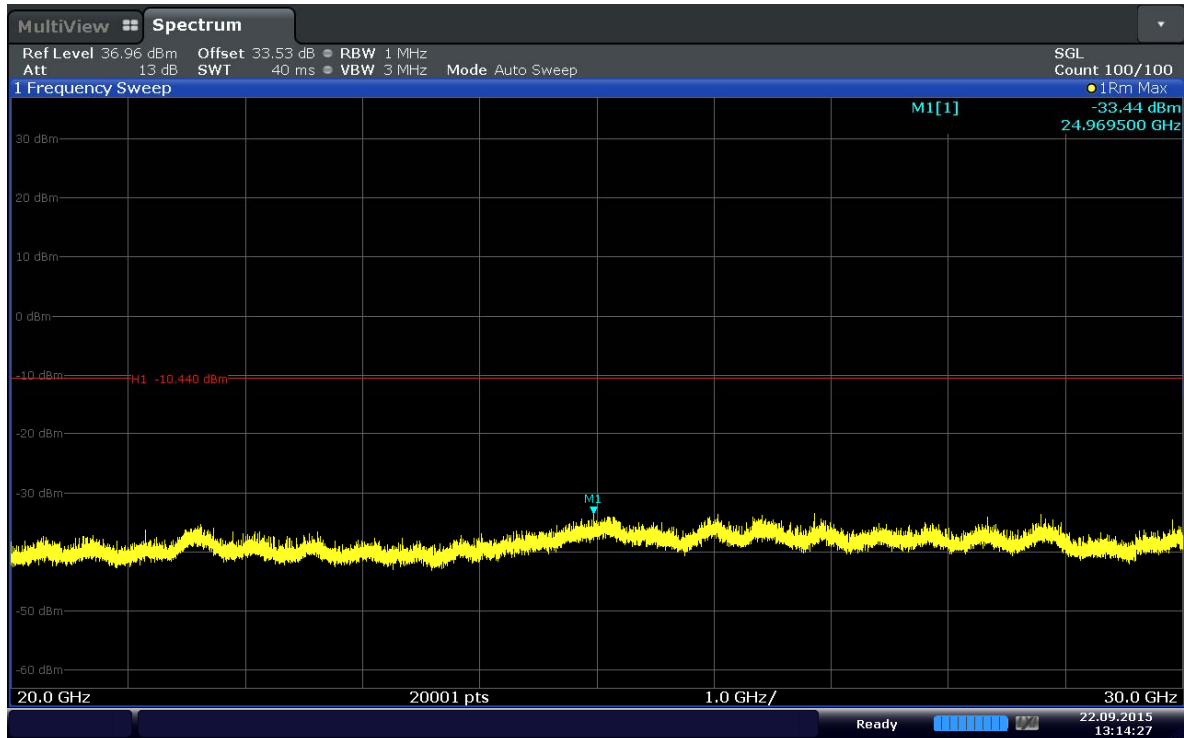

Date: 22.SEP.2015 13:14:27

Plot 6-35. Conducted Spurious Plot (Band 41–15MHz–QPSK–RB Size 1–RB Offset 0–Ch.41165)

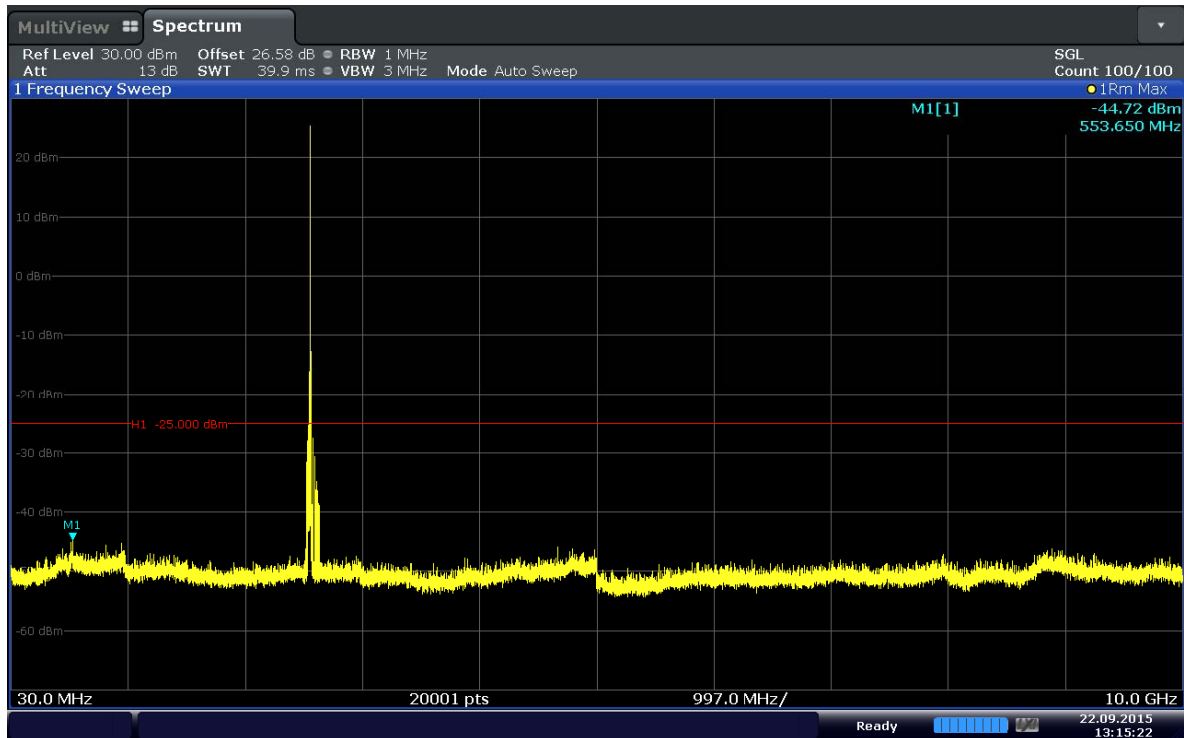

Date: 22.SEP.2015 13:15:22

Plot 6-36. Conducted Spurious Plot (Band 41–20MHz–QPSK–RB Size 1–RB Offset 99–Ch.40340)



Issue Date:

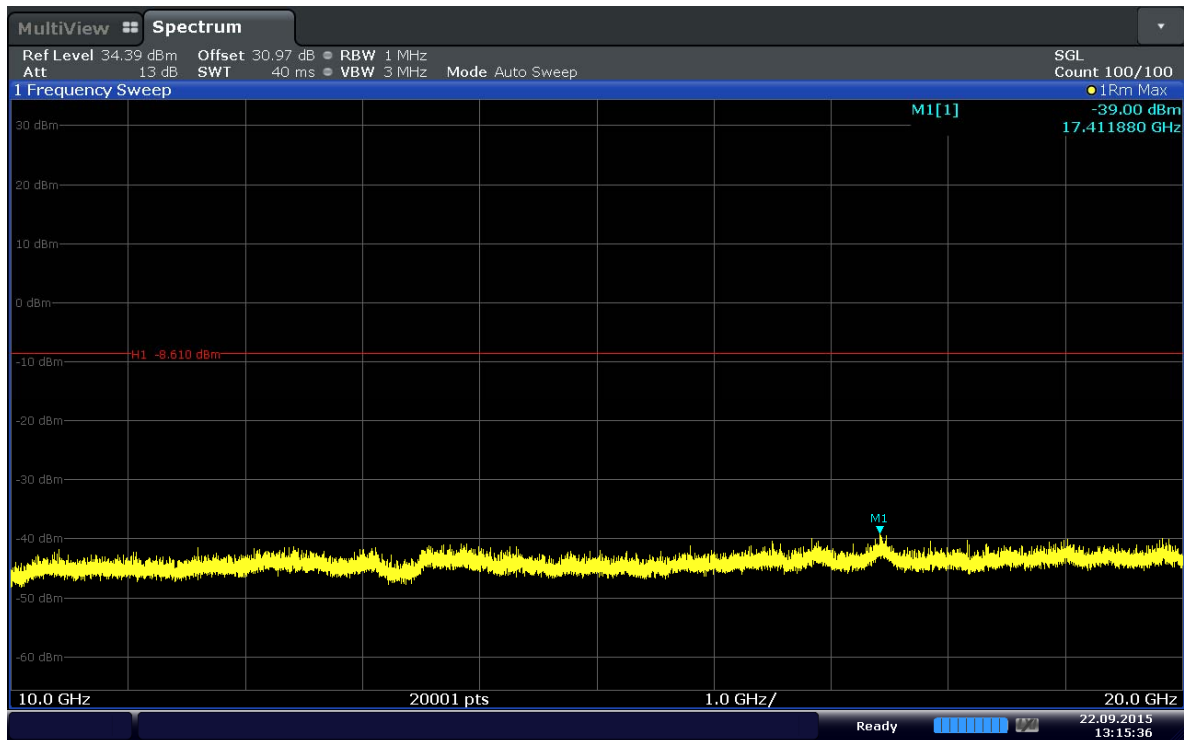

Date: 22.SEP.2015 13:15:36

Plot 6-37. Conducted Spurious Plot (Band 41–20MHz–QPSK–RB Size 1–RB Offset 99–Ch.40340)

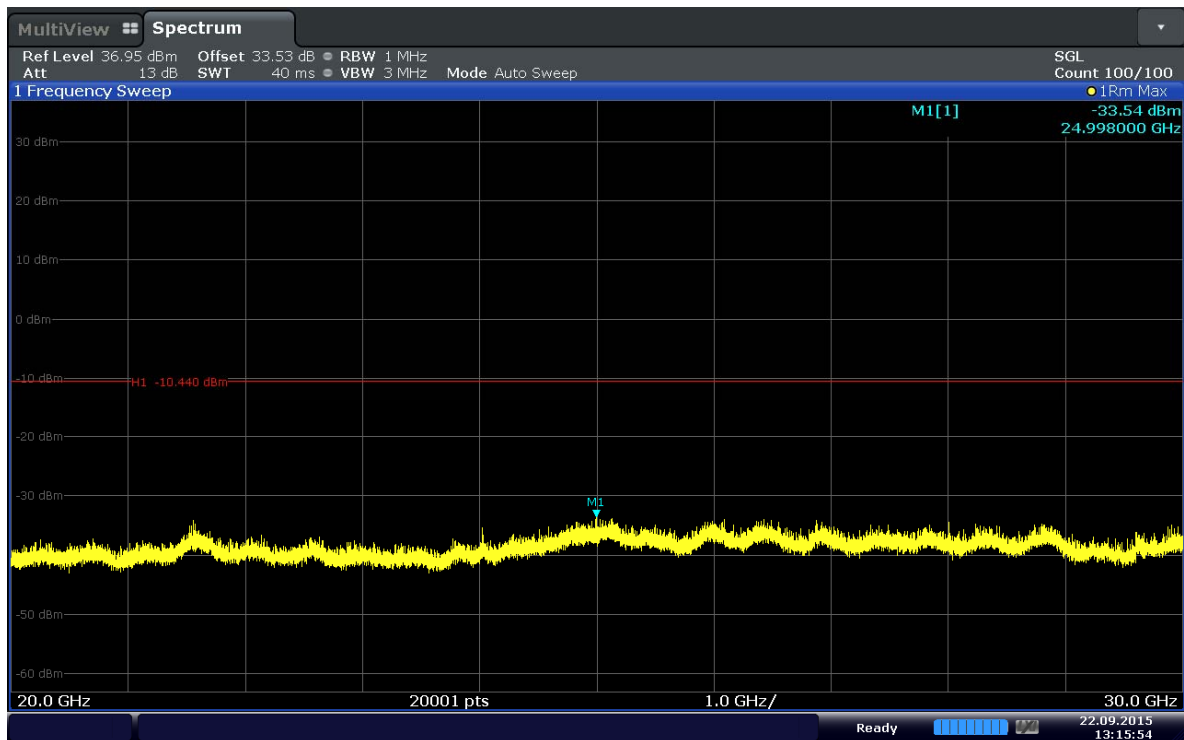

Date: 22.SEP.2015 13:15:54

Plot 6-38. Conducted Spurious Plot (Band 41–20MHz–QPSK–RB Size 1–RB Offset 99–Ch.40340)

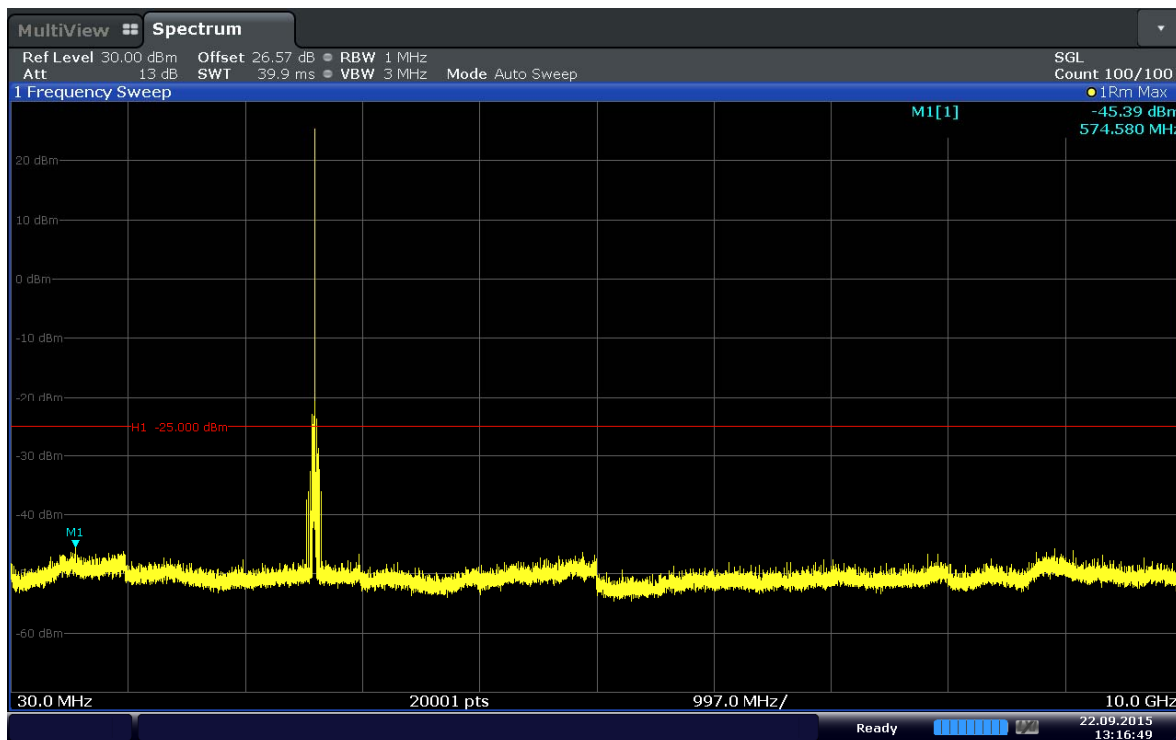

Date: 22.SEP.2015 13:16:49

Plot 6-39. Conducted Spurious Plot (Band 41–20MHz–QPSK–RB Size 1–RB Offset 99–Ch.40740)

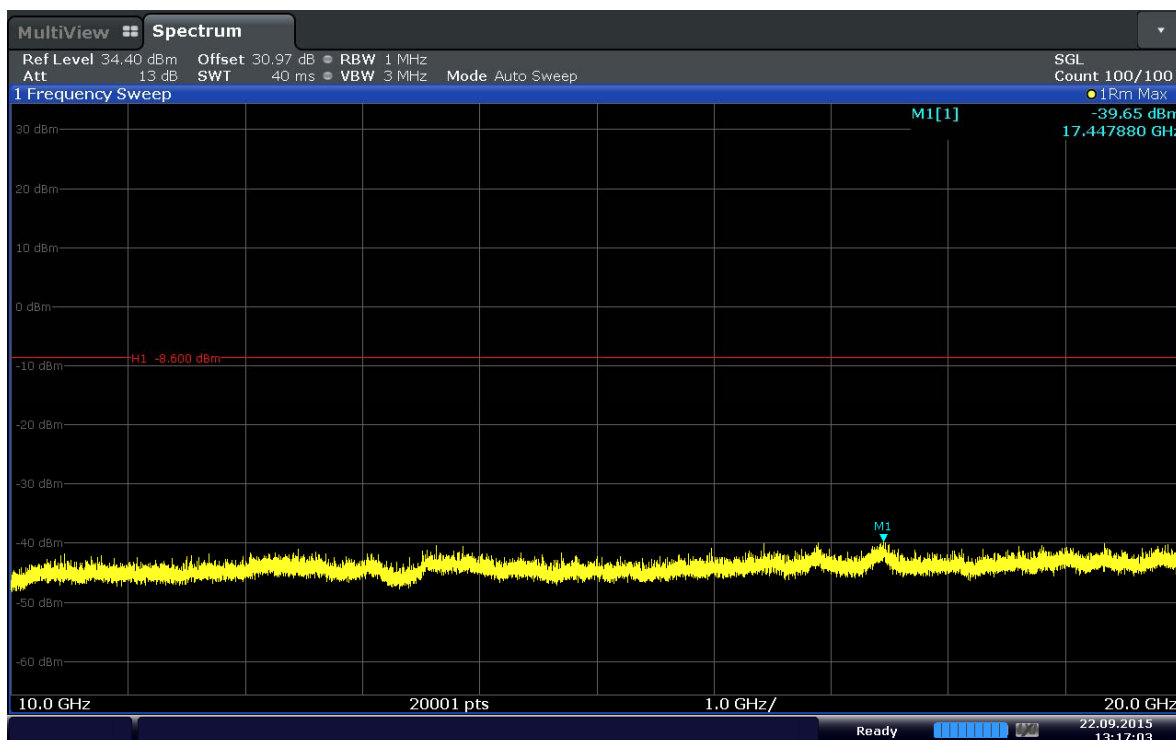

Date: 22.SEP.2015 13:17:04

Plot 6-40. Conducted Spurious Plot (Band 41–20MHz–QPSK–RB Size 1–RB Offset 99–Ch.40740)

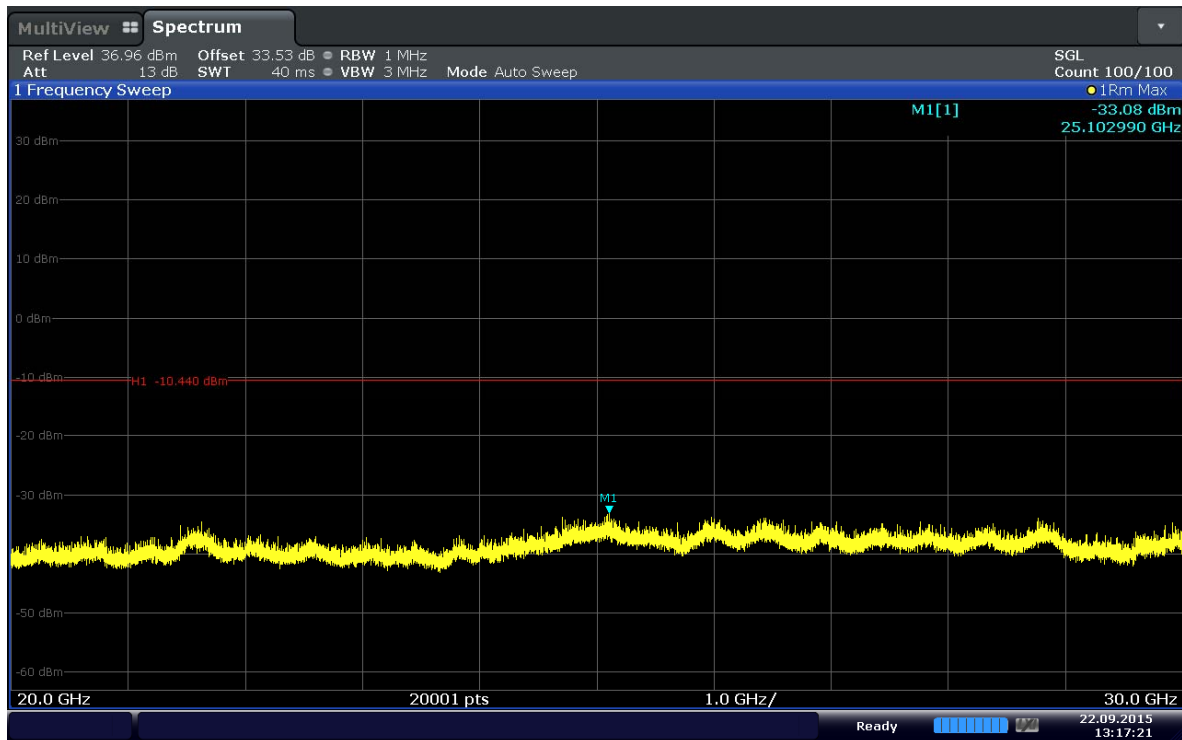

Date: 22.SEP.2015 13:17:22

Plot 6-41. Conducted Spurious Plot (Band 41–20MHz–QPSK–RB Size 1–RB Offset 99–Ch.40740)

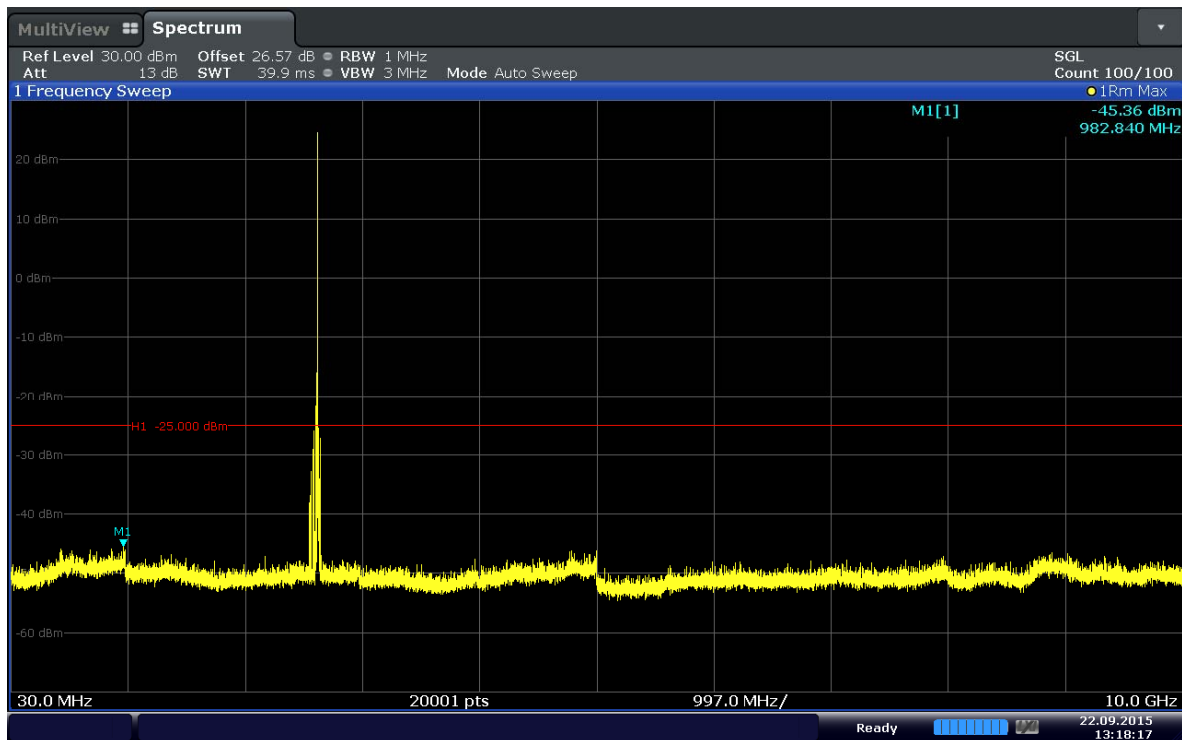

Date: 22.SEP.2015 13:18:17

Plot 6-42. Conducted Spurious Plot (Band 41–20MHz–QPSK–RB Size 1–RB Offset 0–Ch.41140)

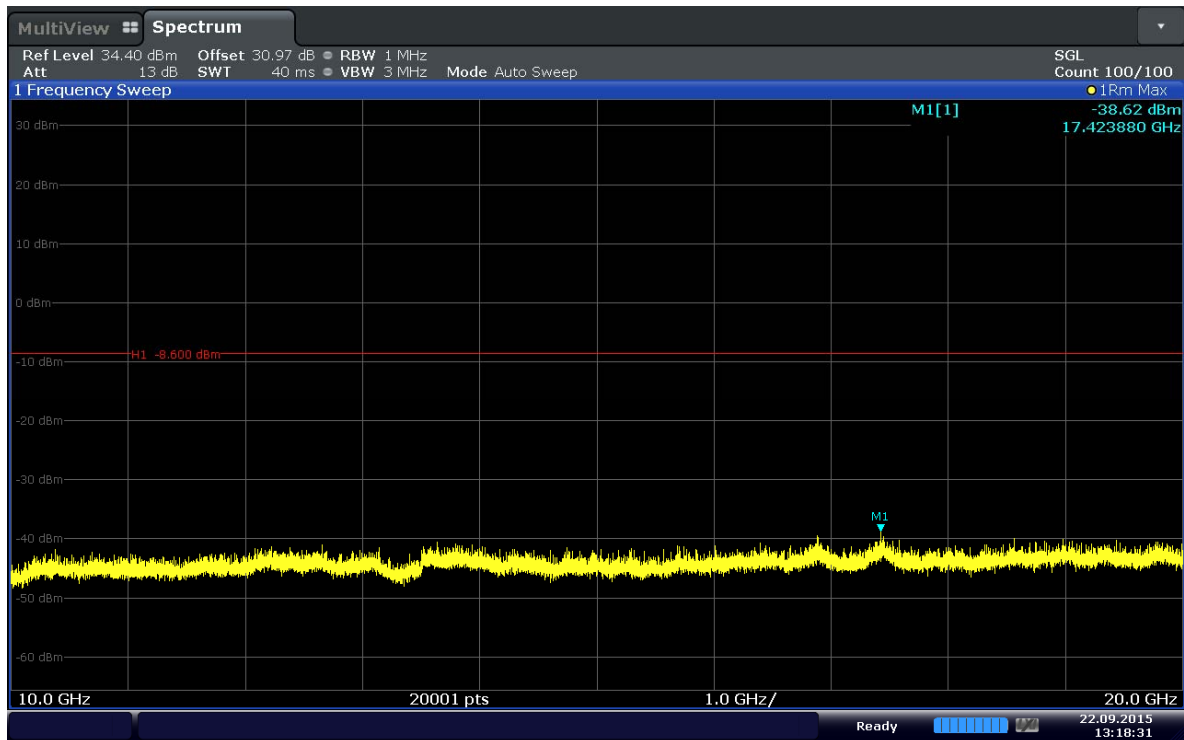

Date: 22.SEP.2015 13:18:31

Plot 6-43. Conducted Spurious Plot (Band 41–20MHz–QPSK–RB Size 1–RB Offset 0–Ch.41140)

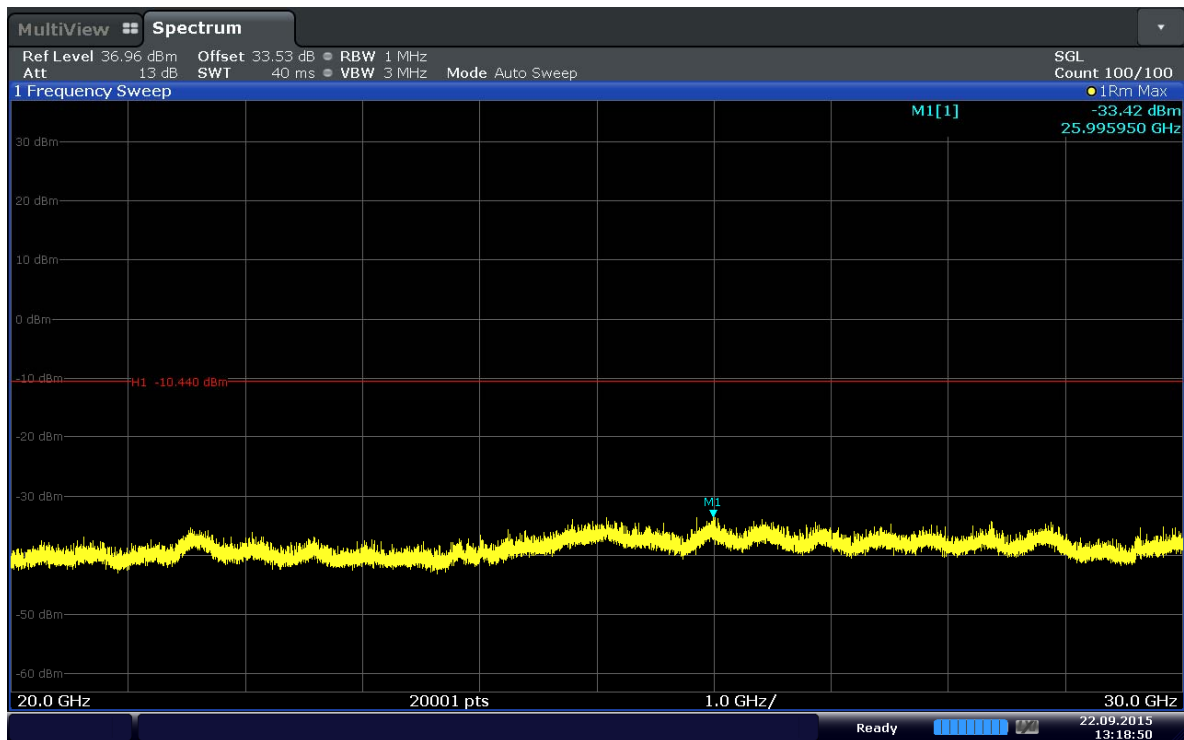

Date: 22.SEP.2015 13:18:50

Plot 6-44. Conducted Spurious Plot (Band 41–20MHz–QPSK–RB Size 1–RB Offset 0–Ch.41140)



6.4. Band Edge Emissions at Antenna Terminal

§2.1051 §27.53(m)

Test Overview

All out of band emissions are measured with a spectrum analyzer connected to the antenna terminal of the EUT while the EUT is operating at its maximum duty cycle, at maximum power, and at the appropriate frequencies. All data rates were investigated to determine the worst case configuration. All modes of operation were investigated and the worst case configuration results are reported in this section.

The minimum permissible attenuation level is $> 40 + 10\log_{10}(P[\text{Watts}])$ between channel edge and 5 MHz from the channel edge, $> 43 + 10\log_{10}(P[\text{Watts}])$ between 5 MHz and X MHz from the channel edge, or between 2490.5 MHz and 2496 MHz, and $> 55 + 10\log_{10}(P[\text{Watts}])$ more than X MHz from the channel edge, or below 2490.5 MHz, where X is the greater of 6 MHz or the actual emission bandwidth.

Test Procedure Used

KDB 971168 v02r02 – Section 6.0

Test Settings

1. Start and stop frequency were set such that the band edge would be placed in the center of the plot.
2. Span was set large enough so as to capture all out of band emissions near the band edge
3. Trigger is set to enable triggering only on full power bursts with the sweep time set less than or equal to the transmission burst duration
4. The “gating” function was enabled to ensure that measurements are performed during times in which the transmitter is operating at its maximum power
5. Please see test note below for RBW settings
6. $VBW \geq 3 \times RBW$
7. Detector = RMS
8. Number of sweep points $\geq 2 \times \text{Span}/RBW$
9. Trace mode = average
10. Sweep time = auto couple
11. The trace was allowed to stabilize

Test Setup

The EUT and measurement equipment were set up as shown in the diagram below.

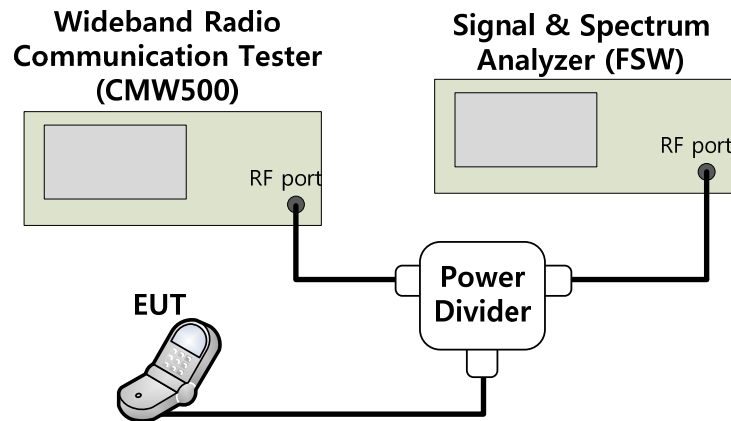

Figure 6-3. Test Instruments & Measurement Setup

Test Note

1. Compliance with these rules is based on the use of measurement instrumentation employing a resolution bandwidth of 1 megahertz or greater. However, in the 1 MHz bands immediately outside and adjacent to the frequency block a resolution bandwidth of at least one percent of the emission bandwidth of the fundamental emission of the transmitter may be employed; for mobile digital stations, in the 1 megahertz bands immediately outside and adjacent to the frequency block a resolution bandwidth of at least two percent may be employed, except when the 1 megahertz band is 2495-2496 MHz, in which case a resolution bandwidth of at least one percent may be employed.



Test Plots

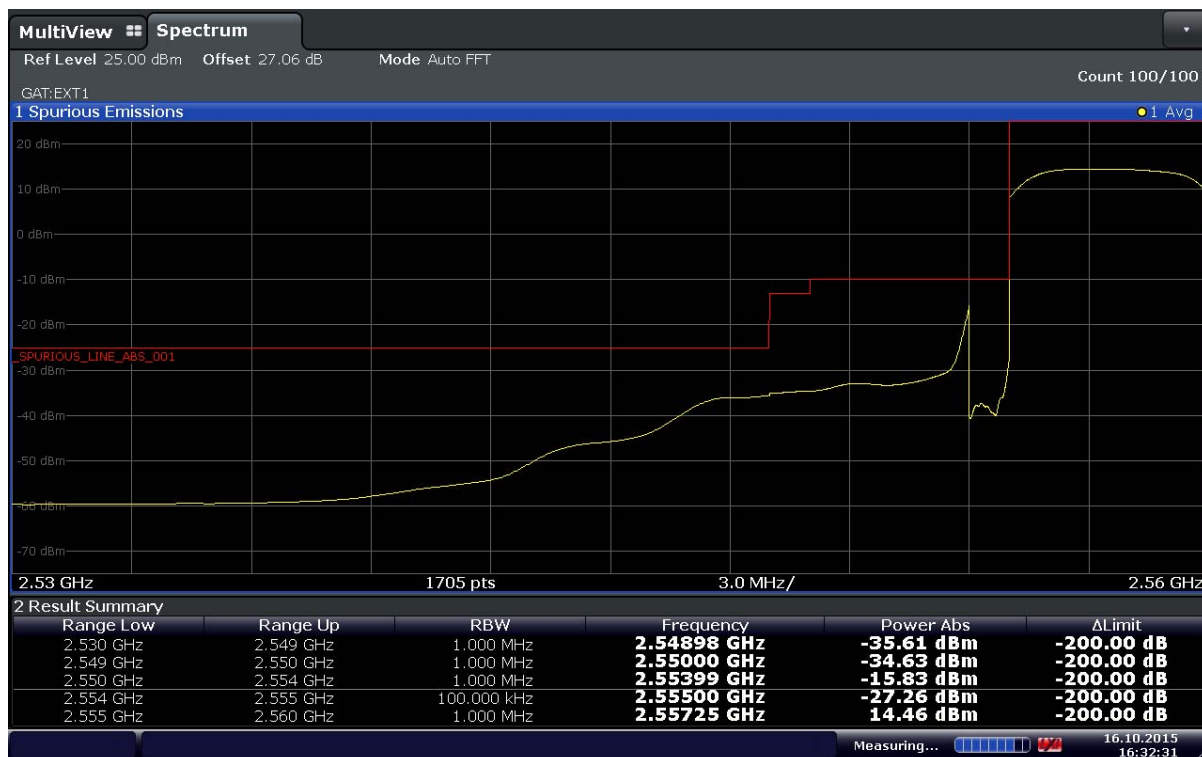

Date: 16.OCT.2015 16:32:31

Plot 6-45. Lower Band Edge Plot (Band41 – 5MHz – QPSK – RB Size 25 – Ch.40265)

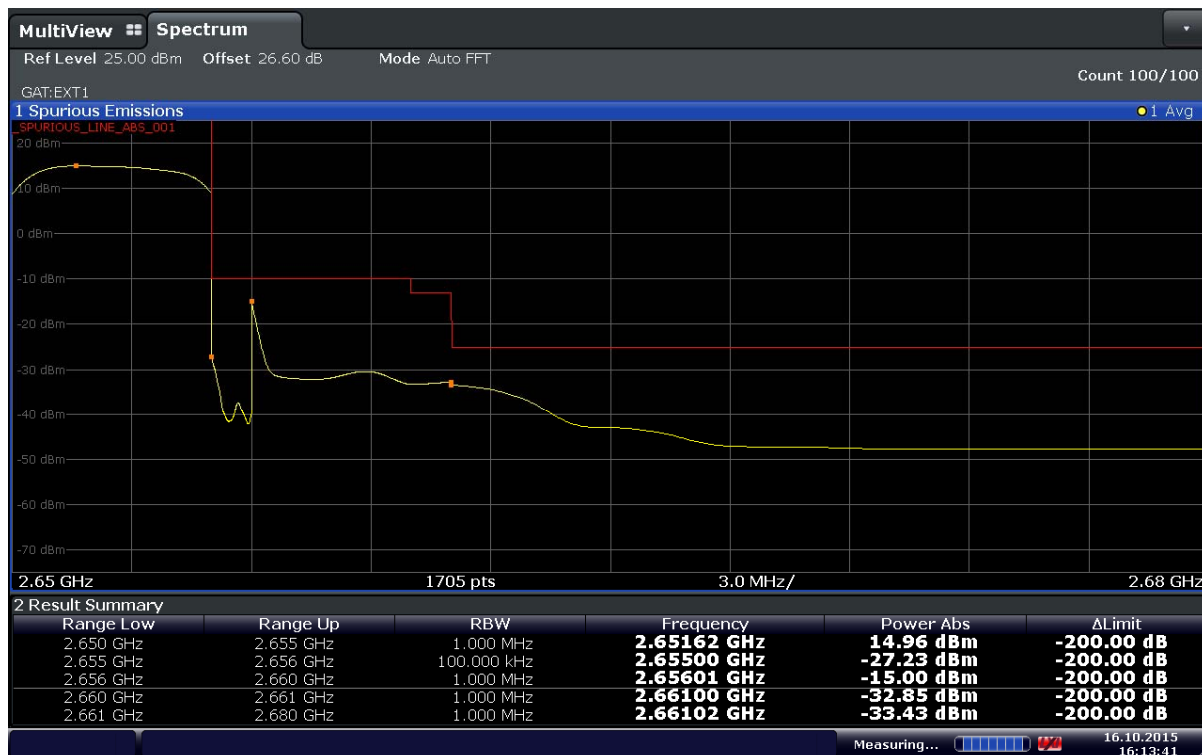

Date: 16.OCT.2015 16:13:42

Plot 6-46. Upper Band Edge Plot (Band41 – 5MHz – QPSK – RB Size 25 – Ch.41215)

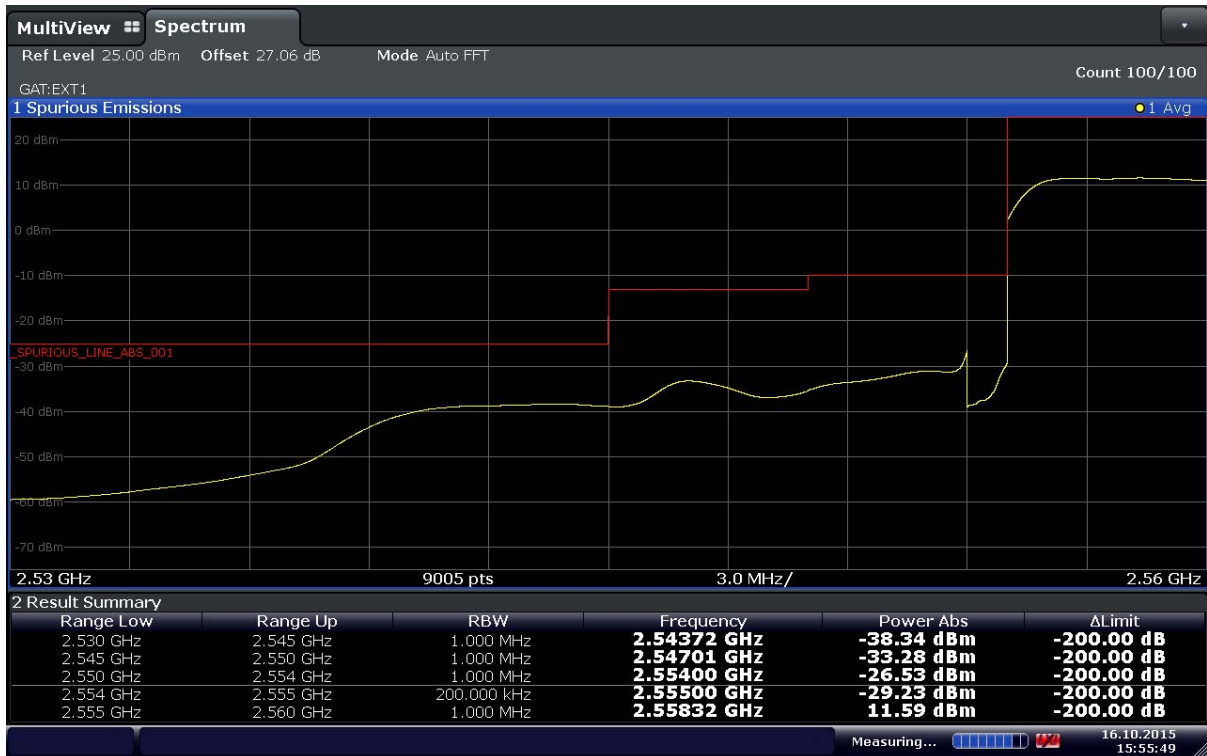

Date: 16.OCT.2015 15:55:48

Plot 6-47. Lower Band Edge Plot (Band41 – 10MHz – QPSK – RB Size 50 – Ch.40290)

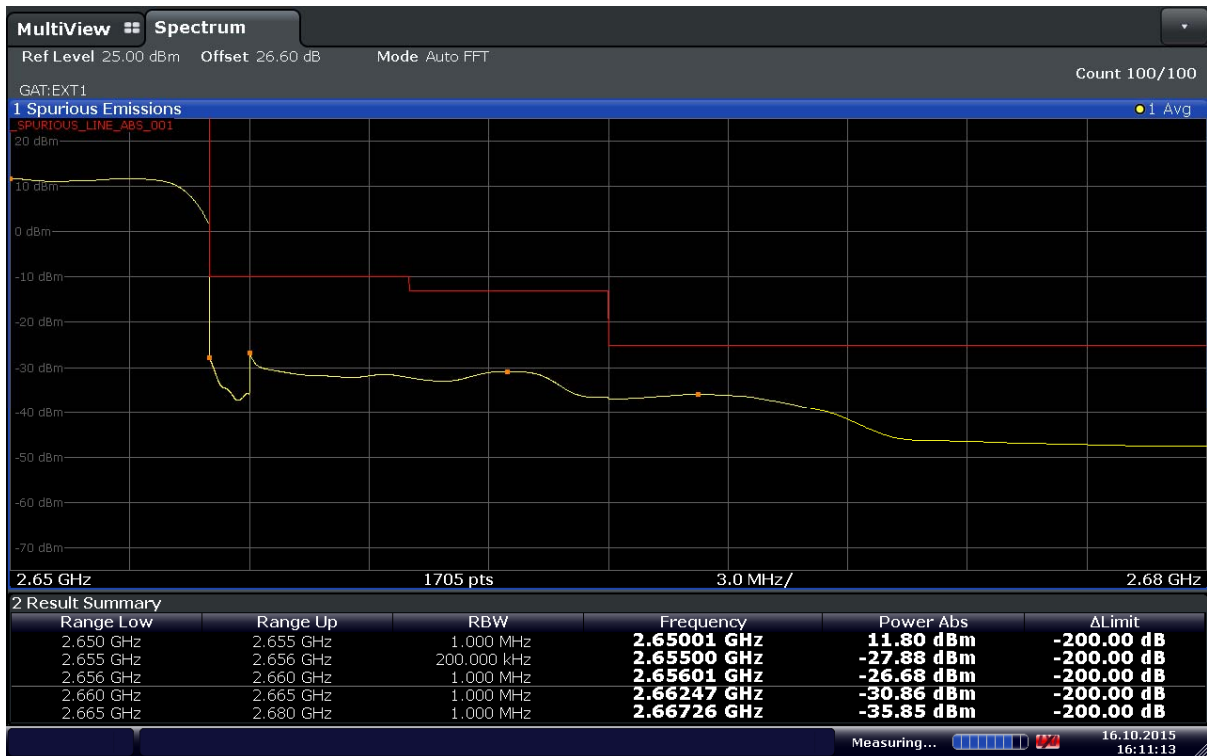

Date: 16.OCT.2015 16:11:13

Plot 6-48. Upper Band Edge Plot (Band41 – 10MHz – QPSK – RB Size 50 – Ch.41190)

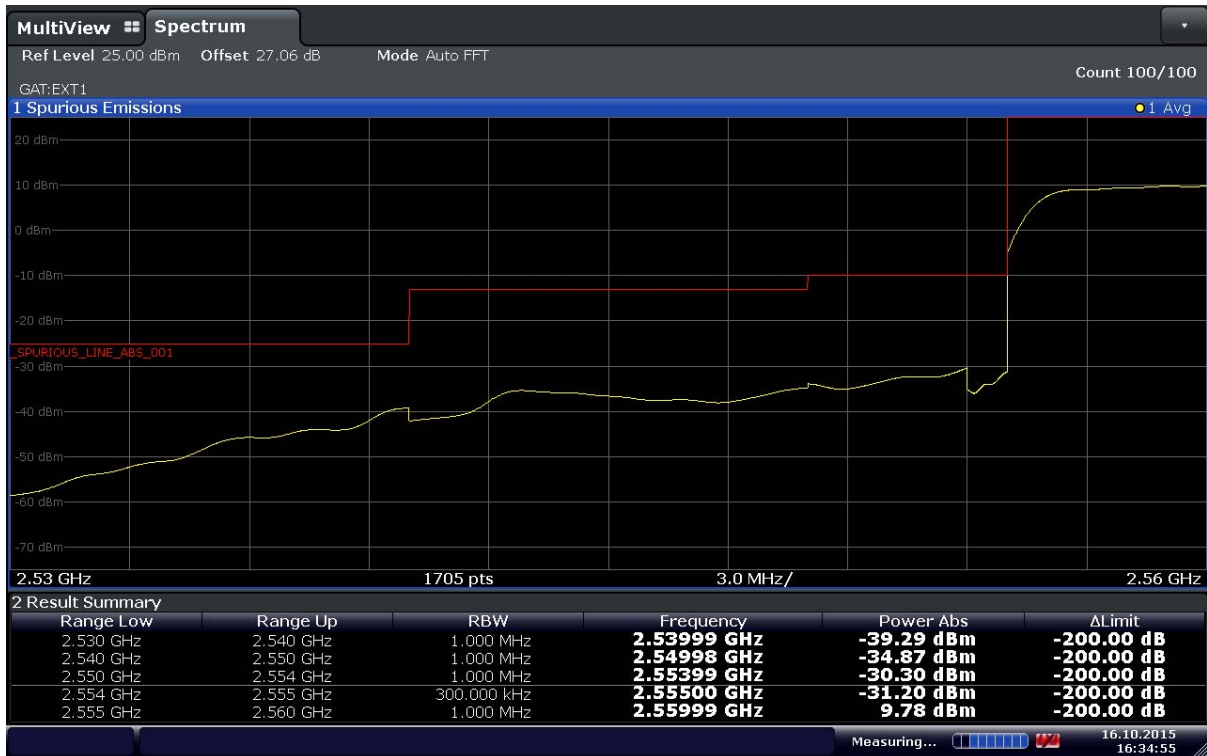

Date: 16.OCT.2015 16:34:55

Plot 6-49. Lower Band Edge Plot (Band41 – 15MHz – QPSK – RB Size 75 – Ch.40315)

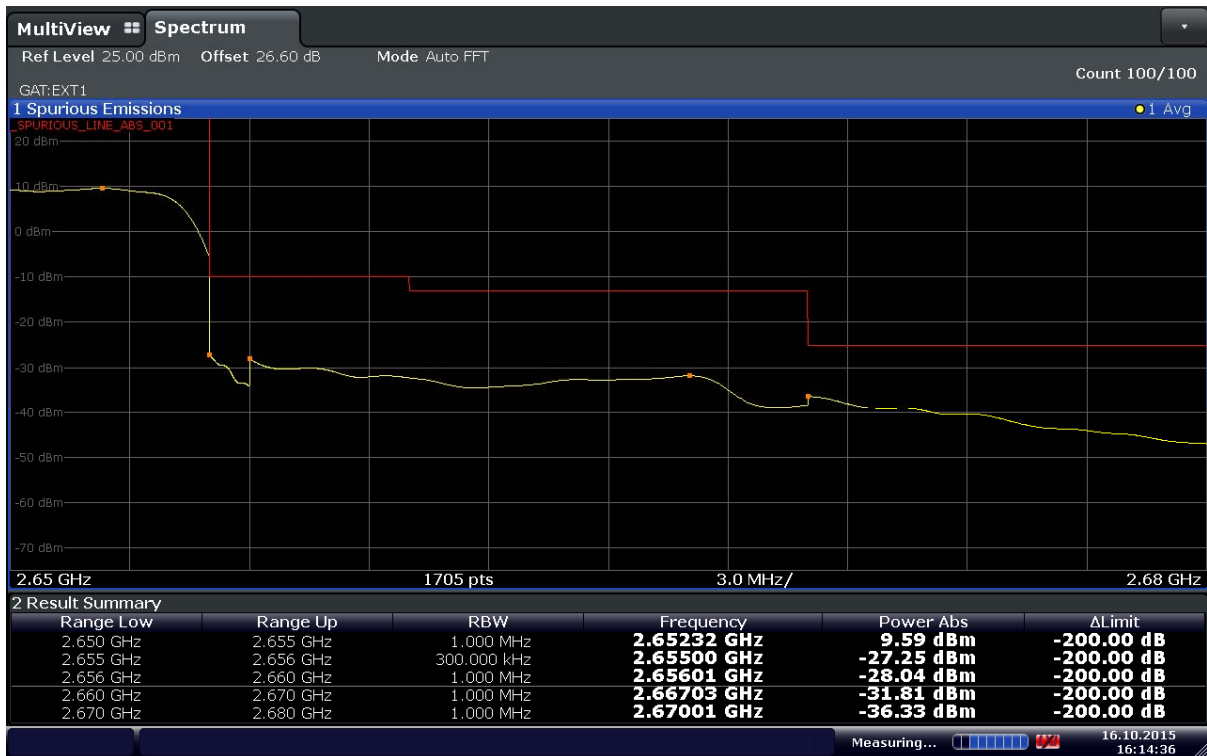

Date: 16.OCT.2015 16:14:36

Plot 6-50. Upper Band Edge Plot (Band41 – 15MHz – QPSK – RB Size 75 – Ch.41165)

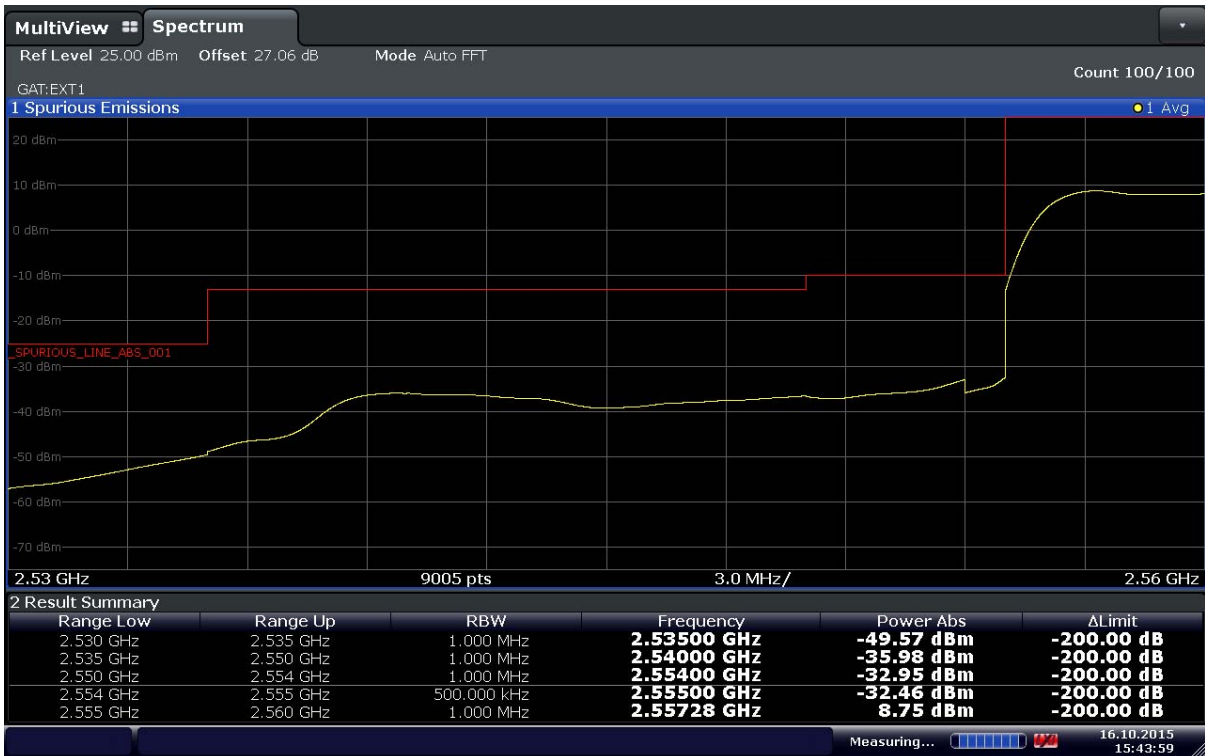

Date: 16.OCT.2015 15:43:59

Plot 6-51. Lower Band Edge Plot (Band41 – 20MHz – QPSK – RB Size 100 – Ch.40340)

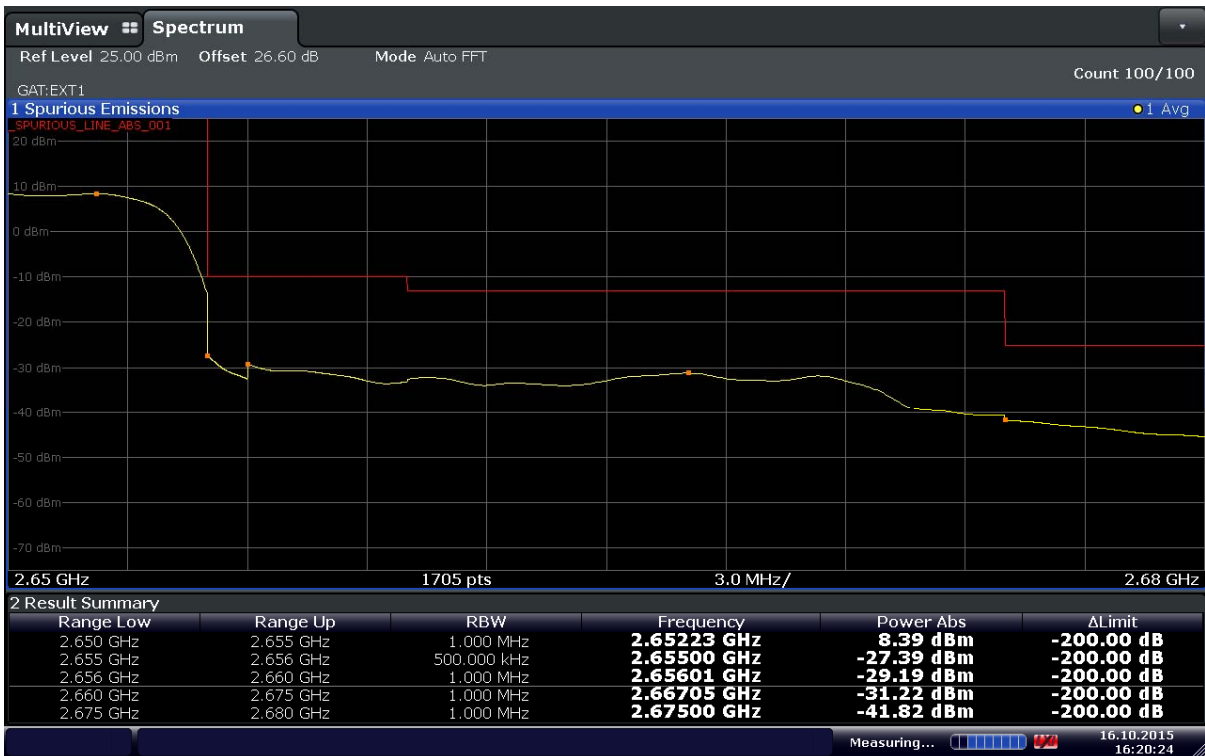

Date: 16.OCT.2015 16:20:24

Plot 6-52. Upper Band Edge Plot (Band41 – 20MHz – QPSK – RB Size 100 – Ch.41140)

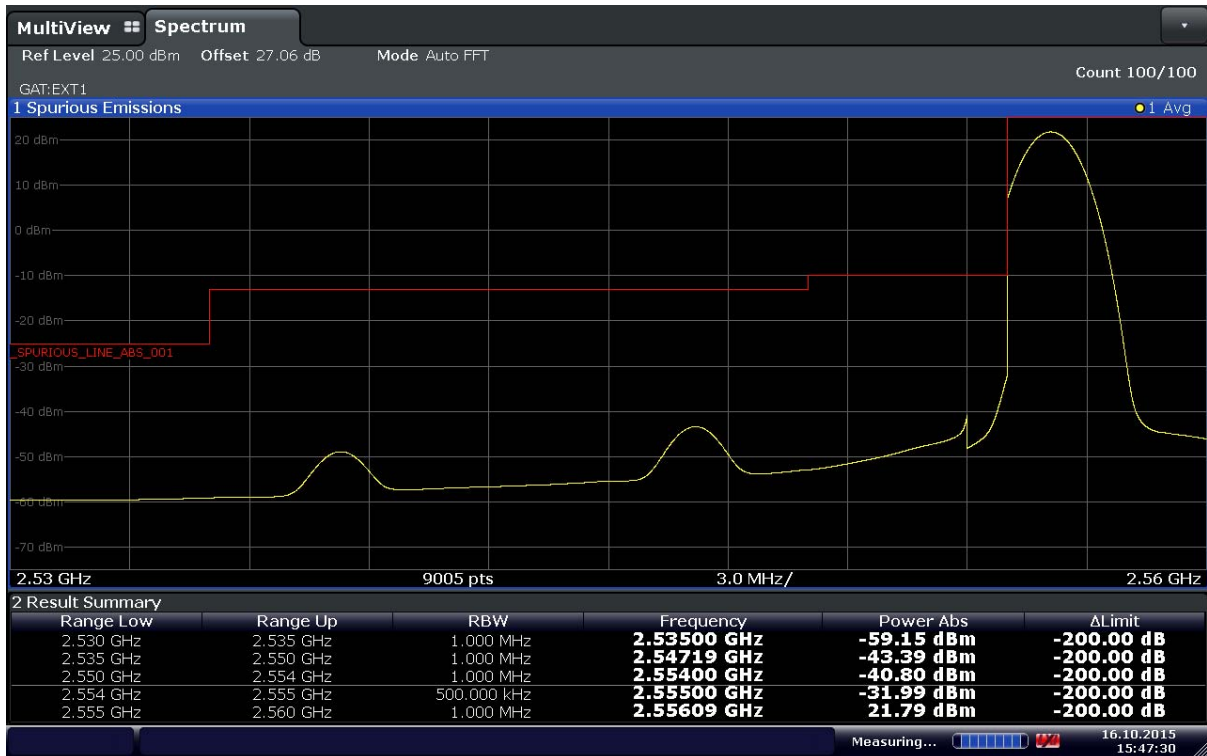

Date: 16.OCT.2015 15:47:30

Plot 6-53. Lower Band Edge Plot (Band41 – 20MHz – QPSK – RB Size 1 – RB Offset 0 – Ch.40340)

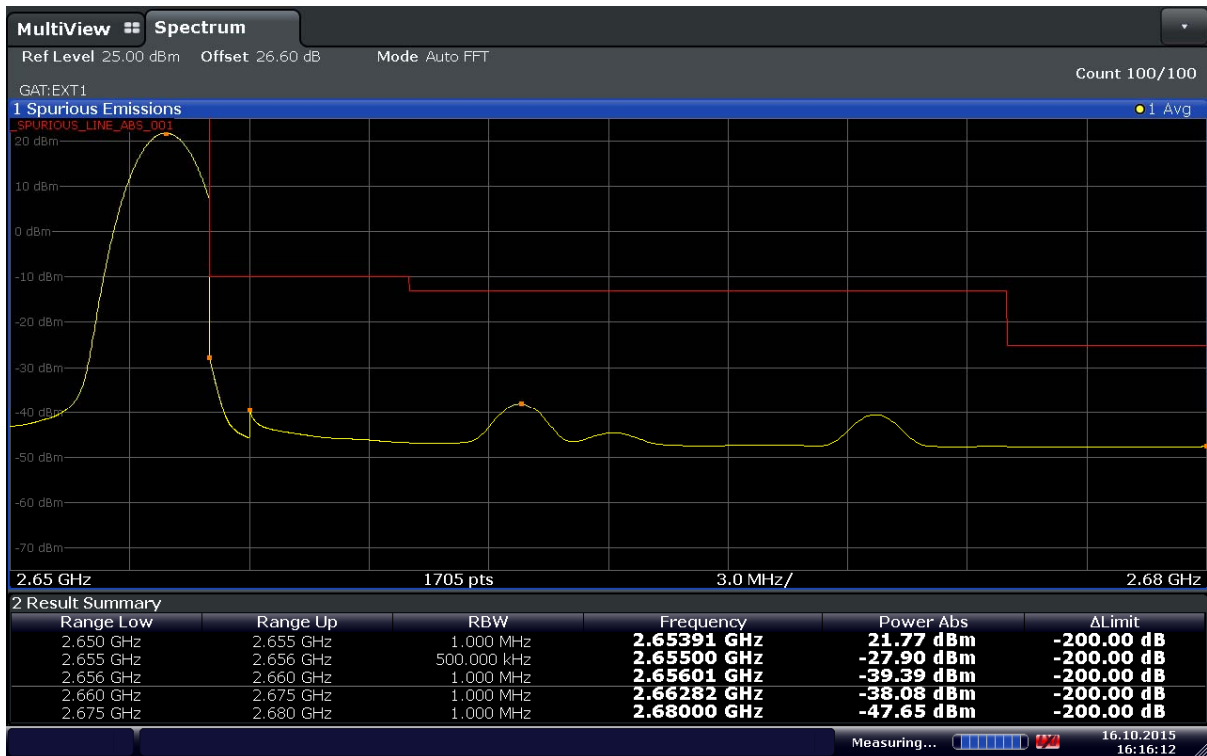

Date: 16.OCT.2015 16:16:11

Plot 6-54. Upper Band Edge Plot (Band41 – 20MHz – QPSK – RB Size 1 – RB Offset 99 – Ch.41140)



6.5. Frequency Stability / Temperature Variation
§2.1055 §27.54

Test Overview and Limit

Frequency stability testing is performed in accordance with the guidelines of ANSI/TIA-603-D-2010. The frequency stability of the transmitter is measured by:

1. Temperature: The temperature is varied from -30°C to +50°C in 10°C increments using an environmental chamber.
2. Primary Supply Voltage: The primary supply voltage is varied from 85% to 115% of the nominal value for other than hand carried battery equipment. For hand-carried, battery-powered equipment, primary supply voltage is reduced to the battery operating end point(=Batt.End) which shall be specified by the manufacturer.

For part 27, the frequency stability shall be sufficient to ensure that the fundamental emission stays within the authorized frequency block.

Test Procedure Used

ANSI/TIA-603-D-2010

Test Settings

1. The equipment is turned on in a "standby" condition for fifteen minutes before applying power to the transmitter. Measurement of the carrier frequency of the transmitter is made within one minute after applying power to the transmitter.
2. Frequency measurements are made at 10°C intervals ranging from -30°C to +50°C. A period of time sufficient to stabilize EUT at each temperature level shall be allowed prior to frequency measurement.

Test Setup

The EUT and measurement equipment were set up as shown in the diagram below.

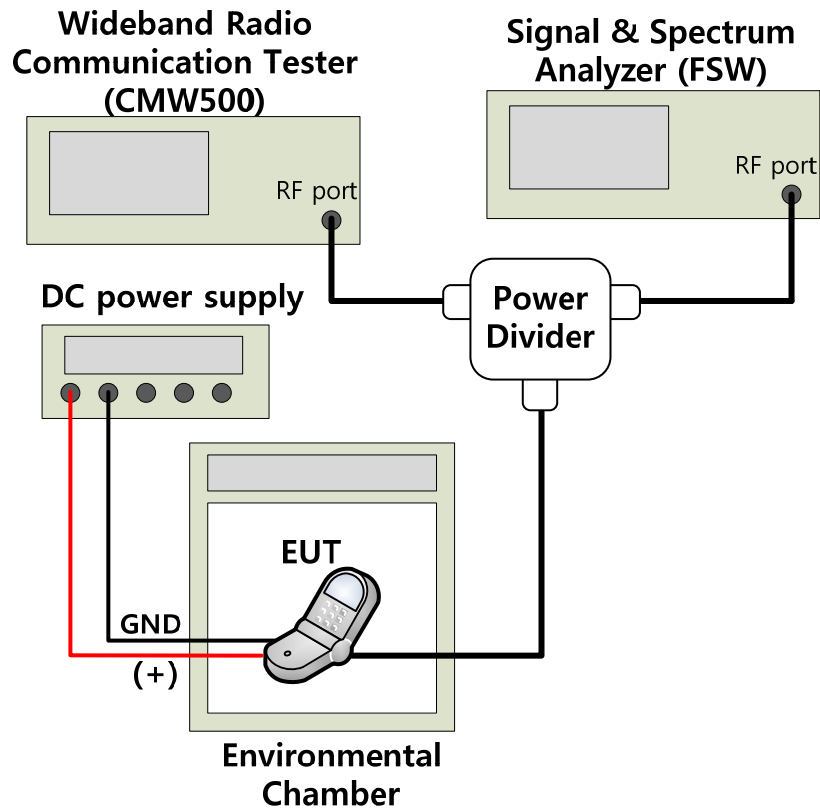

Figure 6-4. Test Instruments & Measurement Setup

Test Notes

1. MCF is the Measured Carrier Frequency
ACF is the Assigned Carrier Frequency
2. Calculate the ppm frequency error by the following:

$$\text{ppm error} = \left(\frac{\text{MCF}_{[\text{MHz}]} - \text{ACF}_{[\text{MHz}]}}{\text{ACF}_{[\text{MHz}]}} \right) \times 10^6$$

3. For part 27, the fundamental emission should stay within the authorized frequency block. But, based on the results of the frequency stability test at the center channel, the frequency deviation results measured are very small. As such it is determined that the channels at the band edge would remain in-band when the maximum measured frequency deviation noted during the frequency stability tests is applied. Therefore the device is determined to remain operating in band over the temperature and voltage range as tested.



Issue Date:

Mode : LTE Band 41
Channel : 40740
Operating Frequency : 2605.0 MHz
Reference Voltage : 3.8 VDC

Voltage [%]	Power [VDC]	Temp [°C]	ACF [MHz]	MCF [MHz]	Freq. Dev. [Hz]	ppm error
100 %	3.80	-30	2605.0	2,605.000015	15.42	0.006
		-20	2605.0	2,605.000016	15.56	0.006
		-10	2605.0	2,605.000015	14.96	0.006
		0	2605.0	2,605.000017	16.55	0.006
		+10	2605.0	2,605.000019	18.64	0.007
		+20	2605.0	2,605.000019	18.91	0.007
		+30	2605.0	2,605.000024	23.88	0.009
		+40	2605.0	2,605.000029	28.97	0.011
		+50	2605.0	2,605.000029	29.31	0.011
85%	3.40	+20	2605.0	2,605.000019	19.43	0.007

Table 6-2. Frequency Stability Data (LTE Band 41)

- End of this page -



6.6. Radiated Power (EIRP) §27.50(h.2)

Test Overview

Equivalent Isotropic Radiated Power (EIRP) measurements are performed using the substitution method described in ANSI/TIA-603-D-2010 with the EUT transmitting into an integral antenna. Measurements on signals operating above 1GHz are performed using horn antennas. All measurements are performed as RMS average measurements while the EUT is operating at its maximum duty cycle, at maximum power, and at the appropriate frequencies.

Test Procedure Used

KDB 971168 v02r02 – Section 5.2.1

ANSI/TIA-603-D-2010 – Section 2.2.17

Test Settings

1. Radiated power measurements are performed using the signal analyzer's "time domain power" measurement capability is used
2. RBW = 1 – 5% of the expected OBW, not to exceed 1MHz
3. VBW \geq 3 x RBW
4. Span = 1.5 times the OBW
5. No. of sweep points \geq 2 x span / RBW
6. Detector = RMS
7. Trigger is set to enable triggering only on full power bursts with the sweep time set less than or equal to the transmission burst duration
8. The "gating" function was enabled to ensure that measurements are performed during times in which the transmitter is operating at its maximum power
9. Trace mode = trace averaging (RMS) over 100 sweeps
10. The trace was allowed to stabilize

Test Setup

The EUT and measurement equipment were set up as shown in the diagram below.

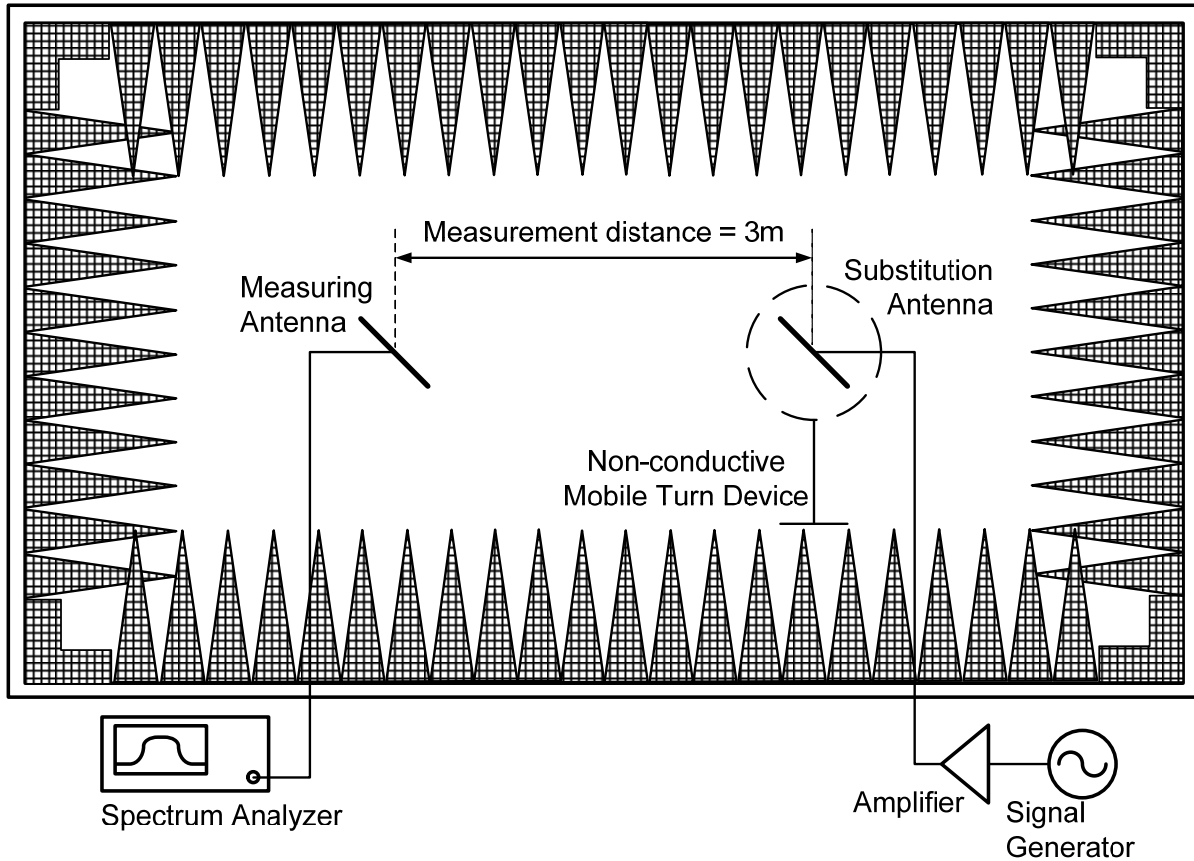

Figure 6-7. Test Instruments & Measurement Setup

Test Notes

1. The EUT was tested with Turn Device and the worst case emissions are reported with the EUT positioning, modulations, RB sizes and offsets, and channel bandwidth configurations shown in the tables below.
2. The EUT was tested with its standard battery. The battery for this model EB-BG530BBC contains an embedded NFC antenna.



Test Results

Channel	Channel BW [MHz]	Mod.	RB Size /Offset	Ant Pol (H/V)	EUT POL [degree]		S/A Reading [dBm]	S/G Level [dBm]	Tx C/L [dB]	Ant. Gain [dBi]	EIRP [dBm]	Margin [dB]
					Azimuth	Elevation						
40265	5	QPSK	1 / 12	V	348	295	-27.63	16.97	5.89	10.33	21.40	11.61
40265	5	16QAM	1 / 12	V	350	295	-29.48	15.12	5.89	10.33	19.55	13.46
40740	5	QPSK	1 / 0	H	15	360	-28.87	16.58	5.96	10.17	20.80	12.21
40740	5	16QAM	1 / 12	H	17	350	-30.85	14.60	5.96	10.17	18.82	14.19
41215	5	QPSK	1 / 12	H	5	350	-29.35	17.53	6.01	10.09	21.61	11.40
41215	5	16QAM	1 / 12	H	10	355	-30.87	16.01	6.01	10.09	20.09	12.92
40290	10	QPSK	1 / 49	V	352	284	-27.88	16.74	5.90	10.32	21.17	11.84
40290	10	16QAM	1 / 24	V	350	280	-29.38	15.24	5.90	10.32	19.67	13.34
40740	10	QPSK	1 / 24	H	14	360	-29.02	16.43	5.96	10.17	20.65	12.36
40740	10	16QAM	1 / 24	H	15	360	-29.91	15.54	5.96	10.17	19.76	13.25
41190	10	QPSK	1 / 0	H	10	360	-28.82	17.99	6.01	10.09	22.07	10.94
41190	10	16QAM	1 / 49	H	7	360	-30.34	16.47	6.01	10.09	20.55	12.46
40315	15	QPSK	1 / 74	V	355	280	-28.05	16.60	5.90	10.31	21.01	12.00
40315	15	16QAM	1 / 74	V	353	282	-29.11	15.54	5.90	10.31	19.95	13.06
40740	15	QPSK	1 / 36	H	10	360	-28.63	16.82	5.96	10.17	21.04	11.97
40740	15	16QAM	1 / 37	H	10	360	-30.08	15.37	5.96	10.17	19.59	13.42
41165	15	QPSK	1 / 0	H	5	348	-28.85	17.88	6.00	10.09	21.97	11.04
41165	15	16QAM	1 / 37	H	10	345	-30.10	16.63	6.00	10.09	20.72	12.29
40340	20	QPSK	1 / 49	V	354	288	-27.70	16.98	5.90	10.30	21.38	11.63
40340	20	16QAM	1 / 99	V	355	290	-28.51	16.17	5.90	10.30	20.57	12.44
40740	20	QPSK	1 / 49	H	15	355	-28.28	17.17	5.96	10.17	21.39	11.62
40740	20	16QAM	1 / 0	V	348	290	-28.91	16.27	5.96	10.17	20.49	12.52
41140	20	QPSK	1 / 0	H	10	360	-28.76	17.89	6.00	10.10	21.99	11.02
41140	20	16QAM	1 / 99	H	10	355	-30.04	16.61	6.00	10.10	20.71	12.30

Table 6-3. EIRP (LTE Band 41)



6.7. Radiated Spurious Emissions Measurements §2.1053 §27.53(m)

Test Overview

Radiated spurious emissions measurements are performed using the substitution method described in ANSI/TIA-603-D-2010 with the EUT transmitting into an integral antenna. Measurements on signals operating below 1GHz are performed using dipole antennas. Measurements on signals operating above 1GHz are performed using broadband horn antennas. All measurements are performed as peak measurements while the EUT is operating at its maximum duty cycle, at maximum power, and at the appropriate frequencies.

Test Procedure Used

KDB 971168 v02r02 – Section 5.8

ANSI/TIA-603-D-2010 – Section 2.2.12

Test Settings

1. RBW = 100kHz for emissions below 1GHz and 1MHz for emissions above 1GHz
2. VBW $\geq 3 \times$ RBW
3. No. of sweep points \geq Span / RBW
4. Detector = Max Peak
5. Trace mode = max hold
6. The trace was allowed to stabilize

– End of this page –

Test Setup

The EUT and measurement equipment were set up as shown in the diagram below.

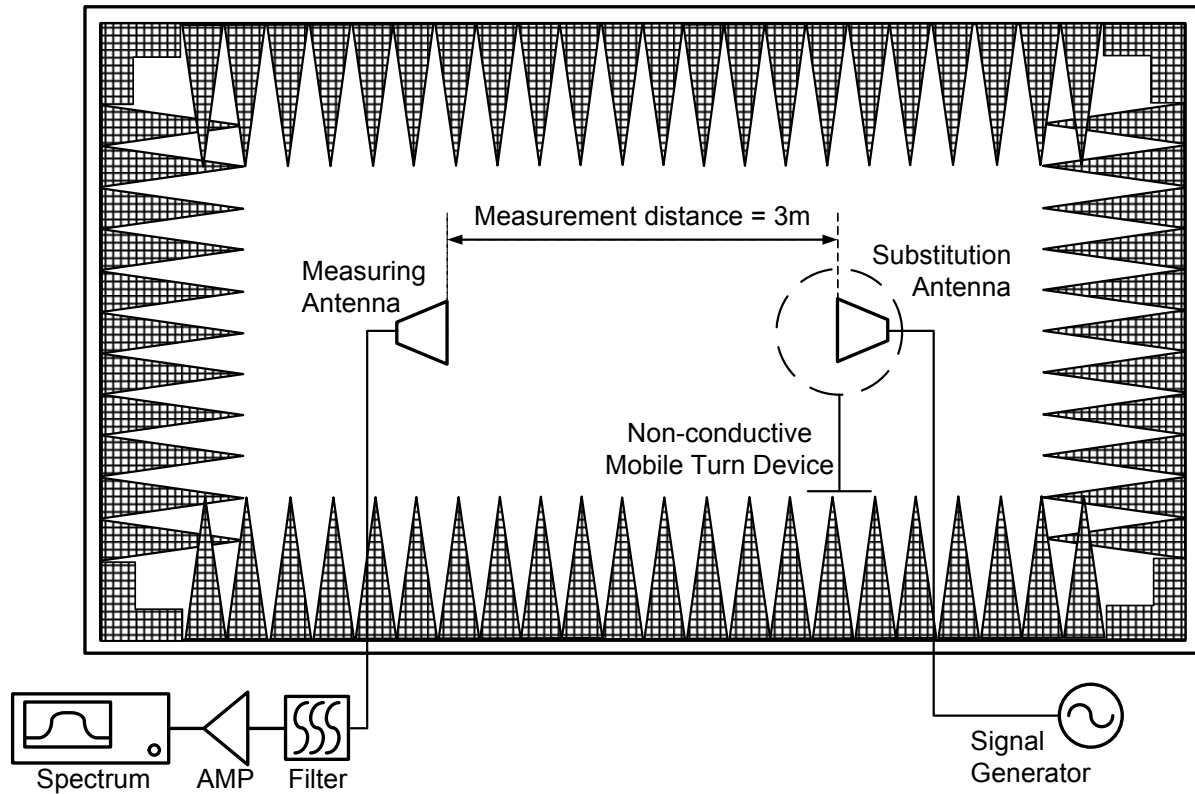

Figure 6-8. Test Instruments & Measurement Setup

Test Notes

1. The EUT was tested with Turn Device and the worst case emissions are reported with the EUT positioning, modulations, RB sizes and offsets, and channel bandwidth configurations shown in the tables below.
2. The EUT was tested with its standard battery. The battery for this model EB-BG530BBC contains an embedded NFC antenna.
3. The spectrum is measured from 9kHz to the 10th harmonic of the fundamental frequency of the transmitter. The worst-case emissions are reported.



Issue Date:

Test Results

Operating Frequency : 2557.5 MHz
 Channel : 40265
 Measured Output Power : 21.40 dBm = 0.138 Watt
 Modulation Signal : QPSK
 Band Width : 5 MHz
 RB Size / Offset : 1 / 12
 Distance : 3 Meters
 Limit : $55 + 10 \log_{10}(W)$ = 46.40 dBc
 RSE Limit : -25 dBm

Freq. [MHz]	Ant Pol (H/V)	EUT Pol [degree]		S/A reading [dBm]	S/G Lev. [dBm]	Tx C/L [dB]	Ant. Gain [dBi]	RSE Level [dBm]
		Azimuth	Elevation					
5115.3	H	21	228	-54.71	-39.54	8.53	11.29	-36.78
7673.0	H	86	253	-56.42	-32.12	10.66	10.42	-32.35
10230.0	H	Noise floor		-58.82	-29.95	12.58	12.03	-30.51

Table 6-4. Radiated Spurious Data (LTE Band 41 – Low Channel)

Operating Frequency : 2605 MHz
 Channel : 40740
 Measured Output Power : 21.39 dBm = 0.138 Watt
 Modulation Signal : QPSK
 Band Width : 20 MHz
 RB Size / Offset : 1 / 49
 Distance : 3 meters
 Limit : $55 + 10 \log_{10}(W)$ = 46.39 dBc
 RSE Limit : -25 dBm

Freq. [MHz]	Ant Pol (H/V)	EUT Pol [degree]		S/A reading [dBm]	S/G Lev. [dBm]	Tx C/L [dB]	Ant. Gain [dBi]	RSE Level [dBm]
		Azimuth	Elevation					
5210.4	V	12	140	-61.21	-46.40	8.68	11.64	-43.44
7815.5	V	355	307	-56.83	-33.56	10.82	10.69	-33.68
10420.0	H	Noise floor		-59.24	-30.53	12.47	11.80	-31.19

Table 6-5. Radiated Spurious Data (LTE Band 41 – Mid Channel)



Issue Date:

Operating Frequency : 2650 MHz
 Channel : 41190
 Measured Output Power : 22.07 dBm = 0.161 Watt
 Modulation Signal : QPSK
 Band Width : 10 MHz
 RB Size / Offset : 1 / 0
 Distance : 3 meters
 Limit : $55 + 10 \log_{10}(W)$ = 47.07 dBc
 RSE Limit : -25 dBm

Freq. [MHz]	Ant Pol (H/V)	EUT Pol [degree]		S/A reading [dBm]	S/G Lev. [dBm]	Tx C/L [dB]	Ant. Gain [dBi]	RSE Level [dBm]
		Azimuth	Elevation					
5291.2	V	227	38	-56.91	-41.95	8.84	11.76	-39.03
7936.7	V	360	307	-56.44	-32.93	10.89	10.90	-32.92
10600.0	H	Noise floor		-58.66	-29.75	12.62	11.84	-30.53

Table 6-6. Radiated Spurious Data (LTE Band 41 – High Channel)

– End of this page –



7. CONCLUSION

The data collected relate only the item(s) tested and show that the Samsung Portable Handset FCC ID: A3LSMJ3109 compliance with all the requirements of Parts 2, 27 of the FCC rules.

– End of this report –