



Issue Date:

129 Samsung-ro,
Yeongtong-gu, Suwon-Si,
Gyeonggi-Do, 16677
Korea
Tel: 82-31-8062-4278
Fax: 82-31-279-9985

FCC TEST REPORT

Manufacturer: SAMSUNG Electronics Co., Ltd.

Model: SM-J3109

FCC ID: A3LSMJ3109

Application Type: Certification

EUT Type: Portable Handset

All measurements reported here are in accordance with FCC Rules,
47CFR Part2, Part22, and Part24.

Prepared By Date
IH Park
Test Engineer

Checked By Date
Jooha Bek
Deputy Technical Manager

Authorized By Date
JD Jang
Technical Manager



Revision History

Rev. #	Issue Date	Revisions	Revised By
1		▪ Initial issue	IH Park

– End of this page –



Table of Contents

§2.1033 General Information	4
1. INTRODUCTION	5
1.1. General.....	5
2. PRODUCT INFORMATION	5
2.1. Equipment Description	5
2.2. Device Capabilities	5
3. DESCRIPTION OF TESTS	6
3.1. Evaluation Procedure	6
3.2. Radiated Measurements	6
3.3. EMI Suppression Device(s)/Modifications	6
4. TEST EQUIPMENT LIST	7
5. SAMPLE CALCULATIONS	8
6. TEST RESULTS	9
6.1. Summary	9
6.2. Occupied Bandwidth.....	10
6.3. Spurious and Harmonic Emissions at Antenna Terminal	13
6.4. Band Edge Emissions at Antenna Terminal	35
6.5. Peak-Average Ratio	43
6.6. Frequency Stability / Temperature Variation	46
6.7. Radiated Power (ERP/EIRP).....	50
6.8. Radiated Spurious Emissions Measurements	53
7. CONCLUSION	60

**§2.1033 General Information**

APPLICANT: Samsung Electronics Co., Ltd.

APPLICANT ADDRESS: 129 Samsung-ro,
Yeongtong-gu, Suwon-si, Gyeonggi-do, 16677, Korea

TEST SITE: Samsung Electronics Co., Ltd.

TEST SITE ADDRESS: 129 Samsung-ro,
Yeongtong-gu, Suwon-si, Gyeonggi-do, 16677, Korea

FCC RULE PART(S): §2, §22, §24

TEST PROCEDURE(S): ANSI/TIA-603-D-2010, KDB971168 v02r02

BASE MODEL: SM-J3109

FCC ID: A3LSMJ3109

FCC CLASSIFICATION: PCS Licensed Transmitter Held to Ear (PCE)

MODE: GSM / EDGE / WCDMA

EMISSION DESIGNATOR: 248KGXW (GSM1900), 247KG7W (EDGE1900)
4M20F9W (WCDMA850)
4M21F9W (WCDMA1900)

TX FREQUENCY RANGE 1850.2 – 1909.8MHz (GSM1900, EDGE1900)
826.4 – 846.6MHz (WCDMA850)
1852.4 – 1907.6MHz (WCDMA1900)

RX FREQUENCY RANGE 1930.2 – 1989.8MHz (GSM1900, EDGE1900)
871.4 – 891.6MHz (WCDMA850)
1932.4 – 1987.6MHz (WCDMA1900)

MAX POWER RATING: 0.776 W EIRP GSM1900 (28.90 dBm)
0.392 W EIRP EDGE1900 (25.93 dBm)
0.033 W ERP WCDMA850 (15.18 dBm)
0.192 W EIRP WCDMA1900 (22.83 dBm)

TEST DEVICE SERIAL NO.: FCM-034-A & FCM-034-B

DATE(S) OF TEST: September 22 – October 15, 2015



1. INTRODUCTION

1.1. General

These measurement tests were conducted at SAMSUNG ELECTRONICS CO., LTD. (SUWON). The site address is 129 Samsung-ro, Yeongtong-gu, Suwon-si, Gyeonggi-do, 16677, Korea.

2. PRODUCT INFORMATION

2.1. Equipment Description

The Equipment Under Test (EUT) is the Samsung Portable Handset FCC ID: A3LSMJ3109. The test data contained in this report pertains only to the emissions due to the EUT's 2G/3G licensed transmitters.

2.2. Device Capabilities

This device contains the following capabilities:

1900 GSM/GPRS/EDGE, 850/1900 WCDMA, Multi-band LTE, 802.11b/g/n WLAN, Bluetooth (1x, EDR, LE, HS), NFC.



3. DESCRIPTION OF TESTS

3.1. Evaluation Procedure

The measurement procedures described in the "Land Mobile FM or PM -Communications Equipment-Measurements and Performance Standards" (ANSI/TIA-603-D-2010) and "Measurement Guidance for Certification of Licensed Digital Transmitters" (KDB 971168 v02r02) were used in the measurement of the Samsung Portable Handset FCC ID: A3LSMJ3109.

3.2. Radiated Measurements

The radiated and spurious measurements were made at the full anechoic chamber. The equipment under test was placed on the Turn Device at the same height and a distance of 3-meters from the measuring antenna.

The turn device is designed for mobile device measurements. Different sized devices can be mounted on the mounting bracket made of Rohacell.

The turn device is mounted onto a turntable to have both 360° vertical and horizontal rotation. The measurement was made for each horizontal/vertical position in combination with horizontally and vertically polarized measuring antenna.

The substitution antenna will replace the EUT antenna at the same position. The frequency of the signal generator shall be set to the frequencies that were measured on the EUT. The output level of the signal generator shall be adjusted until an equal or a known related level that was measured from the EUT. This level was recorded. For emissions above 1 GHz, the above procedure is repeated by using horn antennas and dBi gain is taken into consideration.

The power of the emission is calculated using the following formula:

$$P_{d[\text{dBm}]} = P_{g[\text{dBm}]} - \text{cable loss}_{[\text{dB}]} + \text{antenna gain}_{[\text{dBd,dBi}]}$$

Where P_d is the dipole equivalent power, P_g is the generator output into the substitution antenna, and the antenna gain is the gain of the substitute antenna used relative to either a half-wave dipole(dBd) or an isotropic source(dBi). The cable connects the generator to the substitute antenna and the substitute level is equal to $P_{g[\text{dBm}]} - \text{cable loss}_{[\text{dB}]}$.

Radiated power levels and radiated spurious emissions levels are investigated per ANSI/TIA-603-D-2010.

3.3. EMI Suppression Device(s)/Modifications

No EMI suppression device(s) were added and no modifications were made during testing.



4. TEST EQUIPMENT LIST

The measuring equipment, which was utilized in performing the tests documented herein, has been calibrated in accordance with the manufacturer's recommendations for utilizing calibration equipment, which is traceable to recognized national standards.

Description	Model	Serial No.	Manufacturer	Cal. Date	Cal. Due
Wireless Communications Test Set	E5515C	GB42230535	Agilent	2015-01-08	2016-01-08
Wireless Communications Test Set	E5515C	MY53201087	Agilent	2014-11-06	2015-11-06
PSA Series Spectrum Analyzer	E4440A	MY46187454	Agilent	2015-03-12	2016-03-12
EMI TEST RECEIVER	ESI	836119/010	R&S	2014-10-17	2015-10-17
PSG Analog Signal Generator	E8257D	MY51501209	Agilent	2014-11-07	2015-11-07
EPM Series Power Meter	E4419B	GB41293846	Agilent	2015-09-22	2016-09-22
POWER SENSOR	E9300H	MY41495838	Agilent	2015-09-18	2016-09-18
DC Power Supply	E3632A	MY40027718	Agilent	2015-05-15	2016-05-15
Temperature Humidity Chamber	SH-241	92000548	Espec	2014-11-11	2015-11-11
Loop Antenna	HFH2-Z2	100276	R&S	2014-05-19	2016-05-19
DIPOLE ANTENNA	UHA 9105	9105-2412	Schwarzbeck	2015-09-08	2017-09-08
LOG PERIODIC DIPOLE ANTENNA	HL040	353255/020	R&S	2014-10-15	2016-10-15
DOUBLE-RIDGED HORN Antenna	HF906	360306/011	R&S	2015-01-30	2017-01-30
HORN Antenna	BBHA 9120	9120D-636	Schwarzbeck	2015-01-30	2017-01-30
HORN Antenna & Pre-amplifier assembly	HAP18-26N	216250	Flann	2014-01-09	2016-01-09
HORN Antenna & Pre-amplifier assembly	HAP18-26N	216251	Flann	2015-04-30	2017-04-30
PRE-AMPLIFIER	8449B	3008A00691	Agilent	2014-11-25	2015-11-25
RF Power Amplifier	5S1G4	304866	AR	2015-02-09	2016-02-09
Hygrothermograph Data Logger	SK-L200TH2a	5077	SATO	2014-10-31	2015-10-31
Hygrothermograph Data Logger	SK-L200TH2a	5078	SATO	2014-10-31	2015-10-31
Hygrothermograph Data Logger	SK-L200TH2a	5110	SATO	2014-10-31	2015-10-31
Power Divider	11636B	58456	Agilent	2015-04-27	2016-04-27
Highpass filter	WHK3.0/18G-10SS	206	Wainwright	2015-01-07	2016-01-07
Highpass filter	WHV1.0/15G-10SS	1	Wainwright	2015-04-13	2016-04-13
Attenuator 10dB	8491B	MY39264180	Agilent	2015-06-23	2016-06-23
Attenuator 20dB	8493C	74158	Agilent	2015-08-20	2016-08-20
Network Analyzer	8753E	JP38160590	HP	2015-06-23	2016-06-23

Table 4-1 Test Equipment



5. SAMPLE CALCULATIONS

5.1. GSM Emission Designator

Emission Designator = 250KGXW

GSM BW = 250kHz

G = Phase Modulation

X = Cases not otherwise covered

W = Combination (Audio/Data)

5.2. EDGE Emission Designator

Emission Designator = 250KG7W

EDGE BW = 250kHz

G = Phase Modulation

7 = Quantized/Digital Info

W = Combination (Audio/Data)

5.3. WCDMA Emission Designator

Emission Designator = 4M16F9W

WCDMA BW = 4.16MHz

F = Frequency Modulation

9 = Composite Digital Info

W = Combination (Audio/Data) (Measured at the 99.75% power bandwidth)

5.4. Spurious Radiated Emission

Example: Spurious emission at 3700.40MHz

The receive spectrum analyzer reading at 3 meters with the EUT on the turn device was -81.0dBm. The gain of the substituted antenna is 8.1dBi. The signal generator connected to the substituted antenna terminals is adjusted to produce a reading of -81.0dBm on the spectrum analyzer. The loss of the cable between the signal generator and the terminals of the substituted antenna is 2.0dB at 3700.40MHz. So 6.1dB is added to the signal generator reading of -30.9dBm yielding -24.80dBm. The fundamental EIRP was 25.50dBm so this harmonic was 25.50dBm - (-24.80) = 50.3dBc.



6. TEST RESULTS

6.1. Summary

FCC Part Section(s)	Test Description	Test Limit	Test Condition	Test Result	Reference
TRANSMITTER MODE (TX)					
2.1049	Occupied Bandwidth	N/A	CONDUCTED	PASS	Section 6.2
2.1051 22.917(a) 24.238(a)	Conducted Band Edge / Spurious Emissions	> 43 +10 log ₁₀ (P[Watts]) at Band Edge and for all out-of-band emissions		PASS	Sections 6.3, 6.4
24.232(d)	Peak-Average Ratio	< 13 dB		PASS	Section 6.5
2.1046	Transmitter Conducted Output Power	N/A		PASS	See FCC SAR Report
2.1055 22.355 24.235	Frequency Stability	< 2.5 ppm (part 22) Emission must remain in band (Part 24)		PASS	Section 6.6
22.913(a.2)	Effective Radiated Power	< 7 Watts max. ERP	RADIATED	PASS	Section 6.7
24.232(c)	Equivalent Isotropic Radiated Power	< 2 Watts max. EIRP		PASS	Section 6.7
2.1053 22.917(a) 24.238(a)	Radiated Spurious Emissions	> 43 +10 log ₁₀ (P[Watts]) for all out-of-band emissions		PASS	Section 6.8

Table 6-1. Summary of Test Results

Notes:

1. All modes of operation and data rates were investigated. The test results shown in the following sections represent the worst case emissions.
2. The analyzer plots shown in this section were all taken with a correction value loaded into the analyzer. The correction value was used to account for the losses of the cables and attenuators used as part of the system to connect the EUT to the analyzer at all frequencies of interest.
3. All antenna port conducted emissions testing was performed on a test bench with the antenna port of the EUT connected to the spectrum analyzer through calibrated cables and attenuators.
4. For conducted spurious emissions, automated test software was used to measure emissions and capture the corresponding plots necessary to show compliance. The measurement software utilized is SAMSUNG Electronics "Measurement Automation System", Version 4.1.11.

6.2. Occupied Bandwidth
§2.1049

Test Overview

The Occupied bandwidth, that is the frequency bandwidth such that, below its lower and above its upper frequency limits, the mean powers radiated are each equal to 0.5 percent of the total mean power radiated by a given emission shall be measured. All modes of operation were investigated and the worst case configuration results are reported in this section.

Test Procedure Used

KDB 971168 v02r02 – Section 4.2

Test Settings

1. The signal analyzer's automatic bandwidth measurement capability was used to perform the 99% Occupied bandwidth and the 26dB bandwidth. The bandwidth measurement was not influenced by any intermediate power nulls in the fundamental emission.
2. RBW = 1~5% of the expected OBW
3. VBW \geq 3 x RBW
4. Detector = Peak
5. Trace mode = max hold
6. Sweep = auto couple
7. The trace was allowed to stabilize
8. If necessary, steps 2~7 were repeated after changing the RBW such that it would be within 1~5% of the 99% occupied bandwidth observed in Step 7

Test Setup

The EUT and measurement equipment were set up as shown in the diagram below.

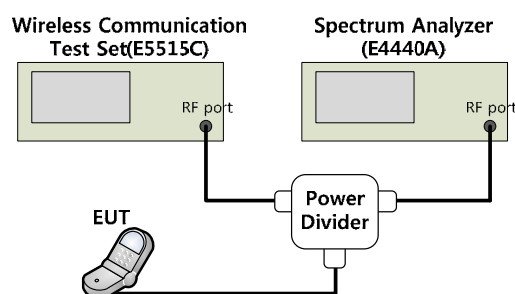
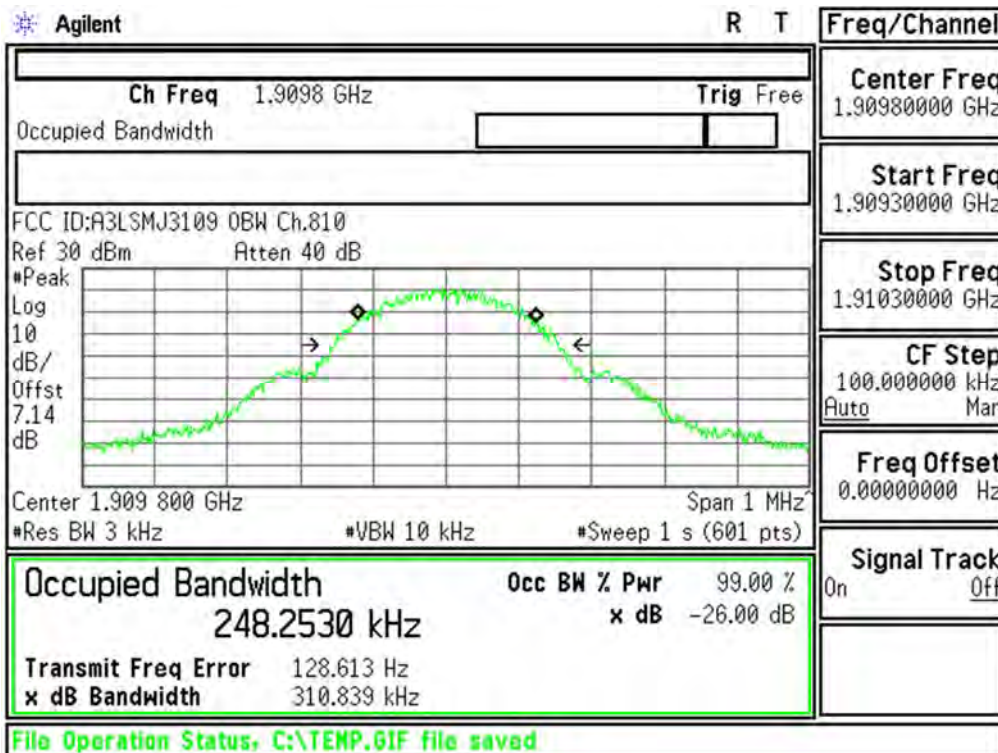

Figure 6-1. Test Instruments & Measurement Setup



Issue Date:

Test Plots



Plot 6-1. Occupied Bandwidth Plot (PCS GSM Mode - Ch.810)

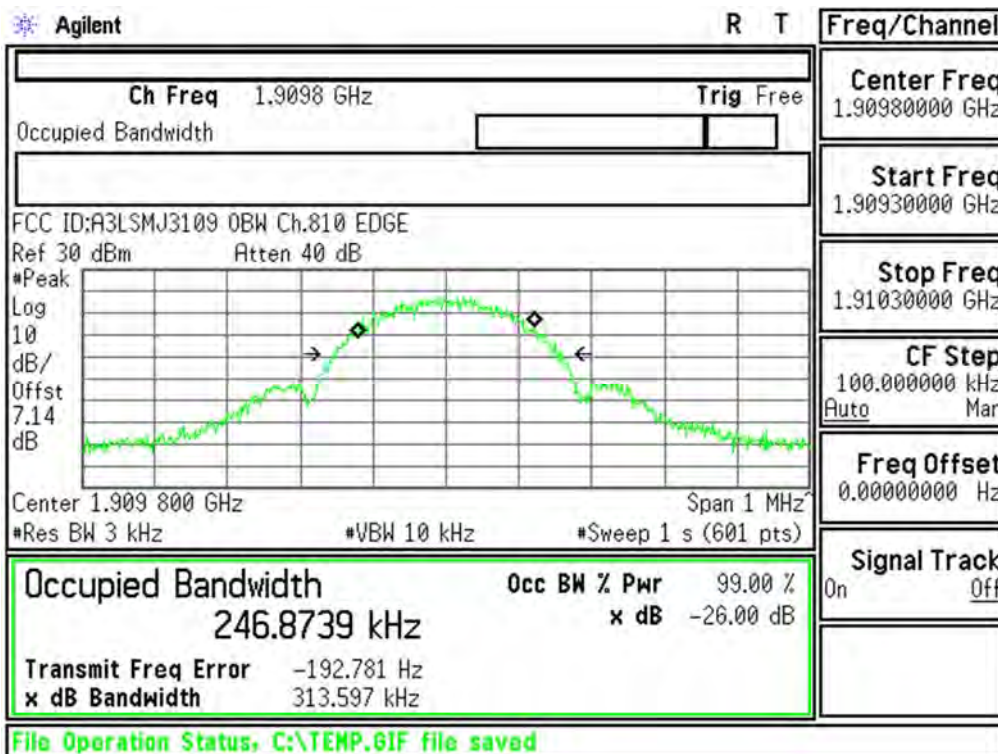

Plot 6-2. Occupied Bandwidth Plot (EDGE1900 Mode - Ch.810)



Issue Date:

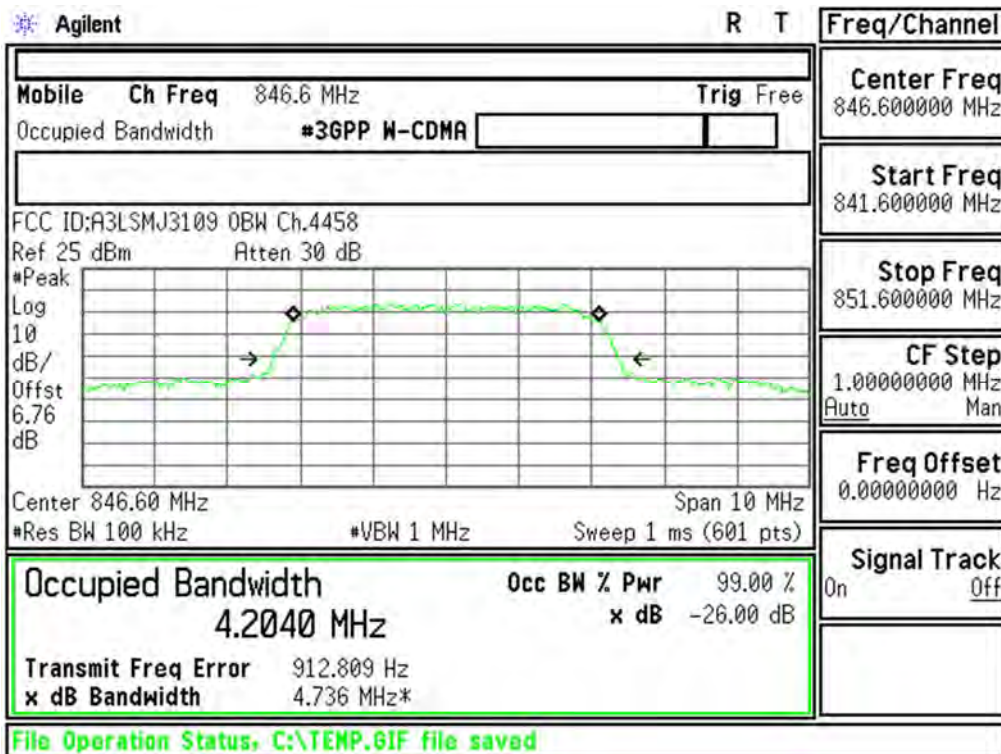

Plot 6-3. Occupied Bandwidth Plot (Cellular WCDMA Mode - Ch.4233(DL4458))

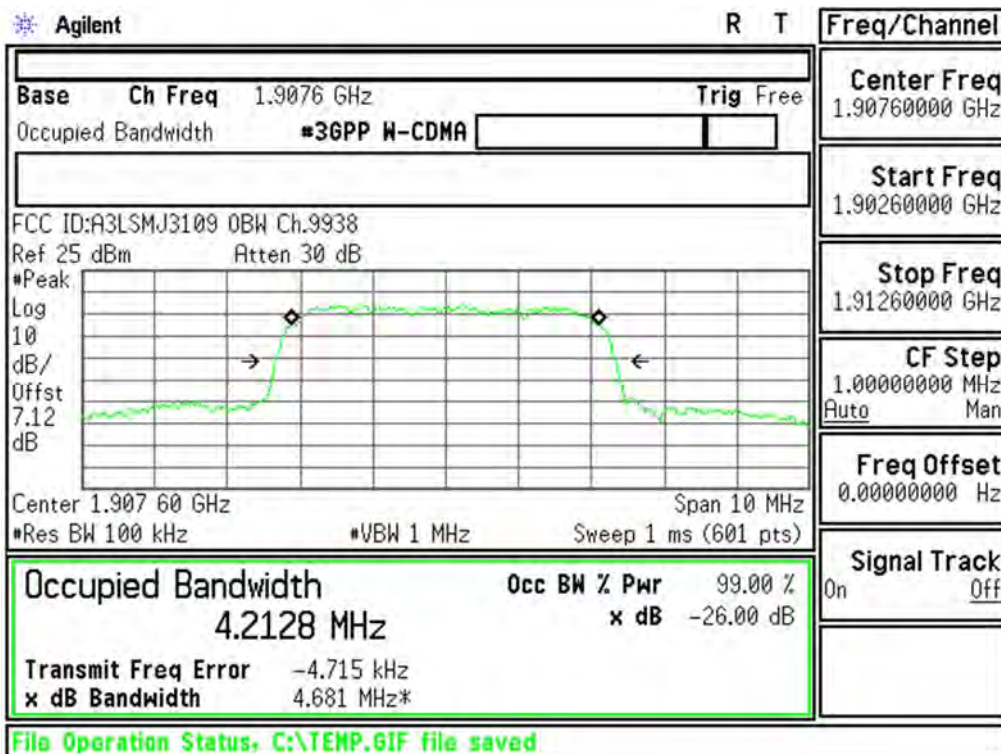

Plot 6-4. Occupied Bandwidth Plot (PCS WCDMA Mode - Ch.9538(DL9938))



6.3. Spurious and Harmonic Emissions at Antenna Terminal
§2.1051 §22.917(a) §24.238(a)

Test Overview

The level of the carrier and the various conducted spurious and harmonic frequencies is measured by means of a calibrated spectrum analyzer. The spectrum is scanned from the lowest frequency generated in the equipment up to a frequency including its 10th harmonic. All out of band emissions are measured with a spectrum analyzer connected to the antenna terminal of the EUT while the EUT is operating at maximum power, and at the appropriate frequencies. All data rates were investigated to determine the worst case configuration. All modes of operation were investigated and the worst case configuration results are reported in this section.

The minimum permissible attenuation level of any spurious emission is $43 + 10 \log_{10}(P_{\text{[Watts]}})$, where P is the transmitter power in Watts. Limit equivalent to -13dBm, calculation shown below.

$$\begin{aligned}43 + 10 \log_{10}(1.567\text{W}) &= 44.95 \text{ dB} \\1.567\text{W} &= 31.95 \text{ dBm} \\31.95 \text{ dBm} - 44.95 \text{ dB} &= -13 \text{ dBm}\end{aligned}$$

Test Procedure Used

KDB 971168 v02r02 – Section 6.0

Test Settings

1. Start frequency was set to 30MHz and stop frequency was set to 12GHz for Cell, 20GHz for PCS (separated into at least two plots per channel)
2. RBW = 1MHz
3. VBW = 3MHz
4. Detector = Max Peak
5. Trace mode = max hold
6. Sweep time = auto couple
7. The trace was allowed to stabilize

Test Setup

The EUT and measurement equipment were set up as shown in the diagram below.

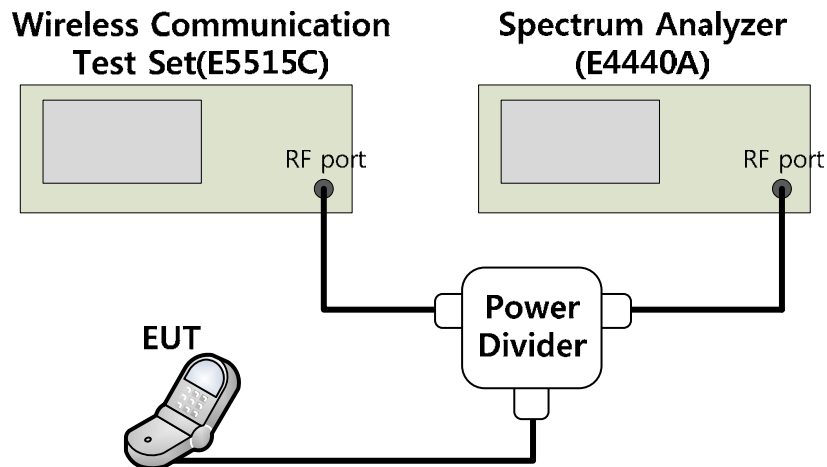

Figure 6-2. Test Instruments & Measurement Setup

Test Notes

1. Compliance with the applicable limits is based on the use of measurement instrumentation employing a resolution bandwidth of 100 kHz or greater for Part 22 and 1 MHz or greater for Part 24. However, in the 1 MHz bands immediately outside and adjacent to the frequency block a resolution bandwidth of at least one percent of the emission bandwidth of the fundamental emission of the transmitter may be employed. The emission bandwidth is defined as the width of the signal between two points, one below the carrier center frequency and one above the carrier center frequency, outside of which all emissions are attenuated at least 26dB below the transmitter power.
2. The offset which applied to above 4GHz frequencies is the worst-case value of the RF path-loss¹ in the frequency range 4GHz to 20GHz.

¹ RF path-loss = EUT output – Spectrum Analyzer input



Issue Date:

Test Plots

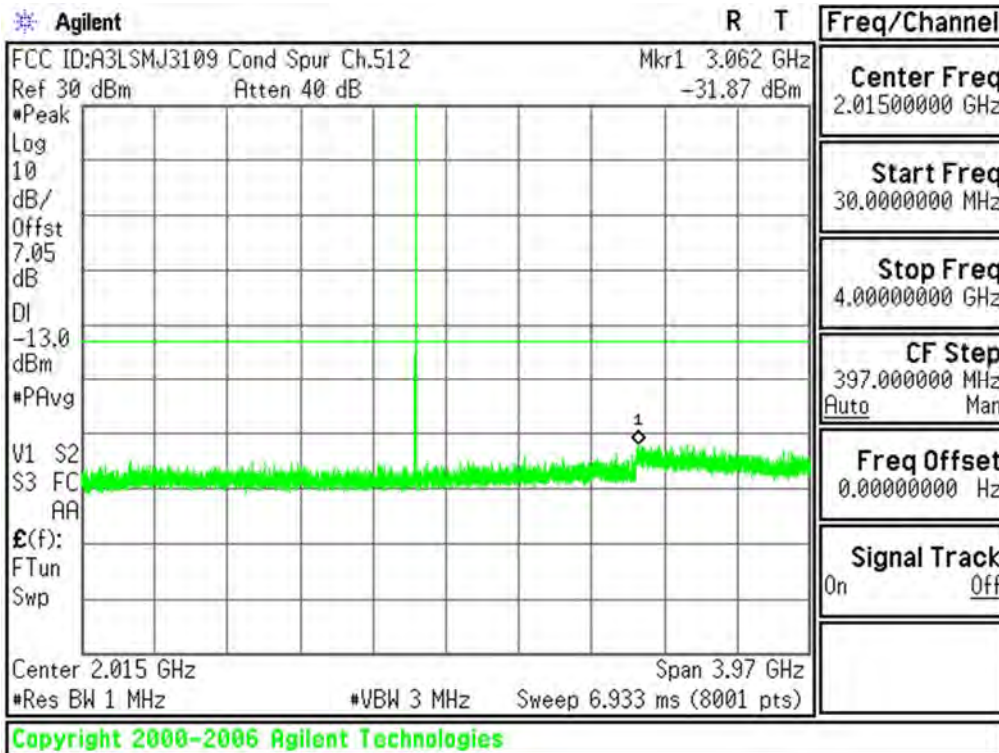

Plot 6-5. Conducted Spurious Plot (PCS GSM Mode - Ch.512)

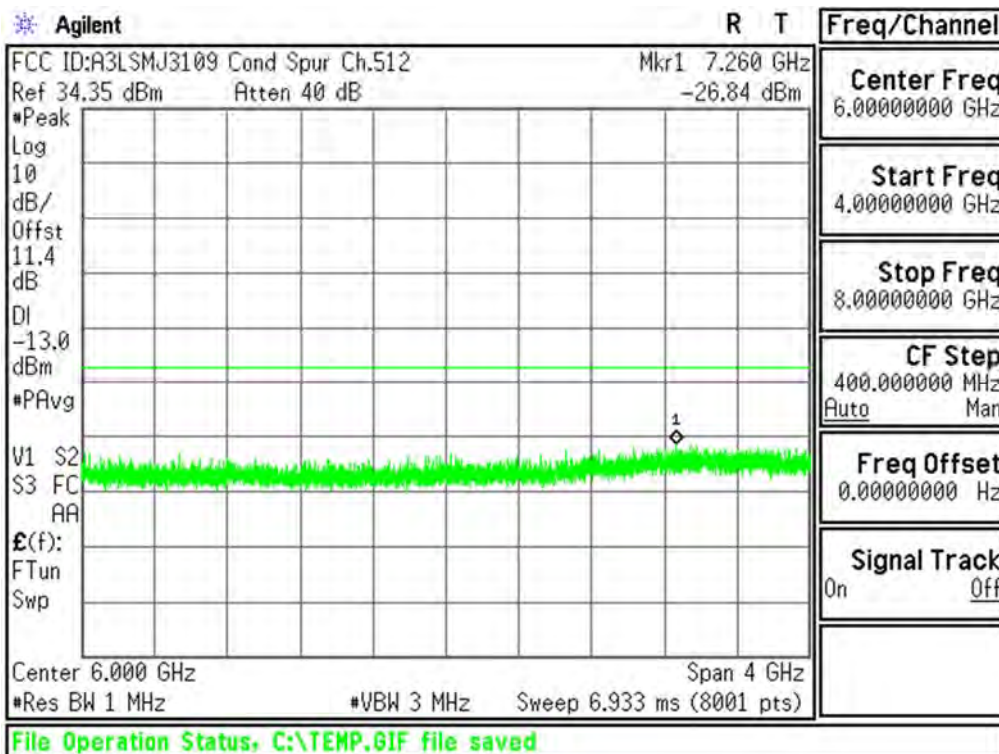

Plot 6-6. Conducted Spurious Plot (PCS GSM Mode - Ch.512)



Issue Date:

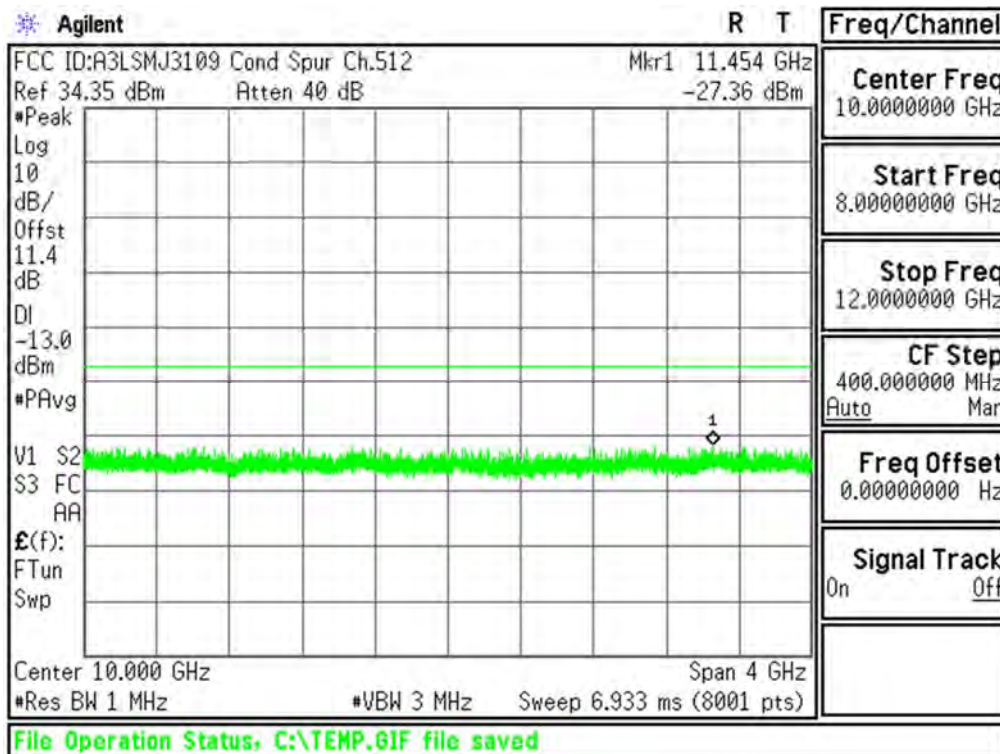

Plot 6-7. Conducted Spurious Plot (PCS GSM Mode - Ch.512)

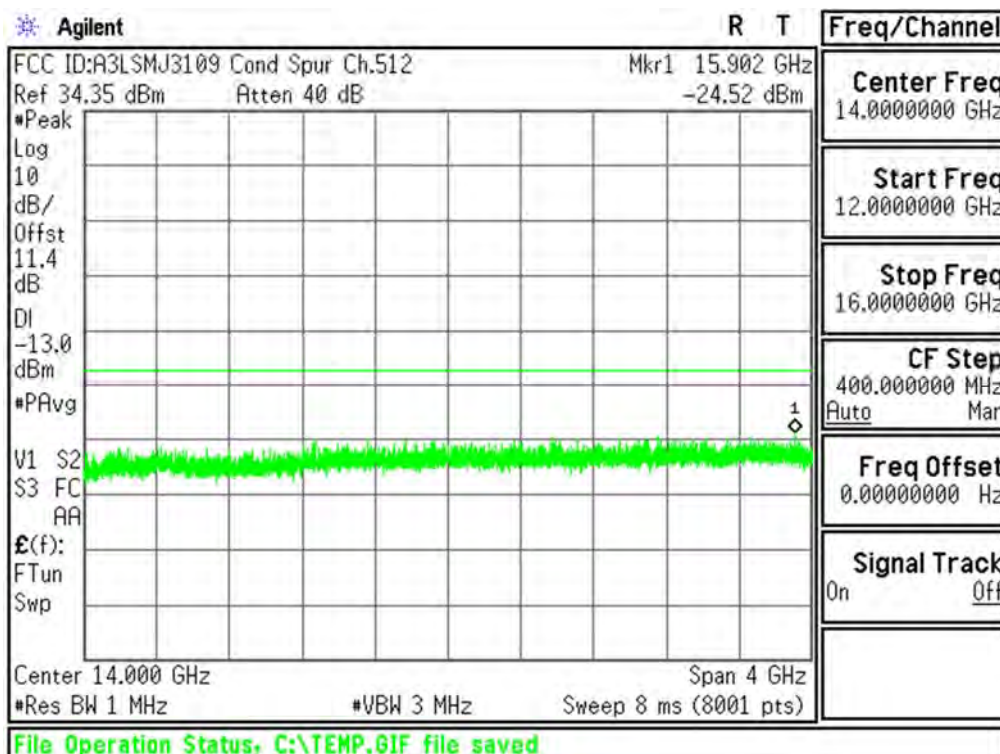

Plot 6-8. Conducted Spurious Plot (PCS GSM Mode - Ch.512)



Issue Date:

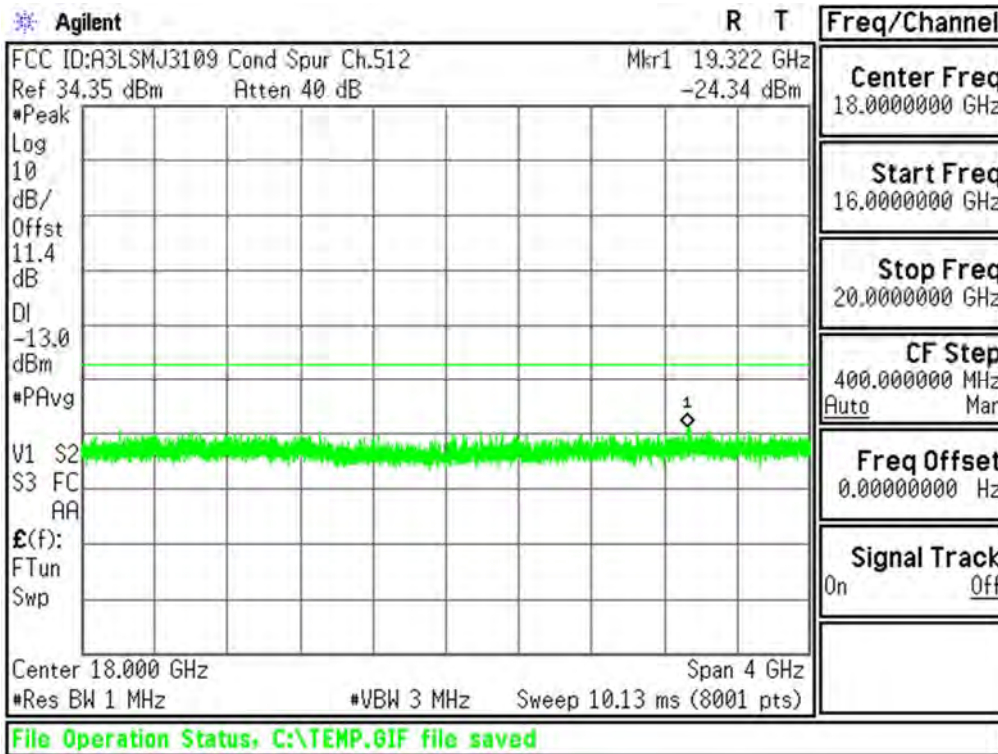

Plot 6-9. Conducted Spurious Plot (PCS GSM Mode - Ch.512)

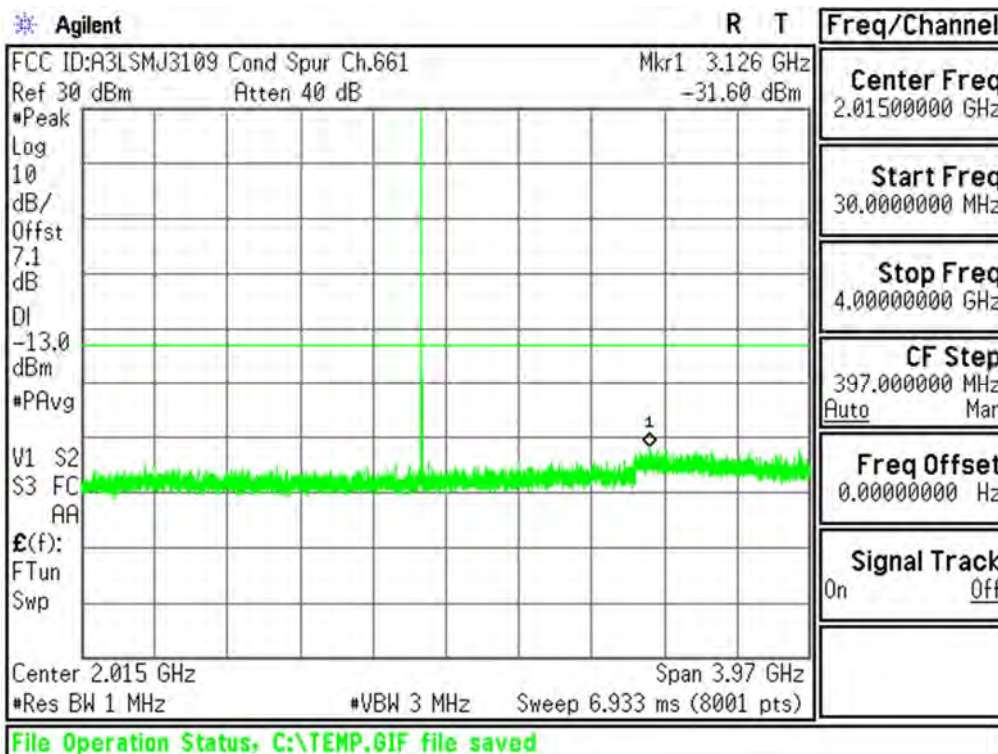

Plot 6-1. Conducted Spurious Plot (PCS GSM Mode - Ch.661)



Issue Date:

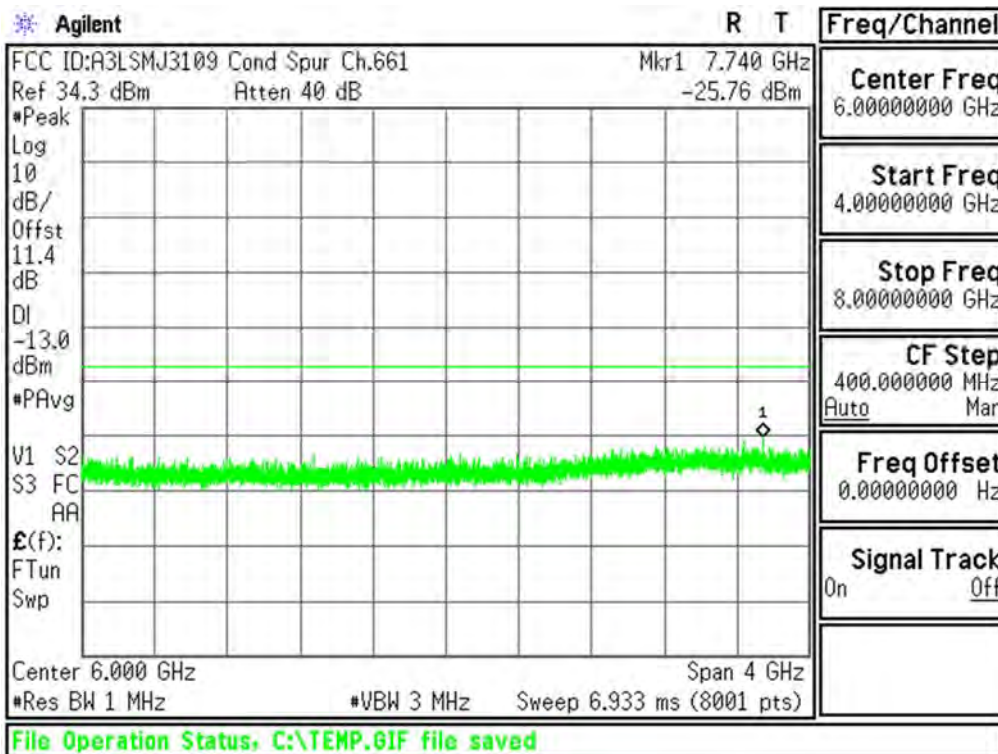

Plot 6-2. Conducted Spurious Plot (PCS GSM Mode - Ch.661)

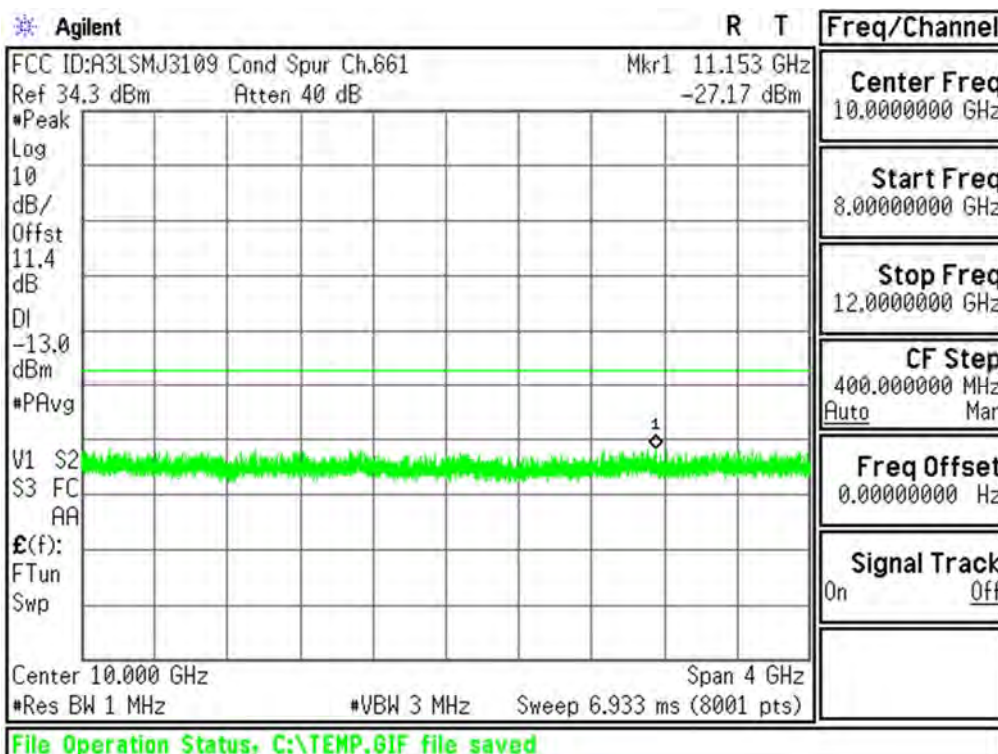

Plot 6-3. Conducted Spurious Plot (PCS GSM Mode - Ch.661)



Issue Date:

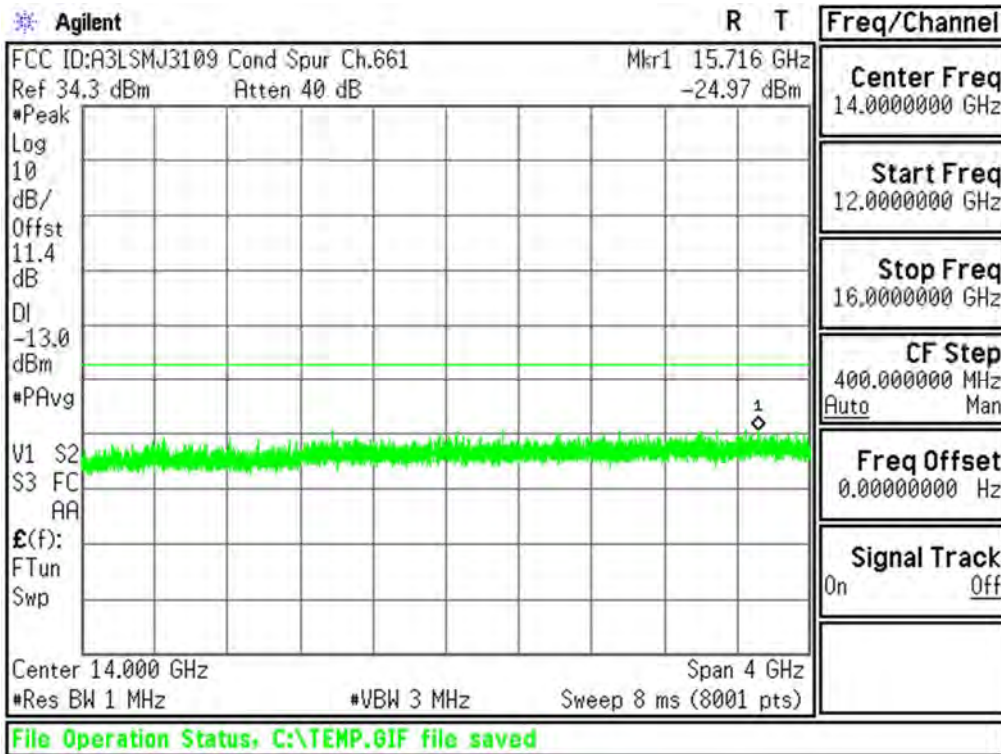

Plot 6-4. Conducted Spurious Plot (PCS GSM Mode - Ch.661)

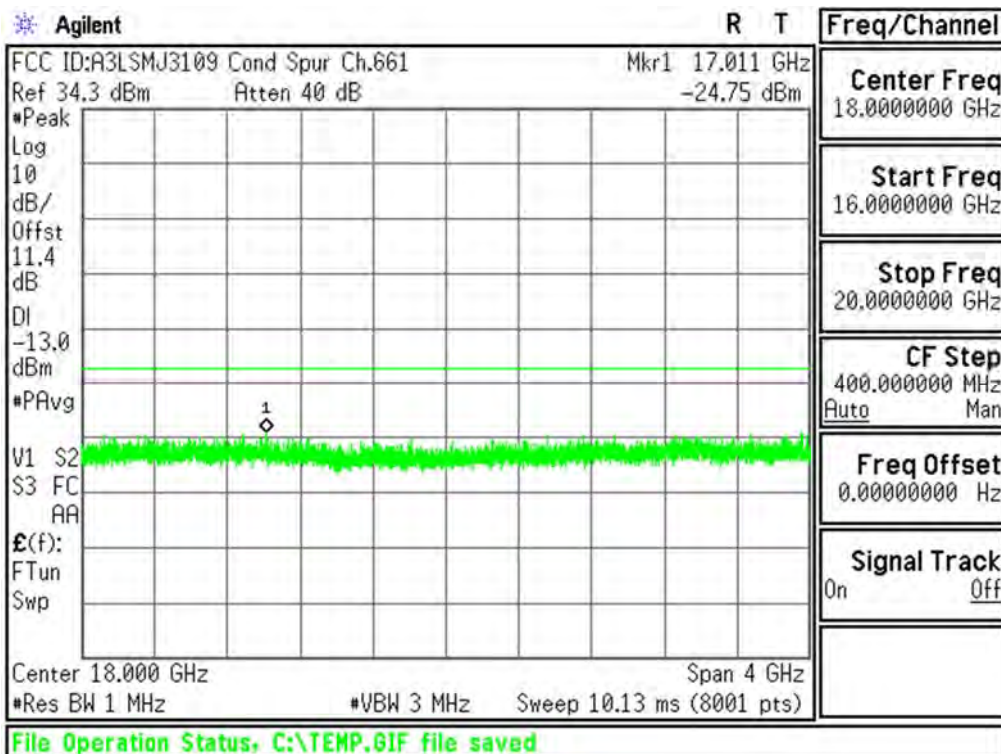

Plot 6-5. Conducted Spurious Plot (PCS GSM Mode - Ch.661)



Issue Date:

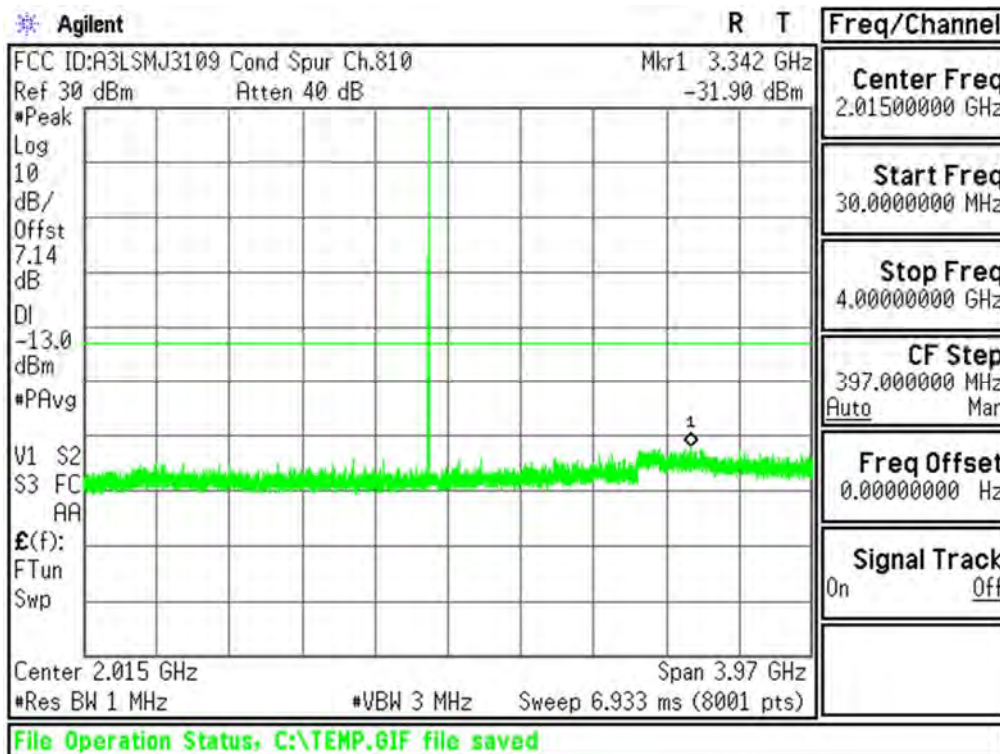

Plot 6-6. Conducted Spurious Plot (PCS GSM Mode - Ch.810)

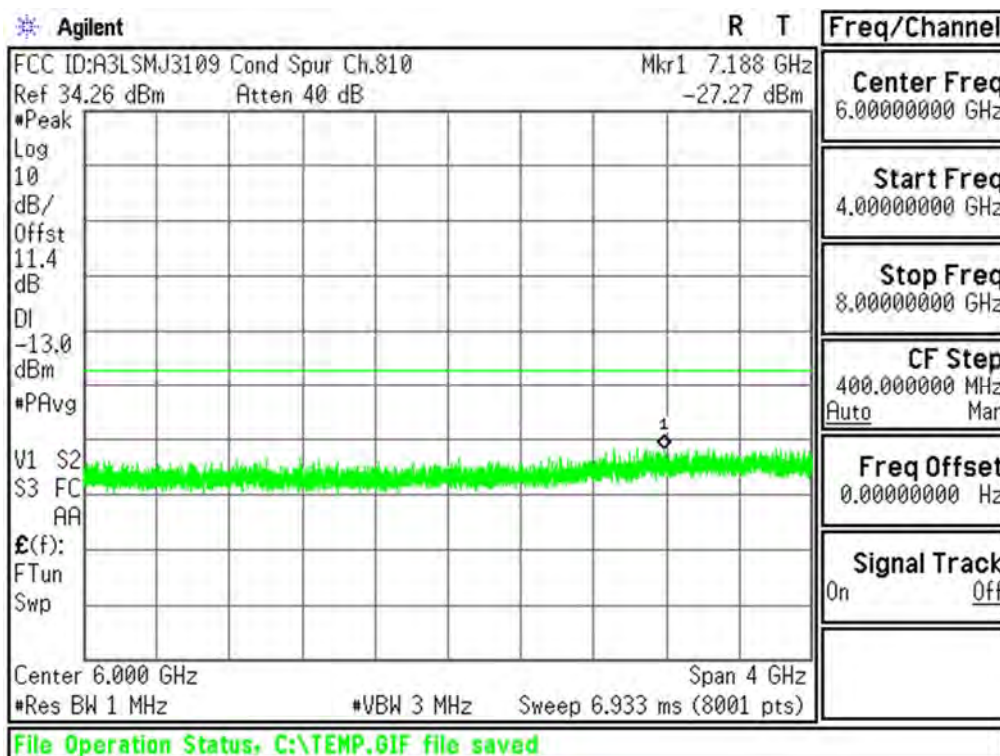

Plot 6-7. Conducted Spurious Plot (PCS GSM Mode - Ch.810)



Issue Date:

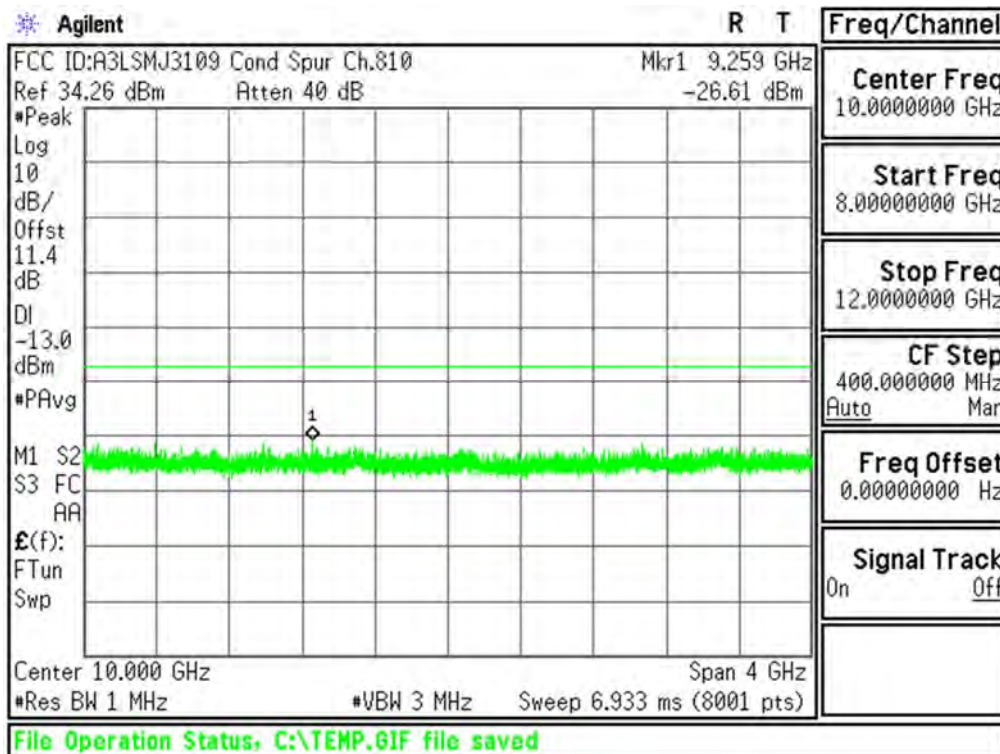

Plot 6-8. Conducted Spurious Plot (PCS GSM Mode - Ch.810)

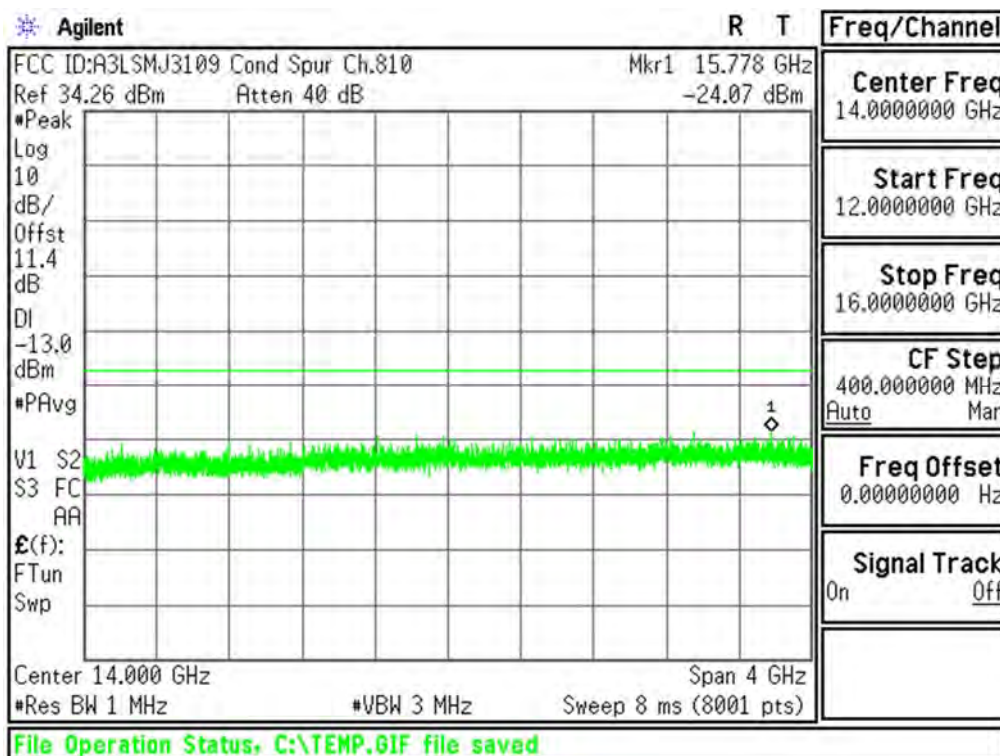

Plot 6-9. Conducted Spurious Plot (PCS GSM Mode - Ch.810)



Issue Date:

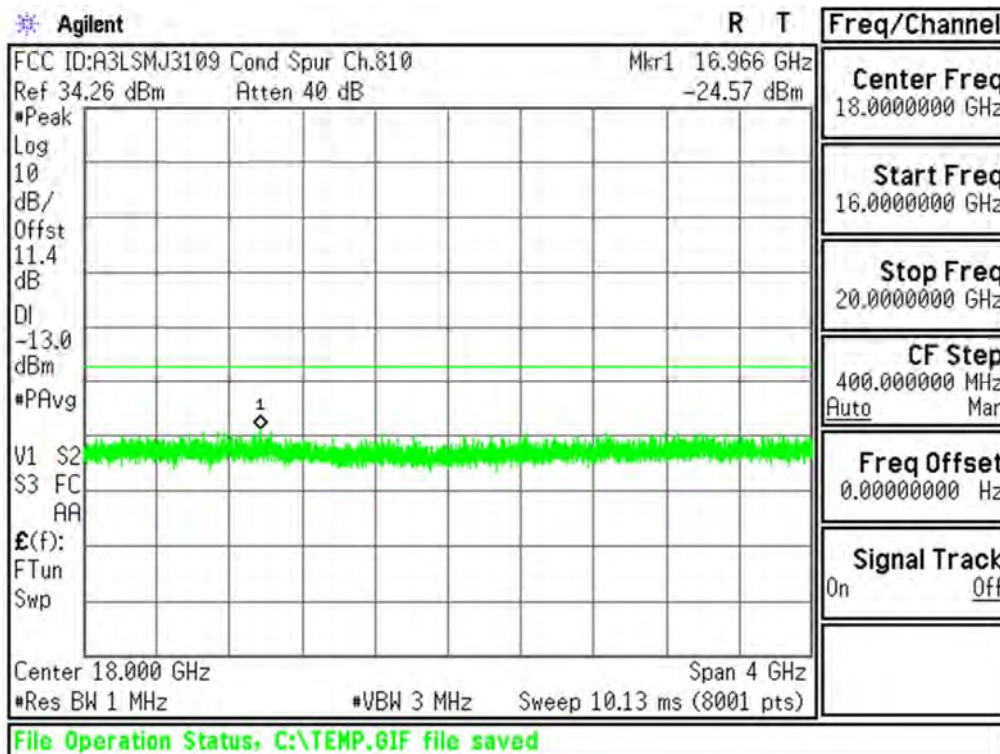

Plot 6-10. Conducted Spurious Plot (PCS GSM Mode - Ch.810)

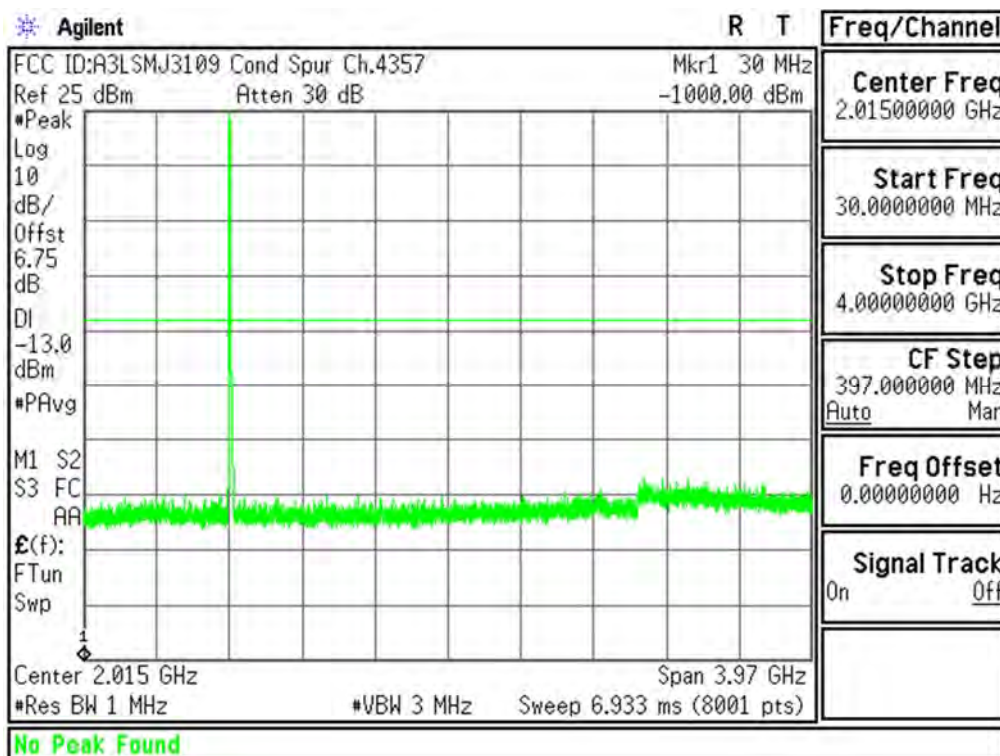

Plot 6-11. Conducted Spurious Plot (Cellular WCDMA Mode - Ch.4132(DL4357))



Issue Date:

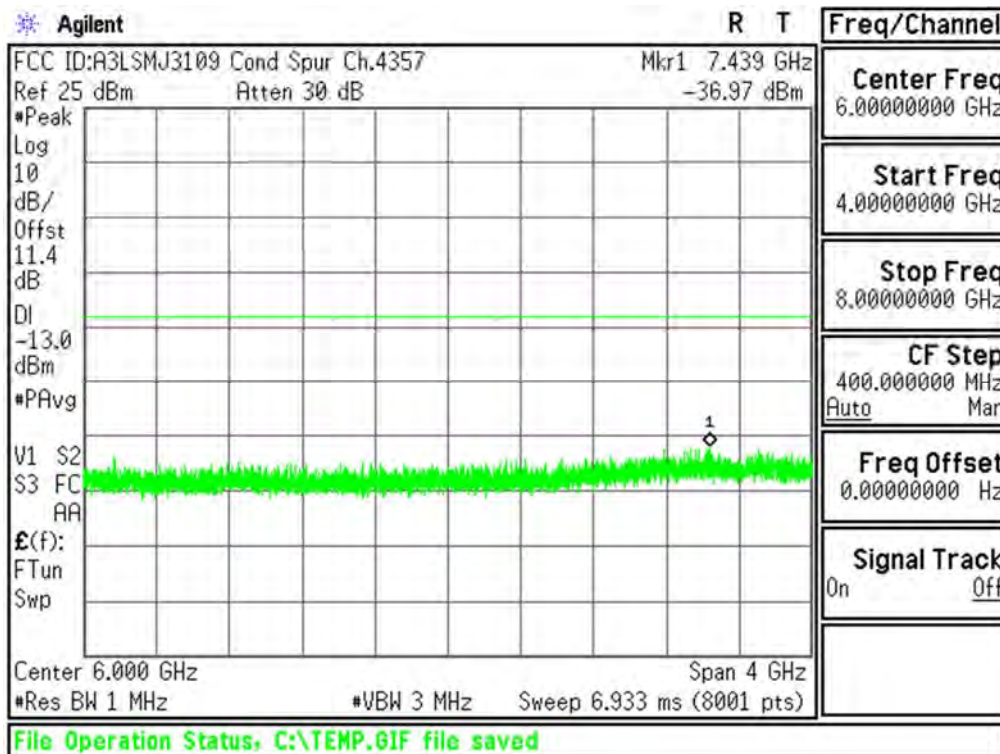

Plot 6-12. Conducted Spurious Plot (Cellular WCDMA Mode - Ch.4132(DL4357))

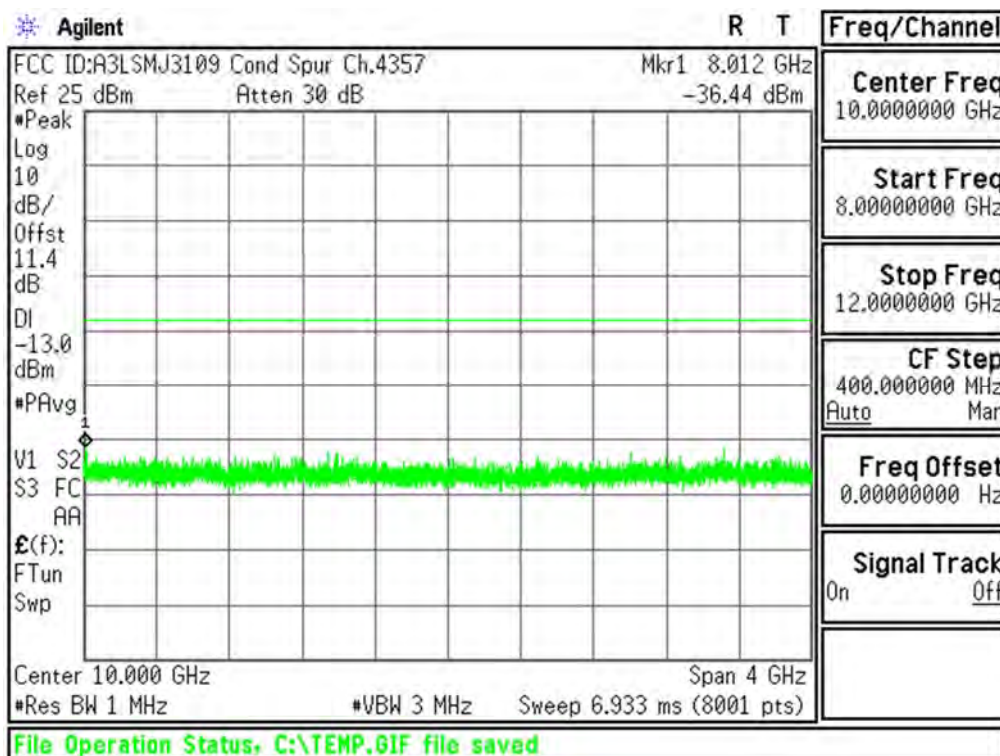

Plot 6-13. Conducted Spurious Plot (Cellular WCDMA Mode - Ch.4132(DL4357))



Issue Date:

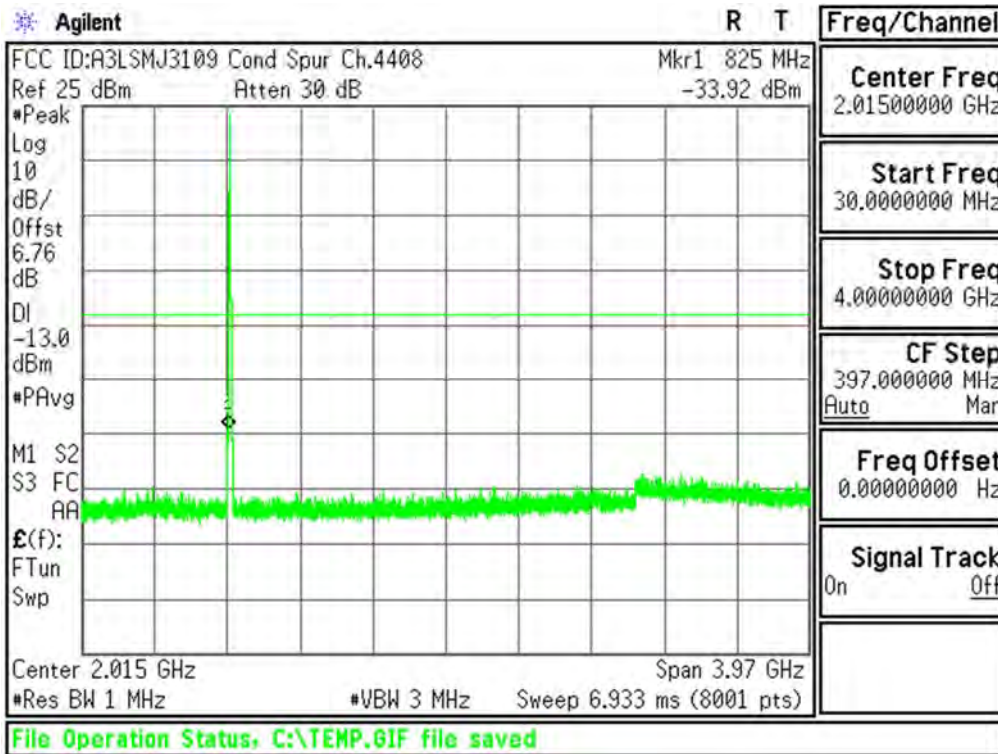

Plot 6-14. Conducted Spurious Plot (Cellular WCDMA Mode - Ch.4183(DL4408))

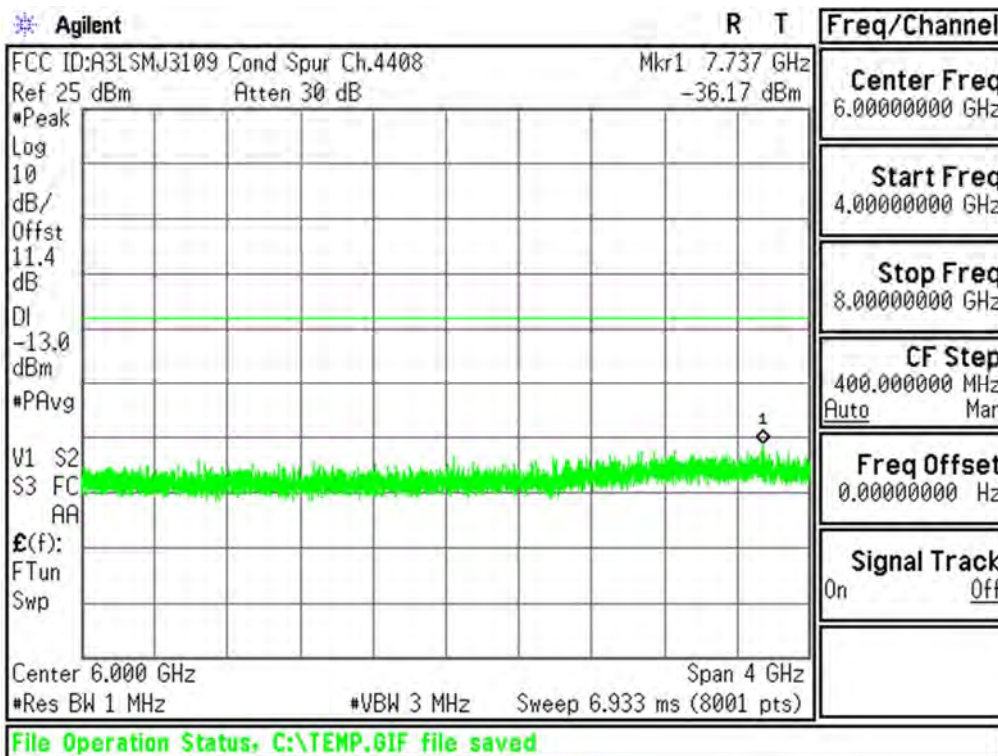

Plot 6-15. Conducted Spurious Plot (Cellular WCDMA Mode - Ch.4183(DL4408))



Issue Date:

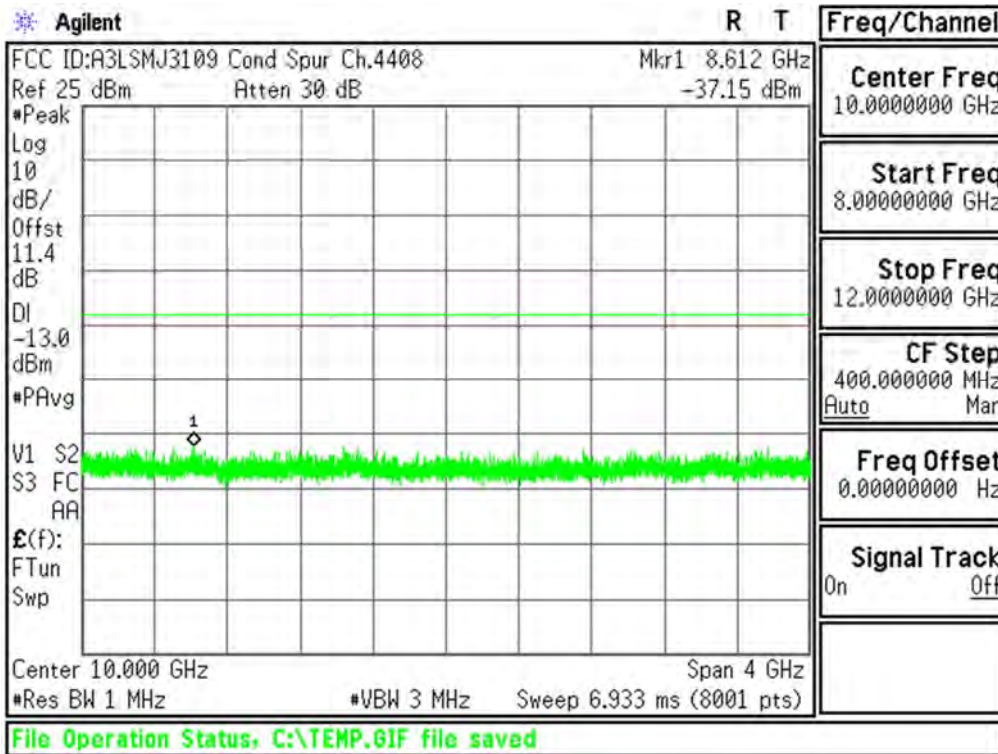

Plot 6-16. Conducted Spurious Plot (Cellular WCDMA Mode - Ch.4183(DL4408))

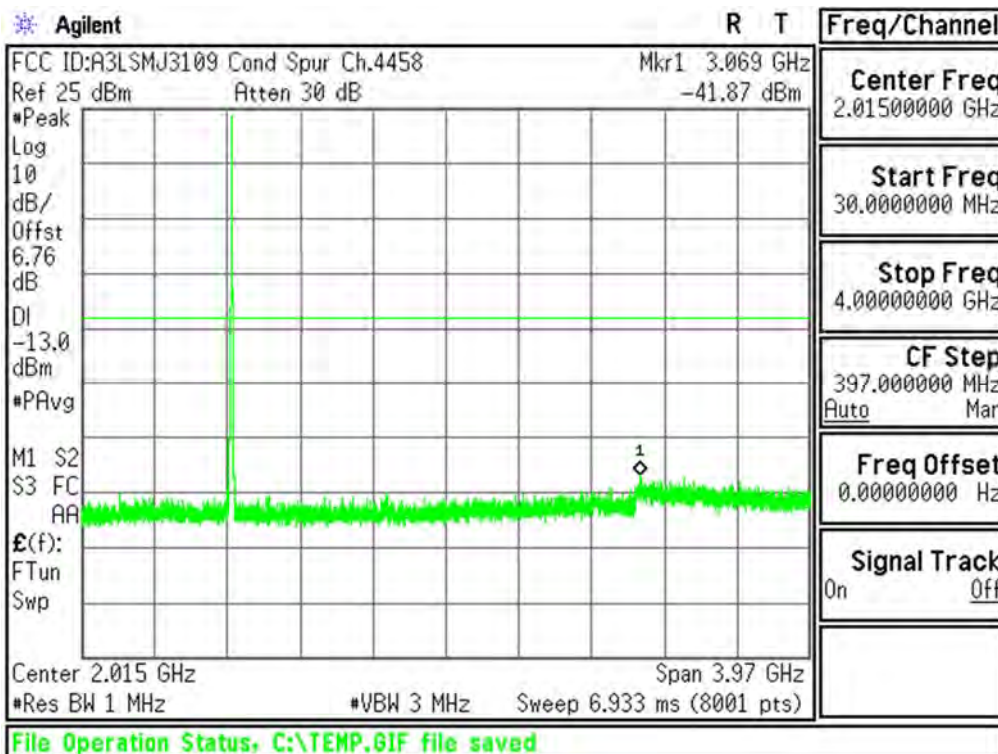

Plot 6-17. Conducted Spurious Plot (Cellular WCDMA Mode - Ch.4233(DL4458))



Issue Date:

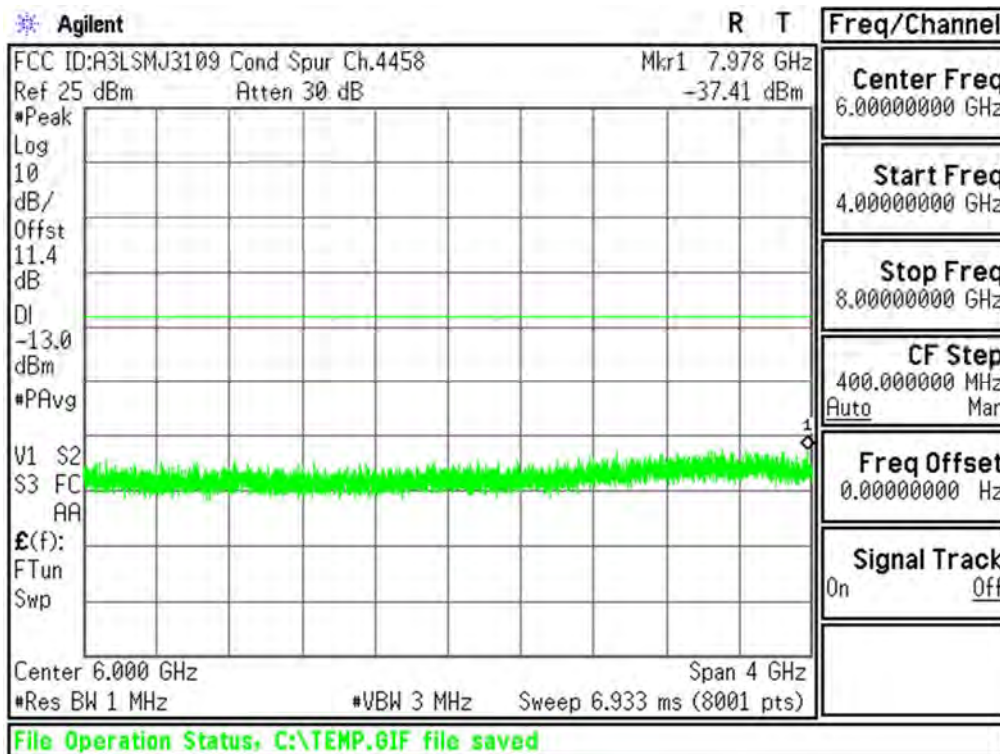

Plot 6-18. Conducted Spurious Plot (Cellular WCDMA Mode - Ch.4233(DL4458))

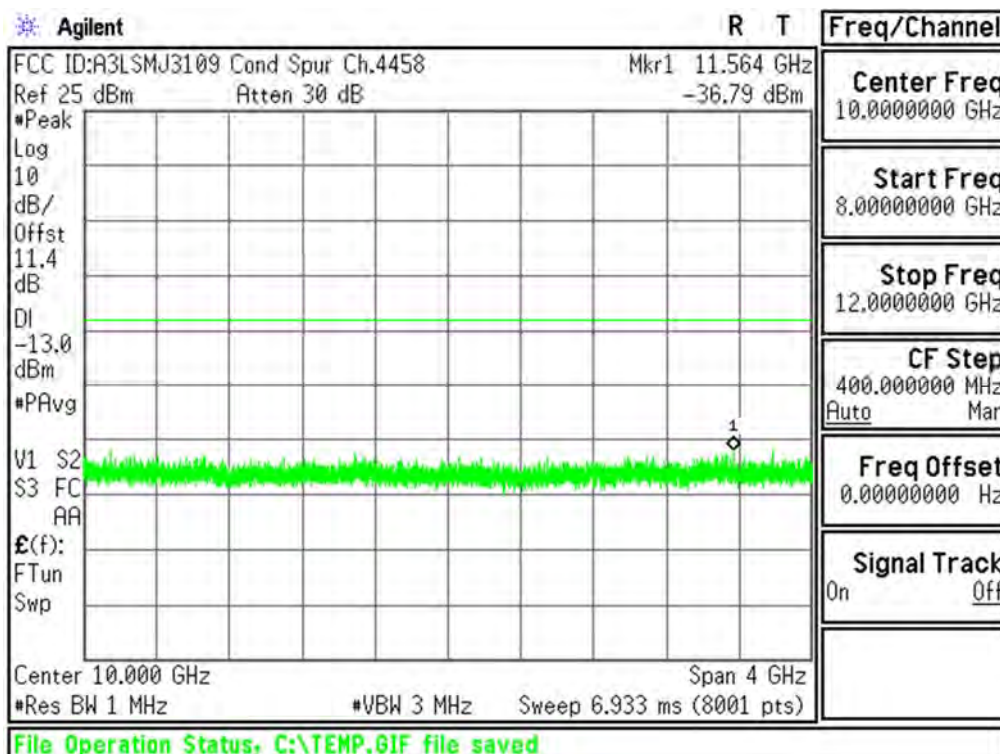

Plot 6-19. Conducted Spurious Plot (Cellular WCDMA Mode - Ch.4233(DL4458))



Issue Date:

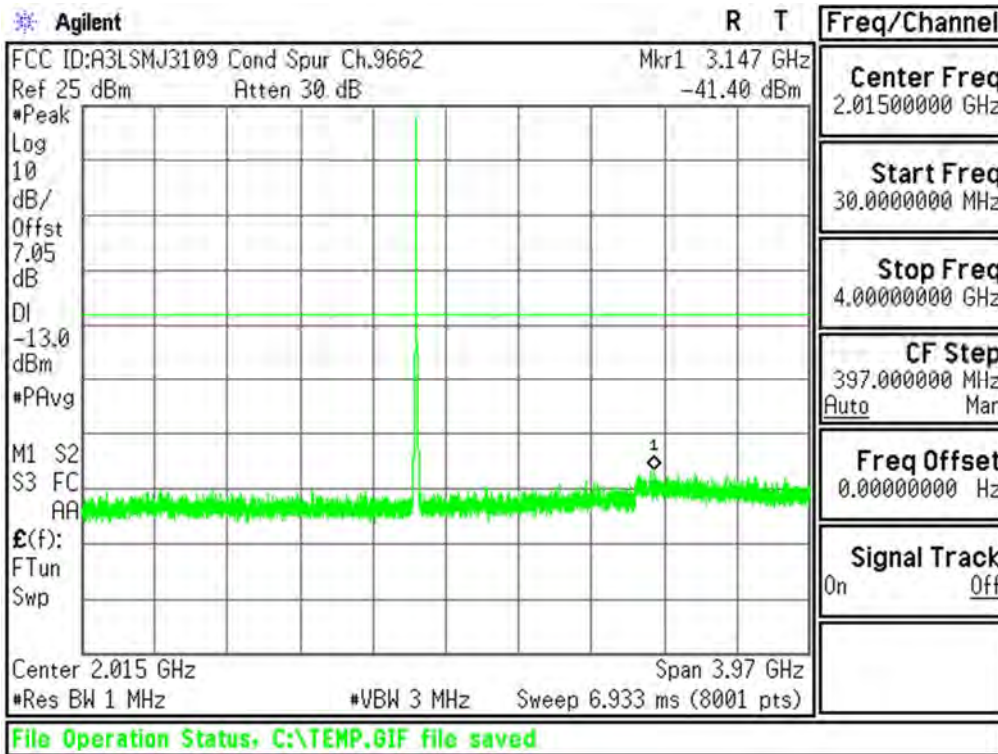

Plot 6-20. Conducted Spurious Plot (PCS WCDMA Mode - Ch.9262(DL9662))

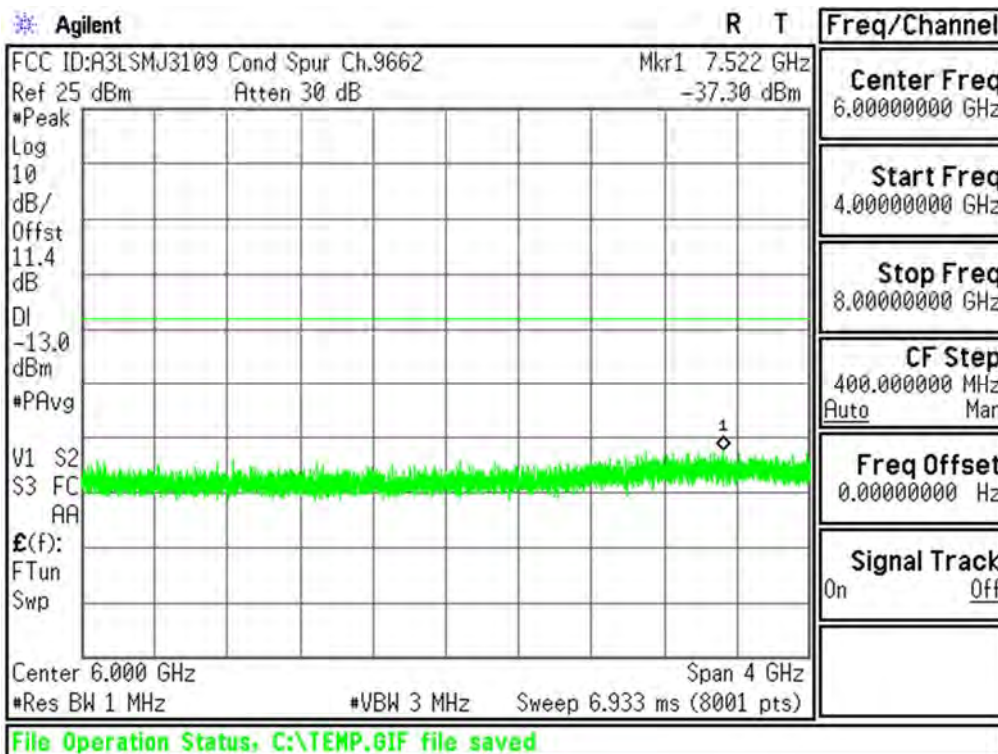

Plot 6-21. Conducted Spurious Plot (PCS WCDMA Mode - Ch.9262(DL9662))



Issue Date:

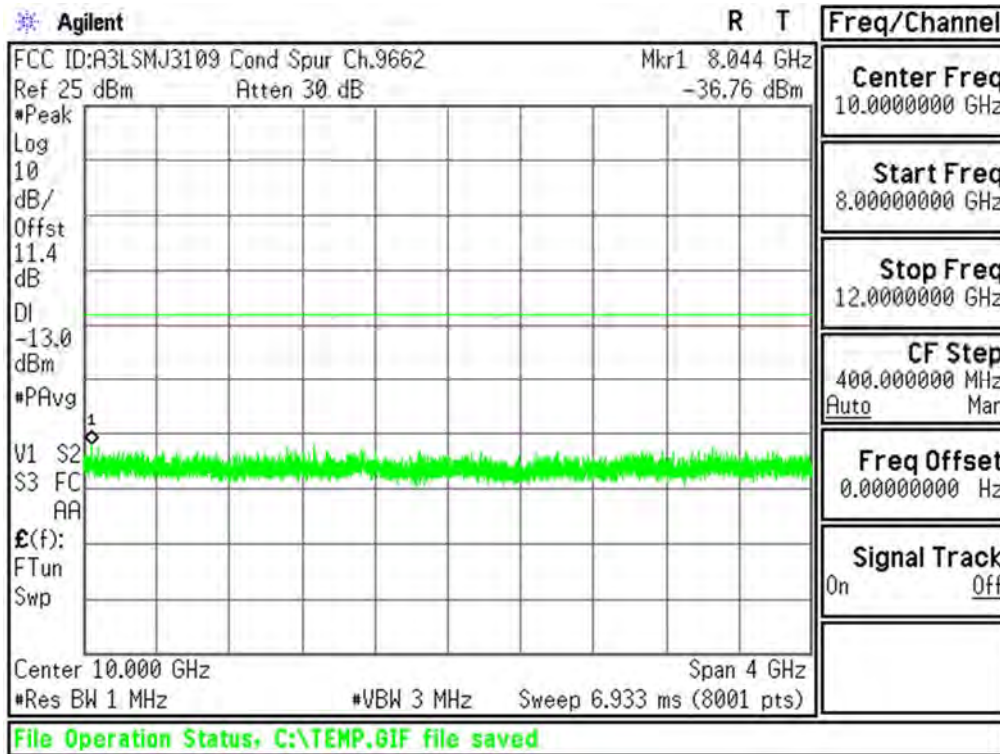

Plot 6-22. Conducted Spurious Plot (PCS WCDMA Mode - Ch.9262(DL9662))

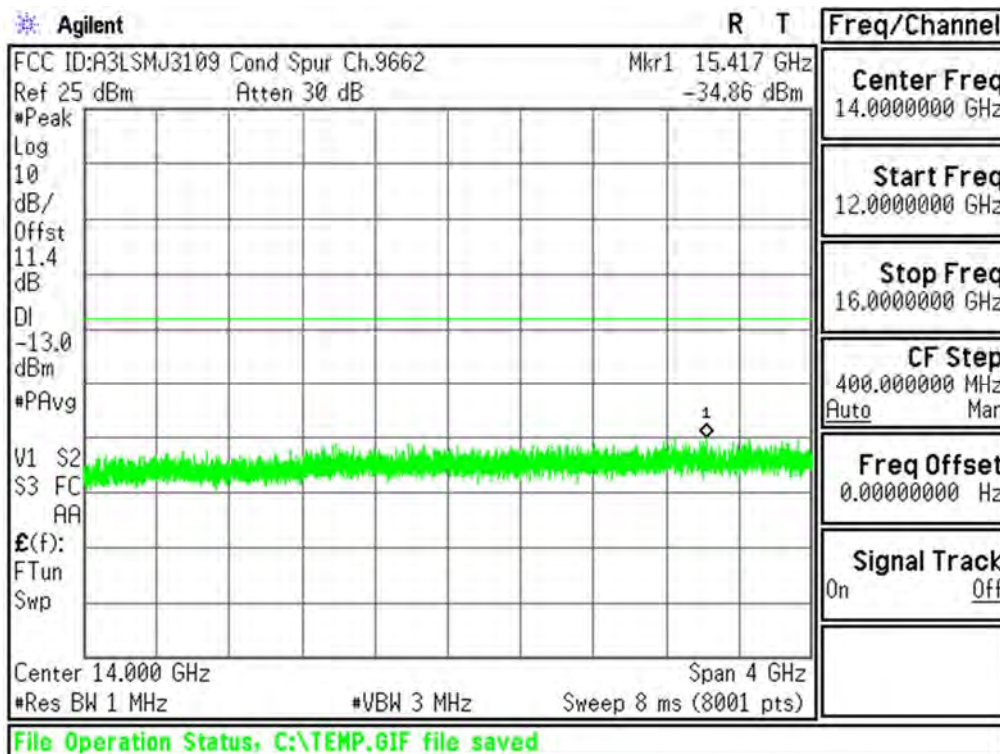

Plot 6-23. Conducted Spurious Plot (PCS WCDMA Mode - Ch.9262(DL9662))



Issue Date:

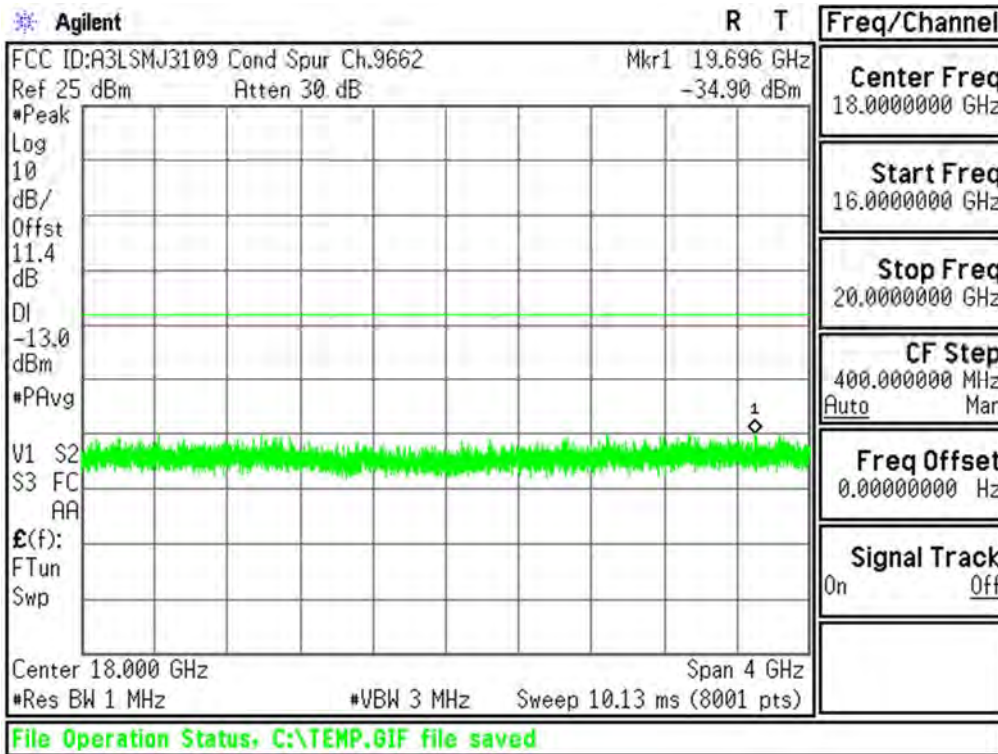

Plot 6-24. Conducted Spurious Plot (PCS WCDMA Mode - Ch.9262(DL9662))

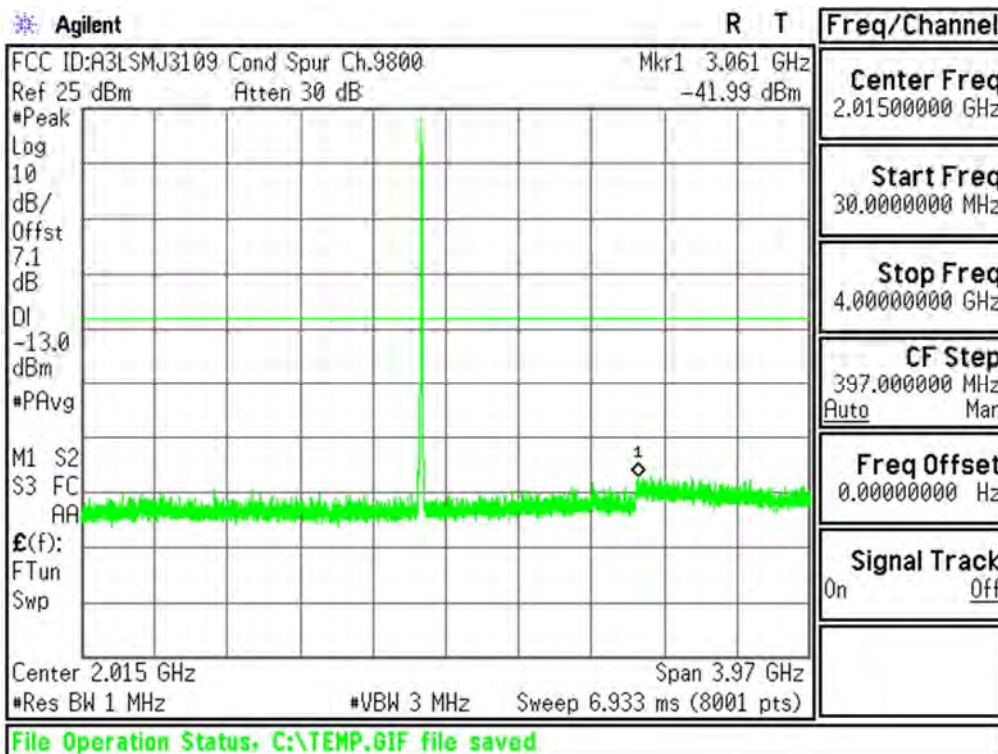

Plot 6-25. Conducted Spurious Plot (PCS WCDMA Mode - Ch.9400(DL9800))



Issue Date:

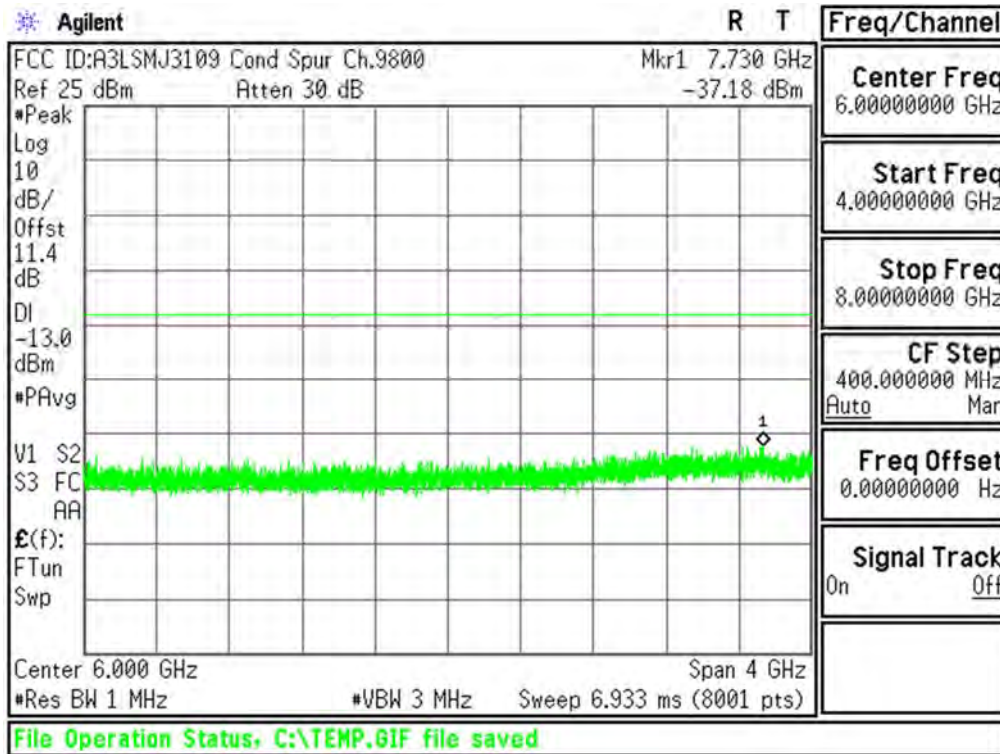

Plot 6-26. Conducted Spurious Plot (PCS WCDMA Mode - Ch.9400(DL9800))

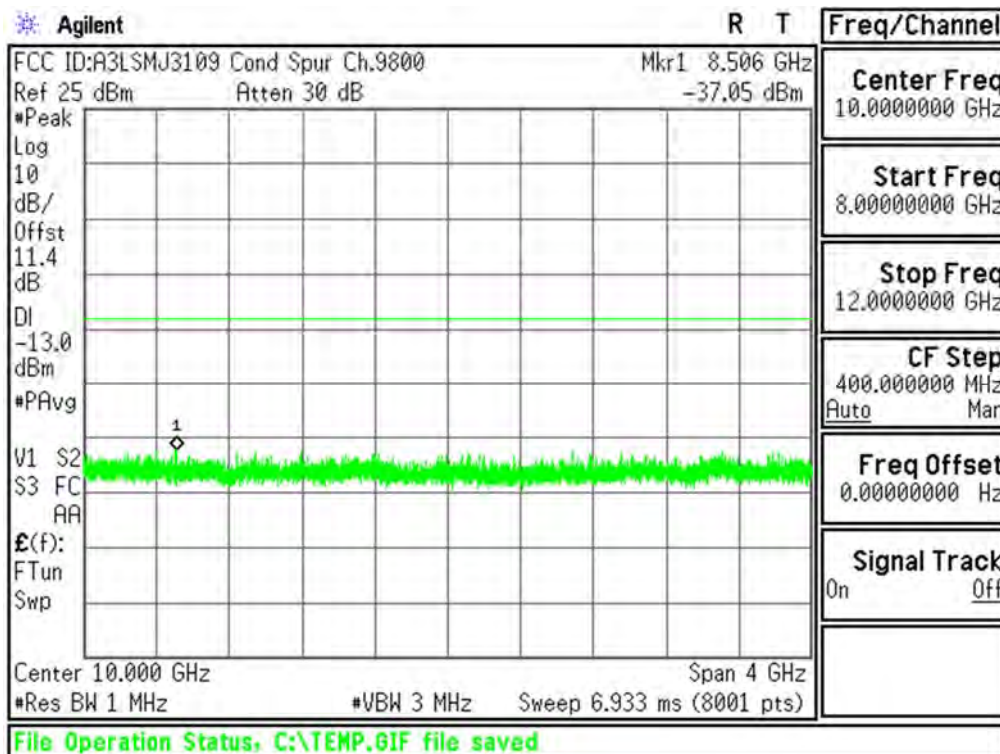

Plot 6-27. Conducted Spurious Plot (PCS WCDMA Mode - Ch.9400(DL9800))



Issue Date:

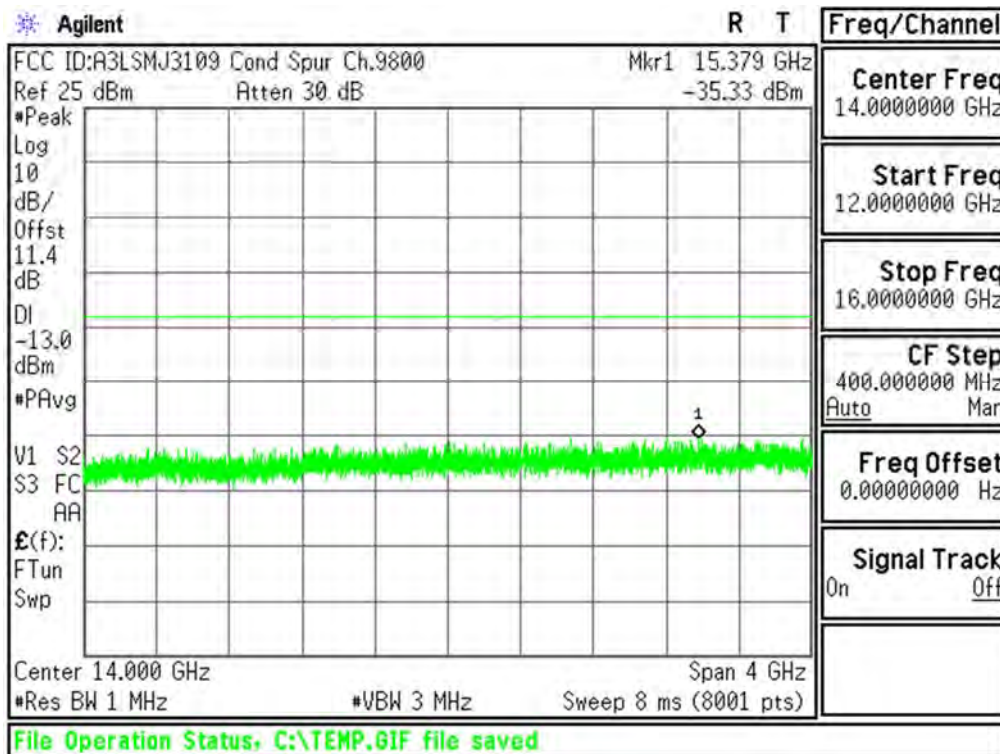

Plot 6-28. Conducted Spurious Plot (PCS WCDMA Mode - Ch.9400(DL9800))

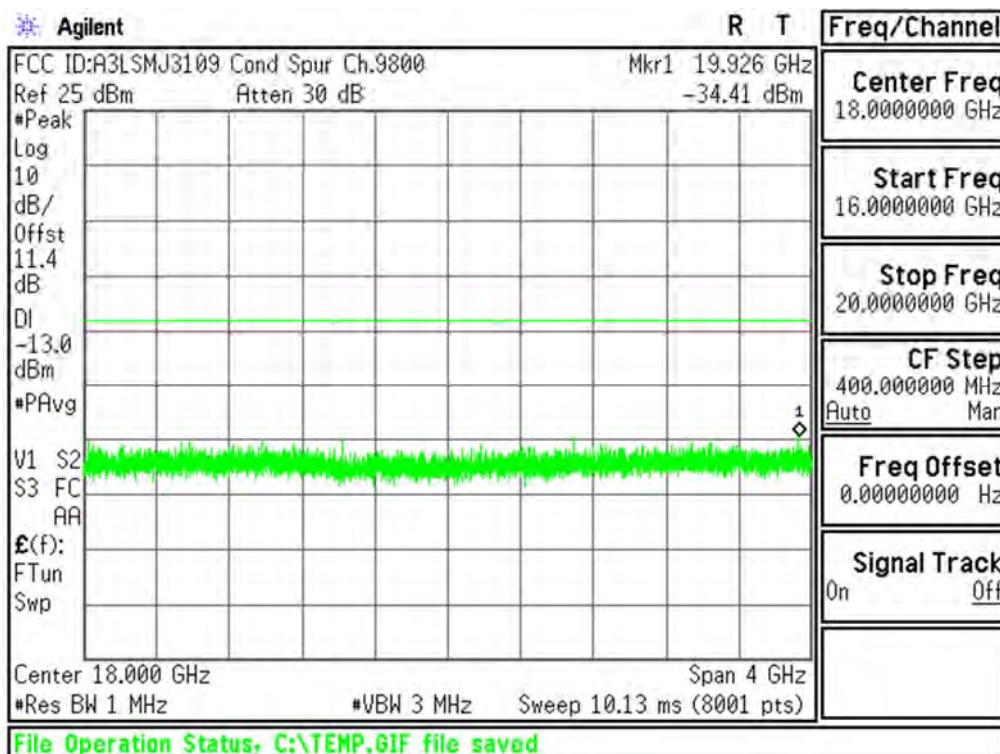

Plot 6-29. Conducted Spurious Plot (PCS WCDMA Mode - Ch.9400(DL9800))



Issue Date:

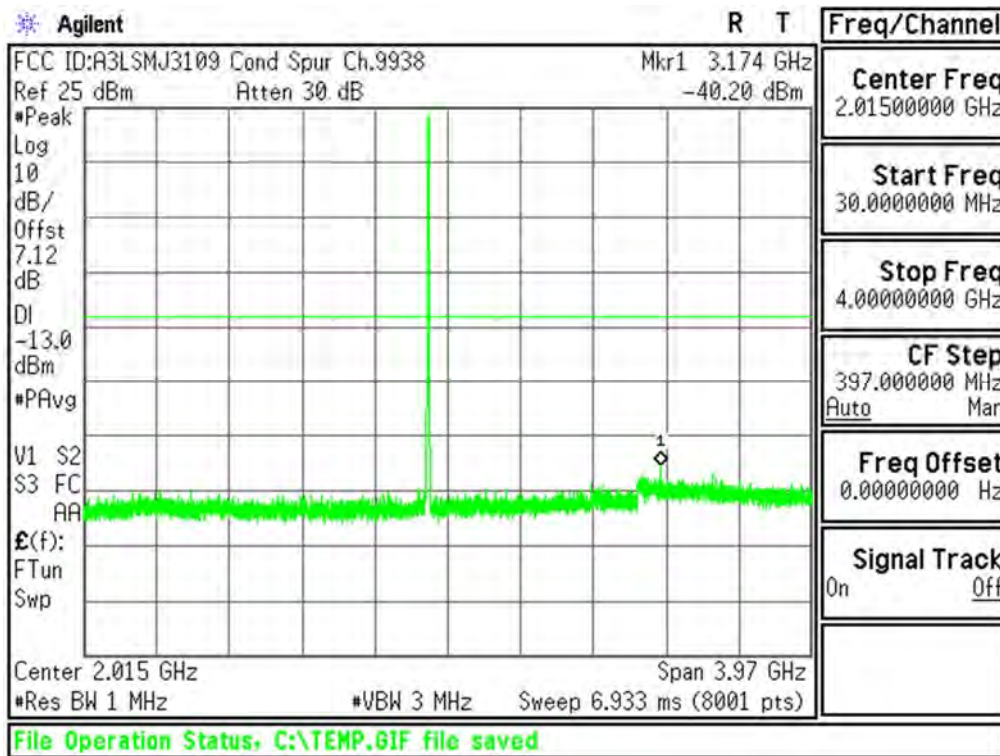

Plot 6-30. Conducted Spurious Plot (PCS WCDMA Mode - Ch.9538(DL9938))

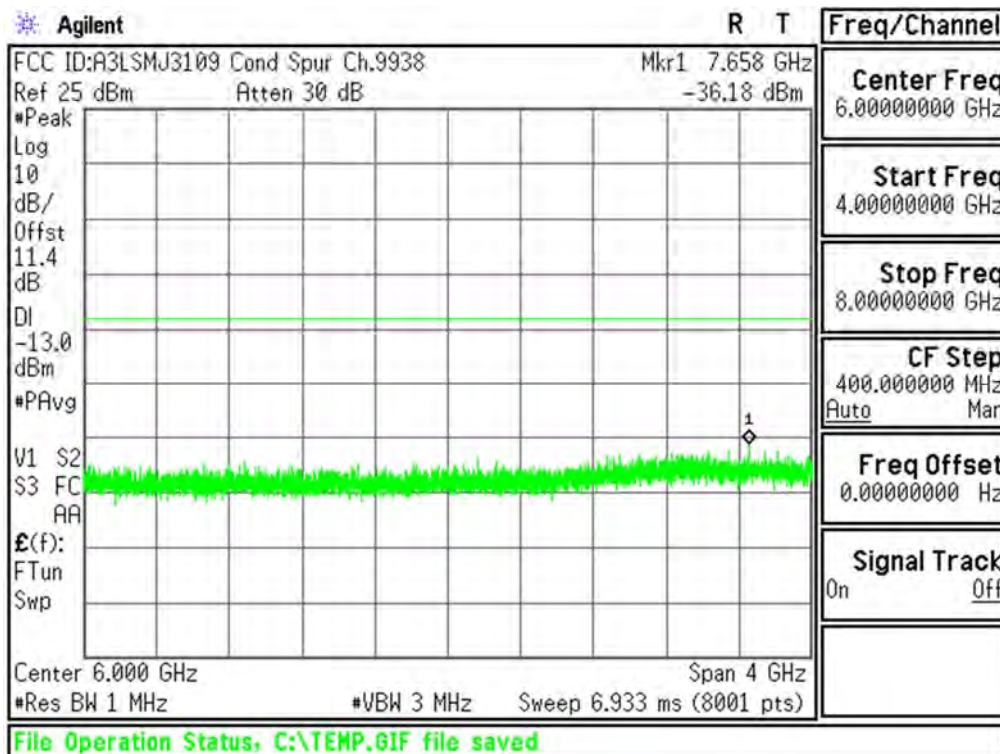

Plot 6-31. Conducted Spurious Plot (PCS WCDMA Mode - Ch.9538(DL9938))



Issue Date:

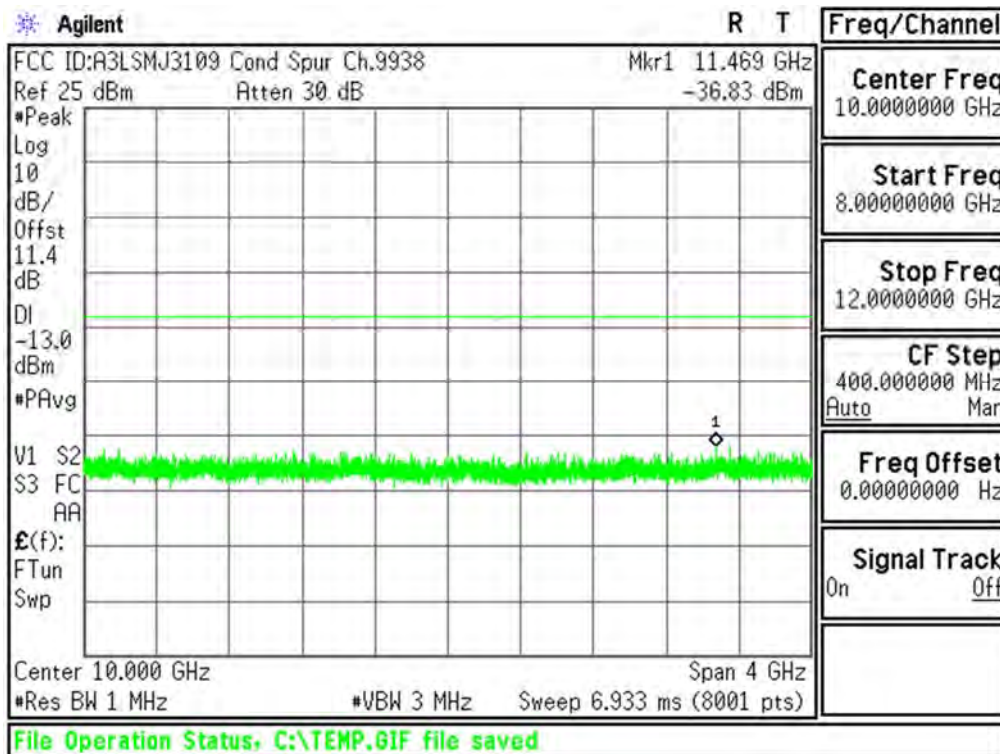

Plot 6-32. Conducted Spurious Plot (PCS WCDMA Mode - Ch.9538(DL9938))

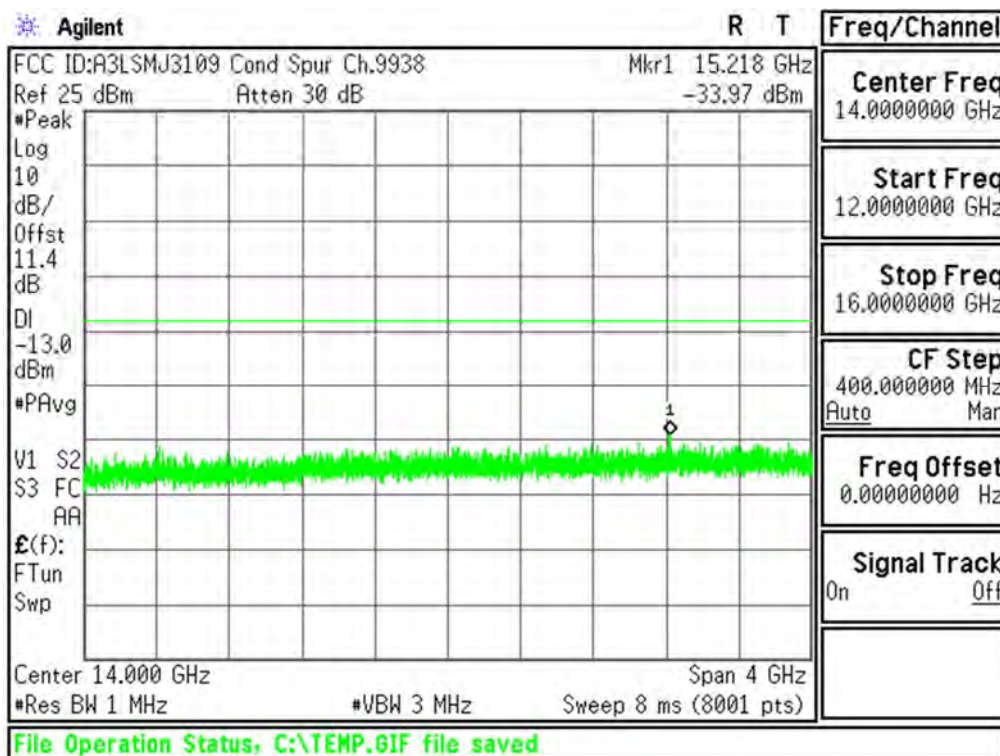

Plot 6-33. Conducted Spurious Plot (PCS WCDMA Mode - Ch.9538(DL9938))



Issue Date:

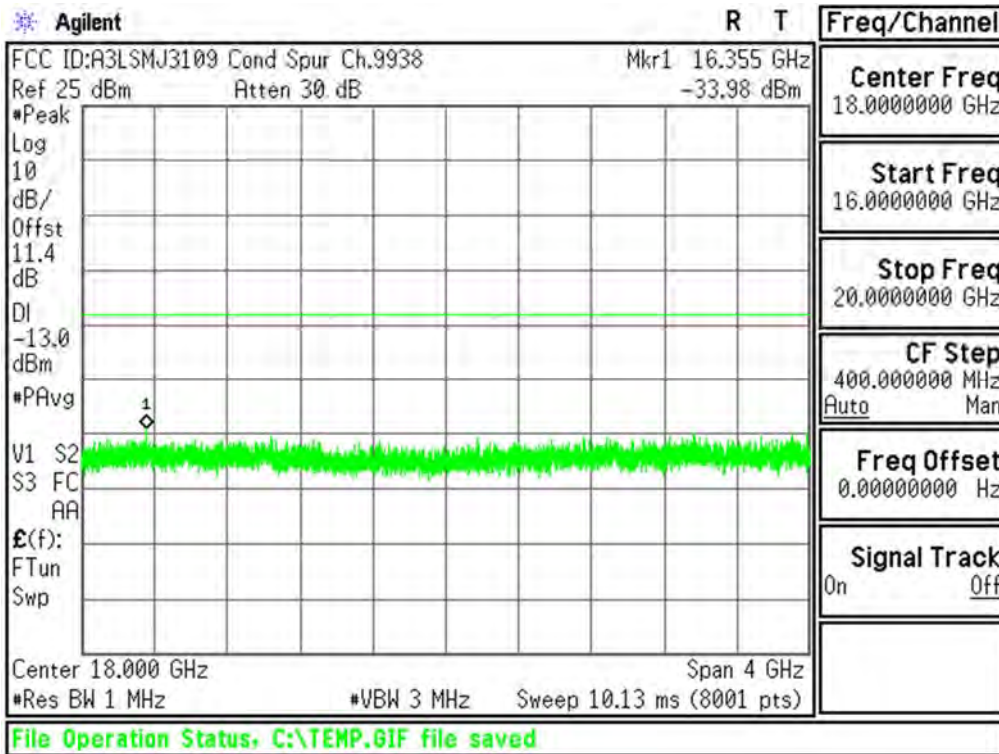

Plot 6-34. Conducted Spurious Plot (PCS WCDMA Mode - Ch.9538(DL9938))

- End of this page -



6.4. Band Edge Emissions at Antenna Terminal §2.1051 § 22.917(a) §24.238(a)

Test Overview

All out of band emissions are measured with a spectrum analyzer connected to the antenna terminal of the EUT while the EUT is operating at its maximum duty cycle, at maximum power, and at the appropriate frequencies. All data rates were investigated to determine the worst case configuration. All modes of operation were investigated and the worst case configuration results are reported in this section.

The minimum permissible attenuation level of any spurious emission is $43 + 10 \log_{10}(P_{\text{Watts}})$, where P is the transmitter power in Watts. Limit equivalent to -13dBm, calculation shown below.

$$43 + 10 \log_{10}(1.567W) = 44.95 \text{ dB}$$

$$1.567W = 31.95 \text{ dBm}$$

$$31.95 \text{ dBm} - 44.95 \text{ dB} = -13 \text{ dBm}$$

Test Procedure Used

KDB 971168 v02r02 – Section 6.0

Test Settings

1. Start and stop frequency were set such that the band edge would be placed at the edge of the plot for GSM, in the center of the plot for WCDMA.
2. Span was set large enough so as to capture all out of band emissions near the band edge
3. RBW > 1% of the emission bandwidth
4. VBW $\geq 3 \times$ RBW
5. Detector = RMS
6. Number of sweep points $\geq 2 \times$ Span/RBW
7. Trace mode = max hold
8. Sweep time = auto couple
9. The trace was allowed to stabilize

Test Setup

The EUT and measurement equipment were set up as shown in the diagram below.

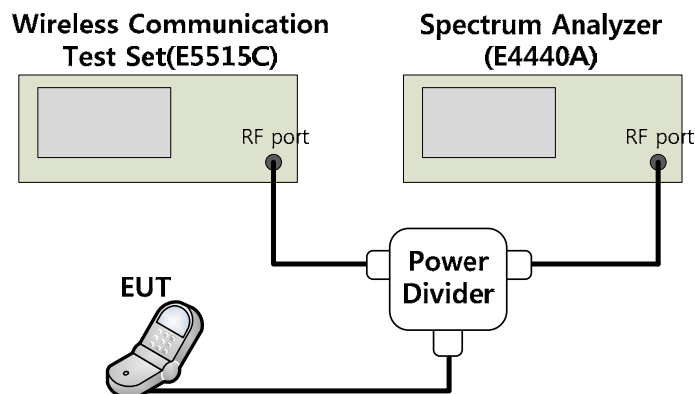

Figure 6-3. Test Instruments & Measurement Setup

Test Notes

1. Per 22.917(b) and 24.238(b), in the 1 MHz bands immediately outside and adjacent to the frequency block a resolution bandwidth of at least one percent of the emission bandwidth of the fundamental emission of the transmitter may be employed to demonstrate compliance with the out-of-band emissions limit.

Example:

In Case of GSM, $0.01 \times 273 \text{ KHz} = 2.73 \text{ KHz}$

A resolution BW of 3 KHz was used for measurement at the band edges.



Issue Date:

Test Plots

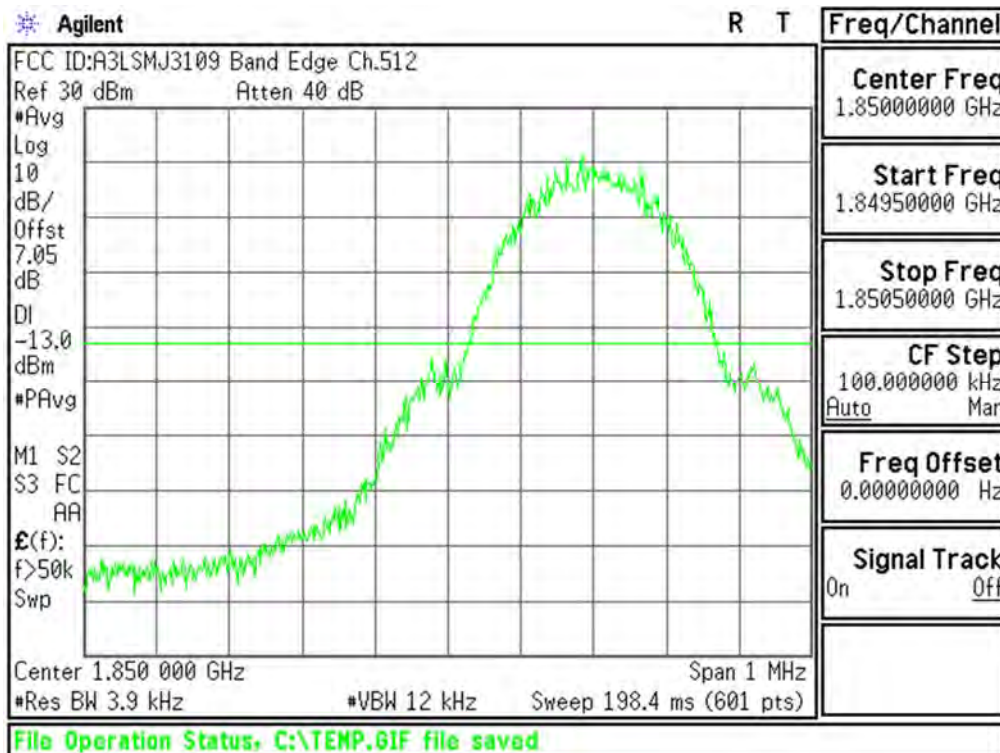

Plot 6-35. Lower Band Edge Plot (PCS GSM Mode – Ch.512)

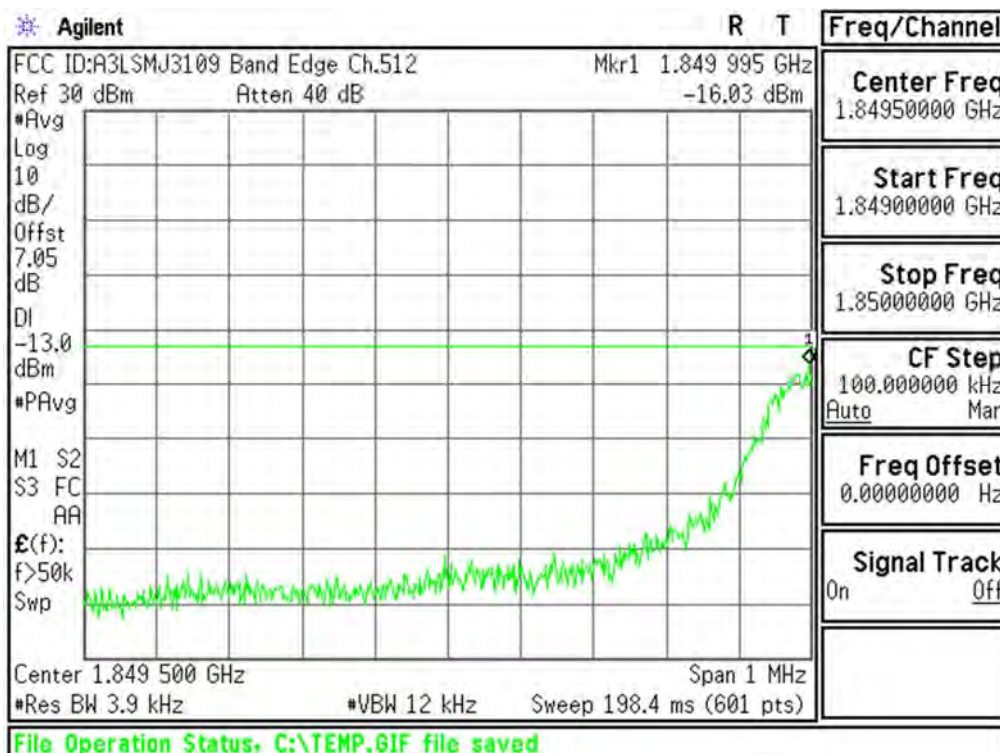

Plot 6-36. Lower Band Edge Plot (PCS GSM Mode – Ch.512)



Issue Date:

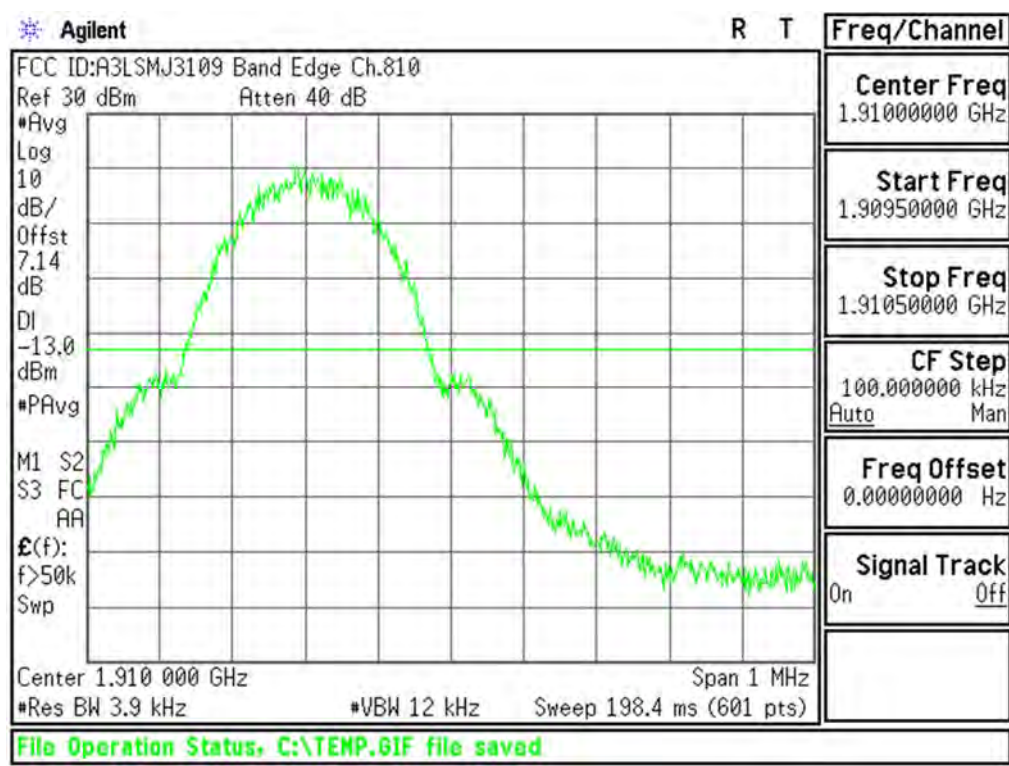

Plot 6-37. Upper Band Edge Plot (PCS GSM Mode – Ch.810)

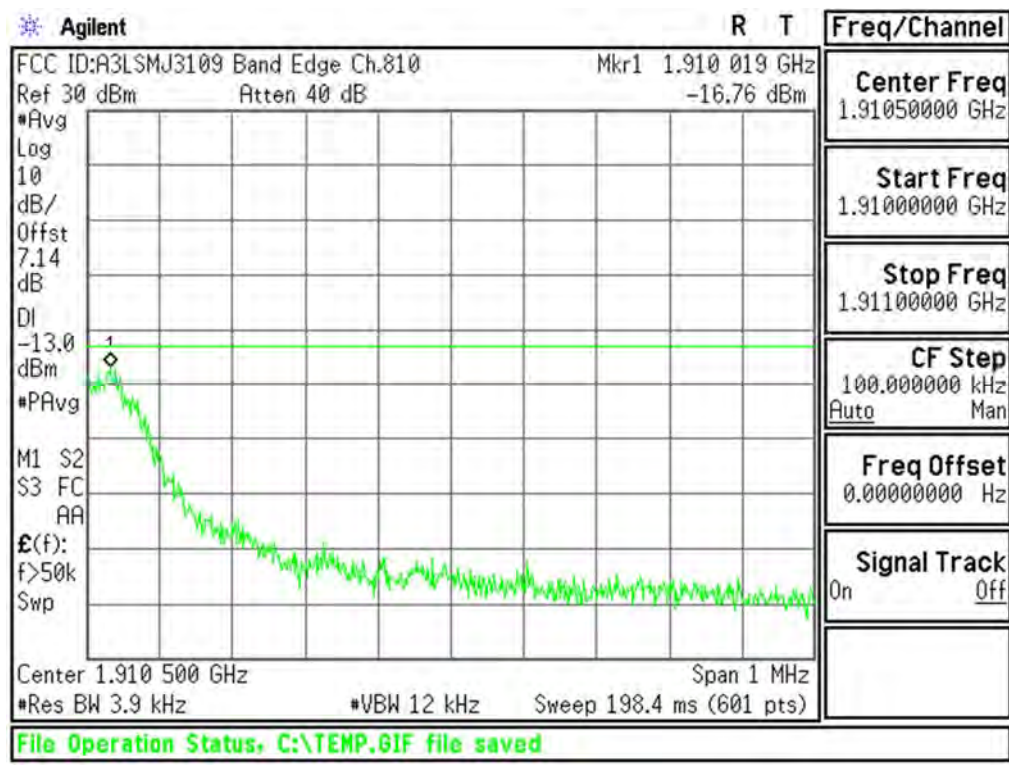

Plot 6-38. Upper Band Edge Plot (PCS GSM Mode – Ch.810)



Issue Date:

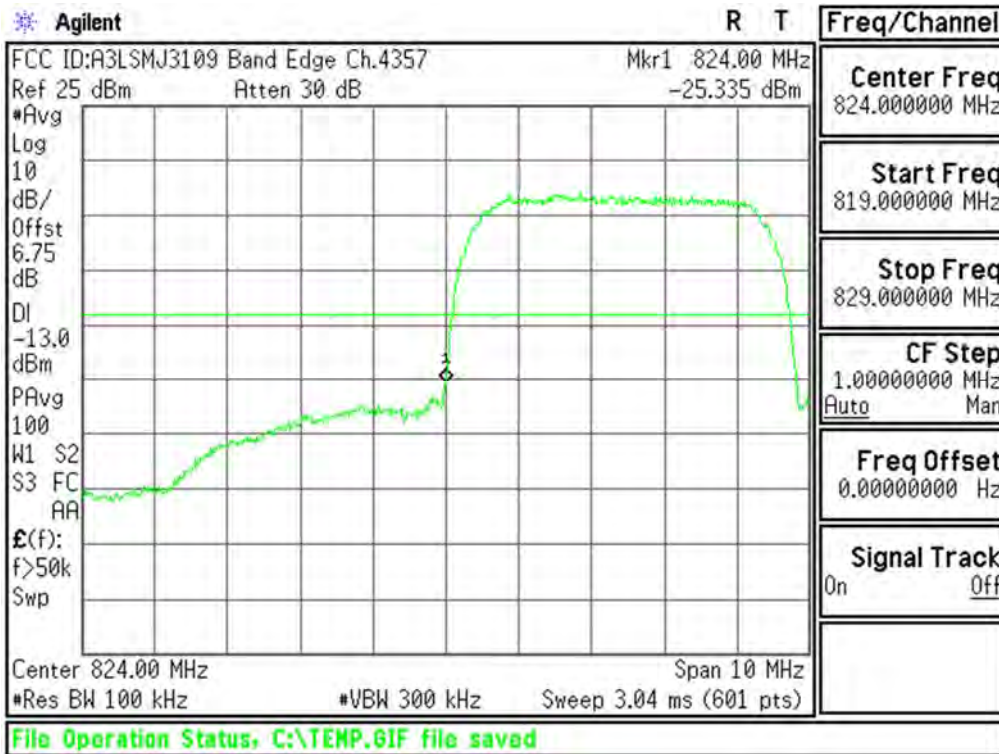

Plot 6-39. Lower Band Edge Plot (Cellular WCDMA Mode - Ch.4132(DL4357))

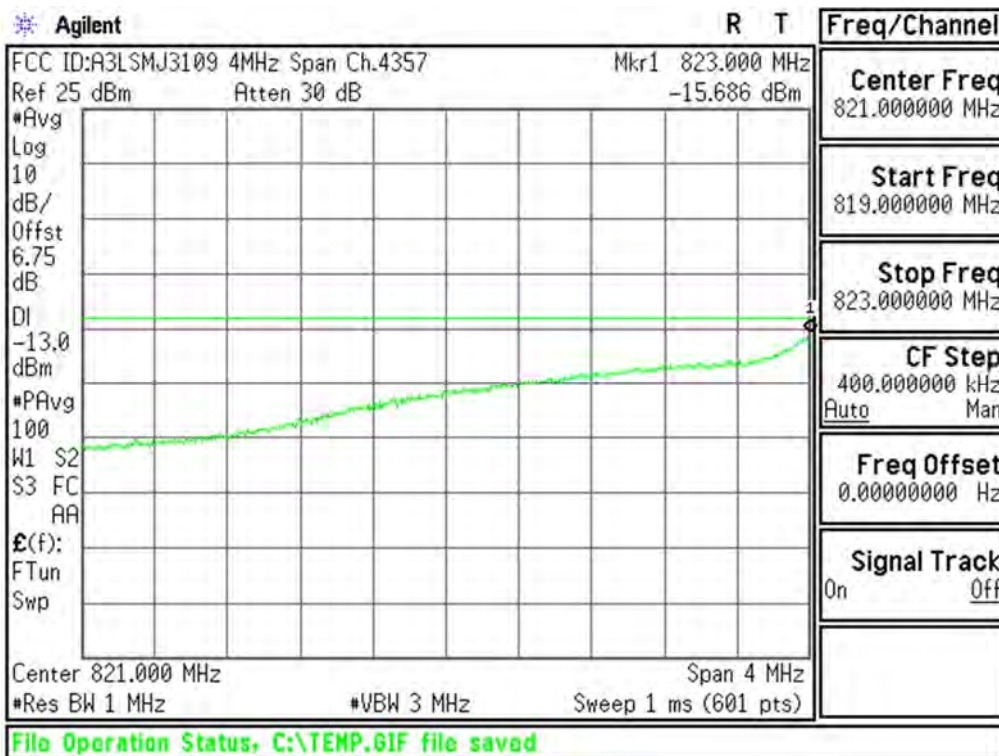

Plot 6-40. Extended Lower Band Edge Plot (Cellular WCDMA Mode - Ch.4132(DL4357))



Issue Date:

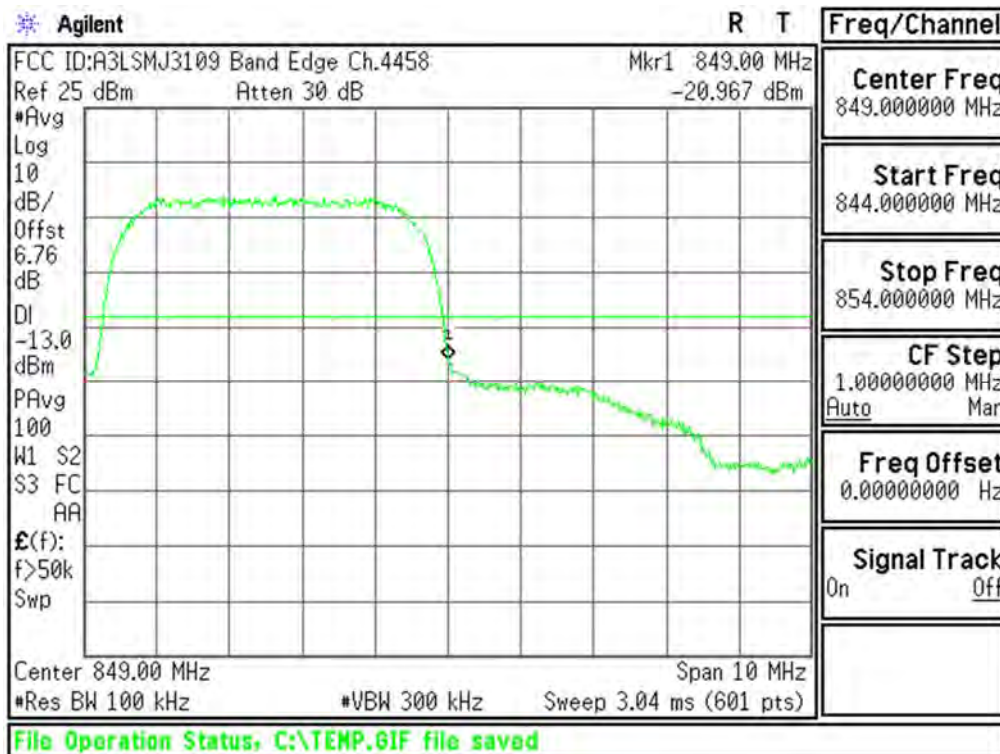

Plot 6-41. Upper Band Edge Plot (Cellular WCDMA Mode - Ch.4233(DL4458))

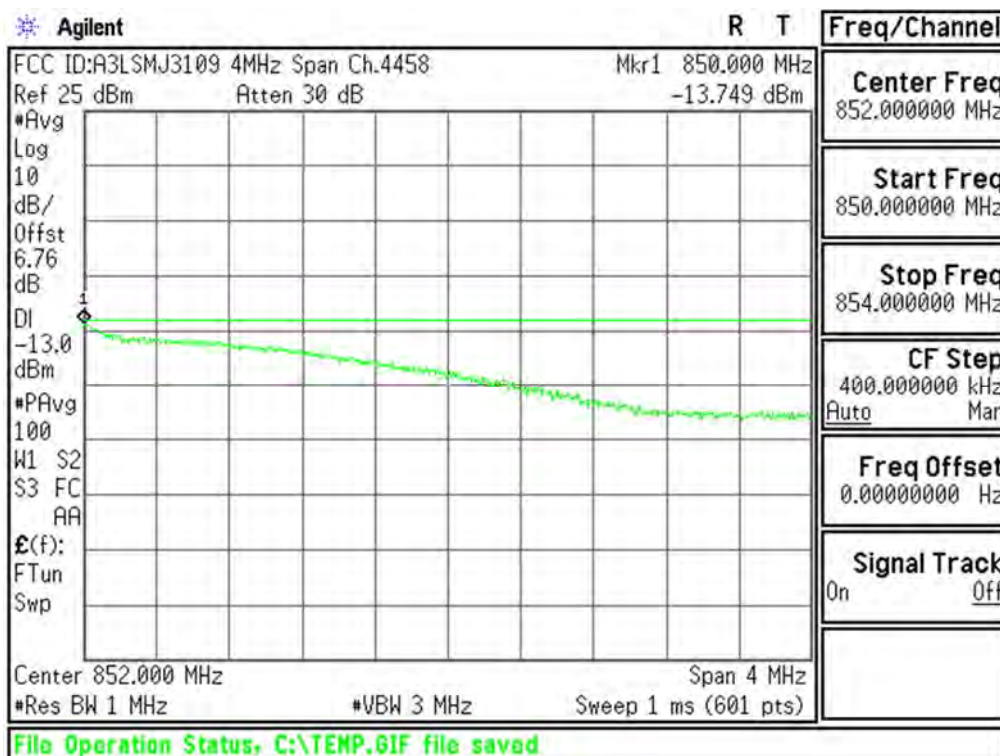

Plot 6-42. Extended Upper Band Edge Plot (Cellular WCDMA Mode - Ch.4233(DL4458))



Issue Date:

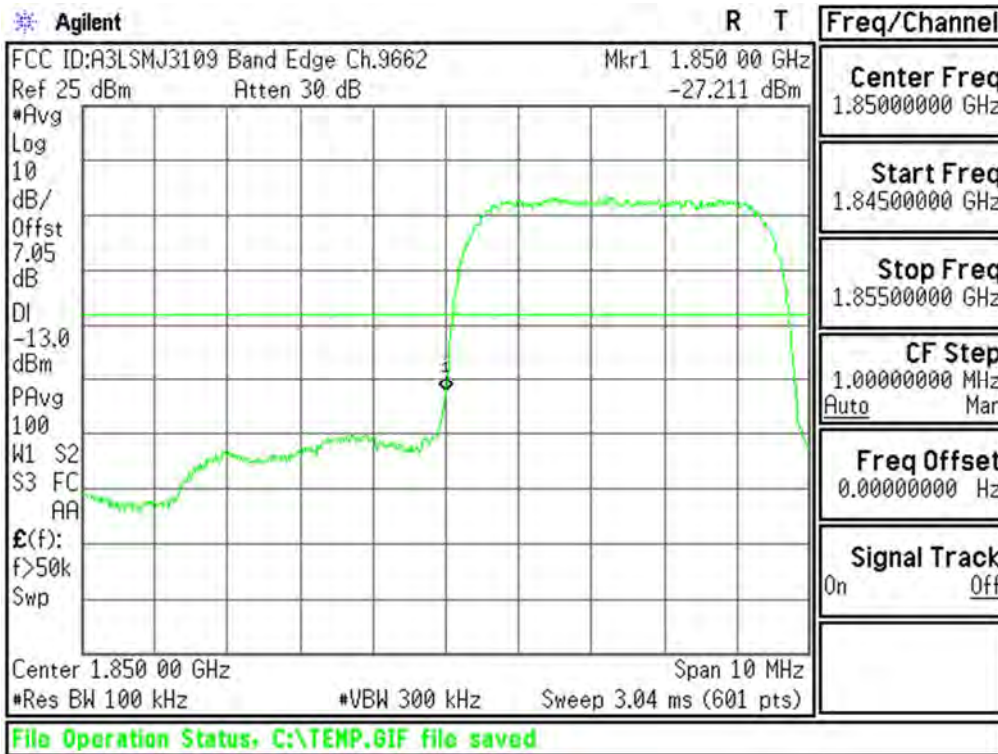

Plot 6-43. Lower Band Edge Plot (PCS WCDMA Mode - Ch.9262(DL9662))

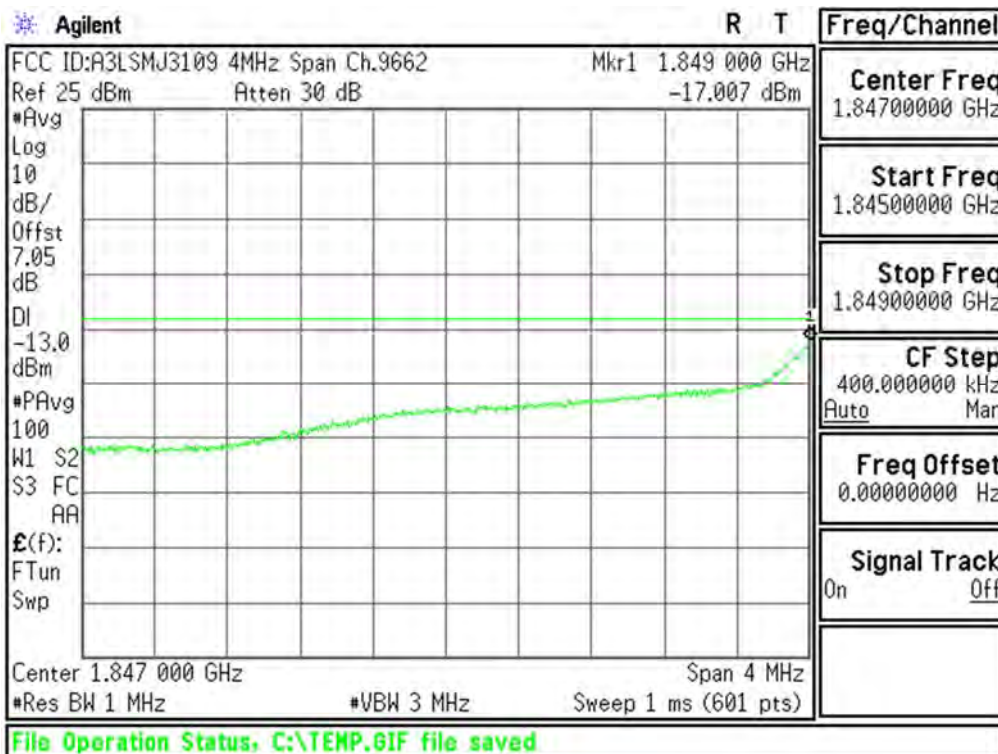

Plot 6-44. Extended Lower Band Edge Plot (PCS WCDMA Mode - Ch.9262(DL9662))



Issue Date:

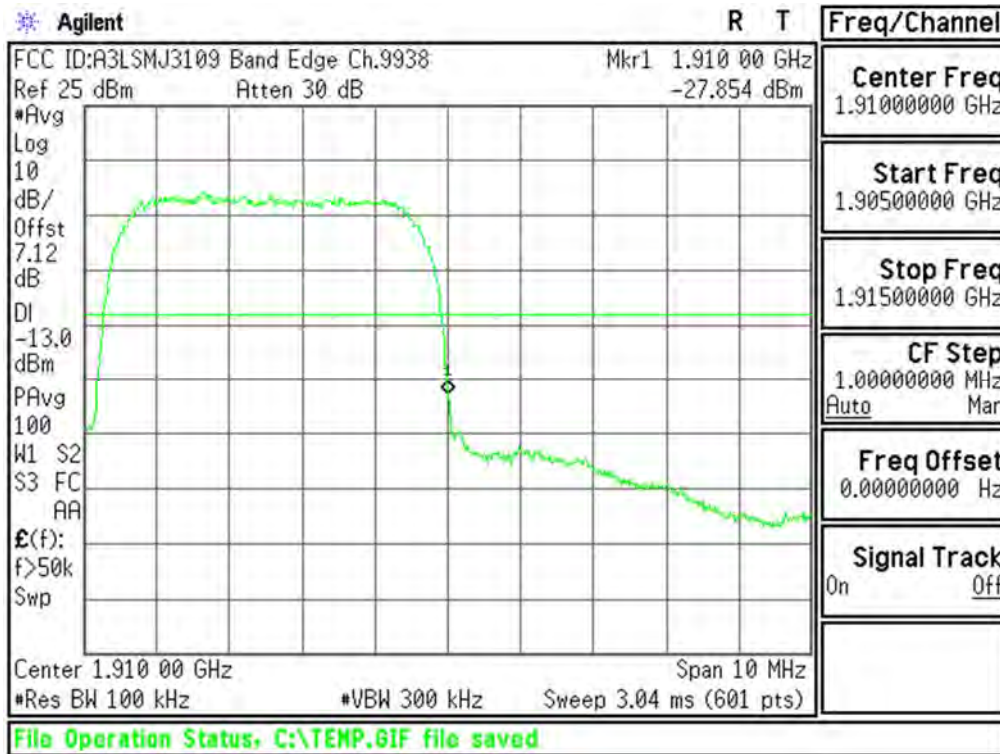

Plot 6-45. Upper Band Edge Plot (PCS WCDMA Mode - Ch.9538(DL9938))

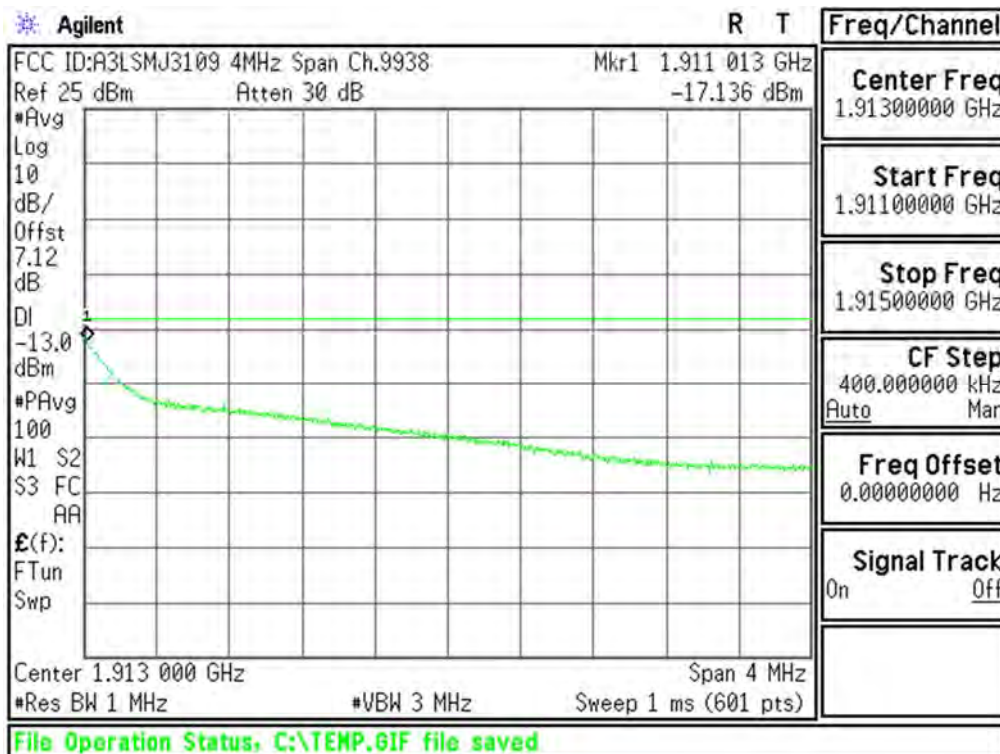

Plot 6-46. Extended Upper Band Edge Plot (PCS WCDMA Mode - Ch.9538(DL9938))

6.5. Peak-Average Ratio §24.232(d)

Test Overview

A peak to average ratio measurement is performed at the conducted port of the EUT. The spectrum analyzers Complementary Cumulative Distribution Function (CCDF) measurement profile is used to determine the largest deviation between the average and the peak power of the EUT in a given bandwidth. The CCDF curve shows how much time the peak waveform spends at or above a given average power level. The percent of time the signal spends at or above the level defines the probability for that particular power level.

Test Procedure Used

KDB 971168 v02r02 – Section 5.7.1

Test Settings

1. The signal analyzer's CCDF measurement profile is enabled
2. Frequency = carrier center frequency
3. Measurement BW > Emission bandwidth of signal
4. The signal analyzer was set to collect 1 million samples to generate the CCDF curve
5. The measurement interval was set depending on the type of signal analyzed. For continuous signals (>98% duty cycle), the measurement interval was set to 1ms. For burst transmissions, the spectrum analyzer was set to use an interval "RF Burst" trigger that is synced with an incoming pulse and the measurement interval is set to less than the duration of the "on time" of one burst to ensure that energy is only captured during a time in which the transmitter is operating at maximum power

Test Setup

The EUT and measurement equipment were set up as shown in the diagram below.

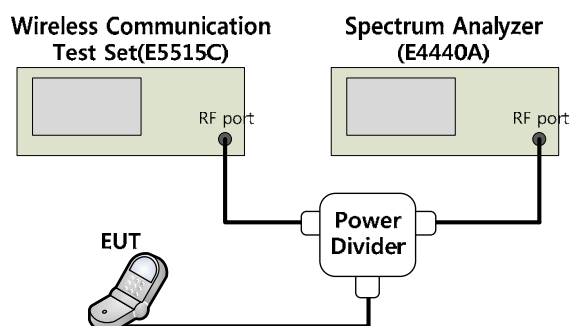
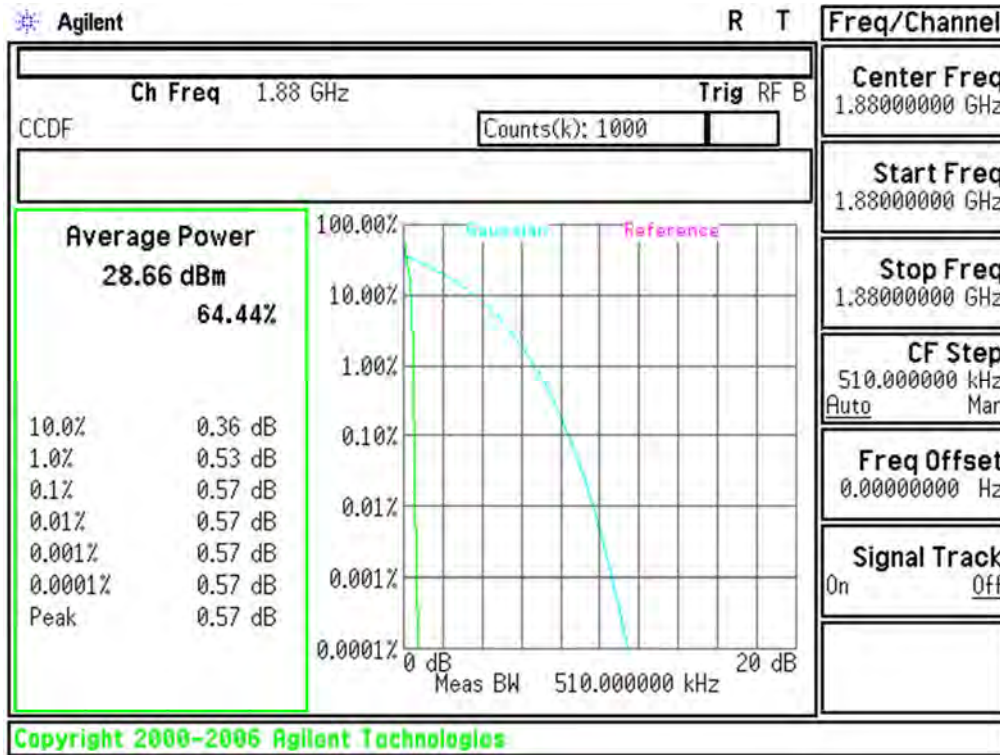

Figure 6-4. Test Instruments & Measurement Setup



Issue Date:

Test Plots



Plot 6-47. Peak-Average Ratio Plot (PCS GSM Mode - Ch.661)

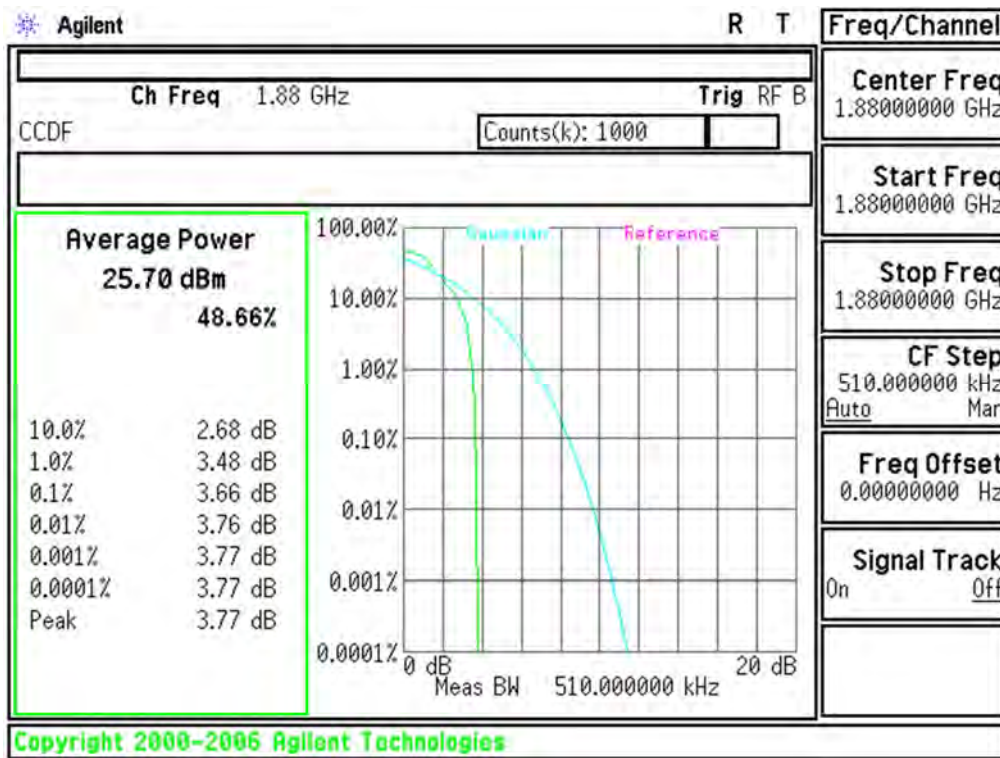

Plot 6-48. Peak-Average Ratio Plot (EDGE1900 Mode - Ch.661)



Issue Date:

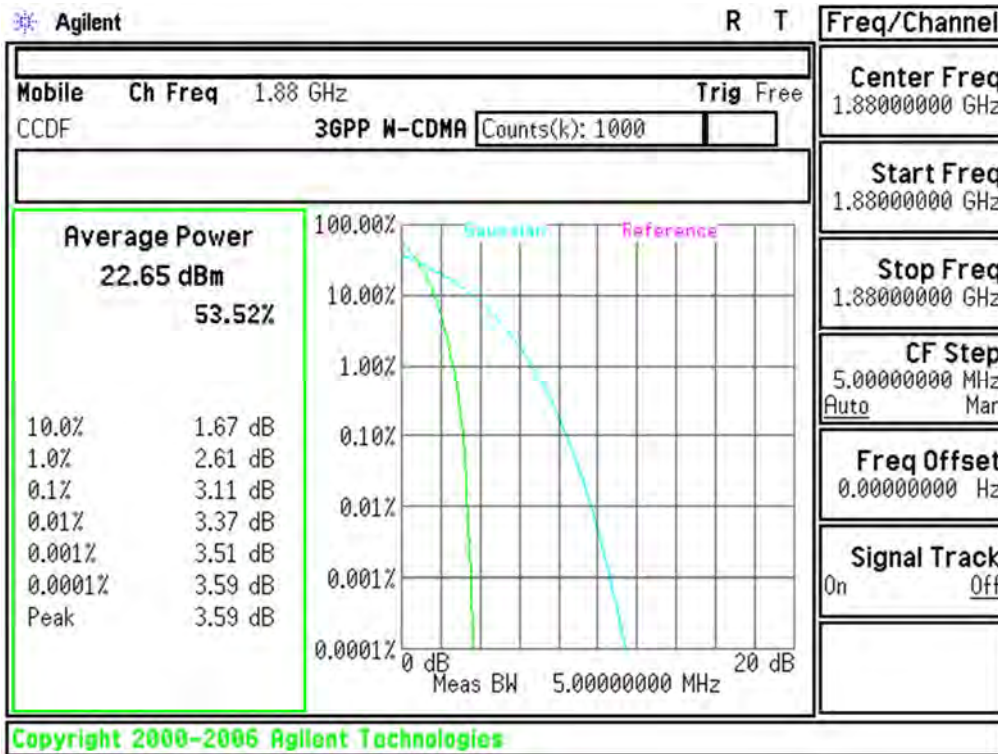

Plot 6-49. Peak-Average Ratio Plot (PCS WCDMA Mode - Ch.9400(DL9800))

- End of this page -



6.6. Frequency Stability / Temperature Variation
§2.1055 §22.355 §24.229 §24.235

Test Overview and Limit

Frequency stability testing is performed in accordance with the guidelines of ANSI/TIA-603-D-2010. The frequency stability of the transmitter is measured by:

1. Temperature: The temperature is varied from -30°C to +50°C in 10°C increments using an environmental chamber.
2. Primary Supply Voltage: The primary supply voltage is varied from 85% to 115% of the nominal value for other than hand carried battery equipment. For hand-carried, battery-powered equipment, primary supply voltage is reduced to the battery operating end point(=Batt.End) which shall be specified by the manufacturer.

For part 22, the frequency stability of the transmitter shall be maintained within $\pm 0.00025\%$ (± 2.5 ppm) of the center frequency. For part 24, the frequency stability shall be sufficient to ensure that the fundamental emission stays within the authorized frequency block.

Test Procedure Used

ANSI/TIA-603-D-2010

Test Settings

1. The equipment is turned on in a "standby" condition for fifteen minutes before applying power to the transmitter. Measurement of the carrier frequency of the transmitter is made within one minute after applying power to the transmitter.
2. Frequency measurements are made at 10°C intervals ranging from -30°C to +50°C. A period of time sufficient to stabilize EUT at each temperature level shall be allowed prior to frequency measurement.

Test Setup

The EUT and measurement equipment were set up as shown in the diagram below.

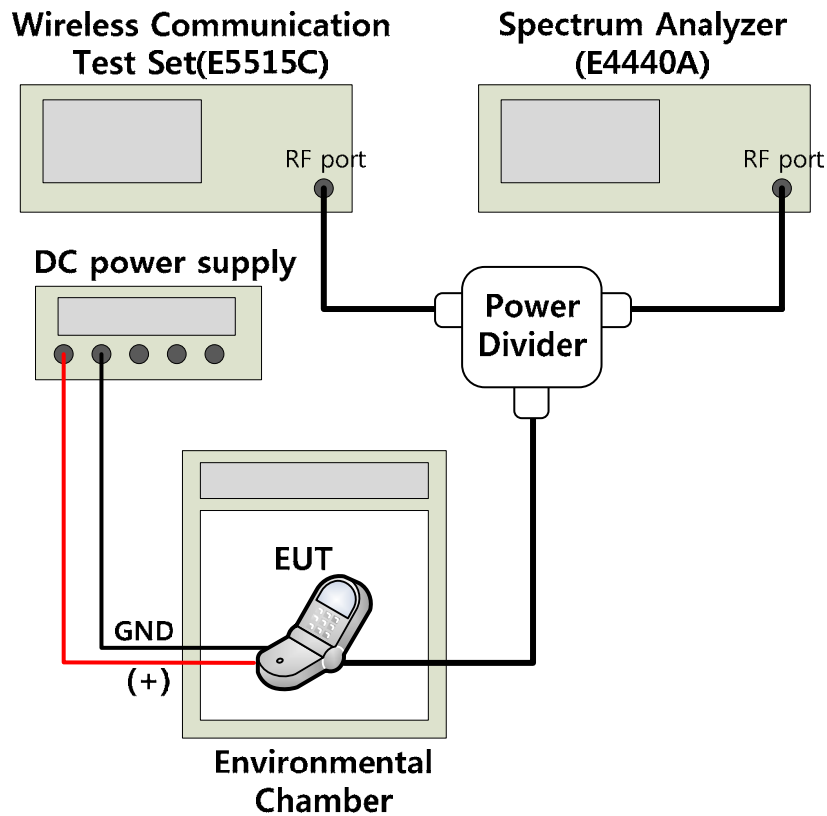

Figure 6-5. Test Instruments & Measurement Setup

Test Notes

1. MCF is the Measured Carrier Frequency
ACF is the Assigned Carrier Frequency
2. Calculate the ppm frequency error by the following:

$$\text{ppm error} = \left(\frac{\text{MCF}_{[\text{MHz}]} - \text{ACF}_{[\text{MHz}]}}{\text{ACF}_{[\text{MHz}]}} \right) \times 10^6$$

3. For part 24, the fundamental emission should stay within the authorized frequency block. But, based on the results of the frequency stability test at the center channel, the frequency deviation results measured are very small. As such it is determined that the channels at the band edge would remain in-band when the maximum measured frequency deviation noted during the frequency stability tests is applied. Therefore the device is determined to remain operating in band over the temperature and voltage range as tested.



Issue Date:

Mode : Cellular GSM
 Mode : PCS GSM
 Channel : 661
 Operating Frequency : 1880 MHz
 Reference Voltage : 3.80 VDC

Voltage [%]	Power [VDC]	Temp [°C]	ACF [MHz]	MCF [MHz]	Freq. Dev. [Hz]	ppm error
100 %	3.80	-30	1880	1,879.999990	-9.60	-0.005
		-20	1880	1,879.999992	-8.35	-0.004
		-10	1880	1,880.000015	15.11	0.008
		0	1880	1,879.999992	-7.69	-0.004
		+10	1880	1,880.000018	17.74	0.009
		+20	1880	1,880.000020	19.87	0.011
		+30	1880	1,880.000019	19.38	0.010
		+40	1880	1,880.000015	15.48	0.008
		+50	1880	1,880.000007	7.42	0.004
Batt.End	3.40	+20	1880	1,880.000011	10.82	0.006

Table 6-2. Frequency Stability Data (PCS GSM Mode - Ch.661)

Mode : Cellular WCDMA
 Channel : 4183
 Operating Frequency : 836.6 MHz
 Reference Voltage : 3.80 VDC

Voltage [%]	Power [VDC]	Temp [°C]	ACF [MHz]	MCF [MHz]	Freq. Dev. [Hz]	ppm error	Limit [ppm]
100 %	3.80	-30	836.6	836.600004	3.74	0.004	±2.5
		-20	836.6	836.600004	3.67	0.004	
		-10	836.6	836.600003	3.34	0.004	
		0	836.6	836.600004	3.53	0.004	
		+10	836.6	836.600004	3.77	0.005	
		+20	836.6	836.600004	3.99	0.005	
		+30	836.6	836.600003	3.31	0.004	
		+40	836.6	836.600003	2.97	0.004	
		+50	836.6	836.600003	3.32	0.004	
Batt.End	3.40	+20	836.6	836.600004	3.93	0.005	

Table 6-3. Frequency Stability Data (Cellular WCDMA Mode - Ch.4183)



Issue Date:

Mode : PCS WCDMA
Channel : 9400
Operating Frequency : 1880 MHz
Reference Voltage : 3.80 VDC

Voltage [%]	Power [VDC]	Temp [°C]	ACF [MHz]	MCF [MHz]	Freq. Dev. [Hz]	ppm error
100 %	3.80	-30	1880	1,880.000003	3.11	0.002
		-20	1880	1,880.000003	3.05	0.002
		-10	1880	1,880.000003	2.68	0.001
		0	1880	1,880.000003	2.91	0.002
		+10	1880	1,880.000003	2.88	0.002
		+20	1880	1,880.000003	2.91	0.002
		+30	1880	1,880.000003	2.87	0.002
		+40	1880	1,880.000003	2.72	0.001
		+50	1880	1,880.000003	2.84	0.002
Batt.End	3.40	+20	1880	1,880.000003	2.89	0.002

Table 6-4. Frequency Stability Data (PCS WCDMA Mode - Ch.9400)

- End of this page -



6.7. Radiated Power (ERP/EIRP)

§22.913(a)(2) §24.232(c)

Test Overview

Effective Radiated Power (ERP) and Equivalent Isotropic Radiated Power (EIRP) measurements are performed using the substitution method described in ANSI/TIA-603-D-2010 with the EUT transmitting into an integral antenna. Measurements on signals operating below 1GHz are performed using dipole antennas. Measurements on signals operating above 1GHz are performed using broadband horn antennas. All measurements are performed as RMS average measurements while the EUT is operating at its maximum duty cycle, at maximum power, and at the appropriate frequencies.

Test Procedure Used

KDB 971168 v02r02 – Section 5.2.1

ANSI/TIA-603-D-2010 – Section 2.2.17

Test Settings

1. Radiated power measurements are performed using the signal analyzer's "channel power" measurement capability for signals with continuous operation. For signals with burst transmission, the signal analyzer's "time domain power" measurement capability is used
2. RBW = 1 – 5% of the expected OBW, not to exceed 1MHz
3. VBW \geq 3 x RBW
4. Span = 1.5 times the OBW
5. No. of sweep points \geq 2 x span / RBW
6. Detector = RMS
7. Trigger is set to "free run" for signals with continuous operation with the sweep times set to "auto". Trigger is set to enable triggering only on full power bursts with the sweep time set less than or equal to the transmission burst duration
8. The integration bandwidth was roughly set equal to the measured OBW of the signal for signals with continuous operation. For signals with burst transmission, the "gating" function was enabled to ensure that measurements are performed during times in which the transmitter is operating at its maximum power
9. Trace mode = trace averaging (RMS) over 100 sweeps
10. The trace was allowed to stabilize

Test Setup

The EUT and measurement equipment were set up as shown in the diagram below.

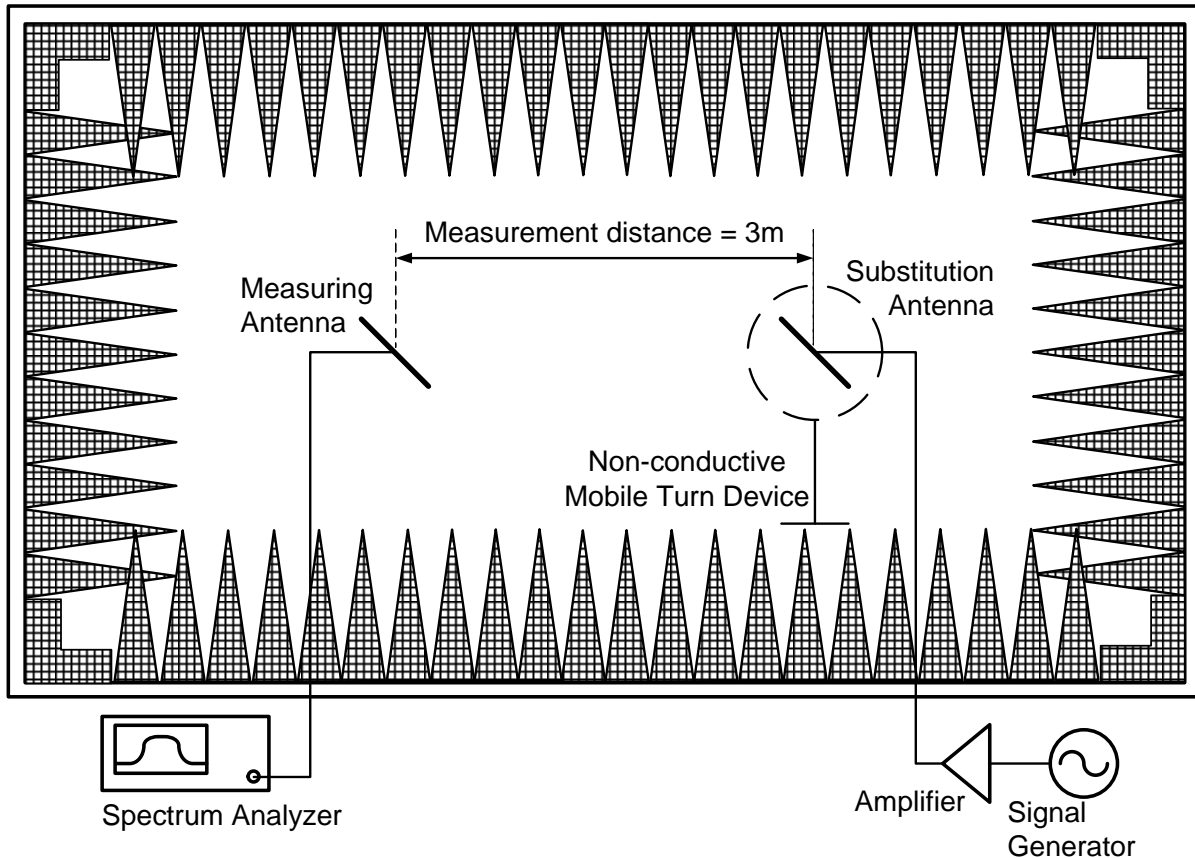

Figure 6-6. Test Instruments & Measurement Setup

Test Notes

1. This device employs GSM, GPRS and EDGE capabilities. The EUT was tested under all configurations and the highest power is reported in GSM mode using a Power Control Level of "0" in the PCS Band and "5" in the Cellular Band.
2. This device employs UMTS technology with WCDMA (AMR/RMC), HSDPA and HSUPA capabilities. For WCDMA and HSUPA transmission, all configurations were investigated and the worst case UMTS emissions were found in RMC WCDMA mode at 12.2kbps with HSDPA inactive and TPC bits all set to "1".
3. The EUT was tested with its standard battery. The battery for this model EB-BG530BBC contains an embedded NFC antenna.
4. The EUT was tested with Turn Device and the worst case test setup is reported in the tables below.



Test Results

Mode	Freq. [MHz]	Ant Pol (H/V)	EUT Pol [degree]		S/A reading [dBm]	S/G Level [dBm]	Substitute Level [dBm]	Ant. Gain [dBi]	EIRP [dBm]	EIRP Limit [dBm]	Margin [dB]
			Azimuth	Elevation							
GSM1900	1850.2	H	342	180	-16.21	-13.65	18.77	9.58	28.35	33.01	4.66
GSM1900	1880.0	H	346	180	-17.99	-14.40	17.78	9.47	27.25	33.01	5.76
GSM1900	1909.8	H	348	180	-16.44	-12.47	19.63	9.27	28.90	33.01	4.11
EDGE1900	1909.8	H	348	180	-19.41	-12.47	19.63	9.27	25.93	33.01	7.08

Table 6-5. EIRP (PCS GSM)

Mode	Freq. [MHz]	Ant Pol (H/V)	EUT Pol [degree]		S/A reading [dBm]	S/G Level [dBm]	Substitute Level [dBm]	Ant. Gain [dBd]	ERP [dBm]	ERP Limit [dBm]	Margin [dB]
			Azimuth	Elevation							
WCDMA850	826.4	H	291	80	-17.72	-19.21	16.32	-1.14	15.18	38.45	23.27
WCDMA850	836.6	H	292	45	-19.20	-19.59	15.84	-1.28	14.56	38.45	23.89
WCDMA850	846.6	H	290	55	-21.24	-20.51	14.77	-1.41	13.36	38.45	25.09

Table 6-6. ERP (Cellular WCDMA)

Mode	Freq. [MHz]	Ant Pol (H/V)	EUT Pol [degree]		S/A reading [dBm]	S/G Level [dBm]	Substitute Level [dBm]	Ant. Gain [dBi]	EIRP [dBm]	EIRP Limit [dBm]	Margin [dB]
			Azimuth	Elevation							
WCDMA1900	1852.4	H	341	180	-23.39	-20.61	11.76	9.58	21.34	33.01	11.67
WCDMA1900	1880.0	H	11	0	-24.04	-20.43	11.73	9.47	21.20	33.01	11.81
WCDMA1900	1907.6	H	337	160	-22.50	-18.51	13.53	9.30	22.83	33.01	10.18

Table 6-7. EIRP (PCS WCDMA)



6.8. Radiated Spurious Emissions Measurements
§2.1053 §22.917(a) §24.238(a)

Test Overview

Radiated spurious emissions measurements are performed using the substitution method described in ANSI/TIA-603-D-2010 with the EUT transmitting into an integral antenna. Measurements on signals operating below 1GHz are performed using dipole antennas. Measurements on signals operating above 1GHz are performed using broadband horn antennas. All measurements are performed as peak measurements while the EUT is operating at its maximum duty cycle, at maximum power, and at the appropriate frequencies.

Test Procedure Used

KDB 971168 v02r02 – Section 5.8

ANSI/TIA-603-D-2010 – Section 2.2.12

Test Settings

1. RBW = 100kHz for emissions below 1GHz and 1MHz for emissions above 1GHz
2. VBW $\geq 3 \times$ RBW
3. Span = 1.5 times the OBW
4. No. of sweep points $\geq 2 \times$ span / RBW
5. Detector = Max Peak
6. Trace mode = max hold
7. The trace was allowed to stabilize

– End of this page –

Test Setup

The EUT and measurement equipment were set up as shown in the diagram below.

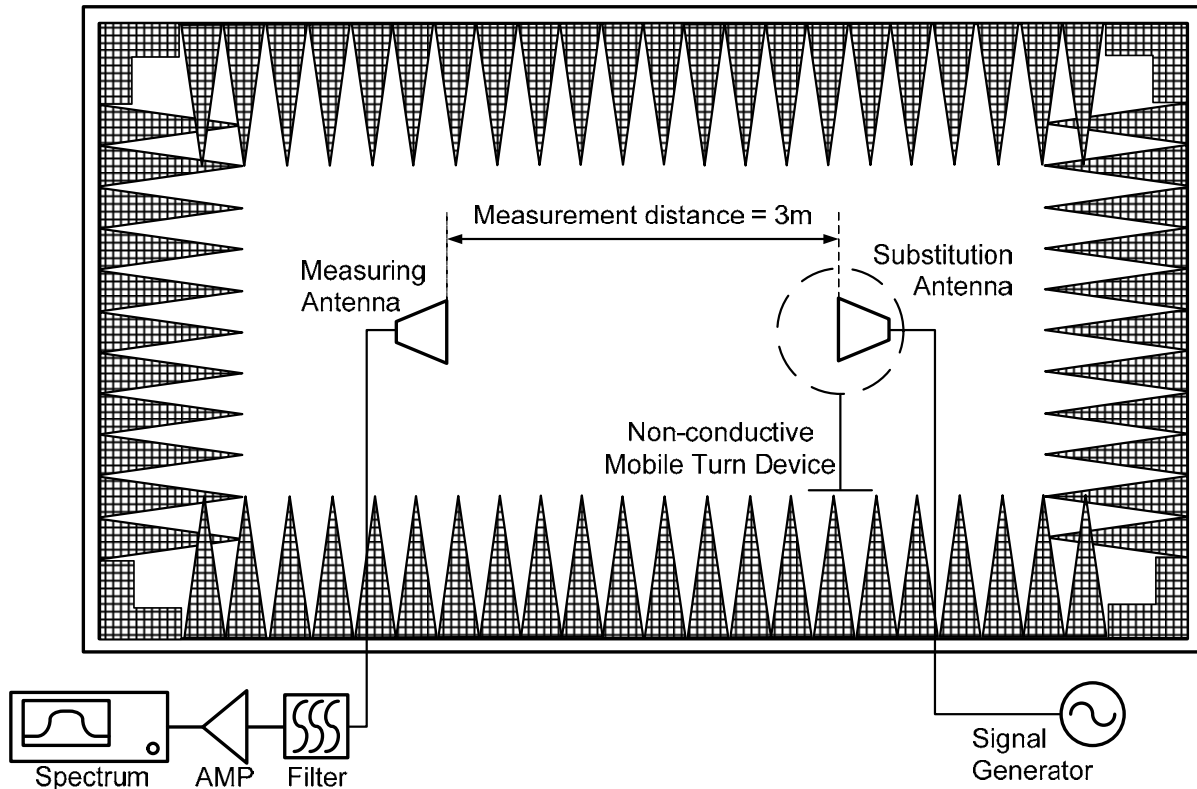

Figure 6-7. Test Instruments & Measurement Setup

Test Notes

1. This device employs GSM, GPRS and EDGE capabilities. The EUT was tested under all configurations and the highest power is reported in GSM mode using a Power Control Level of "0" in the PCS Band and "5" in the Cellular Band.
2. This device employs UMTS technology with WCDMA (AMR/RMC), HSDPA and HSUPA capabilities. For WCDMA and HSUPA transmission, all configurations were investigated and the worst case UMTS emissions were found in RMC WCDMA mode at 12.2kbps with HSDPA inactive and TPC bits all set to "1".
3. The EUT was tested with its standard battery. The battery for this model EB-BG530BBC contains an embedded NFC antenna.
4. The EUT was tested with Turn Device and the worst case test setup is reported in the tables below.
5. The spectrum is measured from 9kHz to the 10th harmonic of the fundamental frequency of the transmitter. The worst-case emissions are reported however emissions whose levels were not within 20dB of the respective limits were not reported.



Issue Date:

Test Results

Operating Frequency : 1850.2 MHz
 Channel : 512
 Measured Output Power : 28.35 dBm = 0.684 Watt
 Modulation Signal : GSM(GMSK)
 Distance : 3 meters
 Limit : $43 + 10 \log_{10}(W)$ = 41.35 dBc
 RSE Limit : -13 dBm

Freq. [MHz]	Ant Pol (H/V)	EUT Pol [degree]		S/A reading [dBm]	S/G Lev. [dBm]	Tx C/L [dB]	Ant. Gain [dBi]	RSE Level [dBm]
		Azimuth	Elevation					
3700.4	H	344	0	-58.69	-43.76	5.91	10.58	-39.09
5550.6	V	258	45	-59.77	-40.18	7.39	11.32	-36.25
7400.8	V	189	0	-59.80	-35.83	8.13	10.05	-33.92
9251.0	H	Noise floor		-66.85	-39.43	10.09	11.24	-38.27

Table 6-8. Radiated Spurious Data (PCS GSM Mode - Ch.512)

Operating Frequency : 1880.0 MHz
 Channel : 661
 Measured Output Power : 27.25 dBm = 0.531 Watt
 Modulation Signal : GSM(GMSK)
 Distance : 3 meters
 Limit : $43 + 10 \log_{10}(W)$ = 40.25 dBc
 RSE Limit : -13 dBm

Freq. [MHz]	Ant Pol (H/V)	EUT Pol [degree]		S/A reading [dBm]	S/G Lev. [dBm]	Tx C/L [dB]	Ant. Gain [dBi]	RSE Level [dBm]
		Azimuth	Elevation					
3760.0	H	210	70	-60.63	-45.00	5.97	10.54	-40.43
5640.0	H	175	135	-60.77	-41.91	7.37	11.17	-38.11
7520.0	H	0	65	-58.78	-35.00	8.30	10.32	-32.98
9400.0	V	186	160	-65.17	-37.87	9.56	11.20	-36.23

Table 6-9. Radiated Spurious Data (PCS GSM Mode - Ch.661)

- End of this page -



Issue Date:

Operating Frequency : 1909.8 MHz
Channel : 810
Measured Output Power : 28.90 dBm = 0.776 Watt
Modulation Signal : GSM(GMSK)
Distance : 3 meters
Limit : $43 + 10 \log_{10}(W)$ = 41.90 dBc
RSE Limit : -13 dBm

Freq. [MHz]	Ant Pol (H/V)	EUT Pol [degree]		S/A reading [dBm]	S/G Lev. [dBm]	Tx C/L [dB]	Ant. Gain [dBi]	RSE Level [dBm]
		Azimuth	Elevation					
3819.6	H	253	80	-59.15	-43.94	5.97	10.54	-39.38
5729.4	V	175	170	-57.55	-38.56	7.44	11.08	-34.92
7639.2	H	349	80	-54.75	-30.69	8.66	10.33	-29.02
9549.0	V	196	20	-63.72	-36.64	9.62	11.46	-34.80

Table 6-10. Radiated Spurious Data (PCS GSM Mode - Ch.810)

- End of this page -



Issue Date:

Operating Frequency : 826.4 MHz
 Channel : 4132
 Measured Output Power : 15.18 dBm = 0.033 Watt
 Modulation Signal : WCDMA
 Distance : 3 meters
 Limit : $43 + 10 \log_{10}(W)$ = 28.18 dBc
 RSE Limit : -13 dBm

Freq. [MHz]	Ant Pol (H/V)	EUT Pol [degree]		S/A reading [dBm]	S/G Lev. [dBm]	Tx C/L [dB]	Ant. Gain [dBd]	RSE Level [dBm]
		Azimuth	Elevation					
1652.8	V	95	35	-68.72	-63.47	3.76	9.12	-58.10
2479.2	H	333	25	-68.71	-59.53	4.73	10.38	-53.88
3305.6	V	123	0	-68.91	-56.40	5.52	10.44	-51.48
4132.0	V	11	100	-70.62	-54.80	6.14	10.46	-50.47
4958.4	V	Noise floor		-66.04	-48.71	6.85	11.33	-44.23

Table 6-11. Radiated Spurious Data (Cellular WCDMA Mode - Ch.4132)

Operating Frequency : 836.6 MHz
 Channel : 4183
 Measured Output Power : 14.56 dBm = 0.029 Watt
 Modulation Signal : WCDMA
 Distance : 3 meters
 Limit : $43 + 10 \log_{10}(W)$ = 27.56 dBc
 RSE Limit : -13 dBm

Freq. [MHz]	Ant Pol (H/V)	EUT Pol [degree]		S/A reading [dBm]	S/G Lev. [dBm]	Tx C/L [dB]	Ant. Gain [dBd]	RSE Level [dBm]
		Azimuth	Elevation					
1673.2	V	209	20	-69.43	-63.69	3.75	9.27	-58.17
2509.8	V	238	80	-68.93	-59.09	4.73	10.37	-53.45
3346.4	H	241	115	-67.66	-54.53	5.60	10.43	-49.70
4183.0	V	206	80	-70.69	-54.62	6.23	10.59	-50.26

Table 6-12. Radiated Spurious Data (Cellular WCDMA Mode - Ch.4183)

Issue Date:

Operating Frequency : 846.6 MHz
 Channel : 4233
 Measured Output Power : 13.36 dBm = 0.022 Watt
 Modulation Signal : WCDMA
 Distance : 3 meters
 Limit : $43 + 10 \log_{10}(W)$ = 26.36 dBc
 RSE Limit : -13 dBm

Freq. [MHz]	Ant Pol (H/V)	EUT Pol [degree]		S/A reading [dBm]	S/G Lev. [dBm]	Tx C/L [dB]	Ant. Gain [dBd]	RSE Level [dBm]
		Azimuth	Elevation					
1693.2	V	354	80	-70.00	-64.48	3.74	9.41	-58.81
2539.8	V	305	110	-69.29	-59.35	4.69	10.30	-53.74
3386.4	H	351	180	-68.94	-55.89	5.51	10.41	-50.99
4233.0	V	183	80	-70.33	-54.68	6.38	10.73	-50.33

Table 6-13. Radiated Spurious Data (Cellular WCDMA Mode - Ch.4233)

Operating Frequency : 1852.4 MHz
 Channel : 9262
 Measured Output Power : 21.34 dBm = 0.136 Watt
 Modulation Signal : WCDMA
 Distance : 3 meters
 Limit : $43 + 10 \log_{10}(W)$ = 34.34 dBc
 RSE Limit : -13 dBm

Freq. [MHz]	Ant Pol (H/V)	EUT Pol [degree]		S/A reading [dBm]	S/G Lev. [dBm]	Tx C/L [dB]	Ant. Gain [dBi]	RSE Level [dBm]
		Azimuth	Elevation					
3704.8	H	310	125	-62.84	-47.86	5.91	10.58	-43.20
5557.2	H	11	155	-63.15	-43.50	7.39	11.30	-39.59
7409.6	V	188	0	-57.13	-33.18	8.15	10.07	-31.26
9262.0	H	71	20	-66.84	-39.46	10.05	11.24	-38.27
11114.4	H	Noise floor		-66.61	-37.93	11.08	12.27	-36.73

Table 6-14. Radiated Spurious Data (PCS WCDMA Mode - Ch.9262)



Issue Date:

Operating Frequency : 1880.0 MHz
 Channel : 9400
 Measured Output Power : 21.20 dBm = 0.132 Watt
 Modulation Signal : WCDMA
 Distance : 3 meters
 Limit : $43 + 10 \log_{10}(W)$ = 34.20 dBc
 RSE Limit : -13 dBm

Freq. [MHz]	Ant Pol (H/V)	EUT Pol [degree]		S/A reading [dBm]	S/G Lev. [dBm]	Tx C/L [dB]	Ant. Gain [dBi]	RSE Level [dBm]
		Azimuth	Elevation					
3760.0	H	252	90	-61.53	-45.90	5.97	10.54	-41.33
5640.0	V	215	10	-63.19	-44.23	7.37	11.17	-40.43
7520.0	H	5	55	-56.55	-32.77	8.30	10.32	-30.75
9400.0	V	Noise floor		-66.00	-38.70	9.56	11.20	-37.06

Table 6-15. Radiated Spurious Data (PCS WCDMA Mode - Ch.9400)

Operating Frequency : 1907.6 MHz
 Channel : 9538
 Measured Output Power : 22.83 dBm = 0.192 Watt
 Modulation Signal : WCDMA
 Distance : 3 meters
 Limit : $43 + 10 \log_{10}(W)$ = 35.83 dBc
 RSE Limit : -13 dBm

Freq. [MHz]	Ant Pol (H/V)	EUT Pol [degree]		S/A reading [dBm]	S/G Lev. [dBm]	Tx C/L [dB]	Ant. Gain [dBi]	RSE Level [dBm]
		Azimuth	Elevation					
3815.2	H	252	90	-60.06	-44.82	5.97	10.54	-40.25
5722.8	H	253	80	-59.65	-40.52	7.44	11.09	-36.87
7630.4	H	242	55	-55.40	-31.36	8.64	10.33	-29.66
9538.0	V	193	10	-63.24	-36.14	9.62	11.44	-34.32

Table 6-16. Radiated Spurious Data (PCS WCDMA Mode - Ch.9538)

- End of this page -



7. CONCLUSION

The data collected relate only the item(s) tested and show that the Samsung Portable Handset FCC ID: A3LSMJ3109 compliance with all the requirements of Parts 2, 22, 24 of the FCC rules.

– End of this report –