



Accredited by the Swiss Accreditation Service (SAS)  
The Swiss Accreditation Service is one of the signatories to the EA  
Multilateral Agreement for the recognition of calibration certificates

Accreditation No.: **SCS 0108**

Client **PC Test**

Certificate No: **D1900V2-5d149\_Jul15**

## CALIBRATION CERTIFICATE

Object **D1900V2 - SN:5d149**

Calibration procedure(s) **QA CAL-05.v9  
Calibration procedure for dipole validation kits above 700 MHz**

Calibration date: **July 14, 2015**

CCV  
8/4/15

This calibration certificate documents the traceability to national standards, which realize the physical units of measurements (SI).  
The measurements and the uncertainties with confidence probability are given on the following pages and are part of the certificate.

All calibrations have been conducted in the closed laboratory facility: environment temperature (22 ± 3)°C and humidity < 70%.

Calibration Equipment used (M&TE critical for calibration)

Primary Standards	ID #	Cal Date (Certificate No.)	Scheduled Calibration
Power meter EPM-442A	GB37480704	07-Oct-14 (No. 217-02020)	Oct-15
Power sensor HP 8481A	US37292783	07-Oct-14 (No. 217-02020)	Oct-15
Power sensor HP 8481A	MY41092317	07-Oct-14 (No. 217-02021)	Oct-15
Reference 20 dB Attenuator	SN: 5058 (20k)	01-Apr-15 (No. 217-02131)	Mar-16
Type-N mismatch combination	SN: 5047.2 / 06327	01-Apr-15 (No. 217-02134)	Mar-16
Reference Probe ES3DV3	SN: 3205	30-Dec-14 (No. ES3-3205_Dec14)	Dec-15
DAE4	SN: 601	18-Aug-14 (No. DAE4-601_Aug14)	Aug-15
Secondary Standards	ID #	Check Date (in house)	Scheduled Check
RF generator R&S SMT-06	100005	04-Aug-99 (in house check Oct-13)	In house check: Oct-16
Network Analyzer HP 8753E	US37390585 S4206	18-Oct-01 (in house check Oct-14)	In house check: Oct-15

Calibrated by: **Leif Klysner** (Name) / **Laboratory Technician** (Function) / *[Signature]* (Signature)

Approved by: **Katja Pokovic** (Name) / **Technical Manager** (Function) / *[Signature]* (Signature)

Issued: July 14, 2015

This calibration certificate shall not be reproduced except in full without written approval of the laboratory.



Accredited by the Swiss Accreditation Service (SAS)

The Swiss Accreditation Service is one of the signatories to the EA Multilateral Agreement for the recognition of calibration certificates

**Glossary:**

TSL	tissue simulating liquid
ConvF	sensitivity in TSL / NORM x,y,z
N/A	not applicable or not measured

**Calibration is Performed According to the Following Standards:**

- a) IEEE Std 1528-2013, "IEEE Recommended Practice for Determining the Peak Spatial-Averaged Specific Absorption Rate (SAR) in the Human Head from Wireless Communications Devices: Measurement Techniques", June 2013
- b) IEC 62209-1, "Procedure to measure the Specific Absorption Rate (SAR) for hand-held devices used in close proximity to the ear (frequency range of 300 MHz to 3 GHz)", February 2005
- c) IEC 62209-2, "Procedure to determine the Specific Absorption Rate (SAR) for wireless communication devices used in close proximity to the human body (frequency range of 30 MHz to 6 GHz)", March 2010
- d) KDB 865664, "SAR Measurement Requirements for 100 MHz to 6 GHz"

**Additional Documentation:**

- e) DASY4/5 System Handbook

**Methods Applied and Interpretation of Parameters:**

- *Measurement Conditions:* Further details are available from the Validation Report at the end of the certificate. All figures stated in the certificate are valid at the frequency indicated.
- *Antenna Parameters with TSL:* The dipole is mounted with the spacer to position its feed point exactly below the center marking of the flat phantom section, with the arms oriented parallel to the body axis.
- *Feed Point Impedance and Return Loss:* These parameters are measured with the dipole positioned under the liquid filled phantom. The impedance stated is transformed from the measurement at the SMA connector to the feed point. The Return Loss ensures low reflected power. No uncertainty required.
- *Electrical Delay:* One-way delay between the SMA connector and the antenna feed point. No uncertainty required.
- *SAR measured:* SAR measured at the stated antenna input power.
- *SAR normalized:* SAR as measured, normalized to an input power of 1 W at the antenna connector.
- *SAR for nominal TSL parameters:* The measured TSL parameters are used to calculate the nominal SAR result.

The reported uncertainty of measurement is stated as the standard uncertainty of measurement multiplied by the coverage factor  $k=2$ , which for a normal distribution corresponds to a coverage probability of approximately 95%.

## Measurement Conditions

DASY system configuration, as far as not given on page 1.

DASY Version	DASY5	V52.8.8
Extrapolation	Advanced Extrapolation	
Phantom	Modular Flat Phantom	
Distance Dipole Center - TSL	10 mm	with Spacer
Zoom Scan Resolution	dx, dy, dz = 5 mm	
Frequency	1900 MHz $\pm$ 1 MHz	

## Head TSL parameters

The following parameters and calculations were applied.

	Temperature	Permittivity	Conductivity
Nominal Head TSL parameters	22.0 °C	40.0	1.40 mho/m
Measured Head TSL parameters	(22.0 $\pm$ 0.2) °C	39.7 $\pm$ 6 %	1.38 mho/m $\pm$ 6 %
Head TSL temperature change during test	< 0.5 °C	----	----

## SAR result with Head TSL

SAR averaged over 1 cm <sup>3</sup> (1 g) of Head TSL	Condition	
SAR measured	250 mW input power	10.1 W/kg
SAR for nominal Head TSL parameters	normalized to 1W	<b>40.7 W/kg <math>\pm</math> 17.0 % (k=2)</b>

SAR averaged over 10 cm <sup>3</sup> (10 g) of Head TSL	condition	
SAR measured	250 mW input power	5.34 W/kg
SAR for nominal Head TSL parameters	normalized to 1W	<b>21.5 W/kg <math>\pm</math> 16.5 % (k=2)</b>

## Body TSL parameters

The following parameters and calculations were applied.

	Temperature	Permittivity	Conductivity
Nominal Body TSL parameters	22.0 °C	53.3	1.52 mho/m
Measured Body TSL parameters	(22.0 $\pm$ 0.2) °C	52.7 $\pm$ 6 %	1.54 mho/m $\pm$ 6 %
Body TSL temperature change during test	< 0.5 °C	----	----

## SAR result with Body TSL

SAR averaged over 1 cm <sup>3</sup> (1 g) of Body TSL	Condition	
SAR measured	250 mW input power	10.2 W/kg
SAR for nominal Body TSL parameters	normalized to 1W	<b>40.4 W/kg <math>\pm</math> 17.0 % (k=2)</b>

SAR averaged over 10 cm <sup>3</sup> (10 g) of Body TSL	condition	
SAR measured	250 mW input power	5.49 W/kg
SAR for nominal Body TSL parameters	normalized to 1W	<b>21.8 W/kg <math>\pm</math> 16.5 % (k=2)</b>

## Appendix (Additional assessments outside the scope of SCS 0108)

### Antenna Parameters with Head TSL

Impedance, transformed to feed point	51.4 $\Omega$ + 5.6 j $\Omega$
Return Loss	- 24.9 dB

### Antenna Parameters with Body TSL

Impedance, transformed to feed point	47.7 $\Omega$ + 6.1 j $\Omega$
Return Loss	- 23.5 dB

### General Antenna Parameters and Design

Electrical Delay (one direction)	1.197 ns
----------------------------------	----------

After long term use with 100W radiated power, only a slight warming of the dipole near the feedpoint can be measured.

The dipole is made of standard semirigid coaxial cable. The center conductor of the feeding line is directly connected to the second arm of the dipole. The antenna is therefore short-circuited for DC-signals. On some of the dipoles, small end caps are added to the dipole arms in order to improve matching when loaded according to the position as explained in the "Measurement Conditions" paragraph. The SAR data are not affected by this change. The overall dipole length is still according to the Standard.

No excessive force must be applied to the dipole arms, because they might bend or the soldered connections near the feedpoint may be damaged.

### Additional EUT Data

Manufactured by	SPEAG
Manufactured on	March 11, 2011

## DASY5 Validation Report for Head TSL

Date: 14.07.2015

Test Laboratory: SPEAG, Zurich, Switzerland

**DUT: Dipole 1900 MHz; Type: D1900V2; Serial: D1900V2 - SN:5d149**

Communication System: UID 0 - CW; Frequency: 1900 MHz

Medium parameters used:  $f = 1900$  MHz;  $\sigma = 1.38$  S/m;  $\epsilon_r = 39.7$ ;  $\rho = 1000$  kg/m<sup>3</sup>

Phantom section: Flat Section

Measurement Standard: DASY5 (IEEE/IEC/ANSI C63.19-2011)

DASY52 Configuration:

- Probe: ES3DV3 - SN3205; ConvF(5, 5, 5); Calibrated: 30.12.2014;
- Sensor-Surface: 3mm (Mechanical Surface Detection)
- Electronics: DAE4 Sn601; Calibrated: 18.08.2014
- Phantom: Flat Phantom 5.0 (front); Type: QD000P50AA; Serial: 1001
- DASY52 52.8.8(1222); SEMCAD X 14.6.10(7331)

### Dipole Calibration for Head Tissue/Pin=250 mW, d=10mm/Zoom Scan (7x7x7)/Cube 0:

Measurement grid: dx=5mm, dy=5mm, dz=5mm

Reference Value = 99.22 V/m; Power Drift = 0.02 dB

Peak SAR (extrapolated) = 18.3 W/kg

**SAR(1 g) = 10.1 W/kg; SAR(10 g) = 5.34 W/kg**

Maximum value of SAR (measured) = 12.9 W/kg

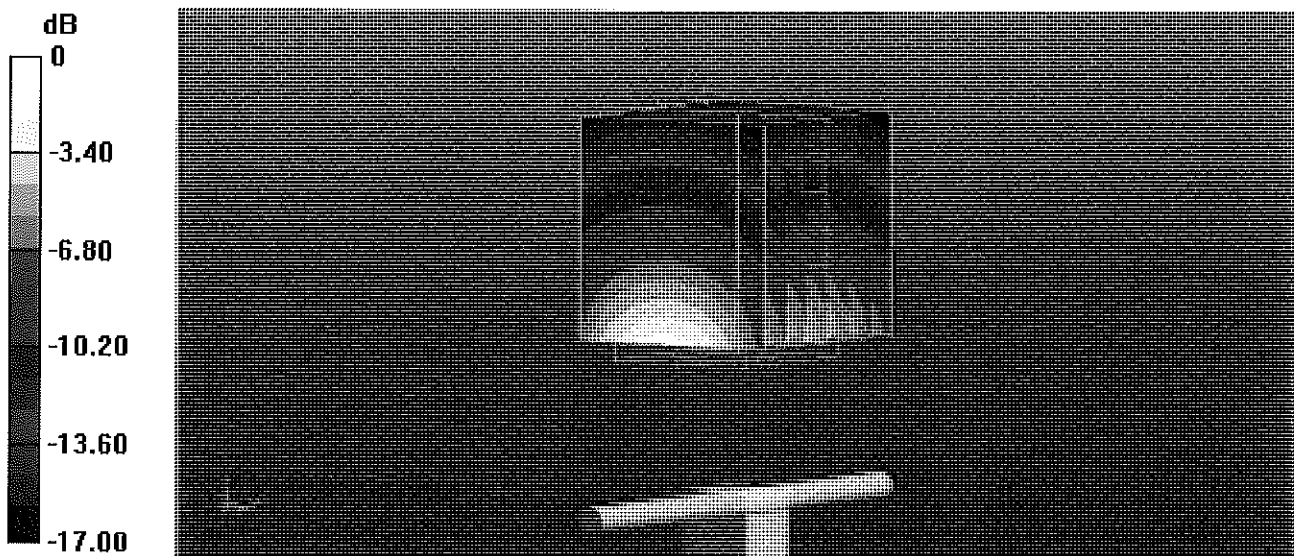

0 dB = 12.9 W/kg = 11.11 dBW/kg

# Impedance Measurement Plot for Head TSL

14 Jul 2015 09:20:59

CH1 S11 1 U FS 1: 51.447  $\Omega$  5.5664  $\Omega$  466.27  $\mu$ H 1 900.000 000 MHz

\*  
De1

CA

Avg  
16

H1d

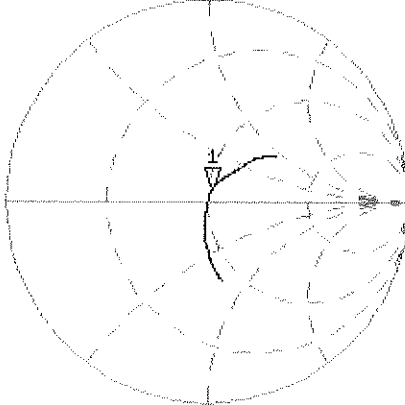

CH2 S11 LOG 5 dB/REF -20 dB 1: -24.943 dB 1 900.000 000 MHz

De1

CA

Avg  
16

H1d

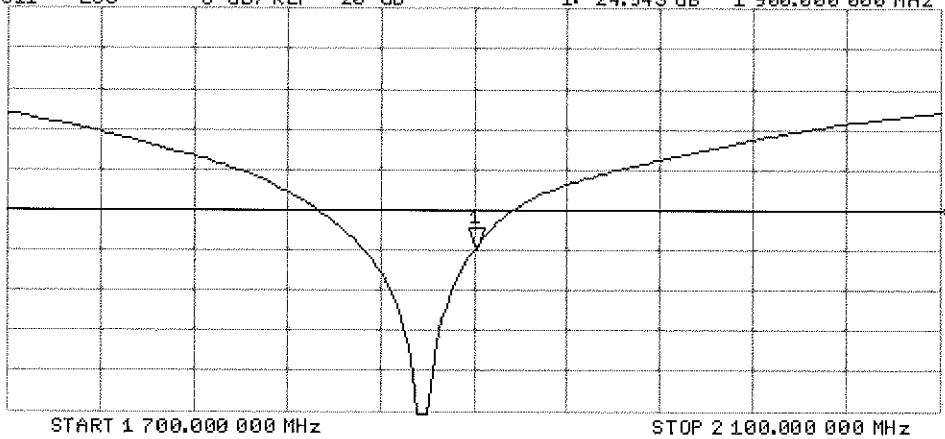

# DASY5 Validation Report for Body TSL

Date: 14.07.2015

Test Laboratory: SPEAG, Zurich, Switzerland

**DUT: Dipole 1900 MHz; Type: D1900V2; Serial: D1900V2 - SN:5d149**

Communication System: UID 0 - CW; Frequency: 1900 MHz

Medium parameters used:  $f = 1900$  MHz;  $\sigma = 1.54$  S/m;  $\epsilon_r = 52.7$ ;  $\rho = 1000$  kg/m<sup>3</sup>

Phantom section: Flat Section

Measurement Standard: DASY5 (IEEE/IEC/ANSI C63.19-2011)

DASY52 Configuration:

- Probe: ES3DV3 - SN3205; ConvF(4.65, 4.65, 4.65); Calibrated: 30.12.2014;
- Sensor-Surface: 3mm (Mechanical Surface Detection)
- Electronics: DAE4 Sn601; Calibrated: 18.08.2014
- Phantom: Flat Phantom 5.0 (back); Type: QD000P50AA; Serial: 1002
- DASY52 52.8.8(1222); SEMCAD X 14.6.10(7331)

## Dipole Calibration for Body Tissue/Pin=250 mW, d=10mm/Zoom Scan (7x7x7)/Cube 0:

Measurement grid: dx=5mm, dy=5mm, dz=5mm

Reference Value = 95.96 V/m; Power Drift = 0.01 dB

Peak SAR (extrapolated) = 17.2 W/kg

**SAR(1 g) = 10.2 W/kg; SAR(10 g) = 5.49 W/kg**

Maximum value of SAR (measured) = 12.9 W/kg

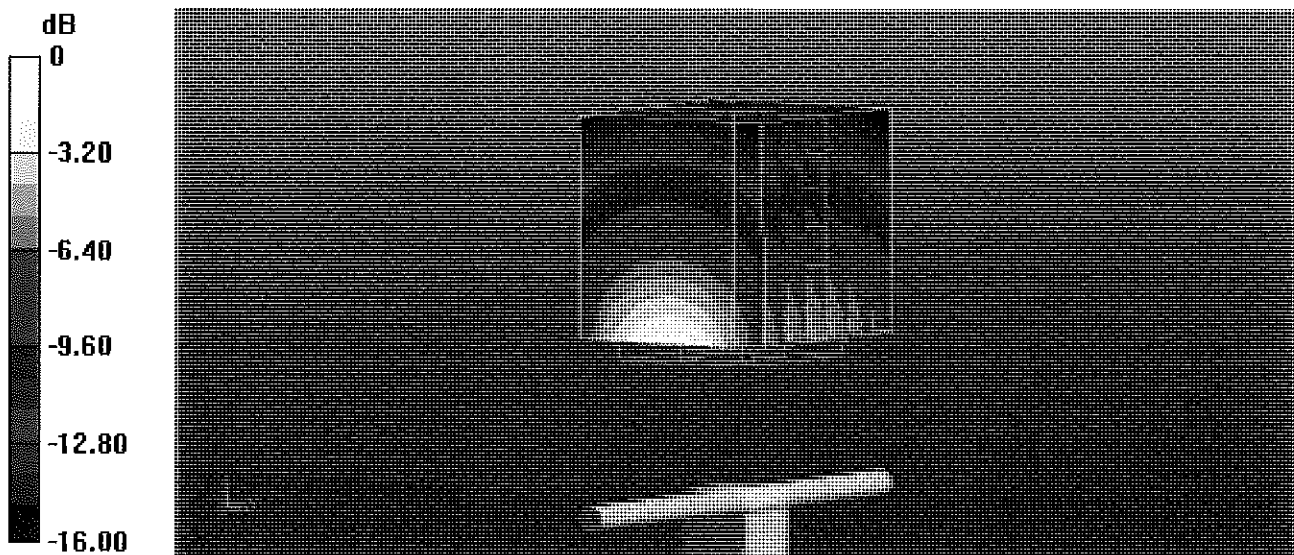

0 dB = 12.9 W/kg = 11.11 dBW/kg

# Impedance Measurement Plot for Body TSL

14 Jul 2015 09:20:09

CH1 S11 1 U FS 1: 47.723  $\omega$  6.1406  $\omega$  514.37 pF 1 900.000 000 MHz

\*  
De1

CΔ

Avg  
16

H1d

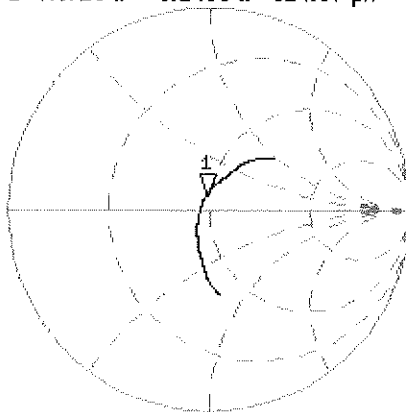

CH2 S11 LOG 5 dB/REF -20 dB 1:-23.490 dB 1 900.000 000 MHz

De1

CΔ

Avg  
16

H1d

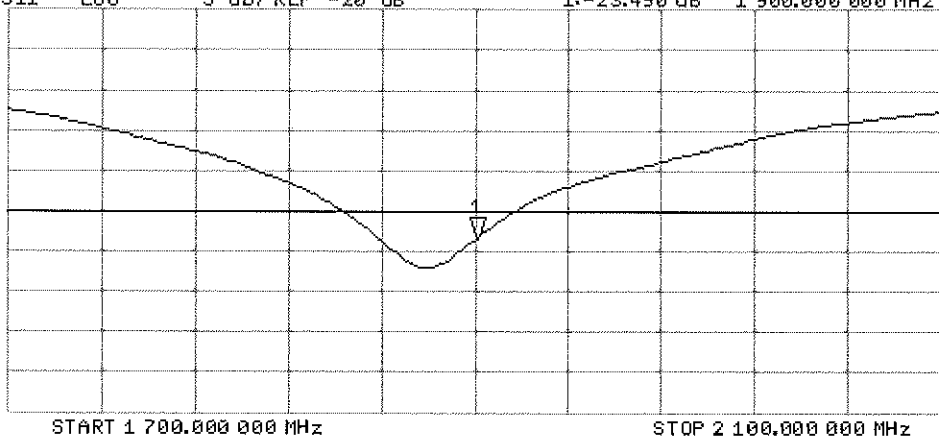



Accredited by the Swiss Accreditation Service (SAS)  
The Swiss Accreditation Service is one of the signatories to the EA  
Multilateral Agreement for the recognition of calibration certificates

Accreditation No.: **SCS 0108**

Client **PC Test**

Certificate No: **D2450V2-719\_Aug15**

## CALIBRATION CERTIFICATE

Object **D2450V2 - SN: 719**

Calibration procedure(s) **QA CAL-05.v9**  
**Calibration procedure for dipole validation kits above 700 MHz**

Calibration date: **August 20, 2015**

*BN ✓  
9/3/15*

This calibration certificate documents the traceability to national standards, which realize the physical units of measurements (SI).  
The measurements and the uncertainties with confidence probability are given on the following pages and are part of the certificate.

All calibrations have been conducted in the closed laboratory facility: environment temperature (22 ± 3)°C and humidity < 70%.

Calibration Equipment used (M&TE critical for calibration)

Primary Standards	ID #	Cal Date (Certificate No.)	Scheduled Calibration
Power meter EPM-442A	GB37480704	07-Oct-14 (No. 217-02020)	Oct-15
Power sensor HP 8481A	US37292783	07-Oct-14 (No. 217-02020)	Oct-15
Power sensor HP 8481A	MY41092317	07-Oct-14 (No. 217-02021)	Oct-15
Reference 20 dB Attenuator	SN: 5058 (20k)	01-Apr-15 (No. 217-02131)	Mar-16
Type-N mismatch combination	SN: 5047.2 / 06327	01-Apr-15 (No. 217-02134)	Mar-16
Reference Probe ES3DV3	SN: 3205	30-Dec-14 (No. ES3-3205_Dec14)	Dec-15
DAE4	SN: 601	17-Aug-15 (No. DAE4-601_Aug15)	Aug-16
Secondary Standards	ID #	Check Date (in house)	Scheduled Check
RF generator R&S SMT-06	100005	04-Aug-99 (in house check Oct-13)	In house check: Oct-16
Network Analyzer HP 8753E	US37390585 S4206	18-Oct-01 (in house check Oct-14)	In house check: Oct-15

Calibrated by: **Name** Michael Weber **Function** Laboratory Technician

**Signature**  
*M. Weber*

Approved by: **Name** Katja Pokovic **Function** Technical Manager

*[Signature]*

Issued: August 21, 2015

This calibration certificate shall not be reproduced except in full without written approval of the laboratory.



Accredited by the Swiss Accreditation Service (SAS)

The Swiss Accreditation Service is one of the signatories to the EA  
Multilateral Agreement for the recognition of calibration certificates

Accreditation No.: **SCS 0108**

### Glossary:

TSL	tissue simulating liquid
ConvF	sensitivity in TSL / NORM x,y,z
N/A	not applicable or not measured

### Calibration is Performed According to the Following Standards:

- IEEE Std 1528-2013, "IEEE Recommended Practice for Determining the Peak Spatial-Averaged Specific Absorption Rate (SAR) in the Human Head from Wireless Communications Devices: Measurement Techniques", June 2013
- IEC 62209-1, "Procedure to measure the Specific Absorption Rate (SAR) for hand-held devices used in close proximity to the ear (frequency range of 300 MHz to 3 GHz)", February 2005
- IEC 62209-2, "Procedure to determine the Specific Absorption Rate (SAR) for wireless communication devices used in close proximity to the human body (frequency range of 30 MHz to 6 GHz)", March 2010
- KDB 865664, "SAR Measurement Requirements for 100 MHz to 6 GHz"

### Additional Documentation:

- DASY4/5 System Handbook

### Methods Applied and Interpretation of Parameters:

- Measurement Conditions:** Further details are available from the Validation Report at the end of the certificate. All figures stated in the certificate are valid at the frequency indicated.
- Antenna Parameters with TSL:** The dipole is mounted with the spacer to position its feed point exactly below the center marking of the flat phantom section, with the arms oriented parallel to the body axis.
- Feed Point Impedance and Return Loss:** These parameters are measured with the dipole positioned under the liquid filled phantom. The impedance stated is transformed from the measurement at the SMA connector to the feed point. The Return Loss ensures low reflected power. No uncertainty required.
- Electrical Delay:** One-way delay between the SMA connector and the antenna feed point. No uncertainty required.
- SAR measured:** SAR measured at the stated antenna input power.
- SAR normalized:** SAR as measured, normalized to an input power of 1 W at the antenna connector.
- SAR for nominal TSL parameters:** The measured TSL parameters are used to calculate the nominal SAR result.

The reported uncertainty of measurement is stated as the standard uncertainty of measurement multiplied by the coverage factor  $k=2$ , which for a normal distribution corresponds to a coverage probability of approximately 95%.

## Measurement Conditions

DASY system configuration, as far as not given on page 1.

<b>DASY Version</b>	DASY5	V52.8.8
<b>Extrapolation</b>	Advanced Extrapolation	
<b>Phantom</b>	Modular Flat Phantom	
<b>Distance Dipole Center - TSL</b>	10 mm	with Spacer
<b>Zoom Scan Resolution</b>	dx, dy, dz = 5 mm	
<b>Frequency</b>	2450 MHz ± 1 MHz	

## Head TSL parameters

The following parameters and calculations were applied.

	Temperature	Permittivity	Conductivity
<b>Nominal Head TSL parameters</b>	22.0 °C	39.2	1.80 mho/m
<b>Measured Head TSL parameters</b>	(22.0 ± 0.2) °C	39.2 ± 6 %	1.87 mho/m ± 6 %
<b>Head TSL temperature change during test</b>	< 0.5 °C	----	----

## SAR result with Head TSL

<b>SAR averaged over 1 cm<sup>3</sup> (1 g) of Head TSL</b>	Condition	
SAR measured	250 mW input power	13.8 W/kg
SAR for nominal Head TSL parameters	normalized to 1W	<b>54.2 W/kg ± 17.0 % (k=2)</b>

<b>SAR averaged over 10 cm<sup>3</sup> (10 g) of Head TSL</b>	condition	
SAR measured	250 mW input power	6.48 W/kg
SAR for nominal Head TSL parameters	normalized to 1W	<b>25.7 W/kg ± 16.5 % (k=2)</b>

## Body TSL parameters

The following parameters and calculations were applied.

	Temperature	Permittivity	Conductivity
<b>Nominal Body TSL parameters</b>	22.0 °C	52.7	1.95 mho/m
<b>Measured Body TSL parameters</b>	(22.0 ± 0.2) °C	53.2 ± 6 %	2.00 mho/m ± 6 %
<b>Body TSL temperature change during test</b>	< 0.5 °C	----	----

## SAR result with Body TSL

<b>SAR averaged over 1 cm<sup>3</sup> (1 g) of Body TSL</b>	Condition	
SAR measured	250 mW input power	13.1 W/kg
SAR for nominal Body TSL parameters	normalized to 1W	<b>51.9 W/kg ± 17.0 % (k=2)</b>

<b>SAR averaged over 10 cm<sup>3</sup> (10 g) of Body TSL</b>	condition	
SAR measured	250 mW input power	6.11 W/kg
SAR for nominal Body TSL parameters	normalized to 1W	<b>24.3 W/kg ± 16.5 % (k=2)</b>

## Appendix (Additional assessments outside the scope of SCS 0108)

### Antenna Parameters with Head TSL

Impedance, transformed to feed point	54.5 $\Omega$ + 5.3 j $\Omega$
Return Loss	- 23.5 dB

### Antenna Parameters with Body TSL

Impedance, transformed to feed point	50.1 $\Omega$ + 6.5 j $\Omega$
Return Loss	- 23.7 dB

### General Antenna Parameters and Design

Electrical Delay (one direction)	1.149 ns
----------------------------------	----------

After long term use with 100W radiated power, only a slight warming of the dipole near the feedpoint can be measured.

The dipole is made of standard semirigid coaxial cable. The center conductor of the feeding line is directly connected to the second arm of the dipole. The antenna is therefore short-circuited for DC-signals. On some of the dipoles, small end caps are added to the dipole arms in order to improve matching when loaded according to the position as explained in the "Measurement Conditions" paragraph. The SAR data are not affected by this change. The overall dipole length is still according to the Standard.

No excessive force must be applied to the dipole arms, because they might bend or the soldered connections near the feedpoint may be damaged.

### Additional EUT Data

Manufactured by	SPEAG
Manufactured on	September 10, 2002

# DASY5 Validation Report for Head TSL

Date: 20.08.2015

Test Laboratory: SPEAG, Zurich, Switzerland

**DUT: Dipole 2450 MHz; Type: D2450V2; Serial: D2450V2 - SN: 719**

Communication System: UID 0 - CW; Frequency: 2450 MHz

Medium parameters used:  $f = 2450$  MHz;  $\sigma = 1.87$  S/m;  $\epsilon_r = 39.2$ ;  $\rho = 1000$  kg/m<sup>3</sup>

Phantom section: Flat Section

Measurement Standard: DASY5 (IEEE/IEC/ANSI C63.19-2011)

DASY52 Configuration:

- Probe: ES3DV3 - SN3205; ConvF(4.54, 4.54, 4.54); Calibrated: 30.12.2014;
- Sensor-Surface: 3mm (Mechanical Surface Detection)
- Electronics: DAE4 Sn601; Calibrated: 17.08.2015
- Phantom: Flat Phantom 5.0 (front); Type: QD000P50AA; Serial: 1001
- DASY52 52.8.8(1222); SEMCAD X 14.6.10(7331)

## Dipole Calibration for Head Tissue/Pin=250 mW, d=10mm/Zoom Scan (7x7x7)/Cube 0:

Measurement grid: dx=5mm, dy=5mm, dz=5mm

Reference Value = 102.2 V/m; Power Drift = -0.01 dB

Peak SAR (extrapolated) = 28.1 W/kg

**SAR(1 g) = 13.8 W/kg; SAR(10 g) = 6.48 W/kg**

Maximum value of SAR (measured) = 18.2 W/kg

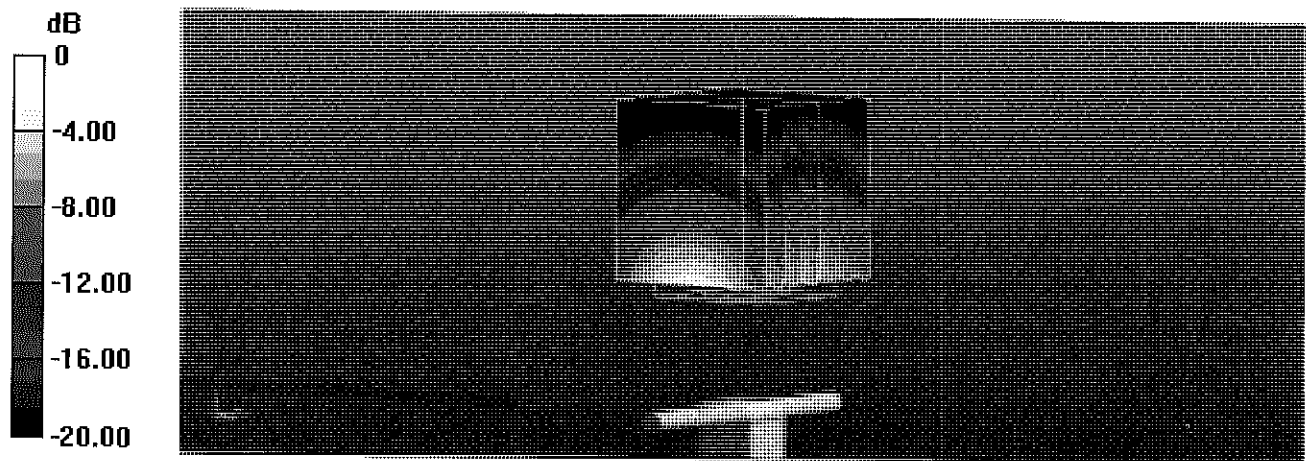

# Impedance Measurement Plot for Head TSL

CH1 S11 1 U FS 19 Aug 2015 12:34:37  
4: 54.510  $\Omega$  5.3223  $\Omega$  345.74 pF 2 450.000 000 MHz

\*  
De1  
CA  
Avg  
16  
H1d

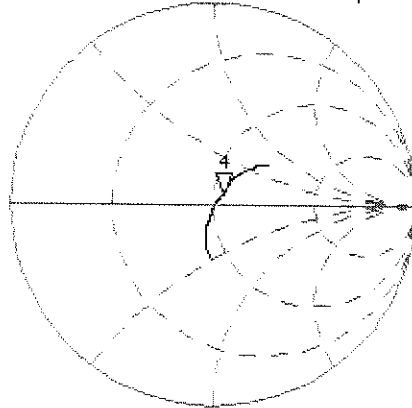

CH2 S11 LOG 5 dB/REF -20 dB 4: -23.517 dB 2 450.000 000 MHz

CA  
Avg  
16  
H1d

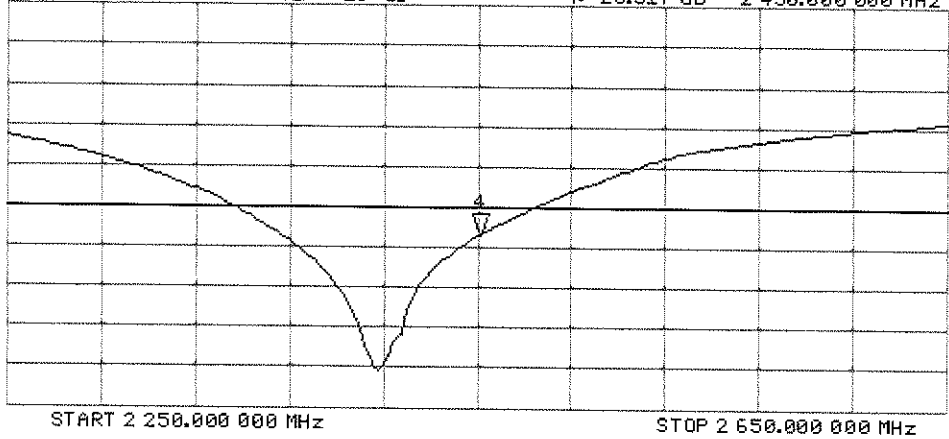

# DASY5 Validation Report for Body TSL

Date: 19.08.2015

Test Laboratory: SPEAG, Zurich, Switzerland

**DUT: Dipole 2450 MHz; Type: D2450V2; Serial: D2450V2 - SN: 719**

Communication System: UID 0 - CW; Frequency: 2450 MHz

Medium parameters used:  $f = 2450$  MHz;  $\sigma = 2$  S/m;  $\epsilon_r = 53.2$ ;  $\rho = 1000$  kg/m<sup>3</sup>

Phantom section: Flat Section

Measurement Standard: DASY5 (IEEE/IEC/ANSI C63.19-2011)

DASY52 Configuration:

- Probe: ES3DV3 - SN3205; ConvF(4.32, 4.32, 4.32); Calibrated: 30.12.2014;
- Sensor-Surface: 3mm (Mechanical Surface Detection)
- Electronics: DAE4 Sn601; Calibrated: 17.08.2015
- Phantom: Flat Phantom 5.0 (back); Type: QD000P50AA; Serial: 1002
- DASY52 52.8.8(1222); SEMCAD X 14.6.10(7331)

## Dipole Calibration for Body Tissue/Pin=250 mW, d=10mm/Zoom Scan (7x7x7)/Cube 0:

Measurement grid: dx=5mm, dy=5mm, dz=5mm

Reference Value = 95.73 V/m; Power Drift = 0.01 dB

Peak SAR (extrapolated) = 26.9 W/kg

**SAR(1 g) = 13.1 W/kg; SAR(10 g) = 6.11 W/kg**

Maximum value of SAR (measured) = 17.3 W/kg

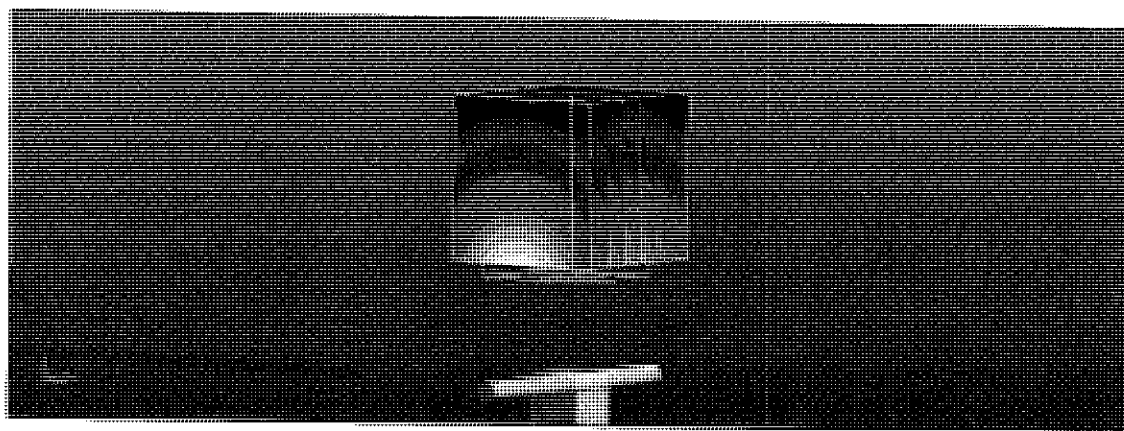
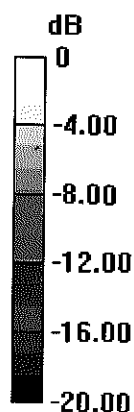

0 dB = 17.3 W/kg = 12.38 dBW/kg

# Impedance Measurement Plot for Body TSL

CH1 S11 1 U FS 19 Aug 2015 12:33:47  
4: 50.098  $\Omega$  6.5195  $\mu$  423.52 pF 2 450.000 000 MHz

\*  
De1  
C $\Delta$   
Avg  
16  
H1d

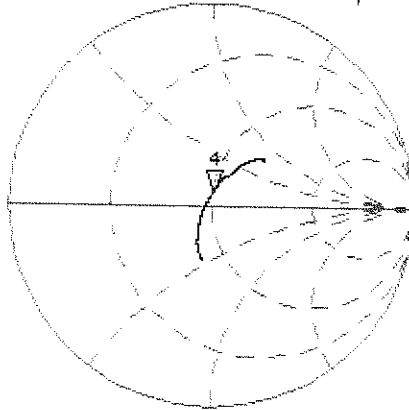

CH2 S11 LOG 5 dB/REF -20 dB 4: -23.742 dB 2 450.000 000 MHz

C $\Delta$   
Avg  
16  
H1d

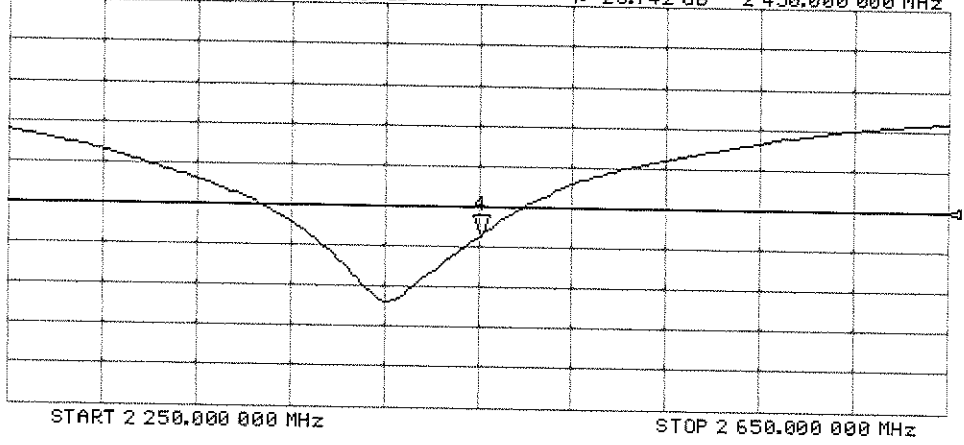



Accredited by the Swiss Accreditation Service (SAS)  
The Swiss Accreditation Service is one of the signatories to the EA  
Multilateral Agreement for the recognition of calibration certificates

Accreditation No.: **SCS 0108**

Client **PC Test**

Certificate No: **D2600V2-1004\_Apr15**

## CALIBRATION CERTIFICATE

Object **D2600V2 - SN: 1004**

Calibration procedure(s) **QA CAL-05.v9  
Calibration procedure for dipole validation kits above 700 MHz**

Calibration date: **April 14, 2015**

*PN ✓  
4/29/15*

This calibration certificate documents the traceability to national standards, which realize the physical units of measurements (SI).  
The measurements and the uncertainties with confidence probability are given on the following pages and are part of the certificate.

All calibrations have been conducted in the closed laboratory facility: environment temperature (22 ± 3)°C and humidity < 70%.

Calibration Equipment used (M&TE critical for calibration)

Primary Standards	ID #	Cal Date (Certificate No.)	Scheduled Calibration
Power meter EPM-442A	GB37480704	07-Oct-14 (No. 217-02020)	Oct-15
Power sensor HP 8481A	US37292783	07-Oct-14 (No. 217-02020)	Oct-15
Power sensor HP 8481A	MY41092317	07-Oct-14 (No. 217-02021)	Oct-15
Reference 20 dB Attenuator	SN: 5058 (20k)	01-Apr-15 (No. 217-02131)	Mar-16
Type-N mismatch combination	SN: 5047.2 / 06327	01-Apr-15 (No. 217-02134)	Mar-16
Reference Probe ES3DV3	SN: 3205	30-Dec-14 (No. ES3-3205_Dec14)	Dec-15
DAE4	SN: 601	18-Aug-14 (No. DAE4-601_Aug14)	Aug-15
Secondary Standards	ID #	Check Date (in house)	Scheduled Check
RF generator R&S SMT-06	100005	04-Aug-99 (in house check Oct-13)	In house check: Oct-16
Network Analyzer HP 8753E	US37390585 S4206	18-Oct-01 (in house check Oct-14)	In house check: Oct-15

Calibrated by: **Claudio Leubler**      Function: **Laboratory Technician**      Signature: *[Signature]*

Approved by: **Katja Pokovic**      Technical Manager      *[Signature]*

Issued: April 14, 2015

This calibration certificate shall not be reproduced except in full without written approval of the laboratory.



Accredited by the Swiss Accreditation Service (SAS)

The Swiss Accreditation Service is one of the signatories to the EA  
Multilateral Agreement for the recognition of calibration certificates

Accreditation No.: **SCS 0108**

### Glossary:

TSL	tissue simulating liquid
ConvF	sensitivity in TSL / NORM x,y,z
N/A	not applicable or not measured

### Calibration is Performed According to the Following Standards:

- IEEE Std 1528-2013, "IEEE Recommended Practice for Determining the Peak Spatial-Averaged Specific Absorption Rate (SAR) in the Human Head from Wireless Communications Devices: Measurement Techniques", June 2013
- IEC 62209-1, "Procedure to measure the Specific Absorption Rate (SAR) for hand-held devices used in close proximity to the ear (frequency range of 300 MHz to 3 GHz)", February 2005
- KDB 865664, "SAR Measurement Requirements for 100 MHz to 6 GHz"

### Additional Documentation:

- DASY4/5 System Handbook

### Methods Applied and Interpretation of Parameters:

- Measurement Conditions:** Further details are available from the Validation Report at the end of the certificate. All figures stated in the certificate are valid at the frequency indicated.
- Antenna Parameters with TSL:** The dipole is mounted with the spacer to position its feed point exactly below the center marking of the flat phantom section, with the arms oriented parallel to the body axis.
- Feed Point Impedance and Return Loss:** These parameters are measured with the dipole positioned under the liquid filled phantom. The impedance stated is transformed from the measurement at the SMA connector to the feed point. The Return Loss ensures low reflected power. No uncertainty required.
- Electrical Delay:** One-way delay between the SMA connector and the antenna feed point. No uncertainty required.
- SAR measured:** SAR measured at the stated antenna input power.
- SAR normalized:** SAR as measured, normalized to an input power of 1 W at the antenna connector.
- SAR for nominal TSL parameters:** The measured TSL parameters are used to calculate the nominal SAR result.

The reported uncertainty of measurement is stated as the standard uncertainty of measurement multiplied by the coverage factor  $k=2$ , which for a normal distribution corresponds to a coverage probability of approximately 95%.

## Measurement Conditions

DASY system configuration, as far as not given on page 1.

<b>DASY Version</b>	DASY5	V52.8.8
<b>Extrapolation</b>	Advanced Extrapolation	
<b>Phantom</b>	Modular Flat Phantom	
<b>Distance Dipole Center - TSL</b>	10 mm	with Spacer
<b>Zoom Scan Resolution</b>	dx, dy, dz = 5 mm	
<b>Frequency</b>	2600 MHz ± 1 MHz	

## Head TSL parameters

The following parameters and calculations were applied.

	Temperature	Permittivity	Conductivity
<b>Nominal Head TSL parameters</b>	22.0 °C	39.0	1.96 mho/m
<b>Measured Head TSL parameters</b>	(22.0 ± 0.2) °C	37.1 ± 6 %	1.99 mho/m ± 6 %
<b>Head TSL temperature change during test</b>	< 0.5 °C	----	----

## SAR result with Head TSL

<b>SAR averaged over 1 cm<sup>3</sup> (1 g) of Head TSL</b>	Condition	
SAR measured	250 mW input power	14.2 W/kg
SAR for nominal Head TSL parameters	normalized to 1W	<b>55.8 W/kg ± 17.0 % (k=2)</b>

<b>SAR averaged over 10 cm<sup>3</sup> (10 g) of Head TSL</b>	condition	
SAR measured	250 mW input power	6.37 W/kg
SAR for nominal Head TSL parameters	normalized to 1W	<b>25.2 W/kg ± 16.5 % (k=2)</b>

## Body TSL parameters

The following parameters and calculations were applied.

	Temperature	Permittivity	Conductivity
<b>Nominal Body TSL parameters</b>	22.0 °C	52.5	2.16 mho/m
<b>Measured Body TSL parameters</b>	(22.0 ± 0.2) °C	50.2 ± 6 %	2.20 mho/m ± 6 %
<b>Body TSL temperature change during test</b>	< 0.5 °C	----	----

## SAR result with Body TSL

<b>SAR averaged over 1 cm<sup>3</sup> (1 g) of Body TSL</b>	Condition	
SAR measured	250 mW input power	14.3 W/kg
SAR for nominal Body TSL parameters	normalized to 1W	<b>56.2 W/kg ± 17.0 % (k=2)</b>

<b>SAR averaged over 10 cm<sup>3</sup> (10 g) of Body TSL</b>	condition	
SAR measured	250 mW input power	6.39 W/kg
SAR for nominal Body TSL parameters	normalized to 1W	<b>25.3 W/kg ± 16.5 % (k=2)</b>

## Appendix (Additional assessments outside the scope of SCS 0108)

### Antenna Parameters with Head TSL

Impedance, transformed to feed point	49.6 $\Omega$ - 4.7 j $\Omega$
Return Loss	- 26.5 dB

### Antenna Parameters with Body TSL

Impedance, transformed to feed point	46.5 $\Omega$ - 3.6 j $\Omega$
Return Loss	- 25.6 dB

### General Antenna Parameters and Design

Electrical Delay (one direction)	1.150 ns
----------------------------------	----------

After long term use with 100W radiated power, only a slight warming of the dipole near the feedpoint can be measured.

The dipole is made of standard semirigid coaxial cable. The center conductor of the feeding line is directly connected to the second arm of the dipole. The antenna is therefore short-circuited for DC-signals. On some of the dipoles, small end caps are added to the dipole arms in order to improve matching when loaded according to the position as explained in the "Measurement Conditions" paragraph. The SAR data are not affected by this change. The overall dipole length is still according to the Standard.

No excessive force must be applied to the dipole arms, because they might bend or the soldered connections near the feedpoint may be damaged.

### Additional EUT Data

Manufactured by	SPEAG
Manufactured on	December 23, 2006

## DASY5 Validation Report for Head TSL

Date: 14.04.2015

Test Laboratory: SPEAG, Zurich, Switzerland

**DUT: Dipole 2600 MHz; Type: D2600V2; Serial: D2600V2 - SN: 1004**

Communication System: UID 0 - CW; Frequency: 2600 MHz

Medium parameters used:  $f = 2600$  MHz;  $\sigma = 1.99$  S/m;  $\epsilon_r = 37.1$ ;  $\rho = 1000$  kg/m<sup>3</sup>

Phantom section: Flat Section

Measurement Standard: DASY5 (IEEE/IEC/ANSI C63.19-2011)

DASY52 Configuration:

- Probe: ES3DV3 - SN3205; ConvF(4.49, 4.49, 4.49); Calibrated: 30.12.2014;
- Sensor-Surface: 3mm (Mechanical Surface Detection)
- Electronics: DAE4 Sn601; Calibrated: 18.08.2014
- Phantom: Flat Phantom 5.0 (front); Type: QD000P50AA; Serial: 1001
- DASY52 52.8.8(1222); SEMCAD X 14.6.10(7331)

### Dipole Calibration for Head/Pin=250 mW, d=10mm/Zoom Scan (7x7x7)/Cube 0:

Measurement grid: dx=5mm, dy=5mm, dz=5mm

Reference Value = 99.70 V/m; Power Drift = 0.06 dB

Peak SAR (extrapolated) = 29.8 W/kg

**SAR(1 g) = 14.2 W/kg; SAR(10 g) = 6.37 W/kg**

Maximum value of SAR (measured) = 17.9 W/kg

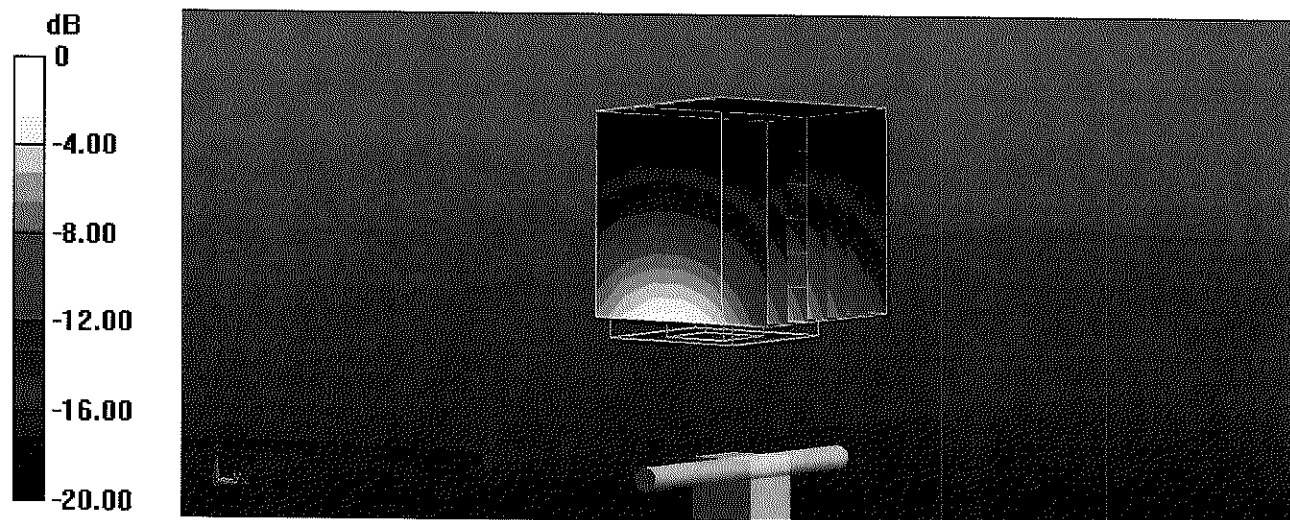

0 dB = 17.9 W/kg = 12.53 dBW/kg

# Impedance Measurement Plot for Head TSL

CH1 S11 1 U FS 14 Apr 2015 14:35:37  
 1: 49.578  $\Omega$  -4.7090  $\Omega$  12.999 pF 2 500.000 000 MHz

\*  
 De1  
 CA  
 Avg  
 16  
 H1d

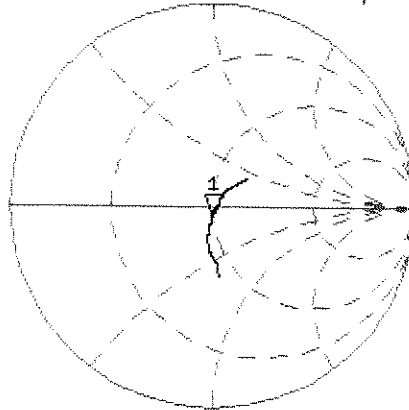

CH2 S11 LOG 5 dB/REF -20 dB 1:-26.482 dB 2 500.000 000 MHz

CA  
 Avg  
 16  
 H1d

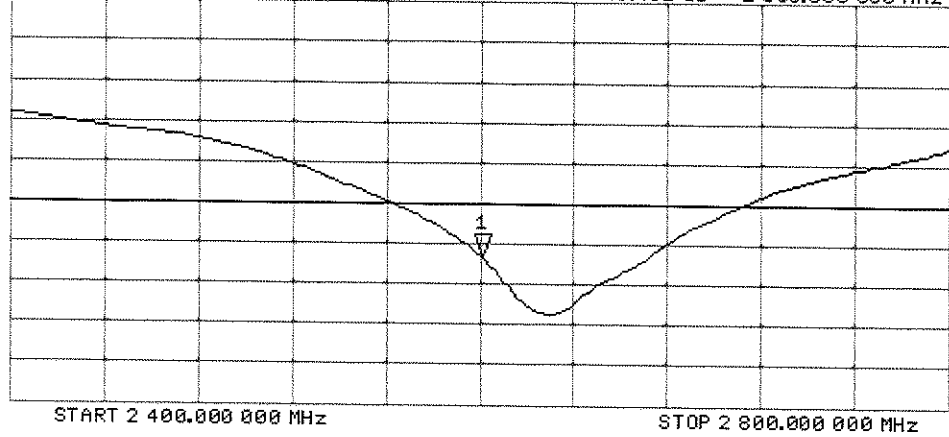

# DASY5 Validation Report for Body TSL

Date: 14.04.2015

Test Laboratory: SPEAG, Zurich, Switzerland

**DUT: Dipole 2600 MHz; Type: D2600V2; Serial: D2600V2 - SN: 1004**

Communication System: UID 0 - CW; Frequency: 2600 MHz

Medium parameters used:  $f = 2600$  MHz;  $\sigma = 2.2$  S/m;  $\epsilon_r = 50.2$ ;  $\rho = 1000$  kg/m<sup>3</sup>

Phantom section: Flat Section

Measurement Standard: DASY5 (IEEE/IEC/ANSI C63.19-2011)

DASY52 Configuration:

- Probe: ES3DV3 - SN3205; ConvF(4.13, 4.13, 4.13); Calibrated: 30.12.2014;
- Sensor-Surface: 3mm (Mechanical Surface Detection)
- Electronics: DAE4 Sn601; Calibrated: 18.08.2014
- Phantom: Flat Phantom 5.0 (back); Type: QD000P50AA; Serial: 1002
- DASY52 52.8.8(1222); SEMCAD X 14.6.10(7331)

## Dipole Calibration for Body/Pin=250 mW, d=10mm/Zoom Scan (7x7x7)/Cube 0:

Measurement grid: dx=5mm, dy=5mm, dz=5mm

Reference Value = 95.83 V/m; Power Drift = 0.06 dB

Peak SAR (extrapolated) = 29.6 W/kg

**SAR(1 g) = 14.3 W/kg; SAR(10 g) = 6.39 W/kg**

Maximum value of SAR (measured) = 18.3 W/kg

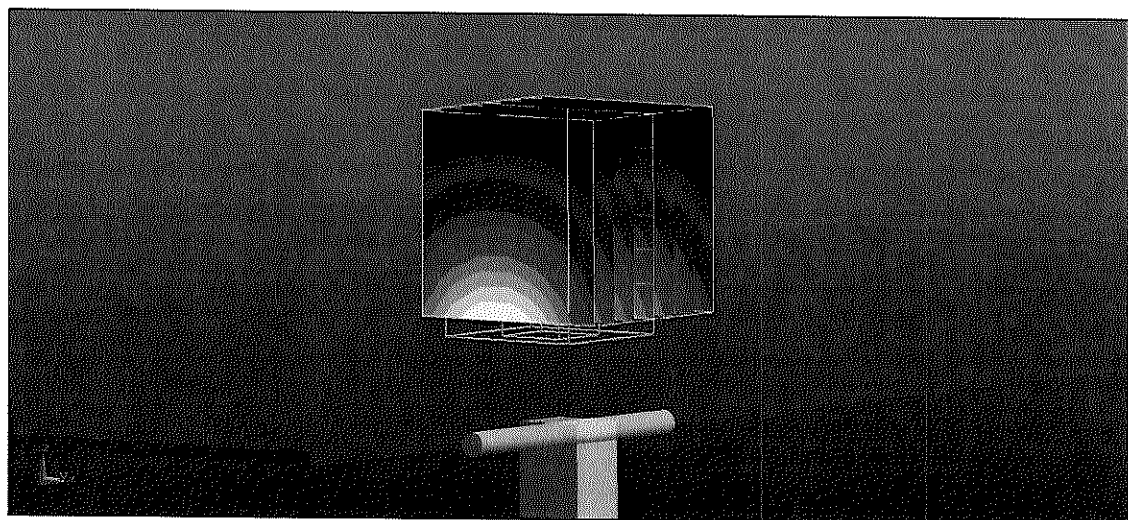
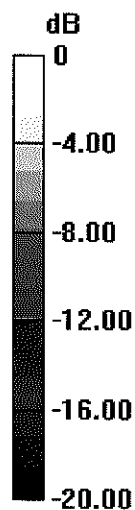

0 dB = 18.3 W/kg = 12.62 dBW/kg

# Impedance Measurement Plot for Body TSL

14 Apr 2015 14:34:51  
[CH1] S11 1 U FS 1: 46.463  $\Omega$  -3.6484  $\Omega$  16.778 pF 2 600.000 000 MHz

\*  
Del  
CA  
Avg  
16

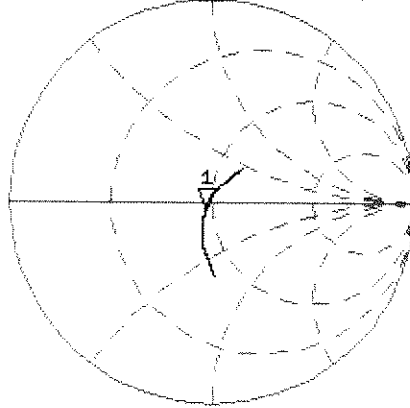

H1d

CH2 S11 LOG 5 dB/REF -20 dB 1:-25.570 dB 2 600.000 000 MHz

CA  
Avg  
16  
H1d

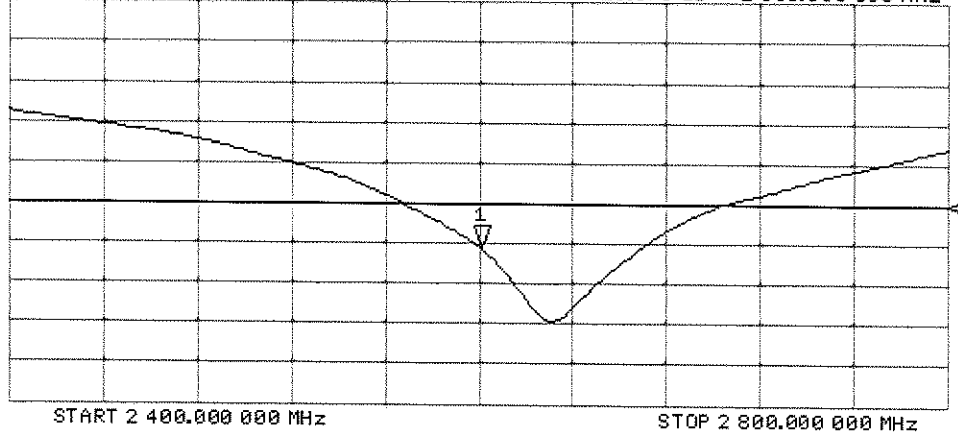



Accredited by the Swiss Accreditation Service (SAS)  
The Swiss Accreditation Service is one of the signatories to the EA  
Multilateral Agreement for the recognition of calibration certificates

Accreditation No.: **SCS 0108**

Client **PC Test**

Certificate No: **D835V2-4d119\_Apr15**

**CALIBRATION CERTIFICATE**

Object **D835V2 - SN:4d119**

Calibration procedure(s) **QA CAL-05.v9  
Calibration procedure for dipole validation kits above 700 MHz**

Calibration date: **April 13, 2015**

*RY ✓  
4/29/15*

This calibration certificate documents the traceability to national standards, which realize the physical units of measurements (SI).  
The measurements and the uncertainties with confidence probability are given on the following pages and are part of the certificate.

All calibrations have been conducted in the closed laboratory facility: environment temperature (22 ± 3)°C and humidity < 70%.

Calibration Equipment used (M&TE critical for calibration)

Primary Standards	ID #	Cal Date (Certificate No.)	Scheduled Calibration
Power meter EPM-442A	GB37480704	07-Oct-14 (No. 217-02020)	Oct-15
Power sensor HP 8481A	US37292783	07-Oct-14 (No. 217-02020)	Oct-15
Power sensor HP 8481A	MY41092317	07-Oct-14 (No. 217-02021)	Oct-15
Reference 20 dB Attenuator	SN: 5058 (20k)	01-Apr-15 (No. 217-02131)	Mar-16
Type-N mismatch combination	SN: 5047.2 / 06327	01-Apr-15 (No. 217-02134)	Mar-16
Reference Probe ES3DV3	SN: 3205	30-Dec-14 (No. ES3-3205_Dec14)	Dec-15
DAE4	SN: 601	18-Aug-14 (No. DAE4-601_Aug14)	Aug-15
Secondary Standards	ID #	Check Date (in house)	Scheduled Check
RF generator R&S SMT-06	100005	04-Aug-99 (in house check Oct-13)	In house check: Oct-16
Network Analyzer HP 8753E	US37390585 S4206	18-Oct-01 (in house check Oct-14)	In house check: Oct-15

Calibrated by: **Israe Elnaouq** (Name) **Laboratory Technician** (Function) *Israe Elnaouq* (Signature)

Approved by: **Katja Pokovic** (Name) **Technical Manager** (Function) *Katja Pokovic* (Signature)

Issued: April 13, 2015

This calibration certificate shall not be reproduced except in full without written approval of the laboratory.



Accredited by the Swiss Accreditation Service (SAS)  
The Swiss Accreditation Service is one of the signatories to the EA  
Multilateral Agreement for the recognition of calibration certificates

Accreditation No.: **SCS 0108**

**Glossary:**

TSL	tissue simulating liquid
ConvF	sensitivity in TSL / NORM x,y,z
N/A	not applicable or not measured

**Calibration is Performed According to the Following Standards:**

- a) IEEE Std 1528-2013, "IEEE Recommended Practice for Determining the Peak Spatial-Averaged Specific Absorption Rate (SAR) in the Human Head from Wireless Communications Devices: Measurement Techniques", June 2013
- b) IEC 62209-1, "Procedure to measure the Specific Absorption Rate (SAR) for hand-held devices used in close proximity to the ear (frequency range of 300 MHz to 3 GHz)", February 2005
- c) KDB 865664, "SAR Measurement Requirements for 100 MHz to 6 GHz"

**Additional Documentation:**

- d) DASY4/5 System Handbook

**Methods Applied and Interpretation of Parameters:**

- *Measurement Conditions:* Further details are available from the Validation Report at the end of the certificate. All figures stated in the certificate are valid at the frequency indicated.
- *Antenna Parameters with TSL:* The dipole is mounted with the spacer to position its feed point exactly below the center marking of the flat phantom section, with the arms oriented parallel to the body axis.
- *Feed Point Impedance and Return Loss:* These parameters are measured with the dipole positioned under the liquid filled phantom. The impedance stated is transformed from the measurement at the SMA connector to the feed point. The Return Loss ensures low reflected power. No uncertainty required.
- *Electrical Delay:* One-way delay between the SMA connector and the antenna feed point. No uncertainty required.
- *SAR measured:* SAR measured at the stated antenna input power.
- *SAR normalized:* SAR as measured, normalized to an input power of 1 W at the antenna connector.
- *SAR for nominal TSL parameters:* The measured TSL parameters are used to calculate the nominal SAR result.

The reported uncertainty of measurement is stated as the standard uncertainty of measurement multiplied by the coverage factor  $k=2$ , which for a normal distribution corresponds to a coverage probability of approximately 95%.

## Measurement Conditions

DASY system configuration, as far as not given on page 1.

DASY Version	DASY5	V52.8.8
Extrapolation	Advanced Extrapolation	
Phantom	Modular Flat Phantom	
Distance Dipole Center - TSL	15 mm	with Spacer
Zoom Scan Resolution	dx, dy, dz = 5 mm	
Frequency	835 MHz $\pm$ 1 MHz	

## Head TSL parameters

The following parameters and calculations were applied.

	Temperature	Permittivity	Conductivity
Nominal Head TSL parameters	22.0 °C	41.5	0.90 mho/m
Measured Head TSL parameters	(22.0 $\pm$ 0.2) °C	40.9 $\pm$ 6 %	0.94 mho/m $\pm$ 6 %
Head TSL temperature change during test	< 0.5 °C	----	----

## SAR result with Head TSL

SAR averaged over 1 cm <sup>3</sup> (1 g) of Head TSL	Condition	
SAR measured	250 mW input power	2.43 W/kg
SAR for nominal Head TSL parameters	normalized to 1W	<b>9.38 W/kg <math>\pm</math> 17.0 % (k=2)</b>

SAR averaged over 10 cm <sup>3</sup> (10 g) of Head TSL	condition	
SAR measured	250 mW input power	1.57 W/kg
SAR for nominal Head TSL parameters	normalized to 1W	<b>6.11 W/kg <math>\pm</math> 16.5 % (k=2)</b>

## Body TSL parameters

The following parameters and calculations were applied.

	Temperature	Permittivity	Conductivity
Nominal Body TSL parameters	22.0 °C	55.2	0.97 mho/m
Measured Body TSL parameters	(22.0 $\pm$ 0.2) °C	55.4 $\pm$ 6 %	1.01 mho/m $\pm$ 6 %
Body TSL temperature change during test	< 0.5 °C	----	----

## SAR result with Body TSL

SAR averaged over 1 cm <sup>3</sup> (1 g) of Body TSL	Condition	
SAR measured	250 mW input power	2.37 W/kg
SAR for nominal Body TSL parameters	normalized to 1W	<b>9.20 W/kg <math>\pm</math> 17.0 % (k=2)</b>

SAR averaged over 10 cm <sup>3</sup> (10 g) of Body TSL	condition	
SAR measured	250 mW input power	1.55 W/kg
SAR for nominal Body TSL parameters	normalized to 1W	<b>6.06 W/kg <math>\pm</math> 16.5 % (k=2)</b>

## Appendix (Additional assessments outside the scope of SCS 0108)

### Antenna Parameters with Head TSL

Impedance, transformed to feed point	50.2 $\Omega$ - 2.2 j $\Omega$
Return Loss	- 33.3 dB

### Antenna Parameters with Body TSL

Impedance, transformed to feed point	47.7 $\Omega$ - 4.9 j $\Omega$
Return Loss	- 25.1 dB

### General Antenna Parameters and Design

Electrical Delay (one direction)	1.386 ns
----------------------------------	----------

After long term use with 100W radiated power, only a slight warming of the dipole near the feedpoint can be measured.

The dipole is made of standard semirigid coaxial cable. The center conductor of the feeding line is directly connected to the second arm of the dipole. The antenna is therefore short-circuited for DC-signals. On some of the dipoles, small end caps are added to the dipole arms in order to improve matching when loaded according to the position as explained in the "Measurement Conditions" paragraph. The SAR data are not affected by this change. The overall dipole length is still according to the Standard.

No excessive force must be applied to the dipole arms, because they might bend or the soldered connections near the feedpoint may be damaged.

### Additional EUT Data

Manufactured by	SPEAG
Manufactured on	June 29, 2010

# DASY5 Validation Report for Head TSL

Date: 13.04.2015

Test Laboratory: SPEAG, Zurich, Switzerland

**DUT: Dipole 835 MHz; Type: D835V2; Serial: D835V2 - SN:4d119**

Communication System: UID 0 - CW; Frequency: 835 MHz

Medium parameters used:  $f = 835$  MHz;  $\sigma = 0.94$  S/m;  $\epsilon_r = 40.9$ ;  $\rho = 1000$  kg/m<sup>3</sup>

Phantom section: Flat Section

Measurement Standard: DASY5 (IEEE/IEC/ANSI C63.19-2011)

DASY52 Configuration:

- Probe: ES3DV3 - SN3205; ConvF(6.2, 6.2, 6.2); Calibrated: 30.12.2014;
- Sensor-Surface: 3mm (Mechanical Surface Detection)
- Electronics: DAE4 Sn601; Calibrated: 18.08.2014
- Phantom: Flat Phantom 4.9L; Type: QD000P49AA; Serial: 1001
- DASY52 52.8.8(1222); SEMCAD X 14.6.10(7331)

## Dipole Calibration for Head Tissue/Pin=250 mW, d=15mm/Zoom Scan (7x7x7)/Cube 0:

Measurement grid: dx=5mm, dy=5mm, dz=5mm

Reference Value = 56.77 V/m; Power Drift = 0.01 dB

Peak SAR (extrapolated) = 3.64 W/kg

**SAR(1 g) = 2.43 W/kg; SAR(10 g) = 1.57 W/kg**

Maximum value of SAR (measured) = 2.85 W/kg

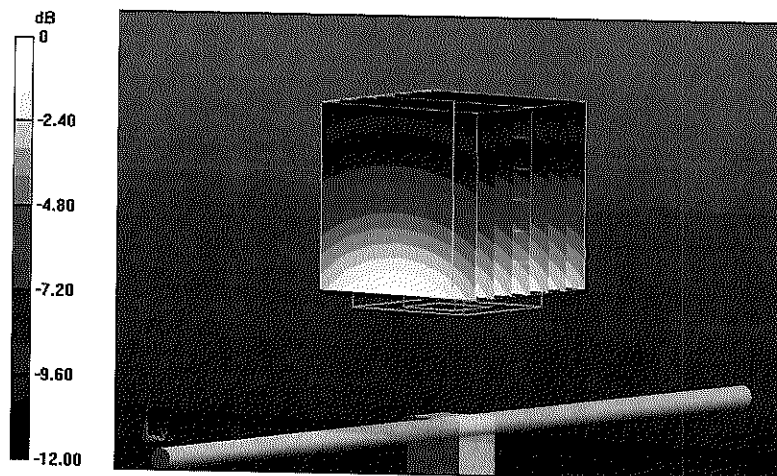

0 dB = 2.85 W/kg = 4.55 dBW/kg

# Impedance Measurement Plot for Head TSL

CH1 S11 1 U FS 13 Apr 2015 13:42:59  
 2: 50.213  $\Omega$  -2.1602  $\angle$  88.237  $\mu$ F 835.000 000 MHz

\*  
 De1  
 CA  
 Avg  
 16  
 H1d

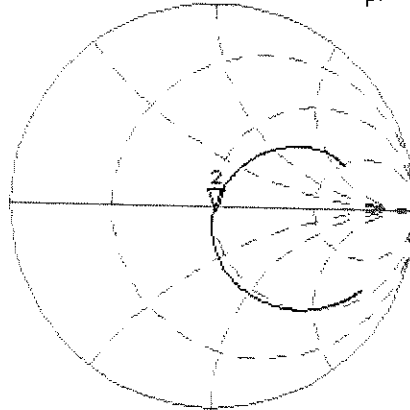

CH2 S11 LOG 5 dB/REF -20 dB 2: -33.275 dB 835.000 000 MHz

CA  
 Avg  
 16  
 H1d

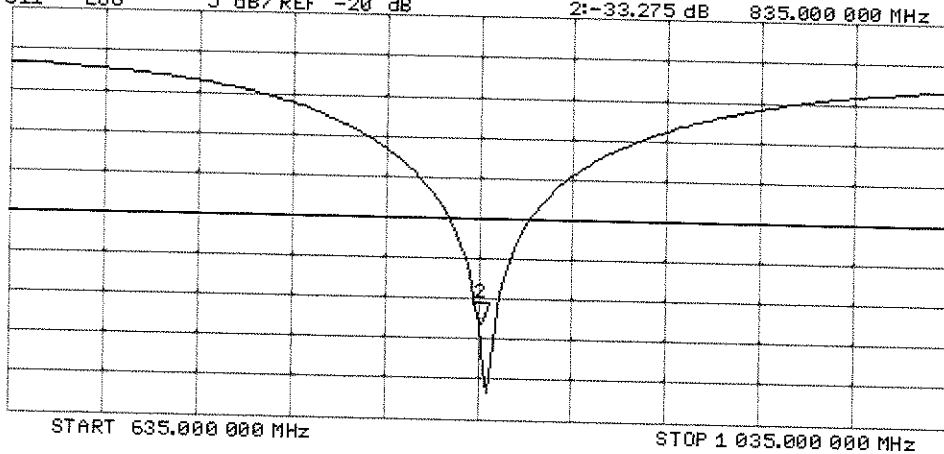

# DASY5 Validation Report for Body TSL

Date: 13.04.2015

Test Laboratory: SPEAG, Zurich, Switzerland

**DUT: Dipole 835 MHz; Type: D835V2; Serial: D835V2 - SN:4d119**

Communication System: UID 0 - CW; Frequency: 835 MHz

Medium parameters used:  $f = 835$  MHz;  $\sigma = 1.01$  S/m;  $\epsilon_r = 55.4$ ;  $\rho = 1000$  kg/m<sup>3</sup>

Phantom section: Flat Section

Measurement Standard: DASY5 (IEEE/IEC/ANSI C63.19-2011)

DASY52 Configuration:

- Probe: ES3DV3 - SN3205; ConvF(6.17, 6.17, 6.17); Calibrated: 30.12.2014;
- Sensor-Surface: 3mm (Mechanical Surface Detection)
- Electronics: DAE4 Sn601; Calibrated: 18.08.2014
- Phantom: Flat Phantom 4.9L; Type: QD000P49AA; Serial: 1001
- DASY52 52.8.8(1222); SEMCAD X 14.6.10(7331)

## Dipole Calibration for Body Tissue/Pin=250 mW, d=15mm/Zoom Scan (7x7x7)/Cube 0:

Measurement grid: dx=5mm, dy=5mm, dz=5mm

Reference Value = 54.44 V/m; Power Drift = -0.06 dB

Peak SAR (extrapolated) = 3.52 W/kg

**SAR(1 g) = 2.37 W/kg; SAR(10 g) = 1.55 W/kg**

Maximum value of SAR (measured) = 2.77 W/kg

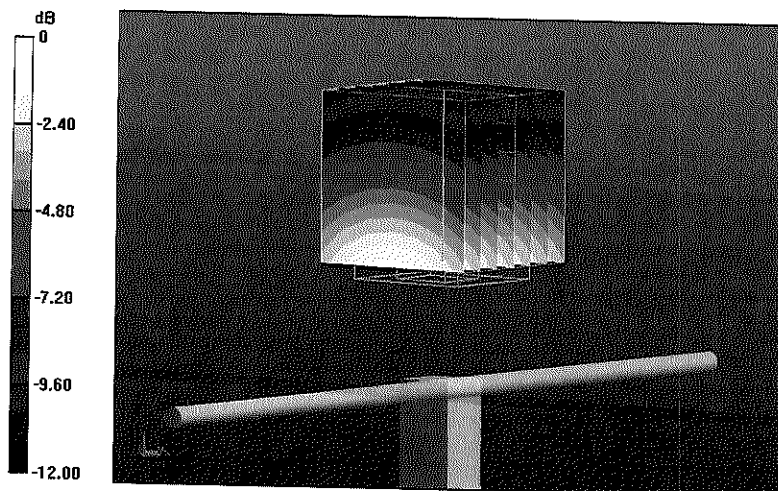

0 dB = 2.77 W/kg = 4.42 dBW/kg

# Impedance Measurement Plot for Body TSL

CH1 S11 1 U FS 13 Apr 2015 10:53:33  
 2: 47.658  $\Omega$  -4.9043  $\Omega$  38.865 pF 835.000 000 MHz

\*  
 Del  
 CA  
 Avg  
 16  
 H1 d

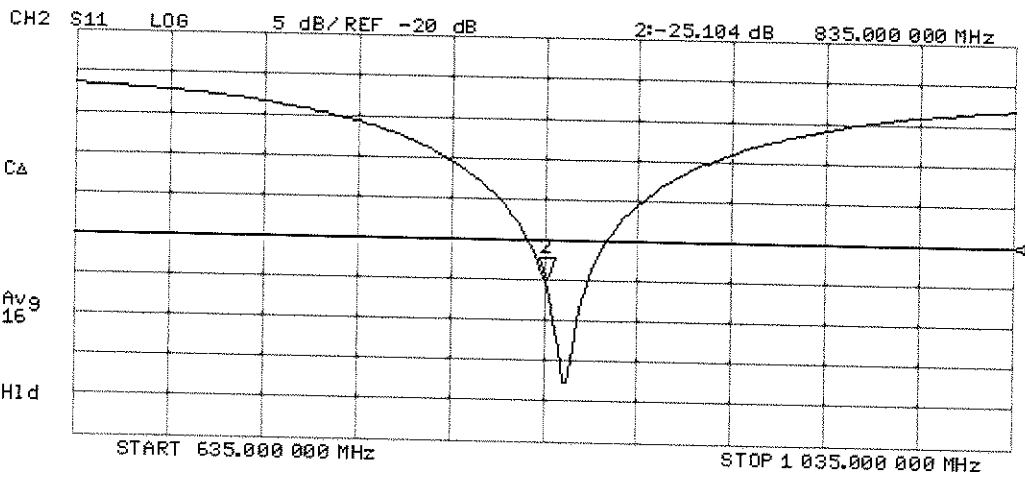
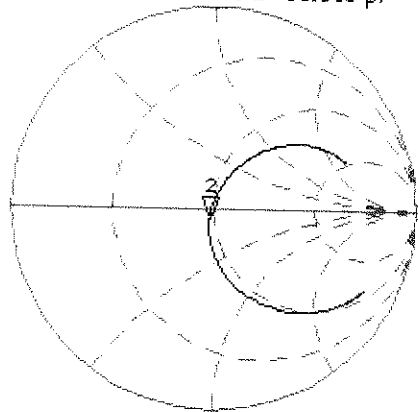

**Calibration Laboratory of  
Schmid & Partner  
Engineering AG**  
Zeughausstrasse 43, 8004 Zurich, Switzerland



**S** Schweizerischer Kalibrierdienst  
**C** Service suisse d'étalonnage  
**S** Servizio svizzero di taratura  
Swiss Calibration Service

Accredited by the Swiss Accreditation Service (SAS)  
The Swiss Accreditation Service is one of the signatories to the EA  
Multilateral Agreement for the recognition of calibration certificates

Accreditation No.: **SCS 0108**

Client **PC Test**

Certificate No: **ES3-3319\_Mar15**

## CALIBRATION CERTIFICATE

Object **ES3DV3 - SN:3319**

Calibration procedure(s) **QA CAL-01.v9, QA CAL-23.v5, QA CAL-25.v6  
Calibration procedure for dosimetric E-field probes**

Calibration date: **March 19, 2015**

*PM ✓  
3/26/15*

This calibration certificate documents the traceability to national standards, which realize the physical units of measurements (SI).  
The measurements and the uncertainties with confidence probability are given on the following pages and are part of the certificate.

All calibrations have been conducted in the closed laboratory facility: environment temperature (22 ± 3)°C and humidity < 70%.

Calibration Equipment used (M&TE critical for calibration)

Primary Standards	ID	Cal Date (Certificate No.)	Scheduled Calibration
Power meter E4419B	GB41293874	03-Apr-14 (No. 217-01911)	Apr-15
Power sensor E4412A	MY41498087	03-Apr-14 (No. 217-01911)	Apr-15
Reference 3 dB Attenuator	SN: S5054 (3c)	03-Apr-14 (No. 217-01915)	Apr-15
Reference 20 dB Attenuator	SN: S5277 (20x)	03-Apr-14 (No. 217-01919)	Apr-15
Reference 30 dB Attenuator	SN: S5129 (30b)	03-Apr-14 (No. 217-01920)	Apr-15
Reference Probe ES3DV2	SN: 3013	30-Dec-14 (No. ES3-3013_Dec14)	Dec-15
DAE4	SN: 660	14-Jan-15 (No. DAE4-660_Jan15)	Jan-16
Secondary Standards	ID	Check Date (in house)	Scheduled Check
RF generator HP 8648C	US3642U01700	4-Aug-99 (in house check Apr-13)	In house check: Apr-16
Network Analyzer HP 8753E	US37390585	18-Oct-01 (in house check Oct-14)	In house check: Oct-15

	Name	Function	Signature
Calibrated by:	Israe Elnaouq	Laboratory Technician	<i>Israe Elnaouq</i>
Approved by:	Katja Pokovic	Technical Manager	<i>Katja Pokovic</i>
			Issued: March 19, 2015
This calibration certificate shall not be reproduced except in full without written approval of the laboratory.			



Accredited by the Swiss Accreditation Service (SAS)

Accreditation No.: **SCS 0108**

The Swiss Accreditation Service is one of the signatories to the EA  
Multilateral Agreement for the recognition of calibration certificates

**Glossary:**

TSL	tissue simulating liquid
NORM <sub>x,y,z</sub>	sensitivity in free space
ConvF	sensitivity in TSL / NORM <sub>x,y,z</sub>
DCP	diode compression point
CF	crest factor (1/duty_cycle) of the RF signal
A, B, C, D	modulation dependent linearization parameters
Polarization $\varphi$	$\varphi$ rotation around probe axis
Polarization $\vartheta$	$\vartheta$ rotation around an axis that is in the plane normal to probe axis (at measurement center), i.e., $\vartheta = 0$ is normal to probe axis
Connector Angle	information used in DASY system to align probe sensor X to the robot coordinate system

**Calibration is Performed According to the Following Standards:**

- a) IEEE Std 1528-2013, "IEEE Recommended Practice for Determining the Peak Spatial-Averaged Specific Absorption Rate (SAR) in the Human Head from Wireless Communications Devices: Measurement Techniques", June 2013
- b) IEC 62209-1, "Procedure to measure the Specific Absorption Rate (SAR) for hand-held devices used in close proximity to the ear (frequency range of 300 MHz to 3 GHz)", February 2005

**Methods Applied and Interpretation of Parameters:**

- *NORM<sub>x,y,z</sub>*: Assessed for E-field polarization  $\vartheta = 0$  ( $f \leq 900$  MHz in TEM-cell;  $f > 1800$  MHz: R22 waveguide). *NORM<sub>x,y,z</sub>* are only intermediate values, i.e., the uncertainties of *NORM<sub>x,y,z</sub>* does not affect the  $E^2$ -field uncertainty inside TSL (see below *ConvF*).
- *NORM(f)<sub>x,y,z</sub>* = *NORM<sub>x,y,z</sub>* \* *frequency\_response* (see Frequency Response Chart). This linearization is implemented in DASY4 software versions later than 4.2. The uncertainty of the frequency response is included in the stated uncertainty of *ConvF*.
- *DCP<sub>x,y,z</sub>*: DCP are numerical linearization parameters assessed based on the data of power sweep with CW signal (no uncertainty required). DCP does not depend on frequency nor media.
- *PAR*: PAR is the Peak to Average Ratio that is not calibrated but determined based on the signal characteristics
- *A<sub>x,y,z</sub>*; *B<sub>x,y,z</sub>*; *C<sub>x,y,z</sub>*; *D<sub>x,y,z</sub>*; *VR<sub>x,y,z</sub>*: *A, B, C, D* are numerical linearization parameters assessed based on the data of power sweep for specific modulation signal. The parameters do not depend on frequency nor media. *VR* is the maximum calibration range expressed in RMS voltage across the diode.
- *ConvF and Boundary Effect Parameters*: Assessed in flat phantom using E-field (or Temperature Transfer Standard for  $f \leq 800$  MHz) and inside waveguide using analytical field distributions based on power measurements for  $f > 800$  MHz. The same setups are used for assessment of the parameters applied for boundary compensation (alpha, depth) of which typical uncertainty values are given. These parameters are used in DASY4 software to improve probe accuracy close to the boundary. The sensitivity in TSL corresponds to *NORM<sub>x,y,z</sub>* \* *ConvF* whereby the uncertainty corresponds to that given for *ConvF*. A frequency dependent *ConvF* is used in DASY version 4.4 and higher which allows extending the validity from  $\pm 50$  MHz to  $\pm 100$  MHz.
- *Spherical isotropy (3D deviation from isotropy)*: in a field of low gradients realized using a flat phantom exposed by a patch antenna.
- *Sensor Offset*: The sensor offset corresponds to the offset of virtual measurement center from the probe tip (on probe axis). No tolerance required.
- *Connector Angle*: The angle is assessed using the information gained by determining the *NORM<sub>x</sub>* (no uncertainty required).

# Probe ES3DV3

## SN:3319

Manufactured: January 10, 2012  
Calibrated: March 19, 2015

Calibrated for DASY/EASY Systems  
(Note: non-compatible with DASY2 system!)

## DASY/EASY - Parameters of Probe: ES3DV3 - SN:3319

### Basic Calibration Parameters

	Sensor X	Sensor Y	Sensor Z	Unc (k=2)
Norm ( $\mu V/(V/m)^2$ ) <sup>A</sup>	1.12	1.08	1.15	$\pm 10.1\%$
DCP (mV) <sup>B</sup>	104.4	106.0	104.4	

### Modulation Calibration Parameters

UID	Communication System Name		A dB	B dB $\sqrt{\mu V}$	C	D dB	VR mV	Unc <sup>E</sup> (k=2)
0	CW	X	0.0	0.0	1.0	0.00	176.1	$\pm 3.3\%$
		Y	0.0	0.0	1.0		192.7	
		Z	0.0	0.0	1.0		174.6	
10010-CAA	SAR Validation (Square, 100ms, 10ms)	X	3.26	64.8	13.4	10.00	41.7	$\pm 1.9\%$
		Y	2.66	62.2	11.7		39.5	
		Z	3.51	64.8	13.2		42.1	
10011-CAB	UMTS-FDD (WCDMA)	X	3.47	68.1	19.1	2.91	142.9	$\pm 0.5\%$
		Y	3.37	67.9	19.1		133.0	
		Z	3.57	68.7	19.4		138.6	
10012-CAB	IEEE 802.11b WiFi 2.4 GHz (DSSS, 1 Mbps)	X	3.48	71.8	20.2	1.87	143.9	$\pm 0.7\%$
		Y	3.23	70.9	19.9		134.6	
		Z	3.68	72.8	20.6		140.5	
10013-CAB	IEEE 802.11g WiFi 2.4 GHz (DSSS-OFDM, 6 Mbps)	X	11.18	70.5	23.1	9.46	143.4	$\pm 3.3\%$
		Y	10.98	70.5	23.2		129.9	
		Z	11.19	70.6	23.1		138.8	
10021-DAB	GSM-FDD (TDMA, GMSK)	X	15.55	92.7	26.1	9.39	126.5	$\pm 1.7\%$
		Y	21.21	98.0	27.2		142.0	
		Z	19.50	96.1	27.0		125.4	
10023-DAB	GPRS-FDD (TDMA, GMSK, TN 0)	X	23.54	100.0	28.4	9.57	142.6	$\pm 2.2\%$
		Y	23.24	99.9	28.0		137.4	
		Z	23.57	99.6	28.2		139.7	
10024-DAB	GPRS-FDD (TDMA, GMSK, TN 0-1)	X	17.00	90.2	22.7	6.56	128.9	$\pm 2.2\%$
		Y	35.20	99.7	24.9		148.2	
		Z	33.12	99.6	25.4		123.8	
10027-DAB	GPRS-FDD (TDMA, GMSK, TN 0-1-2)	X	44.20	99.6	23.6	4.80	146.0	$\pm 1.9\%$
		Y	49.99	99.9	23.0		136.6	
		Z	41.43	99.6	23.9		141.4	
10028-DAB	GPRS-FDD (TDMA, GMSK, TN 0-1-2-3)	X	46.56	99.7	22.7	3.55	127.7	$\pm 2.2\%$
		Y	58.11	99.8	21.9		145.3	
		Z	55.65	99.6	22.2		124.3	
10032-CAA	IEEE 802.15.1 Bluetooth (GFSK, DH5)	X	34.25	99.4	21.1	1.16	140.3	$\pm 1.7\%$
		Y	40.72	100.0	20.6		135.7	
		Z	45.39	100.0	20.8		136.4	
10100-CAB	LTE-FDD (SC-FDMA, 100% RB, 20 MHz, QPSK)	X	6.30	67.1	19.5	5.67	127.4	$\pm 1.4\%$
		Y	6.58	68.4	20.3		149.0	
		Z	6.55	68.0	19.9		146.3	

10103-CAB	LTE-TDD (SC-FDMA, 100% RB, 20 MHz, QPSK)	X	10.47	75.6	25.8	9.29	146.6	±3.0 %
		Y	10.18	75.8	26.3		136.2	
		Z	10.38	75.3	25.6		140.8	
10108-CAC	LTE-FDD (SC-FDMA, 100% RB, 10 MHz, QPSK)	X	6.18	66.6	19.4	5.80	126.9	±1.4 %
		Y	6.40	67.8	20.1		147.0	
		Z	6.44	67.6	19.9		145.7	
10117-CAB	IEEE 802.11n (HT Mixed, 13.5 Mbps, BPSK)	X	10.24	69.0	21.3	8.07	142.7	±2.5 %
		Y	10.25	69.2	21.5		136.7	
		Z	10.16	68.8	21.2		136.6	
10151-CAB	LTE-TDD (SC-FDMA, 50% RB, 20 MHz, QPSK)	X	9.85	74.8	25.6	9.28	140.8	±3.0 %
		Y	9.49	74.7	25.9		130.5	
		Z	9.90	74.8	25.6		136.8	
10154-CAC	LTE-FDD (SC-FDMA, 50% RB, 10 MHz, QPSK)	X	6.13	67.1	19.7	5.75	146.6	±1.4 %
		Y	6.11	67.4	19.9		147.7	
		Z	6.12	67.1	19.7		142.3	
10160-CAB	LTE-FDD (SC-FDMA, 50% RB, 15 MHz, QPSK)	X	6.33	66.7	19.4	5.82	128.9	±1.4 %
		Y	6.33	67.1	19.7		128.7	
		Z	6.57	67.6	19.9		147.4	
10169-CAB	LTE-FDD (SC-FDMA, 1 RB, 20 MHz, QPSK)	X	4.89	66.4	19.5	5.73	127.5	±1.2 %
		Y	4.99	67.5	20.2		149.3	
		Z	5.09	67.3	20.0		145.1	
10172-CAB	LTE-TDD (SC-FDMA, 1 RB, 20 MHz, QPSK)	X	7.99	75.8	26.3	9.21	127.6	±2.7 %
		Y	9.29	81.7	29.6		149.8	
		Z	8.04	75.8	26.3		123.6	
10175-CAC	LTE-FDD (SC-FDMA, 1 RB, 10 MHz, QPSK)	X	5.08	67.3	20.0	5.72	149.3	±1.4 %
		Y	5.00	67.6	20.3		145.0	
		Z	5.09	67.3	20.0		145.0	
10181-CAB	LTE-FDD (SC-FDMA, 1 RB, 15 MHz, QPSK)	X	5.08	67.3	20.0	5.72	148.5	±1.4 %
		Y	5.06	67.9	20.4		147.1	
		Z	5.11	67.4	20.0		144.8	
10196-CAB	IEEE 802.11n (HT Mixed, 6.5 Mbps, BPSK)	X	9.89	68.7	21.2	8.10	134.6	±2.2 %
		Y	9.84	68.9	21.4		130.4	
		Z	9.82	68.5	21.1		130.4	
10225-CAB	UMTS-FDD (HSPA+)	X	7.02	67.1	19.5	5.97	138.0	±1.4 %
		Y	6.88	67.0	19.5		133.2	
		Z	7.01	67.1	19.5		134.6	
10237-CAB	LTE-TDD (SC-FDMA, 1 RB, 10 MHz, QPSK)	X	8.01	75.9	26.4	9.21	128.0	±2.7 %
		Y	9.39	82.1	29.9		149.7	
		Z	8.34	76.9	26.9		129.1	
10252-CAB	LTE-TDD (SC-FDMA, 50% RB, 10 MHz, QPSK)	X	9.05	73.6	25.1	9.24	130.6	±3.0 %
		Y	8.76	73.7	25.5		123.6	
		Z	9.10	73.6	25.1		127.8	
10267-CAB	LTE-TDD (SC-FDMA, 100% RB, 10 MHz, QPSK)	X	9.81	74.7	25.6	9.30	139.3	±3.0 %
		Y	9.50	74.8	25.9		130.7	
		Z	9.81	74.6	25.5		135.0	

10275-CAB	UMTS-FDD (HSUPA, Subtest 5, 3GPP Rel8.4)	X	4.49	67.1	18.9	3.96	140.1	±0.7 %
		Y	4.46	67.2	19.0		137.6	
		Z	4.52	67.1	18.9		137.1	
10291-AAB	CDMA2000, RC3, SO55, Full Rate	X	3.68	67.0	18.8	3.46	129.3	±0.7 %
		Y	3.64	67.3	19.0		130.3	
		Z	3.84	67.9	19.2		148.6	
10292-AAB	CDMA2000, RC3, SO32, Full Rate	X	3.64	67.2	18.8	3.39	131.8	±0.5 %
		Y	3.60	67.4	19.1		128.2	
		Z	3.71	67.5	19.0		128.0	
10297-AAA	LTE-FDD (SC-FDMA, 50% RB, 20 MHz, QPSK)	X	6.43	67.5	19.9	5.81	147.2	±1.7 %
		Y	6.39	67.7	20.0		145.4	
		Z	6.42	67.5	19.8		143.2	
10311-AAA	LTE-FDD (SC-FDMA, 100% RB, 15 MHz, QPSK)	X	6.73	67.1	19.7	6.06	129.7	±1.4 %
		Y	6.75	67.5	19.9		130.8	
		Z	6.75	67.3	19.7		126.2	
10400-AAB	IEEE 802.11ac WiFi (20MHz, 64-QAM, 99pc duty cycle)	X	10.14	68.9	21.5	8.37	136.7	±2.5 %
		Y	10.23	69.5	22.0		136.5	
		Z	10.13	68.9	21.5		132.8	
10403-AAB	CDMA2000 (1xEV-DO, Rev. 0)	X	4.97	69.2	19.3	3.76	143.5	±0.5 %
		Y	4.87	69.3	19.4		141.0	
		Z	5.02	69.2	19.3		139.6	
10404-AAB	CDMA2000 (1xEV-DO, Rev. A)	X	4.91	69.3	19.4	3.77	139.8	±0.7 %
		Y	4.67	68.9	19.1		138.9	
		Z	4.89	69.1	19.3		137.1	
10415-AAA	IEEE 802.11b WiFi 2.4 GHz (DSSS, 1 Mbps, 99pc duty cycle)	X	2.93	70.1	19.6	1.54	137.8	±0.7 %
		Y	2.84	69.8	19.6		138.2	
		Z	3.04	70.8	19.9		134.2	
10416-AAA	IEEE 802.11g WiFi 2.4 GHz (ERP-OFDM, 6 Mbps, 99pc duty cycle)	X	9.94	68.7	21.3	8.23	134.6	±2.2 %
		Y	10.00	69.1	21.7		134.1	
		Z	9.89	68.5	21.2		130.1	

The reported uncertainty of measurement is stated as the standard uncertainty of measurement multiplied by the coverage factor  $k=2$ , which for a normal distribution corresponds to a coverage probability of approximately 95%.

<sup>A</sup> The uncertainties of NormX,Y,Z do not affect the  $E^2$ -field uncertainty inside TSL (see Pages 7 and 8).

<sup>B</sup> Numerical linearization parameter: uncertainty not required.

<sup>E</sup> Uncertainty is determined using the max. deviation from linear response applying rectangular distribution and is expressed for the square of the field value.

## DASY/EASY - Parameters of Probe: ES3DV3 - SN:3319

### Calibration Parameter Determined in Head Tissue Simulating Media

f (MHz) <sup>C</sup>	Relative Permittivity <sup>F</sup>	Conductivity (S/m) <sup>F</sup>	ConvF X	ConvF Y	ConvF Z	Alpha <sup>G</sup>	Depth <sup>G</sup> (mm)	Unct. (k=2)
750	41.9	0.89	6.69	6.69	6.69	0.40	1.70	± 12.0 %
835	41.5	0.90	6.41	6.41	6.41	0.43	1.62	± 12.0 %
1750	40.1	1.37	5.29	5.29	5.29	0.80	1.16	± 12.0 %
1900	40.0	1.40	5.10	5.10	5.10	0.80	1.24	± 12.0 %
2300	39.5	1.67	4.77	4.77	4.77	0.64	1.38	± 12.0 %
2450	39.2	1.80	4.55	4.55	4.55	0.80	1.29	± 12.0 %
2600	39.0	1.96	4.39	4.39	4.39	0.80	1.31	± 12.0 %

<sup>C</sup> Frequency validity above 300 MHz of ± 100 MHz only applies for DASY v4.4 and higher (see Page 2), else it is restricted to ± 50 MHz. The uncertainty is the RSS of the ConvF uncertainty at calibration frequency and the uncertainty for the indicated frequency band. Frequency validity below 300 MHz is ± 10, 25, 40, 50 and 70 MHz for ConvF assessments at 30, 64, 128, 150 and 220 MHz respectively. Above 5 GHz frequency validity can be extended to ± 110 MHz.

<sup>F</sup> At frequencies below 3 GHz, the validity of tissue parameters ( $\epsilon$  and  $\sigma$ ) can be relaxed to ± 10% if liquid compensation formula is applied to measured SAR values. At frequencies above 3 GHz, the validity of tissue parameters ( $\epsilon$  and  $\sigma$ ) is restricted to ± 5%. The uncertainty is the RSS of the ConvF uncertainty for indicated target tissue parameters.

<sup>G</sup> Alpha/Depth are determined during calibration. SPEAG warrants that the remaining deviation due to the boundary effect after compensation is always less than ± 1% for frequencies below 3 GHz and below ± 2% for frequencies between 3-6 GHz at any distance larger than half the probe tip diameter from the boundary.

## DASY/EASY - Parameters of Probe: ES3DV3 - SN:3319

### Calibration Parameter Determined in Body Tissue Simulating Media

f (MHz) <sup>C</sup>	Relative Permittivity <sup>F</sup>	Conductivity (S/m) <sup>F</sup>	ConvF X	ConvF Y	ConvF Z	Alpha <sup>G</sup>	Depth <sup>G</sup> (mm)	Unct. (k=2)
750	55.5	0.96	6.10	6.10	6.10	0.34	1.80	± 12.0 %
835	55.2	0.97	6.07	6.07	6.07	0.47	1.56	± 12.0 %
1750	53.4	1.49	4.83	4.83	4.83	0.70	1.36	± 12.0 %
1900	53.3	1.52	4.53	4.53	4.53	0.71	1.39	± 12.0 %
2300	52.9	1.81	4.24	4.24	4.24	0.80	1.26	± 12.0 %
2450	52.7	1.95	4.11	4.11	4.11	0.80	1.10	± 12.0 %
2600	52.5	2.16	3.90	3.90	3.90	0.80	1.11	± 12.0 %

<sup>C</sup> Frequency validity above 300 MHz of ± 100 MHz only applies for DASY v4.4 and higher (see Page 2), else it is restricted to ± 50 MHz. The uncertainty is the RSS of the ConvF uncertainty at calibration frequency and the uncertainty for the indicated frequency band. Frequency validity below 300 MHz is ± 10, 25, 40, 50 and 70 MHz for ConvF assessments at 30, 64, 128, 150 and 220 MHz respectively. Above 5 GHz frequency validity can be extended to ± 110 MHz.

<sup>F</sup> At frequencies below 3 GHz, the validity of tissue parameters ( $\epsilon$  and  $\sigma$ ) can be relaxed to ± 10% if liquid compensation formula is applied to measured SAR values. At frequencies above 3 GHz, the validity of tissue parameters ( $\epsilon$  and  $\sigma$ ) is restricted to ± 5%. The uncertainty is the RSS of the ConvF uncertainty for indicated target tissue parameters.

<sup>G</sup> Alpha/Depth are determined during calibration. SPEAG warrants that the remaining deviation due to the boundary effect after compensation is always less than ± 1% for frequencies below 3 GHz and below ± 2% for frequencies between 3-6 GHz at any distance larger than half the probe tip diameter from the boundary.

### Frequency Response of E-Field (TEM-Cell:ifi110 EXX, Waveguide: R22)

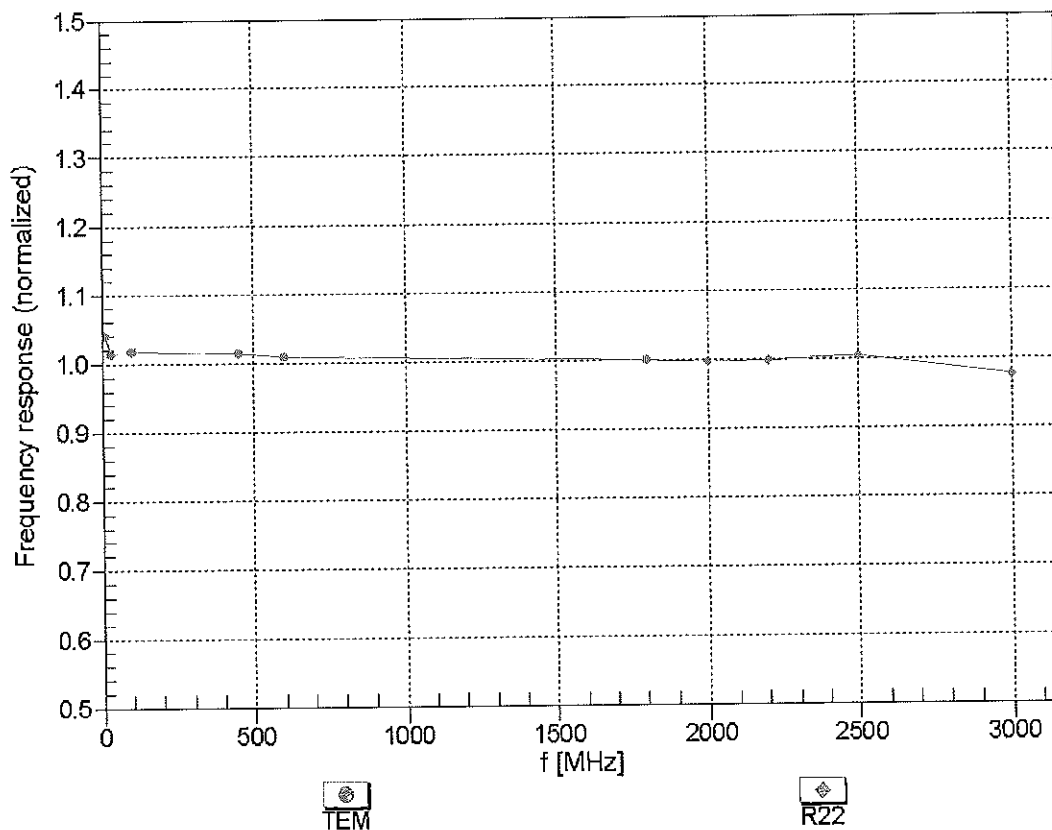

Uncertainty of Frequency Response of E-field:  $\pm 6.3\%$  (k=2)

### Receiving Pattern ( $\phi$ ), $\theta = 0^\circ$

f=600 MHz,TEM

f=1800 MHz,R22

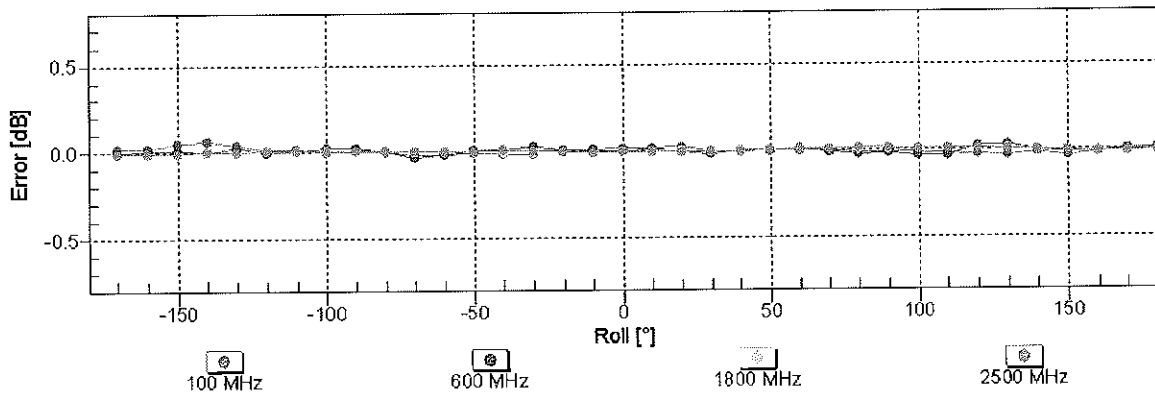
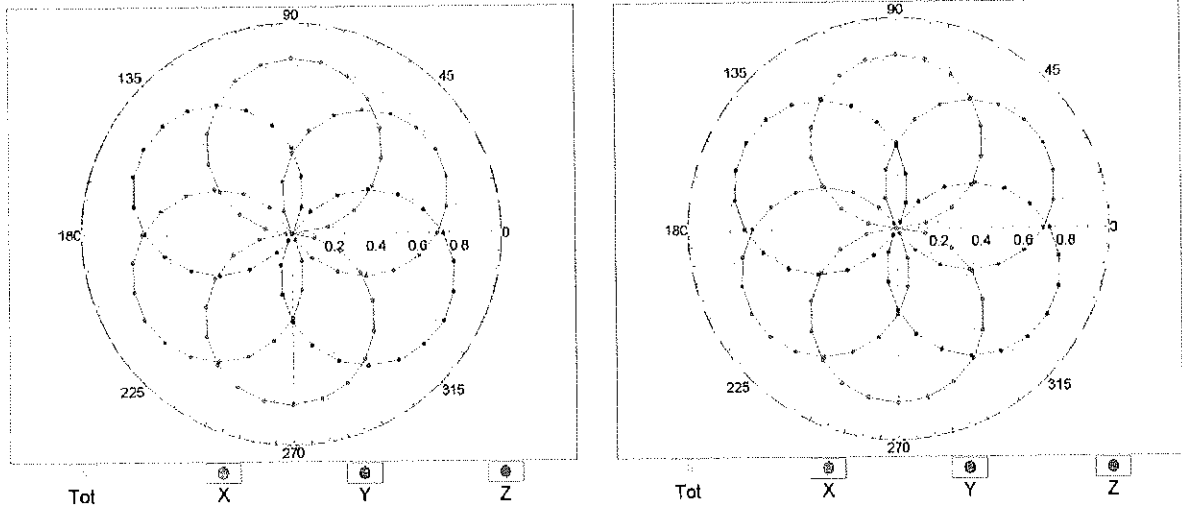

Uncertainty of Axial Isotropy Assessment:  $\pm 0.5\%$  (k=2)

### Dynamic Range $f(SAR_{head})$ (TEM cell , $f_{eval}= 1900$ MHz)

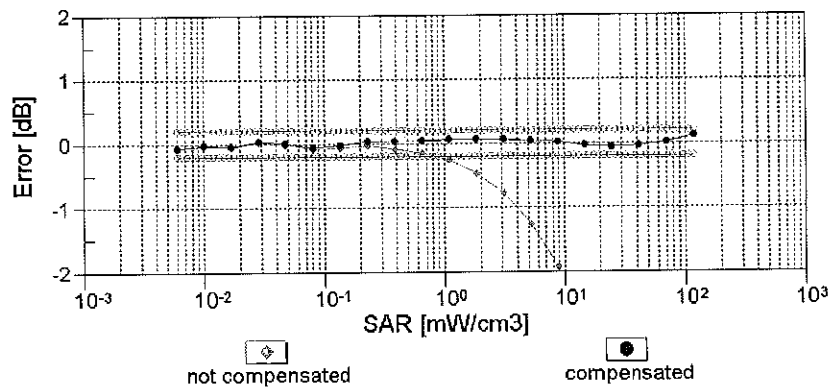
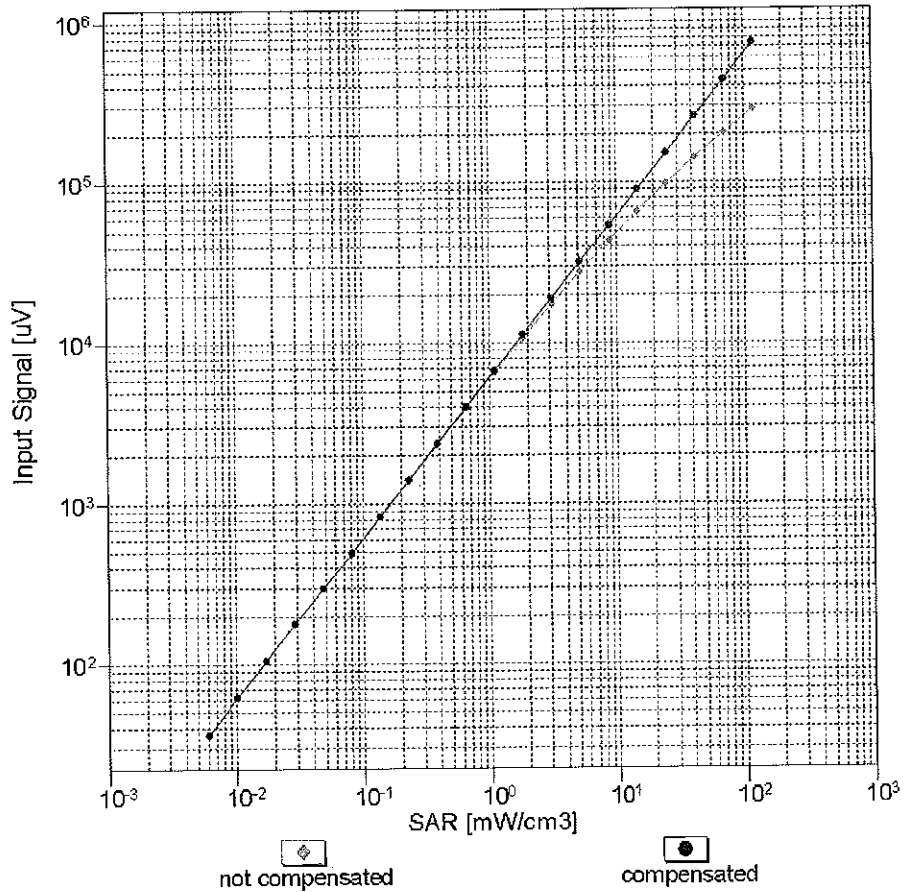

Uncertainty of Linearity Assessment:  $\pm 0.6\%$  ( $k=2$ )

# Conversion Factor Assessment

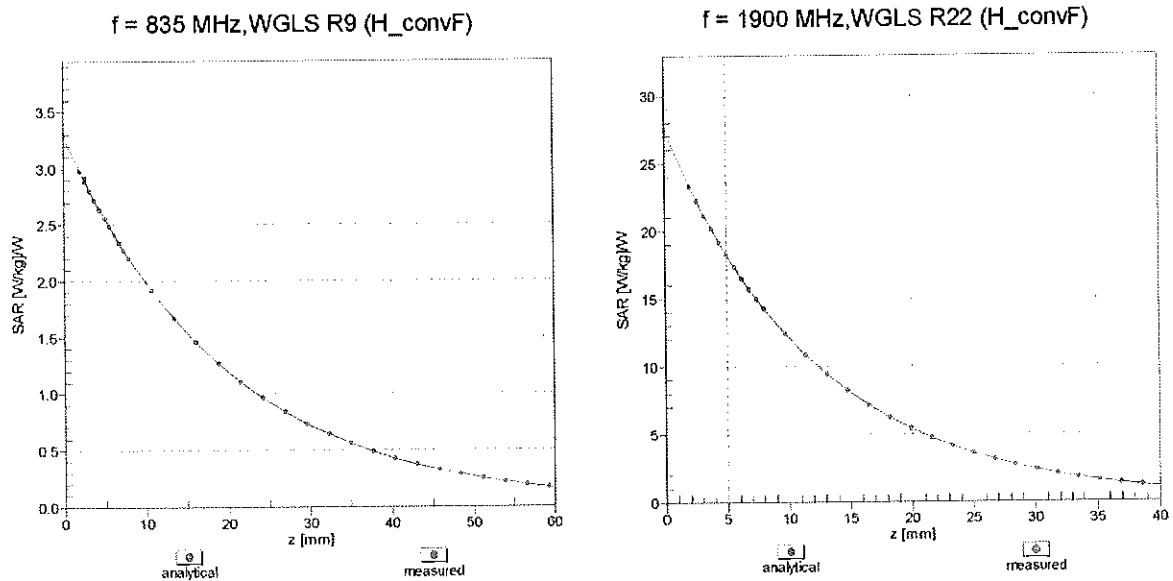

## Deviation from Isotropy in Liquid Error ( $\phi, \theta$ ), f = 900 MHz

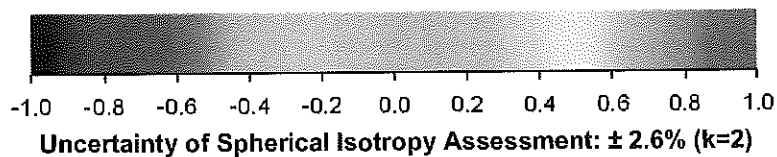
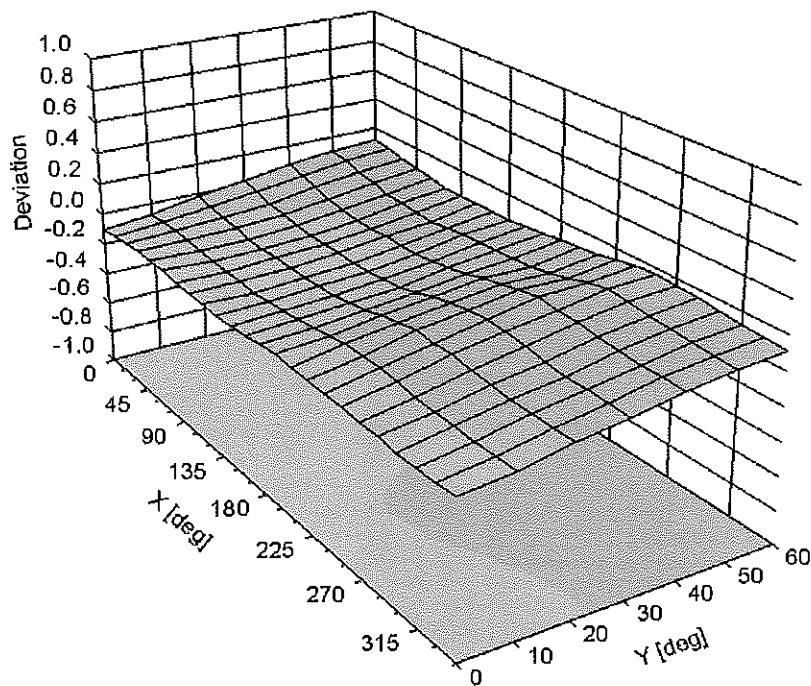

**DASY/EASY - Parameters of Probe: ES3DV3 - SN:3319****Other Probe Parameters**

Sensor Arrangement	Triangular
Connector Angle (°)	-120.2
Mechanical Surface Detection Mode	enabled
Optical Surface Detection Mode	disabled
Probe Overall Length	337 mm
Probe Body Diameter	10 mm
Tip Length	10 mm
Tip Diameter	4 mm
Probe Tip to Sensor X Calibration Point	2 mm
Probe Tip to Sensor Y Calibration Point	2 mm
Probe Tip to Sensor Z Calibration Point	2 mm
Recommended Measurement Distance from Surface	3 mm

**Calibration Laboratory of  
Schmid & Partner  
Engineering AG**  
Zeughausstrasse 43, 8004 Zurich, Switzerland



**S** Schweizerischer Kalibrierdienst  
**C** Service suisse d'étalonnage  
**S** Servizio svizzero di taratura  
**S** Swiss Calibration Service

Accredited by the Swiss Accreditation Service (SAS)  
The Swiss Accreditation Service is one of the signatories to the EA  
Multilateral Agreement for the recognition of calibration certificates

Accreditation No.: **SCS 0108**

Client **PC Test**

Certificate No: **ES3-3022\_Aug15**

**CALIBRATION CERTIFICATE**

Object **ES3DV2 - SN:3022**

Calibration procedure(s) **QA CAL-01.v9, QA CAL-23.v5, QA CAL-25.v6  
Calibration procedure for dosimetric E-field probes**

Calibration date: **August 26, 2015**

*BN ✓  
9/3/2015*

This calibration certificate documents the traceability to national standards, which realize the physical units of measurements (SI).  
The measurements and the uncertainties with confidence probability are given on the following pages and are part of the certificate.

All calibrations have been conducted in the closed laboratory facility: environment temperature (22 ± 3)°C and humidity < 70%.

Calibration Equipment used (M&TE critical for calibration)

Primary Standards	ID	Cal Date (Certificate No.)	Scheduled Calibration
Power meter E4419B	GB41293874	01-Apr-15 (No. 217-02128)	Mar-16
Power sensor E4412A	MY41498087	01-Apr-15 (No. 217-02128)	Mar-16
Reference 3 dB Attenuator	SN: S5054 (3c)	01-Apr-15 (No. 217-02129)	Mar-16
Reference 20 dB Attenuator	SN: S5277 (20x)	01-Apr-15 (No. 217-02132)	Mar-16
Reference 30 dB Attenuator	SN: S5129 (30b)	01-Apr-15 (No. 217-02133)	Mar-16
Reference Probe ES3DV2	SN: 3013	30-Dec-14 (No. ES3-3013_Dec14)	Dec-15
DAE4	SN: 660	14-Jan-15 (No. DAE4-660_Jan15)	Jan-16
Secondary Standards	ID	Check Date (in house)	Scheduled Check
RF generator HP 8648C	US3642U01700	4-Aug-99 (in house check Apr-13)	In house check: Apr-16
Network Analyzer HP 8753E	US37390585	18-Oct-01 (in house check Oct-14)	In house check: Oct-15

Calibrated by:	Name <b>Michael Weber</b>	Function <b>Laboratory Technician</b>	Signature <i>M. Weber</i>
Approved by:	Name <b>Katja Pokovic</b>	Function <b>Technical Manager</b>	Signature <i>K. Pokovic</i>

Issued: August 27, 2015

This calibration certificate shall not be reproduced except in full without written approval of the laboratory.



Accredited by the Swiss Accreditation Service (SAS)  
The Swiss Accreditation Service is one of the signatories to the EA  
Multilateral Agreement for the recognition of calibration certificates

Accreditation No.: **SCS 0108**

### Glossary:

TSL	tissue simulating liquid
NORM <sub>x,y,z</sub>	sensitivity in free space
ConvF	sensitivity in TSL / NORM <sub>x,y,z</sub>
DCP	diode compression point
CF	crest factor (1/duty_cycle) of the RF signal
A, B, C, D	modulation dependent linearization parameters
Polarization $\phi$	$\phi$ rotation around probe axis
Polarization $\vartheta$	$\vartheta$ rotation around an axis that is in the plane normal to probe axis (at measurement center), i.e., $\vartheta = 0$ is normal to probe axis
Connector Angle	information used in DASY system to align probe sensor X to the robot coordinate system

### Calibration is Performed According to the Following Standards:

- IEEE Std 1528-2013, "IEEE Recommended Practice for Determining the Peak Spatial-Averaged Specific Absorption Rate (SAR) in the Human Head from Wireless Communications Devices: Measurement Techniques", June 2013
- IEC 62209-1, "Procedure to measure the Specific Absorption Rate (SAR) for hand-held devices used in close proximity to the ear (frequency range of 300 MHz to 3 GHz)", February 2005
- IEC 62209-2, "Procedure to determine the Specific Absorption Rate (SAR) for wireless communication devices used in close proximity to the human body (frequency range of 30 MHz to 6 GHz)", March 2010
- KDB 865664, "SAR Measurement Requirements for 100 MHz to 6 GHz"

### Methods Applied and Interpretation of Parameters:

- NORM<sub>x,y,z</sub>**: Assessed for E-field polarization  $\vartheta = 0$  ( $f \leq 900$  MHz in TEM-cell;  $f > 1800$  MHz: R22 waveguide). NORM<sub>x,y,z</sub> are only intermediate values, i.e., the uncertainties of NORM<sub>x,y,z</sub> does not affect the E<sup>2</sup>-field uncertainty inside TSL (see below ConvF).
- NORM(f)<sub>x,y,z</sub>** = NORM<sub>x,y,z</sub> \* frequency\_response (see Frequency Response Chart). This linearization is implemented in DASY4 software versions later than 4.2. The uncertainty of the frequency response is included in the stated uncertainty of ConvF.
- DCP<sub>x,y,z</sub>**: DCP are numerical linearization parameters assessed based on the data of power sweep with CW signal (no uncertainty required). DCP does not depend on frequency nor media.
- PAR**: PAR is the Peak to Average Ratio that is not calibrated but determined based on the signal characteristics
- A<sub>x,y,z</sub>; B<sub>x,y,z</sub>; C<sub>x,y,z</sub>; D<sub>x,y,z</sub>; VR<sub>x,y,z</sub>; A, B, C, D** are numerical linearization parameters assessed based on the data of power sweep for specific modulation signal. The parameters do not depend on frequency nor media. VR is the maximum calibration range expressed in RMS voltage across the diode.
- ConvF and Boundary Effect Parameters**: Assessed in flat phantom using E-field (or Temperature Transfer Standard for  $f \leq 800$  MHz) and inside waveguide using analytical field distributions based on power measurements for  $f > 800$  MHz. The same setups are used for assessment of the parameters applied for boundary compensation (alpha, depth) of which typical uncertainty values are given. These parameters are used in DASY4 software to improve probe accuracy close to the boundary. The sensitivity in TSL corresponds to NORM<sub>x,y,z</sub> \* ConvF whereby the uncertainty corresponds to that given for ConvF. A frequency dependent ConvF is used in DASY version 4.4 and higher which allows extending the validity from  $\pm 50$  MHz to  $\pm 100$  MHz.
- Spherical isotropy (3D deviation from isotropy)**: in a field of low gradients realized using a flat phantom exposed by a patch antenna.
- Sensor Offset**: The sensor offset corresponds to the offset of virtual measurement center from the probe tip (on probe axis). No tolerance required.
- Connector Angle**: The angle is assessed using the information gained by determining the NORM<sub>x</sub> (no uncertainty required).

# Probe ES3DV2

## SN:3022

Manufactured: April 15, 2003  
Calibrated: August 26, 2015

Calibrated for DASY/EASY Systems  
(Note: non-compatible with DASY2 system!)

# DASY/EASY - Parameters of Probe: ES3DV2 - SN:3022

## Basic Calibration Parameters

	Sensor X	Sensor Y	Sensor Z	Unc (k=2)
Norm ( $\mu\text{V}/(\text{V}/\text{m})^2$ ) <sup>A</sup>	1.00	1.03	0.95	$\pm 10.1\%$
DCP (mV) <sup>B</sup>	99.9	99.7	100.9	

## Modulation Calibration Parameters

UID	Communication System Name		A dB	B dB/ $\mu\text{V}$	C	D dB	VR mV	Unc <sup>E</sup> (k=2)
0	CW	X	0.0	0.0	1.0	0.00	179.6	$\pm 3.3\%$
		Y	0.0	0.0	1.0		183.9	
		Z	0.0	0.0	1.0		179.0	
10010-CAA	SAR Validation (Square, 100ms, 10ms)	X	3.60	65.9	14.2	10.00	43.5	$\pm 2.2\%$
		Y	2.84	63.5	13.0		43.3	
		Z	2.76	63.7	12.7		41.7	
10011-CAB	UMTS-FDD (WCDMA)	X	3.32	67.0	18.7	2.91	144.4	$\pm 0.7\%$
		Y	3.24	66.3	18.0		147.3	
		Z	3.19	66.3	18.0		143.5	
10012-CAB	IEEE 802.11b WiFi 2.4 GHz (DSSS, 1 Mbps)	X	3.15	69.9	19.5	1.87	146.1	$\pm 0.7\%$
		Y	2.88	67.7	18.0		147.9	
		Z	2.78	67.4	17.8		145.6	
10013-CAB	IEEE 802.11g WiFi 2.4 GHz (DSSS-OFDM, 6 Mbps)	X	11.40	71.3	23.8	9.46	144.9	$\pm 3.3\%$
		Y	11.15	70.5	23.1		146.9	
		Z	10.95	70.5	23.3		140.3	
10021-DAB	GSM-FDD (TDMA, GMSK)	X	20.66	99.8	29.2	9.39	132.6	$\pm 2.2\%$
		Y	14.36	93.3	26.6		145.3	
		Z	17.17	97.2	27.8		145.4	
10023-DAB	GPRS-FDD (TDMA, GMSK, TN 0)	X	17.22	96.5	28.2	9.57	125.4	$\pm 1.9\%$
		Y	11.06	88.6	25.0		136.0	
		Z	8.71	84.6	23.4		130.7	
10024-DAB	GPRS-FDD (TDMA, GMSK, TN 0-1)	X	31.05	99.5	25.9	6.56	135.2	$\pm 2.2\%$
		Y	25.28	97.4	25.0		132.5	
		Z	21.58	95.7	24.5		144.4	
10027-DAB	GPRS-FDD (TDMA, GMSK, TN 0-1-2)	X	42.88	99.9	24.0	4.80	129.5	$\pm 1.9\%$
		Y	40.80	99.6	23.7		124.9	
		Z	38.42	99.7	23.7		137.8	
10028-DAB	GPRS-FDD (TDMA, GMSK, TN 0-1-2-3)	X	44.48	100.0	23.2	3.55	138.2	$\pm 1.9\%$
		Y	44.03	99.7	22.8		133.0	
		Z	41.36	99.8	22.8		147.5	
10032-CAA	IEEE 802.15.1 Bluetooth (GFSK, DH5)	X	16.08	99.5	23.3	1.16	127.5	$\pm 1.4\%$
		Y	79.69	99.6	19.3		146.2	
		Z	45.81	99.9	20.4		138.2	
10100-CAB	LTE-FDD (SC-FDMA, 100% RB, 20 MHz, QPSK)	X	6.43	67.4	19.8	5.67	138.7	$\pm 1.4\%$
		Y	6.27	66.8	19.2		134.9	
		Z	6.16	66.6	19.2		127.6	

10103-CAB	LTE-TDD (SC-FDMA, 100% RB, 20 MHz, QPSK)	X	10.13	75.0	25.9	9.29	129.4	±3.3 %
		Y	9.46	73.0	24.5		131.8	
		Z	9.52	74.0	25.4		137.0	
10108-CAC	LTE-FDD (SC-FDMA, 100% RB, 10 MHz, QPSK)	X	6.27	66.9	19.7	5.80	137.0	±1.7 %
		Y	6.24	66.7	19.3		140.0	
		Z	6.06	66.3	19.2		127.1	
10117-CAB	IEEE 802.11n (HT Mixed, 13.5 Mbps, BPSK)	X	10.16	68.7	21.3	8.07	127.7	±2.2 %
		Y	9.99	68.2	20.9		131.5	
		Z	10.22	69.1	21.4		141.6	
10151-CAB	LTE-TDD (SC-FDMA, 50% RB, 20 MHz, QPSK)	X	9.34	73.4	25.2	9.28	125.0	±3.3 %
		Y	8.92	72.2	24.3		127.2	
		Z	8.95	73.1	25.1		131.9	
10154-CAC	LTE-FDD (SC-FDMA, 50% RB, 10 MHz, QPSK)	X	5.95	66.4	19.4	5.75	134.4	±1.4 %
		Y	5.92	66.2	19.1		137.0	
		Z	5.98	66.7	19.5		146.8	
10160-CAB	LTE-FDD (SC-FDMA, 50% RB, 15 MHz, QPSK)	X	6.39	66.9	19.6	5.82	139.9	±1.7 %
		Y	6.35	66.7	19.3		141.9	
		Z	6.15	66.2	19.2		128.4	
10169-CAB	LTE-FDD (SC-FDMA, 1 RB, 20 MHz, QPSK)	X	4.96	66.6	19.8	5.73	137.3	±1.4 %
		Y	4.85	66.1	19.3		139.8	
		Z	4.85	66.6	19.7		146.7	
10172-CAB	LTE-TDD (SC-FDMA, 1 RB, 20 MHz, QPSK)	X	8.75	78.7	28.3	9.21	138.9	±3.0 %
		Y	7.69	75.1	26.1		140.1	
		Z	7.80	76.6	27.2		144.0	
10175-CAC	LTE-FDD (SC-FDMA, 1 RB, 10 MHz, QPSK)	X	4.88	66.2	19.6	5.72	132.0	±1.4 %
		Y	4.77	65.8	19.1		132.6	
		Z	4.83	66.5	19.6		146.0	
10181-CAB	LTE-FDD (SC-FDMA, 1 RB, 15 MHz, QPSK)	X	4.91	66.3	19.7	5.72	131.7	±1.4 %
		Y	4.82	66.0	19.2		138.4	
		Z	4.86	66.7	19.7		145.7	
10196-CAB	IEEE 802.11n (HT Mixed, 6.5 Mbps, BPSK)	X	10.04	69.1	21.7	8.10	140.9	±2.2 %
		Y	9.62	67.9	20.8		125.2	
		Z	9.74	68.6	21.3		133.3	
10225-CAB	UMTS-FDD (HSPA+)	X	7.01	67.1	19.6	5.97	143.7	±1.4 %
		Y	6.78	66.2	19.0		129.3	
		Z	6.80	66.7	19.3		136.5	
10237-CAB	LTE-TDD (SC-FDMA, 1 RB, 10 MHz, QPSK)	X	8.55	78.0	27.9	9.21	134.6	±3.0 %
		Y	7.79	75.6	26.3		141.6	
		Z	7.89	76.9	27.4		145.2	
10252-CAB	LTE-TDD (SC-FDMA, 50% RB, 10 MHz, QPSK)	X	9.30	74.8	26.1	9.24	134.8	±3.3 %
		Y	8.65	72.5	24.5		136.4	
		Z	8.33	72.3	24.8		126.6	
10267-CAB	LTE-TDD (SC-FDMA, 100% RB, 10 MHz, QPSK)	X	10.20	76.2	26.8	9.30	144.8	±3.3 %
		Y	9.41	73.7	25.1		145.9	
		Z	9.18	73.9	25.6		138.6	

10275-CAB	UMTS-FDD (HSUPA, Subtest 5, 3GPP Rel8.4)	X	4.45	66.7	18.9	3.96	147.0	±0.9 %
		Y	4.21	65.5	17.9		126.5	
		Z	4.36	66.5	18.5		148.0	
10291-AAB	CDMA2000, RC3, SO55, Full Rate	X	3.57	66.3	18.5	3.46	134.3	±0.7 %
		Y	3.48	65.6	17.8		136.8	
		Z	3.51	66.2	18.3		136.4	
10292-AAB	CDMA2000, RC3, SO32, Full Rate	X	3.53	66.4	18.6	3.39	135.8	±0.7 %
		Y	3.45	65.8	17.9		140.4	
		Z	3.50	66.5	18.5		137.0	
10297-AAA	LTE-FDD (SC-FDMA, 50% RB, 20 MHz, QPSK)	X	6.18	66.5	19.5	5.81	129.4	±1.4 %
		Y	6.15	66.3	19.1		133.6	
		Z	6.13	66.5	19.3		131.2	
10311-AAA	LTE-FDD (SC-FDMA, 100% RB, 15 MHz, QPSK)	X	6.77	67.2	19.9	6.06	134.8	±1.7 %
		Y	6.81	67.3	19.7		144.8	
		Z	6.68	67.1	19.7		136.7	
10400-AAC	IEEE 802.11ac WiFi (20MHz, 64-QAM, 99pc duty cycle)	X	10.30	69.4	22.0	8.37	142.0	±2.5 %
		Y	9.90	68.2	21.1		126.8	
		Z	10.15	69.3	21.9		142.6	
10403-AAB	CDMA2000 (1xEV-DO, Rev. 0)	X	4.72	68.1	18.9	3.76	147.8	±0.7 %
		Y	4.56	67.5	18.2		133.6	
		Z	4.61	68.2	18.7		147.4	
10404-AAB	CDMA2000 (1xEV-DO, Rev. A)	X	4.57	67.8	18.8	3.77	144.3	±0.7 %
		Y	4.43	67.3	18.1		131.3	
		Z	4.57	68.3	18.8		145.0	
10415-AAA	IEEE 802.11b WiFi 2.4 GHz (DSSS, 1 Mbps, 99pc duty cycle)	X	2.64	67.9	18.7	1.54	142.1	±0.5 %
		Y	2.36	65.4	16.8		130.3	
		Z	2.50	66.7	17.7		145.0	
10416-AAA	IEEE 802.11g WiFi 2.4 GHz (ERP-OFDM, 6 Mbps, 99pc duty cycle)	X	10.04	69.0	21.7	8.23	138.8	±2.2 %
		Y	9.71	68.0	20.9		125.6	
		Z	9.94	69.0	21.6		140.4	

The reported uncertainty of measurement is stated as the standard uncertainty of measurement multiplied by the coverage factor  $k=2$ , which for a normal distribution corresponds to a coverage probability of approximately 95%.

<sup>A</sup> The uncertainties of Norm X,Y,Z do not affect the E<sup>2</sup>-field uncertainty inside TSL (see Pages 7 and 8).

<sup>B</sup> Numerical linearization parameter: uncertainty not required.

<sup>E</sup> Uncertainty is determined using the max. deviation from linear response applying rectangular distribution and is expressed for the square of the field value.

## DASY/EASY - Parameters of Probe: ES3DV2 - SN:3022

### Calibration Parameter Determined in Head Tissue Simulating Media

f (MHz) <sup>C</sup>	Relative Permittivity <sup>F</sup>	Conductivity (S/m) <sup>F</sup>	ConvF X	ConvF Y	ConvF Z	Alpha <sup>G</sup>	Depth (mm) <sup>G</sup>	Unc (k=2)
750	41.9	0.89	6.33	6.33	6.33	0.46	1.43	± 12.0 %
835	41.5	0.90	6.11	6.11	6.11	0.24	2.08	± 12.0 %
1750	40.1	1.37	5.08	5.08	5.08	0.45	1.47	± 12.0 %
1900	40.0	1.40	4.93	4.93	4.93	0.59	1.25	± 12.0 %
2300	39.5	1.67	4.63	4.63	4.63	0.55	1.39	± 12.0 %
2450	39.2	1.80	4.30	4.30	4.30	0.51	1.47	± 12.0 %
2600	39.0	1.96	4.12	4.12	4.12	0.57	1.46	± 12.0 %

<sup>C</sup> Frequency validity above 300 MHz of ± 100 MHz only applies for DASY v4.4 and higher (see Page 2), else it is restricted to ± 50 MHz. The uncertainty is the RSS of the ConvF uncertainty at calibration frequency and the uncertainty for the indicated frequency band. Frequency validity below 300 MHz is ± 10, 25, 40, 50 and 70 MHz for ConvF assessments at 30, 64, 128, 150 and 220 MHz respectively. Above 5 GHz frequency validity can be extended to ± 110 MHz.

<sup>F</sup> At frequencies below 3 GHz, the validity of tissue parameters ( $\epsilon$  and  $\sigma$ ) can be relaxed to ± 10% if liquid compensation formula is applied to measured SAR values. At frequencies above 3 GHz, the validity of tissue parameters ( $\epsilon$  and  $\sigma$ ) is restricted to ± 5%. The uncertainty is the RSS of the ConvF uncertainty for indicated target tissue parameters.

<sup>G</sup> Alpha/Depth are determined during calibration. SPEAG warrants that the remaining deviation due to the boundary effect after compensation is always less than ± 1% for frequencies below 3 GHz and below ± 2% for frequencies between 3-6 GHz at any distance larger than half the probe tip diameter from the boundary.

# DASY/EASY - Parameters of Probe: ES3DV2 - SN:3022

## Calibration Parameter Determined in Body Tissue Simulating Media

f (MHz) <sup>C</sup>	Relative Permittivity <sup>F</sup>	Conductivity (S/m) <sup>F</sup>	ConvF X	ConvF Y	ConvF Z	Alpha <sup>G</sup>	Depth (mm) <sup>G</sup>	Unc (k=2)
750	55.5	0.96	6.16	6.16	6.16	0.50	1.34	± 12.0 %
835	55.2	0.97	6.13	6.13	6.13	0.25	2.16	± 12.0 %
1750	53.4	1.49	4.79	4.79	4.79	0.61	1.33	± 12.0 %
1900	53.3	1.52	4.56	4.56	4.56	0.31	2.02	± 12.0 %
2300	52.9	1.81	4.32	4.32	4.32	0.79	1.19	± 12.0 %
2450	52.7	1.95	4.08	4.08	4.08	0.80	1.12	± 12.0 %
2600	52.5	2.16	3.96	3.96	3.96	0.80	1.10	± 12.0 %

<sup>C</sup> Frequency validity above 300 MHz of ± 100 MHz only applies for DASY v4.4 and higher (see Page 2), else it is restricted to ± 50 MHz. The uncertainty is the RSS of the ConvF uncertainty at calibration frequency and the uncertainty for the indicated frequency band. Frequency validity below 300 MHz is ± 10, 25, 40, 50 and 70 MHz for ConvF assessments at 30, 64, 128, 150 and 220 MHz respectively. Above 5 GHz frequency validity can be extended to ± 110 MHz.

<sup>F</sup> At frequencies below 3 GHz, the validity of tissue parameters ( $\epsilon$  and  $\sigma$ ) can be relaxed to ± 10% if liquid compensation formula is applied to measured SAR values. At frequencies above 3 GHz, the validity of tissue parameters ( $\epsilon$  and  $\sigma$ ) is restricted to ± 5%. The uncertainty is the RSS of the ConvF uncertainty for indicated target tissue parameters.

<sup>G</sup> Alpha/Depth are determined during calibration. SPEAG warrants that the remaining deviation due to the boundary effect after compensation is always less than ± 1% for frequencies below 3 GHz and below ± 2% for frequencies between 3-6 GHz at any distance larger than half the probe tip diameter from the boundary.

# Frequency Response of E-Field

(TEM-Cell: ifi110 EXX, Waveguide: R22)

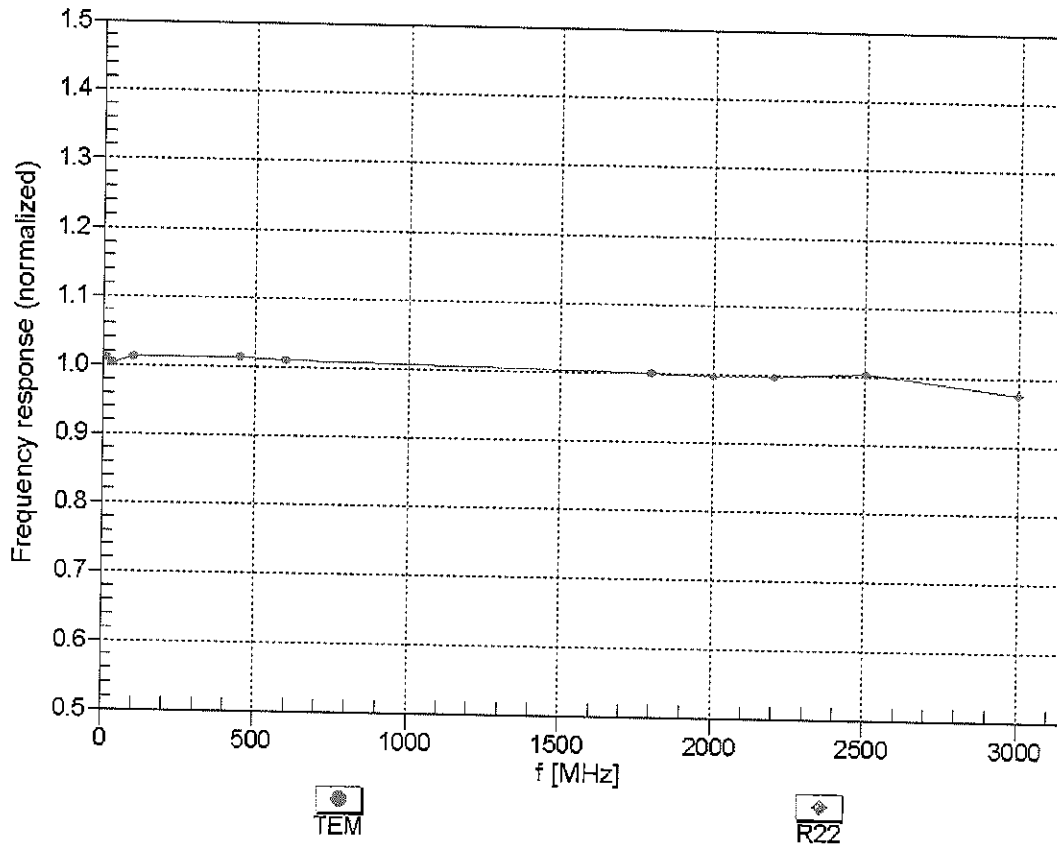

Uncertainty of Frequency Response of E-field:  $\pm 6.3\%$  (k=2)

# Receiving Pattern ( $\phi$ ), $\theta = 0^\circ$

f=600 MHz, TEM

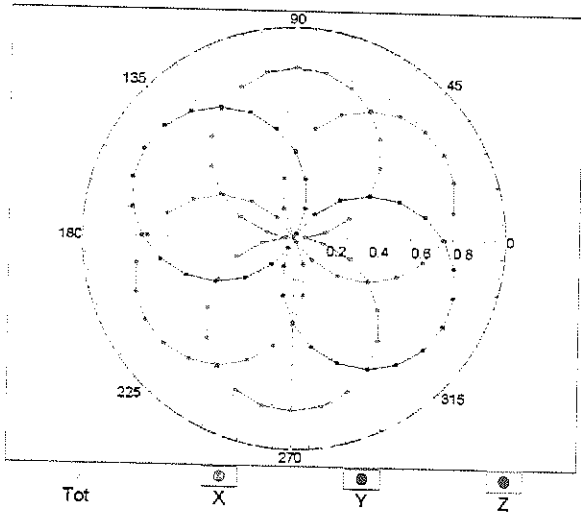

f=1800 MHz, R22

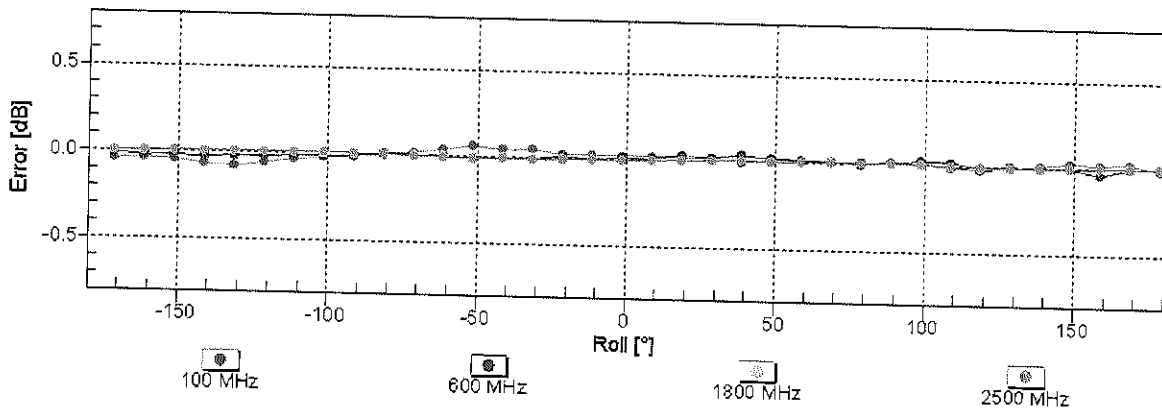
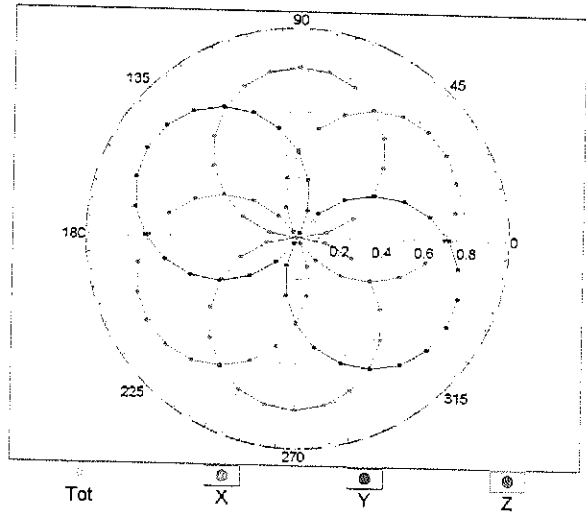

Uncertainty of Axial Isotropy Assessment:  $\pm 0.5\%$  ( $k=2$ )

## Dynamic Range $f(SAR_{head})$ (TEM cell , $f_{eval}= 1900$ MHz)

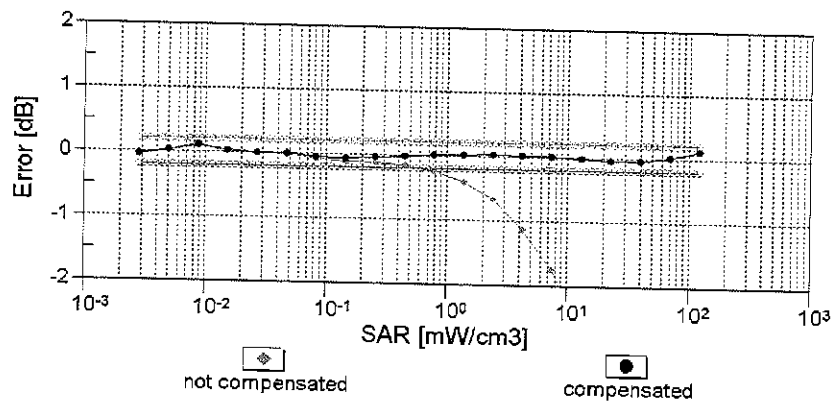
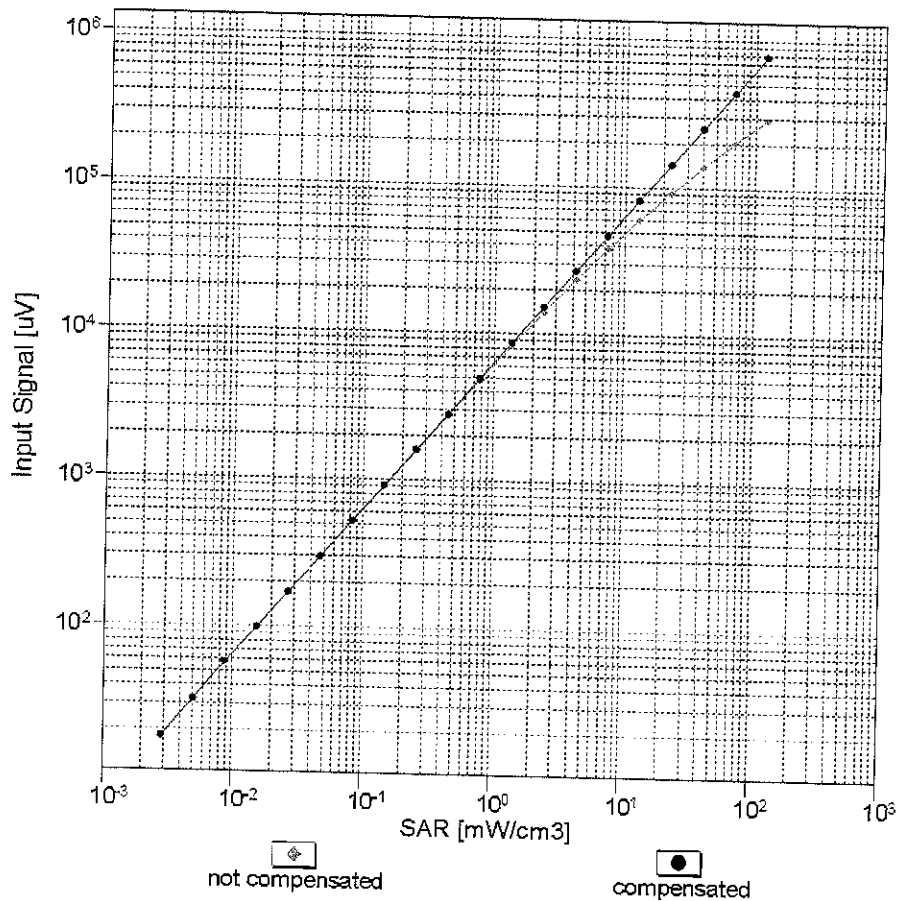

**Uncertainty of Linearity Assessment: ± 0.6% (k=2)**

# Conversion Factor Assessment

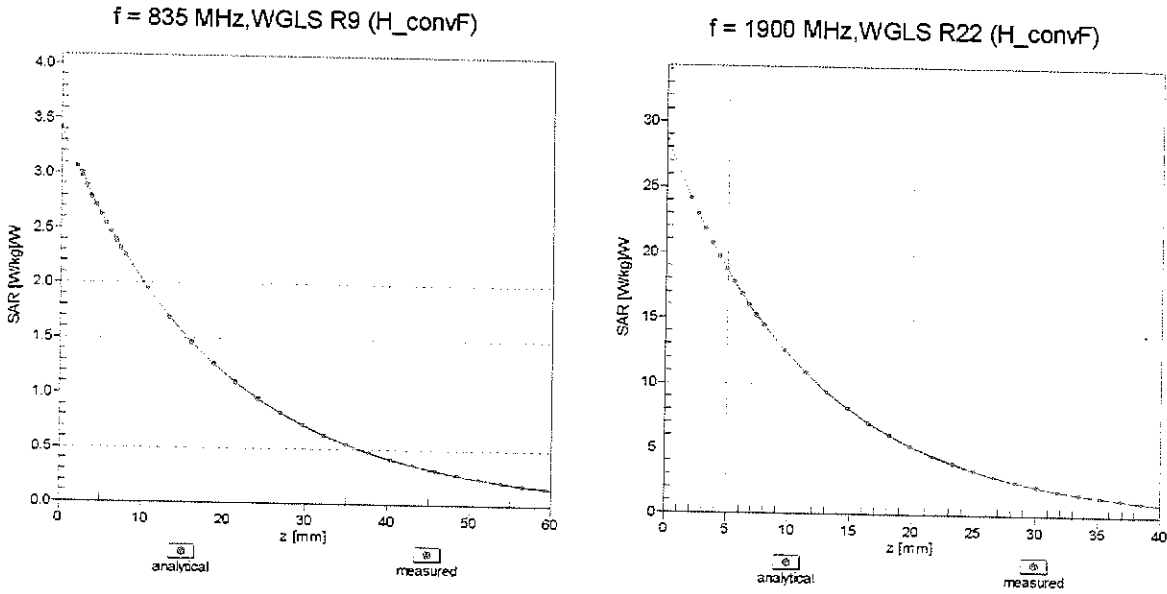

## Deviation from Isotropy in Liquid Error ( $\phi, \theta$ ), f = 900 MHz

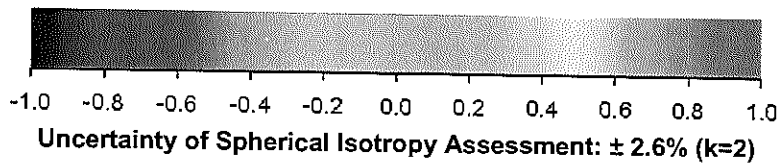
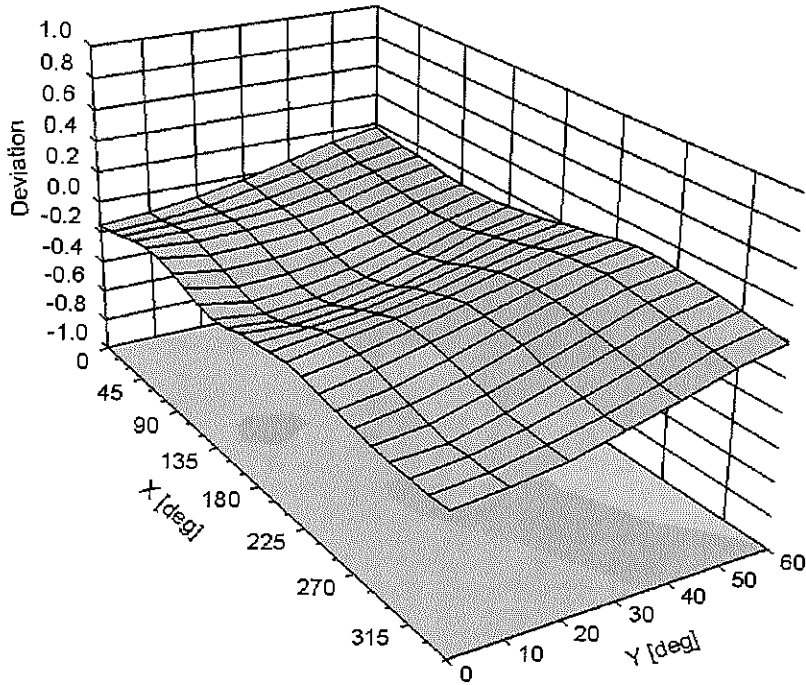

## DASY/EASY - Parameters of Probe: ES3DV2 - SN:3022

### Other Probe Parameters

Sensor Arrangement	Triangular
Connector Angle (°)	98.5
Mechanical Surface Detection Mode	enabled
Optical Surface Detection Mode	disabled
Probe Overall Length	337 mm
Probe Body Diameter	10 mm
Tip Length	10 mm
Tip Diameter	4 mm
Probe Tip to Sensor X Calibration Point	2 mm
Probe Tip to Sensor Y Calibration Point	2 mm
Probe Tip to Sensor Z Calibration Point	2 mm
Recommended Measurement Distance from Surface	3 mm

**Calibration Laboratory of  
Schmid & Partner  
Engineering AG**  
Zeughausstrasse 43, 8004 Zurich, Switzerland



**S** Schweizerischer Kalibrierdienst  
**S** Service suisse d'étalonnage  
**C** Servizio svizzero di taratura  
**S** Swiss Calibration Service

Accredited by the Swiss Accreditation Service (SAS)  
The Swiss Accreditation Service is one of the signatories to the EA  
Multilateral Agreement for the recognition of calibration certificates

Accreditation No.: **SCS 0108**

Client **PC Test**

Certificate No: **ES3-3351\_Jun15**

**CALIBRATION CERTIFICATE**

Object **ES3DV3 - SN:3351**

Calibration procedure(s) **QA CAL-01.v9, QA CAL-23.v5, QA CAL-25.v6  
Calibration procedure for dosimetric E-field probes**

Calibration date: **June 22, 2015**

*BN ✓  
06/25/15*

This calibration certificate documents the traceability to national standards, which realize the physical units of measurements (SI).  
The measurements and the uncertainties with confidence probability are given on the following pages and are part of the certificate.

All calibrations have been conducted in the closed laboratory facility: environment temperature (22 ± 3)°C and humidity < 70%.

Calibration Equipment used (M&TE critical for calibration)

Primary Standards	ID	Cal Date (Certificate No.)	Scheduled Calibration
Power meter E4419B	GB41293874	01-Apr-15 (No. 217-02128)	Mar-16
Power sensor E4412A	MY41498087	01-Apr-15 (No. 217-02128)	Mar-16
Reference 3 dB Attenuator	SN: S5054 (3c)	01-Apr-15 (No. 217-02129)	Mar-16
Reference 20 dB Attenuator	SN: S5277 (20x)	01-Apr-15 (No. 217-02132)	Mar-16
Reference 30 dB Attenuator	SN: S5129 (30b)	01-Apr-15 (No. 217-02133)	Mar-16
Reference Probe ES3DV2	SN: 3013	30-Dec-14 (No. ES3-3013_Dec14)	Dec-15
DAE4	SN: 660	14-Jan-15 (No. DAE4-660_Jan15)	Jan-16
Secondary Standards	ID	Check Date (in house)	Scheduled Check
RF generator HP 8648C	US3642U01700	4-Aug-99 (in house check Apr-13)	In house check: Apr-16
Network Analyzer HP 8753E	US37390585	18-Oct-01 (in house check Oct-14)	In house check: Oct-15

Calibrated by:	Name <b>Leif Klysner</b>	Function <b>Laboratory Technician</b>	Signature <i>Leif Klysner</i>
Approved by:	<b>Katja Pokovic</b>	<b>Technical Manager</b>	<i>Katja Pokovic</i>

Issued: June 22, 2015

This calibration certificate shall not be reproduced except in full without written approval of the laboratory.



Accredited by the Swiss Accreditation Service (SAS)

Accreditation No.: **SCS 0108**

The Swiss Accreditation Service is one of the signatories to the EA  
Multilateral Agreement for the recognition of calibration certificates

### Glossary:

TSL	tissue simulating liquid
NORM <sub>x,y,z</sub>	sensitivity in free space
ConvF	sensitivity in TSL / NORM <sub>x,y,z</sub>
DCP	diode compression point
CF	crest factor (1/duty_cycle) of the RF signal
A, B, C, D	modulation dependent linearization parameters
Polarization φ	φ rotation around probe axis
Polarization ϑ	ϑ rotation around an axis that is in the plane normal to probe axis (at measurement center), i.e., ϑ = 0 is normal to probe axis
Connector Angle	information used in DASY system to align probe sensor X to the robot coordinate system

### Calibration is Performed According to the Following Standards:

- IEEE Std 1528-2013, "IEEE Recommended Practice for Determining the Peak Spatial-Averaged Specific Absorption Rate (SAR) in the Human Head from Wireless Communications Devices: Measurement Techniques", June 2013
- IEC 62209-1, "Procedure to measure the Specific Absorption Rate (SAR) for hand-held devices used in close proximity to the ear (frequency range of 300 MHz to 3 GHz)", February 2005

### Methods Applied and Interpretation of Parameters:

- NORM<sub>x,y,z</sub>**: Assessed for E-field polarization ϑ = 0 (f ≤ 900 MHz in TEM-cell; f > 1800 MHz: R22 waveguide). NORM<sub>x,y,z</sub> are only intermediate values, i.e., the uncertainties of NORM<sub>x,y,z</sub> does not affect the E<sup>2</sup>-field uncertainty inside TSL (see below *ConvF*).
- NORM(f)<sub>x,y,z</sub> = NORM<sub>x,y,z</sub> \* frequency\_response** (see Frequency Response Chart). This linearization is implemented in DASY4 software versions later than 4.2. The uncertainty of the frequency response is included in the stated uncertainty of *ConvF*.
- DCP<sub>x,y,z</sub>**: DCP are numerical linearization parameters assessed based on the data of power sweep with CW signal (no uncertainty required). DCP does not depend on frequency nor media.
- PAR**: PAR is the Peak to Average Ratio that is not calibrated but determined based on the signal characteristics
- A<sub>x,y,z</sub>; B<sub>x,y,z</sub>; C<sub>x,y,z</sub>; D<sub>x,y,z</sub>; VR<sub>x,y,z</sub>; A, B, C, D** are numerical linearization parameters assessed based on the data of power sweep for specific modulation signal. The parameters do not depend on frequency nor media. VR is the maximum calibration range expressed in RMS voltage across the diode.
- ConvF and Boundary Effect Parameters**: Assessed in flat phantom using E-field (or Temperature Transfer Standard for f ≤ 800 MHz) and inside waveguide using analytical field distributions based on power measurements for f > 800 MHz. The same setups are used for assessment of the parameters applied for boundary compensation (alpha, depth) of which typical uncertainty values are given. These parameters are used in DASY4 software to improve probe accuracy close to the boundary. The sensitivity in TSL corresponds to NORM<sub>x,y,z</sub> \* ConvF whereby the uncertainty corresponds to that given for ConvF. A frequency dependent ConvF is used in DASY version 4.4 and higher which allows extending the validity from ± 50 MHz to ± 100 MHz.
- Spherical isotropy (3D deviation from isotropy)**: in a field of low gradients realized using a flat phantom exposed by a patch antenna.
- Sensor Offset**: The sensor offset corresponds to the offset of virtual measurement center from the probe tip (on probe axis). No tolerance required.
- Connector Angle**: The angle is assessed using the information gained by determining the NORM<sub>x</sub> (no uncertainty required).

# Probe ES3DV3

## SN:3351

Manufactured: May 22, 2012  
Calibrated: June 22, 2015

Calibrated for DASY/EASY Systems  
(Note: non-compatible with DASY2 system!)

## DASY/EASY - Parameters of Probe: ES3DV3 - SN:3351

### Basic Calibration Parameters

	Sensor X	Sensor Y	Sensor Z	Unc (k=2)
Norm ( $\mu\text{V}/(\text{V}/\text{m})^2$ ) <sup>A</sup>	0.99	1.17	1.19	$\pm 10.1\%$
DCP (mV) <sup>B</sup>	113.6	105.2	104.5	

### Modulation Calibration Parameters

UID	Communication System Name		A dB	B dB $\sqrt{\mu\text{V}}$	C	D dB	VR mV	Unc <sup>E</sup> (k=2)
0	CW	X	0.0	0.0	1.0	0.00	188.8	$\pm 3.8\%$
		Y	0.0	0.0	1.0		196.2	
		Z	0.0	0.0	1.0		151.3	
10010- CAA	SAR Validation (Square, 100ms, 10ms)	X	2.73	65.7	12.7	10.00	35.9	$\pm 1.2\%$
		Y	1.18	58.1	9.8		37.4	
		Z	2.44	61.9	12.5		42.0	
10011- CAB	UMTS-FDD (WCDMA)	X	3.43	68.2	18.9	2.91	148.5	$\pm 0.5\%$
		Y	3.14	66.5	18.1		114.3	
		Z	3.26	66.5	18.1		119.3	
10012- CAB	IEEE 802.11b WiFi 2.4 GHz (DSSS, 1 Mbps)	X	3.13	70.5	19.4	1.87	149.0	$\pm 0.5\%$
		Y	2.46	65.9	17.0		115.2	
		Z	3.02	68.7	18.5		120.9	
10013- CAB	IEEE 802.11g WiFi 2.4 GHz (DSSS-OFDM, 6 Mbps)	X	10.59	69.9	22.6	9.46	139.1	$\pm 2.5\%$
		Y	10.11	68.9	22.4		103.4	
		Z	10.74	69.4	22.4		114.3	
10021- DAB	GSM-FDD (TDMA, GMSK)	X	4.33	75.1	18.5	9.39	125.5	$\pm 1.4\%$
		Y	5.13	77.6	20.0		144.5	
		Z	17.70	96.1	27.5		123.5	
10023- DAB	GPRS-FDD (TDMA, GMSK, TN 0)	X	4.56	75.8	18.9	9.57	147.7	$\pm 2.2\%$
		Y	5.75	78.8	20.2		140.4	
		Z	18.60	97.9	28.5		117.3	
10024- DAB	GPRS-FDD (TDMA, GMSK, TN 0-1)	X	3.42	71.8	15.3	6.56	119.6	$\pm 1.4\%$
		Y	14.95	90.8	22.0		132.7	
		Z	29.34	98.9	25.6		106.6	
10027- DAB	GPRS-FDD (TDMA, GMSK, TN 0-1-2)	X	28.96	99.9	23.5	4.80	135.7	$\pm 1.9\%$
		Y	55.26	99.9	21.9		107.5	
		Z	35.15	99.9	24.6		120.0	
10028- DAB	GPRS-FDD (TDMA, GMSK, TN 0-1-2-3)	X	36.32	96.2	20.3	3.55	147.5	$\pm 1.9\%$
		Y	73.22	99.9	20.7		117.0	
		Z	52.78	99.6	22.4		128.3	
10032- CAA	IEEE 802.15.1 Bluetooth (GFSK, DH5)	X	31.23	99.5	20.1	1.16	122.8	$\pm 1.4\%$
		Y	0.74	62.4	7.0		135.2	
		Z	56.68	99.6	20.2		141.5	
10100- CAB	LTE-FDD (SC-FDMA, 100% RB, 20 MHz, QPSK)	X	6.01	66.4	18.9	5.67	112.7	$\pm 1.2\%$
		Y	6.14	66.9	19.3		124.6	
		Z	6.37	67.2	19.4		129.3	

10103-CAB	LTE-TDD (SC-FDMA, 100% RB, 20 MHz, QPSK)	X	8.50	71.4	23.6	9.29	137.9	±2.7 %
		Y	8.12	70.6	23.6		105.2	
		Z	9.68	73.4	24.7		118.6	
10108-CAC	LTE-FDD (SC-FDMA, 100% RB, 10 MHz, QPSK)	X	5.88	66.0	18.8	5.80	111.2	±1.2 %
		Y	5.99	66.5	19.2		122.8	
		Z	6.28	66.9	19.4		128.7	
10117-CAB	IEEE 802.11n (HT Mixed, 13.5 Mbps, BPSK)	X	10.19	69.3	21.2	8.07	149.1	±2.2 %
		Y	9.73	68.2	20.9		111.5	
		Z	9.97	68.3	20.8		117.7	
10151-CAB	LTE-TDD (SC-FDMA, 50% RB, 20 MHz, QPSK)	X	8.07	71.0	23.5	9.28	132.7	±2.5 %
		Y	8.82	74.2	25.9		147.0	
		Z	9.11	72.5	24.4		115.3	
10154-CAC	LTE-FDD (SC-FDMA, 50% RB, 10 MHz, QPSK)	X	5.55	65.4	18.6	5.75	107.9	±0.9 %
		Y	5.67	66.0	19.0		120.3	
		Z	5.96	66.3	19.1		126.2	
10160-CAB	LTE-FDD (SC-FDMA, 50% RB, 15 MHz, QPSK)	X	5.96	65.9	18.7	5.82	111.9	±1.2 %
		Y	6.12	66.6	19.3		125.0	
		Z	6.38	66.8	19.3		131.2	
10169-CAB	LTE-FDD (SC-FDMA, 1 RB, 20 MHz, QPSK)	X	4.68	66.6	19.4	5.73	130.7	±0.9 %
		Y	4.81	67.2	20.0		144.7	
		Z	4.74	65.5	18.9		109.9	
10172-CAB	LTE-TDD (SC-FDMA, 1 RB, 20 MHz, QPSK)	X	6.59	73.2	25.1	9.21	143.9	±2.5 %
		Y	6.42	72.7	25.3		113.3	
		Z	7.92	75.5	26.2		127.2	
10175-CAC	LTE-FDD (SC-FDMA, 1 RB, 10 MHz, QPSK)	X	4.68	66.5	19.4	5.72	128.6	±0.9 %
		Y	4.80	67.2	20.0		144.2	
		Z	4.73	65.5	18.9		109.1	
10181-CAB	LTE-FDD (SC-FDMA, 1 RB, 15 MHz, QPSK)	X	4.71	66.7	19.5	5.72	128.9	±1.2 %
		Y	4.78	67.1	19.9		143.9	
		Z	5.12	67.3	19.9		149.9	
10196-CAB	IEEE 802.11n (HT Mixed, 6.5 Mbps, BPSK)	X	9.72	68.8	21.1	8.10	138.3	±1.9 %
		Y	9.32	67.9	20.9		105.9	
		Z	9.58	67.8	20.6		111.2	
10225-CAB	UMTS-FDD (HSPA+)	X	6.60	66.5	18.9	5.97	117.6	±1.2 %
		Y	6.69	66.9	19.3		132.0	
		Z	7.08	67.2	19.5		139.9	
10237-CAB	LTE-TDD (SC-FDMA, 1 RB, 10 MHz, QPSK)	X	6.57	73.1	25.0	9.21	144.5	±2.2 %
		Y	6.59	73.6	25.8		114.3	
		Z	8.03	76.0	26.4		127.7	
10252-CAB	LTE-TDD (SC-FDMA, 50% RB, 10 MHz, QPSK)	X	7.44	70.0	23.2	9.24	122.9	±2.5 %
		Y	8.16	73.3	25.5		138.8	
		Z	8.43	71.6	24.1		108.3	
10267-CAB	LTE-TDD (SC-FDMA, 100% RB, 10 MHz, QPSK)	X	8.01	70.7	23.4	9.30	130.5	±2.7 %
		Y	8.86	74.4	26.1		146.7	
		Z	9.12	72.6	24.5		114.0	

10275-CAB	UMTS-FDD (HSUPA, Subtest 5, 3GPP Rel8.4)	X	4.49	67.5	18.8	3.96	146.9	±0.7 %
		Y	4.13	65.9	18.1		117.5	
		Z	4.36	66.2	18.2		121.1	
10291-AAB	CDMA2000, RC3, SO55, Full Rate	X	3.66	67.7	18.9	3.46	133.9	±0.5 %
		Y	3.37	66.1	18.1		109.3	
		Z	3.54	66.0	18.0		112.1	
10292-AAB	CDMA2000, RC3, SO32, Full Rate	X	3.55	67.5	18.7	3.39	136.7	±0.7 %
		Y	3.35	66.4	18.2		110.1	
		Z	3.44	65.7	17.9		112.9	
10297-AAA	LTE-FDD (SC-FDMA, 50% RB, 20 MHz, QPSK)	X	5.86	65.9	18.8	5.81	109.3	±1.2 %
		Y	6.00	66.5	19.3		122.6	
		Z	6.23	66.7	19.3		126.8	
10311-AAA	LTE-FDD (SC-FDMA, 100% RB, 15 MHz, QPSK)	X	6.42	66.5	19.1	6.06	114.1	±1.2 %
		Y	6.60	67.2	19.7		127.9	
		Z	6.85	67.4	19.7		132.6	
10400-AAC	IEEE 802.11ac WiFi (20MHz, 64-QAM, 99pc duty cycle)	X	10.03	69.2	21.5	8.37	141.2	±1.9 %
		Y	9.51	68.0	21.1		106.9	
		Z	9.90	68.2	21.1		114.0	
10403-AAB	CDMA2000 (1xEV-DO, Rev. 0)	X	5.00	70.6	19.6	3.76	146.5	±0.5 %
		Y	4.32	67.9	18.3		115.0	
		Z	4.63	67.5	18.3		121.9	
10404-AAB	CDMA2000 (1xEV-DO, Rev. A)	X	4.99	71.0	19.8	3.77	143.8	±0.5 %
		Y	4.37	68.5	18.7		113.5	
		Z	4.56	67.5	18.2		120.2	
10415-AAA	IEEE 802.11b WiFi 2.4 GHz (DSSS, 1 Mbps, 99pc duty cycle)	X	3.07	71.2	19.9	1.54	145.7	±0.5 %
		Y	2.43	66.6	17.4		116.6	
		Z	2.59	67.1	17.8		124.3	
10416-AAA	IEEE 802.11g WiFi 2.4 GHz (ERP-OFDM, 6 Mbps, 99pc duty cycle)	X	9.84	69.0	21.3	8.23	139.6	±1.9 %
		Y	9.37	67.9	21.0		106.5	
		Z	9.84	68.4	21.1		117.4	

The reported uncertainty of measurement is stated as the standard uncertainty of measurement multiplied by the coverage factor  $k=2$ , which for a normal distribution corresponds to a coverage probability of approximately 95%.

<sup>A</sup> The uncertainties of NormX,Y,Z do not affect the  $E^2$ -field uncertainty inside TSL (see Pages 7 and 8).

<sup>B</sup> Numerical linearization parameter; uncertainty not required.

<sup>E</sup> Uncertainty is determined using the max. deviation from linear response applying rectangular distribution and is expressed for the square of the field value.

## DASY/EASY - Parameters of Probe: ES3DV3 - SN:3351

### Calibration Parameter Determined in Head Tissue Simulating Media

f (MHz) <sup>C</sup>	Relative Permittivity <sup>F</sup>	Conductivity (S/m) <sup>F</sup>	ConvF X	ConvF Y	ConvF Z	Alpha <sup>G</sup>	Depth <sup>G</sup> (mm)	Unct. (k=2)
750	41.9	0.89	6.43	6.43	6.43	0.31	1.96	± 12.0 %
835	41.5	0.90	6.17	6.17	6.17	0.21	2.59	± 12.0 %
1750	40.1	1.37	5.24	5.24	5.24	0.55	1.35	± 12.0 %
1900	40.0	1.40	5.07	5.07	5.07	0.54	1.42	± 12.0 %
2300	39.5	1.67	4.74	4.74	4.74	0.69	1.31	± 12.0 %
2450	39.2	1.80	4.46	4.46	4.46	0.80	1.26	± 12.0 %
2600	39.0	1.96	4.35	4.35	4.35	0.80	1.26	± 12.0 %

<sup>C</sup> Frequency validity above 300 MHz of ± 100 MHz only applies for DASY v4.4 and higher (see Page 2), else it is restricted to ± 50 MHz. The uncertainty is the RSS of the ConvF uncertainty at calibration frequency and the uncertainty for the indicated frequency band. Frequency validity below 300 MHz is ± 10, 25, 40, 50 and 70 MHz for ConvF assessments at 30, 64, 128, 150 and 220 MHz respectively. Above 5 GHz frequency validity can be extended to ± 110 MHz.

<sup>F</sup> At frequencies below 3 GHz, the validity of tissue parameters ( $\epsilon$  and  $\sigma$ ) can be relaxed to ± 10% if liquid compensation formula is applied to measured SAR values. At frequencies above 3 GHz, the validity of tissue parameters ( $\epsilon$  and  $\sigma$ ) is restricted to ± 5%. The uncertainty is the RSS of the ConvF uncertainty for indicated target tissue parameters.

<sup>G</sup> Alpha/Depth are determined during calibration. SPEAG warrants that the remaining deviation due to the boundary effect after compensation is always less than ± 1% for frequencies below 3 GHz and below ± 2% for frequencies between 3-6 GHz at any distance larger than half the probe tip diameter from the boundary.

## DASY/EASY - Parameters of Probe: ES3DV3 - SN:3351

### Calibration Parameter Determined in Body Tissue Simulating Media

f (MHz) <sup>C</sup>	Relative Permittivity <sup>F</sup>	Conductivity (S/m) <sup>F</sup>	ConvF X	ConvF Y	ConvF Z	Alpha <sup>G</sup>	Depth <sup>G</sup> (mm)	Unct. (k=2)
750	55.5	0.96	6.21	6.21	6.21	0.29	1.98	± 12.0 %
835	55.2	0.97	6.11	6.11	6.11	0.77	1.20	± 12.0 %
1750	53.4	1.49	4.88	4.88	4.88	0.68	1.30	± 12.0 %
1900	53.3	1.52	4.68	4.68	4.68	0.61	1.46	± 12.0 %
2300	52.9	1.81	4.47	4.47	4.47	0.80	1.16	± 12.0 %
2450	52.7	1.95	4.30	4.30	4.30	0.80	1.16	± 12.0 %
2600	52.5	2.16	4.16	4.16	4.16	0.80	1.20	± 12.0 %

<sup>C</sup> Frequency validity above 300 MHz of ± 100 MHz only applies for DASY v4.4 and higher (see Page 2), else it is restricted to ± 50 MHz. The uncertainty is the RSS of the ConvF uncertainty at calibration frequency and the uncertainty for the indicated frequency band. Frequency validity below 300 MHz is ± 10, 25, 40, 50 and 70 MHz for ConvF assessments at 30, 64, 128, 150 and 220 MHz respectively. Above 5 GHz frequency validity can be extended to ± 110 MHz.

<sup>F</sup> At frequencies below 3 GHz, the validity of tissue parameters ( $\epsilon$  and  $\sigma$ ) can be relaxed to ± 10% if liquid compensation formula is applied to measured SAR values. At frequencies above 3 GHz, the validity of tissue parameters ( $\epsilon$  and  $\sigma$ ) is restricted to ± 5%. The uncertainty is the RSS of the ConvF uncertainty for indicated target tissue parameters.

<sup>G</sup> Alpha/Depth are determined during calibration. SPEAG warrants that the remaining deviation due to the boundary effect after compensation is always less than ± 1% for frequencies below 3 GHz and below ± 2% for frequencies between 3-6 GHz at any distance larger than half the probe tip diameter from the boundary.

### Frequency Response of E-Field (TEM-Cell:ifi110 EXX, Waveguide: R22)

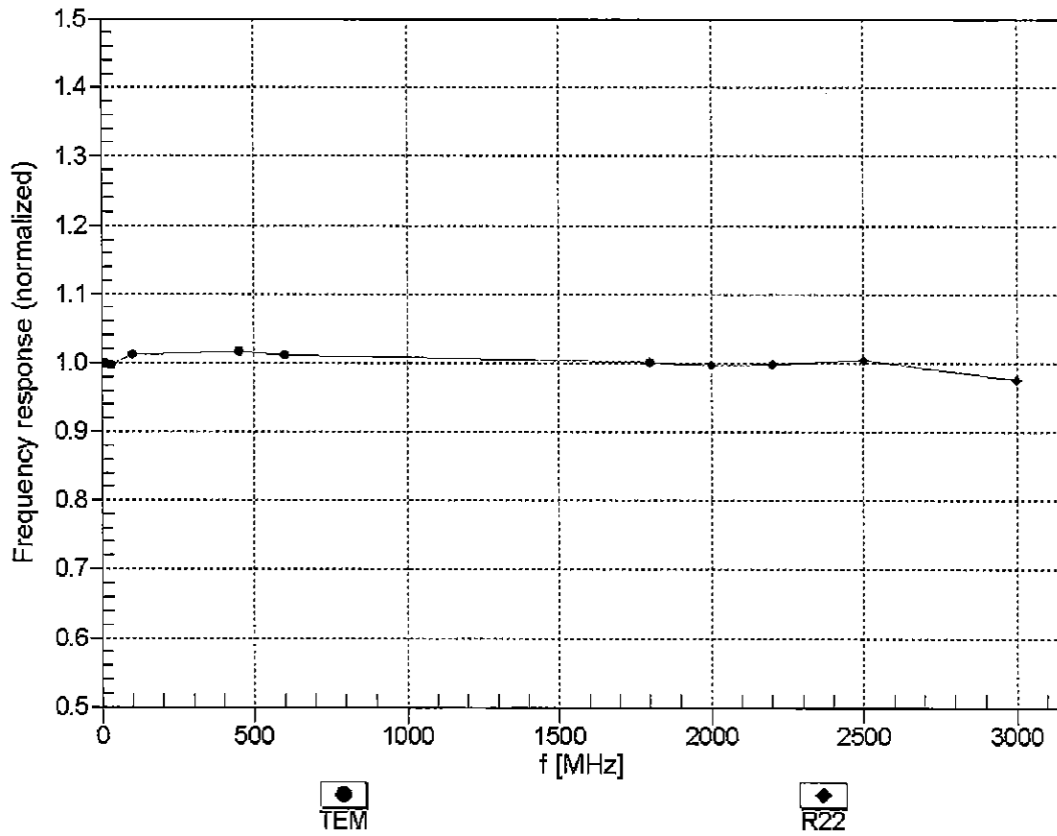

Uncertainty of Frequency Response of E-field:  $\pm 6.3\%$  ( $k=2$ )

### Receiving Pattern ( $\phi$ ), $\theta = 0^\circ$

f=600 MHz,TEM

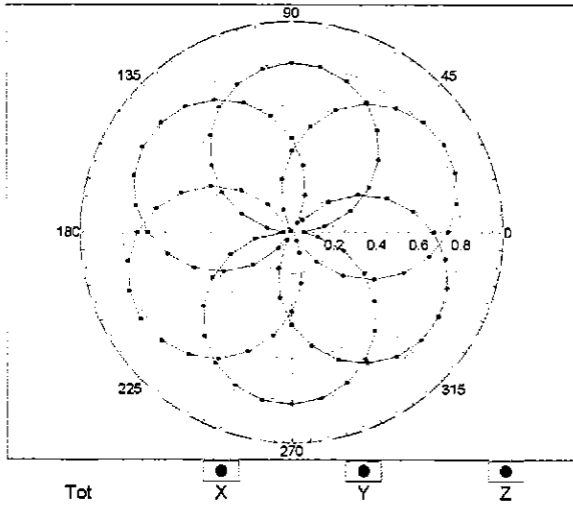

f=1800 MHz,R22

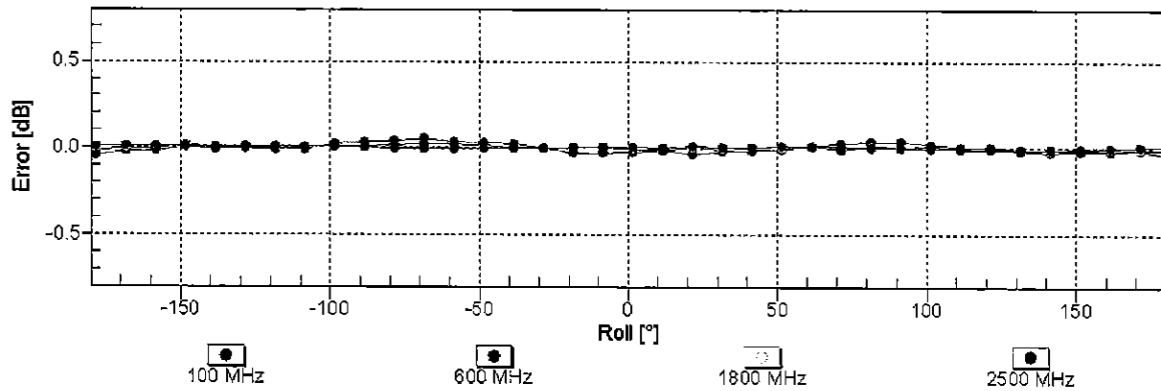
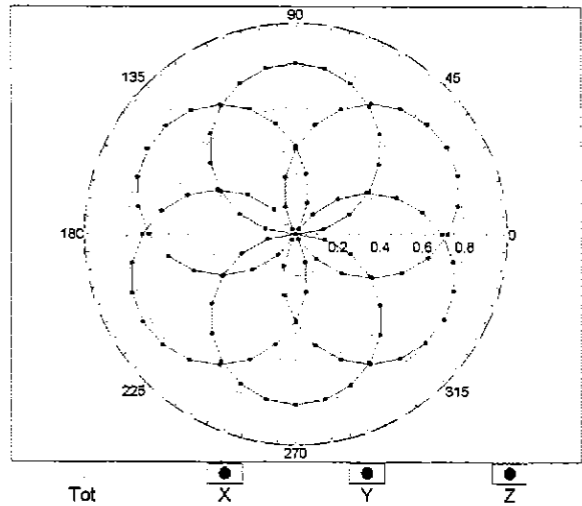

Uncertainty of Axial Isotropy Assessment:  $\pm 0.5\%$  (k=2)

## Dynamic Range $f(SAR_{head})$ (TEM cell , $f_{eval} = 1900$ MHz)

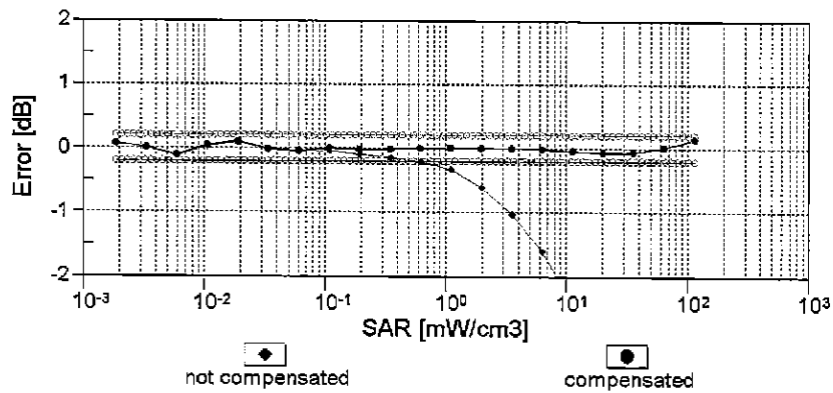
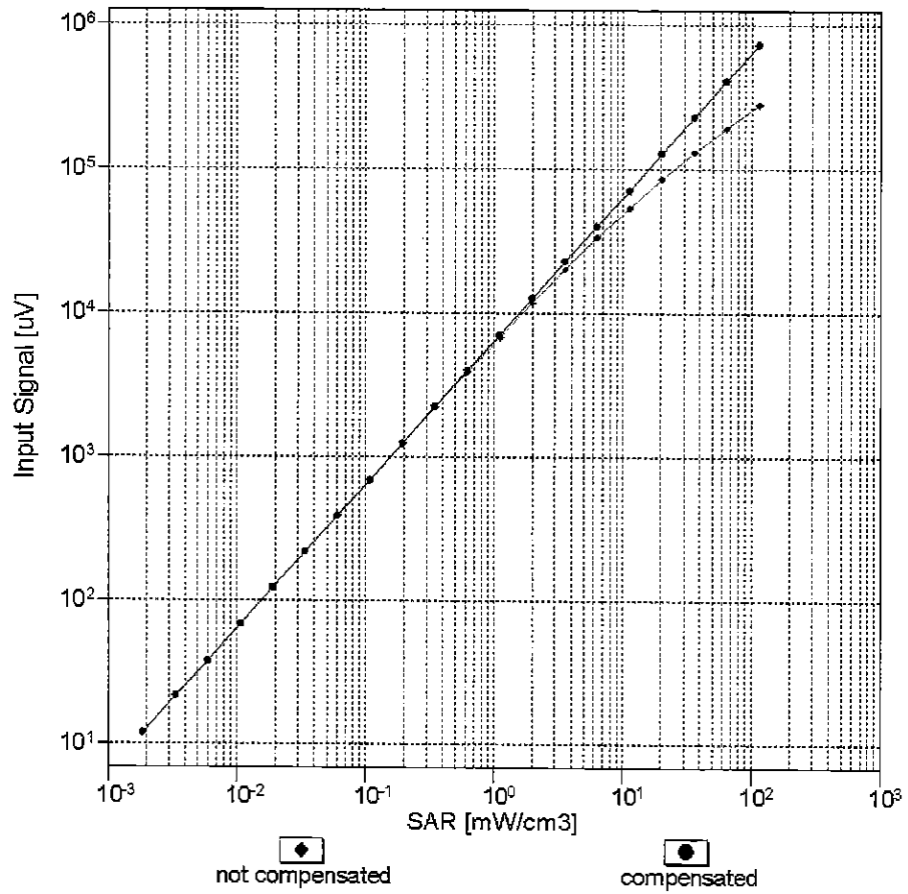

**Uncertainty of Linearity Assessment: ± 0.6% (k=2)**

# Conversion Factor Assessment

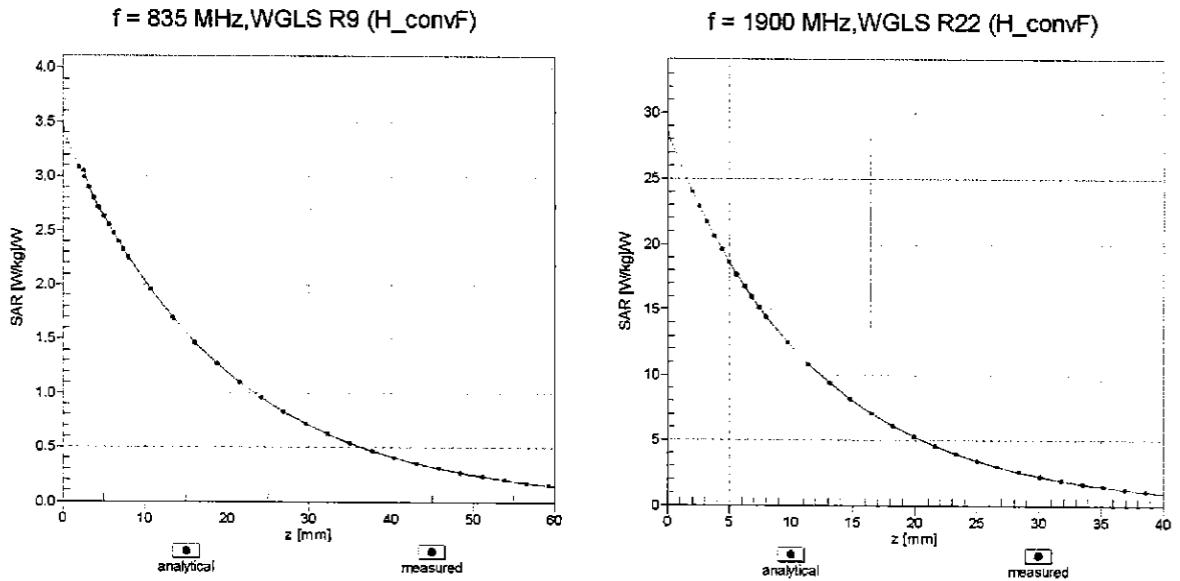

## Deviation from Isotropy in Liquid

Error ( $\phi, \theta$ ), f = 900 MHz

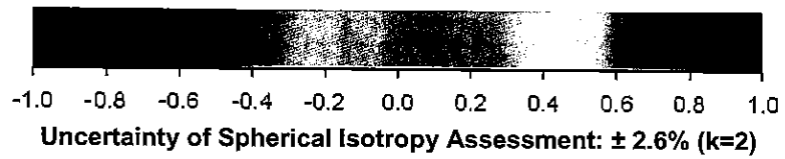
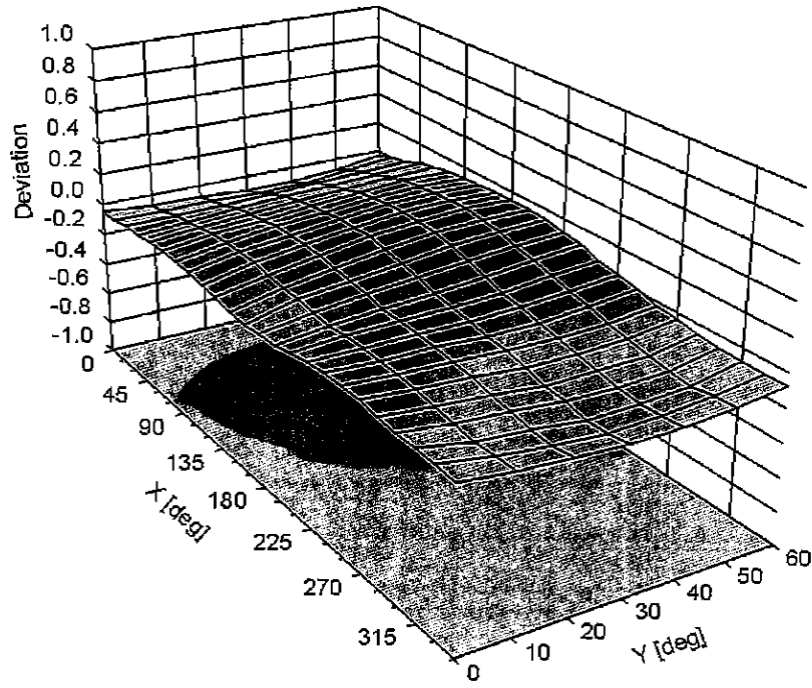

## DASY/EASY - Parameters of Probe: ES3DV3 - SN:3351

### Other Probe Parameters

Sensor Arrangement	Triangular
Connector Angle (°)	21.5
Mechanical Surface Detection Mode	enabled
Optical Surface Detection Mode	disabled
Probe Overall Length	337 mm
Probe Body Diameter	10 mm
Tip Length	10 mm
Tip Diameter	4 mm
Probe Tip to Sensor X Calibration Point	2 mm
Probe Tip to Sensor Y Calibration Point	2 mm
Probe Tip to Sensor Z Calibration Point	2 mm
Recommended Measurement Distance from Surface	3 mm



Accredited by the Swiss Accreditation Service (SAS)  
The Swiss Accreditation Service is one of the signatories to the EA  
Multilateral Agreement for the recognition of calibration certificates

Accreditation No.: **SCS 0108**

Client **PC Test**

Certificate No: **ES3-3263\_May15**

## CALIBRATION CERTIFICATE

Object **ES3DV3 - SN:3263**

Calibration procedure(s) **QA CAL-01.v9, QA CAL-23.v5, QA CAL-25.v6  
Calibration procedure for dosimetric E-field probes**

Calibration date: **May 20, 2015**

*BN ✓  
5/28/15*

This calibration certificate documents the traceability to national standards, which realize the physical units of measurements (SI).  
The measurements and the uncertainties with confidence probability are given on the following pages and are part of the certificate.

All calibrations have been conducted in the closed laboratory facility: environment temperature (22 ± 3)°C and humidity < 70%.

Calibration Equipment used (M&TE critical for calibration)

Primary Standards	ID	Cal Date (Certificate No.)	Scheduled Calibration
Power meter E4419B	GB41293874	01-Apr-15 (No. 217-02128)	Mar-16
Power sensor E4412A	MY41498087	01-Apr-15 (No. 217-02128)	Mar-16
Reference 3 dB Attenuator	SN: S5054 (3c)	01-Apr-15 (No. 217-02129)	Mar-16
Reference 20 dB Attenuator	SN: S5277 (20x)	01-Apr-15 (No. 217-02132)	Mar-16
Reference 30 dB Attenuator	SN: S5129 (30b)	01-Apr-15 (No. 217-02133)	Mar-16
Reference Probe ES3DV2	SN: 3013	30-Dec-14 (No. ES3-3013_Dec14)	Dec-15
DAE4	SN: 660	14-Jan-15 (No. DAE4-660_Jan15)	Jan-16
Secondary Standards	ID	Check Date (in house)	Scheduled Check
RF generator HP 8648C	US3642U01700	4-Aug-99 (in house check Apr-13)	In house check: Apr-16
Network Analyzer HP 8753E	US37390585	18-Oct-01 (in house check Oct-14)	In house check: Oct-15

Calibrated by:	Name <b>Leif Klysner</b>	Function <b>Laboratory Technician</b>	Signature 
Approved by:	Name <b>Katja Pokovic</b>	Function <b>Technical Manager</b>	Signature 
			Issued: May 19, 2015
This calibration certificate shall not be reproduced except in full without written approval of the laboratory.			



Accredited by the Swiss Accreditation Service (SAS)

Accreditation No.: **SCS 0108**

The Swiss Accreditation Service is one of the signatories to the EA  
Multilateral Agreement for the recognition of calibration certificates

**Glossary:**

TSL	tissue simulating liquid
NORM <sub>x,y,z</sub>	sensitivity in free space
ConvF	sensitivity in TSL / NORM <sub>x,y,z</sub>
DCP	diode compression point
CF	crest factor (1/duty_cycle) of the RF signal
A, B, C, D	modulation dependent linearization parameters
Polarization φ	φ rotation around probe axis
Polarization ϑ	ϑ rotation around an axis that is in the plane normal to probe axis (at measurement center), i.e., ϑ = 0 is normal to probe axis
Connector Angle	information used in DASY system to align probe sensor X to the robot coordinate system

**Calibration is Performed According to the Following Standards:**

- a) IEEE Std 1528-2013, "IEEE Recommended Practice for Determining the Peak Spatial-Averaged Specific Absorption Rate (SAR) in the Human Head from Wireless Communications Devices: Measurement Techniques", June 2013
- b) IEC 62209-1, "Procedure to measure the Specific Absorption Rate (SAR) for hand-held devices used in close proximity to the ear (frequency range of 300 MHz to 3 GHz)", February 2005

**Methods Applied and Interpretation of Parameters:**

- *NORM<sub>x,y,z</sub>*: Assessed for E-field polarization ϑ = 0 (f ≤ 900 MHz in TEM-cell; f > 1800 MHz: R22 waveguide). *NORM<sub>x,y,z</sub>* are only intermediate values, i.e., the uncertainties of *NORM<sub>x,y,z</sub>* does not affect the E<sup>2</sup>-field uncertainty inside TSL (see below *ConvF*).
- *NORM(f)<sub>x,y,z</sub>* = *NORM<sub>x,y,z</sub>* \* *frequency\_response* (see Frequency Response Chart). This linearization is implemented in DASY4 software versions later than 4.2. The uncertainty of the frequency response is included in the stated uncertainty of *ConvF*.
- *DCP<sub>x,y,z</sub>*: DCP are numerical linearization parameters assessed based on the data of power sweep with CW signal (no uncertainty required). DCP does not depend on frequency nor media.
- *PAR*: PAR is the Peak to Average Ratio that is not calibrated but determined based on the signal characteristics
- *A<sub>x,y,z</sub>*; *B<sub>x,y,z</sub>*; *C<sub>x,y,z</sub>*; *D<sub>x,y,z</sub>*; *VR<sub>x,y,z</sub>*; *A, B, C, D* are numerical linearization parameters assessed based on the data of power sweep for specific modulation signal. The parameters do not depend on frequency nor media. *VR* is the maximum calibration range expressed in RMS voltage across the diode.
- *ConvF* and *Boundary Effect Parameters*: Assessed in flat phantom using E-field (or Temperature Transfer Standard for f ≤ 800 MHz) and inside waveguide using analytical field distributions based on power measurements for f > 800 MHz. The same setups are used for assessment of the parameters applied for boundary compensation (alpha, depth) of which typical uncertainty values are given. These parameters are used in DASY4 software to improve probe accuracy close to the boundary. The sensitivity in TSL corresponds to *NORM<sub>x,y,z</sub>* \* *ConvF* whereby the uncertainty corresponds to that given for *ConvF*. A frequency dependent *ConvF* is used in DASY version 4.4 and higher which allows extending the validity from ± 50 MHz to ± 100 MHz.
- *Spherical isotropy (3D deviation from isotropy)*: in a field of low gradients realized using a flat phantom exposed by a patch antenna.
- *Sensor Offset*: The sensor offset corresponds to the offset of virtual measurement center from the probe tip (on probe axis). No tolerance required.
- *Connector Angle*: The angle is assessed using the information gained by determining the *NORM<sub>x</sub>* (no uncertainty required).

# Probe ES3DV3

## SN:3263

Manufactured: January 25, 2010  
Calibrated: May 20, 2015

Calibrated for DASY/EASY Systems  
(Note: non-compatible with DASY2 system!)

## DASY/EASY - Parameters of Probe: ES3DV3 - SN:3263

### Basic Calibration Parameters

	Sensor X	Sensor Y	Sensor Z	Unc (k=2)
Norm ( $\mu\text{V}/(\text{V}/\text{m})^2$ ) <sup>A</sup>	1.21	1.25	1.13	$\pm 10.1 \%$
DCP (mV) <sup>B</sup>	106.1	103.6	108.3	

### Modulation Calibration Parameters

UID	Communication System Name		A dB	B dB $\sqrt{\mu\text{V}}$	C	D dB	VR mV	Unc <sup>E</sup> (k=2)
0	CW	X	0.0	0.0	1.0	0.00	205.3	$\pm 3.3 \%$
		Y	0.0	0.0	1.0		207.3	
		Z	0.0	0.0	1.0		199.5	
10010- CAA	SAR Validation (Square, 100ms, 10ms)	X	1.83	58.4	9.4	10.00	41.2	$\pm 1.4 \%$
		Y	3.88	63.3	12.9		47.5	
		Z	1.42	56.8	8.7		39.5	
10011- CAB	UMTS-FDD (WCDMA)	X	3.27	67.4	18.6	2.91	140.1	$\pm 0.7 \%$
		Y	3.39	67.5	18.7		142.7	
		Z	3.32	67.6	18.6		136.9	
10012- CAB	IEEE 802.11b WiFi 2.4 GHz (DSSS, 1 Mbps)	X	2.85	68.8	18.8	1.87	142.2	$\pm 0.7 \%$
		Y	3.38	70.7	19.5		144.8	
		Z	3.07	70.0	19.1		138.1	
10013- CAB	IEEE 802.11g WiFi 2.4 GHz (DSSS-OFDM, 6 Mbps)	X	10.99	70.8	23.4	9.46	135.9	$\pm 2.5 \%$
		Y	11.36	70.3	22.8		124.7	
		Z	10.57	70.0	22.9		129.4	
10021- DAB	GSM-FDD (TDMA, GMSK)	X	9.38	84.7	22.1	9.39	139.8	$\pm 1.9 \%$
		Y	27.79	100.0	28.7		129.4	
		Z	9.29	86.8	23.8		134.5	
10023- DAB	GPRS-FDD (TDMA, GMSK, TN 0)	X	9.63	84.9	22.1	9.57	134.1	$\pm 2.5 \%$
		Y	25.29	98.2	28.2		124.0	
		Z	9.65	87.7	24.3		128.2	
10024- DAB	GPRS-FDD (TDMA, GMSK, TN 0-1)	X	16.20	88.9	21.0	6.56	145.2	$\pm 1.4 \%$
		Y	41.82	99.7	25.6		128.5	
		Z	24.57	96.8	24.1		142.0	
10027- DAB	GPRS-FDD (TDMA, GMSK, TN 0-1-2)	X	55.77	99.6	22.1	4.80	138.5	$\pm 2.2 \%$
		Y	53.39	99.7	23.9		140.5	
		Z	40.28	99.6	23.2		134.3	
10028- DAB	GPRS-FDD (TDMA, GMSK, TN 0-1-2-3)	X	81.43	99.8	20.7	3.55	148.6	$\pm 1.7 \%$
		Y	60.49	99.7	22.9		146.0	
		Z	62.69	99.6	21.2		145.0	
10032- CAA	IEEE 802.15.1 Bluetooth (GFSK, DH5)	X	96.06	93.7	16.0	1.16	140.3	$\pm 1.9 \%$
		Y	77.08	99.9	20.1		149.0	
		Z	99.64	99.9	18.6		138.0	
10100- CAB	LTE-FDD (SC-FDMA, 100% RB, 20 MHz, QPSK)	X	6.24	67.2	19.6	5.67	131.7	$\pm 1.4 \%$
		Y	6.39	67.3	19.5		133.8	
		Z	6.19	67.2	19.6		126.8	

10103-CAB	LTE-TDD (SC-FDMA, 100% RB, 20 MHz, QPSK)	X	10.13	76.3	26.6	9.29	142.6	±2.7 %
		Y	12.07	77.9	26.6		138.9	
		Z	9.41	74.3	25.6		134.1	
10108-CAC	LTE-FDD (SC-FDMA, 100% RB, 10 MHz, QPSK)	X	6.13	66.9	19.5	5.80	129.6	±1.4 %
		Y	6.35	67.1	19.5		133.7	
		Z	6.39	68.0	20.1		150.0	
10117-CAB	IEEE 802.11n (HT Mixed, 13.5 Mbps, BPSK)	X	10.34	69.6	21.7	8.07	147.0	±1.9 %
		Y	10.05	68.3	20.9		123.4	
		Z	10.08	69.1	21.3		138.2	
10151-CAB	LTE-TDD (SC-FDMA, 50% RB, 20 MHz, QPSK)	X	9.44	75.3	26.3	9.28	137.0	±3.5 %
		Y	11.36	76.9	26.3		134.5	
		Z	8.85	73.5	25.3		130.3	
10154-CAC	LTE-FDD (SC-FDMA, 50% RB, 10 MHz, QPSK)	X	5.79	66.2	19.2	5.75	126.9	±1.2 %
		Y	6.05	66.5	19.3		130.9	
		Z	5.92	66.9	19.5		145.5	
10160-CAB	LTE-FDD (SC-FDMA, 50% RB, 15 MHz, QPSK)	X	6.25	66.9	19.5	5.82	131.8	±1.4 %
		Y	6.47	67.0	19.5		135.4	
		Z	6.09	66.5	19.3		127.5	
10169-CAB	LTE-FDD (SC-FDMA, 1 RB, 20 MHz, QPSK)	X	4.78	66.7	19.7	5.73	130.0	±1.2 %
		Y	5.14	66.7	19.5		135.0	
		Z	4.83	67.1	19.9		147.9	
10172-CAB	LTE-TDD (SC-FDMA, 1 RB, 20 MHz, QPSK)	X	8.63	80.4	29.1	9.21	147.7	±2.7 %
		Y	9.72	78.5	27.2		123.9	
		Z	7.63	76.7	27.2		142.5	
10175-CAC	LTE-FDD (SC-FDMA, 1 RB, 10 MHz, QPSK)	X	4.75	66.6	19.6	5.72	128.2	±1.2 %
		Y	5.12	66.6	19.5		134.3	
		Z	4.87	67.1	19.9		148.0	
10181-CAB	LTE-FDD (SC-FDMA, 1 RB, 15 MHz, QPSK)	X	4.76	66.6	19.6	5.72	127.9	±1.2 %
		Y	5.12	66.6	19.5		134.5	
		Z	4.87	67.3	20.0		147.0	
10196-CAB	IEEE 802.11n (HT Mixed, 6.5 Mbps, BPSK)	X	9.87	69.1	21.6	8.10	135.8	±2.2 %
		Y	10.19	69.1	21.4		145.3	
		Z	9.65	68.8	21.3		130.5	
10225-CAB	UMTS-FDD (HSPA+)	X	6.90	67.2	19.5	5.97	139.2	±1.7 %
		Y	7.22	67.3	19.6		148.0	
		Z	6.75	67.0	19.4		134.1	
10237-CAB	LTE-TDD (SC-FDMA, 1 RB, 10 MHz, QPSK)	X	8.68	80.6	29.2	9.21	148.0	±3.0 %
		Y	9.82	78.8	27.3		125.0	
		Z	7.85	77.6	27.7		143.5	
10252-CAB	LTE-TDD (SC-FDMA, 50% RB, 10 MHz, QPSK)	X	8.56	73.7	25.6	9.24	126.6	±3.5 %
		Y	10.58	76.0	25.9		126.3	
		Z	8.84	74.8	26.1		146.7	
10267-CAB	LTE-TDD (SC-FDMA, 100% RB, 10 MHz, QPSK)	X	9.24	74.6	25.9	9.30	133.6	±3.3 %
		Y	11.38	76.9	26.2		134.3	
		Z	8.79	73.2	25.1		128.6	

10275-CAB	UMTS-FDD (HSUPA, Subtest 5, 3GPP Rel8.4)	X	4.39	67.0	18.9	3.96	143.8	±0.9 %
		Y	4.55	67.1	18.8		147.3	
		Z	4.42	67.4	19.0		139.9	
10291-AAB	CDMA2000, RC3, SO55, Full Rate	X	3.59	67.2	18.9	3.46	132.2	±0.5 %
		Y	3.68	66.7	18.5		136.0	
		Z	3.57	67.1	18.6		128.5	
10292-AAB	CDMA2000, RC3, SO32, Full Rate	X	3.50	67.0	18.7	3.39	134.0	±0.7 %
		Y	3.62	66.6	18.4		138.6	
		Z	3.50	67.2	18.7		129.8	
10297-AAA	LTE-FDD (SC-FDMA, 50% RB, 20 MHz, QPSK)	X	6.11	66.8	19.4	5.81	127.7	±1.4 %
		Y	6.33	67.0	19.5		132.1	
		Z	6.28	67.6	19.9		146.6	
10311-AAA	LTE-FDD (SC-FDMA, 100% RB, 15 MHz, QPSK)	X	6.71	67.5	19.9	6.06	134.2	±1.7 %
		Y	6.93	67.7	19.9		138.0	
		Z	6.57	67.2	19.6		128.0	
10400-AAC	IEEE 802.11ac WiFi (20MHz, 64-QAM, 99pc duty cycle)	X	10.17	69.5	21.9	8.37	138.5	±2.5 %
		Y	10.55	69.5	21.8		148.0	
		Z	9.92	69.0	21.6		132.5	
10403-AAB	CDMA2000 (1xEV-DO, Rev. 0)	X	4.79	69.2	19.1	3.76	144.1	±0.7 %
		Y	4.71	67.0	18.2		129.2	
		Z	4.72	69.3	19.2		139.3	
10404-AAB	CDMA2000 (1xEV-DO, Rev. A)	X	4.69	69.2	19.2	3.77	142.1	±0.7 %
		Y	4.71	67.5	18.5		126.7	
		Z	4.51	68.6	18.8		137.3	
10415-AAA	IEEE 802.11b WiFi 2.4 GHz (DSSS, 1 Mbps, 99pc duty cycle)	X	2.55	68.0	18.5	1.54	141.7	±0.7 %
		Y	2.67	68.4	18.6		144.0	
		Z	2.98	70.8	19.5		138.0	
10416-AAA	IEEE 802.11g WiFi 2.4 GHz (ERP-OFDM, 6 Mbps, 99pc duty cycle)	X	10.01	69.3	21.8	8.23	137.3	±2.5 %
		Y	10.31	69.3	21.6		146.0	
		Z	9.69	68.8	21.4		129.9	

The reported uncertainty of measurement is stated as the standard uncertainty of measurement multiplied by the coverage factor  $k=2$ , which for a normal distribution corresponds to a coverage probability of approximately 95%.

<sup>A</sup> The uncertainties of NormX,Y,Z do not affect the  $E^2$ -field uncertainty inside TSL (see Pages 7 and 8).

<sup>B</sup> Numerical linearization parameter: uncertainty not required.

<sup>E</sup> Uncertainty is determined using the max. deviation from linear response applying rectangular distribution and is expressed for the square of the field value.

## DASY/EASY - Parameters of Probe: ES3DV3 - SN:3263

### Calibration Parameter Determined in Head Tissue Simulating Media

f (MHz) <sup>C</sup>	Relative Permittivity <sup>F</sup>	Conductivity (S/m) <sup>F</sup>	ConvF X	ConvF Y	ConvF Z	Alpha <sup>G</sup>	Depth (mm) <sup>G</sup>	Unct. (k=2)
750	41.9	0.89	6.27	6.27	6.27	0.29	1.87	± 12.0 %
835	41.5	0.90	6.18	6.18	6.18	0.49	1.42	± 12.0 %
1750	40.1	1.37	5.27	5.27	5.27	0.49	1.46	± 12.0 %
1900	40.0	1.40	4.96	4.96	4.96	0.66	1.28	± 12.0 %
2300	39.5	1.67	4.63	4.63	4.63	0.58	1.41	± 12.0 %
2450	39.2	1.80	4.40	4.40	4.40	0.71	1.34	± 12.0 %
2600	39.0	1.96	4.25	4.25	4.25	0.80	1.25	± 12.0 %

<sup>C</sup> Frequency validity above 300 MHz of ± 100 MHz only applies for DASY v4.4 and higher (see Page 2), else it is restricted to ± 50 MHz. The uncertainty is the RSS of the ConvF uncertainty at calibration frequency and the uncertainty for the indicated frequency band. Frequency validity below 300 MHz is ± 10, 25, 40, 50 and 70 MHz for ConvF assessments at 30, 64, 128, 150 and 220 MHz respectively. Above 5 GHz frequency validity can be extended to ± 110 MHz.

<sup>F</sup> At frequencies below 3 GHz, the validity of tissue parameters ( $\epsilon$  and  $\sigma$ ) can be relaxed to ± 10% if liquid compensation formula is applied to measured SAR values. At frequencies above 3 GHz, the validity of tissue parameters ( $\epsilon$  and  $\sigma$ ) is restricted to ± 5%. The uncertainty is the RSS of the ConvF uncertainty for indicated target tissue parameters.

<sup>G</sup> Alpha/Depth are determined during calibration. SPEAG warrants that the remaining deviation due to the boundary effect after compensation is always less than ± 1% for frequencies below 3 GHz and below ± 2% for frequencies between 3-6 GHz at any distance larger than half the probe tip diameter from the boundary.

## DASY/EASY - Parameters of Probe: ES3DV3 - SN:3263

### Calibration Parameter Determined in Body Tissue Simulating Media

f (MHz) <sup>C</sup>	Relative Permittivity <sup>F</sup>	Conductivity (S/m) <sup>F</sup>	ConvF X	ConvF Y	ConvF Z	Alpha <sup>G</sup>	Depth <sup>G</sup> (mm)	Unct. (k=2)
750	55.5	0.96	6.07	6.07	6.07	0.53	1.42	± 12.0 %
835	55.2	0.97	6.08	6.08	6.08	0.57	1.36	± 12.0 %
1750	53.4	1.49	4.88	4.88	4.88	0.54	1.50	± 12.0 %
1900	53.3	1.52	4.66	4.66	4.66	0.56	1.51	± 12.0 %
2300	52.9	1.81	4.42	4.42	4.42	0.69	1.33	± 12.0 %
2450	52.7	1.95	4.28	4.28	4.28	0.80	1.08	± 12.0 %
2600	52.5	2.16	4.11	4.11	4.11	0.80	1.09	± 12.0 %

<sup>C</sup> Frequency validity above 300 MHz of ± 100 MHz only applies for DASY v4.4 and higher (see Page 2), else it is restricted to ± 50 MHz. The uncertainty is the RSS of the ConvF uncertainty at calibration frequency and the uncertainty for the indicated frequency band. Frequency validity below 300 MHz is ± 10, 25, 40, 50 and 70 MHz for ConvF assessments at 30, 64, 128, 150 and 220 MHz respectively. Above 5 GHz frequency validity can be extended to ± 110 MHz.

<sup>F</sup> At frequencies below 3 GHz, the validity of tissue parameters ( $\epsilon$  and  $\sigma$ ) can be relaxed to ± 10% if liquid compensation formula is applied to measured SAR values. At frequencies above 3 GHz, the validity of tissue parameters ( $\epsilon$  and  $\sigma$ ) is restricted to ± 5%. The uncertainty is the RSS of the ConvF uncertainty for indicated target tissue parameters.

<sup>G</sup> Alpha/Depth are determined during calibration. SPEAG warrants that the remaining deviation due to the boundary effect after compensation is always less than ± 1% for frequencies below 3 GHz and below ± 2% for frequencies between 3-6 GHz at any distance larger than half the probe tip diameter from the boundary.

# Frequency Response of E-Field

(TEM-Cell:ifi110 EXX, Waveguide: R22)

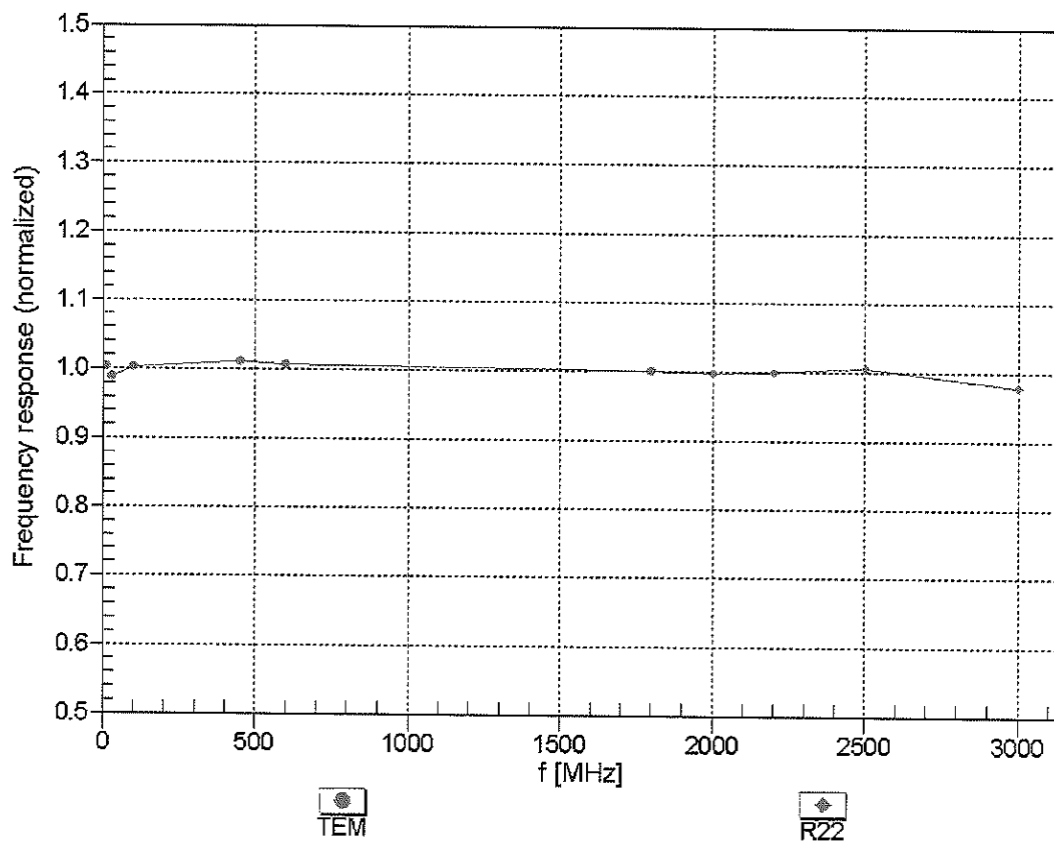

Uncertainty of Frequency Response of E-field:  $\pm 6.3\%$  (k=2)

### Receiving Pattern ( $\phi$ ), $\theta = 0^\circ$

f=600 MHz,TEM

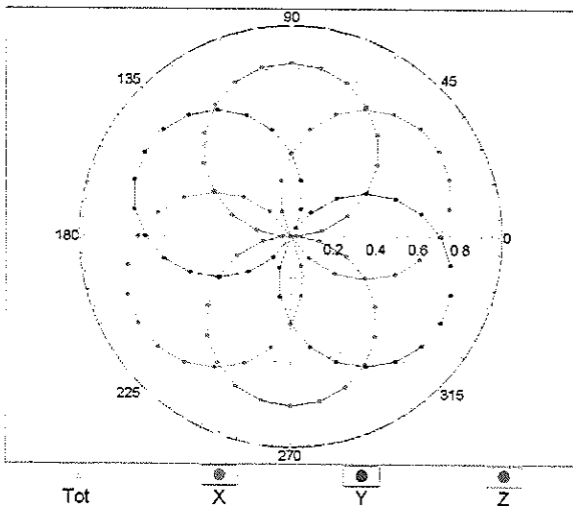

f=1800 MHz,R22

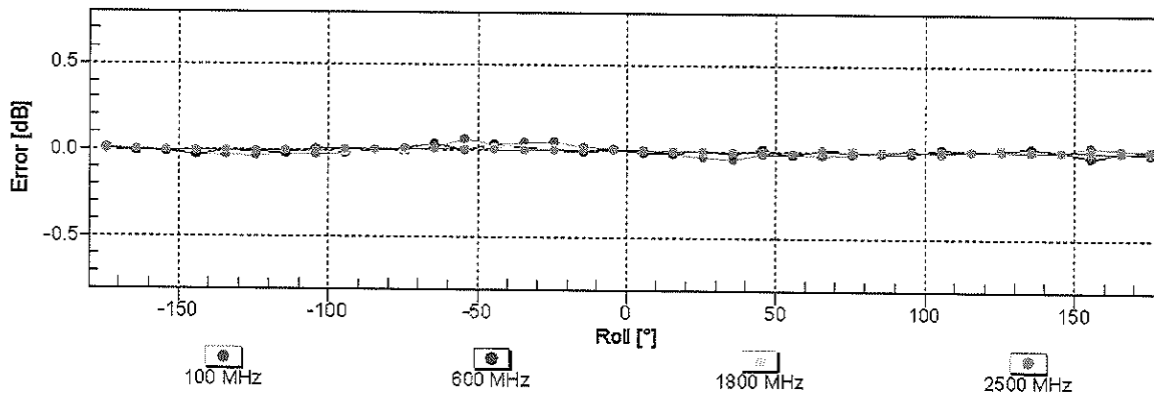
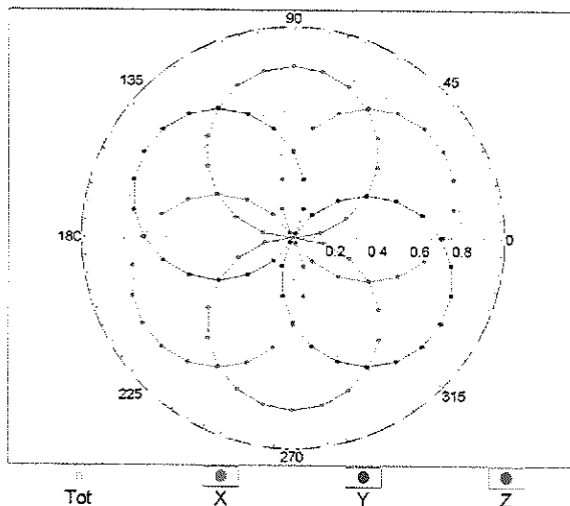

Uncertainty of Axial Isotropy Assessment:  $\pm 0.5\%$  (k=2)

### Dynamic Range $f(SAR_{head})$ (TEM cell, $f_{eval} = 1900$ MHz)

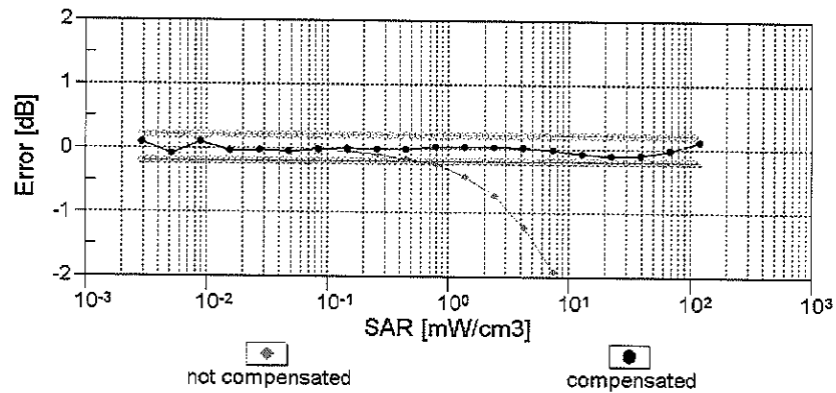
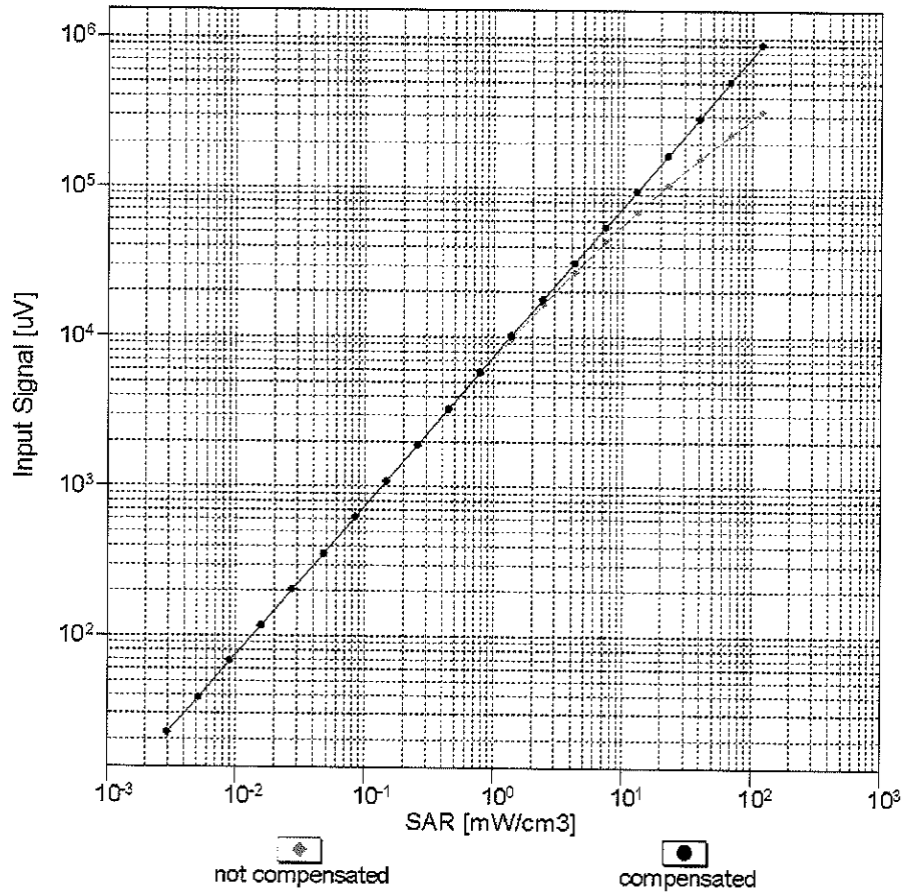

Uncertainty of Linearity Assessment:  $\pm 0.6\%$  ( $k=2$ )

# Conversion Factor Assessment

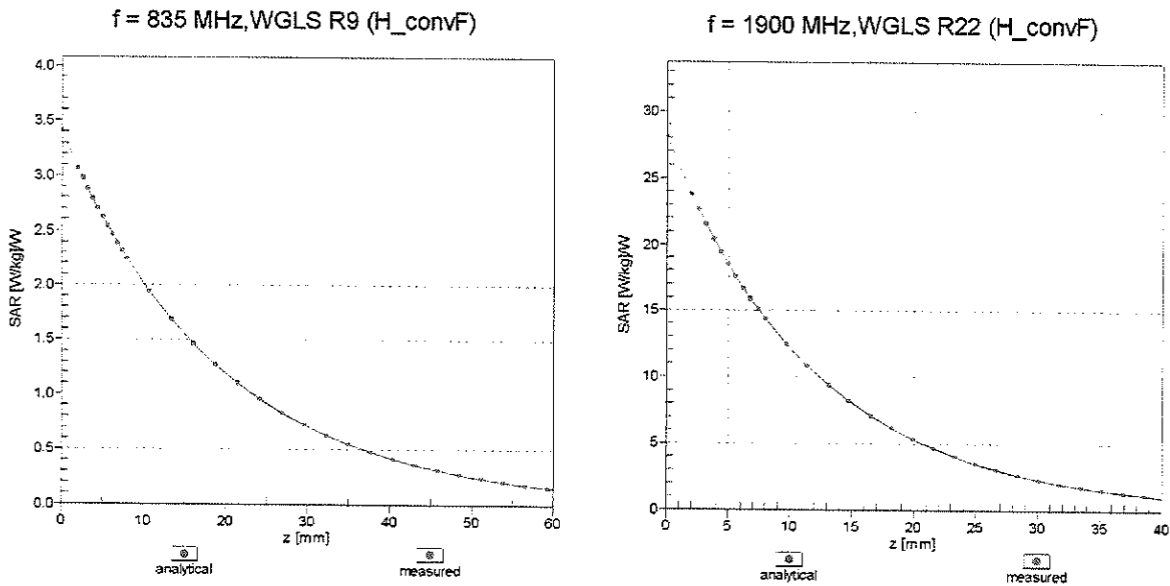

## Deviation from Isotropy in Liquid Error ( $\phi, \theta$ ), f = 900 MHz

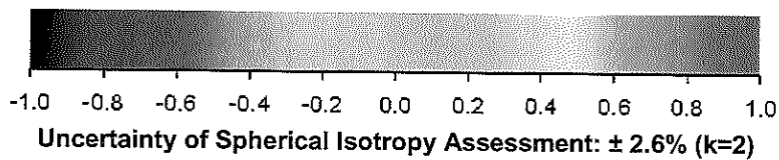
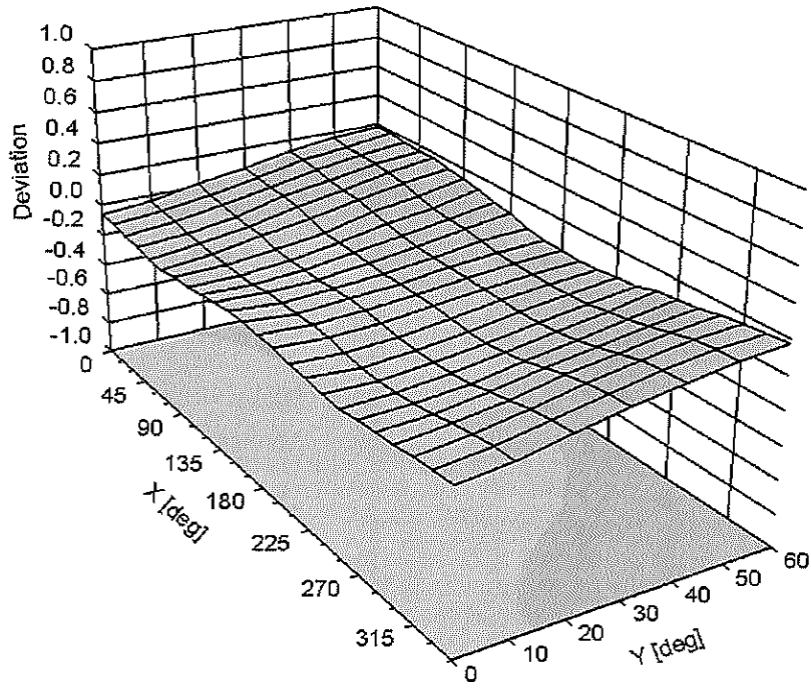

## DASY/EASY - Parameters of Probe: ES3DV3 - SN:3263

### Other Probe Parameters

Sensor Arrangement	Triangular
Connector Angle (°)	65.6
Mechanical Surface Detection Mode	enabled
Optical Surface Detection Mode	disabled
Probe Overall Length	337 mm
Probe Body Diameter	10 mm
Tip Length	10 mm
Tip Diameter	4 mm
Probe Tip to Sensor X Calibration Point	2 mm
Probe Tip to Sensor Y Calibration Point	2 mm
Probe Tip to Sensor Z Calibration Point	2 mm
Recommended Measurement Distance from Surface	3 mm



Accredited by the Swiss Accreditation Service (SAS)  
The Swiss Accreditation Service is one of the signatories to the EA  
Multilateral Agreement for the recognition of calibration certificates

Accreditation No.: **SCS 0108**

Client **PC Test**

Certificate No: **ES3-3333\_Oct15**

## CALIBRATION CERTIFICATE

Object: **ES3DV3 - SN:3333**

Calibration procedure(s): **QA CAL-01.v9, QA CAL-23.v5, QA CAL-25.v6**  
**Calibration procedure for dosimetric E-field probes**

Calibration date: **October 29, 2015**

*BN ✓  
11/03/15*

This calibration certificate documents the traceability to national standards, which realize the physical units of measurements (SI).  
The measurements and the uncertainties with confidence probability are given on the following pages and are part of the certificate.

All calibrations have been conducted in the closed laboratory facility; environment temperature (22 ± 3)°C and humidity < 70%.

Calibration Equipment used (M&TE critical for calibration)

Primary Standards	ID	Cal Date (Certificate No.)	Scheduled Calibration
Power meter E4419B	GB41293874	01-Apr-15 (No. 217-02128)	Mar-16
Power sensor E4412A	MY41498087	01-Apr-15 (No. 217-02128)	Mar-16
Reference 3 dB Attenuator	SN: S5054 (3c)	01-Apr-15 (No. 217-02129)	Mar-16
Reference 20 dB Attenuator	SN: S5277 (20x)	01-Apr-15 (No. 217-02132)	Mar-16
Reference 30 dB Attenuator	SN: S5129 (30b)	01-Apr-15 (No. 217-02133)	Mar-16
Reference Probe ES3DV2	SN: 3013	30-Dec-14 (No. ES3-3013_Dec14)	Dec-15
DAE4	SN: 660	14-Jan-15 (No. DAE4-660_Jan15)	Jan-16
Secondary Standards	ID	Check Date (in house)	Scheduled Check
RF generator HP 8648C	US3642U01700	4-Aug-99 (In house check Apr-13)	In house check: Apr-16
Network Analyzer HP 8753E	US37390585	18-Oct-01 (in house check Oct-15)	In house check: Oct-16

Calibrated by:	Name <b>Lutz Klysner</b>	Function <b>Laboratory Technician</b>	Signature 
Approved by:	Name <b>Katja Pokovic</b>	Function <b>Technical Manager</b>	

Issued: October 29, 2015

This calibration certificate shall not be reproduced except in full without written approval of the laboratory.



Accredited by the Swiss Accreditation Service (SAS)

Accreditation No.: **SCS 0108**

The Swiss Accreditation Service is one of the signatories to the EA  
Multilateral Agreement for the recognition of calibration certificates

### Glossary:

TSL	tissue simulating liquid
NORM <sub>x,y,z</sub>	sensitivity in free space
ConvF	sensitivity in TSL / NORM <sub>x,y,z</sub>
DCP	diode compression point
CF	crest factor (1/duty_cycle) of the RF signal
A, B, C, D	modulation dependent linearization parameters
Polarization $\phi$	$\phi$ rotation around probe axis
Polarization $\theta$	$\theta$ rotation around an axis that is in the plane normal to probe axis (at measurement center), i.e., $\theta = 0$ is normal to probe axis
Connector Angle	information used in DASY system to align probe sensor X to the robot coordinate system

### Calibration is Performed According to the Following Standards:

- IEEE Std 1528-2013, "IEEE Recommended Practice for Determining the Peak Spatial-Averaged Specific Absorption Rate (SAR) in the Human Head from Wireless Communications Devices: Measurement Techniques", June 2013
- IEC 62209-1, "Procedure to measure the Specific Absorption Rate (SAR) for hand-held devices used in close proximity to the ear (frequency range of 300 MHz to 3 GHz)", February 2005
- IEC 62209-2, "Procedure to determine the Specific Absorption Rate (SAR) for wireless communication devices used in close proximity to the human body (frequency range of 30 MHz to 6 GHz)", March 2010
- KDB 865604, "SAR Measurement Requirements for 100 MHz to 6 GHz"

### Methods Applied and Interpretation of Parameters:

- NORM<sub>x,y,z</sub>**: Assessed for E-field polarization  $\theta = 0$  ( $f \leq 900$  MHz in TEM-cell;  $f > 1800$  MHz: R22 waveguide). NORM<sub>x,y,z</sub> are only intermediate values, i.e., the uncertainties of NORM<sub>x,y,z</sub> does not affect the E<sup>2</sup>-field uncertainty inside TSL (see below ConvF).
- NORM(f)<sub>x,y,z</sub>** = NORM<sub>x,y,z</sub> \* frequency\_response (see Frequency Response Chart). This linearization is implemented in DASY4 software versions later than 4.2. The uncertainty of the frequency response is included in the stated uncertainty of ConvF.
- DCP<sub>x,y,z</sub>**: DCP are numerical linearization parameters assessed based on the data of power sweep with CW signal (no uncertainty required). DCP does not depend on frequency nor media.
- PAR**: PAR is the Peak to Average Ratio that is not calibrated but determined based on the signal characteristics
- A<sub>x,y,z</sub>; B<sub>x,y,z</sub>; C<sub>x,y,z</sub>; D<sub>x,y,z</sub>; VR<sub>x,y,z</sub>**: A, B, C, D are numerical linearization parameters assessed based on the data of power sweep for specific modulation signal. The parameters do not depend on frequency nor media. VR is the maximum calibration range expressed in RMS voltage across the diode.
- ConvF and Boundary Effect Parameters**: Assessed in flat phantom using E-field (or Temperature Transfer Standard for  $f \leq 800$  MHz) and inside waveguide using analytical field distributions based on power measurements for  $f > 800$  MHz. The same setups are used for assessment of the parameters applied for boundary compensation (alpha, depth) of which typical uncertainty values are given. These parameters are used in DASY4 software to improve probe accuracy close to the boundary. The sensitivity in TSL corresponds to NORM<sub>x,y,z</sub> \* ConvF whereby the uncertainty corresponds to that given for ConvF. A frequency dependent ConvF is used in DASY version 4.4 and higher which allows extending the validity from  $\pm 50$  MHz to  $\pm 100$  MHz.
- Spherical isotropy (3D deviation from isotropy)**: in a field of low gradients realized using a flat phantom exposed by a patch antenna.
- Sensor Offset**: The sensor offset corresponds to the offset of virtual measurement center from the probe tip (on probe axis). No tolerance required.
- Connector Angle**: The angle is assessed using the information gained by determining the NORM<sub>x</sub> (no uncertainty required).

# Probe ES3DV3

## SN:3333

Manufactured: January 24, 2012  
Calibrated: October 29, 2015

Calibrated for DASY/EASY Systems  
(Note: non-compatible with DASY2 system!)

## DASY/EASY - Parameters of Probe: ES3DV3 - SN:3333

### Basic Calibration Parameters

	Sensor X	Sensor Y	Sensor Z	Unc (k=2)
Norm ( $\mu\text{V}/(\text{V}/\text{m})^2$ ) <sup>A</sup>	1.07	0.90	0.88	$\pm 10.1\%$
DCP (mV) <sup>B</sup>	106.8	108.5	106.8	

### Modulation Calibration Parameters

UID	Communication System Name		A dB	B dB $\sqrt{\mu\text{V}}$	C	D dB	VR mV	Unc <sup>E</sup> (k=2)
0	CW	X	0.0	0.0	1.0	0.00	201.0	$\pm 3.5\%$
		Y	0.0	0.0	1.0		187.1	
		Z	0.0	0.0	1.0		184.8	
10010- CAA	SAR Validation (Square, 100ms, 10ms)	X	2.43	80.7	11.4	10.00	41.6	$\pm 2.2\%$
		Y	4.35	67.4	13.2		35.6	
		Z	1.46	57.0	8.7		36.2	
10011- CAB	UMTS-FDD (WCDMA)	X	3.35	67.9	19.1	2.91	138.2	$\pm 0.5\%$
		Y	3.48	68.8	19.2		127.5	
		Z	3.37	67.6	18.6		149.0	
10012- CAB	IEEE 802.11b WiFi 2.4 GHz (DSSS, 1 Mbps)	X	3.80	72.8	20.8	1.87	141.0	$\pm 0.7\%$
		Y	3.68	73.3	20.8		128.0	
		Z	3.01	69.3	18.8		128.2	
10013- CAB	IEEE 802.11g WiFi 2.4 GHz (DSSS-OFDM, 6 Mbps)	X	11.52	71.7	23.9	9.46	139.3	$\pm 3.0\%$
		Y	10.94	70.4	22.9		147.1	
		Z	10.95	70.8	23.4		144.5	
10021- DAB	GSM-FDD (TDMA, GMSK)	X	21.45	95.2	26.5	9.39	139.9	$\pm 2.5\%$
		Y	9.12	82.9	21.9		142.0	
		Z	11.47	88.1	23.9		127.6	
10023- DAB	GPRS-FDD (TDMA, GMSK, TN 0)	X	20.81	95.6	27.0	9.57	135.8	$\pm 2.2\%$
		Y	9.78	84.4	22.7		135.3	
		Z	8.12	83.5	22.1		144.6	
10024- DAB	GPRS-FDD (TDMA, GMSK, TN 0-1)	X	39.84	99.8	25.2	6.56	140.9	$\pm 1.9\%$
		Y	35.07	100.0	25.0		128.4	
		Z	35.20	99.8	24.7		131.9	
10027- DAB	GPRS-FDD (TDMA, GMSK, TN 0-1-2)	X	47.16	99.8	23.9	4.80	124.9	$\pm 2.5\%$
		Y	49.75	99.6	22.8		145.4	
		Z	45.37	99.9	23.1		148.5	
10028- DAB	GPRS-FDD (TDMA, GMSK, TN 0-1-2-3)	X	56.24	99.6	22.6	3.55	140.4	$\pm 2.7\%$
		Y	56.95	99.7	21.9		129.1	
		Z	48.45	99.6	22.1		133.2	
10032- CAA	IEEE 802.15.1 Bluetooth (GFSK, DH5)	X	18.03	98.1	22.8	1.16	127.5	$\pm 1.9\%$
		Y	35.17	99.6	20.7		141.1	
		Z	21.08	99.9	21.9		127.5	
10100- CAB	LTE-FDD (SC-FDMA, 100% RB, 20 MHz, QPSK)	X	6.36	67.6	19.8	5.67	137.5	$\pm 1.2\%$
		Y	6.29	67.4	19.6		128.9	
		Z	6.35	67.5	19.7		139.5	

10103-CAB	LTE-TDD (SC-FDMA, 100% RB, 20 MHz, QPSK)	X	10.85	76.6	26.4	9.29	130.8	±2.7 %
		Y	9.58	73.7	24.8		143.0	
		Z	9.94	75.6	26.2		149.3	
10108-CAC	LTE-FDD (SC-FDMA, 100% RB, 10 MHz, QPSK)	X	6.21	67.0	19.7	5.80	128.9	±1.2 %
		Y	6.16	66.9	19.5		129.2	
		Z	6.22	67.2	19.7		138.0	
10117-CAB	IEEE 802.11n (HT Mixed, 13.5 Mbps, BPSK)	X	10.05	68.7	21.2	8.07	126.1	±2.5 %
		Y	10.13	69.0	21.3		146.1	
		Z	9.97	68.7	21.1		126.2	
10151-CAB	LTE-TDD (SC-FDMA, 50% RB, 20 MHz, QPSK)	X	10.11	75.5	26.0	9.28	125.8	±3.3 %
		Y	9.08	73.2	24.7		138.2	
		Z	9.32	74.8	26.0		143.1	
10154-CAC	LTE-FDD (SC-FDMA, 50% RB, 10 MHz, QPSK)	X	5.97	66.8	19.6	5.75	133.4	±1.2 %
		Y	5.92	66.7	19.5		127.0	
		Z	5.91	68.7	19.5		134.2	
10160-CAB	LTE-FDD (SC-FDMA, 50% RB, 15 MHz, QPSK)	X	6.40	67.3	19.9	5.82	137.8	±1.2 %
		Y	6.31	67.1	19.6		130.7	
		Z	6.32	67.1	19.6		139.8	
10169-CAB	LTE-FDD (SC-FDMA, 1 RB, 20 MHz, QPSK)	X	5.05	67.3	20.1	5.73	136.8	±1.2 %
		Y	4.89	67.0	19.9		131.1	
		Z	4.93	67.2	20.0		137.4	
10172-CAB	LTE-TDD (SC-FDMA, 1 RB, 20 MHz, QPSK)	X	10.74	83.9	30.3	9.21	136.8	±2.7 %
		Y	7.34	74.3	25.5		125.9	
		Z	7.74	76.6	27.1		131.2	
10175-CAC	LTE-FDD (SC-FDMA, 1 RB, 10 MHz, QPSK)	X	4.97	66.9	19.9	5.72	130.8	±1.2 %
		Y	4.86	66.9	19.8		128.5	
		Z	4.97	67.3	20.1		137.0	
10181-CAB	LTE-FDD (SC-FDMA, 1 RB, 15 MHz, QPSK)	X	4.99	67.0	19.9	5.72	130.1	±1.2 %
		Y	4.88	67.0	19.9		127.6	
		Z	4.95	67.2	20.0		136.2	
10196-CAB	IEEE 802.11n (HT Mixed, 6.5 Mbps, BPSK)	X	10.00	69.2	21.7	8.10	137.9	±2.2 %
		Y	9.75	68.7	21.2		137.5	
		Z	9.94	69.4	21.7		145.3	
10225-CAB	UMTS-FDD (HSPA+)	X	7.08	67.5	19.8	5.97	147.1	±1.4 %
		Y	7.06	67.7	19.8		142.3	
		Z	7.04	67.7	19.9		148.8	
10237-CAB	LTE-TDD (SC-FDMA, 1 RB, 10 MHz, QPSK)	X	10.66	83.5	30.1	9.21	144.0	±3.0 %
		Y	7.43	74.7	25.7		127.6	
		Z	7.86	77.1	27.4		132.3	
10252-CAB	LTE-TDD (SC-FDMA, 50% RB, 10 MHz, QPSK)	X	10.81	78.7	27.9	9.24	139.7	±3.0 %
		Y	8.48	72.4	24.4		130.1	
		Z	8.71	74.1	25.8		135.2	
10267-CAB	LTE-TDD (SC-FDMA, 100% RB, 10 MHz, QPSK)	X	11.73	79.9	28.3	9.30	148.6	±3.3 %
		Y	9.11	73.2	24.8		139.0	
		Z	9.38	74.9	26.1		142.7	

10275-CAB	UMTS-FDD (HSUPA, Subtest 5, 3GPP Rel8.4)	X	4.52	67.6	19.3	3.96	144.5	±0.7 %
		Y	4.67	68.3	19.6		146.0	
		Z	4.41	67.0	18.9		130.0	
10291-AAB	CDMA2000, RC3, SO55, Full Rate	X	3.68	67.2	19.0	3.46	134.5	±0.5 %
		Y	3.91	68.9	19.9		133.2	
		Z	3.86	68.5	19.6		146.9	
10292-AAB	CDMA2000, RC3, SO32, Full Rate	X	3.63	67.5	19.1	3.39	134.9	±0.5 %
		Y	3.93	69.3	20.0		136.0	
		Z	3.81	68.5	19.6		148.6	
10297-AAA	LTE-FDD (SC-FDMA, 50% RB, 20 MHz, QPSK)	X	6.20	67.1	19.7	5.81	129.0	±1.2 %
		Y	6.20	67.0	19.6		128.0	
		Z	6.32	67.5	19.9		142.7	
10311-AAA	LTE-FDD (SC-FDMA, 100% RB, 15 MHz, QPSK)	X	6.76	67.6	20.0	6.06	134.7	±1.4 %
		Y	6.75	67.5	19.9		133.5	
		Z	6.90	68.1	20.3		149.2	
10400-AAC	IEEE 802.11ac WiFi (20MHz, 64-QAM, 99pc duty cycle)	X	10.30	69.7	22.1	8.37	140.1	±2.5 %
		Y	10.05	69.0	21.5		141.2	
		Z	9.94	69.0	21.7		126.3	
10403-AAB	CDMA2000 (1xEV-DO, Rev. 0)	X	4.80	68.5	19.0	3.76	129.3	±0.5 %
		Y	5.30	71.1	20.2		148.4	
		Z	5.10	70.4	19.9		135.2	
10404-AAB	CDMA2000 (1xEV-DO, Rev. A)	X	4.77	68.8	19.2	3.77	127.3	±0.7 %
		Y	5.35	71.7	20.5		145.4	
		Z	5.03	70.6	20.1		133.3	
10415-AAA	IEEE 802.11b WiFi 2.4 GHz (DSSS, 1 Mbps, 99pc duty cycle)	X	2.77	69.7	19.7	1.54	147.0	±0.7 %
		Y	3.73	75.4	22.2		143.7	
		Z	3.25	72.2	20.7		133.9	
10416-AAA	IEEE 802.11g WiFi 2.4 GHz (ERP-OFDM, 6 Mbps, 99pc duty cycle)	X	10.11	69.4	21.8	8.23	144.7	±2.5 %
		Y	9.86	68.8	21.4		139.3	
		Z	9.72	68.6	21.3		126.0	

The reported uncertainty of measurement is stated as the standard uncertainty of measurement multiplied by the coverage factor  $k=2$ , which for a normal distribution corresponds to a coverage probability of approximately 95%.

<sup>A</sup> The uncertainties of Norm X,Y,Z do not affect the  $E^2$ -field uncertainty inside TSL (see Pages 7 and 8).

<sup>B</sup> Numerical linearization parameter: uncertainty not required.

<sup>E</sup> Uncertainty is determined using the max. deviation from linear response applying rectangular distribution and is expressed for the square of the field value.

## DASY/EASY - Parameters of Probe: ES3DV3 - SN:3333

### Calibration Parameter Determined In Head Tissue Simulating Media

f (MHz) <sup>c</sup>	Relative Permittivity <sup>F</sup>	Conductivity (S/m) <sup>F</sup>	ConvF X	ConvF Y	ConvF Z	Alpha <sup>G</sup>	Depth <sup>G</sup> (mm)	Unc (k=2)
750	41.9	0.89	6.46	6.46	6.46	0.75	1.22	± 12.0 %
835	41.5	0.90	6.16	6.16	6.16	0.36	1.67	± 12.0 %
1750	40.1	1.37	5.21	5.21	5.21	0.80	1.19	± 12.0 %
1900	40.0	1.40	5.03	5.03	5.03	0.73	1.25	± 12.0 %
2300	39.5	1.67	4.73	4.73	4.73	0.60	1.43	± 12.0 %
2450	39.2	1.80	4.53	4.53	4.53	0.80	1.28	± 12.0 %
2600	39.0	1.96	4.39	4.39	4.39	0.80	1.29	± 12.0 %

<sup>c</sup> Frequency validity above 300 MHz of ± 100 MHz only applies for DASY v4.4 and higher (see Page 2), else it is restricted to ± 50 MHz. The uncertainty is the RSS of the ConvF uncertainty at calibration frequency and the uncertainty for the indicated frequency band. Frequency validity below 300 MHz is ± 10, 25, 40, 50 and 70 MHz for ConvF assessments at 30, 64, 128, 150 and 220 MHz respectively. Above 5 GHz frequency validity can be extended to ± 110 MHz.

<sup>F</sup> At frequencies below 3 GHz, the validity of tissue parameters ( $\epsilon$  and  $\sigma$ ) can be relaxed to ± 10% if liquid compensation formula is applied to measured SAR values. At frequencies above 3 GHz, the validity of tissue parameters ( $\epsilon$  and  $\sigma$ ) is restricted to ± 5%. The uncertainty is the RSS of the ConvF uncertainty for indicated target tissue parameters.

<sup>G</sup> Alpha/Depth are determined during calibration. SPEAG warrants that the remaining deviation due to the boundary effect after compensation is always less than ± 1% for frequencies below 3 GHz and below ± 2% for frequencies between 3-6 GHz at any distance larger than half the probe tip diameter from the boundary.

## DASY/EASY - Parameters of Probe: ES3DV3 - SN:3333

### Calibration Parameter Determined in Body Tissue Simulating Media

f (MHz) <sup>c</sup>	Relative Permittivity <sup>F</sup>	Conductivity (S/m) <sup>F</sup>	ConvF X	ConvF Y	ConvF Z	Alpha <sup>g</sup>	Depth <sup>g</sup> (mm)	Unc (k=2)
750	55.5	0.98	6.31	6.31	6.31	0.70	1.26	± 12.0 %
835	55.2	0.97	6.25	6.25	6.25	0.47	1.54	± 12.0 %
1750	53.4	1.49	4.90	4.90	4.90	0.49	1.63	± 12.0 %
1900	53.3	1.52	4.70	4.70	4.70	0.54	1.49	± 12.0 %
2300	52.9	1.81	4.51	4.51	4.51	0.80	1.15	± 12.0 %
2450	52.7	1.95	4.34	4.34	4.34	0.80	1.15	± 12.0 %
2600	52.5	2.16	4.23	4.23	4.23	0.80	1.03	± 12.0 %

<sup>c</sup> Frequency validity above 300 MHz of ± 100 MHz only applies for DASY v4.4 and higher (see Page 2), else it is restricted to ± 50 MHz. The uncertainty is the RSS of the ConvF uncertainty at calibration frequency and the uncertainty for the indicated frequency band. Frequency validity below 300 MHz is ± 10, 25, 40, 50 and 70 MHz for ConvF assessments at 30, 64, 128, 160 and 220 MHz respectively. Above 5 GHz frequency validity can be extended to ± 110 MHz.

<sup>F</sup> At frequencies below 3 GHz, the validity of tissue parameters ( $\epsilon$  and  $\sigma$ ) can be relaxed to ± 10% if liquid compensation formula is applied to measured SAR values. At frequencies above 3 GHz, the validity of tissue parameters ( $\epsilon$  and  $\sigma$ ) is restricted to ± 5%. The uncertainty is the RSS of the ConvF uncertainty for indicated target tissue parameters.

<sup>g</sup> Alpha/Depth are determined during calibration. SPEAG warrants that the remaining deviation due to the boundary effect after compensation is always less than ± 1% for frequencies below 3 GHz and below ± 2% for frequencies between 3-6 GHz at any distance larger than half the probe tip diameter from the boundary.

### Frequency Response of E-Field (TEM-Cell:ifi110 EXX, Waveguide: R22)

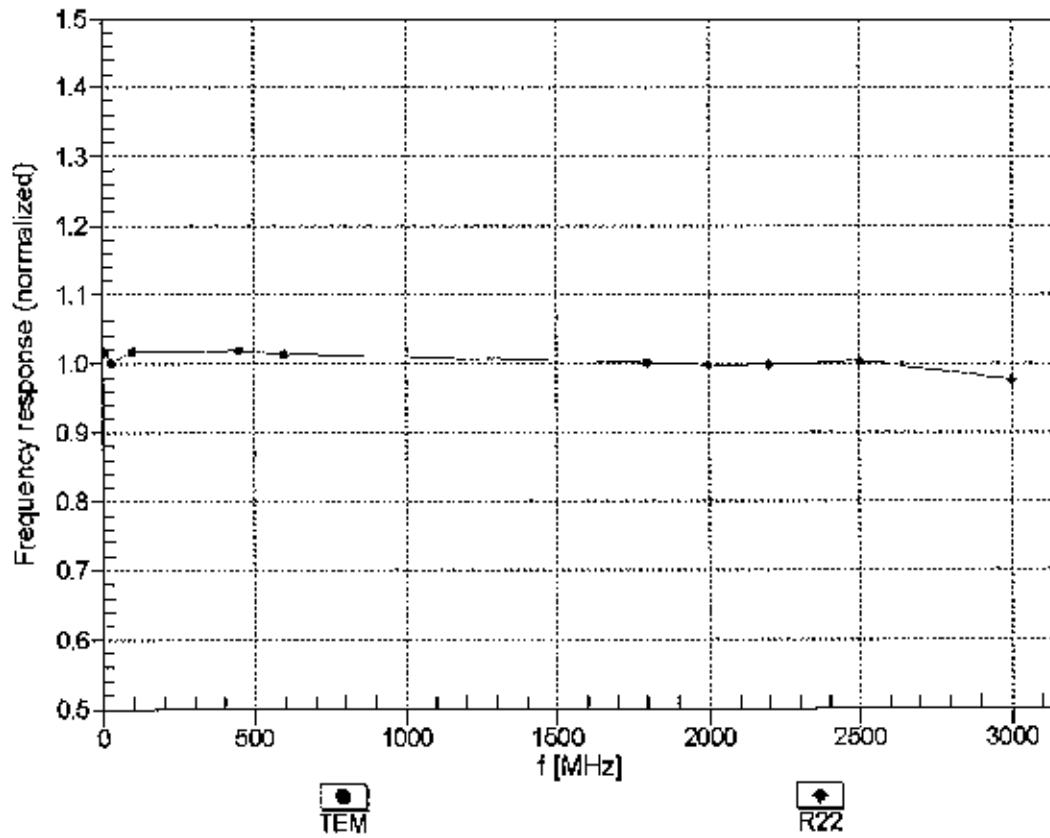

Uncertainty of Frequency Response of E-field:  $\pm 6.3\%$  (k=2)

### Receiving Pattern ( $\phi$ ), $\theta = 0^\circ$

f=600 MHz,TEM

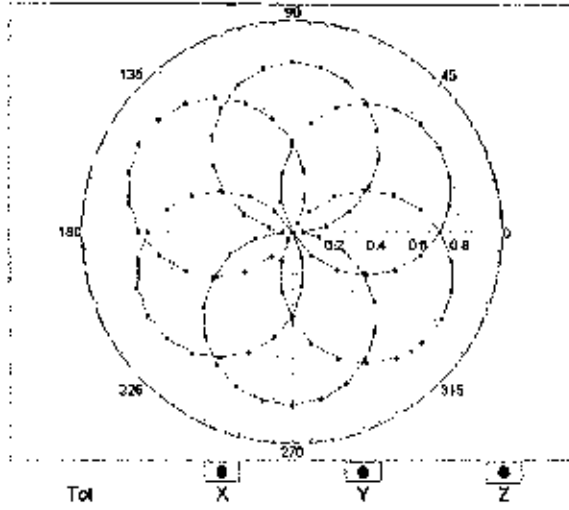

f=1800 MHz,R22

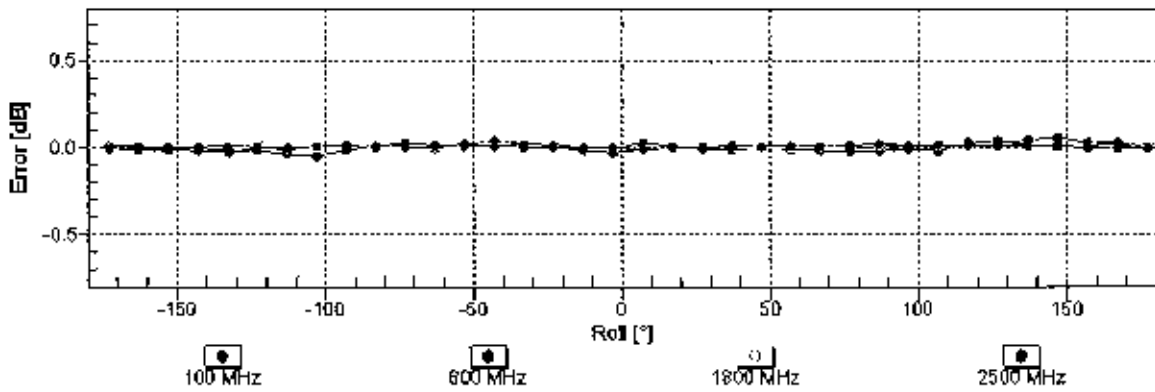
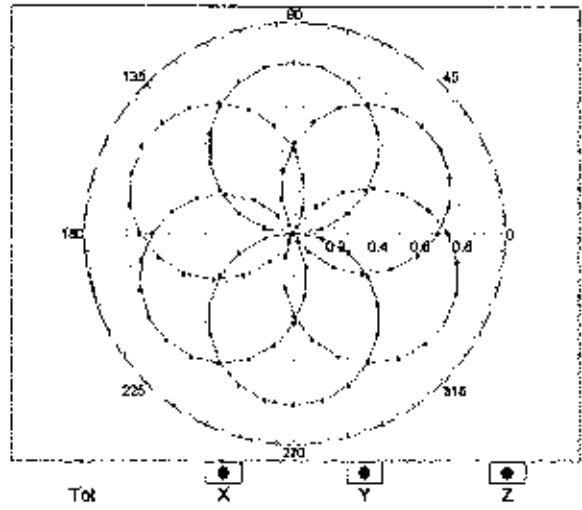

Uncertainty of Axial Isotropy Assessment:  $\pm 0.5\%$  (k=2)

### Dynamic Range f(SAR<sub>head</sub>) (TEM cell , f<sub>eval</sub>= 1900 MHz)

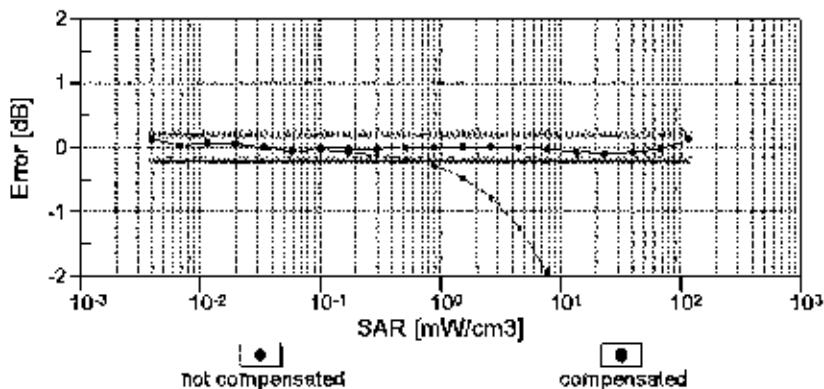
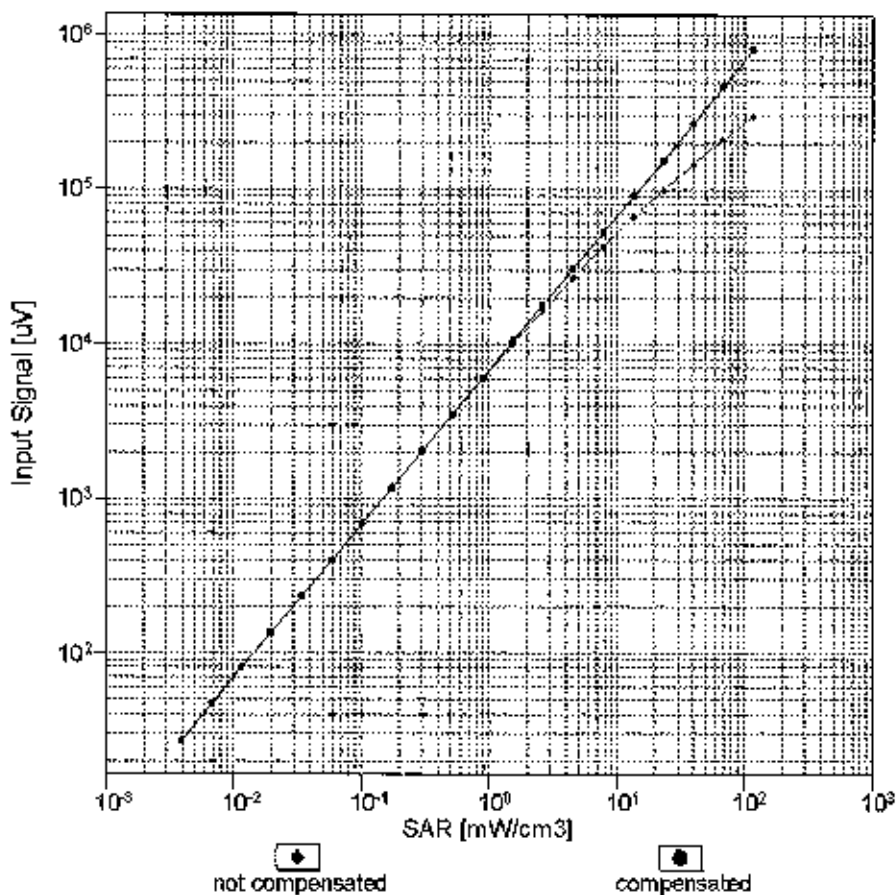

Uncertainty of Linearity Assessment: ± 0.6% (k=2)

## Conversion Factor Assessment

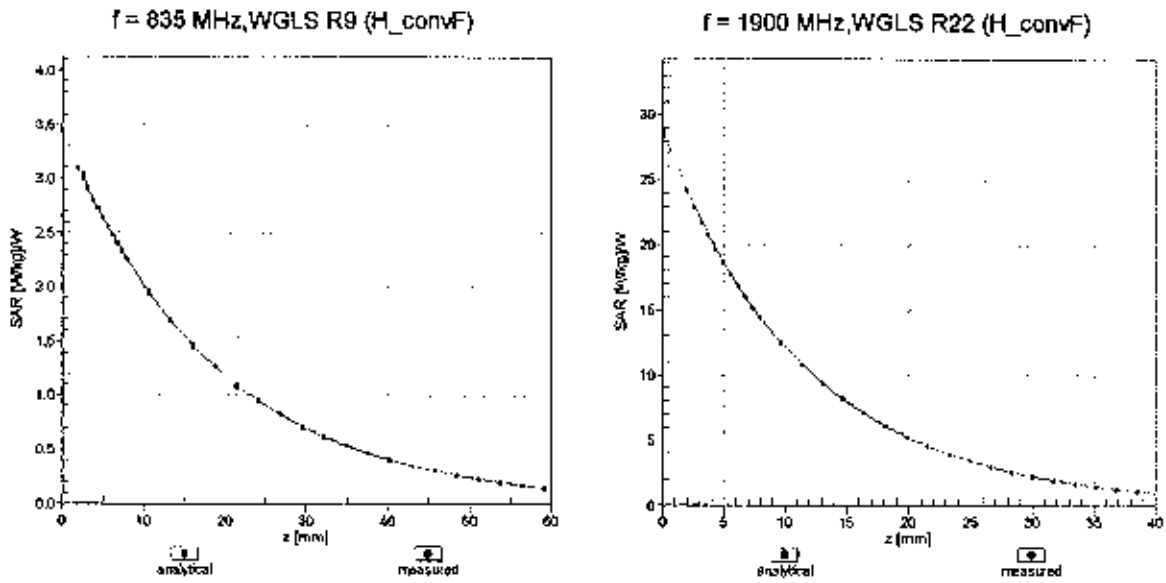

## Deviation from Isotropy in Liquid Error ( $\phi, \theta$ ), f = 900 MHz

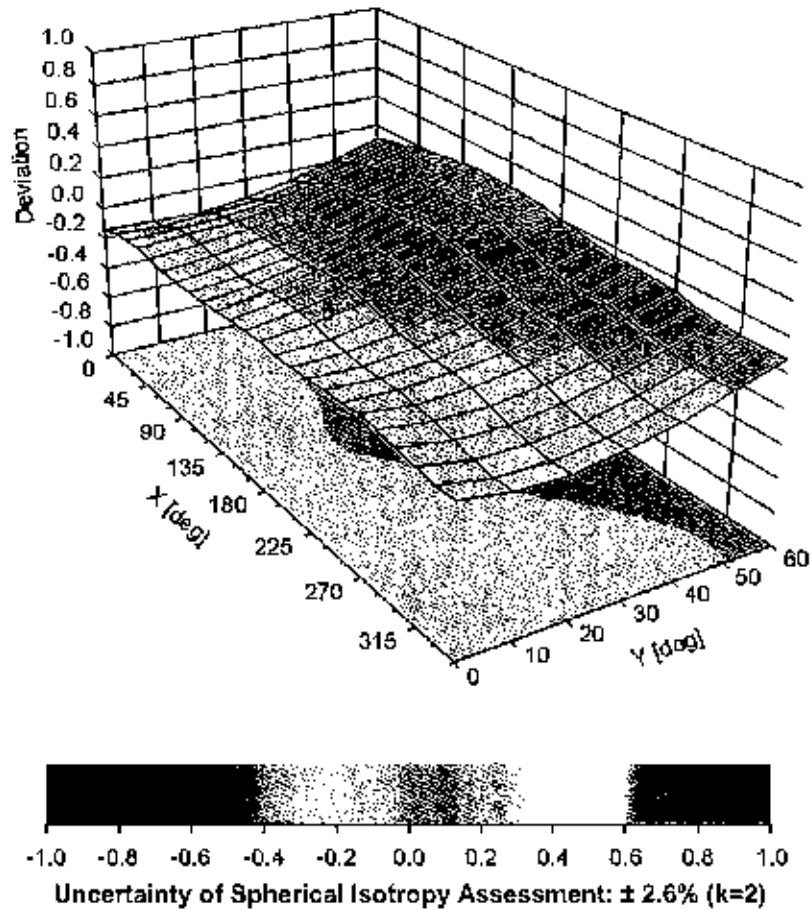

**DASY/EASY - Parameters of Probe: ES3DV3 - SN:3333****Other Probe Parameters**

Sensor Arrangement	Triangular
Connector Angle (°)	-32.8
Mechanical Surface Detection Mode	enabled
Optical Surface Detection Mode	disabled
Probe Overall Length	337 mm
Probe Body Diameter	10 mm
Tip Length	10 mm
Tip Diameter	4 mm
Probe Tip to Sensor X Calibration Point	2 mm
Probe Tip to Sensor Y Calibration Point	2 mm
Probe Tip to Sensor Z Calibration Point	2 mm
Recommended Measurement Distance from Surface	3 mm



Accredited by the Swiss Accreditation Service (SAS)  
The Swiss Accreditation Service is one of the signatories to the EA  
Multilateral Agreement for the recognition of calibration certificates

Accreditation No.: **SCS 0108**

Client **PG Test**

Certificate No: **ES3-3334\_Nov15**

**CALIBRATION CERTIFICATE**

Object **ES3DV3 - SN:3334**

Calibration procedure(s) **QA CAL-01.v9, QA CAL-12.v9, QA CAL-23.v5, QA CAL-25.v6**  
**Calibration procedure for dosimetric E-field probes**

Calibration date: **November 17, 2015**

This calibration certificate documents the traceability to national standards, which realize the physical units of measurements (SI).  
The measurements and the uncertainties with confidence probability are given on the following pages and are part of the certificate.

All calibrations have been conducted in the closed laboratory facility: environment temperature (22 ± 3)°C and humidity < 70%.

Calibration Equipment used (M&TE critical for calibration)

*BV*  
*11/24/15*

Primary Standards	ID	Cal Date (Certificate No.)	Scheduled Calibration
Power meter E4419B	GB41293874	01-Apr-15 (No. 217-02128)	Mar-16
Power sensor E4412A	MY41498087	01-Apr-15 (No. 217-02128)	Mar-16
Reference 3 dB Attenuator	SN: S5054 (3c)	01-Apr-15 (No. 217-02129)	Mar-16
Reference 20 dB Attenuator	SN: S5277 (20x)	01-Apr-15 (No. 217-02132)	Mar-16
Reference 30 dB Attenuator	SN: S5129 (30b)	01-Apr-15 (No. 217-02133)	Mar-16
Reference Probe ES3DV2	SN: 3013	30-Dec-14 (No. ES3-3013 Dec14)	Dec-15
DAE4	SN: 660	14-Jan-15 (No. DAE4-660_Jan15)	Jan-16
Secondary Standards	ID	Check Date (in house)	Scheduled Check
RF generator HP 8648C	US3642U01700	4-Aug-99 (in house check Apr-13)	In house check: Apr-16
Network Analyzer HP 8753E	US3739J585	18-Oct-01 (in house check Oct-15)	In house check: Oct-16

	Name	Function	Signature
Calibrated by:	Jeton Kasrati	Laboratory Technician	<i>[Signature]</i>
Approved by:	Katja Pokovic	Technical Manager	<i>[Signature]</i>

Issued: November 17, 2015

This calibration certificate shall not be reproduced except in full without written approval of the laboratory.



Accredited by the Swiss Accreditation Service (SAS)

Accreditation No.: **SCS 0108**

The Swiss Accreditation Service is one of the signatories to the EA Multilateral Agreement for the recognition of calibration certificates

### Glossary:

TSL	tissue simulating liquid
NORM <sub>x,y,z</sub>	sensitivity in free space
ConvF	sensitivity in TSL / NORM <sub>x,y,z</sub>
DCP	diode compression point
CF	crest factor (1/duty_cycle) of the RF signal
A, B, C, D	modulation dependent linearization parameters
Polarization $\phi$	$\phi$ rotation around probe axis
Polarization $\vartheta$	$\vartheta$ rotation around an axis that is in the plane normal to probe axis (at measurement center), i.e., $\vartheta = 0$ is normal to probe axis
Connector Angle	information used in DASY system to align probe sensor X to the robot coordinate system

### Calibration is Performed According to the Following Standards:

- IEEE Std 1528-2013, "IEEE Recommended Practice for Determining the Peak Spatial-Averaged Specific Absorption Rate (SAR) in the Human Head from Wireless Communications Devices: Measurement Techniques", June 2013
- IEC 62209-1, "Procedure to measure the Specific Absorption Rate (SAR) for hand-held devices used in close proximity to the ear (frequency range of 300 MHz to 3 GHz)", February 2005
- IEC 62209-2, "Procedure to determine the Specific Absorption Rate (SAR) for wireless communication devices used in close proximity to the human body (frequency range of 30 MHz to 6 GHz)", March 2010
- KDB 865664, "SAR Measurement Requirements for 100 MHz to 6 GHz"

### Methods Applied and Interpretation of Parameters:

- NORM<sub>x,y,z</sub>**: Assessed for E-field polarization  $\vartheta = 0$  ( $f \leq 900$  MHz in TEM-cell;  $f > 1800$  MHz: R22 waveguide). NORM<sub>x,y,z</sub> are only intermediate values, i.e., the uncertainties of NORM<sub>x,y,z</sub> does not affect the E<sup>2</sup>-field uncertainty inside TSL (see below ConvF).
- NORM(f)<sub>x,y,z</sub>** = NORM<sub>x,y,z</sub> \* frequency\_response (see Frequency Response Chart). This linearization is implemented in DASY4 software versions later than 4.2. The uncertainty of the frequency response is included in the stated uncertainty of ConvF.
- DCP<sub>x,y,z</sub>**: DCP are numerical linearization parameters assessed based on the data of power sweep with CW signal (no uncertainty required). DCP does not depend on frequency nor media.
- PAR**: PAR is the Peak to Average Ratio that is not calibrated but determined based on the signal characteristics
- A<sub>x,y,z</sub>; B<sub>x,y,z</sub>; C<sub>x,y,z</sub>; D<sub>x,y,z</sub>; VR<sub>x,y,z</sub>**; A, B, C, D are numerical linearization parameters assessed based on the data of power sweep for specific modulation signal. The parameters do not depend on frequency nor media. VR is the maximum calibration range expressed in RMS voltage across the diode.
- ConvF and Boundary Effect Parameters**: Assessed in flat phantom using E-field (or Temperature Transfer Standard for  $f \leq 800$  MHz) and inside waveguide using analytical field distributions based on power measurements for  $f > 800$  MHz. The same setups are used for assessment of the parameters applied for boundary compensation (alpha, depth) of which typical uncertainty values are given. These parameters are used in DASY4 software to improve probe accuracy close to the boundary. The sensitivity in TSL corresponds to NORM<sub>x,y,z</sub> \* ConvF whereby the uncertainty corresponds to that given for ConvF. A frequency dependent ConvF is used in DASY version 4.4 and higher which allows extending the validity from  $\pm 50$  MHz to  $\pm 100$  MHz.
- Spherical isotropy (3D deviation from isotropy)**: in a field of low gradients realized using a flat phantom exposed by a patch antenna.
- Sensor Offset**: The sensor offset corresponds to the offset of virtual measurement center from the probe tip (on probe axis). No tolerance required.
- Connector Angle**: The angle is assessed using the information gained by determining the NORM<sub>x</sub> (no uncertainty required).

# Probe ES3DV3

## SN:3334

Manufactured: January 24, 2012  
Calibrated: November 17, 2015

Calibrated for DASY/EASY Systems  
(Note: non-compatible with DASY2 system!)

## DASY/EASY - Parameters of Probe: ES3DV3 - SN:3334

### Basic Calibration Parameters

	Sensor X	Sensor Y	Sensor Z	Unc (k=2)
Norm ( $\mu\text{V}/(\text{V}/\text{m})^2$ ) <sup>A</sup>	1.03	1.03	0.99	$\pm 10.1\%$
DCP (mV) <sup>B</sup>	107.6	105.3	107.9	

### Modulation Calibration Parameters

UID	Communication System Name		A dB	B dB/ $\mu\text{V}$	C	D dB	VR mV	Unc <sup>E</sup> (k=2)
0	CW	X	0.0	0.0	1.0	0.00	192.1	$\pm 2.7\%$
		Y	0.0	0.0	1.0		183.6	
		Z	0.0	0.0	1.0		183.3	
10010- CAA	SAR Validation (Square, 100ms, 10ms)	X	2.27	60.1	10.2	10.00	38.6	$\pm 1.4\%$
		Y	1.99	59.3	10.2		38.4	
		Z	5.38	67.8	12.9		37.2	
10011- CAB	UMTS-FDD (WCDMA)	X	3.40	68.0	18.9	2.91	131.7	$\pm 0.5\%$
		Y	3.27	67.0	18.2		130.2	
		Z	3.41	68.3	19.1		148.5	
10012- CAB	IEEE 802.11b WiFi 2.4 GHz (DSSS, 1 Mbps)	X	2.93	68.9	18.7	1.87	132.9	$\pm 0.7\%$
		Y	3.12	69.6	18.8		130.2	
		Z	3.24	71.1	19.7		128.2	
10013- CAB	IEEE 802.11g WiFi 2.4 GHz (DSSS-OFDM, 6 Mbps)	X	10.90	70.3	23.0	9.46	133.5	$\pm 3.3\%$
		Y	10.53	69.0	22.1		124.6	
		Z	11.14	71.2	23.6		147.1	
10021- DAB	GSM-FDD (TDMA, GMSK)	X	15.05	91.0	24.4	9.39	139.5	$\pm 1.9\%$
		Y	10.11	85.5	23.3		131.9	
		Z	11.84	87.6	23.4		130.0	
10023- DAB	GPRS-FDD (TDMA, GMSK, TN 0)	X	10.42	84.9	22.6	9.57	131.5	$\pm 3.0\%$
		Y	13.29	89.7	24.6		141.1	
		Z	14.17	90.2	24.2		148.7	
10024- DAB	GPRS-FDD (TDMA, GMSK, TN 0-1)	X	11.26	83.1	19.4	6.56	140.7	$\pm 1.9\%$
		Y	26.29	95.5	23.8		134.7	
		Z	16.82	88.9	21.3		131.6	
10027- DAB	GPRS-FDD (TDMA, GMSK, TN 0-1-2)	X	64.74	99.9	22.2	4.80	131.5	$\pm 2.2\%$
		Y	56.71	99.8	22.7		124.7	
		Z	63.10	99.9	22.2		124.1	
10028- DAB	GPRS-FDD (TDMA, GMSK, TN 0-1-2-3)	X	62.11	99.6	21.6	3.55	146.1	$\pm 1.9\%$
		Y	77.61	99.8	21.2		132.0	
		Z	72.33	99.7	21.2		133.3	
10032- CAA	IEEE 802.15.1 Bluetooth (GFSK, DH5)	X	96.24	92.7	15.9	1.16	137.2	$\pm 1.7\%$
		Y	95.69	93.1	16.2		129.5	
		Z	98.67	94.1	16.4		149.7	
10100- CAB	LTE-FDD (SC-FDMA, 100% RB, 20 MHz, QPSK)	X	6.14	66.8	19.2	5.67	126.2	$\pm 1.7\%$
		Y	6.21	66.8	19.1		139.9	
		Z	6.41	67.9	19.9		145.9	

10103-CAB	LTE-TDD (SC-FDMA, 100% RB, 20 MHz, QPSK)	X	10.07	75.4	25.8	9.29	138.2	±2.5 %
		Y	9.54	73.3	24.5		130.5	
		Z	9.84	75.1	25.8		130.6	
10108-CAC	LTE-FDD (SC-FDMA, 100% RB, 10 MHz, QPSK)	X	6.34	67.6	19.8	5.80	149.5	±1.4 %
		Y	6.13	66.6	19.1		132.1	
		Z	6.19	67.2	19.7		137.8	
10117-CAB	IEEE 802.11n (HT Mixed, 13.5 Mbps, BPSK)	X	10.13	68.9	21.2	8.07	138.8	±2.7 %
		Y	10.16	68.9	21.1		149.6	
		Z	9.96	68.7	21.1		127.1	
10151-CAB	LTE-TDD (SC-FDMA, 50% RB, 20 MHz, QPSK)	X	9.42	74.4	25.5	9.28	132.9	±3.0 %
		Y	9.50	74.0	25.0		143.7	
		Z	9.01	73.4	25.0		126.5	
10154-CAC	LTE-FDD (SC-FDMA, 50% RB, 10 MHz, QPSK)	X	6.03	67.1	19.6	5.75	145.5	±1.4 %
		Y	5.81	66.0	18.9		128.9	
		Z	5.91	66.8	19.5		135.1	
10160-CAB	LTE-FDD (SC-FDMA, 50% RB, 15 MHz, QPSK)	X	6.19	66.5	19.2	5.82	126.7	±1.4 %
		Y	6.20	66.4	19.0		132.8	
		Z	6.39	67.5	19.8		141.1	
10169-CAB	LTE-FDD (SC-FDMA, 1 RB, 20 MHz, QPSK)	X	5.05	67.6	20.0	5.73	146.8	±1.4 %
		Y	4.82	66.2	19.2		132.2	
		Z	4.96	67.4	20.0		143.8	
10172-CAB	LTE-TDD (SC-FDMA, 1 RB, 20 MHz, QPSK)	X	8.88	79.7	28.3	9.21	147.9	±3.0 %
		Y	8.00	76.1	26.2		138.9	
		Z	8.39	78.5	27.8		141.5	
10175-CAC	LTE-FDD (SC-FDMA, 1 RB, 10 MHz, QPSK)	X	4.99	67.3	19.9	5.72	140.7	±1.2 %
		Y	4.80	66.2	19.1		131.3	
		Z	4.90	67.1	19.8		136.1	
10181-CAB	LTE-FDD (SC-FDMA, 1 RB, 15 MHz, QPSK)	X	4.99	67.3	19.9	5.72	145.4	±1.4 %
		Y	4.81	66.2	19.2		130.9	
		Z	4.89	67.1	19.8		136.0	
10196-CAB	IEEE 802.11n (HT Mixed, 6.5 Mbps, BPSK)	X	9.78	68.8	21.3	8.10	131.0	±2.5 %
		Y	9.73	68.4	21.0		140.7	
		Z	9.94	69.4	21.6		146.6	
10225-CAB	UMTS-FDD (HSPA+)	X	6.88	66.9	19.3	5.97	133.9	±1.7 %
		Y	6.96	67.1	19.3		144.8	
		Z	6.71	66.6	19.2		125.7	
10237-CAB	LTE-TDD (SC-FDMA, 1 RB, 10 MHz, QPSK)	X	9.00	80.2	28.5	9.21	148.2	±3.0 %
		Y	7.73	75.1	25.7		131.6	
		Z	8.27	78.2	27.7		136.1	
10252-CAB	LTE-TDD (SC-FDMA, 50% RB, 10 MHz, QPSK)	X	9.59	76.3	26.7	9.24	144.1	±2.7 %
		Y	8.74	72.9	24.5		133.4	
		Z	9.14	75.2	26.1		136.9	
10267-CAB	LTE-TDD (SC-FDMA, 100% RB, 10 MHz, QPSK)	X	9.25	73.9	25.3	9.30	124.8	±3.0 %
		Y	9.40	73.7	24.9		142.1	
		Z	9.86	76.1	26.5		145.3	

10275-CAB	UMTS-FDD (HSUPA, Subtest 5, 3GPP Rel8.4)	X	4.38	66.9	18.7	3.96	133.3	±0.9 %
		Y	4.44	66.9	18.6		148.2	
		Z	4.30	66.7	18.6		128.9	
10291-AAB	CDMA2000, RC3, SQ55, Full Rate	X	3.68	67.3	18.7	3.46	145.8	±0.7 %
		Y	3.58	66.6	18.2		136.3	
		Z	3.62	67.3	18.8		139.4	
10292-AAB	CDMA2000, RC3, SQ32, Full Rate	X	3.73	68.0	19.1	3.39	147.5	±0.7 %
		Y	3.55	66.7	18.3		138.5	
		Z	3.60	67.6	18.9		143.0	
10297-AAA	LTE-FDD (SC-FDMA, 50% RB, 20 MHz, QPSK)	X	6.30	67.4	19.7	5.81	141.4	±1.2 %
		Y	6.11	66.5	19.1		130.3	
		Z	6.17	67.0	19.5		138.8	
10311-AAA	LTE-FDD (SC-FDMA, 100% RB, 15 MHz, QPSK)	X	6.88	68.0	20.1	6.06	147.0	±1.7 %
		Y	6.68	67.1	19.5		136.0	
		Z	6.75	67.7	20.0		141.6	
10400-AAC	IEEE 802.11ac WiFi (20MHz, 64-QAM, 99pc duty cycle)	X	9.97	68.8	21.4	8.37	126.9	±2.7 %
		Y	10.07	68.9	21.4		143.6	
		Z	10.21	69.7	22.0		147.4	
10403-AAB	CDMA2000 (1xEV-DO, Rev. 0)	X	4.77	68.5	18.8	3.76	134.9	±0.5 %
		Y	4.69	68.1	18.5		126.7	
		Z	4.74	68.8	18.9		129.4	
10404-AAB	CDMA2000 (1xEV-DO, Rev. A)	X	4.72	68.7	18.8	3.77	132.9	±0.7 %
		Y	4.78	68.9	18.9		147.4	
		Z	4.63	68.7	18.9		127.1	
10415-AAA	IEEE 802.11b WiFi 2.4 GHz (DSSS, 1 Mbps, 99pc duty cycle)	X	2.72	68.9	18.8	1.54	131.9	±0.5 %
		Y	2.65	68.0	18.1		145.9	
		Z	2.72	69.3	19.0		127.3	
10416-AAA	IEEE 802.11g WiFi 2.4 GHz (ERP-OFDM, 6 Mbps, 99pc duty cycle)	X	9.81	68.6	21.2	8.23	131.6	±2.7 %
		Y	9.90	68.7	21.2		144.1	
		Z	9.97	69.3	21.7		146.0	

The reported uncertainty of measurement is stated as the standard uncertainty of measurement multiplied by the coverage factor  $k=2$ , which for a normal distribution corresponds to a coverage probability of approximately 95%.

<sup>A</sup> The uncertainties of Norm X,Y,Z do not affect the  $E^2$ -field uncertainty inside TSL (see Pages 7 and 8).

<sup>B</sup> Numerical linearization parameter: uncertainty not required.

<sup>C</sup> Uncertainty is determined using the max. deviation from linear response applying rectangular distribution and is expressed for the square of the field value.

## DASY/EASY - Parameters of Probe: ES3DV3 - SN:3334

### Calibration Parameter Determined in Head Tissue Simulating Media

f (MHz) <sup>c</sup>	Relative Permittivity <sup>e</sup>	Conductivity (S/m) <sup>e</sup>	ConvF X	ConvF Y	ConvF Z	Alpha <sup>g</sup>	Depth (mm) <sup>h</sup>	Unc (k=2)
6	55.5	0.75	6.13	6.13	6.13	0.00	1.00	± 13.3 %
13	55.5	0.75	5.76	5.76	5.76	0.00	1.00	± 13.3 %
750	41.9	0.89	6.56	6.56	6.56	0.24	2.36	± 12.0 %
835	41.5	0.90	6.37	6.37	6.37	0.37	1.70	± 12.0 %
1750	40.1	1.37	5.39	5.39	5.39	0.58	1.32	± 12.0 %
1900	40.0	1.40	5.18	5.18	5.18	0.77	1.20	± 12.0 %
2300	39.5	1.67	4.85	4.85	4.85	0.71	1.28	± 12.0 %
2450	39.2	1.80	4.58	4.58	4.58	0.79	1.17	± 12.0 %
2600	39.0	1.96	4.46	4.46	4.46	0.80	1.26	± 12.0 %

<sup>c</sup> Frequency validity above 300 MHz of ± 100 MHz only applies for DASY v4.4 and higher (see Page 2), else it is restricted to ± 50 MHz. The uncertainty is the RSS of the ConvF uncertainty at calibration frequency and the uncertainty for the indicated frequency band. Frequency validity below 300 MHz is ± 10, 25, 40, 50 and 70 MHz for ConvF assessments at 30, 64, 128, 150 and 220 MHz respectively. Above 5 GHz frequency validity can be extended to ± 110 MHz.

<sup>e</sup> At frequencies below 3 GHz, the validity of tissue parameters ( $\epsilon$  and  $\sigma$ ) can be relaxed to ± 10% if liquid compensation formula is applied to measured SAR values. At frequencies above 3 GHz, the validity of tissue parameters ( $\epsilon$  and  $\sigma$ ) is restricted to ± 5%. The uncertainty is the RSS of the ConvF uncertainty for indicated target tissue parameters.

<sup>g</sup> Alpha/Depth are determined during calibration. SPEAG warrants that the remaining deviation due to the boundary effect after compensation is always less than ± 1% for frequencies below 3 GHz and below ± 2% for frequencies between 3-6 GHz at any distance larger than half the probe tip diameter from the boundary.

## DASY/EASY - Parameters of Probe: ES3DV3 - SN:3334

### Calibration Parameter Determined in Body Tissue Simulating Media

f (MHz) <sup>c</sup>	Relative Permittivity <sup>f</sup>	Conductivity (S/m) <sup>f</sup>	ConvF X	ConvF Y	ConvF Z	Alpha <sup>g</sup>	Depth <sup>g</sup> (mm)	Unc (k=2)
750	55.5	0.96	6.37	6.37	6.37	0.74	1.22	± 12.0 %
835	55.2	0.97	6.24	6.24	6.24	0.31	1.94	± 12.0 %
1750	53.4	1.49	5.03	5.03	5.03	0.50	1.57	± 12.0 %
1900	53.3	1.52	4.84	4.84	4.84	0.50	1.58	± 12.0 %
2300	52.9	1.81	4.61	4.61	4.61	0.74	1.23	± 12.0 %
2450	52.7	1.95	4.45	4.45	4.45	0.74	1.20	± 12.0 %
2600	52.5	2.16	4.29	4.29	4.29	0.80	1.20	± 12.0 %

<sup>c</sup> Frequency validity above 300 MHz of ± 100 MHz only applies for DASY v4.4 and higher (see Page 2), else it is restricted to ± 50 MHz. The uncertainty is the RSS of the ConvF uncertainty at calibration frequency and the uncertainty for the indicated frequency band. Frequency validity below 300 MHz is ± 10, 25, 40, 50 and 70 MHz for ConvF assessments at 30, 64, 128, 150 and 220 MHz respectively. Above 5 GHz frequency validity can be extended to ± 110 MHz.

<sup>f</sup> At frequencies below 3 GHz, the validity of tissue parameters ( $\epsilon$  and  $\sigma$ ) can be relaxed to ± 10% if liquid compensation formula is applied to measured SAR values. At frequencies above 3 GHz, the validity of tissue parameters ( $\epsilon$  and  $\sigma$ ) is restricted to ± 5%. The uncertainty is the RSS of the ConvF uncertainty for indicated target tissue parameters.

<sup>g</sup> Alpha/Depth are determined during calibration. SPEAG warrants that the remaining deviation due to the boundary effect after compensation is always less than ± 1% for frequencies below 3 GHz and below ± 2% for frequencies between 3-6 GHz at any distance larger than half the probe tip diameter from the boundary.

# Frequency Response of E-Field

(TEM-Cell:ifi110 EXX, Waveguide: R22)

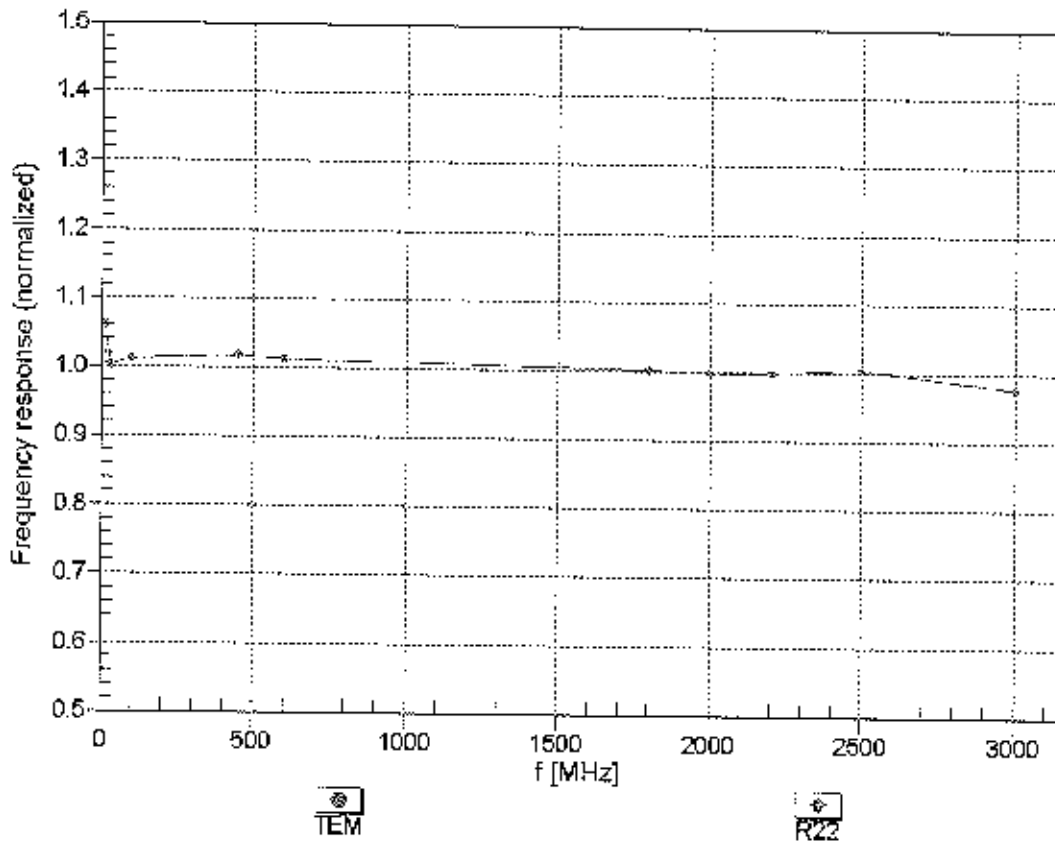

Uncertainty of Frequency Response of E-field:  $\pm 6.3\%$  (k=2)

### Receiving Pattern ( $\phi$ ), $\theta = 0^\circ$

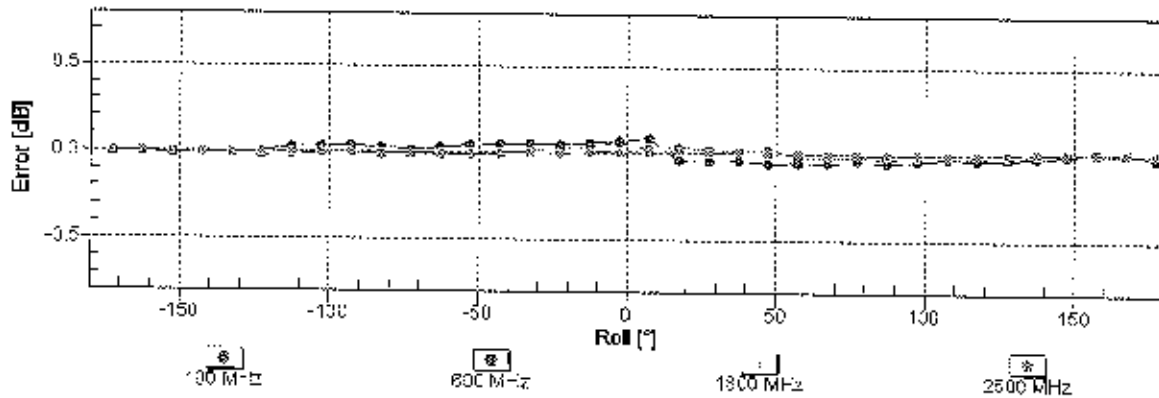
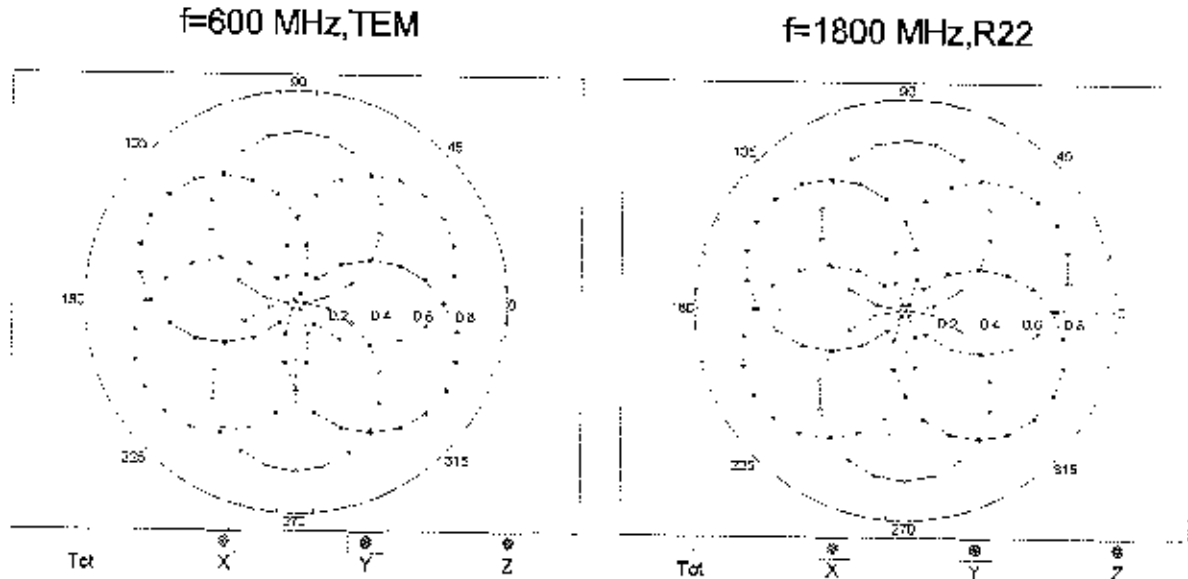

Uncertainty of Axial Isotropy Assessment:  $\pm 0.5\%$  ( $k=2$ )

### Dynamic Range $f(\text{SAR}_{\text{head}})$ (TEM cell, $f_{\text{eval}} = 1900 \text{ MHz}$ )

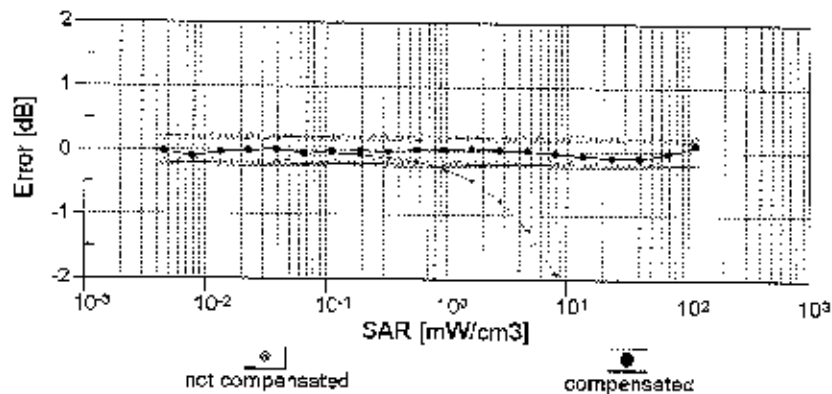
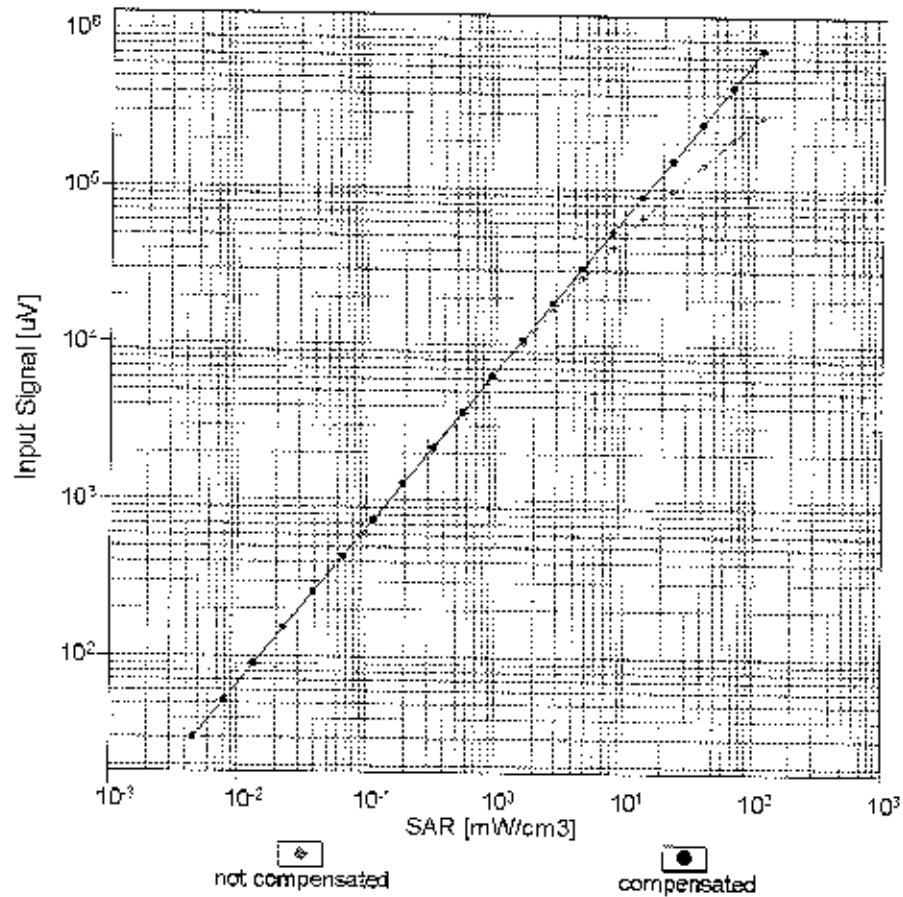

Uncertainty of Linearity Assessment:  $\pm 0.6\%$  ( $k=2$ )

### Conversion Factor Assessment

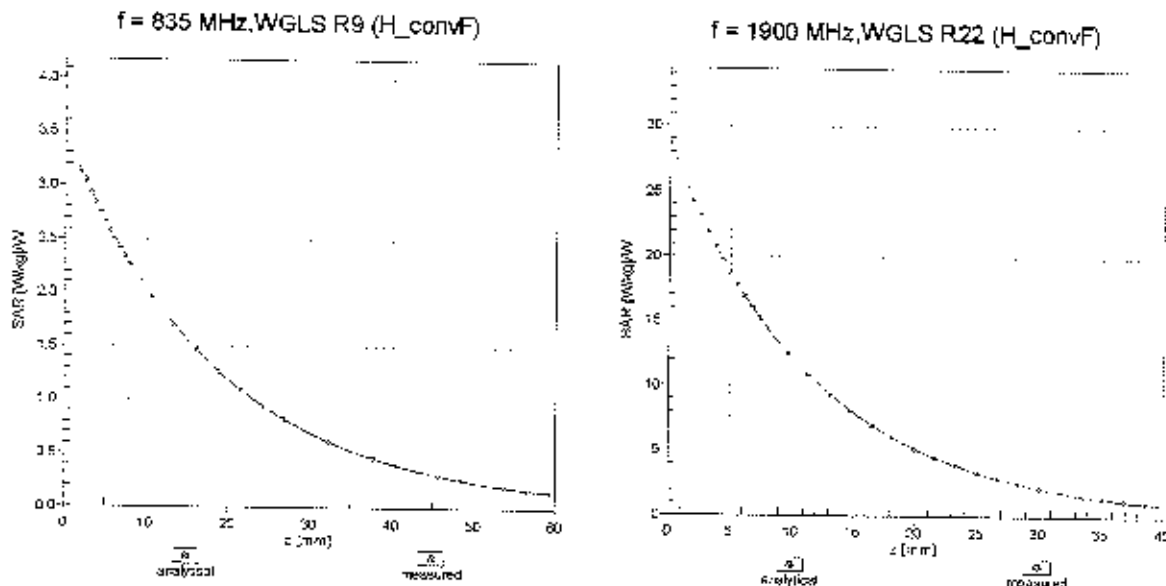

### Deviation from Isotropy in Liquid Error ( $\phi, \theta$ ), f = 900 MHz

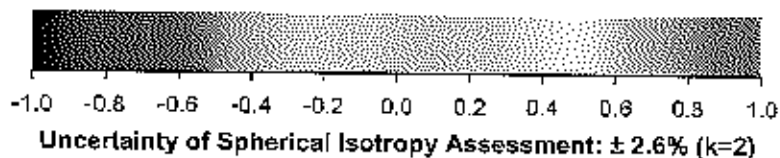
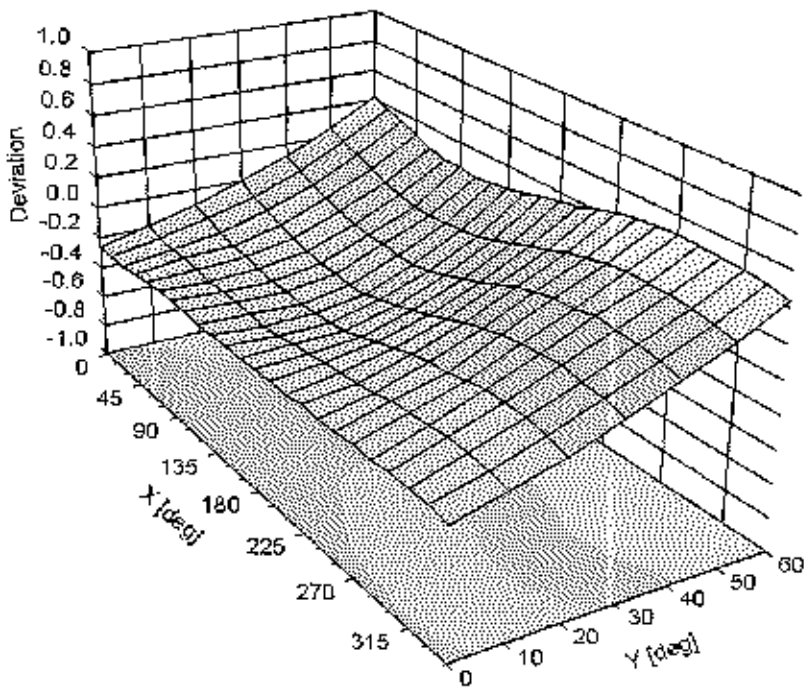

## DASY/EASY - Parameters of Probe: ES3DV3 - SN:3334

### Other Probe Parameters

Sensor Arrangement	Triangular
Connector Angle (°)	17.4
Mechanical Surface Detection Mode	enabled
Optical Surface Detection Mode	disabled
Probe Overall Length	337 mm
Probe Body Diameter	10 mm
Tip Length	10 mm
Tip Diameter	4 mm
Probe Tip to Sensor X Calibration Point	2 mm
Probe Tip to Sensor Y Calibration Point	2 mm
Probe Tip to Sensor Z Calibration Point	2 mm
Recommended Measurement Distance from Surface	3 mm

## APPENDIX D: SAR TISSUE SPECIFICATIONS

Measurement Procedure for Tissue verification:



- 1) The network analyzer and probe system was configured and calibrated.
- 2) The probe was immersed in the tissue. The tissue was placed in a nonmetallic container. Trapped air bubbles beneath the flange were minimized by placing the probe at a slight angle.
- 3) The complex admittance with respect to the probe aperture was measured
- 4) The complex relative permittivity  $\epsilon'$  can be calculated from the below equation (Pournaropoulos and Misra):

$$Y = \frac{j2\omega\epsilon_r\epsilon_0}{[\ln(b/a)]^2} \int_a^b \int_a^b \int_0^\pi \cos\phi' \frac{\exp[-j\omega r(\mu_0\epsilon_r'\epsilon_0)^{1/2}]}{r} d\phi' d\rho' d\rho$$

where  $Y$  is the admittance of the probe in contact with the sample, the primed and unprimed coordinates refer to source and observation points, respectively,  $r^2 = \rho^2 + \rho'^2 - 2\rho\rho' \cos\phi'$ ,  $\omega$  is the angular frequency, and  $j = \sqrt{-1}$ .

**Table D-I  
Composition of the Tissue Equivalent Matter**

Frequency (MHz)	835	835	1900	1900	2450 - 2600	2450 - 2600
Tissue	Head	Body	Head	Body	Head	Body
Ingredients (% by weight)						
Bactericide	0.1	0.1			See page 2	
DGBE			44.92	29.44		26.7
HEC	1	1				
NaCl	1.45	0.94	0.18	0.39		0.1
Sucrose	57	44.9				
Water	40.45	53.06	54.9	70.17		73.2

<b>FCC ID:</b> A3LSMJ120P		<b>SAR EVALUATION REPORT</b>		<b>Reviewed by:</b> Quality Manager
<b>Test Dates:</b> 02/15/16 - 02/26/16	<b>DUT Type:</b> Portable Handset			APPENDIX D: Page 1 of 2

## 2 Composition / Information on ingredients

The Item is composed of the following ingredients:

H <sub>2</sub> O	Water, 52 – 75%
C <sub>8</sub> H <sub>18</sub> O <sub>3</sub>	Diethylene glycol monobutyl ether (DGBE), 25 – 48% (CAS-No. 112-34-5, EC-No. 203-961-6, EC-index-No. 603-096-00-8) Relevant for safety; Refer to the respective Safety Data Sheet*.
NaCl	Sodium Chloride, <1.0%

Figure D-1

### Composition of 2.4 GHz Head Tissue Equivalent Matter

**Note:** 2.4 GHz head liquid recipes are proprietary SPEAG. Since the composition is approximate to the actual liquids utilized, the manufacturer tissue-equivalent liquid data sheets are provided below.

#### Measurement Certificate / Material Test

Item Name	Head Tissue Simulating Liquid (HSL2450V2)
Product No.	SL AAH 245 BA (Charge: 150206-3)
Manufacturer	SPEAG

#### Measurement Method

TSL dielectric parameters measured using calibrated OCP probe.

#### Setup Validation

Validation results were within  $\pm 2.5\%$  towards the target values of Methanol.

#### Target Parameters

Target parameters as defined in the IEEE 1528 and IEC 62209 compliance standards.

#### Test Condition

Ambient	Environment temperatur ( $22 \pm 3$ )°C and humidity < 70%.
TSL Temperature	23°C
Test Date	11-Feb-15
Operator	IEN

#### Additional Information

TSL Density	0.988 g/cm <sup>3</sup>
TSL Heat-capacity	3.680 kJ/(kg*K)

f (MHz)	Measured			Target		Diff.to Target (%)	
	HP-e'	HP-e''	sigma	eps	sigma	Δ-eps	Δ-sigma
1900	40.4	11.89	1.26	40.0	1.40	1.0	-10.2
1925	40.3	11.98	1.28	40.0	1.40	0.7	-8.3
1950	40.2	12.07	1.31	40.0	1.40	0.4	-6.4
1975	40.1	12.15	1.34	40.0	1.40	0.2	-4.6
2000	40.0	12.23	1.36	40.0	1.40	-0.1	-2.8
2025	39.9	12.32	1.39	40.0	1.42	-0.2	-2.4
2050	39.8	12.41	1.42	39.9	1.44	-0.3	-2.0
2075	39.7	12.50	1.44	39.9	1.47	-0.4	-1.6
2100	39.6	12.59	1.47	39.8	1.49	-0.5	-1.2
2125	39.5	12.66	1.50	39.8	1.51	-0.7	-0.9
2150	39.4	12.73	1.52	39.7	1.53	-0.8	-0.7
2175	39.3	12.83	1.55	39.7	1.56	-0.9	-0.2
2200	39.2	12.92	1.58	39.6	1.58	-1.1	0.2
2225	39.1	13.00	1.61	39.6	1.60	-1.2	0.6
2250	39.0	13.08	1.64	39.6	1.62	-1.3	0.9
2275	38.9	13.17	1.67	39.5	1.64	-1.5	1.4
2300	38.8	13.26	1.70	39.5	1.67	-1.7	1.8
2325	38.7	13.34	1.73	39.4	1.69	-1.8	2.2
2350	38.6	13.42	1.75	39.4	1.71	-2.0	2.5
2375	38.5	13.50	1.78	39.3	1.73	-2.1	2.9
2400	38.4	13.58	1.81	39.3	1.76	-2.3	3.3
2425	38.3	13.65	1.84	39.2	1.78	-2.4	3.6
2450	38.2	13.73	1.87	39.2	1.80	-2.6	3.9
2475	38.1	13.80	1.90	39.2	1.83	-2.8	4.0
2500	38.0	13.87	1.93	39.1	1.85	-3.0	4.0
2525	37.9	13.90	1.95	39.1	1.88	-3.1	3.8
2550	37.8	13.93	1.98	39.1	1.91	-3.2	3.5
2575	37.7	14.05	2.01	39.0	1.94	-3.5	4.0
2600	37.6	14.17	2.05	39.0	1.96	-3.7	4.4
2625	37.4	14.23	2.08	39.0	1.99	-3.9	4.4
2650	37.3	14.29	2.11	38.9	2.02	-4.1	4.4
2675	37.2	14.37	2.14	38.9	2.05	-4.3	4.6
2700	37.1	14.45	2.17	38.9	2.07	-4.5	4.7

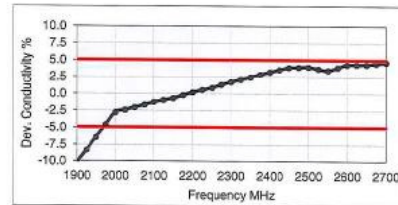
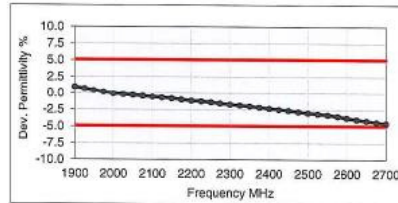



Figure D-2

### 2.4 GHz Head Tissue Equivalent Matter

FCC ID: A3LSMJ120P		SAR EVALUATION REPORT		Reviewed by: Quality Manager
Test Dates: 02/15/16 - 02/26/16	DUT Type: Portable Handset			APPENDIX D: Page 2 of 2

## APPENDIX E: SAR SYSTEM VALIDATION



Per FCC KDB Publication 865664 D02v01r02, SAR system validation status should be documented to confirm measurement accuracy. The SAR systems (including SAR probes, system components and software versions) used for this device were validated against its performance specifications prior to the SAR measurements. Reference dipoles were used with the required tissue- equivalent media for system validation, according to the procedures outlined in FCC KDB Publication 865664 D01v01r04 and IEEE 1528-2013. Since SAR probe calibrations are frequency dependent, each probe calibration point was validated at a frequency within the valid frequency range of the probe calibration point, using the system that normally operates with the probe for routine SAR measurements and according to the required tissue-equivalent media.

A tabulated summary of the system validation status including the validation date(s), measurement frequencies, SAR probes and tissue dielectric parameters has been included.

**Table E-I**  
**SAR System Validation Summary**

SAR SYSTEM #	FREQ. [MHz]	DATE	PROBE SN	PROBE TYPE	PROBE CAL. POINT		COND.	PERM.	CW VALIDATION			MOD. VALIDATION		
							( $\sigma$ )	( $\epsilon_r$ )	SENSITIVITY	PROBE LINEARITY	PROBE ISOTROPY	MOD. TYPE	DUTY FACTOR	PAR
J	835	5/19/2015	3319	ES3DV3	835	Head	0.911	41.529	PASS	PASS	PASS	GMSK	PASS	N/A
K	1900	9/14/2015	3022	ES3DV2	1900	Head	1.450	39.133	PASS	PASS	PASS	GMSK	PASS	N/A
E	2450	9/15/2015	3351	ES3DV3	2450	Head	1.871	38.712	PASS	PASS	PASS	OFDM/TDD	PASS	PASS
E	2600	9/15/2015	3351	ES3DV3	2600	Head	2.040	38.138	PASS	PASS	PASS	TDD	PASS	N/A
H	835	7/22/2015	3263	ES3DV3	835	Body	0.992	53.114	PASS	PASS	PASS	GMSK	PASS	N/A
J	835	4/28/2015	3319	ES3DV3	835	Body	0.992	54.192	PASS	PASS	PASS	GMSK	PASS	N/A
I	1900	11/4/2015	3333	ES3DV3	1900	Body	1.579	51.524	PASS	PASS	PASS	GMSK	PASS	N/A
G	2450	12/4/2015	3334	ES3DV3	2450	Body	1.997	51.699	PASS	PASS	PASS	OFDM/TDD	PASS	PASS
H	2450	7/21/2015	3263	ES3DV3	2450	Body	2.039	51.453	PASS	PASS	PASS	OFDM/TDD	PASS	PASS
G	2600	12/4/2015	3334	ES3DV3	2600	Body	2.198	51.174	PASS	PASS	PASS	TDD	PASS	N/A

NOTE: While the probes have been calibrated for both CW and modulated signals, all measurements were performed using communication systems calibrated for CW signals only. Modulations in the table above represent test configurations for which the measurement system has been validated per FCC KDB Publication 865664 D01v01r04 for scenarios when CW probe calibrations are used with other signal types. SAR systems were validated for modulated signals with a periodic duty cycle, such as GMSK, or with a high peak to average ratio (>5 dB), such as OFDM according to FCC KDB Publication 865664 D01v01r04.

FCC ID: A3LSMJ120P		SAR EVALUATION REPORT		Reviewed by: Quality Manager
Test Dates: 02/15/16 - 02/26/16	DUT Type: Portable Handset	APPENDIX E: Page 1 of 1		