

HEARING AID COMPATIBILITY

Applicant Name:
 Samsung Electronics Co., Ltd.
 129, Samsung-ro, Maetan dong,
 Yeongtong-gu, Suwon-si
 Gyeonggi-do 16677, Korea

Date of Testing:
 12/20/2021 - 1/17/2022
Test Site/Location:
 PCTEST, Columbia, MD, USA
Test Report Serial No.:
 1M2101110004-05.A3L
Date of Issue:
 2/7/2022

| | |
|-------------------|--------------------------------------|
| FCC ID: | A3LSMG998U |
| APPLICANT: | SAMSUNG ELECTRONICS CO., LTD. |

Scope of Test: Audio Band Magnetic Testing (T-Coil)
Application Type: Class II Permissive Change
FCC Rule Part(s): CFR §20.19(b)
HAC Standard: ANSI C63.19-2011
 285076 D01 HAC Guidance v05
 285076 D02 T-Coil testing for CMRS IP v03
DUT Type: Portable Handset
Model: SM-G998U
Additional Model(s): SM-G998U1
Test Device Serial No.: *Pre-Production Sample [S/N: 0769M]*
Class II Permissive Change(s): See FCC Change Document

| | |
|----------------------------------|---|
| C63.19-2011 HAC Category: | T3 (SIGNAL TO NOISE CATEGORY, NR n48 ONLY) |
|----------------------------------|---|

This report and category pertain only to NR n48 supported by this wireless portable device. The overall category rating of the device is determined by the lowest rating obtained over all air interfaces supported by the device. This wireless portable device has been shown to be hearing-aid compatible under the above rated category, specified in ANSI/IEEE Std. C63.19-2011 and has been tested in accordance with the specified measurement procedures. Test results reported herein relate only to the item(s) tested. Hearing-Aid Compatibility is based on the assumption that all production units will be designed electrically identical to the device tested in this report. North American Bands only.

I attest to the accuracy of data. All measurements reported herein were performed by me or were made under my supervision and are correct to the best of my knowledge and belief. I assume full responsibility for the completeness of these measurements and vouch for the qualifications of all persons taking them.

 Randy Ortanez
 President







| | | | | |
|---|---|--------------------------------------|---|--|
| FCC ID: A3LSMG998U |  | HAC (T-COIL) TEST REPORT |  | Approved by: Quality Manager |
| Filename: 1M2101110004-05.A3L | Test Dates: 12/20/2021 - 1/17/2022 | DUT Type: Portable Handset | | Page 1 of 47 |

TABLE OF CONTENTS

| | | |
|-----|--|----|
| 1. | INTRODUCTION | 3 |
| 2. | DUT DESCRIPTION..... | 4 |
| 3. | ANSI C63.19-2011 PERFORMANCE CATEGORIES | 6 |
| 4. | METHOD OF MEASUREMENT | 8 |
| 5. | OTT VOIP TEST SYSTEM AND DUT CONFIGURATION | 17 |
| 6. | T-COIL TEST SUMMARY | 20 |
| 7. | MEASUREMENT UNCERTAINTY | 24 |
| 8. | EQUIPMENT LIST..... | 25 |
| 9. | TEST DATA..... | 26 |
| 10. | CALIBRATION CERTIFICATES..... | 35 |
| 11. | CONCLUSION..... | 42 |
| 12. | REFERENCES | 43 |
| 13. | TEST SETUP PHOTOGRAPHS | 45 |

| | | | | |
|---|--|--------------------------------------|---|--|
| FCC ID: A3LSMG998U |  <small>Head to toe part of device</small> | HAC (T-COIL) TEST REPORT |  | Approved by: Quality Manager |
| Filename: 1M2101110004-05.A3L | Test Dates: 12/20/2021 - 1/17/2022 | DUT Type: Portable Handset | Page 2 of 47 | |

1. INTRODUCTION

On July 10, 2003, the Federal Communications Commission (FCC) adopted new rules requiring wireless manufacturers and service providers to provide digital wireless phones that are compatible with hearing aids. The FCC has modified the exemption for wireless phones under the Hearing Aid Compatibility Act of 1998 (HAC Act) in WT Docket 01-309 RM-8658¹ to extend the benefits of wireless telecommunications to individuals with hearing disabilities. These benefits encompass business, social and emergency communications, which increase the value of the wireless network for everyone. An estimated more than 10% of the population in the United States show signs of hearing impairment and of that fraction, almost 80% use hearing aids. Approximately 500 million people worldwide and 30 million people in the United States suffer from hearing loss.

Compatibility Tests Involved:

The standard calls for wireless communications devices to be measured for:

- RF Electric-field emissions
- T-coil mode, magnetic-signal strength in the audio band
- T-coil mode, magnetic-signal frequency response through the audio band
- T-coil mode, magnetic-signal and noise articulation index

The hearing aid must be measured for:

- RF immunity in microphone mode
- RF immunity in T-coil mode

In the following tests and results, this report includes the evaluation for a wireless communications device.

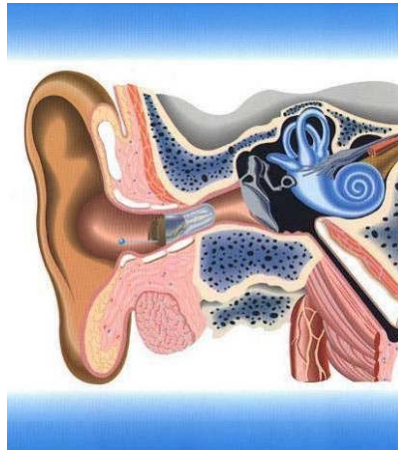



Figure 1-1 Hearing Aid *in-vitu*



¹ FCC Rule & Order, WT Docket 01-309 RM-8658

| | | | | |
|----------------------------------|---|-------------------------------|---|---------------------------------|
| FCC ID: A3LSMG998U |  | HAC (T-COIL) TEST REPORT |  | Approved by: Quality Manager |
| Filename: 1M2101110004-05.A3L | Test Dates: 12/20/2021 - 1/17/2022 | DUT Type: Portable Handset | Page 3 of 47 | |

2. DUT DESCRIPTION



FCC ID: A3LSMG998U
Applicant: Samsung Electronics Co., Ltd.
129, Samsung-ro, Maetan dong,
Yeongtong-gu, Suwon-si
Gyeonggi-do 16677, Korea
Model: SM-G998U
Additional Model(s): SM-G998U1
Serial Number: 0769M
HW Version: REV1.0
SW Version: G998USQU0ATK9
Antenna: Internal Antenna
DUT Type: Portable Handset

| | | | | |
|---|--|--------------------------------------|---|--|
| FCC ID: A3LSMG998U |  PCTEST Head to toe part of solutions | HAC (T-COIL) TEST REPORT |  | Approved by: Quality Manager |
| Filename: 1M2101110004-05.A3L | Test Dates: 12/20/2021 - 1/17/2022 | DUT Type: Portable Handset | | Page 4 of 47 |



© 2022 PCTEST

REV 3.5.M
8/18/2020

© 2022 PCTEST All rights reserved. Unless otherwise specified, no part of this report may be reproduced or utilized in any part, form or by any means, electronic or mechanical, including photocopying and microfilm, without permission in writing from PCTEST. If you have any questions about this international copyright or have an enquiry about obtaining additional rights to this report or assembly of contents thereof, please contact INFO@PCTEST.COM.

Table 2-1
A3LSMG998U HAC Air Interfaces

| Air-Interface | Band (MHz) | Type Transport | HAC Tested | Simultaneous But Not Tested | Name of Voice Service | Audio Codec Evaluated |
|---|-----------------|----------------|---|----------------------------------|---|---|
| CDMA | 835 | VO | No ² | Yes: WIFI or BT | CMRS Voice | EVRC |
| | 1900 | | | | | |
| | EvDO | VD | No ² | Yes: WIFI or BT | Google Duo | OPUS |
| GSM | 850 | VO | No ² | Yes: WIFI or BT | CMRS Voice | EFR |
| | 1900 | | | | | |
| | GPRS/EDGE | VD | No ² | Yes: WIFI or BT | Google Duo | OPUS |
| UMTS | 850 | VD | No ² | Yes: WIFI or BT | CMRS Voice | NB AMR |
| | 1700 | | | | | |
| | 1900 | | | | | |
| | HSPA | VD | No ² | Yes: WIFI or BT | Google Duo | OPUS |
| LTE (FDD) | 680 (B71) | VD | No ² | Yes: NR, WIFI, or BT | VoLTE, Google Duo | VoLTE: NB AMR, WB AMR, EVS Google Duo: OPUS |
| | 700 (B12) | | | | | |
| | 780 (B13) | | | | | |
| | 790 (B14) | | | | | |
| | 850 (B5) | | | | | |
| | 850 (B26) | | | | | |
| | 1700 (B4) | | | | | |
| | 1700 (B66) | | | | | |
| | 1900 (B2) | | | | | |
| | 1900 (B25) | | | | | |
| | 2300 (B30) | | | | | |
| 2500 (B7) | | | | | | |
| LTE (TDD) | 2600 (B38) | VD | No ² | Yes: NR, WIFI, or BT | VoLTE, Google Duo | VoLTE: NB AMR, WB AMR, EVS Google Duo: OPUS |
| | 2600 (B41) | | | | | |
| | 3600 (B48) | | | | | |
| NR (FDD) | 680 (n71) | VD | No ² | Yes: LTE, WIFI, or BT | VoNR ¹ , Google Duo ¹ | VoNR: NB AMR, WB AMR, EVS Google Duo: OPUS |
| | 700 (n12) | | | | | |
| | 850 (n5) | | | | | |
| | 1700 (n66) | | | | | |
| | 1900 (n2) | | | | | |
| | 1900 (n25) | | | | | |
| 2300 (n30) | | | | | | |
| NR (TDD) | 2600 (n41) | VD | No ² | Yes: LTE, WIFI, or BT | VoNR ¹ , Google Duo ¹ | VoNR: NB AMR, WB AMR, EVS Google Duo: OPUS |
| | 3500 (n48) | | | | | |
| | 3800 (n77) | | | | | |
| | 28000 (n261) | | | | | |
| | 39000 (n260) | | | | | |
| WIFI | 2450 | VD | No ² | Yes: CDMA, GSM, UMTS, LTE, or NR | VoWIFI, Google Duo | VoWIFI: NB AMR, WB AMR, EVS Google Duo: OPUS |
| | 5200 (U-NII 1) | | | | | |
| | 5300 (U-NII 2A) | | | | | |
| | 5500 (U-NII 2C) | | | | | |
| | 5800 (U-NII 3) | | | | | |
| | 6175 (U-NII 5) | | | | | |
| | 6475 (U-NII 6) | | | | | |
| | 6700 (U-NII 7) | | | | | |
| 7000 (U-NII 8) | | | | | | |
| BT | 2450 | DT | No | Yes: CDMA, GSM, UMTS, LTE, or NR | N/A | N/A |
| Type Transport VO = Voice Only DT = Digital Data - Not intended for Voice Services VD = CMRS and/or IP Voice over Data Transport | | | Notes: 1. Reference level is -20dBm0 in accordance with FCC KDB 285076 D02 2. This report pertains only to NR n48. For full data, please refer to the Original Certification Test Report (T-Coil Report S/N: 1M2009230152-21-R2.A3L) and the Class II Permissive Change Test Report (T-Coil Report S/N: 1M2107130081-01.A3L). | | | |

| | | | | |
|---|---|--------------------------------------|---|--|
| FCC ID: A3LSMG998U |  | HAC (T-COIL) TEST REPORT |  | Approved by: Quality Manager |
| Filename: 1M2101110004-05.A3L | Test Dates: 12/20/2021 - 1/17/2022 | DUT Type: Portable Handset | Page 5 of 47 | |

3. ANSI C63.19-2011 PERFORMANCE CATEGORIES

I. MAGNETIC COUPLING

Axial and Radial Field Intensity

All orientations of the magnetic field, in the axial and radial position along the measurement plane shall be ≥ -18 dB(A/m) at 1 kHz in a 1/3 octave band filter per §8.3.1.

Frequency Response

The frequency response of the axial component of the magnetic field shall follow the response curve specified in EIA RS-504-1983, over the frequency range 300 Hz – 3000 Hz per §8.3.2.

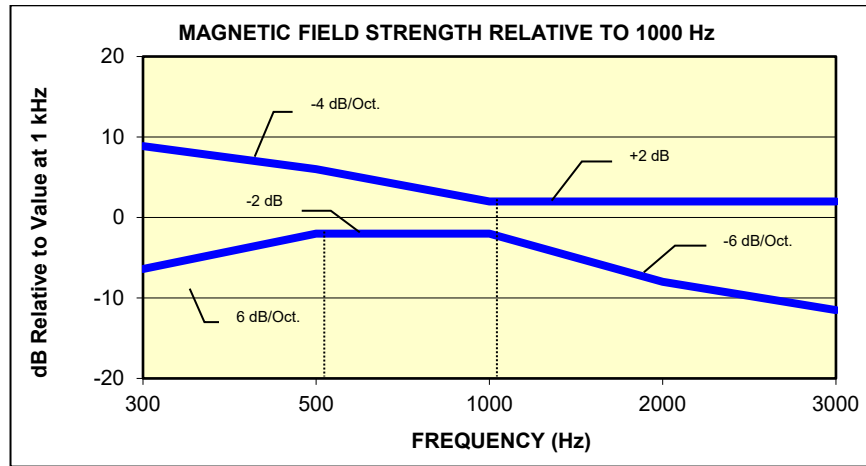

Figure 3-1
Magnetic field frequency response for Wireless Devices with an axial field ≤ -15 dB(A/m) at 1 kHz

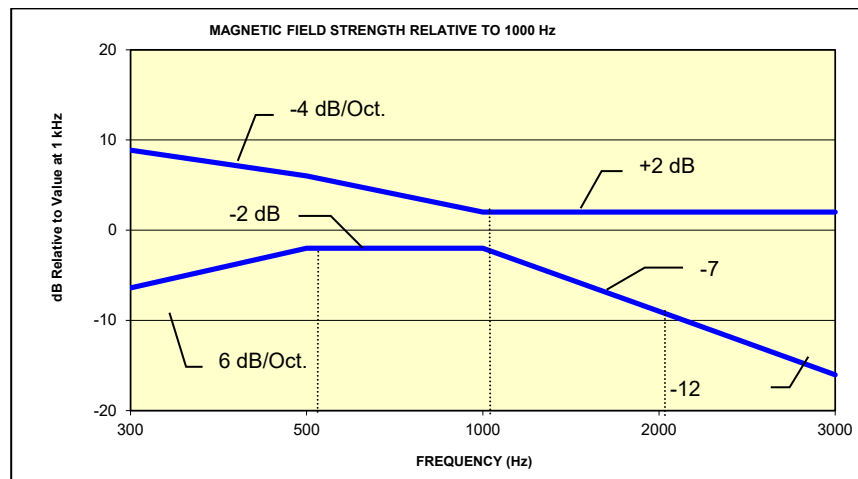



Figure 3-2
Magnetic Field frequency response for wireless devices with an axial field that exceeds -15 dB(A/m) at 1 kHz

| | | | | |
|----------------------------------|---|-------------------------------|---|---------------------------------|
| FCC ID: A3LSMG998U |  PCTEST Proud to be part of Samsung | HAC (T-COIL) TEST REPORT |  | Approved by: Quality Manager |
| Filename: 1M2101110004-05.A3L | Test Dates: 12/20/2021 - 1/17/2022 | DUT Type: Portable Handset | | Page 6 of 47 |

Signal Quality



The table below provides the signal quality requirement for the intended audio magnetic signal from a wireless device. Only the RF immunity of the hearing aid is measured in T-coil mode. It is assumed that a hearing aid can have no immunity to an interference signal in the audio band, which is the intended reception band for this mode. The only criterion that can be measured is the RF immunity in T-coil mode. This is measured using the same procedure as the audio coupling mode at the same levels.

The signal quality of the axial and radial components of the magnetic field was used to determine the T-coil mode category.

| Category | Telephone RF Parameters |
|----------|--|
| | Wireless Device Signal Quality [(Signal + Noise)-to-noise ratio in dB] |
| T1 | 0 to 10 dB |
| T2 | 10 to 20 dB |
| T3 | 20 to 30 dB |
| T4 | > 30 dB |

Table 3-1
Magnetic Coupling Parameters

Note: The FCC limit for SNNR is 20dB and the test data margins will indicate a margin from the FCC limit for compliance.

| | | | | |
|----------------------------------|--|-------------------------------|---|---------------------------------|
| FCC ID: A3LSMG998U |  PCTEST Head to toe part of device | HAC (T-COIL) TEST REPORT |  | Approved by: Quality Manager |
| Filename: 1M2101110004-05.A3L | Test Dates: 12/20/2021 - 1/17/2022 | DUT Type: Portable Handset | | Page 7 of 47 |

4. METHOD OF MEASUREMENT

I. Test Setup

The equipment was connected as shown in an acoustic/RF hemi-anechoic chamber:

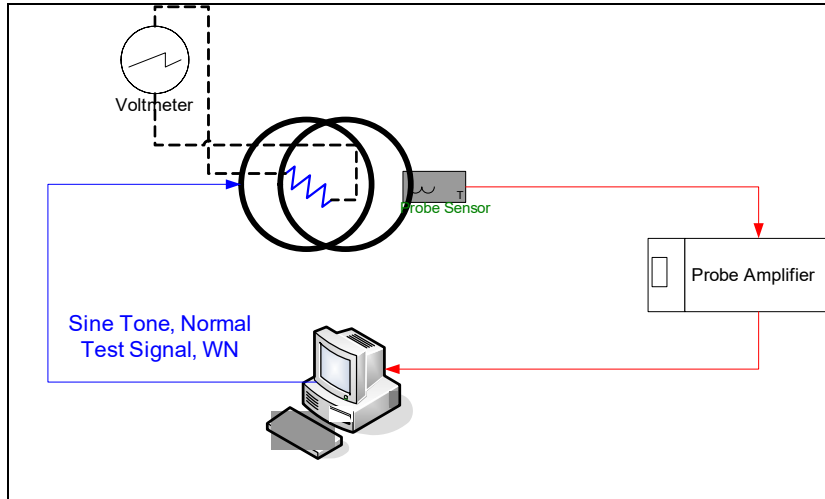

Figure 4-1
Validation Setup with Helmholtz Coil

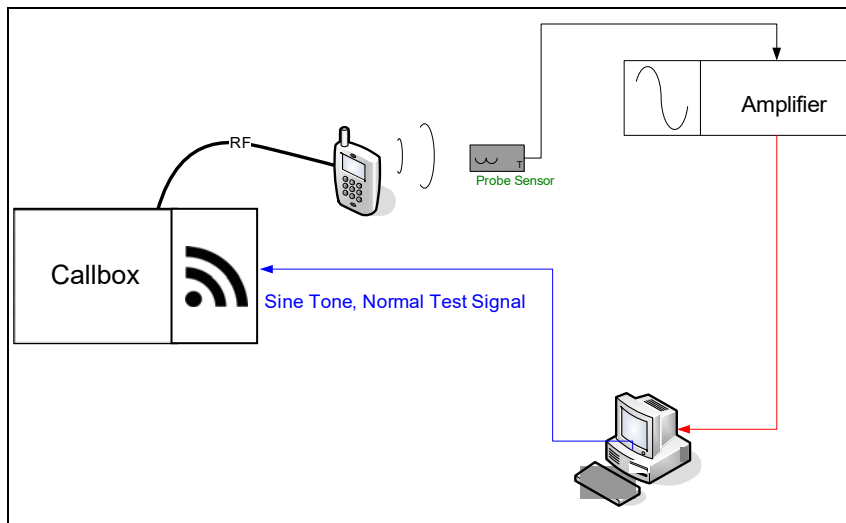



Figure 4-2
T-Coil Test Setup

| | | | |
|---|---|--------------------------------------|--|
| FCC ID: A3LSMG998U |  | HAC (T-COIL) TEST REPORT |  Approved by: Quality Manager |
| Filename: 1M2101110004-05.A3L | Test Dates: 12/20/2021 - 1/17/2022 | DUT Type: Portable Handset | Page 8 of 47 |

II. Scanning Mechanism

| | |
|------------------------|--------------------------------|
| Manufacturer: | TEM |
| Accuracy: | ± 0.83 cm/meter |
| Minimum Step Size: | 0.1 mm |
| Maximum speed | 6.1 cm/sec |
| Line Voltage: | 115 VAC |
| Line Frequency: | 60 Hz |
| Material Composite: | Delrin (Acetal) |
| Data Control: | Parallel Port |
| Dynamic Range (X-Y-Z): | 45 x 31.75 x 47 cm |
| Dimensions: | 36" x 25" x 38" |
| Operating Area: | 36" x 49" x 55" |
| Reflections: | < -20 dB (in anechoic chamber) |

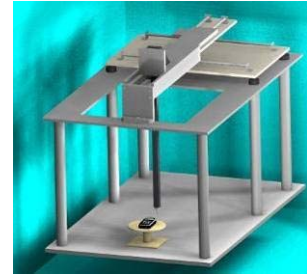

Figure 4-3
RF Near-Field Scanner

III. 3GPP2 Normal Test Signal (Speech)

| | |
|-------------------------|---|
| Manufacturer: | 3GPP2 (TIA 1042 §3.3.1) |
| Stimulus Type: | Modified-IRS weighted, multi-talker speech signal, 4 Male and 4 Female speakers (alternating) |
| Single Sample Duration: | 51.62 seconds |
| Activity Level: | 77.4% |

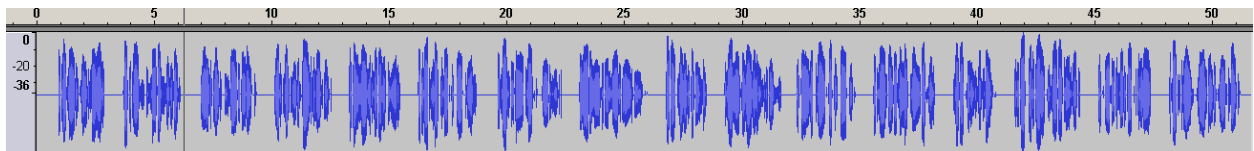



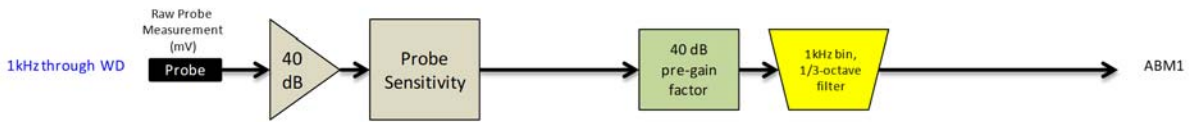

Figure 4-4
Temporal Characteristic of Normal Test Signal

| | | | | |
|----------------------------------|---|-------------------------------|---|---------------------------------|
| FCC ID: A3LSMG998U |  PCTEST Proud to be part of  | HAC (T-COIL) TEST REPORT |  | Approved by: Quality Manager |
| Filename: 1M2101110004-05.A3L | Test Dates: 12/20/2021 - 1/17/2022 | DUT Type: Portable Handset | | Page 9 of 47 |

ABM1 Measurement Block Diagram:



ABM2 Measurement Block Diagram:

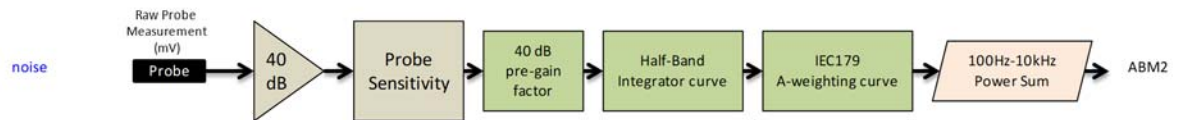

Figure 4-5 Magnetic Measurement Processing Steps

IV. Test Procedure

1. Ambient Noise Check per C63.19 §7.3.1
 - a. Ambient interference was monitored using a Real-Time Analyzer between 100-10,000 Hz with 1/3 octave filtering.
 - b. “A-weighting” and Half-Band Integration was applied to the measurements.
 - c. Since this measurement was measured in the same method as ABM2 measurements, this level was verified to be more than 10 dB below the lowest measurement signal (which is the highest ABM2 measurement for a T4 WD). Therefore the maximum noise level for a T4 WD with an ABM1 = -18 dBA/m is:



$$-18 - 30 - 10 = -58 \text{ dBA/m}$$
2. Measurement System Validation (See Figure 4-1)
 - a. The measurement system including the probe, pre-amplifier and acquisition system were validated as an entire system to ensure the reliability of test measurements.
 - b. ABM1 Validation
 The magnetic field at the center of the Helmholtz coil is given by the equation (per C63.19 Annex D.10.1):

$$H_c = \frac{NI}{r\sqrt{1.25^3}} = \frac{N(\frac{V}{R})}{r\sqrt{1.25^3}}$$

Where H_c = magnetic field strength in amperes per meter
 N = number of turns per coil
 For the Helmholtz Coil, $N=20$; $r=0.13\text{m}$; $R=10.193\Omega$ and using $V=29\text{mV}$:

$$H_c = \frac{20 \cdot (\frac{0.029}{10.193})}{0.13 \cdot \sqrt{1.25^3}} = 0.316 \text{ A/m} \approx -10 \text{ dB(A/m)}$$

Therefore a pure tone of 1kHz was applied into the coils such that 29mV was observed across the resistor. The voltmeter used for measurement was verified to be capable of measurements in the audio band range. This theoretically generates an expected field of -10 dB(A/m) in the center of the Helmholtz coil which was used to validate the probe measurement at -10dB(A/m). This was verified to be within ± 0.5 dB of the -10dB(A/m) value (see Page 22).

| | | | | |
|----------------------------------|---|-------------------------------|---|---------------------------------|
| FCC ID: A3LSMG998U |  | HAC (T-COIL) TEST REPORT |  | Approved by: Quality Manager |
| Filename: 1M2101110004-05.A3L | Test Dates: 12/20/2021 - 1/17/2022 | DUT Type: Portable Handset | | Page 10 of 47 |

c. Frequency Response Validation

The frequency response through the Helmholtz Coil was verified to be within 0.5 dB relative to 1kHz, between 300 – 3000 Hz using the Normal signal as shown below:

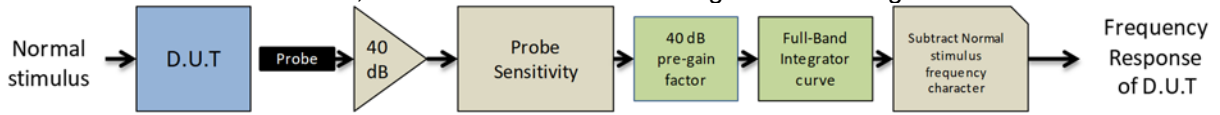

Figure 4-6 Frequency Response Validation

d. ABM2 Measurement Validation

WD noise measurements are filtered with A-weighting and Half-Band Integration over a frequency range of 100Hz – 10kHz to process ABM2 measurements. Below is the verification of the system processing A-weighting and Half-Band integration between system input to output within 0.5 dB of the theoretical result:

Table 4-1
ABM2 Frequency Response Validation

| f (Hz) | HBI, A - Measured (dB re 1kHz) | HBI, A - Theoretical (dB re 1kHz) | dB Var. |
|--------|--------------------------------|-----------------------------------|---------|
| 100 | -16.180 | -16.170 | -0.010 |
| 125 | -13.257 | -13.250 | -0.007 |
| 160 | -10.347 | -10.340 | -0.007 |
| 200 | -8.017 | -8.010 | -0.007 |
| 250 | -5.925 | -5.920 | -0.005 |
| 315 | -4.045 | -4.040 | -0.005 |
| 400 | -2.405 | -2.400 | -0.005 |
| 500 | -1.212 | -1.210 | -0.002 |
| 630 | -0.349 | -0.350 | 0.001 |
| 800 | 0.071 | 0.070 | 0.001 |
| 1000 | 0.000 | 0.000 | 0.000 |
| 1250 | -0.503 | -0.500 | -0.003 |
| 1600 | -1.513 | -1.510 | -0.003 |
| 2000 | -2.778 | -2.780 | 0.002 |
| 2500 | -4.316 | -4.320 | 0.004 |
| 3150 | -6.166 | -6.170 | 0.004 |
| 4000 | -8.322 | -8.330 | 0.008 |
| 5000 | -10.573 | -10.590 | 0.017 |
| 6300 | -13.178 | -13.200 | 0.022 |
| 8000 | -16.241 | -16.270 | 0.029 |
| 10000 | -19.495 | -19.520 | 0.025 |

| | | | | |
|----------------------------------|---|-------------------------------|--|---------------------------------|
| FCC ID: A3LSMG998U | PCTEST Head to the point of delivery | HAC (T-COIL) TEST REPORT | | Approved by: Quality Manager |
| Filename: 1M2101110004-05.A3L | Test Dates: 12/20/2021 - 1/17/2022 | DUT Type: Portable Handset | | Page 11 of 47 |

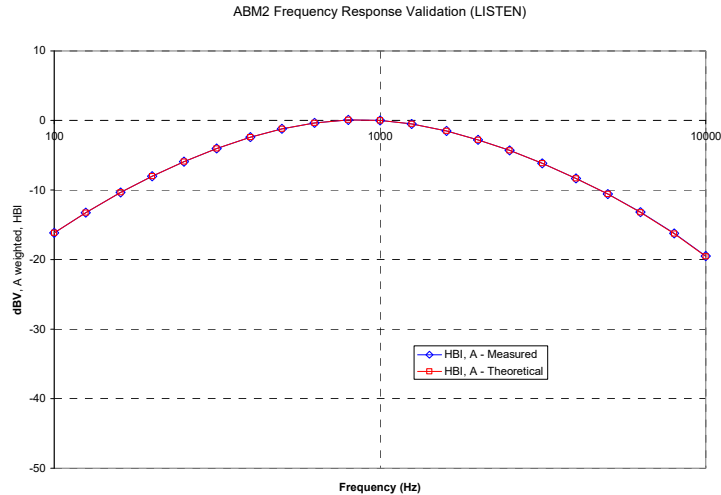

Figure 4-7
ABM2 Frequency Response Validation

The ABM2 result is a power sum from 100Hz to 10kHz with half-band integration and A-weighting. To verify the power sum measurement, a power sum over the full band was measured and verified to track with the source level (See Figure 4-8). Therefore the setup in this step was used to verify the power sum post-processing for ABM2 measurements. See below block diagram:

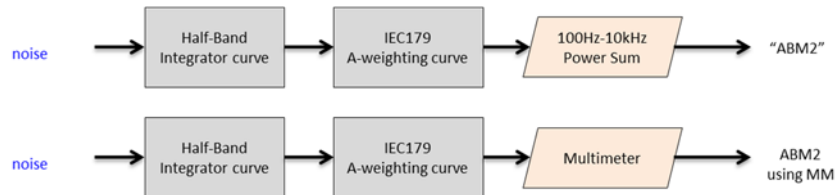



Figure 4-8
ABM2 Validation Block Diagram

The power summed output results for a known input were compared to the multi-meter results to verify any deviation in the post-processing implemented with the power-sum.

Table 4-2
ABM2 Power Sum Validation

| WN Input (dBV) | Power Sum (dBV) | Multimeter-Full (dBV) | Dev (dB) |
|----------------|-----------------|-----------------------|----------|
| -60 | -60.36 | -60.2 | 0.16 |
| -50 | -50.19 | -50.13 | 0.06 |
| -40 | -40.14 | -40.03 | 0.11 |
| -30 | -30.13 | -30.01 | 0.12 |
| -20 | -20.12 | -20 | 0.12 |
| -10 | -10.14 | -10 | 0.14 |

| | | | | |
|---|---|--------------------------------------|---|--|
| FCC ID: A3LSMG998U |  | HAC (T-COIL) TEST REPORT |  | Approved by: Quality Manager |
| Filename: 1M2101110004-05.A3L | Test Dates: 12/20/2021 - 1/17/2022 | DUT Type: Portable Handset | | Page 12 of 47 |

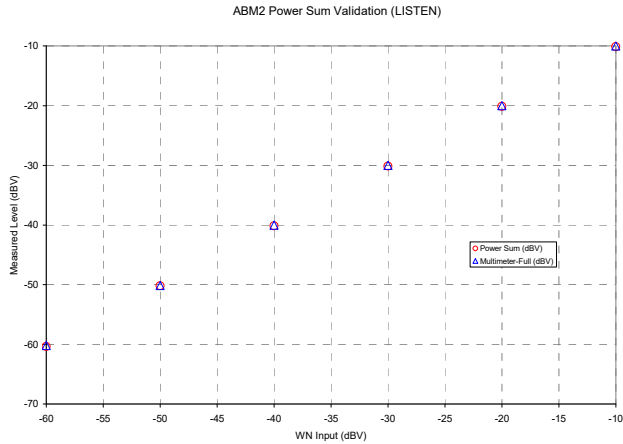

Figure 4-9
ABM2 Power Sum Validation

3. Measurement Test Setup

a. Fine scan above the WD (TEM)

- i. A multitone signal was applied to the handset such that the phone acoustic output was stable within 1dB over the probe settling time and with the acoustic output level at the C63.19 specified levels (below). The measurement step size was in 2 mm increments at a distance of 10 mm between the surface of the wireless device as shown below (note that in Figure 4-11, the grid is not to scale but merely a graphical representation of the coordinate system in use):

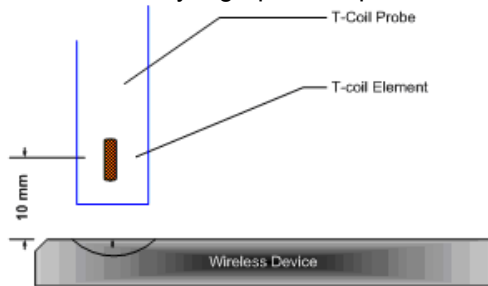

Figure 4-10
Measurement Distance

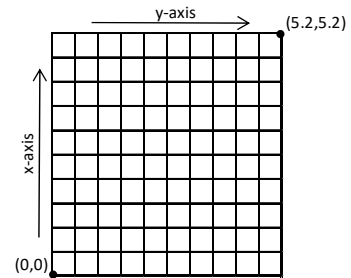





Figure 4-11
Measurement Grid

- ii. After scanning, the planar field maximum point was determined. The position of the probe was moved to this location to setup the test using the SoundCheck system.
 - iii. These steps were repeated for all T-coil orientations (axial and radial) per Figure 4-13 after a T-coil orientation was fully measured with the SoundCheck system.
- b. Speech Signal Setup to Base Station Simulator
- i. C63.19 Table 7-1 states audio reference input levels for various technologies:

| Standard | Technology | Input Level (dBm0) |
|-----------------|---------------------|--------------------|
| TIA/EIA/IS-2000 | CDMA | -18 |
| J-STD-007 | GSM (217) | -16 |
| T1/T1P1/3GPP | UMTS (WCDMA) | -16 |
| IDEN™ | TDMA (22 and 11 Hz) | -18 |

| | | | |
|----------------------------------|---------------------------------------|-------------------------------|---------------------------------|
| FCC ID: A3LSMG998U | PCTEST Proud to be part of | HAC (T-COIL) TEST REPORT | Approved by: Quality Manager |
| Filename: 1M2101110004-05.A3L | Test Dates: 12/20/2021 - 1/17/2022 | DUT Type: Portable Handset | Page 13 of 47 |

- ii. See Section 5 for more information regarding CMW500 and CMX500 audio level settings for Voice Over NR (VoNR).
 - iii. See Section 6 for more information regarding audio level settings for Over-The-Top (OTT) Voice Over IP (VoIP) Testing.
 - c. Real-Time Analyzer (RTA)
 - i. The Real-Time Analyzer was configured to analyze measurements using 1/3 Octave band weighted filtering.
 - d. WD Radio Configuration Selection
 - i. The device was chosen to be tested in the worst-case ABM2 condition (NR configuration information can be found in Section 5.)
- 4. Signal Quality Data Analysis
 - a. Narrow-band Magnetic Intensity
 - i. The standard specifies a 1kHz 1/3 octave band minimum field intensity for a sine tone. The ABM1 measurements were evaluated at 1kHz with 1/3 octave band filtering over an averaged period of 10 seconds.
 - b. Frequency Response
 - i. The appropriate frequency response curve was measured to curves in Figure 3-1 or Figure 3-2 between 300 – 3000 Hz using digital linear averaging (limit lines chosen according to measurement found in step 4a). A linear average over 3x the length of the artificial voice signal (3x sampling) was performed. A 10 second delay was configured in the measurement process of the stimulus to ensure handset vocoder latency effects and echo cancellation devices (if any) were appropriately stabilized during measurements.
 - ii. The appropriate post-processing was applied according to the system processing chain illustrated in Figure 4-6. All R10 frequencies were plotted with respect to 0dB at 1kHz value and aligned with respect to the EIA-504 mask.
 - iii. The margin is represented by the closest measured data point on the curve to the EIA-504 limit lines, in dB.
 - c. Signal Quality Index
 - i. Ensuring the WD was at maximum RF power, maximum volume, backlight off, display on, maximum contrast setting, keypad lights on (when possible) with no audio signal through the vocoder, the WD was measured over at least 100 Hz – 10,000 Hz, maximized over 5 seconds with a 50ms sample time for the ABM2 measurement (5 second time period is used in noise measurements under standards such as IEEE 269, etc.).
 - ii. After applying half-band integration and A-weighting to the result, a power sum was applied over each 1/3 octave bandwidth frequency for an ABM2 value.
 - iii. This result was subtracted from the ABM1 result in step a, to obtain the Signal Quality.

| | | | | |
|---|--|--------------------------------------|---|--|
| FCC ID: A3LSMG998U |  PCTEST Proud to be part of  | HAC (T-COIL) TEST REPORT |  | Approved by: Quality Manager |
| Filename: 1M2101110004-05.A3L | Test Dates: 12/20/2021 - 1/17/2022 | DUT Type: Portable Handset | Page 14 of 47 | |

V. Test Setup

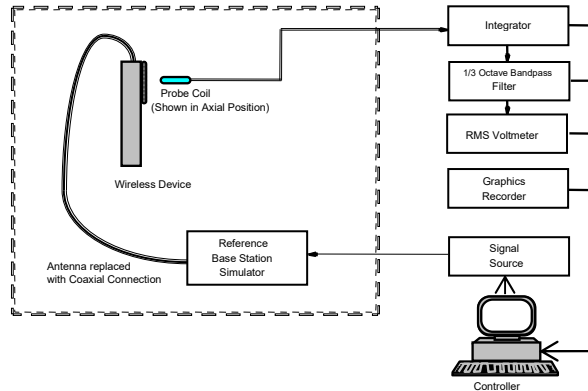

Figure 4-12
Audio Magnetic Field Test Setup

Environmental conditions such as temperature and relative humidity are monitored to ensure there are no impacts on system specifications. Proper voltage and power line frequency conditions are maintained with three phase power sources. Environmental noise and reflections are monitored through system checks.

VI. Deviation from C63.19 Test Procedure

Non-conducted RF connection due to inaccessible RF ports.



VII. Air Interface Technologies Tested

All air interfaces which support voice capabilities over a managed CMRS or pre-installed OTT VoIP applications were tested for T-coil unless otherwise noted. See Table 2-1 for more details regarding which modes were tested.

VIII. Wireless Device Channels and Frequencies

1. 5G (NR) Modes

The bandwidth from each probe orientation resulting in the worst-case SNNR was additionally tested using low, low-mid, mid-high, and high channels. See Tables 7-2 and 7-3 for NR bandwidths and channels.

| | | | | |
|----------------------------------|--|-------------------------------|---|---------------------------------|
| FCC ID: A3LSMG998U |  PCTEST Proud to be part of  | HAC (T-COIL) TEST REPORT |  | Approved by: Quality Manager |
| Filename: 1M2101110004-05.A3L | Test Dates: 12/20/2021 - 1/17/2022 | DUT Type: Portable Handset | | Page 15 of 47 |

IX. Test Flow

The flow diagram below was followed (From C63.19):

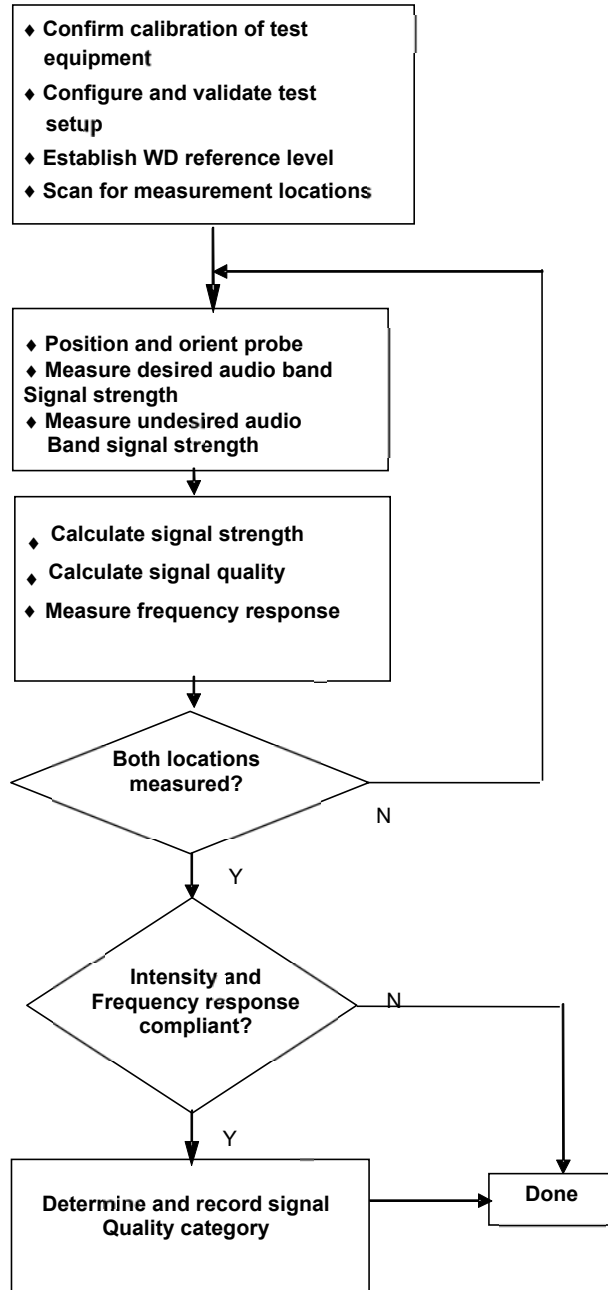



Figure 4-13
C63.19 T-Coil Signal Test Process

| | | | | |
|----------------------------------|---|-------------------------------|---|---------------------------------|
| FCC ID: A3LSMG998U |  | HAC (T-COIL) TEST REPORT |  | Approved by: Quality Manager |
| Filename: 1M2101110004-05.A3L | Test Dates: 12/20/2021 - 1/17/2022 | DUT Type: Portable Handset | | Page 16 of 47 |

5. VONR TEST SYSTEM SETUP AND DUT CONFIGURATION

I. Test System Setup for VoNR over IMS T-coil Testing

1. Equipment Setup

The general test setup used for VoNR over IMS is shown below. The callboxes used when performing VoNR over IMS T-coil measurements are CMW500 and CMX500. The Data Application Unit (DAU) of the CMW500 was used to simulate the IP Multimedia Subsystem (IMS) server. The CMX500 provided the baseband signal to perform NR signaling. An external USB audio interface is used to perform the A/D conversion and ensure proper speech input level to the DUT.

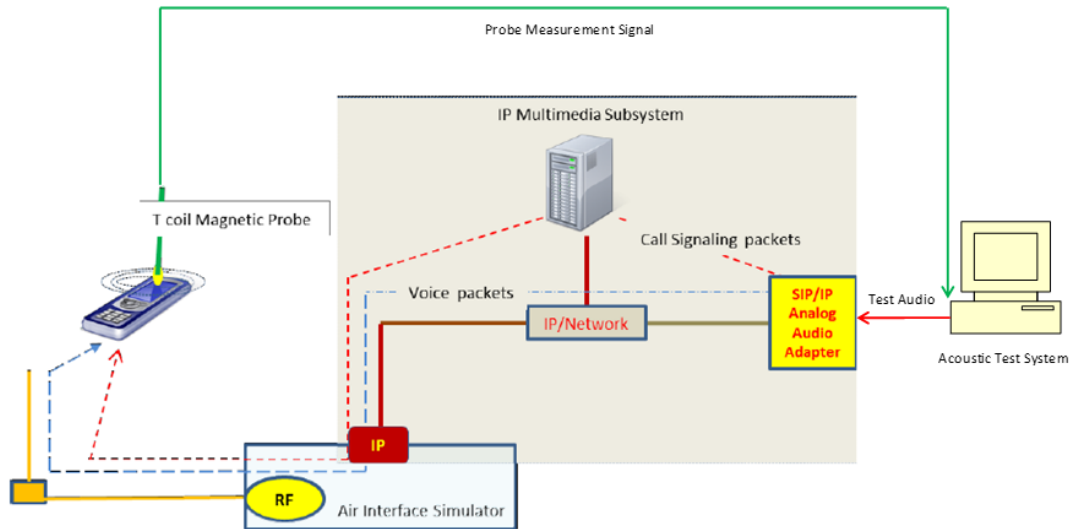



Figure 5-1
Test Setup for VoNR over IMS T-Coil Measurements

2. Audio Level Settings

According to KDB 285076 D02 released by the FCC OET regarding the appropriate audio levels to be used for VoNR over IMS T-Coil testing, -20dBm₀ shall be used for the normal speech input level². The acoustic test system was manually configured to ensure that the settings for speech input and full scale levels resulted in the -20dBm₀ speech input level to the DUT for the VoNR over IMS connection.

² FCC Office of Engineering and Technology KDB, "285076 D02 T-Coil Testing for CMRS IP v03," September 13, 2017

| | | | | |
|----------------------------------|---|-------------------------------|---|---------------------------------|
| FCC ID: A3LSMG998U |  | HAC (T-COIL) TEST REPORT |  | Approved by: Quality Manager |
| Filename: 1M2101110004-05.A3L | Test Dates: 12/20/2021 - 1/17/2022 | DUT Type: Portable Handset | | Page 17 of 47 |



II. DUT Configuration for VoNR over IMS T-coil Testing

1. Radio Configuration

An investigation was performed to determine the waveform, modulation, and RB configuration to be used for testing. The effects of waveform, modulation, and RB configuration were found to be independent of band and bandwidth; therefore, only one band and bandwidth were used for this investigation. DFT-s-OFDM, 16QAM, 50%RB, 0RB offset was used for the testing as the worst-case configuration for the handset. Please refer to the Class II Permissive Change report (T-Coil report S/N: 1M2107130081-01.A3L) for full evaluation.

2. Codec Configuration

An investigation was performed to determine the audio codec configuration to be used for testing. The effects of codec configuration were found to be independent of radio configuration; therefore, only one radio configuration was used for this investigation. The NB AMR 4.75kbps setting was used for the audio codec on the CMX500 for VoNR over IMS T-coil testing. Please refer to the Class II Permissive Change report (T-Coil report S/N: 1M2107130081-01.A3L) for full evaluation.

| | | | | |
|---|---|--------------------------------------|---|--|
| FCC ID: A3LSMG998U |  PCTEST Head to toe part of the solution | HAC (T-COIL) TEST REPORT |  | Approved by: Quality Manager |
| Filename: 1M2101110004-05.A3L | Test Dates: 12/20/2021 - 1/17/2022 | DUT Type: Portable Handset | Page 18 of 47 | |

6. OTT VOIP TEST SYSTEM AND DUT CONFIGURATION

I. Test System Setup for OTT VoIP T-Coil Testing

1. OTT VoIP Application

Google Duo is a pre-installed application on the DUT which allows for VoIP calls in a held-to-ear scenario. Duo uses the OPUS audio codec and supports a bitrate range of 6kb/s to 75kb/s. All air interfaces capable of a data connection were evaluated with Google Duo.

2. Equipment Setup

A CMW500 callbox and a CMX500 callbox were used together to perform NR OTT VoIP T-coil measurements. The Data Application Unit (DAU) of the CMW500 was connected to the internet and allowed for an IP data connection on the DUT. An auxiliary VoIP unit was used to initiate an OTT VoIP call to the DUT. The auxiliary VoIP unit allowed for the configuration and monitoring of the OTT VoIP codec bitrate during a call. Both high and low bitrate settings were evaluated in to determine the worst-case configuration.

3. Audio Level Settings

According to KDB 285076 D02, the average speech level of -20dBm0 shall be used for protocols not specifically listed in Table 7.1 of ANSI C63.19-2011 or the ANSI C63.19-2011 VoLTE interpretation³. The auxiliary VoIP unit allowed for monitoring the signal input level to ensure that the settings for speech input and full scale levels resulted in the -20dBm0 speech input level to the DUT for the OTT VoIP call.

Note: The green highlighted text is approved by FCC under the TCB PAG Re-Use Policy 388624 D01 IV. D. for T-Coil Testing for WI-FI calling and Google Duo.

II. DUT Configuration for OTT VoIP T-Coil Testing



1. Codec Configuration

An investigation was performed for each applicable data mode to determine the audio codec configuration to be used for testing. The effects of codec configuration were found to be independent of radio configuration; therefore, only one radio configuration for each applicable data mode was used for these investigations. The 6kbps codec setting was used for the audio codec on the auxiliary VoIP unit for OTT VoIP T-Coil testing. See below the table for comparisons between codec data rates:

**Table 6-1
Codec Investigation – OTT VoIP (NR)**

| Codec Setting: | 75kbps | 6kbps | Orientation | Band / BW | Channel |
|--------------------|--------|--------|-------------|-----------------|---------|
| ABM1 (dBA/m) | 11.42 | 11.16 | Axial | NR n48 40MHz | 641666 |
| ABM2 (dBA/m) | -43.28 | -42.97 | | | |
| Frequency Response | Pass | Pass | | | |
| S+N/N (dB) | 54.70 | 54.13 | | | |

³ FCC Office of Engineering and Technology KDB, "285076 D02 T-Coil Testing for CMRS IP v03," September 13, 2017

| | | | |
|----------------------------------|---|-------------------------------|---------------------------------|
| FCC ID: A3LSMG998U |  PCTEST Proud to be part of  | HAC (T-COIL) TEST REPORT | Approved by: Quality Manager |
| Filename: 1M2101110004-05.A3L | Test Dates: 12/20/2021 - 1/17/2022 | DUT Type: Portable Handset | Page 19 of 47 |

7. T-COIL TEST SUMMARY

**Table 7-1
Consolidated Tabled Results**

| | | Freq. Response Margin | | Magnetic Intensity Verdict | | FCC SNNR Verdict | | Margin from FCC Limit (dB) | C63.19-2011 Rating |
|-------------------|-----|-----------------------|--------|----------------------------|--------|------------------|--------|----------------------------|--------------------|
| | | 8.3.2 | | 8.3.1 | | 8.3.4 | | | |
| C63.19 Section | | Axial | Radial | Axial | Radial | Axial | Radial | | |
| NR TDD | n48 | PASS | NA | PASS | PASS | PASS | PASS | -5.23 | T3 |
| NR TDD (OTT VoIP) | n48 | PASS | NA | PASS | PASS | PASS | PASS | -23.07 | T4 |



I. Raw Handset Data

**Table 7-2
Raw Data Results for NR n48**

| Mode | Orientation | Bandwidth | Channel | ABM1 [dB(A/m)] | ABM2 [dB(A/m)] | Ambient Noise [dB(A/m)] | Frequency Response Margin (dB) | S+N/N (dB) | FCC Limit (dB) | Margin from FCC Limit (dB) | C63.19-2011 Rating | Test Coordinates |
|--------|-------------|-----------|---------|----------------|----------------|-------------------------|--------------------------------|------------|----------------|----------------------------|--------------------|------------------|
| NR n48 | Axial | 40MHz | 641666 | -6.75 | -45.27 | -58.41 | 2.00 | 38.52 | 20.00 | -18.52 | T4 | 1.4, 1.2 |
| | | 20MHz | 646000 | -6.34 | -45.83 | | 1.96 | 39.49 | 20.00 | -19.49 | T4 | |
| | | 20MHz | 643834 | -6.38 | -45.78 | | 2.00 | 39.40 | 20.00 | -19.40 | T4 | |
| | | 20MHz | 641666 | -6.43 | -44.87 | | 1.98 | 38.44 | 20.00 | -18.44 | T4 | |
| | | 20MHz | 639500 | -6.37 | -45.15 | | 2.00 | 38.78 | 20.00 | -18.78 | T4 | |
| | | 20MHz | 637334 | -6.28 | -44.38 | | 2.00 | 38.10 | 20.00 | -18.10 | T4 | |
| | | 10MHz | 641666 | -6.45 | -45.20 | | 2.00 | 38.75 | 20.00 | -18.75 | T4 | |
| | Radial | 40MHz | 641666 | -13.92 | -39.26 | -62.51 | N/A | 25.34 | 20.00 | -5.34 | T3 | 1.4, 0.4 |
| | | 20MHz | 646000 | -13.83 | -39.99 | | | 26.16 | 20.00 | -6.16 | T3 | |
| | | 20MHz | 643834 | -13.80 | -40.50 | | | 26.70 | 20.00 | -6.70 | T3 | |
| | | 20MHz | 641666 | -13.66 | -38.89 | | | 25.23 | 20.00 | -5.23 | T3 | |
| | | 20MHz | 639500 | -13.80 | -39.66 | | | 25.86 | 20.00 | -5.86 | T3 | |
| | | 20MHz | 637334 | -13.77 | -39.55 | | | 25.78 | 20.00 | -5.78 | T3 | |
| | | 10MHz | 641666 | -13.77 | -39.70 | | | 25.93 | 20.00 | -5.93 | T3 | |

**Table 7-3
Raw Data Results for NR n48 (OTT VoIP)**

| Mode | Orientation | Bandwidth | Channel | ABM1 [dB(A/m)] | ABM2 [dB(A/m)] | Ambient Noise [dB(A/m)] | Frequency Response Margin (dB) | S+N/N (dB) | FCC Limit (dB) | Margin from FCC Limit (dB) | C63.19-2011 Rating | Test Coordinates |
|--------|-------------|-----------|---------|----------------|----------------|-------------------------|--------------------------------|------------|----------------|----------------------------|--------------------|------------------|
| NR n48 | Axial | 40MHz | 641666 | 11.13 | -42.80 | -59.85 | 2.00 | 53.93 | 20.00 | -33.93 | T4 | 1.4, 1.2 |
| | | 20MHz | 646000 | 11.07 | -43.96 | | 2.00 | 55.03 | 20.00 | -35.03 | T4 | |
| | | 20MHz | 643834 | 11.14 | -43.49 | | 2.00 | 54.63 | 20.00 | -34.63 | T4 | |
| | | 20MHz | 641666 | 11.10 | -41.13 | | 1.72 | 52.23 | 20.00 | -32.23 | T4 | |
| | | 20MHz | 639500 | 11.05 | -42.33 | | 1.85 | 53.38 | 20.00 | -33.38 | T4 | |
| | | 20MHz | 637334 | 11.05 | -42.99 | | 1.87 | 54.04 | 20.00 | -34.04 | T4 | |
| | | 10MHz | 641666 | 11.08 | -43.52 | | 2.00 | 54.60 | 20.00 | -34.60 | T4 | |
| | Radial | 40MHz | 641666 | 3.15 | -40.08 | -60.58 | N/A | 43.23 | 20.00 | -23.23 | T4 | 1.4, 0.4 |
| | | 20MHz | 646000 | 3.07 | -40.28 | | | 43.35 | 20.00 | -23.35 | T4 | |
| | | 20MHz | 643834 | 3.12 | -40.86 | | | 43.98 | 20.00 | -23.98 | T4 | |
| | | 20MHz | 641666 | 3.10 | -40.06 | | | 43.16 | 20.00 | -23.16 | T4 | |
| | | 20MHz | 639500 | 3.11 | -39.96 | | | 43.07 | 20.00 | -23.07 | T4 | |
| | | 20MHz | 637334 | 3.17 | -40.71 | | | 43.88 | 20.00 | -23.88 | T4 | |
| | | 10MHz | 641666 | 3.17 | -40.06 | | | 43.23 | 20.00 | -23.23 | T4 | |

| | | | | |
|----------------------------------|---|-------------------------------|---|---------------------------------|
| FCC ID: A3LSMG998U |  | HAC (T-COIL) TEST REPORT |  | Approved by: Quality Manager |
| Filename: 1M2101110004-05.A3L | Test Dates: 12/20/2021 - 1/17/2022 | DUT Type: Portable Handset | Page 20 of 47 | |

II. Test Notes

A. General

1. Phone Condition: Mute on; Backlight off; Max Volume; Max Contrast
2. 'Radial' orientation refers to radial transverse.
3. Hearing Aid Mode (**Phone→Settings→Other call settings→Hearing aid compatibility**) was set to ON for T-Coil testing
4. Bluetooth and WIFI were disabled while testing 5G modes.
5. The Margin from FCC limit column indicates a margin from the FCC limit for compliance (T3).

B. NR TDD

1. Power Configuration: TPC = "Max Power"
2. Radio Configuration: DFT-s-OFDM, 16QAM, 50%RB, 0RB offset
 - a. Please refer to the Class II Permissive Change test report for more information regarding radio configuration selection.
3. Vocoder Configuration: NB AMR 4.75kbps
 - a. Please refer to the Class II Permissive Change test report for more information regarding vocoder configuration selection.
4. The worst-case band and bandwidth combination for each probe orientation is additionally tested on the low, low-mid, high-mid, and high channels for those combinations. NR n48 at 20MHz is the worst-case for both Axial and Radial probe orientations.



C. OTT VoIP

1. Vocoder Configuration: 6kbps
2. NR TDD Configuration
 - a. Power Configuration: TPC = "Max Power"
 - b. Radio Configuration: DFT-s-OFDM, 16QAM, 50%RB, 0RB offset
 - i. Please refer to the Class II Permissive Change test report for more information regarding vocoder configuration selection.
 - c. The worst-case band and bandwidth combination for each probe orientation is additionally tested on the low, low-mid, high-mid, and high channels for those combinations. NR n48 at 20MHz is the worst-case for both Axial and Radial probe orientations.

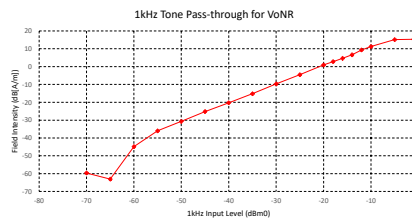
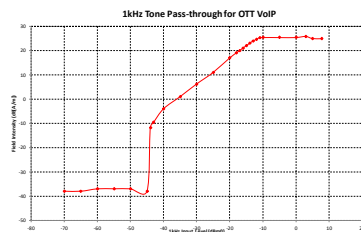
III. 1 kHz Vocoder Application Check



This model was verified to be within the linear region for ABM1 measurements at -20 dBm0 for VoNR over IMS and OTT VoIP. This measurement was taken in the axial configuration above the maximum location.

| | | | | |
|----------------------------------|---|-------------------------------|---|---------------------------------|
| FCC ID: A3LSMG998U |  PCTEST Proud to be part of Samsung | HAC (T-COIL) TEST REPORT |  | Approved by: Quality Manager |
| Filename: 1M2101110004-05.A3L | Test Dates: 12/20/2021 - 1/17/2022 | DUT Type: Portable Handset | | Page 21 of 47 |



IV. T-Coil Validation Test Results

**Table 7-4
Helmholtz Coil Validation Table of Results (12/20/2021)**

| Item | Target | Result | Verdict |
|---------------------------------|--------------|---------|---------|
| Axial | | | |
| Magnetic Intensity, -10 dBA/m | -10 ± 0.5 dB | -9.848 | PASS |
| Environmental Noise | < -58 dBA/m | -58.41 | PASS |
| Frequency Response, from limits | > 0 dB | 0.50 | PASS |
| Radial | | | |
| Magnetic Intensity, -10 dBA/m | -10 ± 0.5 dB | -10.316 | PASS |
| Environmental Noise | < -58 dBA/m | -62.51 | PASS |
| Frequency Response, from limits | > 0 dB | 0.70 | PASS |

**Table 7-5
Helmholtz Coil Validation Table of Results (1/17/2022)**

| Item | Target | Result | Verdict |
|---------------------------------|--------------|---------|---------|
| Axial | | | |
| Magnetic Intensity, -10 dBA/m | -10 ± 0.5 dB | -9.988 | PASS |
| Environmental Noise | < -58 dBA/m | -59.85 | PASS |
| Frequency Response, from limits | > 0 dB | 0.60 | PASS |
| Radial | | | |
| Magnetic Intensity, -10 dBA/m | -10 ± 0.5 dB | -10.177 | PASS |
| Environmental Noise | < -58 dBA/m | -60.58 | PASS |
| Frequency Response, from limits | > 0 dB | 0.70 | PASS |

| | | | | |
|----------------------------------|---|-------------------------------|---|---------------------------------|
| FCC ID: A3LSMG998U |  PCTEST Head to toe part of solutions | HAC (T-COIL) TEST REPORT |  | Approved by: Quality Manager |
| Filename: 1M2101110004-05.A3L | Test Dates: 12/20/2021 - 1/17/2022 | DUT Type: Portable Handset | | Page 22 of 47 |

V. ABM1 Magnetic Field Distribution Scan Overlays

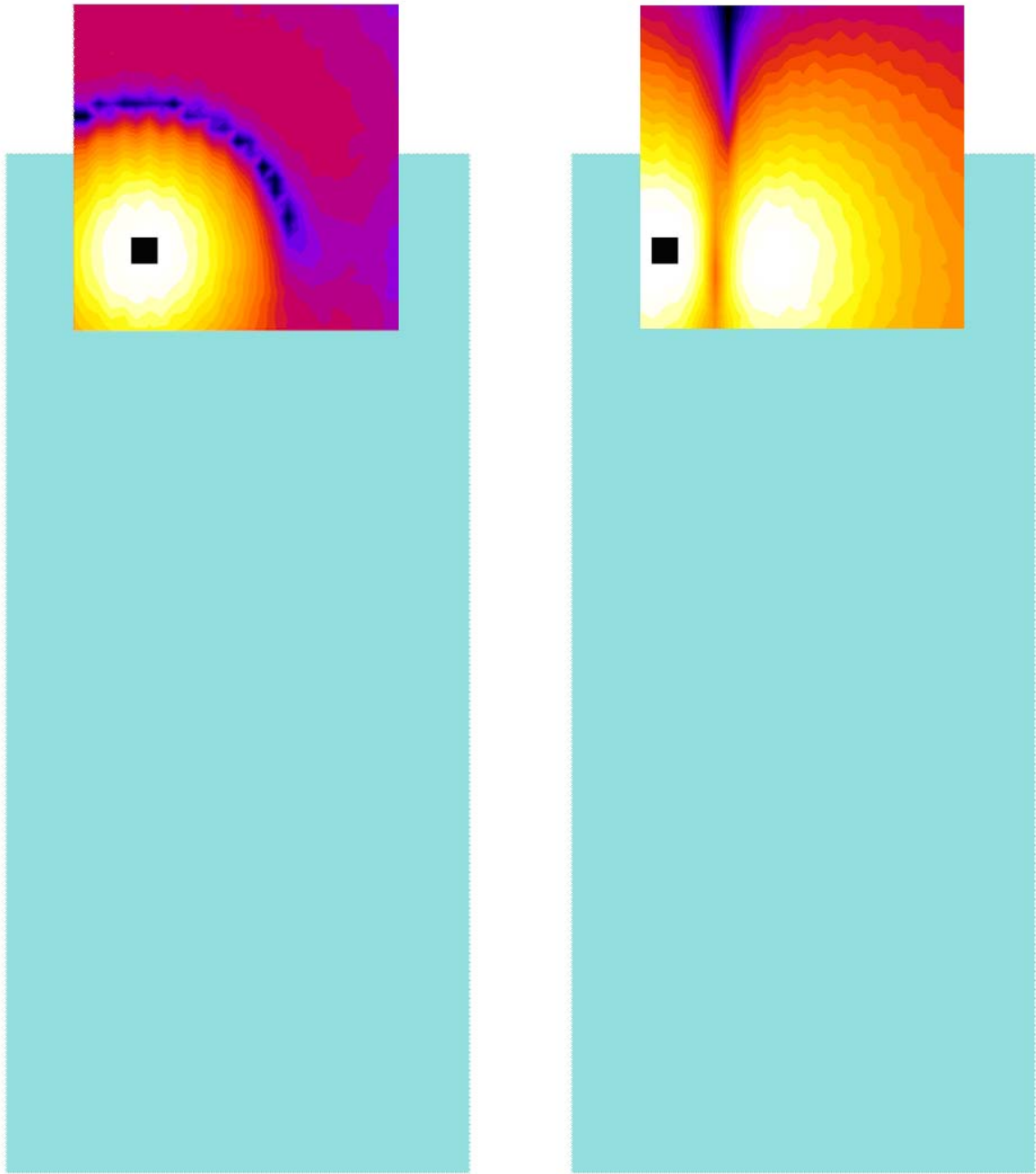



Axial

Radial (Transverse)

**Figure 7-1
T-Coil Scan Overlay Magnetic Field Distributions**

Notes:

1. Final measurement locations are indicated by a cursor on the contour plots.
2. See Test Setup Photographs for actual WD overlay.

| | | | | |
|----------------------------------|---|-------------------------------|---|---------------------------------|
| FCC ID: A3LSMG998U |  | HAC (T-COIL) TEST REPORT |  | Approved by: Quality Manager |
| Filename: 1M2101110004-05.A3L | Test Dates: 12/20/2021 - 1/17/2022 | DUT Type: Portable Handset | Page 23 of 47 | |

© 2022 PCTEST

REV 3.5.M
8/18/2020

© 2022 PCTEST All rights reserved. Unless otherwise specified, no part of this report may be reproduced or utilized in any part, form or by any means, electronic or mechanical, including photocopying and microfilm, without permission in writing from PCTEST. If you have any questions about this international copyright or have an enquiry about obtaining additional rights to this report or assembly of contents thereof, please contact INFO@PCTEST.COM.

8. MEASUREMENT UNCERTAINTY



**Table 8-1
Uncertainty Estimation Table**

| Contribution | Data +/- % | Data +/- dB | Data Type | Probability distribution | Divisor | Standard uncertainty | Standard Uncertainty (dB) |
|--|------------|-------------|---------------|--------------------------|---------|----------------------|---------------------------|
| ABM Noise | 7.0% | 0.29 | Std. Dev. | Normal k=1 | 1.00 | 7.0% | |
| RF Reflections | 4.7% | 0.20 | Specification | Rectangular | 1.73 | 2.7% | |
| Reference Signal Level | 12.2% | 0.50 | Specification | Rectangular | 1.73 | 7.0% | |
| Positioning Accuracy | 10.0% | 0.41 | Uncertainty | Rectangular | 1.73 | 5.8% | |
| Probe Coil Sensitivity | 12.2% | 0.50 | Specification | Rectangular | 1.73 | 7.0% | |
| Probe Linearity | 2.4% | 0.10 | Std. Dev. | Normal k=1 | 1.00 | 2.4% | |
| Cable Loss | 2.8% | 0.12 | Specification | Rectangular | 1.73 | 1.6% | |
| Frequency Analyzer | 5.0% | 0.21 | Specification | Rectangular | 1.73 | 2.9% | |
| System Repeatability | 5.0% | 0.21 | Std. Dev. | Normal k=1 | 1.00 | 5.0% | |
| WD Repeatability | 9.0% | 0.37 | Std. Dev. | Normal k=1 | 1.00 | 9.0% | |
| Positioner Accuracy | 1.0% | 0.04 | Specification | Rectangular | 1.73 | 0.6% | |
| Combined standard uncertainty, u_c (k=1) | | | | | | 17.7% | 0.71 |
| Expanded uncertainty (k=2), 95% confidence level | | | | | | 35.3% | 1.31 |

Notes:

1. Test equipments are calibrated according to techniques outlined in NIS81, NIS3003 and NIST Tech Note 1297.
2. All equipments have traceability according to NIST. Measurement Uncertainties are defined in further detail in NIS 81 and NIST Tech Note 1297 and UKAS M3003.



Measurement uncertainty reflects the quality and accuracy of a measured result as compared to the true value. Such statements are generally required when stating results of measurements so that it is clear to the intended audience that the results may differ when reproduced by different facilities. Measurement results vary due to the measurement uncertainty of the instrumentation, measurement technique, and test engineer. Most uncertainties are calculated using the tolerances of the instrumentation used in the measurement, the measurement setup variability, and the technique used in performing the test. While not generally included, the variability of the equipment under test also figures into the overall measurement uncertainty. Another component of the overall uncertainty is based on the variability of repeated measurements (so-called Type A uncertainty). This may mean that the Hearing Aid compatibility tests may have to be repeated by taking down the test setup and resetting it up so that there are a statistically significant number of repeat measurements to identify the measurement uncertainty. By combining the repeat measurement results with that of the instrumentation chain using the technique contained in NIS 81 and NIS 3003, the overall measurement uncertainty was estimated.

| | | | | |
|---|---|--------------------------------------|---|--|
| FCC ID: A3LSMG998U |  <small>Head to the point of delivery</small> | HAC (T-COIL) TEST REPORT |  | Approved by: Quality Manager |
| Filename: 1M2101110004-05.A3L | Test Dates: 12/20/2021 - 1/17/2022 | DUT Type: Portable Handset | Page 24 of 47 | |



9. EQUIPMENT LIST

**Table 9-1
Equipment List**

| Manufacturer | Model | Description | Cal Date | Cal Interval | Cal Due | Serial Number |
|-----------------|---------------------|---|-----------|--------------|-----------|---------------|
| Dell | Latitude E6540 | SoundCheck Acoustic Analyzer Laptop | 9/29/2020 | Biennial | 9/29/2022 | 2655082910 |
| Listen | SoundConnect | Microphone Power Supply | 9/24/2020 | Biennial | 9/24/2022 | 0899-PS150 |
| RME | Fireface UC | Soundcheck Acoustic Analyzer External Audio Interface | 9/29/2020 | Biennial | 9/29/2022 | 23792992 |
| Rohde & Schwarz | CMW500 | Wideband Radio Communication Tester | 9/24/2021 | Annual | 9/24/2022 | 167286 |
| Rohde & Schwarz | CMX500 | 5G Radio Communication Tester | N/A | N/A | N/A | 100298 |
| Seekonk | NC-100 | Torque Wrench (8" lb) | 8/4/2020 | Biennial | 8/4/2022 | 21053 |
| TEM | Axial T-Coil Probe | Axial T-Coil Probe | 9/23/2020 | Biennial | 9/23/2022 | TEM-1123 |
| TEM | Radial T-Coil Probe | Radial T-Coil Probe | 9/23/2020 | Biennial | 9/23/2022 | TEM-1129 |
| TEM | | HAC Positioner | N/A | N/A | N/A | N/A |
| TEM | | HAC System Controller with Software | N/A | N/A | N/A | N/A |
| TEM | Helmholtz Coil | Helmholtz Coil | 9/23/2020 | Biennial | 9/23/2022 | SBI 1052 |
| YellowTec | YT4211 | USB Audio Interface | N/A | N/A | N/A | 20000365 |
| Control Company | 4040 | Therm./ Clock/ Humidity Monitor | 3/12/2021 | Biennial | 3/12/2023 | 210202053 |
| Netgear | XS708E | Ethernet Switch | N/A | N/A | N/A | 4FU3875C001A8 |

| | | | | |
|---|--|--------------------------------------|---|--|
| FCC ID: A3LSMG998U |  PCTEST Proud to be part of  | HAC (T-COIL) TEST REPORT |  | Approved by: Quality Manager |
| Filename: 1M2101110004-05.A3L | Test Dates: 12/20/2021 - 1/17/2022 | DUT Type: Portable Handset | | Page 25 of 47 |

10. TEST DATA

| | | | | |
|---|---|--------------------------------------|---|--|
| FCC ID: A3LSMG998U |  PCTEST <small>Head to toe part of</small> | HAC (T-COIL) TEST REPORT |  | Approved by: Quality Manager |
| Filename: 1M2101110004-05.A3L | Test Dates: 12/20/2021 - 1/17/2022 | DUT Type: Portable Handset | Page 26 of 47 | |

© 2022 PCTEST

REV 3.5.M
8/18/2020

© 2022 PCTEST All rights reserved. Unless otherwise specified, no part of this report may be reproduced or utilized in any part, form or by any means, electronic or mechanical, including photocopying and microfilm, without permission in writing from PCTEST. If you have any questions about this international copyright or have an enquiry about obtaining additional rights to this report or assembly of contents thereof, please contact INFO@PCTEST.COM.



PCTEST Hearing-Aid Compatibility Facility

DUT: HH Coil – SN: SBI 1052

Type: HH Coil
Serial: SBI 1052

Measurement Standard: ANSI C63.19-2011

Equipment:

- Probe: Axial T-Coil Probe – SN: TEM-1123; Calibrated: 9/23/2020
- Helmholtz Coil – SN: SBI 1052; Calibrated: 9/23/2020

Noise Spectrum

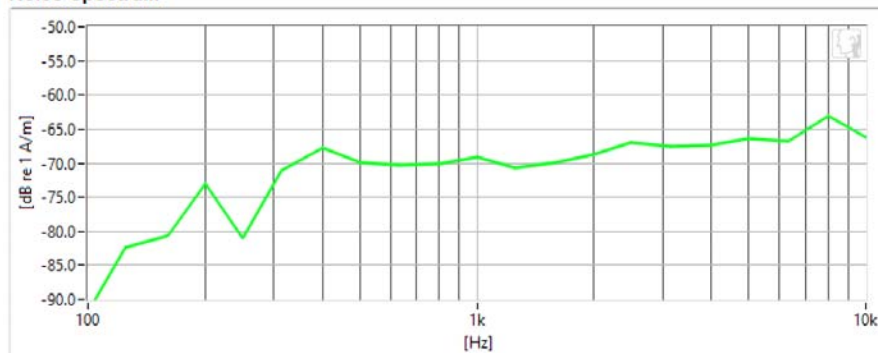

Frequency Response

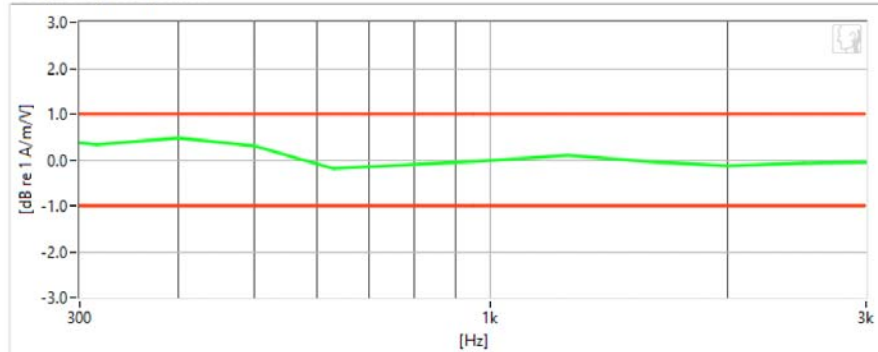

Results

| | | | | |
|-----------------------------|-----------|---|------------------|--------------|
| Verification 1kHz Intensity | -9.848 dB | ✓ | Max/Min | -9.5/-10.5 |
| Verification ABM2 | -58.41 dB | ✓ | Maximum | -58.0 |
| Frequency Response Margin | 500m dB | ✓ | Tolerance curves | Aligned Data |

| | | | | |
|---|--|--------------------------------------|--|--|
| FCC ID: A3LSMG998U | | HAC (T-COIL) TEST REPORT | | Approved by: Quality Manager |
| Filename: 1M2101110004-05.A3L | Test Dates: 12/20/2021 - 1/17/2022 | DUT Type: Portable Handset | | Page 27 of 47 |



PCTEST Hearing-Aid Compatibility Facility

DUT: HH Coil – SN: SBI 1052

Type: HH Coil
Serial: SBI 1052

Measurement Standard: ANSI C63.19-2011

Equipment:

- Probe: Axial T-Coil Probe – SN: TEM-1123; Calibrated: 9/23/2020
- Helmholtz Coil – SN: SBI 1052; Calibrated: 9/23/2020

Noise Spectrum

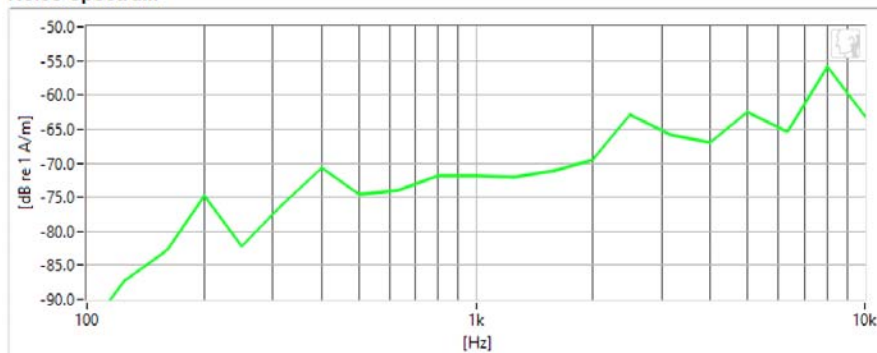

Frequency Response

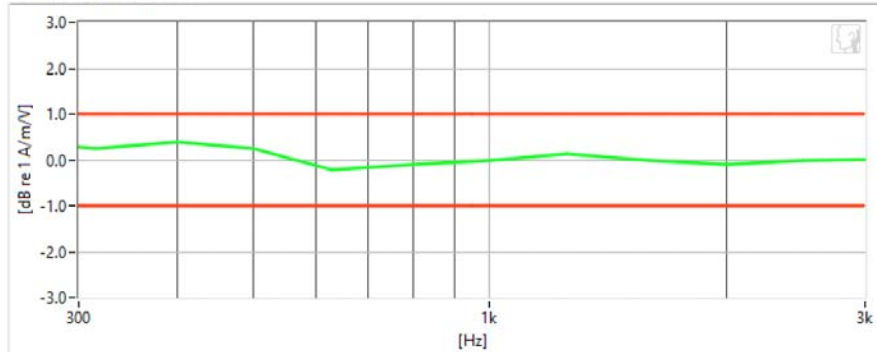

Results

| | | | | |
|-----------------------------|-----------|---|------------------|--------------|
| Verification 1kHz Intensity | -9.988 dB | ✓ | Max/Min | -9.5/-10.5 |
| Verification ABM2 | -59.85 dB | ✓ | Maximum | -58.0 |
| Frequency Response Margin | 600m dB | ✓ | Tolerance curves | Aligned Data |

| | | | | |
|----------------------------------|---------------------------------------|-------------------------------|--|---------------------------------|
| FCC ID: A3LSMG998U | | HAC (T-COIL) TEST REPORT | | Approved by: Quality Manager |
| Filename: 1M2101110004-05.A3L | Test Dates: 12/20/2021 - 1/17/2022 | DUT Type: Portable Handset | | Page 28 of 47 |



PCTEST Hearing-Aid Compatibility Facility

DUT: HH Coil – SN: SBI 1052

Type: HH Coil
Serial: SBI 1052

Measurement Standard: ANSI C63.19-2011

Equipment:

- Probe: Radial T-Coil Probe – SN: TEM-1129; Calibrated: 9/23/2020
- Helmholtz Coil – SN: SBI 1052; Calibrated: 9/23/2020

Noise Spectrum

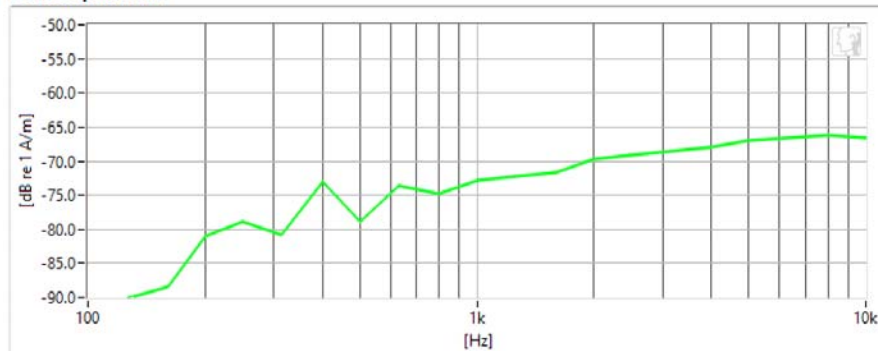

Frequency Response

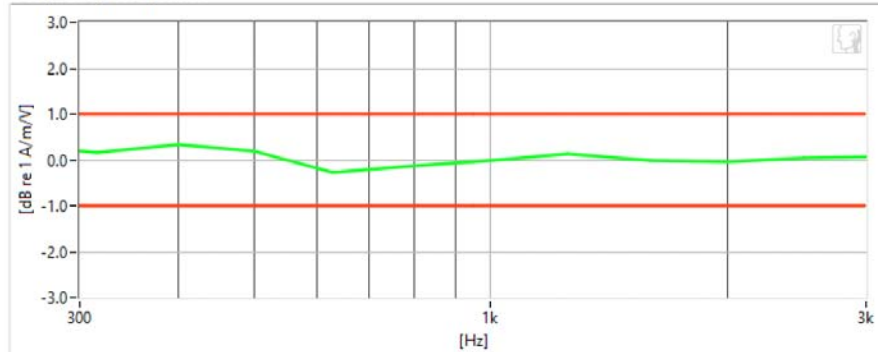

Results

| | | | | |
|-----------------------------|------------|---|------------------|--------------|
| Verification 1kHz Intensity | -10.316 dB | ✓ | Max/Min | -9.5/-10.5 |
| Verification ABM2 | -62.51 dB | ✓ | Maximum | -58.0 |
| Frequency Response Margin | 700m dB | ✓ | Tolerance curves | Aligned Data |

| | | | | |
|---|--|--------------------------------------|--|--|
| FCC ID: A3LSMG998U | | HAC (T-COIL) TEST REPORT | | Approved by: Quality Manager |
| Filename: 1M2101110004-05.A3L | Test Dates: 12/20/2021 - 1/17/2022 | DUT Type: Portable Handset | | Page 29 of 47 |



PCTEST Hearing-Aid Compatibility Facility

DUT: HH Coil – SN: SBI 1052

Type: HH Coil
Serial: SBI 1052

Measurement Standard: ANSI C63.19-2011

Equipment:

- Probe: Radial T-Coil Probe – SN: TEM-1129; Calibrated: 9/23/2020
- Helmholtz Coil – SN: SBI 1052; Calibrated: 9/23/2020

Noise Spectrum

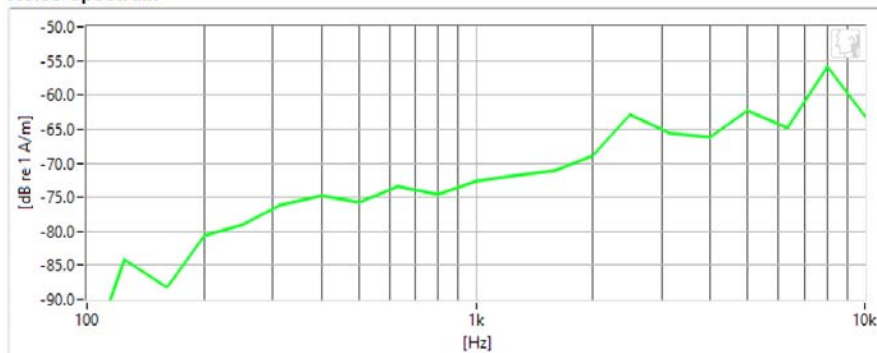

Frequency Response

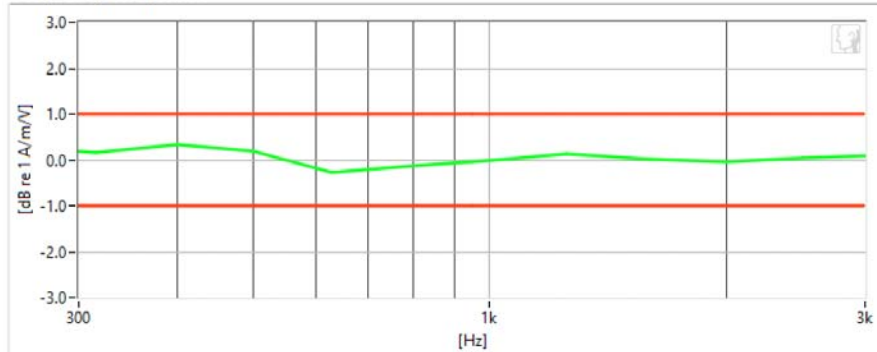

Results

| | | | | |
|-----------------------------|------------|---|------------------|--------------|
| Verification 1kHz Intensity | -10.177 dB | ✓ | Max/Min | -9.5/-10.5 |
| Verification ABM2 | -60.58 dB | ✓ | Maximum | -58.0 |
| Frequency Response Margin | 700m dB | ✓ | Tolerance curves | Aligned Data |

| | | | | |
|---|--|--------------------------------------|--|--|
| FCC ID: A3LSMG998U | | HAC (T-COIL) TEST REPORT | | Approved by: Quality Manager |
| Filename: 1M2101110004-05.A3L | Test Dates: 12/20/2021 - 1/17/2022 | DUT Type: Portable Handset | | Page 30 of 47 |



PCTEST Hearing-Aid Compatibility Facility

DUT: A3LSMG998U

Type: Portable Handset
Serial: 0769M

Measurement Standard: ANSI C63.19-2011

Equipment:

- Probe: Axial T-Coil Probe – SN: TEM-1123; Calibrated: 09/23/2020

Test Configuration:

- Mode: NR TDD n48
- Bandwidth: 20MHz
- Channel: 637334
- Speech Signal: 3GPP2 Normal Test Signal

Noise Spectrum

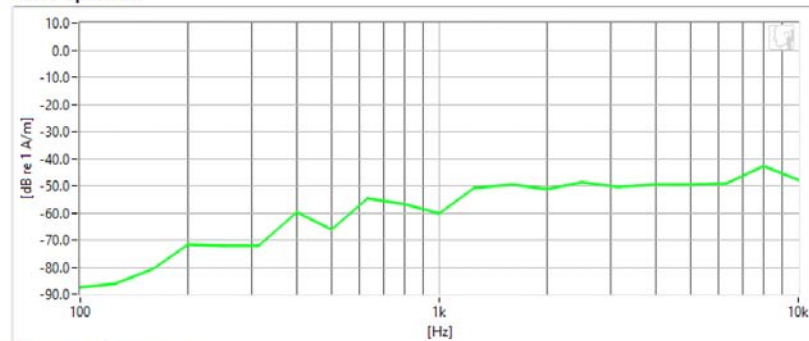

Frequency Response

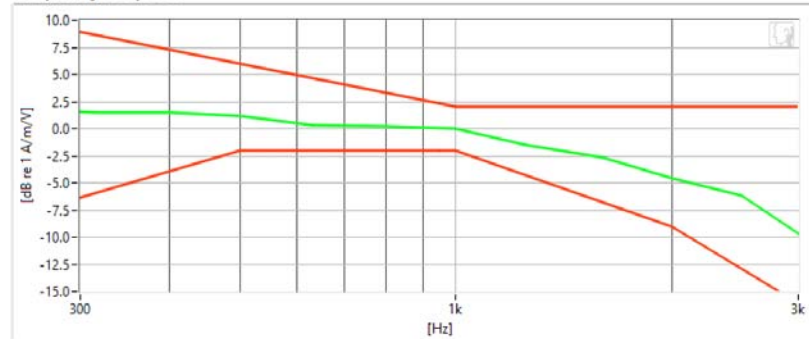

Results

| | | | | |
|---------------------------|-----------|---|------------------|--------------|
| ABM1 | -6.28 dB | ✓ | Minimum | -18.0 |
| ABM2 | -44.38 dB | ✓ | Maximum | 0.0 |
| SNNR | 38.1 dB | ✓ | Minimum | 20.0 |
| Aligned Response - Normal | 2 dB | ✓ | Tolerance curves | Aligned Data |

| | | | | |
|----------------------------------|---------------------------------------|-------------------------------|--|---------------------------------|
| FCC ID: A3LSMG998U | | HAC (T-COIL) TEST REPORT | | Approved by: Quality Manager |
| Filename: 1M2101110004-05.A3L | Test Dates: 12/20/2021 - 1/17/2022 | DUT Type: Portable Handset | | Page 31 of 47 |



PCTEST Hearing-Aid Compatibility Facility

DUT: A3LSMG998U

Type: Portable Handset
Serial: 0769M

Measurement Standard: ANSI C63.19-2011

Equipment:

- Probe: Axial T-Coil Probe – SN: TEM-1123; Calibrated: 09/23/2020

Test Configuration:

- VoIP Application: Google Duo
- Mode: NR TDD n48
- Bandwidth: 20MHz
- Channel: 641666
- Speech Signal: 3GPP2 Normal Test Signal

Noise Spectrum

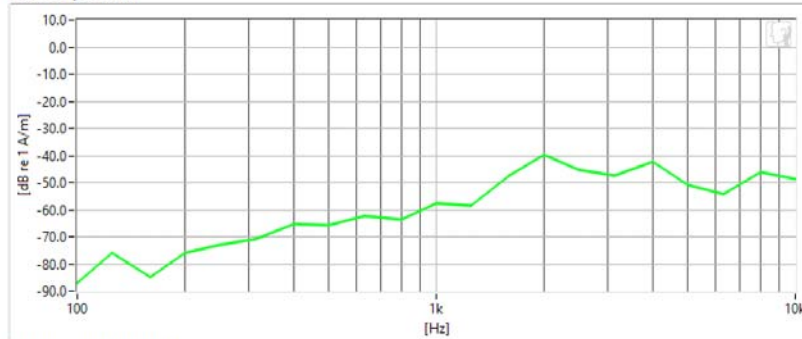

Frequency Response

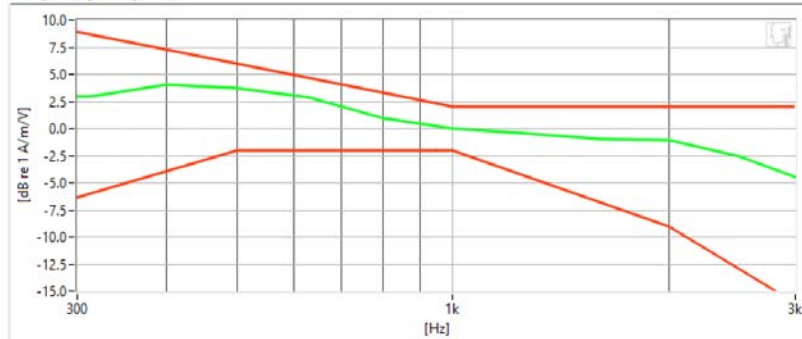

Results

| | | | | |
|---------------------------|-----------|---|------------------|--------------|
| ABM1 | 11.1 dB | ✓ | Minimum | -18.0 |
| ABM2 | -41.13 dB | ✓ | Maximum | 0.0 |
| SNNR | 52.23 dB | ✓ | Minimum | 20.0 |
| Aligned Response - Normal | 1.72 dB | ✓ | Tolerance curves | Aligned Data |

| | | | | |
|----------------------------------|---------------------------------------|-------------------------------|--|---------------------------------|
| FCC ID: A3LSMG998U | | HAC (T-COIL) TEST REPORT | | Approved by: Quality Manager |
| Filename: 1M2101110004-05.A3L | Test Dates: 12/20/2021 - 1/17/2022 | DUT Type: Portable Handset | | Page 32 of 47 |



PCTEST Hearing-Aid Compatibility Facility

DUT: A3LSMG998U

Type: Portable Handset
Serial: 0769M

Measurement Standard: ANSI C63.19-2011

Equipment:

- Probe: Radial T-Coil Probe – SN: TEM-1129; Calibrated: 09/23/2020

Test Configuration:

- Mode: NR TDD n48
- Bandwidth: 20MHz
- Channel: 641666

Noise Spectrum

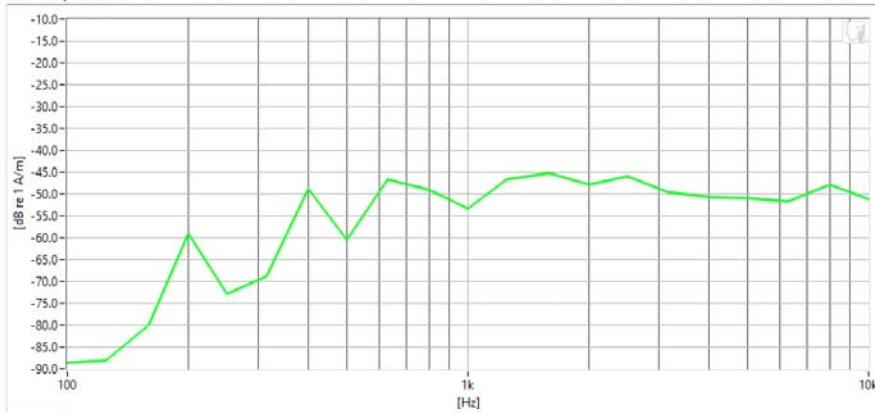

Results

| | | | | |
|------|-----------|---|---------|-------|
| ABM1 | -13.66 dB | ✓ | Minimum | -18.0 |
| ABM2 | -38.89 dB | ✓ | Maximum | 0.0 |
| SNNR | 25.23 dB | ✓ | Minimum | 20.0 |

| | | | | |
|---|--|--------------------------------------|---------------|--|
| FCC ID: A3LSMG998U | | HAC (T-COIL) TEST REPORT | | Approved by: Quality Manager |
| Filename: 1M2101110004-05.A3L | Test Dates: 12/20/2021 - 1/17/2022 | DUT Type: Portable Handset | Page 33 of 47 | |



PCTEST Hearing-Aid Compatibility Facility

DUT: A3LSMG998U

Type: Portable Handset
Serial: 0769M

Measurement Standard: ANSI C63.19-2011

Equipment:

- Probe: Radial T-Coil Probe – SN: TEM-1129; Calibrated: 09/23/2020

Test Configuration:

- VoIP Application: Google Duo
- Mode: NR TDD n48
- Bandwidth: 20MHz
- Channel: 639500

Noise Spectrum

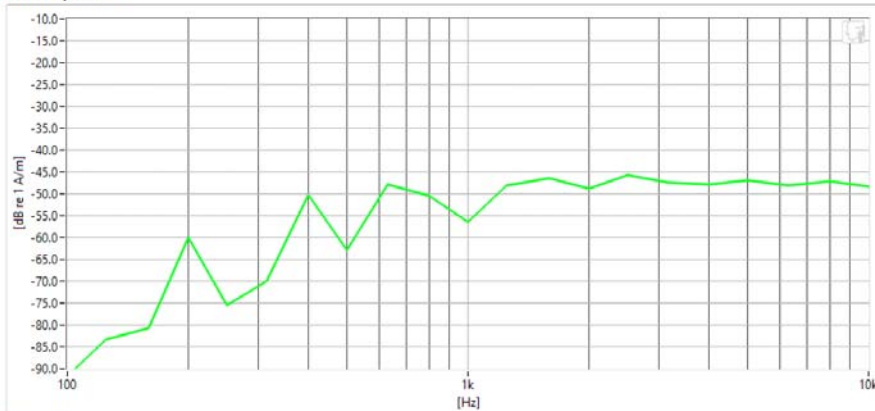



Results

| | | | | |
|------|-----------|---|---------|-------|
| ABM1 | 3.11 dB | ✓ | Minimum | -18.0 |
| ABM2 | -39.96 dB | ✓ | Maximum | 0.0 |
| SNNR | 43.07 dB | ✓ | Minimum | 20.0 |

| | | | | |
|---|--|--------------------------------------|---------------|--|
| FCC ID: A3LSMG998U | | HAC (T-COIL) TEST REPORT | | Approved by: Quality Manager |
| Filename: 1M2101110004-05.A3L | Test Dates: 12/20/2021 - 1/17/2022 | DUT Type: Portable Handset | Page 34 of 47 | |

11. CALIBRATION CERTIFICATES

| | | | | |
|---|---|--------------------------------------|---|--|
| FCC ID: A3LSMG998U |  <small>Head to toe part of</small> | HAC (T-COIL) TEST REPORT |  | Approved by: Quality Manager |
| Filename: 1M2101110004-05.A3L | Test Dates: 12/20/2021 - 1/17/2022 | DUT Type: Portable Handset | Page 35 of 47 | |

© 2022 PCTEST

REV 3.5.M
8/18/2020

© 2022 PCTEST All rights reserved. Unless otherwise specified, no part of this report may be reproduced or utilized in any part, form or by any means, electronic or mechanical, including photocopying and microfilm, without permission in writing from PCTEST. If you have any questions about this international copyright or have an enquiry about obtaining additional rights to this report or assembly of contents thereof, please contact INFO@PCTEST.COM.

West Caldwell Calibration Laboratories Inc.

Certificate of Conformance

for

AXIAL T COIL PROBE

Manufactured by: TEM CONSULTING
 Model No: AXIAL T COIL PROBE
 Serial No: TEM-1123
 Calibration Recall No: 31288

Submitted By:

Customer: ANDREW HARWELL
 Company: PCTEST ENGINEERING LAB
 Address: 6660-B DOBBIN ROAD
 COLUMBIA MD 21045

The subject instrument was calibrated to the indicated specification using standards traceable to the SI through the National Institute of Standards and Technology or to accepted values of natural physical constants. This document certifies that the instrument met the following specification upon its return to the submitter.

West Caldwell Calibration Laboratories Procedure No. AXIAL T C TEM C

✓
10/13/2020

Upon receipt for Calibration, the instrument was found to be:

Within (X)

tolerance of the indicated specification. See attached Report of Calibration.
 The information supplied relates to the calibrated item listed above and statment of conformance for ALL given specifications and standards fall under the decision rule: $A=(L-(U95))$, where A is acceptance limit, L is manufacturer specifications and U95 is confidence level of 95% at $k=2$. This includes but not limited to: 1. Measured value does not meet manufacturer's tolerance, 2. Manufacturer's tolerance is too small compared to calibration and measurment capability uncertainties, 3. Test uncertainty ratio does not meet the 4:1 ratio due to test instrumentation limitations. The decision rule has been communicated and approved by customer during contract
 West Caldwell Calibration Laboratories' calibration control system meets the following requirements, ISO 10012-1 MIL STD 45662A, ANSI/NCSL Z540-1, IEC Guide 25, ISO 9001:2015, and ISO 17025

Note: With this Certificate, Report of Calibration is included.

Approved by:

James Zhu

Quality Manager
 ISO/IEC 17025:2017

Calibration Date: 23-Sep-20

Certificate No: 31288 -2

QA Doc. #1051 Rev. 3.0 5/29/20

Certificate Page 1 of 1

West Caldwell Calibration Laboratories, Inc.
 uncompromised calibration
 1575 State Route 96, Victor, NY 14564, U.S.A.



Calibration Lab. Cert. # 1533.01

| | | | | |
|----------------------------------|--|-------------------------------|--|---------------------------------|
| FCC ID: A3LSMG998U | PCTEST Head to the point of service | HAC (T-COIL) TEST REPORT | | Approved by: Quality Manager |
| Filename: 1M2101110004-05.A3L | Test Dates: 12/20/2021 - 1/17/2022 | DUT Type: Portable Handset | | Page 36 of 47 |



REPORT OF CALIBRATION

for

TEM Consulting LP Axial T Coil Probe
Company: PCTest Engineering Lab

Model No.: Axial T Coil Probe

Serial No.: TEM-1123
I. D. No.: XXXX

| | | | |
|--|--------|---------|-----------------------------------|
| Calibration results: | | | |
| Probe Sensitivity measured with Helmholtz Coil | | | |
| <i>Helmholtz Coil;</i> | | | |
| the number of turns on each coil; | 10 | No. | Before & after data same: ...X... |
| the radius of each coil, in meters; | 0.204 | m | |
| the current in the coils, in amperes.; | 0.08 | A | |
| <i>Helmholtz Coil Constant;</i> | | | |
| | 7.04 | A/m/V | Laboratory Environment: |
| <i>Helmholtz Coil magnetic field;</i> | | | |
| | 5.71 | A/m | Ambient Temperature: 20.7 °C |
| | | | Ambient Humidity: 42.1 % RH |
| | | | Ambient Pressure: 99.094 kPa |
| | | | Calibration Date: 23-Sep-2020 |
| | | | Calibration Due: |
| Probe Sensitivity at | 1000 | Hz. | Report Number: 31288 -2 |
| was | -60.24 | dBV/A/m | Control Number: 31288 |
| | 0.972 | mV/A/m | |
| Probe resistance | 898 | Ohms | |
| The above listed instrument meets or exceeds the tested manufacturer's specifications. | | | |
| This Calibration is traceable through NIST test numbers: 684.07/O-0000001126-20 | | | |
| The expanded uncertainty of calibration: 0.30dB at 95% confidence level with a coverage factor of k=2. | | | |

Graph represents Probes Frequency Response.

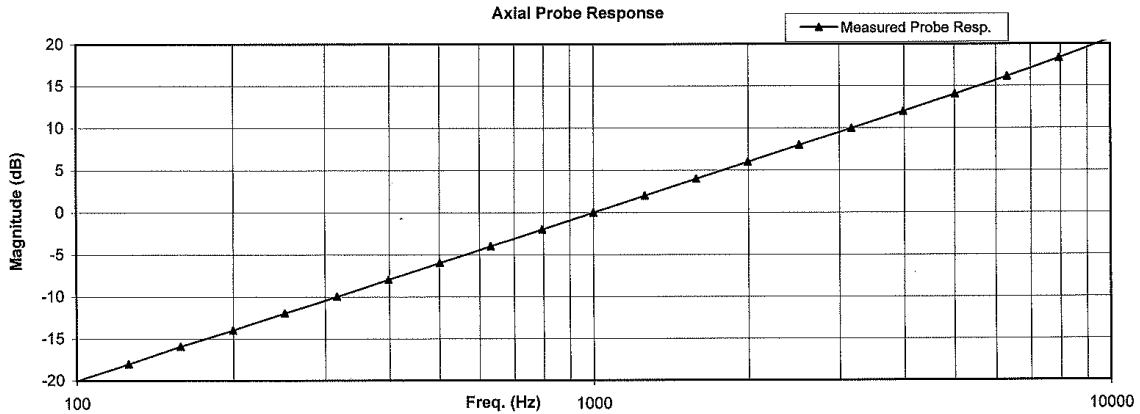

The above listed instrument was checked using calibration procedure documented in West Caldwell Calibration Laboratories Inc. procedure : Rev. 7.0 Jan. 24, 2014 Doc. # 1038 HCATEMC
Calibration was performed by West Caldwell Calibration Laboratories Inc. under Operating Procedures intended to implement the requirements of ISO10012-1, IEC Guide 25, ANSI/NCSL Z540-1, (MIL-STD-45662A) and ISO 9001:2015, ISO 17025

Cal. Date: 23-Sep-2020
Calibrated on WCCL system type 9700

Measurements performed by: James Zhu

This document shall not be reproduced, except in full, without the written approval from West Caldwell Cal. Labs. Inc.

Rev. 7.0 Jan. 24, 2014 Doc. # 1038 HCATEMC

| | | | | |
|----------------------------------|--|-------------------------------|--|---------------------------------|
| FCC ID: A3LSMG998U | PCTEST Head to the point of service | HAC (T-COIL) TEST REPORT | | Approved by: Quality Manager |
| Filename: 1M2101110004-05.A3L | Test Dates: 12/20/2021 - 1/17/2022 | DUT Type: Portable Handset | | Page 37 of 47 |

HCATEMC_TEM-1123_Sep-23-2020

West Caldwell Calibration Laboratories Inc.

1575 State Route 96, Victor NY 14564
Tel. (585) 586-3900 FAX (585) 586-4327

Calibration Data Record

TEM Consulting LP Axial T Coil Probe
Company: PCTest Engineering Lab

for
Model No.: Axial T Coil Probe

Serial No.: TEM-1123

| Test | Function | Tolerance | Measured values | | |
|-------|--------------------------|-----------------------|-----------------|--------|---------|
| | | | Before | Out | Remarks |
| 1.0 | Probe Sensitivity at | 1000 Hz. dBV/A/m | -60.24 | | |
| 2.0 | Probe Level Linearity | Ref. (0 dB) | 6 | 6.03 | |
| | | | 0 | 0.00 | |
| | | | -6 | -6.03 | |
| | | | -12 | -12.05 | |
| 3.0 | Probe Frequency Response | Ref. (0 dB) | 100 | -20.0 | |
| | | | 126 | -18.0 | |
| | | | 158 | -15.9 | |
| | | | 200 | -14.0 | |
| | | | 251 | -12.0 | |
| | | | 316 | -10.0 | |
| | | | 398 | -8.0 | |
| | | | 501 | -6.0 | |
| | | | 631 | -4.0 | |
| | | | 794 | -2.0 | |
| | | | 1000 | 0.0 | |
| | | | 1259 | 2.0 | |
| | | | 1585 | 4.0 | |
| | | | 1995 | 6.0 | |
| | | | 2512 | 8.0 | |
| | | | 3162 | 10.0 | |
| | | | 3981 | 12.0 | |
| 5012 | 14.0 | | | | |
| 6310 | 16.1 | | | | |
| 7943 | 18.3 | | | | |
| 10000 | 20.7 | | | | |



| Instruments used for calibration: | Date of Cal. | Traceability No. | Due Date |
|-----------------------------------|--------------|------------------------|------------|
| HP 34401A S/N US360641 | 2-Jul-2020 | ,610119 | 2-Jul-2021 |
| HP 34401A S/N US361024 | 2-Jul-2020 | ,610119 | 2-Jul-2021 |
| HP 33120A S/N US360437 | 2-Jul-2020 | ,610119 | 2-Jul-2021 |
| B&K 2133 S/N 1583254 | 1-Jul-2020 | 684.07/O-0000001126-20 | 1-Jul-2021 |

Cal. Date: 23-Sep-2020
Calibrated on WCCL system type 9700

Tested by: James Zhu

This document shall not be reproduced, except in full, without the written approval from West Caldwell Cal. Labs, Inc.

Rev. 7.0 Jan. 24, 2014 Doc. # 1038 HCATEMC

| | | | | |
|----------------------------------|---|-------------------------------|---|---------------------------------|
| FCC ID: A3LSMG998U |  | HAC (T-COIL) TEST REPORT |  | Approved by: Quality Manager |
| Filename: 1M2101110004-05.A3L | Test Dates: 12/20/2021 - 1/17/2022 | DUT Type: Portable Handset | | Page 38 of 47 |

West Caldwell Calibration Laboratories Inc.

Certificate of Conformance

for

RADIAL T COIL PROBE

Manufactured by: TEM CONSULTING
Model No: RADIAL T COIL PROBE
Serial No: TEM-1129
Calibration Recall No: 31288

Submitted By:

Customer: ANDREW HARWELL
Company: PCTEST ENGINEERING LAB
Address: 6660-B DOBBIN ROAD
COLUMBIA MD 21045

The subject instrument was calibrated to the indicated specification using standards traceable to the SI through the National Institute of Standards and Technology or to accepted values of natural physical constants. This document certifies that the instrument met the following specification upon its return to the submitter.

West Caldwell Calibration Laboratories Procedure No. RADIAL T TEM C

Upon receipt for Calibration, the instrument was found to be:

Within (X)

tolerance of the indicated specification. See attached Report of Calibration.
The information supplied relates to the calibrated item listed above and statement of conformance for ALL given specifications and standards fall under the decision rule: $A=(L-(U95))$, where A is acceptance limit, L is manufacturer specifications and U95 is confidence level of 95% at $k=2$. This includes but not limited to: 1. Measured value does not meet manufacturer's tolerance, 2. Manufacturer's tolerance is too small compared to calibration and measurement capability uncertainties, 3. Test uncertainty ratio does not meet the 4:1 ratio due to test instrumentation limitations. The decision rule has been communicated and approved by customer during contract

West Caldwell Calibration Laboratories' calibration control system meets the following requirements, ISO 10012-1 MIL STD 45662A, ANSI/NCSL Z540-1, IEC Guide 25, ISO 9001:2015, and ISO 17025

Note: With this Certificate, Report of Calibration is included.

Approved by:

Calibration Date: 23-Sep-20

James Zhu

Certificate No: 31288 - 1

Quality Manager
ISO/IEC 17025:2017



QA Doc. #1051 Rev. 3.0 5/29/20

Certificate Page 1 of 1

West Caldwell Calibration Laboratories, Inc.
uncompromised calibration
1575 State Route 96, Victor, NY 14564, U.S.A.



Calibration Lab. Cert. # 1533.01

| | | | | |
|----------------------------------|---|-------------------------------|---|---------------------------------|
| FCC ID: A3LSMG998U |  | HAC (T-COIL) TEST REPORT |  | Approved by: Quality Manager |
| Filename: 1M2101110004-05.A3L | Test Dates: 12/20/2021 - 1/17/2022 | DUT Type: Portable Handset | | Page 39 of 47 |

© 2022 PCTEST

REV 3.5.M
8/18/2020

© 2022 PCTEST All rights reserved. Unless otherwise specified, no part of this report may be reproduced or utilized in any part, form or by any means, electronic or mechanical, including photocopying and microfilm, without permission in writing from PCTEST. If you have any questions about this international copyright or have an enquiry about obtaining additional rights to this report or assembly of contents thereof, please contact INFO@PCTEST.COM.



REPORT OF CALIBRATION

for

TEM Consulting LP Radial T Coil Probe
Company: PCTest Engineering Lab

Model No.: Radial T Coil Probe

Serial No.: TEM-1129
I. D. No.: XXXX

| | | | |
|--|--------|---------|-----------------------------------|
| Calibration results: | | | |
| Probe Sensitivity measured with Helmholtz Coil | | | |
| <i>Helmholtz Coil;</i> | | | |
| the number of turns on each coil; | 10 | No. | Before & after data same: ...X... |
| the radius of each coil, in meters; | 0.204 | m | |
| the current in the coils, in amperes.; | 0.08 | A | |
| <i>Helmholtz Coil Constant;</i> | 7.04 | A/m/V | Laboratory Environment: |
| <i>Helmholtz Coil magnetic field;</i> | 5.70 | A/m | Ambient Temperature: 20.7 °C |
| | | | Ambient Humidity: 42.1 % RH |
| | | | Ambient Pressure: 99.094 kPa |
| | | | Calibration Date: 23-Sep-2020 |
| Probe Sensitivity at | 1000 | Hz. | Re-calibration Due: |
| was | -60.37 | dBV/A/m | Report Number: 31288 -1 |
| | 0.959 | mV/A/m | Control Number: 31288 |
| Probe resistance | 897 | Ohms | |
| The above listed instrument meets or exceeds the tested manufacturer's specifications. | | | |
| This Calibration is traceable through NIST test numbers: 684.07/O-0000001126-20 | | | |
| The expanded uncertainty of calibration: 0.30dB at 95% confidence level with a coverage factor of k=2. | | | |

Graph represents Probes Frequency Response.

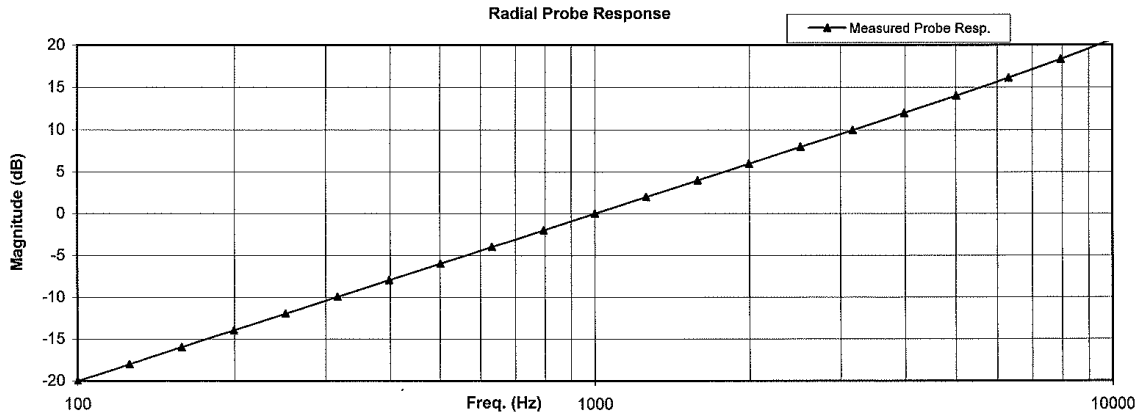

The above listed instrument was checked using calibration procedure documented in West Caldwell Calibration Laboratories Inc. procedure : Rev. 7.0 Jan. 24, 2014 Doc. # 1038 HCRTEMC
Calibration was performed by West Caldwell Calibration Laboratories Inc. under Operating Procedures intended to implement the requirements of ISO10012-1, IEC Guide 25, ANSI/NCSL Z540-1, (MIL-STD-45662A) and ISO 9001:2015, ISO 17025

Cal. Date: 23-Sep-2020
Calibrated on WCCL system type 9700

Measurements performed by: *[Signature]*
James Zhu

This document shall not be reproduced, except in full, without the written approval from West Caldwell Cal. Labs. Inc.

Rev. 7.0 Jan. 24, 2014 Doc. # 1038 HCRTEMC

| | | | | |
|----------------------------------|---------------------------------------|-------------------------------|--|---------------------------------|
| FCC ID: A3LSMG998U | | HAC (T-COIL) TEST REPORT | | Approved by: Quality Manager |
| Filename: 1M2101110004-05.A3L | Test Dates: 12/20/2021 - 1/17/2022 | DUT Type: Portable Handset | | Page 40 of 47 |

HCRTEMC_TEM-1129_Sep-23-2020

West Caldwell Calibration Laboratories Inc.

1575 State Route 96, Victor NY 14564
Tel. (585) 586-3900 FAX (585) 586-4327

Calibration Data Record

TEM Consulting LP Radial T Coil Probe
Company: PCTest Engineering Lab

for
Model No.: Radial T Coil Probe

Serial No.: TEM-1129

| Test | Function | Tolerance | Measured values | | |
|-------|--------------------------|-----------------------|-----------------|--------|---------|
| | | | Before | Out | Remarks |
| 1.0 | Probe Sensitivity at | 1000 Hz. dBV/A/m | -60.37 | | |
| 2.0 | Probe Level Linearity | Ref. (0 dB) | dB | | |
| | | | 6 | 6.04 | |
| | | | 0 | 0.00 | |
| | | | -6 | -6.03 | |
| | | | -12 | -12.05 | |
| 3.0 | Probe Frequency Response | Ref. (0 dB) | Hz | | |
| | | | 100 | -20.0 | |
| | | | 126 | -18.0 | |
| | | | 158 | -16.0 | |
| | | | 200 | -14.0 | |
| | | | 251 | -12.0 | |
| | | | 316 | -10.0 | |
| | | | 398 | -8.0 | |
| | | | 501 | -6.0 | |
| | | | 631 | -4.0 | |
| | | | 794 | -2.0 | |
| | | | 1000 | 0.0 | |
| | | | 1259 | 2.0 | |
| | | | 1585 | 4.0 | |
| | | | 1995 | 6.0 | |
| | | | 2512 | 8.0 | |
| | | | 3162 | 10.0 | |
| 3981 | 12.0 | | | | |
| 5012 | 14.0 | | | | |
| 6310 | 16.1 | | | | |
| 7943 | 18.3 | | | | |
| 10000 | 20.7 | | | | |

| Instruments used for calibration: | | | Date of Cal. | Traceability No. | Due Date |
|-----------------------------------|--------|--------------|--------------|------------------------|------------|
| HP | 34401A | S/N US360641 | 2-Jul-2020 | ,610119 | 2-Jul-2021 |
| HP | 34401A | S/N US361024 | 2-Jul-2020 | ,610119 | 2-Jul-2021 |
| HP | 33120A | S/N US360437 | 2-Jul-2020 | ,610119 | 2-Jul-2021 |
| B&K | 2133 | S/N 1583254 | 1-Jul-2020 | 684.07/O-0000001126-20 | 1-Jul-2021 |



Cal. Date: 23-Sep-2020

Tested by: James Zhu

Calibrated on WCCL system type 9700

This document shall not be reproduced, except in full, without the written approval from West Caldwell Cal. Labs. Inc.



Rev. 7.0 Jan. 24, 2014 Doc. # 1038 HCRTEMC

| | | | | |
|----------------------------------|---|-------------------------------|---|---------------------------------|
| FCC ID: A3LSMG998U |  | HAC (T-COIL) TEST REPORT |  | Approved by: Quality Manager |
| Filename: 1M2101110004-05.A3L | Test Dates: 12/20/2021 - 1/17/2022 | DUT Type: Portable Handset | | Page 41 of 47 |

12. CONCLUSION

The measurements indicate that NR n48 for the wireless communications device complies with the HAC limits specified in accordance with the ANSI C63.19 Standard and FCC WT Docket No. 01-309 RM-8658. Precise laboratory measures were taken to assure repeatability of the tests. The tested device complies with the requirements in respect to all parameters specific to the test. The test results and statements relate only to the item(s) tested.

The measurement system and techniques presented in this evaluation are proposed in the ANSI standard as a means of best approximating wireless device compatibility with a hearing-aid. The literature is under continual re-construction.

| | | | | |
|---|--|--------------------------------------|---|--|
| FCC ID: A3LSMG998U |  PCTEST Head to the point of connection | HAC (T-COIL) TEST REPORT |  | Approved by: Quality Manager |
| Filename: 1M2101110004-05.A3L | Test Dates: 12/20/2021 - 1/17/2022 | DUT Type: Portable Handset | Page 42 of 47 | |



© 2022 PCTEST

REV 3.5.M
8/18/2020

© 2022 PCTEST All rights reserved. Unless otherwise specified, no part of this report may be reproduced or utilized in any part, form or by any means, electronic or mechanical, including photocopying and microfilm, without permission in writing from PCTEST. If you have any questions about this international copyright or have an enquiry about obtaining additional rights to this report or assembly of contents thereof, please contact INFO@PCTEST.COM.

13. REFERENCES

1. ANSI C63.19-2011, American National Standard for Methods of Measurement of Compatibility between Wireless communication devices and Hearing Aids., New York, NY, IEEE, May 2011
2. FCC Office of Engineering and Technology KDB, "285076 D01 HAC Guidance v05," September 13, 2017
3. FCC Office of Engineering and Technology KDB, "285076 D02 T-Coil Testing for CMRS IP v03," September 13, 2017
4. FCC Public Notice DA 06-1215, *Wireless Telecommunications Bureau and Office of Engineering and Technology Clarify Use of Revised Wireless Phone Hearing Aid Compatibility Standard*, June 6, 2006
5. FCC 3G Review Guidance, Laboratory Division OET FCC, May/June 2006
6. Berger, H. S., "Compatibility Between Hearing Aids and Wireless Devices," Electronic Industries Forum, Boston, MA, May, 1997
7. Berger, H. S., "Hearing Aid and Cellular Phone Compatibility: Working Toward Solutions," *Wireless Telephones and Hearing Aids: New Challenges for Audiology*, Gallaudet University, Washington, D.C., May, 1997 (To be reprinted in the American Journal of Audiology).
8. Berger, H. S., "Hearing Aid Compatibility with Wireless Communications Devices," IEEE International Symposium on Electromagnetic Compatibility, Austin, TX, August, 1997.
9. Bronaugh, E. L., "Simplifying EMI Immunity (Susceptibility) Tests in TEM Cells," in the 1990 IEEE International Symposium on Electromagnetic Compatibility Symposium Record, Washington, D.C., August 1990, pp. 488-491
10. Byrne, D. and Dillon, H., The National Acoustics Laboratory (NAL) New Procedure for Selecting the Gain and Frequency Response of a Hearing Aid, Ear and Hearing 7:257-265, 1986.
11. Crawford, M. L., "Measurement of Electromagnetic Radiation from Electronic Equipment using TEM Transmission Cells," U.S. Department of Commerce, National Bureau of Standards, NBSIR 73-306, Feb. 1973.
12. Crawford, M. L., and Workman, J. L., "Using a TEM Cell for EMC Measurements of Electronic Equipment," U.S. Department of Commerce, National Bureau of Standards. Technical Note 1013, July 1981.
13. EHIMA GSM Project, Development phase, Project Report (1st part) Revision A. Technical-Audiological Laboratory and Telecom Denmark, October 1993.
14. EHIMA GSM Project, Development phase, Part II Project Report. Technical-Audiological Laboratory and Telecom Denmark, June 1994.
15. EHIMA GSM Project Final Report, Hearing Aids and GSM Mobile Telephones: Interference Problems, Methods of Measurement and Levels of Immunity. Technical-Audiological Laboratory and Telecom Denmark, 1995.
16. HAMPIS Report, Comparison of Mobile phone electromagnetic near field with an upscaled electromagnetic far field, using hearing aid as reference, 21 October 1999.
17. Hearing Aids/GSM, Report from OTWIDAM, Technical-Audiological Laboratory and Telecom Denmark, April 1993.
18. IEEE 100, The Authoritative Dictionary of IEEE Standards Terms, Seventh Edition.
19. Joyner, K. H, et. al., Interference to Hearing Aids by the New Digital Mobile Telephone System, Global System for Mobile (GSM) Communication Standard, National Acoustic Laboratory, Australian Hearing Series, Sydney 1993.
20. Joyner, K. H., et. al., Interference to Hearing Aids by the Digital Mobile Telephone System, Global System for Mobile Communications (GSM), NAL Report #131, National Acoustic Laboratory, Australian Hearing Series, Sydney, 1995.
21. Kecker, W. T., Crawford, M. L., and Wilson, W. A., "Construction of a Transverse Electromagnetic Cell", U.S. Department of Commerce, National Bureau of Standards, Technical Note 1011, Nov. 1978.
22. Konigstein, D., and Hansen, D., "A New Family of TEM Cells with enlarged bandwidth and Optimized working Volume," in the Proceedings of the 7th International Symposium on EMC, Zurich, Switzerland, March 1987; 50:9, pp. 127-132.



| | | | | |
|---|---|--------------------------------------|---|--|
| FCC ID: A3LSMG998U |  | HAC (T-COIL) TEST REPORT |  | Approved by: Quality Manager |
| Filename: 1M2101110004-05.A3L | Test Dates: 12/20/2021 - 1/17/2022 | DUT Type: Portable Handset | Page 43 of 47 | |

© 2022 PCTEST

REV 3.5.M
8/18/2020

© 2022 PCTEST All rights reserved. Unless otherwise specified, no part of this report may be reproduced or utilized in any part, form or by any means, electronic or mechanical, including photocopying and microfilm, without permission in writing from PCTEST. If you have any questions about this international copyright or have an enquiry about obtaining additional rights to this report or assembly of contents thereof, please contact INFO@PCTEST.COM.

23. Kuk, F., and Hjorstgaard, N. K., "Factors affecting interference from digital cellular telephones," Hearing Journal, 1997; 50:9, pp 32-34.
24. Ma, M. A., and Kanda, M., "Electromagnetic Compatibility and Interference Metrology," U.S. Department of Commerce, National Bureau of Standards, Technical Note 1099, July 1986, pp. 17-43.
25. Ma, M. A., Sreenivashiah, I. , and Chang, D. C., "A Method of Determining the Emission and Susceptibility Levels of Electrically Small Objects Using a TEM Cell," U.S. Department of Commerce, National Bureau of Standards, Technial Note 1040, July 1981.
26. McCandless, G. A., and Lyregaard, P. E., Prescription of Gain/Output (POGO) for Hearing Aids, Hearing Instruments 1:16-21, 1983
27. Skopec, M., "Hearing Aid Electromagnetic Interference from Digital Wireless Telephones, "IEEE Transactions on Rehabilitation Engineering, vol. 6, no. 2, pp. 235-239, June 1998.
28. Technical Report, GSM 05.90, GSM EMC Considerations, European Telecommunications Standards Institute, January 1993.
29. Victorian, T. A., "Digital Cellular Telephone Interference and Hearing Aid Compatibility—an Update," Hearing Journal 1998; 51:10, pp. 53-60
30. Wong, G. S. K., and Embleton, T. F. W., eds., AIP Handbook of Condenser Microphones: Theory, Calibration and Measurements, AIP Press.

| | | | | |
|---|---|--------------------------------------|---|--|
| FCC ID: A3LSMG998U |  PCTEST Head to toe part of solution | HAC (T-COIL) TEST REPORT |  | Approved by: Quality Manager |
| Filename: 1M2101110004-05.A3L | Test Dates: 12/20/2021 - 1/17/2022 | DUT Type: Portable Handset | Page 44 of 47 | |

© 2022 PCTEST

REV 3.5.M
8/18/2020

© 2022 PCTEST All rights reserved. Unless otherwise specified, no part of this report may be reproduced or utilized in any part, form or by any means, electronic or mechanical, including photocopying and microfilm, without permission in writing from PCTEST. If you have any questions about this international copyright or have an enquiry about obtaining additional rights to this report or assembly of contents thereof, please contact INFO@PCTEST.COM.