



## SAR EVALUATION REPORT

**Applicant Name:**  
 Samsung Electronics Co., Ltd.  
 129, Samsung-ro, Maetan dong,  
 Yeongtong-gu, Suwon-si  
 Gyeonggi-do, 16677, Korea

**Date of Testing:**  
 01/17/21 - 01/25/21  
**Test Site/Location:**  
 PCTEST Lab, Columbia, MD, USA  
**Document Serial No.:**  
 1M2101110003-01.A3L

**FCC ID:** A3LSMG998JPN

**APPLICANT:** SAMSUNG ELECTRONICS CO., LTD.

**DUT Type:** Portable Handset  
**Application Type:** Certification  
**FCC Rule Part(s):** CFR §2.1093  
**Model:** SC-52B

Equipment Class	Band & Mode	Tx Frequency	SAR			
			1g Head (W/kg)	1g Body-Worn (W/kg)	1g Hotspot (W/kg)	10g Phablet (W/kg)
PCE	GSM/GPRS/EDGE 850	824.20 - 848.80 MHz	< 0.1	0.18	0.40	N/A
PCE	GSM/GPRS/EDGE 1900	1850.20 - 1909.80 MHz	< 0.1	0.28	0.90	1.20
PCE	UMTS 850	826.40 - 846.60 MHz	0.14	0.24	0.53	N/A
PCE	LTE Band 12	699.7 - 715.3 MHz	< 0.1	0.12	0.24	N/A
PCE	LTE Band 13	779.5 - 784.5 MHz	0.12	0.18	0.31	N/A
PCE	LTE Band 5 (Cell)	824.7 - 848.3 MHz	0.15	0.25	0.54	N/A
PCE	LTE Band 4 (AWS)	1710.7 - 1754.3 MHz	0.11	0.59	0.77	2.53
PCE	LTE Band 41	2498.5 - 2687.5 MHz	< 0.1	0.34	0.43	1.88
DTS	2.4 GHz WLAN	2412 - 2472 MHz	0.21	< 0.1	0.20	N/A
NII	U-NII-1	5180 - 5240 MHz	N/A	N/A	N/A	N/A
NII	U-NII-2A	5260 - 5320 MHz	0.27*	0.70*	N/A	2.06*
NII	U-NII-2C	5500 - 5720 MHz	< 0.1*	0.52*	N/A	1.19*
NII	U-NII-3	5745 - 5825 MHz	< 0.1*	0.58*	0.87*	N/A
DSS/DTS	Bluetooth	2402 - 2480 MHz	0.14	< 0.1	0.19	N/A
<b>Simultaneous SAR per KDB 690783 D01v01r03:</b>			0.65	1.40	1.59	3.51

Note: \* SAR values represent RF exposure during MIMO operations.

This wireless portable device has been shown to be capable of compliance for localized specific absorption rate (SAR) for uncontrolled environment/general population exposure limits specified in ANSI/IEEE C95.1-1992 and has been tested in accordance with the measurement procedures specified in Section 1.9 of this report; for North American frequency bands only.

I attest to the accuracy of data. All measurements reported herein were performed by me or were made under my supervision and are correct to the best of my knowledge and belief. I assume full responsibility for the completeness of these measurements and vouch for the qualifications of all persons taking them. Test results reported herein relate only to the item(s) tested.

Randy Ortanez  
 President





The SAR Tick is an initiative of the Mobile & Wireless Forum (MWF). While a product may be considered eligible, use of the SAR Tick logo requires an agreement with the MWF. Further details can be obtained by emailing: sartick@mwfai.info.

FCC ID: A3LSMG998JPN	<b>PCTEST</b> Proud to be part of element	<b>SAR EVALUATION REPORT</b>		<b>Approved by:</b> Quality Manager
<b>Document S/N:</b> 1M2101110003-01.A3L	<b>Test Dates:</b> 01/17/21 - 01/25/21	<b>DUT Type:</b> Portable Handset	Page 1 of 71	

# TABLE OF CONTENTS

1	DEVICE UNDER TEST .....	3
2	LTE INFORMATION .....	14
3	INTRODUCTION .....	15
4	DOSIMETRIC ASSESSMENT .....	16
5	DEFINITION OF REFERENCE POINTS.....	17
6	TEST CONFIGURATION POSITIONS.....	18
7	RF EXPOSURE LIMITS .....	22
8	FCC MEASUREMENT PROCEDURES.....	23
9	RF CONDUCTED POWERS.....	28
10	SYSTEM VERIFICATION.....	42
11	SAR DATA SUMMARY .....	46
12	FCC MULTI-TX AND ANTENNA SAR CONSIDERATIONS.....	60
13	SAR MEASUREMENT VARIABILITY .....	66
14	EQUIPMENT LIST.....	67
15	MEASUREMENT UNCERTAINTIES.....	68
16	CONCLUSION.....	69
17	REFERENCES .....	70
APPENDIX A: SAR TEST PLOTS		
APPENDIX B: SAR DIPOLE VERIFICATION PLOTS		
APPENDIX C: SAR TISSUE SPECIFICATIONS		
APPENDIX D: SAR SYSTEM VALIDATION		
APPENDIX E: DUT ANTENNA DIAGRAM & SAR TEST SETUP PHOTOGRAPHS		
APPENDIX F: LTE LOWER BANDWIDTH RF CONDUCTED POWERS		
APPENDIX G: POWER REDUCTION VERIFICATION		
APPENDIX H: 802.11ax RU SAR EXCLUSION		
APPENDIX I: PROBE AND DIPOLE CALIBRATION CERTIFICATES		

FCC ID: A3LSMG998JPN	 <b>PCTEST</b> <small>Proud to be part of </small>	<b>SAR EVALUATION REPORT</b>		<b>Approved by:</b> Quality Manager
<b>Document S/N:</b> 1M2101110003-01.A3L	<b>Test Dates:</b> 01/17/21 - 01/25/21	<b>DUT Type:</b> Portable Handset	Page 2 of 71	

# 1 DEVICE UNDER TEST

## 1.1 Device Overview

Band & Mode	Operating Modes	Tx Frequency
GSM/GPRS/EDGE 850	Voice/Data	824.20 - 848.80 MHz
GSM/GPRS/EDGE 1900	Voice/Data	1850.20 - 1909.80 MHz
UMTS 850	Voice/Data	826.40 - 846.60 MHz
LTE Band 12	Voice/Data	699.7 - 715.3 MHz
LTE Band 13	Voice/Data	779.5 - 784.5 MHz
LTE Band 5 (Cell)	Voice/Data	824.7 - 848.3 MHz
LTE Band 4 (AWS)	Voice/Data	1710.7 - 1754.3 MHz
LTE Band 41	Voice/Data	2498.5 - 2687.5 MHz
2.4 GHz WLAN	Voice/Data	2412 - 2472 MHz
U-NII-1	Voice/Data	5180 - 5240 MHz
U-NII-2A	Voice/Data	5260 - 5320 MHz
U-NII-2C	Voice/Data	5500 - 5720 MHz
U-NII-3	Voice/Data	5745 - 5825 MHz
Bluetooth	Data	2402 - 2480 MHz
NFC	Data	13.56 MHz

## 1.2 Time-Averaging Algorithm for RF Exposure Compliance

This device is enabled with the Qualcomm® Smart Transmit feature. This feature performs time averaging algorithm in real time to control and manage transmitting power and ensure the time-averaged RF exposure is in compliance with FCC requirements all the time. **For this device, all US Operations are limited to peak exposure mode only.**



Note that WLAN operations are not enabled with Smart Transmit.

In Peak Exposure mode, the output power of the device is limited to the lower of the Pmax and the Plimit for each characterized technology and band (see RF Exposure Part 0 Test Report, report SN could be found in Section 1.11 - Bibliography).

Below table shows Plimit EFS settings and maximum tune up output power Pmax configured for this EUT for various transmit conditions (Device State Index DSI). Note that the device uncertainty for sub-6GHz WWAN is 1.0dB for this EUT.

Exposure Scenario:		Body-Worn	Phablet	Phablet	Head	Hotspot	Earjack	Maximum Tune-up Output Power*
Averaging Volume:		1g	10g	10g	1g	1g	10g	
Spacing:		15 mm	8, 6, 11 mm	0 mm	0 mm	10 mm	0 mm	
DSI:		0	0	6	2	3	4	
Technology/Band	Antenna	Plimit corresponding to 1mW/g (SAR_design_target)						Pmax
GSM/GPRS/EDGE 850 MHz	A	31.8		27.6	35.1	27.6	27.6	24.8
GSM/GPRS/EDGE 1900 MHz	A	26.3		17.8	33.1	17.8	17.8	21.3
UMTS B5	A	31.7		27.0	34.1	27.0	27.0	24.5
LTE FDD B12	A	33.1		27.4	34.5	27.4	27.4	23.0
LTE FDD B13	A	31.3		28.4	33.0	28.4	28.4	23.0
LTE FDD B5	A	31.3		28.2	33.9	28.1	28.2	24.8
LTE FDD B4	A	26.3		18.5	33.6	18.5	18.5	23.0
LTE TDD B41	B	26.8		19.0	34.9	19.0	19.0	22.0

\*Note all  $P_{limit}$  EFS and maximum tune up output power  $P_{max}$  levels entered in above Table correspond to average power levels after accounting for duty cycle in the case of TDD modulation schemes (e.g. GSM and LTE TDD).

FCC ID: A3LSMG998JPN	 PCTEST Proud to be part of Element	SAR EVALUATION REPORT		Approved by: Quality Manager
Document S/N: 1M2101110003-01.A3L	Test Dates: 01/17/21 - 01/25/21	DUT Type: Portable Handset		Page 3 of 71

\*Maximum tune up output power  $P_{max}$  is used to configure EUT during RF tune up procedure. The maximum allowed output power is equal to maximum Tune up output power + 1dB device design uncertainty.



The maximum time-averaged output power (dBm) for any 2G/3G/4G WWAN technology, band, and DSI = minimum of " $P_{limit}$  EFS" and "Maximum tune up output power  $P_{max}$ " + 1dB device uncertainty. SAR values in this report were scaled to this maximum time-averaged output power to determine compliance per KDB Publication 447498 D01v06.

The purpose of this report (Part 1 test) is to demonstrate that the EUT meets FCC SAR limits when transmitting in static transmission scenario at maximum allowable time-averaged power levels.

**Measurement Condition: All conducted power and SAR measurements in this report (Part 1 test) were performed by setting *Reserve\_power\_margin* (Smart Transmit EFS entry) to 0dB.**

### 1.3 Power Reduction for SAR

This device used an independent fixed level power reduction mechanism for WLAN/BT during all voice or VoIP held to ear scenarios. Per FCC Guidance, the held-to-ear exposure conditions were evaluated at reduced power according to the head SAR positions described in IEEE 1528-2013. Detailed descriptions of the power reduction mechanism are included in the operational description.

FCC ID: A3LSMG998JPN	 <small>Proud to be part of</small> 	SAR EVALUATION REPORT	 <b>Approved by:</b> Quality Manager
<b>Document S/N:</b> 1M2101110003-01.A3L	<b>Test Dates:</b> 01/17/21 - 01/25/21	<b>DUT Type:</b> Portable Handset	Page 4 of 71

## 1.4 Nominal and Maximum Output Power Specifications

This device operates using the following maximum and nominal output power specifications. SAR values were scaled to the maximum allowed power to determine compliance per KDB Publication 447498 D01v06.

### 1.4.1 2G/3G/4G Output Power



GSM/GPRS/EDGE 850										
Power Level		Voice (in dBm)	Data - Burst Average GMSK (in dBm)				Data - Burst Average 8-PSK (in dBm)			
		1 TX Slot	1 TX Slots	2 TX Slots	3 TX Slots	4 TX Slots	1 TX Slots	2 TX Slots	3 TX Slots	4 TX Slots
Max	Max allowed power	33.5	33.5	32.0	30.0	28.0	27.5	25.5	23.5	22.5
	Nominal	32.5	32.5	31.0	29.0	27.0	26.5	24.5	22.5	21.5
GSM/GPRS/EDGE 1900										
Power Level		Voice (in dBm)	Data - Burst Average GMSK (in dBm)				Data - Burst Average 8-PSK (in dBm)			
		1 TX Slot	1 TX Slots	2 TX Slots	3 TX Slots	4 TX Slots	1 TX Slots	2 TX Slots	3 TX Slots	4 TX Slots
Max	Max allowed power	30.0	30.0	28.5	26.5	24.5	26.5	24.0	22.0	21.0
	Nominal	29.0	29.0	27.5	25.5	23.5	25.5	23.0	21.0	20.0
Hotspot Mode Active	Max allowed power	N/A	28.0	25.0	23.2	22.0	26.5	24.0	22.0	21.0
	Nominal	N/A	27.0	24.0	22.2	21.0	25.5	23.0	21.0	20.0
Proximity Sensor Active	Max allowed power	28.0	28.0	25.0	23.2	22.0	26.5	24.0	22.0	21.0
	Nominal	27.0	27.0	24.0	22.2	21.0	25.5	23.0	21.0	20.0

For GSM, the above powers listed are GSM burst average values.

UMTS Band 5 (850 MHz)					
Power Level		Modulated Average Output Power (in dBm)			
		3GPP WCDMA Rel 99	3GPP HSDPA Rel 5	3GPP HSUPA Rel 6	3GPP DC-HSDPA Rel 8
Max	Max allowed power	25.5	24.5	24.5	24.5
	Nominal	24.5	23.5	23.5	23.5

Mode / Band		Modulated Average Output Power (in dBm)		
		Max	Hotspot Mode Active	Proximity Sensor Active
LTE FDD Band 12	Max allowed power	24.0		
	Nominal	23.0		
LTE FDD Band 13	Max allowed power	24.0		
	Nominal	23.0		
LTE FDD Band 5	Max allowed power	25.8		
	Nominal	24.8		
LTE FDD Band 4	Max allowed power	24.0	19.5	19.5
	Nominal	23.0	18.5	18.5
LTE TDD Band 41	Max allowed power	25.0	22.0	22.0
	Nominal	24.0	21.0	21.0

For LTE TDD the above powers listed are TDD burst average values.

FCC ID: A3LSMG998JPN	 PCTEST Proud to be part of element	SAR EVALUATION REPORT		Approved by: Quality Manager
Document S/N: 1M2101110003-01.A3L	Test Dates: 01/17/21 - 01/25/21	DUT Type: Portable Handset	Page 5 of 71	

## 1.4.2 2.4 GHz Maximum SISO/MIMO WLAN Output Power

Note: Targets for 802.11ax RU operations can be found in Appendix H

Mode	Band	IEEE 802.11 (in dBm)							
		SISO		MIMO					
		Antenna 1 & Antenna 2		g (CDD + STBC)		n (CDD + STBC, SDM)		ax (SU) (CDD + STBC, SDM)	
		b							
		Nominal	Maximum	Nominal	Maximum	Nominal	Maximum	Nominal	Maximum
2.4 GHz WIFI	2.45 GHz	18.0	19.0	20.5 ch. 12: 17.5 ch. 13: 17.0	21.5 ch. 12: 18.5 ch. 13: 18.0	20.5 ch. 12: 17.5 ch. 13: 17.0	21.5 ch. 12: 18.5 ch. 13: 18.0	20.5 ch. 1: 17.0 ch. 11: 17.5 ch. 12: 17.5 ch. 13: 17.0	21.5 ch. 1: 18.0 ch. 11: 18.5 ch. 12: 18.5 ch. 13: 18.0

## 1.4.3 2.4 GHz Reduced WLAN Output Powers

Note: Targets for 802.11ax RU operations can be found in Appendix H

The below table is applicable in the following conditions:



- RCV Active
- Simultaneous conditions with 5 GHz WLAN (RCV not Active)

Mode	Band	IEEE 802.11 (in dBm)							
		SISO		MIMO					
		Antenna 1 & Antenna 2		g (CDD + STBC)		n (CDD + STBC, SDM)		ax (SU) (CDD + STBC, SDM)	
		b							
		Nominal	Maximum	Nominal	Maximum	Nominal	Maximum	Nominal	Maximum
2.4 GHz WIFI	2.45 GHz	16.0	17.0	19.0 ch. 12: 17.5 ch. 13: 17.0	20.0 ch. 12: 18.5 ch. 13: 18.0	19.0 ch. 12: 17.5 ch. 13: 17.0	20.0 ch. 12: 18.5 ch. 13: 18.0	19.0 ch. 1: 17.0 ch. 11: 17.5 ch. 12: 17.5 ch. 13: 17.0	20.0 ch. 1: 18.0 ch. 11: 18.5 ch. 12: 18.5 ch. 13: 18.0

The below table is applicable in the following conditions:

- RCV Active during simultaneous conditions with 5 GHz WLAN



Mode	Band	IEEE 802.11 (in dBm)							
		SISO		MIMO					
		Antenna 1 & Antenna 2		g (CDD + STBC)		n (CDD + STBC, SDM)		ax (SU) (CDD + STBC, SDM)	
		b							
		Nominal	Maximum	Nominal	Maximum	Nominal	Maximum	Nominal	Maximum
2.4 GHz WIFI	2.45 GHz	13.0	14.0	16.0	17.0	16.0	17.0	16.0	17.0

FCC ID: A3LSMG998JPN	 <b>PCTEST</b> Proud to be part of element	<b>SAR EVALUATION REPORT</b>		<b>Approved by:</b> Quality Manager
<b>Document S/N:</b> 1M2101110003-01.A3L	<b>Test Dates:</b> 01/17/21 - 01/25/21	<b>DUT Type:</b> Portable Handset		Page 6 of 71

## 1.4.4 5 GHz Maximum SISO/MIMO WLAN Output Power

Note: Targets for 802.11ax RU operations can be found in Appendix H

Mode	Band	IEEE 802.11 (in dBm)							
		MIMO							
		a (CDD + STBC)		n (CDD + STBC, SDM)		ac (CDD + STBC, SDM)		ax (SU) (CDD + STBC, SDM)	
		Nominal	Maximum	Nominal	Maximum	Nominal	Maximum	Nominal	Maximum
5 GHz WIFI (20MHz BW)	5200 MHz	19.5	20.5	19.5	20.5	19.5	20.5	19.5	20.5
	5300 MHz	19.5	20.5	19.5	20.5	19.5	20.5	19.5	20.5
	5500 MHz	19.5	20.5	19.5	20.5	19.5	20.5	19.5	20.5
	5800 MHz	19.5	20.5	19.5	20.5	19.5	20.5	19.5	20.5
5 GHz WIFI (40MHz BW)	5200 MHz			19.0 ch. 38 17.0	20.0 ch. 38 18.0	19.0 ch. 38 17.0	20.0 ch. 38 18.0	19.0 ch. 38 17.0	20.0 ch. 38 18.0
	5300 MHz			19.0 ch. 62 17.0	20.0 ch. 62 18.0	19.0 ch. 62 17.0	20.0 ch. 62 18.0	19.0 ch. 62 17.0	20.0 ch. 62 18.0
	5500 MHz			19.0 ch. 102 17.5	20.0 ch. 102 18.5	19.0 ch. 102 17.5	20.0 ch. 102 18.5	19.0 ch. 102 17.5	20.0 ch. 102 18.5
	5800 MHz			19.0	20.0	19.0	20.0	19.0	20.0
5 GHz WIFI (80MHz BW)	5200 MHz					17.0	18.0	17.0	18.0
	5300 MHz					17.0	18.0	17.0	18.0
	5500 MHz					18.5	19.5	18.5	19.5
	5800 MHz					18.5	19.5	18.5	19.5
5 GHz WIFI (160MHz BW)	5250 MHz					15.0	16.0	15.0	16.0
	5570 MHz					16.5	17.5	16.5	17.5

FCC ID: A3LSMG998JPN	 <b>PCTEST</b> Proud to be part of 	<b>SAR EVALUATION REPORT</b>		<b>Approved by:</b> Quality Manager
<b>Document S/N:</b> 1M2101110003-01.A3L	<b>Test Dates:</b> 01/17/21 - 01/25/21	<b>DUT Type:</b> Portable Handset		Page 7 of 71



## 1.4.5 5 GHz Reduced WLAN Output Powers

Note: Targets for 802.11ax RU operations can be found in Appendix H

The below table is applicable in the following conditions:

- RCV Active
- Simultaneous conditions with 2.4 GHz WLAN
- RCV Active during simultaneous conditions with 2.4 GHz WLAN

Mode	Band	IEEE 802.11 (in dBm)							
		MIMO							
		a (CDD + STBC)		n (CDD + STBC, SDM)		ac (CDD + STBC, SDM)		ax (SU) (CDD + STBC, SDM)	
		Nominal	Maximum	Nominal	Maximum	Nominal	Maximum	Nominal	Maximum
5 GHz WIFI (20MHz BW)	5200 MHz	16.0	17.0	16.0	17.0	16.0	17.0	16.0	17.0
	5300 MHz	16.0	17.0	16.0	17.0	16.0	17.0	16.0	17.0
	5500 MHz	16.0	17.0	16.0	17.0	16.0	17.0	16.0	17.0
	5800 MHz	16.0	17.0	16.0	17.0	16.0	17.0	16.0	17.0
5 GHz WIFI (40MHz BW)	5200 MHz			16.0	17.0	16.0	17.0	16.0	17.0
	5300 MHz			16.0	17.0	16.0	17.0	16.0	17.0
	5500 MHz			16.0	17.0	16.0	17.0	16.0	17.0
	5800 MHz			16.0	17.0	16.0	17.0	16.0	17.0
5 GHz WIFI (80MHz BW)	5200 MHz					16.0	17.0	16.0	17.0
	5300 MHz					16.0	17.0	16.0	17.0
	5500 MHz					16.0	17.0	16.0	17.0
	5800 MHz					16.0	17.0	16.0	17.0
5 GHz WIFI (160MHz BW)	5250 MHz					15.0	16.0	15.0	16.0
	5570 MHz					16.0	17.0	16.0	17.0

FCC ID: A3LSMG998JPN	 <b>PCTEST</b> Proud to be part of 	<b>SAR EVALUATION REPORT</b>		<b>Approved by:</b> Quality Manager
<b>Document S/N:</b> 1M2101110003-01.A3L	<b>Test Dates:</b> 01/17/21 - 01/25/21	<b>DUT Type:</b> Portable Handset	Page 8 of 71	



## 1.4.6 2.4 GHz Maximum Bluetooth Output Power



Mode	Single Antenna				Single Antenna in Dual Mode				Dual	
	Antenna 1		Antenna 2		Antenna 1		Antenna 2			
	Nominal	Maximum	Nominal	Maximum	Nominal	Maximum	Nominal	Maximum	Nominal	Maximum
Bluetooth (in dBm)	16.0	17.0	16.0	17.0	11.1	12.1	10.9	11.9	14.0	15.0
Bluetooth EDR (in dBm)	13.0	14.0	13.0	14.0	15.0	16.0	12.6	13.6	17.0	18.0
Bluetooth LE 2Mbps (in dBm)			9.0	10.0						
Bluetooth LE 1Mbps, 125/500 kbps (in dBm)			9.0	10.0						

## 1.4.7 2.4 GHz Reduced Bluetooth Output Power

The below table is applicable in the following conditions:

- RCV active

Mode	Single Antenna				Single Antenna in Dual Mode				Dual	
	Antenna 1		Antenna 2		Antenna 1		Antenna 2			
	Nominal	Maximum	Nominal	Maximum	Nominal	Maximum	Nominal	Maximum	Nominal	Maximum
Bluetooth (in dBm)	13.0	14.0	13.0	14.0	10.0	11.0	10.0	11.0	13.0	14.0
Bluetooth EDR (in dBm)	13.0	14.0	13.0	14.0	10.0	11.0	10.0	11.0	13.0	14.0
Bluetooth LE 2Mbps (in dBm)			9.0	10.0						
Bluetooth LE 1Mbps, 125/500 kbps (in dBm)			9.0	10.0						

FCC ID: A3LSMG998JPN	 <b>PCTEST</b> Proud to be part of 	<b>SAR EVALUATION REPORT</b>		Approved by: Quality Manager
Document S/N: 1M2101110003-01.A3L	Test Dates: 01/17/21 - 01/25/21	DUT Type: Portable Handset	Page 9 of 71	

## 1.5 DUT Antenna Locations

The overall dimensions of this device are > 9 x 5 cm. A diagram showing the location of the device antennas can be found in Appendix E. Since the diagonal dimension of this device is > 160 mm and <200 mm, it is considered a “phablet.”



**Table 1-1  
Device Edges/Sides for SAR Testing**

Mode	Back	Front	Top	Bottom	Right	Left
GPRS 850	Yes	Yes	No	Yes	Yes	Yes
GPRS 1900	Yes	Yes	No	Yes	Yes	Yes
UMTS 850	Yes	Yes	No	Yes	Yes	Yes
LTE Band 12	Yes	Yes	No	Yes	Yes	Yes
LTE Band 13	Yes	Yes	No	Yes	Yes	Yes
LTE Band 5 (Cell)	Yes	Yes	No	Yes	Yes	Yes
LTE Band 4 (AWS)	Yes	Yes	No	Yes	Yes	Yes
LTE Band 41	Yes	Yes	No	Yes	No	Yes
2.4 GHz WLAN Ant 1	Yes	Yes	Yes	No	No	Yes
2.4 GHz WLAN Ant 2	Yes	Yes	No	No	No	Yes
5 GHz WLAN MIMO	Yes	Yes	Yes	No	No	Yes
Bluetooth Ant 1	Yes	Yes	Yes	No	No	Yes
Bluetooth Ant 2	Yes	Yes	No	No	No	Yes
Bluetooth MIMO	Yes	Yes	Yes	No	No	Yes

Note: Particular DUT edges were not required to be evaluated for wireless router SAR or phablet SAR if the edges were greater than 2.5 cm from the transmitting antenna according to FCC KDB Publication 941225 D06v02r01 Section III and FCC KDB Publication 648474 D04v01r03. The distances between the transmit antennas and the edges of the device are included in the filing. When wireless router mode is enabled, U-NII-1, U-NII-2A, and U-NII-2C operations are disabled.

## 1.6 Near Field Communications (NFC) Antenna

This DUT has NFC operations. The NFC antenna is integrated into the device for this model. Therefore, all SAR tests were performed with the device which already incorporates the NFC antenna. A diagram showing the location of the NFC antenna can be found in Appendix E.

FCC ID: A3LSMG998JPN	 <b>PCTEST</b> Proud to be part of 	<b>SAR EVALUATION REPORT</b>		<b>Approved by:</b> Quality Manager
<b>Document S/N:</b> 1M2101110003-01.A3L	<b>Test Dates:</b> 01/17/21 - 01/25/21	<b>DUT Type:</b> Portable Handset	Page 10 of 71	

## 1.7 Simultaneous Transmission Capabilities



According to FCC KDB Publication 447498 D01v06, transmitters are considered to be operating simultaneously when there is overlapping transmission, with the exception of transmissions during network hand-offs with maximum hand-off duration less than 30 seconds.

This device contains multiple transmitters that may operate simultaneously, and therefore requires a simultaneous transmission analysis according to FCC KDB Publication 447498 D01v06 4.3.2 procedures.

**Table 1-2  
Simultaneous Transmission Scenarios**

No.	Capable Transmit Configuration	Head	Body-Worn Accessory	Wireless Router	Phablet	Notes
1	GSM voice + 2.4 GHz WLAN	Yes	Yes	N/A	Yes	
2	GSM voice + 2.4 GHz WLAN MIMO	Yes	Yes	N/A	Yes	
3	GSM voice + 5 GHz WLAN MIMO	Yes	Yes	N/A	Yes	
4	GSM voice + 2.4 GHz WLAN + 5 GHz WLAN MIMO	Yes	Yes	N/A	Yes	
5	GSM voice + 2.4 GHz WLAN MIMO + 5 GHz WLAN MIMO	Yes	Yes	N/A	Yes	
6	GSM voice + 2.4 GHz Bluetooth Ant 1	Yes <sup>^</sup>	Yes	N/A	Yes	<sup>^</sup> Bluetooth Tethering is considered
7	GSM voice + 2.4 GHz Bluetooth Ant 2	Yes <sup>^</sup>	Yes	N/A	Yes	<sup>^</sup> Bluetooth Tethering is considered
8	GSM voice + 2.4 GHz Bluetooth Ant 1 + 5 GHz WLAN MIMO	Yes <sup>^</sup>	Yes	N/A	Yes	<sup>^</sup> Bluetooth Tethering is considered
9	GSM voice + 2.4 GHz Bluetooth Ant 2 + 5 GHz WLAN MIMO	Yes <sup>^</sup>	Yes	N/A	Yes	<sup>^</sup> Bluetooth Tethering is considered
10	GSM voice + 2.4 GHz Bluetooth Ant 1 + 2.4 GHz Bluetooth Ant 2	Yes <sup>^</sup>	Yes	N/A	Yes	<sup>^</sup> Bluetooth Tethering is considered
11	GSM voice + 2.4 GHz Bluetooth Ant 1 + 2.4 GHz Bluetooth Ant 2 + 5 GHz WLAN MIMO	Yes <sup>^</sup>	Yes	N/A	Yes	<sup>^</sup> Bluetooth Tethering is considered
12	UMTS + 2.4 GHz WLAN	Yes	Yes	Yes	Yes	
13	UMTS + 2.4 GHz WLAN MIMO	Yes	Yes	Yes	Yes	
14	UMTS + 5 GHz WLAN MIMO	Yes	Yes	Yes	Yes	
15	UMTS + 2.4 GHz WLAN + 5 GHz WLAN MIMO	Yes	Yes	Yes	Yes	
16	UMTS + 2.4 GHz WLAN MIMO + 5 GHz WLAN MIMO	Yes	Yes	Yes	Yes	
17	UMTS + 2.4 GHz Bluetooth Ant 1	Yes <sup>^</sup>	Yes	Yes <sup>^</sup>	Yes	<sup>^</sup> Bluetooth Tethering is considered
18	UMTS + 2.4 GHz Bluetooth Ant 2	Yes <sup>^</sup>	Yes	Yes <sup>^</sup>	Yes	<sup>^</sup> Bluetooth Tethering is considered
19	UMTS + 2.4 GHz Bluetooth Ant 1 + 5 GHz WLAN MIMO	Yes <sup>^</sup>	Yes	Yes <sup>^</sup>	Yes	<sup>^</sup> Bluetooth Tethering is considered
20	UMTS + 2.4 GHz Bluetooth Ant 2 + 5 GHz WLAN MIMO	Yes <sup>^</sup>	Yes	Yes <sup>^</sup>	Yes	<sup>^</sup> Bluetooth Tethering is considered
21	UMTS + 2.4 GHz Bluetooth Ant 1 + 2.4 GHz Bluetooth Ant 2	Yes <sup>^</sup>	Yes	Yes <sup>^</sup>	Yes	<sup>^</sup> Bluetooth Tethering is considered
22	UMTS + 2.4 GHz Bluetooth Ant 1 + 2.4 GHz Bluetooth Ant 2 + 5 GHz WLAN MIMO	Yes <sup>^</sup>	Yes	Yes <sup>^</sup>	Yes	<sup>^</sup> Bluetooth Tethering is considered
23	LTE + 2.4 GHz WLAN	Yes	Yes	Yes	Yes	
24	LTE + 2.4 GHz WLAN MIMO	Yes	Yes	Yes	Yes	
25	LTE + 5 GHz WLAN MIMO	Yes	Yes	Yes	Yes	
26	LTE + 2.4 GHz WLAN + 5 GHz WLAN MIMO	Yes	Yes	Yes	Yes	
27	LTE + 2.4 GHz WLAN MIMO + 5 GHz WLAN MIMO	Yes	Yes	Yes	Yes	
28	LTE + 2.4 GHz Bluetooth Ant 1	Yes <sup>^</sup>	Yes	Yes <sup>^</sup>	Yes	<sup>^</sup> Bluetooth Tethering is considered
29	LTE + 2.4 GHz Bluetooth Ant 2	Yes <sup>^</sup>	Yes	Yes <sup>^</sup>	Yes	<sup>^</sup> Bluetooth Tethering is considered
30	LTE + 2.4 GHz Bluetooth Ant 1 + 5 GHz WLAN MIMO	Yes <sup>^</sup>	Yes	Yes <sup>^</sup>	Yes	<sup>^</sup> Bluetooth Tethering is considered
31	LTE + 2.4 GHz Bluetooth Ant 2 + 5 GHz WLAN MIMO	Yes <sup>^</sup>	Yes	Yes <sup>^</sup>	Yes	<sup>^</sup> Bluetooth Tethering is considered
32	LTE + 2.4 GHz Bluetooth Ant 1 + 2.4 GHz Bluetooth Ant 2	Yes <sup>^</sup>	Yes	Yes <sup>^</sup>	Yes	<sup>^</sup> Bluetooth Tethering is considered
33	LTE + 2.4 GHz Bluetooth Ant 1 + 2.4 GHz Bluetooth Ant 2 + 5 GHz WLAN MIMO	Yes <sup>^</sup>	Yes	Yes <sup>^</sup>	Yes	<sup>^</sup> Bluetooth Tethering is considered
34	GPRS/EDGE + 2.4 GHz WLAN	N/A	N/A	Yes	Yes	
35	GPRS/EDGE + 2.4 GHz WLAN MIMO	N/A	N/A	Yes	Yes	
36	GPRS/EDGE + 5 GHz WLAN MIMO	N/A	N/A	Yes	Yes	
37	GPRS/EDGE + 2.4 GHz WLAN + 5 GHz WLAN MIMO	N/A	N/A	Yes	Yes	
38	GPRS/EDGE + 2.4 GHz WLAN MIMO + 5 GHz WLAN MIMO	N/A	N/A	Yes	Yes	
39	GPRS/EDGE + 2.4 GHz Bluetooth Ant 1	N/A	N/A	Yes <sup>^</sup>	Yes	<sup>^</sup> Bluetooth Tethering is considered
40	GPRS/EDGE + 2.4 GHz Bluetooth Ant 2	N/A	N/A	Yes <sup>^</sup>	Yes	<sup>^</sup> Bluetooth Tethering is considered
41	GPRS/EDGE + 2.4 GHz Bluetooth Ant 1 + 5 GHz WLAN MIMO	N/A	N/A	Yes <sup>^</sup>	Yes	<sup>^</sup> Bluetooth Tethering is considered
42	GPRS/EDGE + 2.4 GHz Bluetooth Ant 2 + 5 GHz WLAN MIMO	N/A	N/A	Yes <sup>^</sup>	Yes	<sup>^</sup> Bluetooth Tethering is considered
43	GPRS/EDGE + 2.4 GHz Bluetooth Ant 1 + 2.4 GHz Bluetooth Ant 2	N/A	N/A	Yes <sup>^</sup>	Yes	<sup>^</sup> Bluetooth Tethering is considered
44	GPRS/EDGE + 2.4 GHz Bluetooth Ant 1 + 2.4 GHz Bluetooth Ant 2 + 5 GHz WLAN MIMO	N/A	N/A	Yes <sup>^</sup>	Yes	<sup>^</sup> Bluetooth Tethering is considered

- 2.4 GHz WLAN and 2.4 GHz Bluetooth share the same antenna path and cannot transmit simultaneously.
- All licensed modes share the same antenna path and cannot transmit simultaneously.
- When the user utilizes multiple services in UMTS 3G mode it uses multi-Radio Access Bearer or multi-RAB. The power control is based on a physical control channel (Dedicated Physical Control Channel [DPCCH]) and power control will be adjusted to meet the needs of both services. Therefore, the UMTS+WLAN scenario also represents the UMTS Voice/DATA + WLAN Hotspot scenario.
- Per the manufacturer, WIFI Direct is not expected to be used in conjunction with a held-to-ear or body-worn accessory voice call. Therefore, there are no simultaneous transmission scenarios involving WIFI direct beyond that listed in the above table.

FCC ID: A3LSMG998JPN	 PCTEST Proud to be part of 	SAR EVALUATION REPORT		Approved by: Quality Manager
Document S/N: 1M2101110003-01.A3L	Test Dates: 01/17/21 - 01/25/21	DUT Type: Portable Handset		Page 11 of 71

5. 5 GHz Wireless Router is only supported for the U-NII-3 by S/W, therefore U-NII-1, U-NII2A, and U-NII2C were not evaluated for wireless router conditions.
6. This device supports 2x2 MIMO Tx for WLAN 802.11a/g/n/ac/ax. 802.11a/g/n/ac/ax supports CDD and STBC and 802.11n/ac/ax additionally supports SDM. 2.4 GHz WLAN antenna can transmit independently or together when operating with MIMO. 5 GHz WLAN can transmit only when operating with MIMO.
7. This device supports VoWiFi.
8. This device supports Bluetooth Tethering.
9. This device supports VoLTE.

## 1.8 Miscellaneous SAR Test Considerations

### (A) WIFI/BT

Since U-NII-1 and U-NII-2A bands have the same maximum output power and the highest reported SAR for U-NII-2A is less than 1.2 W/kg, SAR is not required for U-NII-1 band according to FCC KDB Publication 248227 D01v02r02.

Since Wireless Router operations are not allowed by the chipset firmware using U-NII-1, U-NII-2A & U-NII-2C WIFI, only 2.4 GHz and U-NII-3 WIFI Hotspot SAR tests and combinations are considered for SAR with respect to Wireless Router configurations according to FCC KDB 941225 D06v02r01.

This device supports IEEE 802.11ax with the following features:

- a) Up to 160 MHz Bandwidth only for 5 GHz
- b) Up to 20 MHz Bandwidth only for 2.4 GHz
- c) No aggregate channel configurations
- d) 2 Tx antenna output
- e) Up to 1024 QAM is supported
- f) TDWR and Band gap channels are supported for 5 GHz
- g) MU-MIMO UL Operations are not supported

Per FCC KDB Publication 648474 D04v01r03, this device is considered a "phablet" since the diagonal dimension is greater than 160mm and less than 200mm. Phablet SAR tests are required when wireless router mode does not apply or if wireless router 1g SAR > 1.2 W/kg. Because wireless router operations are not supported for U-NII-1, U-NII-2A & U-NII-2C WLAN, phablet SAR tests were performed. Phablet SAR was not evaluated for 2.4 GHz and U-NII-3 WLAN operations since wireless router 1g SAR was < 1.2 W/kg.

Per April 2019 TCB Workshop Notes, SAR testing was not required for 802.11ax when applying the initial test configuration procedures of KDB 248227, with 802.11ax considered a higher order 802.11 mode.

### (B) Licensed Transmitter(s)



For all US Operations, device is limited to peak exposure mode only. Additionally, this device does not support simultaneous tx conditions managed by Smart Tx or any bands that operate in different time windows. Therefore, no Part 2 tests were required.

GSM/GPRS/EDGE DTM is not supported for US bands. Therefore, the GSM Voice modes in this report do not transmit simultaneously with GPRS/EDGE Data.

This device is only capable of QPSK HSUPA in the uplink. Therefore, no additional SAR tests are required beyond that described for devices with HSUPA in KDB 941225 D01v03r01.

LTE SAR for the higher modulations and lower bandwidths were not tested since the maximum average output power of all required channels and configurations was not more than 0.5 dB higher than the highest bandwidth; and the reported LTE SAR for the highest bandwidth was less than 1.45 W/kg for all configurations according to FCC KDB 941225 D05v02r04.

Per FCC KDB Publication 648474 D04v01r03, this device is considered a "phablet" since the diagonal dimension is greater than 160mm and less than 200mm. Therefore, phablet SAR tests are required when wireless router mode does not apply or if wireless router 1g SAR > 1.2 W/kg.

FCC ID: A3LSMG998JPN	 <b>PCTEST</b> Proud to be part of 	SAR EVALUATION REPORT		Approved by: Quality Manager
Document S/N: 1M2101110003-01.A3L	Test Dates: 01/17/21 - 01/25/21	DUT Type: Portable Handset		Page 12 of 71

## 1.9 Guidance Applied



- IEEE 1528-2013
- FCC KDB Publication 941225 D01v03r01, D05v02r04, D05Av01r02, D06v02r01 (2G/3G/4G and Hotspot)
- FCC KDB Publication 248227 D01v02r02 (SAR Considerations for 802.11 Devices)
- FCC KDB Publication 447498 D01v06 (General SAR Guidance)
- FCC KDB Publication 865664 D01v01r04, D02v01r02 (SAR Measurements up to 6 GHz)
- FCC KDB Publication 648474 D04v01r03 (Phablet Procedures)
- FCC KDB Publication 616217 D04v01r02 (Proximity Sensor)
- October 2013 TCB Workshop Notes (GPRS Testing Considerations)
- April 2019 TCB Workshop Notes (IEEE 802.11ax)

## 1.10 Device Serial Numbers

Several samples with identical hardware were used to support SAR testing. The manufacturer has confirmed that the device(s) tested have the same physical, mechanical and thermal characteristics and are within operational tolerances expected for production units. The serial numbers used for each test are indicated alongside the results in Section 11.

## 1.11 Bibliography



Report Type	Report Serial Number
RF Exposure Part 0 Test Report	1M2101110003-17.A3L

FCC ID: A3LSMG998JPN	 <b>PCTEST</b> <small>Proud to be part of </small>	SAR EVALUATION REPORT		Approved by: Quality Manager
Document S/N: 1M2101110003-01.A3L	Test Dates: 01/17/21 - 01/25/21	DUT Type: Portable Handset	Page 13 of 71	

# 2

# LTE INFORMATION

LTE Information					
Form Factor	Portable Handset				
	LTE Band 12 (699.7 - 715.3 MHz)				
	LTE Band 13 (779.5 - 784.5 MHz)				
	LTE Band 5 (Cell) (824.7 - 848.3 MHz)				
	LTE Band 4 (AWS) (1710.7 - 1754.3 MHz)				
	LTE Band 41 (2498.5 - 2687.5 MHz)				
	LTE Band 12: 1.4 MHz, 3 MHz, 5 MHz, 10 MHz				
	LTE Band 13: 5 MHz, 10 MHz				
	LTE Band 5 (Cell): 1.4 MHz, 3 MHz, 5 MHz, 10 MHz				
	LTE Band 4 (AWS): 1.4 MHz, 3 MHz, 5 MHz, 10 MHz, 15 MHz, 20 MHz				
LTE Band 41: 5 MHz, 10 MHz, 15 MHz, 20 MHz					
Channel Numbers and Frequencies (MHz)	Low	Low-Mid	Mid	Mid-High	High
LTE Band 12: 1.4 MHz	699.7 (23017)		707.5 (23095)		715.3 (23173)
LTE Band 12: 3 MHz	700.5 (23025)		707.5 (23095)		714.5 (23165)
LTE Band 12: 5 MHz	701.5 (23035)		707.5 (23095)		713.5 (23155)
LTE Band 12: 10 MHz	704 (23060)		707.5 (23095)		711 (23130)
LTE Band 13: 5 MHz	779.5 (23205)		782 (23230)		784.5 (23255)
LTE Band 13: 10 MHz	N/A		782 (23230)		N/A
LTE Band 5 (Cell): 1.4 MHz	824.7 (20407)		836.5 (20525)		848.3 (20643)
LTE Band 5 (Cell): 3 MHz	825.5 (20415)		836.5 (20525)		847.5 (20635)
LTE Band 5 (Cell): 5 MHz	826.5 (20425)		836.5 (20525)		846.5 (20625)
LTE Band 5 (Cell): 10 MHz	829 (20450)		836.5 (20525)		844 (20600)
LTE Band 4 (AWS): 1.4 MHz	1710.7 (19957)		1732.5 (20175)		1754.3 (20393)
LTE Band 4 (AWS): 3 MHz	1711.5 (19965)		1732.5 (20175)		1753.5 (20385)
LTE Band 4 (AWS): 5 MHz	1712.5 (19975)		1732.5 (20175)		1752.5 (20375)
LTE Band 4 (AWS): 10 MHz	1715 (20000)		1732.5 (20175)		1750 (20350)
LTE Band 4 (AWS): 15 MHz	1717.5 (20025)		1732.5 (20175)		1747.5 (20325)
LTE Band 4 (AWS): 20 MHz	1720 (20050)		1732.5 (20175)		1745 (20300)
LTE Band 41: 5 MHz	2506 (39750)	2549.5 (40185)	2593 (40620)	2636.5 (41055)	2680 (41490)
LTE Band 41: 10 MHz	2506 (39750)	2549.5 (40185)	2593 (40620)	2636.5 (41055)	2680 (41490)
LTE Band 41: 15 MHz	2506 (39750)	2549.5 (40185)	2593 (40620)	2636.5 (41055)	2680 (41490)
LTE Band 41: 20 MHz	2506 (39750)	2549.5 (40185)	2593 (40620)	2636.5 (41055)	2680 (41490)
UE Category	DL UE Cat 20, UL UE Cat 5				
Modulations Supported in UL	QPSK, 16QAM, 64QAM				
LTE MPR Permanently implemented per 3GPP TS 36.101 section 6.2.3-6.2.5? (manufacturer attestation to be provided)	YES				
A-MPR (Additional MPR) disabled for SAR Testing?	YES				
LTE Carrier Aggregation Possible Combinations	The technical description includes all the possible carrier aggregation combinations				
LTE Additional Information	This device does not support full CA features on 3GPP Release 14. All uplink communications are identical to the Release 8 Specifications. Uplink communications are done on the PCC. The following LTE Release 14 Features are not supported: Relay, HetNet, Enhanced MIMO, eICIC, WIFI Offloading, eMBMS, Cross-Carrier Scheduling, Enhanced SC-FDMA.				

FCC ID: A3LSMG998JPN	 PCTEST Proud to be part of 	SAR EVALUATION REPORT		Approved by: Quality Manager
Document S/N: 1M2101110003-01.A3L	Test Dates: 01/17/21 - 01/25/21	DUT Type: Portable Handset	Page 14 of 71	

The FCC and Innovation, Science, and Economic Development Canada have adopted the guidelines for evaluating the environmental effects of radio frequency (RF) radiation in ET Docket 93-62 on Aug. 6, 1996 and Health Canada Safety Code 6 to protect the public and workers from the potential hazards of RF emissions due to FCC-regulated portable devices. [1]

The safety limits used for the environmental evaluation measurements are based on the criteria published by the American National Standards Institute (ANSI) for localized specific absorption rate (SAR) in IEEE/ANSI C95.1-1992 Standard for Safety Levels with Respect to Human Exposure to Radio Frequency Electromagnetic Fields, 3 kHz to 300 GHz [3] and Health Canada RF Exposure Guidelines Safety Code 6 [22]. The measurement procedure described in IEEE/ANSI C95.3-2002 Recommended Practice for the Measurement of Potentially Hazardous Electromagnetic Fields - RF and Microwave [4] is used for guidance in measuring the Specific Absorption Rate (SAR) due to the RF radiation exposure from the Equipment Under Test (EUT). These criteria for SAR evaluation are similar to those recommended by the International Committee for Non-Ionizing Radiation Protection (ICNIRP) in Biological Effects and Exposure Criteria for Radiofrequency Electromagnetic Fields,” Report No. Vol 74. SAR is a measure of the rate of energy absorption due to exposure to an RF transmitting source. SAR values have been related to threshold levels for potential biological hazards.

### 3.1 SAR Definition

Specific Absorption Rate is defined as the time derivative (rate) of the incremental energy (dU) absorbed by (dissipated in) an incremental mass (dm) contained in a volume element (dV) of a given density ( $\rho$ ). It is also defined as the rate of RF energy absorption per unit mass at a point in an absorbing body (see Equation 3-1).

**Equation 3-1**  
**SAR Mathematical Equation**

$$SAR = \frac{d}{dt} \left( \frac{dU}{dm} \right) = \frac{d}{dt} \left( \frac{dU}{\rho dv} \right)$$



SAR is expressed in units of Watts per Kilogram (W/kg).

$$SAR = \frac{\sigma \cdot E^2}{\rho}$$

where:

- $\sigma$  = conductivity of the tissue-simulating material (S/m)
- $\rho$  = mass density of the tissue-simulating material (kg/m<sup>3</sup>)
- E = Total RMS electric field strength (V/m)

NOTE: The primary factors that control rate of energy absorption were found to be the wavelength of the incident field in relation to the dimensions and geometry of the irradiated organism, the orientation of the organism in relation to the polarity of field vectors, the presence of reflecting surfaces, and whether conductive contact is made by the organism with a ground plane.[6]

FCC ID: A3LSMG998JPN	 <b>PCTEST</b> Proud to be part of 	<b>SAR EVALUATION REPORT</b>		<b>Approved by:</b> Quality Manager
<b>Document S/N:</b> 1M2101110003-01.A3L	<b>Test Dates:</b> 01/17/21 - 01/25/21	<b>DUT Type:</b> Portable Handset	Page 15 of 71	

## 4 DOSIMETRIC ASSESSMENT

### 4.1 Measurement Procedure

The evaluation was performed using the following procedure compliant to FCC KDB Publication 865664 D01v01r04 and IEEE 1528-2013:

1. The SAR distribution at the exposed side of the head or body was measured at a distance no greater than 5.0 mm from the inner surface of the shell. The area covered the entire dimension of the device-head and body interface and the horizontal grid resolution was determined per FCC KDB Publication 865664 D01v01r04 (See Table 4-1) and IEEE 1528-2013.
2. The point SAR measurement was taken at the maximum SAR region determined from Step 1 to enable the monitoring of SAR fluctuations/drifts during the 1g/10g cube evaluation. SAR at this fixed point was measured and used as a reference value.
3. Based on the area scan data, the peak of the region with maximum SAR was determined by spline interpolation. Around this point, a volume was assessed according to the measurement resolution and volume size requirements of FCC KDB Publication 865664 D01v01r04 (See Table 4-1) and IEEE 1528-2013. On the basis of this data set, the spatial peak SAR value was evaluated with the following procedure (see references or the DASYS manual online for more details):
  - a. SAR values at the inner surface of the phantom are extrapolated from the measured values along the line away from the surface with spacing no greater than that in Table 4-1. The extrapolation was based on a least-squares algorithm. A polynomial of the fourth order was calculated through the points in the z-axis (normal to the phantom shell).
  - b. After the maximum interpolated values were calculated between the points in the cube, the SAR was averaged over the spatial volume (1g or 10g) using a 3D-Spline interpolation algorithm. The 3D-spline is composed of three one-dimensional splines with the “Not a knot” condition (in x, y, and z directions). The volume was then integrated with the trapezoidal algorithm. One thousand points (10 x 10 x 10) were obtained through interpolation, in order to calculate the averaged SAR.
  - c. All neighboring volumes were evaluated until no neighboring volume with a higher average value was found.
4. The SAR reference value, at the same location as step 2, was re-measured after the zoom scan was complete to calculate the SAR drift. If the drift deviated by more than 5%, the SAR test and drift measurements were repeated.

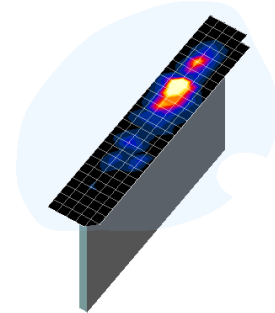



**Figure 4-1**  
**Sample SAR Area Scan**

**Table 4-1**  
**Area and Zoom Scan Resolutions per FCC KDB Publication 865664 D01v01r04\***

Frequency	Maximum Area Scan Resolution (mm) ( $\Delta x_{\text{area}}, \Delta y_{\text{area}}$ )	Maximum Zoom Scan Resolution (mm) ( $\Delta x_{\text{zoom}}, \Delta y_{\text{zoom}}$ )	Maximum Zoom Scan Spatial Resolution (mm)			Minimum Zoom Scan Volume (mm) (x, y, z)
			Uniform Grid	Graded Grid		
			$\Delta z_{\text{zoom}}(n)$	$\Delta z_{\text{zoom}}(1)^*$	$\Delta z_{\text{zoom}}(n>1)^*$	
≤ 2 GHz	≤ 15	≤ 8	≤ 5	≤ 4	≤ 1.5* $\Delta z_{\text{zoom}}(n-1)$	≥ 30
2-3 GHz	≤ 12	≤ 5	≤ 5	≤ 4	≤ 1.5* $\Delta z_{\text{zoom}}(n-1)$	≥ 30
3-4 GHz	≤ 12	≤ 5	≤ 4	≤ 3	≤ 1.5* $\Delta z_{\text{zoom}}(n-1)$	≥ 28
4-5 GHz	≤ 10	≤ 4	≤ 3	≤ 2.5	≤ 1.5* $\Delta z_{\text{zoom}}(n-1)$	≥ 25
5-6 GHz	≤ 10	≤ 4	≤ 2	≤ 2	≤ 1.5* $\Delta z_{\text{zoom}}(n-1)$	≥ 22

\*Also compliant to IEEE 1528-2013 Table 6

FCC ID: A3LSMG998JPN	 PCTEST Proud to be part of 	SAR EVALUATION REPORT		Approved by: Quality Manager
Document S/N: 1M2101110003-01.A3L	Test Dates: 01/17/21 - 01/25/21	DUT Type: Portable Handset		Page 16 of 71



# 5

## DEFINITION OF REFERENCE POINTS

### 5.1 EAR REFERENCE POINT

Figure 5-2 shows the front, back and side views of the SAM Twin Phantom. The point “M” is the reference point for the center of the mouth, “LE” is the left ear reference point (ERP), and “RE” is the right ERP. The ERP is 15mm posterior to the entrance to the ear canal (EEC) along the B-M line (Back-Mouth), as shown in Figure 5-1. The plane passing through the two ear canals and M is defined as the Reference Plane. The line N-F (Neck-Front), also called the Reference Pivoting Line, is not perpendicular to the reference plane (see Figure 5-1). Line B-M is perpendicular to the N-F line. Both N-F and B-M lines are marked on the external phantom shell to facilitate handset positioning [5].

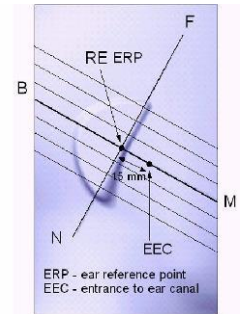

**Figure 5-1**  
Close-Up Side view of ERP

### 5.2 HANDSET REFERENCE POINTS

Two imaginary lines on the handset were established: the vertical centerline and the horizontal line. The test device was placed in a normal operating position with the acoustic output located along the “vertical centerline” on the front of the device aligned to the “ear reference point” (See Figure 5-3). The acoustic output was then located at the same level as the center of the ear reference point. The test device was positioned so that the “vertical centerline” was bisecting the front surface of the handset at its top and bottom edges, positioning the “ear reference point” on the outer surface of the both the left and right head phantoms on the ear reference point.



**Figure 5-2**  
Front, back and side view of SAM Twin Phantom

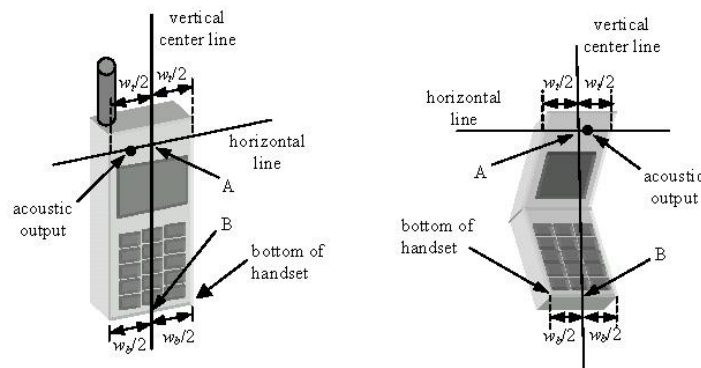

**Figure 5-3**  
Handset Vertical Center & Horizontal Line Reference Points

FCC ID: A3LSMG998JPN	PCTEST Proud to be part of element	SAR EVALUATION REPORT		Approved by: Quality Manager
Document S/N: 1M2101110003-01.A3L	Test Dates: 01/17/21 - 01/25/21	DUT Type: Portable Handset		Page 17 of 71

## 6 TEST CONFIGURATION POSITIONS

### 6.1 Device Holder

The device holder is made out of low-loss POM material having the following dielectric parameters: relative permittivity  $\epsilon = 3$  and loss tangent  $\delta = 0.02$ .

### 6.2 Positioning for Cheek

1. The test device was positioned with the device close to the surface of the phantom such that point A is on the (virtual) extension of the line passing through points RE and LE on the phantom (see Figure 6-1), such that the plane defined by the vertical center line and the horizontal line of the phone is approximately parallel to the sagittal plane of the phantom.

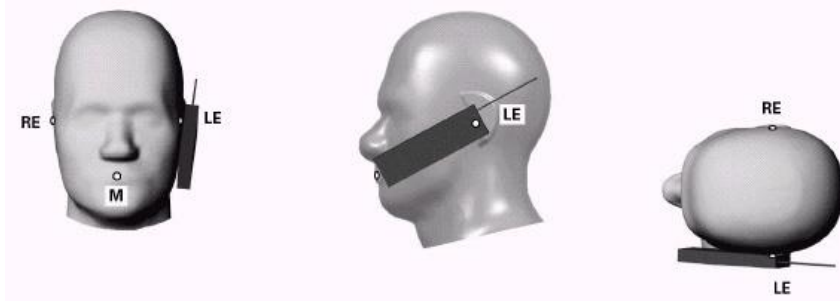





Figure 6-1 Front, Side and Top View of Cheek Position

2. The handset was translated towards the phantom along the line passing through RE & LE until the handset touches the pinna.
3. While maintaining the handset in this plane, the handset was rotated around the LE-RE line until the vertical centerline was in the reference plane.
4. The phone was then rotated around the vertical centerline until the phone (horizontal line) was symmetrical with respect to the line NF.
5. While maintaining the vertical centerline in the reference plane, keeping point A on the line passing through RE and LE, and maintaining the device contact with the ear, the device was rotated about the NF line until any point on the handset made contact with a phantom point below the ear (cheek) (See Figure 6-2).

### 6.3 Positioning for Ear / 15° Tilt

With the test device aligned in the “Cheek Position”:

1. While maintaining the orientation of the phone, the phone was retracted parallel to the reference plane far enough to enable a rotation of the phone by 15 degrees.
2. The phone was then rotated around the horizontal line by 15 degrees.
3. While maintaining the orientation of the phone, the phone was moved parallel to the reference plane until any part of the handset touched the head. (In this position, point A was located on the line RE-LE). The tilted position is obtained when the contact is on the pinna. If the contact was at any location other than the pinna, the angle of the phone would then be reduced. In this situation, the tilted position was obtained when any part of the phone was in contact of the ear as well as a second part of the phone was in contact with the head (see Figure 6-2).

FCC ID: A3LSMG998JPN	 PCTEST Proud to be part of 	SAR EVALUATION REPORT		Approved by: Quality Manager
Document S/N: 1M2101110003-01.A3L	Test Dates: 01/17/21 - 01/25/21	DUT Type: Portable Handset	Page 18 of 71	

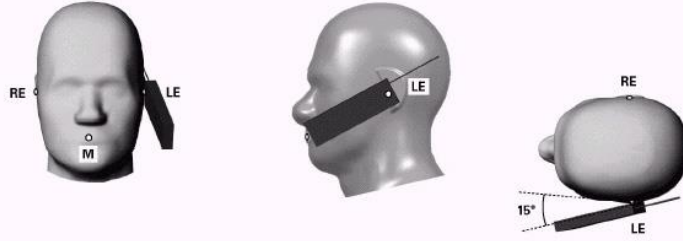

**Figure 6-2 Front, Side and Top View of Ear/15° Tilt Position**

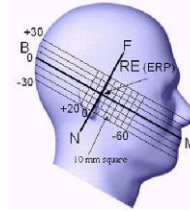

**Figure 6-3 Side view w/ relevant markings**

## 6.4 SAR Evaluations near the Mouth/Jaw Regions of the SAM Phantom

Antennas located near the bottom of a phone may require SAR measurements around the mouth and jaw regions of the SAM head phantom. This typically applies to clam-shell style phones that are generally longer in the unfolded normal use positions or to certain older style long rectangular phones. Per IEEE 1528-2013, a rotated SAM phantom is necessary to allow probe access to such regions. Both SAM heads of the TwinSAM-Chin20 are rotated 20 degrees around the NF line. Each head can be removed from the table for emptying and cleaning.

Under these circumstances, the following procedures apply, adopted from the FCC guidance on SAR handsets document FCC KDB Publication 648474 D04v01r03. The SAR required in these regions of SAM should be measured using a flat phantom. The phone should be positioned with a separation distance of 4 mm between the ear reference point (ERP) and the outer surface of the flat phantom shell. While maintaining this distance at the ERP location, the low (bottom) edge of the phone should be lowered from the phantom to establish the same separation distance between the peak SAR location identified by the truncated partial SAR distribution measured with the SAM phantom. The distance from the peak SAR location to the phone is determined by the straight line passing perpendicularly through the phantom surface. When it is not feasible to maintain 4 mm separation at the ERP while also establishing the required separation at the peak SAR location, the top edge of the phone will be allowed to touch the phantom with a separation < 4 mm at the ERP. The phone should not be tilted to the left or right while placed in this inclined position to the flat phantom.

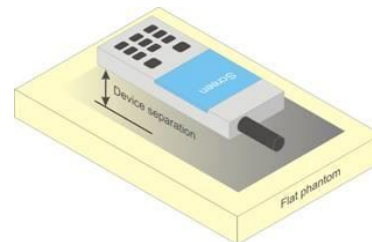

## 6.5 Body-Worn Accessory Configurations

Body-worn operating configurations are tested with the belt-clips and holsters attached to the device and positioned against a flat phantom in a normal use configuration (see Figure 6-4). Per FCC KDB Publication 648474 D04v01r03, Body-worn accessory exposure is typically related to voice mode operations when handsets are carried in body-worn accessories. The body-worn accessory procedures in FCC KDB Publication 447498 D01v06 should be used to test for body-worn accessory SAR compliance, without a headset connected to it. This enables the test results for such configuration to be compatible with that required for hotspot mode when the body-worn accessory test separation distance is greater than or equal to that required for hotspot mode, when applicable. When the reported SAR for a body-worn accessory, measured without a headset connected to the handset, is > 1.2 W/kg, the highest reported SAR configuration for that wireless mode and frequency band should be repeated for that body-worn accessory with a headset attached to the handset.



**Figure 6-4 Sample Body-Worn Diagram**

Accessories for Body-worn operation configurations are divided into two categories: those that do not contain metallic components and those that do contain metallic components. When multiple accessories that do not contain metallic components are supplied with the device, the device is tested with only the accessory that

FCC ID: A3LSMG998JPN	 <b>PCTEST</b> Proud to be part of 	<b>SAR EVALUATION REPORT</b>		<b>Approved by:</b> Quality Manager
<b>Document S/N:</b> 1M2101110003-01.A3L	<b>Test Dates:</b> 01/17/21 - 01/25/21	<b>DUT Type:</b> Portable Handset	Page 19 of 71	

dictates the closest spacing to the body. Then multiple accessories that contain metallic components are tested with the device with each accessory. If multiple accessories share an identical metallic component (i.e. the same metallic belt-clip used with different holsters with no other metallic components) only the accessory that dictates the closest spacing to the body is tested.

Body-worn accessories may not always be supplied or available as options for some devices intended to be authorized for body-worn use. In this case, a test configuration with a separation distance between the back of the device and the flat phantom is used. Test position spacing was documented. Transmitters that are designed to operate in front of a person's face, as in push-to-talk configurations, are tested for SAR compliance with the front of the device positioned to face the flat phantom in head fluid. For devices that are carried next to the body such as a shoulder, waist or chest-worn transmitters, SAR compliance is tested with the accessories, including headsets and microphones, attached to the device and positioned against a flat phantom in a normal use configuration.

## 6.6 Extremity Exposure Configurations

Devices that are designed or intended for use on extremities or mainly operated in extremity only exposure conditions; i.e., hands, wrists, feet and ankles, may require extremity SAR evaluation. When the device also operates in close proximity to the user's body, SAR compliance for the body is also required. The 1g body and 10g extremity SAR Exclusion Thresholds found in KDB Publication 447498 D01v06 should be applied to determine SAR test requirements.

Per KDB Publication 447498 D01v06, Cell phones (handsets) are not normally designed to be used on extremities or operated in extremity only exposure conditions. The maximum output power levels of handsets generally do not require extremity SAR testing to show compliance. Therefore, extremity SAR was not evaluated for this device.



## 6.7 Wireless Router Configurations

Some battery-operated handsets have the capability to transmit and receive user data through simultaneous transmission of WIFI simultaneously with a separate licensed transmitter. The FCC has provided guidance in FCC KDB Publication 941225 D06v02r01 where SAR test considerations for handsets (L x W ≥ 9 cm x 5 cm) are based on a composite test separation distance of 10 mm from the front, back and edges of the device containing transmitting antennas within 2.5 cm of their edges, determined from general mixed use conditions for this type of devices. Since the hotspot SAR results may overlap with the body-worn accessory SAR requirements, the more conservative configurations can be considered, thus excluding some body-worn accessory SAR tests.

When the user enables the personal wireless router functions for the handset, actual operations include simultaneous transmission of both the WIFI transmitter and another licensed transmitter. Both transmitters often do not transmit at the same transmitting frequency and thus cannot be evaluated for SAR under actual use conditions due to the limitations of the SAR assessment probes. Therefore, SAR must be evaluated for each frequency transmission and mode separately and spatially summed with the WIFI transmitter according to FCC KDB Publication 447498 D01v06 procedures. The "Portable Hotspot" feature on the handset was NOT activated during SAR assessments, to ensure the SAR measurements were evaluated for a single transmission frequency RF signal at a time.

## 6.8 Phablet Configurations

For smart phones with a display diagonal dimension > 150 mm or an overall diagonal dimension > 160 mm that provide similar mobile web access and multimedia support found in mini-tablets or UMPC mini-tablets that support voice calls next to the ear, the phablets procedures outlined in KDB Publication 648474 D04v01r03 should be applied to evaluate SAR compliance. A device marketed as phablets, regardless of form factors and operating characteristics must be tested as a phablet to determine SAR compliance. In addition to the normally required head and body-worn accessory SAR test procedures required for handsets, the UMPC mini-tablet

FCC ID: A3LSMG998JPN	 <b>PCTEST</b> Proud to be part of 	<b>SAR EVALUATION REPORT</b>		<b>Approved by:</b> Quality Manager
<b>Document S/N:</b> 1M2101110003-01.A3L	<b>Test Dates:</b> 01/17/21 - 01/25/21	<b>DUT Type:</b> Portable Handset	Page 20 of 71	



procedures must also be applied to test the SAR of all surfaces and edges with an antenna  $\leq 25$  mm from that surface or edge, in direct contact with the phantom, for 10g SAR. The UMPC mini-tablet 1g SAR at 5 mm is not required. When hotspot mode applies, 10g SAR is required only for the surfaces and edges with hotspot mode 1g SAR  $> 1.2$  W/kg.

## 6.9 Proximity Sensor Considerations

This device uses a power reduction mechanism to reduce output powers in certain use conditions when the device is used close the user's body.

When the device's antenna is within a certain distance of the user, the sensor activates and reduces the maximum allowed output power. However, the sensor is not active when the device is moved beyond the sensor triggering distance and the maximum output power is no longer limited. Therefore, additional evaluation is needed in the vicinity of the triggering distance to ensure SAR is compliant when the device is allowed to operate at a non-reduced output power level. FCC KDB Publication 616217 D04v01r02 Section 6 was used as a guideline for selecting SAR test distances for this device at these additional test positions. Sensor triggering distance summary data is included in Appendix G.

The sensor is designed to support sufficient detection range and sensitivity to cover regions of the sensors in all applicable directions since the sensor entirely covers the antennas.

FCC ID: A3LSMG998JPN	 <small>Proud to be part of</small> 	SAR EVALUATION REPORT	 <b>Approved by:</b> Quality Manager
<b>Document S/N:</b> 1M2101110003-01.A3L	<b>Test Dates:</b> 01/17/21 - 01/25/21	<b>DUT Type:</b> Portable Handset	Page 21 of 71

# 7 RF EXPOSURE LIMITS

## 7.1 Uncontrolled Environment

UNCONTROLLED ENVIRONMENTS are defined as locations where there is the exposure of individuals who have no knowledge or control of their exposure. The general population/uncontrolled exposure limits are applicable to situations in which the general public may be exposed or in which persons who are exposed as a consequence of their employment may not be made fully aware of the potential for exposure or cannot exercise control over their exposure. Members of the general public would come under this category when exposure is not employment-related; for example, in the case of a wireless transmitter that exposes persons in its vicinity.



## 7.2 Controlled Environment

CONTROLLED ENVIRONMENTS are defined as locations where there is exposure that may be incurred by persons who are aware of the potential for exposure, (i.e. as a result of employment or occupation). In general, occupational/controlled exposure limits are applicable to situations in which persons are exposed as a consequence of their employment, who have been made fully aware of the potential for exposure and can exercise control over their exposure. This exposure category is also applicable when the exposure is of a transient nature due to incidental passage through a location where the exposure levels may be higher than the general population/uncontrolled limits, but the exposed person is fully aware of the potential for exposure and can exercise control over his or her exposure by leaving the area or by some other appropriate means.

**Table 7-1  
SAR Human Exposure Specified in ANSI/IEEE C95.1-1992 and Health Canada Safety Code 6**

HUMAN EXPOSURE LIMITS		
	UNCONTROLLED ENVIRONMENT <i>General Population</i> (W/kg) or (mW/g)	CONTROLLED ENVIRONMENT <i>Occupational</i> (W/kg) or (mW/g)
Peak Spatial Average SAR Head	1.6	8.0
Whole Body SAR	0.08	0.4
Peak Spatial Average SAR Hands, Feet, Ankle, Wrists, etc.	4.0	20

1. The Spatial Peak value of the SAR averaged over any 1 gram of tissue (defined as a tissue volume in the shape of a cube) and over the appropriate averaging time.
2. The Spatial Average value of the SAR averaged over the whole body.
3. The Spatial Peak value of the SAR averaged over any 10 grams of tissue (defined as a tissue volume in the shape of a cube) and over the appropriate averaging time.

FCC ID: A3LSMG998JPN	 <b>PCTEST</b> <small>Proud to be part of </small>	SAR EVALUATION REPORT		Approved by: Quality Manager
Document S/N: 1M2101110003-01.A3L	Test Dates: 01/17/21 - 01/25/21	DUT Type: Portable Handset		Page 22 of 71

Power measurements for licensed transmitters are performed using a base station simulator under digital average power.

### 8.1 Measured and Reported SAR

Per FCC KDB Publication 447498 D01v06, when SAR is not measured at the maximum power level allowed for production units, the results must be scaled to the maximum tune-up tolerance limit according to the power applied to the individual channels tested to determine compliance. For simultaneous transmission, the measured aggregate SAR must be scaled according to the sum of the differences between the maximum tune-up tolerance and actual power used to test each transmitter. When SAR is measured at or scaled to the maximum tune-up tolerance limit, the results are referred to as *reported* SAR. The highest *reported* SAR results are identified on the grant of equipment authorization according to procedures in KDB 690783 D01v01r03.

### 8.2 3G SAR Test Reduction Procedure

In FCC KDB Publication 941225 D01v03r01, certain transmission modes within a frequency band and wireless mode evaluated for SAR are defined as primary modes. The equivalent modes considered for SAR test reduction are denoted as secondary modes. When the maximum output power including tune-up tolerance specified for production units in a secondary mode is  $\leq 0.25$  dB higher than the primary mode or when the highest reported SAR of the primary mode, scaled by the ratio of specified maximum output power and tune-up tolerance of secondary to primary mode, is  $\leq 1.2$  W/kg, SAR measurements are not required for the secondary mode. These criteria are referred to as the 3G SAR test reduction procedure. When the 3G SAR test reduction procedure is not satisfied, SAR measurements are additionally required for the secondary mode.

### 8.3 Procedures Used to Establish RF Signal for SAR



The following procedures are according to FCC KDB Publication 941225 D01v03r01 “3G SAR Measurement Procedures.”

The device is placed into a simulated call using a base station simulator in a RF shielded chamber. Establishing connections in this manner ensure a consistent means for testing SAR and are recommended for evaluating SAR [4]. Devices under test are evaluated prior to testing, with a fully charged battery and were configured to operate at maximum output power. In order to verify that the device is tested throughout the SAR test at maximum output power, the SAR measurement system measures a “point SAR” at an arbitrary reference point at the start and end of the 1 gram SAR evaluation, to assess for any power drifts during the evaluation. If the power drift deviates by more than 5%, the SAR test and drift measurements are repeated.

### 8.4 SAR Measurement Conditions for UMTS

#### 8.4.1 Output Power Verification

Maximum output power is verified on the High, Middle and Low channels according to the general descriptions in section 5.2 of 3GPP TS 34.121, using the appropriate RMC with TPC (transmit power control) set to all “1s” or applying the required inner loop power control procedures to maintain maximum output power while HSUPA is active. Results for all applicable physical channel configurations (DPCCH, DPDCHn and spreading codes, HS-DPCCH etc) are tabulated in this test report. All configurations that are not supported by the DUT or cannot be measured due to technical or equipment limitations are identified.

FCC ID: A3LSMG998JPN	 <b>PCTEST</b> Proud to be part of 	SAR EVALUATION REPORT		Approved by: Quality Manager
Document S/N: 1M2101110003-01.A3L	Test Dates: 01/17/21 - 01/25/21	DUT Type: Portable Handset	Page 23 of 71	

## 8.4.2 Head SAR Measurements

SAR for next to the ear head exposure is measured using a 12.2 kbps RMC with TPC bits configured to all “1’s”. The 3G SAR test reduction procedure is applied to AMR configurations with 12.2 kbps RMC as the primary mode. Otherwise, SAR is measured for 12.2 kbps AMR in 3.4 kbps SRB (signaling radio bearer) using the highest reported SAR configuration in 12.2 kbps RMC for head exposure.

## 8.4.3 Body SAR Measurements

SAR for body exposure configurations is measured using the 12.2 kbps RMC with the TPC bits all “1s”. The 3G SAR test reduction procedure is applied to other spreading codes and multiple DPDCH<sub>n</sub> configurations supported by the handset with 12.2 kbps RMC as the primary mode. Otherwise, SAR is measured using an applicable RMC configuration with the corresponding spreading code or DPDCH<sub>n</sub>, for the highest reported SAR configuration in 12.2 kbps RMC.

## 8.4.4 SAR Measurements with Rel 5 HSDPA

The 3G SAR test reduction procedure is applied to HSDPA body configurations with 12.2 kbps RMC as the primary mode. Otherwise, Body SAR for HSDPA is measured using an FRC with H-Set 1 in Sub-test 1 and a 12.2 kbps RMC configured in Test Loop Mode 1, for the highest reported SAR configuration in 12.2 kbps RMC without HSDPA. Handsets with both HSDPA and HSUPA are tested according to Release 6 HSPA test procedures.

## 8.4.5 SAR Measurements with Rel 6 HSUPA

The 3G SAR test reduction procedure is applied to HSPA (HSUPA/HSDPA with RMC) body configurations with 12.2 kbps RMC as the primary mode. Otherwise, Body SAR for HSPA is measured with E-DCH Sub-test 5, using H-Set 1 and QPSK for FRC and a 12.2 kbps RMC configured in Test Loop Mode 1 and power control algorithm 2, according to the highest reported body SAR configuration in 12.2 kbps RMC without HSPA.



When VOIP applies to head exposure, the 3G SAR test reduction procedure is applied with 12.2 kbps RMC as the primary mode; otherwise, the same HSPA configuration used for body SAR measurements are applied to head exposure testing.

## 8.4.6 SAR Measurement Conditions for DC-HSDPA

SAR is required for Rel. 8 DC-HSDPA when SAR is required for Rel. 5 HSDPA; otherwise, the 3G SAR test reduction procedure is applied to DC-HSDPA with 12.2 kbps RMC as the primary mode. Power is measured for DC-HSDPA according to the H-Set 12, FRC configuration in Table C.8.1.12 of 3GPP TS 34.121-1 to determine SAR test reduction. A primary and a secondary serving HS-DSCH Cell are required to perform the power measurement and for the results to be acceptable.

## 8.5 SAR Measurement Conditions for LTE

LTE modes are tested according to FCC KDB 941225 D05v02r04 publication. Establishing connections with base station simulators ensure a consistent means for testing SAR and are recommended for evaluating SAR [4]. The R&S CMW500 or Anritsu MT8820C simulators are used for LTE output power measurements and SAR testing. Closed loop power control was used so the UE transmits with maximum output power during SAR testing. SAR tests were performed with the same number of RB and RB offsets transmitting on all TTI frames (maximum TTI).

FCC ID: A3LSMG998JPN	 <b>PCTEST</b> Proud to be part of 	SAR EVALUATION REPORT		Approved by: Quality Manager
Document S/N: 1M2101110003-01.A3L	Test Dates: 01/17/21 - 01/25/21	DUT Type: Portable Handset		Page 24 of 71



### 8.5.1 Spectrum Plots for RB Configurations

A properly configured base station simulator was used for SAR tests and power measurements. Therefore, spectrum plots for RB configurations were not required to be included in this report.

### 8.5.2 MPR

MPR is permanently implemented for this device by the manufacturer. The specific manufacturer target MPR is indicated alongside the SAR results. MPR is enabled for this device, according to 3GPP TS36.101 Section 6.2.3 – 6.2.5 under Table 6.2.3-1.

### 8.5.3 A-MPR

A-MPR (Additional MPR) has been disabled for all SAR tests by setting NS=01 on the base station simulator.

### 8.5.4 Required RB Size and RB Offsets for SAR Testing

According to FCC KDB 941225 D05v02r04:



- a. Per Section 5.2.1, SAR is required for QPSK 1 RB Allocation for the largest bandwidth
  - i. The required channel and offset combination with the highest maximum output power is required for SAR.
  - ii. When the reported SAR is  $\leq 0.8$  W/kg, testing of the remaining RB offset configurations and required test channels is not required. Otherwise, SAR is required for the remaining required test channels using the RB offset configuration with highest output power for that channel.
  - iii. When the reported SAR for a required test channel is  $> 1.45$  W/kg, SAR is required for all RB offset configurations for that channel.
- b. Per Section 5.2.2, SAR is required for 50% RB allocation using the largest bandwidth following the same procedures outlined in Section 5.2.1.
- c. Per Section 5.2.3, QPSK SAR is not required for the 100% allocation when the highest maximum output power for the 100% allocation is less than the highest maximum output power of the 1 RB and 50% RB allocations and the reported SAR for the 1 RB and 50% RB allocations is  $< 0.8$  W/kg.
- d. Per Section 5.2.4 and 5.3, SAR tests for higher order modulations and lower bandwidths configurations are not required when the conducted power of the required test configurations determined by Sections 5.2.1 through 5.2.3 is less than or equal to  $\frac{1}{2}$  dB higher than the equivalent configuration using QPSK modulation and when the QPSK SAR for those configurations is  $< 1.45$  W/kg.

### 8.5.5 TDD

LTE TDD testing is performed using the SAR test guidance provided in FCC KDB 941225 D05v02r04. TDD is tested at the highest duty factor using UL-DL configuration 0 with special subframe configuration 6 and applying the FDD LTE procedures in KDB 941225 D05v02r04. SAR testing is performed using the extended cyclic prefix listed in 3GPP TS 36.211 Section 4.

## 8.6 SAR Testing with 802.11 Transmitters

The normal network operating configurations of 802.11 transmitters are not suitable for SAR measurements. Unpredictable fluctuations in network traffic and antenna diversity conditions can introduce undesirable variations in SAR results. The SAR for these devices should be measured using chipset based test mode software to ensure the results are consistent and reliable. See KDB Publication 248227 D01v02r02 for more details.

FCC ID: A3LSMG998JPN	 <b>PCTEST</b> Proud to be part of 	SAR EVALUATION REPORT		Approved by: Quality Manager
Document S/N: 1M2101110003-01.A3L	Test Dates: 01/17/21 - 01/25/21	DUT Type: Portable Handset	Page 25 of 71	

## 8.6.1 General Device Setup

Chipset based test mode software is hardware dependent and generally varies among manufacturers. The device operating parameters established in test mode for SAR measurements must be identical to those programmed in production units, including output power levels, amplifier gain settings and other RF performance tuning parameters.

A periodic duty factor is required for current generation SAR systems to measure SAR. When 802.11 frame gaps are accounted for in the transmission, a maximum transmission duty factor of 92 - 96% is typically achievable in most test mode configurations. A minimum transmission duty factor of 85% is required to avoid certain hardware and device implementation issues related to wide range SAR scaling. The reported SAR is scaled to 100% transmission duty factor to determine compliance at the maximum tune-up tolerance limit.

## 8.6.2 U-NII-1 and U-NII-2A

For devices that operate in both U-NII-1 and U-NII-2A bands, when the same maximum output power is specified for both bands, SAR measurement using OFDM SAR test procedures is not required for U-NII-1 unless the highest reported SAR for U-NII-2A is  $> 1.2$  W/kg. When different maximum output powers are specified for the bands, SAR measurement for the U-NII band with the lower maximum output power is not required unless the highest reported SAR for the U-NII band with the higher maximum output power, adjusted by the ratio of lower to higher specified maximum output power for the two bands, is  $> 1.2$  W/kg. When 10g SAR measurement is considered, a factor of 2.5 is applied to the thresholds above.

## 8.6.3 U-NII-2C and U-NII-3

The frequency range covered by U-NII-2C and U-NII-3 is 380 MHz (5.47 – 5.85 GHz), which requires a minimum of at least two SAR probe calibration frequency points to support SAR measurements. When Terminal Doppler Weather Radar (TDWR) restriction applies, the channels at 5.60 – 5.65 GHz in U-NII-2C band must be disabled with acceptable mechanisms and documented in the equipment certification. Unless band gap channels are permanently disabled, SAR must be considered for these channels. Each band is tested independently according to the normally required OFDM SAR measurement and probe calibration frequency points requirements.



## 8.6.4 Initial Test Position Procedure

For exposure conditions with multiple test positions, such as handset operating next to the ear, devices with hotspot mode or UMPC mini-tablet, procedures for initial test position can be applied. Using the transmission mode determined by the DSSS procedure or initial test configuration, area scans are measured for all positions in an exposure condition. The test position with the highest extrapolated (peak) SAR is used as the initial test position. When reported SAR for the initial test position is  $\leq 0.4$  W/kg, no additional testing for the remaining test positions is required. Otherwise, SAR is evaluated at the subsequent highest peak SAR positions until the reported SAR result is  $\leq 0.8$  W/kg or all test positions are measured. When 10g SAR measurement is considered, a factor of 2.5 is applied to the thresholds above.

## 8.6.5 2.4 GHz SAR Test Requirements

SAR is measured for 2.4 GHz 802.11b DSSS using either the fixed test position or, when applicable, the initial test position procedure. SAR test reduction is determined according to the following:

- 1) When the reported SAR of the highest measured maximum output power channel for the exposure configuration is  $\leq 0.8$  W/kg, no further SAR testing is required for 802.11b DSSS in that exposure configuration.
- 2) When the reported SAR is  $> 0.8$  W/kg, SAR is required for that position using the next highest measured output power channel. When any reported SAR is  $> 1.2$  W/kg, SAR is required for the third channel; i.e., all channels require testing.

FCC ID: A3LSMG998JPN	 <b>PCTEST</b> Proud to be part of 	SAR EVALUATION REPORT		Approved by: Quality Manager
Document S/N: 1M2101110003-01.A3L	Test Dates: 01/17/21 - 01/25/21	DUT Type: Portable Handset		Page 26 of 71

2.4 GHz 802.11 g/n/ax OFDM are additionally evaluated for SAR if the highest reported SAR for 802.11b, adjusted by the ratio of the OFDM to DSSS specified maximum output power, is > 1.2 W/kg. When SAR is required for OFDM modes in 2.4 GHz band, the Initial Test Configuration Procedures should be followed. When 10g SAR measurement is considered, a factor of 2.5 is applied to the thresholds above.

### 8.6.6 OFDM Transmission Mode and SAR Test Channel Selection

When the same maximum output power was specified for multiple OFDM transmission mode configurations in a frequency band or aggregated band, SAR is measured using the configuration with the largest channel bandwidth, lowest order modulation and lowest data rate. When the maximum output power of a channel is the same for equivalent OFDM configurations; for example, 802.11a, 802.11n and 802.11ac or 802.11g and 802.11n with the same channel bandwidth, modulation and data rate etc., the lower order 802.11 mode i.e., 802.11a, then 802.11n and 802.11ac or 802.11g then 802.11n, is used for SAR measurement. Per April 2019 TCB Workshop guidance, 802.11ax was considered the highest order 802.11 mode. When the maximum output power are the same for multiple test channels, either according to the default or additional power measurement requirements, SAR is measured using the channel closest to the middle of the frequency band or aggregated band. When there are multiple channels with the same maximum output power, SAR is measured using the higher number channel.

### 8.6.7 Initial Test Configuration Procedure

For OFDM, an initial test configuration is determined for each frequency band and aggregated band, according to the transmission mode with the highest maximum output power specified for SAR measurements. When the same maximum output power is specified for multiple OFDM transmission mode configurations in a frequency band or aggregated band, SAR is measured using the configuration(s) with the largest channel bandwidth, lowest order modulation, lowest data rate and lowest order IEEE 802.11 mode. The channel of the transmission mode with the highest average RF output conducted power will be the initial test configuration.



When the reported SAR is ≤ 0.8 W/kg, no additional measurements on other test channels are required. Otherwise, SAR is evaluated using the subsequent highest average RF output channel until the reported SAR result is ≤ 1.2 W/kg or all channels are measured. When there are multiple untested channels having the same subsequent highest average RF output power, the channel with higher frequency from the lowest 802.11 mode is considered for SAR measurements (See Section 8.6.6). When 10g SAR measurement is considered, a factor of 2.5 is applied to the thresholds above.

### 8.6.8 Subsequent Test Configuration Procedures

For OFDM configurations in each frequency band and aggregated band, SAR is evaluated for initial test configuration using the fixed test position or the initial test position procedure. When the highest reported SAR (for the initial test configuration), adjusted by the ratio of the specified maximum output power of the subsequent test configuration to initial test configuration, is ≤ 1.2 W/kg, no additional SAR tests for the subsequent test configurations are required. When 10g SAR measurement is considered, a factor of 2.5 is applied to the thresholds above.

### 8.6.9 MIMO SAR considerations

Per KDB Publication 248227 D01v02r02, the simultaneous SAR provisions in KDB Publication 447498 D01v06 should be applied to determine simultaneous transmission SAR test exclusion for WIFI MIMO. If the sum of 1g single transmission chain SAR measurements is <1.6 W/kg, no additional SAR measurements for MIMO are required. Alternatively, SAR for MIMO can be measured with all antennas transmitting simultaneously at the specified maximum output power of MIMO operation. When 10g SAR measurement is considered, a factor of 2.5 is applied to the thresholds above.

FCC ID: A3LSMG998JPN	 <b>PCTEST</b> Proud to be part of 	SAR EVALUATION REPORT		Approved by: Quality Manager
Document S/N: 1M2101110003-01.A3L	Test Dates: 01/17/21 - 01/25/21	DUT Type: Portable Handset	Page 27 of 71	

# 9 RF CONDUCTED POWERS

All conducted power measurements for 2G/3G/4G WWAN technologies and bands in this section were performed by setting Reserve\_power\_margin (Qualcomm® Smart Transmit EFS entry) to 0dB, so that the EUT transmits continuously at minimum (P<sub>limit</sub>, maximum tune up output power P<sub>max</sub>).



## 9.1 GSM Conducted Powers

**Table 9-1**  
**Measured P<sub>max</sub>**

Maximum Burst-Averaged Output Power										
Band	Channel	Voice	GPRS/EDGE Data (GMSK)				EDGE Data (8-PSK)			
		GSM [dBm] CS (1 Slot)	GPRS [dBm] 1 Tx Slot	GPRS [dBm] 2 Tx Slot	GPRS [dBm] 3 Tx Slot	GPRS [dBm] 4 Tx Slot	EDGE [dBm] 1 Tx Slot	EDGE [dBm] 2 Tx Slot	EDGE [dBm] 3 Tx Slot	EDGE [dBm] 4 Tx Slot
GSM 850	128	33.41	33.25	31.87	<b>29.49</b>	27.64	27.37	25.50	23.24	22.39
	190	33.29	33.13	31.91	<b>29.56</b>	27.45	27.36	25.47	23.50	22.29
	251	33.34	33.16	31.68	<b>29.53</b>	27.49	27.43	25.49	23.31	22.16
GSM 1900	512	29.62	29.59	28.38	<b>25.68</b>	24.18	25.42	23.72	21.51	20.54
	661	29.64	29.71	28.44	<b>26.08</b>	23.90	25.51	23.99	21.93	20.81
	810	29.62	29.70	28.40	<b>25.86</b>	24.27	25.48	23.95	21.75	20.49

Calculated Maximum Frame-Averaged Output Power										
Band	Channel	Voice	GPRS/EDGE Data (GMSK)				EDGE Data (8-PSK)			
		GSM [dBm] CS (1 Slot)	GPRS [dBm] 1 Tx Slot	GPRS [dBm] 2 Tx Slot	GPRS [dBm] 3 Tx Slot	GPRS [dBm] 4 Tx Slot	EDGE [dBm] 1 Tx Slot	EDGE [dBm] 2 Tx Slot	EDGE [dBm] 3 Tx Slot	EDGE [dBm] 4 Tx Slot
GSM 850	128	24.21	24.05	25.68	<b>25.06</b>	24.46	18.17	19.31	18.81	19.21
	190	24.09	23.93	25.72	<b>25.13</b>	24.27	18.16	19.28	19.07	19.11
	251	24.14	23.96	25.49	<b>25.10</b>	24.31	18.23	19.30	18.88	18.98
GSM 1900	512	20.42	20.39	22.19	<b>21.25</b>	21.00	16.22	17.53	17.08	17.36
	661	20.44	20.51	22.25	<b>21.65</b>	20.72	16.31	17.80	17.50	17.63
	810	20.42	20.50	22.21	<b>21.43</b>	21.09	16.28	17.76	17.32	17.31

GSM 850	Frame	23.30	23.30	24.81	<b>24.57</b>	23.82	17.30	18.31	18.07	18.32
GSM 1900	Avg.Targets:	19.80	19.80	21.31	<b>21.07</b>	20.32	16.30	16.81	16.57	16.82

FCC ID: A3LSMG998JPN	 <b>PCTEST</b> Proud to be part of 	<b>SAR EVALUATION REPORT</b>		Approved by: Quality Manager
Document S/N: 1M2101110003-01.A3L	Test Dates: 01/17/21 - 01/25/21	DUT Type: Portable Handset		Page 28 of 71

**Table 9-2**  
**Measured Plimit for DSI = 6 (Phablet with grip sensor active), DSI = 3 (Hotspot mode),**  
**and/or DSI = 4 (Earjack active)**

Maximum Burst-Averaged Output Power										
Band	Channel	Voice	GPRS/EDGE Data (GMSK)				EDGE Data (8-PSK)			
		GSM [dBm] CS (1 Slot)	GPRS [dBm] 1 Tx Slot	GPRS [dBm] 2 Tx Slot	GPRS [dBm] 3 Tx Slot	GPRS [dBm] 4 Tx Slot	EDGE [dBm] 1 Tx Slot	EDGE [dBm] 2 Tx Slot	EDGE [dBm] 3 Tx Slot	EDGE [dBm] 4 Tx Slot
GSM 1900	512	27.30	27.33	24.31	22.35	21.27	25.42	23.72	21.51	20.54
	661	27.31	27.32	23.86	22.04	20.89	25.51	23.99	21.93	20.81
	810	27.45	27.52	24.23	22.21	21.28	25.48	23.95	21.75	20.49

Calculated Maximum Frame-Averaged Output Power										
Band	Channel	Voice	GPRS/EDGE Data (GMSK)				EDGE Data (8-PSK)			
		GSM [dBm] CS (1 Slot)	GPRS [dBm] 1 Tx Slot	GPRS [dBm] 2 Tx Slot	GPRS [dBm] 3 Tx Slot	GPRS [dBm] 4 Tx Slot	EDGE [dBm] 1 Tx Slot	EDGE [dBm] 2 Tx Slot	EDGE [dBm] 3 Tx Slot	EDGE [dBm] 4 Tx Slot
GSM 1900	512	18.10	18.13	18.12	17.92	18.09	16.22	17.53	17.08	17.36
	661	18.11	18.12	17.67	17.61	17.71	16.31	17.80	17.50	17.63
	810	18.25	18.32	18.04	17.78	18.10	16.28	17.76	17.32	17.31

GSM 1900	Frame Avg.Targets:	17.80	17.80	17.81	17.77	17.82	16.30	16.81	16.57	16.82
----------	--------------------	-------	-------	-------	-------	-------	-------	-------	-------	-------

Note:

- Both burst-averaged and calculated frame-averaged powers are included. Frame-averaged power was calculated from the measured burst-averaged power by converting the slot powers into linear units and calculating the energy over 8 timeslots.
- GPRS/EDGE (GMSK) output powers were measured with coding scheme setting of 1 (CS1) on the base station simulator. CS1 was configured to measure GPRS output power measurements and SAR to ensure GMSK modulation in the signal. Our Investigation has shown that CS1 - CS4 settings do not have any impact on the output levels or modulation in the GPRS modes.
- EDGE (8-PSK) output powers were measured with MCS7 on the base station simulator. MCS7 coding scheme was used to measure the output powers for EDGE since investigation has shown that choosing MCS7 coding scheme will ensure 8-PSK modulation. It has been shown that MCS levels that produce 8-PSK modulation do not have an impact on output power.

**GSM Class: B**  
**GPRS Multislot class: 33 (Max 4 Tx uplink slots)**  
**EDGE Multislot class: 33 (Max 4 Tx uplink slots)**  
**DTM Multislot Class: N/A**

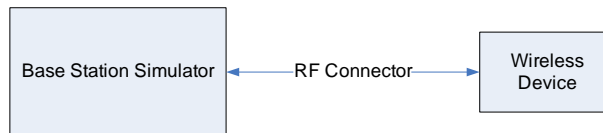

**Figure 9-1**  
**Power Measurement Setup**

FCC ID: A3LSMG998JPN	PCTEST Proud to be part of element	SAR EVALUATION REPORT		Approved by: Quality Manager
Document S/N: 1M2101110003-01.A3L	Test Dates: 01/17/21 - 01/25/21	DUT Type: Portable Handset	Page 29 of 71	

## 9.2 UMTS Conducted Powers

**Table 9-3  
Measured Pmax**

3GPP Release Version	Mode	3GPP 34.121 Subtest	Cellular Band [dBm]			3GPP MPR [dB]
			4132	4183	4233	
99	WCDMA	12.2 kbps RMC	24.56	24.51	24.50	-
99		12.2 kbps AMR	24.50	24.40	24.40	-
6	HSDPA	Subtest 1	23.57	23.33	23.27	0
6		Subtest 2	23.45	23.47	23.31	0
6		Subtest 3	23.06	23.00	22.99	0.5
6		Subtest 4	23.00	22.96	22.94	0.5
6	HSUPA	Subtest 1	23.56	23.46	23.45	0
6		Subtest 2	21.53	21.50	21.48	2
6		Subtest 3	22.55	22.54	22.50	1
6		Subtest 4	21.56	21.51	21.51	2
6		Subtest 5	23.60	23.50	23.50	0
8	DC-HSDPA	Subtest 1	23.50	23.51	23.49	0
8		Subtest 2	23.54	23.50	23.50	0
8		Subtest 3	23.01	23.00	23.00	0.5
8		Subtest 4	23.00	22.97	22.99	0.5



### DC-HSDPA considerations

- 3GPP Specification 34.121-1 Release 8 Ver 8.10.0 was used for DC-HSDPA guidance
- H-Set 12 (QPSK) was confirmed to be used during DC-HSDPA measurements
- The DUT supports UE category 24 for HSDPA

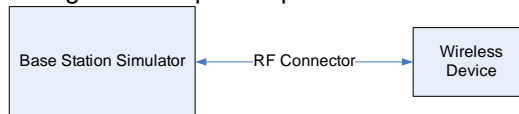
It is expected by the manufacturer that MPR for some HSPA subtests may be up to 1 dB more than specified by 3GPP, but also as low as 0 dB according to the chipset implementation in this model.



**Figure 9-2  
Power Measurement Setup**

FCC ID: A3LSMG998JPN	 <b>PCTEST</b> Proud to be part of 	<b>SAR EVALUATION REPORT</b>		<b>Approved by:</b> Quality Manager
<b>Document S/N:</b> 1M2101110003-01.A3L	<b>Test Dates:</b> 01/17/21 - 01/25/21	<b>DUT Type:</b> Portable Handset	Page 30 of 71	

### 9.3 LTE Conducted Powers



Note: Per FCC KDB Publication 941225 D05v02r05, LTE SAR for the lower bandwidths was not required for testing since the maximum average output power of all required channels and configurations was not more than 0.5 dB higher than the highest bandwidth and the reported LTE SAR for the highest bandwidth was less than 1.45 W/kg. Lower bandwidth conducted powers for all LTE bands can be found in appendix F.

#### 9.3.1 LTE Band 12

**Table 9-4**  
**LTE Band 12 Measured  $P_{Max}$  for all DSI - 10 MHz Bandwidth**

LTE Band 12 10 MHz Bandwidth					
Modulation	RB Size	RB Offset	Mid Channel	MPR Allowed per 3GPP [dB]	MPR [dB]
			23095 (707.5 MHz) Conducted Power [dBm]		
QPSK	1	0	23.30	0	0
	1	25	23.25		0
	1	49	23.10		0
	25	0	22.13	0-1	1
	25	12	<b>22.28</b>		1
	25	25	22.12		1
16QAM	50	0	22.17	0-1	1
	1	0	22.59		1
	1	25	22.45		1
	1	49	22.40	0-2	1
	25	0	21.17		2
	25	12	21.26		2
64QAM	25	25	21.09	0-2	2
	50	0	21.19		2
	1	0	21.51		0-2
	1	25	21.45	2	
	1	49	21.33	2	
	64QAM	25	0	20.24	0-3
25		12	20.35	3	
25		25	20.19	3	
50		0	20.22	3	

Note: LTE Band 12 at 10 MHz bandwidth does not support three non-overlapping channels. Per KDB Publication 941225 D05v02, when a device supports overlapping channel assignment in a channel bandwidth configuration, the middle channel of the group of overlapping channels should be selected for testing.

FCC ID: A3LSMG998JPN	 <b>PCTEST</b> Proud to be part of 	<b>SAR EVALUATION REPORT</b>		Approved by: Quality Manager
Document S/N: 1M2101110003-01.A3L	Test Dates: 01/17/21 - 01/25/21	DUT Type: Portable Handset	Page 31 of 71	

### 9.3.2 LTE Band 13

**Table 9-5**  
**LTE Band 13 Measured  $P_{Max}$  for all DSI - 10 MHz Bandwidth**



LTE Band 13 10 MHz Bandwidth					
Modulation	RB Size	RB Offset	Mid Channel	MPR Allowed per 3GPP [dB]	MPR [dB]
			23230 (782.0 MHz)		
			Conducted Power [dBm]		
QPSK	1	0	22.90	0	0
	1	25	22.91		0
	1	49	22.96		0
	25	0	22.12	0-1	1
	25	12	22.13		1
	25	25	22.01		1
16QAM	50	0	22.07	0-1	1
	1	0	22.23		1
	1	25	22.24		1
	1	49	22.33	0-2	1
	25	0	21.02		2
	25	12	21.10		2
64QAM	25	25	21.10	0-2	2
	50	0	21.02		2
	1	0	21.22		0-2
	1	25	21.22	2	
	1	49	21.10	2	
	64QAM	25	0	20.01	0-3
25		12	20.12	3	
25		25	20.05	3	
50		0	20.06	3	

### 9.3.3 LTE Band 5

**Table 9-6**  
**LTE Band 5 (Cell) Measured  $P_{Max}$  for all DSI - 10 MHz Bandwidth**

LTE Band 5 (Cell) 10 MHz Bandwidth					
Modulation	RB Size	RB Offset	Mid Channel	MPR Allowed per 3GPP [dB]	MPR [dB]
			20525 (836.5 MHz)		
			Conducted Power [dBm]		
QPSK	1	0	25.46	0	0
	1	25	25.19		0
	1	49	25.15		0
	25	0	24.27	0-1	1
	25	12	24.24		1
	25	25	24.22		1
16QAM	50	0	24.14	0-1	1
	1	0	24.62		1
	1	25	24.64		1
	1	49	24.48	0-2	1
	25	0	23.30		2
	25	12	23.33		2
64QAM	25	25	23.23	0-2	2
	50	0	23.16		2
	1	0	23.44		0-2
	1	25	23.55	2	
	1	49	23.45	2	
	64QAM	25	0	22.33	0-3
25		12	22.31	3	
25		25	22.29	3	
50		0	22.22	3	

Note: LTE Band 5 at 10 MHz bandwidth does not support three non-overlapping channels. Per KDB Publication 941225 D05v02, when a device supports overlapping channel assignment in a channel bandwidth configuration, the middle channel of the group of overlapping channels should be selected for testing.

FCC ID: A3LSMG998JPN	 <b>PCTEST</b> Proud to be part of 	<b>SAR EVALUATION REPORT</b>		<b>Approved by:</b> Quality Manager
<b>Document S/N:</b> 1M2101110003-01.A3L	<b>Test Dates:</b> 01/17/21 - 01/25/21	<b>DUT Type:</b> Portable Handset	Page 32 of 71	



### 9.3.4 LTE Band 4

**Table 9-7**  
**LTE Band 4 (AWS) Measured  $P_{Max}$  for DSI = 0 (Body-worn, or Phablet with grip sensor inactive), or DSI = 2 (Head) - 20 MHz Bandwidth**



LTE Band 4 (AWS) 20 MHz Bandwidth					
Modulation	RB Size	RB Offset	Mid Channel	MPR Allowed per 3GPP [dB]	MPR [dB]
			20175 (1732.5 MHz)		
			Conducted Power [dBm]		
QPSK	1	0	23.12	0	0
	1	50	<b>23.30</b>		0
	1	99	23.22		0
	50	0	22.32	0-1	1
	50	25	<b>22.48</b>		1
	50	50	22.40		1
16QAM	100	0	22.46	0-1	1
	1	0	22.41		1
	1	50	22.64		1
	1	99	22.61	0-2	1
	50	0	21.36		2
	50	25	21.48		2
64QAM	50	50	21.46	0-2	2
	100	0	21.42		2
	1	0	21.44		2
	1	50	21.48	0-3	2
	1	99	21.42		2
	50	0	20.35		3
64QAM	50	25	20.52	0-3	3
	50	50	20.42		3
	100	0	20.41		3

Note: LTE Band 4 at 20 MHz bandwidth does not support three non-overlapping channels. Per KDB Publication 941225 D05v02, when a device supports overlapping channel assignment in a channel bandwidth configuration, the middle channel of the group of overlapping channels should be selected for testing.

**Table 9-8**  
**LTE Band 4 (AWS) Measured  $P_{Limit}$  for DSI = 6 (Phablet with grip sensor active), or DSI = 3 (Hotspot Mode) and/or DSI = 4 (Earjack Active) - 20 MHz Bandwidth**

LTE Band 4 (AWS) 20 MHz Bandwidth					
Modulation	RB Size	RB Offset	Mid Channel	MPR Allowed per 3GPP [dB]	MPR [dB]
			20175 (1732.5 MHz)		
			Conducted Power [dBm]		
QPSK	1	0	18.48	0	0
	1	50	<b>18.69</b>		0
	1	99	18.45		0
	50	0	18.62	0-1	0
	50	25	<b>18.77</b>		0
	50	50	18.64		0
16QAM	100	0	18.67	0-1	0
	1	0	18.84		0
	1	50	19.09		0
	1	99	18.75	0-2	0
	50	0	18.72		0
	50	25	18.86		0
64QAM	50	50	18.71	0-2	0
	100	0	18.72		0
	1	0	18.77		0
	1	50	18.97	0-3	0
	1	99	18.76		0
	50	0	18.71		0
64QAM	50	25	18.83	0-3	0
	50	50	18.73		0
	100	0	18.78		0

Note: LTE Band 4 at 20 MHz bandwidth does not support three non-overlapping channels. Per KDB Publication 941225 D05v02, when a device supports overlapping channel assignment in a channel bandwidth configuration, the middle channel of the group of overlapping channels should be selected for testing.

FCC ID: A3LSMG998JPN	 <b>PCTEST</b> Proud to be part of 	<b>SAR EVALUATION REPORT</b>		<b>Approved by:</b> Quality Manager
<b>Document S/N:</b> 1M2101110003-01.A3L	<b>Test Dates:</b> 01/17/21 - 01/25/21	<b>DUT Type:</b> Portable Handset	Page 33 of 71	



### 9.3.5 LTE Band 41

**Table 9-9**  
**LTE Band 41 Measured P<sub>Max</sub> for DSI = 0 (Body-worn, or Phablet with grip sensor inactive), or DSI = 2 (Head) - 20 MHz Bandwidth**

LTE Band 41 20 MHz Bandwidth									MPR Allowed per 3GPP [dB]	MPR [dB]
Modulation	RB Size	RB Offset	Low Channel	Low-Mid Channel	Mid Channel	Mid-High Channel	High Channel			
			39750 (2506.0 MHz)	40185 (2549.5 MHz)	40620 (2593.0 MHz)	41055 (2636.5 MHz)	41490 (2680.0 MHz)			
Conducted Power [dBm]										
QPSK	1	0	24.17	24.34	24.16	24.17	23.92	0	0	
	1	50	24.22	24.35	24.48	24.37	24.34		0	
	1	99	24.19	24.34	24.21	23.96	24.12		0	
	50	0	23.11	23.18	23.26	23.26	23.15	0-1	1	
	50	25	23.30	23.33	23.42	23.40	23.41		1	
	50	50	23.24	23.27	23.38	23.25	23.35		1	
100	0	23.19	23.20	23.29	23.29	23.30	0-1	1		
16QAM	1	0	23.08	23.08	23.12	22.88		22.97	0-1	1
	1	50	23.13	23.07	23.46	22.71		23.31		1
	1	99	23.15	22.99	23.17	22.67	23.24	1		
	50	0	21.94	22.08	22.25	22.16	22.09	0-2	2	
	50	25	22.18	22.25	22.36	22.28	22.06		2	
	50	50	22.12	22.10	22.31	22.18	22.31		2	
100	0	22.08	22.14	22.20	22.21	22.24	0-2	2		
64QAM	1	0	22.56	22.25	22.11	22.26		21.94	0-2	2
	1	50	22.59	22.22	22.50	22.51		22.35		2
	1	99	22.65	21.95	22.23	22.06	22.20	2		
	50	0	21.14	21.23	21.35	21.31	21.20	0-3	3	
	50	25	21.35	21.39	21.32	21.42	21.44		3	
	50	50	21.30	21.25	21.42	21.28	21.36		3	
100	0	21.18	21.29	21.34	21.31	21.33	0-3	3		

**Table 9-10**  
**LTE Band 41 Measured P<sub>Limit</sub> for DSI = 6 (Phablet with grip sensor active), or DSI = 3 (Hotspot Mode) and/or DSI = 4 (Earjack Active) - 20 MHz Bandwidth**

LTE Band 41 20 MHz Bandwidth									MPR Allowed per 3GPP [dB]	MPR [dB]
Modulation	RB Size	RB Offset	Low Channel	Low-Mid Channel	Mid Channel	Mid-High Channel	High Channel			
			39750 (2506.0 MHz)	40185 (2549.5 MHz)	40620 (2593.0 MHz)	41055 (2636.5 MHz)	41490 (2680.0 MHz)			
Conducted Power [dBm]										
QPSK	1	0	21.25	21.31	21.01	21.08	20.96	0	0	
	1	50	21.24	21.29	21.29	21.37	21.36		0	
	1	99	21.27	21.26	21.02	20.92	21.28		0	
	50	0	21.08	21.20	21.28	21.31	21.24	0-1	0	
	50	25	21.28	21.37	21.37	21.46	21.45		0	
	50	50	21.23	21.16	21.36	21.31	21.44		0	
100	0	21.21	21.25	21.27	21.35	21.32	0-1	0		
16QAM	1	0	21.05	21.50	21.00	21.09		21.06	0-1	0
	1	50	21.16	21.35	21.38	21.38		21.44		0
	1	99	21.22	21.41	21.11	20.91	21.31	0		
	50	0	21.13	21.24	21.27	21.22	21.20	0-2	0	
	50	25	21.31	21.38	21.37	21.41	21.45		0	
	50	50	21.28	21.28	21.36	21.20	21.39		0	
100	0	21.27	21.28	21.29	21.29	21.35	0-2	0		
64QAM	1	0	21.24	21.12	21.07	21.14		20.98	0-2	0
	1	50	21.31	21.15	21.42	21.52		21.17		0
	1	99	21.41	21.09	21.22	21.09	21.12	0		
	50	0	21.05	21.16	21.23	21.22	21.10	0-3	0	
	50	25	21.23	21.30	21.34	21.37	21.36		0	
	50	50	21.19	21.17	21.34	21.21	21.32		0	
100	0	21.09	21.23	21.24	21.21	21.31	0-3	0		

FCC ID: A3LSMG998JPN	 PCTEST Proud to be part of Element	SAR EVALUATION REPORT		Approved by: Quality Manager
Document S/N: 1M2101110003-01.A3L	Test Dates: 01/17/21 - 01/25/21	DUT Type: Portable Handset		Page 34 of 71

## 9.4 WLAN Conducted Powers

**Table 9-11**  
**2.4 GHz WLAN Maximum Average RF Power – Ant 1**

2.4GHz Conducted Power [dBm]		
Freq [MHz]	Channel	IEEE Transmission Mode
		802.11b
		Average
2412	1	18.99
2437	6	18.99
2462	11	18.74

**Table 9-12**  
**2.4 GHz WLAN Maximum Average RF Power – Ant 2**



2.4GHz Conducted Power [dBm]		
Freq [MHz]	Channel	IEEE Transmission Mode
		802.11b
		Average
2412	1	18.31
2437	6	18.95
2462	11	18.52

**Table 9-13**  
**2.4 GHz WLAN Reduced Average RF Power with RCV Active – Ant 1**

2.4GHz Conducted Power [dBm]		
Freq [MHz]	Channel	IEEE Transmission Mode
		802.11b
		Average
2412	1	16.43
2437	6	16.81
2462	11	16.15

**Table 9-14**  
**2.4 GHz WLAN Reduced Average RF Power with RCV Active – Ant 2**

2.4GHz Conducted Power [dBm]		
Freq [MHz]	Channel	IEEE Transmission Mode
		802.11b
		Average
2412	1	16.33
2437	6	16.88
2462	11	16.31

FCC ID: A3LSMG998JPN	 <b>PCTEST</b> Proud to be part of 	SAR EVALUATION REPORT		Approved by: Quality Manager
Document S/N: 1M2101110003-01.A3L	Test Dates: 01/17/21 - 01/25/21	DUT Type: Portable Handset		Page 35 of 71

**Table 9-15**  
**5 GHz WLAN Maximum Average RF Power – MIMO**

5GHz (20MHz) 802.11n Conducted Power [dBm]				
Freq [MHz]	Channel	ANT1	ANT2	MIMO
5180	36	16.43	17.08	19.78
5200	40	16.32	17.10	19.74
5220	44	16.38	17.17	19.80
5240	48	16.34	17.18	19.79
5260	52	16.37	16.92	19.66
5280	56	16.37	16.86	19.63
5300	60	16.36	17.09	19.75
5320	64	16.31	17.11	19.74
5500	100	16.68	17.19	19.95
5600	120	16.54	17.08	19.83
5620	124	16.58	16.97	19.79
5720	144	16.18	16.83	19.53
5745	149	17.03	17.48	20.27
5785	157	17.21	17.46	20.35
5825	165	17.04	17.50	20.29

**Table 9-16**  
**5 GHz WLAN Reduced Average RF Power - MIMO**

5GHz (80MHz) 802.11ac Conducted Power [dBm]				
Freq [MHz]	Channel	ANT1	ANT2	MIMO
5210	42	13.93	13.81	16.88
5290	58	13.32	12.76	16.06
5530	106	13.97	13.81	16.90
5610	122	13.93	13.86	16.91
5690	138	13.77	13.96	16.88
5775	155	13.05	13.82	16.46

Justification for test configurations for WLAN per KDB Publication 248227 D01v02r02:

- Power measurements were performed for the transmission mode configuration with the highest maximum output power specified for production units.
- For transmission modes with the same maximum output power specification, powers were measured for the largest channel bandwidth, lowest order modulation and lowest data rate.
- For transmission modes with identical maximum specified output power, channel bandwidth, modulation and data rates, power measurements were required for all identical configurations.
- For each transmission mode configuration, powers were measured for the highest and lowest channels; and at the mid-band channel(s) when there were at least 3 channels supported. For configurations with multiple mid-band channels, due to an even number of channels, both channels were measured.

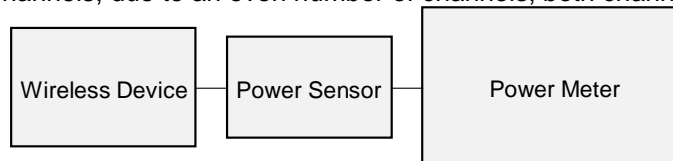

**Figure 9-3**  
**Power Measurement Setup**

FCC ID: A3LSMG998JPN	PCTEST Proud to be part of  element	SAR EVALUATION REPORT		Approved by: Quality Manager
Document S/N: 1M2101110003-01.A3L	Test Dates: 01/17/21 - 01/25/21	DUT Type: Portable Handset	Page 36 of 71	



## 9.5 Bluetooth Conducted Powers

**Table 9-17**  
**Bluetooth Maximum Average RF Power– Antenna 1**

Frequency [MHz]	Data Rate [Mbps]	Channel No.	Avg Conducted Power	
			[dBm]	[mW]
2402	1.0	0	16.21	41.774
2441	1.0	39	16.29	42.566
2480	1.0	78	15.71	37.280
2402	2.0	0	12.95	19.713
2441	2.0	39	13.40	21.879
2480	2.0	78	13.46	22.182
2402	3.0	0	13.67	23.292
2441	3.0	39	13.48	22.290
2480	3.0	78	13.53	22.563

**Table 9-18**  
**Bluetooth Maximum Average RF Power– Antenna 2**

Frequency [MHz]	Data Rate [Mbps]	Channel No.	Avg Conducted Power	
			[dBm]	[mW]
2402	1.0	0	14.96	31.354
2441	1.0	39	16.76	47.467
2480	1.0	78	16.44	44.030
2402	2.0	0	10.03	10.074
2441	2.0	39	13.28	21.263
2480	2.0	78	12.29	16.930
2402	3.0	0	11.21	13.208
2441	3.0	39	13.53	22.517
2480	3.0	78	13.64	23.124

FCC ID: A3LSMG998JPN	 <b>PCTEST</b> Proud to be part of 	<b>SAR EVALUATION REPORT</b>		Approved by: Quality Manager
Document S/N: 1M2101110003-01.A3L	Test Dates: 01/17/21 - 01/25/21	DUT Type: Portable Handset		Page 37 of 71

**Table 9-19  
Bluetooth Maximum Average RF Power– MIMO**



Frequency [MHz]	Data Rate [Mbps]	Channel No.	Avg Conducted Power_ANT1		Avg Conducted Power_ANT2		Avg Conducted Power_DUAL	
			[dBm]	[mW]	[dBm]	[mW]	[dBm]	[mW]
2402	1.0	0	11.85	15.318	11.57	14.362	14.72	29.648
2441	1.0	39	12.03	15.970	11.50	14.132	14.79	30.130
2480	1.0	78	11.81	15.157	11.06	12.753	14.46	27.925
2402	2.0	0	14.79	30.151	11.73	14.894	16.54	45.082
2441	2.0	39	15.87	38.619	12.15	16.395	17.40	54.954
2480	2.0	78	13.28	21.262	11.96	15.707	15.68	36.983
2402	3.0	0	14.96	31.326	11.79	15.115	16.67	46.452
2441	3.0	39	15.81	38.142	12.26	16.811	17.40	54.954
2480	3.0	78	13.94	24.757	11.88	15.424	16.04	40.179

**Table 9-20  
Bluetooth Reduced Average RF Power (RCV Active) – Antenna 1**

Frequency [MHz]	Data Rate [Mbps]	Channel No.	Avg Conducted Power	
			[dBm]	[mW]
2402	1.0	0	13.38	21.767
2441	1.0	39	13.29	21.321
2480	1.0	78	12.65	18.391

**Table 9-21  
Bluetooth Reduced Average RF Power (RCV Active) – Antenna 2**

Frequency [MHz]	Data Rate [Mbps]	Channel No.	Avg Conducted Power	
			[dBm]	[mW]
2402	1.0	0	12.39	17.326
2441	1.0	39	12.90	19.476
2480	1.0	78	12.55	17.993

FCC ID: A3LSMG998JPN	 <b>PCTEST</b> <small>Proud to be part of element</small>	<b>SAR EVALUATION REPORT</b>		Approved by: Quality Manager
Document S/N: 1M2101110003-01.A3L	Test Dates: 01/17/21 - 01/25/21	DUT Type: Portable Handset		Page 38 of 71

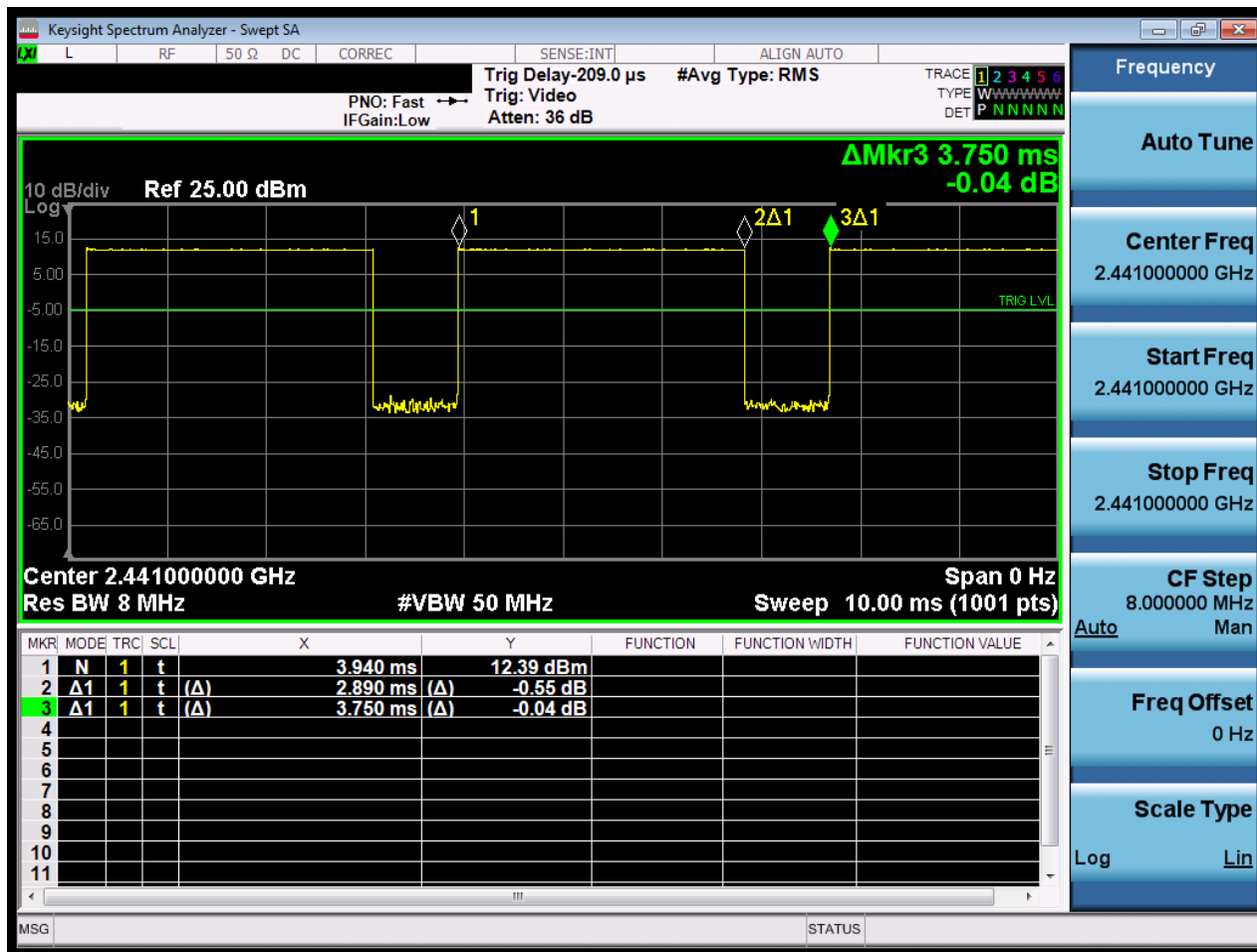

Figure 9-4  
Bluetooth Antenna 1 Transmission Plot

Equation 9-1  
Bluetooth Antenna 1 Duty Cycle Calculation

$$Duty\ Cycle = \frac{Pulse\ Width}{Period} * 100\% = \frac{2.89ms}{3.75ms} * 100\% = 77.1\%$$

FCC ID: A3LSMG998JPN	PCTEST Proud to be part of element	SAR EVALUATION REPORT		Approved by: Quality Manager
Document S/N: 1M2101110003-01.A3L	Test Dates: 01/17/21 - 01/25/21	DUT Type: Portable Handset		Page 39 of 71

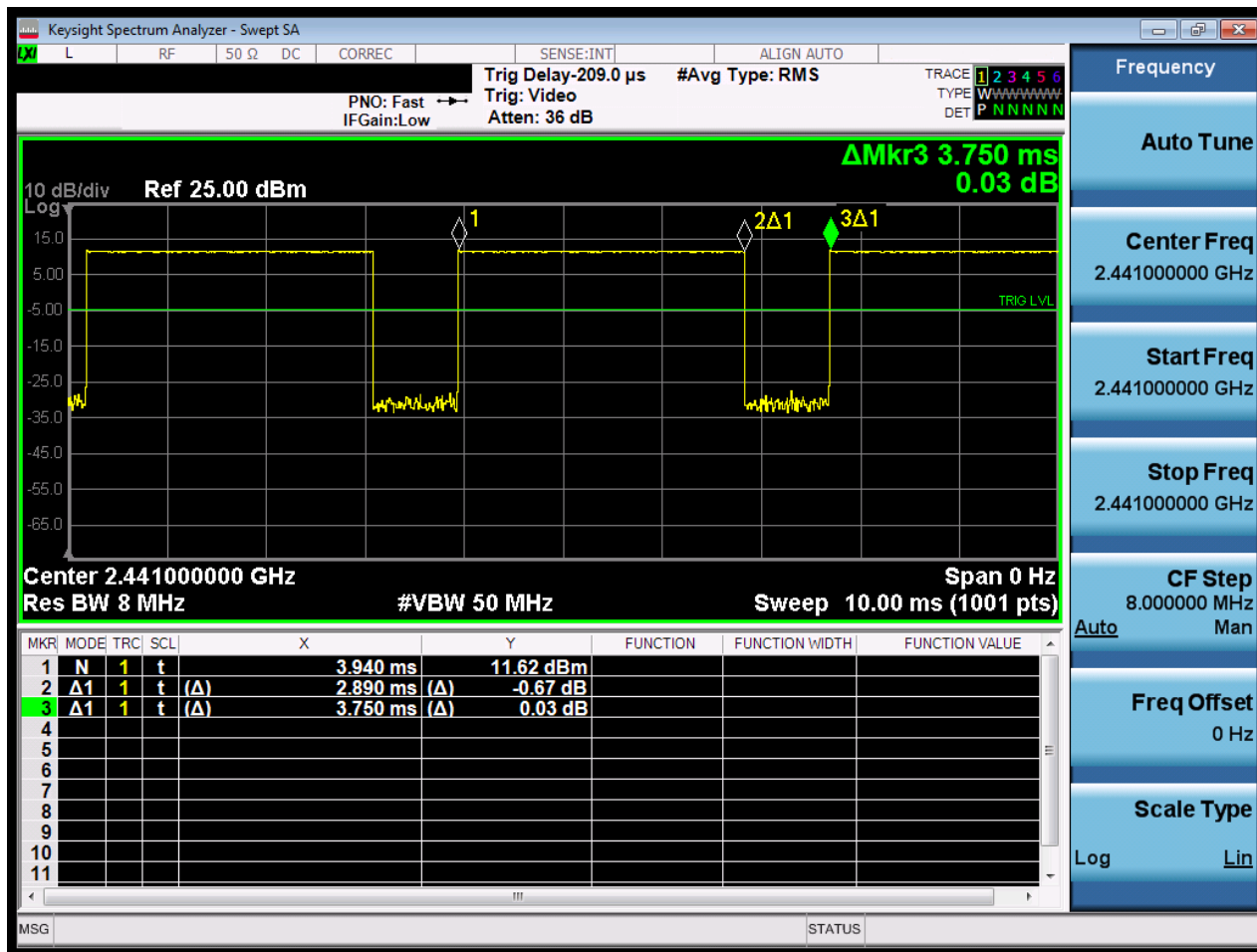

Figure 9-5  
Bluetooth Antenna 2 Transmission Plot

Equation 9-2  
Bluetooth Antenna 2 Duty Cycle Calculation

$$Duty\ Cycle = \frac{Pulse\ Width}{Period} * 100\% = \frac{2.89ms}{3.75ms} * 100\% = 77.1\%$$

FCC ID: A3LSMG998JPN	PCTEST Proud to be part of element	SAR EVALUATION REPORT		Approved by: Quality Manager
Document S/N: 1M2101110003-01.A3L	Test Dates: 01/17/21 - 01/25/21	DUT Type: Portable Handset		Page 40 of 71



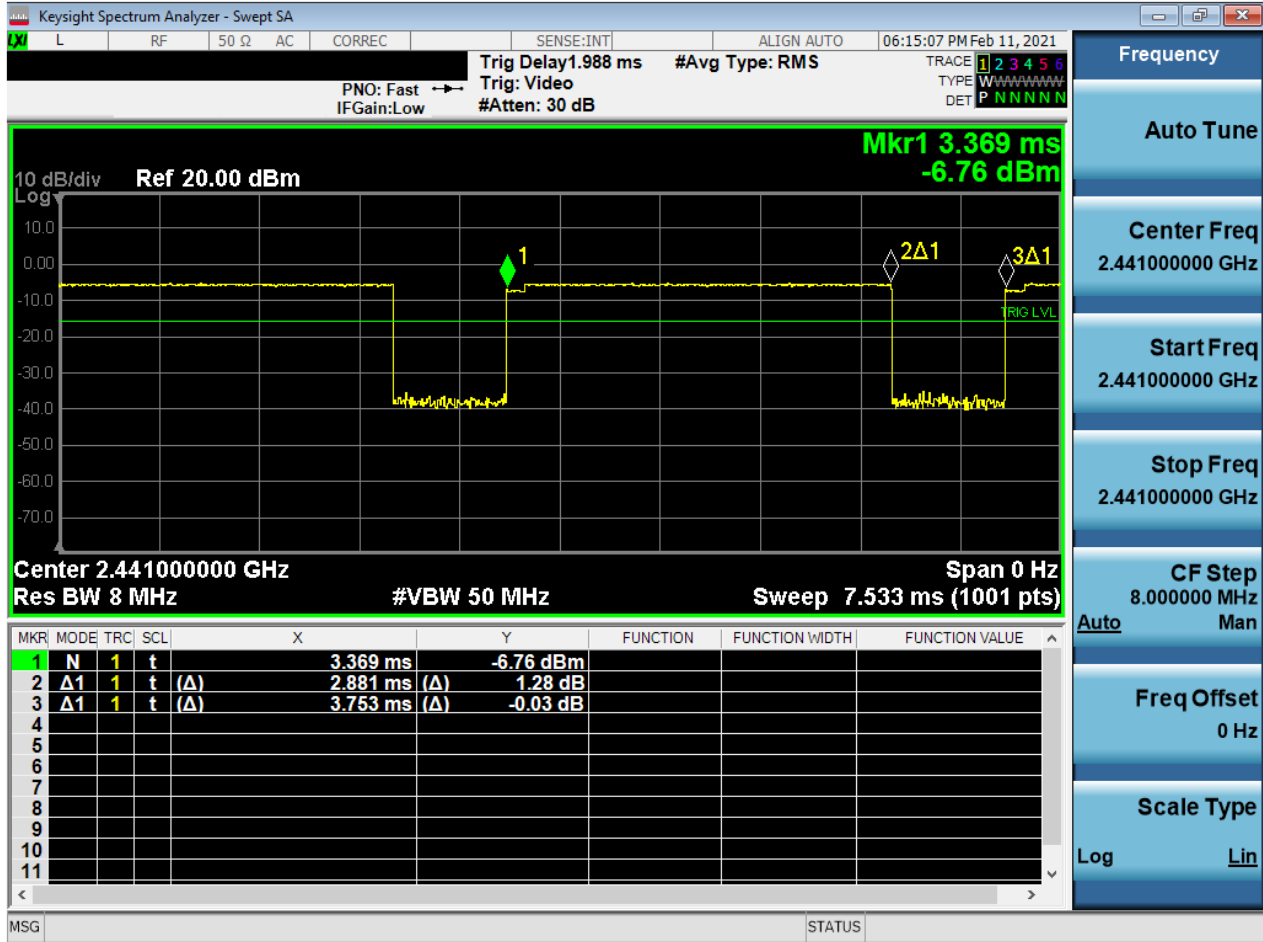

Figure 9-6  
Bluetooth MIMO Transmission Plot

Equation 9-3  
Bluetooth MIMO Duty Cycle Calculation

$$Duty\ Cycle = \frac{Pulse\ Width}{Period} * 100\% = \frac{2.88ms}{3.75ms} * 100\% = 76.8\%$$

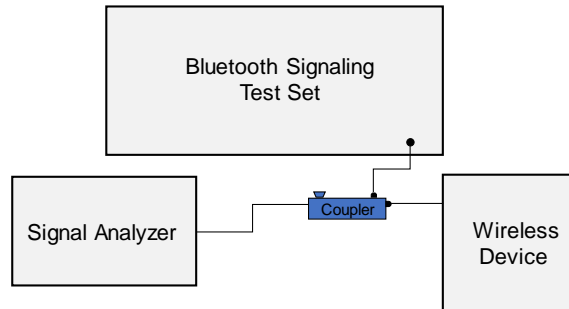

Figure 9-7  
Power Measurement Setup



FCC ID: A3LSMG998JPN	PCTEST Proud to be part of  element	SAR EVALUATION REPORT		Approved by: Quality Manager
Document S/N: 1M2101110003-01.A3L	Test Dates: 01/17/21 - 01/25/21	DUT Type: Portable Handset		Page 41 of 71

# 10 SYSTEM VERIFICATION

## 10.1 Tissue Verification

**Table 10-1  
Measured Head Tissue Properties**



Calibrated for Tests Performed on:	Tissue Type	Tissue Temp During Calibration (°C)	Measured Frequency (MHz)	Measured Conductivity, $\sigma$ (S/m)	Measured Dielectric Constant, $\epsilon$	TARGET Conductivity, $\sigma$ (S/m)	TARGET Dielectric Constant, $\epsilon$	% dev $\sigma$	% dev $\epsilon$
01/21/2021	750H	22.3	700	0.905	41.563	0.889	42.201	1.80%	-1.51%
			710	0.909	41.518	0.890	42.149	2.13%	-1.50%
			750	0.924	41.418	0.894	41.942	3.36%	-1.25%
			770	0.930	41.387	0.895	41.838	3.91%	-1.08%
			785	0.934	41.322	0.896	41.760	4.24%	-1.05%
01/20/2021	835H	20.4	820	0.867	41.193	0.899	41.578	-3.56%	-0.93%
			835	0.882	40.983	0.900	41.500	-2.00%	-1.25%
			850	0.895	40.769	0.916	41.500	-2.29%	-1.76%
01/19/2021	1750H	22.6	1720	1.366	39.799	1.354	40.126	0.89%	-0.81%
			1745	1.393	39.529	1.368	40.087	1.83%	-1.39%
			1750	1.399	39.491	1.371	40.079	2.04%	-1.47%
01/21/2021	1900H	25.0	1850	1.353	40.596	1.400	40.000	-3.36%	1.49%
			1860	1.364	40.539	1.400	40.000	-2.57%	1.35%
			1880	1.385	40.438	1.400	40.000	-1.07%	1.10%
			1900	1.406	40.359	1.400	40.000	0.43%	0.90%
			1905	1.411	40.342	1.400	40.000	0.79%	0.85%
			1910	1.415	40.325	1.400	40.000	1.07%	0.81%
01/18/2021	2450H	23.8	2400	1.800	38.883	1.756	39.289	2.51%	-1.03%
			2450	1.860	38.686	1.800	39.200	3.33%	-1.31%
			2480	1.894	38.566	1.833	39.162	3.33%	-1.52%
01/20/2021	2450-2600H	23.9	2400	1.718	38.208	1.756	39.289	-2.16%	-2.75%
			2450	1.776	37.990	1.800	39.200	-1.33%	-3.09%
			2500	1.831	37.821	1.855	39.136	-1.29%	-3.36%
			2510	1.842	37.753	1.866	39.123	-1.29%	-3.50%
			2535	1.873	37.650	1.893	39.092	-1.06%	-3.69%
			2550	1.892	37.594	1.909	39.073	-0.89%	-3.79%
			2560	1.902	37.579	1.920	39.060	-0.94%	-3.79%
			2600	1.947	37.437	1.964	39.009	-0.87%	-4.03%
			2650	2.006	37.226	2.018	38.945	-0.59%	-4.41%
			2680	2.038	37.127	2.051	38.907	-0.63%	-4.58%
01/22/2021	5200-5800H	23.0	5250	4.504	34.612	4.706	35.929	-4.29%	-3.67%
			5290	4.541	34.515	4.748	35.883	-4.36%	-3.81%
			5600	4.889	34.021	5.065	35.529	-3.47%	-4.24%
			5610	4.902	34.011	5.076	35.518	-3.43%	-4.24%
			5750	5.053	33.784	5.219	35.357	-3.18%	-4.45%
			5775	5.068	33.749	5.245	35.329	-3.37%	-4.47%

FCC ID: A3LSMG998JPN	 <b>PCTEST</b> Proud to be part of 	<b>SAR EVALUATION REPORT</b>		Approved by: Quality Manager
Document S/N: 1M2101110003-01.A3L	Test Dates: 01/17/21 - 01/25/21	DUT Type: Portable Handset		Page 42 of 71

**Table 10-2  
Measured Body Tissue Properties**

Calibrated for Tests Performed on:	Tissue Type	Tissue Temp During Calibration (°C)	Measured Frequency (MHz)	Measured Conductivity, $\sigma$ (S/m)	Measured Dielectric Constant, $\epsilon$	TARGET Conductivity, $\sigma$ (S/m)	TARGET Dielectric Constant, $\epsilon$	% dev $\sigma$	% dev $\epsilon$
01/20/2021	750B	20.9	700	0.944	54.097	0.959	55.726	-1.56%	-2.92%
			710	0.947	54.068	0.960	55.687	-1.35%	-2.91%
			750	0.962	53.971	0.964	55.531	-0.21%	-2.81%
			770	0.969	53.943	0.965	55.453	0.41%	-2.72%
			785	0.975	53.916	0.966	55.395	0.93%	-2.67%
01/20/2021	835B	22.3	820	0.943	53.733	0.969	55.258	-2.68%	-2.76%
			835	0.959	53.583	0.970	55.200	-1.13%	-2.93%
			850	0.975	53.420	0.988	55.154	-1.32%	-3.14%
01/18/2021	1750B	21.5	1720	1.480	51.340	1.469	53.511	0.75%	-4.06%
			1745	1.506	51.230	1.485	53.445	1.41%	-4.14%
			1750	1.511	51.209	1.488	53.432	1.55%	-4.16%
01/17/2021	1900B	24.8	1850	1.488	52.535	1.520	53.300	-2.11%	-1.44%
			1860	1.496	52.493	1.520	53.300	-1.58%	-1.51%
			1880	1.514	52.402	1.520	53.300	-0.39%	-1.68%
			1900	1.538	52.326	1.520	53.300	1.18%	-1.83%
			1905	1.545	52.313	1.520	53.300	1.64%	-1.85%
			1910	1.551	52.302	1.520	53.300	2.04%	-1.87%
01/24/2021	1900B	24.4	1850	1.485	53.166	1.520	53.300	-2.30%	-0.25%
			1860	1.496	53.137	1.520	53.300	-1.58%	-0.31%
			1880	1.516	53.076	1.520	53.300	-0.26%	-0.42%
			1900	1.538	53.024	1.520	53.300	1.18%	-0.52%
			1905	1.544	53.012	1.520	53.300	1.58%	-0.54%
01/18/2021	2450B	22.3	2400	1.981	53.052	1.902	52.767	4.15%	0.54%
			2450	2.041	52.916	1.950	52.700	4.67%	0.41%
			2480	2.075	52.830	1.993	52.662	4.11%	0.32%
			2450	2.015	51.918	1.950	52.700	3.33%	-1.48%
			2500	2.087	51.743	2.021	52.636	3.27%	-1.70%
01/21/2021	2450-2600B	22.3	2510	2.102	51.714	2.035	52.623	3.29%	-1.73%
			2535	2.135	51.623	2.071	52.592	3.09%	-1.84%
			2550	2.156	51.561	2.092	52.573	3.06%	-1.92%
			2560	2.170	51.519	2.106	52.560	3.04%	-1.98%
			2600	2.228	51.353	2.163	52.509	3.01%	-2.20%
			2650	2.299	51.180	2.234	52.445	2.91%	-2.41%
			2680	2.338	51.048	2.277	52.407	2.68%	-2.59%
			2450	2.036	51.167	1.950	52.700	4.41%	-2.91%
01/24/2021	2450-2600B	23.0	2500	2.108	50.978	2.021	52.636	4.30%	-3.15%
			2510	2.122	50.944	2.035	52.623	4.28%	-3.19%
			2535	2.154	50.853	2.071	52.592	4.01%	-3.31%
			2550	2.173	50.795	2.092	52.573	3.87%	-3.38%
			2560	2.186	50.753	2.106	52.560	3.80%	-3.44%
			2600	2.244	50.584	2.163	52.509	3.74%	-3.67%
			2650	2.314	50.422	2.234	52.445	3.58%	-3.86%
			2680	2.352	50.290	2.277	52.407	3.29%	-4.04%
01/25/2021	2450B	22.7	2400	1.986	51.005	1.902	52.767	4.42%	-3.34%
			2450	2.043	50.856	1.950	52.700	4.77%	-3.50%
			2480	2.080	50.758	1.993	52.662	4.37%	-3.62%
01/18/2021	5200-5800B	21.7	5250	5.528	46.833	5.358	48.947	3.17%	-4.32%
			5260	5.539	46.811	5.369	48.933	3.17%	-4.34%
			5300	5.604	46.729	5.416	48.879	3.47%	-4.40%
			5320	5.630	46.697	5.439	48.851	3.51%	-4.41%
			5500	5.862	46.409	5.650	48.607	3.75%	-4.52%
			5600	6.001	46.239	5.766	48.471	4.08%	-4.60%
			5745	6.213	45.988	5.936	48.275	4.67%	-4.74%
			5750	6.219	45.985	5.942	48.268	4.66%	-4.73%
			5775	6.243	45.959	5.971	48.234	4.56%	-4.72%
			5785	6.257	45.935	5.982	48.220	4.60%	-4.74%
			5825	6.325	45.839	6.029	48.166	4.91%	-4.83%

The above measured tissue parameters were used in the DASY software. The DASY software was used to perform interpolation to determine the dielectric parameters at the SAR test device frequencies (per KDB Publication 865664 D01v01r04 and IEEE 1528-2013 6.6.1.2). The tissue parameters listed in the SAR test plots may slightly differ from the table above due to significant digit rounding in the software.



FCC ID: A3LSMG998JPN	 <b>PCTEST</b> Proud to be part of 	<b>SAR EVALUATION REPORT</b>		Approved by: Quality Manager
Document S/N: 1M2101110003-01.A3L	Test Dates: 01/17/21 - 01/25/21	DUT Type: Portable Handset	Page 43 of 71	

## 10.2 Test System Verification

Prior to SAR assessment, the system is verified to  $\pm 10\%$  of the SAR measurement on the reference dipole at the time of calibration by the calibration facility. Full system validation status and result summary can be found in Appendix D.

**Table 10-3  
System Verification Results – 1g**

System Verification TARGET & MEASURED												
SAR System #	Tissue Frequency (MHz)	Tissue Type	Date	Amb. Temp (°C)	Liquid Temp (°C)	Input Power (W)	Source SN	Probe SN	Measured SAR <sub>1g</sub> (W/kg)	1 W Target SAR <sub>1g</sub> (W/kg)	1 W Normalized SAR <sub>1g</sub> (W/kg)	Deviation <sub>1g</sub> (%)
E	750	HEAD	01/21/2021	23.3	22.3	0.200	1003	7571	1.710	8.780	8.550	-2.62%
L	835	HEAD	01/20/2021	22.3	20.4	0.200	4d047	7539	1.960	9.420	9.800	4.03%
H	1750	HEAD	01/19/2021	22.6	22.6	0.100	1150	7357	3.790	36.500	37.900	3.84%
H	1900	HEAD	01/21/2021	23.5	25.0	0.100	5d149	7357	3.950	39.300	39.500	0.51%
E	2450	HEAD	01/18/2021	22.9	22.3	0.100	797	7571	4.980	52.400	49.800	-4.96%
E	2450	HEAD	01/20/2021	23.1	22.4	0.100	797	7571	4.910	52.400	49.100	-6.30%
E	2600	HEAD	01/20/2021	23.1	22.4	0.100	1064	7571	5.880	58.100	58.800	1.20%
H	5250	HEAD	01/22/2021	22.5	23.0	0.050	1237	7357	3.750	81.300	75.000	-7.75%
H	5600	HEAD	01/22/2021	22.5	23.0	0.050	1237	7357	3.890	85.700	77.800	-9.22%
H	5750	HEAD	01/22/2021	22.5	23.0	0.050	1237	7357	3.900	80.600	78.000	-3.23%
P	750	BODY	01/20/2021	24.1	20.9	0.200	1054	7308	1.720	8.530	8.600	0.82%
D	835	BODY	01/20/2021	23.1	22.3	0.200	4d133	7552	1.960	9.750	9.800	0.51%
H	1750	BODY	01/18/2021	20.0	21.0	0.100	1150	7357	3.560	36.600	35.600	-2.73%
J	1900	BODY	01/17/2021	20.3	22.8	0.100	5d080	7410	4.100	39.200	41.000	4.59%
J	1900	BODY	01/24/2021	22.1	22.6	0.100	5d149	7410	3.870	39.400	38.700	-1.78%
K	2450	BODY	01/18/2021	23.2	22.3	0.100	719	7409	4.900	50.700	49.000	-3.35%
P	2450	BODY	01/21/2021	23.9	22.7	0.100	797	7308	5.100	49.400	51.000	3.24%
K	2450	BODY	01/25/2021	21.0	22.7	0.100	719	7409	5.230	50.700	52.300	3.16%
P	2600	BODY	01/21/2021	23.9	22.7	0.100	1064	7308	5.470	55.600	54.700	-1.62%
G	5250	BODY	01/18/2021	23.5	22.4	0.050	1191	7406	3.570	74.600	71.400	-4.29%
G	5600	BODY	01/18/2021	23.5	22.4	0.050	1191	7406	3.940	78.100	78.800	0.90%
G	5750	BODY	01/18/2021	23.5	22.4	0.050	1191	7406	3.590	74.900	71.800	-4.14%

FCC ID: A3LSMG998JPN	 <b>PCTEST</b> Proud to be part of 	<b>SAR EVALUATION REPORT</b>		<b>Approved by:</b> Quality Manager
<b>Document S/N:</b> 1M2101110003-01.A3L	<b>Test Dates:</b> 01/17/21 - 01/25/21	<b>DUT Type:</b> Portable Handset	Page 44 of 71	

**Table 10-4  
System Verification Results – 10g**

System Verification TARGET & MEASURED												
SAR System #	Tissue Frequency (MHz)	Tissue Type	Date	Amb. Temp (°C)	Liquid Temp (°C)	Input Power (W)	Source SN	Probe SN	Measured SAR <sub>10g</sub> (W/kg)	1 W Target SAR <sub>10g</sub> (W/kg)	1 W Normalized SAR <sub>10g</sub> (W/kg)	Deviation <sub>10g</sub> (%)
H	1750	BODY	01/18/2021	20.0	21.0	0.100	1150	7357	1.850	19.400	18.500	-4.64%
J	1900	BODY	01/24/2021	22.1	22.6	0.100	5d149	7410	1.980	20.700	19.800	-4.35%
P	2450	BODY	01/24/2021	23.1	23.1	0.100	797	7308	2.380	23.400	23.800	1.71%
P	2600	BODY	01/24/2021	23.1	23.1	0.100	1064	7308	2.360	25.000	23.600	-5.60%
G	5250	BODY	01/18/2021	23.5	22.4	0.050	1191	7406	0.997	21.000	19.940	-5.05%
G	5600	BODY	01/18/2021	23.5	22.4	0.050	1191	7406	1.090	21.700	21.800	0.46%

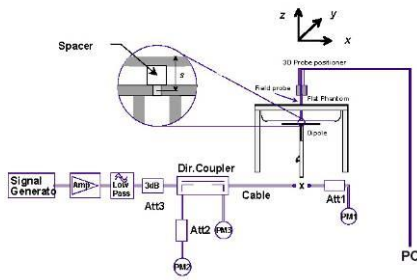

**Figure 10-1  
System Verification Setup Diagram**



**Figure 10-2  
System Verification Setup Photo**

FCC ID: A3LSMG998JPN	PCTEST Proud to be part of  element	SAR EVALUATION REPORT		Approved by: Quality Manager
Document S/N: 1M2101110003-01.A3L	Test Dates: 01/17/21 - 01/25/21	DUT Type: Portable Handset	Page 45 of 71	

# 11 SAR DATA SUMMARY

## 11.1 Standalone Head SAR Data

**Table 11-1  
GSM 850 Head SAR**



MEASUREMENT RESULTS														
FREQUENCY		Mode	Service	Maximum Allowed Power [dBm]	Conducted Power [dBm]	Power Drift [dB]	Side	Test Position	Device Serial Number	Duty Cycle	SAR (1g)	Scaling Factor	Reported SAR (1g)	Plot #
MHz	Ch.										(W/kg)		(W/kg)	
836.60	190	GSM 850	GSM	33.5	33.29	0.03	Right	Cheek	0523M	1:8.3	0.079	1.050	0.083	A1
836.60	190	GSM 850	GSM	33.5	33.29	0.18	Right	Tilt	0523M	1:8.3	0.034	1.050	0.036	
836.60	190	GSM 850	GSM	33.5	33.29	0.07	Left	Cheek	0523M	1:8.3	0.052	1.050	0.055	
836.60	190	GSM 850	GSM	33.5	33.29	0.16	Left	Tilt	0523M	1:8.3	0.033	1.050	0.035	
ANSI / IEEE C95.1 1992 - SAFETY LIMIT Spatial Peak Uncontrolled Exposure/General Population							Head 1.6 W/kg (mW/g) averaged over 1 gram							

**Table 11-2  
GSM 1900 Head SAR**

MEASUREMENT RESULTS														
FREQUENCY		Mode	Service	Maximum Allowed Power [dBm]	Conducted Power [dBm]	Power Drift [dB]	Side	Test Position	Device Serial Number	Duty Cycle	SAR (1g)	Scaling Factor	Reported SAR (1g)	Plot #
MHz	Ch.										(W/kg)		(W/kg)	
1880.00	661	GSM 1900	GSM	30.0	29.64	-0.08	Right	Cheek	0482M	1:8.3	0.034	1.086	0.037	
1880.00	661	GSM 1900	GSM	30.0	29.64	0.02	Right	Tilt	0482M	1:8.3	0.027	1.086	0.029	
1880.00	661	GSM 1900	GSM	30.0	29.64	0.07	Left	Cheek	0482M	1:8.3	0.054	1.086	0.059	A2
1880.00	661	GSM 1900	GSM	30.0	29.64	0.17	Left	Tilt	0482M	1:8.3	0.030	1.086	0.033	
ANSI / IEEE C95.1 1992 - SAFETY LIMIT Spatial Peak Uncontrolled Exposure/General Population							Head 1.6 W/kg (mW/g) averaged over 1 gram							

**Table 11-3  
UMTS 850 Head SAR**

MEASUREMENT RESULTS														
FREQUENCY		Mode	Service	Maximum Allowed Power [dBm]	Conducted Power [dBm]	Power Drift [dB]	Side	Test Position	Device Serial Number	Duty Cycle	SAR (1g)	Scaling Factor	Reported SAR (1g)	Plot #
MHz	Ch.										(W/kg)		(W/kg)	
836.60	4183	UMTS 850	RMC	25.5	24.51	0.02	Right	Cheek	0482M	1:1	0.111	1.256	0.139	A3
836.60	4183	UMTS 850	RMC	25.5	24.51	0.16	Right	Tilt	0482M	1:1	0.050	1.256	0.063	
836.60	4183	UMTS 850	RMC	25.5	24.51	0.03	Left	Cheek	0482M	1:1	0.077	1.256	0.097	
836.60	4183	UMTS 850	RMC	25.5	24.51	-0.02	Left	Tilt	0482M	1:1	0.050	1.256	0.063	
ANSI / IEEE C95.1 1992 - SAFETY LIMIT Spatial Peak Uncontrolled Exposure/General Population							Head 1.6 W/kg (mW/g) averaged over 1 gram							

FCC ID: A3LSMG998JPN	 PCTEST Proud to be part of 	SAR EVALUATION REPORT		Approved by: Quality Manager
Document S/N: 1M2101110003-01.A3L	Test Dates: 01/17/21 - 01/25/21	DUT Type: Portable Handset	Page 46 of 71	

**Table 11-4  
LTE Band 12 Head SAR**



MEASUREMENT RESULTS																			
FREQUENCY		Mode	Bandwidth [MHz]	Maximum Allowed Power [dBm]	Conducted Power [dBm]	Power Drift [dB]	MPR [dB]	Side	Test Position	Modulation	RB Size	RB Offset	Device Serial Number	Duty Cycle	SAR (1g)	Scaling Factor	Reported SAR (1g)	Plot #	
MHz	Ch.														(W/kg)		(W/kg)		
707.50	23095	Mid	LTE Band 12	10	24.0	23.30	0.00	0	Right	Cheek	QPSK	1	0	0521M	1:1	0.074	1.175	0.087	A4
707.50	23095	Mid	LTE Band 12	10	23.0	22.28	0.03	1	Right	Cheek	QPSK	25	12	0521M	1:1	0.060	1.180	0.071	
707.50	23095	Mid	LTE Band 12	10	24.0	23.30	-0.09	0	Right	Tilt	QPSK	1	0	0521M	1:1	0.032	1.175	0.038	
707.50	23095	Mid	LTE Band 12	10	23.0	22.28	0.09	1	Right	Tilt	QPSK	25	12	0521M	1:1	0.024	1.180	0.028	
707.50	23095	Mid	LTE Band 12	10	24.0	23.30	0.14	0	Left	Cheek	QPSK	1	0	0521M	1:1	0.057	1.175	0.067	
707.50	23095	Mid	LTE Band 12	10	23.0	22.28	0.02	1	Left	Cheek	QPSK	25	12	0521M	1:1	0.038	1.180	0.045	
707.50	23095	Mid	LTE Band 12	10	24.0	23.30	-0.18	0	Left	Tilt	QPSK	1	0	0521M	1:1	0.024	1.175	0.028	
707.50	23095	Mid	LTE Band 12	10	23.0	22.28	0.04	1	Left	Tilt	QPSK	25	12	0521M	1:1	0.017	1.180	0.020	
ANSI / IEEE C95.1 1992 - SAFETY LIMIT Spatial Peak Uncontrolled Exposure/General Population										Head 1.6 W/kg (mW/g) averaged over 1 gram									

**Table 11-5  
LTE Band 13 Head SAR**

MEASUREMENT RESULTS																			
FREQUENCY		Mode	Bandwidth [MHz]	Maximum Allowed Power [dBm]	Conducted Power [dBm]	Power Drift [dB]	MPR [dB]	Side	Test Position	Modulation	RB Size	RB Offset	Device Serial Number	Duty Cycle	SAR (1g)	Scaling Factor	Reported SAR (1g)	Plot #	
MHz	Ch.														(W/kg)		(W/kg)		
782.00	23230	Mid	LTE Band 13	10	24.0	22.96	0.05	0	Right	Cheek	QPSK	1	49	0521M	1:1	0.094	1.271	0.119	A5
782.00	23230	Mid	LTE Band 13	10	23.0	22.13	0.01	1	Right	Cheek	QPSK	25	12	0521M	1:1	0.082	1.222	0.100	
782.00	23230	Mid	LTE Band 13	10	24.0	22.96	0.16	0	Right	Tilt	QPSK	1	49	0521M	1:1	0.045	1.271	0.057	
782.00	23230	Mid	LTE Band 13	10	23.0	22.13	0.05	1	Right	Tilt	QPSK	25	12	0521M	1:1	0.037	1.222	0.045	
782.00	23230	Mid	LTE Band 13	10	24.0	22.96	-0.02	0	Left	Cheek	QPSK	1	49	0521M	1:1	0.067	1.271	0.085	
782.00	23230	Mid	LTE Band 13	10	23.0	22.13	0.12	1	Left	Cheek	QPSK	25	12	0521M	1:1	0.059	1.222	0.072	
782.00	23230	Mid	LTE Band 13	10	24.0	22.96	0.11	0	Left	Tilt	QPSK	1	49	0521M	1:1	0.038	1.271	0.048	
782.00	23230	Mid	LTE Band 13	10	23.0	22.13	0.07	1	Left	Tilt	QPSK	25	12	0521M	1:1	0.035	1.222	0.043	
ANSI / IEEE C95.1 1992 - SAFETY LIMIT Spatial Peak Uncontrolled Exposure/General Population										Head 1.6 W/kg (mW/g) averaged over 1 gram									

**Table 11-6  
LTE Band 5 (Cell) Head SAR**

MEASUREMENT RESULTS																			
FREQUENCY		Mode	Bandwidth [MHz]	Maximum Allowed Power [dBm]	Conducted Power [dBm]	Power Drift [dB]	MPR [dB]	Side	Test Position	Modulation	RB Size	RB Offset	Device Serial Number	Duty Cycle	SAR (1g)	Scaling Factor	Reported SAR (1g)	Plot #	
MHz	Ch.														(W/kg)		(W/kg)		
836.50	20525	Mid	LTE Band 5 (Cell)	10	25.8	25.46	0.00	0	Right	Cheek	QPSK	1	0	0523M	1:1	0.142	1.081	0.154	A6
836.50	20525	Mid	LTE Band 5 (Cell)	10	24.8	24.27	-0.01	1	Right	Cheek	QPSK	25	0	0523M	1:1	0.109	1.130	0.123	
836.50	20525	Mid	LTE Band 5 (Cell)	10	25.8	25.46	0.02	0	Right	Tilt	QPSK	1	0	0523M	1:1	0.053	1.081	0.057	
836.50	20525	Mid	LTE Band 5 (Cell)	10	24.8	24.27	0.12	1	Right	Tilt	QPSK	25	0	0523M	1:1	0.043	1.130	0.049	
836.50	20525	Mid	LTE Band 5 (Cell)	10	25.8	25.46	-0.11	0	Left	Cheek	QPSK	1	0	0523M	1:1	0.085	1.081	0.092	
836.50	20525	Mid	LTE Band 5 (Cell)	10	24.8	24.27	-0.10	1	Left	Cheek	QPSK	25	0	0523M	1:1	0.069	1.130	0.078	
836.50	20525	Mid	LTE Band 5 (Cell)	10	25.8	25.46	-0.02	0	Left	Tilt	QPSK	1	0	0523M	1:1	0.050	1.081	0.054	
836.50	20525	Mid	LTE Band 5 (Cell)	10	24.8	24.27	-0.16	1	Left	Tilt	QPSK	25	0	0523M	1:1	0.040	1.130	0.045	
ANSI / IEEE C95.1 1992 - SAFETY LIMIT Spatial Peak Uncontrolled Exposure/General Population										Head 1.6 W/kg (mW/g) averaged over 1 gram									

FCC ID: A3LSMG998JPN	 PCTEST Proud to be part of Element	<b>SAR EVALUATION REPORT</b>		Approved by: Quality Manager
Document S/N: 1M2101110003-01.A3L	Test Dates: 01/17/21 - 01/25/21	DUT Type: Portable Handset		Page 47 of 71

**Table 11-7  
LTE Band 4 (AWS) Head SAR**



MEASUREMENT RESULTS																			
FREQUENCY		Mode	Bandwidth [MHz]	Maximum Allowed Power [dBm]	Conducted Power [dBm]	Power Drift [dB]	MPR [dB]	Side	Test Position	Modulation	RB Size	RB Offset	Device Serial Number	Duty Cycle	SAR (1g)	Scaling Factor	Reported SAR (1g)	Plot #	
MHz	Ch.														(W/kg)		(W/kg)		
1732.50	20175	Mid	LTE Band 4 (AWS)	20	24.0	23.30	0.01	0	Right	Cheek	QPSK	1	50	0482M	1:1	0.054	1.175	0.063	
1732.50	20175	Mid	LTE Band 4 (AWS)	20	23.0	22.48	0.02	1	Right	Cheek	QPSK	50	25	0482M	1:1	0.042	1.127	0.047	
1732.50	20175	Mid	LTE Band 4 (AWS)	20	24.0	23.30	0.18	0	Right	Tilt	QPSK	1	50	0482M	1:1	0.043	1.175	0.051	
1732.50	20175	Mid	LTE Band 4 (AWS)	20	23.0	22.48	0.15	1	Right	Tilt	QPSK	50	25	0482M	1:1	0.038	1.127	0.043	
1732.50	20175	Mid	LTE Band 4 (AWS)	20	24.0	23.30	0.11	0	Left	Cheek	QPSK	1	50	0482M	1:1	0.091	1.175	0.107	A7
1732.50	20175	Mid	LTE Band 4 (AWS)	20	23.0	22.48	0.02	1	Left	Cheek	QPSK	50	25	0482M	1:1	0.077	1.127	0.087	
1732.50	20175	Mid	LTE Band 4 (AWS)	20	24.0	23.30	0.14	0	Left	Tilt	QPSK	1	50	0482M	1:1	0.058	1.175	0.068	
1732.50	20175	Mid	LTE Band 4 (AWS)	20	23.0	22.48	-0.04	1	Left	Tilt	QPSK	50	25	0482M	1:1	0.044	1.127	0.050	
ANSI / IEEE C95.1 1992 - SAFETY LIMIT Spatial Peak Uncontrolled Exposure/General Population										Head 1.6 W/kg (mW/g) averaged over 1 gram									

**Table 11-8  
LTE Band 41 Head SAR**

MEASUREMENT RESULTS																			
FREQUENCY		Mode	Bandwidth [MHz]	Maximum Allowed Power [dBm]	Conducted Power [dBm]	Power Drift [dB]	MPR [dB]	Side	Test Position	Modulation	RB Size	RB Offset	Device Serial Number	Duty Cycle	SAR (1g)	Scaling Factor	Reported SAR (1g)	Plot #	
MHz	Ch.														(W/kg)		(W/kg)		
2593.00	40620	Mid	LTE Band 41	20	25.0	24.48	0.04	0	Right	Cheek	QPSK	1	50	0482M	1:1.58	0.058	1.127	0.065	A8
2593.00	40620	Mid	LTE Band 41	20	24.0	23.42	0.02	1	Right	Cheek	QPSK	50	25	0482M	1:1.58	0.045	1.143	0.051	
2593.00	40620	Mid	LTE Band 41	20	25.0	24.48	0.19	0	Right	Tilt	QPSK	1	50	0482M	1:1.58	0.042	1.127	0.047	
2593.00	40620	Mid	LTE Band 41	20	24.0	23.42	0.02	1	Right	Tilt	QPSK	50	25	0482M	1:1.58	0.033	1.143	0.038	
2593.00	40620	Mid	LTE Band 41	20	25.0	24.48	0.13	0	Left	Cheek	QPSK	1	50	0482M	1:1.58	0.056	1.127	0.063	
2593.00	40620	Mid	LTE Band 41	20	24.0	23.42	0.03	1	Left	Cheek	QPSK	50	25	0482M	1:1.58	0.043	1.143	0.049	
2593.00	40620	Mid	LTE Band 41	20	25.0	24.48	0.04	0	Left	Tilt	QPSK	1	50	0482M	1:1.58	0.034	1.127	0.038	
2593.00	40620	Mid	LTE Band 41	20	24.0	23.42	0.02	1	Left	Tilt	QPSK	50	25	0482M	1:1.58	0.028	1.143	0.032	
ANSI / IEEE C95.1 1992 - SAFETY LIMIT Spatial Peak Uncontrolled Exposure/General Population										Head 1.6 W/kg (mW/g) averaged over 1 gram									

**Table 11-9  
DTS Head SISO SAR**

MEASUREMENT RESULTS																			
FREQUENCY		Mode	Service	Bandwidth [MHz]	Maximum Allowed Power [dBm]	Conducted Power [dBm]	Power Drift [dB]	Side	Test Position	Antenna Config.	Device Serial Number	Data Rate (Mbps)	Duty Cycle (%)	Peak SAR of Area Scan	SAR (1g)	Scaling Factor (Power)	Scaling Factor (Duty Cycle)	Reported SAR (1g)	Plot #
MHz	Ch.													(W/kg)	(W/kg)	(W/kg)	(W/kg)		
2437	6	802.11b	DSSS	22	17.0	16.81	0.14	Right	Cheek	1	0280M	1	98.9	0.024	-	1.045	1.011	-	
2437	6	802.11b	DSSS	22	17.0	16.81	0.05	Right	Tilt	1	0280M	1	98.9	0.023	-	1.045	1.011	-	
2437	6	802.11b	DSSS	22	17.0	16.81	0.15	Left	Cheek	1	0280M	1	98.9	0.017	-	1.045	1.011	-	
2437	6	802.11b	DSSS	22	17.0	16.81	0.05	Left	Tilt	1	0280M	1	98.9	0.025	0.015	1.045	1.011	0.016	
2437	6	802.11b	DSSS	22	17.0	16.88	0.05	Right	Cheek	2	0280M	1	98.9	0.168	-	1.028	1.011	-	
2437	6	802.11b	DSSS	22	17.0	16.88	0.03	Right	Tilt	2	0280M	1	98.9	0.038	-	1.028	1.011	-	
2437	6	802.11b	DSSS	22	17.0	16.88	0.14	Left	Cheek	2	0280M	1	98.9	0.392	0.202	1.028	1.011	0.210	A9
2437	6	802.11b	DSSS	22	17.0	16.88	0.07	Left	Tilt	2	0280M	1	98.9	0.026	-	1.028	1.011	-	
ANSI / IEEE C95.1 1992 - SAFETY LIMIT Spatial Peak Uncontrolled Exposure/General Population										Head 1.6 W/kg (mW/g) averaged over 1 gram									

FCC ID: A3LSMG998JPN	 PCTEST Proud to be part of element	SAR EVALUATION REPORT		Approved by: Quality Manager
Document S/N: 1M2101110003-01.A3L	Test Dates: 01/17/21 - 01/25/21	DUT Type: Portable Handset	Page 48 of 71	



**Table 11-10  
NII MIMO Head SAR**

MEASUREMENT RESULTS																					
FREQUENCY		Mode	Service	Bandwidth [MHz]	Maximum Allowed Power (Ant 1) [dBm]	Conducted Power (Ant 1) [dBm]	Maximum Allowed Power (Ant 2) [dBm]	Conducted Power (Ant 2) [dBm]	Power Drift [dB]	Side	Test Position	Antenna Config.	Device Serial Number	Data Rate (Mbps)	Duty Cycle (%)	Peak SAR of Area Scan [W/kg]	SAR (1g) [W/kg]	Scaling Factor (Power)	Scaling Factor (Duty Cycle)	Reported SAR (1g) [W/kg]	Plot #
MHz	Ch.																				
5290	58	802.11ac	OFDM	80	14.0	13.32	14.0	12.76	0.07	Right	Cheek	MIMO	0289M	58.5	91.3	0.320	-	1.330	1.095	-	-
5290	58	802.11ac	OFDM	80	14.0	13.32	14.0	12.76	0.13	Right	Tilt	MIMO	0289M	58.5	91.3	0.126	-	1.330	1.095	-	-
5290	58	802.11ac	OFDM	80	14.0	13.32	14.0	12.76	0.12	Left	Cheek	MIMO	0289M	58.5	91.3	0.450	0.182	1.330	1.095	0.265	A10
5290	58	802.11ac	OFDM	80	14.0	13.32	14.0	12.76	0.04	Left	Tilt	MIMO	0289M	58.5	91.3	0.124	-	1.330	1.095	-	-
5610	122	802.11ac	OFDM	80	14.0	13.93	14.0	13.86	0.18	Right	Cheek	MIMO	0289M	58.5	91.3	0.115	-	1.033	1.095	-	-
5610	122	802.11ac	OFDM	80	14.0	13.93	14.0	13.86	0.10	Right	Tilt	MIMO	0289M	58.5	91.3	0.048	-	1.033	1.095	-	-
5610	122	802.11ac	OFDM	80	14.0	13.93	14.0	13.86	-0.11	Left	Cheek	MIMO	0289M	58.5	91.3	0.187	0.056	1.033	1.095	0.063	-
5610	122	802.11ac	OFDM	80	14.0	13.93	14.0	13.86	0.09	Left	Tilt	MIMO	0289M	58.5	91.3	0.043	-	1.033	1.095	-	-
5775	155	802.11ac	OFDM	80	14.0	13.05	14.0	13.82	-0.04	Right	Cheek	MIMO	0289M	58.5	91.3	0.163	-	1.245	1.095	-	-
5775	155	802.11ac	OFDM	80	14.0	13.05	14.0	13.82	0.10	Right	Tilt	MIMO	0289M	58.5	91.3	0.051	-	1.245	1.095	-	-
5775	155	802.11ac	OFDM	80	14.0	13.05	14.0	13.82	0.16	Left	Cheek	MIMO	0289M	58.5	91.3	0.198	0.057	1.245	1.095	0.078	-
5775	155	802.11ac	OFDM	80	14.0	13.05	14.0	13.82	0.10	Left	Tilt	MIMO	0289M	58.5	91.3	0.033	-	1.245	1.095	-	-
ANSI / IEEE C95.1 1992 - SAFETY LIMIT Spatial Peak Uncontrolled Exposure/General Population															Head 1.6 W/kg (mW/g) averaged over 1 gram						

Note: To achieve the 17.0 dBm maximum allowed MIMO power shown in the documentation, each antenna transmits at a maximum allowed power of 14.0 dBm.



**Table 11-11  
DSS Head SAR**

MEASUREMENT RESULTS																	
FREQUENCY		Mode	Service	Maximum Allowed Power [dBm]	Conducted Power [dBm]	Power Drift [dB]	Side	Test Position	Antenna Config.	Device Serial Number	Data Rate (Mbps)	Duty Cycle (%)	SAR (1g) [W/kg]	Scaling Factor (Cond Power)	Scaling Factor (Duty Cycle)	Reported SAR (1g) [W/kg]	Plot #
MHz	Ch.																
2402.00	0	Bluetooth	FHSS	14.0	13.38	0.12	Right	Cheek	1	0023M	1	77.1	0.004	1.154	1.297	0.006	-
2402.00	0	Bluetooth	FHSS	14.0	13.38	-0.13	Right	Tilt	1	0023M	1	77.1	0.007	1.154	1.297	0.010	-
2402.00	0	Bluetooth	FHSS	14.0	13.38	0.06	Left	Cheek	1	0023M	1	77.1	0.003	1.154	1.297	0.004	-
2402.00	0	Bluetooth	FHSS	14.0	13.38	0.19	Left	Tilt	1	0023M	1	77.1	0.006	1.154	1.297	0.009	-
2441.00	39	Bluetooth	FHSS	14.0	12.90	-0.02	Right	Cheek	2	0023M	1	77.1	0.058	1.290	1.297	0.097	-
2441.00	39	Bluetooth	FHSS	14.0	12.90	0.09	Right	Tilt	2	0023M	1	77.1	0.012	1.290	1.297	0.020	-
2441.00	39	Bluetooth	FHSS	14.0	12.90	0.14	Left	Cheek	2	0023M	1	77.1	0.086	1.290	1.297	0.144	A11
2441.00	39	Bluetooth	FHSS	14.0	12.90	0.08	Left	Tilt	2	0023M	1	77.1	0.007	1.290	1.297	0.012	-
ANSI / IEEE C95.1 1992 - SAFETY LIMIT Spatial Peak Uncontrolled Exposure/General Population												Head 1.6 W/kg (mW/g) averaged over 1 gram					

## 11.2 Standalone Body-Worn SAR Data

**Table 11-12  
GSM/UMTS Body-Worn SAR Data**

MEASUREMENT RESULTS														
FREQUENCY		Mode	Service	Maximum Allowed Power [dBm]	Conducted Power [dBm]	Power Drift [dB]	Spacing	Device Serial Number	Duty Cycle	Side	SAR (1g) [W/kg]	Scaling Factor	Reported SAR (1g) [W/kg]	Plot #
MHz	Ch.													
836.60	190	GSM850	GSM	33.5	33.29	-0.02	15 mm	0532M	1:8.3	back	0.168	1.050	0.176	A12
1880.00	661	GSM 1900	GSM	30.0	29.64	-0.11	15 mm	0521M	1:8.3	back	0.257	1.086	0.279	A14
836.60	4183	UMTS 850	RMC	25.5	24.51	0.00	15 mm	0482M	1:1	back	0.190	1.256	0.239	A16
ANSI / IEEE C95.1 1992 - SAFETY LIMIT Spatial Peak Uncontrolled Exposure/General Population										Body 1.6 W/kg (mW/g) averaged over 1 gram				

FCC ID: A3LSMG998JPN	 PCTEST Proud to be part of Element	SAR EVALUATION REPORT		Approved by: Quality Manager
Document S/N: 1M2101110003-01.A3L	Test Dates: 01/17/21 - 01/25/21	DUT Type: Portable Handset	Page 49 of 71	

**Table 11-13  
LTE Body-Worn SAR**

MEASUREMENT RESULTS																			
FREQUENCY		Mode	Service	Bandwidth [MHz]	Maximum Allowed Power [dBm]	Conducted Power [dBm]	Power Drift [dB]	MPR [dB]	Device Serial Number	Modulation	RB Size	RB Offset	Spacing	Side	Duty Cycle	SAR (1g)	Scaling Factor	Reported SAR (1g)	Plot #
MHz	Ch.															(W/kg)		(W/kg)	
707.50	23095	Mid	LTE Band 12	10	24.0	23.30	0.00	0	0470M	QPSK	1	0	15 mm	back	1:1	0.105	1.175	0.123	A18
707.50	23095	Mid	LTE Band 12	10	23.0	22.28	0.00	1	0470M	QPSK	25	12	15 mm	back	1:1	0.083	1.180	0.098	
782.00	23230	Mid	LTE Band 13	10	24.0	22.96	0.08	0	0470M	QPSK	1	49	15 mm	back	1:1	0.144	1.271	0.183	A20
782.00	23230	Mid	LTE Band 13	10	23.0	22.13	0.00	1	0470M	QPSK	25	12	15 mm	back	1:1	0.122	1.222	0.149	
836.50	20525	Mid	LTE Band 5 (Cell)	10	25.8	25.46	0.03	0	0532M	QPSK	1	0	15 mm	back	1:1	0.232	1.081	0.251	A22
836.50	20525	Mid	LTE Band 5 (Cell)	10	24.8	24.27	0.03	1	0532M	QPSK	25	0	15 mm	back	1:1	0.197	1.130	0.223	
1732.50	20175	Mid	LTE Band 4 (AWS)	20	24.0	23.30	0.01	0	0532M	QPSK	1	50	15 mm	back	1:1	0.499	1.175	0.586	A24
1732.50	20175	Mid	LTE Band 4 (AWS)	20	23.0	22.48	0.00	1	0532M	QPSK	50	25	15 mm	back	1:1	0.395	1.127	0.445	
2593.00	40620	Mid	LTE Band 41	20	25.0	24.48	0.03	0	0466M	QPSK	1	50	15 mm	back	1:1.58	0.301	1.127	0.339	A26
2593.00	40620	Mid	LTE Band 41	20	24.0	23.42	0.02	1	0466M	QPSK	50	25	15 mm	back	1:1.58	0.242	1.143	0.277	
ANSI / IEEE C95.1 1992 - SAFETY LIMIT Spatial Peak Uncontrolled Exposure/General Population										Body 1.6 W/kg (mW/g) averaged over 1 gram									

**Table 11-14  
DTS SISO Body-Worn SAR**

MEASUREMENT RESULTS																			
FREQUENCY		Mode	Service	Bandwidth [MHz]	Maximum Allowed Power [dBm]	Conducted Power [dBm]	Power Drift [dB]	Spacing	Antenna Config.	Device Serial Number	Data Rate (Mbps)	Side	Duty Cycle (%)	Peak SAR of Area Scan	SAR (1g)	Scaling Factor (Power)	Scaling Factor (Duty Cycle)	Reported SAR (1g)	Plot #
MHz	Ch.													(W/kg)	(W/kg)			(W/kg)	
2437	6	802.11b	DSSS	22	19.0	18.99	0.02	15 mm	1	0289M	1	back	98.9	0.104	0.080	1.002	1.011	0.081	A28
2437	6	802.11b	DSSS	22	19.0	18.95	0.02	15 mm	2	0289M	1	back	98.9	0.049	0.033	1.012	1.011	0.034	
ANSI / IEEE C95.1 1992 - SAFETY LIMIT Spatial Peak Uncontrolled Exposure/General Population										Body 1.6 W/kg (mW/g) averaged over 1 gram									



**Table 11-15  
NII MIMO Body-Worn SAR**

MEASUREMENT RESULTS																					
FREQUENCY		Mode	Service	Bandwidth [MHz]	Maximum Allowed Power (Ant 1) [dBm]	Conducted Power (Ant 1) [dBm]	Maximum Allowed Power (Ant 2) [dBm]	Conducted Power (Ant 2) [dBm]	Power Drift [dB]	Spacing	Antenna Config.	Device Serial Number	Data Rate (Mbps)	Side	Duty Cycle (%)	Peak SAR of Area Scan	SAR (1g)	Scaling Factor (Power)	Scaling Factor (Duty Cycle)	Reported SAR (1g)	Plot #
MHz	Ch.															(W/kg)	(W/kg)			(W/kg)	
5260	52	802.11n	OFDM	20	17.5	16.37	17.5	16.92	-0.03	15 mm	MIMO	0023M	13	back	98.9	0.842	0.432	1.297	1.011	0.566	
5300	60	802.11n	OFDM	20	17.5	16.36	17.5	17.09	-0.04	15 mm	MIMO	0023M	13	back	98.9	1.013	0.532	1.300	1.011	0.699	
5320	64	802.11n	OFDM	20	17.5	16.31	17.5	17.11	0.03	15 mm	MIMO	0023M	13	back	98.9	0.875	0.443	1.315	1.011	0.589	
5500	100	802.11n	OFDM	20	17.5	16.68	17.5	17.19	-0.12	15 mm	MIMO	0023M	13	back	98.9	1.011	0.429	1.208	1.011	0.524	
5785	157	802.11n	OFDM	20	17.5	17.21	17.5	17.46	0.03	15 mm	MIMO	0023M	13	back	98.9	1.189	0.534	1.069	1.011	0.577	A30
ANSI / IEEE C95.1 1992 - SAFETY LIMIT Spatial Peak Uncontrolled Exposure/General Population										Body 1.6 W/kg (mW/g) averaged over 1 gram											

Note: To achieve the 20.5 dBm maximum allowed MIMO power shown in the documentation, each antenna transmits at a maximum allowed power of 17.5 dBm.

**Table 11-16  
DSS Body-Worn SAR**

MEASUREMENT RESULTS																		
FREQUENCY		Mode	Service	Maximum Allowed Power [dBm]	Conducted Power [dBm]	Power Drift [dB]	Spacing	Antenna Config.	Device Serial Number	Data Rate (Mbps)	Side	Duty Cycle (%)	SAR (1g)	Scaling Factor (Cond Power)	Scaling Factor (Duty Cycle)	Reported SAR (1g)	Plot #	
MHz	Ch.												(W/kg)			(W/kg)		
2441	39	Bluetooth	FHSS	17.0	16.29	0.15	15 mm	1	0289M	1	back	77.1	0.047	1.177	1.297	0.072	A32	
2441	39	Bluetooth	FHSS	17.0	16.76	0.03	15 mm	2	0289M	1	back	77.1	0.030	1.056	1.297	0.041		
ANSI / IEEE C95.1 1992 - SAFETY LIMIT Spatial Peak Uncontrolled Exposure/General Population										Body 1.6 W/kg (mW/g) averaged over 1 gram								

FCC ID: A3LSMG998JPN	 PCTEST Proud to be part of element	SAR EVALUATION REPORT		Approved by: Quality Manager
Document S/N: 1M2101110003-01.A3L	Test Dates: 01/17/21 - 01/25/21	DUT Type: Portable Handset		Page 50 of 71

## 11.3 Standalone Hotspot SAR Data

**Table 11-17  
GPRS 850 Hotspot SAR Data**



MEASUREMENT RESULTS															
FREQUENCY		Mode	Service	Maximum Allowed Power [dBm]	Conducted Power [dBm]	Power Drift [dB]	Spacing	Device Serial Number	# of Time Slots	Duty Cycle	Side	SAR (1g)	Scaling Factor	Reported SAR (1g)	Plot #
MHz	Ch.											(W/kg)		(W/kg)	
836.60	190	GSM 850	GPRS	30.0	29.56	-0.08	10 mm	0532M	3	1:2.76	back	0.363	1.107	0.402	A13
836.60	190	GSM 850	GPRS	30.0	29.56	-0.04	10 mm	0532M	3	1:2.76	front	0.241	1.107	0.267	
836.60	190	GSM 850	GPRS	30.0	29.56	-0.01	10 mm	0532M	3	1:2.76	bottom	0.220	1.107	0.244	
836.60	190	GSM 850	GPRS	30.0	29.56	-0.02	10 mm	0532M	3	1:2.76	right	0.131	1.107	0.145	
836.60	190	GSM 850	GPRS	30.0	29.56	0.02	10 mm	0532M	3	1:2.76	left	0.034	1.107	0.038	
ANSI / IEEE C95.1 1992 - SAFETY LIMIT Spatial Peak Uncontrolled Exposure/General Population							Body 1.6 W/kg (mW/g) averaged over 1 gram								

**Table 11-18  
GPRS 1900 Hotspot SAR Data**

MEASUREMENT RESULTS															
FREQUENCY		Mode	Service	Maximum Allowed Power [dBm]	Conducted Power [dBm]	Power Drift [dB]	Spacing	Device Serial Number	# of Time Slots	Duty Cycle	Side	SAR (1g)	Scaling Factor	Reported SAR (1g)	Plot #
MHz	Ch.											(W/kg)		(W/kg)	
1880.00	661	GSM 1900	GPRS	22.0	20.89	-0.04	10 mm	0521M	4	1:2.076	back	0.253	1.291	0.327	
1880.00	661	GSM 1900	GPRS	22.0	20.89	-0.05	10 mm	0521M	4	1:2.076	front	0.217	1.291	0.280	
1850.20	512	GSM 1900	GPRS	22.0	21.27	-0.09	10 mm	0521M	4	1:2.076	bottom	0.536	1.183	0.634	
1880.00	661	GSM 1900	GPRS	22.0	20.89	-0.06	10 mm	0521M	4	1:2.076	bottom	0.630	1.291	0.813	
1909.80	810	GSM 1900	GPRS	22.0	21.28	-0.04	10 mm	0521M	4	1:2.076	bottom	0.766	1.180	0.904	A15
1880.00	661	GSM 1900	GPRS	22.0	20.89	0.04	10 mm	0521M	4	1:2.076	right	0.047	1.291	0.061	
1880.00	661	GSM 1900	GPRS	22.0	20.89	0.02	10 mm	0521M	4	1:2.076	left	0.040	1.291	0.052	
ANSI / IEEE C95.1 1992 - SAFETY LIMIT Spatial Peak Uncontrolled Exposure/General Population							Body 1.6 W/kg (mW/g) averaged over 1 gram								

**Table 11-19  
UMTS Hotspot SAR Data**

MEASUREMENT RESULTS														
FREQUENCY		Mode	Service	Maximum Allowed Power [dBm]	Conducted Power [dBm]	Power Drift [dB]	Spacing	Device Serial Number	Duty Cycle	Side	SAR (1g)	Scaling Factor	Reported SAR (1g)	Plot #
MHz	Ch.										(W/kg)		(W/kg)	
836.60	4183	UMTS 850	RMC	25.5	24.51	-0.03	10 mm	0482M	1:1	back	0.424	1.256	0.533	A17
836.60	4183	UMTS 850	RMC	25.5	24.51	-0.07	10 mm	0482M	1:1	front	0.227	1.256	0.285	
836.60	4183	UMTS 850	RMC	25.5	24.51	-0.04	10 mm	0482M	1:1	bottom	0.243	1.256	0.305	
836.60	4183	UMTS 850	RMC	25.5	24.51	0.00	10 mm	0482M	1:1	right	0.146	1.256	0.183	
836.60	4183	UMTS 850	RMC	25.5	24.51	0.04	10 mm	0482M	1:1	left	0.045	1.256	0.057	
ANSI / IEEE C95.1 1992 - SAFETY LIMIT Spatial Peak Uncontrolled Exposure/General Population							Body 1.6 W/kg (mW/g) averaged over 1 gram							

FCC ID: A3LSMG998JPN	 PCTEST Proud to be part of element	SAR EVALUATION REPORT		Approved by: Quality Manager
Document S/N: 1M2101110003-01.A3L	Test Dates: 01/17/21 - 01/25/21	DUT Type: Portable Handset	Page 51 of 71	

**Table 11-20  
LTE Band 12 Hotspot SAR**



MEASUREMENT RESULTS																			
FREQUENCY		Mode	Bandwidth [MHz]	Maximum Allowed Power [dBm]	Conducted Power [dBm]	Power Drift [dB]	MPR [dB]	Device Serial Number	Modulation	RB Size	RB Offset	Spacing	Side	Duty Cycle	SAR (1g)	Scaling Factor	Reported SAR (1g)	Plot #	
MHz	Ch.														(W/kg)		(W/kg)		
707.50	23095	Mid	LTE Band 12	10	24.0	23.30	-0.04	0	0470M	QPSK	1	0	10 mm	back	1:1	0.200	1.175	0.235	A19
707.50	23095	Mid	LTE Band 12	10	23.0	22.28	-0.04	1	0470M	QPSK	25	12	10 mm	back	1:1	0.166	1.180	0.196	
707.50	23095	Mid	LTE Band 12	10	24.0	23.30	0.01	0	0470M	QPSK	1	0	10 mm	front	1:1	0.102	1.175	0.120	
707.50	23095	Mid	LTE Band 12	10	23.0	22.28	0.03	1	0470M	QPSK	25	12	10 mm	front	1:1	0.086	1.180	0.101	
707.50	23095	Mid	LTE Band 12	10	24.0	23.30	0.03	0	0470M	QPSK	1	0	10 mm	bottom	1:1	0.106	1.175	0.125	
707.50	23095	Mid	LTE Band 12	10	23.0	22.28	0.04	1	0470M	QPSK	25	12	10 mm	bottom	1:1	0.087	1.180	0.103	
707.50	23095	Mid	LTE Band 12	10	24.0	23.30	0.04	0	0470M	QPSK	1	0	10 mm	right	1:1	0.150	1.175	0.176	
707.50	23095	Mid	LTE Band 12	10	23.0	22.28	0.07	1	0470M	QPSK	25	12	10 mm	right	1:1	0.124	1.180	0.146	
707.50	23095	Mid	LTE Band 12	10	24.0	23.30	0.12	0	0470M	QPSK	1	0	10 mm	left	1:1	0.082	1.175	0.096	
707.50	23095	Mid	LTE Band 12	10	23.0	22.28	0.01	1	0470M	QPSK	25	12	10 mm	left	1:1	0.058	1.180	0.068	
ANSI / IEEE C95.1 1992 - SAFETY LIMIT Spatial Peak Uncontrolled Exposure/General Population										Body 1.6 W/kg (mW/g) averaged over 1 gram									

**Table 11-21  
LTE Band 13 Hotspot SAR**

MEASUREMENT RESULTS																			
FREQUENCY		Mode	Bandwidth [MHz]	Maximum Allowed Power [dBm]	Conducted Power [dBm]	Power Drift [dB]	MPR [dB]	Device Serial Number	Modulation	RB Size	RB Offset	Spacing	Side	Duty Cycle	SAR (1g)	Scaling Factor	Reported SAR (1g)	Plot #	
MHz	Ch.														(W/kg)		(W/kg)		
782.00	23230	Mid	LTE Band 13	10	24.0	22.96	-0.01	0	0470M	QPSK	1	49	10 mm	back	1:1	0.243	1.271	0.309	A21
782.00	23230	Mid	LTE Band 13	10	23.0	22.13	-0.01	1	0470M	QPSK	25	12	10 mm	back	1:1	0.205	1.222	0.251	
782.00	23230	Mid	LTE Band 13	10	24.0	22.96	-0.05	0	0470M	QPSK	1	49	10 mm	front	1:1	0.166	1.271	0.211	
782.00	23230	Mid	LTE Band 13	10	23.0	22.13	0.00	1	0470M	QPSK	25	12	10 mm	front	1:1	0.141	1.222	0.172	
782.00	23230	Mid	LTE Band 13	10	24.0	22.96	-0.06	0	0470M	QPSK	1	49	10 mm	bottom	1:1	0.150	1.271	0.191	
782.00	23230	Mid	LTE Band 13	10	23.0	22.13	-0.02	1	0470M	QPSK	25	12	10 mm	bottom	1:1	0.129	1.222	0.158	
782.00	23230	Mid	LTE Band 13	10	24.0	22.96	-0.03	0	0470M	QPSK	1	49	10 mm	right	1:1	0.126	1.271	0.160	
782.00	23230	Mid	LTE Band 13	10	23.0	22.13	0.02	1	0470M	QPSK	25	12	10 mm	right	1:1	0.118	1.222	0.144	
782.00	23230	Mid	LTE Band 13	10	24.0	22.96	0.12	0	0470M	QPSK	1	49	10 mm	left	1:1	0.040	1.271	0.051	
782.00	23230	Mid	LTE Band 13	10	23.0	22.13	-0.10	1	0470M	QPSK	25	12	10 mm	left	1:1	0.033	1.222	0.040	
ANSI / IEEE C95.1 1992 - SAFETY LIMIT Spatial Peak Uncontrolled Exposure/General Population										Body 1.6 W/kg (mW/g) averaged over 1 gram									

**Table 11-22  
LTE Band 5 (Cell) Hotspot SAR**

MEASUREMENT RESULTS																			
FREQUENCY		Mode	Bandwidth [MHz]	Maximum Allowed Power [dBm]	Conducted Power [dBm]	Power Drift [dB]	MPR [dB]	Device Serial Number	Modulation	RB Size	RB Offset	Spacing	Side	Duty Cycle	SAR (1g)	Scaling Factor	Reported SAR (1g)	Plot #	
MHz	Ch.														(W/kg)		(W/kg)		
836.50	20525	Mid	LTE Band 5 (Cell)	10	25.8	25.46	-0.01	0	0532M	QPSK	1	0	10 mm	back	1:1	0.498	1.081	0.538	A23
836.50	20525	Mid	LTE Band 5 (Cell)	10	24.8	24.27	-0.01	1	0532M	QPSK	25	0	10 mm	back	1:1	0.419	1.130	0.473	
836.50	20525	Mid	LTE Band 5 (Cell)	10	25.8	25.46	0.02	0	0532M	QPSK	1	0	10 mm	front	1:1	0.333	1.081	0.360	
836.50	20525	Mid	LTE Band 5 (Cell)	10	24.8	24.27	0.06	1	0532M	QPSK	25	0	10 mm	front	1:1	0.275	1.130	0.311	
836.50	20525	Mid	LTE Band 5 (Cell)	10	25.8	25.46	-0.07	0	0532M	QPSK	1	0	10 mm	bottom	1:1	0.312	1.081	0.337	
836.50	20525	Mid	LTE Band 5 (Cell)	10	24.8	24.27	-0.05	1	0532M	QPSK	25	0	10 mm	bottom	1:1	0.261	1.130	0.295	
836.50	20525	Mid	LTE Band 5 (Cell)	10	25.8	25.46	-0.01	0	0532M	QPSK	1	0	10 mm	right	1:1	0.195	1.081	0.211	
836.50	20525	Mid	LTE Band 5 (Cell)	10	24.8	24.27	-0.01	1	0532M	QPSK	25	0	10 mm	right	1:1	0.163	1.130	0.184	
836.50	20525	Mid	LTE Band 5 (Cell)	10	25.8	25.46	0.07	0	0532M	QPSK	1	0	10 mm	left	1:1	0.056	1.081	0.061	
836.50	20525	Mid	LTE Band 5 (Cell)	10	24.8	24.27	-0.02	1	0532M	QPSK	25	0	10 mm	left	1:1	0.047	1.130	0.053	
ANSI / IEEE C95.1 1992 - SAFETY LIMIT Spatial Peak Uncontrolled Exposure/General Population										Body 1.6 W/kg (mW/g) averaged over 1 gram									

FCC ID: A3LSMG998JPN	 PCTEST Proud to be part of Element	SAR EVALUATION REPORT		Approved by: Quality Manager
Document S/N: 1M2101110003-01.A3L	Test Dates: 01/17/21 - 01/25/21	DUT Type: Portable Handset	Page 52 of 71	

**Table 11-23  
LTE Band 4 (AWS) Hotspot SAR**



MEASUREMENT RESULTS																			
FREQUENCY		Mode	Bandwidth [MHz]	Maximum Allowed Power [dBm]	Conducted Power [dBm]	Power Drift [dB]	MPR [dB]	Device Serial Number	Modulation	RB Size	RB Offset	Spacing	Side	Duty Cycle	SAR (1g)	Scaling Factor	Reported SAR (1g)	Plot #	
MHz	Ch.														(W/kg)		(W/kg)		
1732.50	20175	Mid	LTE Band 4 (AWS)	20	19.5	18.69	0.00	0	0532M	QPSK	1	50	10 mm	back	1:1	0.330	1.205	0.398	
1732.50	20175	Mid	LTE Band 4 (AWS)	20	19.5	18.77	0.04	0	0532M	QPSK	50	25	10 mm	back	1:1	0.338	1.183	0.400	
1732.50	20175	Mid	LTE Band 4 (AWS)	20	19.5	18.69	0.01	0	0532M	QPSK	1	50	10 mm	front	1:1	0.303	1.205	0.365	
1732.50	20175	Mid	LTE Band 4 (AWS)	20	19.5	18.77	0.02	0	0532M	QPSK	50	25	10 mm	front	1:1	0.311	1.183	0.368	
1732.50	20175	Mid	LTE Band 4 (AWS)	20	19.5	18.69	0.03	0	0532M	QPSK	1	50	10 mm	bottom	1:1	0.637	1.205	0.768	
1732.50	20175	Mid	LTE Band 4 (AWS)	20	19.5	18.77	-0.01	0	0532M	QPSK	50	25	10 mm	bottom	1:1	0.640	1.183	0.757	A25
1732.50	20175	Mid	LTE Band 4 (AWS)	20	19.5	18.69	0.16	0	0532M	QPSK	1	50	10 mm	right	1:1	0.047	1.205	0.057	
1732.50	20175	Mid	LTE Band 4 (AWS)	20	19.5	18.77	0.09	0	0532M	QPSK	50	25	10 mm	right	1:1	0.047	1.183	0.056	
1732.50	20175	Mid	LTE Band 4 (AWS)	20	19.5	18.69	0.13	0	0532M	QPSK	1	50	10 mm	left	1:1	0.066	1.205	0.080	
1732.50	20175	Mid	LTE Band 4 (AWS)	20	19.5	18.77	0.10	0	0532M	QPSK	50	25	10 mm	left	1:1	0.067	1.183	0.079	
ANSI / IEEE C95.1 1992 - SAFETY LIMIT Spatial Peak Uncontrolled Exposure/General Population										Body 1.6 W/kg (mW/g) averaged over 1 gram									

**Table 11-24  
LTE Band 41 Hotspot SAR**

MEASUREMENT RESULTS																			
FREQUENCY		Mode	Bandwidth [MHz]	Maximum Allowed Power [dBm]	Conducted Power [dBm]	Power Drift [dB]	MPR [dB]	Device Serial Number	Modulation	RB Size	RB Offset	Spacing	Side	Duty Cycle	SAR (1g)	Scaling Factor	Reported SAR (1g)	Plot #	
MHz	Ch.														(W/kg)		(W/kg)		
2636.50	41055	Mid-High	LTE Band 41	20	22.0	21.37	-0.06	0	0466M	QPSK	1	50	10 mm	back	1:1.58	0.363	1.156	0.420	
2636.50	41055	Mid-High	LTE Band 41	20	22.0	21.46	-0.05	0	0466M	QPSK	50	25	10 mm	back	1:1.58	0.366	1.132	0.414	
2636.50	41055	Mid-High	LTE Band 41	20	22.0	21.37	-0.04	0	0466M	QPSK	1	50	10 mm	front	1:1.58	0.333	1.156	0.385	
2636.50	41055	Mid-High	LTE Band 41	20	22.0	21.46	0.00	0	0466M	QPSK	50	25	10 mm	front	1:1.58	0.340	1.132	0.385	
2636.50	41055	Mid-High	LTE Band 41	20	22.0	21.37	-0.01	0	0466M	QPSK	1	50	10 mm	bottom	1:1.58	0.367	1.156	0.424	
2636.50	41055	Mid-High	LTE Band 41	20	22.0	21.46	-0.03	0	0466M	QPSK	50	25	10 mm	bottom	1:1.58	0.378	1.132	0.428	A27
2636.50	41055	Mid-High	LTE Band 41	20	22.0	21.37	0.00	0	0466M	QPSK	1	50	10 mm	left	1:1.58	0.159	1.156	0.184	
2636.50	41055	Mid-High	LTE Band 41	20	22.0	21.46	-0.03	0	0466M	QPSK	50	25	10 mm	left	1:1.58	0.163	1.132	0.185	
ANSI / IEEE C95.1 1992 - SAFETY LIMIT Spatial Peak Uncontrolled Exposure/General Population										Body 1.6 W/kg (mW/g) averaged over 1 gram									

**Table 11-25  
DTS SISO WLAN Hotspot SAR**

MEASUREMENT RESULTS																			
FREQUENCY		Mode	Service	Bandwidth [MHz]	Maximum Allowed Power [dBm]	Conducted Power [dBm]	Power Drift [dB]	Spacing	Antenna Config.	Device Serial Number	Data Rate (Mbps)	Side	Duty Cycle (%)	Peak SAR of Area Scan (W/kg)	SAR (1g)	Scaling Factor (Power)	Scaling Factor (Duty Cycle)	Reported SAR (1g)	Plot #
MHz	Ch.														(W/kg)			(W/kg)	
2437	6	802.11b	DSSS	22	19.0	18.99	0.05	10 mm	1	0289M	1	back	98.9	0.268	0.200	1.002	1.011	0.203	A29
2437	6	802.11b	DSSS	22	19.0	18.99	0.08	10 mm	1	0289M	1	front	98.9	0.009	-	1.002	1.011	-	
2437	6	802.11b	DSSS	22	19.0	18.99	0.13	10 mm	1	0289M	1	top	98.9	0.036	-	1.002	1.011	-	
2437	6	802.11b	DSSS	22	19.0	18.99	0.04	10 mm	1	0289M	1	left	98.9	0.036	-	1.002	1.011	-	
2437	6	802.11b	DSSS	22	19.0	18.95	0.14	10 mm	2	0289M	1	back	98.9	0.124	0.076	1.012	1.011	0.078	
2437	6	802.11b	DSSS	22	19.0	18.95	0.08	10 mm	2	0289M	1	front	98.9	0.125	-	1.012	1.011	-	
2437	6	802.11b	DSSS	22	19.0	18.95	0.07	10 mm	2	0289M	1	left	98.9	0.292	0.167	1.012	1.011	0.171	
ANSI / IEEE C95.1 1992 - SAFETY LIMIT Spatial Peak Uncontrolled Exposure/General Population										Body 1.6 W/kg (mW/g) averaged over 1 gram									

FCC ID: A3LSMG998JPN	 PCTEST Proud to be part of Element	SAR EVALUATION REPORT		Approved by: Quality Manager
Document S/N: 1M2101110003-01.A3L	Test Dates: 01/17/21 - 01/25/21	DUT Type: Portable Handset	Page 53 of 71	

**Table 11-26  
NII MIMO WLAN Hotspot SAR**

MEASUREMENT RESULTS																					
FREQUENCY		Mode	Service	Bandwidth [MHz]	Maximum Allowed Power (Ant 1) [dBm]	Conducted Power (Ant 1) [dBm]	Maximum Allowed Power (Ant 2) [dBm]	Conducted Power (Ant 2) [dBm]	Power Drift [dB]	Spacing	Antenna Config.	Device Serial Number	Data Rate (Mbps)	Side	Duty Cycle (%)	Peak SAR of Area Scan [W/kg]	SAR (1g) (W/kg)	Scaling Factor (Power)	Scaling Factor (Duty Cycle)	Reported SAR (1g) (W/kg)	Plot #
MHz	Ch.																				
5745	149	802.11n	OFDM	20	17.5	17.03	17.5	17.48	0.06	10 mm	MIMO	0023M	13	back	98.9	1.604	0.728	1.114	1.011	0.820	
5785	157	802.11n	OFDM	20	17.5	17.21	17.5	17.46	0.10	10 mm	MIMO	0023M	13	back	98.9	1.901	0.798	1.069	1.011	0.862	A31
5825	165	802.11n	OFDM	20	17.5	17.04	17.5	17.50	0.03	10 mm	MIMO	0023M	13	back	98.9	1.871	0.773	1.112	1.011	0.869	
5785	157	802.11n	OFDM	20	17.5	17.21	17.5	17.46	0.03	10 mm	MIMO	0023M	13	front	98.9	0.147	-	1.069	1.011	-	
5785	157	802.11n	OFDM	20	17.5	17.21	17.5	17.46	0.05	10 mm	MIMO	0023M	13	top	98.9	0.264	-	1.069	1.011	-	
5785	157	802.11n	OFDM	20	17.5	17.21	17.5	17.46	0.13	10 mm	MIMO	0023M	13	left	98.9	0.487	0.201	1.069	1.011	0.217	
ANSI / IEEE C95.1 1992 - SAFETY LIMIT											Body										
Spatial Peak											1.6 W/kg (mW/g)										
Uncontrolled Exposure/General Population											averaged over 1 gram										

Note: To achieve the 20.5 dBm maximum allowed MIMO power shown in the documentation, each antenna transmits at a maximum allowed power of 17.5 dBm

**Table 11-27  
NII MIMO Hotspot SAR for Conditions with DTS WLAN SAR**

MEASUREMENT RESULTS																					
FREQUENCY		Mode	Service	Bandwidth [MHz]	Maximum Allowed Power (Ant 1) [dBm]	Conducted Power (Ant 1) [dBm]	Maximum Allowed Power (Ant 2) [dBm]	Conducted Power (Ant 2) [dBm]	Power Drift [dB]	Spacing	Antenna Config.	Device Serial Number	Data Rate (Mbps)	Side	Duty Cycle (%)	Peak SAR of Area Scan [W/kg]	SAR (1g) (W/kg)	Scaling Factor (Power)	Scaling Factor (Duty Cycle)	Reported SAR (1g) (W/kg)	Plot #
MHz	Ch.																				
5775	155	802.11ac	OFDM	80	14.0	13.05	14.0	13.82	0.19	10 mm	MIMO	0023M	58.5	back	91.3	0.778	0.314	1.245	1.095	0.428	
5775	155	802.11ac	OFDM	80	14.0	13.05	14.0	13.82	0.07	10 mm	MIMO	0023M	58.5	front	91.3	0.056	-	1.245	1.095	-	
5775	155	802.11ac	OFDM	80	14.0	13.05	14.0	13.82	0.08	10 mm	MIMO	0023M	58.5	top	91.3	0.114	-	1.245	1.095	-	
5775	155	802.11ac	OFDM	80	14.0	13.05	14.0	13.82	0.03	10 mm	MIMO	0023M	58.5	left	91.3	0.150	0.074	1.245	1.095	0.101	
ANSI / IEEE C95.1 1992 - SAFETY LIMIT											Body										
Spatial Peak											1.6 W/kg (mW/g)										
Uncontrolled Exposure/General Population											averaged over 1 gram										

Note: 5 GHz MIMO was additionally evaluated at the maximum allowed output power during operations with Simultaneous 2.4 GHz and 5 GHz WLAN. 2.4 GHz WIFI was not transmitting during the above evaluations.



**Table 11-28  
DSS SISO Hotspot SAR**

MEASUREMENT RESULTS																		
FREQUENCY		Mode	Service	Maximum Allowed Power [dBm]	Conducted Power [dBm]	Power Drift [dB]	Spacing	Antenna Config.	Device Serial Number	Data Rate (Mbps)	Side	Duty Cycle (%)	SAR (1g) (W/kg)	Scaling Factor (Cond Power)	Scaling Factor (Duty Cycle)	Reported SAR (1g) (W/kg)	Plot #	
MHz	Ch.																	
2441	39	Bluetooth	FHSS	17.0	16.29	0.07	10 mm	1	0289M	1	back	77.1	0.122	1.177	1.297	0.186		
2441	39	Bluetooth	FHSS	17.0	16.29	0.07	10 mm	1	0289M	1	front	77.1	0.003	1.177	1.297	0.005		
2441	39	Bluetooth	FHSS	17.0	16.29	0.13	10 mm	1	0289M	1	top	77.1	0.009	1.177	1.297	0.014		
2441	39	Bluetooth	FHSS	17.0	16.29	0.15	10 mm	1	0289M	1	left	77.1	0.015	1.177	1.297	0.023		
2441	39	Bluetooth	FHSS	17.0	16.76	0.16	10 mm	2	0289M	1	back	77.1	0.060	1.056	1.297	0.082		
2441	39	Bluetooth	FHSS	17.0	16.76	0.11	10 mm	2	0289M	1	front	77.1	0.054	1.056	1.297	0.074		
2441	39	Bluetooth	FHSS	17.0	16.76	-0.03	10 mm	2	0289M	1	left	77.1	0.124	1.056	1.297	0.170	A33	
ANSI / IEEE C95.1 1992 - SAFETY LIMIT											Body							
Spatial Peak											1.6 W/kg (mW/g)							
Uncontrolled Exposure/General Population											averaged over 1 gram							

**Table 11-29  
DSS MIMO Hotspot SAR**

MEASUREMENT RESULTS																				
FREQUENCY		Mode	Service	Maximum Allowed Power (Ant 1) [dBm]	Conducted Power (Ant 1) [dBm]	Maximum Allowed Power (Ant 2) [dBm]	Conducted Power (Ant 2) [dBm]	Power Drift [dB]	Spacing	Antenna Config.	Device Serial Number	Data Rate (Mbps)	Side	Duty Cycle (%)	SAR (1g) (W/kg)	Scaling Factor (Cond Power)	Scaling Factor (Duty Cycle)	Reported SAR (1g) (W/kg)	Plot #	
MHz	Ch.																			
2441	39	Bluetooth	FHSS	16.0	15.87	13.6	12.15	0.03	10 mm	MIMO	0289M	2	back	76.8	0.043	1.397	1.302	0.078		
2441	39	Bluetooth	FHSS	16.0	15.87	13.6	12.15	-0.02	10 mm	MIMO	0289M	2	front	76.8	0.027	1.397	1.302	0.049		
2441	39	Bluetooth	FHSS	16.0	15.87	13.6	12.15	0.10	10 mm	MIMO	0289M	2	top	76.8	0.007	1.397	1.302	0.013		
2441	39	Bluetooth	FHSS	16.0	15.87	13.6	12.15	-0.05	10 mm	MIMO	0289M	2	left	76.8	0.046	1.397	1.302	0.084		
ANSI / IEEE C95.1 1992 - SAFETY LIMIT											Body									
Spatial Peak											1.6 W/kg (mW/g)									
Uncontrolled Exposure/General Population											averaged over 1 gram									

Note: To achieve the 18.0 dBm maximum allowed MIMO power shown in the documentation, antenna 1 transmits at a maximum allowed power of 16.0 dBm and antenna 2 transmits at a maximum allowed power of 13.6 dBm.

FCC ID: A3LSMG998JPN		SAR EVALUATION REPORT		Approved by: Quality Manager
Document S/N: 1M2101110003-01.A3L	Test Dates: 01/17/21 - 01/25/21	DUT Type: Portable Handset	Page 54 of 71	

# 11.4 Standalone Phablet SAR Data



**Table 11-30  
GPRS Phablet SAR Data**

MEASUREMENT RESULTS																
FREQUENCY		Mode	Service	Maximum Allowed Power [dBm]	Conducted Power [dBm]	Power Drift [dB]	Spacing	Device Serial Number	# of Time Slots	Duty Cycle	Side	SAR (10g)	Scaling Factor	Reported SAR (10g)	Plot #	
MHz	Ch.											(W/kg)		(W/kg)		
1880.00	661	GSM 1900	GPRS	26.5	26.08	-0.07	8 mm	0521M	3	1:2.76	back	0.448	1.102	0.494		
1880.00	661	GSM 1900	GPRS	26.5	26.08	-0.04	6 mm	0521M	3	1:2.76	front	0.560	1.102	0.617		
1880.00	661	GSM 1900	GPRS	26.5	26.08	-0.10	11 mm	0521M	3	1:2.76	bottom	0.741	1.102	0.817		
1880.00	661	GSM 1900	GPRS	26.5	26.08	-0.05	0 mm	0521M	3	1:2.76	right	0.227	1.102	0.250		
1880.00	661	GSM 1900	GPRS	26.5	26.08	-0.19	0 mm	0521M	3	1:2.76	left	0.299	1.102	0.329		
1880.00	661	GSM 1900	GPRS	22.0	20.89	-0.04	0 mm	0521M	4	1:2.076	back	0.752	1.291	0.971		
1880.00	661	GSM 1900	GPRS	22.0	20.89	0.07	0 mm	0521M	4	1:2.076	front	0.804	1.291	1.038		
1880.00	661	GSM 1900	GPRS	22.0	20.89	0.07	0 mm	0521M	4	1:2.076	bottom	0.932	1.291	1.203	A34	
ANSI / IEEE C95.1 1992 - SAFETY LIMIT Spatial Peak Uncontrolled Exposure/General Population							Phablet 4.0 W/kg (mW/g) averaged over 10 grams									

**Table 11-31  
LTE Band 4 (AWS) Phablet SAR**



MEASUREMENT RESULTS																			
FREQUENCY		Mode	Bandwidth [MHz]	Maximum Allowed Power [dBm]	Conducted Power [dBm]	Power Drift [dB]	MPR [dB]	Serial Number	Modulation	RB Size	RB Offset	Spacing	Side	Duty Cycle	SAR (10g)	Scaling Factor	Reported SAR (10g)	Plot #	
MHz	Ch.														(W/kg)		(W/kg)		
1732.50	20175	Mid	LTE Band 4 (AWS)	20	24.0	23.30	-0.02	0	0532M	QPSK	1	50	8 mm	back	1:1	0.714	1.175	0.839	
1732.50	20175	Mid	LTE Band 4 (AWS)	20	23.0	22.48	-0.03	1	0532M	QPSK	50	25	8 mm	back	1:1	0.589	1.127	0.664	
1732.50	20175	Mid	LTE Band 4 (AWS)	20	24.0	23.30	0.07	0	0532M	QPSK	1	50	6 mm	front	1:1	0.938	1.175	1.102	
1732.50	20175	Mid	LTE Band 4 (AWS)	20	23.0	22.48	0.09	1	0532M	QPSK	50	25	6 mm	front	1:1	0.775	1.127	0.873	
1732.50	20175	Mid	LTE Band 4 (AWS)	20	24.0	23.30	-0.01	0	0532M	QPSK	1	50	11 mm	bottom	1:1	0.882	1.175	1.036	
1732.50	20175	Mid	LTE Band 4 (AWS)	20	23.0	22.48	-0.03	1	0532M	QPSK	50	25	11 mm	bottom	1:1	0.706	1.127	0.796	
1732.50	20175	Mid	LTE Band 4 (AWS)	20	24.0	23.30	0.00	0	0532M	QPSK	1	50	0 mm	right	1:1	0.290	1.175	0.341	
1732.50	20175	Mid	LTE Band 4 (AWS)	20	23.0	22.48	0.00	1	0532M	QPSK	50	25	0 mm	right	1:1	0.238	1.127	0.268	
1732.50	20175	Mid	LTE Band 4 (AWS)	20	24.0	23.30	-0.18	0	0532M	QPSK	1	50	0 mm	left	1:1	0.358	1.175	0.421	
1732.50	20175	Mid	LTE Band 4 (AWS)	20	23.0	22.48	-0.11	1	0532M	QPSK	50	25	0 mm	left	1:1	0.300	1.127	0.338	
1732.50	20175	Mid	LTE Band 4 (AWS)	20	19.5	18.69	0.03	0	0532M	QPSK	1	50	0 mm	back	1:1	0.985	1.205	1.187	
1732.50	20175	Mid	LTE Band 4 (AWS)	20	19.5	18.77	0.01	0	0532M	QPSK	50	25	0 mm	back	1:1	1.020	1.183	1.207	
1732.50	20175	Mid	LTE Band 4 (AWS)	20	19.5	18.69	0.02	0	0532M	QPSK	1	50	0 mm	front	1:1	0.913	1.205	1.100	
1732.50	20175	Mid	LTE Band 4 (AWS)	20	19.5	18.77	0.06	0	0532M	QPSK	50	25	0 mm	front	1:1	0.952	1.183	1.126	
1732.50	20175	Mid	LTE Band 4 (AWS)	20	19.5	18.69	-0.11	0	0532M	QPSK	1	50	0 mm	bottom	1:1	2.050	1.205	2.470	
1732.50	20175	Mid	LTE Band 4 (AWS)	20	19.5	18.77	0.00	0	0532M	QPSK	50	25	0 mm	bottom	1:1	2.100	1.183	2.484	A35
1732.50	20175	Mid	LTE Band 4 (AWS)	20	19.5	18.67	-0.05	0	0532M	QPSK	100	0	0 mm	bottom	1:1	2.090	1.211	2.531	
1732.50	20175	Mid	LTE Band 4 (AWS)	20	19.5	18.77	-0.08	0	0532M	QPSK	50	25	0 mm	bottom	1:1	2.090	1.183	2.472	
ANSI / IEEE C95.1 1992 - SAFETY LIMIT Spatial Peak Uncontrolled Exposure/General Population							Phablet 4.0 W/kg (mW/g) averaged over 10 grams												

Note: Blue entry represents variability measurement

FCC ID: A3LSMG998JPN	 PCTEST Proud to be part of Element	SAR EVALUATION REPORT		Approved by: Quality Manager
Document S/N: 1M2101110003-01.A3L	Test Dates: 01/17/21 - 01/25/21	DUT Type: Portable Handset	Page 55 of 71	

**Table 11-32  
LTE Band 41 Phablet SAR**

MEASUREMENT RESULTS																			
FREQUENCY		Mode	Bandwidth [MHz]	Maximum Allowed Power [dBm]	Conducted Power [dBm]	Power Drift [dB]	MPR [dB]	Serial Number	Modulation	RB Size	RB Offset	Spacing	Side	Duty Cycle	SAR (10g) (W/kg)	Scaling Factor	Reported SAR (10g) (W/kg)	Plot #	
MHz	Ch.																		
2593.00	40620	Mid	LTE Band 41	20	25.0	24.48	-0.03	0	0466M	QPSK	1	50	8 mm	back	1:1.58	0.440	1.127	0.496	
2593.00	40620	Mid	LTE Band 41	20	24.0	23.42	0.05	1	0466M	QPSK	50	25	8 mm	back	1:1.58	0.357	1.143	0.408	
2593.00	40620	Mid	LTE Band 41	20	25.0	24.48	0.04	0	0466M	QPSK	1	50	6 mm	front	1:1.58	0.496	1.127	0.559	
2593.00	40620	Mid	LTE Band 41	20	24.0	23.42	0.00	1	0466M	QPSK	50	25	6 mm	front	1:1.58	0.410	1.143	0.469	
2593.00	40620	Mid	LTE Band 41	20	25.0	24.48	0.02	0	0466M	QPSK	1	50	11 mm	bottom	1:1.58	0.257	1.127	0.290	
2593.00	40620	Mid	LTE Band 41	20	24.0	23.42	0.00	1	0466M	QPSK	50	25	11 mm	bottom	1:1.58	0.205	1.143	0.234	
2593.00	40620	Mid	LTE Band 41	20	25.0	24.48	-0.07	0	0466M	QPSK	1	50	0 mm	left	1:1.58	0.867	1.127	0.977	
2593.00	40620	Mid	LTE Band 41	20	24.0	23.42	-0.09	1	0466M	QPSK	50	25	0 mm	left	1:1.58	0.721	1.143	0.824	
2506.00	39750	Low	LTE Band 41	20	22.0	21.27	-0.01	0	0466M	QPSK	1	99	0 mm	back	1:1.58	1.500	1.183	1.775	
2549.50	40185	Low-Mid	LTE Band 41	20	22.0	21.31	-0.01	0	0466M	QPSK	1	0	0 mm	back	1:1.58	1.460	1.172	1.711	
2593.00	40620	Mid	LTE Band 41	20	22.0	21.29	-0.12	0	0466M	QPSK	1	50	0 mm	back	1:1.58	1.350	1.178	1.590	
2636.50	41055	Mid-High	LTE Band 41	20	22.0	21.37	-0.14	0	0466M	QPSK	1	50	0 mm	back	1:1.58	1.310	1.156	1.514	
2680.00	41490	High	LTE Band 41	20	22.0	21.36	-0.02	0	0466M	QPSK	1	50	0 mm	back	1:1.58	1.600	1.159	1.854	
2506.00	39750	Low	LTE Band 41	20	22.0	21.28	-0.06	0	0466M	QPSK	50	25	0 mm	back	1:1.58	1.590	1.180	1.876	
2549.50	40185	Low-Mid	LTE Band 41	20	22.0	21.37	-0.01	0	0466M	QPSK	50	25	0 mm	back	1:1.58	1.450	1.156	1.676	
2593.00	40620	Mid	LTE Band 41	20	22.0	21.37	-0.14	0	0466M	QPSK	50	25	0 mm	back	1:1.58	1.390	1.156	1.607	
2636.50	41055	Mid-High	LTE Band 41	20	22.0	21.46	-0.11	0	0466M	QPSK	50	25	0 mm	back	1:1.58	1.540	1.132	1.743	
2680.00	41490	High	LTE Band 41	20	22.0	21.45	-0.11	0	0466M	QPSK	50	25	0 mm	back	1:1.58	1.640	1.135	1.861	A36
2636.50	41055	Mid-High	LTE Band 41	20	22.0	21.35	0.01	0	0466M	QPSK	100	0	0 mm	back	1:1.58	1.510	1.161	1.753	
2506.00	39750	Low	LTE Band 41	20	22.0	21.27	0.01	0	0466M	QPSK	1	99	0 mm	front	1:1.58	1.050	1.183	1.242	
2549.50	40185	Low-Mid	LTE Band 41	20	22.0	21.31	-0.03	0	0466M	QPSK	1	0	0 mm	front	1:1.58	0.991	1.172	1.161	
2593.00	40620	Mid	LTE Band 41	20	22.0	21.29	-0.01	0	0466M	QPSK	1	50	0 mm	front	1:1.58	1.190	1.178	1.402	
2636.50	41055	Mid-High	LTE Band 41	20	22.0	21.37	0.00	0	0466M	QPSK	1	50	0 mm	front	1:1.58	1.350	1.156	1.561	
2680.00	41490	High	LTE Band 41	20	22.0	21.36	-0.03	0	0466M	QPSK	1	50	0 mm	front	1:1.58	1.380	1.159	1.599	
2506.00	39750	Low	LTE Band 41	20	22.0	21.28	-0.06	0	0466M	QPSK	50	25	0 mm	front	1:1.58	1.110	1.180	1.310	
2549.50	40185	Low-Mid	LTE Band 41	20	22.0	21.37	-0.04	0	0466M	QPSK	50	25	0 mm	front	1:1.58	1.020	1.156	1.179	
2593.00	40620	Mid	LTE Band 41	20	22.0	21.37	0.02	0	0466M	QPSK	50	25	0 mm	front	1:1.58	1.250	1.156	1.445	
2636.50	41055	Mid-High	LTE Band 41	20	22.0	21.46	-0.03	0	0466M	QPSK	50	25	0 mm	front	1:1.58	1.400	1.132	1.585	
2680.00	41490	High	LTE Band 41	20	22.0	21.45	-0.02	0	0466M	QPSK	50	25	0 mm	front	1:1.58	1.420	1.135	1.612	
2636.50	41055	Mid-High	LTE Band 41	20	22.0	21.35	0.04	0	0466M	QPSK	100	0	0 mm	front	1:1.58	1.360	1.161	1.579	
2506.00	39750	Low	LTE Band 41	20	22.0	21.27	0.12	0	0466M	QPSK	1	99	0 mm	bottom	1:1.58	1.210	1.183	1.431	
2549.50	40185	Low-Mid	LTE Band 41	20	22.0	21.31	0.03	0	0466M	QPSK	1	0	0 mm	bottom	1:1.58	1.110	1.172	1.301	
2593.00	40620	Mid	LTE Band 41	20	22.0	21.29	0.01	0	0466M	QPSK	1	50	0 mm	bottom	1:1.58	1.380	1.178	1.626	
2636.50	41055	Mid-High	LTE Band 41	20	22.0	21.37	-0.05	0	0466M	QPSK	1	50	0 mm	bottom	1:1.58	1.470	1.156	1.699	
2680.00	41490	High	LTE Band 41	20	22.0	21.36	0.02	0	0466M	QPSK	1	50	0 mm	bottom	1:1.58	1.510	1.159	1.750	
2506.00	39750	Low	LTE Band 41	20	22.0	21.28	0.10	0	0466M	QPSK	50	25	0 mm	bottom	1:1.58	1.320	1.180	1.558	
2549.50	40185	Low-Mid	LTE Band 41	20	22.0	21.37	0.06	0	0466M	QPSK	50	25	0 mm	bottom	1:1.58	1.090	1.156	1.260	
2593.00	40620	Mid	LTE Band 41	20	22.0	21.37	0.02	0	0466M	QPSK	50	25	0 mm	bottom	1:1.58	1.450	1.156	1.676	
2636.50	41055	Mid-High	LTE Band 41	20	22.0	21.46	-0.04	0	0466M	QPSK	50	25	0 mm	bottom	1:1.58	1.550	1.132	1.755	
2680.00	41490	High	LTE Band 41	20	22.0	21.45	0.00	0	0466M	QPSK	50	25	0 mm	bottom	1:1.58	1.550	1.135	1.759	
2636.50	41055	Mid-High	LTE Band 41	20	22.0	21.35	-0.02	0	0466M	QPSK	100	0	0 mm	bottom	1:1.58	1.520	1.161	1.765	
ANSI / IEEE C95.1 1992 - SAFETY LIMIT Spatial Peak Uncontrolled Exposure/General Population										Phablet 4.0 W/kg (mW/g) averaged over 10 grams									

FCC ID: A3LSMG998JPN	 PCTEST Proud to be part of Element	SAR EVALUATION REPORT		Approved by: Quality Manager
Document S/N: 1M2101110003-01.A3L	Test Dates: 01/17/21 - 01/25/21	DUT Type: Portable Handset		Page 56 of 71



**Table 11-33  
WLAN MIMO Phablet SAR**



MEASUREMENT RESULTS																					
FREQUENCY		Mode	Service	Bandwidth [MHz]	Maximum Allowed Power (Ant 1) [dBm]	Conducted Power (Ant 1) [dBm]	Maximum Allowed Power (Ant 2) [dBm]	Conducted Power (Ant 2) [dBm]	Power Drift [dB]	Spacing	Antenna Config.	Device Serial Number	Data Rate (Mbps)	Side	Duty Cycle (%)	Peak SAR of Area Scan	SAR (10g)	Scaling Factor (Power)	Scaling Factor (Duty Cycle)	Reported SAR (10g) (W/kg)	Plot #
MHz	Ch.															W/kg	(W/kg)	(W/kg)	(W/kg)		
5300	60	802.11n	OFDM	20	17.5	16.36	17.5	17.09	0.03	0 mm	MIMO	0023M	13	back	98.9	11.055	1.240	1.300	1.011	1.630	
5300	60	802.11n	OFDM	20	17.5	16.36	17.5	17.09	0.12	0 mm	MIMO	0023M	13	front	98.9	8.863	0.747	1.300	1.011	0.982	
5300	60	802.11n	OFDM	20	17.5	16.36	17.5	17.09	0.09	0 mm	MIMO	0023M	13	top	98.9	1.887	-	1.300	1.011	-	
5260	52	802.11n	OFDM	20	17.5	16.37	17.5	16.92	0.18	0 mm	MIMO	0023M	13	left	98.9	22.292	1.570	1.297	1.011	2.059	A37
5300	60	802.11n	OFDM	20	17.5	16.36	17.5	17.09	0.02	0 mm	MIMO	0023M	13	left	98.9	22.402	1.410	1.300	1.011	1.853	
5320	64	802.11n	OFDM	20	17.5	16.31	17.5	17.11	0.02	0 mm	MIMO	0023M	13	left	98.9	16.088	1.380	1.315	1.011	1.835	
5500	100	802.11n	OFDM	20	17.5	16.68	17.5	17.19	0.03	0 mm	MIMO	0023M	13	back	98.9	7.046	0.814	1.208	1.011	0.994	
5500	100	802.11n	OFDM	20	17.5	16.68	17.5	17.19	0.10	0 mm	MIMO	0023M	13	front	98.9	3.019	0.266	1.208	1.011	0.325	
5500	100	802.11n	OFDM	20	17.5	16.68	17.5	17.19	0.11	0 mm	MIMO	0023M	13	top	98.9	0.732	-	1.208	1.011	-	
5500	100	802.11n	OFDM	20	17.5	16.68	17.5	17.19	0.11	0 mm	MIMO	0023M	13	left	98.9	15.331	0.976	1.208	1.011	1.192	
ANSI / IEEE C95.1 1992 - SAFETY LIMIT Spatial Peak Uncontrolled Exposure/General Population											Phablet 4.0 W/kg (mW/g) averaged over 10 grams										

Note: To achieve the 20.5 dBm maximum allowed MIMO power shown in the documentation, each antenna transmits at a maximum allowed power of 17.5 dBm.

### 11.5 SAR Test Notes

General Notes:

- The test data reported are the worst-case SAR values according to test procedures specified in IEEE 1528-2013, and FCC KDB Publication 447498 D01v06.
- Batteries are fully charged at the beginning of the SAR measurements.
- Liquid tissue depth was at least 15.0 cm for all frequencies.
- The manufacturer has confirmed that the device(s) tested have the same physical, mechanical and thermal characteristics and are within operational tolerances expected for production units.
- SAR results were scaled to the maximum allowed power to demonstrate compliance per FCC KDB Publication 447498 D01v06.
- Device was tested using a fixed spacing for body-worn accessory testing. A separation distance of 15 mm was considered because the manufacturer has determined that there will be body-worn accessories available in the marketplace for users to support this separation distance.
- Per FCC KDB Publication 648474 D04v01r03, body-worn SAR was evaluated without a headset connected to the device. Since the standalone reported body-worn SAR was ≤ 1.2 W/kg, no additional body-worn SAR evaluations using a headset cable were required.
- Per FCC KDB 865664 D01v01r04, variability SAR tests were performed when the measured 10g SAR results for a frequency band were greater than or equal to 2.0 W/kg. Repeated SAR measurements are highlighted in the tables above for clarity. Please see Section 13 for variability analysis.
- During SAR Testing for the Wireless Router conditions per FCC KDB Publication 941225 D06v02r01, the actual Portable Hotspot operation (with actual simultaneous transmission of a transmitter with WIFI) was not activated (See Section 6.7 for more details).
- Per FCC KDB Publication 648474 D04v01r03, this device is considered a "phablet" since the diagonal dimension is > 160 mm and < 200 mm. Therefore, phablet SAR tests are required when wireless router mode does not apply or if wireless router 1g SAR > 1.2 W/kg.
- Additional SAR tests for phablet SAR were evaluated per KDB 616217 Section 6 (See Section 6.9 for more information).
- Unless otherwise noted, when 10g SAR measurement is considered, a factor of 2.5 is applied to the 1g thresholds for the equivalent test cases.

FCC ID: A3LSMG998JPN	 PCTEST Proud to be part of Element	SAR EVALUATION REPORT		Approved by: Quality Manager
Document S/N: 1M2101110003-01.A3L	Test Dates: 01/17/21 - 01/25/21	DUT Type: Portable Handset	Page 57 of 71	

**GSM Test Notes:**

1. Body-Worn accessory testing is typically associated with voice operations. Therefore, GSM voice was evaluated for body-worn SAR.
2. Justification for reduced test configurations per KDB Publication 941225 D01v03r01 and October 2013 TCB Workshop Notes: The source-based frame-averaged output power was evaluated for all GPRS/EDGE slot configurations. The configuration with the highest target frame averaged output power was evaluated for hotspot SAR. When the maximum frame-averaged powers are equivalent across two or more slots (within 0.25 dB), the configuration with the most number of time slots was tested.
3. Per FCC KDB Publication 447498 D01v06, if the reported (scaled) SAR measured at the middle channel or highest output power channel for each test configuration is  $\leq 0.8$  W/kg for 1g evaluations then testing at the other channels is not required for such test configuration(s). When the maximum output power variation across the required test channels is  $> \frac{1}{2}$  dB, instead of the middle channel, the highest output power channel was used.

**UMTS Notes:**



1. UMTS mode was tested under RMC 12.2 kbps with HSPA Inactive per KDB Publication 941225 D01v03r01. AMR and HSPA SAR was not required per the 3G Test Reduction Procedure in KDB Publication 941225 D01v03r01.
2. Per FCC KDB Publication 447498 D01v06, if the reported (scaled) SAR measured at the middle channel or highest output power channel for each test configuration is  $\leq 0.8$  W/kg for 1g evaluations then testing at the other channels is not required for such test configuration(s). When the maximum output power variation across the required test channels is  $> \frac{1}{2}$  dB, instead of the middle channel, the highest output power channel was used.

**LTE Notes:**

1. LTE test configurations are determined according to SAR Evaluation Considerations for LTE Devices in FCC KDB Publication 941225 D05v02r04. The general test procedures used for testing can be found in Section 8.5.4.
2. MPR is permanently implemented for this device by the manufacturer. The specific manufacturer target MPR is indicated alongside the SAR results. MPR is enabled for this device, according to 3GPP TS36.101 Section 6.2.3 – 6.2.5 under Table 6.2.3-1.
3. A-MPR was disabled for all SAR tests by setting NS=01 and MCC=001 on the base station simulator. SAR tests were performed with the same number of RB and RB offsets transmitting on all TTI frames (maximum TTI).
4. Per FCC KDB Publication 447498 D01v06, when the reported 1g SAR measured at the highest output power channel in a given a test configuration was  $> 0.6$  W/kg for LTE B41 testing at the other channels was required for such test configurations.
5. TDD LTE was tested per the guidance provided in FCC KDB Publication 941225 D05v02r04. Testing was performed using UL-DL configuration 0 with 6 UL subframes and 2 S subframes using extended cyclic prefix only and special subframe configuration 6. SAR tests were performed at maximum output power and worst-case transmission duty factor in extended cyclic prefix. Per 3GPP 36.211 Section 4, the duty factor for special subframe configuration 6 using extended cyclic prefix is 0.633.

**WLAN Notes:**



1. For held-to-ear, and hotspot, and phablet operations, the initial test position procedures were applied. The test position with the highest extrapolated peak SAR will be used as the initial test position. When reported SAR for the initial test position is  $\leq 0.4$  W/kg for 1g evaluations, no additional testing for the remaining test positions was required. Otherwise, SAR is evaluated at the subsequent highest peak SAR positions until the reported SAR result is  $\leq 0.8$  W/kg or all test positions are measured.
2. Justification for test configurations for WLAN per KDB Publication 248227 D01v02r02 for 2.4 GHz WIFI single transmission chain operations, the highest measured maximum output power channel for DSSS was selected for SAR measurement. SAR for OFDM modes (2.4 GHz 802.11g/n/ax) was not required due to the maximum allowed powers and the highest reported DSSS SAR. See Section 8.6.5 for more information.

FCC ID: A3LSMG998JPN	 <small>Proud to be part of</small> 	SAR EVALUATION REPORT		Approved by: Quality Manager
Document S/N: 1M2101110003-01.A3L	Test Dates: 01/17/21 - 01/25/21	DUT Type: Portable Handset	Page 58 of 71	

3. Justification for test configurations for WLAN per KDB Publication 248227 D01v02r02 for 5 GHz WIFI operations, the initial test configuration was selected according to the transmission mode with the highest maximum allowed powers. Other transmission modes were not investigated since the highest reported SAR for initial test configuration adjusted by the ratio of maximum output powers is less than 1.2 W/kg for 1g evaluations. See Section 8.6.6 for more information.
4. Per KDB Publication 248227 D01v02r02, SAR for MIMO was evaluated by following the simultaneous SAR provisions from KDB Publication 447498 D01v06 by either evaluating the sum of the 1g SAR values of each antenna transmitting independently or making a SAR measurement with both antennas transmitting simultaneously. Please see Section 12 for complete analysis.
5. When the maximum reported 1g averaged SAR is  $\leq 0.8$  W/kg, SAR testing on additional channels was not required. Otherwise, SAR for the next highest output power channel was required until the reported SAR result was  $\leq 1.20$  W/kg for 1g evaluations or all test channels were measured.
6. The device was configured to transmit continuously at the required data rate, channel bandwidth and signal modulation, using the highest transmission duty factor supported by the test mode tools. The reported SAR was scaled to the 100% transmission duty factor to determine compliance. Procedures used to measure the duty factor are identical to that in the associated EMC test reports.
7. When 10g SAR measurement is considered, a factor of 2.5 is applied to the thresholds above.

**Bluetooth Notes**

1. Bluetooth SAR was measured with the device connected to a call box with hopping disabled with DH5 operation and Tx Tests test mode type. Per October 2016 TCB Workshop Notes, the reported SAR was scaled to the 100% transmission duty factor to determine compliance. See Section 9.5 for the time domain plot and calculation for the duty factor of the device.
2. Head and Hotspot Bluetooth SAR were evaluated for BT BR tethering applications, Hotspot Bluetooth MIMO EDR SAR was also evaluated.

FCC ID: A3LSMG998JPN	 <b>PCTEST</b> <small>Proud to be part of element</small>	SAR EVALUATION REPORT		Approved by: Quality Manager
Document S/N: 1M2101110003-01.A3L	Test Dates: 01/17/21 - 01/25/21	DUT Type: Portable Handset	Page 59 of 71	

# 12 FCC MULTI-TX AND ANTENNA SAR CONSIDERATIONS

## 12.1 Introduction

The following procedures adopted from FCC KDB Publication 447498 D01v06 are applicable to devices with built-in unlicensed transmitters such as 802.11 and Bluetooth devices which may simultaneously transmit with the licensed transmitter.

## 12.2 Simultaneous Transmission Procedures

This device contains transmitters that may operate simultaneously. Therefore, simultaneous transmission analysis is required. Per FCC KDB Publication 447498 D01v06 4.3.2 and IEEE 1528-2013 Section 6.3.4.1.2, simultaneous transmission SAR test exclusion may be applied when the sum of the 1g SAR for all the simultaneous transmitting antennas in a specific a physical test configuration is  $\leq 1.6$  W/kg. The different test positions in an exposure condition may be considered collectively to determine SAR test exclusion according to the sum of 1g or 10g SAR.

Per FCC KDB Publication 941225 D06v02r01, the devices edges with antennas more than 2.5 cm from edge are not required to be evaluated for SAR (“-“).

(\*) For test positions that were not required to be evaluated for WLAN SAR per FCC KDB publication 248227, the worst case WLAN SAR result for the applicable exposure conditions was used for simultaneous transmission analysis.



## 12.3 Head SAR Simultaneous Transmission Analysis

**Table 12-1**  
**Simultaneous Transmission Scenario with 2.4 GHz WLAN (Held to Ear)**

Configuration	Mode	2G/3G/4G SAR (W/kg)	2.4 GHz WLAN Ant 1 SAR (W/kg)	2.4 GHz WLAN Ant 2 SAR (W/kg)	$\Sigma$ SAR (W/kg)		
		1	2	3	1+2	1+3	1+2+3
Head SAR	GSM 850	0.083	0.016	0.210	0.099	0.293	0.309
	GSM 1900	0.059	0.016	0.210	0.075	0.269	0.285
	UMTS 850	0.139	0.016	0.210	0.155	0.349	0.365
	LTE Band 12	0.087	0.016	0.210	0.103	0.297	0.313
	LTE Band 13	0.119	0.016	0.210	0.135	0.329	0.345
	LTE Band 5 (Cell)	0.154	0.016	0.210	0.170	0.364	<b>0.380</b>
	LTE Band 4 (AWS)	0.107	0.016	0.210	0.123	0.317	0.333
	LTE Band 41	0.065	0.016	0.210	0.081	0.275	0.291

**Table 12-2**  
**Simultaneous Transmission Scenario with 5 GHz WLAN MIMO (Held to Ear)**

Configuration	Mode	2G/3G/4G SAR (W/kg)	5 GHz WLAN MIMO SAR (W/kg)	$\Sigma$ SAR (W/kg)
		1	2	1+2
Head SAR	GSM 850	0.083	0.265	0.348
	GSM 1900	0.059	0.265	0.324
	UMTS 850	0.139	0.265	0.404
	LTE Band 12	0.087	0.265	0.352
	LTE Band 13	0.119	0.265	0.384
	LTE Band 5 (Cell)	0.154	0.265	<b>0.419</b>
	LTE Band 4 (AWS)	0.107	0.265	0.372
	LTE Band 41	0.065	0.265	0.330

FCC ID: A3LSMG998JPN	 <b>PCTEST</b> Proud to be part of 	<b>SAR EVALUATION REPORT</b>		Approved by: Quality Manager
Document S/N: 1M2101110003-01.A3L	Test Dates: 01/17/21 - 01/25/21	DUT Type: Portable Handset	Page 60 of 71	

**Table 12-3**  
**Simultaneous Transmission Scenario with 2.4 GHz WLAN and 5 GHz WLAN MIMO (Held to Ear)**

Configuration	Mode	2G/3G/4G SAR (W/kg)	2.4 GHz WLAN Ant 1 SAR (W/kg)	2.4 GHz WLAN Ant 2 SAR (W/kg)	5 GHz WLAN MIMO SAR (W/kg)	Σ SAR (W/kg)		
		1	2	3	4	1+2+4	1+3+4	1+2+3+4
Head SAR	GSM 850	0.083	0.016	0.210	0.265	0.364	0.558	0.574
	GSM 1900	0.059	0.016	0.210	0.265	0.340	0.534	0.550
	UMTS 850	0.139	0.016	0.210	0.265	0.420	0.614	0.630
	LTE Band 12	0.087	0.016	0.210	0.265	0.368	0.562	0.578
	LTE Band 13	0.119	0.016	0.210	0.265	0.400	0.594	0.610
	LTE Band 5 (Cell)	0.154	0.016	0.210	0.265	0.435	0.629	<b>0.645</b>
	LTE Band 4 (AWS)	0.107	0.016	0.210	0.265	0.388	0.582	0.598
	LTE Band 41	0.065	0.016	0.210	0.265	0.346	0.540	0.556

**Table 12-4**  
**Simultaneous Transmission Scenario with Bluetooth (Held to Ear)**

Configuration	Mode	2G/3G/4G SAR (W/kg)	2.4 GHz Bluetooth Ant 1 SAR (W/kg)	2.4 GHz Bluetooth Ant 2 SAR (W/kg)	Σ SAR (W/kg)		
		1	2	3	1+2	1+3	1+2+3
Head SAR	GSM 850	0.083	0.010	0.144	0.093	0.227	0.237
	GSM 1900	0.059	0.010	0.144	0.069	0.203	0.213
	UMTS 850	0.139	0.010	0.144	0.149	0.283	0.293
	LTE Band 12	0.087	0.010	0.144	0.097	0.231	0.241
	LTE Band 13	0.119	0.010	0.144	0.129	0.263	0.273
	LTE Band 5 (Cell)	0.154	0.010	0.144	0.164	0.298	<b>0.308</b>
	LTE Band 4 (AWS)	0.107	0.010	0.144	0.117	0.251	0.261
	LTE Band 41	0.065	0.010	0.144	0.075	0.209	0.219



**Table 12-5**  
**Simultaneous Transmission Scenario with Bluetooth and 5 GHz WLAN MIMO (Held to Ear)**

Configuration	Mode	2G/3G/4G SAR (W/kg)	2.4 GHz Bluetooth Ant 1 SAR (W/kg)	2.4 GHz Bluetooth Ant 2 SAR (W/kg)	5 GHz WLAN MIMO SAR (W/kg)	Σ SAR (W/kg)		
		1	2	3	4	1+2+4	1+3+4	1+2+3+4
Head SAR	GSM 850	0.083	0.010	0.144	0.265	0.358	0.492	0.502
	GSM 1900	0.059	0.010	0.144	0.265	0.334	0.468	0.478
	UMTS 850	0.139	0.010	0.144	0.265	0.414	0.548	0.558
	LTE Band 12	0.087	0.010	0.144	0.265	0.362	0.496	0.506
	LTE Band 13	0.119	0.010	0.144	0.265	0.394	0.528	0.538
	LTE Band 5 (Cell)	0.154	0.010	0.144	0.265	0.429	0.563	<b>0.573</b>
	LTE Band 4 (AWS)	0.107	0.010	0.144	0.265	0.382	0.516	0.526
	LTE Band 41	0.065	0.010	0.144	0.265	0.340	0.474	0.484

## 12.4 Body-Worn Simultaneous Transmission Analysis

**Table 12-6**  
**Simultaneous Transmission Scenario with 2.4 GHz WLAN (Body-Worn at 1.5 cm)**

Configuration	Mode	2G/3G/4G SAR (W/kg)	2.4 GHz WLAN Ant 1 SAR (W/kg)	2.4 GHz WLAN Ant 2 SAR (W/kg)	Σ SAR (W/kg)		
		1	2	3	1+2	1+3	1+2+3
Body - Worn SAR	GSM 850	0.176	0.081	0.034	0.257	0.210	0.291
	GSM 1900	0.279	0.081	0.034	0.360	0.313	0.394
	UMTS 850	0.239	0.081	0.034	0.320	0.273	0.354
	LTE Band 12	0.123	0.081	0.034	0.204	0.157	0.238
	LTE Band 13	0.183	0.081	0.034	0.264	0.217	0.298
	LTE Band 5 (Cell)	0.251	0.081	0.034	0.332	0.285	0.366
	LTE Band 4 (AWS)	0.586	0.081	0.034	0.667	0.620	<b>0.701</b>
	LTE Band 41	0.339	0.081	0.034	0.420	0.373	0.454

FCC ID: A3LSMG998JPN	 <b>PCTEST</b> Proud to be part of Element	<b>SAR EVALUATION REPORT</b>		Approved by: Quality Manager
Document S/N: 1M2101110003-01.A3L	Test Dates: 01/17/21 - 01/25/21	DUT Type: Portable Handset	Page 61 of 71	

**Table 12-7**  
**Simultaneous Transmission Scenario with 5 GHz WLAN MIMO (Body-Worn at 1.5 cm)**

Configuration	Mode	2G/3G/4G SAR (W/kg)	5 GHz WLAN MIMO SAR (W/kg)	Σ SAR (W/kg)
		1	2	
Body - Worn SAR	GSM 850	0.176	0.699	0.875
	GSM 1900	0.279	0.699	0.978
	UMTS 850	0.239	0.699	0.938
	LTE Band 12	0.123	0.699	0.822
	LTE Band 13	0.183	0.699	0.882
	LTE Band 5 (Cell)	0.251	0.699	0.950
	LTE Band 4 (AWS)	0.586	0.699	<b>1.285</b>
	LTE Band 41	0.339	0.699	1.038

**Table 12-8**  
**Simultaneous Transmission Scenario with 2.4 GHz WLAN and 5 GHz WLAN MIMO (Body-Worn at 1.5 cm)**



Configuration	Mode	2G/3G/4G/5G SAR (W/kg)	2.4 GHz WLAN Ant 1 SAR (W/kg)	2.4 GHz WLAN Ant 2 SAR (W/kg)	5 GHz WLAN MIMO SAR (W/kg)	Σ SAR (W/kg)		
		1	2	3	4	1+2+4	1+3+4	1+2+3+4
Body - Worn SAR	GSM 850	0.176	0.081	0.034	0.699	0.956	0.909	0.990
	GSM 1900	0.279	0.081	0.034	0.699	1.059	1.012	1.093
	UMTS 850	0.239	0.081	0.034	0.699	1.019	0.972	1.053
	LTE Band 12	0.123	0.081	0.034	0.699	0.903	0.856	0.937
	LTE Band 13	0.183	0.081	0.034	0.699	0.963	0.916	0.997
	LTE Band 5 (Cell)	0.251	0.081	0.034	0.699	1.031	0.984	1.065
	LTE Band 4 (AWS)	0.586	0.081	0.034	0.699	1.366	1.319	<b>1.400</b>
	LTE Band 41	0.339	0.081	0.034	0.699	1.119	1.072	1.153

**Table 12-9**  
**Simultaneous Transmission Scenario with Bluetooth (Body-Worn at 1.5 cm)**

Configuration	Mode	2G/3G/4G SAR (W/kg)	2.4 GHz Bluetooth Ant 1 SAR (W/kg)	2.4 GHz Bluetooth Ant 2 SAR (W/kg)	Σ SAR (W/kg)		
		1	2	3	1+2	1+3	1+2+3
Body - Worn SAR	GSM 850	0.176	0.072	0.041	0.248	0.217	0.289
	GSM 1900	0.279	0.072	0.041	0.351	0.320	0.392
	UMTS 850	0.239	0.072	0.041	0.311	0.280	0.352
	LTE Band 12	0.123	0.072	0.041	0.195	0.164	0.236
	LTE Band 13	0.183	0.072	0.041	0.255	0.224	0.296
	LTE Band 5 (Cell)	0.251	0.072	0.041	0.323	0.292	0.364
	LTE Band 4 (AWS)	0.586	0.072	0.041	0.658	0.627	<b>0.699</b>
	LTE Band 41	0.339	0.072	0.041	0.411	0.380	0.452

**Table 12-10**  
**Simultaneous Transmission Scenario with Bluetooth and 5 GHz WLAN MIMO (Body-Worn at 1.5 cm)**

Configuration	Mode	2G/3G/4G SAR (W/kg)	2.4 GHz Bluetooth Ant 1 SAR (W/kg)	2.4 GHz Bluetooth Ant 2 SAR (W/kg)	5 GHz WLAN MIMO SAR (W/kg)	Σ SAR (W/kg)		
		1	2	3	4	1+2+4	1+3+4	1+2+3+4
Body - Worn SAR	GSM 850	0.176	0.072	0.041	0.699	0.947	0.916	0.988
	GSM 1900	0.279	0.072	0.041	0.699	1.050	1.019	1.091
	UMTS 850	0.239	0.072	0.041	0.699	1.010	0.979	1.051
	LTE Band 12	0.123	0.072	0.041	0.699	0.894	0.863	0.935
	LTE Band 13	0.183	0.072	0.041	0.699	0.954	0.923	0.995
	LTE Band 5 (Cell)	0.251	0.072	0.041	0.699	1.022	0.991	1.063
	LTE Band 4 (AWS)	0.586	0.072	0.041	0.699	1.357	1.326	<b>1.398</b>
	LTE Band 41	0.339	0.072	0.041	0.699	1.110	1.079	1.151

FCC ID: A3LSMG998JPN	 <b>PCTEST</b> Proud to be part of Element	<b>SAR EVALUATION REPORT</b>		Approved by: Quality Manager
Document S/N: 1M2101110003-01.A3L	Test Dates: 01/17/21 - 01/25/21	DUT Type: Portable Handset		Page 62 of 71

## 12.5 Hotspot SAR Simultaneous Transmission Analysis

**Table 12-11**  
**Simultaneous Transmission Scenario with 2.4 GHz WLAN (Hotspot at 1.0 cm)**

Configuration	Mode	2G/3G/4G SAR (W/kg)	2.4 GHz WLAN Ant 1 SAR (W/kg)	2.4 GHz WLAN Ant 2 SAR (W/kg)	Σ SAR (W/kg)		
		1	2	3	1+2	1+3	1+2+3
Hotspot SAR	GPRS 850	0.402	0.203	0.171	0.605	0.573	0.776
	GPRS 1900	0.904	0.203	0.171	1.107	1.075	1.278
	UMTS 850	0.533	0.203	0.171	0.736	0.704	0.907
	LTE Band 12	0.235	0.203	0.171	0.438	0.406	0.609
	LTE Band 13	0.309	0.203	0.171	0.512	0.480	0.683
	LTE Band 5 (Cell)	0.538	0.203	0.171	0.741	0.709	0.912
	LTE Band 4 (AWS)	0.768	0.203	0.171	0.971	0.939	1.142
	LTE Band 41	0.428	0.203	0.171	0.631	0.599	0.802

**Table 12-12**  
**Simultaneous Transmission Scenario with 5 GHz WLAN MIMO (Hotspot at 1.0 cm)**

Configuration	Mode	2G/3G/4G SAR (W/kg)	5 GHz WLAN MIMO SAR (W/kg)	Σ SAR (W/kg)
		1	2	1+2
Hotspot SAR	GPRS 850	0.402	0.869	1.271
	GPRS 1900	0.904	0.869	See Table Below
	UMTS 850	0.533	0.869	1.402
	LTE Band 12	0.235	0.869	1.104
	LTE Band 13	0.309	0.869	1.178
	LTE Band 5 (Cell)	0.538	0.869	1.407
	LTE Band 4 (AWS)	0.768	0.869	See Table Below
	LTE Band 41	0.428	0.869	1.297



  

Simult Tx	Configuration	GPRS 1900 SAR (W/kg)	5 GHz WLAN MIMO SAR (W/kg)	Σ SAR (W/kg)	Simult Tx	Configuration	LTE Band 4 (AWS) SAR (W/kg)	5 GHz WLAN MIMO SAR (W/kg)	Σ SAR (W/kg)
		1	2	1+2			1	2	1+2
Hotspot SAR	Back	0.327	0.869	1.196	Hotspot SAR	Back	0.400	0.869	1.269
	Front	0.280	0.869*	1.149		Front	0.368	0.869*	1.237
	Top	-	0.869*	0.869		Top	-	0.869*	0.869
	Bottom	0.904	-	0.904		Bottom	0.768	-	0.768
	Right	0.061	-	0.061		Right	0.057	-	0.057
	Left	0.052	0.217	0.269		Left	0.080	0.217	0.297

**Table 12-13**  
**Simultaneous Transmission Scenario with 2.4 GHz WLAN and 5 GHz WLAN MIMO (Hotspot at 1.0 cm)**

Configuration	Mode	2G/3G/4G SAR (W/kg)	2.4 GHz WLAN Ant 1 SAR (W/kg)	2.4 GHz WLAN Ant 2 SAR (W/kg)	5 GHz WLAN MIMO at 16 dBm SAR (W/kg)	Σ SAR (W/kg)		
		1	2	3	4	1+2+4	1+3+4	1+2+3+4
Hotspot SAR	GPRS 850	0.402	0.203	0.171	0.428	1.033	1.001	1.204
	GPRS 1900	0.904	0.203	0.171	0.428	1.535	1.503	See Table Below
	UMTS 850	0.533	0.203	0.171	0.428	1.164	1.132	1.335
	LTE Band 12	0.235	0.203	0.171	0.428	0.866	0.834	1.037
	LTE Band 13	0.309	0.203	0.171	0.428	0.940	0.908	1.111
	LTE Band 5 (Cell)	0.538	0.203	0.171	0.428	1.169	1.137	1.340
	LTE Band 4 (AWS)	0.768	0.203	0.171	0.428	1.399	1.367	1.570
	LTE Band 41	0.428	0.203	0.171	0.428	1.059	1.027	1.230

Simult Tx	Configuration	GPRS 1900 SAR (W/kg)	2.4 GHz WLAN Ant 1 SAR (W/kg)	2.4 GHz WLAN Ant 2 SAR (W/kg)	5 GHz WLAN MIMO at 16 dBm SAR (W/kg)	Σ SAR (W/kg)
		1	2	3	4	1+2+3+4
Hotspot SAR	Back	0.327	0.203	0.078	0.428	1.036
	Front	0.280	0.203*	0.171*	0.428*	1.082
	Top	-	0.203*	-	0.428*	0.631
	Bottom	0.904	-	-	-	0.904
	Right	0.061	-	-	-	0.061
	Left	0.052	0.203*	0.171	0.101	0.527

FCC ID: A3LSMG998JPN	 <b>PCTEST</b> Proud to be part of 	<b>SAR EVALUATION REPORT</b>		<b>Approved by:</b> Quality Manager
<b>Document S/N:</b> 1M2101110003-01.A3L	<b>Test Dates:</b> 01/17/21 - 01/25/21	<b>DUT Type:</b> Portable Handset		Page 63 of 71

**Table 12-14**  
**Simultaneous Transmission Scenario with Bluetooth (Hotspot at 1.0 cm)**

Configuration	Mode	2G/3G/4G SAR (W/kg)	2.4 GHz Bluetooth Ant 1 SAR (W/kg)	2.4 GHz Bluetooth Ant 2 SAR (W/kg)	Σ SAR (W/kg)		
		1	2	3	1+2	1+3	1+2+3
Hotspot SAR	GPRS 850	0.402	0.186	0.170	0.588	0.572	0.758
	GPRS 1900	0.904	0.186	0.170	1.090	1.074	1.260
	UMTS 850	0.533	0.186	0.170	0.719	0.703	0.889
	LTE Band 12	0.235	0.186	0.170	0.421	0.405	0.591
	LTE Band 13	0.309	0.186	0.170	0.495	0.479	0.665
	LTE Band 5 (Cell)	0.538	0.186	0.170	0.724	0.708	0.894
	LTE Band 4 (AWS)	0.768	0.186	0.170	0.954	0.938	1.124
	LTE Band 41	0.428	0.186	0.170	0.614	0.598	0.784

**Table 12-15**  
**Simultaneous Transmission Scenario with Bluetooth SISO and 5 GHz WLAN MIMO (Hotspot at 1.0 cm)**



Configuration	Mode	2G/3G/4G SAR (W/kg)	2.4 GHz Bluetooth Ant 1 SAR (W/kg)	2.4 GHz Bluetooth Ant 2 SAR (W/kg)	5 GHz WLAN MIMO SAR (W/kg)	Σ SAR (W/kg)	
		1	2	3	4	1+2+4	1+3+4
Hotspot SAR	GPRS 850	0.402	0.186	0.170	0.869	1.457	1.441
	GPRS 1900	0.904	0.186	0.170	0.869	See Table Below	See Table Below
	UMTS 850	0.533	0.186	0.170	0.869	1.588	1.572
	LTE Band 12	0.235	0.186	0.170	0.869	1.290	1.274
	LTE Band 13	0.309	0.186	0.170	0.869	1.364	1.348
	LTE Band 5 (Cell)	0.538	0.186	0.170	0.869	1.593	1.577
	LTE Band 4 (AWS)	0.768	0.186	0.170	0.869	See Table Below	See Table Below
	LTE Band 41	0.428	0.186	0.170	0.869	1.483	1.467

Simult Tx	Configuration	GPRS 1900 SAR (W/kg)	2.4 GHz Bluetooth Ant 1 SAR (W/kg)	2.4 GHz Bluetooth Ant 2 SAR (W/kg)	5 GHz WLAN MIMO SAR (W/kg)	Σ SAR (W/kg)		Simult Tx	Configuration	LTE Band 4 (AWS) SAR (W/kg)	2.4 GHz Bluetooth Ant 1 SAR (W/kg)	2.4 GHz Bluetooth Ant 2 SAR (W/kg)	5 GHz WLAN MIMO SAR (W/kg)	Σ SAR (W/kg)	
		1	2	3	4	1+2+4	1+3+4			1	2	3	4	1+2+4	1+3+4
Hotspot SAR	Back	0.327	0.186	0.082	0.869	1.382	1.278	Hotspot SAR	Back	0.400	0.186	0.082	0.869	1.455	1.351
	Front	0.280	0.005	0.074	0.869*	1.154	1.223		Front	0.368	0.005	0.074	0.869*	1.242	1.311
	Top	-	0.014	-	0.869*	0.883	0.869		Top	-	0.014	-	0.869*	0.883	0.869
	Bottom	0.904	-	-	-	0.904	0.904		Bottom	0.768	-	-	-	0.768	0.768
	Right	0.061	-	-	-	0.061	0.061		Right	0.057	-	-	-	0.057	0.057
	Left	0.052	0.023	0.170	0.217	0.292	0.439		Left	0.080	0.023	0.170	0.217	0.320	0.467

**Table 12-16**  
**Simultaneous Transmission Scenario with Bluetooth MIMO and 5 GHz WLAN MIMO (Hotspot at 1.0 cm)**

Configuration	Mode	2G/3G/4G SAR (W/kg)	2.4 GHz Bluetooth MIMO SAR (W/kg)	5 GHz WLAN MIMO SAR (W/kg)	Σ SAR (W/kg)
		1	2	3	1+2+3
Hotspot SAR	GPRS 850	0.402	0.084	0.869	1.355
	GPRS 1900	0.904	0.084	0.869	0.988
	UMTS 850	0.533	0.084	0.869	0.617
	LTE Band 12	0.235	0.084	0.869	0.319
	LTE Band 13	0.309	0.084	0.869	0.393
	LTE Band 5 (Cell)	0.538	0.084	0.869	0.622
	LTE Band 4 (AWS)	0.768	0.084	0.869	0.852
	LTE Band 41	0.428	0.084	0.869	0.512

FCC ID: A3LSMG998JPN	 PCTEST Proud to be part of Element	SAR EVALUATION REPORT		Approved by: Quality Manager
Document S/N: 1M2101110003-01.A3L	Test Dates: 01/17/21 - 01/25/21	DUT Type: Portable Handset	Page 64 of 71	



## 12.6 Phablet Simultaneous Transmission Analysis

For SAR summation, the highest reported SAR across all test distances was used as the most conservative evaluation for simultaneous transmission analysis for each device edge.



Per FCC KDB Publication 648474 D04 Handset SAR, Phablet SAR tests were not required if wireless router 1g SAR (scaled to the maximum output power, including tolerance) < 1.2 W/kg. Therefore no further analysis beyond the tables included in this section was required to determine that possible simultaneous transmission scenarios would not exceed the SAR limit.

**Table 12-17**  
**Simultaneous Transmission Scenario with 5 GHz WLAN MIMO (Phablet)**

Simult Tx	Configuration	GPRS 1900 SAR (W/kg)	5 GHz WLAN MIMO SAR (W/kg)	Σ SAR (W/kg)	Simult Tx	Configuration	LTE Band 4 (AWS) SAR (W/kg)	5 GHz WLAN MIMO SAR (W/kg)	Σ SAR (W/kg)	Simult Tx	Configuration	LTE Band 41 SAR (W/kg)	5 GHz WLAN MIMO SAR (W/kg)	Σ SAR (W/kg)
		1	2	1+2			1	2	1+2			1	2	1+2
Phablet SAR	Back	0.971	1.630	<b>2.601</b>	Phablet SAR	Back	1.207	1.630	<b>2.837</b>	Phablet SAR	Back	1.876	1.630	<b>3.506</b>
	Front	1.038	0.982	2.020		Front	1.126	0.982	2.108		Front	1.612	0.982	2.594
	Top	-	2.059*	2.059		Top	-	2.059*	2.059		Top	-	2.059*	2.059
	Bottom	1.203	-	1.203		Bottom	2.531	-	2.531		Bottom	1.765	-	1.765
	Right	0.250	-	0.250		Right	0.341	-	0.341		Right	-	-	-
	Left	0.329	2.059	2.388		Left	0.421	2.059	2.480		Left	0.977	2.059	3.036

## 12.7 Simultaneous Transmission Conclusion

The above numerical summed SAR results for all the worst-case simultaneous transmission conditions were below the SAR limit. Therefore, the above analysis is sufficient to determine that simultaneous transmission cases will not exceed the SAR limit and therefore no measured volumetric simultaneous SAR summation is required per FCC KDB Publication 447498 D01v06 and IEEE 1528-2013 Section 6.3.4.1.2.

FCC ID: A3LSMG998JPN	 <b>PCTEST</b> Proud to be part of 	<b>SAR EVALUATION REPORT</b>		<b>Approved by:</b> Quality Manager
<b>Document S/N:</b> 1M2101110003-01.A3L	<b>Test Dates:</b> 01/17/21 - 01/25/21	<b>DUT Type:</b> Portable Handset	Page 65 of 71	

# 13 SAR MEASUREMENT VARIABILITY

## 13.1 Measurement Variability

Per FCC KDB Publication 865664 D01v01r04, SAR measurement variability was assessed for each frequency band, which was determined by the SAR probe calibration point and tissue-equivalent medium used for the device measurements. When both head and body tissue-equivalent media were required for SAR measurements in a frequency band, the variability measurement procedures were applied to the tissue medium with the highest measured SAR, using the highest measured SAR configuration for that tissue-equivalent medium. These additional measurements were repeated after the completion of all measurements requiring the same head or body tissue-equivalent medium in a frequency band. The test device was returned to ambient conditions (normal room temperature) with the battery fully charged before it was re-mounted on the device holder for the repeated measurement(s) to minimize any unexpected variations in the repeated results.

SAR Measurement Variability was assessed using the following procedures for each frequency band:



- 1) When the original highest measured SAR is  $\geq 0.80$  W/kg, the measurement was repeated once.
- 2) A second repeated measurement was performed only if the ratio of largest to smallest SAR for the original and first repeated measurements was  $> 1.20$  or when the original or repeated measurement was  $\geq 1.45$  W/kg (~10% from the 1g SAR limit).
- 3) A third repeated measurement was performed only if the original, first or second repeated measurement was  $\geq 1.5$  W/kg and the ratio of largest to smallest SAR for the original, first and second repeated measurements is  $> 1.20$ .
- 4) Repeated measurements are not required when the original highest measured SAR is  $< 0.80$  W/kg
- 5) When 10g SAR measurement is considered, a factor of 2.5 is applied to the thresholds above.

**Table 13-1  
Phablet SAR Measurement Variability Results**

PHABLET VARIABILITY RESULTS													
Band	FREQUENCY		Mode	Service	Side	Spacing	Measured SAR (10g)	1st Repeated SAR (10g)	Ratio	2nd Repeated SAR (10g)	Ratio	3rd Repeated SAR (10g)	Ratio
	MHz	Ch.					(W/kg)	(W/kg)		(W/kg)		(W/kg)	
1750	1732.50	20175	LTE Band 4 (AWS), 20 MHz Bandwidth	QPSK, 50 RB, 25 RB Offset	bottom	0 mm	2.100	2.090	1.00	N/A	N/A	N/A	N/A
ANSI / IEEE C95.1 1992 - SAFETY LIMIT Spatial Peak Uncontrolled Exposure/General Population							Phablet 4.0 W/kg (mW/g) averaged over 10 grams						



## 13.2 Measurement Uncertainty

The measured SAR was  $< 1.5$  W/kg for 1g and  $< 3.75$  W/kg for 10g for all frequency bands. Therefore, per KDB Publication 865664 D01v01r04, the extended measurement uncertainty analysis per IEEE 1528-2013 was not required.

FCC ID: A3LSMG998JPN	 <b>PCTEST</b> Proud to be part of 	<b>SAR EVALUATION REPORT</b>		<b>Approved by:</b> Quality Manager
<b>Document S/N:</b> 1M2101110003-01.A3L	<b>Test Dates:</b> 01/17/21 - 01/25/21	<b>DUT Type:</b> Portable Handset	Page 66 of 71	



Manufacturer	Model	Description	Cal Date	Cal Interval	Cal Due	Serial Number	
Agilent	8594A	(9kHz-2.9GHz) Spectrum Analyzer	N/A	N/A	N/A	3051A00187	
Agilent	85033E	3.5mm Standard Calibration Kit	6/6/2020	Annual	6/6/2021	MV53402352	
Agilent	E5515C	8960 Series 10 Wireless Communications Test Set	2/10/2020	Annual	2/10/2021	GB42230325	
Agilent	E4438C	ESG Vector Signal Generator	12/14/2020	Biennial	12/14/2022	MY42082385	
Agilent	E4438C	ESG Vector Signal Generator	8/10/2020	Annual	8/10/2021	MY47270002	
Agilent	N5182A	MXG Vector Signal Generator	5/13/2020	Annual	5/13/2021	MY47420603	
Agilent	N5182A	MXG Vector Signal Generator	2/19/2020	Annual	2/19/2021	MY47420651	
Agilent	8753E5	S-Parameter Network Analyzer	9/16/2020	Annual	9/16/2021	MY40000670	
Agilent	8753E5	S-Parameter Vector Network Analyzer	12/15/2020	Annual	12/15/2021	MY40003841	
Agilent	E5515C	Wireless Communications Test Set	1/14/2020	Triennial	1/14/2023	GB43304447	
Agilent	E5515C	Wireless Communications Test Set	2/26/2020	Annual	2/26/2021	GB44400860	
Agilent	N4010A	Wireless Connectivity Test Set	CBT	N/A	CBT	GB44450273	
Agilent	N4010A	Wireless Connectivity Test Set	N/A	N/A	N/A	GB46170464	
Amplifier Research	1551G6	Amplifier	CBT	N/A	CBT	353317	
Amplifier Research	1551G6	Amplifier	CBT	N/A	CBT	353468	
Anritsu	MN8110B	I/O Adaptor	CBT	N/A	CBT	6261747881	
Anritsu	ML2495A	Power Meter	1/18/2021	Annual	1/18/2022	941001	
Anritsu	ML2496A	Power Meter	2/13/2020	Annual	2/13/2021	1306009	
Anritsu	MA2411B	Pulse Power Sensor	12/18/2020	Annual	12/18/2021	1126066	
Anritsu	MA2411B	Pulse Power Sensor	7/28/2020	Annual	7/28/2021	139018	
Anritsu	MT8821C	Radio Communication Analyzer	3/10/2020	Annual	3/10/2021	6200901190	
Anritsu	MT8820C	Radio Communication Analyzer	9/17/2020	Annual	9/17/2021	6201300731	
Anritsu	MT8821C	Radio Communication Analyzer	6/15/2020	Annual	6/15/2021	6201381794	
Anritsu	MA24106A	USB Power Sensor	1/15/2021	Annual	1/15/2022	1344554	
Anritsu	MA24106A	USB Power Sensor	6/8/2020	Annual	6/8/2021	1344555	
Anritsu	MA24106A	USB Power Sensor	7/24/2020	Annual	7/24/2021	1344556	
Anritsu	MT8862A	Wireless Connectivity Test Set	10/29/2020	Annual	10/29/2021	6261782395	
COMTECH	AR85729-5	Solid State Amplifier	CBT	N/A	CBT	M155A00-009	
COMTECH	AR85729-5/5759B	Solid State Amplifier	CBT	N/A	CBT	M3W1A00-1002	
Control Company	4352	Long Stem Thermometer	6/26/2019	Biennial	6/26/2021	192282739	
Control Company	4352	Long Stem Thermometer	5/16/2020	Biennial	5/16/2022	200294604	
Control Company	4040	Therm./Clock/Humidity Monitor	2/17/2020	Biennial	2/17/2022	200113269	
Control Company	4040	Therm./Clock/Humidity Monitor	6/29/2019	Biennial	6/29/2021	192291470	
Keysight	772D	Dual Directional Coupler	CBT	N/A	CBT	MV52180215	
Keysight Technologies	N6705B	DC Power Analyzer	4/27/2019	Biennial	4/27/2021	MV53000059	
Keysight Technologies	N9020A	MXA Signal Analyzer	8/14/2020	Annual	8/14/2021	US46470561	
Keysight Technologies	85032E	Standard Mechanical Calibration Kit (DC to 9GHz, 3.5mm)	9/1/2020	Annual	9/1/2021	MV53401181	
Mini-Circuits	NCL	BW-N6W5+	6dB Attenuator	CBT	N/A	CBT	1139
Mini-Circuits	VLF-6000+	VLF-6000+	Low Pass Filter	CBT	N/A	CBT	N/A
Mini-Circuits	SLP-2400+	SLP-2400+	Low Pass Filter	CBT	N/A	CBT	R8979500903
Mini-Circuits	BW-N20W5+	BW-N20W5+	DC to 18 GHz Precision Fixed 20 dB Attenuator	CBT	N/A	CBT	N/A
Mini-Circuits	NLP-1200+	NLP-1200+	Low Pass Filter DC to 1000 MHz	CBT	N/A	CBT	N/A
Mini-Circuits	NLP-2950+	NLP-2950+	Low Pass Filter DC to 2700 MHz	CBT	N/A	CBT	N/A
Mini-Circuits	BW-N20W5	BW-N20W5	Power Attenuator	CBT	N/A	CBT	1226
Narda	4014C-6	4 - 8 GHz SMA 6 dB Directional Coupler	CBT	N/A	CBT	N/A	
Narda	BW-53W2	Attenuator (3dB)	CBT	N/A	CBT	120	
Narda	4772-3	Attenuator (3dB)	CBT	N/A	CBT	9406	
Pasternack	PE2208-6	Bidirectional Coupler	CBT	N/A	CBT	N/A	
Pasternack	PE2209-10	Bidirectional Coupler	CBT	N/A	CBT	N/A	
Pasternack	NC-100	Torque Wrench	8/4/2020	Biennial	8/4/2022	1445	
Pasternack	NC-100	Torque Wrench	12/1/2020	Annual	12/1/2021	N/A	
Rohde & Schwarz	CMW500	Radio Communication Tester	6/25/2020	Annual	6/25/2021	140148	
Rohde & Schwarz	CMW500	Radio Communication Tester	10/27/2020	Annual	10/27/2021	166462	
Rohde & Schwarz	CMW500	Radio Communication Tester	4/23/2020	Annual	4/23/2021	167283	
Rohde & Schwarz	ZNL6E	Vector Network Analyzer	9/29/2020	Annual	9/29/2021	101307	
SPEAG	DAK-3.5	Dielectric Assessment Kit	10/14/2020	Annual	10/14/2021	1091	
SPEAG	DAK-12	Dielectric Assessment Kit (10MHz - 3GHz)	3/17/2020	Annual	3/17/2021	1102	
SPEAG	DAK-3.5	Dielectric Parameter Probes	12/9/2020	Annual	12/9/2021	1278	
SPEAG	D750V3	750 MHz SAR Dipole	3/16/2020	Annual	3/16/2021	1003	
SPEAG	D750V3	750 MHz SAR Dipole	3/11/2020	Annual	3/11/2021	1054	
SPEAG	D835V2	835 MHz SAR Dipole	3/13/2019	Biennial	3/13/2021	4d047	
SPEAG	D835V2	835 MHz SAR Dipole	10/19/2018	Triennial	10/19/2021	4d133	
SPEAG	D1750V2	1750 MHz SAR Dipole	10/22/2018	Triennial	10/22/2021	1150	
SPEAG	D1900V2	1900 MHz SAR Dipole	10/23/2018	Triennial	10/23/2021	5d080	
SPEAG	D1900V2	1900 MHz SAR Dipole	10/23/2018	Triennial	10/23/2021	5d149	
SPEAG	D2450V2	2450 MHz SAR Dipole	8/14/2020	Annual	8/14/2021	719	
SPEAG	D2450V2	2450 MHz SAR Dipole	9/9/2020	Annual	9/9/2021	797	
SPEAG	D2600V2	2600 MHz SAR Dipole	6/14/2019	Biennial	6/14/2021	1064	
SPEAG	D5GHzV2	5 GHz SAR Dipole	9/10/2020	Annual	9/10/2021	1191	
SPEAG	D5GHzV2	5 GHz SAR Dipole	8/10/2018	Triennial	8/10/2021	1237	
SPEAG	DAE4	Dasy Data Acquisition Electronics	5/20/2020	Annual	5/20/2021	728	
SPEAG	DAE4	Dasy Data Acquisition Electronics	7/15/2020	Annual	7/15/2021	1322	
SPEAG	DAE4	Dasy Data Acquisition Electronics	6/18/2020	Annual	6/18/2021	1334	
SPEAG	DAE4	Dasy Data Acquisition Electronics	4/15/2020	Annual	4/15/2021	1407	
SPEAG	DAE4	Dasy Data Acquisition Electronics	9/10/2020	Annual	9/10/2021	1449	
SPEAG	DAE4	Dasy Data Acquisition Electronics	8/11/2020	Annual	8/11/2021	1450	
SPEAG	DAE4	Dasy Data Acquisition Electronics	12/7/2020	Annual	12/7/2021	1533	
SPEAG	DAE4	Dasy Data Acquisition Electronics	5/14/2020	Annual	5/14/2021	1583	
SPEAG	EX3DV4	SAR Probe	7/31/2020	Annual	7/31/2021	7308	
SPEAG	EX3DV4	SAR Probe	4/21/2020	Annual	4/21/2021	7357	
SPEAG	EX3DV4	SAR Probe	6/23/2020	Annual	6/23/2021	7406	
SPEAG	EX3DV4	SAR Probe	6/23/2020	Annual	6/23/2021	7409	
SPEAG	EX3DV4	SAR Probe	7/20/2020	Annual	7/20/2021	7410	
SPEAG	EX3DV4	SAR Probe	10/20/2020	Annual	10/20/2021	7539	
SPEAG	EX3DV4	SAR Probe	9/11/2020	Annual	9/11/2021	7552	
SPEAG	EX3DV4	SAR Probe	12/11/2020	Annual	12/11/2021	7571	

Note: CBT (Calibrated Before Testing). Prior to testing, the measurement paths containing a cable, amplifier, attenuator, coupler or filter were connected to a calibrated source (i.e. a signal generator) to determine the losses of the measurement path. The power meter offset was then adjusted to compensate for the measurement system losses. This level offset is stored within the power meter before measurements are made. This calibration verification procedure applies to the system verification and output power measurements. The calibrated reading is then taken directly from the power meter after compensation of the losses for all final power measurements.

FCC ID: A3LSMG998JPN	 <b>PCTEST</b> Proud to be part of 	<b>SAR EVALUATION REPORT</b>		<b>Approved by:</b> Quality Manager
<b>Document S/N:</b> 1M2101110003-01.A3L	<b>Test Dates:</b> 01/17/21 - 01/25/21	<b>DUT Type:</b> Portable Handset	Page 67 of 71	

# 15 MEASUREMENT UNCERTAINTIES

a	c	d	e= f(d,k)	f	g	h = c x f/e	i = c x g/e	k
Uncertainty Component	Tol. (± %)	Prob. Dist.	Div.	c <sub>i</sub> 1gm	c <sub>i</sub> 10 gms	1gm u <sub>i</sub> (± %)	10gms u <sub>i</sub> (± %)	v <sub>i</sub>
<b>Measurement System</b>								
Probe Calibration	6.55	N	1	1.0	1.0	6.6	6.6	∞
Axial Isotropy	0.25	N	1	0.7	0.7	0.2	0.2	∞
Hemishperical Isotropy	1.3	N	1	0.7	0.7	0.9	0.9	∞
Boundary Effect	2.0	R	1.73	1.0	1.0	1.2	1.2	∞
Linearity	0.3	N	1	1.0	1.0	0.3	0.3	∞
System Detection Limits	0.25	R	1.73	1.0	1.0	0.1	0.1	∞
Readout Electronics	0.3	N	1	1.0	1.0	0.3	0.3	∞
Response Time	0.8	R	1.73	1.0	1.0	0.5	0.5	∞
Integration Time	2.6	R	1.73	1.0	1.0	1.5	1.5	∞
RF Ambient Conditions - Noise	3.0	R	1.73	1.0	1.0	1.7	1.7	∞
RF Ambient Conditions - Reflections	3.0	R	1.73	1.0	1.0	1.7	1.7	∞
Probe Positioner Mechanical Tolerance	0.4	R	1.73	1.0	1.0	0.2	0.2	∞
Probe Positioning w/ respect to Phantom	6.7	R	1.73	1.0	1.0	3.9	3.9	∞
Extrapolation, Interpolation & Integration algorithms for Max. SAR Evaluation	4.0	R	1.73	1.0	1.0	2.3	2.3	∞
<b>Test Sample Related</b>								
Test Sample Positioning	2.7	N	1	1.0	1.0	2.7	2.7	35
Device Holder Uncertainty	1.67	N	1	1.0	1.0	1.7	1.7	5
Output Power Variation - SAR drift measurement	5.0	R	1.73	1.0	1.0	2.9	2.9	∞
SAR Scaling	0.0	R	1.73	1.0	1.0	0.0	0.0	∞
<b>Phantom &amp; Tissue Parameters</b>								
Phantom Uncertainty (Shape & Thickness tolerances)	7.6	R	1.73	1.0	1.0	4.4	4.4	∞
Liquid Conductivity - measurement uncertainty	4.2	N	1	0.78	0.71	3.3	3.0	10
Liquid Permittivity - measurement uncertainty	4.1	N	1	0.23	0.26	1.0	1.1	10
Liquid Conductivity - Temperature Uncertainty	3.4	R	1.73	0.78	0.71	1.5	1.4	∞
Liquid Permittivity - Temperature Uncertainty	0.6	R	1.73	0.23	0.26	0.1	0.1	∞
Liquid Conductivity - deviation from target values	5.0	R	1.73	0.64	0.43	1.8	1.2	∞
Liquid Permittivity - deviation from target values	5.0	R	1.73	0.60	0.49	1.7	1.4	∞
Combined Standard Uncertainty (k=1)	RSS					11.5	11.3	60
Expanded Uncertainty (95% CONFIDENCE LEVEL)	k=2					23.0	22.6	



FCC ID: A3LSMG998JPN	 <b>PCTEST</b> Proud to be part of 	<b>SAR EVALUATION REPORT</b>		<b>Approved by:</b> Quality Manager
<b>Document S/N:</b> 1M2101110003-01.A3L	<b>Test Dates:</b> 01/17/21 - 01/25/21	<b>DUT Type:</b> Portable Handset	Page 68 of 71	

## 16 CONCLUSION

### 16.1 Measurement Conclusion



The SAR evaluation indicates that the EUT complies with the RF radiation exposure limits of the FCC and Innovation, Science, and Economic Development Canada, with respect to all parameters subject to this test. These measurements were taken to simulate the RF effects of RF exposure under worst-case conditions. Precise laboratory measures were taken to assure repeatability of the tests. The results and statements relate only to the item(s) tested.

Please note that the absorption and distribution of electromagnetic energy in the body are very complex phenomena that depend on the mass, shape, and size of the body, the orientation of the body with respect to the field vectors, and the electrical properties of both the body and the environment. Other variables that may play a substantial role in possible biological effects are those that characterize the environment (e.g. ambient temperature, air velocity, relative humidity, and body insulation) and those that characterize the individual (e.g. age, gender, activity level, debilitation, or disease). Because various factors may interact with one another to vary the specific biological outcome of an exposure to electromagnetic fields, any protection guide should consider maximal amplification of biological effects as a result of field-body interactions, environmental conditions, and physiological variables. [3]



<b>FCC ID:</b> A3LSMG998JPN	 Proud to be part of 	<b>SAR EVALUATION REPORT</b>		<b>Approved by:</b> Quality Manager
<b>Document S/N:</b> 1M2101110003-01.A3L	<b>Test Dates:</b> 01/17/21 - 01/25/21	<b>DUT Type:</b> Portable Handset	Page 69 of 71	

# 17 REFERENCES

- [1] Federal Communications Commission, ET Docket 93-62, Guidelines for Evaluating the Environmental Effects of Radiofrequency Radiation, Aug. 1996.
- [2] ANSI/IEEE C95.1-2005, American National Standard safety levels with respect to human exposure to radio frequency electromagnetic fields, 3kHz to 300GHz, New York: IEEE, 2006.
- [3] ANSI/IEEE C95.1-1992, American National Standard safety levels with respect to human exposure to radio frequency electromagnetic fields, 3kHz to 300GHz, New York: IEEE, Sept. 1992.
- [4] ANSI/IEEE C95.3-2002, IEEE Recommended Practice for the Measurement of Potentially Hazardous Electromagnetic Fields - RF and Microwave, New York: IEEE, December 2002.
- [5] IEEE Standards Coordinating Committee 39 –Standards Coordinating Committee 34 – IEEE Std. 1528-2013, IEEE Recommended Practice for Determining the Peak Spatial-Average Specific Absorption Rate (SAR) in the Human Head from Wireless Communications Devices: Measurement Techniques.
- [6] NCRP, National Council on Radiation Protection and Measurements, Biological Effects and Exposure Criteria for RadioFrequency Electromagnetic Fields, NCRP Report No. 86, 1986. Reprinted Feb. 1995.
- [7] T. Schmid, O. Egger, N. Kuster, Automated E-field scanning system for dosimetric assessments, IEEE Transaction on Microwave Theory and Techniques, vol. 44, Jan. 1996, pp. 105-113.
- [8] K. Pokovic, T. Schmid, N. Kuster, Robust setup for precise calibration of E-field probes in tissue simulating liquids at mobile communications frequencies, ICECOM97, Oct. 1997, pp. 1 -124.
- [9] K. Pokovic, T. Schmid, and N. Kuster, E-field Probe with improved isotropy in brain simulating liquids, Proceedings of the ELMAR, Zadar, Croatia, June 23-25, 1996, pp. 172-175.
- [10] Schmid & Partner Engineering AG, Application Note: Data Storage and Evaluation, June 1998, p2.
- [11] V. Hombach, K. Meier, M. Burkhardt, E. Kuhn, N. Kuster, The Dependence of EM Energy Absorption upon Human Modeling at 900 MHz, IEEE Transaction on Microwave Theory and Techniques, vol. 44 no. 10, Oct. 1996, pp. 1865-1873.
- [12] N. Kuster and Q. Balzano, Energy absorption mechanism by biological bodies in the near field of dipole antennas above 300MHz, IEEE Transaction on Vehicular Technology, vol. 41, no. 1, Feb. 1992, pp. 17-23.
- [13] G. Hartsgrove, A. Kraszewski, A. Surowiec, Simulated Biological Materials for Electromagnetic Radiation Absorption Studies, University of Ottawa, Bioelectromagnetics, Canada: 1987, pp. 29-36.
- [14] Q. Balzano, O. Garay, T. Manning Jr., Electromagnetic Energy Exposure of Simulated Users of Portable Cellular Telephones, IEEE Transactions on Vehicular Technology, vol. 44, no.3, Aug. 1995.
- [15] W. Gander, Computermathematik, Birkhaeuser, Basel, 1992.
- [16] W.H. Press, S.A. Teukolsky, W.T. Vetterling, and B.P. Flannery, Numerical Recipes in C, The Art of Scientific Computing, Second edition, Cambridge University Press, 1992.
- [17] N. Kuster, R. Kastle, T. Schmid, Dosimetric evaluation of mobile communications equipment with known precision, IEEE Transaction on Communications, vol. E80-B, no. 5, May 1997, pp. 645-652.

FCC ID: A3LSMG998JPN	 <b>PCTEST</b> <small>Proud to be part of element</small>	<b>SAR EVALUATION REPORT</b>		<b>Approved by:</b> Quality Manager
<b>Document S/N:</b> 1M2101110003-01.A3L	<b>Test Dates:</b> 01/17/21 - 01/25/21	<b>DUT Type:</b> Portable Handset	Page 70 of 71	

- [18] CENELEC CLC/SC111B, European Prestandard (prENV 50166-2), Human Exposure to Electromagnetic Fields High-frequency: 10kHz-300GHz, Jan. 1995.
- [19] Prof. Dr. Niels Kuster, ETH, Eidgenössische Technische Hochschule Zürich, Dosimetric Evaluation of the Cellular Phone.
- [20] IEC 62209-1, Measurement procedure for the assessment of specific absorption rate of human exposure to radio frequency fields from hand-held and body-mounted wireless communication devices - Part 1: Devices used next to the ear (Frequency range of 300 MHz to 6 GHz), July 2016.
- [21] Innovation, Science, Economic Development Canada RSS-102 Radio Frequency Exposure Compliance of Radiocommunication Apparatus (All Frequency Bands) Issue 5, March 2015.
- [22] Health Canada Safety Code 6 Limits of Human Exposure to Radio Frequency Electromagnetic Fields in the Frequency Range from 3 kHz – 300 GHz, 2015
- [23] FCC SAR Test Procedures for 2G-3G Devices, Mobile Hotspot and UMPC Devices KDB Publications 941225, D01-D07
- [24] SAR Measurement Guidance for IEEE 802.11 Transmitters, KDB Publication 248227 D01
- [25] FCC SAR Considerations for Handsets with Multiple Transmitters and Antennas, KDB Publications 648474 D03-D04
- [26] FCC SAR Evaluation Considerations for Laptop, Notebook, Netbook and Tablet Computers, FCC KDB Publication 616217 D04
- [27] FCC SAR Measurement and Reporting Requirements for 100MHz – 6 GHz, KDB Publications 865664 D01-D02
- [28] FCC General RF Exposure Guidance and SAR Procedures for Dongles, KDB Publication 447498, D01-D02
- [29] Anexo à Resolução No. 533, de 10 de Setembro de 2009.
- [30] IEC 62209-2, Human exposure to radio frequency fields from hand-held and body-mounted wireless communication devices - Human models, instrumentation, and procedures - Part 2: Procedure to determine the specific absorption rate (SAR) for wireless communication devices used in close proximity to the human body (frequency range of 30 MHz to 6 GHz), Mar. 2010.

<b>FCC ID:</b> A3LSMG998JPN	 <b>PCTEST</b> <small>Proud to be part of element</small>	<b>SAR EVALUATION REPORT</b>		<b>Approved by:</b> Quality Manager
<b>Document S/N:</b> 1M2101110003-01.A3L	<b>Test Dates:</b> 01/17/21 - 01/25/21	<b>DUT Type:</b> Portable Handset	Page 71 of 71	

## APPENDIX A: SAR TEST DATA



# PCTEST

**DUT: A3LSMG998JPN; Type: Portable Handset; Serial: 0523M**

Communication System: UID 0, GSM; Frequency: 836.6 MHz; Duty Cycle: 1:8.3

Medium: 835 Head; Medium parameters used (interpolated):

$f = 836.6$  MHz;  $\sigma = 0.883$  S/m;  $\epsilon_r = 40.96$ ;  $\rho = 1000$  kg/m<sup>3</sup>

Phantom section: Right Section

Test Date: 01/20/2021; Ambient Temp: 22.3°C; Tissue Temp: 20.4°C

Probe: EX3DV4 - SN7539; ConvF(9.96, 9.96, 9.96) @ 836.6 MHz; Calibrated: 10/20/2020

Sensor-Surface: 1.4mm (Mechanical Surface Detection)

Electronics: DAE4 Sn728; Calibrated: 5/20/2020

Phantom: Twin-SAM V8.0; Type: QD 000 P41 Ax; Serial: 1966

Measurement SW: DASY52, Version 52.10 (4);SEMCAD X Version 14.6.14 (7483)

**Mode: GSM 850, Right Head, Cheek, Mid.ch**

**Area Scan (9x13x1):** Measurement grid: dx=15mm, dy=15mm

**Zoom Scan (5x5x7)/Cube 0:** Measurement grid: dx=8mm, dy=8mm, dz=5mm

Reference Value = 9.444 V/m; Power Drift = 0.03 dB

Peak SAR (extrapolated) = 0.101 W/kg

**SAR(1 g) = 0.079 W/kg**

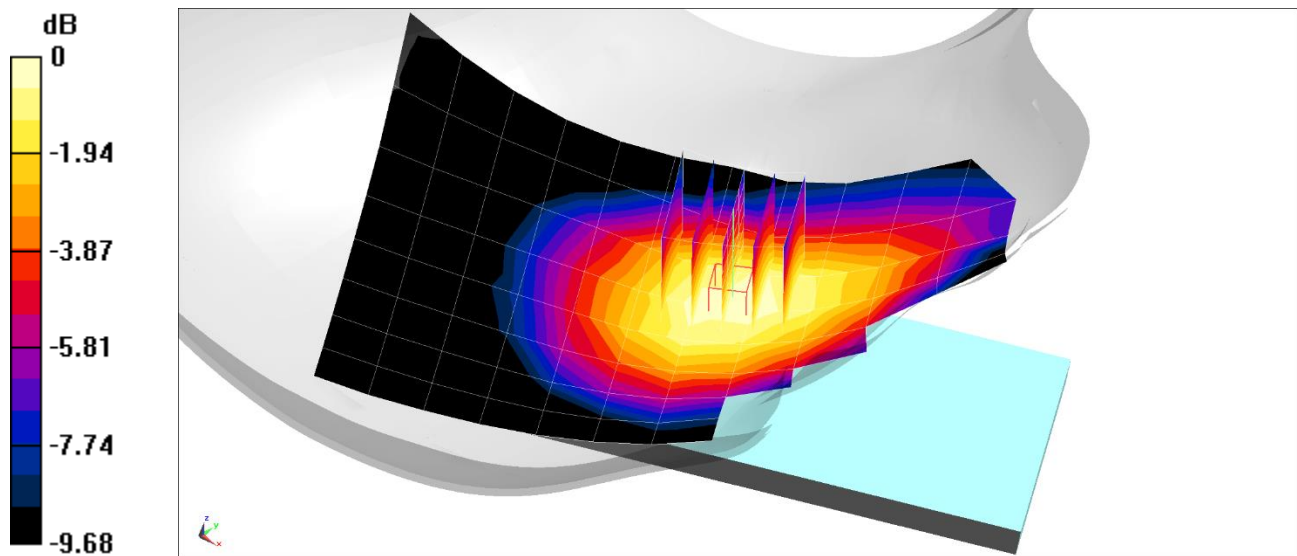

0 dB = 0.0938 W/kg = -10.28 dBW/kg

# PCTEST

**DUT: A3LSMG998JPN; Type: Portable Handset; Serial: 0482M**

Communication System: UID 0, GSM; Frequency: 1880 MHz; Duty Cycle: 1:8.3

Medium: 1900 Head; Medium parameters used:

$f = 1880$  MHz;  $\sigma = 1.385$  S/m;  $\epsilon_r = 40.438$ ;  $\rho = 1000$  kg/m<sup>3</sup>

Phantom section: Left Section

Test Date: 01/21/2021; Ambient Temp: 23.5°C; Tissue Temp: 25.0°C

Probe: EX3DV4 - SN7357; ConvF(8.32, 8.32, 8.32) @ 1880 MHz; Calibrated: 4/21/2020

Sensor-Surface: 1.4mm (Mechanical Surface Detection)

Electronics: DAE4 Sn1407; Calibrated: 4/15/2020

Phantom: Twin-SAM V5.0 Left 30; Type: QD 000 P40 CD; Serial: 1715

Measurement SW: DASY52, Version 52.10 (4);SEMCAD X Version 14.6.14 (7483)

**Mode: GSM 1900, Left Head, Cheek, Mid.ch**

**Area Scan (9x15x1):** Measurement grid: dx=15mm, dy=15mm

**Zoom Scan (5x5x7)/Cube 0:** Measurement grid: dx=8mm, dy=8mm, dz=5mm

Reference Value = 6.659 V/m; Power Drift = 0.07 dB

Peak SAR (extrapolated) = 0.0870 W/kg

**SAR(1 g) = 0.054 W/kg**

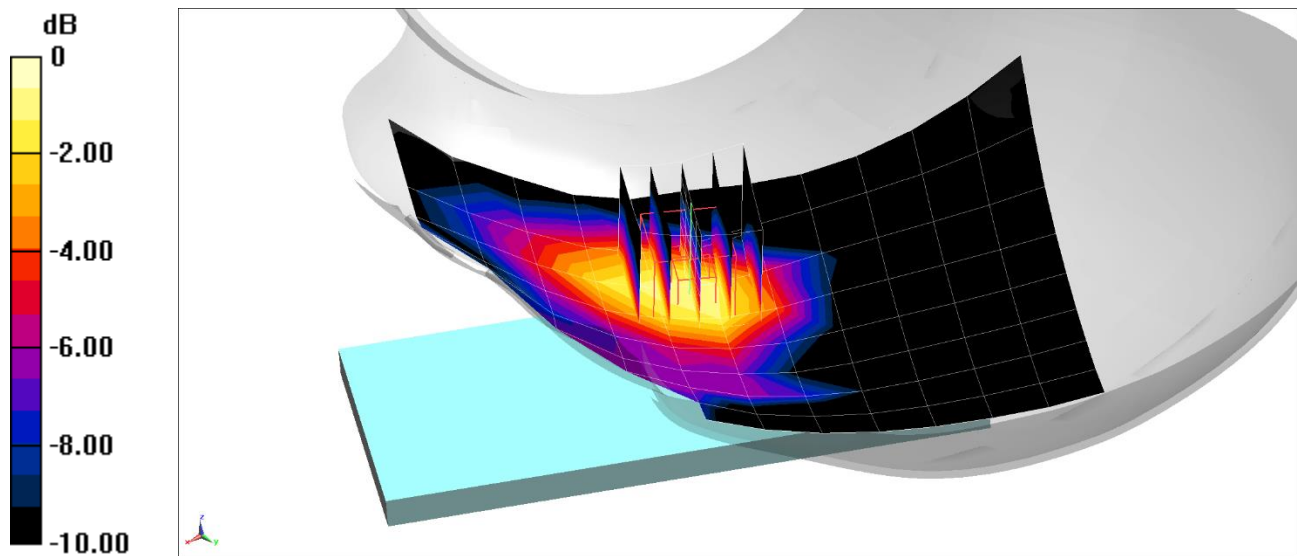

0 dB = 0.0759 W/kg = -11.20 dBW/kg

# PCTEST

**DUT: A3LSMG998JPN; Type: Portable Handset; Serial: 0482M**

Communication System: UID 0, UMTS; Frequency: 836.6 MHz; Duty Cycle: 1:1  
Medium: 835 Head; Medium parameters used (interpolated):  
 $f = 836.6 \text{ MHz}$ ;  $\sigma = 0.883 \text{ S/m}$ ;  $\epsilon_r = 40.96$ ;  $\rho = 1000 \text{ kg/m}^3$   
Phantom section: Right Section

Test Date: 01/20/2021; Ambient Temp: 22.3°C; Tissue Temp: 20.4°C

Probe: EX3DV4 - SN7539; ConvF(9.96, 9.96, 9.96) @ 836.6 MHz; Calibrated: 10/20/2020  
Sensor-Surface: 1.4mm (Mechanical Surface Detection)  
Electronics: DAE4 Sn728; Calibrated: 5/20/2020  
Phantom: Twin-SAM V8.0; Type: QD 000 P41 Ax; Serial: 1966  
Measurement SW: DASY52, Version 52.10 (4);SEMCAD X Version 14.6.14 (7483)

**Mode: UMTS 850, Right Head, Cheek, Mid.ch**

**Area Scan (9x13x1):** Measurement grid: dx=15mm, dy=15mm

**Zoom Scan (5x5x7)/Cube 0:** Measurement grid: dx=8mm, dy=8mm, dz=5mm

Reference Value = 11.41 V/m; Power Drift = 0.02 dB

Peak SAR (extrapolated) = 0.143 W/kg

**SAR(1 g) = 0.111 W/kg**

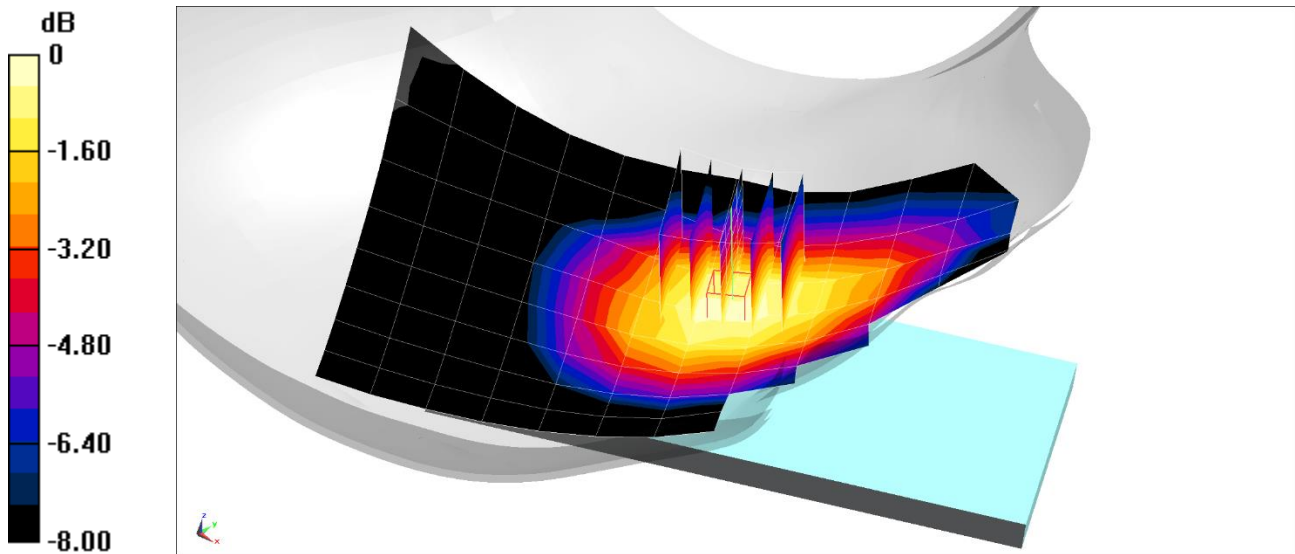

0 dB = 0.132 W/kg = -8.79 dBW/kg

# PCTEST

**DUT: A3LSMG998JPN; Type: Portable Handset; Serial: 0521M**

Communication System: UID 0, LTE Band 12; Frequency: 707.5 MHz; Duty Cycle: 1:1  
Medium: 750 Head; Medium parameters used (interpolated):  
 $f = 707.5$  MHz;  $\sigma = 0.908$  S/m;  $\epsilon_r = 41.529$ ;  $\rho = 1000$  kg/m<sup>3</sup>  
Phantom section: Right Section

Test Date: 01/21/2021; Ambient Temp: 23.3°C; Tissue Temp: 22.3°C

Probe: EX3DV4 - SN7571; ConvF(10.02, 10.02, 10.02) @ 707.5 MHz; Calibrated: 12/11/2020  
Sensor-Surface: 1.4mm (Mechanical Surface Detection)  
Electronics: DAE4 Sn1533; Calibrated: 12/7/2020  
Phantom: Front Twin-SAM V5.0 (30); Type: QD 000 P40 CD; Serial: 1648  
Measurement SW: DASY52, Version 52.10 (4);SEMCAD X Version 14.6.14 (7483)

**Mode: LTE Band 12, Right Head, Cheek, Mid.ch,  
10 MHz Bandwidth, QPSK, 1 RB, 0 RB Offset**

**Area Scan (9x13x1):** Measurement grid: dx=15mm, dy=15mm  
**Zoom Scan (5x5x7)/Cube 0:** Measurement grid: dx=8mm, dy=8mm, dz=5mm  
Reference Value = 9.513 V/m; Power Drift = 0.00 dB  
Peak SAR (extrapolated) = 0.0960 W/kg  
**SAR(1 g) = 0.074 W/kg**

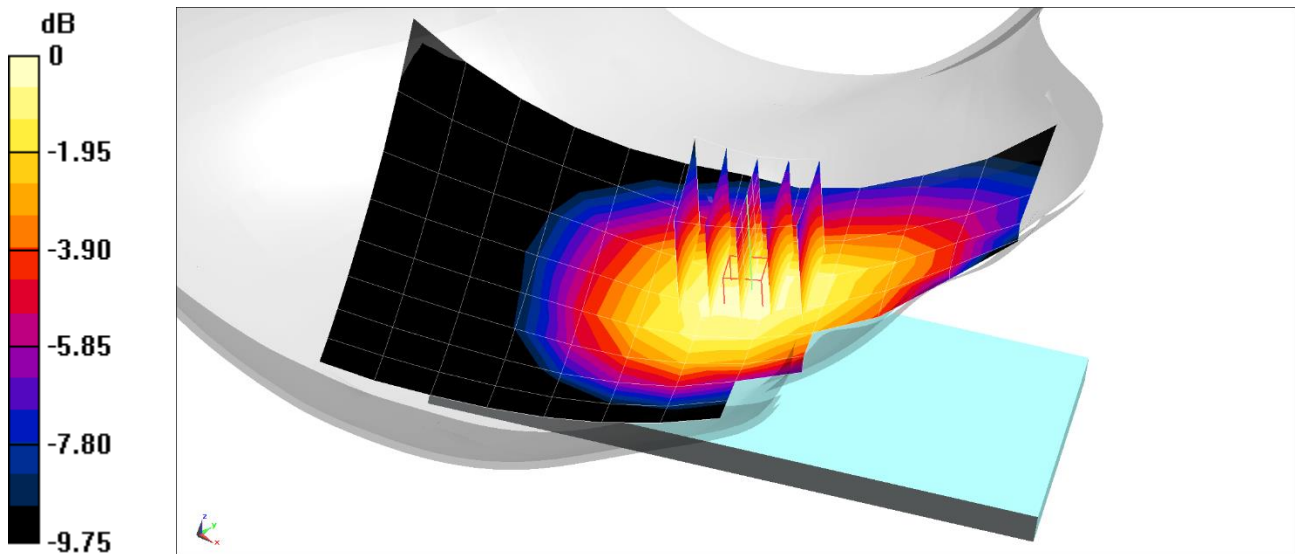

0 dB = 0.0887 W/kg = -10.52 dBW/kg

# PCTEST

**DUT: A3LSMG998JPN; Type: Portable Handset; Serial: 0521M**

Communication System: UID 0, LTE Band 13; Frequency: 782 MHz; Duty Cycle: 1:1  
Medium: 750 Head; Medium parameters used (interpolated):  
 $f = 782 \text{ MHz}$ ;  $\sigma = 0.933 \text{ S/m}$ ;  $\epsilon_r = 41.335$ ;  $\rho = 1000 \text{ kg/m}^3$   
Phantom section: Right Section

Test Date: 01/21/2021; Ambient Temp: 23.3°C; Tissue Temp: 22.3°C

Probe: EX3DV4 - SN7571; ConvF(10.02, 10.02, 10.02) @ 782 MHz; Calibrated: 12/11/2020  
Sensor-Surface: 1.4mm (Mechanical Surface Detection)  
Electronics: DAE4 Sn1533; Calibrated: 12/7/2020  
Phantom: Front Twin-SAM V5.0 (30); Type: QD 000 P40 CD; Serial: 1648  
Measurement SW: DASY52, Version 52.10 (4);SEMCAD X Version 14.6.14 (7483)

**Mode: LTE Band 13, Right Head, Cheek, Mid.ch,  
10 MHz Bandwidth, QPSK, 1 RB, 49 RB Offset**

**Area Scan (9x15x1):** Measurement grid: dx=15mm, dy=15mm  
**Zoom Scan (5x5x7)/Cube 0:** Measurement grid: dx=8mm, dy=8mm, dz=5mm  
Reference Value = 10.62 V/m; Power Drift = 0.05 dB  
Peak SAR (extrapolated) = 0.123 W/kg  
**SAR(1 g) = 0.094 W/kg**

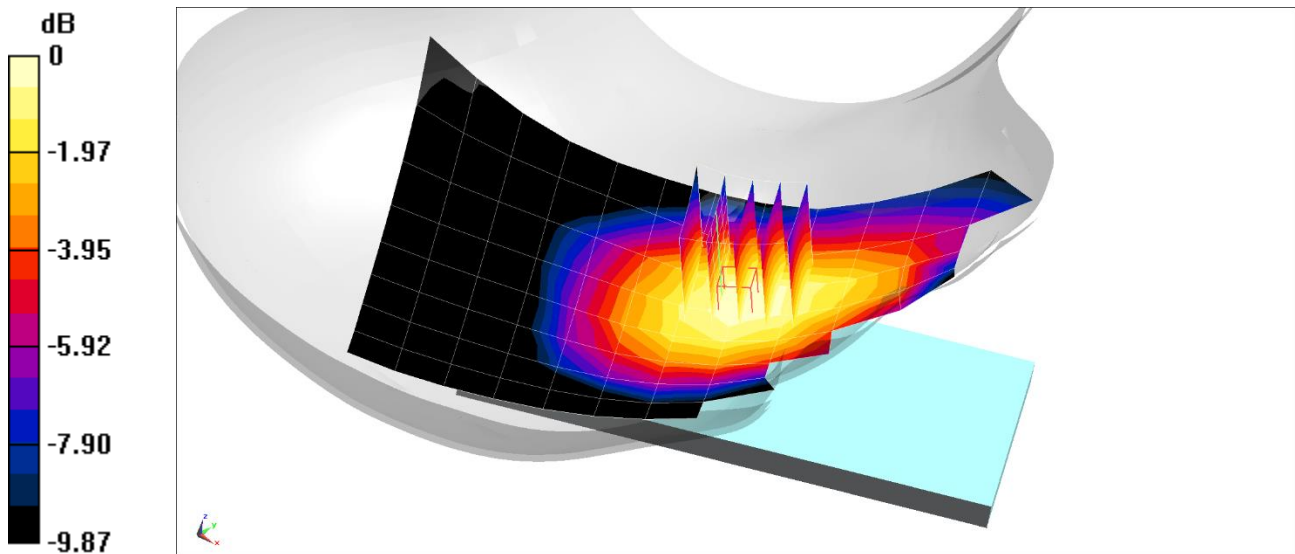

0 dB = 0.111 W/kg = -9.55 dBW/kg

# PCTEST

**DUT: A3LSMG998JPN; Type: Portable Handset; Serial: 0523M**

Communication System: UID 0, LTE Band 5 (Cell.); Frequency: 836.5 MHz; Duty Cycle: 1:1  
Medium: 835 Head; Medium parameters used (interpolated):  
 $f = 836.5$  MHz;  $\sigma = 0.883$  S/m;  $\epsilon_r = 40.962$ ;  $\rho = 1000$  kg/m<sup>3</sup>  
Phantom section: Right Section

Test Date: 01/20/2021; Ambient Temp: 22.3°C; Tissue Temp: 20.4°C

Probe: EX3DV4 - SN7539; ConvF(9.96, 9.96, 9.96) @ 836.5 MHz; Calibrated: 10/20/2020  
Sensor-Surface: 1.4mm (Mechanical Surface Detection)  
Electronics: DAE4 Sn728; Calibrated: 5/20/2020  
Phantom: Twin-SAM V8.0; Type: QD 000 P41 Ax; Serial: 1966  
Measurement SW: DASY52, Version 52.10 (4);SEMCAD X Version 14.6.14 (7483)

**Mode: LTE Band 5 (Cell.), Right Head, Cheek, Mid.ch,  
10 MHz Bandwidth, QPSK, 1 RB, 0 RB Offset**

**Area Scan (9x13x1):** Measurement grid: dx=15mm, dy=15mm  
**Zoom Scan (5x5x7)/Cube 0:** Measurement grid: dx=8mm, dy=8mm, dz=5mm  
Reference Value = 13.29 V/m; Power Drift = 0.00 dB  
Peak SAR (extrapolated) = 0.183 W/kg  
**SAR(1 g) = 0.142 W/kg**

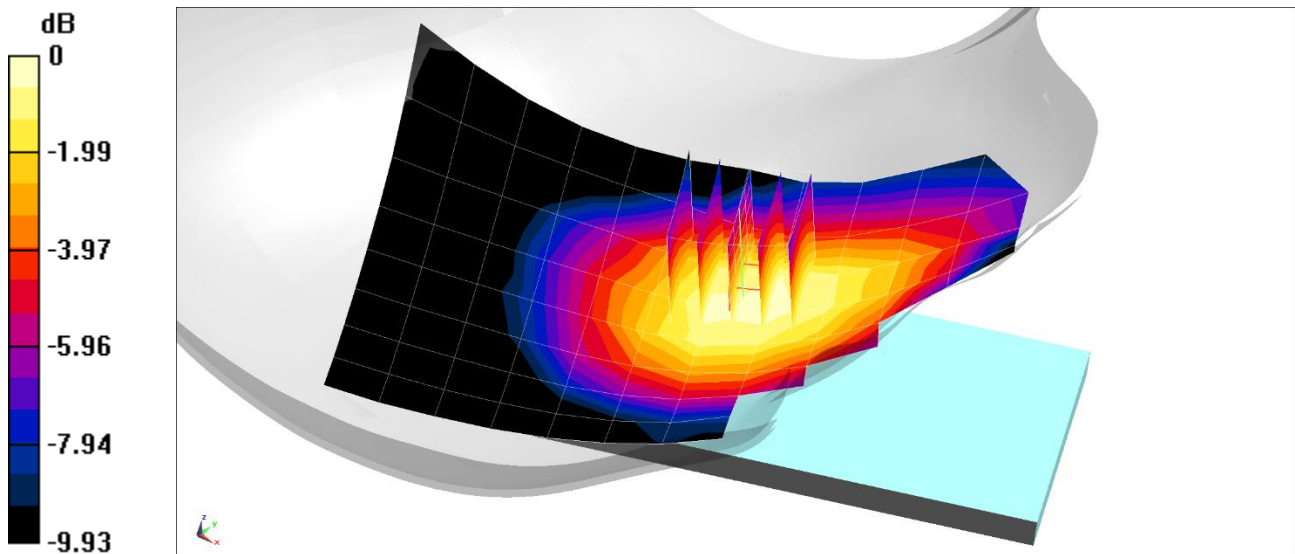

0 dB = 0.170 W/kg = -7.70 dBW/kg

# PCTEST

**DUT: A3LSMG998JPN; Type: Portable Handset; Serial: 0482M**

Communication System: UID 0, LTE Band 4 (AWS); Frequency: 1732.5 MHz; Duty Cycle: 1:1  
Medium: 1750 Head; Medium parameters used (interpolated):  
 $f = 1732.5$  MHz;  $\sigma = 1.38$  S/m;  $\epsilon_r = 39.664$ ;  $\rho = 1000$  kg/m<sup>3</sup>  
Phantom section: Left Section

Test Date: 01/19/2021; Ambient Temp: 22.6°C; Tissue Temp: 22.6°C

Probe: EX3DV4 - SN7357; ConvF(8.69, 8.69, 8.69) @ 1732.5 MHz; Calibrated: 4/21/2020  
Sensor-Surface: 1.4mm (Mechanical Surface Detection)  
Electronics: DAE4 Sn1407; Calibrated: 4/15/2020  
Phantom: Twin-SAM V5.0 Left 30; Type: QD 000 P40 CD; Serial: 1715  
Measurement SW: DASY52, Version 52.10 (4);SEMCAD X Version 14.6.14 (7483)

**Mode: LTE Band 4 (AWS), Left Head, Cheek, Mid.ch,  
20 MHz Bandwidth, QPSK, 1 RB, 50 RB Offset**

**Area Scan (9x13x1):** Measurement grid: dx=15mm, dy=15mm  
**Zoom Scan (5x5x7)/Cube 0:** Measurement grid: dx=8mm, dy=8mm, dz=5mm  
Reference Value = 8.729 V/m; Power Drift = 0.11 dB  
Peak SAR (extrapolated) = 0.142 W/kg  
**SAR(1 g) = 0.091 W/kg**

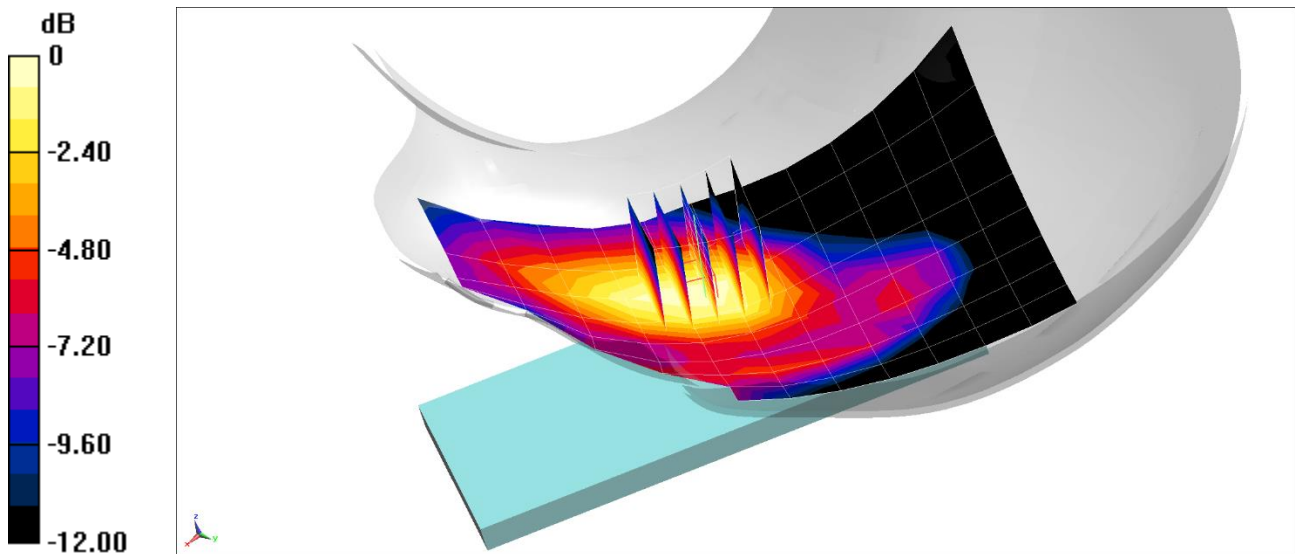

0 dB = 0.119 W/kg = -9.24 dBW/kg

# PCTEST

**DUT: A3LSMG998JPN; Type: Portable Handset; Serial: 0482M**

Communication System: UID 0, LTE Band 41; Frequency: 2593 MHz; Duty Cycle: 1:1.58  
Medium: 2450 Head; Medium parameters used (interpolated):  
 $f = 2593 \text{ MHz}$ ;  $\sigma = 1.939 \text{ S/m}$ ;  $\epsilon_r = 37.462$ ;  $\rho = 1000 \text{ kg/m}^3$   
Phantom section: Right Section

Test Date: 01/20/2021; Ambient Temp: 23.1°C; Tissue Temp: 22.4°C

Probe: EX3DV4 - SN7571; ConvF(7.05, 7.05, 7.05) @ 2593 MHz; Calibrated: 12/11/2020  
Sensor-Surface: 1.4mm (Mechanical Surface Detection)  
Electronics: DAE4 Sn1533; Calibrated: 12/7/2020  
Phantom: Twin-SAM V5.0 (30); Type: QD 000 P40 CD; Serial: 1647  
Measurement SW: DASY52, Version 52.10 (4);SEMCAD X Version 14.6.14 (7483)

**Mode: LTE Band 41, Right Head, Cheek, Mid.ch,  
20 MHz Bandwidth, QPSK, 1 RB, 50 RB Offset**

**Area Scan (11x17x1):** Measurement grid: dx=12mm, dy=12mm

**Zoom Scan (7x7x7)/Cube 0:** Measurement grid: dx=5mm, dy=5mm, dz=5mm

Reference Value = 6.021 V/m; Power Drift = 0.04 dB

Peak SAR (extrapolated) = 0.108 W/kg

**SAR(1 g) = 0.058 W/kg**

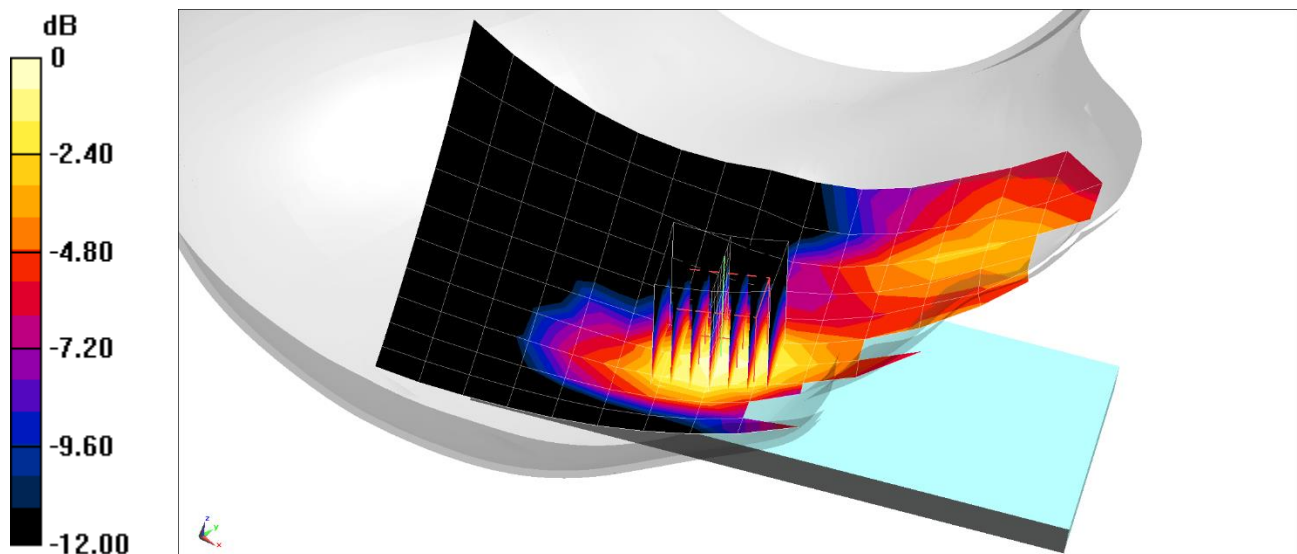

0 dB = 0.0883 W/kg = -10.54 dBW/kg



# PCTEST

**DUT: A3LSMG998JPN; Type: Portable Handset; Serial: 0280M**

Communication System: UID 0, IEEE 802.11b; Frequency: 2437 MHz; Duty Cycle: 1:1  
Medium: 2450 Head; Medium parameters used (interpolated):  
 $f = 2437$  MHz;  $\sigma = 1.761$  S/m;  $\epsilon_r = 38.047$ ;  $\rho = 1000$  kg/m<sup>3</sup>  
Phantom section: Left Section

Test Date: 01/20/2021; Ambient Temp: 23.1°C; Tissue Temp: 22.4°C

Probe: EX3DV4 - SN7571; ConvF(7.28, 7.28, 7.28) @ 2437 MHz; Calibrated: 12/11/2020  
Sensor-Surface: 1.4mm (Mechanical Surface Detection)  
Electronics: DAE4 Sn1533; Calibrated: 12/7/2020  
Phantom: Twin-SAM V5.0 (30); Type: QD 000 P40 CD; Serial: 1647  
Measurement SW: DASY52, Version 52.10 (4);SEMCAD X Version 14.6.14 (7483)

**Mode: IEEE 802.11b, Antenna 2, 22 MHz Bandwidth,  
Left Head, Cheek, Ch 6, 1 Mbps**

**Area Scan (11x18x1):** Measurement grid: dx=12mm, dy=12mm  
**Zoom Scan (7x7x7)/Cube 0:** Measurement grid: dx=5mm, dy=5mm, dz=5mm  
Reference Value = 2.927 V/m; Power Drift = 0.14 dB  
Peak SAR (extrapolated) = 0.533 W/kg  
**SAR(1 g) = 0.202 W/kg**

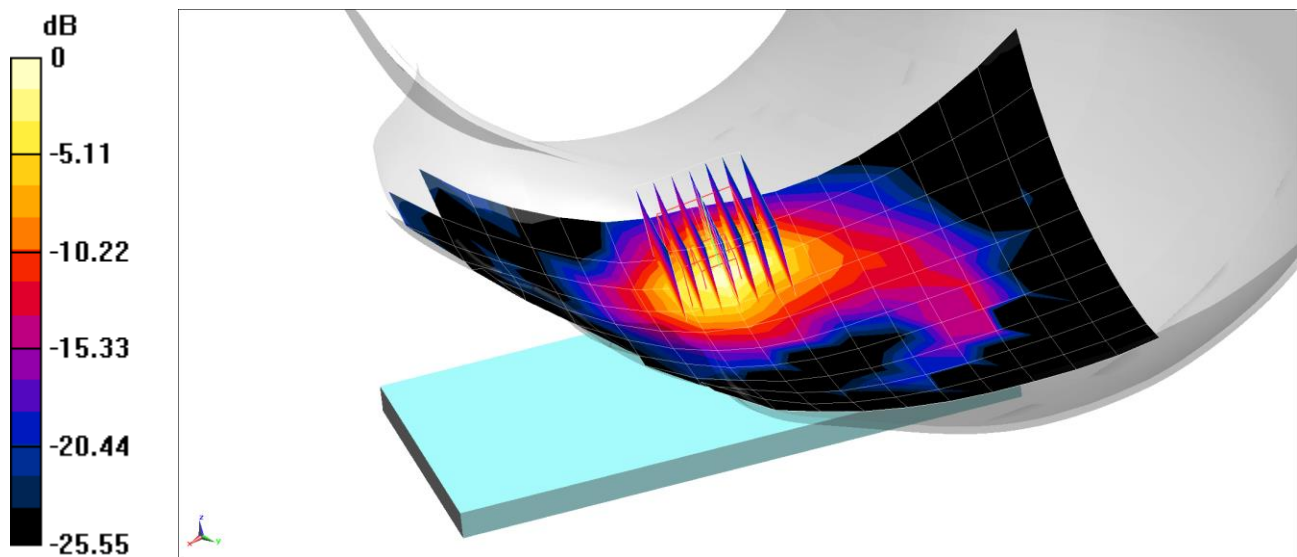

0 dB = 0.371 W/kg = -4.31 dBW/kg

# PCTEST

**DUT: A3LSMG998JPN; Type: Portable Handset; Serial: 0289M**

Communication System: UID 0, IEEE 802.11ac; Frequency: 5290 MHz; Duty Cycle: 1:1  
Medium: 5200-5800 Head; Medium parameters used:  
 $f = 5290 \text{ MHz}$ ;  $\sigma = 4.541 \text{ S/m}$ ;  $\epsilon_r = 34.515$ ;  $\rho = 1000 \text{ kg/m}^3$   
Phantom section: Left Section

Test Date: 01/22/2021; Ambient Temp: 22.5°C; Tissue Temp: 23.0°C

Probe: EX3DV4 - SN7357; ConvF(5.5, 5.5, 5.5) @ 5290 MHz; Calibrated: 4/21/2020  
Sensor-Surface: 1.4mm (Mechanical Surface Detection)  
Electronics: DAE4 Sn1407; Calibrated: 4/15/2020  
Phantom: Twin-SAM V5.0 Left 20; Type: QD 000 P40 CD; Serial: 1715  
Measurement SW: DASY52, Version 52.10 (4);SEMCAD X Version 14.6.14 (7483)

**Mode: IEEE 802.11ac, MIMO, U-NII-2A, 80 MHz Bandwidth,  
Left Head, Cheek, Ch 58, 58.5 Mbps**

**Area Scan (13x21x1):** Measurement grid: dx=10mm, dy=10mm

**Zoom Scan (8x8x7)/Cube 0:** Measurement grid: dx=4mm, dy=4mm, dz=1.4mm; Graded Ratio: 1.4

Reference Value = 0.4110 V/m; Power Drift = 0.12 dB

Peak SAR (extrapolated) = 0.719 W/kg

**SAR(1 g) = 0.182 W/kg**

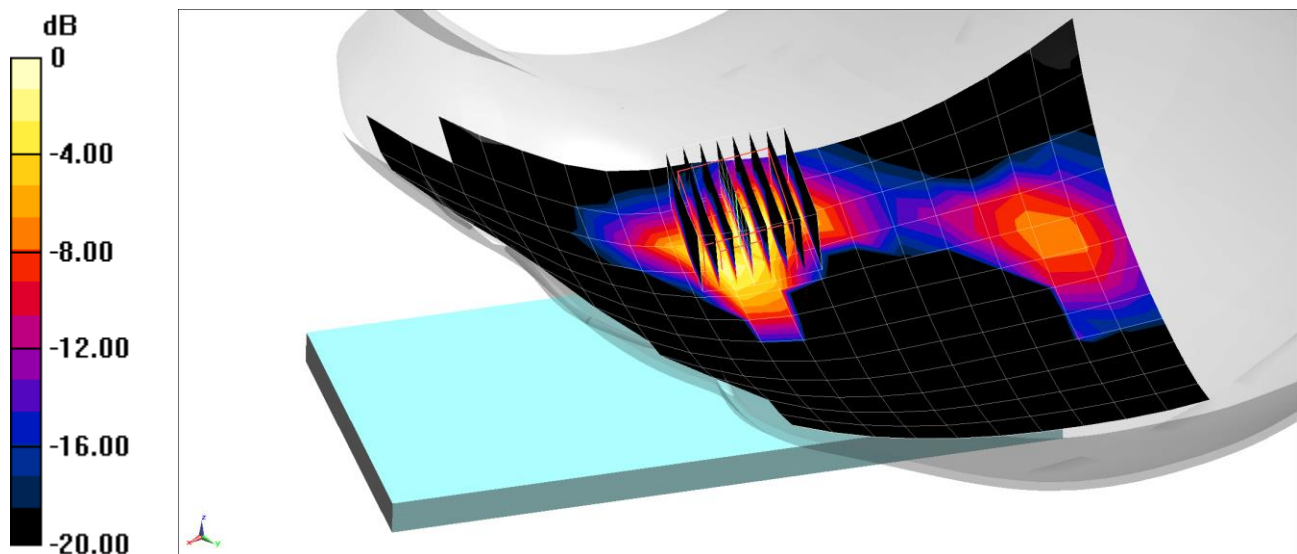

0 dB = 0.453 W/kg = -3.44 dBW/kg

# PCTEST

**DUT: A3LSMG998JPN; Type: Portable Handset; Serial: 0023M**

Communication System: UID 0, Bluetooth; Frequency: 2441 MHz; Duty Cycle: 1:1.297  
Medium: 2450 Head; Medium parameters used (interpolated):  
 $f = 2441 \text{ MHz}$ ;  $\sigma = 1.849 \text{ S/m}$ ;  $\epsilon_r = 38.721$ ;  $\rho = 1000 \text{ kg/m}^3$   
Phantom section: Left Section

Test Date: 01/18/2021; Ambient Temp: 22.9°C; Tissue Temp: 22.3°C

Probe: EX3DV4 - SN7571; ConvF(7.28, 7.28, 7.28) @ 2441 MHz; Calibrated: 12/11/2020  
Sensor-Surface: 1.4mm (Mechanical Surface Detection)  
Electronics: DAE4 Sn1533; Calibrated: 12/7/2020  
Phantom: Twin-SAM V5.0 (30); Type: QD 000 P40 CD; Serial: 1647  
Measurement SW: DASY52, Version 52.10 (4);SEMCAD X Version 14.6.14 (7483)

**Mode: Bluetooth, Antenna 2, Left Head, Cheek, Ch 39, 1 Mbps**

**Area Scan (11x17x1):** Measurement grid: dx=12mm, dy=12mm

**Zoom Scan (7x7x7)/Cube 0:** Measurement grid: dx=5mm, dy=5mm, dz=5mm

Reference Value = 7.119 V/m; Power Drift = 0.14 dB

Peak SAR (extrapolated) = 0.232 W/kg

**SAR(1 g) = 0.086 W/kg**

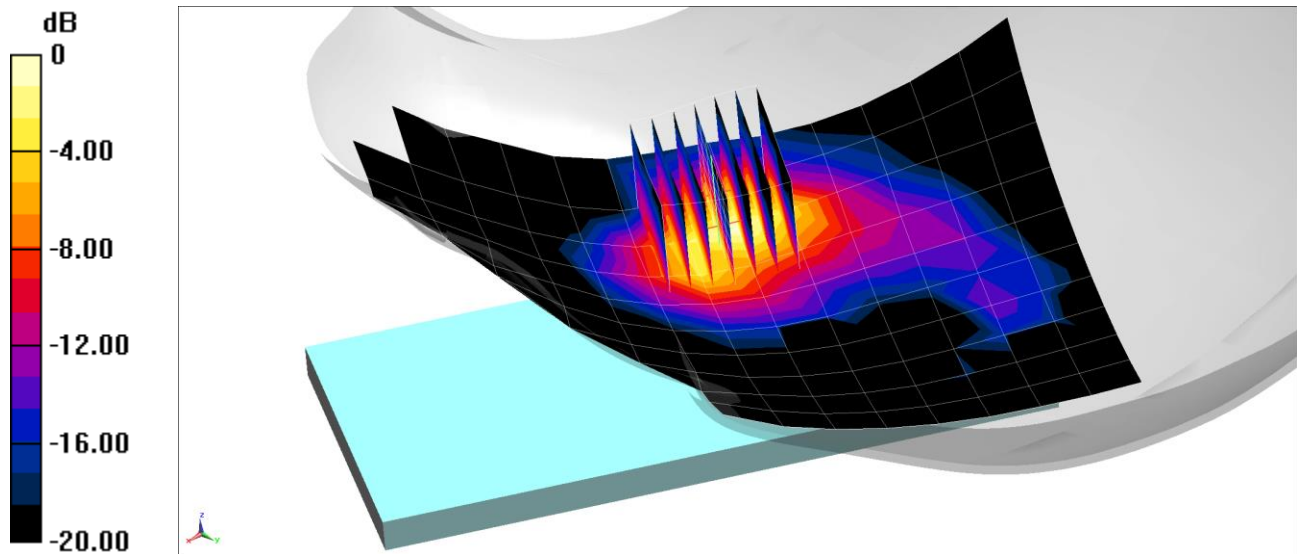

0 dB = 0.161 W/kg = -7.93 dBW/kg

# PCTEST

**DUT: A3LSMG998JPN; Type: Portable Handset; Serial: 0532M**

Communication System: UID 0, GSM; Frequency: 836.6 MHz; Duty Cycle: 1:8.3  
Medium: 835 Body; Medium parameters used (interpolated):  
 $f = 836.6$  MHz;  $\sigma = 0.961$  S/m;  $\epsilon_r = 53.566$ ;  $\rho = 1000$  kg/m<sup>3</sup>  
Phantom section: Flat Section; Space: 1.5 cm

Test Date: 01/20/2021; Ambient Temp: 23.1°C; Tissue Temp: 22.3°C

Probe: EX3DV4 - SN7552; ConvF(9.96, 9.96, 9.96) @ 836.6 MHz; Calibrated: 9/11/2020  
Sensor-Surface: 1.4mm (Mechanical Surface Detection)  
Electronics: DAE4 Sn1449; Calibrated: 9/10/2020  
Phantom: Twin-SAM V4.0 Left 30; Type: QD 000 P40 CC; Serial: 1687  
Measurement SW: DASY52, Version 52.10 (4);SEMCAD X Version 14.6.14 (7483)

**Mode: GSM 850, Body SAR, Back side, Mid.ch**

**Area Scan (9x15x1):** Measurement grid: dx=15mm, dy=15mm

**Zoom Scan (5x5x7)/Cube 0:** Measurement grid: dx=8mm, dy=8mm, dz=5mm

Reference Value = 13.79 V/m; Power Drift = -0.02 dB

Peak SAR (extrapolated) = 0.278 W/kg

**SAR(1 g) = 0.168 W/kg**

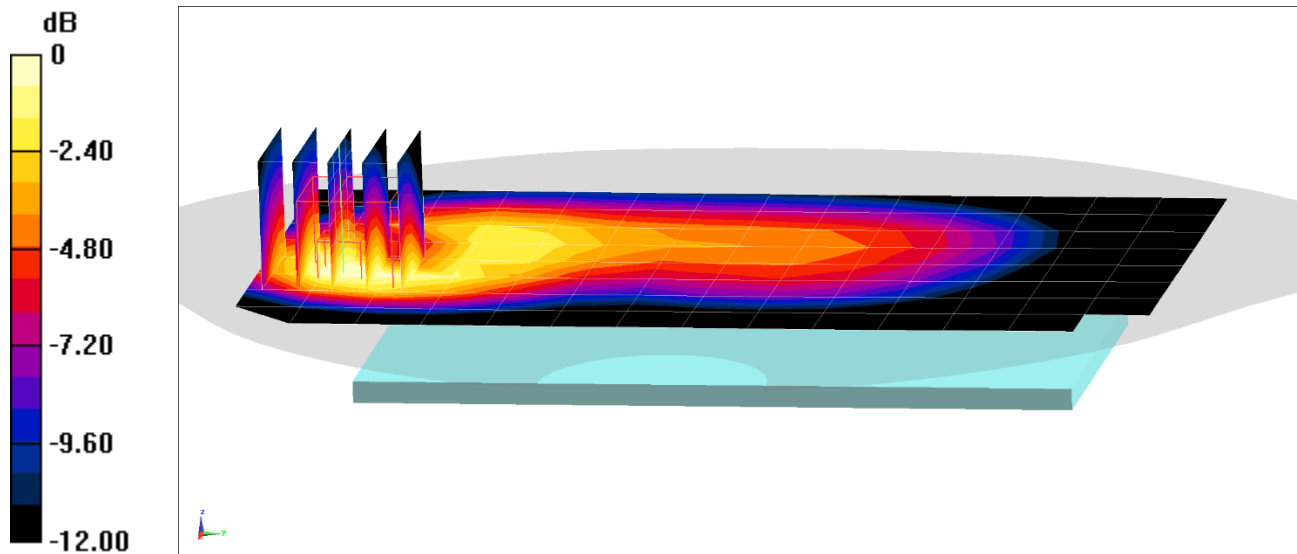

0 dB = 0.239 W/kg = -6.22 dBW/kg

# PCTEST

**DUT: A3LSMG998JPN; Type: Portable Handset; Serial: 0532M**

Communication System: UID 0, GSM GPRS; 3 Tx slots; Frequency: 836.6 MHz; Duty Cycle: 1:2.76  
Medium: 835 Body; Medium parameters used (interpolated):  
 $f = 836.6 \text{ MHz}$ ;  $\sigma = 0.961 \text{ S/m}$ ;  $\epsilon_r = 53.566$ ;  $\rho = 1000 \text{ kg/m}^3$   
Phantom section: Flat Section; Space: 1.0 cm

Test Date: 01/20/2021; Ambient Temp: 23.1°C; Tissue Temp: 22.3°C

Probe: EX3DV4 - SN7552; ConvF(9.96, 9.96, 9.96) @ 836.6 MHz; Calibrated: 9/11/2020  
Sensor-Surface: 1.4mm (Mechanical Surface Detection)  
Electronics: DAE4 Sn1449; Calibrated: 9/10/2020  
Phantom: Twin-SAM V4.0 Left 30; Type: QD 000 P40 CC; Serial: 1687  
Measurement SW: DASY52, Version 52.10 (4);SEMCAD X Version 14.6.14 (7483)

**Mode: GPRS 850, Body SAR, Back side, Mid.ch, 3 Tx Slots**

**Area Scan (9x15x1):** Measurement grid: dx=15mm, dy=15mm

**Zoom Scan (5x5x7)/Cube 0:** Measurement grid: dx=8mm, dy=8mm, dz=5mm

Reference Value = 19.87 V/m; Power Drift = -0.08 dB

Peak SAR (extrapolated) = 0.632 W/kg

**SAR(1 g) = 0.363 W/kg**

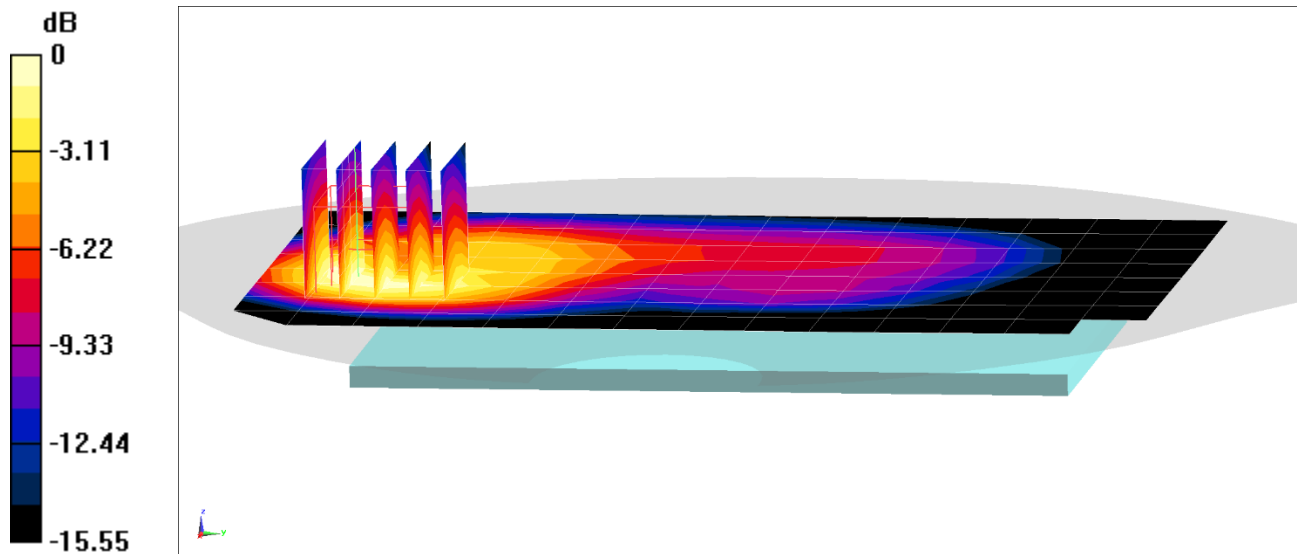

0 dB = 0.513 W/kg = -2.90 dBW/kg

# PCTEST

**DUT: A3LSMG998JPN; Type: Portable Handset; Serial: 0521M**

Communication System: UID 0, GSM; Frequency: 1880 MHz; Duty Cycle: 1:8.3

Medium: 1900 Body; Medium parameters used:

$f = 1880 \text{ MHz}$ ;  $\sigma = 1.514 \text{ S/m}$ ;  $\epsilon_r = 52.402$ ;  $\rho = 1000 \text{ kg/m}^3$

Phantom section: Flat Section; Space: 1.5 cm

Test Date: 01/17/2021; Ambient Temp: 20.3°C; Tissue Temp: 22.8°C

Probe: EX3DV4 - SN7410; ConvF(7.76, 7.76, 7.76) @ 1880 MHz; Calibrated: 7/20/2020

Sensor-Surface: 1.4mm (Mechanical Surface Detection)

Electronics: DAE4 Sn1322; Calibrated: 7/15/2020

Phantom: SAM Left; Type: QD000P40CC; Serial: TP: 1375

Measurement SW: DASY52, Version 52.10 (4);SEMCAD X Version 14.6.14 (7483)

**Mode: GSM 1900, Body SAR, Back side, Mid.ch**

**Area Scan (9x15x1):** Measurement grid: dx=15mm, dy=15mm

**Zoom Scan (5x5x7)/Cube 0:** Measurement grid: dx=8mm, dy=8mm, dz=5mm

Reference Value = 13.75 V/m; Power Drift = -0.11 dB

Peak SAR (extrapolated) = 0.406 W/kg

**SAR(1 g) = 0.257 W/kg**

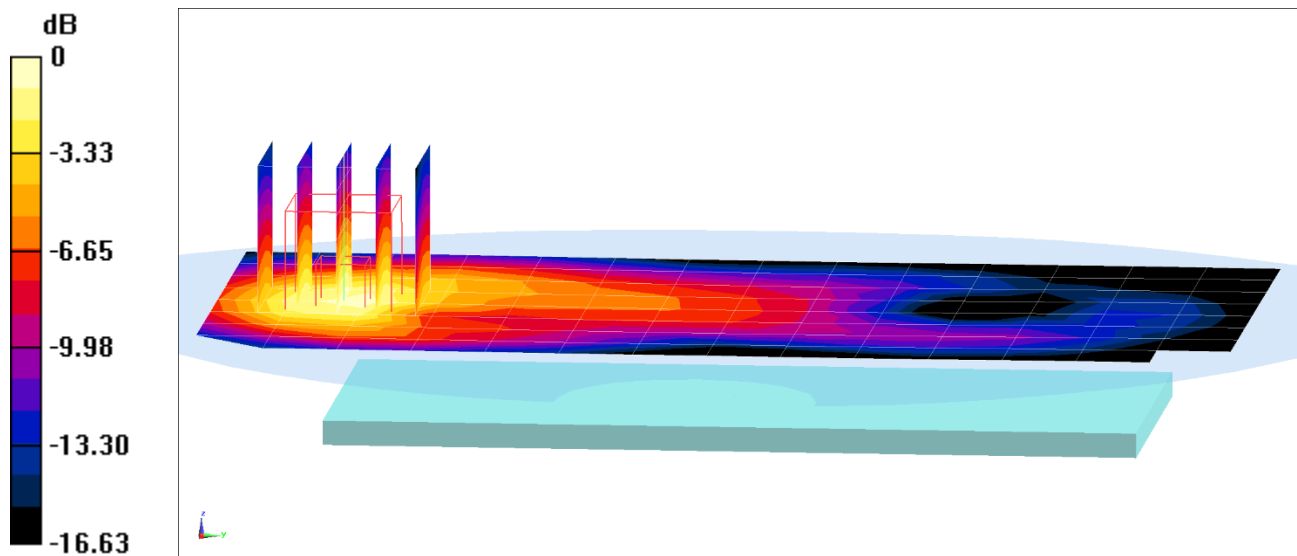

0 dB = 0.357 W/kg = -4.47 dBW/kg

# PCTEST

**DUT: A3LSMG998JPN; Type: Portable Handset; Serial: 0521M**

Communication System: UID 0, GSM GPRS; 4 Tx slots; Frequency: 1909.8 MHz; Duty Cycle: 1:2.076

Medium: 1900 Body; Medium parameters used:  
 $f = 1910 \text{ MHz}$ ;  $\sigma = 1.55 \text{ S/m}$ ;  $\epsilon_r = 53$ ;  $\rho = 1000 \text{ kg/m}^3$   
Phantom section: Flat Section; Space: 1.0 cm

Test Date: 01/24/2021; Ambient Temp: 22.1°C; Tissue Temp: 22.6°C

Probe: EX3DV4 - SN7410; ConvF(7.76, 7.76, 7.76) @ 1909.8 MHz; Calibrated: 7/20/2020

Sensor-Surface: 1.4mm (Mechanical Surface Detection)

Electronics: DAE4 Sn1322; Calibrated: 7/15/2020

Phantom: SAM Left; Type: QD000P40CC; Serial: TP: 1375

Measurement SW: DASY52, Version 52.10 (4);SEMCAD X Version 14.6.14 (7483)

**Mode: GPRS 1900, Body SAR, Bottom Edge, High.ch, 4 Tx Slots**

**Area Scan (10x7x1):** Measurement grid: dx=5mm, dy=15mm

**Zoom Scan (5x5x7)/Cube 0:** Measurement grid: dx=8mm, dy=8mm, dz=5mm

Reference Value = 23.50 V/m; Power Drift = -0.04 dB

Peak SAR (extrapolated) = 1.35 W/kg

**SAR(1 g) = 0.766 W/kg**

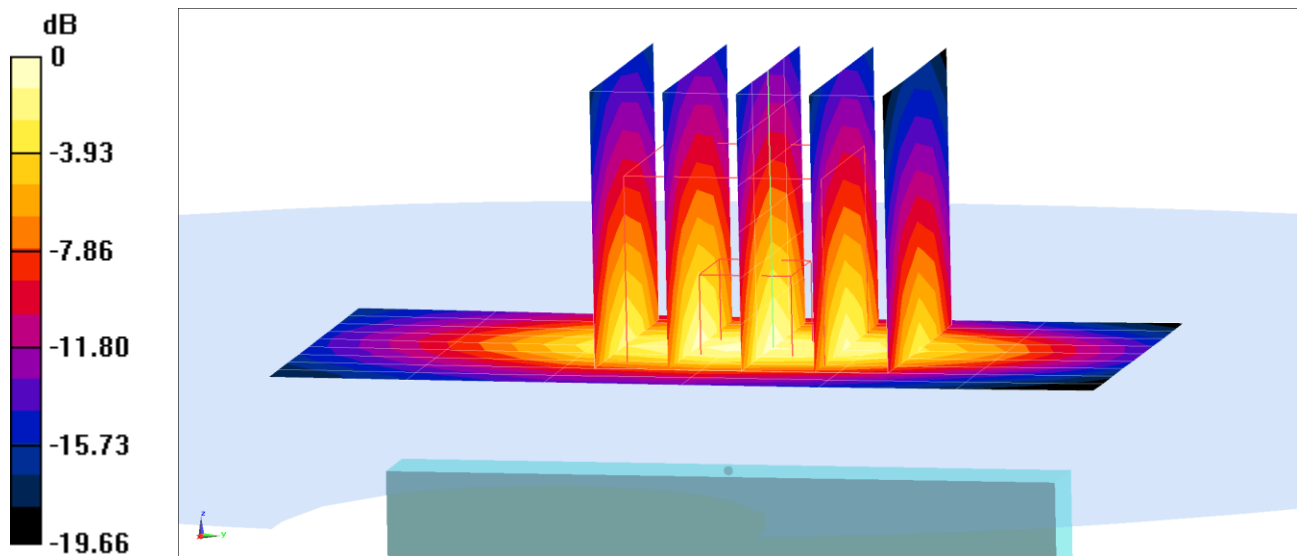

0 dB = 1.14 W/kg = 0.57 dBW/kg

# PCTEST

**DUT: A3LSMG998JPN; Type: Portable Handset; Serial: 0482M**

Communication System: UID 0, UMTS; Frequency: 836.6 MHz; Duty Cycle: 1:1  
Medium: 835 Body; Medium parameters used (interpolated):  
 $f = 836.6$  MHz;  $\sigma = 0.961$  S/m;  $\epsilon_r = 53.566$ ;  $\rho = 1000$  kg/m<sup>3</sup>  
Phantom section: Flat Section; Space: 1.5 cm

Test Date: 01/20/2021; Ambient Temp: 23.1°C; Tissue Temp: 22.3°C

Probe: EX3DV4 - SN7552; ConvF(9.96, 9.96, 9.96) @ 836.6 MHz; Calibrated: 9/11/2020  
Sensor-Surface: 1.4mm (Mechanical Surface Detection)  
Electronics: DAE4 Sn1449; Calibrated: 9/10/2020  
Phantom: Twin-SAM V4.0 Left 30; Type: QD 000 P40 CC; Serial: 1687  
Measurement SW: DASY52, Version 52.10 (4);SEMCAD X Version 14.6.14 (7483)

**Mode: UMTS 850, Body SAR, Back side, Mid.ch**

**Area Scan (9x15x1):** Measurement grid: dx=15mm, dy=15mm

**Zoom Scan (5x5x7)/Cube 0:** Measurement grid: dx=8mm, dy=8mm, dz=5mm

Reference Value = 14.53 V/m; Power Drift = 0.00 dB

Peak SAR (extrapolated) = 0.307 W/kg

**SAR(1 g) = 0.190 W/kg**

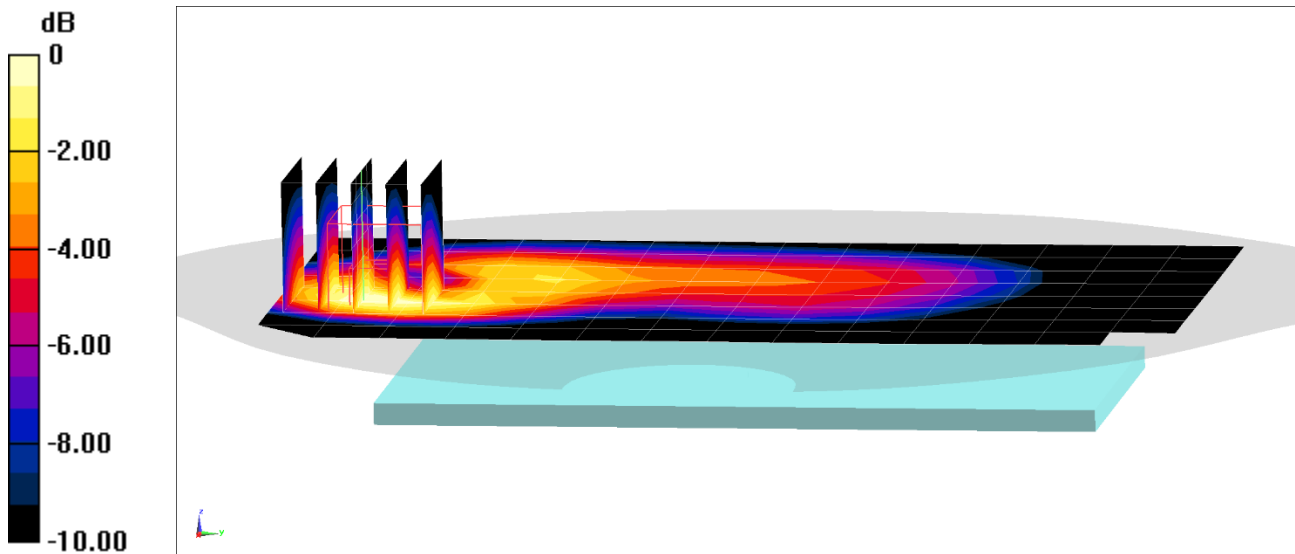

0 dB = 0.264 W/kg = -5.78 dBW/kg



# PCTEST

**DUT: A3LSMG998JPN; Type: Portable Handset; Serial: 0482M**

Communication System: UID 0, UMTS; Frequency: 836.6 MHz; Duty Cycle: 1:1  
Medium: 835 Body; Medium parameters used (interpolated):  
 $f = 836.6 \text{ MHz}$ ;  $\sigma = 0.961 \text{ S/m}$ ;  $\epsilon_r = 53.566$ ;  $\rho = 1000 \text{ kg/m}^3$   
Phantom section: Flat Section; Space: 1.0 cm

Test Date: 01/20/2021; Ambient Temp: 23.1°C; Tissue Temp: 22.3°C

Probe: EX3DV4 - SN7552; ConvF(9.96, 9.96, 9.96) @ 836.6 MHz; Calibrated: 9/11/2020  
Sensor-Surface: 1.4mm (Mechanical Surface Detection)  
Electronics: DAE4 Sn1449; Calibrated: 9/10/2020  
Phantom: Twin-SAM V4.0 Left 30; Type: QD 000 P40 CC; Serial: 1687  
Measurement SW: DASY52, Version 52.10 (4);SEMCAD X Version 14.6.14 (7483)

**Mode: UMTS 850, Body SAR, Back side, Mid.ch**

**Area Scan (9x15x1):** Measurement grid: dx=15mm, dy=15mm

**Zoom Scan (5x5x7)/Cube 0:** Measurement grid: dx=8mm, dy=8mm, dz=5mm

Reference Value = 21.83 V/m; Power Drift = -0.03 dB

Peak SAR (extrapolated) = 0.734 W/kg

**SAR(1 g) = 0.424 W/kg**

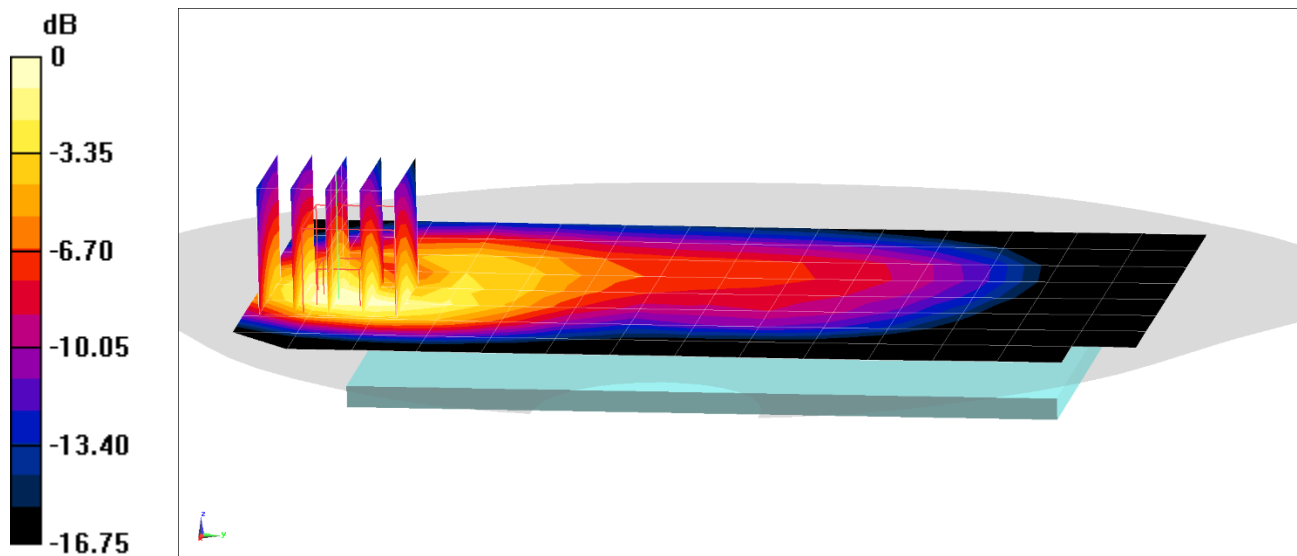

0 dB = 0.621 W/kg = -2.07 dBW/kg

# PCTEST

**DUT: A3LSMG998JPN; Type: Portable Handset; Serial: 0470M**

Communication System: UID 0, LTE Band 12; Frequency: 707.5 MHz; Duty Cycle: 1:1  
Medium: 750 Body; Medium parameters used (interpolated):  
 $f = 707.5$  MHz;  $\sigma = 0.946$  S/m;  $\epsilon_r = 54.075$ ;  $\rho = 1000$  kg/m<sup>3</sup>  
Phantom section: Flat Section; Space: 1.5 cm

Test Date: 01/20/2021; Ambient Temp: 24.1°C; Tissue Temp: 20.9°C

Probe: EX3DV4 - SN7308; ConvF(10.19, 10.19, 10.19) @ 707.5 MHz; Calibrated: 7/31/2020  
Sensor-Surface: 1.4mm (Mechanical Surface Detection)  
Electronics: DAE4 Sn1450; Calibrated: 8/11/2020  
Phantom: Twin-SAM V5.0; Type: QD 000 P40 CD; Serial: 1792  
Measurement SW: DASY52, Version 52.10 (4);SEMCAD X Version 14.6.14 (7483)

**Mode: LTE Band 12, Body SAR, Back side, Mid.ch,  
10 MHz Bandwidth, QPSK, 1 RB, 0 RB Offset**

**Area Scan (9x15x1):** Measurement grid: dx=15mm, dy=15mm  
**Zoom Scan (5x5x7)/Cube 0:** Measurement grid: dx=8mm, dy=8mm, dz=5mm  
Reference Value = 10.69 V/m; Power Drift = 0.00 dB  
Peak SAR (extrapolated) = 0.143 W/kg  
**SAR(1 g) = 0.105 W/kg**

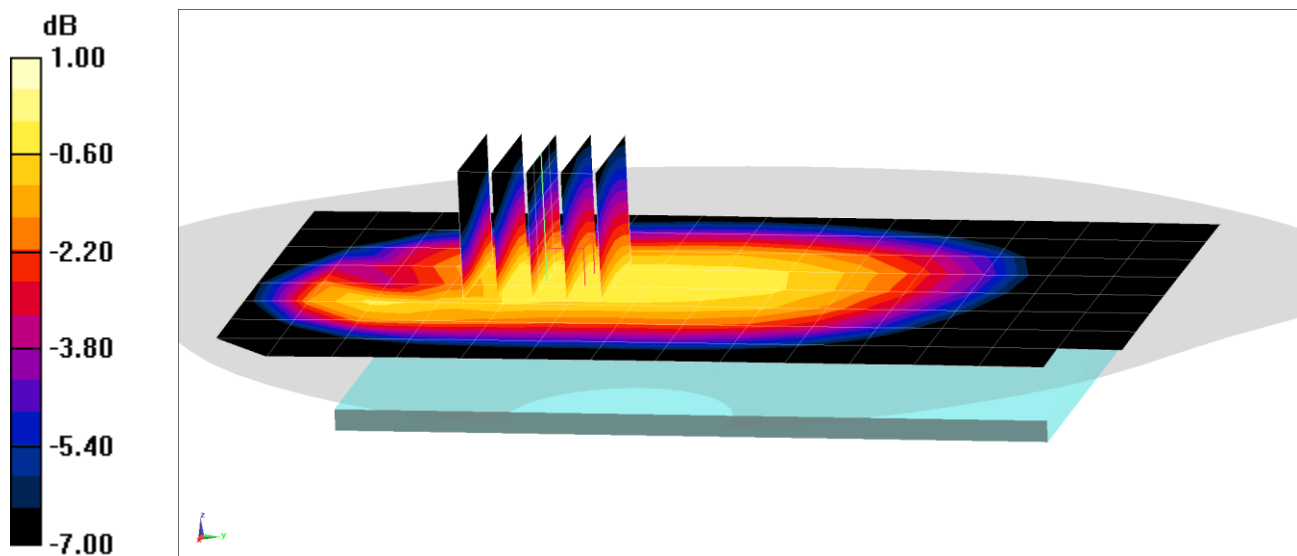

0 dB = 0.129 W/kg = -8.89 dBW/kg

# PCTEST

**DUT: A3LSMG998JPN; Type: Portable Handset; Serial: 0470M**

Communication System: UID 0, LTE Band 12; Frequency: 707.5 MHz; Duty Cycle: 1:1  
Medium: 750 Body; Medium parameters used (interpolated):  
 $f = 707.5$  MHz;  $\sigma = 0.946$  S/m;  $\epsilon_r = 54.075$ ;  $\rho = 1000$  kg/m<sup>3</sup>  
Phantom section: Flat Section; Space: 1.0 cm

Test Date: 01/20/2021; Ambient Temp: 24.1°C; Tissue Temp: 20.9°C

Probe: EX3DV4 - SN7308; ConvF(10.19, 10.19, 10.19) @ 707.5 MHz; Calibrated: 7/31/2020  
Sensor-Surface: 1.4mm (Mechanical Surface Detection)  
Electronics: DAE4 Sn1450; Calibrated: 8/11/2020  
Phantom: Twin-SAM V5.0; Type: QD 000 P40 CD; Serial: 1792  
Measurement SW: DASY52, Version 52.10 (4);SEMCAD X Version 14.6.14 (7483)

**Mode: LTE Band 12, Body SAR, Back side, Mid.ch,  
10 MHz Bandwidth, QPSK, 1 RB, 0 RB Offset**

**Area Scan (9x13x1):** Measurement grid: dx=15mm, dy=15mm  
**Zoom Scan (5x5x7)/Cube 0:** Measurement grid: dx=8mm, dy=8mm, dz=5mm  
Reference Value = 14.75 V/m; Power Drift = -0.04 dB  
Peak SAR (extrapolated) = 0.396 W/kg  
**SAR(1 g) = 0.200 W/kg**

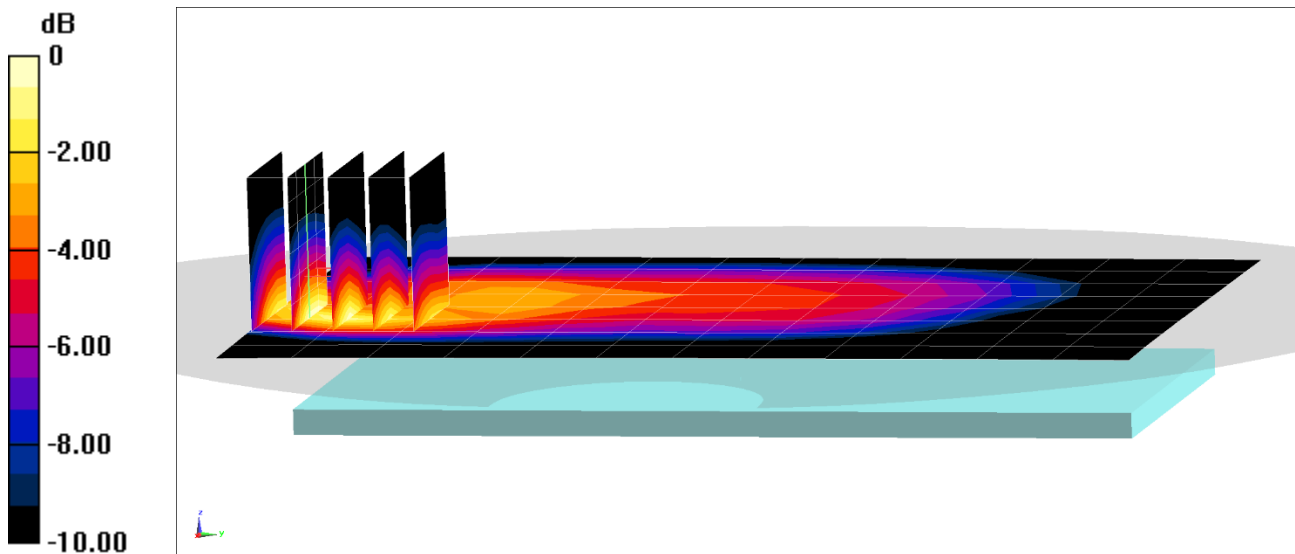

0 dB = 0.301 W/kg = -5.21 dBW/kg

# PCTEST

**DUT: A3LSMG998JPN; Type: Portable Handset; Serial: 0470M**

Communication System: UID 0, LTE Band 13; Frequency: 782 MHz; Duty Cycle: 1:1

Medium: 750 Body; Medium parameters used (interpolated):

$f = 782 \text{ MHz}$ ;  $\sigma = 0.974 \text{ S/m}$ ;  $\epsilon_r = 53.921$ ;  $\rho = 1000 \text{ kg/m}^3$

Phantom section: Flat Section; Space: 1.5 cm

Test Date: 01/20/2021; Ambient Temp: 24.1°C; Tissue Temp: 20.9°C

Probe: EX3DV4 - SN7308; ConvF(10.19, 10.19, 10.19) @ 782 MHz; Calibrated: 7/31/2020

Sensor-Surface: 1.4mm (Mechanical Surface Detection)

Electronics: DAE4 Sn1450; Calibrated: 8/11/2020

Phantom: Twin-SAM V5.0; Type: QD 000 P40 CD; Serial: 1792

Measurement SW: DASY52, Version 52.10 (4);SEMCAD X Version 14.6.14 (7483)

**Mode: LTE Band 13, Body SAR, Back side, Mid.ch,  
10 MHz Bandwidth, QPSK, 1 RB, 49 RB Offset**

**Area Scan (9x13x1):** Measurement grid: dx=15mm, dy=15mm

**Zoom Scan (5x5x7)/Cube 0:** Measurement grid: dx=8mm, dy=8mm, dz=5mm

Reference Value = 12.37 V/m; Power Drift = 0.08 dB

Peak SAR (extrapolated) = 0.201 W/kg

**SAR(1 g) = 0.144 W/kg**

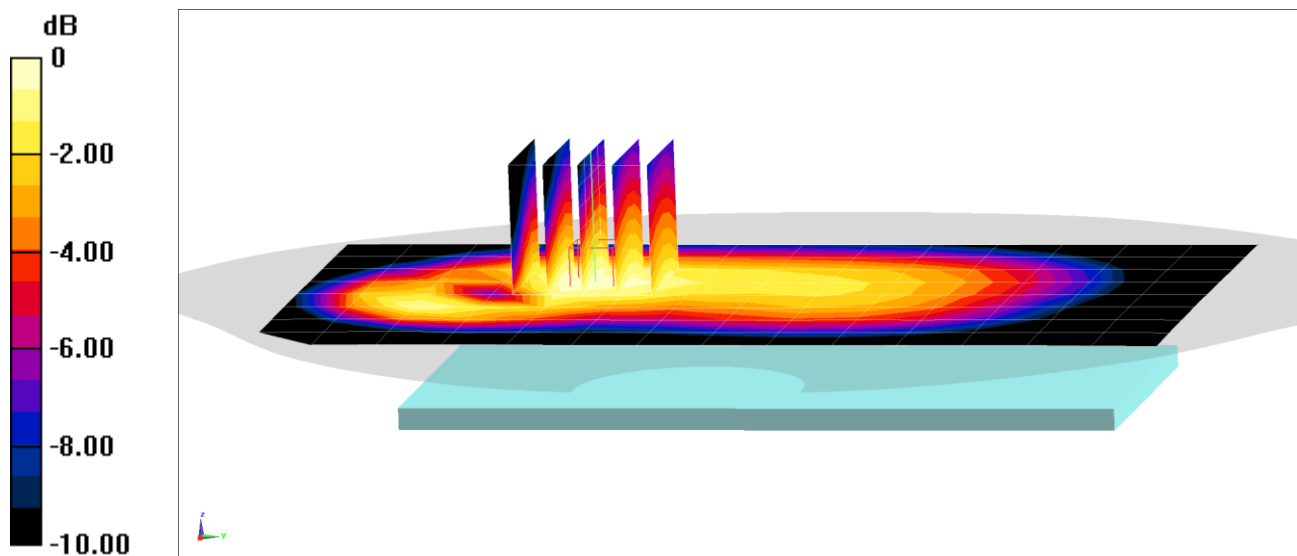

0 dB = 0.168 W/kg = -7.75 dBW/kg

# PCTEST

**DUT: A3LSMG998JPN; Type: Portable Handset; Serial: 0470M**

Communication System: UID 0, LTE Band 13; Frequency: 782 MHz; Duty Cycle: 1:1

Medium: 750 Body; Medium parameters used (interpolated):

$f = 782 \text{ MHz}$ ;  $\sigma = 0.974 \text{ S/m}$ ;  $\epsilon_r = 53.921$ ;  $\rho = 1000 \text{ kg/m}^3$

Phantom section: Flat Section; Space: 1.0 cm

Test Date: 01/20/2021; Ambient Temp: 24.1°C; Tissue Temp: 20.9°C

Probe: EX3DV4 - SN7308; ConvF(10.19, 10.19, 10.19) @ 782 MHz; Calibrated: 7/31/2020

Sensor-Surface: 1.4mm (Mechanical Surface Detection)

Electronics: DAE4 Sn1450; Calibrated: 8/11/2020

Phantom: Twin-SAM V5.0; Type: QD 000 P40 CD; Serial: 1792

Measurement SW: DASY52, Version 52.10 (4);SEMCAD X Version 14.6.14 (7483)

**Mode: LTE Band 13, Body SAR, Back side, Mid.ch,  
10 MHz Bandwidth, QPSK, 1 RB, 49 RB Offset**

**Area Scan (9x14x1):** Measurement grid: dx=15mm, dy=15mm

**Zoom Scan (5x5x7)/Cube 0:** Measurement grid: dx=8mm, dy=8mm, dz=5mm

Reference Value = 16.49 V/m; Power Drift = -0.01 dB

Peak SAR (extrapolated) = 0.433 W/kg

**SAR(1 g) = 0.243 W/kg**

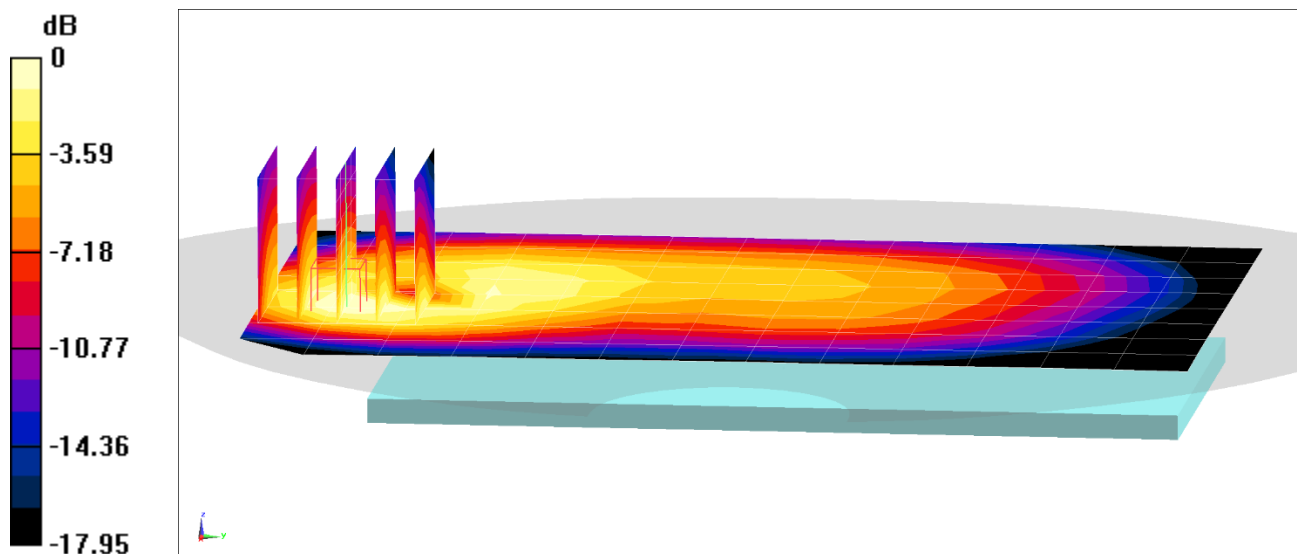

0 dB = 0.361 W/kg = -4.42 dBW/kg

# PCTEST

**DUT: A3LSMG998JPN; Type: Portable Handset; Serial: 0532M**

Communication System: UID 0, LTE Band 5; Frequency: 836.5 MHz; Duty Cycle: 1:1  
Medium: 835 Body; Medium parameters used (interpolated):  
 $f = 836.5$  MHz;  $\sigma = 0.961$  S/m;  $\epsilon_r = 53.567$ ;  $\rho = 1000$  kg/m<sup>3</sup>  
Phantom section: Flat Section; Space: 1.5 cm

Test Date: 01/20/2021; Ambient Temp: 23.1°C; Tissue Temp: 22.3°C

Probe: EX3DV4 - SN7552; ConvF(9.96, 9.96, 9.96) @ 836.5 MHz; Calibrated: 9/11/2020  
Sensor-Surface: 1.4mm (Mechanical Surface Detection)  
Electronics: DAE4 Sn1449; Calibrated: 9/10/2020  
Phantom: Twin-SAM V4.0 Left 30; Type: QD 000 P40 CC; Serial: 1687  
Measurement SW: DASY52, Version 52.10 (4);SEMCAD X Version 14.6.14 (7483)

**Mode: LTE Band 5 (Cell.), Body SAR, Back side, Mid.ch,  
10 MHz Bandwidth, QPSK, 1 RB, 0 RB Offset**

**Area Scan (9x15x1):** Measurement grid: dx=15mm, dy=15mm  
**Zoom Scan (5x5x7)/Cube 0:** Measurement grid: dx=8mm, dy=8mm, dz=5mm  
Reference Value = 16.10 V/m; Power Drift = 0.03 dB  
Peak SAR (extrapolated) = 0.378 W/kg  
**SAR(1 g) = 0.232 W/kg**

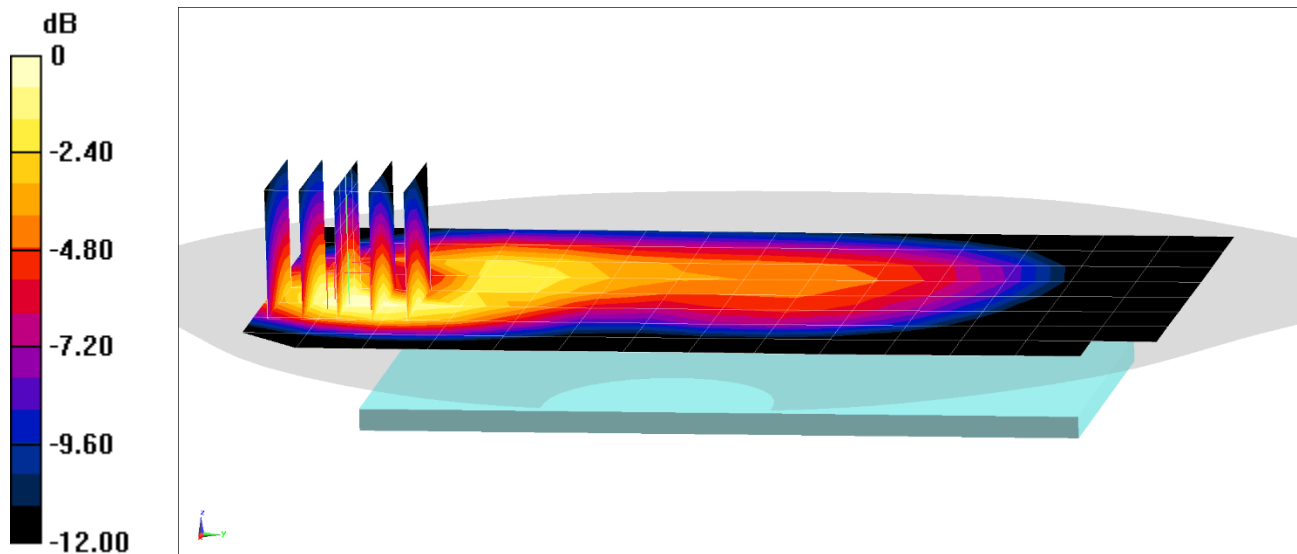

0 dB = 0.326 W/kg = -4.87 dBW/kg

# PCTEST

**DUT: A3LSMG998JPN; Type: Portable Handset; Serial: 0532M**

Communication System: UID 0, LTE Band 5; Frequency: 836.5 MHz; Duty Cycle: 1:1  
Medium: 835 Body; Medium parameters used (interpolated):  
 $f = 836.5$  MHz;  $\sigma = 0.961$  S/m;  $\epsilon_r = 53.567$ ;  $\rho = 1000$  kg/m<sup>3</sup>  
Phantom section: Flat Section; Space: 1.0 cm

Test Date: 01/20/2021; Ambient Temp: 23.1°C; Tissue Temp: 22.3°C

Probe: EX3DV4 - SN7552; ConvF(9.96, 9.96, 9.96) @ 836.5 MHz; Calibrated: 9/11/2020  
Sensor-Surface: 1.4mm (Mechanical Surface Detection)  
Electronics: DAE4 Sn1449; Calibrated: 9/10/2020  
Phantom: Twin-SAM V4.0 Left 30; Type: QD 000 P40 CC; Serial: 1687  
Measurement SW: DASY52, Version 52.10 (4);SEMCAD X Version 14.6.14 (7483)

**Mode: LTE Band 5 (Cell.), Body SAR, Back side, Mid.ch,  
10 MHz Bandwidth, QPSK, 1 RB, 0 RB Offset**

**Area Scan (9x15x1):** Measurement grid: dx=15mm, dy=15mm  
**Zoom Scan (5x5x7)/Cube 0:** Measurement grid: dx=8mm, dy=8mm, dz=5mm  
Reference Value = 23.76 V/m; Power Drift = -0.01 dB  
Peak SAR (extrapolated) = 0.870 W/kg  
**SAR(1 g) = 0.498 W/kg**

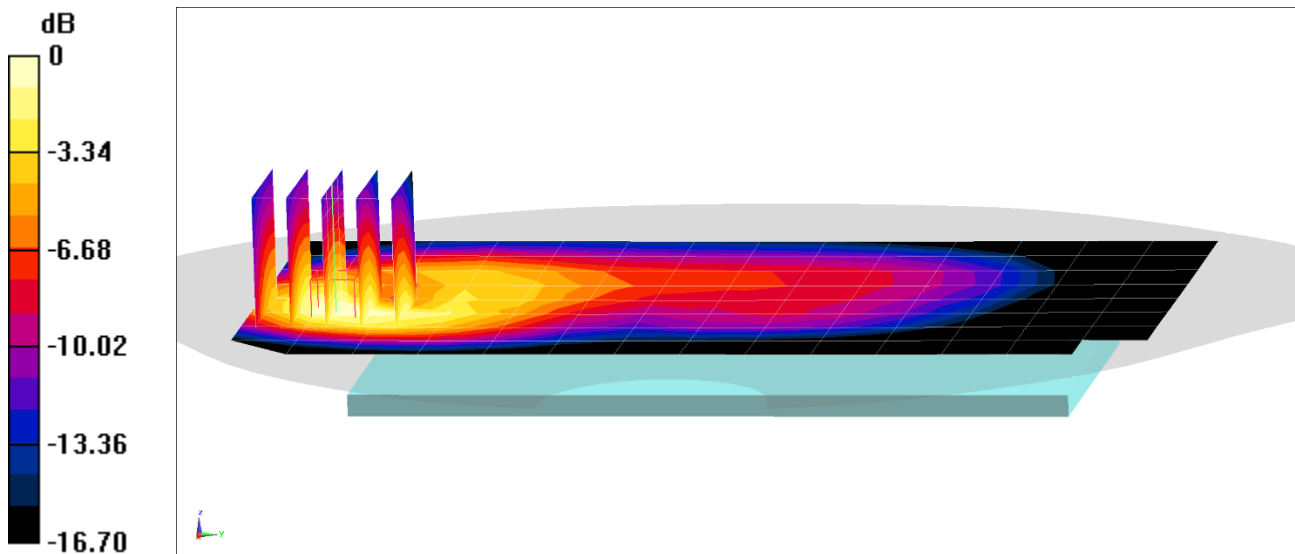

0 dB = 0.734 W/kg = -1.34 dBW/kg

# PCTEST

**DUT: A3LSMG998JPN; Type: Portable Handset; Serial: 0532M**

Communication System: UID 0, LTE Band 4 (AWS); Frequency: 1732.5 MHz; Duty Cycle: 1:1  
Medium: 1750 Body; Medium parameters used (interpolated):  
 $f = 1732.5$  MHz;  $\sigma = 1.493$  S/m;  $\epsilon_r = 51.285$ ;  $\rho = 1000$  kg/m<sup>3</sup>  
Phantom section: Flat Section; Space: 1.5 cm

Test Date: 01/18/2021; Ambient Temp: 20.0°C; Tissue Temp: 21.0°C

Probe: EX3DV4 - SN7357; ConvF(8.17, 8.17, 8.17) @ 1732.5 MHz; Calibrated: 4/21/2020  
Sensor-Surface: 1.4mm (Mechanical Surface Detection)  
Electronics: DAE4 Sn1407; Calibrated: 4/15/2020  
Phantom: Twin-SAM V5.0 Right 30; Type: QD 000 P40 CD; Serial: 1759  
Measurement SW: DASY52, Version 52.10 (4);SEMCAD X Version 14.6.14 (7483)

**Mode: LTE Band 4 (AWS), Body SAR, Back side, Mid.ch,  
20 MHz Bandwidth, QPSK, 1 RB, 50 RB Offset**

**Area Scan (9x14x1):** Measurement grid: dx=15mm, dy=15mm  
**Zoom Scan (5x5x7)/Cube 0:** Measurement grid: dx=8mm, dy=8mm, dz=5mm  
Reference Value = 19.03 V/m; Power Drift = 0.01 dB  
Peak SAR (extrapolated) = 0.812 W/kg  
**SAR(1 g) = 0.499 W/kg**

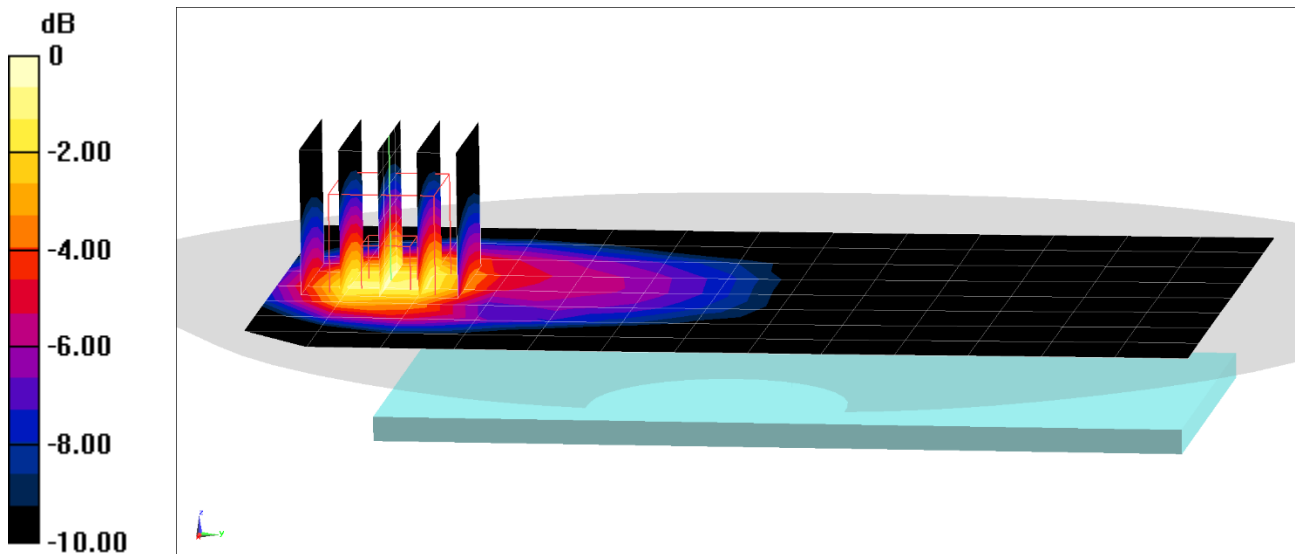



# PCTEST

**DUT: A3LSMG998JPN; Type: Portable Handset; Serial: 0532M**

Communication System: UID 0, LTE Band 4 (AWS); Frequency: 1732.5 MHz; Duty Cycle: 1:1  
Medium: 1750 Body; Medium parameters used (interpolated):  
 $f = 1732.5$  MHz;  $\sigma = 1.493$  S/m;  $\epsilon_r = 51.285$ ;  $\rho = 1000$  kg/m<sup>3</sup>  
Phantom section: Flat Section; Space: 1.0 cm

Test Date: 01/18/2021; Ambient Temp: 20.0°C; Tissue Temp: 21.0°C

Probe: EX3DV4 - SN7357; ConvF(8.17, 8.17, 8.17) @ 1732.5 MHz; Calibrated: 4/21/2020  
Sensor-Surface: 1.4mm (Mechanical Surface Detection)  
Electronics: DAE4 Sn1407; Calibrated: 4/15/2020  
Phantom: Twin-SAM V5.0 Right 30; Type: QD 000 P40 CD; Serial: 1759  
Measurement SW: DASY52, Version 52.10 (4);SEMCAD X Version 14.6.14 (7483)

**Mode: LTE Band 4 (AWS), Body SAR, Bottom Edge, Mid.ch,  
20 MHz Bandwidth, QPSK, 50 RB, 25 RB Offset**

**Area Scan (12x9x1):** Measurement grid: dx=5mm, dy=15mm  
**Zoom Scan (5x5x7)/Cube 0:** Measurement grid: dx=8mm, dy=8mm, dz=5mm  
Reference Value = 21.88 V/m; Power Drift = -0.01 dB  
Peak SAR (extrapolated) = 1.11 W/kg  
**SAR(1 g) = 0.640 W/kg**

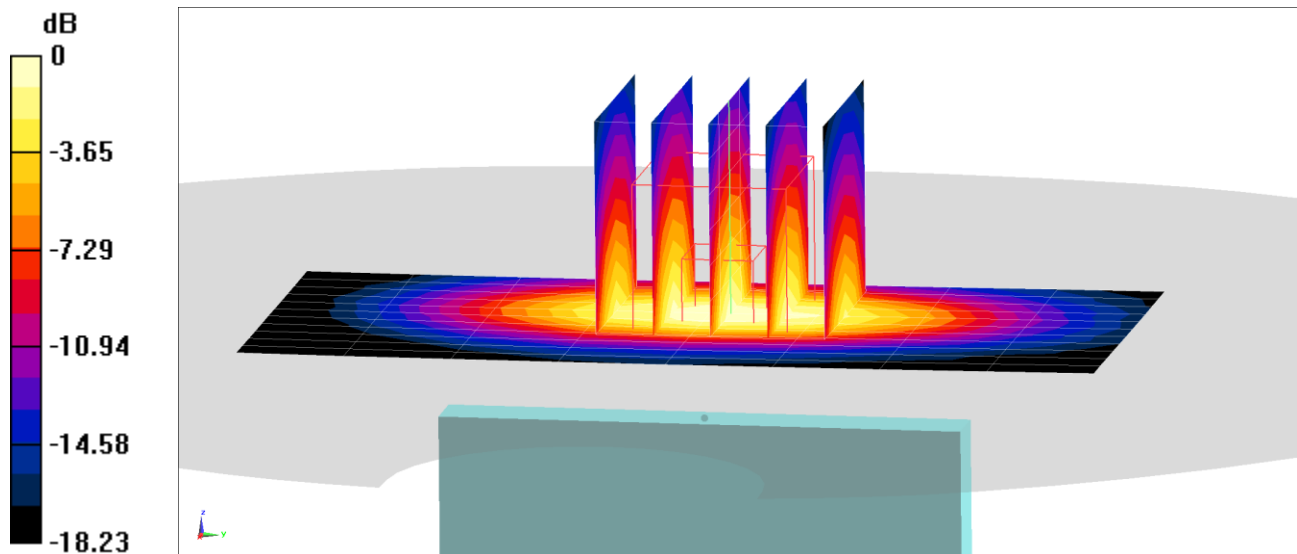

0 dB = 0.950 W/kg = -0.22 dBW/kg

# PCTEST

**DUT: A3LSMG998JPN; Type: Portable Handset; Serial: 0466M**

Communication System: UID 0, LTE Band 41; Frequency: 2593 MHz; Duty Cycle: 1:1.58

Medium: 2450 Body; Medium parameters used (interpolated):

$f = 2593$  MHz;  $\sigma = 2.218$  S/m;  $\epsilon_r = 51.382$ ;  $\rho = 1000$  kg/m<sup>3</sup>

Phantom section: Flat Section; Space: 1.5 cm

Test Date: 01/21/2021; Ambient Temp: 23.9°C; Tissue Temp: 22.7°C

Probe: EX3DV4 - SN7308; ConvF(7.37, 7.37, 7.37) @ 2593 MHz; Calibrated: 7/31/2020

Sensor-Surface: 1.4mm (Mechanical Surface Detection)

Electronics: DAE4 Sn1450; Calibrated: 8/11/2020

Phantom: Twin-SAM V5.0; Type: QD 000 P40 CD; Serial: 1792

Measurement SW: DASY52, Version 52.10 (4);SEMCAD X Version 14.6.14 (7483)

**Mode: LTE Band 41, Body SAR, Back side, Mid.ch,  
20 MHz Bandwidth, QPSK, 1 RB, 50 RB Offset**

**Area Scan (11x18x1):** Measurement grid: dx=12mm, dy=12mm

**Zoom Scan (7x7x7)/Cube 0:** Measurement grid: dx=5mm, dy=5mm, dz=5mm

Reference Value = 12.13 V/m; Power Drift = 0.03 dB

Peak SAR (extrapolated) = 0.635 W/kg

**SAR(1 g) = 0.301 W/kg**

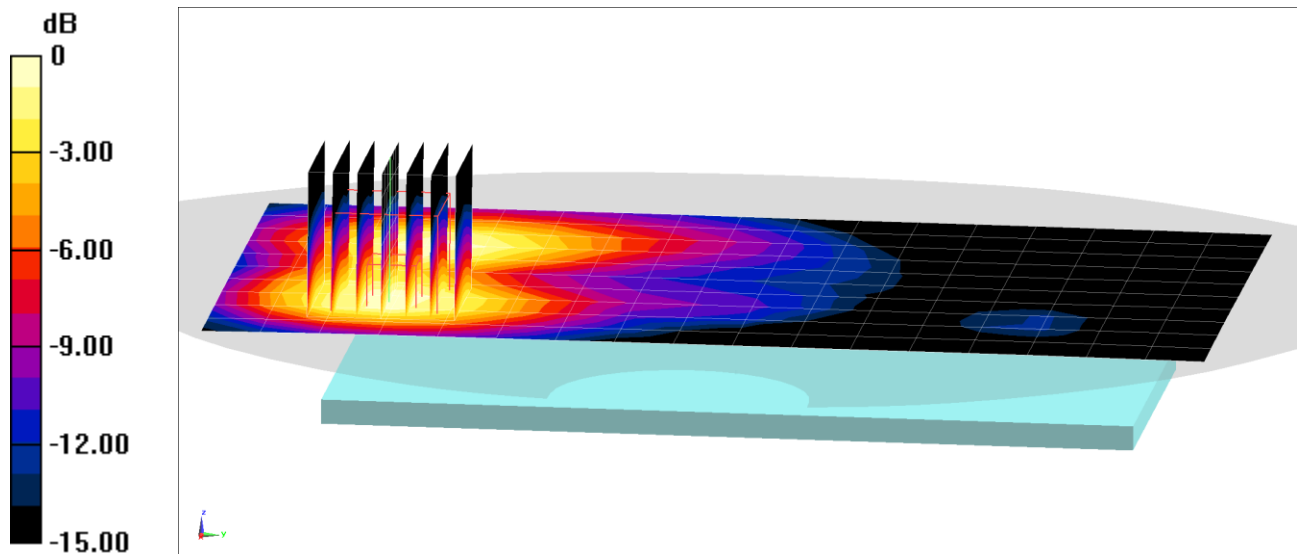

0 dB = 0.496 W/kg = -3.05 dBW/kg

# PCTEST

**DUT: A3LSMG998JPN; Type: Portable Handset; Serial: 0466M**

Communication System: UID 0, LTE Band 41; Frequency: 2636.5 MHz; Duty Cycle: 1:1.58  
Medium: 2450 Body; Medium parameters used (interpolated):  
 $f = 2636.5$  MHz;  $\sigma = 2.28$  S/m;  $\epsilon_r = 51.227$ ;  $\rho = 1000$  kg/m<sup>3</sup>  
Phantom section: Flat Section; Space: 1.0 cm

Test Date: 01/21/2021; Ambient Temp: 23.9°C; Tissue Temp: 22.7°C

Probe: EX3DV4 - SN7308; ConvF(7.37, 7.37, 7.37) @ 2636.5 MHz; Calibrated: 7/31/2020  
Sensor-Surface: 1.4mm (Mechanical Surface Detection)  
Electronics: DAE4 Sn1450; Calibrated: 8/11/2020  
Phantom: Twin-SAM V5.0; Type: QD 000 P40 CD; Serial: 1792  
Measurement SW: DASY52, Version 52.10 (4);SEMCAD X Version 14.6.14 (7483)

**Mode: LTE Band 41, Body SAR, Bottom Edge, Mid-High.ch,  
20 MHz Bandwidth, QPSK, 50 RB, 25 RB Offset**

**Area Scan (11x10x1):** Measurement grid: dx=5mm, dy=12mm  
**Zoom Scan (7x7x7)/Cube 0:** Measurement grid: dx=5mm, dy=5mm, dz=5mm  
Reference Value = 13.64 V/m; Power Drift = -0.03 dB  
Peak SAR (extrapolated) = 0.868 W/kg  
**SAR(1 g) = 0.378 W/kg**

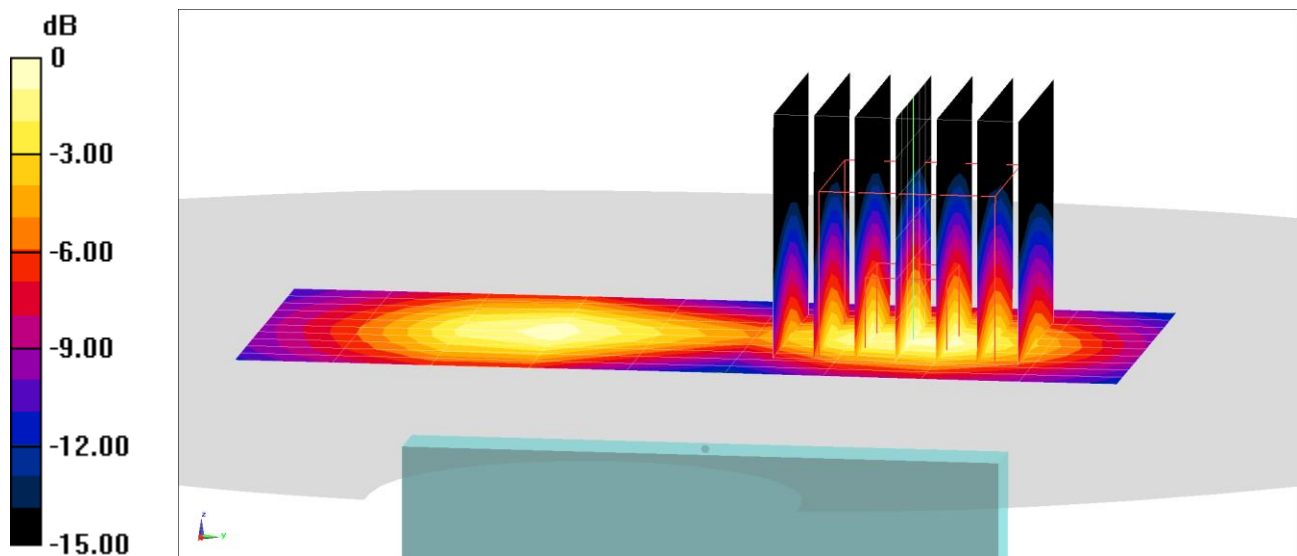

0 dB = 0.665 W/kg = -1.77 dBW/kg

# PCTEST

**DUT: A3LSMG998JPN; Type: Portable Handset; Serial: 0289M**

Communication System: UID 0, IEEE 802.11b; Frequency: 2437 MHz; Duty Cycle: 1:1  
Medium: 2450 Body; Medium parameters used (interpolated):  
 $f = 2437 \text{ MHz}$ ;  $\sigma = 2.025 \text{ S/m}$ ;  $\epsilon_r = 52.951$ ;  $\rho = 1000 \text{ kg/m}^3$   
Phantom section: Flat Section; Space: 1.5 cm

Test Date: 01/18/2021; Ambient Temp: 23.2°C; Tissue Temp: 22.3°C

Probe: EX3DV4 - SN7409; ConvF(7.24, 7.24, 7.24) @ 2437 MHz; Calibrated: 6/23/2020  
Sensor-Surface: 1.4mm (Mechanical Surface Detection)  
Electronics: DAE4 Sn1334; Calibrated: 6/18/2020  
Phantom: LeftTwin-SAM V5.0; Type: QD 000 P40 CD; Serial: TP1375  
Measurement SW: DASY52, Version 52.10 (4);SEMCAD X Version 14.6.14 (7483)

**Mode: IEEE 802.11b, Antenna 1, 22 MHz Bandwidth, Body SAR, Ch 6, 1 Mbps, Back Side**

**Area Scan (11x17x1):** Measurement grid: dx=12mm, dy=12mm

**Zoom Scan (7x7x7)/Cube 0:** Measurement grid: dx=5mm, dy=5mm, dz=5mm

Reference Value = 6.747 V/m; Power Drift = 0.02 dB

Peak SAR (extrapolated) = 0.161 W/kg

**SAR(1 g) = 0.080 W/kg**

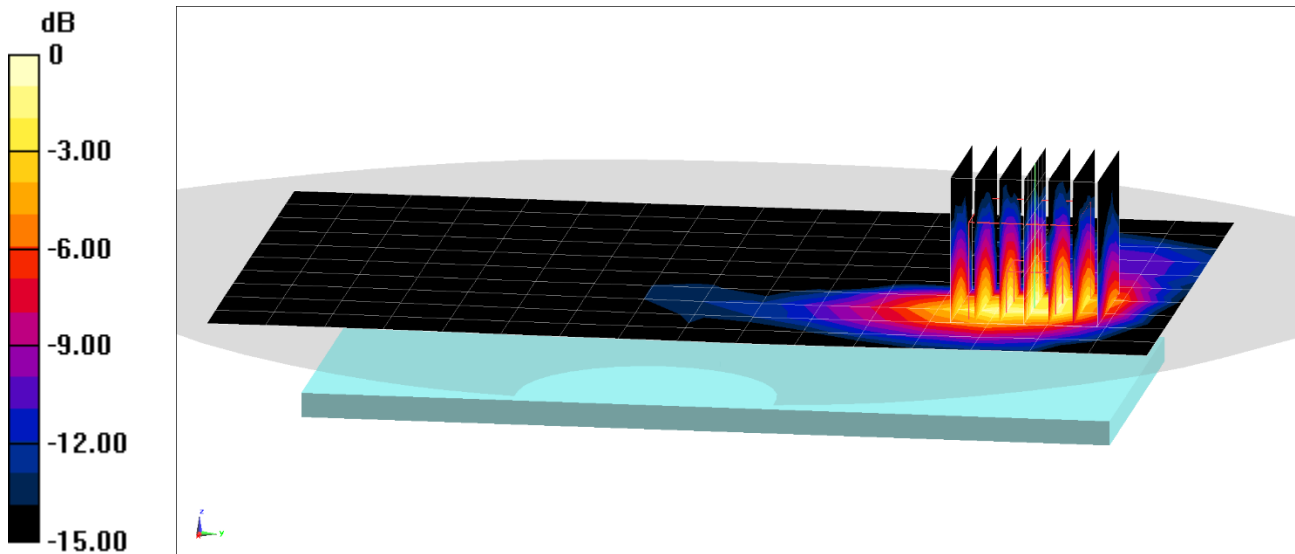

0 dB = 0.130 W/kg = -8.86 dBW/kg

# PCTEST

**DUT: A3LSMG998JPN; Type: Portable Handset; Serial: 0289M**

Communication System: UID 0, IEEE 802.11b; Frequency: 2437 MHz; Duty Cycle: 1:1  
Medium: 2450 Body; Medium parameters used (interpolated):  
 $f = 2437 \text{ MHz}$ ;  $\sigma = 2.025 \text{ S/m}$ ;  $\epsilon_r = 52.951$ ;  $\rho = 1000 \text{ kg/m}^3$   
Phantom section: Flat Section; Space: 1.0 cm

Test Date: 01/18/2021; Ambient Temp: 23.2°C; Tissue Temp: 22.3°C

Probe: EX3DV4 - SN7409; ConvF(7.24, 7.24, 7.24) @ 2437 MHz; Calibrated: 6/23/2020  
Sensor-Surface: 1.4mm (Mechanical Surface Detection)  
Electronics: DAE4 Sn1334; Calibrated: 6/18/2020  
Phantom: LeftTwin-SAM V5.0; Type: QD 000 P40 CD; Serial: TP1375  
Measurement SW: DASY52, Version 52.10 (4);SEMCAD X Version 14.6.14 (7483)

**Mode: IEEE 802.11b, Antenna 1, 22 MHz Bandwidth, Body SAR, Ch 6, 1 Mbps, Back Side**

**Area Scan (11x17x1):** Measurement grid: dx=12mm, dy=12mm

**Zoom Scan (7x7x7)/Cube 0:** Measurement grid: dx=5mm, dy=5mm, dz=5mm

Reference Value = 10.80 V/m; Power Drift = 0.05 dB

Peak SAR (extrapolated) = 0.430 W/kg

**SAR(1 g) = 0.200 W/kg**

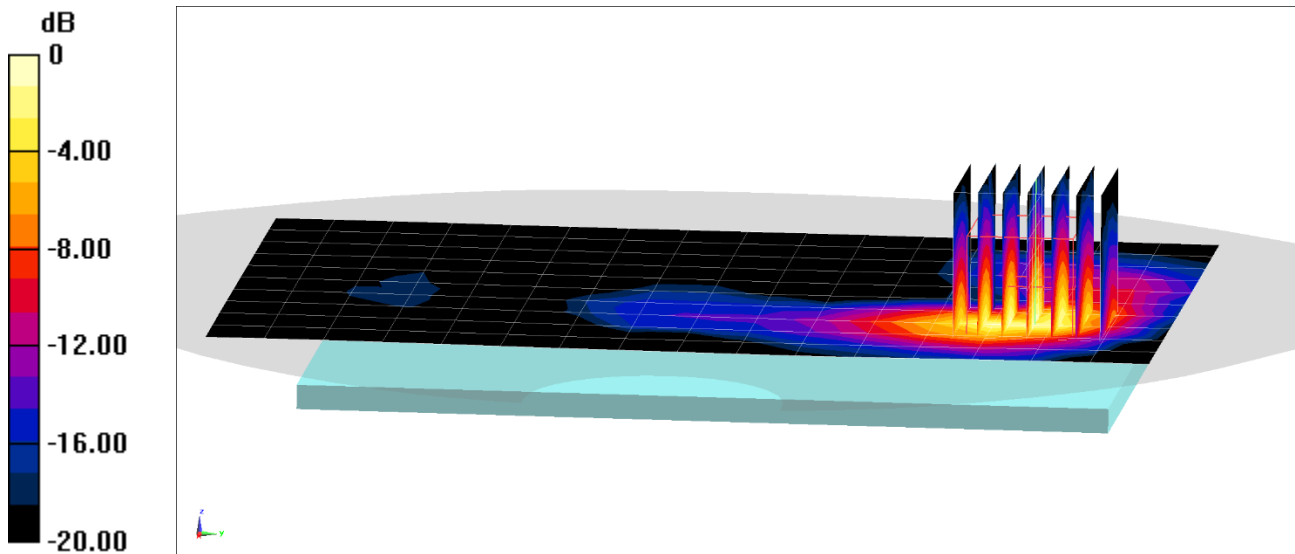

# PCTEST

**DUT: A3LSMG998JPN; Type: Portable Handset; Serial: 0023M**

Communication System: UID 0, IEEE 802.11n; Frequency: 5785 MHz; Duty Cycle: 1:1  
Medium: 5200-5800 Body; Medium parameters used:  
 $f = 5785 \text{ MHz}$ ;  $\sigma = 6.257 \text{ S/m}$ ;  $\epsilon_r = 45.935$ ;  $\rho = 1000 \text{ kg/m}^3$   
Phantom section: Flat Section; Space: 1.5 cm

Test Date: 01/18/2021; Ambient Temp: 23.5°C; Tissue Temp: 22.4°C

Probe: EX3DV4 - SN7406; ConvF(4.56, 4.56, 4.56) @ 5785 MHz; Calibrated: 6/23/2020  
Sensor-Surface: 1.4mm (Mechanical Surface Detection)  
Electronics: DAE4 Sn1583; Calibrated: 5/14/2020  
Phantom: Front; Type: QD 000 P40 CD; Serial: 1686  
Measurement SW: DASY52, Version 52.10 (4);SEMCAD X Version 14.6.14 (7483)

**Mode: IEEE 802.11n, MIMO, U-NII-3, 20 MHz Bandwidth,  
Body SAR, Ch 157, 13 Mbps, Back Side**

**Area Scan (13x22x1):** Measurement grid: dx=10mm, dy=10mm

**Zoom Scan (7x7x7)/Cube 0:** Measurement grid: dx=4mm, dy=4mm, dz=1.4mm; Graded Ratio: 1.4

Reference Value = 9.400 V/m; Power Drift = 0.03 dB

Peak SAR (extrapolated) = 2.17 W/kg

**SAR(1 g) = 0.534 W/kg**

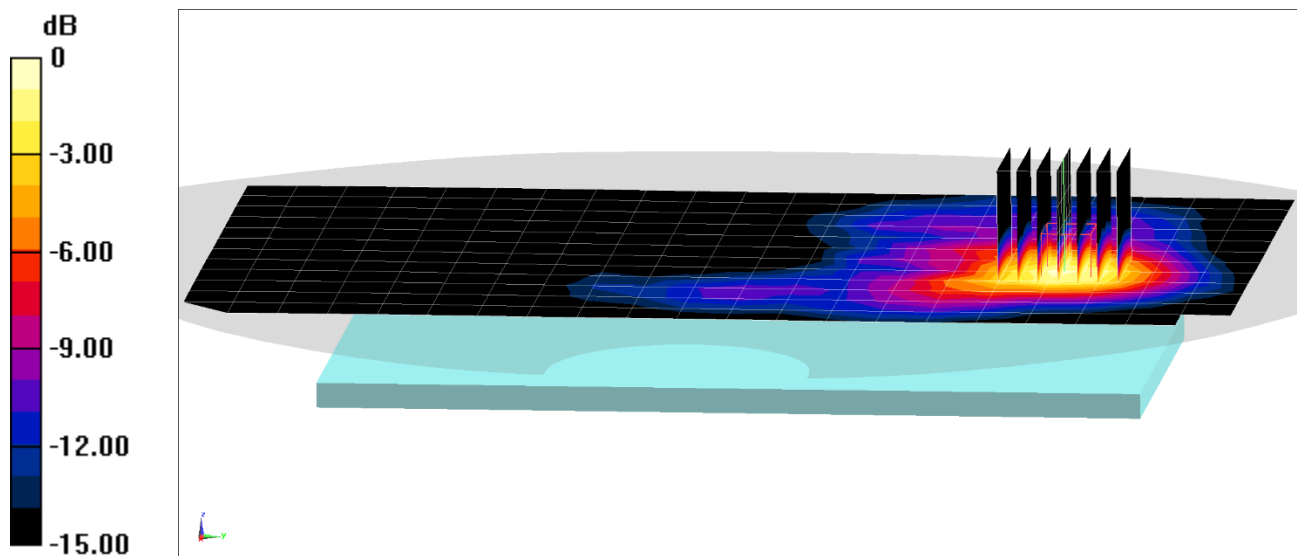

0 dB = 1.24 W/kg = 0.93 dBW/kg

# PCTEST

**DUT: A3LSMG998JPN; Type: Portable Handset; Serial: 0023M**

Communication System: UID 0, IEEE 802.11n; Frequency: 5785 MHz; Duty Cycle: 1:1  
Medium: 5200-5800 Body; Medium parameters used:  
 $f = 5785 \text{ MHz}$ ;  $\sigma = 6.257 \text{ S/m}$ ;  $\epsilon_r = 45.935$ ;  $\rho = 1000 \text{ kg/m}^3$   
Phantom section: Flat Section; Space: 1.0 cm

Test Date: 01/18/2021; Ambient Temp: 23.5°C; Tissue Temp: 22.4°C

Probe: EX3DV4 - SN7406; ConvF(4.56, 4.56, 4.56) @ 5785 MHz; Calibrated: 6/23/2020  
Sensor-Surface: 1.4mm (Mechanical Surface Detection)  
Electronics: DAE4 Sn1583; Calibrated: 5/14/2020  
Phantom: Front; Type: QD 000 P40 CD; Serial: 1686  
Measurement SW: DASY52, Version 52.10 (4);SEMCAD X Version 14.6.14 (7483)

**Mode: IEEE 802.11n, MIMO, U-NII-3, 20 MHz Bandwidth,  
Body SAR, Ch 157, 13 Mbps, Back Side**

**Area Scan (13x22x1):** Measurement grid: dx=10mm, dy=10mm

**Zoom Scan (7x7x7)/Cube 0:** Measurement grid: dx=4mm, dy=4mm, dz=1.4mm; Graded Ratio: 1.4

Reference Value = 1.805 V/m; Power Drift = 0.10 dB

Peak SAR (extrapolated) = 3.38 W/kg

**SAR(1 g) = 0.798 W/kg**

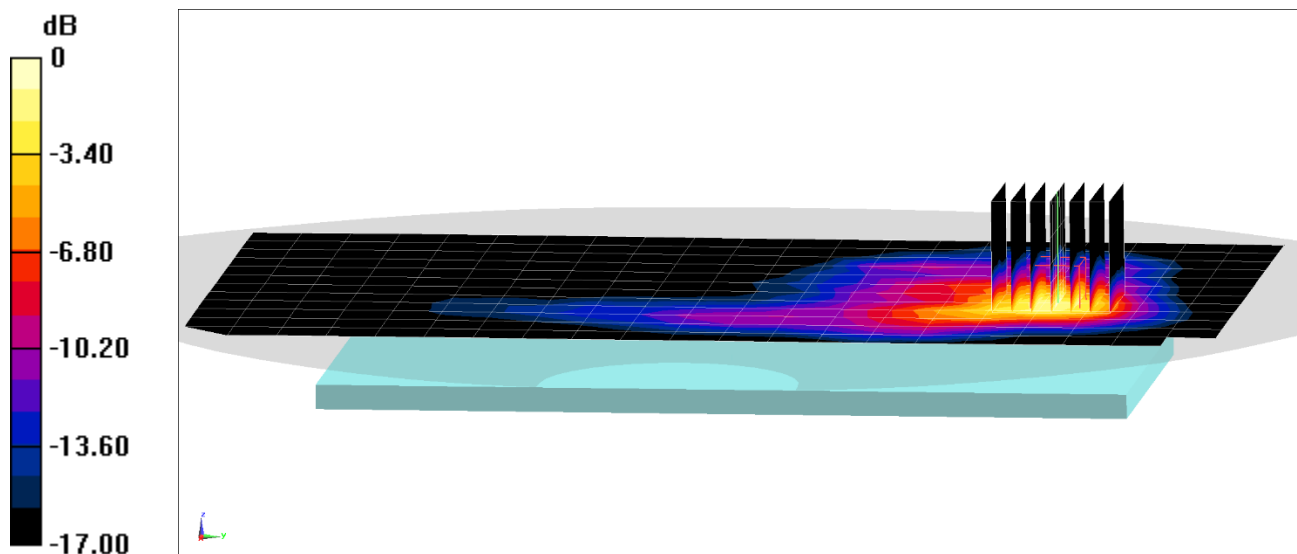

0 dB = 1.96 W/kg = 2.92 dBW/kg

# PCTEST

**DUT: A3LSMG998JPN; Type: Portable Handset; Serial: 0289M**

Communication System: UID 0, Bluetooth; Frequency: 2441 MHz; Duty Cycle: 1:1.297

Medium: 2450 Body; Medium parameters used (interpolated):

$f = 2441$  MHz;  $\sigma = 2.033$  S/m;  $\epsilon_r = 50.883$ ;  $\rho = 1000$  kg/m<sup>3</sup>

Phantom section: Flat Section; Space: 1.5 cm

Test Date: 01/25/2021; Ambient Temp: 21.0°C; Tissue Temp: 22.7°C

Probe: EX3DV4 - SN7409; ConvF(7.24, 7.24, 7.24) @ 2441 MHz; Calibrated: 6/23/2020

Sensor-Surface: 1.4mm (Mechanical Surface Detection)

Electronics: DAE4 Sn1334; Calibrated: 6/18/2020

Phantom: LeftTwin-SAM V5.0; Type: QD 000 P40 CD; Serial: TP1375

Measurement SW: DASY52, Version 52.10 (4);SEMCAD X Version 14.6.14 (7483)

**Mode: Bluetooth, Antenna 1, Body SAR, Ch 39, 1 Mbps, Back Side**

**Area Scan (11x17x1):** Measurement grid: dx=12mm, dy=12mm

**Zoom Scan (7x8x7)/Cube 0:** Measurement grid: dx=5mm, dy=5mm, dz=5mm

Reference Value = 4.074 V/m; Power Drift = 0.15 dB

Peak SAR (extrapolated) = 0.0980 W/kg

**SAR(1 g) = 0.047 W/kg**

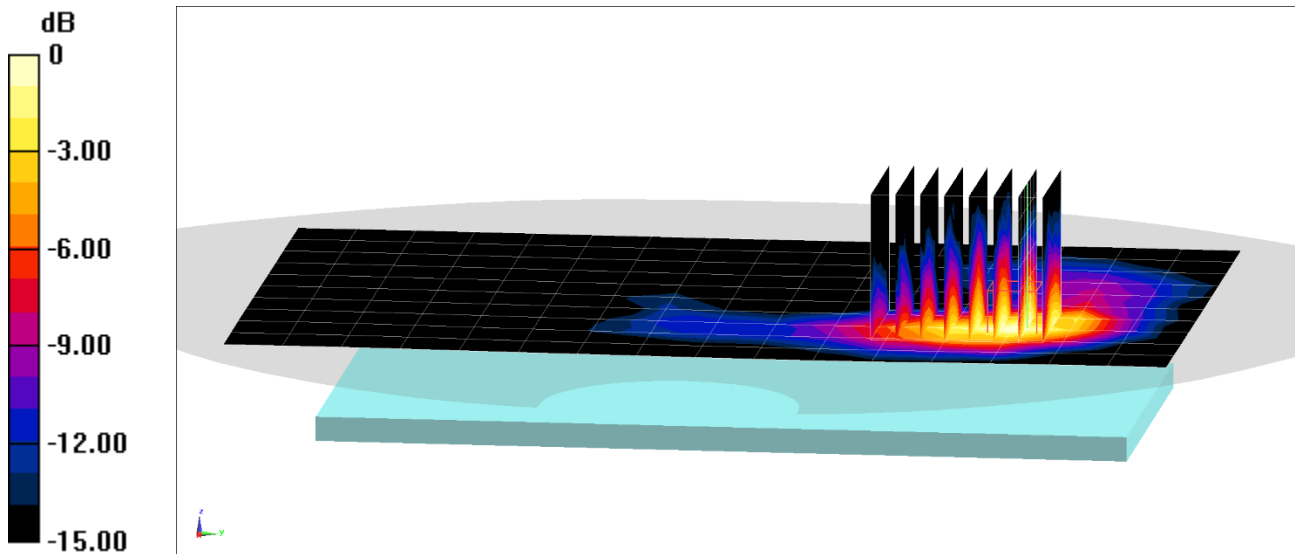

0 dB = 0.0776 W/kg = -11.10 dBW/kg



# PCTEST

**DUT: A3LSMG998JPN; Type: Portable Handset; Serial: 0289M**

Communication System: UID 0, Bluetooth; Frequency: 2441 MHz; Duty Cycle: 1:1.297

Medium: 2450 Body; Medium parameters used (interpolated):

$f = 2441$  MHz;  $\sigma = 2.033$  S/m;  $\epsilon_r = 50.883$ ;  $\rho = 1000$  kg/m<sup>3</sup>

Phantom section: Flat Section; Space: 1.0 cm

Test Date: 01/25/2021; Ambient Temp: 21.0°C; Tissue Temp: 22.7°C

Probe: EX3DV4 - SN7409; ConvF(7.24, 7.24, 7.24) @ 2441 MHz; Calibrated: 6/23/2020

Sensor-Surface: 1.4mm (Mechanical Surface Detection)

Electronics: DAE4 Sn1334; Calibrated: 6/18/2020

Phantom: LeftTwin-SAM V5.0; Type: QD 000 P40 CD; Serial: TP1375

Measurement SW: DASY52, Version 52.10 (4);SEMCAD X Version 14.6.14 (7483)

**Mode: Bluetooth, Antenna 2, Body SAR, Ch 39, 1 Mbps, Left Edge**

**Area Scan (10x16x1):** Measurement grid: dx=5mm, dy=12mm

**Zoom Scan (7x7x7)/Cube 0:** Measurement grid: dx=5mm, dy=5mm, dz=5mm

Reference Value = 8.655 V/m; Power Drift = -0.03 dB

Peak SAR (extrapolated) = 0.290 W/kg

**SAR(1 g) = 0.124 W/kg**

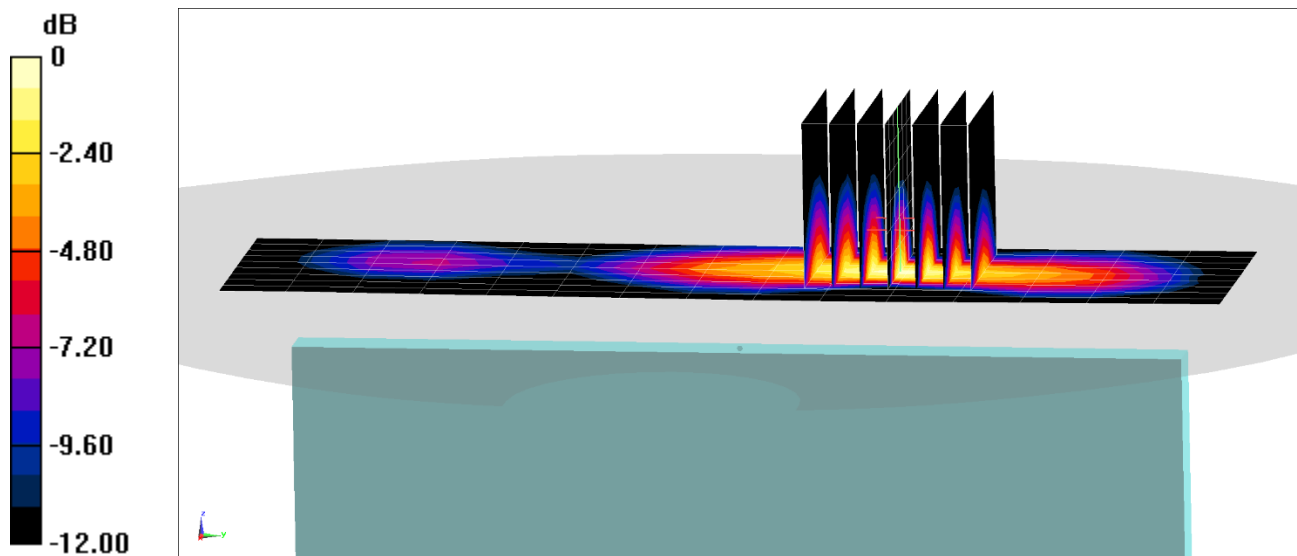

0 dB = 0.228 W/kg = -6.42 dBW/kg

# PCTEST

**DUT: A3LSMG998JPN; Type: Portable Handset; Serial: 0521M**

Communication System: UID 0, GSM GPRS; 4 Tx slots; Frequency: 1880 MHz; Duty Cycle: 1:2.076

Medium: 1900 Body; Medium parameters used:

$f = 1880 \text{ MHz}$ ;  $\sigma = 1.516 \text{ S/m}$ ;  $\epsilon_r = 53.076$ ;  $\rho = 1000 \text{ kg/m}^3$

Phantom section: Flat Section; Space: 0.0 cm

Test Date: 01/24/2021; Ambient Temp: 22.1°C; Tissue Temp: 22.6°C

Probe: EX3DV4 - SN7410; ConvF(7.76, 7.76, 7.76) @ 1880 MHz; Calibrated: 7/20/2020

Sensor-Surface: 1.4mm (Mechanical Surface Detection)

Electronics: DAE4 Sn1322; Calibrated: 7/15/2020

Phantom: SAM Left; Type: QD000P40CC; Serial: TP: 1375

Measurement SW: DASY52, Version 52.10 (4);SEMCAD X Version 14.6.14 (7483)

**Mode: GPRS 1900, Phablet SAR, Bottom Edge, Mid.ch, 4 Tx Slots**

**Area Scan (10x9x1):** Measurement grid: dx=5mm, dy=15mm

**Zoom Scan (10x13x8)/Cube 0:** Measurement grid: dx=3.8mm, dy=3.8mm, dz=1.4mm; Graded Ratio: 1.4

Reference Value = 38.01 V/m; Power Drift = 0.07 dB

Peak SAR (extrapolated) = 7.88 W/kg

**SAR(10 g) = 0.932 W/kg**

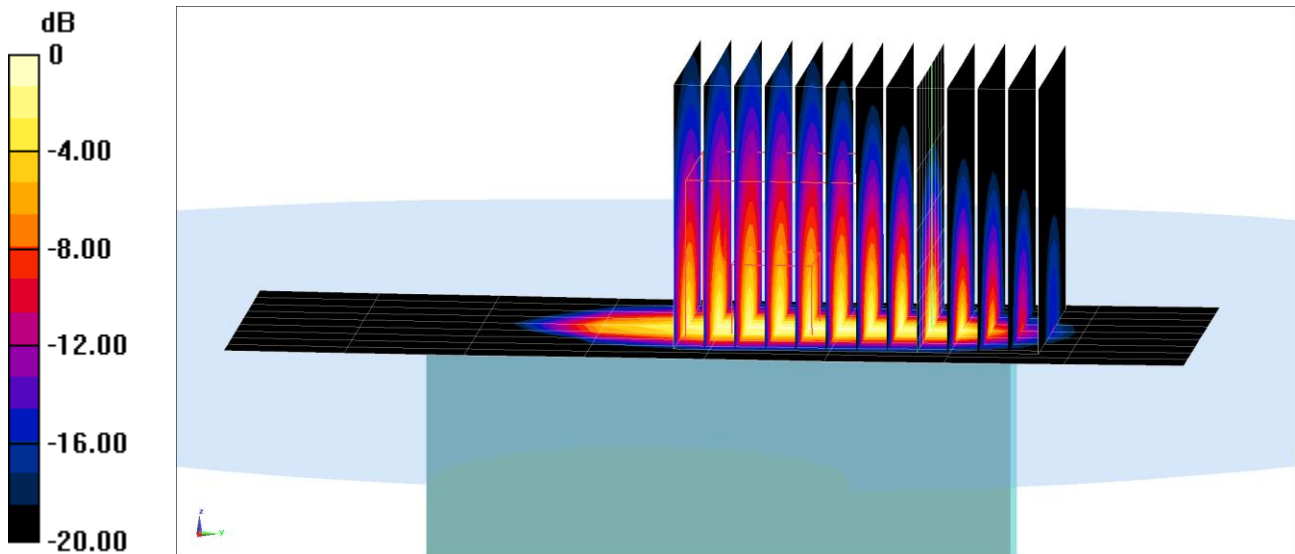

0 dB = 4.29 W/kg = 6.32 dBW/kg

# PCTEST

**DUT: A3LSMG998JPN; Type: Portable Handset; Serial: 0532M**

Communication System: UID 0, LTE Band 4 (AWS); Frequency: 1732.5 MHz; Duty Cycle: 1:1  
Medium: 1750 Body; Medium parameters used (interpolated):  
 $f = 1732.5$  MHz;  $\sigma = 1.493$  S/m;  $\epsilon_r = 51.285$ ;  $\rho = 1000$  kg/m<sup>3</sup>  
Phantom section: Flat Section; Space: 0.0 cm

Test Date: 01/18/2021; Ambient Temp: 20.0°C; Tissue Temp: 21.0°C

Probe: EX3DV4 - SN7357; ConvF(8.17, 8.17, 8.17) @ 1732.5 MHz; Calibrated: 4/21/2020  
Sensor-Surface: 1.4mm (Mechanical Surface Detection)  
Electronics: DAE4 Sn1407; Calibrated: 4/15/2020  
Phantom: Twin-SAM V5.0 Right 30; Type: QD 000 P40 CD; Serial: 1759  
Measurement SW: DASY52, Version 52.10 (4);SEMCAD X Version 14.6.14 (7483)

**Mode: LTE Band 4 (AWS), Phablet SAR, Bottom Edge, Mid.ch,  
20 MHz Bandwidth, QPSK, 50 RB, 25 RB Offset**

**Area Scan (11x9x1):** Measurement grid: dx=5mm, dy=15mm

**Zoom Scan (10x10x8)/Cube 0:** Measurement grid: dx=3.8mm, dy=3.8mm, dz=1.4mm; Graded Ratio: 1.4

Reference Value = 61.17 V/m; Power Drift = 0.00 dB

Peak SAR (extrapolated) = 11.6 W/kg

**SAR(10 g) = 2.1 W/kg**

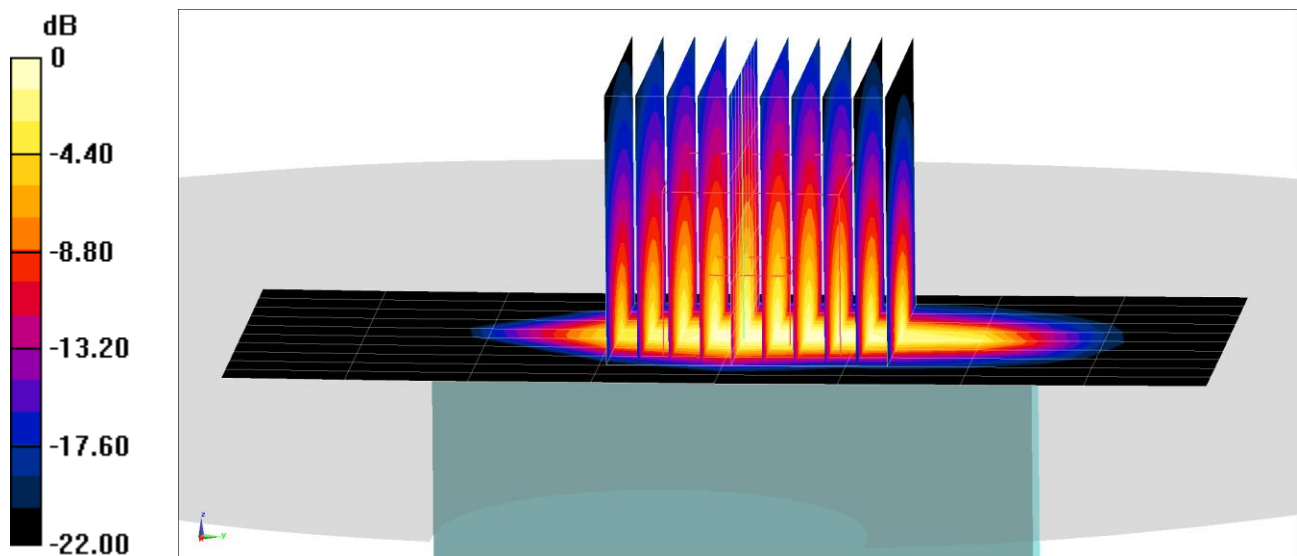

0 dB = 8.02 W/kg = 9.04 dBW/kg

# PCTEST

**DUT: A3LSMG998JPN; Type: Portable Handset; Serial: 0466M**

Communication System: UID 0, LTE Band 41; Frequency: 2680 MHz; Duty Cycle: 1:1.58

Medium: 2450 Body; Medium parameters used:

$f = 2680 \text{ MHz}$ ;  $\sigma = 2.352 \text{ S/m}$ ;  $\epsilon_r = 50.29$ ;  $\rho = 1000 \text{ kg/m}^3$

Phantom section: Flat Section; Space: 0.0 cm

Test Date: 01/24/2021; Ambient Temp: 23.1°C; Tissue Temp: 23.1°C

Probe: EX3DV4 - SN7308; ConvF(7.37, 7.37, 7.37) @ 2680 MHz; Calibrated: 7/31/2020

Sensor-Surface: 1.4mm (Mechanical Surface Detection)

Electronics: DAE4 Sn1450; Calibrated: 8/11/2020

Phantom: Twin-SAM V5.0; Type: QD 000 P40 CD; Serial: 1792

Measurement SW: DASY52, Version 52.10 (4);SEMCAD X Version 14.6.14 (7483)

**Mode: LTE Band 41, Phablet SAR, Back side, High.ch,  
20 MHz Bandwidth, QPSK, 50 RB, 25 RB Offset**

**Area Scan (11x18x1):** Measurement grid: dx=12mm, dy=12mm

**Zoom Scan (7x7x7)/Cube 0:** Measurement grid: dx=5mm, dy=5mm, dz=5mm

Reference Value = 40.73 V/m; Power Drift = -0.11 dB

Peak SAR (extrapolated) = 14.3 W/kg

**SAR(10 g) = 1.64 W/kg**

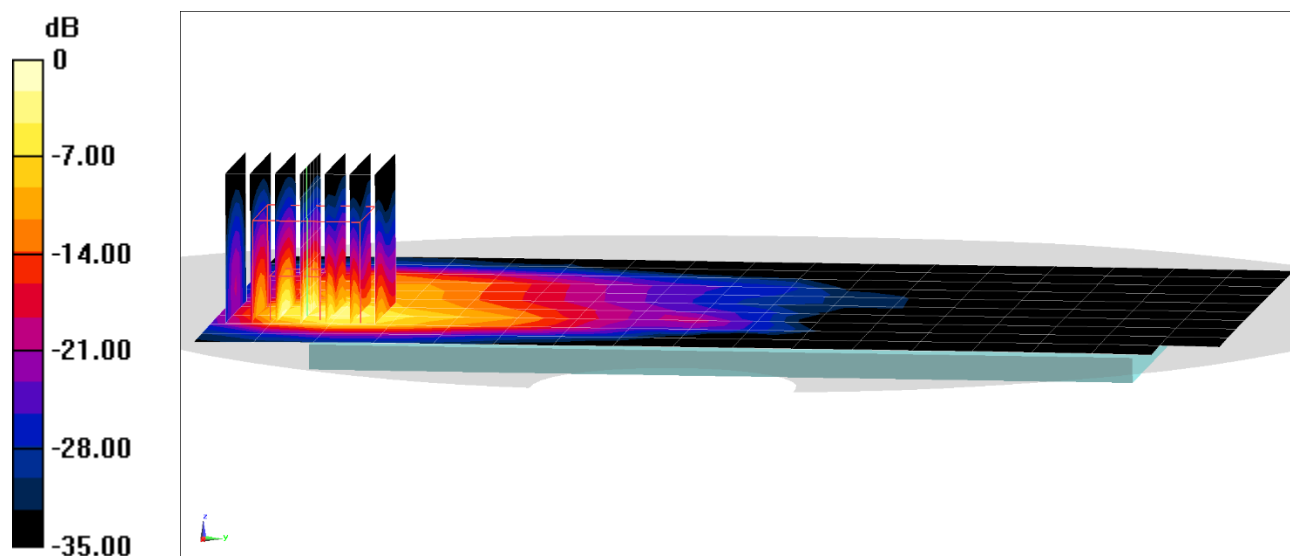

0 dB = 9.75 W/kg = 9.89 dBW/kg

# PCTEST

**DUT: A3LSMG998JPN; Type: Portable Handset; Serial: 0023M**

Communication System: UID 0, IEEE 802.11n; Frequency: 5260 MHz; Duty Cycle: 1:1  
Medium: 5200-5800 Body; Medium parameters used:  
 $f = 5260 \text{ MHz}$ ;  $\sigma = 5.539 \text{ S/m}$ ;  $\epsilon_r = 46.811$ ;  $\rho = 1000 \text{ kg/m}^3$   
Phantom section: Flat Section; Space: 0.0 cm

Test Date: 01/18/2021; Ambient Temp: 23.5°C; Tissue Temp: 22.4°C

Probe: EX3DV4 - SN7406; ConvF(5.05, 5.05, 5.05) @ 5260 MHz; Calibrated: 6/23/2020  
Sensor-Surface: 1.4mm (Mechanical Surface Detection)  
Electronics: DAE4 Sn1583; Calibrated: 5/14/2020  
Phantom: Front; Type: QD 000 P40 CD; Serial: 1686  
Measurement SW: DASY52, Version 52.10 (4);SEMCAD X Version 14.6.14 (7483)

**Mode: IEEE 802.11n, MIMO, U-NII-2A, 20 MHz Bandwidth,  
Phablet SAR, Ch 52, 13 Mbps, Left Edge**

**Area Scan (10x19x1):** Measurement grid: dx=5mm, dy=10mm

**Zoom Scan (17x17x7)/Cube 0:** Measurement grid: dx=1.9mm, dy=1.9mm, dz=1.4mm; Graded Ratio: 1.4

Reference Value = 2.430 V/m; Power Drift = 0.18 dB

Peak SAR (extrapolated) = 62.6 W/kg

**SAR(10 g) = 1.57 W/kg**

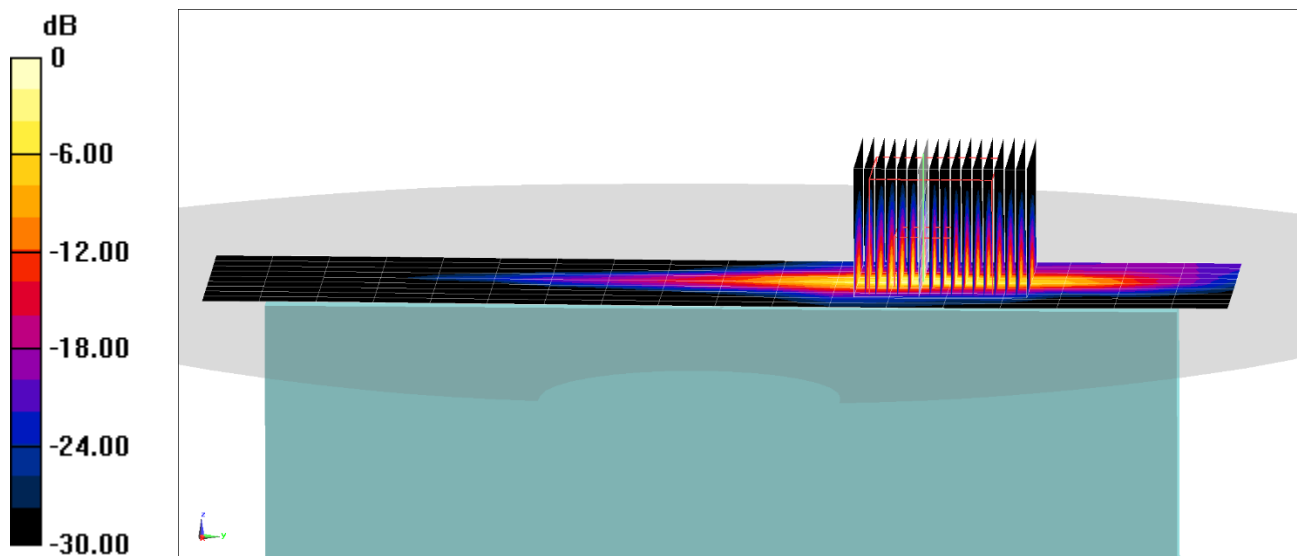

0 dB = 30.0 W/kg = 14.77 dBW/kg

## APPENDIX B: SYSTEM VERIFICATION

# PCTEST

**DUT: Dipole 750 MHz; Type: D750V3; Serial: 1003**

Communication System: UID 0, CW; Frequency: 750 MHz; Duty Cycle: 1:1

Medium: 750 Head Medium parameters used:

$f = 750 \text{ MHz}$ ;  $\sigma = 0.924 \text{ S/m}$ ;  $\epsilon_r = 41.418$ ;  $\rho = 1000 \text{ kg/m}^3$

Phantom section: Flat Section; Space: 1.5 cm

Test Date: 01/21/2021; Ambient Temp: 23.3°C; Tissue Temp: 22.3°C

Probe: EX3DV4 - SN7571; ConvF(10.02, 10.02, 10.02) @ 750 MHz; Calibrated: 12/11/2020

Sensor-Surface: 1.4mm (Mechanical Surface Detection)

Electronics: DAE4 Sn1533; Calibrated: 12/7/2020

Phantom: Front Twin-SAM V5.0 (30); Type: QD 000 P40 CD; Serial: 1648

Measurement SW: DASY52, Version 52.10 (4);SEMCAD X Version 14.6.14 (7483)

## 750 MHz System Verification at 23.0 dBm (200 mW)

**Area Scan (7x15x1):** Measurement grid: dx=15mm, dy=15mm

**Zoom Scan (5x5x7)/Cube 0:** Measurement grid: dx=8mm, dy=8mm, dz=5mm

Peak SAR (extrapolated) = 2.58 W/kg

**SAR(1 g) = 1.71 W/kg**

Deviation(1 g) = -2.62%

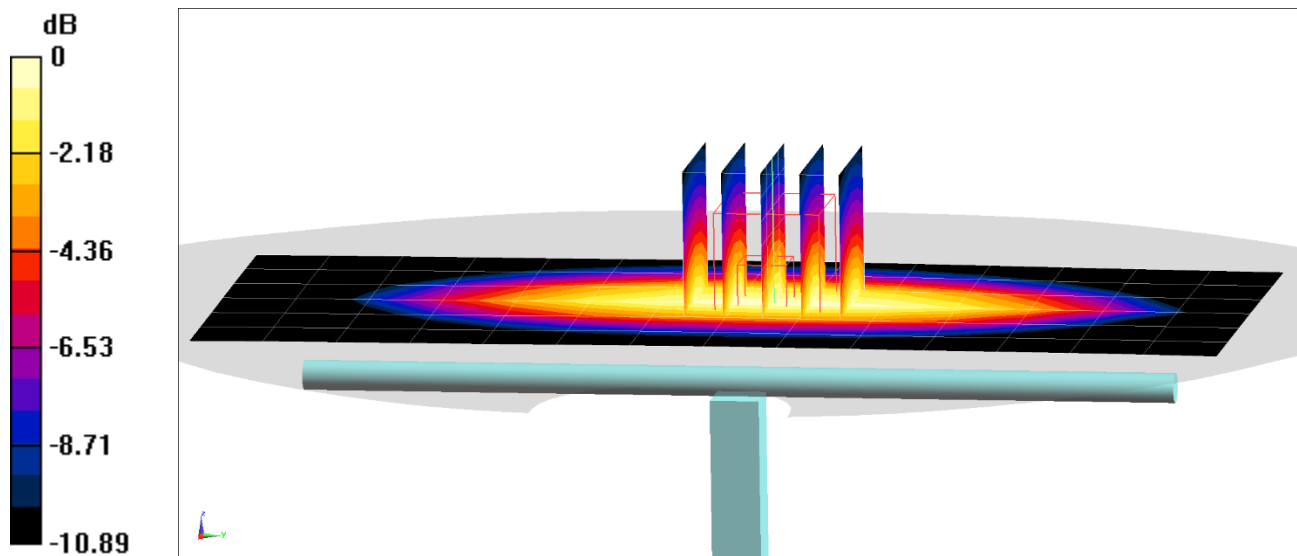

# PCTEST

**DUT: Dipole 835 MHz; Type: D835V2; Serial: 4d047**

Communication System: UID 0, CW; Frequency: 835 MHz; Duty Cycle: 1:1

Medium: 835 Head Medium parameters used:

$f = 835 \text{ MHz}$ ;  $\sigma = 0.882 \text{ S/m}$ ;  $\epsilon_r = 40.983$ ;  $\rho = 1000 \text{ kg/m}^3$

Phantom section: Flat Section; Space: 1.5 cm

Test Date: 01/20/2021; Ambient Temp: 22.3°C; Tissue Temp: 20.4°C

Probe: EX3DV4 - SN7539; ConvF(9.96, 9.96, 9.96) @ 835 MHz; Calibrated: 10/20/2020

Sensor-Surface: 1.4mm (Mechanical Surface Detection)

Electronics: DAE4 Sn728; Calibrated: 5/20/2020

Phantom: Twin-SAM V8.0; Type: QD 000 P41 Ax; Serial: 1966

Measurement SW: DASY52, Version 52.10 (4); SEMCAD X Version 14.6.14 (7483)

## 835 MHz System Verification at 23.0 dBm (200 mW)

**Area Scan (7x14x1):** Measurement grid: dx=15mm, dy=15mm

**Zoom Scan (5x5x7)/Cube 0:** Measurement grid: dx=8mm, dy=8mm, dz=5mm

Peak SAR (extrapolated) = 2.96 W/kg

**SAR(1 g) = 1.96 W/kg**

Deviation(1 g) = 4.03%

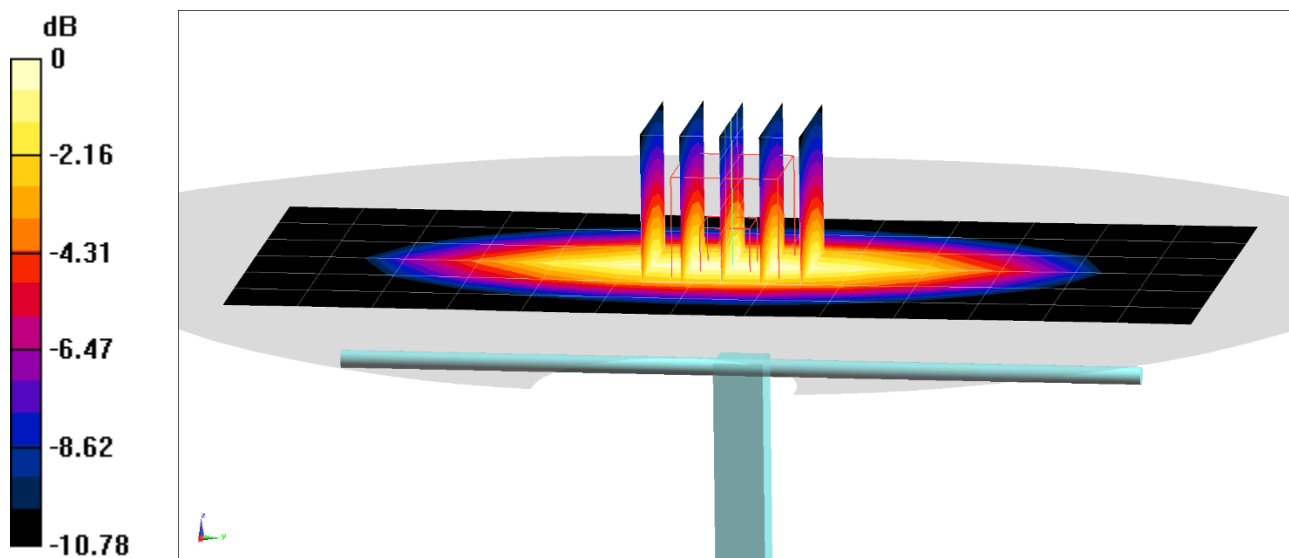

0 dB = 2.62 W/kg = 4.18 dBW/kg



# PCTEST

**DUT: Dipole 1750 MHz; Type: D1750V2; Serial: 1150**

Communication System: UID 0, CW; Frequency: 1750 MHz; Duty Cycle: 1:1

Medium: 1750 Head Medium parameters used:

$f = 1750 \text{ MHz}$ ;  $\sigma = 1.399 \text{ S/m}$ ;  $\epsilon_r = 39.491$ ;  $\rho = 1000 \text{ kg/m}^3$

Phantom section: Flat Section; Space: 1.0 cm

Test Date: 01/19/2021; Ambient Temp: 22.6°C; Tissue Temp: 22.6°C

Probe: EX3DV4 - SN7357; ConvF(8.69, 8.69, 8.69) @ 1750 MHz; Calibrated: 4/21/2020

Sensor-Surface: 1.4mm (Mechanical Surface Detection)

Electronics: DAE4 Sn1407; Calibrated: 4/15/2020

Phantom: Twin-SAM V5.0 Left 20; Type: QD 000 P40 CD; Serial: 1715

Measurement SW: DASY52, Version 52.10 (4);SEMCAD X Version 14.6.14 (7483)

## 1750 MHz System Verification at 20.0 dBm (100 mW)

**Area Scan (7x9x1):** Measurement grid: dx=15mm, dy=15mm

**Zoom Scan (5x5x7)/Cube 0:** Measurement grid: dx=8mm, dy=8mm, dz=5mm

Peak SAR (extrapolated) = 7.01 W/kg

**SAR(1 g) = 3.79 W/kg**

Deviation(1 g) = 3.84%

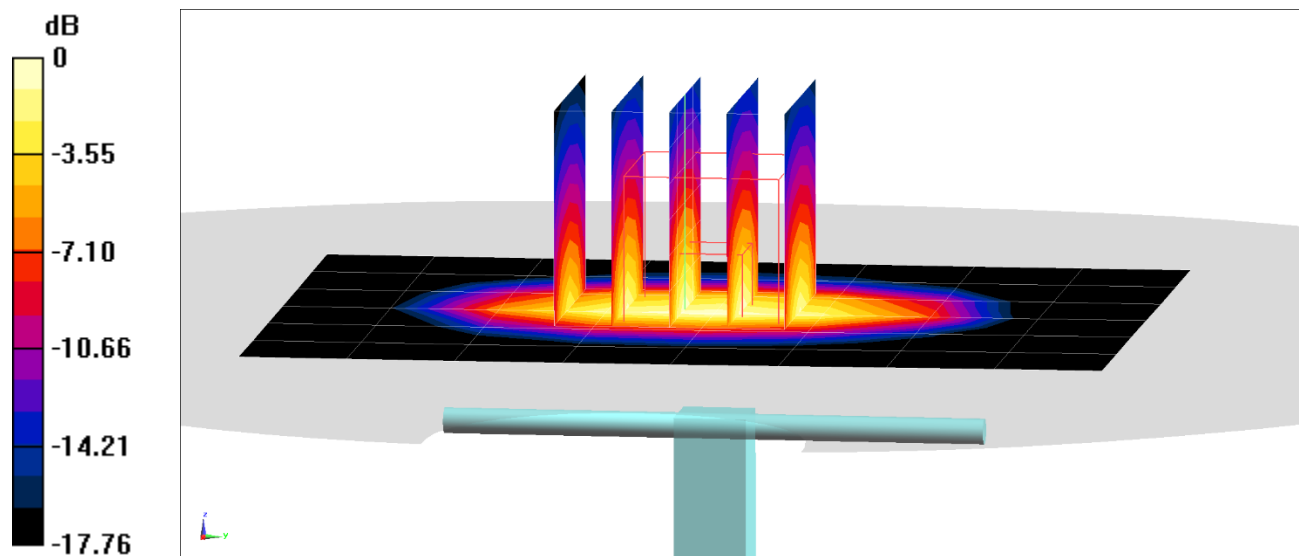

0 dB = 5.80 W/kg = 7.63 dBW/kg

# PCTEST

**DUT: Dipole 1900 MHz; Type: D1900V2; Serial: 5d149**

Communication System: UID 0, CW; Frequency: 1900 MHz; Duty Cycle: 1:1

Medium: 1900 Head Medium parameters used:

$f = 1900$  MHz;  $\sigma = 1.406$  S/m;  $\epsilon_r = 40.359$ ;  $\rho = 1000$  kg/m<sup>3</sup>

Phantom section: Flat Section; Space: 1.0 cm

Test Date: 01/21/2021; Ambient Temp: 23.5°C; Tissue Temp: 25.0°C

Probe: EX3DV4 - SN7357; ConvF(8.32, 8.32, 8.32) @ 1900 MHz; Calibrated: 4/21/2020

Sensor-Surface: 1.4mm (Mechanical Surface Detection)

Electronics: DAE4 Sn1407; Calibrated: 4/15/2020

Phantom: Twin-SAM V5.0 Left 30; Type: QD 000 P40 CD; Serial: 1715

Measurement SW: DASY52, Version 52.10 (4);SEMCAD X Version 14.6.14 (7483)

## 1900 MHz System Verification at 20.0 dBm (100 mW)

**Area Scan (7x11x1):** Measurement grid: dx=15mm, dy=15mm

**Zoom Scan (5x5x7)/Cube 0:** Measurement grid: dx=8mm, dy=8mm, dz=5mm

Peak SAR (extrapolated) = 7.51 W/kg

**SAR(1 g) = 3.95 W/kg**

Deviation(1 g) = 0.51%

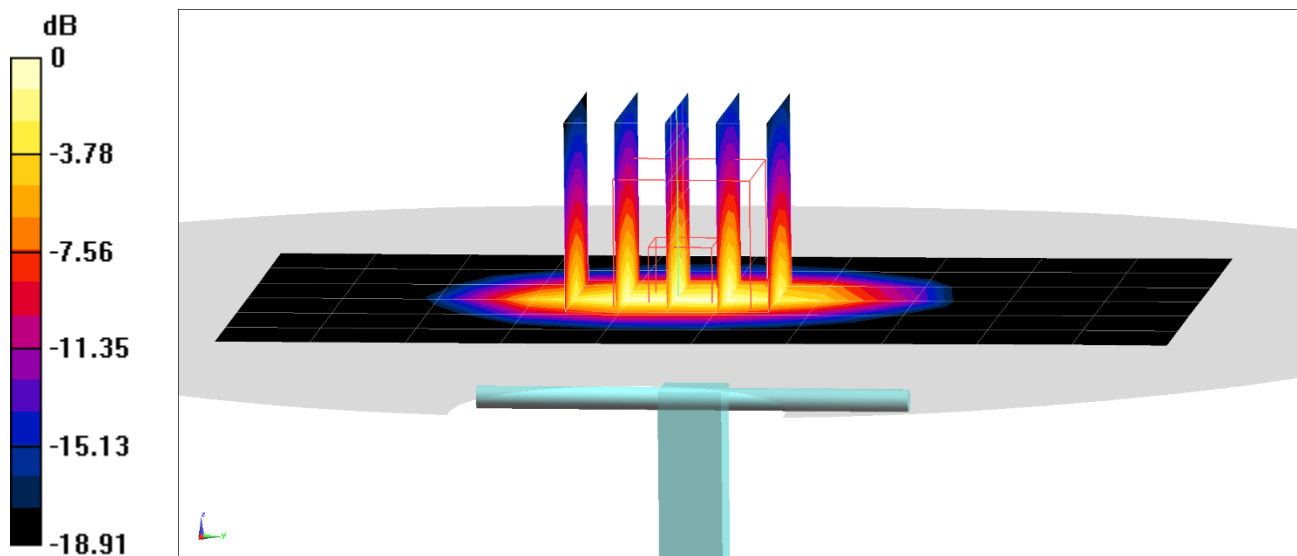

0 dB = 6.24 W/kg = 7.95 dBW/kg

# PCTEST

**DUT: Dipole 2450 MHz; Type: D2450V2; Serial: 797**

Communication System: UID 0, CW; Frequency: 2450 MHz; Duty Cycle: 1:1

Medium: 2450 Head Medium parameters used:

$f = 2450 \text{ MHz}$ ;  $\sigma = 1.86 \text{ S/m}$ ;  $\epsilon_r = 38.686$ ;  $\rho = 1000 \text{ kg/m}^3$

Phantom section: Flat Section; Space: 1.0 cm

Test Date: 01/18/2021; Ambient Temp: 22.9°C; Tissue Temp: 22.3°C

Probe: EX3DV4 - SN7571; ConvF(7.28, 7.28, 7.28) @ 2450 MHz; Calibrated: 12/11/2020

Sensor-Surface: 1.4mm (Mechanical Surface Detection)

Electronics: DAE4 Sn1533; Calibrated: 12/7/2020

Phantom: Twin-SAM V5.0 (30); Type: QD 000 P40 CD; Serial: 1647

Measurement SW: DASY52, Version 52.10 (4);SEMCAD X Version 14.6.14 (7483)

## 2450 MHz System Verification at 20.0 dBm (100 mW)

**Area Scan (8x9x1):** Measurement grid: dx=12mm, dy=12mm

**Zoom Scan (7x7x7)/Cube 0:** Measurement grid: dx=5mm, dy=5mm, dz=5mm

Peak SAR (extrapolated) = 10.8 W/kg

**SAR(1 g) = 4.98 W/kg**

Deviation(1 g) = -4.96%

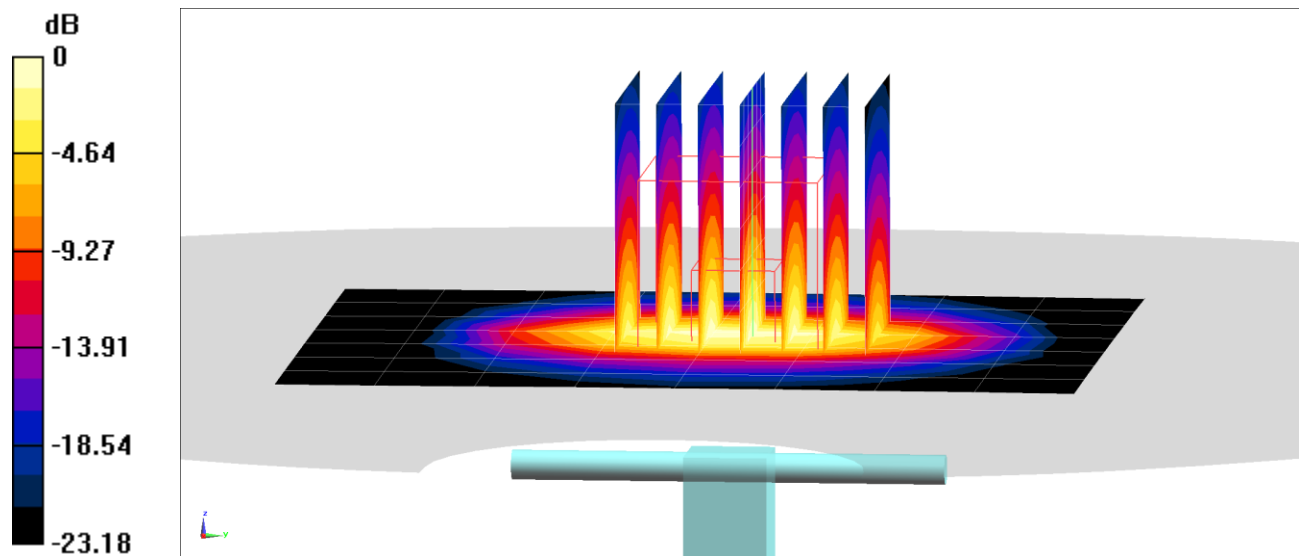

0 dB = 8.48 W/kg = 9.28 dBW/kg

# PCTEST

**DUT: Dipole 2450 MHz; Type: D2450V2; Serial: 797**

Communication System: UID 0, CW; Frequency: 2450 MHz; Duty Cycle: 1:1

Medium: 2450 Head Medium parameters used:

$f = 2450 \text{ MHz}$ ;  $\sigma = 1.776 \text{ S/m}$ ;  $\epsilon_r = 37.99$ ;  $\rho = 1000 \text{ kg/m}^3$

Phantom section: Flat Section; Space: 1.0 cm

Test Date: 01/20/2021; Ambient Temp: 23.1°C; Tissue Temp: 22.4°C

Probe: EX3DV4 - SN7571; ConvF(7.28, 7.28, 7.28) @ 2450 MHz; Calibrated: 12/11/2020

Sensor-Surface: 1.4mm (Mechanical Surface Detection)

Electronics: DAE4 Sn1533; Calibrated: 12/7/2020

Phantom: Twin-SAM V5.0 (30); Type: QD 000 P40 CD; Serial: 1647

Measurement SW: DASY52, Version 52.10 (4);SEMCAD X Version 14.6.14 (7483)

## 2450 MHz System Verification at 20.0 dBm (100 mW)

**Area Scan (8x9x1):** Measurement grid: dx=12mm, dy=12mm

**Zoom Scan (7x7x7)/Cube 0:** Measurement grid: dx=5mm, dy=5mm, dz=5mm

Peak SAR (extrapolated) = 10.6 W/kg

**SAR(1 g) = 4.91 W/kg**

Deviation(1 g) = -6.30%

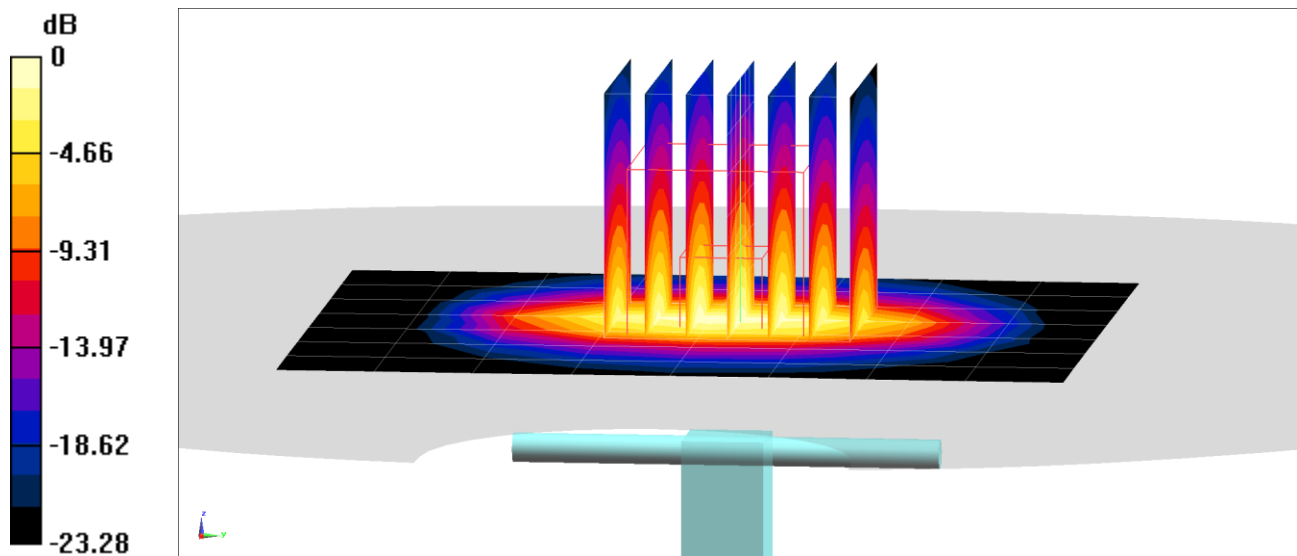

# PCTEST

**DUT: Dipole 2600 MHz; Type: D2600V2; Serial: 1064**

Communication System: UID 0, CW; Frequency: 2600 MHz; Duty Cycle: 1:1

Medium: 2600 Head Medium parameters used:

$f = 2600$  MHz;  $\sigma = 1.947$  S/m;  $\epsilon_r = 37.437$ ;  $\rho = 1000$  kg/m<sup>3</sup>

Phantom section: Flat Section; Space: 1.0 cm

Test Date: 01/20/2021; Ambient Temp: 23.1°C; Tissue Temp: 22.4°C

Probe: EX3DV4 - SN7571; ConvF(7.05, 7.05, 7.05) @ 2600 MHz; Calibrated: 12/11/2020

Sensor-Surface: 1.4mm (Mechanical Surface Detection)

Electronics: DAE4 Sn1533; Calibrated: 12/7/2020

Phantom: Twin-SAM V5.0 (30); Type: QD 000 P40 CD; Serial: 1647

Measurement SW: DASY52, Version 52.10 (4);SEMCAD X Version 14.6.14 (7483)

## 2600 MHz System Verification at 20.0 dBm (100 mW)

**Area Scan (8x9x1):** Measurement grid: dx=12mm, dy=12mm

**Zoom Scan (7x7x7)/Cube 0:** Measurement grid: dx=5mm, dy=5mm, dz=5mm

Peak SAR (extrapolated) = 13.3 W/kg

**SAR(1 g) = 5.88 W/kg**

Deviation(1 g) = 1.20%

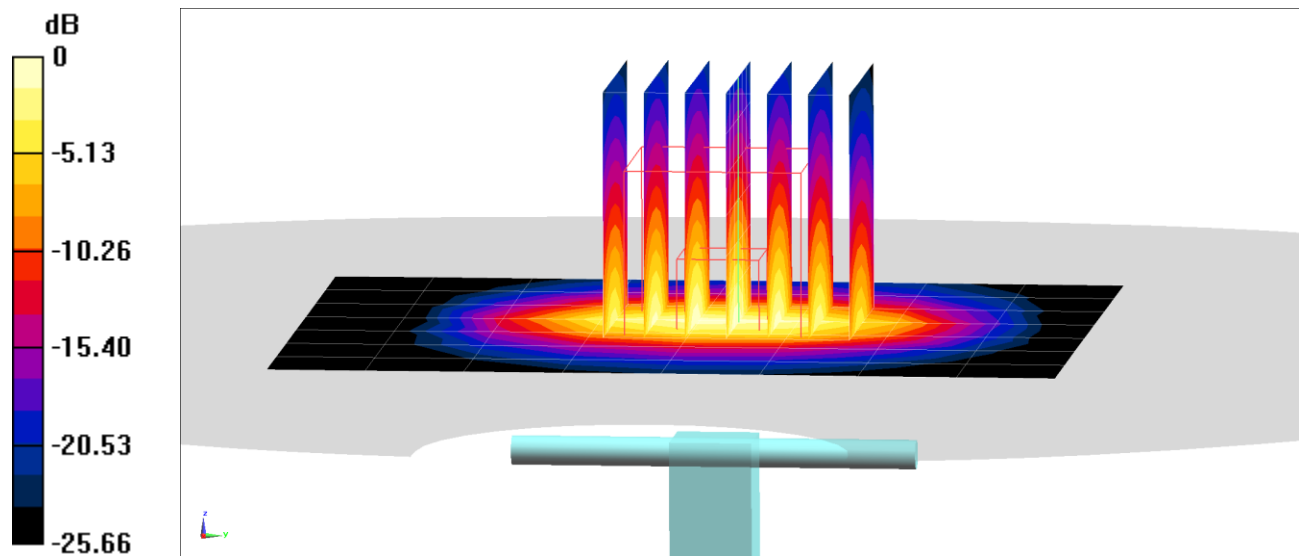

0 dB = 9.78 W/kg = 9.90 dBW/kg

# PCTEST

**DUT: Dipole 5 GHz; Type: D5GHzV2; Serial: 1237**

Communication System: UID 0, CW; Frequency: 5250 MHz; Duty Cycle: 1:1

Medium: 5200-5800 Head Medium parameters used:

$f = 5250$  MHz;  $\sigma = 4.504$  S/m;  $\epsilon_r = 34.612$ ;  $\rho = 1000$  kg/m<sup>3</sup>

Phantom section: Flat Section; Space: 1.0 cm

Test Date: 01/22/2021; Ambient Temp: 22.5°C; Tissue Temp: 23.0°C

Probe: EX3DV4 - SN7357; ConvF(5.5, 5.5, 5.5) @ 5250 MHz; Calibrated: 4/21/2020

Sensor-Surface: 1.4mm (Mechanical Surface Detection)

Electronics: DAE4 Sn1407; Calibrated: 4/15/2020

Phantom: Twin-SAM V5.0 Left 20; Type: QD 000 P40 CD; Serial: 1715

Measurement SW: DASY52, Version 52.10 (4);SEMCAD X Version 14.6.14 (7483)

## 5250 MHz System Verification at 17.0 dBm (50 mW)

**Area Scan (7x7x1):** Measurement grid: dx=10mm, dy=10mm

**Zoom Scan (8x8x7)/Cube 0:** Measurement grid: dx=4mm, dy=4mm, dz=1.4mm; Graded Ratio: 1.4

Peak SAR (extrapolated) = 14.7 W/kg

**SAR(1 g) = 3.75 W/kg**

Deviation(1 g) = -7.75%

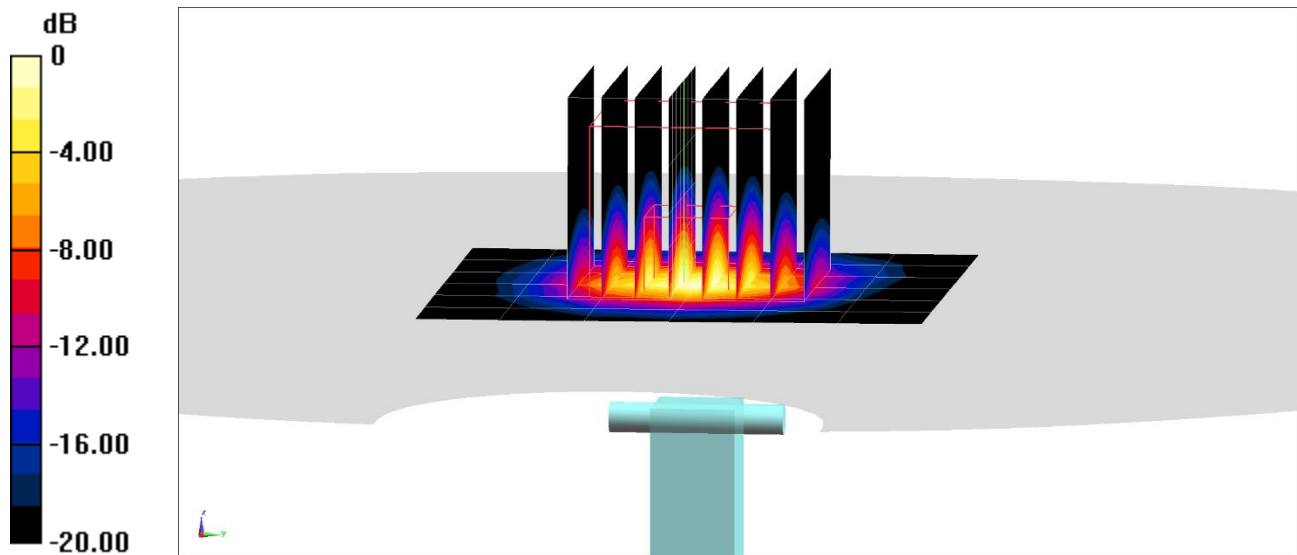

0 dB = 8.71 W/kg = 9.40 dBW/kg

# PCTEST

**DUT: Dipole 5 GHz; Type: D5GHzV2; Serial: 1237**

Communication System: UID 0, CW; Frequency: 5600 MHz; Duty Cycle: 1:1

Medium: 5200-5800 Head Medium parameters used:

$f = 5600$  MHz;  $\sigma = 4.889$  S/m;  $\epsilon_r = 34.021$ ;  $\rho = 1000$  kg/m<sup>3</sup>

Phantom section: Flat Section; Space: 1.0 cm

Test Date: 01/22/2021; Ambient Temp: 22.5°C; Tissue Temp: 23.0°C

Probe: EX3DV4 - SN7357; ConvF(4.93, 4.93, 4.93) @ 5600 MHz; Calibrated: 4/21/2020

Sensor-Surface: 1.4mm (Mechanical Surface Detection)

Electronics: DAE4 Sn1407; Calibrated: 4/15/2020

Phantom: Twin-SAM V5.0 Left 20; Type: QD 000 P40 CD; Serial: 1715

Measurement SW: DASY52, Version 52.10 (4);SEMCAD X Version 14.6.14 (7483)

## 5600 MHz System Verification at 17.0 dBm (50 mW)

**Area Scan (7x7x1):** Measurement grid: dx=10mm, dy=10mm

**Zoom Scan (8x8x7)/Cube 0:** Measurement grid: dx=4mm, dy=4mm, dz=1.4mm; Graded Ratio: 1.4

Peak SAR (extrapolated) = 16.9 W/kg

**SAR(1 g) = 3.89 W/kg**

Deviation(1 g) = -9.22%

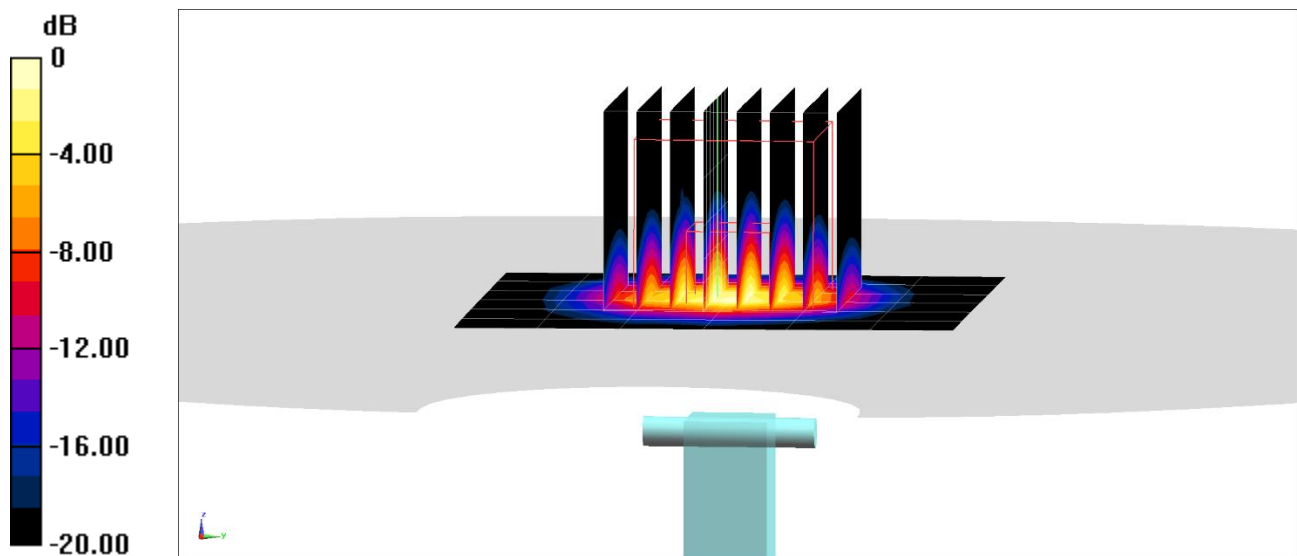

0 dB = 9.41 W/kg = 9.74 dBW/kg

# PCTEST

**DUT: Dipole 5 GHz; Type: D5GHzV2; Serial: 1237**

Communication System: UID 0, CW; Frequency: 5750 MHz; Duty Cycle: 1:1

Medium: 5200-5800 Head Medium parameters used:

$f = 5750$  MHz;  $\sigma = 5.053$  S/m;  $\epsilon_r = 33.784$ ;  $\rho = 1000$  kg/m<sup>3</sup>

Phantom section: Flat Section; Space: 1.0 cm

Test Date: 01/22/2021; Ambient Temp: 22.5°C; Tissue Temp: 23.0°C

Probe: EX3DV4 - SN7357; ConvF(5.05, 5.05, 5.05) @ 5750 MHz; Calibrated: 4/21/2020

Sensor-Surface: 1.4mm (Mechanical Surface Detection)

Electronics: DAE4 Sn1407; Calibrated: 4/15/2020

Phantom: Twin-SAM V5.0 Left 20; Type: QD 000 P40 CD; Serial: 1715

Measurement SW: DASY52, Version 52.10 (4);SEMCAD X Version 14.6.14 (7483)

## 5750 MHz System Verification at 17.0 dBm (50 mW)

**Area Scan (7x7x1):** Measurement grid: dx=10mm, dy=10mm

**Zoom Scan (8x8x7)/Cube 0:** Measurement grid: dx=4mm, dy=4mm, dz=1.4mm; Graded Ratio: 1.4

Peak SAR (extrapolated) = 16.9 W/kg

**SAR(1 g) = 3.9 W/kg**

Deviation(1 g) = -3.23%

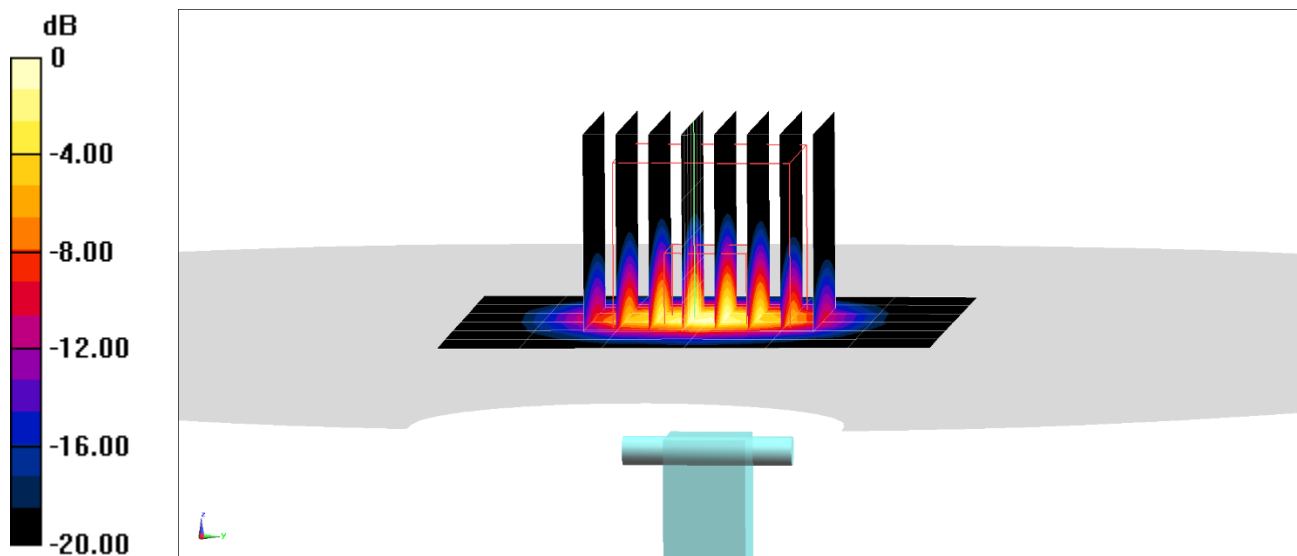



# PCTEST

**DUT: Dipole 750 MHz; Type: D750V3; Serial: 1054**

Communication System: UID 0, CW; Frequency: 750 MHz; Duty Cycle: 1:1

Medium: 750 Body Medium parameters used:

$f = 750 \text{ MHz}$ ;  $\sigma = 0.962 \text{ S/m}$ ;  $\epsilon_r = 53.971$ ;  $\rho = 1000 \text{ kg/m}^3$

Phantom section: Flat Section; Space: 1.5 cm

Test Date: 01/20/2021; Ambient Temp: 24.1°C; Tissue Temp: 20.9°C

Probe: EX3DV4 - SN7308; ConvF(10.19, 10.19, 10.19) @ 750 MHz; Calibrated: 7/31/2020

Sensor-Surface: 1.4mm (Mechanical Surface Detection)

Electronics: DAE4 Sn1450; Calibrated: 8/11/2020

Phantom: Twin-SAM V5.0; Type: QD 000 P40 CD; Serial: 1792

Measurement SW: DASY52, Version 52.10 (4);SEMCAD X Version 14.6.14 (7483)

## 750 MHz System Verification at 23.0 dBm (200 mW)

**Area Scan (7x15x1):** Measurement grid: dx=15mm, dy=15mm

**Zoom Scan (5x5x7)/Cube 0:** Measurement grid: dx=8mm, dy=8mm, dz=5mm

Peak SAR (extrapolated) = 2.69 W/kg

**SAR(1 g) = 1.72 W/kg**

Deviation(1 g) = 0.82%

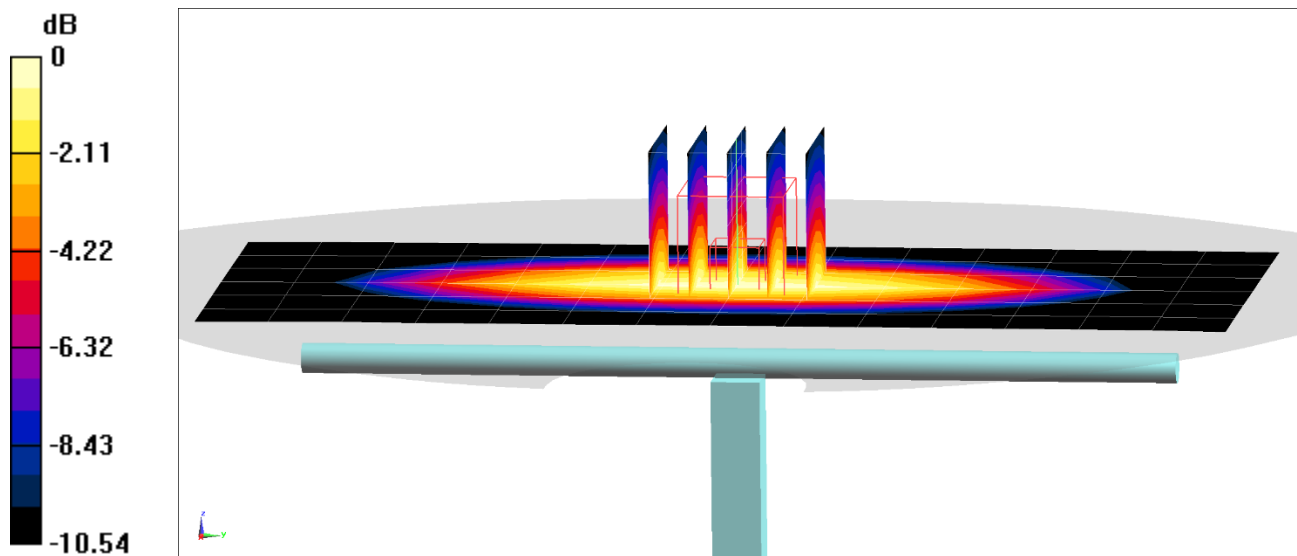

0 dB = 2.34 W/kg = 3.69 dBW/kg

# PCTEST

**DUT: Dipole 835 MHz; Type: D835V2; Serial: 4d133**

Communication System: UID 0, CW; Frequency: 835 MHz; Duty Cycle: 1:1

Medium: 835 Body Medium parameters used:

$f = 835 \text{ MHz}$ ;  $\sigma = 0.959 \text{ S/m}$ ;  $\epsilon_r = 53.583$ ;  $\rho = 1000 \text{ kg/m}^3$

Phantom section: Flat Section; Space: 1.5 cm

Test Date: 01/20/2021; Ambient Temp: 23.1°C; Tissue Temp: 22.3°C

Probe: EX3DV4 - SN7552; ConvF(9.96, 9.96, 9.96) @ 835 MHz; Calibrated: 9/11/2020

Sensor-Surface: 1.4mm (Mechanical Surface Detection)

Electronics: DAE4 Sn1449; Calibrated: 9/10/2020

Phantom: Twin-SAM V4.0 Left 30; Type: QD 000 P40 CC; Serial: 1687

Measurement SW: DASY52, Version 52.10 (4);SEMCAD X Version 14.6.14 (7483)

## 835 MHz System Verification at 23.0 dBm (200 mW)

**Area Scan (7x14x1):** Measurement grid: dx=15mm, dy=15mm

**Zoom Scan (5x5x7)/Cube 0:** Measurement grid: dx=8mm, dy=8mm, dz=5mm

Peak SAR (extrapolated) = 3.00 W/kg

**SAR(1 g) = 1.96 W/kg**

Deviation(1 g) = 0.51%

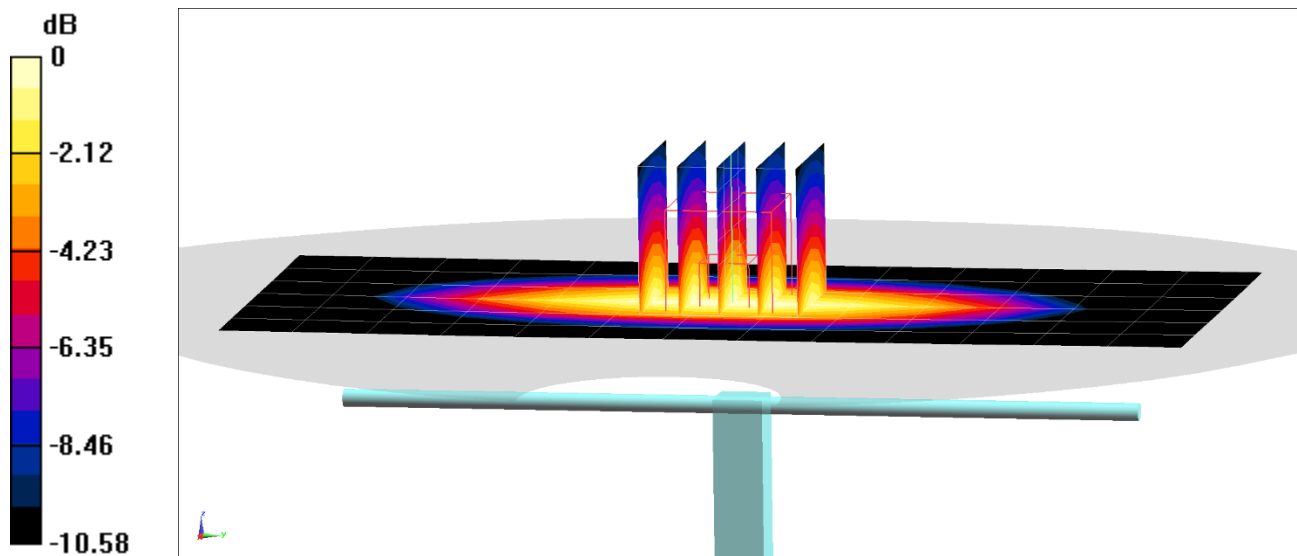

0 dB = 2.64 W/kg = 4.22 dBW/kg

# PCTEST

**DUT: Dipole 1750 MHz; Type: D1750V2; Serial: 1150**

Communication System: UID 0, CW; Frequency: 1750 MHz; Duty Cycle: 1:1

Medium: 1750 Body Medium parameters used:

$f = 1750$  MHz;  $\sigma = 1.511$  S/m;  $\epsilon_r = 51.209$ ;  $\rho = 1000$  kg/m<sup>3</sup>

Phantom section: Flat Section; Space: 1.0 cm

Test Date: 01/18/2021; Ambient Temp: 20.0°C; Tissue Temp: 21.0°C

Probe: EX3DV4 - SN7357; ConvF(8.17, 8.17, 8.17) @ 1750 MHz; Calibrated: 4/21/2020

Sensor-Surface: 1.4mm (Mechanical Surface Detection)

Electronics: DAE4 Sn1407; Calibrated: 4/15/2020

Phantom: Twin-SAM V5.0 Right 30; Type: QD 000 P40 CD; Serial: 1759

Measurement SW: DASY52, Version 52.10 (4);SEMCAD X Version 14.6.14 (7483)

## 1750 MHz System Verification at 20.0 dBm (100 mW)

**Area Scan (7x9x1):** Measurement grid: dx=15mm, dy=15mm

**Zoom Scan (5x5x7)/Cube 0:** Measurement grid: dx=8mm, dy=8mm, dz=5mm

Peak SAR (extrapolated) = 6.58 W/kg

**SAR(1 g) = 3.56 W/kg; SAR(10 g) = 1.85 W/kg**

Deviation(1 g) = -2.73%; Deviation(10 g) = -4.64%

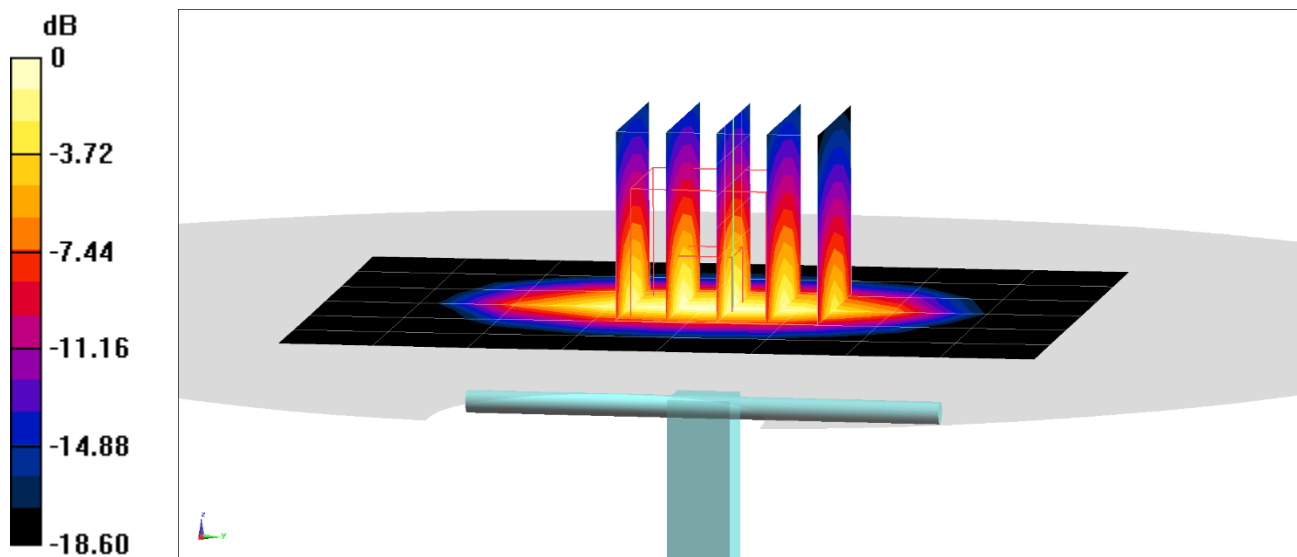

0 dB = 5.44 W/kg = 7.36 dBW/kg

# PCTEST

**DUT: Dipole 1900 MHz; Type: D1900V2; Serial: 5d080**

Communication System: UID 0, CW; Frequency: 1900 MHz; Duty Cycle: 1:1

Medium: 1900 Body Medium parameters used:

$f = 1900$  MHz;  $\sigma = 1.538$  S/m;  $\epsilon_r = 52.326$ ;  $\rho = 1000$  kg/m<sup>3</sup>

Phantom section: Flat Section; Space: 1.0 cm

Test Date: 01/17/2021; Ambient Temp: 20.3°C; Tissue Temp: 22.8°C

Probe: EX3DV4 - SN7410; ConvF(7.76, 7.76, 7.76) @ 1900 MHz; Calibrated: 7/20/2020

Sensor-Surface: 1.4mm (Mechanical Surface Detection)

Electronics: DAE4 Sn1322; Calibrated: 7/15/2020

Phantom: SAM Left; Type: QD000P40CC; Serial: TP: 1375

Measurement SW: DASY52, Version 52.10 (4);SEMCAD X Version 14.6.14 (7483)

## 1900 MHz System Verification at 20.0 dBm (100 mW)

**Area Scan (7x11x1):** Measurement grid: dx=15mm, dy=15mm

**Zoom Scan (5x5x7)/Cube 0:** Measurement grid: dx=8mm, dy=8mm, dz=5mm

Peak SAR (extrapolated) = 7.68 W/kg

**SAR(1 g) = 4.1 W/kg**

Deviation(1 g) = 4.59%

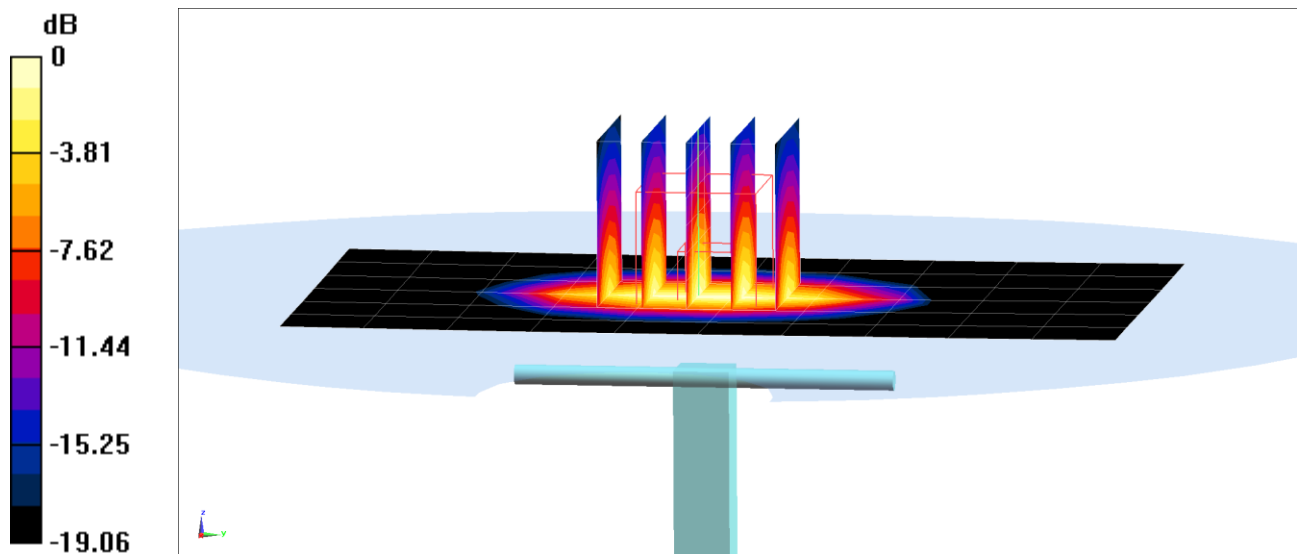

0 dB = 6.41 W/kg = 8.07 dBW/kg