

## MEASUREMENT REPORT

### FCC PART 15.407 / ISED RSS-247 DFS

**Applicant Name:**  
Samsung Electronics Co., Ltd.  
129, Samsung-ro,  
Yeongtong-gu, Suwon-si  
Gyeonggi-do, 16677, Korea

**Date of Testing:**  
1/16 – 1/22/2021  
**Test Site/Location:**  
PCTEST Lab. Columbia, MD, USA  
**Test Report Serial No.:**  
1M2101110003-10.A3L

<b>FCC ID:</b>	<b>A3LSMG998JPN</b>
<b>APPLICANT:</b>	<b>Samsung Electronics Co., Ltd.</b>

**Application Type:** Certification  
**Model:** SC-52B  
**EUT Type:** Client Only Device, No Radar Detection Capability  
**Max. RF Output Power:** 97.50mW (19.89dBm) Conducted  
 (802.11a UNII Band 2C)  
**Frequency Range:** 5500 – 5720 MHz (UNII-2C Band)  
**FCC Classification:** Unlicensed National Information Infrastructure (UNII)  
**FCC Rule Part(s):** Part 15.407(UNII)  
**Test Procedure(s):** KDB 905462 D02 v02

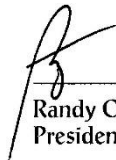

This equipment has been shown to be capable of compliance with the applicable technical standards as indicated in the measurement report and was tested in accordance with the measurement procedures specified in KDB 905462 D02 v02 Compliance Measurement Procedures for Unlicensed-National Information Infrastructure Devices Operating in the 5.25 – 5.35 GHz and 5.47 – 5.725 GHz Bands Incorporating Dynamic Frequency Selection. Test results reported herein relate only to the item(s) tested.

I attest to the accuracy of data. All measurements reported herein were performed by me or were made under my supervision and are correct to the best of my knowledge and belief. I assume full responsibility for the completeness of these measurements and vouch for the qualifications of all persons taking them.





\_\_\_\_\_  
Randy Ortanez  
President



<b>FCC ID:</b> A3LSMG998JPN	 <b>MEASUREMENT REPORT</b> (Certification)		<b>Approved by:</b> Quality Manager
<b>Test Report S/N:</b> 1M2101110003-10.A3L	<b>Test Dates:</b> 1/16 – 1/22/2021	<b>EUT Type:</b> Portable Handset	Page 1 of 22

## TABLE OF CONTENTS

1.0	INTRODUCTION .....	3
1.1	Scope .....	3
1.2	PCTEST Test Location .....	3
1.3	Test Facility / Accreditations .....	3
2.0	PRODUCT INFORMATION .....	4
2.1	Equipment Description .....	4
2.2	EUT Capabilities .....	4
2.1	Antenna Description .....	5
2.2	Test Support Equipment .....	5
2.3	Client Parameters .....	5
2.4	Software and Firmware .....	5
2.5	Modifications .....	5
3.0	DESCRIPTION OF TESTS .....	6
3.1	Evaluation Procedure .....	6
3.2	Environmental Conditions .....	6
4.0	ANTENNA REQUIREMENTS .....	7
5.0	MEASUREMENT UNCERTAINTY .....	8
6.0	TEST EQUIPMENT .....	9
7.0	DESCRIPTION OF DYNAMIC FREQUENCY SELECTION TEST .....	10
7.1	Applicability .....	10
7.2	Requirements .....	11
7.3	DFS Detection Threshold Values .....	12
7.4	DFS Response Requirements .....	12
7.5	Parameters of DFS Test Signals .....	13
7.6	Procedure .....	14
7.7	System Calibration: .....	15
8.0	EUT TEST SETUP .....	17
9.0	TEST RESULTS .....	18
9.1	Summary .....	18
9.2	Channel Loading .....	19
9.3	Channel Move/ Closing Transmission Time .....	20
9.4	Non-Occupancy Period .....	21
10.0	CONCLUSION .....	22

<b>FCC ID:</b> A3LSMG998JPN	 <b>PCTEST</b> <small>Proud to be part of  element</small>	<b>MEASUREMENT REPORT (Certification)</b>		<b>Approved by:</b> Quality Manager
<b>Test Report S/N:</b> 1M2101110003-10.A3L	<b>Test Dates:</b> 1/16 – 1/22/2021	<b>EUT Type:</b> Portable Handset	Page 2 of 22	

## 1.0 INTRODUCTION

### 1.1 Scope

This report has been prepared to demonstrate compliance with the requirements for Dynamic Frequency Selection (DFS) as stated in KDB 905462 D02 v02. Testing was performed on the **Samsung Portable Handset FCC ID: A3LSMG998JPN**. As of July 20, 2007 all devices operating in the 5250 – 5350 MHz and/or the 5470 – 5725 MHz bands must comply with the DFS requirements. As the EUT does not have radar detection capability it was evaluated as a Client Only Device. All test results reported herein are applicable to the sample selected for testing. The unit used for testing was supplied by Samsung Electronics Co., Ltd..



### 1.2 PCTEST Test Location

These measurement tests were conducted at the PCTEST facility located at 7185 Oakland Mills Road, Columbia, MD 21046. The measurement facility is compliant with the test site requirements specified in ANSI C63.4-2014 and KDB 414788 D01 v01.

### 1.3 Test Facility / Accreditations

Measurements were performed at PCTEST located in Columbia, MD 21046, U.S.A.

- PCTEST is an ISO 17025-2017 accredited test facility under the American Association for Laboratory Accreditation (A2LA) with Certificate number 2041.02 for Specific Absorption Rate (SAR), Hearing Aid Compatibility (HAC) testing, where applicable, and Electromagnetic Compatibility (EMC) testing for FCC and Innovation, Science, and Economic Development Canada rules.
- PCTEST TCB is a Telecommunication Certification Body (TCB) accredited to ISO/IEC 17065-2012 by A2LA (Certificate number 2041.03) in all scopes of FCC Rules and ISED Standards (RSS).
- PCTEST facility is a registered (2451B) test laboratory with the site description on file with ISED.

FCC ID: A3LSMG998JPN		MEASUREMENT REPORT (Certification)		Approved by: Quality Manager
Test Report S/N: 1M2101110003-10.A3L	Test Dates: 1/16 – 1/22/2021	EUT Type: Portable Handset	Page 3 of 22	

## 2.0 PRODUCT INFORMATION

### 2.1 Equipment Description

The Equipment Under Test (EUT) is the **Samsung Portable Handset FCC ID: A3LSMG998JPN**.

**Mode of Operation:**

Master Device	<input type="checkbox"/>
Client Device (No radar detection)	<input checked="" type="checkbox"/>
Client Device with Radar Detection	<input type="checkbox"/>

Test Device Serial No.: 0280M, 0301M

### 2.2 EUT Capabilities

This device contains the following capabilities:

850/1900GSM/GPRS/EDGE, 850 WCDMA/HSPA, Multi-band LTE, 802.11b/g/n/ax WLAN, 802.11a/n/ac/ax UNII, Bluetooth (1x, EDR, LE), NFC, Wireless Power Transfer, UWB

#### Band 2A

Ch.	Frequency (MHz)
52	5260
:	:
56	5280
:	:
64	5320

#### Band 2C

Ch.	Frequency (MHz)
100	5500
:	:
116	5580
:	:
144	5720

Table 2-1. 802.11a / 802.11n / 802.11ac / 802.11ax (20MHz) Frequency / Channel Operations

#### Band 2A

Ch.	Frequency (MHz)
54	5270
:	:
62	5310

#### Band 2C

Ch.	Frequency (MHz)
102	5510
:	:
110	5550
:	:
142	5710

Table 2-2. 802.11n / 802.11ac / 802.11ax (40MHz BW) Frequency / Channel Operations



#### Band 2A

Ch.	Frequency (MHz)
58	5290

#### Band 2C

Ch.	Frequency (MHz)
106	5530
:	:
138	5690

Table 2-3. 802.11ac / 802.11ax (80MHz BW) Frequency / Channel Operations

FCC ID: A3LSMG998JPN	 PCTEST Proud to be part of element	MEASUREMENT REPORT (Certification)		Approved by: Quality Manager
Test Report S/N: 1M2101110003-10.A3L	Test Dates: 1/16 – 1/22/2021	EUT Type: Portable Handset		Page 4 of 22

## 2.1 Antenna Description

Following antenna was used for the testing.

Frequency [GHz]	Antenna Gain (dBi)
5.260 - 5.350	-6.3
5.470 - 5.725	-6.5

Table 2-4. Highest Antenna Gain

## 2.2 Test Support Equipment

The following equipment was used in support of the DFS testing.

Device	Manufacturer	Model	Description	S/N:
Master	Samsung	WDS-A453E/XAR	Access Point	2XLU060011P
		WDS-C8050/XAR	Controller	2XGV250016L

Table 2-5. Test Support Equipment Used

## 2.3 Client Parameters

Parameters of EUT:	
Frequency	5500 – 5720 MHz
Output Power:	97.50mW (19.89dBm) Conducted (802.11a UNII Band 2C)
Modulation:	OFDM
Channel Bandwidth:	20, 40, 80 MHz



Table 2-6. Parameters of EUT

## 2.4 Software and Firmware

The test was done with firmware version iG998USQU0ATJ7 nstalled on the EUT.

## 2.5 Modifications

No modifications to the EUT were required in order to comply with the DFS specifications.

FCC ID: A3LSMG998JPN	 PCTEST® Proud to be part of element	MEASUREMENT REPORT (Certification)		Approved by: Quality Manager
Test Report S/N: 1M2101110003-10.A3L	Test Dates: 1/16 – 1/22/2021	EUT Type: Portable Handset		Page 5 of 22

## 3.0 DESCRIPTION OF TESTS



### 3.1 Evaluation Procedure

The measurement procedures described in KDB 905462 D02 v02 were used in the measurement of the EUT. Conducted test methodology was used for the DFS evaluation procedure of the EUT. No deviations to the test procedure and test methods occurred during the evaluation of the EUT.

**Deviation from measurement procedure.....None**

### 3.2 Environmental Conditions

The temperature is controlled within range of 15°C to 35°C. The relative humidity is controlled within range of 10% to 75%. The atmospheric pressure is monitored within the range 86-106kPa (860-1060mbar).

<b>FCC ID:</b> A3LSMG998JPN	 <small>Proud to be part of  element</small>	<b>MEASUREMENT REPORT (Certification)</b>		<b>Approved by:</b> Quality Manager
<b>Test Report S/N:</b> 1M2101110003-10.A3L	<b>Test Dates:</b> 1/16 – 1/22/2021	<b>EUT Type:</b> Portable Handset	Page 6 of 22	

## 4.0 ANTENNA REQUIREMENTS



### Excerpt from §15.203 of the FCC Rules/Regulations:

“An intentional radiator antenna shall be designed to ensure that no antenna other than that furnished by the responsible party can be used with the device. The use of a permanently attached antenna or of an antenna that uses a unique coupling to the intentional radiator shall be considered sufficient to comply with the provisions of this section.”

- The antennas of the EUT are **permanently attached**.
- There are no provisions for connection to an external antenna.

### Conclusion:



The EUT complies with the requirement of §15.203.

FCC ID: A3LSMG998JPN		MEASUREMENT REPORT (Certification)		Approved by: Quality Manager
Test Report S/N: 1M2101110003-10.A3L	Test Dates: 1/16 – 1/22/2021	EUT Type: Portable Handset	Page 7 of 22	

## 5.0 MEASUREMENT UNCERTAINTY

The measurement uncertainties shown below were calculated in accordance with the requirements of ANSI C63.10-2013. All measurement uncertainty values are shown with a coverage factor of  $k = 2$  to indicate a 95% level of confidence. The measurement uncertainty shown below meets or exceeds the  $U_{\text{CISPR}}$  measurement uncertainty values specified in CISPR 16-4-2 and, thus, can be compared directly to specified limits to determine compliance.

Parameter	Expanded Uncertainty
Time	$\pm 0.02\%$

<b>FCC ID:</b> A3LSMG998JPN	 Proud to be part of  element	<b>MEASUREMENT REPORT (Certification)</b>		<b>Approved by:</b> Quality Manager
<b>Test Report S/N:</b> 1M2101110003-10.A3L	<b>Test Dates:</b> 1/16 – 1/22/2021	<b>EUT Type:</b> Portable Handset		Page 8 of 22





## 6.0 TEST EQUIPMENT

Test Equipment Calibration is traceable to the National Institute of Standards and Technology (NIST). Measurements antennas used during testing were calibrated in accordance to the requirements of ANSI C63.5-2006.

Manufacturer	Model	Description	Cal Date	Cal Interval	Cal Due	Serial Number
Keysight Technologies	N9038A	MXE EMI Receiver	8/11/2020	Annual	8/11/2021	MY51210133
Aeroflex	PXI 82531	PXI RF Synthesizer	2/18/2019	Biennial	2/18/2021	1082329

**Table 6-1. Annual Test Equipment Calibration Schedule**

<b>FCC ID:</b> A3LSMG998JPN	 Proud to be part of  element	<b>MEASUREMENT REPORT (Certification)</b>		<b>Approved by:</b> Quality Manager
<b>Test Report S/N:</b> 1M2101110003-10.A3L	<b>Test Dates:</b> 1/16 – 1/22/2021	<b>EUT Type:</b> Portable Handset		Page 9 of 22

## 7.0 DESCRIPTION OF DYNAMIC FREQUENCY SELECTION TEST

### 7.1 Applicability

The following table from KDB 905462 D02 v02 lists the applicable requirements for the DFS testing. The device evaluated in this report is considered a client device without radar detection capability.

Requirement	Operational Mode		
	Master	Client Without Radar Detection	Client With Radar Detection
Non-Occupancy Period	Yes	Not required	Yes
DFS Detection Threshold	Yes	Not required	Yes
Channel Availability Check Time	Yes	Not required	Not required
U-NII Detection Bandwidth	Yes	Not required	Yes



Table 7-1. DFS Applicability

Requirement	Operational Mode		
	Master	Client Without Radar Detection	Client With Radar Detection
DFS Detection Threshold	Yes	Not required	Yes
Channel Closing Transmission Time	Yes	Yes	Yes
Channel Move Time	Yes	Yes	Yes
U-NII Detection Bandwidth	Yes	Not required	Yes

Table 7-2. DFS Applicability During Normal Operation

Additional requirements for devices with multiple bandwidth modes	Master Device or Client with Radar Detection	Client without Radar Detection
U-NII Detection Bandwidth and Statistical Performance Check	All BW modes must be tested	Not required
Channel Move Time and Channel Closing Transmission Time	Test using widest BW mode available	Test using the widest BW mode available for the link
All other tests	Any single BW mode	Not required
<p><b>Note:</b> Frequencies selected for statistical performance check (Section 7.8.4) should include several frequencies within the radar detection bandwidth and frequencies near the edge of the radar detection bandwidth. For 802.11 devices it is suggested to select frequencies in each of the bonded 20 MHz channels and the channel center frequency.</p>		

Table 7-3. Additional Requirement for Devices with Multiple Bandwidth Modes

FCC ID: A3LSMG998JPN		MEASUREMENT REPORT (Certification)		Approved by: Quality Manager
Test Report S/N: 1M2101110003-10.A3L	Test Dates: 1/16 – 1/22/2021	EUT Type: Portable Handset	Page 10 of 22	

## 7.2 Requirements



Per KDB 905462 D02 v02 the following are the requirements for Client Devices:

- a) A Client Device will not transmit before having received appropriate control signals from a Master Device.
- b) A Client Device will stop all its transmissions whenever instructed by a Master Device to which it is associated and will meet the Channel Move Time and Channel Closing Transmission Time requirements. The Client Device will not resume any transmissions until it has again received control signals from a Master Device.
- c) If a Client Device is performing In-Service Monitoring and detects a Radar Waveform above the DFS Detection Threshold, it will inform the Master Device. This is equivalent to the Master Device detecting the Radar Waveform and d) through f) of section 5.1.1 apply.
- d) Irrespective of Client Device or Master Device detection the Channel Move Time and Channel Closing Transmission Time requirements remain the same.
- e) The client test frequency must be monitored to ensure no transmission of any type has occurred for 30 minutes.  
Note: If the client moves with the master, the device is considered compliant if nothing appears in the client non-occupancy period test. For devices that shutdown (rather than moving channels), no beacons should appear.

Channel Move Time and Channel Closing Transmission Time requirements are listed in the following table.

Parameter	Value
Non-occupancy period	Minimum 30 minutes
Channel Availability Check Time	60 seconds
Channel Move Time	10 seconds See Note 1.
Channel Closing Transmission Time	200 milliseconds + an aggregate of 60 milliseconds over remaining 10 second period. See Notes 1 and 2.
U-NII Detection Bandwidth	Minimum 100% of the U-NII 99% transmission power bandwidth. See Note 3.
<p><b>Note 1:</b> <i>Channel Move Time</i> and the <i>Channel Closing Transmission Time</i> should be performed with Radar Type 0. The measurement timing begins at the end of the Radar Type 0 burst.</p> <p><b>Note 2:</b> The <i>Channel Closing Transmission Time</i> is comprised of 200 milliseconds starting at the beginning of the <i>Channel Move Time</i> plus any additional intermittent control signals required to facilitate a <i>Channel</i> move (an aggregate of 60 milliseconds) during the remainder of the 10 second period. The aggregate duration of control signals will not count quiet periods in between transmissions.</p> <p><b>Note 3:</b> During the <i>U-NII Detection Bandwidth</i> detection test, radar type 0 should be used. For each frequency step the minimum percentage of detection is 90 percent. Measurements are performed with no data traffic.</p>	

**Table 7-4: DFS Response Requirements**

FCC ID: A3LSMG998JPN		MEASUREMENT REPORT (Certification)		Approved by: Quality Manager
Test Report S/N: 1M2101110003-10.A3L	Test Dates: 1/16 – 1/22/2021	EUT Type: Portable Handset	Page 11 of 22	

### 7.3 DFS Detection Threshold Values

The DFS detection thresholds are defined for Master devices and Client Devices with In-service monitoring. These detection thresholds are listed in the following table.

Maximum Transmit Power	Value (See Notes 1 and 2)
≥ 200 milliwatt	-64 dBm
< 200 milliwatt	-62 dBm
<p>Note 1: This is the level at the input of the receiver assuming a 0 dBi receive antenna.</p> <p>Note 2: Throughout these test procedures an additional 1 dB has been added to the amplitude of the test transmission waveforms to account for variations in measurement equipment. This will ensure that the test signal is at or above the detection threshold level to trigger a DFS response.</p>	



**Table 7-5: Detection Thresholds for Master Devices and Client Devices with Radar Detection**

### 7.4 DFS Response Requirements

DFS response requirements for Master and Client Devices are listed in the following table.

Parameter	Value
Non-occupancy period	Minimum 30 minutes
Channel Availability Check Time	60 seconds
Channel Move Time	10 seconds See Note1
Channel Closing Transmission Time	200 milliseconds + an aggregate of 60 milliseconds over remaining 10 second period. See Note 1 and 2.
U-NII Detection Bandwidth	Minimum 100% of the U- NII 99% transmission power bandwidth. See Note 3.
<p><b>Note 1:</b> Channel Move Time and the Channel Closing Transmission Time should be performed with Radar Type 0. The measurement timing begins at the end of the Radar Type 0 burst</p> <p><b>Note 2:</b> The Channel Closing Transmission Time is comprised of 200 milliseconds starting at the beginning of the Channel Move Time plus any additional intermittent control signals required to facilitate a Channel move (an aggregate of 60 milliseconds) during the remainder of the 10 second period. The aggregate duration of control signals will not count quiet periods in between transmissions.</p> <p>frequency step the minimum percentage of detection is 90 percent. Measurements are performed with no data traffic.</p>	

**Table 7-6: DFS Response Requirements**

FCC ID: A3LSMG998JPN		MEASUREMENT REPORT (Certification)		Approved by: Quality Manager
Test Report S/N: 1M2101110003-10.A3L	Test Dates: 1/16 – 1/22/2021	EUT Type: Portable Handset	Page 12 of 22	

## 7.5 Parameters of DFS Test Signals

As the EUT is a Client Device with no Radar Detection only one type radar pulse is required for the testing. Radar Pulse type 1 was used in the evaluation of the Client device for the purpose of measuring the Channel Move Time and the Channel Closing Transmission Time. Table 7-7 lists the parameters for the Short Pulse Radar Waveforms. A plot of the Radar Pulse Type 1 used for testing is included in Section 9.2 of this report.

Radar Type	Pulse Width (µsec)	PRI (µsec)	Number of Pulses	Minimum Percentage of Successful Detection	Minimum Number of Trials
0	1	1425	18	See Note 1	See Note 1
1	1	Test A: 15 unique PRI values randomly selected from the list of 23 PRI values in Table 5a	$\text{Roundup} \left\{ \left( \frac{1}{360} \right) \cdot \left( \frac{19 \cdot 10^6}{PRI_{\mu\text{sec}}} \right) \right\}$	60%	30
		Test B: 15 unique PRI values randomly selected within the range of 518-3066 µsec, with a minimum increment of 1 µsec, excluding PRI values selected in Test A			
2	1-5	150-230	23-29	60%	30
3	6-10	200-500	16-18	60%	30
4	11-20	200-500	12-16	60%	30
Aggregate (Radar Types 1-4)				80%	120
<b>Note 1:</b> Short Pulse Radar Type 0 should be used for the detection bandwidth test, channel move time, and channel closing time tests.					



Table 7-7: Parameters for Short Pulse Radar Waveforms

Radar Type	Pulse Width (µsec)	Chirp Width (MHz)	PRI (µsec)	Number of Pulses per Burst	Number of Bursts	Minimum Percentage of Successful Detection	Minimum Number of Trials
5	50 - 100	5 - 20	1000-2000	1 - 3	8 - 20	80%	30

Table 7-8. Parameters for Long Pulse Radar Waveforms

Radar Type	Pulse Width (µsec)	PRI (µsec)	Pulses per Hop	Hopping Rate (kHz)	Hopping Sequence Length (msec)	Minimum Percentage of Successful Detection	Minimum Number of Trials
6	1	333	9	0.333	300	70%	30

Table 7-9. Parameters for Frequency Hopping Radar Waveforms

FCC ID: A3LSMG998JPN		MEASUREMENT REPORT (Certification)		Approved by: Quality Manager
Test Report S/N: 1M2101110003-10.A3L	Test Dates: 1/16 – 1/22/2021	EUT Type: Portable Handset	Page 13 of 22	

## 7.6 Procedure

### DFS Test Setup:

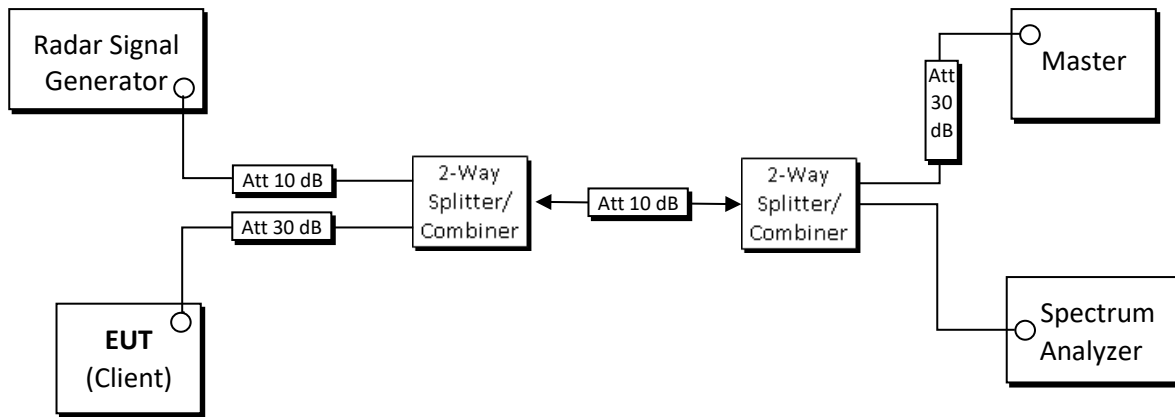

<b>Radiated DFS Test Setup</b>	<input type="checkbox"/>
<b>Conducted DFS Test Setup</b>	<input checked="" type="checkbox"/>

KDB 905462 D02 v02 describes a radiated test setup and a conducted test setup. The conducted test setup was used for this testing. Figure 7-1 shows the typical test setup. In Band 2C, one channel selected between 5500 and 5720 MHz was chosen for testing.



**Figure 7-1. Conducted Test Setup for DFS**

1. The “Aeroflex PXI DFS Radar Simulator and Analyzer Test Suite” is setup to provide a simulated radar pulse at the frequency that the Master and Client are operating. A Type 0 radar pulse was used.
2. The Client Device (EUT) is set up per the diagram in Figure 7-1 and communications between the Master device and the Client is established.
3. An MPEG or data file that is typical for the device is streamed from the Master to the Client to properly load the network.
4. The “Aeroflex PXI DFS Radar Simulator and Analyzer Test Suite” is set to record and display 12 seconds of time, starting from where the simulated radar is generated. This time domain plot captures any transmissions occurring up to and after 10sec. Aggregate time is computed to ensure compliance. (Note: the channel may be different since the Master and Client have changed channels due to the detection of the initial radar pulse.)
5. After the initial radar burst the channel is monitored for 10 minutes to ensure no transmissions or beacons occur. A second monitoring setup is used to verify that the Master and Client have both moved to different channels.

<b>FCC ID:</b> A3LSMG998JPN	 <b>PCTEST</b> Proud to be part of 	<b>MEASUREMENT REPORT (Certification)</b>		<b>Approved by:</b> Quality Manager
<b>Test Report S/N:</b> 1M2101110003-10.A3L	<b>Test Dates:</b> 1/16 – 1/22/2021	<b>EUT Type:</b> Portable Handset	Page 14 of 22	

## 7.7 System Calibration:

The following equipment setup was used to calibrate the Radar Waveform. A spectrum analyzer was used to establish the test signal level for each radar type. During this process, there were no transmissions by either the Master or Client Device. The spectrum analyzer was switched to the zero span (Time Domain) mode at the frequency of the Radar Waveform generator. Peak detection was utilized. The spectrum analyzer resolution bandwidth (RBW) and video bandwidth (VBW) were set to 3 MHz.

The signal generator amplitude is adjusted so that the power level measured at the spectrum analyzer is equal to the DFS detection threshold  $-64 \text{ dBm}$ . The required conducted threshold at the antenna port is  $-64 \text{ dBm} + \text{EUT Antenna Gain (dBi)} + 1 \text{ dB} = -63 \text{ dBm}$  (Section 7.2).

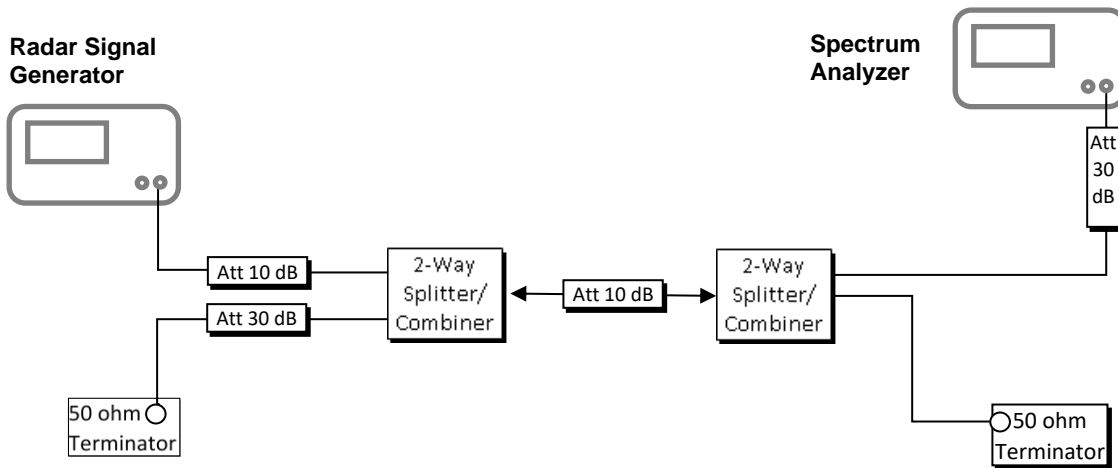

**Figure 7-2. Radar Waveform Calibration**

<b>FCC ID:</b> A3LSMG998JPN	<b>PCTEST</b> Proud to be part of element	<b>MEASUREMENT REPORT (Certification)</b>	<b>SAMSUNG</b>	<b>Approved by:</b> Quality Manager
<b>Test Report S/N:</b> 1M2101110003-10.A3L	<b>Test Dates:</b> 1/16 – 1/22/2021	<b>EUT Type:</b> Portable Handset		Page 15 of 22

### Radar Waveform Calibration Plot:

The conducted plots of the Radar Pulse Signals (Type 0) are given below after performing the system calibration as described in Section 7.7.

### Short Pulse Radar Type 0:

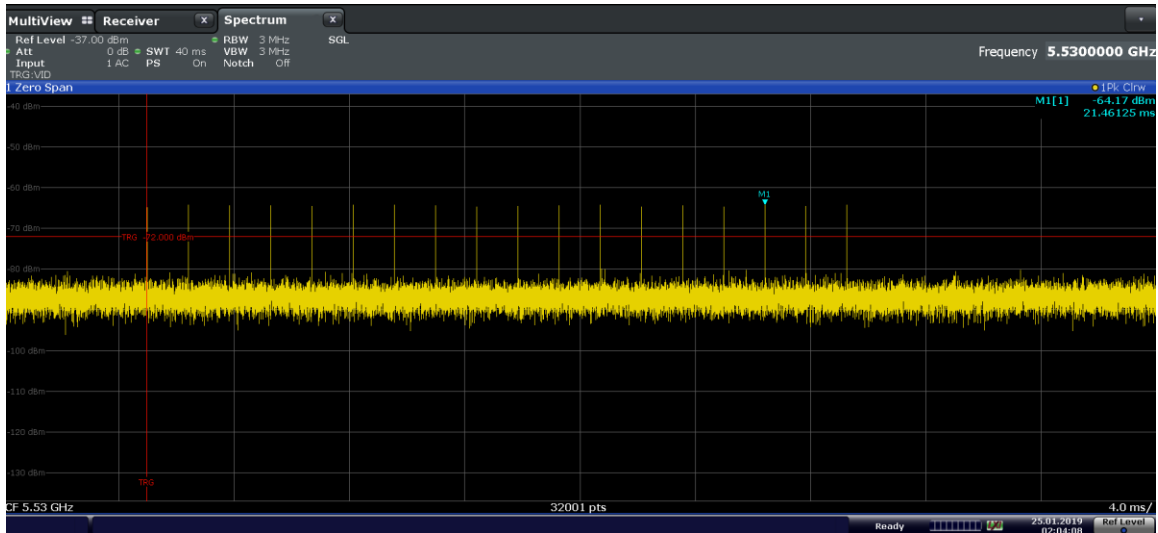





Figure 7-3. 5530MHz – Radar Pulse Type 0 (80MHz)

<b>FCC ID:</b> A3LSMG998JPN	 Proud to be part of 	<b>MEASUREMENT REPORT (Certification)</b>	 <b>Approved by:</b> Quality Manager
<b>Test Report S/N:</b> 1M2101110003-10.A3L	<b>Test Dates:</b> 1/16 – 1/22/2021	<b>EUT Type:</b> Portable Handset	Page 16 of 22



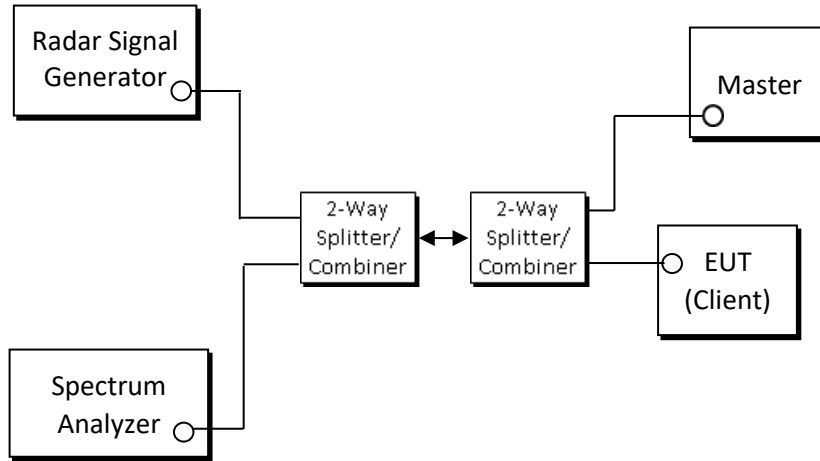

## 8.0 EUT TEST SETUP

Client is connected to Master (AP) via WLAN network and plays a video test file “6 ½ Magic Hours” in a Server (Laptop). This Server is connected to the Master (AP) via ethernet cable. The Vivaldi antenna is adjusted so that the WLAN traffic level, as displayed on the spectrum analyzer, is at lower amplitude than the radar detection threshold.



**Figure 8-1. Test Setup**

<b>FCC ID:</b> A3LSMG998JPN	 <small>Proud to be part of </small>	<b>MEASUREMENT REPORT (Certification)</b>		<b>Approved by:</b> Quality Manager
<b>Test Report S/N:</b> 1M2101110003-10.A3L	<b>Test Dates:</b> 1/16 – 1/22/2021	<b>EUT Type:</b> Portable Handset	Page 17 of 22	

## 9.0 TEST RESULTS

### 9.1 Summary



Company Name: Samsung Electronics Co., Ltd.  
 FCC ID: A3LSMG998JPN  
 FCC Classification: Unlicensed National Information Infrastructure (UNII)

	Parameter	Measured	Limit	Result
5470 – 5725 MHz UNII – 2C Band	Channel Move Time	3.87s	10 seconds	Pass
	Channel Closing Transmission Time	< 200ms + 1.8ms (aggregate)	200ms + aggregate of 60ms over remaining 10 second period	Pass
	Client beacon test	Monitored for 30 minutes with no client transmission	No client transmission occurred	Pass

**Table 9-1. Summary of Test Results**

#### Notes:

- 1) The EUT was found to be compliant with the requirements for DFS as required for a Client Device per Part 15.407(h), RSS-247 and KDB 905462 D02 v02.
- 2) Automated test software was used to measure emissions and capture the corresponding plots necessary to show compliance. The list is given below,
  - DFS threshold count v1.1
  - DFS Radar Simulator and Analyzer v2.8 (Aeroflex Inc.)
  - iPerf Software

FCC ID: A3LSMG998JPN	 PCTEST® Proud to be part of element	MEASUREMENT REPORT (Certification)		Approved by: Quality Manager
Test Report S/N: 1M2101110003-10.A3L	Test Dates: 1/16 – 1/22/2021	EUT Type: Portable Handset	Page 18 of 22	

## 9.2 Channel Loading

### Channel Loading Notes:

Per KDB 905462 D02 v02, timing plots are required with calculations demonstrating a minimum channel loading of approximately 17% or greater. For example, you can zero span the spectrum analyzer and approximate the transmission time.

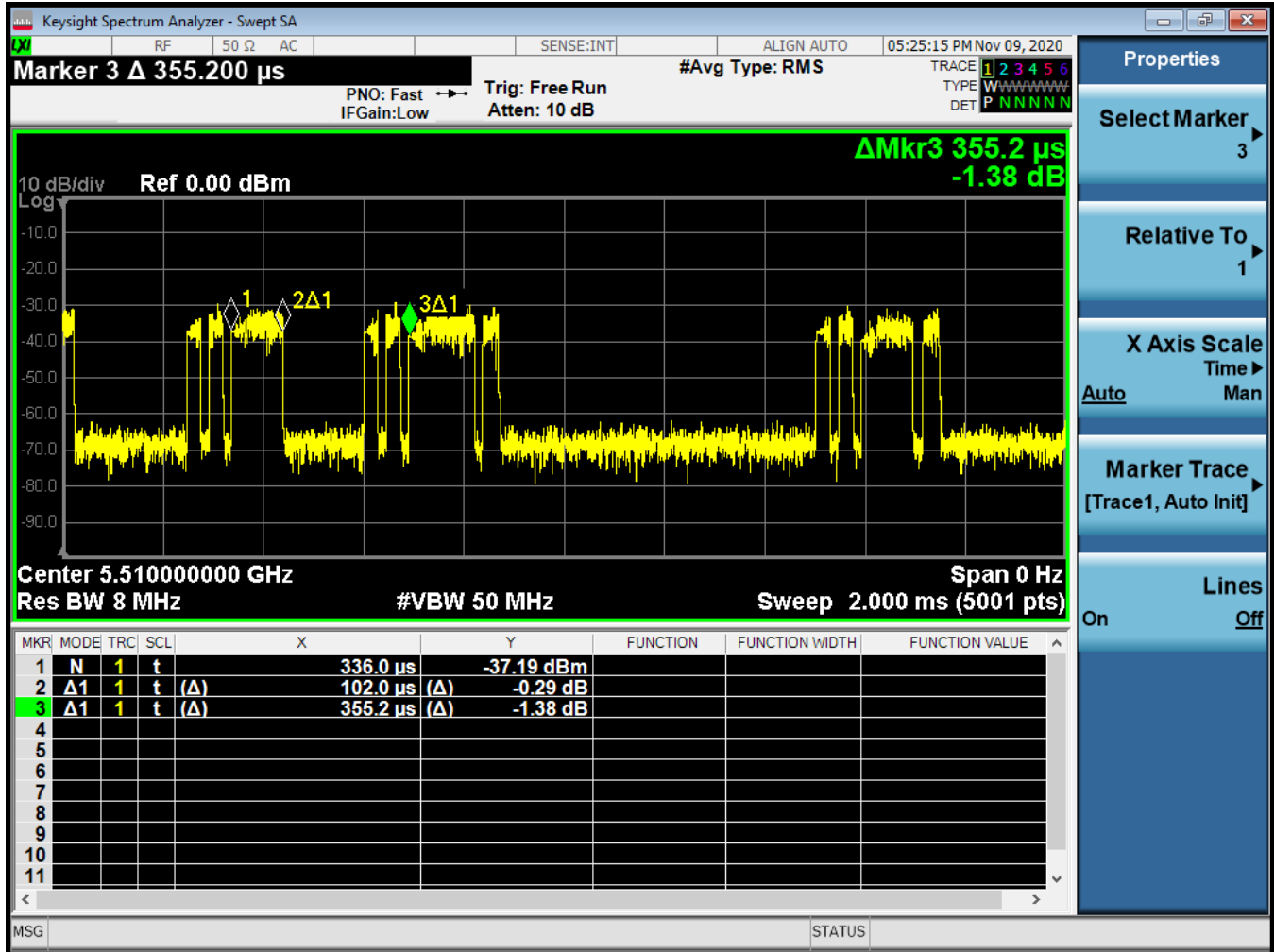



Figure 9-1. Band 2C Duty Cycle

$$\text{Channel Loading} = \text{Pulse Width} / \text{Period} = 102.0 \mu\text{s} / 355.2 \mu\text{s} = 28.72 \%$$

FCC ID: A3LSMG998JPN		MEASUREMENT REPORT (Certification)		Approved by: Quality Manager
Test Report S/N: 1M2101110003-10.A3L	Test Dates: 1/16 – 1/22/2021	EUT Type: Portable Handset		Page 19 of 22

### 9.3 Channel Move/ Closing Transmission Time

#### Move Time and Aggregate Time Notes:

1. Trigger Threshold was configured to only capture client pulses. The pulses shown in the plots below have been determined to be from the Master AP.
2. Marker Info and Aggregate time results are shown on the right side of the plots below.

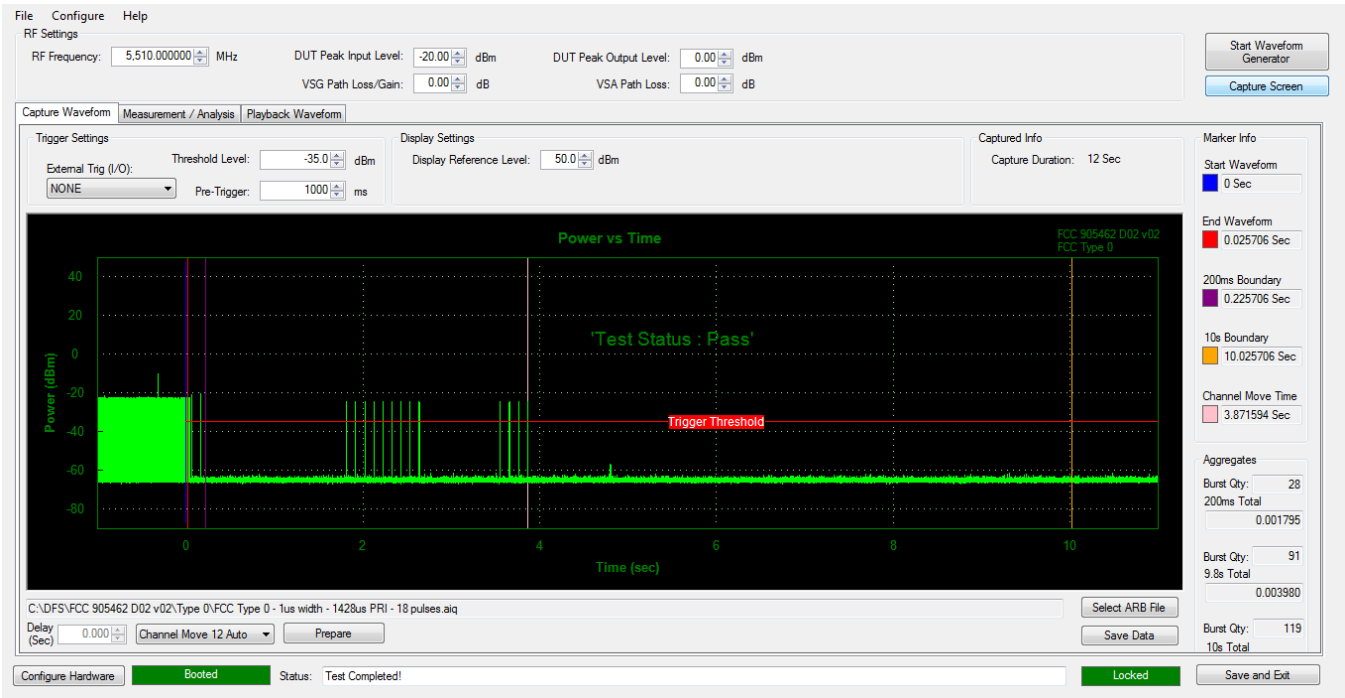



Figure 9-2. Band 2C Move Time and Aggregate Time

FCC ID: A3LSMG998JPN	 PCTEST Proud to be part of element	MEASUREMENT REPORT (Certification)		Approved by: Quality Manager
Test Report S/N: 1M2101110003-10.A3L	Test Dates: 1/16 – 1/22/2021	EUT Type: Portable Handset		Page 20 of 22

## 9.4 Non-Occupancy Period

### Notes:

No frequency transmission detected during the Non-Occupancy Period of 30 minutes monitoring.

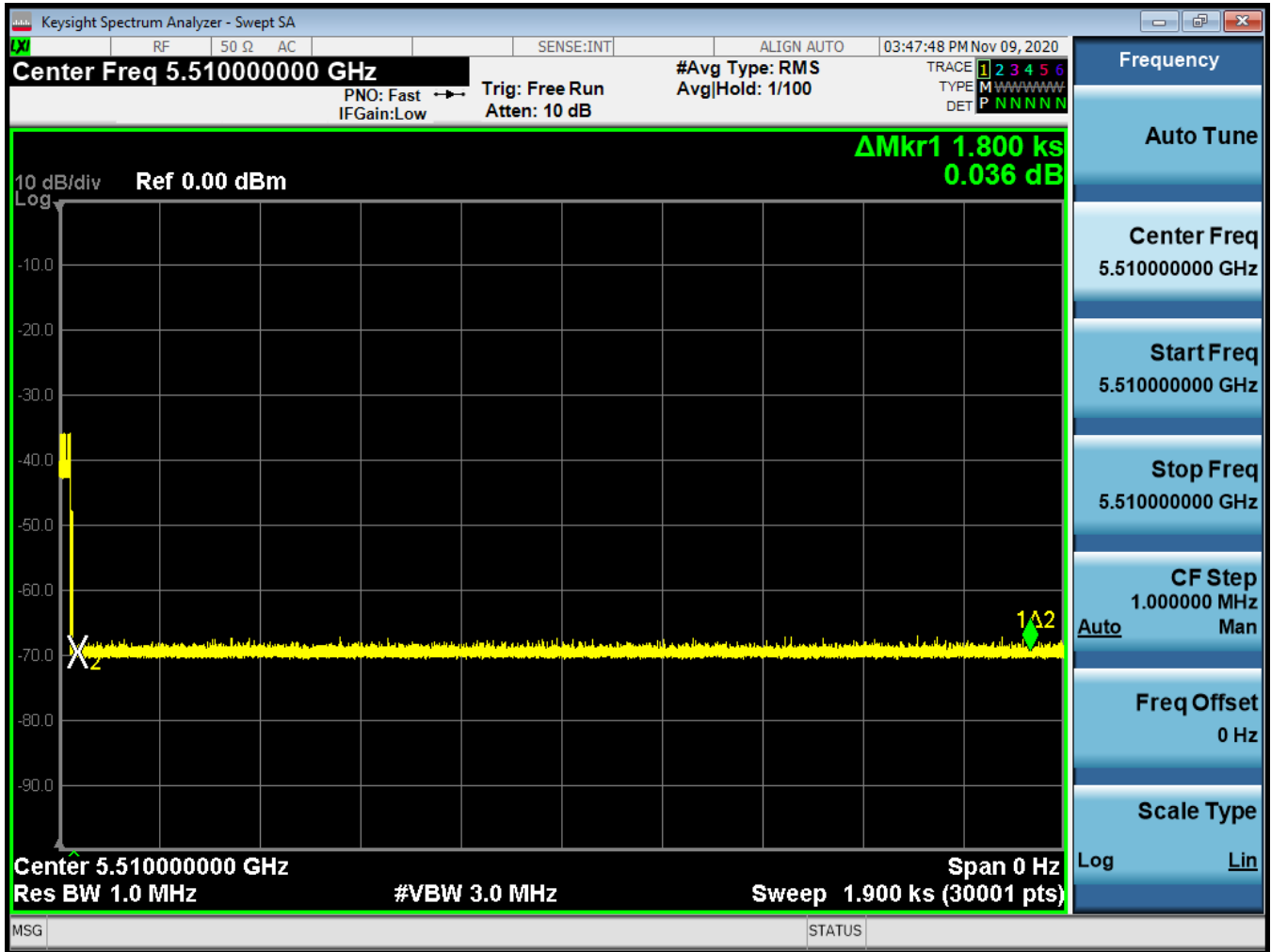





Figure 9-3. Band 2C Client Beacon Test – Monitoring live spectrum – Elapse time 30 minutes

FCC ID: A3LSMG998JPN	<b>PCTEST</b> Proud to be part of element	MEASUREMENT REPORT (Certification)	<b>SAMSUNG</b>	Approved by: Quality Manager
Test Report S/N: 1M2101110003-10.A3L	Test Dates: 1/16 – 1/22/2021	EUT Type: Portable Handset		Page 21 of 22

## 10.0 CONCLUSION

The data collected relate only to the item(s) tested and show that the **Samsung Portable Handset FCC ID: A3LSMG998JPN** is in compliance with the DFS requirements for a Client Device without radar detection in accordance with Part 15.407 of the FCC Rules.

<b>FCC ID:</b> A3LSMG998JPN	 Proud to be part of  element	<b>MEASUREMENT REPORT (Certification)</b>		<b>Approved by:</b> Quality Manager
<b>Test Report S/N:</b> 1M2101110003-10.A3L	<b>Test Dates:</b> 1/16 – 1/22/2021	<b>EUT Type:</b> Portable Handset	Page 22 of 22	