



74, Seoicheon-ro 578beon-gil, Majang-myeon, Icheon-si, Gyeonggi-do, Korea  
TEL: +82-31-645-6300 FAX: +82-31-645-6401

## HAC T-COIL Test Report

**Applicant Name:**

**SAMSUNG Electronics Co., Ltd.**

129, Samsung-ro, Yeongtong-gu, Suwon-Si, Gyeonggi-do,  
16677 Rep. of Korea

**Date of Issue:** Nov. 02, 2020

**Test Report No.:** HCT-SR-2011-FC001

**Test Site:** HCT CO., LTD.

**FCC ID**

**A3LSMG991U**

**Equipment Type:**

**Mobile Phone**

**Application Type**

**Certification**

**FCC Rule Part(s):**

**CFR §20.19 , ANSI C63.19-2011**

**Model Name:**

**SM-G991U**

**Additional Model Name:**

**SM-G991U1**

**Date of Test:**

**09/15/2020 ~ 10/06/2020**

**C63.19-2011  
HAC Category**

**T3 (T-COIL CATEGORY)**

This wireless portable device has been shown to be hearing-aid compatible under the above rated category, specified in ANSI/IEEE Std. C63.19-2011 and had been tested in accordance with the specified measurement procedures. Hearing-Aid Compatibility is based on the assumption that all production units will be designed electrically identical to the device tested in this report.

I attest to the accuracy of data. All measurements reported herein were performed by me or were made under my supervision and are correct to the best of my knowledge and belief. I assume full responsibility for the completeness of these measurements and vouch for the qualifications of all persons taking them.

**Tested By**

**Reviewed By**

**Jung-Hun, Park  
Test Engineer  
SAR Team  
Certification Division**

**Yun-jeang, Heo  
Technical Manager  
SAR Team  
Certification Division**

This report only responds to the tested sample and may not be reproduced, except in full, without written approval of the HCT Co., Ltd.

## REVISION HISTORY

The revision history for this test report is shown in table.

Revision No.	Date of Issue	Description
0	Nov. 02, 2020	Initial Release

This test results were applied only to the test methods required by the standard.

The above Test Report is not related to the accredited test result by (KS Q) ISO/IEC 17025 and KOLAS(Korea Laboratory Accreditation Scheme), which signed the ILAC-MRA.

## Table of Contents

1. Test Regulations .....	4
2. ATTESTATION OF TEST RESULT OF DEVICE UNDER TEST .....	5
3. DEVICE UNDER TEST DESCRIPTION.....	6
4. Test Methodology .....	7
5. Measuring Instrument Calibraion .....	8
6. Measurement Uncertainty.....	9
7. Test Procedures for all Technologies .....	10
8. Audio Level and Gain Measurements.....	14
9 T-coil Measurement Criteria .....	16
10. Device Under Test.....	18
11. Air Interfaces and Operating Mode .....	19
12. HAC (T-coil) Test Results .....	20
Attachment 1. HAC T-COIL Test Plots .....	45
Attachment 2. HAC T-Coil Probe Certificates .....	265

## 1. Test Regulations

The tests were performed according to the following regulations:

Test Standard	FCC 47 CFR §20.19 ANSI C63.19-2011
Test Method	<ul style="list-style-type: none"><li>· FCC CFR47 Part 20.19</li><li>· ANSI C63.19 2011-version</li><li>· FCC KDB 285076 D01 HAC Guidance v05r01</li><li>· FCC KDB 285076 D02 T Coil testing v03</li><li>· FCC KDB 285076 D03 HAC FAQ v01r03</li></ul>

## 2. ATTESTATION OF TEST RESULT OF DEVICE UNDER TEST

Test Laboratory	
Company Name:	HCT Co., LTD
Address:	74, Seoicheon-ro 578beon-gil, Majang-myeon, Icheon-si, Gyeonggi-do, 17383, Rep. of Korea
Telephone:	+82 31 645 6300
Fax.:	+82 31 645 6401

Attestation of SAR test result	
Applicant Name:	SAMSUNG Electronics Co., Ltd.
Model:	SM-G991U
Additional Model Name:	SM-G991U1
EUT Type:	Mobile Phone
Application Type:	Certification

### 2.1 Test Methodology

The Tests document in this report were performed in accordance with ANSI C63.19-2011 method of Measurement of Compatibility between Wireless Communication Devices and Hearing Aids, FCC published KDB 285076 D01 HAC Guidance v05r01, FCC Published KDB285076 D03 HAC FAQ v01r03 and TCB Workshop updates .

### 3. DEVICE UNDER TEST DESCRIPTION

#### 3.1 DUT specification

Device Wireless specification overview		
Band & Mode	Operating Mode	Tx Frequency
CDMA/EVDO BC10	Voice / Data	817.90 MHz ~ 823.10 MHz
CDMA/EVDO BC0	Voice / Data	824.70 MHz ~ 848.31 MHz
CDMA/EVDO BC1	Voice / Data	1 851.25 MHz ~ 1 908.75 MHz
GSM850	Voice / Data	824.2 MHz ~ 848.8 MHz
GSM1900	Voice / Data	1 850.2 MHz ~ 1 909.8 MHz
UMTS 850	Voice / Data	826.4 MHz ~ 846.6 MHz
UMTS 1700	Voice / Data	1 712.4 MHz ~ 1 752.6 MHz
UMTS 1900	Voice / Data	1 852.4 MHz ~ 1 907.6 MHz
LTE Band 2 (PCS)	Voice / Data	1 850.7 MHz ~ 1 909.3 MHz
LTE Band 4 (AWS)	Voice / Data	1 710.7 MHz ~ 1 754.3 MHz
LTE Band 5 (Cell)	Voice / Data	824.7 MHz ~ 848.3 MHz
LTE Band 7	Voice / Data	2 502.5 MHz ~ 2 567.5 MHz
LTE Band 12	Voice / Data	699.7 MHz ~ 715.3 MHz
LTE Band 13	Voice / Data	779.5 MHz ~ 784.5 MHz
LTE Band 14	Voice / Data	790.5 MHz ~ 795.5 MHz
LTE Band 25	Voice / Data	1 850.7 MHz ~ 1 914.3 MHz
LTE Band 26	Voice / Data	814.7 MHz ~ 848.3 MHz
LTE Band 30	Voice / Data	2 307.5 MHz ~ 2 312.5 MHz
LTE TDD Band 38	Voice / Data	2 572.5 MHz ~ 2 617.5 MHz
LTE TDD Band 40	Voice / Data	2 302.5 MHz ~ 2 397.5 MHz
LTE TDD Band 41	Voice / Data	2 498.5 MHz ~ 2 687.5 MHz
LTE TDD Band 48	Voice / Data	3 552.5 MHz ~ 3 697.5 MHz
LTE Band 66 (AWS)	Voice / Data	1 710.7 MHz ~ 1 779.3 MHz
LTE Band 71	Voice / Data	665.5 MHz ~ 695.5 MHz
NR Band n2 (PCS)	Data	1 852.5 MHz ~ 1 907.5 MHz
NR Band n5 (Cell)	Data	826.5 MHz ~ 846.5 MHz
NR Band n12	Data	701.5 MHz ~ 713.5 MHz
NR Band n25	Data	1852.5 MHz ~ 1912.5 MHz
NR Band n30	Data	2 307.5 MHz ~ 2 312.5 MHz
NR Band n41	Data	2 506.02 MHz ~ 2 679.99 MHz
NR Band n66	Data	1 712.5 MHz ~ 1 777.5 MHz
NR Band n71	Data	665.5 MHz - 695.5 MHz
NR Band n77	Data	3 710 MHz ~ 3 969.99 MHz
NR Band n260	Data	37000 - 40000 MHz
NR Band n261	Data	27500 - 28350 MHz
U-NII-1	Voice / Data	5 180 MHz ~ 5 240 MHz
U-NII-2A	Voice / Data	5 260 MHz ~ 5 320 MHz
U-NII-2C	Voice / Data	5 500 MHz ~ 5 720 MHz
U-NII-3	Voice / Data	5 745 MHz ~ 5 825 MHz
2.4 GHz WLAN	Voice / Data	2 412 MHz ~ 2 472 MHz
Bluetooth / LE 5.0	Data	2 402 MHz ~ 2 480 MHz
NFC	Data	13.56 MHz

## 4. Test Methodology

The tests documented in this report were performed in accordance with ANSI C63.19-2011 Methods of Measurement of Compatibility between Wireless Communications Devices and Hearing Aids and FCC published procedure

KDB 285076 D01 HAC Guidance v05r01

KDB 285076 D03 HAC FAQ v01r03

TCB workshop updates

KDB 285076 D02 T-Coil testing for CMRS v03

## 5. Measuring Instrument Calibraion

The measuring equipment used to perform the tests documented in this report has been calibrated in accordance with the manufacturers' recommendations and is traceable to recognized national standards.

Name of Equipment	Manufacturer	Type/Model	Serial No.	Cal. Due Date
ABM Probe	SPEAG	AM1DV2	1013	04/23/2021
Data Acquisition Electronics	SPEAG	DAE4	1629	08/11/20201
ABM Probe	SPEAG	AM1DV3	3049	05/26/2021
Data Acquisition Electronics	SPEAG	DAE4	466	07/29/2021
DAC	Sound Devices	USBPre 2	HB1318341009	N/A
Radio Communication Tester	R & S	CMW 500	167916	10/20/2021
Radio Communication Tester	R & S	CMW 500	167918	04/17/2021
Radio Communication Tester	R & S	CMW 500	115733	05/15/2021



## 6. Measurement Uncertainty

### Measurement Uncertainty for Audio Band Magnetic Measurement

Error Description	Uncertainty values (±%)	Probe Dist.	Div.	C <sub>i</sub> ABM1	C <sub>i</sub> ABM2	Std. Unc.	
						ABM1 (±%)	ABM2 (±%)
<b>Probe Sensitivity</b>							
ReFereNce Level	3.00	N	1	1	1	3.00	3.00
AMCC Geometry	0.40	R	1.73	1	1	0.23	0.23
AMCC Current	1.00	R	1.73	1	1	0.58	0.58
Porbe Positioning during Calibr.	0.10	R	1.73	1	1	0.06	0.06
Noise Contribution	0.70	R	1.73	0.0143	1	0.01	0.40
Frequency Slope	5.90	R	1.73	0.1	1	0.34	3.41
<b>Probe System</b>							
Repeatability / Drift	1.00	R	1.73	1	1	0.58	0.58
Linearity / Dynamic Range	0.60	R	1.73	1	1	0.35	0.35
Acoustic Noise	1.00	R	1.73	0.1	1	0.06	0.58
Probe Angle	2.30	R	1.73	1	1	1.33	1.33
Spectral Processing	0.90	R	1.73	1	1	0.52	0.52
Integration Time	0.60	N	1.00	1	5	0.60	3.00
Field Disturbation	0.20	R	1.73	1	1	0.12	0.12
<b>Test Signal</b>							
Ref. Signal Spectral Response	0.60	R	1.73	0	1	0.00	0.35
<b>Positioning</b>							
Probe Positioning	1.90	R	1.73	1	1	1.10	1.10
Phantom Thickness	0.90	R	1.73	1	1	0.52	0.52
DUT Positioning	1.90	R	1.73	1	1	1.10	1.10
<b>External Contributions</b>							
RF Interference	0.00	R	1.73	1	0.3	0.00	0.00
Test Signal Variation	2.00	R	1.73	1	1	1.2	1.2
<b>Combined Std. Uncertainty (ABM field)</b>						<b>4.1</b>	<b>6.1</b>
<b>Expanded Std. Uncertainty (%)</b>						<b>8.1</b>	<b>12.3</b>
Notes for table N - Nomal R - Rectangular Div. - Divisor used to obtain standard uncertainty							

## 7. Test Procedures for all Technologies

### 7.1 General Procedures C63.19-2011, Section 7

ANSI C63.19-2011, Section 7

This document describes the procedures used to measure the ABM (T-Coil) performance of the WD. In addition to measuring the absolute signal levels, the A-weighted magnitude of the unintended signal shall also be determined. In order to assure that the required signal quality is measured, the measurement of the intended signal and the measurement of the unintended signal must be made at the same location for all measurement positions. In addition, the RF field strength at each measurement location must be at or below that required for the assigned category.

Measurements shall not include undesired properties from the WD's RF field; therefore, use of a coaxial connection to a base station simulator or non-radiating load may be necessary. However, even then with a coaxial connection to a base station simulator or non-radiating load there may still be RF leakage from the WD, which may interfere with the desired measurement. Pre-measurement checks should be made to avoid this possibility. All measurements shall be done with the WD operating on battery power with an appropriate normal speech audio signal input level given in Table 7.1. If the device display can be turned off during a phone call then that may be done during the measurement as well.

Measurements shall be performed at two locations specified in A.3, with the correct probe orientation for a particular location, in a multistage sequence by first measuring the field intensity of the desired T-Coil signal (ABM1) that is useful to a hearing aid T-Coil. The undesired magnetic components (ABM2) must be measured at the same location as the desired ABM or T-Coil signal (ABM1), and the ratio of desired to undesired ABM signals must be calculated. For the perpendicular field location, only the ABM1 frequency response shall be determined in a third measurement stage. The flow chart in Figure 7.3 illustrates this three-stage, two orientation process.

The following steps summarize the basic test flow for determining ABM1 and ABM2. These steps assume that a sine wave or narrowband 1/3 octave signal can be used for the measurement of ABM1.

A validation of the test setup and instrumentation may be performed using a TMFS or Helmholtz coil. Measure the emissions and confirm that they are within the specified tolerance.

Position the WD in the test setup and connect the WD RF connector to a base station simulator or a non-radiating load as shown in Figure 7.1 or Figure 7.2. Confirm that equipment that requires calibration has been calibrated, and that the noise level meets the requirements given in 7.3.1.

The drive level to the WD is set such that the reference input level specified in Table 7.1 is input to the base station simulator (or manufacturer's test mode equivalent) in the 1 kHz, 1/3 octave band. This drive level shall be used for the T-Coil signal test (ABM1) at  $f = 1$  kHz. Either a sine wave at 1025 Hz or a voice-like signal, band-limited to the 1 kHz 1/3 octave, as defined in 7.4.2, shall be used for the reference audio signal. If interference is found at 1025 Hz an alternative nearby reference audio signal frequency may be used.<sup>46</sup> The same drive level will be used for the ABM1 frequency response measurements at each 1/3 octave band center frequency. The WD volume control may be set at any level up to maximum, provided that a signal at any frequency at maximum modulation would not result in clipping or signal overload.

Determine the magnetic measurement locations for the WD device (A.3), if not already specified by the manufacturer, as described in 7.4.4.1.1 and 7.4.4.2.

At each measurement location, measure and record the desired T-Coil magnetic signals (ABM1 at  $f_i$ ) as described in 7.4.4.2 in each individual ISO 266-1975 R10 standard 1/3 octave band. The desired audio band input frequency ( $f_i$ ) shall be centered in each 1/3 octave band maintaining the same drive level as determined in item c) and the reading taken for that band.

Equivalent methods of determining the frequency response may also be employed, such as fast Fourier transform (FFT) analysis using noise excitation or input-output comparison using simulated speech. The full-band integrated or half-band integrated probe output, as specified in D.9, may be used, as long as the appropriate calibration curve is applied to the measured result, so as to yield an accurate measurement of the field magnitude. (The resulting measurement shall be an accurate measurement in dB A/m.)

All measurements of the desired signal shall be shown to be of the desired signal and not of an undesired signal. This may be shown by turning the desired signal ON and OFF with the probe measuring the same

location. If the scanning method is used the scans shall show that all measurement points selected for the ABM1 measurement meet the ambient and test system noise criteria in 7.3.1.

At the measurement location for each orientation, measure and record the undesired broadband audio magnetic signal (ABM2) as specified in 7.4.4.4 with no audio signal applied (or digital zero applied, if appropriate) using A-weighting and the half-band integrator. Calculate the ratio of the desired to undesired signal strength (i.e., signal quality).

Obtain the data from the postprocessor, SEMCAD, and determine the category that properly classifies the signal quality based on Table 8.5.

**Test Setup Diagram**

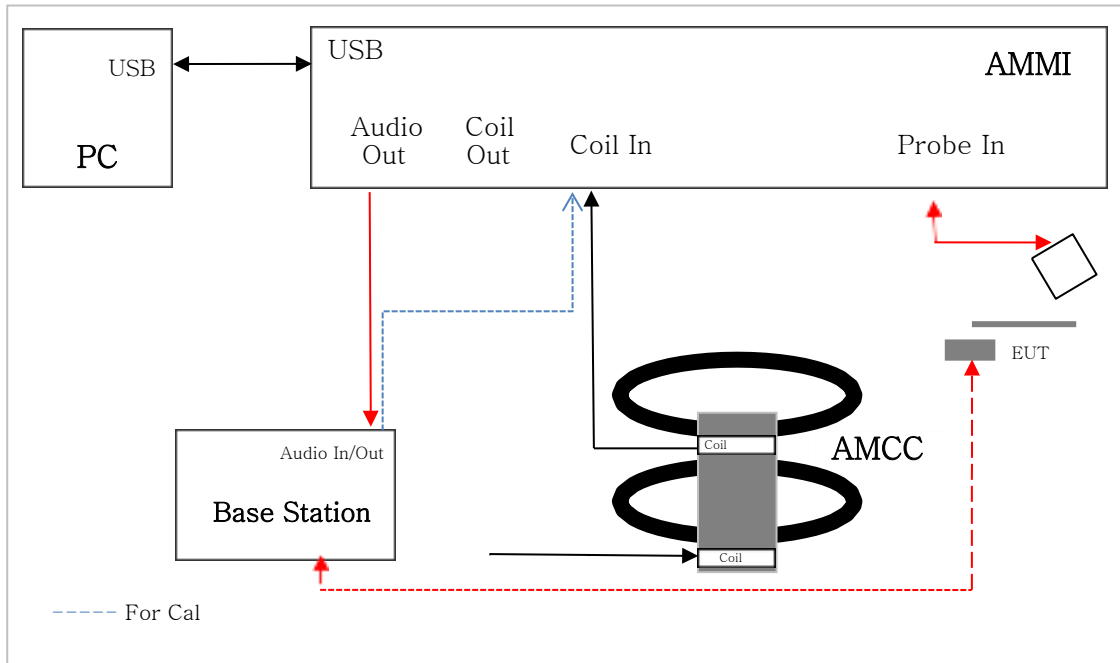

**7.2 VoWiFi – For PAG REUSE**

This device supports Wi-Fi calling (aka Voice over Wi-Fi or VoWiFi) which is an extended feature of the carriers CMRS service to offload VoLTE calls onto local area networks over WI-FI via the internet and subject to HAC assessment for phones with a HAC rating. HAC assessment for this feature is subject to Pre Approval Guidance.

The set up for VoWiFi uses the Base station as described in section 7.1 with the exception that the reference audio level is set at -20dBm0. The reference level is calibrated using the standard call box calibration procedures with the exception of the -20dBm0 reference level being used (refer to section 8.4).

An investigation was performed to determine worst case codec, bit rate and air interface configuration (refer to sections 12.5 and 12.6).

### 7.3 Over the Top(OTT) – For PAG REUSE

This device supports VoIP via a preinstalled application that uses the **Google Duo** service, using **OPUS** as its only codec (refer to §11 for air interface details and §12.7 for codec bit rates). VoIP capabilities require HAC assessment when voice calls are supported over the cellular data connection via pre-installed VoIP applications and the assessment is subject to Pre-Approval Guidance procedures.

The equipment is set up as shown below with a support device used to originate the call using the IP transport. The support device connects to the cloud-based **Google Duo** service via Wi-Fi access point and router, or RJ45. The DUT connects to the VoIP service via a cellular/unlicensed air interface to the call box and an Ethernet connection from call box to Internet. The various codec bit rate and air interface configurations are evaluated to determine the worst-case configuration (refer to §12.7).

#### Test Setup configuration for OTT calls

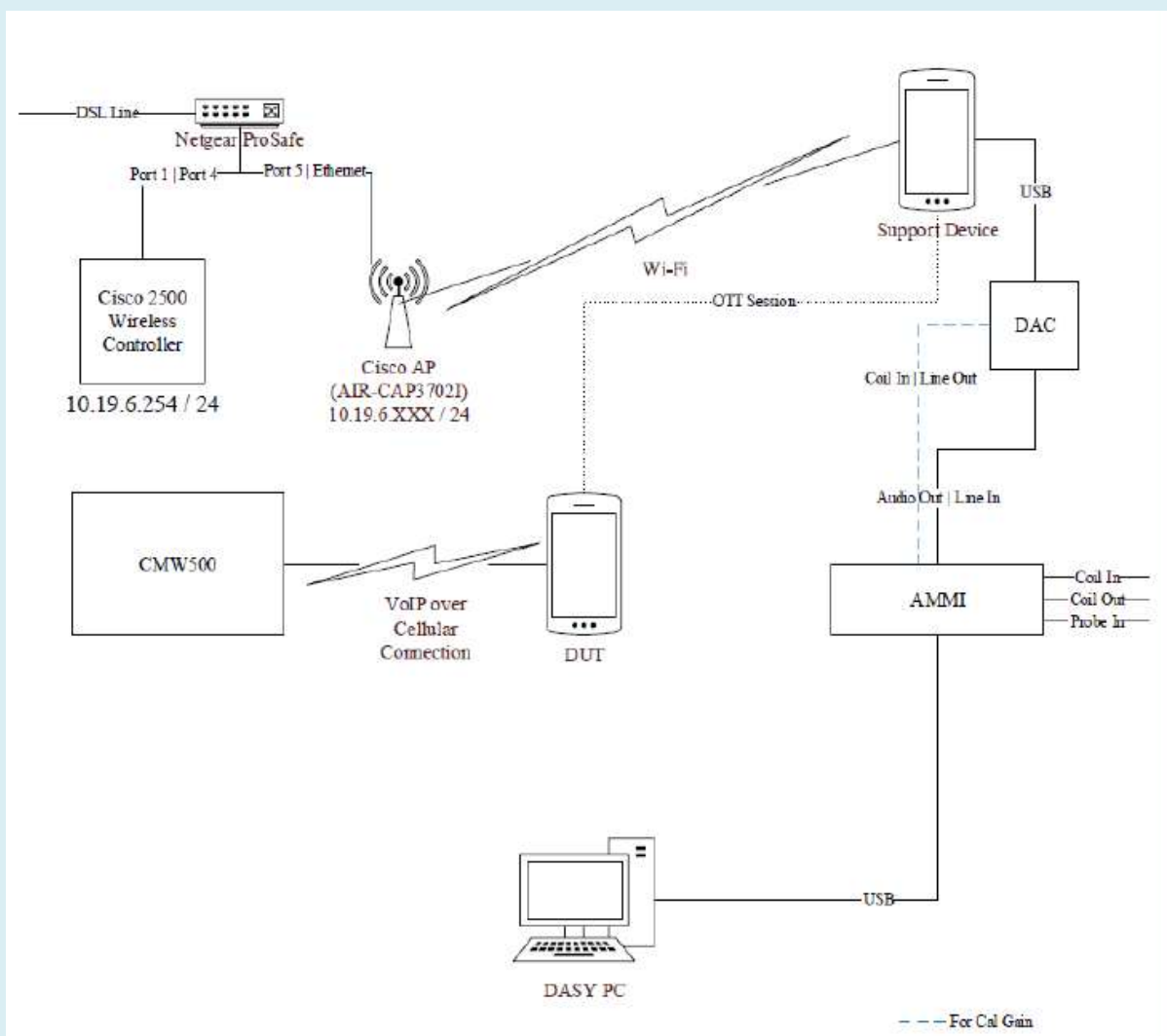

For the OTT call, the calibrated audio card within the CMW500 cannot be used so the AMMI is connected to an external Digital-Analog Converter (DAC) and the DAC is connected to the Support Device via USB. The test signal is sent from the DASY PC to the AMMI, from the AMMI to the DAC, from the DAC to the Support Device, and, via the VoIP call, to the DUT.

As this test set up uses an external DAC between the AMMI's audio output and support device, the appropriate gain factor for the OTT call needs be determined. This is done by connecting the DAC between the AMMI Audio output and Coil input as shown below.

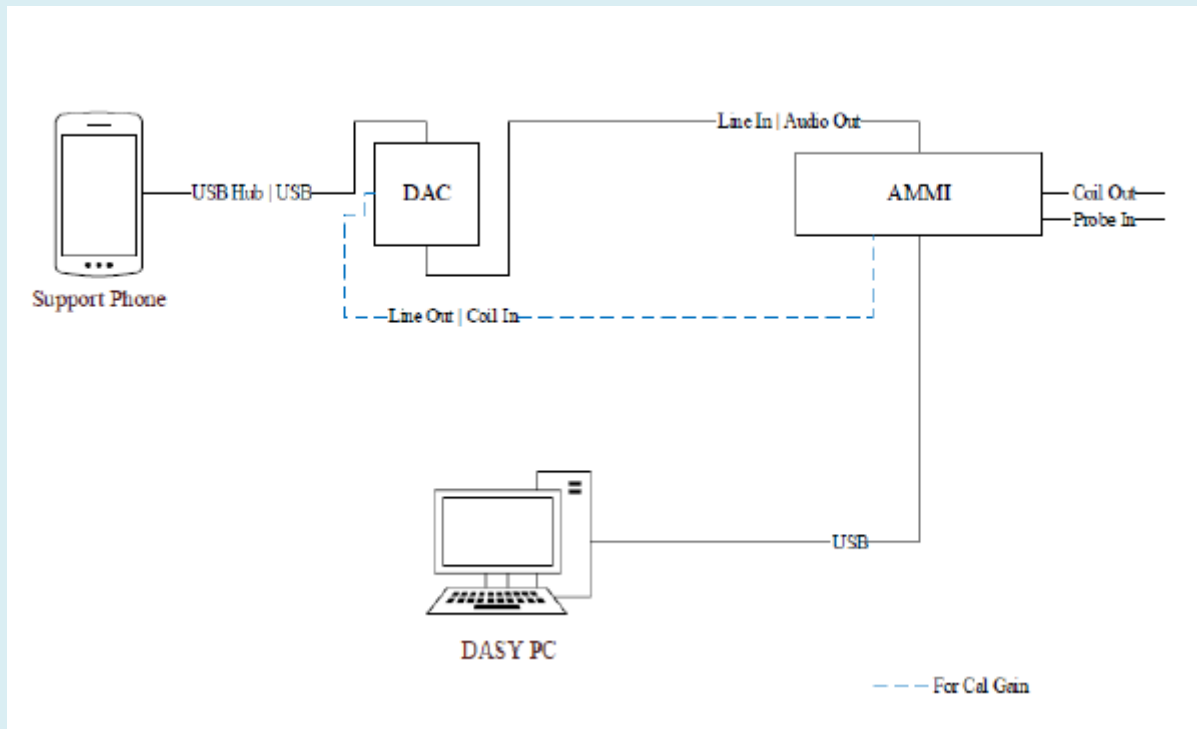

Using the metering function on the DAC, the DAC gain is adjusted until the volume reaches 0 dBFS (3.14 dBm0 based on TIA/EIA 810-A). SPEAG's "TN-LK-05042018-C-T-Coil\_Levels" document (Appendix E) steps E through H are then followed to determine the adjusted gain values as detailed in §8.5 so that the reference level is set to 23.14dB below full scale, i.e. at -20dBm0. A verification of the DAC's output is performed prior to testing.

## 8. Audio Level and Gain Measurements

### 8.1 GSM

Refer to the below table for the gains used to measure GSM.

Signal Type	Audio Level [dBm]	Gain [dB]	Gain [linear]
Voice 1 kHz	-16	27.72	24.32
Voice 300 - 3 kHz	-19	34.35	52.17

### 8.2 W-CDMA

Refer to the below table for the gains used to measure W-CDMA.

Signal Type	Audio Level [dBm]	Gain [dB]	Gain [linear]
Voice 1 kHz	-16	27.87	24.74
Voice 300 - 3 kHz	-19	34.53	53.28

### 8.3 CDMA

Refer to the below table for the gains used to measure GSM.

Signal Type	Audio Level [dBm]	Gain [dB]	Gain [linear]
Voice 1 kHz	-18	25.71	19.30
Voice 300 - 3 kHz	-19	34.36	52.25

### 8.4 VOLTE

Refer to the below table for the gains used to measure VoLTE.

The following software/firmware was used to simulate the VoLTE server for testing:

Firmware	License Keys	Software Name
V3.7.30 for LTE	KS500 KS550	LTE FDD R8 SIG BASIC LTE TDD R8 SIG BASIC
V3.7.20 for Audio	KA100 KA150 KAA20 KM050 KS104	IP APPL ENABLING IPv4 IP APPL ENABLING IPv6 IP APPL IMS BASIC DATA APPL MEAS EVS SPEECH CODEC

#### FDD

Signal Type	Audio Level [dBm]	Gain [dB]	Gain [linear]
Voice 1 kHz	-16	27.74	24.38
Voice 300 - 3 kHz	-19	34.39	52.45

#### TDD

Signal Type	Audio Level [dBm]	Gain [dB]	Gain [linear]
Voice 1 kHz	-16	27.75	24.41
Voice 300 - 3 kHz	-19	34.39	52.45

## 8.5 VOWi-Fi

Refer to the below table for the gains used to measure VoWi-Fi.

Firmware	License Keys	Software Name
V3.7.40 for WLAN	KS650	WLAN A/B/G SIG BASIC
	KS651	WLAN N SIG BASIC
	KS656	WLAN IEEE 802.11ac
	KS657	WLAN IEEE 802.11ax
V3.7.20 for Audio	KA100	IP APPL ENABLING IPv4
	KA150	IP APPL ENABLING IPv4
	KAA20	IP APPL IMS BASIC
	KM050	DATA APPL MEAS
	KS104	EVS SPEECH CODEC

### 2.4GHz

Signal Type	Audio Level [dBm]	Gain [dB]	Gain [linear]
Voice 1 kHz	-20	23.67	15.26
Voice 300 - 3 kHz	-20	33.33	46.39

### 5GHz

Signal Type	Audio Level [dBm]	Gain [dB]	Gain [linear]
Voice 1 kHz	-20	23.67	15.26
Voice 300 - 3 kHz	-20	33.30	46.24

## 8.6 Over the Top(OTT) – For PAG REUSE

For EDGE, HSPA, LTE and Wi-Fi the linear gain levels listed below were used. The results below are based on a reference input level of -20 dBm.

To calibrate the DAC (refer §7.3), three. Way audio files (sine wave, 1kHz voice, and 300 to 3 kHz voice) are sent from the DASY5 PC to the AMMI, then to the DAC. The Helmholtz resonator measures the field strength, which represents the AMMI to DAC input sensitivity. After determining the input sensitivity, the adjusted linear gain values can then be calculated.

Signal Type	Audio Level [dBm]	Gain [dB]	Gain [linear]
Voice 1 kHz	-20	25.53	18.90
Voice 300-3 kHz	-20	35.20	57.55

## 9 T-coil Measurement Criteria

### 9.1 Frequency Responses

The frequency response of the axial component of the magnetic field, measured in 1/3 octave bands, shall follow the response curve, over the frequency range 300 Hz to 3000 Hz.

Figure 8.1 and Figure 8.2 provide the boundaries for the specified frequency. These response curves are for true field strength measurements of the T-Coil signal. Thus the 6 dB/octave probe response has been corrected from the raw readings.

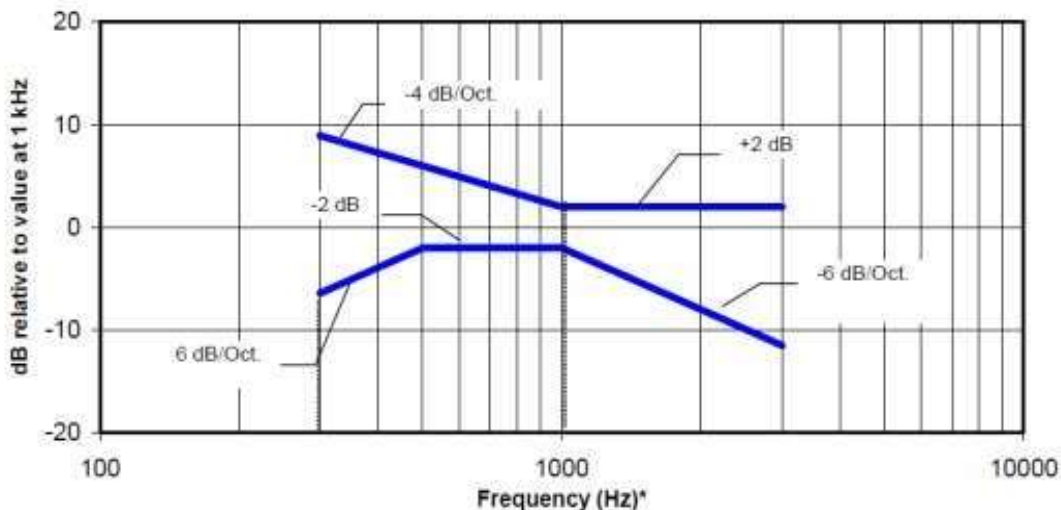

NOTE—The frequency response is between 300 Hz and 3000 Hz.

**Figure 8.1—Magnetic field frequency response for WDs with field strength  $\leq -15$  dB (A/m) at 1 kHz**

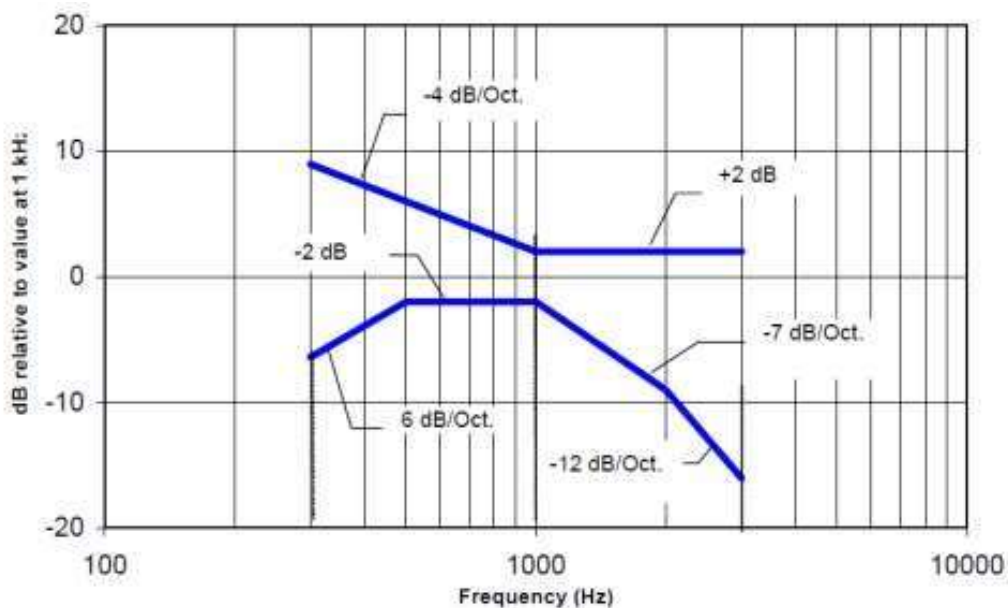

NOTE—The frequency response is between 300 Hz and 3000 Hz.

**Figure 8.2—Magnetic field frequency response for WDs with a field that exceeds  $-15$  dB(A/m) at 1 kHz**



## 9.2 Signal to Noise

This specifies the signal-to-noise quality requirement for the intended T-Coil signal from a WD. The worst signal to noise of the two T-Coil signal measurements, as determined in Clause 7, shall be used to determine the T-Coil mode category per Table 8.5.

Only the RF immunity of the hearing aid is measured in T-Coil mode. It is assumed that a hearing aid can have no immunity to an interference signal in the audio band, which is the intended reception band for this mode. So, the only criterion that can be measured is the RF immunity in T-Coil Mode. This is measured using the same procedure as for the audio coupling mode and at the same levels as specified in 6.4.

Category	Telephone parameters WD signal quality [(signal+noise)-to-noise ratio in decibels]
Category T1	0 dB to 10 dB
Category T2	10 dB to 20 dB
Category T3	20 dB to 30 dB
Category T4	> 30 dB

Table 8.5- T-Coil signal-to-noise categories

Measurement locations and reference plane to be used for the T-coil measurements.

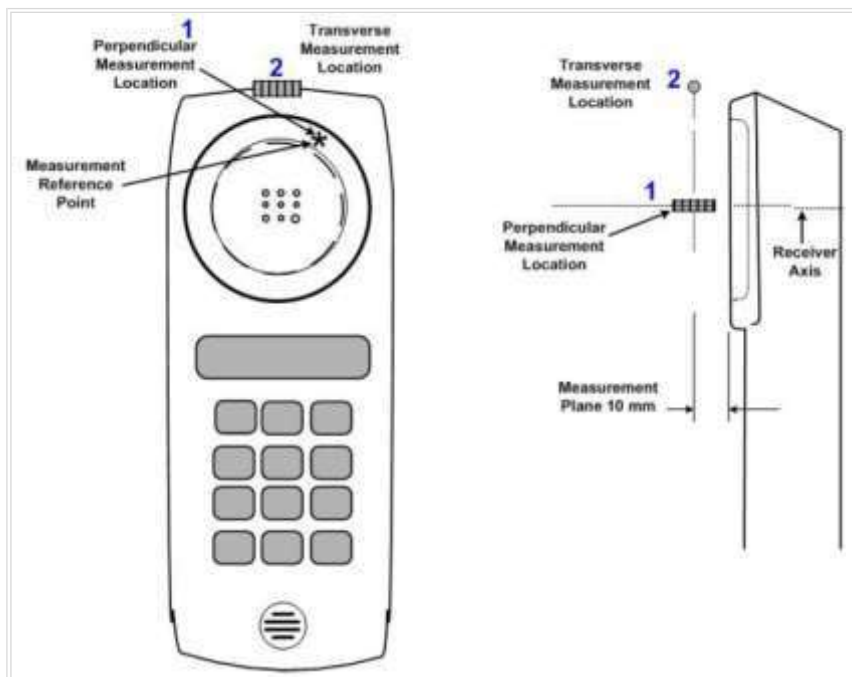

## 10. Device Under Test

<b>Normal operation</b>	Held to head	
<b>Back Cover</b>	The Back Cover is not removable	
<b>Test sample information</b>	S/N	Notes
	THV0971M	T-coil Test
	THV0943M	T-coil Test
	TII0384M	T-coil Test

## 11. Air Interfaces and Operating Mode

Air Interface	Bands (MHz)	Type	C63.19 Tested	Simultaneous Transmitter	Audio Codecs Evaluated
GSM	850	VO	Yes	Wi-Fi, BT	EFR
	1900				
	GPRS/EDGE	VD	Yes <sup>3</sup>	Wi-Fi, BT	OPUS <sup>2</sup>
W-CDMA (UMTS)	850	VO	Yes	Wi-Fi, BT	AMR-NB & AMR-WB
	1700				
	1900				
	HSPA	VD	Yes <sup>3</sup>	Wi-Fi, BT	OPUS <sup>2</sup>
CDMA	800	VO	Yes	Wi-Fi, BT	EVRC-B & 8k-EVRC
	850	VO	Yes	Wi-Fi, BT	
	1900	VO	Yes	Wi-Fi, BT	
	1xEVDO	VD	Yes <sup>3</sup>	Wi-Fi, BT	OPUS <sup>2</sup>
LTE - FDD	680(B 71)	VD	Yes <sup>1</sup>	Wi-Fi, BT	AMR-NB, AMR- WB, EVS-NB, EVS-WB & OPUS <sup>2</sup>
	700 (B12/13/17)				
	850 (B5/26)				
	1700 (B4/66)				
	1900 (B2/25)				
	2300 (B30)				
	2500 (B7)				
LTE – TDD	2600 (B41)	VD	Yes <sup>1,3</sup>	Wi-Fi, BT	AMR-NB, AMR- WB, EVS-NB, EVS-WB & OPUS <sup>2</sup>
	3600 (B48)				
	2600 (B38)				
	2300 (B40)				
NR -FDD	700(B12)	VD	Yes <sup>4</sup>	Wi-Fi, BT	OPUS <sup>2</sup>
	680(B71)				
	850(B5)				
	1700(B66)				
	1900(B2, B25)				
	2300(B30)				
NR -TDD	2600(B41)	VD	Yes <sup>4</sup>	Wi-Fi, BT	OPUS <sup>2</sup>
	3800(B77)		Yes <sup>4</sup>		
	28000 (n261)		No <sup>5</sup>		
	39000 (n260)		No <sup>5</sup>		
Wi-Fi	2450	VD	Yes <sup>3</sup>	WWAN	AMR-NB, AMR- WB, EVS-NB, EVS-WB & OPUS <sup>2</sup>
	5200 (U-NII-1)				
	5300 (U-NII-2A)				
	5500 (U-NII-2C)				
	5800 (U-NII-3)				
BT	2450	DT	NA	WWAN and Wifi 5GHz	N/A
Type: VO: Legacy Cellular Voice Service DT: Digital Transport only (no voice) CMRS: Commercial Mobile Radio Service VD: IP Voice service over Digital Transport				Note: 1. Ref Lev in accordance with the July 2012 VoLTE interpretation 2. Ref Lev -20 dBm0 3. For PAG REUSE 4. NR was evaluated using an interim procedure outlined section 12.9.1 5. n260,n261 are currently outside the scope of ANSI C63.19 and FCC HAC regulations. This DUT dose not support VOMmWave for n260,n261	

## 12. HAC (T-coil) Test Results

### 12.1 Codec Investigation

An investigation between the various codec configurations (Low/High bit rates for Narrowband, Wideband) and specific parameters are documented (ABM1, ABM2, S+N/N, frequency response) to determine the worst-case bit rates for each voice service type. The table below compares the varying codec configurations. A codec investigation was performed on one band of each CDMA, GSM, W-CDMA, LTE FDD/TDD.

The highlighted results below were determined to be the worst case codec configuration(s) for CDMA,GSM, W- CDMA and LTE.

Codec Investigation				
Codec State	AMR-NB (kbit/s)		Orientation	Band/ Channel
	EVRC-B	8k-EVRC		
ABM1 (dB/m)	1.17	3.03	z (Axial)	CDMA/EVDO BC0 CH. 384
ABM2 (dBA/m)	-38.61	-33.62		
S+N/N (dB)	39.77	36.65		
Freq. Resposne (dB)	2.00	1.91		
ABM1 (dB/m)	-7.90	-10.39	y (Transversal)	
ABM2 (dBA/m)	-46.91	-46.65		
S+N/N (dB)	39.01	<b>36.26</b>		

Codec Investigation				
Codec State	AMR-NB (kbit/s)		Orientation	Band/ Channel
	FR V1	HR V1		
ABM1 (dB/m)	2.44	3.95	z (Axial)	GSM 850 CH.190
ABM2 (dBA/m)	-24.27	-25.98		
S+N/N (dB)	<b>26.71</b>	29.93		
Freq. Resposne (dB)	2.00	1.32		
ABM1 (dB/m)	-5.42	-3.72	y (Transversal)	
ABM2 (dBA/m)	-36.32	-36.70		
S+N/N (dB)	30.90	32.98		

Codec Investigation								
Codec State	AMR-NB (kbit/s)			AMR-WB (kbit/s)			Orientation	Band/ Bandwidth/ Channel
	4.75	7.4	12.2	6.6	15.85	23.85		
ABM1 (dB/m)	1.79	2.14	-0.68	2.19	3.01	8.99	z (Axial)	WCDMA Band II Rel.99 CH.9400
ABM2 (dBA/m)	-32.31	-32.21	-34.39	-29.37	-28.99	-22.94		
S+N/N (dB)	34.10	34.35	33.72	31.57	32.01	31.93		
Freq. Resposne (dB)	2.00	2.00	2.00	2.00	1.92	1.95		
ABM1 (dB/m)	-5.14	-4.97	-1.45	-1.89	-2.61	2.22	y (Transversal)	
ABM2 (dBA/m)	-39.25	-39.09	-35.13	-33.32	-34.55	-29.71		
S+N/N (dB)	34.11	34.12	33.68	<b>31.44</b>	31.94	31.92		

Codec Investigation											
Codec State	AMR-NB (kbit/s)			AMR-WB (kbit/s)			Orientation	Band/ Bandwidth/ Channel			
	4.75	7.4	12.2	6.6	15.85	23.85					
ABM1 (dB/m)	3.84	4.18	4.47	5.43	0.92	-0.22	z (Axial)	LTE Band 25 CH.26365 20 MHz BW QPSK RB 100/0			
ABM2 (dBA/m)	-28.70	-28.84	-28.15	-25.11	-30.23	-31.25					
S+N/N (dB)	32.54	33.02	32.62	30.54	31.14	31.03					
Freq. Resposne(dB)	2.00	2.00	2.00	2.00	1.82	1.82					
ABM1 (dB/m)	-3.97	-3.58	-3.29	-0.60	0.12	-1.56	y (Transversal)				
ABM2 (dBA/m)	-36.10	-35.96	-35.16	-31.29	-31.09	-32.66					
S+N/N (dB)	32.13	32.38	31.87	30.69	31.21	31.10					

Codec Investigation														
Codec State	EVS-NB (kbit/s)			EVS-WB (kbit/s)			EVS-SWB (kbit/s)			Orientation	Band/ BandWidth/ Channel			
	5.9	13.2	24.4	5.9	24.4	128	9.6	24.4	128					
ABM1 (dB/m)	-3.81	2.59	-8.55	-8.83	11.11	5.62	-5.11	8.84	6.63	z (Axial))	LTE Band 25 CH.26365 20 MHz BW QPSK RB 100/0			
ABM2 (dBA/m)	-33.89	-28.28	-39.96	-36.74	-19.52	-35.27	-36.37	-20.96	-22.70					
S+N/N (dB)	30.08	30.87	31.41	27.90	30.63	40.89	31.26	29.80	29.34					
Freq.Resposne(dB)	1.70	2.00	2.00	2.00	1.87	1.90	1.55	1.62	1.58					
ABM1 (dB/m)	-11.34	-5.33	-4.96	-3.98	-6.04	-0.73	-4.72	-0.10	-4.96	y (Transversal)				
ABM2 (dBA/m)	-43.20	-36.23	-36.40	-31.18	-36.29	-30.44	-35.93	-30.00	-34.28					
S+N/N (dB)	31.86	30.90	31.45	27.19	30.26	29.71	31.21	29.90	29.32					

Codec Investigation											
Codec State	AMR-NB (kbit/s)			AMR-WB (kbit/s)			Orientation	Band/ Bandwidth/ Channel			
	4.75	7.4	12.2	6.6	15.85	23.85					
ABM1 (dB/m)	3.44	3.68	-0.71	2.56	7.54	7.69	z (Axial)	LTE Band 41 CH.40620 20 MHz BW QPSK RB 100/0			
ABM2 (dBA/m)	-35.47	-35.08	-38.44	-30.43	-26.43	-26.06					
S+N/N (dB)	38.91	38.76	37.73	32.99	33.97	33.75					
Freq. Resposne(dB)	2.00	2.00	2.00	2.00	1.90	1.87					
ABM1 (dB/m)	-7.58	-6.54	-7.08	-11.79	-0.26	-10.96	y (Transversal)				
ABM2 (dBA/m)	-45.64	-44.74	-45.00	-45.18	-33.80	-44.41					
S+N/N (dB)	38.06	38.20	37.93	33.38	33.54	33.46					

Codec Investigation														
Codec State	EVS-NB (kbit/s)			EVS-WB (kbit/s)			EVS-SWB (kbit/s)			Orientation	Band/ BandWidth/ Channel			
	5.9	13.2	24.4	5.9	24.4	128	9.6	24.4	128					
ABM1 (dB/m)	2.94	3.97	3.83	7.37	8.10	10.19	2.40	6.96	9.94	z (Axial))	LTE Band 41 CH.40620 20 MHz BW QPSK RB 100/0			
ABM2 (dBA/m)	-29.98	-30.47	-30.78	-24.04	-28.07	-25.92	-35.06	-29.70	-26.64					
S+N/N (dB)	32.92	34.44	34.61	31.41	36.17	36.11	37.46	36.66	36.58					
Freq.Resposne(dB)	2.00	2.00	2.00	2.00	1.87	1.86	1.52	1.46	1.37					
ABM1 (dB/m)	-6.70	-5.83	-3.78	-1.42	-5.48	-7.97	-1.08	-6.09	-5.41	y (Transversal)				
ABM2 (dBA/m)	-39.97	-40.28	-38.03	-33.22	-41.15	-43.94	-38.20	-41.16	-40.74					
S+N/N (dB)	33.26	34.45	34.25	31.80	35.68	35.97	37.12	35.07	35.33					

## 12.2 TDD Configuration

### LTE TDD Uplink-Downlink Configuration Investigation for VoLTE over IMS

An investigation was performed to determine the worst-case Uplink-Downlink configuration for VoLTE over IMS T-Coil testing. The effects of UL-DL configuration were found to be independent of band and bandwidth; therefore, only one band and bandwidth were used for this investigation.

Per 3GPP TS 36.211, the total frame length for each TDD radio frame of length  $T_f = 307200 \cdot T_s = 10$  ms, where  $T_s$  is a number of time units equal to  $1/(15000 \times 2048)$  seconds. Additionally, each radio frame consists of 10 subframes, each of length  $30720 \cdot T_s = 1$  ms, and subframes can be designated as uplink (U), downlink (D), or special subframe (S), depending on the Uplink-Downlink configuration as indicated in Table 4.2-2 of 3GPP TS 36.211. In the transmission duty factor calculation, the special subframe configuration with the shortest UpPTS duration within the special subframe is used and will be applied for measurement. From 3GPP TS 36.211 Table 4.2-1, the shortest UpPTS is  $2192 \cdot T_s$  which occurs in the normal cyclic prefix and special subframe configuration 4.

See table below outlining the calculated transmission duty cycles for each Uplink-Downlink configuration:

Uplink-Downlink Configurations for Type 2 Frame Structures

Uplink-downlink configuration	Downlink-to-Uplink Switch-point periodicity	Subframe number										Calculated Transmission Duty Cycle (%)
		0	1	2	3	4	5	6	7	8	9	
0	5 ms	D	S	U	U	U	D	S	U	U	U	61.4%
1	5 ms	D	S	U	U	D	D	S	U	U	D	41.4%
2	5 ms	D	S	U	D	D	D	S	U	D	D	21.4%
3	10 ms	D	S	U	U	U	D	D	D	D	D	30.7%
4	10 ms	D	S	U	U	D	D	D	D	D	D	20.7%
5	10 ms	D	S	U	D	D	D	D	D	D	D	10.7%
6	5 ms	D	S	U	U	U	D	S	U	U	D	51.4%

### Power Class 3 Uplink-Downlink Configuration Investigation

VoLTE over IMS was evaluated with the following radio configuration → channel 40620, 20MHz BW, QPSK, 100RB, 0Offset. all configurations (0-6) are supported. The configuration which resulted in the worst z (Axial), y(Transversal) SNR was used for full testing. Uplink-Downlink configuration 0 was used as the worst-case configuration for VoLTE over IMS T-Coil testing. See table below for the SNR comparison between each Uplink-Downlink configuration:

VoLTE over IMS SNNR by UL-DL Configuration

Frequency [MHz]	Channel	Bandwidth [MHz]	Modulation	RB Size	RB Offset	UL-DL Configuration	ABM1 [dB(A/m)]	ABM2 [dB(A/m)]	Orientation	Freq. Response (dB)	SNR [dB]
2593.0	40620	20	QPSK	100	0	0	7.37	-24.04	z (Axial)	2.00	31.41
2593.0	40620	20	QPSK	100	0	1	5.54	-28.62		2.00	34.15
2593.0	40620	20	QPSK	100	0	2	-0.20	-31.27		2.00	31.07
2593.0	40620	20	QPSK	100	0	3	-9.17	-40.18		1.91	31.01
2593.0	40620	20	QPSK	100	0	4	-3.89	-36.99		1.86	33.10
2593.0	40620	20	QPSK	100	0	5	3.02	-28.88		1.94	31.91
2593.0	40620	20	QPSK	100	0	6	4.85	-27.22		2.00	32.07
2593.0	40620	20	QPSK	100	0	0	-1.42	-33.22	y (Transversal)		31.80
2593.0	40620	20	QPSK	100	0	1	-12.28	-44.31			32.04
2593.0	40620	20	QPSK	100	0	2	-12.77	-46.02			33.26
2593.0	40620	20	QPSK	100	0	3	-12.60	-46.19			33.58
2593.0	40620	20	QPSK	100	0	4	-4.51	-36.48			31.96
2593.0	40620	20	QPSK	100	0	5	-7.15	-38.23			31.07
2593.0	40620	20	QPSK	100	0	6	-6.12	-36.72			<b>30.60</b>

Per the investigations above, UL-DL Configuration 2 was used to evaluate VoLTE over IMS

### 12.3 Air Interface Investigation

Use the worst-case codec test and document a limited set of bands/modulations/channels/bandwidth. Observe the effect of changing the band and bandwidth to ensure that there are no unexpected variations.

#### GSM / W-CDMA / CDMA (UMTS)

Mode	Ch. Freq.	Orientation	ABM1 dB (A/m)	ABM2 dB (A/m)	Ambient Noise dB(A/m)	Freq. Response (dB)	ABMSNR (dB)	T-Rating	Plot No.
GSM 850 Voice Coder Speech Codec: FR V1	CH.128 824.2 MHz	z(Axial)	2.55	-24.85	-58.95	2.00	27.40	T3	
		y(Transversal)	-5.26	-36.18	-58.88		30.92	T4	
	CH.190 836.6 MHz	z(Axial)	2.44	-24.27	-58.95	2.00	<b>26.71</b>	T3	1/ 2
		y(Transversal)	-5.42	-36.32	-58.88		30.90	T4	3
	CH.251 848.8 MHz	z(Axial)	2.81	-24.10	-58.95	2.00	26.91	T3	
		y(Transversal)	-4.91	-35.77	-58.88		30.86	T4	
GSM 1900 Voice Coder Speech Codec: FR V1	CH.661 1880.0 MHz	z(Axial)	2.55	-26.51	-58.95	2.00	29.05	T3	4/ 5
		y(Transversal)	-5.42	-36.64	-58.88		31.22	T4	6
W-CDMA Band II Voice AMR WB Codec:6.6 kbit/s	CH.9262 1852.4 MHz	z(Axial)	-6.80	-38.16	-55.21	2.00	<b>31.36</b>	T4	7/ 8
		y(Transversal)	-11.07	-42.46	-55.79		31.39	T4	9
	CH.9400 1880.0 MHz	z(Axial)	2.19	-29.37	-55.21	2.00	31.57	T4	
		y(Transversal)	-1.89	-33.32	-55.79		31.44	T4	
	CH.9538 836.6 MHz	z(Axial)	2.00	-31.31	-55.21	2.00	33.31	T4	
		y(Transversal)	-0.33	-33.36	-55.79		33.03	T4	
W-CDMA Band IV Voice AMR WB Codec: 6.6 kbit/s	CH.1412 1732.4 MHz	z(Axial)	-8.39	-39.88	-55.21	2.00	31.49	T4	10/11
		y(Transversal)	-1.68	-33.27	-55.79		31.59	T4	12
W-CDMA Band V Voice AMR WB Codec: 6.6 kbit/s	CH.4183 836.6 MHz	z(Axial)	-6.94	-38.53	-55.21	2.00	31.60	T4	13/14
		y(Transversal)	-1.50	-32.95	-55.79		31.45	T4	15
CDMA BC0 8k-EVRC 1/1	CH. 384 836.52 MHz	z(Axial)	3.03	-33.62	-58.97	1.91	36.65	T4	16/17
		y(Transversal)	-10.39	-46.65	-58.95		36.26	T4	18
CDMA BC1 8k-EVRC 1/1	CH. 25 1851.25 MHz	z(Axial)	0.77	-36.87	-58.97	1.92	37.64	T4	
		y(Transversal)	-7.15	-49.52	-58.95		42.37	T4	
	CH. 600 1880 MHz	z(Axial)	0.29	-35.50	-58.97	1.89	35.79	T4	
		y(Transversal)	-12.18	-50.69	-58.95		38.51	T4	
	CH. 1175 1908.75 MHz	z(Axial)	1.31	-34.85	-58.97	1.88	36.17	T4	
		y(Transversal)	-8.04	-44.05	-58.95		36.01	T4	
CDMA BC1 8k-EVRC 3/3	CH. 600 1880 MHz	z(Axial)	0.79	-36.59	-58.97	1.92	37.38	T4	19/20
		y(Transversal)	-8.20	-41.25	-58.95		<b>33.05</b>	T4	21
CDMA BC1 8k-EVRC 4/3	CH. 600 1880 MHz	z(Axial)	0.62	-43.26	-58.97	1.84	43.89	T4	
		y(Transversal)	-10.45	-54.21	-58.95		43.76	T4	
CDMA BC10 8k-EVRC 1/1	CH. 560 820 MHz	z(Axial)	0.18	-36.65	-58.97	2.00	36.83	T4	22/23
		y(Transversal)	-10.91	-48.73	-58.95		37.81	T4	24

Air Interface Investigation(Contiued)

LTE-FDD

Mode:	Ch. Freq.	BW	BW/ Modulation	RB Config.	Orientation	ABM1 dB(A/m)	ABM2 dB(A/m)	Ambient Noise dB(A/m)	Freq. Response (dB)	ABM SNR (dB)	T-Rating	Plot No.	
LTE Band 25 Voice EVS-WB Codec: 5.9 kbit/s	CH.26365 1882.5 MHz	20 MHz	QPSK	1/0	z(Axial)	-14.36	-41.01	-55.35	2.00	26.64	T3		
					y(Transversal)	-3.16	-31.38	-55.70		28.22	T3		
				1/49	z(Axial)	-18.43	-45.37	-55.35	2.00	26.94	T3		
					y(Transversal)	-16.85	-44.01	-55.70		27.17	T3		
				1/99	z(Axial)	2.49	-25.19	-55.35	2.00	27.67	T3		
					y(Transversal)	-22.59	-48.17	-55.70		25.58	T3		
				50/0	z(Axial)	-12.32	-38.79	-55.35	2.00	26.46	T3		
					y(Transversal)	-5.99	-33.65	-55.70		27.67	T3		
				50/25	z(Axial)	3.27	-22.64	-55.35	1.89	25.91	T3		
					y(Transversal)	-9.45	-35.08	-55.70		25.63	T3		
				50/49	z(Axial)	-4.88	-30.69	-55.35	2.00	25.81	T3		
					y(Transversal)	-1.31	-28.09	-55.70		26.78	T3		
				100/0	z(Axial)	-8.83	-36.74	-55.35	2.00	27.90	T3		
					y(Transversal)	-3.98	-31.18	-55.70		27.19	T3		
				16QAM	1/99	z(Axial)	3.91	-23.00	-55.35	2.00	26.90	T3	
						y(Transversal)	-16.97	-43.49	-55.70		26.52	T3	
				64QAM	1/99	z(Axial)	4.66	-20.80	-55.35	1.77	25.46	T3	
						y(Transversal)	-10.22	-35.85	-55.70		25.63	T3	
		256QAM	1/99	z(Axial)	-7.36	-33.19	-55.35	2.00	25.82	T3			
				y(Transversal)	-0.12	-27.56	-55.70		27.43	T3			
		15 MHz	64QAM	1/74	z(Axial)	2.67	-22.68	-55.21	1.82	25.34	T3	25/ 26	
					y(Transversal)	-1.19	-28.83	-55.79		27.64	T3	27	
		10 MHz	64QAM	1/49	z(Axial)	-5.04	-31.19	-55.21	1.81	26.15	T3		
					y(Transversal)	-16.97	-44.13	-55.79		27.16	T3		
		5 MHz	64QAM	1/24	z(Axial)	-7.07	-32.90	-55.21	1.84	25.83	T3		
					y(Transversal)	-5.52	-31.42	-55.79		25.90	T3		
		3 MHz	64QAM	1/14	z(Axial)	6.89	-19.09	-55.21	2.00	25.99	T3		
					y(Transversal)	-15.80	-42.17	-55.79		26.37	T3		
		1.4 MHz	64QAM	1/5	z(Axial)	3.96	-21.69	-55.21	1.92	25.65	T3		
					y(Transversal)	-11.40	-38.30	-55.79		26.91	T3		



**Air Interface Investigation(Contiued)**

**LTE-FDD**

Mode	Ch. Freq.	Band width	BW/ Mode	RB Config.	Orientation	ABM1 dB(A/m)	ABM2 dB(A/m)	Ambient Noise dB(A/m)	Freq. Response (dB)	ABM SNR (dB)	T-Rating	Plot No.
LTE Band 7 Voice EVS WB Codec: 5.9 kbit/s	CH.21100 2535 MHz	15 MHz	64QAM	1/74	z(Axial)	-2.27	-28.30	-54.94	1.92	26.04	T3	28/ 29
					y(Transversal)	-3.84	-29.95	-55.74		26.11	T3	30
LTE Band 12 Voice EVS WB Codec: 5.9 kbit/s	CH.23095 707.5 MHz	10 MHz	64QAM	1/49	z(Axial)	3.66	-23.22	-54.94	1.95	26.88	T3	31/ 32
					y(Transversal)	-7.43	-32.71	-55.74		25.27	T3	33
LTE Band 13 Voice EVS WB Codec: 5.9 kbit/s	CH.23230 782 MHz	10 MHz	64QAM	1/49	z(Axial)	-8.83	-33.80	-54.94	1.92	24.97	T3	34/ 35
					y(Transversal)	-7.83	-34.17	-55.74		26.34	T3	36
LTE Band 14 Voice EVS WB Codec: 5.9 kbit/s	CH.23330 793 MHz	10 MHz	64QAM	1/49	z(Axial)	-2.85	-28.51	-54.94	2.00	25.66	T3	37/ 38
					y(Transversal)	-7.94	-34.70	-55.74		26.76	T3	39
LTE Band 26 Voice EVS WB Codec: 5.9 kbit/s	CH.26865 831.5 MHz	15 MHz	64QAM	1/74	z(Axial)	3.45	-23.15	-54.94	1.92	26.60	T3	40/ 41
					y(Transversal)	-2.39	-29.20	-55.74		26.81	T3	42
LTE Band 30 Voice EVS WB Codec: 5.9 kbit/s	CH.27710 2310 MHz	10 MHz	64QAM	1/49	z(Axial)	-1.18	-26.41	-54.94	2.00	25.24	T3	43/ 44
					y(Transversal)	-2.08	-27.14	-55.74		25.06	T3	45
LTE Band 66 Voice EVS WB Codec: 5.9 kbit/s	CH.132322 1745 MHz	15 MHz	64QAM	1/74	z(Axial)	5.62	-23.16	-54.94	1.77	28.78	T3	46/ 47
					y(Transversal)	-14.79	-40.35	-55.74		25.56	T3	48
LTE Band 71 Voice EVS WB Codec: 5.9 kbit/s	CH.133322 683 MHz	15 MHz	64QAM	1/74	z(Axial)	5.02	-20.70	-54.94	2.00	25.72	T3	49/ 50
					y(Transversal)	0.14	-26.28	-55.74		26.42	T3	51
LTE Band 13 Voice EVS WB Codec: 5.9 kbit/s	CH.23205 779.5 MHz	5 MHz	64QAM	1/24	z(Axial)	0.04	-26.58	-54.94	2.00	26.62	T3	
					y(Transversal)	-2.48	-30.96	-55.74		28.48	T3	
	CH.23255 784.5 MHz	5 MHz	64QAM	1/24	z(Axial)	6.02	-19.72	-54.94	1.70	25.73	T3	
					y(Transversal)	-12.60	-39.40	-55.74		26.80	T3	

Air Interface Investigation(Contiued)

LTE-TDD

Mode	Ch. Freq.	BW	BW/ Modulation	RB Config.	Orientation	ABM1 dB(A/m)	ABM2 dB(A/m)	Ambient Noise dB(A/m)	Freq. Response (dB)	ABM SNR (dB)	T-Rating	Plot No.
LTE Band 41 Voice EVS-WB Codec: 5.9kbit/s	CH.40620 2593 MHz	20 MHz	QPSK	1/0	z(Axial)	6.74	-24.85	-58.56	1.98	31.59	T4	
					y(Transversal)	-4.31	-35.60	-58.12		31.28	T4	
				1/49	z(Axial)	7.05	-23.54	-58.56	2.00	30.59	T4	
					y(Transversal)	-8.86	-38.75	-58.12		29.88	T3	
				1/99	z(Axial)	5.11	-25.90	-58.56	2.00	31.02	T4	
					y(Transversal)	-8.71	-38.45	-58.12		29.75	T3	
				50/0	z(Axial)	6.26	-25.10	-58.56	2.00	31.36	T4	
					y(Transversal)	-11.24	-41.97	-58.12		30.73	T4	
				50/25	z(Axial)	1.00	-30.74	-58.56	2.00	31.74	T4	
					y(Transversal)	-6.07	-35.17	-58.12		29.11	T3	
				50/49	z(Axial)	5.41	-25.54	-58.56	2.00	30.94	T4	52/ 53
					y(Transversal)	-3.20	-32.14	-58.12		<b>28.94</b>	T3	54
				100/0	z(Axial)	4.85	-27.22	-58.56	2.00	32.07	T4	
					y(Transversal)	-6.12	-36.72	-58.12		30.60	T3	
		16QAM	50/49	z(Axial)	4.93	-25.74	-58.56	1.73	30.67	T4		
				y(Transversal)	-7.75	-38.47	-58.12		30.72	T4		
		64QAM	50/49	z(Axial)	0.05	-32.67	-58.56	1.81	32.72	T4		
				y(Transversal)	-6.22	-37.81	-58.12		31.59	T4		
		256QAM	50/49	z(Axial)	-1.28	-35.62	-58.58	1.73	34.34	T4		
				y(Transversal)	-16.21	-47.97	-58.18		31.76	T4		
		15 MHz	QPSK	36/39	z(Axial)	-2.36	-34.95	-58.58	1.93	32.59	T4	
					y(Transversal)	-11.23	-41.34	-58.18		30.12	T4	
		10 MHz	QPSK	25/24	z(Axial)	1.95	-29.05	-58.58	2.00	31.00	T4	
					y(Transversal)	-6.38	-36.06	-58.18		29.68	T3	
		5 MHz	QPSK	12/11	z(Axial)	-0.75	-29.77	-58.58	1.95	29.02	T3	
					y(Transversal)	-17.20	-46.31	-58.18		29.12	T3	

Mode	Ch. Freq.	BW	BW/ Modulation	RB Config.	Orientation	ABM1 dB(A/m)	ABM2 dB(A/m)	Ambient Noise dB(A/m)	Freq. Response (dB)	ABM SNR (dB)	T-Rating	Plot No.
LTE Band 38 Voice EVS-WB Codec: 5.9kbit/s	CH.38000 2595 MHz	20 MHz	QPSK	50/49	z(Axial)	1.60	-29.26	-58.58	1.82	30.85	T4	55/ 56
					y(Transversal)	-6.56	-36.18	-58.18		29.62	T3	57
LTE Band 40 Voice Lower EVS-WB Codec: 5.9kbit/s	CH.38750 2310 MHz	10 MHz	QPSK	25/24	z(Axial)	1.34	-29.06	-58.58	1.55	30.39	T4	58/ 59
					y(Transversal)	-8.83	-37.58	-58.18		<b>28.75</b>	T3	60
LTE Band 40 Voice Upper EVS-WB Codec: 5.9kbit/s	CH.39200 2355 MHz			25/24	z(Axial)	-4.02	-33.81	-58.58	1.94	29.80	T3	
					y(Transversal)	-6.49	-38.38	-58.18		31.88	T4	
LTE Band 40 Voice Lower EVS-WB Codec: 5.9kbit/s	CH.38725 2307.5 MHz	5 MHz	QPSK	12/11	z(Axial)	4.30	-26.46	-58.58	1.94	30.77	T4	
					y(Transversal)	-12.26	-41.92	-58.18		29.66	T3	
	CH.38775 2312.5 MHz			12/11	z(Axial)	3.57	-26.64	-58.58	1.88	30.21	T4	
					y(Transversal)	-3.03	-35.64	-58.18		32.61	T4	
LTE Band 48 Voice EVS-WB Codec: 5.9kbit/s	CH.55990 3625 MHz	20 MHz	QPSK	50/49	z(Axial)	4.82	-28.80	-58.58	1.90	33.62	T4	61/ 62
					y(Transversal)	-11.69	-44.00	-58.18		32.31	T4	63

## 12.4 VoWi-Fi Codec Investigation

An investigation between the various codec configurations (Low/High bit rates for Narrowband, Wideband) and specific parameters are documented (ABM1, ABM2, S+N/N, frequency response) to determine the worst-case bit rates for each voice service type. The table below compares the varying codec configurations. A codec investigation was performed for each Wi-Fi 2.4 GHz and 5 GHz.

The highlighted results below were determined to be the worst case codec configuration(s) for Wi-Fi 2.4 GHz and 5 GHz.

Codec Investigation								
Codec State	AMR-NB (kbit/s)			AMR-WB (kbit/s)			Orientation	Band/ Bandwidth/ Channel
	4.75	7.4	12.2	6.6	15.85	23.85		
ABM1 (dB/m)	-3.03	-2.55	-2.23	0.74	7.01	0.36	z (Axial)	802.11b CH.6 2437 MHz DSSS 1 Mbps
ABM2 (dBA/m)	-34.61	-34.78	-34.09	-29.60	-23.38	-30.26		
S+N/N (dB)	31.58	32.23	31.87	30.33	30.39	30.62		
Freq. Resposne(dB)	2.00	2.00	2.00	2.00	1.86	1.78		
ABM1 (dB/m)	-8.46	-9.22	-8.76	-5.62	-3.83	-4.94	y (Transversal)	
ABM2 (dBA/m)	-40.15	-41.14	-40.26	-35.94	-34.19	-35.43		
S+N/N (dB)	31.70	31.92	31.50	30.31	30.36	30.49		

Codec Investigation											
Codec State	EVS-NB (kbit/s)			EVS-WB (kbit/s)			EVS-SWB (kbit/s)			Orientation	Band/ BandWidth/ Channel
	5.9	13.2	24.4	5.9	24.4	128	9.6	24.4	128		
ABM1 (dB/m)	-2.57	2.44	3.60	-0.06	2.63	2.18	3.88	3.60	-0.19	z (Axial)	802.11b CH.6 2437 MHz DSSS 1 Mbps
ABM2 (dBA/m)	-33.31	-29.22	-28.81	-26.91	-28.97	-30.70	-28.31	-29.42	-33.50		
S+N/N (dB)	30.75	31.66	32.41	<b>26.85</b>	31.61	32.88	32.19	33.02	33.31		
Freq.Resposne(dB)	1.99	2.00	2.00	2.00	1.79	1.73	1.56	1.33	1.32		
ABM1 (dB/m)	-7.56	-7.90	-13.41	-12.71	-2.85	-8.21	-10.83	-6.84	-10.42	y (Transversal)	
ABM2 (dBA/m)	-38.12	-39.31	-45.33	-39.88	-33.63	-40.06	-42.32	-38.73	-42.66		
S+N/N (dB)	30.56	31.41	31.92	27.17	30.78	31.85	31.49	31.89	32.25		

Codec Investigation								
Codec State	AMR-NB (kbit/s)			AMR-WB (kbit/s)			Orientation	Band/ Bandwidth/ Channel
	4.75	7.4	12.2	6.6	15.85	23.85		
ABM1 (dB/m)	-3.71	1.52	-0.37	1.73	6.80	5.61	z (Axial)	802.11a CH.40 5200 MHz BPSK 6 Mbps
ABM2 (dBA/m)	-30.40	-25.64	-28.21	-23.39	-19.36	-20.54		
S+N/N (dB)	26.69	27.16	27.83	25.12	26.16	26.15		
Freq. Resposne(dB)	2.00	2.00	2.00	2.00	1.74	1.71		
ABM1 (dB/m)	-6.51	-9.11	-4.39	-5.67	-1.71	-6.84	y (Transversal)	
ABM2 (dBA/m)	-33.08	-35.20	-31.34	-30.73	-27.72	-32.49		
S+N/N (dB)	26.56	26.10	26.95	25.06	26.01	25.64		

Codec Investigation											
Codec State	EVS-NB (kbit/s)			EVS-WB (kbit/s)			EVS-SWB (kbit/s)			Orientation	Band/ BandWidth/ Channel
	5.9	13.2	24.4	5.9	24.4	128	9.6	24.4	128		
ABM1 (dB/m)	-3.97	2.48	1.37	-6.11	-0.34	-2.36	-0.37	3.86	-0.69	z (Axial))	802.11a CH.40 5200 MHz BPSK 6 Mbps
ABM2 (dBA/m)	-30.61	-23.44	-25.92	-29.50	-27.27	-28.99	-27.08	-21.90	-26.32		
S+N/N (dB)	26.64	25.92	27.30	23.39	26.94	26.62	26.71	25.76	25.63		
Freq.Resposne(dB)	1.65	2.00	2.00	1.96	1.84	1.68	1.71	1.51	1.49		
ABM1 (dB/m)	-14.49	-5.07	-5.49	-3.07	-7.85	-7.33	-10.02	-3.18	-8.53	y (Transversal)	
ABM2 (dBA/m)	-41.49	-31.70	-32.85	-26.37	-34.30	-33.19	-36.71	-28.93	-33.79		
S+N/N (dB)	26.99	26.63	27.35	<b>23.30</b>	26.44	25.86	26.68	25.75	25.26		

## 12.5 VoWi-Fi Antennas Investigation

EVS-WB 5.9 kbit/s was the worst case bit-rates for 802.11b and 802.11a. The secondary antenna was investigated to determine which antennas yields a worse SNNR. The worst case codec and bit-rate from Antenna 1 was used to determine Antenna 2's exclusion. Since Antenna 2 yielded a better SNNR than Antenna 1, all subsequent measurements were measured using Antenna 1.

Antenna	Mode	Ch. Freq.	BW	BW /Modulation	Orientation	ABM1 dB(A/m)	ABM2 dB(A/m)	Ambient Noise dB(A/m)	Freq. Response (dB)	ABM SNR (dB)	T- Rating
WiFi Ant 1	802.11a Voice EVS-WB Codec: 5.9 kbit/s	CH.40 5200 MHz	20 MHz	BPSK 6 Mbps	z(Axial)	-6.11	-29.50	-55.43	1.96	23.39	T3
y(Transversal)					-3.07	-26.37	-55.69	<b>23.30</b>	T3		
WiFi Ant 2					z(Axial)	4.60	-20.00	-55.43	1.98	24.60	T3
y(Transversal)					-21.59	-46.65	-55.69		25.06	T3	

## 12.6 VoWi-Fi Air Interface Investigation

Using the data from §9.4, further testing was performed on the remaining 802.11 modes. The objective of these measurements is to ensure that changing the modulation, bandwidth, and data rate, whilst using the worst case codec configuration measured in §9.4, yields no unexpected variations.

Moe	Ch. Freq.	BW	BW/ Modeulation	Orientation	ABM1 dB(A/m)	ABM2 dB(A/m)	Ambient Noise dB(A/m)	Freq. Response (dB)	ABM SNR (dB)	T-Rating	Plot No.
802.11b Voice EVS-WB Codec: 5.9 kbit/s	CH.6 2437 MHz	20 MHz	DSSS 1 Mbps	z(Axial)	-0.06	-26.91	-58.53	2.00	26.85	T3	
				y(Transversal)	-12.71	-39.88	-58.34		27.17	T3	
			CCK 5.5 Mbps	z(Axial)	-12.58	-38.91	-58.53	2.00	<b>26.33</b>	T3	64/65
				y(Transversal)	-2.70	-29.96	-58.34		27.27	T3	66
	CCK 11 Mbps		z(Axial)	-5.01	-32.09	-58.53	1.73	27.08	T3		
			y(Transversal)	-13.23	-41.23	-58.34		28.00	T3		
	CH.1 2412 MHz		DSSS 5.5 Mbps	z(Axial)	1.46	-25.56	-58.53	1.93	27.02	T3	
				y(Transversal)	-5.46	-31.89	-58.34		26.44	T3	
CH.11 2462 MHz	DSSS 5.5 Mbps	z(Axial)	4.29	-25.70	-58.53	2.00	29.98	T3			
		y(Transversal)	-3.62	-32.31	-58.34		28.69	T3			
802.11g Voice EVS-WB Codec: 5.9 kbit/s	CH.6 2437 MHz	20 MHz	QPSK 6 Mbps	z(Axial)	-5.95	-33.83	-58.53	1.58	27.88	T3	
				y(Transversal)	-2.44	-29.83	-58.34		27.39	T3	
802.11n HT20 Voice EVS-WB Codec: 5.9 kbit/s	CH.6 2437 MHz	20 MHz	QPSK MCS 0	z(Axial)	-12.78	-39.79	-58.53	1.58	27.00	T3	
				y(Transversal)	-5.97	-33.81	-58.34		27.84	T3	
802.11ax HE20 Voice EVS-WB Codec: 5.9 kbit/s	CH.6 2437 MHz	20 MHz	64QAM MCS 6	z(Axial)	-2.55	-31.41	-58.53	1.88	28.86	T3	
				y(Transversal)	-15.96	-43.36	-58.34		27.40	T3	

VoWi-Fi Air Interface Investigation (Continued)

Mode	Ch. Freq.	BW	BW /Modulation	Orientation	ABM1 dB(A/m)	ABM2 dB(A/m)	Ambient Noise dB(A/m)	Freq. Response (dB)	ABM SNR (dB)	T-Rating	Plot No.
802.11a Voice EVS-WB Codec: 5.9kbit/s	CH.40 5200 MHz	20 MHz	BPSK 6 Mbps	z(Axial)	-6.11	-29.50	-55.43	1.96	23.39	T3	
				y(Transversal)	-3.07	-26.37	-55.69		23.30	T3	
			QPSK 18 Mbps	z(Axial)	-12.17	-36.48	-55.43	1.81	24.30	T3	
				y(Transversal)	-12.33	-35.72	-55.69		23.40	T3	
			64QAM 54 Mbps	z(Axial)	6.69	-17.20	-55.43	1.60	23.89	T3	
				y(Transversal)	-7.71	-31.98	-55.69		24.27	T3	
802.11n HT20 Voice EVS-WB Codec: 5.9kbit/s	CH.40 5200 MHz	20 MHz	MCS 0 6.5 Mbps	z(Axial)	-14.18	-37.41	-55.43	1.93	<b>23.23</b>	T3	67/68
				y(Transversal)	-4.40	-28.61	-55.69		24.21	T3	69
			MCS 3 26 Mbps	z(Axial)	-11.14	-34.70	-55.43	1.98	23.57	T3	
				y(Transversal)	-12.37	-36.63	-55.69		24.26	T3	
			MCS 7 65 Mbps	z(Axial)	4.50	-20.39	-55.43	2.00	24.89	T3	
				y(Transversal)	-3.28	-28.27	-55.69		24.98	T3	
802.11n HT40 Voice EVS-WB Codec: 5.9kbit/s	CH.38 5190 MHz	40 MHz	MCS 0 13.5 Mbps	z(Axial)	1.92	-21.92	-55.43	1.78	23.84	T3	
				y(Transversal)	-5.52	-30.34	-55.69		24.81	T3	
			MCS 3 54 Mbps	z(Axial)	-8.91	-32.70	-55.43	1.87	23.79	T3	
				y(Transversal)	-2.54	-27.25	-55.69		24.71	T3	
			MCS 7 135 Mbps	z(Axial)	2.14	-22.61	-55.43	1.62	24.75	T3	
				y(Transversal)	-6.27	-30.19	-55.69		23.92	T3	
802.11ac VHT20 Voice EVS-WB Codec: 5.9kbit/s	CH.40 5200 MHz	20 MHz	MCS 0 6.5 Mbps	z(Axial)	4.69	-19.37	-55.43	2.00	24.06	T3	
				y(Transversal)	-7.44	-32.04	-55.69		24.60	T3	
			MCS 4 39 Mbps	z(Axial)	0.77	-25.49	-55.43	1.15	26.26	T3	
				y(Transversal)	-6.97	-32.90	-55.69		25.93	T3	
			MCS 8 78 Mbps	z(Axial)	1.12	-26.39	-55.43	1.35	27.51	T3	
				y(Transversal)	-9.75	-36.16	-55.69		26.40	T3	
802.11ac VHT40 Voice EVS-WB Codec: 5.9kbit/s	CH.38 5190 MHz	40 MHz	MCS 0 13.5 Mbps	z(Axial)	2.96	-21.01	-55.43	1.95	23.97	T3	
				y(Transversal)	-12.83	-38.07	-55.69		25.24	T3	
			MCS 4 81 Mbps	z(Axial)	-10.08	-34.07	-55.43	2.00	23.99	T3	
				y(Transversal)	-4.06	-28.67	-55.69		24.61	T3	
			MCS 9 180 Mbps	z(Axial)	-3.55	-27.98	-55.43	2.00	24.42	T3	
				y(Transversal)	-4.91	-28.90	-55.69		23.99	T3	
802.11ac VHT80 Voice EVS-WB Codec: 5.9kbit/s	CH.42 5210 MHz	80 MHz	MCS 0 29.3 Mbps	z(Axial)	-2.26	-25.87	-55.43	2.00	23.61	T3	
				y(Transversal)	-8.11	-31.62	-55.69		23.51	T3	
			MCS 4 175.5Mbps	z(Axial)	6.29	-17.51	-55.43	2.00	23.80	T3	
				y(Transversal)	-5.87	-29.79	-55.69		23.92	T3	
			MCS 9 390 Mbps	z(Axial)	-0.74	-24.26	-55.43	2.00	23.51	T3	
				y(Transversal)	-7.72	-31.25	-55.69		23.53	T3	

Mode	Ch. Freq.	BW	BW /Modulation	Orientation	ABM1 dB(A/m)	ABM2 dB(A/m)	Ambient Noise dB(A/m)	Freq. Response (dB)	ABM SNR (dB)	T-Rating	Plot No.
802.11ax HE20 Voice EVS-WB Codec: 5.9kbit/s	CH.40 5200 MHz	20 MHz	MCS 0 8.6 Mbps	z(Axial)	7.17	-17.37	-55.43	1.78	24.54	T3	
				y(Transversal)	-13.85	-38.07	-55.69		24.23	T3	
			MCS 6 77.4 Mbps	z(Axial)	-3.01	-27.38	-55.43	2.00	24.37	T3	
				y(Transversal)	-19.90	-44.05	-55.69		24.16	T3	
MCS 11 159.9Mbps	z(Axial)	-0.36	-25.01	-55.43	2.00	24.65	T3				
	y(Transversal)	-1.28	-26.38	-55.69		25.11	T3				
802.11ax HE40 Voice EVS-WB Codec: 5.9kbit/s	CH.38 5190 MHz	40 MHz	MCS 0 17.2 Mbps	z(Axial)	4.22	-20.00	-55.43	1.86	24.22	T3	
				y(Transversal)	-16.23	-39.53	-55.69		23.30	T3	
			MCS 6 154.9Mbps	z(Axial)	4.26	-19.95	-55.43	1.69	24.22	T3	
				y(Transversal)	-9.92	-33.72	-55.69		23.79	T3	
MCS 11 286.8Mbps	z(Axial)	-9.43	-32.71	-55.43	2.00	23.28	T3				
	y(Transversal)	-10.25	-34.44	-55.69		24.18	T3				
802.11ax HE80 Voice EVS-WB Codec: 5.9kbit/s	CH.42 5210 MHz	80 MHz	MCS 0 36 Mbps	z(Axial)	6.34	-17.63	-59.45	2.00	23.97	T3	
				y(Transversal)	-5.74	-29.55	-59.50		23.80	T3	
			MCS 6 324.3Mbps	z(Axial)	7.97	-17.67	-59.45	1.92	25.64	T3	
				y(Transversal)	-7.60	-32.27	-59.50		24.67	T3	
MCS 11 600.5Mbps	z(Axial)	6.51	-17.55	-59.45	1.67	24.07	T3				
	y(Transversal)	-9.76	-33.58	-59.50		23.82	T3				
802.11n HT20 Voice EVS-WB Codec: 5.9kbit/s	CH.56 5280 MHz	20 MHz	MCS 0 6.5 Mbps	z(Axial)	-1.35	-25.08	-59.45	2.00	23.73	T3	70/71
				y(Transversal)	-4.34	-28.74	-59.50		24.40	T3	72
802.11n HT20 Voice EVS-WB Codec: 5.9kbit/s	CH.120 5600 MHz	20 MHz	MCS 0 6.5 Mbps	z(Axial)	-3.14	-27.49	-59.45	2.00	24.35	T3	73/74
				y(Transversal)	-13.39	-37.67	-59.50		24.28	T3	75
802.11n HT20 Voice EVS-WB Codec: 5.9kbit/s	CH.157 5785 MHz	20 MHz	MCS 0 6.5 Mbps	z(Axial)	4.82	-18.31	-59.45	1.68	<b>23.13</b>	T3	76/77
				y(Transversal)	-1.59	-25.33	-59.50		23.74	T3	78
802.11n HT20 Voice EVS-WB Codec: 5.9kbit/s	CH.149 5745 MHz	20 MHz	MCS 0 6.5 Mbps	z(Axial)	0.39	-24.66	-59.45	1.76	25.05	T3	79/80
				y(Transversal)	-2.66	-30.24	-59.50		27.58	T3	81
802.11n HT20 Voice EVS-WB Codec: 5.9kbit/s	CH.165 5825 MHz	20 MHz	MCS 0 6.5 Mbps	z(Axial)	2.81	-21.35	-59.45	1.82	24.16	T3	82/83
				y(Transversal)	-19.96	-44.05	-59.50		24.10	T3	84



## 12.7 OTT Codec Investigation

The DUT's nested OTT application supports range of codec bit rate 6 – 64 kbit/s, thus an investigation between the various codec configurations (6/64 as Low/High bit rates) and specific parameters are documented (ABM1, ABM2, S+N/N, frequency response) to determine the worst-case bit rates for each service type.

The table below compares the varying codec configurations.

Codec Investigation					
Codec State	codec bit rate (kbit/s)			Orientation	Band/ BandWidth/ Channel
	6	40	75		
ABM1 (dB/m)	12.68	11.10	8.74	z (Axial)	GSM 850 EDGE 2 slots CH.190 836.6 MHz
ABM2 (dBA/m)	-30.00	-33.74	-34.31		
S+N/N (dB)	<b>42.68</b>	44.83	43.05		
Freq.Resposne (dB)	1.93	1.73	2.00		
ABM1 (dB/m)	5.21	-3.43	-1.74	y(Transversal)	
ABM2 (dBA/m)	-45.86	-48.14	-45.20		
S+N/N (dB)	51.07	44.71	43.46		
ABM1 (dB/m)	11.86	12.04	12.14	z (Axial)	
ABM2 (dBA/m)	-40.06	-38.29	-36.97		
S+N/N (dB)	51.92	50.33	49.12		
Freq.Resposne (dB)	1.96	2.00	2.00		
ABM1 (dB/m)	4.45	3.07	4.62	y(Transversal)	
ABM2 (dBA/m)	-46.58	-46.44	-44.12		
S+N/N (dB)	51.03	49.52	<b>48.74</b>		
ABM1 (dB/m)	9.69	11.80	11.81	z (Axial)	LTE Band 13 10 MHz QPSK RB 1/49 CH.23230 782.0 MHz
ABM2 (dBA/m)	-42.50	-38.21	-36.28		
S+N/N (dB)	52.20	50.01	<b>48.09</b>		
Freq.Resposne (dB)	1.81	1.96	2.00		
ABM1 (dB/m)	4.07	4.71	4.04	y(Transversal)	
ABM2 (dBA/m)	-48.57	-48.53	-45.23		
S+N/N (dB)	52.64	53.24	49.27		

Codec Investigation					
Codec State	codec bit rate (kbit/s)			Orientation	Band/ BandWidth/ Channel
	6	40	75		
ABM1 (dB/m)	13.58	13.89	13.77	z (Axial)	LTE Band 40 10 MHz QPSK RB 25/24 CH.38750 2310 MHz
ABM2 (dBA/m)	-33.50	-32.65	-31.75		
S+N/N (dB)	47.07	46.54	45.52		
Freq.Resposne (dB)	2.00	2.00	2.00		
ABM1 (dB/m)	1.69	1.81	1.94	y(Transversal)	
ABM2 (dBA/m)	-43.85	-43.65	-43.05		
S+N/N (dB)	45.54	45.46	<b>44.99</b>		
ABM1 (dB/m)	10.34	15.00	12.71	z (Axial)	
ABM2 (dBA/m)	-41.68	-35.63	-36.72		
S+N/N (dB)	52.03	50.63	<b>49.43</b>		
Freq.Resposne (dB)	1.99	2.00	2.00		
ABM1 (dB/m)	-0.17	5.19	5.19	y(Transversal)	
ABM2 (dBA/m)	-49.82	-45.26	-44.56		
S+N/N (dB)	49.64	50.45	49.75		
ABM1 (dB/m)	13.75	14.09	13.87	z (Axial)	802.11b CH.6 2437 MHz 5.5 Mbps
ABM2 (dBA/m)	-35.67	-34.40	-33.23		
S+N/N (dB)	49.42	48.49	47.10		
Freq.Resposne (dB)	2.00	2.00	1.96		
ABM1 (dB/m)	4.32	3.77	4.64	y(Transversal)	
ABM2 (dBA/m)	-42.74	-42.37	-41.40		
S+N/N (dB)	47.05	46.14	<b>46.05</b>		
ABM1 (dB/m)	12.25	12.21	12.36	z (Axial)	
ABM2 (dBA/m)	-39.19	-37.87	-36.80		
S+N/N (dB)	51.45	50.08	49.16		
Freq.Resposne (dB)	2.00	2.00	1.96		
ABM1 (dB/m)	4.17	3.48	3.53	y(Transversal)	
ABM2 (dBA/m)	-46.63	-46.27	-45.34		
S+N/N (dB)	50.80	49.75	<b>48.87</b>		

### 12.8 OTT Air Interface Investigation

Mode	Ch. Freq.	BW	BW/ Mode	RB Config.	Orientation	ABM1 dB(A/m)	ABM2 dB(A/m)	Ambient Noise dB(A/m)	Freq. Response (dB)	ABM SNR (dB)	T-Rating	Plot No.		
GSM850 EDGE 2 slots Duo Codec: 6 kbit/s	CH.128 824.4 MHz				z(Axial)	12.55	-31.43	-54.96	2.00	43.98	T4			
					y(Transversal)	4.35	-45.29	-55.66		49.65	T4			
	CH.190 836.6 MHz					z(Axial)	12.68	-30.00	-54.96	1.93	<b>42.68</b>	T4	85/ 86	
						y(Transversal)	5.21	-45.86	-55.66		51.07	T4	87	
	CH.251 848.8 MHz						z(Axial)	11.48	-33.08	-54.96	1.85	44.56	T4	
							y(Transversal)	-0.55	-47.49	-55.66		46.94	T4	
GSM1900 EDGE 2 slots Duo Codec: 6 kbit/s	CH.661 1880 MHz					z(Axial)	12.09	-33.90	-54.96	2.00	45.99	T4	88/ 89	
						y(Transversal)	-0.97	-45.02	-55.66		44.05	T4	90	
WCDMA Band II HSUPA subtest1 Duo Codec: 75 kbit/s	CH.9262 1852.4 MHz					z(Axial)	12.14	-36.97	-55.48	2.00	49.12	T4	91/ 92	
						y(Transversal)	4.62	-44.12	-55.77		48.74	T4	93	
WCDMA Band IV HSUPA subtest1 Duo Codec: 75 kbit/s	CH.1412 1732.4 MHz					z(Axial)	12.29	-36.60	-55.48	2.00	48.89	T4	94/ 95	
						y(Transversal)	4.64	-44.15	-55.77		48.80	T4	96	
WCDMA Band V HSUPA subtest1 Duo Codec: 75 kbit/s	CH.4183 836.6 MHz					z(Axial)	12.45	-36.61	-55.48	1.98	49.06	T4	97/ 98	
						y(Transversal)	5.40	-43.04	-55.77		48.44	T4	99	
LTE Band 7 Google Duo Codec: 75 kbit/s	CH.21100 2535 MHz	15 MHz	64OAM	1/74		z(Axial)	13.04	-36.03	-52.09	2.00	49.07	T4	100/ 101	
						y(Transversal)	5.91	-43.40	-54.68		49.31	T4	102	
LTE Band 12 Google Duo Codec: 75 kbit/s	CH.23095 707.5 MHz	10 MHz	64QAM	1/49		z(Axial)	12.62	-36.37	-52.09	2.00	48.99	T4	103/ 104	
						y(Transversal)	2.40	-48.65	-54.68		51.05	T4	105	
LTE Band 13 Google Duo Codec: 75 kbit/s	CH.23230 782 MHz	10 MHz	64OAM	1/49		z(Axial)	11.81	-36.28	-52.09	2.00	48.09	T4	106/ 107	
						y(Transversal)	4.04	-45.23	-54.68		49.27	T4	108	
LTE Band 14 Google Duo Codec: 75 kbit/s	CH.23330 793 MHz	10 MHz	64QAM	1/49		z(Axial)	5.54	-44.55	-52.09	1.95	50.09	T4	109/ 110	
						y(Transversal)	4.24	-43.37	-54.68		47.61	T4	111	
LTE Band 25 Google Duo Codec: 75 kbit/s	CH.26365 1882.5 MHz	15 MHz	64OAM	1/74		z(Axial)	11.99	-36.50	-52.09	2.00	48.49	T4	112/ 113	
						y(Transversal)	4.52	-44.57	-54.68		49.09	T4	114	
LTE Band 26 Google Duo Codec: 75 kbit/s	CH.26865 831.5 MHz	15 MHz	64QAM	1/74		z(Axial)	12.97	-36.22	-52.09	2.00	49.18	T4	115/ 116	
						y(Transversal)	4.78	-44.40	-54.68		49.18	T4	117	
LTE Band 30 Google Duo Codec: 75 kbit/s	CH.27710 2310 MHz	10 MHz	64OAM	1/49		z(Axial)	13.04	-35.98	-52.09	2.00	49.02	T4	118/ 119	
						y(Transversal)	-0.60	-47.01	-54.68		46.41	T4	120	
LTE Band 66 Google Duo Codec: 75 kbit/s	CH.132322 1745 MHz	15 MHz	64QAM	1/74		z(Axial)	13.83	-31.35	-52.09	2.00	45.19	T4	121/ 122	
						y(Transversal)	-0.85	-46.58	-54.68		45.73	T4	123	
LTE Band 71 Google Duo Codec: 75 kbit/s	CH.133322 683 MHz	15 MHz	64OAM	1/74		z(Axial)	12.79	-34.86	-52.09	2.00	47.65	T4	124/ 125	
						y(Transversal)	4.27	-43.13	-54.68		47.41	T4	126	

Mode:	Ch./ Freq.	BW/ Data Rate	BW/ Modulation	RB Config.	Orientation	ABM1 dB(A/m)	ABM2 dB(A/m)	Ambient Noise dB(A/m)	Freq. Response (dB)	ABM SNR(dB)	T-Rating	Plot No.
LTE Band 38 Google Duo Codec: 75 kbit/s	CH.38000 2595 MHz	20 MHz	QPSK	50/49	z(Axial)	14.03	-31.77	-55.48	2.00	45.80	T4	127/ 128
					y(Transversal)	2.05	-42.89	-55.77		44.94	T4	129
LTE Band 40 Google Duo Codec: 75 kbit/s	CH.38750 2310 MHz	10 MHz	QPSK	25/24	z(Axial)	13.77	-31.75	-55.48	2.00	45.52	T4	130/ 131
					y(Transversal)	1.94	-43.05	-55.77		44.99	T4	132
LTE Band 40 Google Duo Codec: 75 kbit/s	CH.39200 2355 MHz	10 MHz	QPSK	25/24	z(Axial)	14.00	-32.08	-55.48	2.00	46.08	T4	133/ 134
					y(Transversal)	2.08	-43.73	-55.77		45.81	T4	135
LTE Band 41 Google Duo Codec: 75 kbit/s	CH.40620 2593 MHz	20 MHz	QPSK	50/49	z(Axial)	13.97	-31.53	-55.48	2.00	45.51	T4	136/ 137
					y(Transversal)	2.12	-42.17	-55.77		44.29	T4	138
LTE Band 48 Google Duo Codec: 75 kbit/s	CH.55990 3626 MHz	20 MHz	QPSK	50/49	z(Axial)	11.63	-38.06	-55.48	1.97	49.68	T4	139/ 140
					y(Transversal)	5.12	-43.25	-55.77		48.38	T4	141
Wi-Fi 2.4 GHz 802.11b Google Duo Codec: 75 kbit/s	CH.6 2437 MHz	20 MHz	5.5Mbps		z(Axial)	13.87	-33.23	-55.48	1.96	47.10	T4	142/ 143
					y(Transversal)	4.64	-41.40	-55.77		46.05	T4	144
U-NII 5.2 GHz 802.11n HT20 Google Duo Codec: 75 kbit/s	CH.40 5200 MHz	20 MHz	MCS0		z(Axial)	12.35	-36.74	-55.48	2.00	49.09	T4	145/ 146
					y(Transversal)	3.51	-45.13	-55.77		48.63	T4	147
U-NII 5.3 GHz 802.11n HT20 Google Duo Codec: 75 kbit/s	CH.56 5280 MHz	20 MHz	MCS0		z(Axial)	12.29	-36.67	-55.48	2.00	48.95	T4	148/ 149
					y(Transversal)	4.48	-44.25	-55.77		48.73	T4	150
U-NII 5.6 GHz 802.11n HT20 Google Duo Codec: 75 kbit/s	CH.120 5600 MHz	20 MHz	MCS0		z(Axial)	12.29	-36.46	-55.48	1.98	48.76	T4	151/ 152
					y(Transversal)	4.69	-43.97	-55.77		48.66	T4	153
U-NII 5.8 GHz 802.11n HT20 Google Duo Codec: 75 kbit/s	CH.157 5785 MHz	20 MHz	MCS0		z(Axial)	12.36	-36.80	-55.48	1.96	49.16	T4	154/155
					y(Transversal)	3.53	-45.34	-55.77		48.87	T4	156
EVDO BC0 Rev.A Google Duo Codec: 75 kbit/s	CH.384 836.52 MHz				z(Axial)	5.41	-42.01	-54.96	2.00	47.42	T4	157/158
					y(Transversal)	2.72	-44.21	-55.66		46.93	T4	159
EVDO BC1 Rev.A Google Duo Codec: 75 kbit/s	CH.600 1880 MHz				z(Axial)	12.71	-36.72	-54.96	2.00	49.43	T4	160/161
					y(Transversal)	5.19	-44.56	-55.66		49.75	T4	162
EVDO BC10 Rev.A Google Duo Codec: 75 kbit/s	CH.560 820 MHz				z(Axial)	8.42	-38.94	-54.96	2.00	47.37	T4	163/164
					y(Transversal)	3.28	-44.04	-55.66		47.32	T4	165

## 12.9 Radio Configuration for OTT VoIP (NR)

An investigation was performed to determine the waveform, modulation, and RB configuration to be used for testing. Due to equipment limitations, the worst-case ABM1 from OTT VoIP was used with the ABM2 measured for each NR radio configuration. CP-OFDM 16QAM, 1RB, 99%RB offset was determined to be the worst-case configuration for the handset and will be used for full testing. Frequency Response measurements were not possible due to equipment limitations

### NR OTT VoIP SNNR by Radio Configuration (CP-OFDM)

Mode:	Ch./ Freq.	BW	BW/ Mode	RB Config.	Orientation	ABM1 dB(A/m)	ABM2 dB(A/m)	Ambient Noise dB(A/m)	Freq. Response (dB)	ABM SNR (dB)
n66 CP-OFDM	CH.345000 1725 MHz	40 MHz	QPSK	1/1	z(Axial)	13.83	-40.38	-55.51		54.21
					y(Transversal)	-0.85	-51.99	-55.81		51.14
n66 CP-OFDM	CH.345000 1725 MHz	40 MHz	QPSK	1/108	z(Axial)	13.83	-40.36	-55.51		54.19
					y(Transversal)	-0.85	-51.27	-55.81		50.42
n66 CP-OFDM	CH.345000 1725 MHz	40 MHz	QPSK	1/214	z(Axial)	13.83	-41.93	-55.51		55.76
					y(Transversal)	-0.85	-53.15	-55.81		52.3
n66 CP-OFDM	CH.345000 1725 MHz	40 MHz	QPSK	108/0	z(Axial)	13.83	-46.62	-55.51		60.45
					y(Transversal)	-0.85	-54.74	-55.81		53.89
n66 CP-OFDM	CH.345000 1725 MHz	40 MHz	QPSK	108/54	z(Axial)	13.83	-49.02	-55.51		62.85
					y(Transversal)	-0.85	-54.74	-55.81		53.89
n66 CP-OFDM	CH.345000 1725 MHz	40 MHz	QPSK	108/108	z(Axial)	13.83	-48.73	-55.51		62.56
					y(Transversal)	-0.85	-54.57	-55.81		53.72
n66 CP-OFDM	CH.345000 1725 MHz	40 MHz	QPSK	216/0	z(Axial)	13.83	-48.50	-55.51		62.33
					y(Transversal)	-0.85	-54.47	-55.81		53.62
n66 CP-OFDM	CH.345000 1725 MHz	40 MHz	16QAM	1/1	z(Axial)	13.83	-42.84	-55.51		56.67
					y(Transversal)	-0.85	-53.51	-55.81		52.66
n66 CP-OFDM	CH.345000 1725 MHz	40 MHz	16QAM	1/108	z(Axial)	13.83	-41.08	-55.51		54.91
					y(Transversal)	-0.85	-53.76	-55.81		52.91
n66 CP-OFDM	CH.345000 1725 MHz	40 MHz	16QAM	1/214	z(Axial)	13.83	-37.31	-55.51		51.14
					y(Transversal)	-0.85	-47.40	-55.81		<b>46.55</b>
n66 CP-OFDM	CH.345000 1725 MHz	40 MHz	16QAM	108/0	z(Axial)	13.83	-49.03	-55.51		62.86
					y(Transversal)	-0.85	-54.80	-55.81		53.95
n66 CP-OFDM	CH.345000 1725 MHz	40 MHz	16QAM	108/54	z(Axial)	13.83	-49.01	-55.51		62.84
					y(Transversal)	-0.85	-54.63	-55.81		53.78
n66 CP-OFDM	CH.345000 1725 MHz	40 MHz	16QAM	108/108	z(Axial)	13.83	-48.52	-55.51		62.35
					y(Transversal)	-0.85	-54.67	-55.81		53.82
n66 CP-OFDM	CH.345000 1725 MHz	40 MHz	16QAM	216/0	z(Axial)	13.83	-48.50	-55.51		62.33
					y(Transversal)	-0.85	-54.65	-55.81		53.8
n66 CP-OFDM	CH.345000 1725 MHz	40 MHz	64QAM	1/1	z(Axial)	13.83	-44.63	-55.51		58.46
					y(Transversal)	-0.85	-54.23	-55.81		53.38
n66 CP-OFDM	CH.345000 1725 MHz	40 MHz	64QAM	1/108	z(Axial)	13.83	-44.78	-55.51		58.61
					y(Transversal)	-0.85	-54.24	-55.81		53.39
n66 CP-OFDM	CH.345000 1725 MHz	40 MHz	64QAM	1/214	z(Axial)	13.83	-43.68	-55.51		57.51
					y(Transversal)	-0.85	-54.02	-55.81		53.17
n66 CP-OFDM	CH.345000 1725 MHz	40 MHz	64QAM	108/0	z(Axial)	13.83	-48.76	-55.51		62.59
					y(Transversal)	-0.85	-54.63	-55.81		53.78

Mode:	Ch./ Freq.	BW	BW/ Mode	RB Config.	Orientation	ABM1 dB(A/m)	ABM2 dB(A/m)	Ambient Noise dB(A/m)	Freq. Response (dB)	ABM SNR (dB)
n66 CP-OFDM	CH.345000 1725 MHz	40 MHz	64QAM	108/54	z(Axial)	13.83	-49.06	-55.51		62.89
					y(Transversal)	-0.85	-54.62	-55.81		53.77
n66 CP-OFDM	CH.345000 1725 MHz	40 MHz	64QAM	108/108	z(Axial)	13.83	-49.21	-55.51		63.04
					y(Transversal)	-0.85	-54.68	-55.81		53.83
n66 CP-OFDM	CH.345000 1725 MHz	40 MHz	64QAM	216/0	z(Axial)	13.83	-48.68	-55.51		62.51
					y(Transversal)	-0.85	-54.83	-55.81		53.98
n66 CP-OFDM	CH.345000 1725 MHz	40 MHz	256QAM	1/1	z(Axial)	13.83	-46.92	-55.51		60.75
					y(Transversal)	-0.85	-54.51	-55.81		53.66
n66 CP-OFDM	CH.345000 1725 MHz	40 MHz	256QAM	1/108	z(Axial)	13.83	-47.33	-55.51		61.16
					y(Transversal)	-0.85	-54.38	-55.81		53.53
n66 CP-OFDM	CH.345000 1725 MHz	40 MHz	256QAM	1/214	z(Axial)	13.83	-47.49	-55.51		61.32
					y(Transversal)	-0.85	-54.53	-55.81		53.68
n66 CP-OFDM	CH.345000 1725 MHz	40 MHz	256QAM	108/0	z(Axial)	13.83	-49.06	-55.51		62.89
					y(Transversal)	-0.85	-54.76	-55.81		53.91
n66 CP-OFDM	CH.345000 1725 MHz	40 MHz	256QAM	108/54	z(Axial)	13.83	-48.75	-55.51		62.58
					y(Transversal)	-0.85	-54.67	-55.81		53.82
n66 CP-OFDM	CH.345000 1725 MHz	40 MHz	256QAM	108/108	z(Axial)	13.83	-48.84	-55.51		62.67
					y(Transversal)	-0.85	-54.67	-55.81		53.82
n66 CP-OFDM	CH.345000 1725 MHz	40 MHz	256QAM	216/0	z(Axial)	13.83	-49.11	-55.51		62.94
					y(Transversal)	-0.85	-54.77	-55.81		53.92

**NR OTT VoIP SNNR by Radio Configuration (DFT-s-OFDM)**

Mode:	Ch./ Freq.	BW	BW/ Mode	RB Config.	Orientation	ABM1 dB(A/m)	ABM2 dB(A/m)	Ambient Noise dB(A/m)	Freq. Response (dB)	ABM SNR (dB)
N66 DFTs-OFDM	CH.3450000 1725 MHz	40 MHz	BPSK	1/1	z(Axial)	13.83	-44.80	-55.51		58.63
					y(Transversal)	-0.85	-53.77	-55.81		52.92
N66 DFTs-OFDM	CH.3450000 1725 MHz	40 MHz	BPSK	1/108	z(Axial)	13.83	-44.40	-55.51		58.23
					y(Transversal)	-0.85	-53.78	-55.81		52.93
N66 DFTs-OFDM	CH.3450000 1725 MHz	40 MHz	BPSK	1/214	z(Axial)	13.83	-41.69	-55.51		55.52
					y(Transversal)	-0.85	-53.46	-55.81		52.61
N66 DFTs-OFDM	CH.3450000 1725 MHz	40 MHz	BPSK	108/0	z(Axial)	13.83	-48.51	-55.51		62.34
					y(Transversal)	-0.85	-54.73	-55.81		53.88
N66 DFTs-OFDM	CH.3450000 1725 MHz	40 MHz	BPSK	108/54	z(Axial)	13.83	-47.67	-55.51		61.5
					y(Transversal)	-0.85	-54.79	-55.81		53.94
N66 DFTs-OFDM	CH.3450000 1725 MHz	40 MHz	BPSK	108/108	z(Axial)	13.83	-48.12	-55.51		61.95
					y(Transversal)	-0.85	-54.93	-55.81		54.08
N66 DFTs-OFDM	CH.3450000 1725 MHz	40 MHz	BPSK	216/0	z(Axial)	13.83	-47.95	-55.51		61.78
					y(Transversal)	-0.85	-54.64	-55.81		53.79
N66 DFTs-OFDM	CH.3450000 1725 MHz	40 MHz	QPSK	1/1	z(Axial)	13.83	-48.38	-55.15		62.21
					y(Transversal)	-0.85	-54.44	-55.78		53.59
N66 DFTs-OFDM	CH.3450000 1725 MHz	40 MHz	QPSK	1/108	z(Axial)	13.83	-46.73	-55.15		60.56
					y(Transversal)	-0.85	-53.21	-55.78		52.36
N66 DFTs-OFDM	CH.3450000 1725 MHz	40 MHz	QPSK	1/214	z(Axial)	13.83	-48.23	-55.15		62.06
					y(Transversal)	-0.85	-54.22	-55.78		53.37
N66 DFTs-OFDM	CH.3450000 1725 MHz	40 MHz	QPSK	108/0	z(Axial)	13.83	-49.20	-55.15		63.03
					y(Transversal)	-0.85	-54.83	-55.78		53.98
N66 DFTs-OFDM	CH.3450000 1725 MHz	40 MHz	QPSK	108/54	z(Axial)	13.83	-48.75	-55.15		62.58
					y(Transversal)	-0.85	-54.75	-55.78		53.9
N66 DFTs-OFDM	CH.3450000 1725 MHz	40 MHz	QPSK	108/108	z(Axial)	13.83	-48.22	-55.15		62.05
					y(Transversal)	-0.85	-54.68	-55.78		53.83
N66 DFTs-OFDM	CH.3450000 1725 MHz	40 MHz	QPSK	216/0	z(Axial)	13.83	-48.12	-55.15		61.95
					y(Transversal)	-0.85	-54.61	-55.78		53.76
N66 DFTs-OFDM	CH.3450000 1725 MHz	40 MHz	16QAM	1/1	z(Axial)	13.83	-51.28	-55.15		65.11
					y(Transversal)	-0.85	-55.50	-55.78		54.65
N66 DFTs-OFDM	CH.3450000 1725 MHz	40 MHz	16QAM	1/108	z(Axial)	13.83	-51.75	-55.15		65.58
					y(Transversal)	-0.85	-55.45	-55.78		54.6
N66 DFTs-OFDM	CH.3450000 1725 MHz	40 MHz	16QAM	1/214	z(Axial)	13.83	-50.89	-55.15		64.72
					y(Transversal)	-0.85	-55.41	-55.78		54.56

N66 DFTs-OFDM	CH.3450000 1725 MHz	40 MHz	16QAM	108/0	z(Axial)	13.83	-50.49	-55.15		64.32
					y(Transversal)	-0.85	-55.39	-55.78		54.54
N66 DFTs-OFDM	CH.3450000 1725 MHz	40 MHz	16QAM	108/54	z(Axial)	13.83	-50.86	-55.15		64.69
					y(Transversal)	-0.85	-55.17	-55.78		54.32
N66 DFTs-OFDM	CH.3450000 1725 MHz	40 MHz	16QAM	108/10 8	z(Axial)	13.83	-50.48	-55.15		64.31
					y(Transversal)	-0.85	-55.03	-55.78		54.18
N66 DFTs-OFDM	CH.3450000 1725 MHz	40 MHz	16QAM	216/0	z(Axial)	13.83	-50.28	-55.15		64.11
					y(Transversal)	-0.85	-55.17	-55.78		54.32
N66 DFTs-OFDM	CH.3450000 1725 MHz	40 MHz	64QAM	1/1	z(Axial)	13.83	-50.66	-55.15		64.49
					y(Transversal)	-0.85	-55.18	-55.78		54.33
N66 DFTs-OFDM	CH.3450000 1725 MHz	40 MHz	64QAM	1/108	z(Axial)	13.83	-50.30	-55.15		64.13
					y(Transversal)	-0.85	-55.15	-55.78		54.3
N66 DFTs-OFDM	CH.3450000 1725 MHz	40 MHz	64QAM	1/214	z(Axial)	13.83	-50.65	-55.15		64.48
					y(Transversal)	-0.85	-55.25	-55.78		54.4
N66 DFTs-OFDM	CH.3450000 1725 MHz	40 MHz	64QAM	108/0	z(Axial)	13.83	-50.42	-55.15		64.25
					y(Transversal)	-0.85	-55.22	-55.78		54.37
N66 DFTs-OFDM	CH.3450000 1725 MHz	40 MHz	64QAM	108/54	z(Axial)	13.83	-49.86	-55.15		63.69
					y(Transversal)	-0.85	-55.29	-55.78		54.44
N66 DFTs-OFDM	CH.3450000 1725 MHz	40 MHz	64QAM	108/108	z(Axial)	13.83	-49.99	-55.15		63.82
					y(Transversal)	-0.85	-55.20	-55.78		54.35
N66 DFTs-OFDM	CH.3450000 1725 MHz	40 MHz	64QAM	216/0	z(Axial)	13.83	-50.79	-55.15		64.62
					y(Transversal)	-0.85	-55.17	-55.78		54.32
N66 DFTs-OFDM	CH.3450000 1725 MHz	40 MHz	256QAM	1/1	z(Axial)	13.83	-50.19	-55.15		64.02
					y(Transversal)	-0.85	-55.03	-55.78		54.18
N66 DFTs-OFDM	CH.3450000 1725 MHz	40 MHz	256QAM	1/108	z(Axial)	13.83	-50.31	-55.15		64.14
					y(Transversal)	-0.85	-55.24	-55.78		54.39
N66 DFTs-OFDM	CH.3450000 1725 MHz	40 MHz	256QAM	1/214	z(Axial)	13.83	-50.30	-55.15		64.13
					y(Transversal)	-0.85	-55.29	-55.78		54.44
N66 DFTs-OFDM	CH.3450000 1725 MHz	40 MHz	256QAM	108/0	z(Axial)	13.83	-38.66	-55.51		52.49
					y(Transversal)	-0.85	-54.98	-55.81		54.13
N66 DFTs-OFDM	CH.3450000 1725 MHz	40 MHz	256QAM	108/54	z(Axial)	13.83	-48.64	-55.51		62.47
					y(Transversal)	-0.85	-54.72	-55.81		53.87
N66 DFTs-OFDM	CH.3450000 1725 MHz	40 MHz	256QAM	108/108	z(Axial)	13.83	-48.39	-55.51		62.22
					y(Transversal)	-0.85	-54.84	-55.81		53.99
N66 DFTs-OFDM	CH.3450000 1725 MHz	40 MHz	256QAM	216/0	z(Axial)	13.83	-47.58	-55.51		61.41
					y(Transversal)	-0.85	-54.74	-55.81		53.89



An investigation was performed to determine the worst-case NR band to be used for OTT VoIP testing. NR n71 was used for the testing as the worst-case configuration for the handset. See below table for SNNR comparison between different NR bands

### 12.9.1 Interim Procedure for evaluation OTT VoIP(NR)

The following procedure is used to evaluate OTT VoIP (NR) given equipment limitations.

- a. This procedure is applicable for OTT VoIP (NR) voice calls that use the same protocol, codec(s), and reference level as OTT VoIP (LTE) (i.e. -20dBm0).
- b. Establish the ABM1NR value by using the ABM1LTE magnetic intensity for an LTE call using a correlating LTE band through existing procedures and test equipment.
- c. Establish an ABM2NR value using factory test mode (FTM) to simulate a NR connection for the desired NR band and channel under test.
- d. The following information is documented in Section 9:
  1. ABM2LTE and ABM2NR for respective tests.
  2. Calculate SNNR:
    - i.  $ABM1 = ABM1LTE$
    - ii.  $ABM2 = ABM2NR$
    - iii.  $SNNRNR = [ABM1LTE - ABM2NR] - 3dB$
  - A 3dB margin is built in to ensure conservative results with this interim procedure.

The above is only applicable for OTT VoIP scenarios, this device does not support VoNR over IMS.

The manufacturer has confirmed the handset as designed is expected to exhibit similar audio intensity levels between an OTT VoIP call placed over a 4G LTE and a 5G Sub-6GHz data connection.

**OTT VoIP (NR) SNNR by Band**

Mode:	Ch./ Freq.	BW	BW/ Mode	RB Config.	Orientation	ABM1 dB(A/m)	ABM2 dB(A/m)	Ambient Noise dB(A/m)	Freq. Response (dB)	ABM SNR (dB)	ABM SNRNR -3dB(dB)	T-Rating	Plot No.
n2 CP-OFDM	CH.376000 1880 MHz	20 MHz	16QAM	1/104	z(Axial)	11.99	-42.09	-55.51		54.08	51.08	T4	166
					y(Transversal)	4.52	-52.78	-55.81		57.30	54.3	T4	167
n5 CP-OFDM	CH.167300 836.5 MHz	20 MHz	16QAM	1/104	z(Axial)	12.97	-46.81	-55.51		59.78	56.78	T4	168
					y(Transversal)	4.78	-52.77	-55.81		57.55	54.55	T4	169
n12 CP-OFDM	CH.141500 707.5 MHz	15 MHz	16QAM	1/77	z(Axial)	12.62	-48.43	-55.51		61.05	58.05	T4	170
					y(Transversal)	2.4	-50.80	-55.81		53.20	50.2	T4	171
n25 CP-OFDM	CH.376500 1882.5 MHz	40 MHz	16QAM	1/214	z(Axial)	11.99	-42.74	-55.51		54.73	51.73	T4	172
					y(Transversal)	4.52	-52.31	-55.81		56.83	53.83	T4	173
n30 CP-OFDM	CH.462000 2310 MHz	10 MHz	16QAM	1/50	z(Axial)	13.04	-45.12	-55.51		58.16	55.16	T4	174
					y(Transversal)	-0.60	-53.73	-55.81		53.13	50.13	T4	175
n66 CP-OFDM	CH.349000 1745 MHz	40 MHz	16QAM	1/214	z(Axial)	13.83	-37.31	-55.51		51.14	48.14	T4	176
					y(Transversal)	-0.85	-47.40	-55.81		<b>46.55</b>	<b>43.55</b>	T4	177
n71 CP-OFDM	CH.136100 680.5 MHz	20 MHz	16QAM	1/104	z(Axial)	12.79	-48.46	-55.51		61.25	58.25	T4	178
					y(Transversal)	4.27	-48.22	-55.81		52.49	49.49	T4	179

**Raw Data Results for NR n66 (OTT VoIP)**

Mode:	Ch./ Freq.	BW	BW/ Mode	RB Config.	Orientation	ABM1 dB(A/m)	ABM2 dB(A/m)	Ambient Noise dB(A/m)	Freq. Response (dB)	ABM SNR (dB)	ABM SNRNR -3dB(dB)	T-Rating	Plot No.
N66 CP-OFDM	CH.349000 1745 MHz	20 MHz	16QAM	1/104	z(Axial)	13.83	-40.32	-55.51		54.15	51.15	T4	180
					y(Transversal)	-0.85	-52.41	-55.81		51.56	48.56	T4	181
N66 CP-OFDM	CH.349000 1745 MHz	15 MHz	16QAM	1/77	z(Axial)	13.83	-40.72	-55.51		54.55	51.55	T4	182
					y(Transversal)	-0.85	-52.33	-55.81		<b>51.48</b>	<b>48.48</b>	T4	183
N66 CP-OFDM	CH.349000 1745 MHz	10 MHz	16QAM	1/50	z(Axial)	13.83	-44.17	-55.51		58.00	55.00	T4	184
					y(Transversal)	-0.85	-54.18	-55.81		53.33	50.33	T4	185
N66 CP-OFDM	CH.349000 1745 MHz	5 MHz	16QAM	1/23	z(Axial)	13.83	-44.11	-55.51		57.94	54.94	T4	186
					y(Transversal)	-0.85	-54.19	-55.81		53.34	50.34	T4	187
N66 CP-OFDM	CH.349000 1745 MHz	30 MHz	16QAM	1/158	z(Axial)	13.83	-40.20	-55.51		53.85	50.85	T4	188
					y(Transversal)	-0.85	-52.90	-55.81		52.05	49.05	T4	189
N66 CP-OFDM	CH.349000 1745 MHz	40 MHz	16QAM	1/214	z(Axial)	13.83	-44.26	-55.51		58.09	55.09	T4	190
					y(Transversal)	-0.85	-54.25	-55.81		53.40	50.40	T4	191
N66 CP-OFDM	CH.343500 1717.5 MHz	15 MHz	16QAM	1/77	z(Axial)	13.83	-41.09	-55.51		54.92	51.92	T4	192
					y(Transversal)	-0.85	-52.41	-55.81		51.56	48.56	T4	193
N66 CP-OFDM	CH.354500 1772.5 MHz	15 MHz	16QAM	1/77	z(Axial)	13.83	-42.52	-55.51		56.35	53.35	T4	194
					y(Transversal)	-0.85	-53.10	-55.81		52.25	49.25	T4	195

**Raw Data Results for NR n41 (OTT VoIP)**

Mode:	Ch./ Freq.	BW	BW/ Mode	RB Config.	Orientation	ABM1 dB(A/m)	ABM2 dB(A/m)	Ambient Noise dB(A/m)	Freq. Response (dB)	ABM SNR (dB)	ABM SNRNR -3dB(dB)	T-Rating	Plot No.
n41 CP-OFDM	CH.518598 2592.99 MHz	20 MHz	16QAM	1/49	z(Axial)	13.97	-46.44	-55.39		60.41	57.41	T4	196
					y(Transversal)	2.12	-53.44	-55.77		55.56	52.56	T4	197
n41 CP-OFDM	CH.518598 2592.99 MHz	40 MHz	16QAM	1/104	z(Axial)	13.97	-45.89	-55.39		59.86	56.86	T4	198
					y(Transversal)	2.12	-53.16	-55.77		55.28	52.28	T4	199
n41 CP-OFDM	CH.518598 2592.99 MHz	50 MHz	16QAM	1/131	z(Axial)	13.97	-45.30	-55.39		59.27	56.27	T4	200
					y(Transversal)	2.12	-53.27	-55.77		55.39	52.39	T4	201
n41 CP-OFDM	CH.518598 2592.99 MHz	60 MHz	16QAM	1/160	z(Axial)	13.97	-46.96	-55.39		60.93	57.93	T4	202
					y(Transversal)	2.12	-53.01	-55.77		55.13	52.13	T4	203
n41 CP-OFDM	CH.518598 2592.99 MHz	80 MHz	16QAM	1/215	z(Axial)	13.97	-45.64	-55.39		59.61	56.61	T4	204
					y(Transversal)	2.12	-52.62	-55.77		54.74	51.74	T4	205
n41 CP-OFDM	CH.518598 2592.99 MHz	90 MHz	16QAM	1/243	z(Axial)	13.97	-46.50	-55.39		60.47	57.47	T4	206
					y(Transversal)	2.12	-52.95	-55.77		55.07	52.07	T4	207
n41 CP-OFDM	CH.518598 2592.99 MHz	100 MHz	16QAM	1/271	z(Axial)	13.97	-44.43	-55.39		58.4	55.4	T4	208
					y(Transversal)	2.12	-51.54	-55.77		53.66	50.66	T4	209
n77 CP-OFDM	CH.656000 3840 MHz	100 MHz	16QAM	1/271	z(Axial)	13.77	-48.81	-55.39		62.58	59.58	T4	212
					y(Transversal)	1.94	-52.18	-55.77		54.12	51.12	T4	213
n41 CP-OFDM	CH.509202 2546.01 MHz	100 MHz	16QAM	1/271	z(Axial)	13.97	-45.79	-55.39		59.76	56.76	T4	214
					y(Transversal)	2.12	-52.22	-55.77		54.34	51.34	T4	215
n41 CP-OFDM	CH.513900 2569.5 MHz	100 MHz	16QAM	1/271	z(Axial)	13.97	-46.84	-55.39		60.81	57.81	T4	216
					y(Transversal)	2.12	-53.13	-55.77		55.25	52.25	T4	217
n41 CP-OFDM	CH.523302 2616.51 MHz	100 MHz	16QAM	1/271	z(Axial)	13.97	-47.10	-55.39		61.07	58.07	T4	218
					y(Transversal)	2.12	-52.96	-55.77		55.08	52.08	T4	219
n41 CP-OFDM	CH.528000 2640 MHz	100 MHz	16QAM	1/271	z(Axial)	13.97	-46.97	-55.39		60.94	57.94	T4	220
					y(Transversal)	2.12	-53.04	-55.77		55.16	52.16	T4	221

## Attachment 1. HAC T-COIL Test Plots

**Plot No.1**

**GSM850 FR V1 190ch z(axial)**

**DUT: SM-G991U; Type: Bar**

Communication System: UID 0, GSM 850 (0); Frequency: 836.6 MHz;Duty Cycle: 1:8.30042  
 Medium parameters used:  $\sigma = 0$  S/m,  $\epsilon_r = 1$ ;  $\rho = 0$  kg/m<sup>3</sup>  
 Phantom section: TCoil Section

DASY Configuration:

- Probe: AM1DV2 - 1013; ;
- Sensor-Surface: 0mm (Fix Surface)
- Electronics: DAE4 Sn1629; Calibrated: 2020-08-11
- Phantom: HAC Test Arch with AMCC
- Measurement SW: DASY52, Version 52.10 (4);

**T-Coil scan (scan for ANSI C63.19-2007 & 2011 compliance)/General Scans/z (axial) 4.2mm 50 x**

**50/ABM Signal(x,y,z) (13x13x1):** Measurement grid: dx=10mm, dy=10mm

Signal Type: Audio File (.wav) 48k\_voice\_1kHz\_1s.wav

Output Gain: 24.32

Measure Window Start: 300ms

Measure Window Length: 1000ms

BWC applied: 0.12 dB

Device Reference Point: 0, 0, -6.3 mm

**Cursor:**

ABM1 comp = 2.44 dBA/m

BWC Factor = 0.12 dB

Location: 8.3, -12.5, 3.7 mm

**Cursor:**

ABM2 = -24.27 dBA/m

Location: 8.3, -12.5, 3.7 mm

**Cursor:**

ABM1/ABM2 = 26.71 dB

ABM1 comp = 2.44 dBA/m

BWC Factor = 0.12 dB

Location: 8.3, -12.5, 3.7 mm

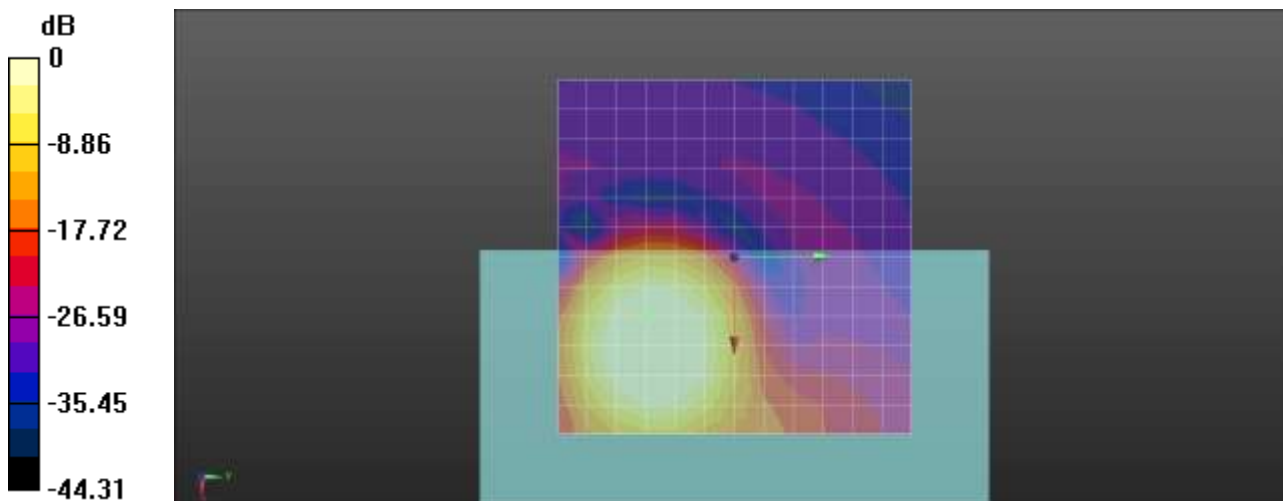

0 dB = 1.000 A/m = 0.00 dBA/m

**Plot No.2**

**GSM850 190ch FR V1 190ch Freq. Response**

**DUT: SM-G991U; Type: Bar**

Communication System: UID 0, GSM 850 (0); Frequency: 836.6 MHz;Duty Cycle: 1:8.30042  
 Medium parameters used:  $\sigma = 0$  S/m,  $\epsilon_r = 1$ ;  $\rho = 0$  kg/m<sup>3</sup>  
 Phantom section: TCoil Section

**T-Coil scan (scan for ANSI C63.19-2007 & 2011 compliance)/General Scans/z (axial) wideband at best S/N/ABM Freq Resp(x,y,z,f) (1x1x1):** Measurement grid: dx=10mm, dy=10mm  
 Signal Type: Audio File (.wav) 48k\_Normal\_51s new.wav  
 Output Gain: 52.17  
 Measure Window Start: 300ms  
 Measure Window Length: 51000ms  
 BWC applied: 9.44 dB  
 Device Reference Point: 0, 0, -6.3 mm

Category	Telephone parameters WD signal quality [(signal+noise)-to-noise ratio in decibels]
Category T1	0 dB to 10 dB
Category T2	10 dB to 20 dB
Category T3	20 dB to 30 dB
Category T4	> 30 dB

**Cursor:**

Diff = 2.00 dB  
 BWC Factor = 9.44 dB  
 Location: 8.3, -12.4, 3.7 mm

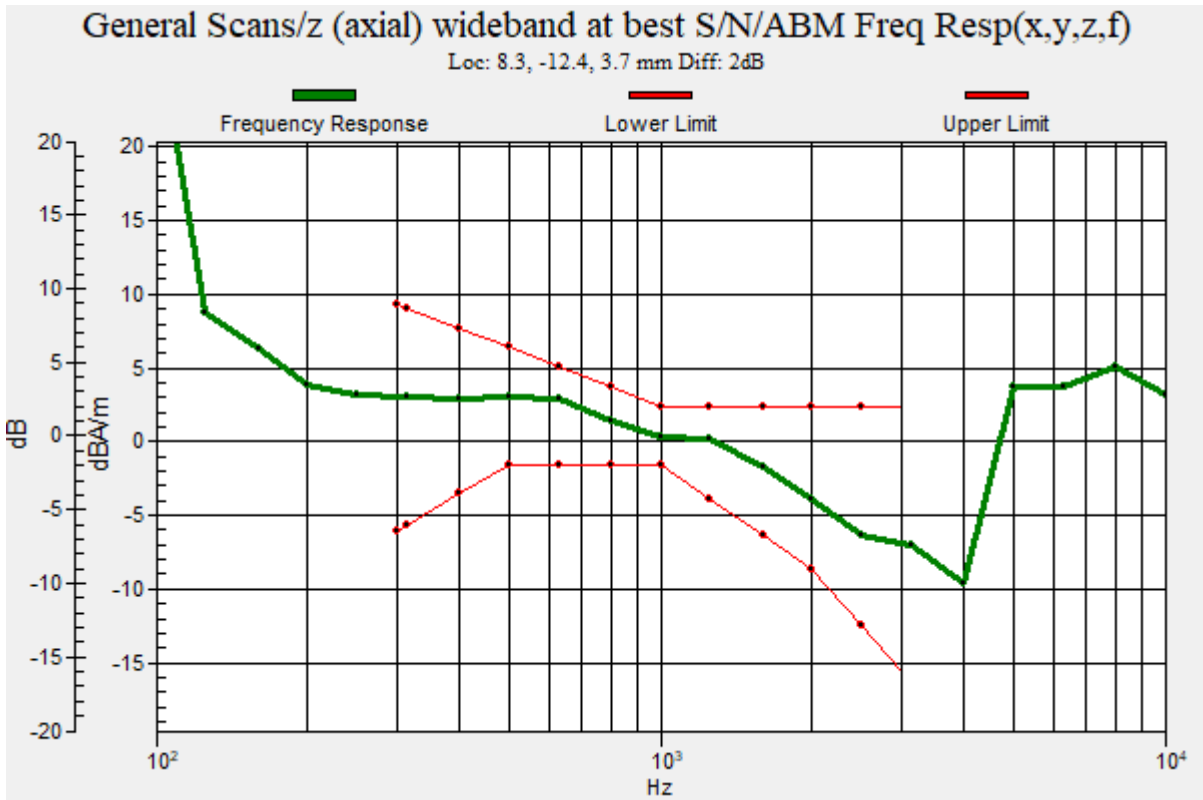

**Plot No.3**

**GSM850 190ch FR V1 190ch y(transversal)**

**DUT: SM-G991U; Type: Bar**

Communication System: UID 0, GSM 850 (0); Frequency: 836.6 MHz;Duty Cycle: 1:8.30042  
Medium parameters used:  $\sigma = 0$  S/m,  $\epsilon_r = 1$ ;  $\rho = 0$  kg/m<sup>3</sup>  
Phantom section: TCoil Section

DASY Configuration:

- Probe: AM1DV2 - 1013; ;
- Sensor-Surface: 0mm (Fix Surface)
- Electronics: DAE4 Sn1629; Calibrated: 2020-08-11
- Phantom: HAC Test Arch with AMCC
- Measurement SW: DASY52, Version 52.10 (4);

**T-Coil scan (scan for ANSI C63.19-2007 & 2011 compliance)/General Scans/y (transversal) 4.2mm 50**

**x 50/ABM Signal(x,y,z) (13x13x1):** Measurement grid: dx=10mm, dy=10mm

Signal Type: Audio File (.wav) 48k\_voice\_1kHz\_1s.wav

Output Gain: 24.32

Measure Window Start: 300ms

Measure Window Length: 1000ms

BWC applied: 0.12 dB

Device Reference Point: 0, 0, -6.3 mm

**Cursor:**

ABM1 comp = -5.42 dBA/m

BWC Factor = 0.12 dB

Location: 8.3, -20.8, 3.7 mm

**Cursor:**

ABM2 = -36.32 dBA/m

Location: 8.3, -20.8, 3.7 mm

**Cursor:**

ABM1/ABM2 = 30.90 dB

ABM1 comp = -5.42 dBA/m

BWC Factor = 0.12 dB

Location: 8.3, -20.8, 3.7 mm

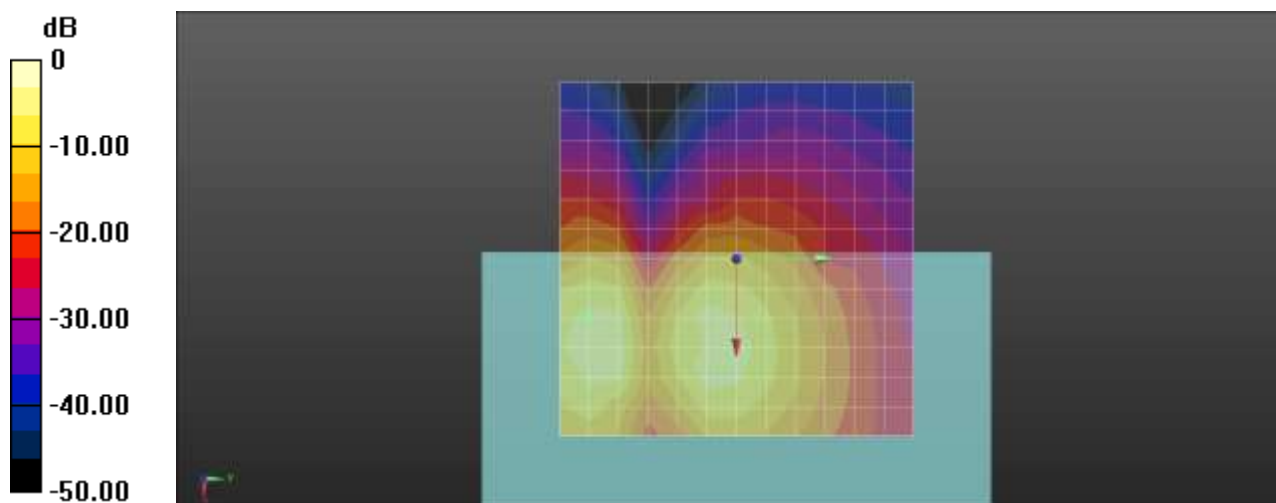

0 dB = 1.000 A/m = 0.00 dBA/m



**Plot No.4**

**GSM1900 FR V1 661ch z(axial)**

**DUT: SM-G991U; Type: Bar**

Communication System: UID 0, GSM 1900 (0); Frequency: 1880 MHz;Duty Cycle: 1:8.30042  
 Medium parameters used:  $\sigma = 0$  S/m,  $\epsilon_r = 1$ ;  $\rho = 0$  kg/m<sup>3</sup>  
 Phantom section: TCoil Section

DASY Configuration:

- Probe: AM1DV2 - 1013; ;
- Sensor-Surface: 0mm (Fix Surface)
- Electronics: DAE4 Sn1629; Calibrated: 2020-08-11
- Phantom: HAC Test Arch with AMCC
- Measurement SW: DASY52, Version 52.10 (4);

**T-Coil scan (scan for ANSI C63.19-2007 & 2011 compliance)/General Scans/z (axial) 4.2mm 50 x**

**50/ABM Signal(x,y,z) (13x13x1):** Measurement grid: dx=10mm, dy=10mm

Signal Type: Audio File (.wav) 48k\_voice\_1kHz\_1s.wav

Output Gain: 24.32

Measure Window Start: 300ms

Measure Window Length: 1000ms

BWC applied: 0.11 dB

Device Reference Point: 0, 0, -6.3 mm

**Cursor:**

ABM1 comp = 2.55 dBA/m

BWC Factor = 0.11 dB

Location: 8.3, -12.5, 3.7 mm

**Cursor:**

ABM2 = -26.51 dBA/m

Location: 8.3, -12.5, 3.7 mm

**Cursor:**

ABM1/ABM2 = 29.05 dB

ABM1 comp = 2.55 dBA/m

BWC Factor = 0.11 dB

Location: 8.3, -12.5, 3.7 mm

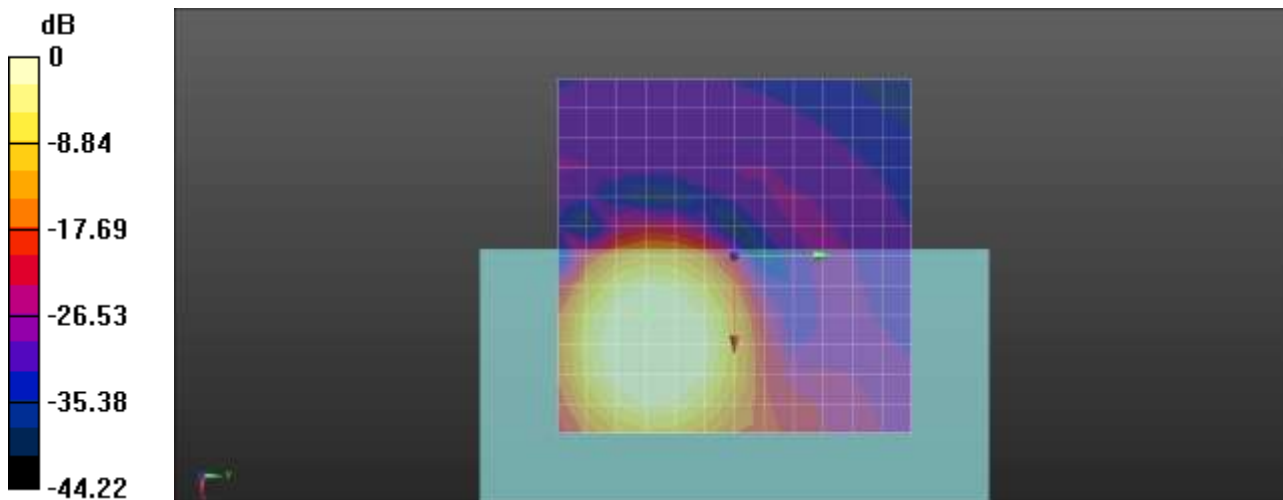

0 dB = 1.000 A/m = 0.00 dBA/m

**Plot No.5**

**GSM1900 FR V1 661ch Freq. Response**

**DUT: SM-G991U; Type: Bar**

Communication System: UID 0, GSM 1900 (0); Frequency: 1880 MHz;Duty Cycle: 1:8.30042  
 Medium parameters used:  $\sigma = 0$  S/m,  $\epsilon_r = 1$ ;  $\rho = 0$  kg/m<sup>3</sup>  
 Phantom section: TCoil Section

**T-Coil scan (scan for ANSI C63.19-2007 & 2011 compliance)/General Scans/z (axial) wideband at best S/N/ABM Freq Resp(x,y,z,f) (1x1x1):** Measurement grid: dx=10mm, dy=10mm  
 Signal Type: Audio File (.wav) 48k\_Normal\_51s new.wav  
 Output Gain: 52.17  
 Measure Window Start: 300ms  
 Measure Window Length: 51000ms  
 BWC applied: 9.43 dB  
 Device Reference Point: 0, 0, -6.3 mm

Category	Telephone parameters WD signal quality [(signal+noise)-to-noise ratio in decibels]
Category T1	0 dB to 10 dB
Category T2	10 dB to 20 dB
Category T3	20 dB to 30 dB
Category T4	> 30 dB

**Cursor:**

Diff = 2.00 dB  
 BWC Factor = 9.43 dB  
 Location: 8.4, -12.2, 3.7 mm

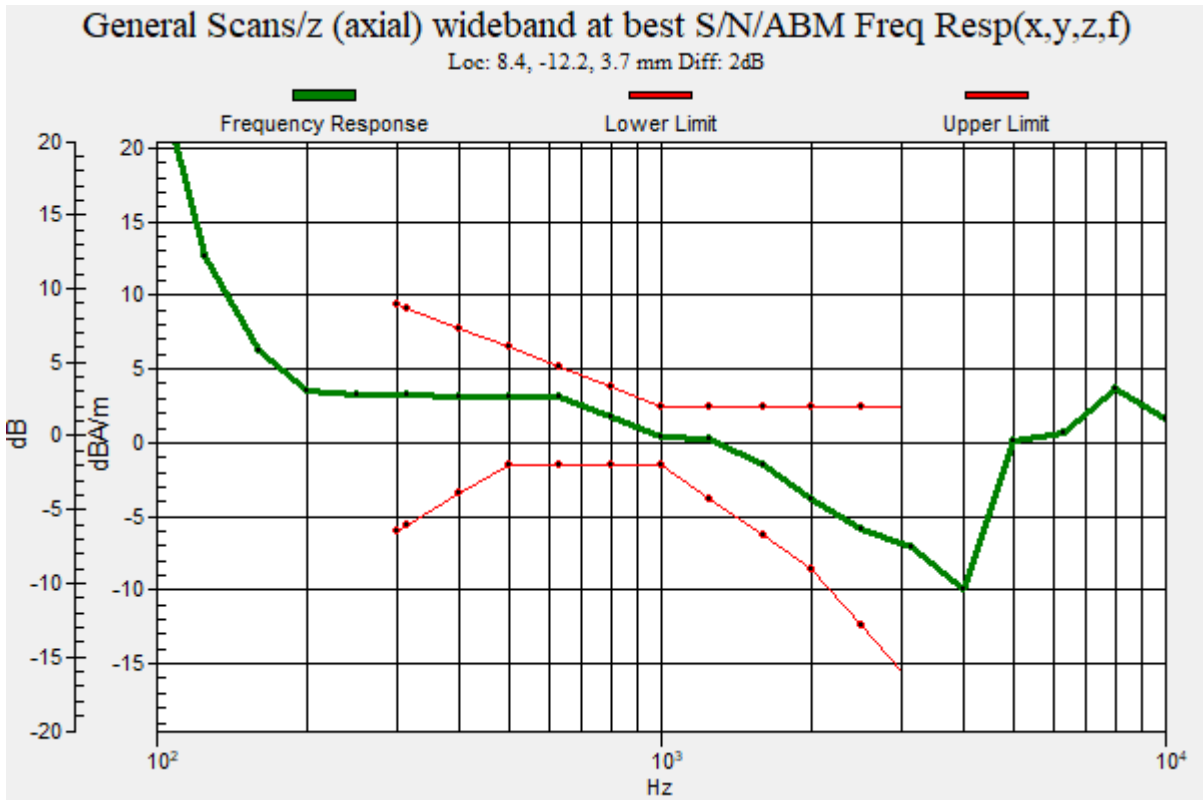

**Plot No.6**

**GSM1900 FR V1 661ch y(transversal)**

**DUT: SM-G991U; Type: Bar**

Communication System: UID 0, GSM 1900 (0); Frequency: 1880 MHz;Duty Cycle: 1:8.30042  
Medium parameters used:  $\sigma = 0$  S/m,  $\epsilon_r = 1$ ;  $\rho = 0$  kg/m<sup>3</sup>  
Phantom section: TCoil Section

DASY Configuration:

- Probe: AM1DV2 - 1013; ;
- Sensor-Surface: 0mm (Fix Surface)
- Electronics: DAE4 Sn1629; Calibrated: 2020-08-11
- Phantom: HAC Test Arch with AMCC
- Measurement SW: DASY52, Version 52.10 (4);

**T-Coil scan (scan for ANSI C63.19-2007 & 2011 compliance)/General Scans/y (transversal) 4.2mm 50**

**x 50/ABM Signal(x,y,z) (13x13x1):** Measurement grid: dx=10mm, dy=10mm

Signal Type: Audio File (.wav) 48k\_voice\_1kHz\_1s.wav

Output Gain: 24.32

Measure Window Start: 300ms

Measure Window Length: 1000ms

BWC applied: 0.11 dB

Device Reference Point: 0, 0, -6.3 mm

**Cursor:**

ABM1 comp = -5.42 dBA/m

BWC Factor = 0.11 dB

Location: 8.3, -20.8, 3.7 mm

**Cursor:**

ABM2 = -36.64 dBA/m

Location: 8.3, -20.8, 3.7 mm

**Cursor:**

ABM1/ABM2 = 31.22 dB

ABM1 comp = -5.42 dBA/m

BWC Factor = 0.11 dB

Location: 8.3, -20.8, 3.7 mm

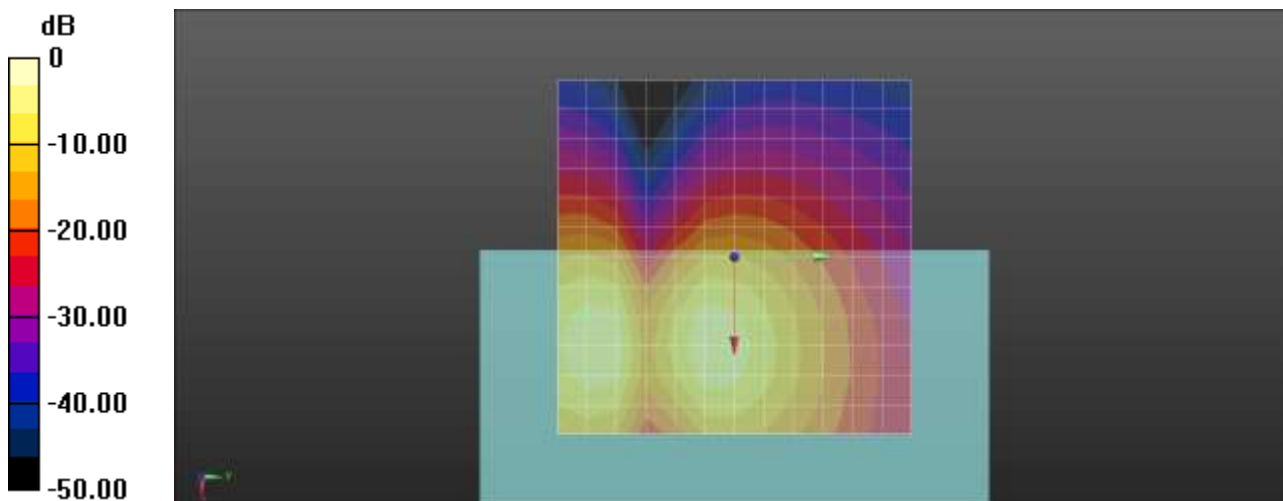

0 dB = 1.000 A/m = 0.00 dBA/m

**Plot No.7**

**WCDMA Band 2 9262ch AMR WB 6\_6 z(axial)**

**DUT: SM-G991U; Type: Bar**

Communication System: UID 0, WCDMA1900 (0); Frequency: 1852.4 MHz;Duty Cycle: 1:1  
Medium parameters used:  $\sigma = 0$  S/m,  $\epsilon_r = 1$ ;  $\rho = 0$  kg/m<sup>3</sup>  
Phantom section: TCoil Section

DASY Configuration:

- Probe: AM1DV3 - 3049; ;
- Sensor-Surface: 0mm (Fix Surface)
- Electronics: DAE4 Sn466; Calibrated: 2020-04-22
- Phantom: HAC Test Arch with AMCC
- Measurement SW: DASY52, Version 52.10 (4);

**T-Coil scan (scan for ANSI C63.19-2007 & 2011 compliance)/General Scans/z (axial) 4.2mm 50 x**

**50/ABM Signal(x,y,z) (13x13x1):** Measurement grid: dx=10mm, dy=10mm

Signal Type: Audio File (.wav) 48k\_voice\_1kHz\_1s.wav

Output Gain: 24.74

Measure Window Start: 300ms

Measure Window Length: 1000ms

BWC applied: 0.16 dB

Device Reference Point: 0, 0, -6.3 mm

**Cursor:**

ABM1 comp = -6.80 dBA/m

BWC Factor = 0.16 dB

Location: 0, -12.5, 3.7 mm

**Cursor:**

ABM2 = -38.16 dBA/m

Location: 0, -12.5, 3.7 mm

**Cursor:**

ABM1/ABM2 = 31.36 dB

ABM1 comp = -6.80 dBA/m

BWC Factor = 0.16 dB

Location: 0, -12.5, 3.7 mm

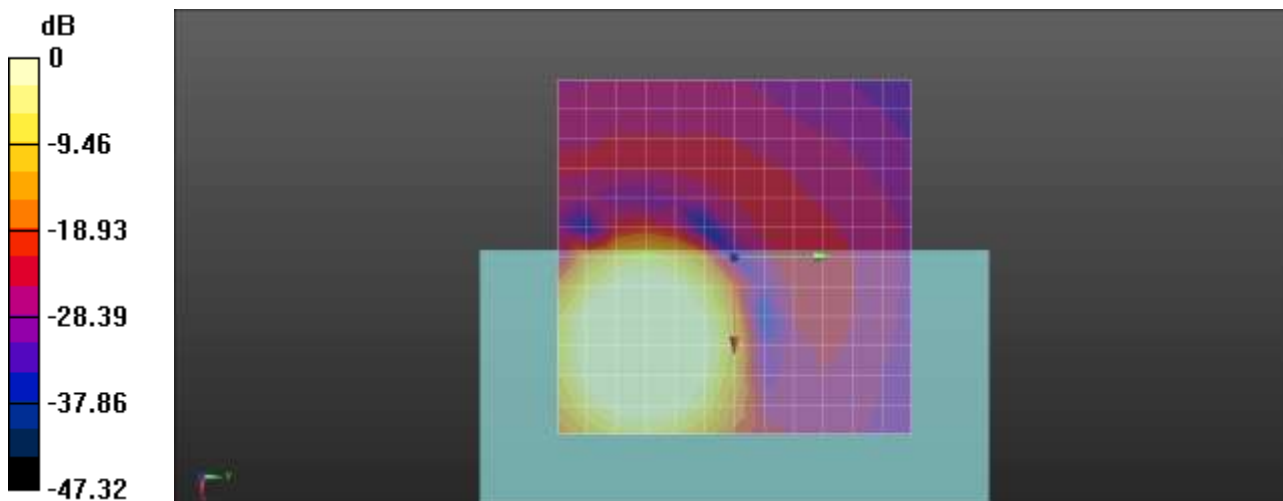

0 dB = 1.000 A/m = 0.00 dBA/m

**Plot No.8**

**WCDMA Band 2 9262ch AMR WB 6\_6 Freq. Response**

**DUT: SM-G991U; Type: Bar**

Communication System: UID 0, WCDMA1900 (0); Frequency: 1852.4 MHz;Duty Cycle: 1:1  
 Medium parameters used:  $\sigma = 0$  S/m,  $\epsilon_r = 1$ ;  $\rho = 0$  kg/m<sup>3</sup>  
 Phantom section: TCoil Section

**T-Coil scan (scan for ANSI C63.19-2007 & 2011 compliance)/General Scans/z (axial) wideband at best**

**S/N/ABM Freq Resp(x,y,z,f) (1x1x1):** Measurement grid: dx=10mm, dy=10mm

Signal Type: Audio File (.wav) 48k\_Normal\_51s new.wav

Output Gain: 53.28

Measure Window Start: 300ms

Measure Window Length: 51000ms

BWC applied: 9.48 dB

Device Reference Point: 0, 0, -6.3 mm

Category	Telephone parameters WD signal quality [(signal+noise)-to-noise ratio in decibels]
Category T1	0 dB to 10 dB
Category T2	10 dB to 20 dB
Category T3	20 dB to 30 dB
Category T4	> 30 dB

**Cursor:**

Diff = 2.00 dB

BWC Factor = 9.48 dB

Location: 1.3, -12.5, 3.7 mm

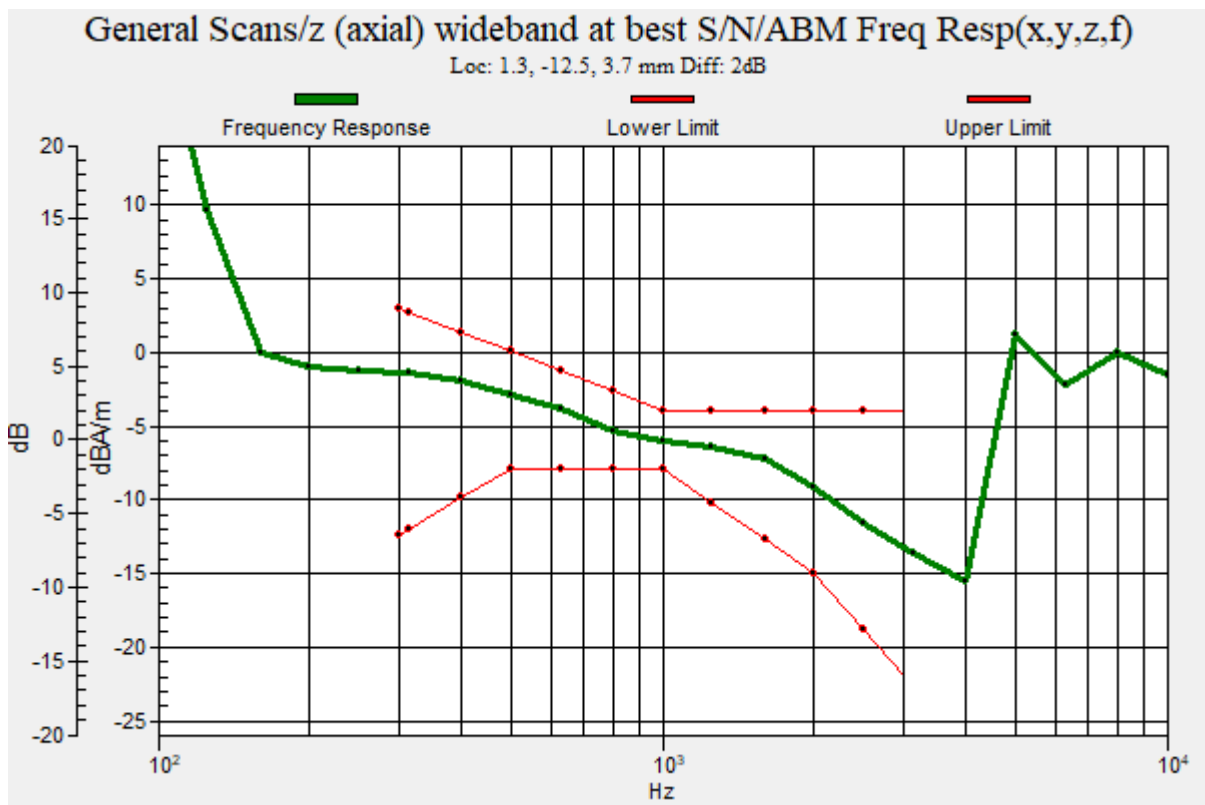

**Plot No.9**

**WCDMA Band 2 9262ch AMR WB 6\_6 y(transversal)**

**DUT: SM-G991U; Type: Bar**

Communication System: UID 0, WCDMA1900 (0); Frequency: 1852.4 MHz;Duty Cycle: 1:1  
 Medium parameters used:  $\sigma = 0$  S/m,  $\epsilon_r = 1$ ;  $\rho = 0$  kg/m<sup>3</sup>  
 Phantom section: TCoil Section

DASY Configuration:

- Probe: AM1DV3 - 3049; ;
- Sensor-Surface: 0mm (Fix Surface)
- Electronics: DAE4 Sn466; Calibrated: 2020-04-22
- Phantom: HAC Test Arch with AMCC
- Measurement SW: DASY52, Version 52.10 (4);

**T-Coil scan (scan for ANSI C63.19-2007 & 2011 compliance)/General Scans/y (transversal) 4.2mm 50**

**x 50/ABM Signal(x,y,z) (13x13x1):** Measurement grid: dx=10mm, dy=10mm

Signal Type: Audio File (.wav) 48k\_voice\_1kHz\_1s.wav

Output Gain: 24.74

Measure Window Start: 300ms

Measure Window Length: 1000ms

BWC applied: 0.16 dB

Device Reference Point: 0, 0, -6.3 mm

**Cursor:**

ABM1 comp = -11.07 dBA/m

BWC Factor = 0.16 dB

Location: 0, -16.7, 3.7 mm

**Cursor:**

ABM2 = -42.46 dBA/m

Location: 0, -16.7, 3.7 mm

**Cursor:**

ABM1/ABM2 = 31.39 dB

ABM1 comp = -11.07 dBA/m

BWC Factor = 0.16 dB

Location: 0, -16.7, 3.7 mm

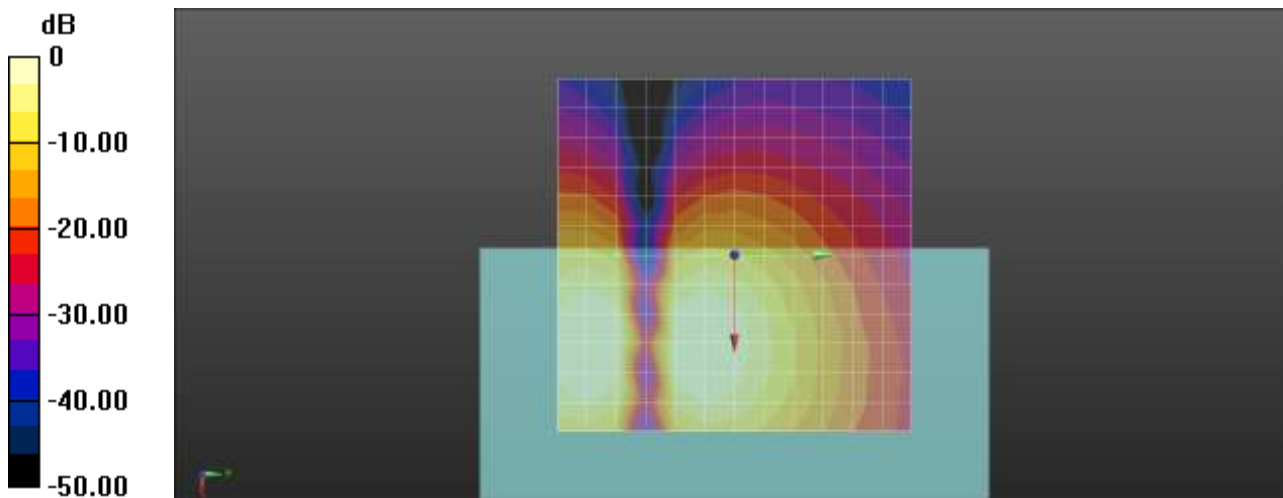

0 dB = 1.000 A/m = 0.00 dBA/m

**Plot No.10**

**WCDMA Band 4 1412ch AMR WB 6\_6 z(axial)**

**DUT: SM-G991U; Type: Bar**

Communication System: UID 0, WCDMA IV (0); Frequency: 1732.4 MHz;Duty Cycle: 1:1  
Medium parameters used:  $\sigma = 0$  S/m,  $\epsilon_r = 1$ ;  $\rho = 0$  kg/m<sup>3</sup>  
Phantom section: TCoil Section

DASY Configuration:

- Probe: AM1DV3 - 3049; ;
- Sensor-Surface: 0mm (Fix Surface)
- Electronics: DAE4 Sn466; Calibrated: 2020-04-22
- Phantom: HAC Test Arch with AMCC
- Measurement SW: DASY52, Version 52.10 (4);

**T-Coil scan (scan for ANSI C63.19-2007 & 2011 compliance)/General Scans/z (axial) 4.2mm 50 x**

**50/ABM Signal(x,y,z) (13x13x1):** Measurement grid: dx=10mm, dy=10mm

Signal Type: Audio File (.wav) 48k\_voice\_1kHz\_1s.wav

Output Gain: 24.74

Measure Window Start: 300ms

Measure Window Length: 1000ms

BWC applied: 0.16 dB

Device Reference Point: 0, 0, -6.3 mm

**Cursor:**

ABM1 comp = -8.39 dBA/m

BWC Factor = 0.16 dB

Location: 0, -8.3, 3.7 mm

**Cursor:**

ABM2 = -39.88 dBA/m

Location: 0, -8.3, 3.7 mm

**Cursor:**

ABM1/ABM2 = 31.49 dB

ABM1 comp = -8.39 dBA/m

BWC Factor = 0.16 dB

Location: 0, -8.3, 3.7 mm

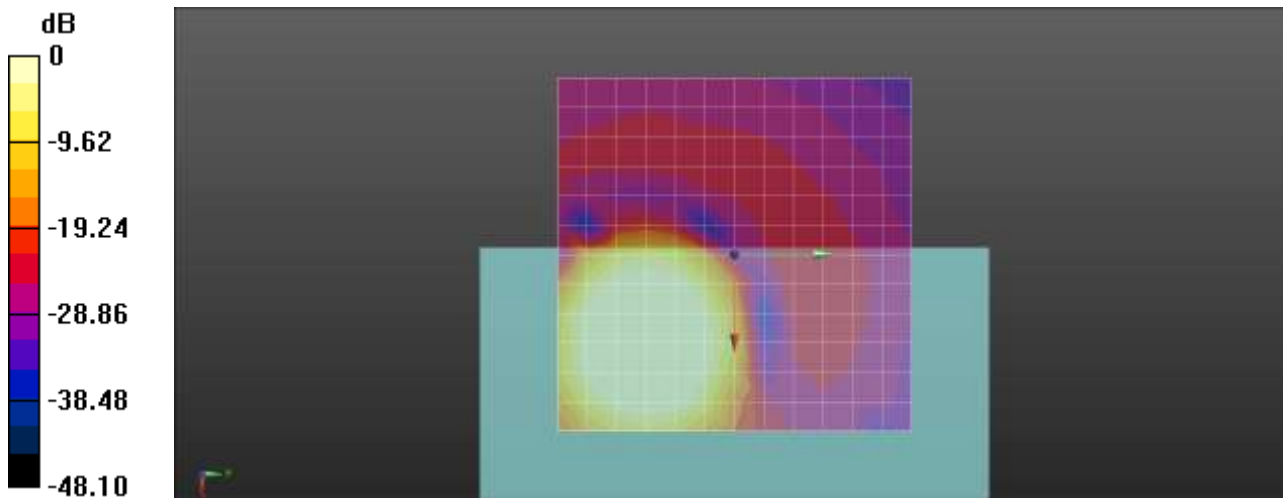

0 dB = 1.000 A/m = 0.00 dBA/m

**Plot No.11**

**WCDMA Band 4 1412ch AMR WB 6\_6 Freq. Response**

**DUT: SM-G991U; Type: Bar**

Communication System: UID 0, WCDMA IV (0); Frequency: 1732.4 MHz;Duty Cycle: 1:1  
 Medium parameters used:  $\sigma = 0$  S/m,  $\epsilon_r = 1$ ;  $\rho = 0$  kg/m<sup>3</sup>  
 Phantom section: TCoil Section

**T-Coil scan (scan for ANSI C63.19-2007 & 2011 compliance)/General Scans/z (axial) wideband at best S/N/ABM Freq Resp(x,y,z,f) (1x1x1):** Measurement grid: dx=10mm, dy=10mm  
 Signal Type: Audio File (.wav) 48k\_Normal\_51s new.wav  
 Output Gain: 53.28  
 Measure Window Start: 300ms  
 Measure Window Length: 51000ms  
 BWC applied: 9.48 dB  
 Device Reference Point: 0, 0, -6.3 mm

Category	Telephone parameters WD signal quality [(signal+noise)-to-noise ratio in decibels]
Category T1	0 dB to 10 dB
Category T2	10 dB to 20 dB
Category T3	20 dB to 30 dB
Category T4	> 30 dB

**Cursor:**

Diff = 2.00 dB  
 BWC Factor = 9.48 dB  
 Location: 1, -7.6, 3.7 mm

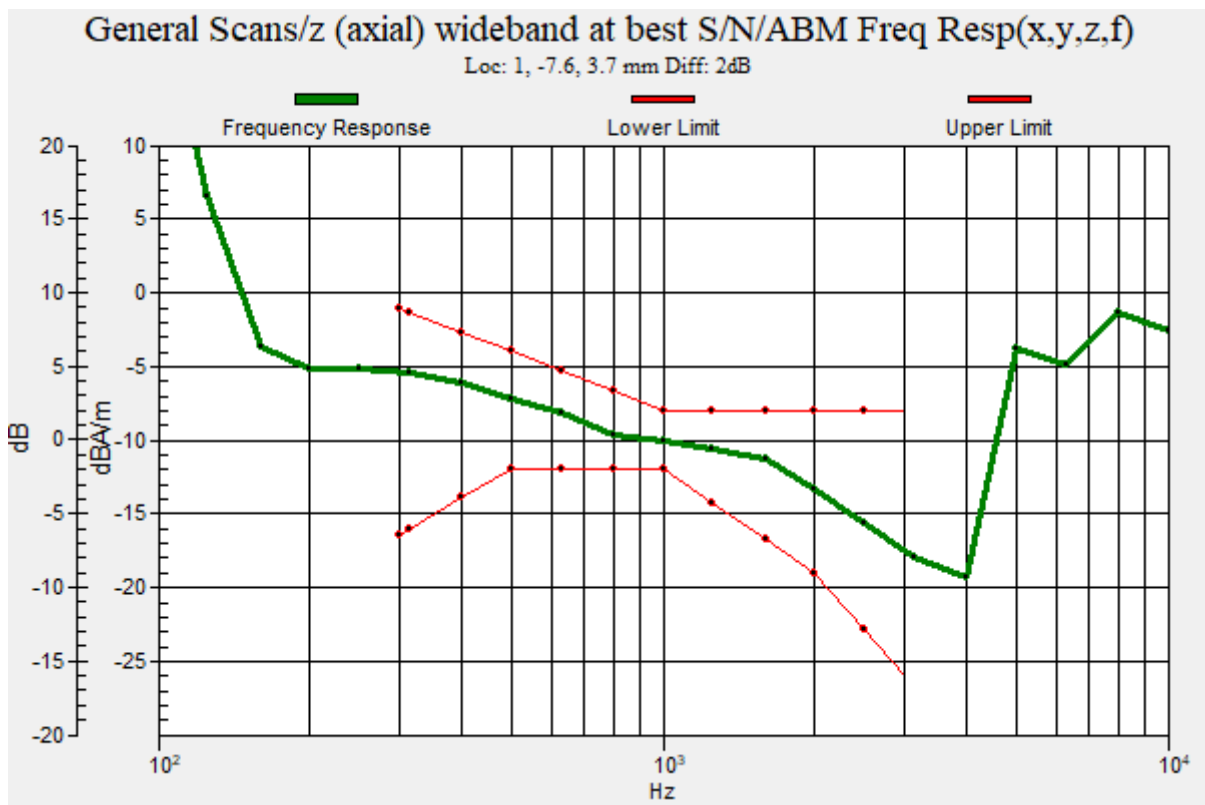



**Plot No.12**

**WCDMA Band 4 1412ch AMR WB 6\_6 y(transversal)**

**DUT: SM-G991U; Type: Bar**

Communication System: UID 0, WCDMA IV (0); Frequency: 1732.4 MHz;Duty Cycle: 1:1  
Medium parameters used:  $\sigma = 0$  S/m,  $\epsilon_r = 1$ ;  $\rho = 0$  kg/m<sup>3</sup>  
Phantom section: TCoil Section

DASY Configuration:

- Probe: AM1DV3 - 3049; ;
- Sensor-Surface: 0mm (Fix Surface)
- Electronics: DAE4 Sn466; Calibrated: 2020-04-22
- Phantom: HAC Test Arch with AMCC
- Measurement SW: DASY52, Version 52.10 (4);

**T-Coil scan (scan for ANSI C63.19-2007 & 2011 compliance)/General Scans/y (transversal) 4.2mm 50**

**x 50/ABM Signal(x,y,z) (13x13x1):** Measurement grid: dx=10mm, dy=10mm

Signal Type: Audio File (.wav) 48k\_voice\_1kHz\_1s.wav

Output Gain: 24.74

Measure Window Start: 300ms

Measure Window Length: 1000ms

BWC applied: 0.16 dB

Device Reference Point: 0, 0, -6.3 mm

**Cursor:**

ABM1 comp = -1.68 dBA/m

BWC Factor = 0.16 dB

Location: 8.3, -16.7, 3.7 mm

**Cursor:**

ABM2 = -33.27 dBA/m

Location: 8.3, -16.7, 3.7 mm

**Cursor:**

ABM1/ABM2 = 31.59 dB

ABM1 comp = -1.68 dBA/m

BWC Factor = 0.16 dB

Location: 8.3, -16.7, 3.7 mm

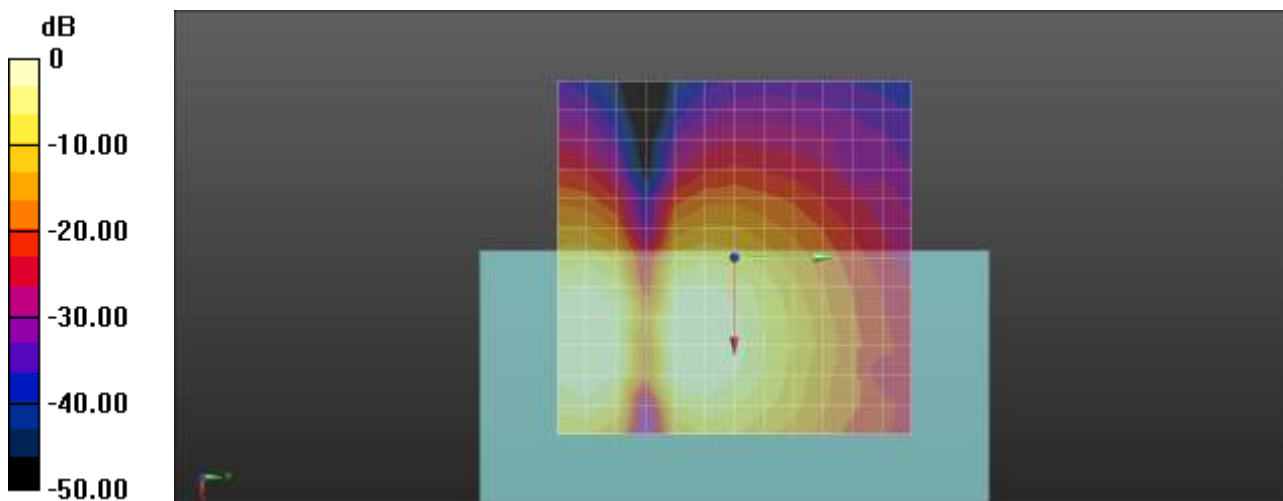

0 dB = 1.000 A/m = 0.00 dBA/m

**Plot No.13**

**WCDMA Band 5 4183ch AMR WB 6\_6 z(axial)**

**DUT: SM-G991U; Type: Bar**

Communication System: UID 0, WCDMA850 (0); Frequency: 836.6 MHz;Duty Cycle: 1:1  
Medium parameters used:  $\sigma = 0$  S/m,  $\epsilon_r = 1$ ;  $\rho = 0$  kg/m<sup>3</sup>  
Phantom section: TCoil Section

DASY Configuration:

- Probe: AM1DV3 - 3049; ;
- Sensor-Surface: 0mm (Fix Surface)
- Electronics: DAE4 Sn466; Calibrated: 2020-04-22
- Phantom: HAC Test Arch with AMCC
- Measurement SW: DASY52, Version 52.10 (4);

**T-Coil scan (scan for ANSI C63.19-2007 & 2011 compliance)/General Scans/z (axial) 4.2mm 50 x**

**50/ABM Signal(x,y,z) (13x13x1):** Measurement grid: dx=10mm, dy=10mm

Signal Type: Audio File (.wav) 48k\_voice\_1kHz\_1s.wav

Output Gain: 24.74

Measure Window Start: 300ms

Measure Window Length: 1000ms

BWC applied: 0.16 dB

Device Reference Point: 0, 0, -6.3 mm

**Cursor:**

ABM1 comp = -6.94 dBA/m

BWC Factor = 0.16 dB

Location: 0, -12.5, 3.7 mm

**Cursor:**

ABM2 = -38.53 dBA/m

Location: 0, -12.5, 3.7 mm

**Cursor:**

ABM1/ABM2 = 31.60 dB

ABM1 comp = -6.94 dBA/m

BWC Factor = 0.16 dB

Location: 0, -12.5, 3.7 mm

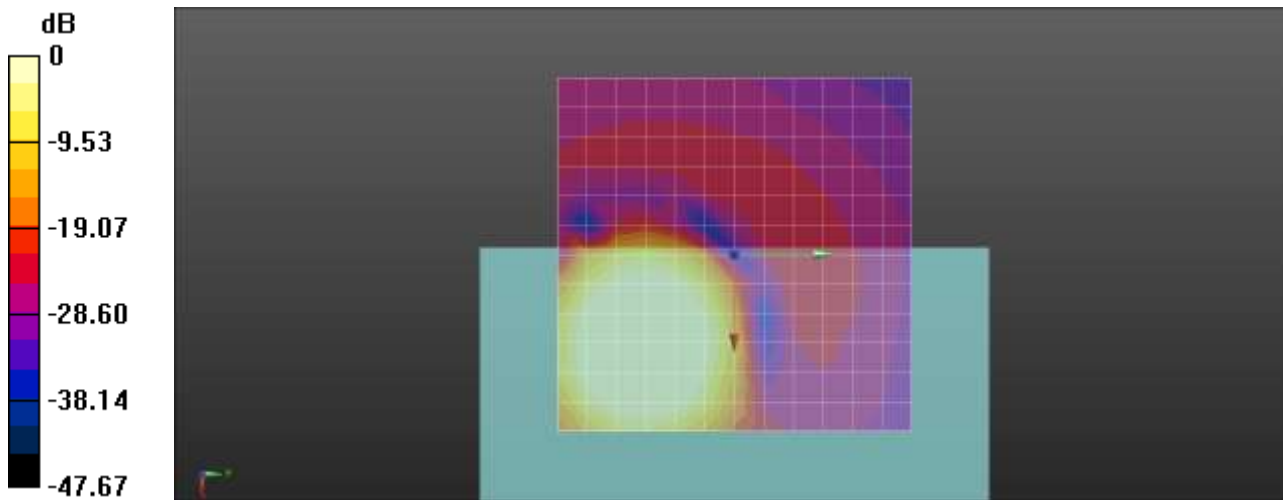

0 dB = 1.000 A/m = 0.00 dBA/m

**Plot No.14**

**WCDMA Band 5 4183ch AMR WB 6\_6 Freq. Response**

**DUT: SM-G991U; Type: Bar**

Communication System: UID 0, WCDMA850 (0); Frequency: 836.6 MHz;Duty Cycle: 1:1  
 Medium parameters used:  $\sigma = 0$  S/m,  $\epsilon_r = 1$ ;  $\rho = 0$  kg/m<sup>3</sup>  
 Phantom section: TCoil Section

**T-Coil scan (scan for ANSI C63.19-2007 & 2011 compliance)/General Scans/z (axial) wideband at best**

**S/N/ABM Freq Resp(x,y,z,f) (1x1x1):** Measurement grid: dx=10mm, dy=10mm

Signal Type: Audio File (.wav) 48k\_Normal\_51s new.wav

Output Gain: 53.28

Measure Window Start: 300ms

Measure Window Length: 51000ms

BWC applied: 9.48 dB

Device Reference Point: 0, 0, -6.3 mm

Category	Telephone parameters WD signal quality [(signal+noise)-to-noise ratio in decibels]
Category T1	0 dB to 10 dB
Category T2	10 dB to 20 dB
Category T3	20 dB to 30 dB
Category T4	> 30 dB

**Cursor:**

Diff = 2.00 dB

BWC Factor = 9.48 dB

Location: 1.5, -19.8, 3.7 mm

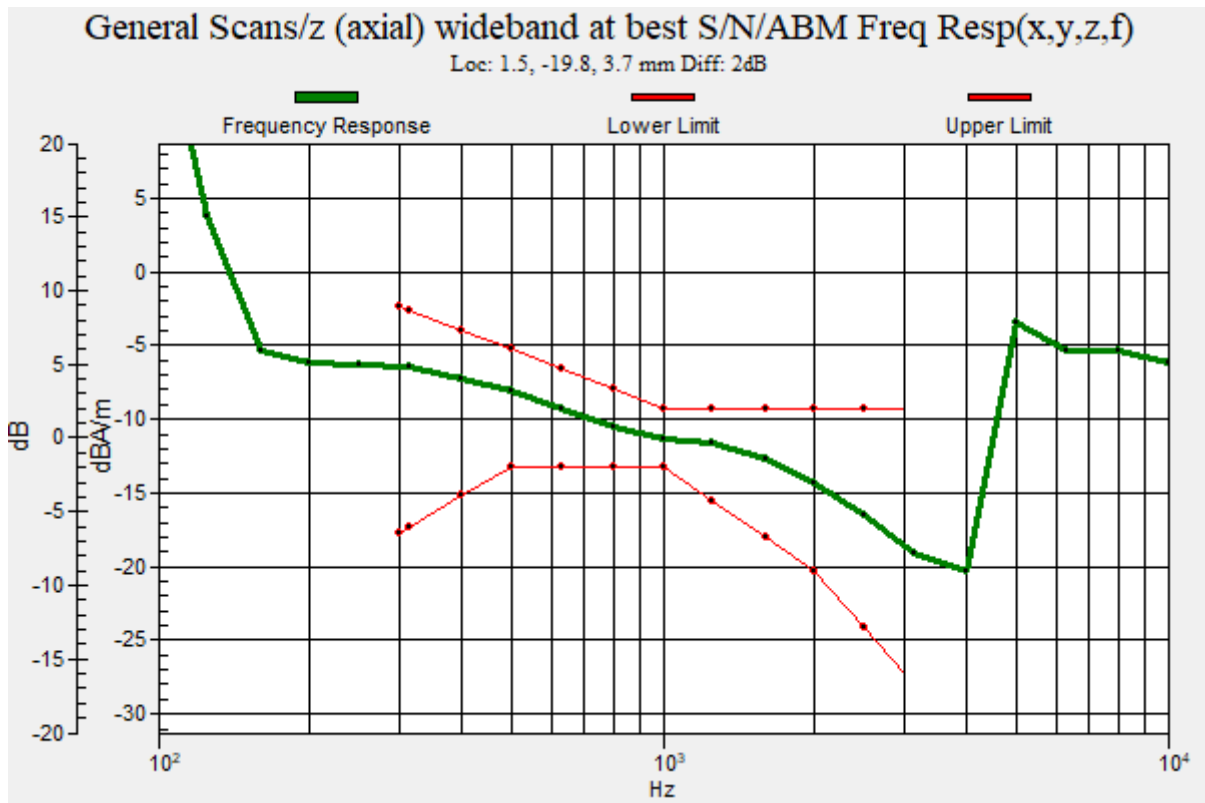

**Plot No.15**

**WCDMA Band 5 4183ch AMR WB 6\_6 y(transversal)**

**DUT: SM-G991U; Type: Bar**

Communication System: UID 0, WCDMA850 (0); Frequency: 836.6 MHz;Duty Cycle: 1:1  
Medium parameters used:  $\sigma = 0$  S/m,  $\epsilon_r = 1$ ;  $\rho = 0$  kg/m<sup>3</sup>  
Phantom section: TCoil Section

DASY Configuration:

- Probe: AM1DV3 - 3049; ;
- Sensor-Surface: 0mm (Fix Surface)
- Electronics: DAE4 Sn466; Calibrated: 2020-04-22
- Phantom: HAC Test Arch with AMCC
- Measurement SW: DASY52, Version 52.10 (4);

**T-Coil scan (scan for ANSI C63.19-2007 & 2011 compliance)/General Scans/y (transversal) 4.2mm 50**

**x 50/ABM Signal(x,y,z) (13x13x1):** Measurement grid: dx=10mm, dy=10mm

Signal Type: Audio File (.wav) 48k\_voice\_1kHz\_1s.wav

Output Gain: 24.74

Measure Window Start: 300ms

Measure Window Length: 1000ms

BWC applied: 0.16 dB

Device Reference Point: 0, 0, -6.3 mm

**Cursor:**

ABM1 comp = -1.50 dBA/m

BWC Factor = 0.16 dB

Location: 16.7, -16.7, 3.7 mm

**Cursor:**

ABM2 = -32.95 dBA/m

Location: 16.7, -16.7, 3.7 mm

**Cursor:**

ABM1/ABM2 = 31.45 dB

ABM1 comp = -1.50 dBA/m

BWC Factor = 0.16 dB

Location: 16.7, -16.7, 3.7 mm

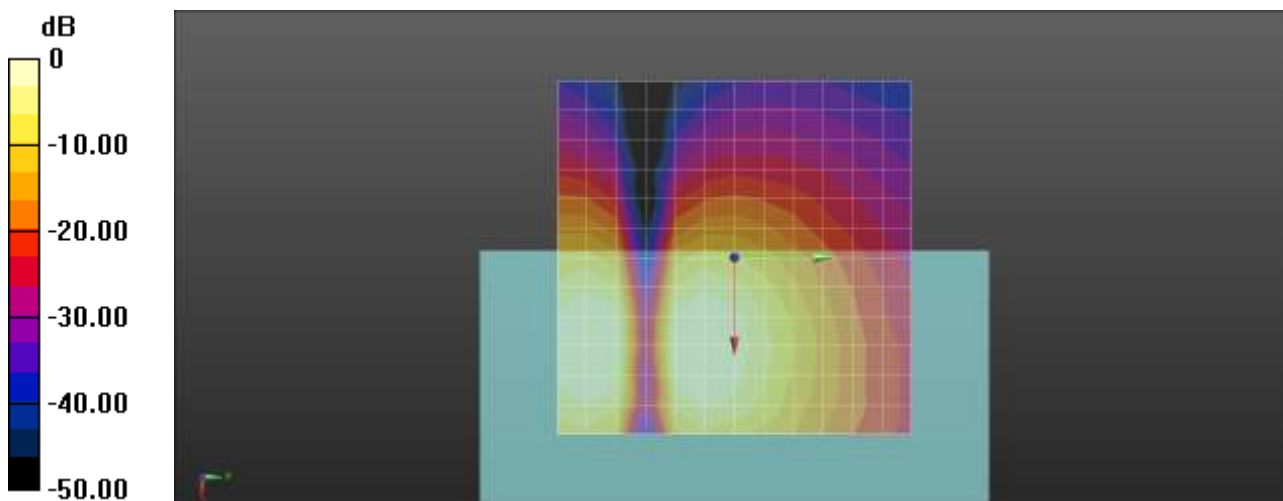

0 dB = 1.000 A/m = 0.00 dBA/m

**Plot No.16**  
**CDMA BC0 8k-EVRC 1/1 384ch z(axial)**

**DUT: SM-G991U; Type: Bar**

Communication System: UID 0, CDMA 835MHz FCC (0); Frequency: 836.52 MHz;Duty Cycle: 1:1  
Medium parameters used:  $\sigma = 0$  S/m,  $\epsilon_r = 1$ ;  $\rho = 0$  kg/m<sup>3</sup>  
Phantom section: TCoil Section

DASY Configuration:

- Probe: AM1DV2 - 1013; ;
- Sensor-Surface: 0mm (Fix Surface)
- Electronics: DAE4 Sn1629; Calibrated: 2020-08-11
- Phantom: HAC Test Arch with AMCC
- Measurement SW: DASY52, Version 52.10 (4);

**T-Coil scan (scan for ANSI C63.19-2007 & 2011 compliance)/General Scans/z (axial) 4.2mm 50 x 50/ABM Signal(x,y,z) (13x13x1):** Measurement grid: dx=10mm, dy=10mm

Signal Type: Audio File (.wav) 48k\_voice\_1kHz\_1s.wav

Output Gain: 19.3

Measure Window Start: 300ms

Measure Window Length: 1000ms

BWC applied: 0.13 dB

Device Reference Point: 0, 0, -6.3 mm

**Cursor:**

ABM1 comp = 3.03 dBA/m

BWC Factor = 0.13 dB

Location: 12.5, -12.5, 3.7 mm

**Cursor:**

ABM2 = -33.62 dBA/m

Location: 12.5, -12.5, 3.7 mm

**Cursor:**

ABM1/ABM2 = 36.65 dB

ABM1 comp = 3.03 dBA/m

BWC Factor = 0.13 dB

Location: 12.5, -12.5, 3.7 mm

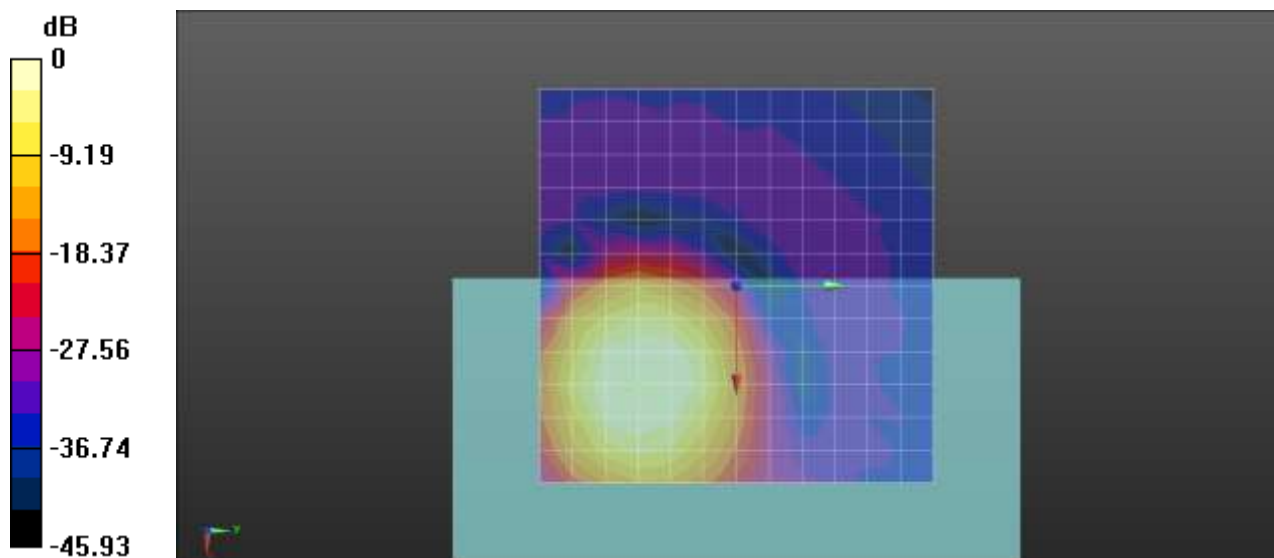

0 dB = 1.000 A/m = 0.00 dBA/m

**Plot No.17**  
**CDMA BC0 8k-EVRC 1/1 384ch Freq.Response**

**DUT: SM-G991U; Type: Bar**

Communication System: UID 0, CDMA 835MHz FCC (0); Frequency: 836.52 MHz;Duty Cycle: 1:1  
Medium parameters used:  $\sigma = 0$  S/m,  $\epsilon_r = 1$ ;  $\rho = 0$  kg/m<sup>3</sup>  
Phantom section: TCoil Section

**T-Coil scan (scan for ANSI C63.19-2007 & 2011 compliance)/General Scans/z (axial) wideband at best S/N/ABM Freq Resp(x,y,z,f) (1x1x1):** Measurement grid: dx=10mm, dy=10mm  
Signal Type: Audio File (.wav) 48k\_Normal\_51s new.wav  
Output Gain: 52.25  
Measure Window Start: 300ms  
Measure Window Length: 51000ms  
BWC applied: 9.45 dB  
Device Reference Point: 0, 0, -6.3 mm

Category	Telephone parameters WD signal quality [(signal+noise)-to-noise ratio in decibels]
Category T1	0 dB to 10 dB
Category T2	10 dB to 20 dB
Category T3	20 dB to 30 dB
Category T4	> 30 dB

**Cursor:**  
Diff = 1.91 dB  
BWC Factor = 9.45 dB  
Location: 11.7, -12.8, 3.7 mm

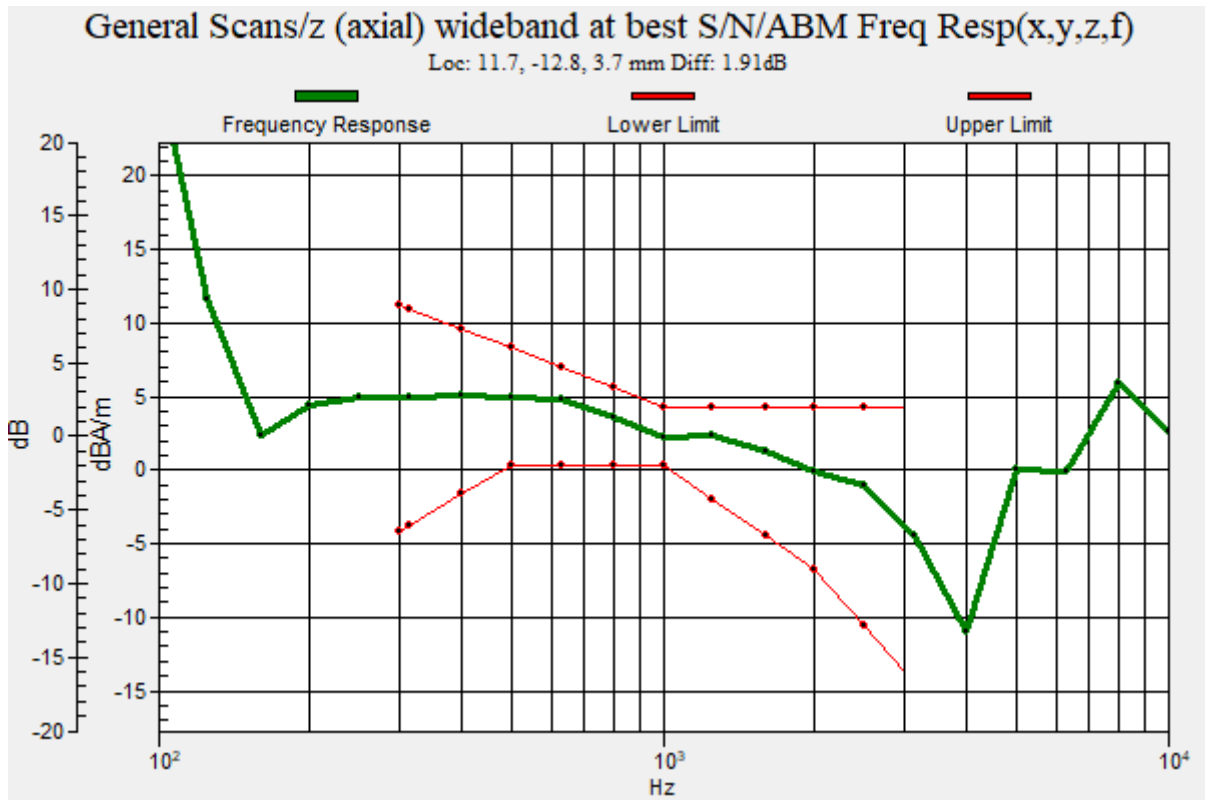

**Plot No.18**  
**CDMA BC0 8k-EVRC 1/1 384ch y(transversal)**

**DUT: SM-G991U; Type: Bar**

Communication System: UID 0, CDMA 835MHz FCC (0); Frequency: 836.52 MHz;Duty Cycle: 1:1  
Medium parameters used:  $\sigma = 0$  S/m,  $\epsilon_r = 1$ ;  $\rho = 0$  kg/m<sup>3</sup>  
Phantom section: TCoil Section

DASY Configuration:

- Probe: AM1DV2 - 1013; ;
- Sensor-Surface: 0mm (Fix Surface)
- Electronics: DAE4 Sn1629; Calibrated: 2020-08-11
- Phantom: HAC Test Arch with AMCC
- Measurement SW: DASY52, Version 52.10 (4);

**T-Coil scan (scan for ANSI C63.19-2007 & 2011 compliance)/General Scans/y (transversal) 4.2mm 50**

**x 50/ABM Signal(x,y,z) (13x13x1):** Measurement grid: dx=10mm, dy=10mm

Signal Type: Audio File (.wav) 48k\_voice\_1kHz\_1s.wav

Output Gain: 19.3

Measure Window Start: 300ms

Measure Window Length: 1000ms

BWC applied: 0.13 dB

Device Reference Point: 0, 0, -6.3 mm

**Cursor:**

ABM1 comp = -10.39 dBA/m

BWC Factor = 0.13 dB

Location: 4.2, -20.8, 3.7 mm

**Cursor:**

ABM2 = -46.65 dBA/m

Location: 4.2, -20.8, 3.7 mm

**Cursor:**

ABM1/ABM2 = 36.26 dB

ABM1 comp = -10.39 dBA/m

BWC Factor = 0.13 dB

Location: 4.2, -20.8, 3.7 mm

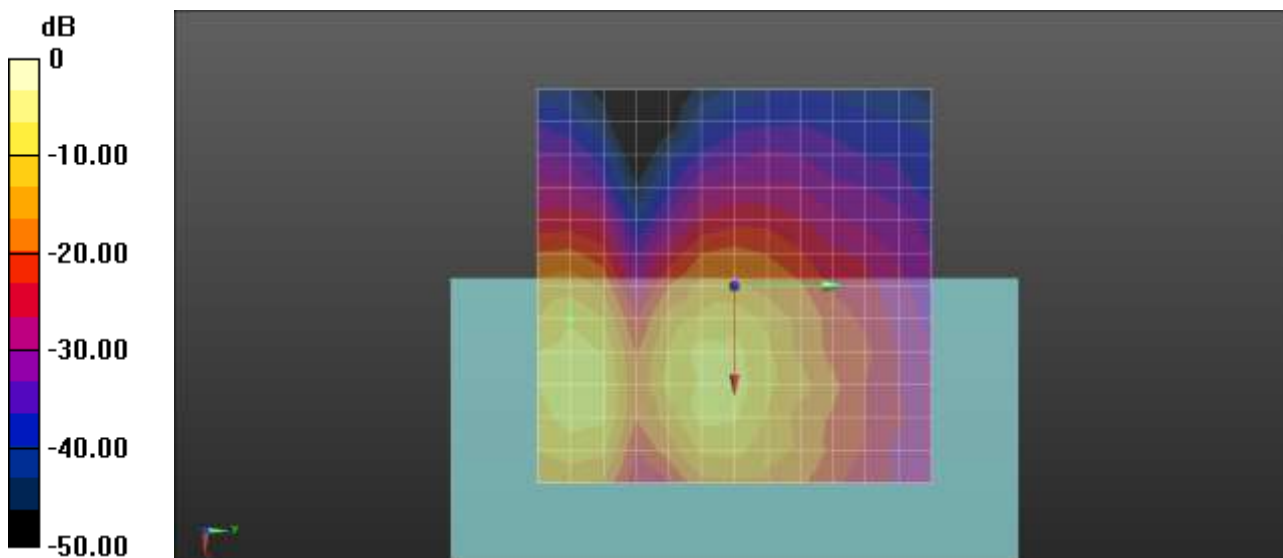

0 dB = 1.000 A/m = 0.00 dBA/m

**Plot No.19**  
**CDMA BC1 8k-EVRC 3/3 600ch z(axial)**

**DUT: SM-G991U; Type: Bar**

Communication System: UID 0, CDMA BC1 (0); Frequency: 1880 MHz;Duty Cycle: 1:1  
Medium parameters used:  $\sigma = 0$  S/m,  $\epsilon_r = 1$ ;  $\rho = 0$  kg/m<sup>3</sup>  
Phantom section: TCoil Section

DASY Configuration:

- Probe: AM1DV2 - 1013; ;
- Sensor-Surface: 0mm (Fix Surface)
- Electronics: DAE4 Sn1629; Calibrated: 2020-08-11
- Phantom: HAC Test Arch with AMCC
- Measurement SW: DASY52, Version 52.10 (4);

**T-Coil scan (scan for ANSI C63.19-2007 & 2011 compliance)/General Scans/z (axial) 4.2mm 50 x 50/ABM Signal(x,y,z) (13x13x1):** Measurement grid: dx=10mm, dy=10mm

Signal Type: Audio File (.wav) 48k\_voice\_1kHz\_1s.wav

Output Gain: 19.3

Measure Window Start: 300ms

Measure Window Length: 1000ms

BWC applied: 0.13 dB

Device Reference Point: 0, 0, -6.3 mm

**Cursor:**

ABM1 comp = 0.79 dBA/m

BWC Factor = 0.13 dB

Location: 8.3, -12.5, 3.7 mm

**Cursor:**

ABM2 = -36.59 dBA/m

Location: 8.3, -12.5, 3.7 mm

**Cursor:**

ABM1/ABM2 = 37.38 dB

ABM1 comp = 0.79 dBA/m

BWC Factor = 0.13 dB

Location: 8.3, -12.5, 3.7 mm

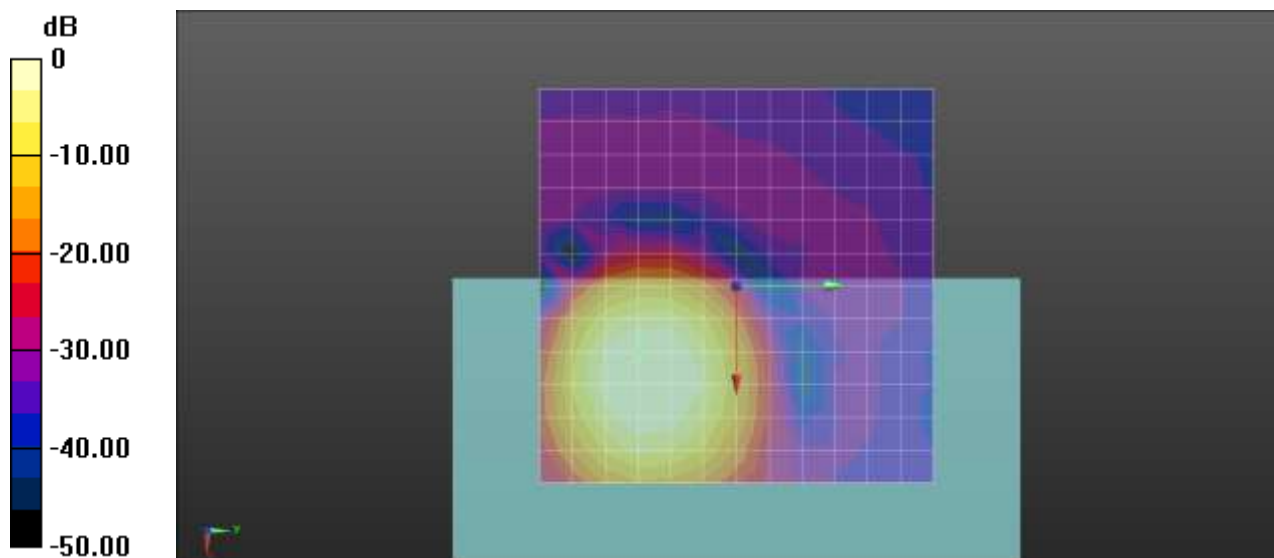

0 dB = 1.000 A/m = 0.00 dBA/m



**Plot No.20**  
**CDMA BC1 8k-EVRC 3/3 600ch Freq. Response**

**DUT: SM-G991U; Type: Bar**

Communication System: UID 0, CDMA BC1 (0); Frequency: 1880 MHz;Duty Cycle: 1:1  
Medium parameters used:  $\sigma = 0$  S/m,  $\epsilon_r = 1$ ;  $\rho = 0$  kg/m<sup>3</sup>  
Phantom section: TCoil Section

**T-Coil scan (scan for ANSI C63.19-2007 & 2011 compliance)/General Scans/z (axial) wideband at best S/N/ABM Freq Resp(x,y,z,f) (1x1x1):** Measurement grid: dx=10mm, dy=10mm  
Signal Type: Audio File (.wav) 48k\_Normal\_51s new.wav  
Output Gain: 52.25  
Measure Window Start: 300ms  
Measure Window Length: 51000ms  
BWC applied: 9.45 dB  
Device Reference Point: 0, 0, -6.3 mm

Category	Telephone parameters WD signal quality [(signal+noise)-to-noise ratio in decibels]
Category T1	0 dB to 10 dB
Category T2	10 dB to 20 dB
Category T3	20 dB to 30 dB
Category T4	> 30 dB

**Cursor:**  
Diff = 1.92 dB  
BWC Factor = 9.45 dB  
Location: 10.7, -12.2, 3.7 mm

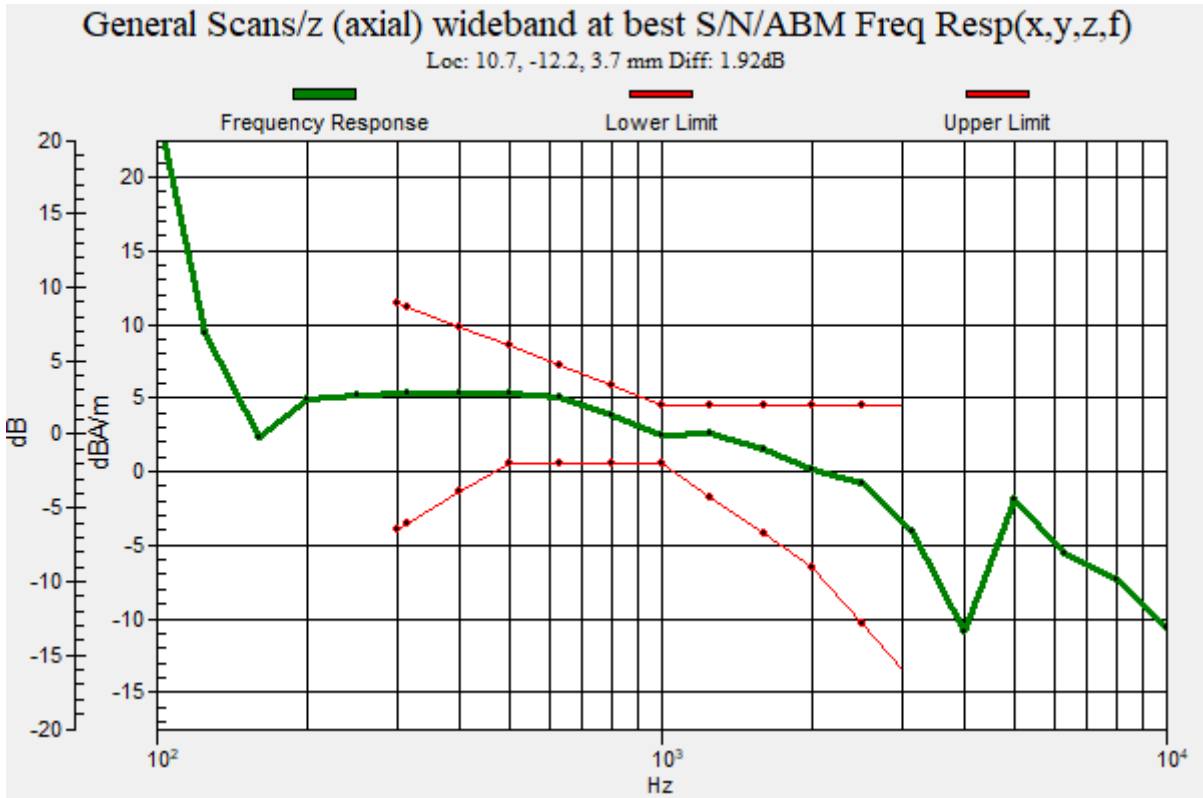

**Plot No.21**

**CDMA BC1 8k-EVRC 3/3 600ch y(transversal)**

**DUT: SM-G991U; Type: Bar**

Communication System: UID 0, CDMA BC1 (0); Frequency: 1880 MHz;Duty Cycle: 1:1  
Medium parameters used:  $\sigma = 0$  S/m,  $\epsilon_r = 1$ ;  $\rho = 0$  kg/m<sup>3</sup>  
Phantom section: TCoil Section

DASY Configuration:

- Probe: AM1DV2 - 1013; ;
- Sensor-Surface: 0mm (Fix Surface)
- Electronics: DAE4 Sn1629; Calibrated: 2020-08-11
- Phantom: HAC Test Arch with AMCC
- Measurement SW: DASY52, Version 52.10 (4);

**T-Coil scan (scan for ANSI C63.19-2007 & 2011 compliance)/General Scans/y (transversal) 4.2mm 50**

**x 50/ABM Signal(x,y,z) (13x13x1):** Measurement grid: dx=10mm, dy=10mm

Signal Type: Audio File (.wav) 48k\_voice\_1kHz\_1s.wav

Output Gain: 19.3

Measure Window Start: 300ms

Measure Window Length: 1000ms

BWC applied: 0.13 dB

Device Reference Point: 0, 0, -6.3 mm

**Cursor:**

ABM1 comp = -8.20 dBA/m

BWC Factor = 0.13 dB

Location: 12.5, -20.8, 3.7 mm

**Cursor:**

ABM2 = -41.25 dBA/m

Location: 12.5, -20.8, 3.7 mm

**Cursor:**

ABM1/ABM2 = 33.05 dB

ABM1 comp = -8.20 dBA/m

BWC Factor = 0.13 dB

Location: 12.5, -20.8, 3.7 mm

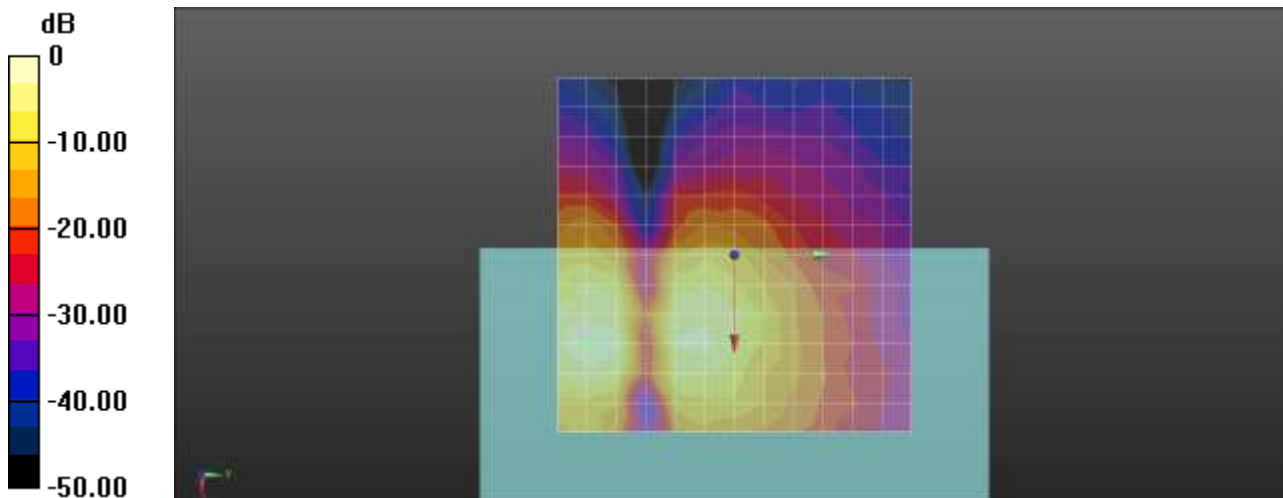

0 dB = 1.000 A/m = 0.00 dBA/m

**Plot No.22**

**CDMA BC10 8k-EVRC 1/1 560ch z(axial)**

**DUT: SM-G991U; Type: Bar**

Communication System: UID 0, CDMA800(BC10) (0); Frequency: 820 MHz;Duty Cycle: 1:1  
Medium parameters used:  $\sigma = 0$  S/m,  $\epsilon_r = 1$ ;  $\rho = 0$  kg/m<sup>3</sup>  
Phantom section: TCoil Section

DASY Configuration:

- Probe: AM1DV2 - 1013; ;
- Sensor-Surface: 0mm (Fix Surface)
- Electronics: DAE4 Sn1629; Calibrated: 2020-08-11
- Phantom: HAC Test Arch with AMCC
- Measurement SW: DASY52, Version 52.10 (4);

**T-Coil scan (scan for ANSI C63.19-2007 & 2011 compliance)/General Scans/z (axial) 4.2mm 50 x 50/ABM Signal(x,y,z) (13x13x1):** Measurement grid: dx=10mm, dy=10mm

Signal Type: Audio File (.wav) 48k\_voice\_1kHz\_1s.wav

Output Gain: 19.3

Measure Window Start: 300ms

Measure Window Length: 1000ms

BWC applied: 0.14 dB

Device Reference Point: 0, 0, -6.3 mm

**Cursor:**

ABM1 comp = 0.18 dBA/m

BWC Factor = 0.14 dB

Location: 8.3, -8.3, 3.7 mm

**Cursor:**

ABM2 = -36.65 dBA/m

Location: 8.3, -8.3, 3.7 mm

**Cursor:**

ABM1/ABM2 = 36.83 dB

ABM1 comp = 0.18 dBA/m

BWC Factor = 0.14 dB

Location: 8.3, -8.3, 3.7 mm

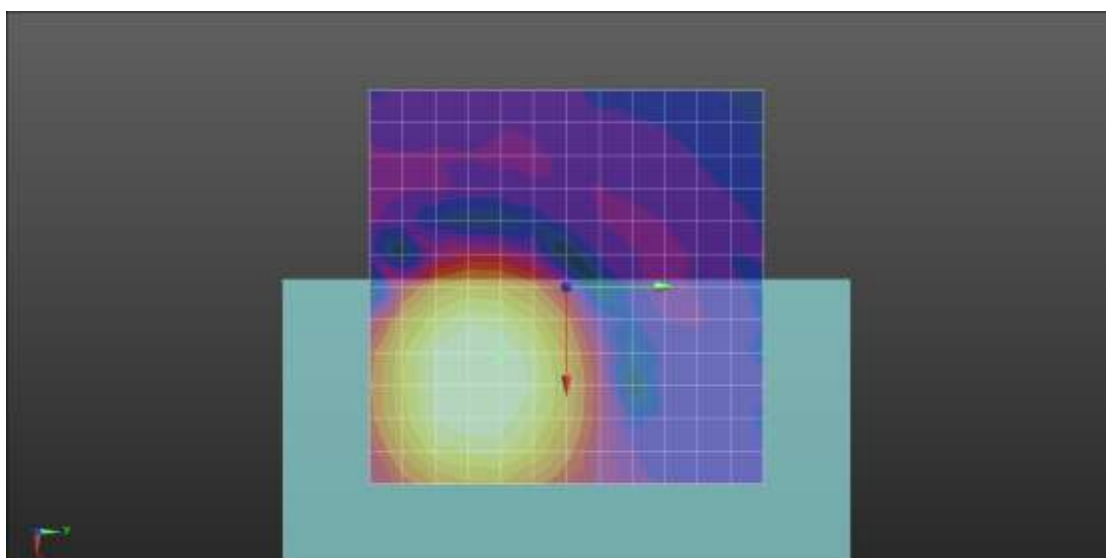
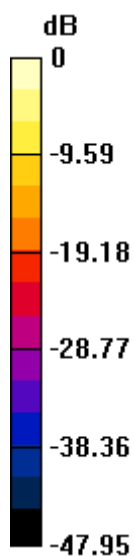

0 dB = 1.000 A/m = 0.00 dBA/m

**Plot No.23**  
**CDMA BC10 8k-EVRC 1/1 560ch Freq. Response**

**DUT: SM-G991U; Type: Bar**

Communication System: UID 0, CDMA800(BC10) (0); Frequency: 820 MHz;Duty Cycle: 1:1  
Medium parameters used:  $\sigma = 0$  S/m,  $\epsilon_r = 1$ ;  $\rho = 0$  kg/m<sup>3</sup>  
Phantom section: TCoil Section

**T-Coil scan (scan for ANSI C63.19-2007 & 2011 compliance)/General Scans/z (axial) wideband at best S/N/ABM Freq Resp(x,y,z,f) (1x1x1):** Measurement grid: dx=10mm, dy=10mm  
Signal Type: Audio File (.wav) 48k\_Normal\_51s new.wav  
Output Gain: 52.25  
Measure Window Start: 300ms  
Measure Window Length: 51000ms  
BWC applied: 9.46 dB  
Device Reference Point: 0, 0, -6.3 mm

Category	Telephone parameters WD signal quality [(signal+noise)-to-noise ratio in decibels]
Category T1	0 dB to 10 dB
Category T2	10 dB to 20 dB
Category T3	20 dB to 30 dB
Category T4	> 30 dB

**Cursor:**  
Diff = 2.00 dB  
BWC Factor = 9.46 dB  
Location: 8.7, -9.7, 3.7 mm

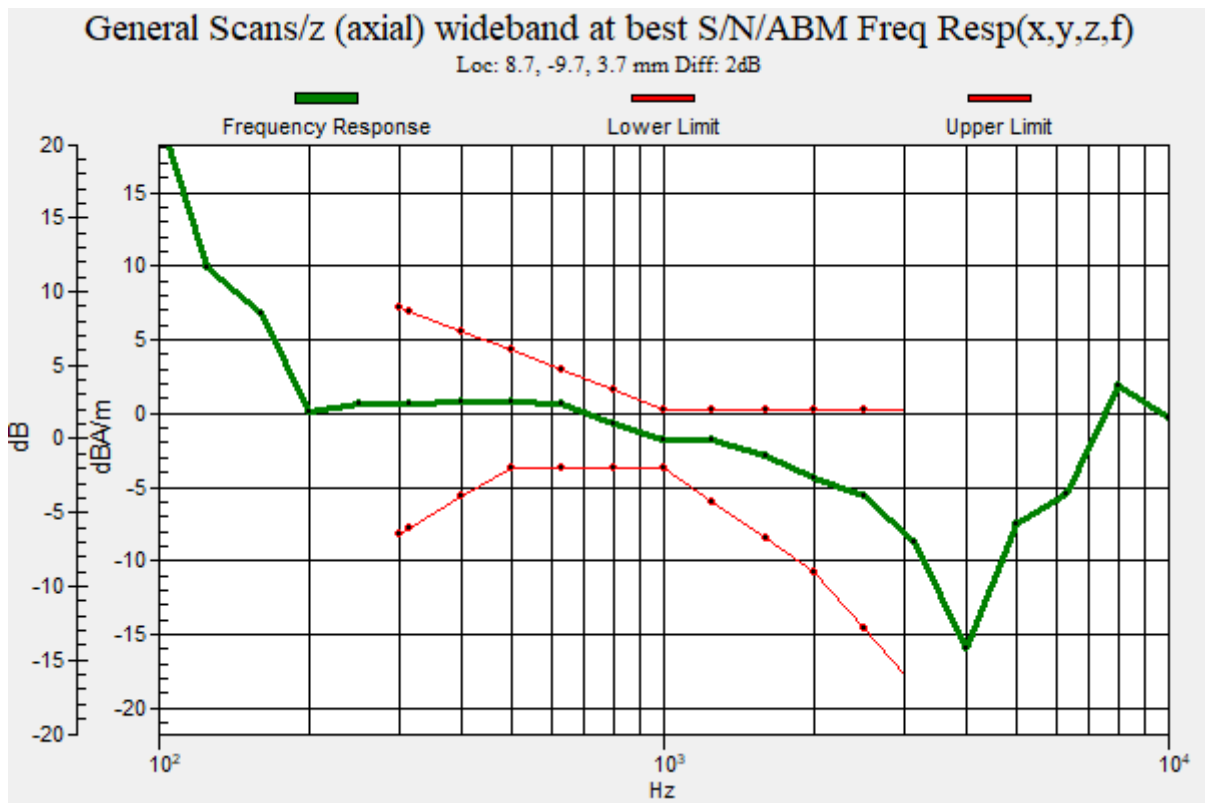

**Plot No.24**  
**CDMA BC10 8k-EVRC 1/1 560ch y(transversal)**

**DUT: SM-G991U; Type: Bar**

Communication System: UID 0, CDMA800(BC10) (0); Frequency: 820 MHz;Duty Cycle: 1:1  
Medium parameters used:  $\sigma = 0$  S/m,  $\epsilon_r = 1$ ;  $\rho = 0$  kg/m<sup>3</sup>  
Phantom section: TCoil Section

DASY Configuration:

- Probe: AM1DV2 - 1013; ;
- Sensor-Surface: 0mm (Fix Surface)
- Electronics: DAE4 Sn1629; Calibrated: 2020-08-11
- Phantom: HAC Test Arch with AMCC
- Measurement SW: DASY52, Version 52.10 (4);

**T-Coil scan (scan for ANSI C63.19-2007 & 2011 compliance)/General Scans/y (transversal) 4.2mm 50**

**x 50/ABM Signal(x,y,z) (13x13x1):** Measurement grid: dx=10mm, dy=10mm

Signal Type: Audio File (.wav) 48k\_voice\_1kHz\_1s.wav

Output Gain: 19.3

Measure Window Start: 300ms

Measure Window Length: 1000ms

BWC applied: 0.14 dB

Device Reference Point: 0, 0, -6.3 mm

**Cursor:**

ABM1 comp = -10.91 dBA/m

BWC Factor = 0.14 dB

Location: 4.2, -20.8, 3.7 mm

**Cursor:**

ABM2 = -48.73 dBA/m

Location: 4.2, -20.8, 3.7 mm

**Cursor:**

ABM1/ABM2 = 37.81 dB

ABM1 comp = -10.91 dBA/m

BWC Factor = 0.14 dB

Location: 4.2, -20.8, 3.7 mm

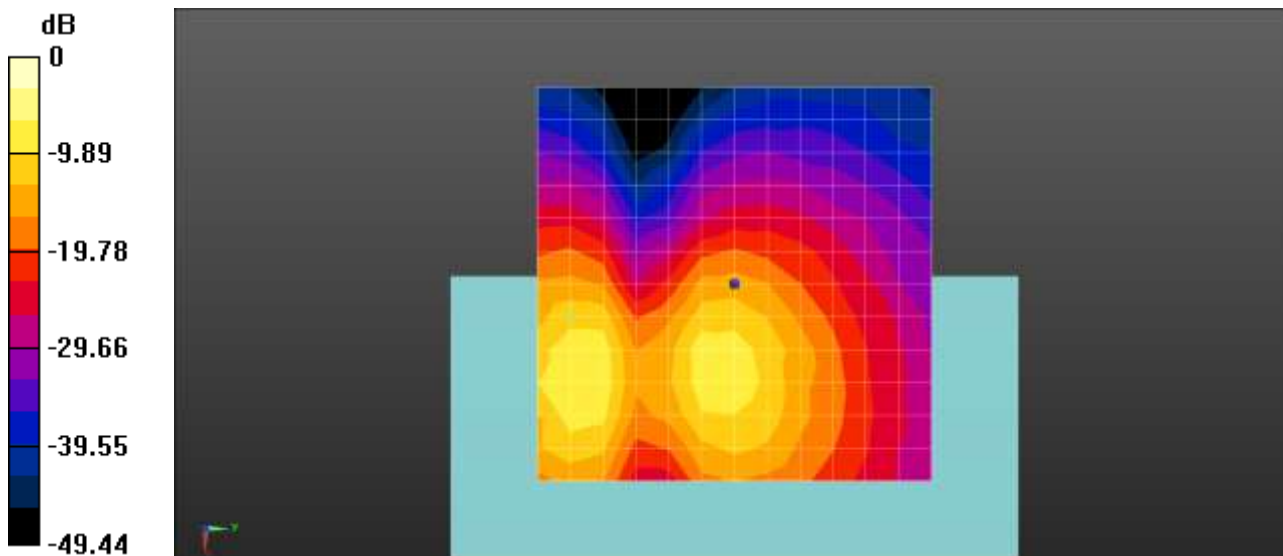

0 dB = 1.000 A/m = 0.00 dBA/m

**Plot No.25**

**LTE 25 64QAM EVS WB 5.9bitrate 15MHz 1RB 74offset 26365ch z(axial)**

**DUT: SM-G991U; Type: Bar**

Communication System: UID 0, LTE Band 25 (0); Frequency: 1882.5 MHz;Duty Cycle: 1:1  
 Medium parameters used:  $\sigma = 0$  S/m,  $\epsilon_r = 1$ ;  $\rho = 0$  kg/m<sup>3</sup>  
 Phantom section: TCoil Section

DASY Configuration:

- Probe: AM1DV3 - 3049; ;
- Sensor-Surface: 0mm (Fix Surface)
- Electronics: DAE4 Sn466; Calibrated: 2020-04-22
- Phantom: HAC Test Arch with AMCC
- Measurement SW: DASY52, Version 52.10 (4);

**T-Coil scan (scan for ANSI C63.19-2007 & 2011 compliance)/General Scans/z (axial) 4.2mm 50 x**

**50/ABM Signal(x,y,z) (13x13x1):** Measurement grid: dx=10mm, dy=10mm

Signal Type: Audio File (.wav) 48k\_voice\_1kHz\_1s.wav

Output Gain: 24.38

Measure Window Start: 300ms

Measure Window Length: 1000ms

BWC applied: 0.16 dB

Device Reference Point: 0, 0, -6.3 mm

**Cursor:**

ABM1 comp = 2.67 dBA/m

BWC Factor = 0.16 dB

Location: 8.3, -16.7, 3.7 mm

**Cursor:**

ABM2 = -22.68 dBA/m

Location: 8.3, -16.7, 3.7 mm

**Cursor:**

ABM1/ABM2 = 25.34 dB

ABM1 comp = 2.67 dBA/m

BWC Factor = 0.16 dB

Location: 8.3, -16.7, 3.7 mm

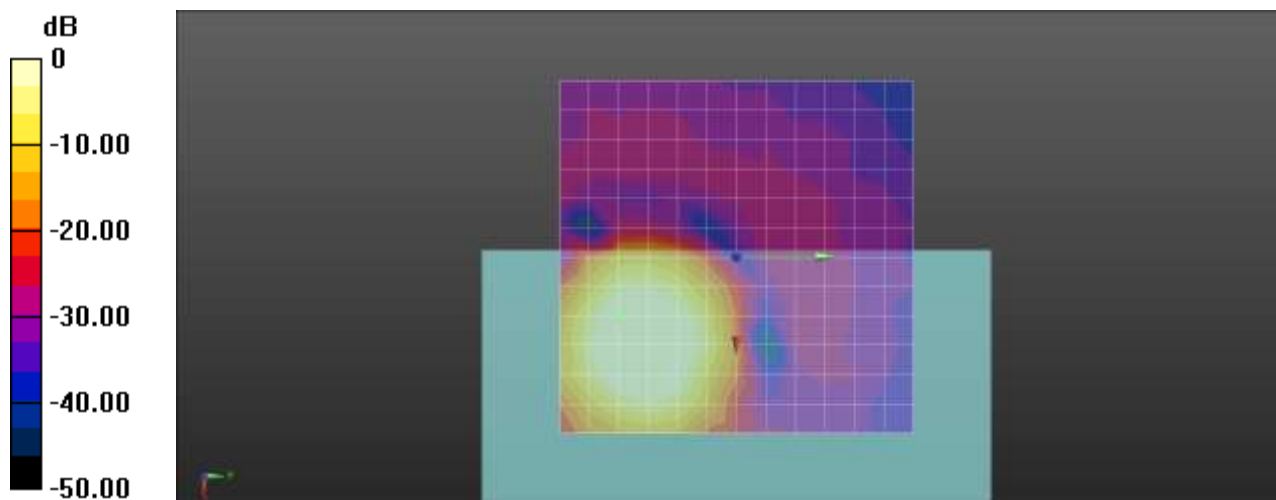

0 dB = 1.000 A/m = 0.00 dBA/m

**Plot No.26**

**LTE 25 64QAM EVS WB 5.9bitrate 15MHz 1RB 74offset 26365ch Freq.Response**

**DUT: SM-G991U; Type: Bar**

Communication System: UID 0, LTE Band 25 (0); Frequency: 1882.5 MHz;Duty Cycle: 1:1  
Medium parameters used:  $\sigma = 0$  S/m,  $\epsilon_r = 1$ ;  $\rho = 0$  kg/m<sup>3</sup>  
Phantom section: TCoil Section

**T-Coil scan (scan for ANSI C63.19-2007 & 2011 compliance)/General Scans/z (axial) wideband at best S/N/ABM Freq Resp(x,y,z,f) (1x1x1):** Measurement grid: dx=10mm, dy=10mm  
Signal Type: Audio File (.wav) 48k\_Normal\_51s new.wav  
Output Gain: 52.45  
Measure Window Start: 300ms  
Measure Window Length: 51000ms  
BWC applied: 9.48 dB  
Device Reference Point: 0, 0, -6.3 mm

Category	Telephone parameters WD signal quality [(signal+noise)-to-noise ratio in decibels]
Category T1	0 dB to 10 dB
Category T2	10 dB to 20 dB
Category T3	20 dB to 30 dB
Category T4	> 30 dB

**Cursor:**

Diff = 1.82 dB  
BWC Factor = 9.48 dB  
Location: 8.5, -16.6, 3.7 mm

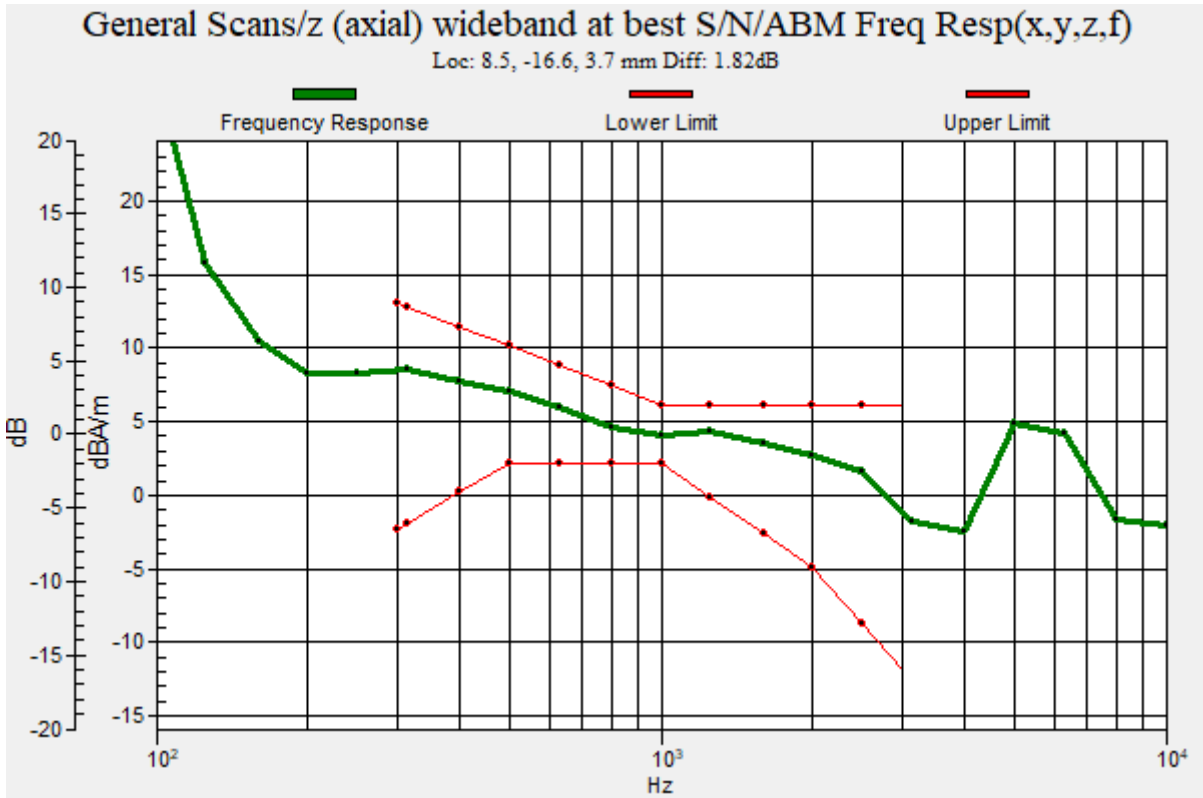

**Plot No.27**

**LTE 25 64QAM EVS WB 5.9bitrate 15MHz 1RB 74offset 26365ch y(transversal)**

**DUT: SM-G991U; Type: Bar**

Communication System: UID 0, LTE Band 25 (0); Frequency: 1882.5 MHz;Duty Cycle: 1:1  
Medium parameters used:  $\sigma = 0$  S/m,  $\epsilon_r = 1$ ;  $\rho = 0$  kg/m<sup>3</sup>  
Phantom section: TCoil Section

DASY Configuration:

- Probe: AM1DV3 - 3049; ;
- Sensor-Surface: 0mm (Fix Surface)
- Electronics: DAE4 Sn466; Calibrated: 2020-04-22
- Phantom: HAC Test Arch with AMCC
- Measurement SW: DASY52, Version 52.10 (4);

**T-Coil scan (scan for ANSI C63.19-2007 & 2011 compliance)/General Scans/y (transversal) 4.2mm 50**

**x 50/ABM Signal(x,y,z) (13x13x1):** Measurement grid: dx=10mm, dy=10mm

Signal Type: Audio File (.wav) 48k\_voice\_1kHz\_1s.wav

Output Gain: 24.38

Measure Window Start: 300ms

Measure Window Length: 1000ms

BWC applied: 0.16 dB

Device Reference Point: 0, 0, -6.3 mm

**Cursor:**

ABM1 comp = -1.19 dBA/m

BWC Factor = 0.16 dB

Location: 8.3, -4.2, 3.7 mm

**Cursor:**

ABM2 = -28.83 dBA/m

Location: 8.3, -4.2, 3.7 mm

**Cursor:**

ABM1/ABM2 = 27.64 dB

ABM1 comp = -1.19 dBA/m

BWC Factor = 0.16 dB

Location: 8.3, -4.2, 3.7 mm

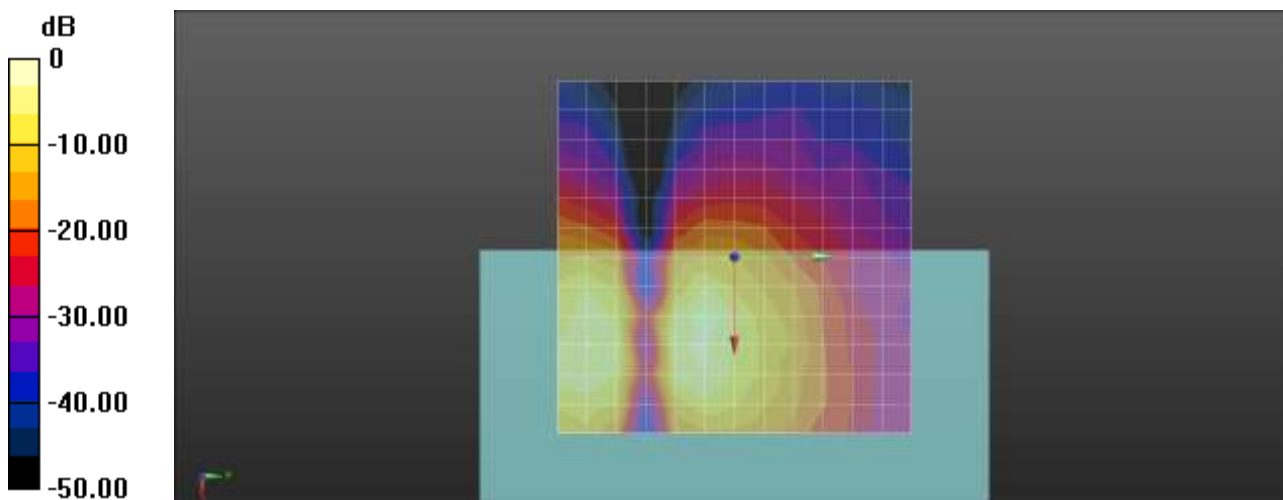

0 dB = 1.000 A/m = 0.00 dBA/m



**Plot No.28**

**LTE 7 64QAM EVS WB 5.9bitrate 15MHz 1RB 74offset 21100ch z(axial)**

**DUT: SM-G991U; Type: Bar**

Communication System: UID 0, LTE Band 7 (0); Frequency: 2535 MHz;Duty Cycle: 1:1  
Medium parameters used:  $\sigma = 0$  S/m,  $\epsilon_r = 1$ ;  $\rho = 0$  kg/m<sup>3</sup>  
Phantom section: TCoil Section

DASY Configuration:

- Probe: AM1DV3 - 3049; ;
- Sensor-Surface: 0mm (Fix Surface)
- Electronics: DAE4 Sn466; Calibrated: 2020-04-22
- Phantom: HAC Test Arch with AMCC
- Measurement SW: DASY52, Version 52.10 (4);

**T-Coil scan (scan for ANSI C63.19-2007 & 2011 compliance)/General Scans/z (axial) 4.2mm 50 x**

**50/ABM Signal(x,y,z) (13x13x1):** Measurement grid: dx=10mm, dy=10mm

Signal Type: Audio File (.wav) 48k\_voice\_1kHz\_1s.wav

Output Gain: 24.38

Measure Window Start: 300ms

Measure Window Length: 1000ms

BWC applied: 0.17 dB

Device Reference Point: 0, 0, -6.3 mm

**Cursor:**

ABM1 comp = -2.27 dBA/m

BWC Factor = 0.17 dB

Location: 12.5, -20.8, 3.7 mm

**Cursor:**

ABM2 = -28.30 dBA/m

Location: 12.5, -20.8, 3.7 mm

**Cursor:**

ABM1/ABM2 = 26.04 dB

ABM1 comp = -2.27 dBA/m

BWC Factor = 0.17 dB

Location: 12.5, -20.8, 3.7 mm

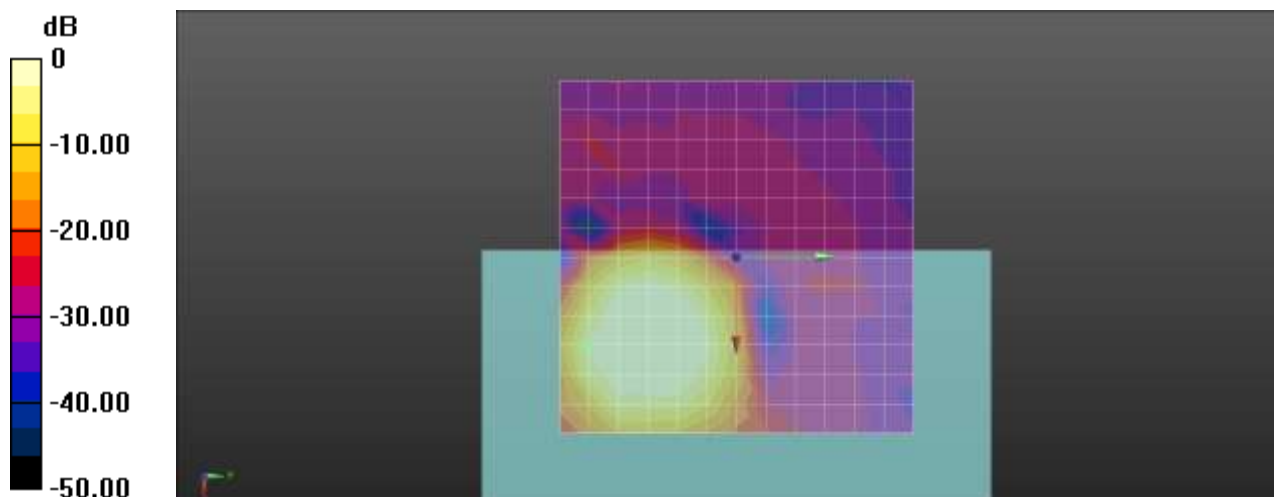

0 dB = 1.000 A/m = 0.00 dBA/m

**Plot No.29**

**LTE 7 64QAM EVS WB 5.9bitrate 15MHz 1RB 74offset 21100ch Freq.Response**

**DUT: SM-G991U; Type: Bar**

Communication System: UID 0, LTE Band 7 (0); Frequency: 2535 MHz;Duty Cycle: 1:1  
Medium parameters used:  $\sigma = 0$  S/m,  $\epsilon_r = 1$ ;  $\rho = 0$  kg/m<sup>3</sup>  
Phantom section: TCoil Section

**T-Coil scan (scan for ANSI C63.19-2007 & 2011 compliance)/General Scans/z (axial) wideband at best S/N/ABM Freq Resp(x,y,z,f) (1x1x1):** Measurement grid: dx=10mm, dy=10mm  
Signal Type: Audio File (.wav) 48k\_Normal\_51s new.wav  
Output Gain: 52.45  
Measure Window Start: 300ms  
Measure Window Length: 51000ms  
BWC applied: 9.49 dB  
Device Reference Point: 0, 0, -6.3 mm

Category	Telephone parameters WD signal quality [(signal+noise)-to-noise ratio in decibels]
Category T1	0 dB to 10 dB
Category T2	10 dB to 20 dB
Category T3	20 dB to 30 dB
Category T4	> 30 dB

**Cursor:**

Diff = 1.92 dB  
BWC Factor = 9.49 dB  
Location: 12.4, -20.4, 3.7 mm

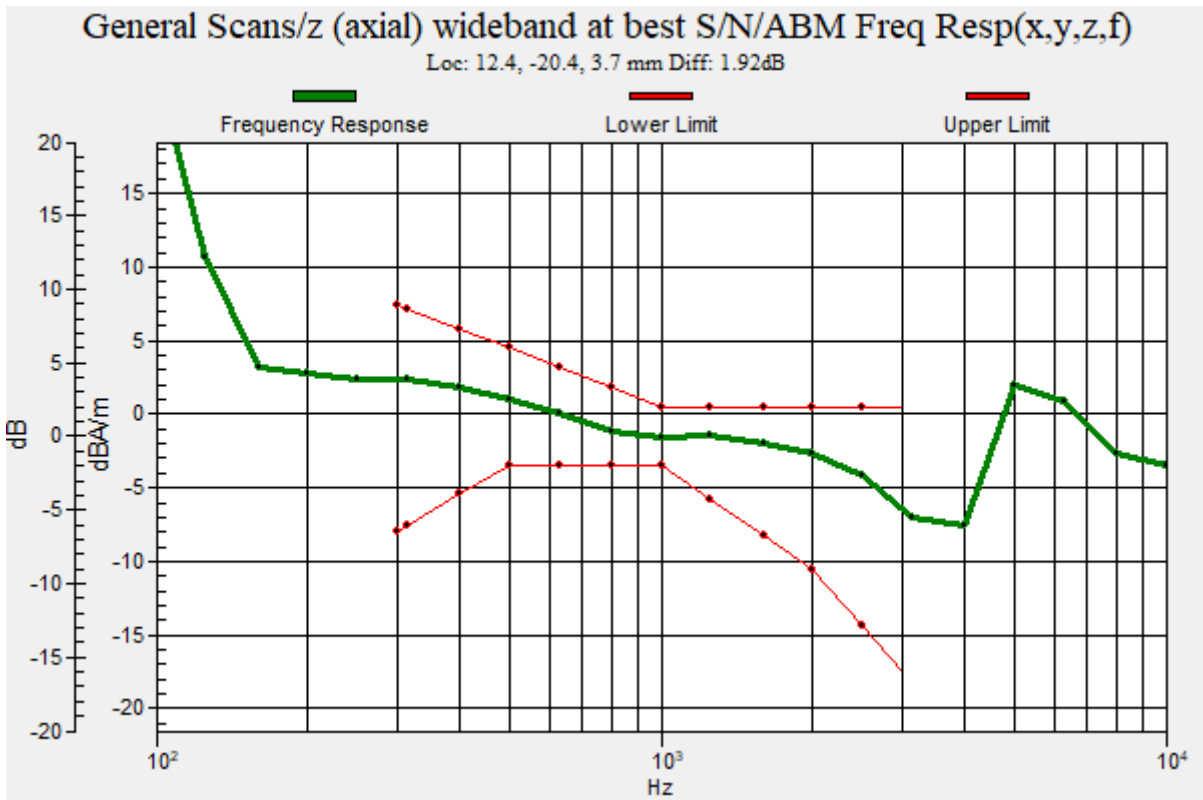

**Plot No.30**

**LTE 7 64QAM EVS WB 5.9bitrate 15MHz 1RB 74offset 21100ch y(transversal)**

**DUT: SM-G991U; Type: Bar**

Communication System: UID 0, LTE Band 7 (0); Frequency: 2535 MHz;Duty Cycle: 1:1  
Medium parameters used:  $\sigma = 0$  S/m,  $\epsilon_r = 1$ ;  $\rho = 0$  kg/m<sup>3</sup>  
Phantom section: TCoil Section

DASY Configuration:

- Probe: AM1DV3 - 3049; ;
- Sensor-Surface: 0mm (Fix Surface)
- Electronics: DAE4 Sn466; Calibrated: 2020-04-22
- Phantom: HAC Test Arch with AMCC
- Measurement SW: DASY52, Version 52.10 (4);

**T-Coil scan (scan for ANSI C63.19-2007 & 2011 compliance)/General Scans/y (transversal) 4.2mm 50**

**x 50/ABM Signal(x,y,z) (13x13x1):** Measurement grid: dx=10mm, dy=10mm

Signal Type: Audio File (.wav) 48k\_voice\_1kHz\_1s.wav

Output Gain: 24.38

Measure Window Start: 300ms

Measure Window Length: 1000ms

BWC applied: 0.17 dB

Device Reference Point: 0, 0, -6.3 mm

**Cursor:**

ABM1 comp = -3.84 dBA/m

BWC Factor = 0.17 dB

Location: 12.5, 0, 3.7 mm

**Cursor:**

ABM2 = -29.95 dBA/m

Location: 12.5, 0, 3.7 mm

**Cursor:**

ABM1/ABM2 = 26.11 dB

ABM1 comp = -3.84 dBA/m

BWC Factor = 0.17 dB

Location: 12.5, 0, 3.7 mm

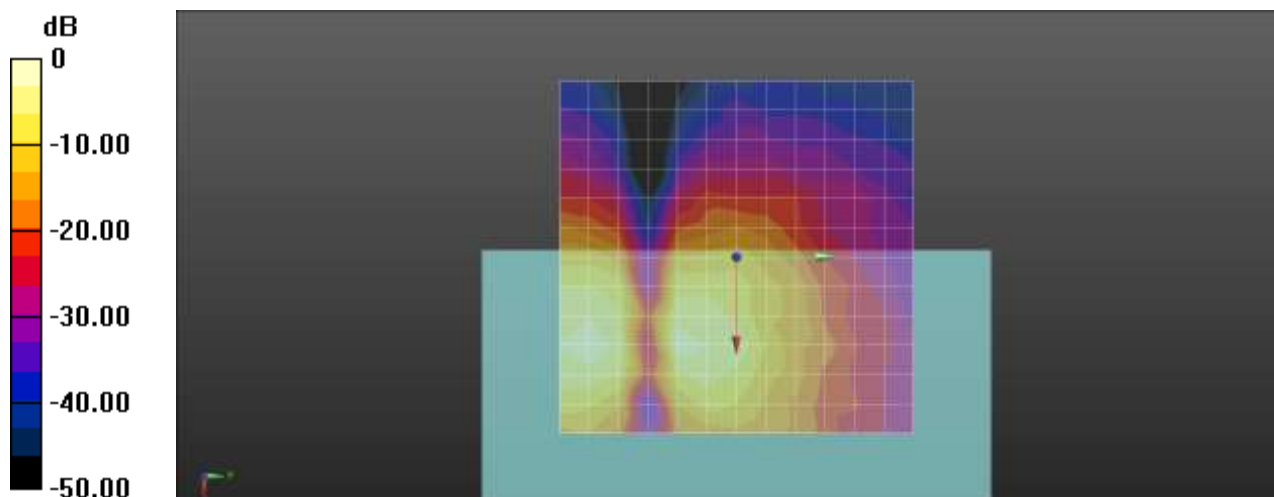

0 dB = 1.000 A/m = 0.00 dBA/m

**Plot No.31**

**LTE 12 64QAM EVS WB 5.9bitrate 10MHz 1RB 49offset 23095ch z(axial)**

**DUT: SM-G991U; Type: Bar**

Communication System: UID 0, LTE Band12 (0); Frequency: 707.5 MHz;Duty Cycle: 1:1  
Medium parameters used:  $\sigma = 0$  S/m,  $\epsilon_r = 1$ ;  $\rho = 0$  kg/m<sup>3</sup>  
Phantom section: TCoil Section

DASY Configuration:

- Probe: AM1DV3 - 3049; ;
- Sensor-Surface: 0mm (Fix Surface)
- Electronics: DAE4 Sn466; Calibrated: 2020-04-22
- Phantom: HAC Test Arch with AMCC
- Measurement SW: DASY52, Version 52.10 (4);

**T-Coil scan (scan for ANSI C63.19-2007 & 2011 compliance)/General Scans/z (axial) 4.2mm 50 x**

**50/ABM Signal(x,y,z) (13x13x1):** Measurement grid: dx=10mm, dy=10mm

Signal Type: Audio File (.wav) 48k\_voice\_1kHz\_1s.wav

Output Gain: 24.38

Measure Window Start: 300ms

Measure Window Length: 1000ms

BWC applied: 0.17 dB

Device Reference Point: 0, 0, -6.3 mm

**Cursor:**

ABM1 comp = 3.66 dBA/m

BWC Factor = 0.17 dB

Location: 8.3, -8.3, 3.7 mm

**Cursor:**

ABM2 = -23.22 dBA/m

Location: 8.3, -8.3, 3.7 mm

**Cursor:**

ABM1/ABM2 = 26.88 dB

ABM1 comp = 3.66 dBA/m

BWC Factor = 0.17 dB

Location: 8.3, -8.3, 3.7 mm

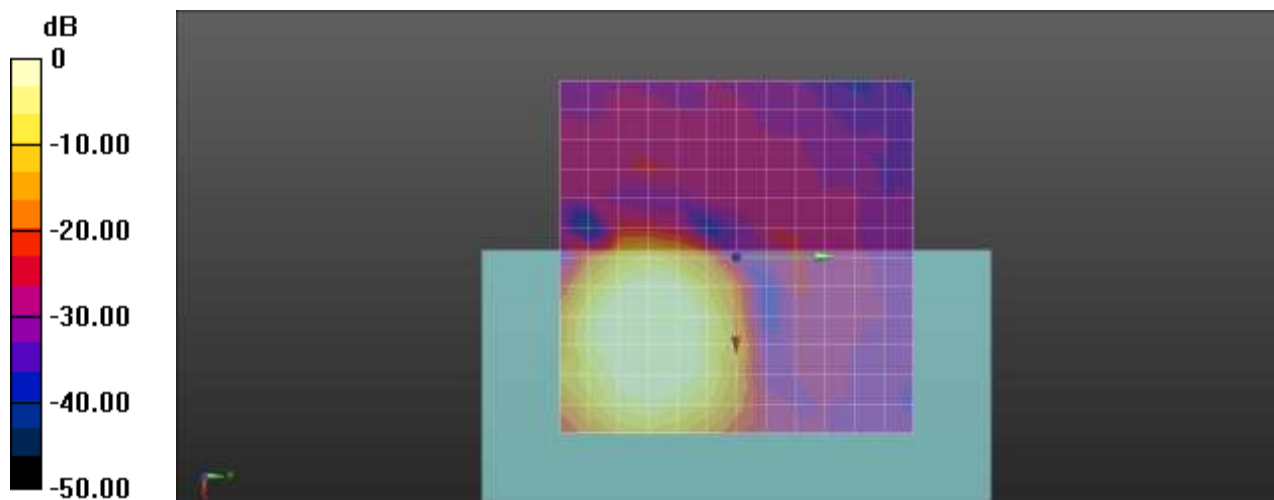

0 dB = 1.000 A/m = 0.00 dBA/m

**Plot No.32**

**LTE 12 64QAM EVS WB 5.9bitrate 10MHz 1RB 49offset 23095ch Freq.Response**

**DUT: SM-G991U; Type: Bar**

Communication System: UID 0, LTE Band12 (0); Frequency: 707.5 MHz;Duty Cycle: 1:1  
Medium parameters used:  $\sigma = 0$  S/m,  $\epsilon_r = 1$ ;  $\rho = 0$  kg/m<sup>3</sup>  
Phantom section: TCoil Section

**T-Coil scan (scan for ANSI C63.19-2007 & 2011 compliance)/General Scans/z (axial) wideband at best S/N/ABM Freq Resp(x,y,z,f) (1x1x1):** Measurement grid: dx=10mm, dy=10mm  
Signal Type: Audio File (.wav) 48k\_Normal\_51s new.wav  
Output Gain: 52.45  
Measure Window Start: 300ms  
Measure Window Length: 51000ms  
BWC applied: 9.50 dB  
Device Reference Point: 0, 0, -6.3 mm

Category	Telephone parameters WD signal quality [(signal+noise)-to-noise ratio in decibels]
Category T1	0 dB to 10 dB
Category T2	10 dB to 20 dB
Category T3	20 dB to 30 dB
Category T4	> 30 dB

**Cursor:**

Diff = 1.95 dB  
BWC Factor = 9.50 dB  
Location: 7.3, -8.5, 3.7 mm

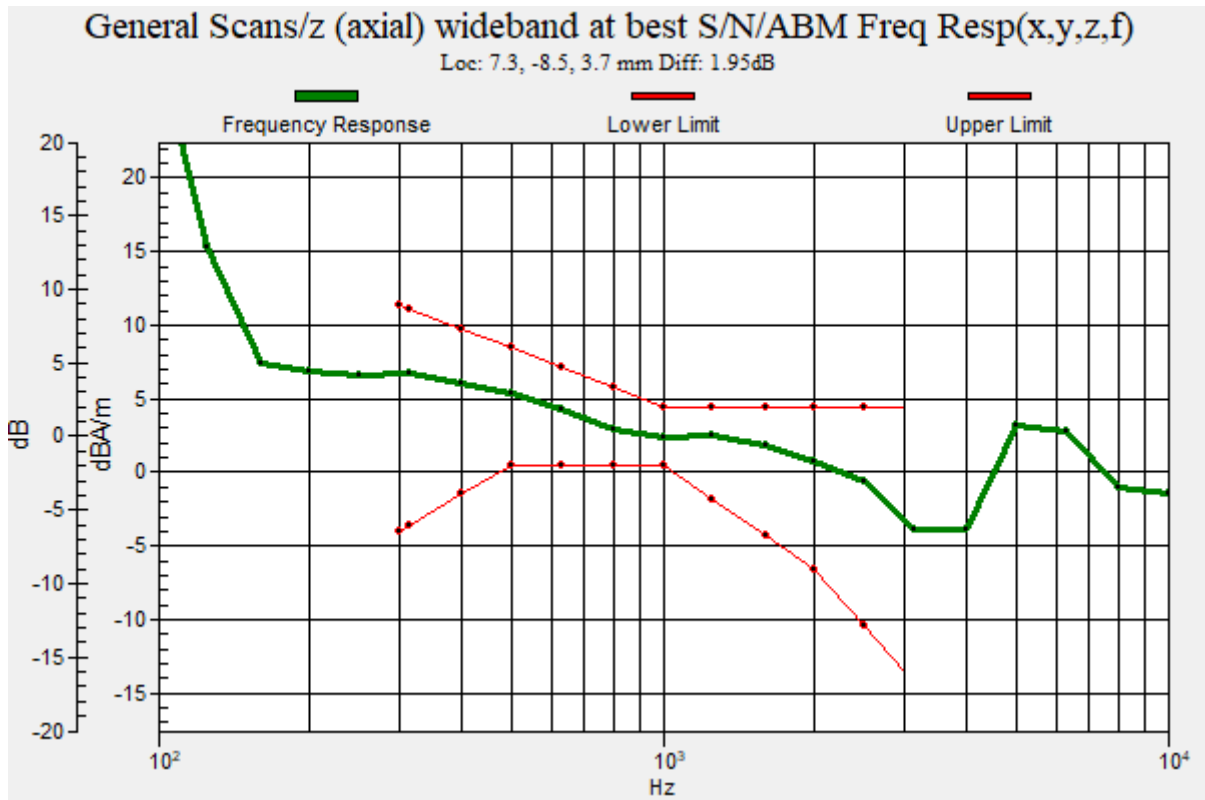

**Plot No.33**

**LTE 12 64QAM EVS WB 5.9bitrate 10MHz 1RB 49offset 23095ch y(transversal)**

**DUT: SM-G991U; Type: Bar**

Communication System: UID 0, LTE Band12 (0); Frequency: 707.5 MHz;Duty Cycle: 1:1  
Medium parameters used:  $\sigma = 0$  S/m,  $\epsilon_r = 1$ ;  $\rho = 0$  kg/m<sup>3</sup>  
Phantom section: TCoil Section

DASY Configuration:

- Probe: AM1DV3 - 3049; ;
- Sensor-Surface: 0mm (Fix Surface)
- Electronics: DAE4 Sn466; Calibrated: 2020-04-22
- Phantom: HAC Test Arch with AMCC
- Measurement SW: DASY52, Version 52.10 (4);

**T-Coil scan (scan for ANSI C63.19-2007 & 2011 compliance)/General Scans/y (transversal) 4.2mm 50**

**x 50/ABM Signal(x,y,z) (13x13x1):** Measurement grid: dx=10mm, dy=10mm

Signal Type: Audio File (.wav) 48k\_voice\_1kHz\_1s.wav

Output Gain: 24.38

Measure Window Start: 300ms

Measure Window Length: 1000ms

BWC applied: 0.17 dB

Device Reference Point: 0, 0, -6.3 mm

**Cursor:**

ABM1 comp = -7.43 dBA/m

BWC Factor = 0.17 dB

Location: 4.2, 0, 3.7 mm

**Cursor:**

ABM2 = -32.71 dBA/m

Location: 4.2, 0, 3.7 mm

**Cursor:**

ABM1/ABM2 = 25.27 dB

ABM1 comp = -7.43 dBA/m

BWC Factor = 0.17 dB

Location: 4.2, 0, 3.7 mm

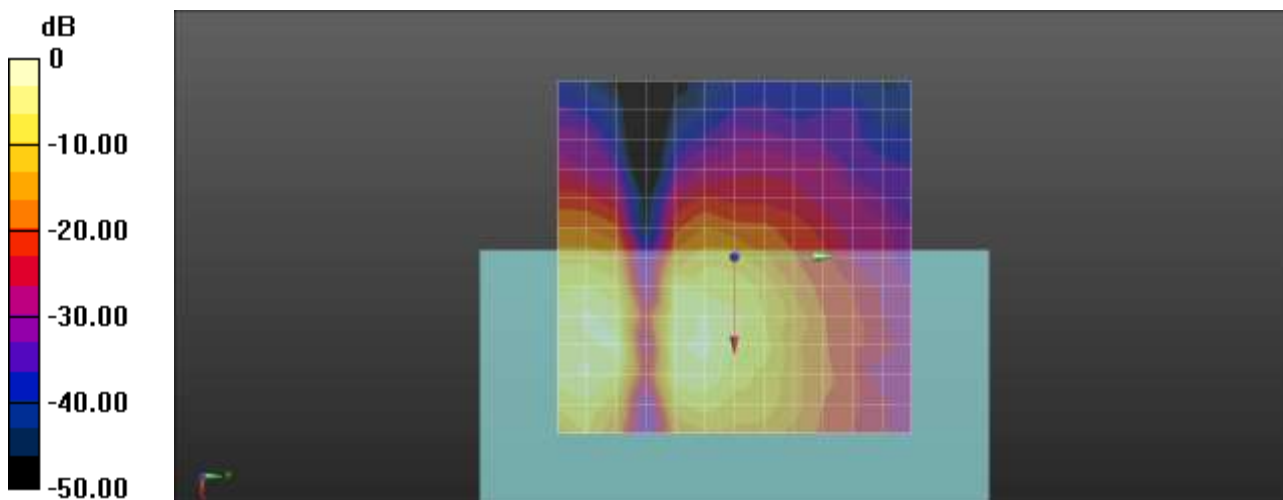

0 dB = 1.000 A/m = 0.00 dBA/m

**Plot No.34**

**LTE 13 64QAM EVS WB 5.9bitrate 10MHz 1RB 49offsett 23230ch z(axial)**

**DUT: SM-G991U; Type: Bar**

Communication System: UID 0, LTE Band 13 (0); Frequency: 782 MHz;Duty Cycle: 1:1  
Medium parameters used:  $\sigma = 0$  S/m,  $\epsilon_r = 1$ ;  $\rho = 0$  kg/m<sup>3</sup>  
Phantom section: TCoil Section

DASY Configuration:

- Probe: AM1DV3 - 3049; ;
- Sensor-Surface: 0mm (Fix Surface)
- Electronics: DAE4 Sn466; Calibrated: 2020-04-22
- Phantom: HAC Test Arch with AMCC
- Measurement SW: DASY52, Version 52.10 (4);

**T-Coil scan (scan for ANSI C63.19-2007 & 2011 compliance)/General Scans/z (axial) 4.2mm 50 x**

**50/ABM Noise(x,y,z) (13x13x1):** Measurement grid: dx=10mm, dy=10mm

Signal Type: Audio File (.wav) 48k\_voice\_1kHz\_1s.wav

Output Gain: 24.38

Measure Window Start: 300ms

Measure Window Length: 1000ms

Device Reference Point: 0, 0, -6.3 mm

**Cursor:**

ABM1 comp = -8.83 dBA/m

BWC Factor = 0.17 dB

Location: 4.2, -20.8, 3.7 mm

**Cursor:**

ABM2 = -33.80 dBA/m

Location: 4.2, -20.8, 3.7 mm

**Cursor:**

ABM1/ABM2 = 24.97 dB

ABM1 comp = -8.83 dBA/m

BWC Factor = 0.17 dB

Location: 4.2, -20.8, 3.7 mm

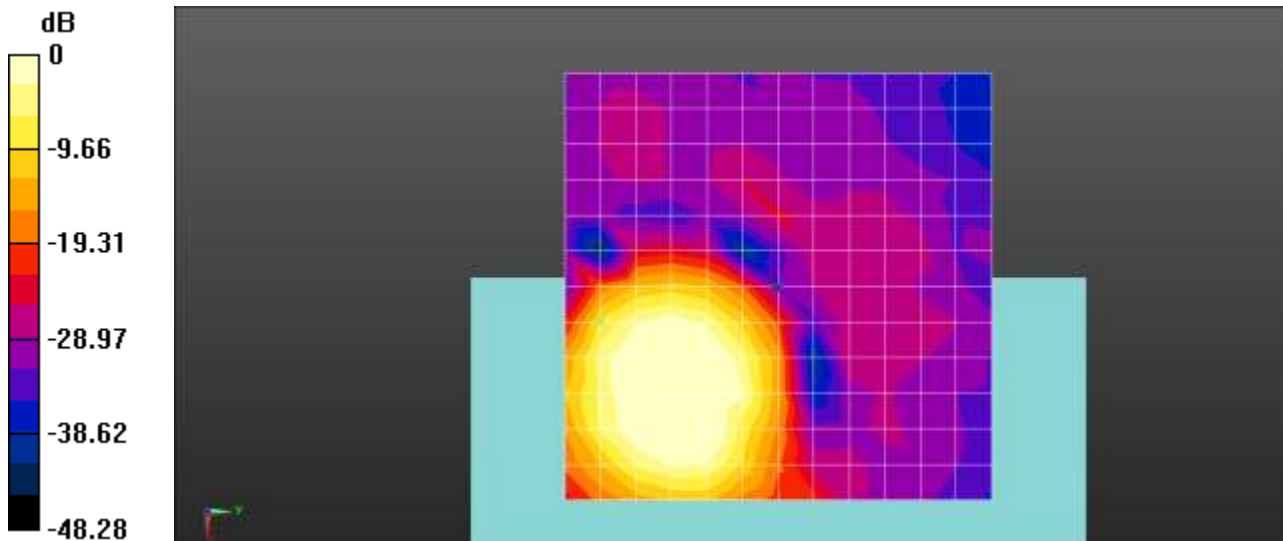

0 dB = 1.000 A/m = 0.00 dBA/m

**Plot No.35**

**LTE 13 64QAM EVS WB 5.9bitrate 10MHz 1RB 49offset 23230ch Freq.Response**

**DUT: SM-G991U; Type: Bar**

Communication System: UID 0, LTE Band 13 (0); Frequency: 782 MHz;Duty Cycle: 1:1  
Medium parameters used:  $\sigma = 0$  S/m,  $\epsilon_r = 1$ ;  $\rho = 0$  kg/m<sup>3</sup>  
Phantom section: TCoil Section

**T-Coil scan (scan for ANSI C63.19-2007 & 2011 compliance)/General Scans/z (axial) wideband at best**

**S/N/ABM Freq Resp(x,y,z,f) (1x1x1):** Measurement grid: dx=10mm, dy=10mm

Signal Type: Audio File (.wav) 48k\_Normal\_51s new.wav

Output Gain: 52.45

Measure Window Start: 300ms

Measure Window Length: 51000ms

BWC applied: 9.49 dB

Device Reference Point: 0, 0, -6.3 mm

Category	Telephone parameters WD signal quality [(signal+noise)-to-noise ratio in decibels]
Category T1	0 dB to 10 dB
Category T2	10 dB to 20 dB
Category T3	20 dB to 30 dB
Category T4	> 30 dB

**Cursor:**

Diff = 1.92 dB

BWC Factor = 9.49 dB

Location: 5, -19.9, 3.7 mm

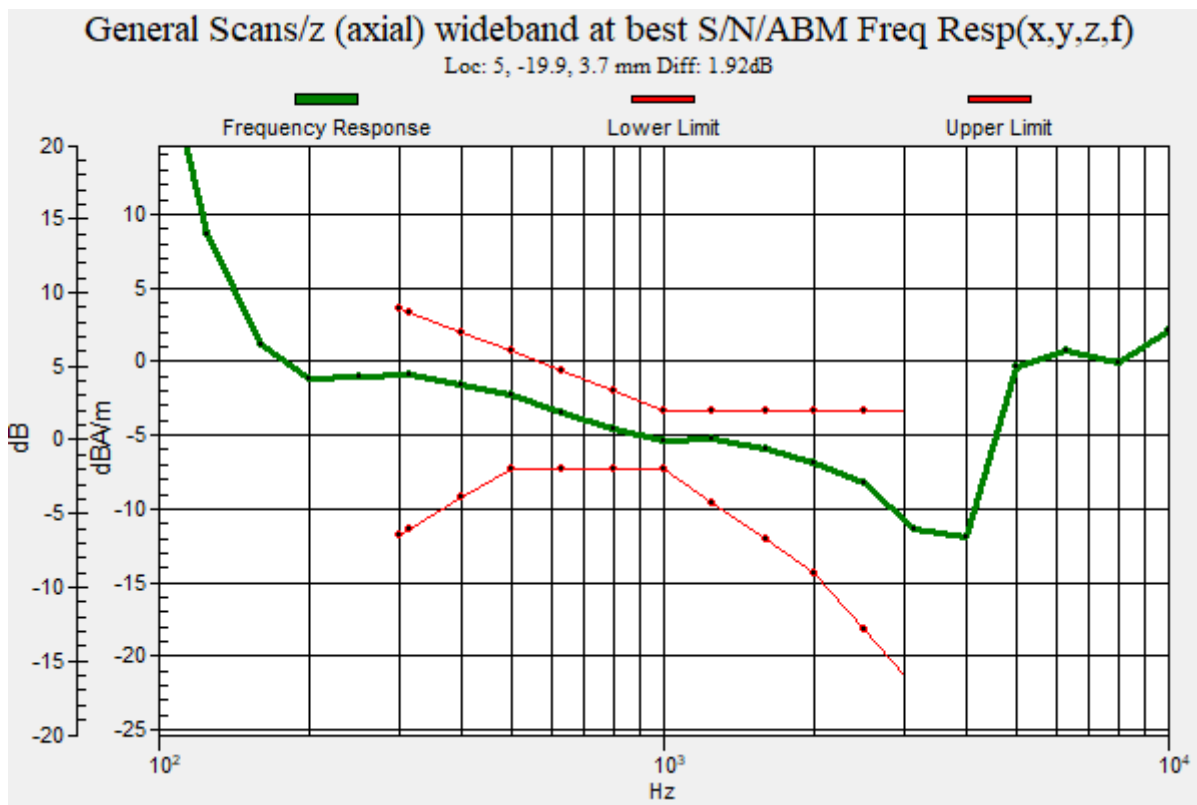



**Plot No.36**

**LTE 13 64QAM EVS WB 5.9bitrate 10MHz 1RB 49offset 23230ch y(transversal)**

**DUT: SM-G991U; Type: Bar**

Communication System: UID 0, LTE Band 13 (0); Frequency: 782 MHz;Duty Cycle: 1:1  
Medium parameters used:  $\sigma = 0$  S/m,  $\epsilon_r = 1$ ;  $\rho = 0$  kg/m<sup>3</sup>  
Phantom section: TCoil Section

DASY Configuration:

- Probe: AM1DV3 - 3049; ;
- Sensor-Surface: 0mm (Fix Surface)
- Electronics: DAE4 Sn466; Calibrated: 2020-04-22
- Phantom: HAC Test Arch with AMCC
- Measurement SW: DASY52, Version 52.10 (4);

**T-Coil scan (scan for ANSI C63.19-2007 & 2011 compliance)/General Scans/y (transversal) 4.2mm 50**

**x 50/ABM Signal(x,y,z) (13x13x1):** Measurement grid: dx=10mm, dy=10mm

Signal Type: Audio File (.wav) 48k\_voice\_1kHz\_1s.wav

Output Gain: 24.38

Measure Window Start: 300ms

Measure Window Length: 1000ms

BWC applied: 0.17 dB

Device Reference Point: 0, 0, -6.3 mm

**Cursor:**

ABM1 comp = -7.83 dBA/m

BWC Factor = 0.17 dB

Location: 0, -4.2, 3.7 mm

**Cursor:**

ABM2 = -34.17 dBA/m

Location: 0, -4.2, 3.7 mm

**Cursor:**

ABM1/ABM2 = 26.34 dB

ABM1 comp = -7.83 dBA/m

BWC Factor = 0.17 dB

Location: 0, -4.2, 3.7 mm

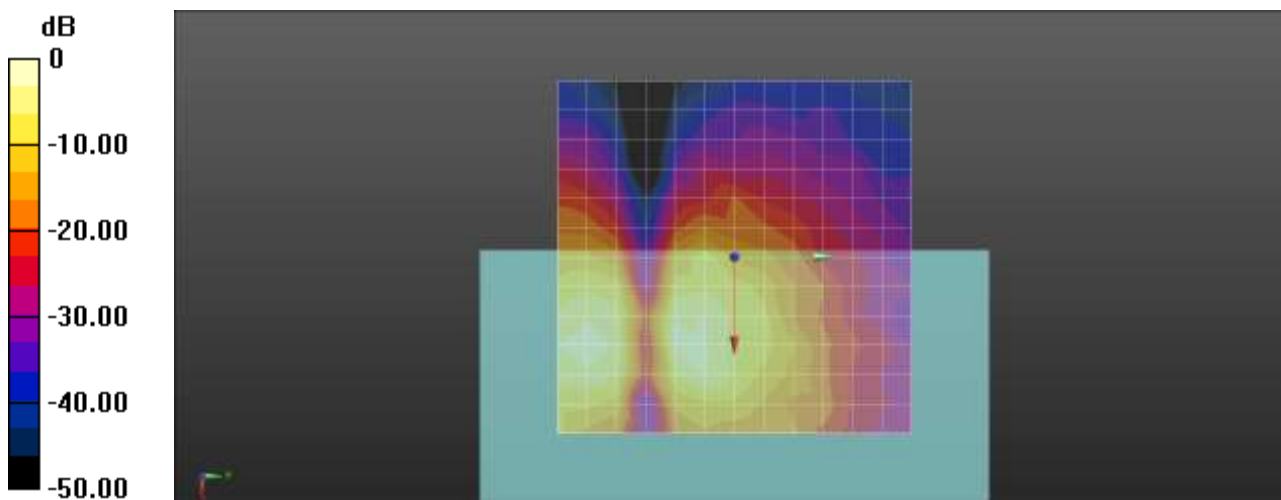

0 dB = 1.000 A/m = 0.00 dBA/m

**Plot No.37**

**LTE 14 64QAM EVS WB 5.9bitrate 10MHz 1RB 49offset 23330ch z(axial)**

**DUT: SM-G991U; Type: Bar**

Communication System: UID 0, LTE Band 14 (0); Frequency: 793 MHz;Duty Cycle: 1:1  
Medium parameters used:  $\sigma = 0$  S/m,  $\epsilon_r = 1$ ;  $\rho = 0$  kg/m<sup>3</sup>  
Phantom section: TCoil Section

DASY Configuration:

- Probe: AM1DV3 - 3049; ;
- Sensor-Surface: 0mm (Fix Surface)
- Electronics: DAE4 Sn466; Calibrated: 2020-04-22
- Phantom: HAC Test Arch with AMCC
- Measurement SW: DASY52, Version 52.10 (4);

**T-Coil scan (scan for ANSI C63.19-2007 & 2011 compliance)/General Scans/z (axial) 4.2mm 50 x**

**50/ABM Signal(x,y,z) (13x13x1):** Measurement grid: dx=10mm, dy=10mm

Signal Type: Audio File (.wav) 48k\_voice\_1kHz\_1s.wav

Output Gain: 24.38

Measure Window Start: 300ms

Measure Window Length: 1000ms

BWC applied: 0.16 dB

Device Reference Point: 0, 0, -6.3 mm

**Cursor:**

ABM1 comp = -2.85 dBA/m

BWC Factor = 0.16 dB

Location: 4.2, -16.7, 3.7 mm

**Cursor:**

ABM2 = -28.51 dBA/m

Location: 4.2, -16.7, 3.7 mm

**Cursor:**

ABM1/ABM2 = 25.66 dB

ABM1 comp = -2.85 dBA/m

BWC Factor = 0.16 dB

Location: 4.2, -16.7, 3.7 mm

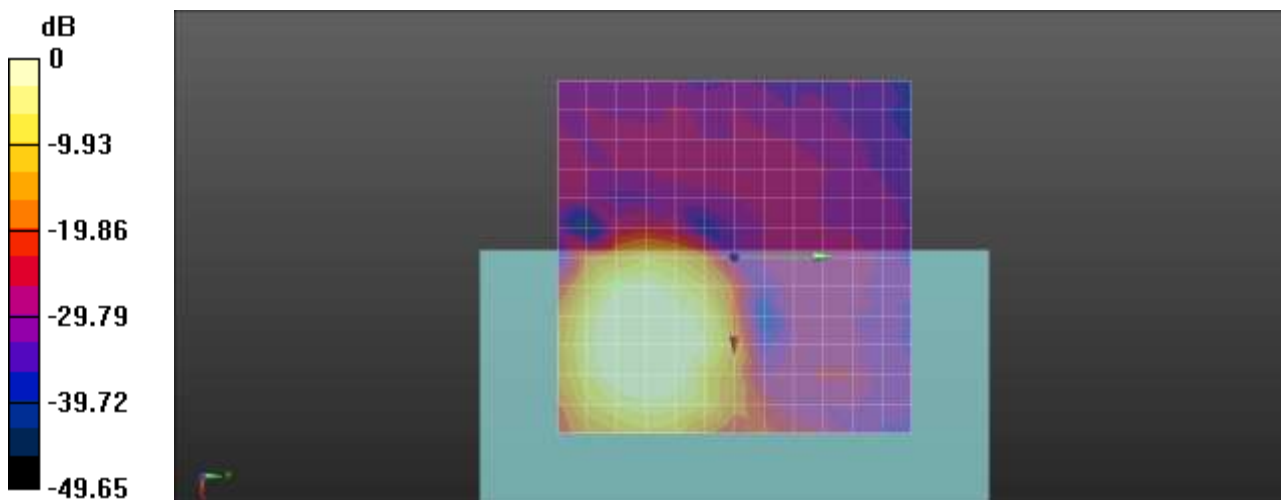

0 dB = 1.000 A/m = 0.00 dBA/m

**Plot No.38**

**LTE 14 64QAM EVS WB 5.9bitrate 10MHz 1RB 49offset 23330ch Freq.Response**

**DUT: SM-G991U; Type: Bar**

Communication System: UID 0, LTE Band 14 (0); Frequency: 793 MHz;Duty Cycle: 1:1  
Medium parameters used:  $\sigma = 0$  S/m,  $\epsilon_r = 1$ ;  $\rho = 0$  kg/m<sup>3</sup>  
Phantom section: TCoil Section

**T-Coil scan (scan for ANSI C63.19-2007 & 2011 compliance)/General Scans/z (axial) wideband at best**

**S/N/ABM Freq Resp(x,y,z,f) (1x1x1):** Measurement grid: dx=10mm, dy=10mm

Signal Type: Audio File (.wav) 48k\_Normal\_51s new.wav

Output Gain: 52.45

Measure Window Start: 300ms

Measure Window Length: 51000ms

BWC applied: 9.48 dB

Device Reference Point: 0, 0, -6.3 mm

Category	Telephone parameters WD signal quality [(signal+noise)-to-noise ratio in decibels]
Category T1	0 dB to 10 dB
Category T2	10 dB to 20 dB
Category T3	20 dB to 30 dB
Category T4	> 30 dB

**Cursor:**

Diff = 2.00 dB

BWC Factor = 9.48 dB

Location: 4.7, -15.9, 3.7 mm

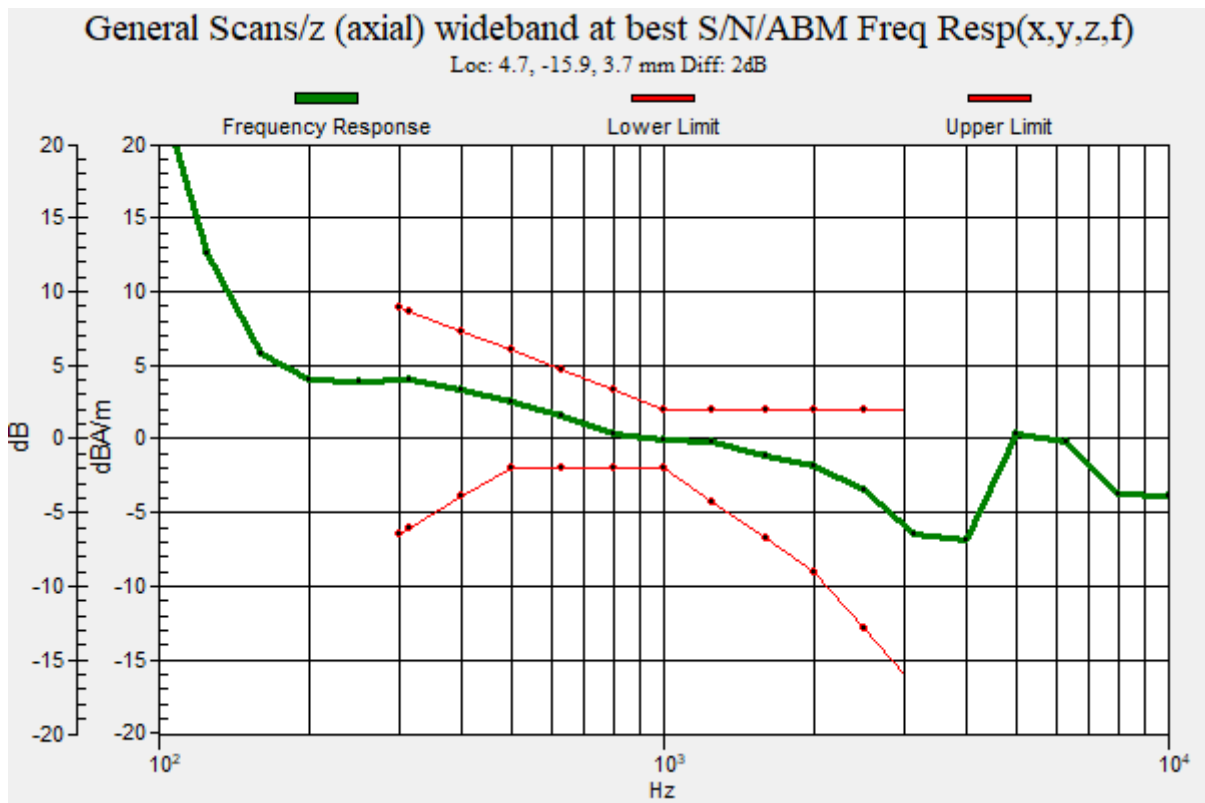

**Plot No.39**

**LTE 14 64QAM EVS WB 5.9bitrate 10MHz 1RB 49offset 23330ch y(transversal)**

**DUT: SM-G991U; Type: Bar**

Communication System: UID 0, LTE Band 14 (0); Frequency: 793 MHz;Duty Cycle: 1:1  
Medium parameters used:  $\sigma = 0$  S/m,  $\epsilon_r = 1$ ;  $\rho = 0$  kg/m<sup>3</sup>  
Phantom section: TCoil Section

DASY Configuration:

- Probe: AM1DV3 - 3049; ;
- Sensor-Surface: 0mm (Fix Surface)
- Electronics: DAE4 Sn466; Calibrated: 2020-04-22
- Phantom: HAC Test Arch with AMCC
- Measurement SW: DASY52, Version 52.10 (4);

**T-Coil scan (scan for ANSI C63.19-2007 & 2011 compliance)/General Scans/y (transversal) 4.2mm 50**

**x 50/ABM Signal(x,y,z) (13x13x1):** Measurement grid: dx=10mm, dy=10mm

Signal Type: Audio File (.wav) 48k\_voice\_1kHz\_1s.wav

Output Gain: 24.38

Measure Window Start: 300ms

Measure Window Length: 1000ms

BWC applied: 0.16 dB

Device Reference Point: 0, 0, -6.3 mm

**Cursor:**

ABM1 comp = -7.94 dBA/m

BWC Factor = 0.16 dB

Location: 8.3, 4.2, 3.7 mm

**Cursor:**

ABM2 = -34.70 dBA/m

Location: 8.3, 4.2, 3.7 mm

**Cursor:**

ABM1/ABM2 = 26.76 dB

ABM1 comp = -7.94 dBA/m

BWC Factor = 0.16 dB

Location: 8.3, 4.2, 3.7 mm

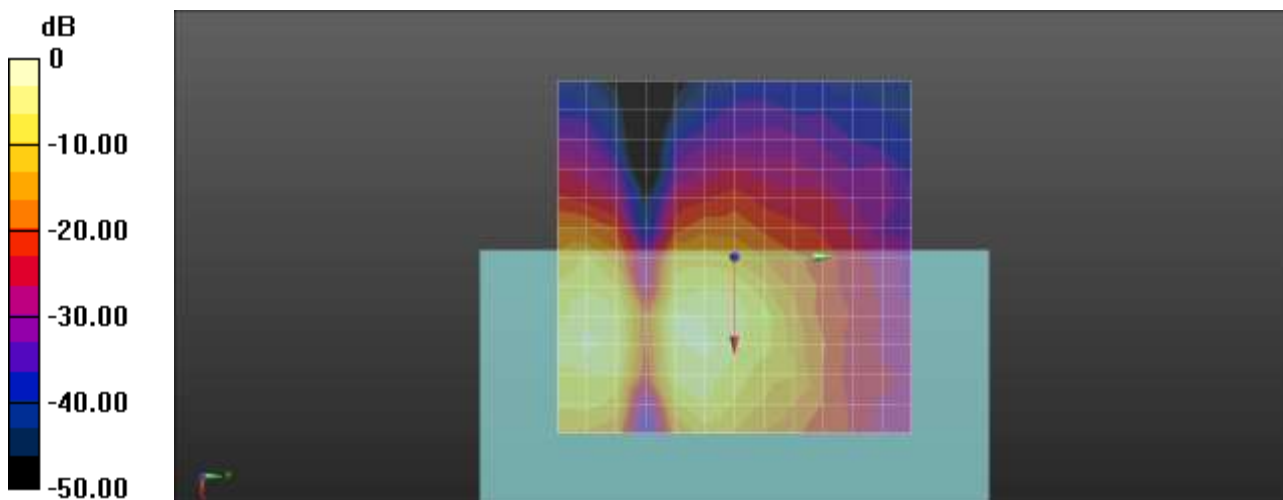

0 dB = 1.000 A/m = 0.00 dBA/m

**Plot No.40**

**LTE 26 64QAM EVS WB 5.9bitrate 15MHz 1RB 74offset 26865ch z(axial)**

**DUT: SM-G991U; Type: Bar**

Communication System: UID 0, LTE Band 26 (0); Frequency: 831.5 MHz;Duty Cycle: 1:1  
Medium parameters used:  $\sigma = 0$  S/m,  $\epsilon_r = 1$ ;  $\rho = 0$  kg/m<sup>3</sup>  
Phantom section: TCoil Section

DASY Configuration:

- Probe: AM1DV3 - 3049; ;
- Sensor-Surface: 0mm (Fix Surface)
- Electronics: DAE4 Sn466; Calibrated: 2020-04-22
- Phantom: HAC Test Arch with AMCC
- Measurement SW: DASY52, Version 52.10 (4);

**T-Coil scan (scan for ANSI C63.19-2007 & 2011 compliance)/General Scans/z (axial) 4.2mm 50 x**

**50/ABM Signal(x,y,z) (13x13x1):** Measurement grid: dx=10mm, dy=10mm

Signal Type: Audio File (.wav) 48k\_voice\_1kHz\_1s.wav

Output Gain: 24.38

Measure Window Start: 300ms

Measure Window Length: 1000ms

BWC applied: 0.16 dB

Device Reference Point: 0, 0, -6.3 mm

**Cursor:**

ABM1 comp = 3.45 dBA/m

BWC Factor = 0.16 dB

Location: 8.3, -8.3, 3.7 mm

**Cursor:**

ABM2 = -23.15 dBA/m

Location: 8.3, -8.3, 3.7 mm

**Cursor:**

ABM1/ABM2 = 26.60 dB

ABM1 comp = 3.45 dBA/m

BWC Factor = 0.16 dB

Location: 8.3, -8.3, 3.7 mm

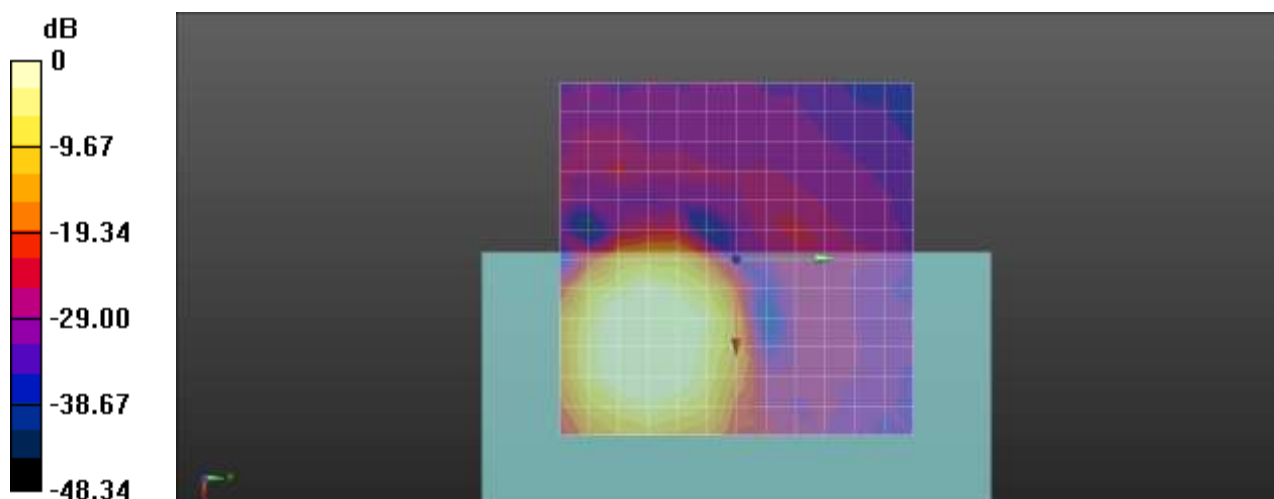

0 dB = 1.000 A/m = 0.00 dBA/m

**Plot No.41**

**LTE 26 64QAM EVS WB 5.9bitrate 15MHz 1RB 74offset 26865ch Freq.Response**

**DUT: SM-G991U; Type: Bar**

Communication System: UID 0, LTE Band 26 (0); Frequency: 831.5 MHz;Duty Cycle: 1:1  
Medium parameters used:  $\sigma = 0$  S/m,  $\epsilon_r = 1$ ;  $\rho = 0$  kg/m<sup>3</sup>  
Phantom section: TCoil Section

**T-Coil scan (scan for ANSI C63.19-2007 & 2011 compliance)/General Scans/z (axial) wideband at best S/N/ABM Freq Resp(x,y,z,f) (1x1x1):** Measurement grid: dx=10mm, dy=10mm  
Signal Type: Audio File (.wav) 48k\_Normal\_51s new.wav  
Output Gain: 52.45  
Measure Window Start: 300ms  
Measure Window Length: 51000ms  
BWC applied: 9.48 dB  
Device Reference Point: 0, 0, -6.3 mm

Category	Telephone parameters WD signal quality [(signal+noise)-to-noise ratio in decibels]
Category T1	0 dB to 10 dB
Category T2	10 dB to 20 dB
Category T3	20 dB to 30 dB
Category T4	> 30 dB

**Cursor:**

Diff = 1.92 dB  
BWC Factor = 9.48 dB  
Location: 8.4, -7.8, 3.7 mm

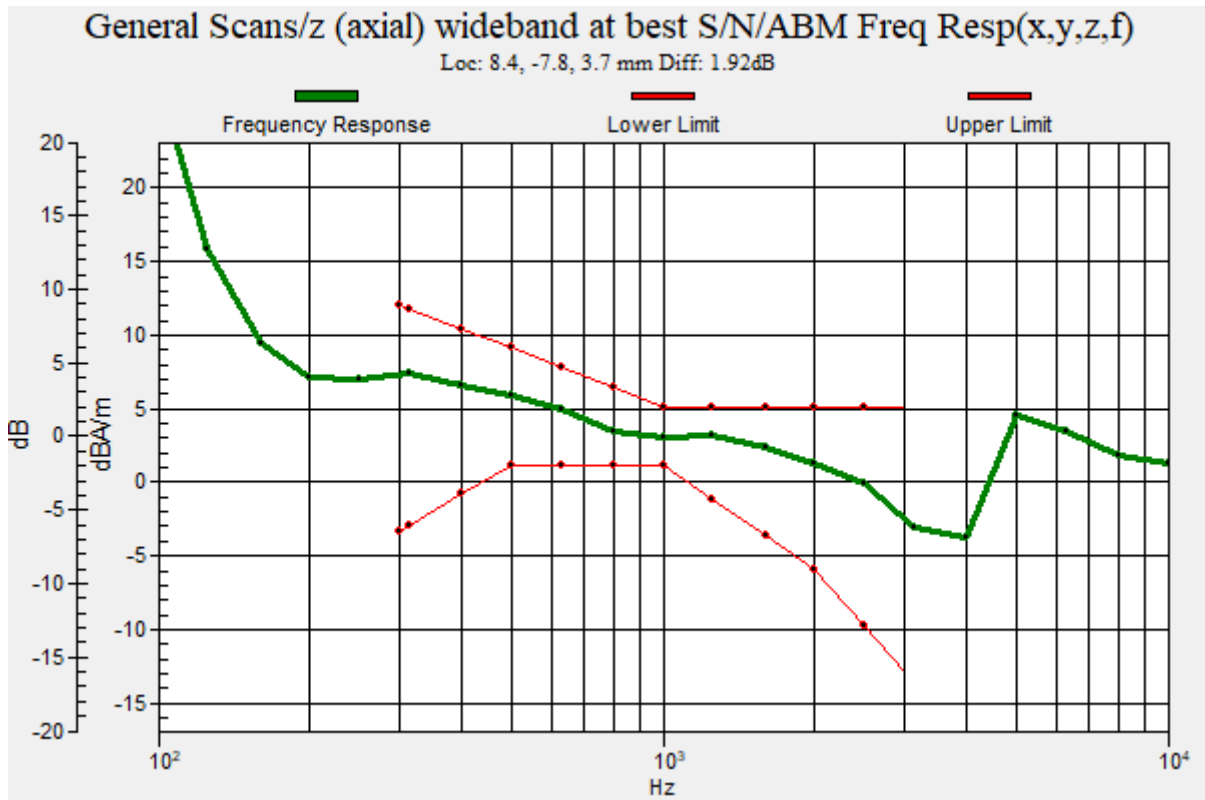

**Plot No.42**

**LTE 26 64QAM EVS WB 5.9bitrate 15MHz 1RB 74offset 26865ch y(transversal)**

**DUT: SM-G991U; Type: Bar**

Communication System: UID 0, LTE Band 26 (0); Frequency: 831.5 MHz;Duty Cycle: 1:1  
Medium parameters used:  $\sigma = 0$  S/m,  $\epsilon_r = 1$ ;  $\rho = 0$  kg/m<sup>3</sup>  
Phantom section: TCoil Section

DASY Configuration:

- Probe: AM1DV3 - 3049; ;
- Sensor-Surface: 0mm (Fix Surface)
- Electronics: DAE4 Sn466; Calibrated: 2020-04-22
- Phantom: HAC Test Arch with AMCC
- Measurement SW: DASY52, Version 52.10 (4);

**T-Coil scan (scan for ANSI C63.19-2007 & 2011 compliance)/General Scans/y (transversal) 4.2mm 50**

**x 50/ABM Signal(x,y,z) (13x13x1):** Measurement grid: dx=10mm, dy=10mm

Signal Type: Audio File (.wav) 48k\_voice\_1kHz\_1s.wav

Output Gain: 24.38

Measure Window Start: 300ms

Measure Window Length: 1000ms

BWC applied: 0.16 dB

Device Reference Point: 0, 0, -6.3 mm

**Cursor:**

ABM1 comp = -2.39 dBA/m

BWC Factor = 0.16 dB

Location: 8.3, -25, 3.7 mm

**Cursor:**

ABM2 = -29.20 dBA/m

Location: 8.3, -25, 3.7 mm

**Cursor:**

ABM1/ABM2 = 26.81 dB

ABM1 comp = -2.39 dBA/m

BWC Factor = 0.16 dB

Location: 8.3, -25, 3.7 mm

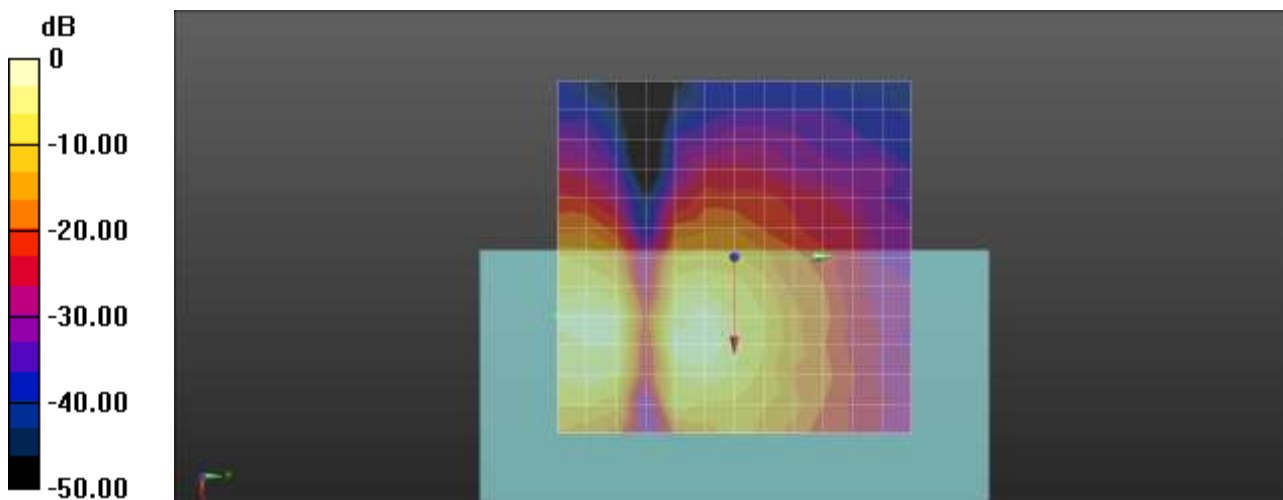

0 dB = 1.000 A/m = 0.00 dBA/m

**Plot No.43**

**LTE 30 64QAM EVS WB 5.9bitrate 10MHz 1RB 49offset 27710ch z(axial)**

**DUT: SM-G991U; Type: Bar**

Communication System: UID 0, LTE Band30 (0); Frequency: 2310 MHz;Duty Cycle: 1:1  
Medium parameters used:  $\sigma = 0$  S/m,  $\epsilon_r = 1$ ;  $\rho = 0$  kg/m<sup>3</sup>  
Phantom section: TCoil Section

DASY Configuration:

- Probe: AM1DV3 - 3049; ;
- Sensor-Surface: 0mm (Fix Surface)
- Electronics: DAE4 Sn466; Calibrated: 2020-04-22
- Phantom: HAC Test Arch with AMCC
- Measurement SW: DASY52, Version 52.10 (4);

**T-Coil scan (scan for ANSI C63.19-2007 & 2011 compliance)/General Scans/z (axial) 4.2mm 50 x**

**50/ABM Signal(x,y,z) (13x13x1):** Measurement grid: dx=10mm, dy=10mm

Signal Type: Audio File (.wav) 48k\_voice\_1kHz\_1s.wav

Output Gain: 24.38

Measure Window Start: 300ms

Measure Window Length: 1000ms

BWC applied: 0.16 dB

Device Reference Point: 0, 0, -6.3 mm

**Cursor:**

ABM1 comp = -1.18 dBA/m

BWC Factor = 0.16 dB

Location: 4.2, -12.5, 3.7 mm

**Cursor:**

ABM2 = -26.41 dBA/m

Location: 4.2, -12.5, 3.7 mm

**Cursor:**

ABM1/ABM2 = 25.24 dB

ABM1 comp = -1.18 dBA/m

BWC Factor = 0.16 dB

Location: 4.2, -12.5, 3.7 mm

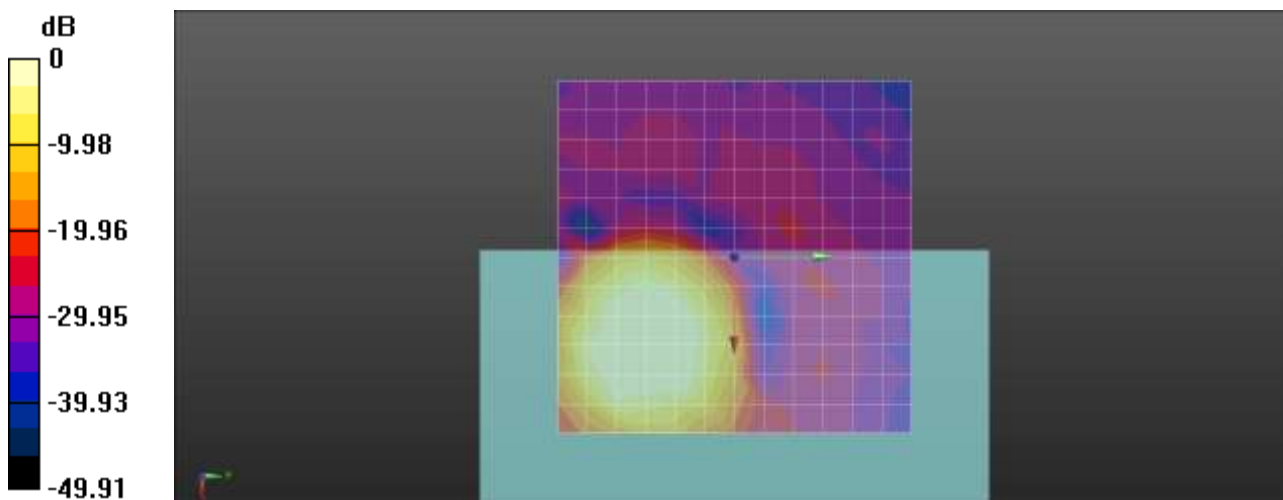

0 dB = 1.000 A/m = 0.00 dBA/m



**Plot No.44**

**LTE 30 64QAM EVS WB 5.9bitrate 10MHz 1RB 49offset 27710ch Freq.Response**

**DUT: SM-G991U; Type: Bar**

Communication System: UID 0, LTE Band30 (0); Frequency: 2310 MHz;Duty Cycle: 1:1  
Medium parameters used:  $\sigma = 0$  S/m,  $\epsilon_r = 1$ ;  $\rho = 0$  kg/m<sup>3</sup>  
Phantom section: TCoil Section

**T-Coil scan (scan for ANSI C63.19-2007 & 2011 compliance)/General Scans/z (axial) wideband at best S/N/ABM Freq Resp(x,y,z,f) (1x1x1):** Measurement grid: dx=10mm, dy=10mm  
Signal Type: Audio File (.wav) 48k\_Normal\_51s new.wav  
Output Gain: 52.45  
Measure Window Start: 300ms  
Measure Window Length: 51000ms  
BWC applied: 9.48 dB  
Device Reference Point: 0, 0, -6.3 mm

Category	Telephone parameters WD signal quality [(signal+noise)-to-noise ratio in decibels]
Category T1	0 dB to 10 dB
Category T2	10 dB to 20 dB
Category T3	20 dB to 30 dB
Category T4	> 30 dB

**Cursor:**

Diff = 2.00 dB  
BWC Factor = 9.48 dB  
Location: 4.6, -12.5, 3.7 mm

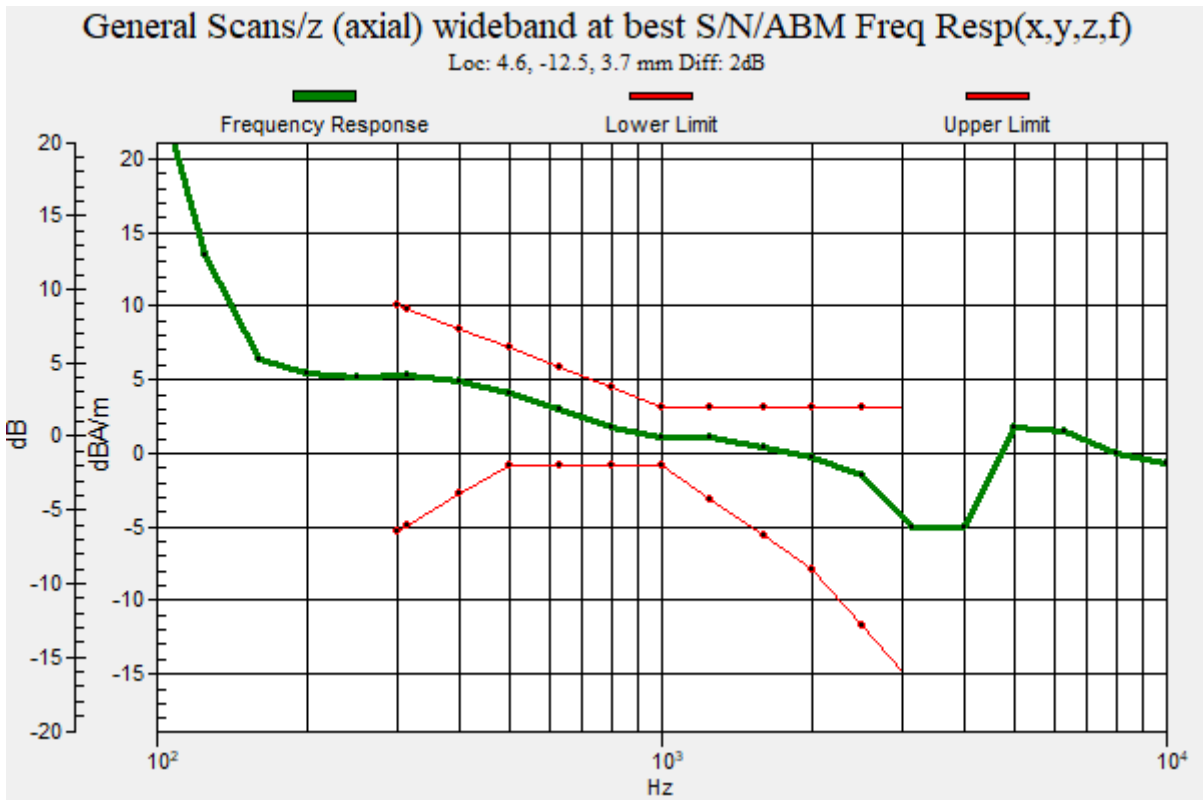

**Plot No.45**

**LTE 30 64QAM EVS WB 5.9bitrate 10MHz 1RB 49offset 27710ch y(transversal)**

**DUT: SM-G991U; Type: Bar**

Communication System: UID 0, LTE Band30 (0); Frequency: 2310 MHz;Duty Cycle: 1:1  
Medium parameters used:  $\sigma = 0$  S/m,  $\epsilon_r = 1$ ;  $\rho = 0$  kg/m<sup>3</sup>  
Phantom section: TCoil Section

DASY Configuration:

- Probe: AM1DV3 - 3049; ;
- Sensor-Surface: 0mm (Fix Surface)
- Electronics: DAE4 Sn466; Calibrated: 2020-04-22
- Phantom: HAC Test Arch with AMCC
- Measurement SW: DASY52, Version 52.10 (4);

**T-Coil scan (scan for ANSI C63.19-2007 & 2011 compliance)/General Scans/y (transversal) 4.2mm 50**

**x 50/ABM Signal(x,y,z) (13x13x1):** Measurement grid: dx=10mm, dy=10mm

Signal Type: Audio File (.wav) 48k\_voice\_1kHz\_1s.wav

Output Gain: 24.38

Measure Window Start: 300ms

Measure Window Length: 1000ms

BWC applied: 0.16 dB

Device Reference Point: 0, 0, -6.3 mm

**Cursor:**

ABM1 comp = -2.08 dBA/m

BWC Factor = 0.16 dB

Location: 8.3, -4.2, 3.7 mm

**Cursor:**

ABM2 = -27.14 dBA/m

Location: 8.3, -4.2, 3.7 mm

**Cursor:**

ABM1/ABM2 = 25.06 dB

ABM1 comp = -2.08 dBA/m

BWC Factor = 0.16 dB

Location: 8.3, -4.2, 3.7 mm

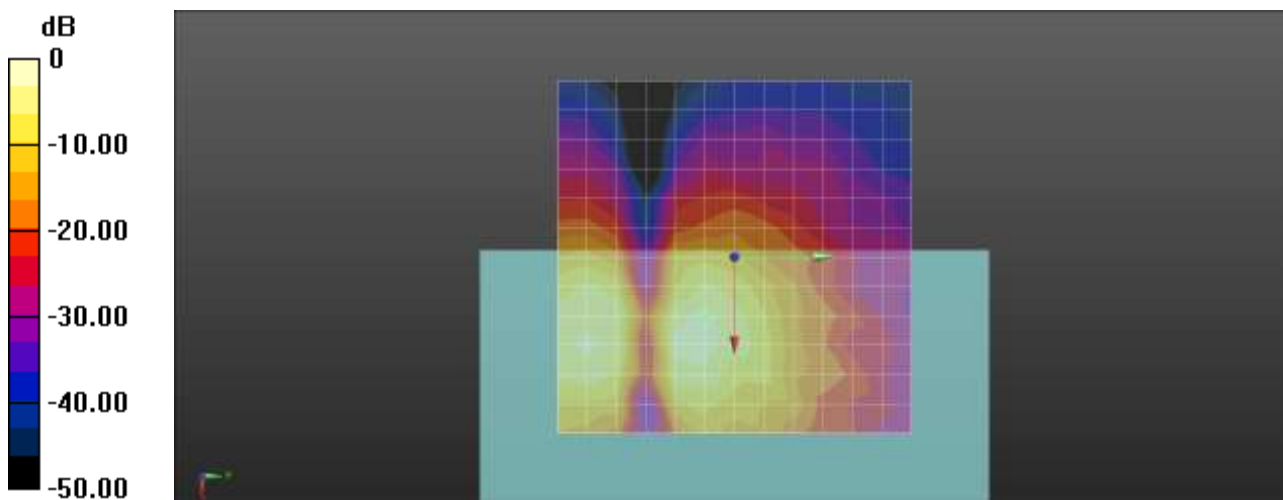

0 dB = 1.000 A/m = 0.00 dBA/m

**Plot No.46**

**LTE 66 64QAM EVS WB 5.9bitrate 15MHz 1RB 74offset 132322ch z(axial)**

**DUT: SM-G991U; Type: Bar**

Communication System: UID 0, LTE Band66 (0); Frequency: 1745 MHz;Duty Cycle: 1:1  
Medium parameters used:  $\sigma = 0$  S/m,  $\epsilon_r = 1$ ;  $\rho = 0$  kg/m<sup>3</sup>  
Phantom section: TCoil Section

DASY Configuration:

- Probe: AM1DV3 - 3049; ;
- Sensor-Surface: 0mm (Fix Surface)
- Electronics: DAE4 Sn466; Calibrated: 2020-04-22
- Phantom: HAC Test Arch with AMCC
- Measurement SW: DASY52, Version 52.10 (4);

**T-Coil scan (scan for ANSI C63.19-2007 & 2011 compliance)/General Scans/z (axial) 4.2mm 50 x**

**50/ABM Signal(x,y,z) (13x13x1):** Measurement grid: dx=10mm, dy=10mm

Signal Type: Audio File (.wav) 48k\_voice\_1kHz\_1s.wav

Output Gain: 24.38

Measure Window Start: 300ms

Measure Window Length: 1000ms

BWC applied: 0.16 dB

Device Reference Point: 0, 0, -6.3 mm

**Cursor:**

ABM1 comp = 5.62 dBA/m

BWC Factor = 0.16 dB

Location: 8.3, -8.3, 3.7 mm

**Cursor:**

ABM2 = -23.16 dBA/m

Location: 8.3, -8.3, 3.7 mm

**Cursor:**

ABM1/ABM2 = 28.78 dB

ABM1 comp = 5.62 dBA/m

BWC Factor = 0.16 dB

Location: 8.3, -8.3, 3.7 mm

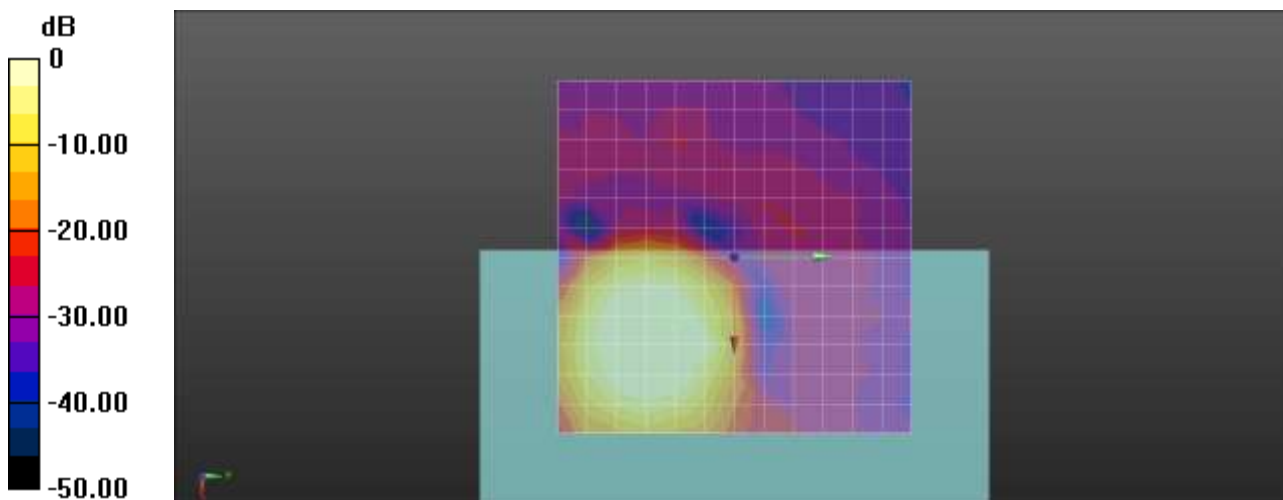

0 dB = 1.000 A/m = 0.00 dBA/m

**Plot No.47**

**LTE 66 64QAM EVS WB 5.9bitrate 15MHz 1RB 74offset 132322ch Freq.Response**

**DUT: SM-G991U; Type: Bar**

Communication System: UID 0, LTE Band66 (0); Frequency: 1745 MHz;Duty Cycle: 1:1  
Medium parameters used:  $\sigma = 0$  S/m,  $\epsilon_r = 1$ ;  $\rho = 0$  kg/m<sup>3</sup>  
Phantom section: TCoil Section

**T-Coil scan (scan for ANSI C63.19-2007 & 2011 compliance)/General Scans/z (axial) wideband at best**

**S/N/ABM Freq Resp(x,y,z,f) (1x1x1):** Measurement grid: dx=10mm, dy=10mm

Signal Type: Audio File (.wav) 48k\_Normal\_51s new.wav

Output Gain: 52.45

Measure Window Start: 300ms

Measure Window Length: 51000ms

BWC applied: 9.48 dB

Device Reference Point: 0, 0, -6.3 mm

Category	Telephone parameters WD signal quality [(signal+noise)-to-noise ratio in decibels]
Category T1	0 dB to 10 dB
Category T2	10 dB to 20 dB
Category T3	20 dB to 30 dB
Category T4	> 30 dB

**Cursor:**

Diff = 1.77 dB

BWC Factor = 9.48 dB

Location: 8.2, -8.4, 3.7 mm

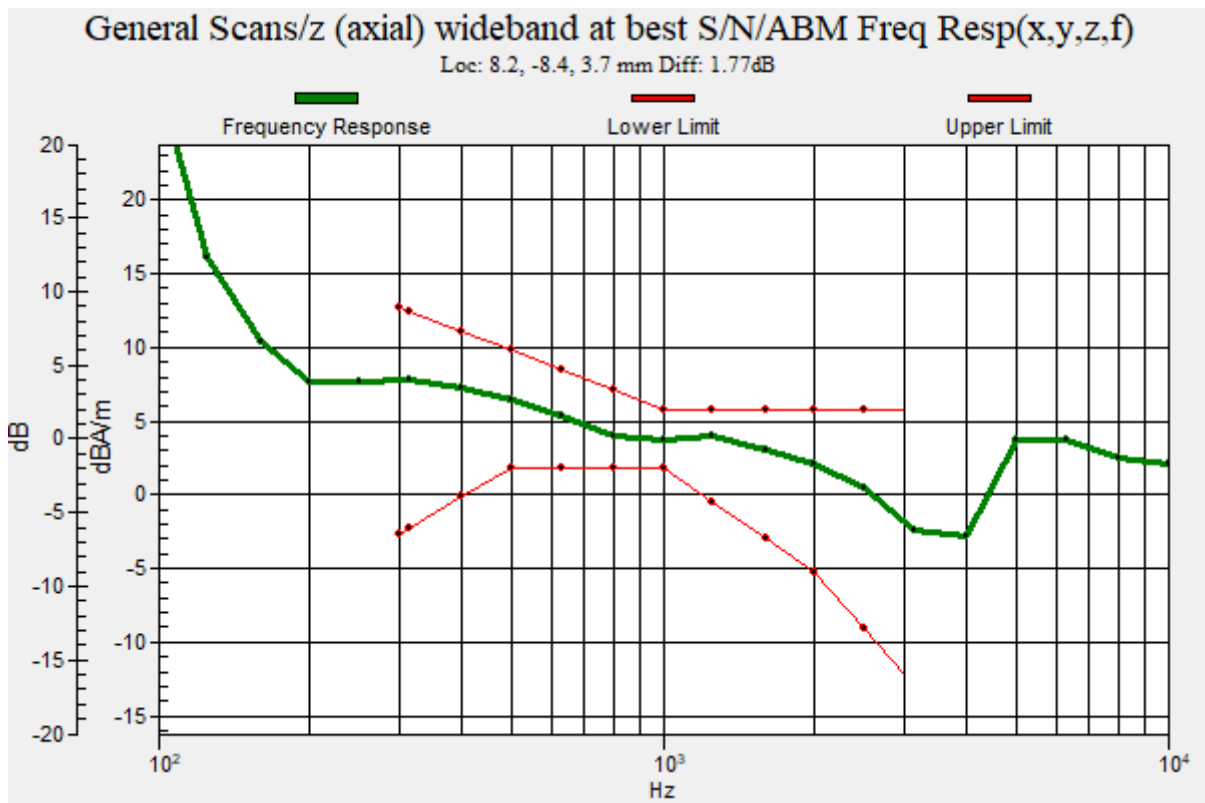

**Plot No.48**

**LTE 66 64QAM EVS WB 5.9bitrate 15MHz 1RB 74offset 132322ch y(transversal)**

**DUT: SM-G991U; Type: Bar**

Communication System: UID 0, LTE Band66 (0); Frequency: 1745 MHz;Duty Cycle: 1:1  
Medium parameters used:  $\sigma = 0$  S/m,  $\epsilon_r = 1$ ;  $\rho = 0$  kg/m<sup>3</sup>  
Phantom section: TCoil Section

DASY Configuration:

- Probe: AM1DV3 - 3049; ;
- Sensor-Surface: 0mm (Fix Surface)
- Electronics: DAE4 Sn466; Calibrated: 2020-04-22
- Phantom: HAC Test Arch with AMCC
- Measurement SW: DASY52, Version 52.10 (4);

**T-Coil scan (scan for ANSI C63.19-2007 & 2011 compliance)/General Scans/y (transversal) 4.2mm 50**

**x 50/ABM Signal(x,y,z) (13x13x1):** Measurement grid: dx=10mm, dy=10mm

Signal Type: Audio File (.wav) 48k\_voice\_1kHz\_1s.wav

Output Gain: 24.38

Measure Window Start: 300ms

Measure Window Length: 1000ms

BWC applied: 0.16 dB

Device Reference Point: 0, 0, -6.3 mm

**Cursor:**

ABM1 comp = -14.79 dBA/m

BWC Factor = 0.16 dB

Location: -4.2, -20.8, 3.7 mm

**Cursor:**

ABM2 = -40.35 dBA/m

Location: -4.2, -20.8, 3.7 mm

**Cursor:**

ABM1/ABM2 = 25.56 dB

ABM1 comp = -14.79 dBA/m

BWC Factor = 0.16 dB

Location: -4.2, -20.8, 3.7 mm

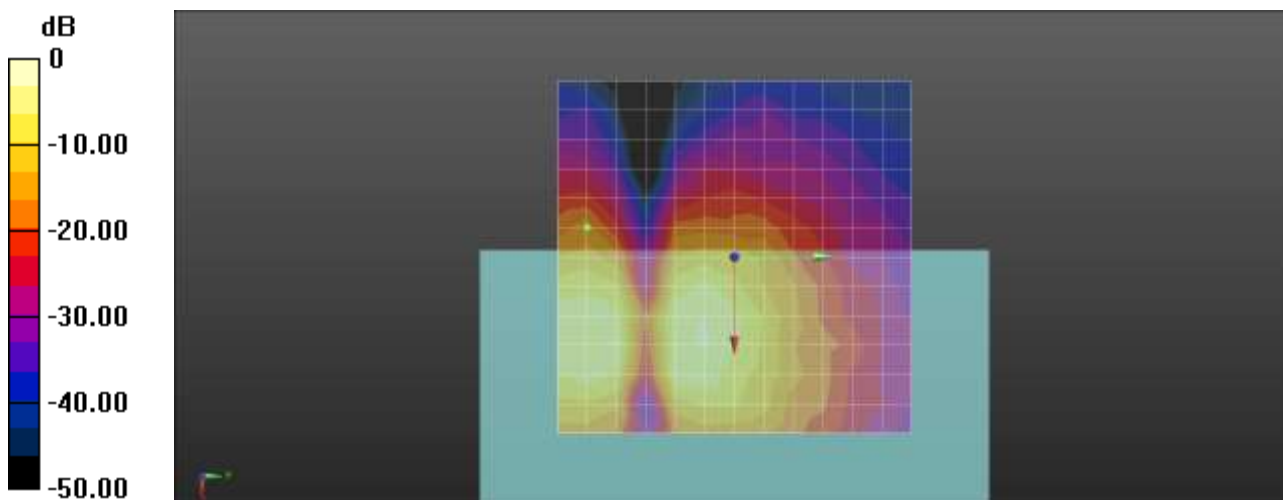

0 dB = 1.000 A/m = 0.00 dBA/m

**Plot No.49**

**LTE 71 64QAM EVS WB 5.9bitrate 15MHz 1RB 74offset 133322ch z(axial)**

**DUT: SM-G991U; Type: Bar**

Communication System: UID 0, LTE Band 71 (0); Frequency: 683 MHz;Duty Cycle: 1:1  
Medium parameters used:  $\sigma = 0$  S/m,  $\epsilon_r = 1$ ;  $\rho = 0$  kg/m<sup>3</sup>  
Phantom section: TCoil Section

DASY Configuration:

- Probe: AM1DV3 - 3049; ;
- Sensor-Surface: 0mm (Fix Surface)
- Electronics: DAE4 Sn466; Calibrated: 2020-04-22
- Phantom: HAC Test Arch with AMCC
- Measurement SW: DASY52, Version 52.10 (4);

**T-Coil scan (scan for ANSI C63.19-2007 & 2011 compliance)/General Scans/z (axial) 4.2mm 50 x 50/ABM Signal(x,y,z) (13x13x1):**

Measurement grid: dx=10mm, dy=10mm

Signal Type: Audio File (.wav) 48k\_voice\_1kHz\_1s.wav

Output Gain: 24.38

Measure Window Start: 300ms

Measure Window Length: 1000ms

BWC applied: 0.16 dB

Device Reference Point: 0, 0, -6.3 mm

**Cursor:**

ABM1 comp = 5.02 dBA/m

BWC Factor = 0.16 dB

Location: 8.3, -12.5, 3.7 mm

**Cursor:**

ABM2 = -20.70 dBA/m

Location: 8.3, -12.5, 3.7 mm

**Cursor:**

ABM1/ABM2 = 25.72 dB

ABM1 comp = 5.02 dBA/m

BWC Factor = 0.16 dB

Location: 8.3, -12.5, 3.7 mm

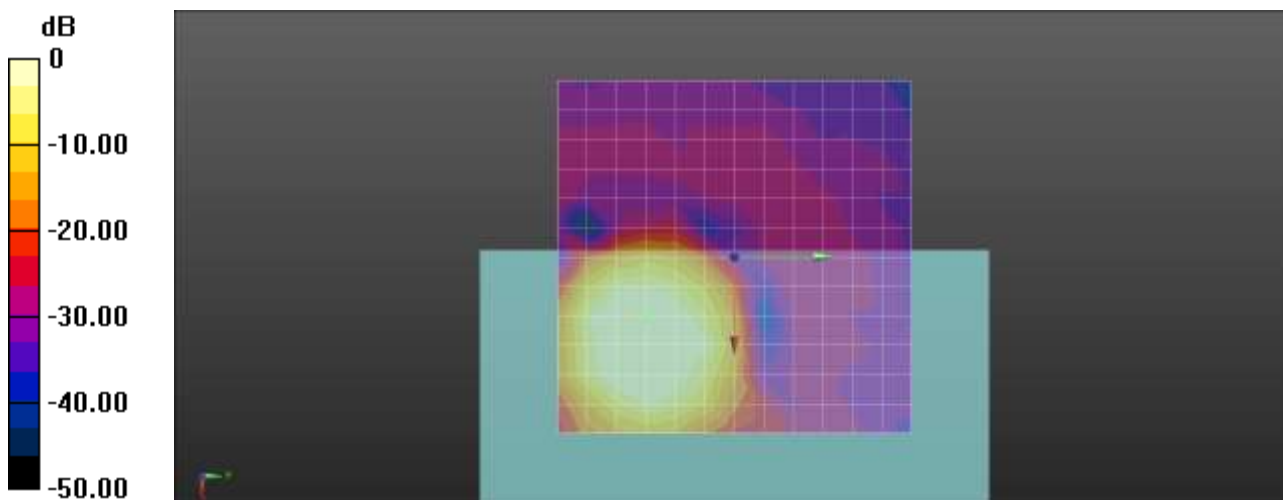

0 dB = 1.000 A/m = 0.00 dBA/m

**Plot No.50**

**LTE 71 64QAM EVS WB 5.9bitrate 15MHz 1RB 74offset 133322ch Freq.Response**

**DUT: SM-G991U; Type: Bar**

Communication System: UID 0, LTE Band 71 (0); Frequency: 683 MHz;Duty Cycle: 1:1  
Medium parameters used:  $\sigma = 0$  S/m,  $\epsilon_r = 1$ ;  $\rho = 0$  kg/m<sup>3</sup>  
Phantom section: TCoil Section

**T-Coil scan (scan for ANSI C63.19-2007 & 2011 compliance)/General Scans/z (axial) wideband at best**

**S/N/ABM Freq Resp(x,y,z,f) (1x1x1):** Measurement grid: dx=10mm, dy=10mm

Signal Type: Audio File (.wav) 48k\_Normal\_51s new.wav

Output Gain: 52.45

Measure Window Start: 300ms

Measure Window Length: 51000ms

BWC applied: 9.48 dB

Device Reference Point: 0, 0, -6.3 mm

Category	Telephone parameters WD signal quality [(signal+noise)-to-noise ratio in decibels]
Category T1	0 dB to 10 dB
Category T2	10 dB to 20 dB
Category T3	20 dB to 30 dB
Category T4	> 30 dB

**Cursor:**

Diff = 2.00 dB

BWC Factor = 9.48 dB

Location: 8.5, -12.6, 3.7 mm

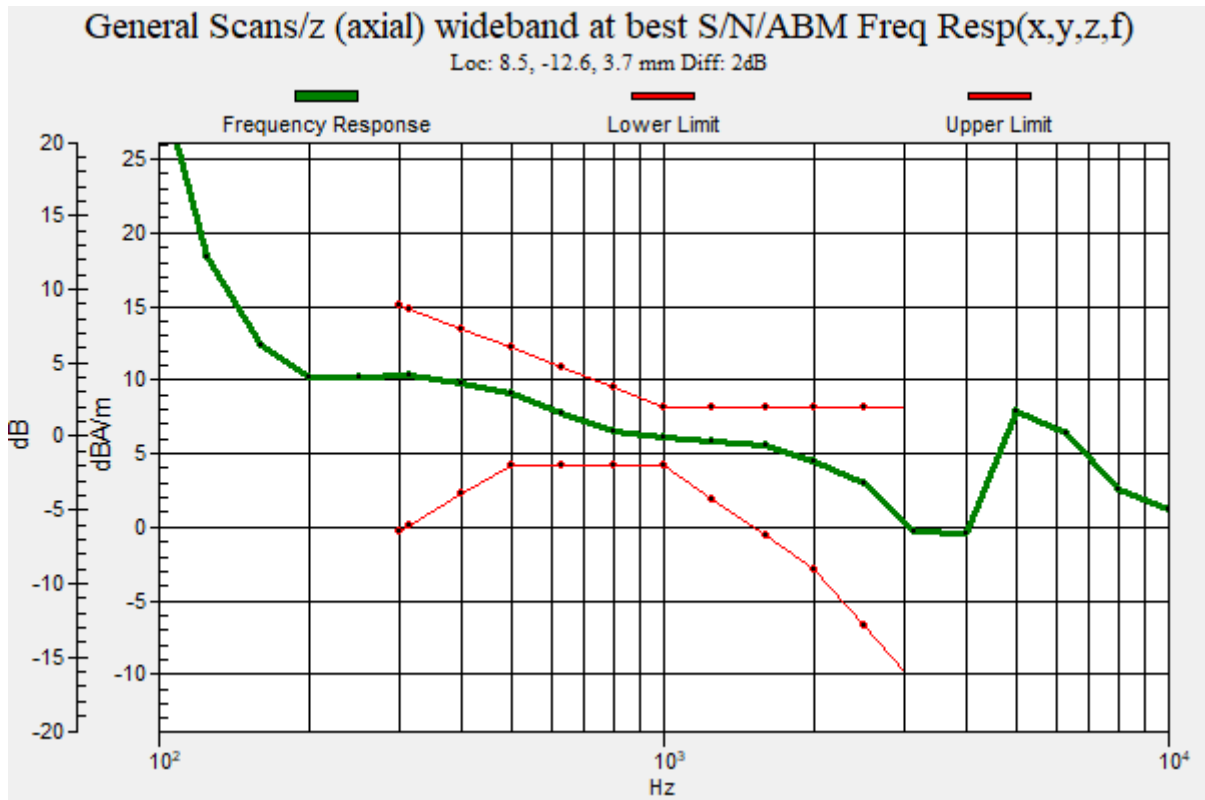

**Plot No.51**

**LTE 71 64QAM EVS WB 5.9bitrate 15MHz 1RB 74offset 133322ch y(transversal)**

**DUT: SM-G991U; Type: Bar**

Communication System: UID 0, LTE Band 71 (0); Frequency: 683 MHz;Duty Cycle: 1:1  
Medium parameters used:  $\sigma = 0$  S/m,  $\epsilon_r = 1$ ;  $\rho = 0$  kg/m<sup>3</sup>  
Phantom section: TCoil Section

DASY Configuration:

- Probe: AM1DV3 - 3049; ;
- Sensor-Surface: 0mm (Fix Surface)
- Electronics: DAE4 Sn466; Calibrated: 2020-04-22
- Phantom: HAC Test Arch with AMCC
- Measurement SW: DASY52, Version 52.10 (4);

**T-Coil scan (scan for ANSI C63.19-2007 & 2011 compliance)/General Scans/y (transversal) 4.2mm 50**

**x 50/ABM Signal(x,y,z) (13x13x1):** Measurement grid: dx=10mm, dy=10mm

Signal Type: Audio File (.wav) 48k\_voice\_1kHz\_1s.wav

Output Gain: 24.38

Measure Window Start: 300ms

Measure Window Length: 1000ms

BWC applied: 0.16 dB

Device Reference Point: 0, 0, -6.3 mm

**Cursor:**

ABM1 comp = 0.14 dBA/m

BWC Factor = 0.16 dB

Location: 12.5, -20.8, 3.7 mm

**Cursor:**

ABM2 = -26.28 dBA/m

Location: 12.5, -20.8, 3.7 mm

**Cursor:**

ABM1/ABM2 = 26.42 dB

ABM1 comp = 0.14 dBA/m

BWC Factor = 0.16 dB

Location: 12.5, -20.8, 3.7 mm

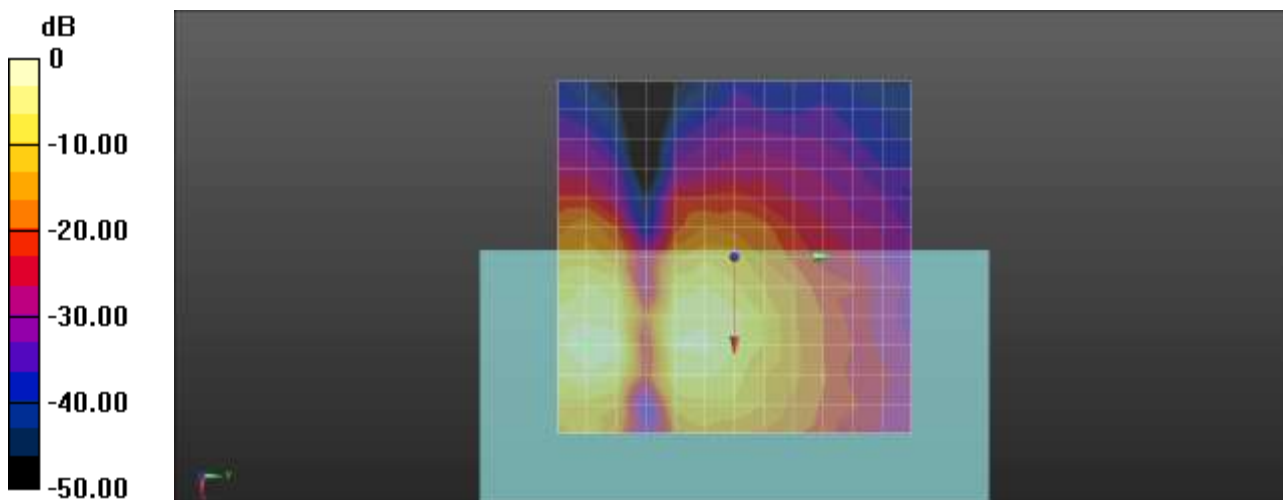

0 dB = 1.000 A/m = 0.00 dBA/m



**Plot No.52**

**LTE 41 QPSK EVS wb 5\_9bitrate 20MHz 50RB 49offset 40620ch 6 6 z(axial)**

**DUT: SM-G991U; Type: Bar**

Communication System: UID 0, LTE Band 41 (FCC) (0); Frequency: 2593 MHz;Duty Cycle: 1:1.95209  
Medium parameters used:  $\sigma = 0$  S/m,  $\epsilon_r = 1$ ;  $\rho = 0$  kg/m<sup>3</sup>  
Phantom section: TCoil Section

DASY Configuration:

- Probe: AM1DV2 - 1013; ;
- Sensor-Surface: 0mm (Fix Surface)
- Electronics: DAE4 Sn1629; Calibrated: 2020-08-11
- Phantom: HAC Test Arch with AMCC
- Measurement SW: DASY52, Version 52.10 (4);

**T-Coil scan (scan for ANSI C63.19-2007 & 2011 compliance)/General Scans/z (axial) 4.2mm 50 x 50/ABM Signal(x,y,z) (13x13x1):** Measurement grid: dx=10mm, dy=10mm

Signal Type: Audio File (.wav) 48k\_voice\_1kHz\_1s.wav  
Output Gain: 24.41  
Measure Window Start: 300ms  
Measure Window Length: 1000ms  
BWC applied: 0.14 dB  
Device Reference Point: 0, 0, -6.3 mm

**Cursor:**

ABM1 comp = 5.41 dBA/m  
BWC Factor = 0.14 dB  
Location: 8.3, -12.5, 3.7 mm

**Cursor:**

ABM2 = -25.54 dBA/m  
Location: 8.3, -12.5, 3.7 mm

**Cursor:**

ABM1/ABM2 = 30.94 dB  
ABM1 comp = 5.41 dBA/m  
BWC Factor = 0.14 dB  
Location: 8.3, -12.5, 3.7 mm

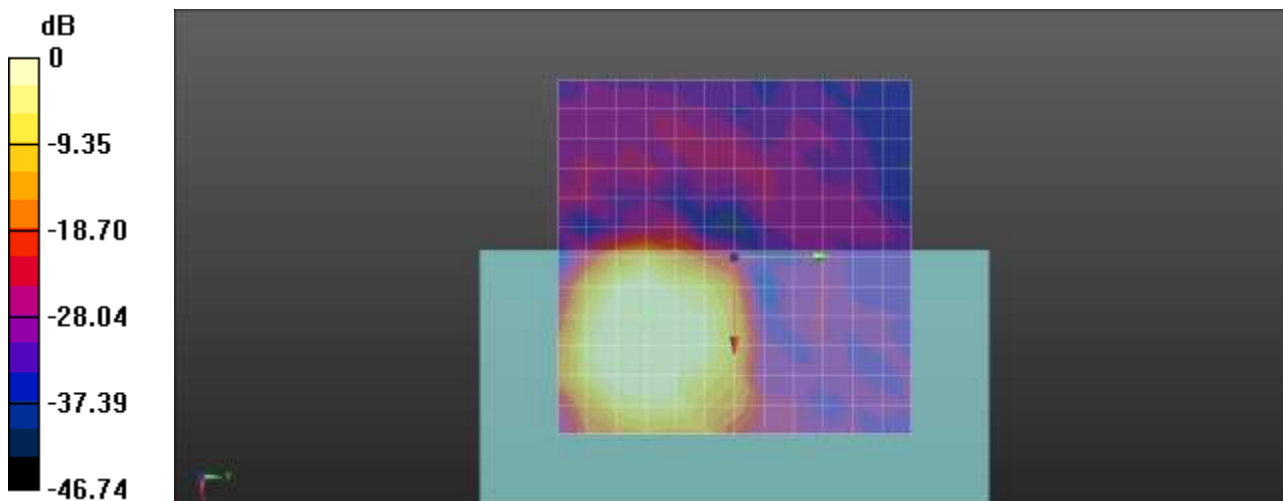

0 dB = 1.000 A/m = 0.00 dBA/m

**Plot No.53**

LTE 41 QPSK EVS wb 5\_9bitrate 20MHz 50RB 49offset 40620ch 6 6 Freq.Response

**DUT: SM-G991U; Type: Bar**

Communication System: UID 0, LTE Band 41 (FCC) (0); Frequency: 2593 MHz;Duty Cycle: 1:1. 95209  
 Medium parameters used:  $\sigma = 0$  S/m,  $\epsilon_r = 1$ ;  $\rho = 0$  kg/m<sup>3</sup>  
 Phantom section: TCoil Section

**T-Coil scan (scan for ANSI C63.19-2007 & 2011 compliance)/General Scans/z (axial) wideband at best**

**S/N/ABM Freq Resp(x,y,z,f) (1x1x1):** Measurement grid: dx=10mm, dy=10mm

Signal Type: Audio File (.wav) 48k\_Normal\_51s new.wav

Output Gain: 52.45

Measure Window Start: 300ms

Measure Window Length: 51000ms

BWC applied: 9.46 dB

Device Reference Point: 0, 0, -6.3 mm

Category	Telephone parameters WD signal quality [(signal+noise)-to-noise ratio in decibels]
Category T1	0 dB to 10 dB
Category T2	10 dB to 20 dB
Category T3	20 dB to 30 dB
Category T4	> 30 dB

**Cursor:**

Diff = 2.00 dB

BWC Factor = 9.46 dB

Location: 7, -13.1, 3.7 mm

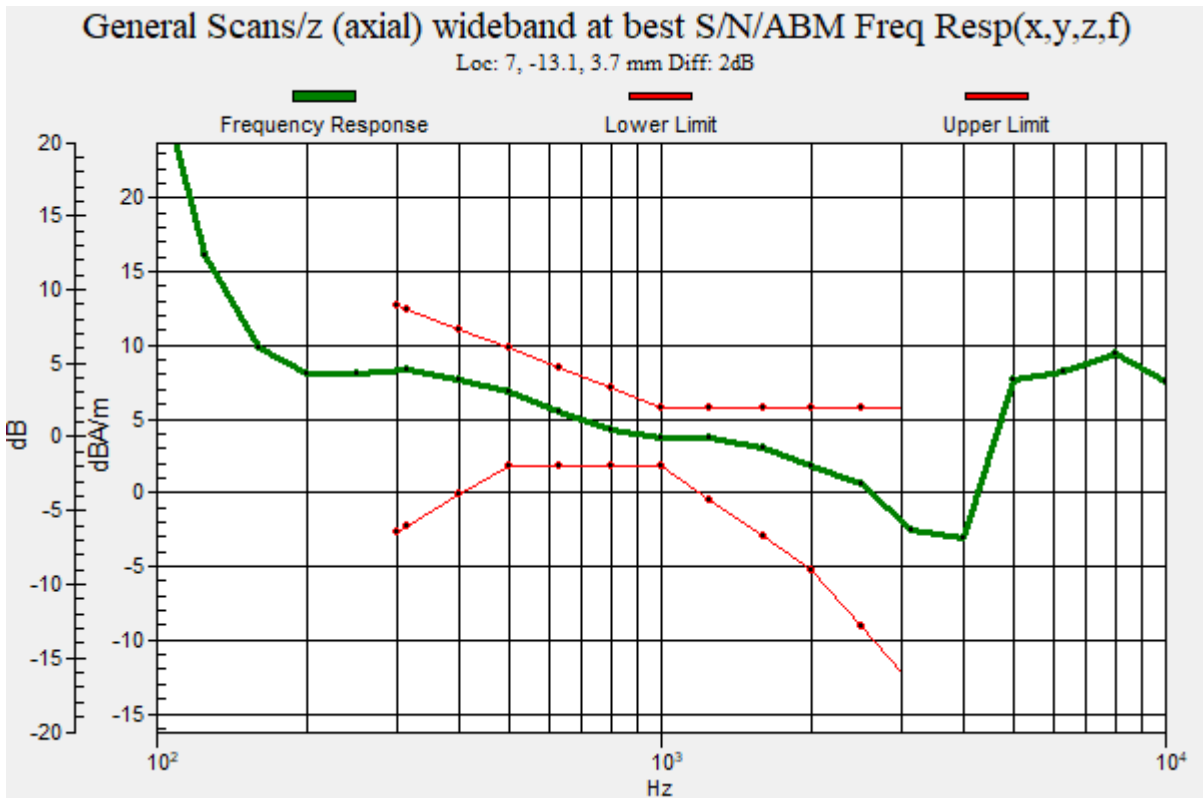

**Plot No.54**

**LTE 41 QPSK EVS wb 5\_9bitrate 20MHz 50RB 49offset 40620ch 6 6 y(transversal)**

**DUT: SM-G991U; Type: Bar**

Communication System: UID 0, LTE Band 41 (FCC) (0); Frequency: 2593 MHz;Duty Cycle: 1:1.90546  
Medium parameters used:  $\sigma = 0$  S/m,  $\epsilon_r = 1$ ;  $\rho = 0$  kg/m<sup>3</sup>  
Phantom section: TCoil Section

DASY Configuration:

- Probe: AM1DV2 - 1013; ;
- Sensor-Surface: 0mm (Fix Surface)
- Electronics: DAE4 Sn1629; Calibrated: 2020-08-11
- Phantom: HAC Test Arch with AMCC
- Measurement SW: DASY52, Version 52.10 (4);

**T-Coil scan (scan for ANSI C63.19-2007 & 2011 compliance)/General Scans/y (transversal) 4.2mm 50**

**x 50/ABM Signal(x,y,z) (13x13x1):** Measurement grid: dx=10mm, dy=10mm

Signal Type: Audio File (.wav) 48k\_voice\_1kHz\_1s.wav

Output Gain: 24.41

Measure Window Start: 300ms

Measure Window Length: 1000ms

BWC applied: 0.14 dB

Device Reference Point: 0, 0, -6.3 mm

**Cursor:**

ABM1 comp = -3.20 dBA/m

BWC Factor = 0.14 dB

Location: 8.3, -20.8, 3.7 mm

**Cursor:**

ABM2 = -32.14 dBA/m

Location: 8.3, -20.8, 3.7 mm

**Cursor:**

ABM1/ABM2 = 28.94 dB

ABM1 comp = -3.20 dBA/m

BWC Factor = 0.14 dB

Location: 8.3, -20.8, 3.7 mm

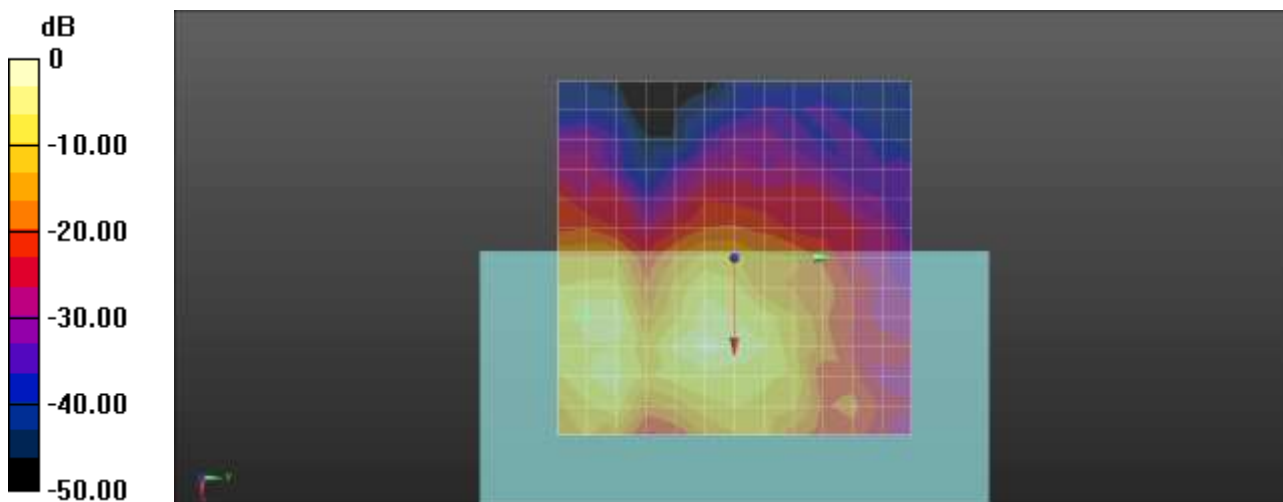

0 dB = 1.000 A/m = 0.00 dBA/m

**Plot No.55**

**LTE 38 QPSK EVS wb 5\_9bitrate 20MHz 50RB 49offset 38000ch 6 6 z(axial)**

**DUT: SM-G991U; Type: Bar**

Communication System: UID 0, LTE38 (0); Frequency: 2595 MHz;Duty Cycle: 1:1.95209  
Medium parameters used:  $\sigma = 0$  S/m,  $\epsilon_r = 1$ ;  $\rho = 0$  kg/m<sup>3</sup>  
Phantom section: TCoil Section

DASY Configuration:

- Probe: AM1DV2 - 1013; ;
- Sensor-Surface: 0mm (Fix Surface)
- Electronics: DAE4 Sn1629; Calibrated: 2020-08-11
- Phantom: HAC Test Arch with AMCC
- Measurement SW: DASY52, Version 52.10 (4);

**T-Coil scan (scan for ANSI C63.19-2007 & 2011 compliance)/General Scans/z (axial) 4.2mm 50 x**

**50/ABM Signal(x,y,z) (13x13x1):** Measurement grid: dx=10mm, dy=10mm

Signal Type: Audio File (.wav) 48k\_voice\_1kHz\_1s.wav

Output Gain: 24.41

Measure Window Start: 300ms

Measure Window Length: 1000ms

BWC applied: 0.15 dB

Device Reference Point: 0, 0, -6.3 mm

**Cursor:**

ABM1 comp = 1.60 dBA/m

BWC Factor = 0.15 dB

Location: 8.3, -12.5, 3.7 mm

**Cursor:**

ABM2 = -29.26 dBA/m

Location: 8.3, -12.5, 3.7 mm

**Cursor:**

ABM1/ABM2 = 30.85 dB

ABM1 comp = 1.60 dBA/m

BWC Factor = 0.15 dB

Location: 8.3, -12.5, 3.7 mm

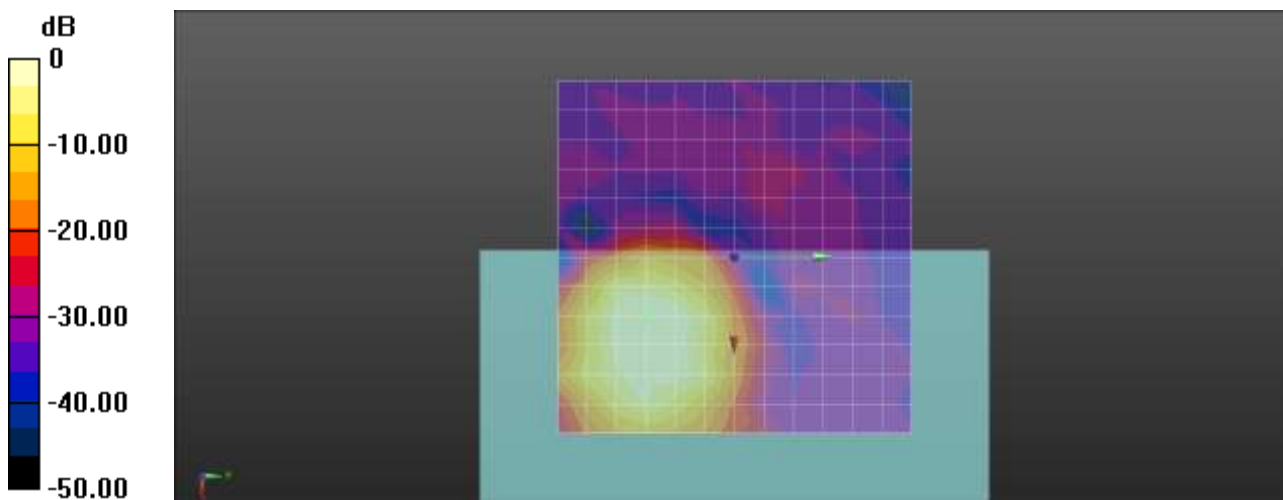

0 dB = 1.000 A/m = 0.00 dBA/m

**Plot No.56**

**LTE 38 QPSK EVS wb 5\_9bitrate 20MHz 50RB 49offset 38000ch 6 6 Freq.Response**

**DUT: SM-G991U; Type: Bar**

Communication System: UID 0, LTE38 (0); Frequency: 2595 MHz;Duty Cycle: 1:1.95209  
Medium parameters used:  $\sigma = 0$  S/m,  $\epsilon_r = 1$ ;  $\rho = 0$  kg/m<sup>3</sup>  
Phantom section: TCoil Section

**T-Coil scan (scan for ANSI C63.19-2007 & 2011 compliance)/General Scans/z (axial) wideband at best**

**S/N/ABM Freq Resp(x,y,z,f) (1x1x1):** Measurement grid: dx=10mm, dy=10mm

Signal Type: Audio File (.wav) 48k\_Normal\_51s new.wav

Output Gain: 52.45

Measure Window Start: 300ms

Measure Window Length: 51000ms

BWC applied: 9.47 dB

Device Reference Point: 0, 0, -6.3 mm

Category	Telephone parameters WD signal quality [(signal+noise)-to-noise ratio in decibels]
Category T1	0 dB to 10 dB
Category T2	10 dB to 20 dB
Category T3	20 dB to 30 dB
Category T4	> 30 dB

**Cursor:**

Diff = 1.82 dB

BWC Factor = 9.47 dB

Location: 10.4, -12.1, 3.7 mm

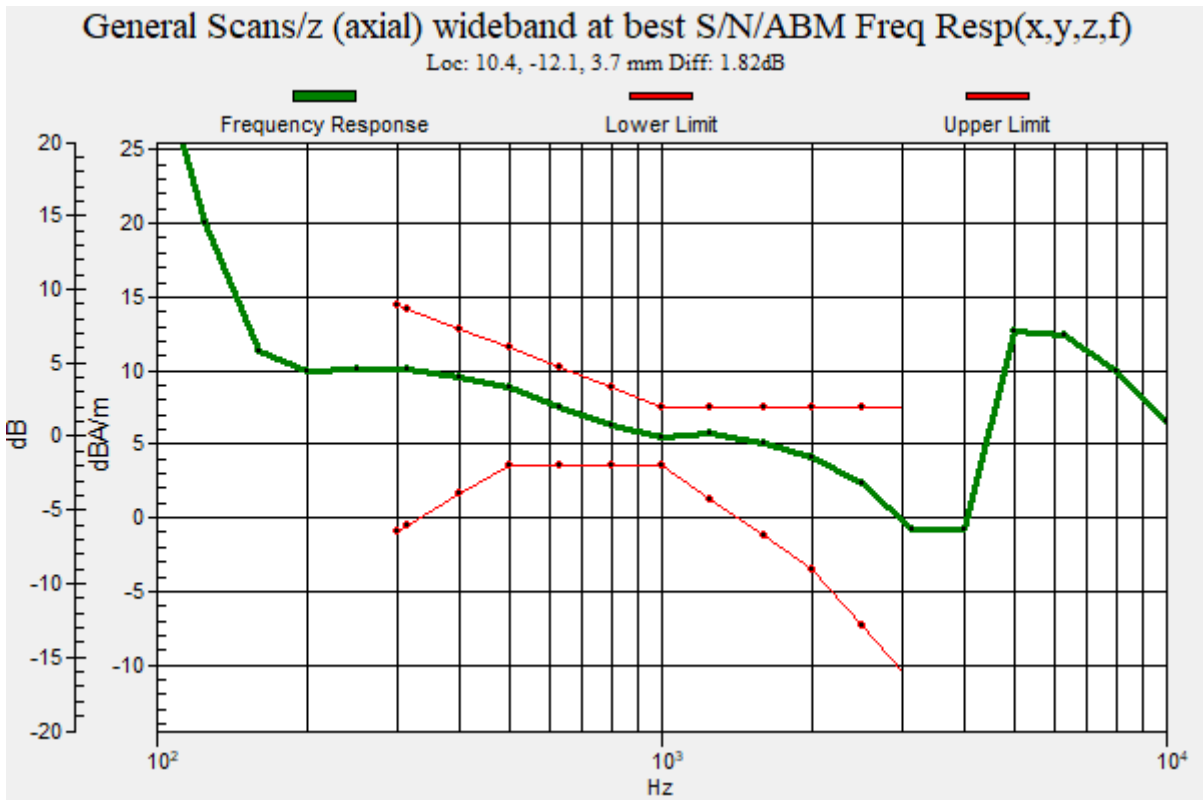

**Plot No.57**

**LTE 38 QPSK EVS wb 5\_9bitrate 20MHz 50RB 49offset 38000ch 6 6 y(transversal)**

**DUT: SM-G991U; Type: Bar**

Communication System: UID 0, LTE38 (0); Frequency: 2595 MHz;Duty Cycle: 1:1.95209

Medium parameters used:  $\sigma = 0$  S/m,  $\epsilon_r = 1$ ;  $\rho = 0$  kg/m<sup>3</sup>

Phantom section: TCoil Section

DASY Configuration:

- Probe: AM1DV2 - 1013; ;
- Sensor-Surface: 0mm (Fix Surface)
- Electronics: DAE4 Sn1629; Calibrated: 2020-08-11
- Phantom: HAC Test Arch with AMCC
- Measurement SW: DASY52, Version 52.10 (4);

**T-Coil scan (scan for ANSI C63.19-2007 & 2011 compliance)/General Scans/y (transversal) 4.2mm 50**

**x 50/ABM Signal(x,y,z) (13x13x1):** Measurement grid: dx=10mm, dy=10mm

Signal Type: Audio File (.wav) 48k\_voice\_1kHz\_1s.wav

Output Gain: 24.41

Measure Window Start: 300ms

Measure Window Length: 1000ms

BWC applied: 0.15 dB

Device Reference Point: 0, 0, -6.3 mm

**Cursor:**

ABM1 comp = -6.56 dBA/m

BWC Factor = 0.15 dB

Location: 12.5, 0, 3.7 mm

**Cursor:**

ABM2 = -36.18 dBA/m

**Cursor:**

ABM1/ABM2 = 29.62 dB

ABM1 comp = -6.56 dBA/m

BWC Factor = 0.15 dB

Location: 12.5, 0, 3.7 mm

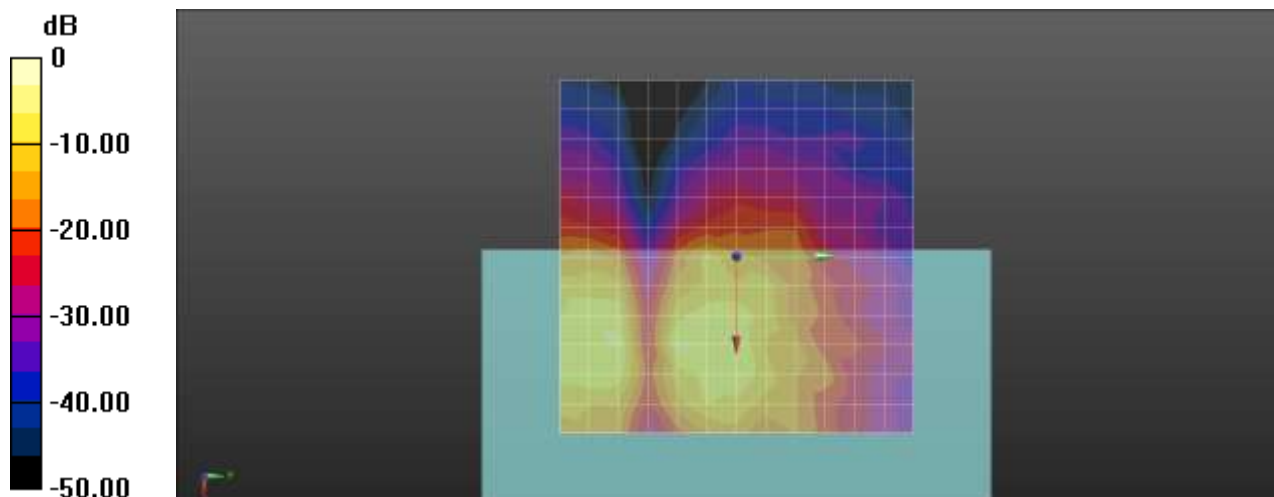

0 dB = 1.000 A/m = 0.00 dBA/m

**Plot No.58**

**LTE 40 QPSK EVS wb 5\_9bitrate 10MHz 25RB 24offset 38750ch 6 6 z(axial)**

**DUT: SM-G991U; Type: Bar**

Communication System: UID 0, LTE40 (0); Frequency: 2310 MHz;Duty Cycle: 1:1.95209

Medium parameters used:  $\sigma = 0$  S/m,  $\epsilon_r = 1$ ;  $\rho = 0$  kg/m<sup>3</sup>

Phantom section: TCoil Section

DASY Configuration:

- Probe: AM1DV2 - 1013; ;
- Sensor-Surface: 0mm (Fix Surface)
- Electronics: DAE4 Sn1629; Calibrated: 2020-08-11
- Phantom: HAC Test Arch with AMCC
- Measurement SW: DASY52, Version 52.10 (4);

**T-Coil scan (scan for ANSI C63.19-2007 & 2011 compliance)/General Scans/z (axial) 4.2mm 50 x**

**50/ABM Signal(x,y,z) (13x13x1):** Measurement grid: dx=10mm, dy=10mm

Signal Type: Audio File (.wav) 48k\_voice\_1kHz\_1s.wav

Output Gain: 24.41

Measure Window Start: 300ms

Measure Window Length: 1000ms

BWC applied: 0.15 dB

Device Reference Point: 0, 0, -6.3 mm

**Cursor:**

ABM1 comp = 1.34 dBA/m

BWC Factor = 0.15 dB

Location: 12.5, -8.3, 3.7 mm

**Cursor:**

ABM2 = -29.06 dBA/m

Location: 12.5, -8.3, 3.7 mm

**Cursor:**

ABM1/ABM2 = 30.39 dB

ABM1 comp = 1.34 dBA/m

BWC Factor = 0.15 dB

Location: 12.5, -8.3, 3.7 mm

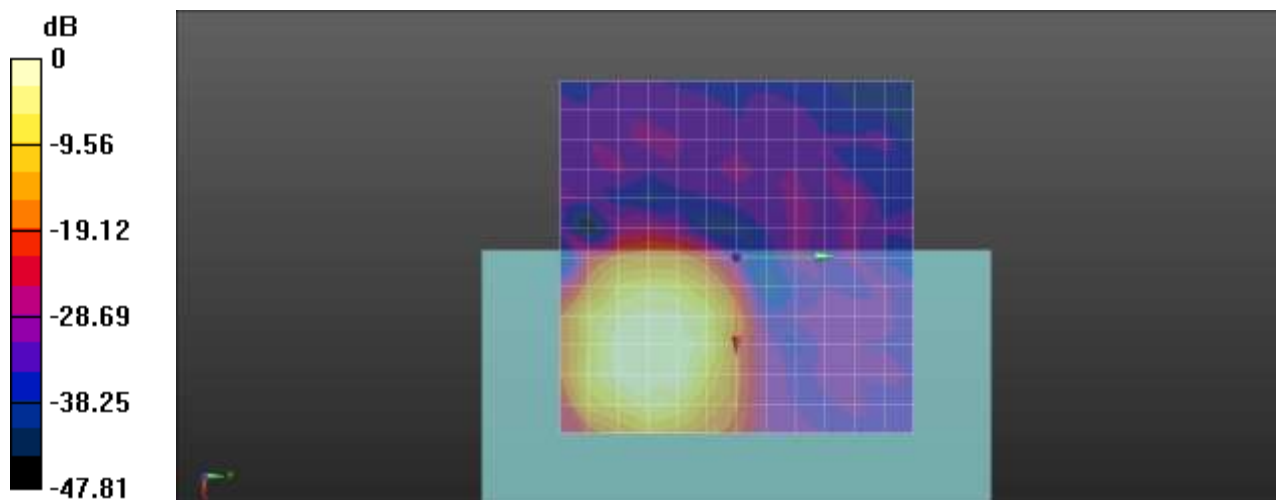

0 dB = 1.000 A/m = 0.00 dBA/m

**Plot No.59**

**LTE 40 QPSK EVS wb 5\_9bitrate 10MHz 25RB 24offset 38750ch 6 6 Freq.Response**

**DUT: SM-G991U; Type: Bar**

Communication System: UID 0, LTE40 (0); Frequency: 2310 MHz;Duty Cycle: 1:1.95209  
 Medium parameters used:  $\sigma = 0$  S/m,  $\epsilon_r = 1$ ;  $\rho = 0$  kg/m<sup>3</sup>  
 Phantom section: TCoil Section

**T-Coil scan (scan for ANSI C63.19-2007 & 2011 compliance)/General Scans/z (axial) wideband at best**

**S/N/ABM Freq Resp(x,y,z,f) (1x1x1):** Measurement grid: dx=10mm, dy=10mm

Signal Type: Audio File (.wav) 48k\_Normal\_51s new.wav

Output Gain: 52.45

Measure Window Start: 300ms

Measure Window Length: 51000ms

BWC applied: 9.47 dB

Device Reference Point: 0, 0, -6.3 mm

Category	Telephone parameters WD signal quality [(signal+noise)-to-noise ratio in decibels]
Category T1	0 dB to 10 dB
Category T2	10 dB to 20 dB
Category T3	20 dB to 30 dB
Category T4	> 30 dB

**Cursor:**

Diff = 1.55 dB

BWC Factor = 9.47 dB

Location: 12.2, -8.6, 3.7 mm

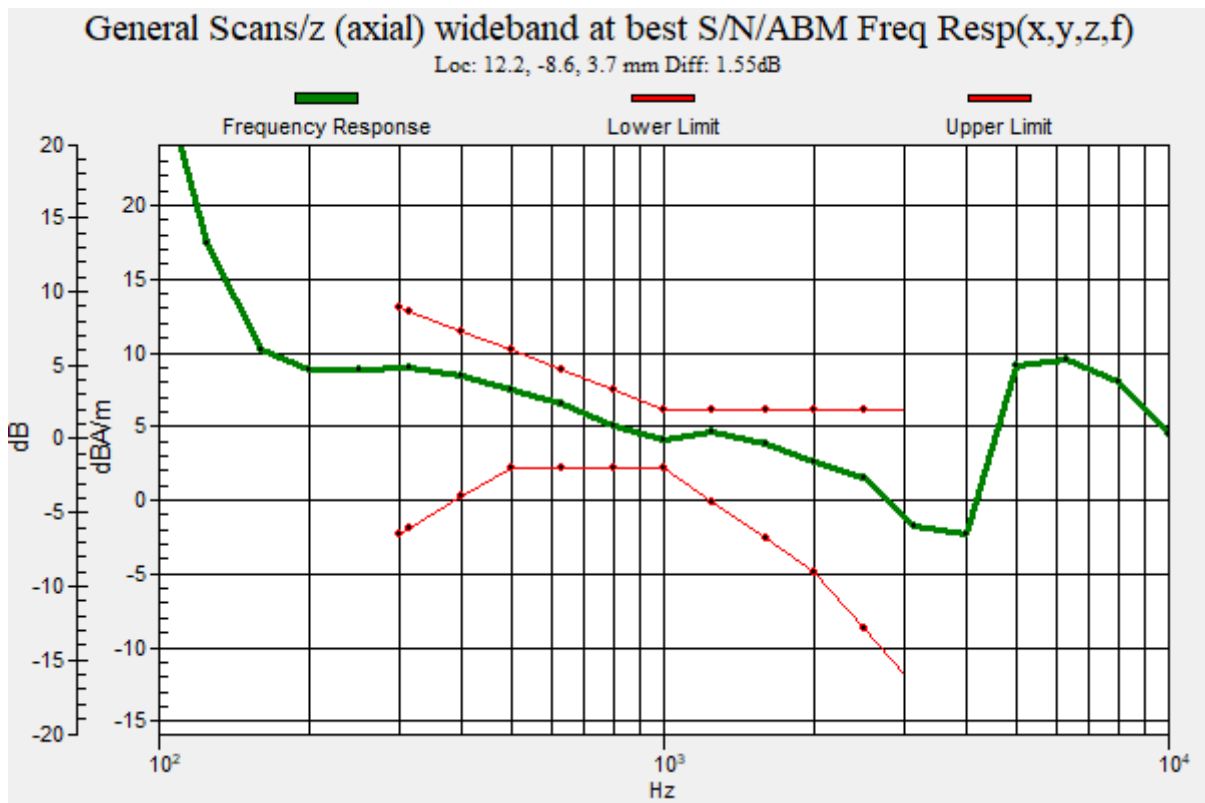



**Plot No.60**

**LTE 40 QPSK EVS wb 5\_9bitrate 10MHz 25RB 24offset 38750ch 6 6 y(transversal)**

**DUT: SM-G991U; Type: Bar**

Communication System: UID 0, LTE40 (0); Frequency: 2310 MHz;Duty Cycle: 1:1.95209

Medium parameters used:  $\sigma = 0$  S/m,  $\epsilon_r = 1$ ;  $\rho = 0$  kg/m<sup>3</sup>

Phantom section: TCoil Section

DASY Configuration:

- Probe: AM1DV2 - 1013; ;
- Sensor-Surface: 0mm (Fix Surface)
- Electronics: DAE4 Sn1629; Calibrated: 2020-08-11
- Phantom: HAC Test Arch with AMCC
- Measurement SW: DASY52, Version 52.10 (4);

**T-Coil scan (scan for ANSI C63.19-2007 & 2011 compliance)/General Scans/y (transversal) 4.2mm 50**

**x 50/ABM Signal(x,y,z) (13x13x1):** Measurement grid: dx=10mm, dy=10mm

Signal Type: Audio File (.wav) 48k\_voice\_1kHz\_1s.wav

Output Gain: 24.41

Measure Window Start: 300ms

Measure Window Length: 1000ms

BWC applied: 0.15 dB

Device Reference Point: 0, 0, -6.3 mm

**Cursor:**

ABM1 comp = -8.83 dBA/m

BWC Factor = 0.15 dB

Location: 8.3, -25, 3.7 mm

**Cursor:**

ABM2 = -37.58 dBA/m

Location: 8.3, -25, 3.7 mm

**Cursor:**

ABM1/ABM2 = 28.75 dB

ABM1 comp = -8.83 dBA/m

BWC Factor = 0.15 dB

Location: 8.3, -25, 3.7 mm

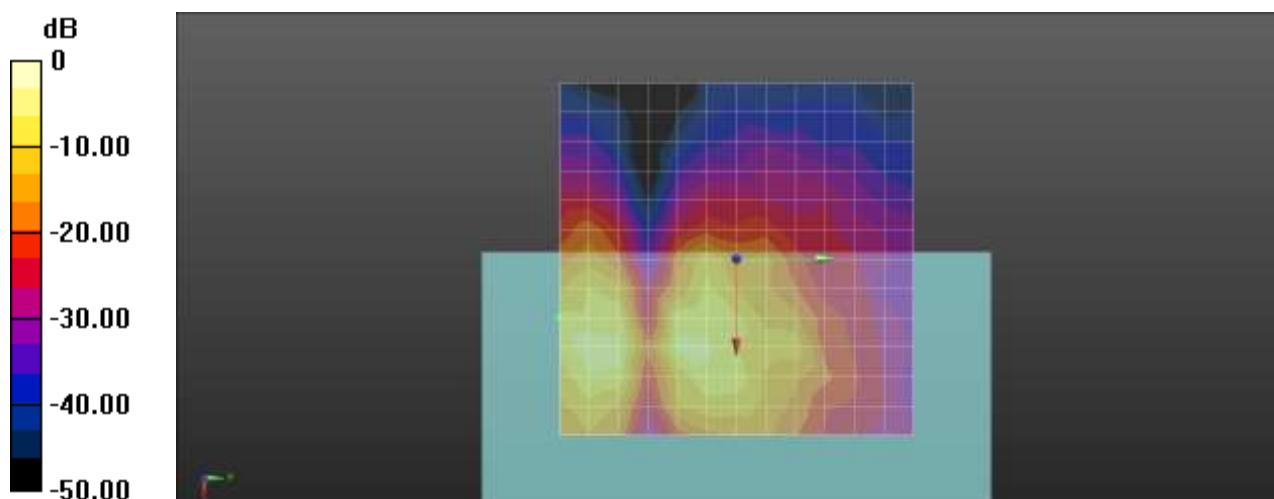

0 dB = 1.000 A/m = 0.00 dBA/m

**Plot No.61**

**LTE 48 QPSK EVS wb 5\_9bitrate 20MHz 50RB 49offset 55990ch 6 6 z(axial)**

**DUT: SM-G991U; Type: Bar**

Communication System: UID 0, LTE 48; Frequency: 3625 MHz;Duty Cycle: 1:1.95209  
Medium parameters used:  $\sigma = 0$  S/m,  $\epsilon_r = 1$ ;  $\rho = 0$  kg/m<sup>3</sup>  
Phantom section: TCoil Section

DASY Configuration:

- Probe: AM1DV2 - 1013; ;
- Sensor-Surface: 0mm (Fix Surface)
- Electronics: DAE4 Sn1629; Calibrated: 2020-08-11
- Phantom: HAC Test Arch with AMCC
- Measurement SW: DASY52, Version 52.10 (4);

**T-Coil scan (scan for ANSI C63.19-2007 & 2011 compliance)/General Scans/z (axial) 4.2mm 50 x**

**50/ABM Signal(x,y,z) (13x13x1):** Measurement grid: dx=10mm, dy=10mm

Signal Type: Audio File (.wav) 48k\_voice\_1kHz\_1s.wav

Output Gain: 24.41

Measure Window Start: 300ms

Measure Window Length: 1000ms

BWC applied: 0.15 dB

Device Reference Point: 0, 0, -6.3 mm

**Cursor:**

ABM1 comp = 4.82 dBA/m

BWC Factor = 0.15 dB

Location: 12.5, -16.7, 3.7 mm

**Cursor:**

ABM2 = -28.80 dBA/m

Location: 12.5, -16.7, 3.7 mm

**Cursor:**

ABM1/ABM2 = 33.62 dB

ABM1 comp = 4.82 dBA/m

BWC Factor = 0.15 dB

Location: 12.5, -16.7, 3.7 mm

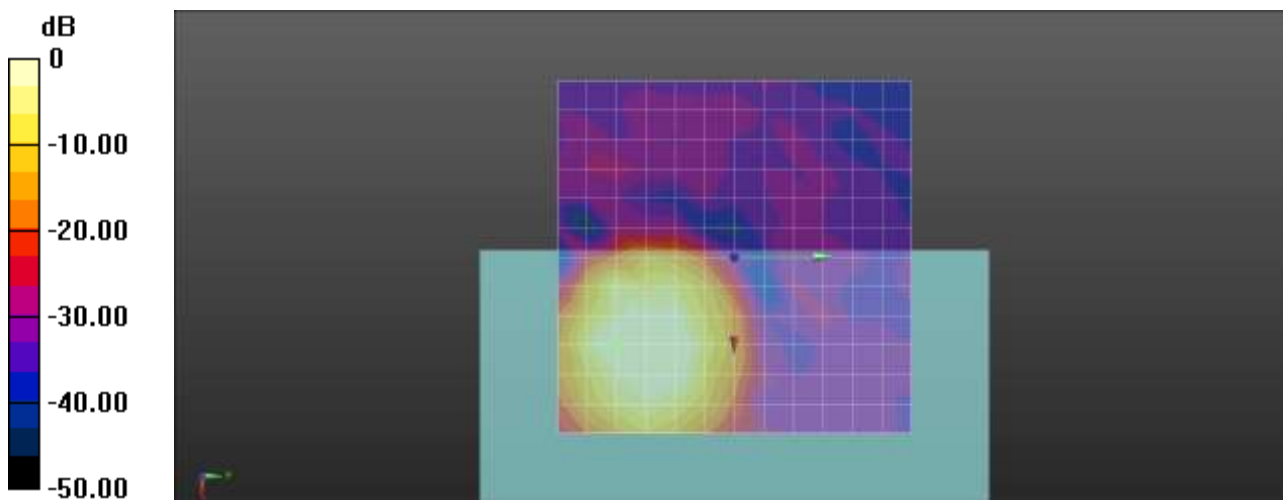

0 dB = 1.000 A/m = 0.00 dBA/m

**Plot No.62**

**LTE 48 QPSK EVS wb 5\_9bitrate 20MHz 50RB 49offset 55990ch 6 6 Freq.Response**

**DUT: SM-G991U; Type: Bar**

Communication System: UID 0, LTE 48; Frequency: 3625 MHz;Duty Cycle: 1:1.95209  
 Medium parameters used:  $\sigma = 0$  S/m,  $\epsilon_r = 1$ ;  $\rho = 0$  kg/m<sup>3</sup>  
 Phantom section: TCoil Section

**T-Coil scan (scan for ANSI C63.19-2007 & 2011 compliance)/General Scans/z (axial) wideband at best**

**S/N/ABM Freq Resp(x,y,z,f) (1x1x1):** Measurement grid: dx=10mm, dy=10mm

Signal Type: Audio File (.wav) 48k\_Normal\_51s new.wav

Output Gain: 52.45

Measure Window Start: 300ms

Measure Window Length: 51000ms

BWC applied: 9.47 dB

Device Reference Point: 0, 0, -6.3 mm

Category	Telephone parameters WD signal quality [(signal+noise)-to-noise ratio in decibels]
Category T1	0 dB to 10 dB
Category T2	10 dB to 20 dB
Category T3	20 dB to 30 dB
Category T4	> 30 dB

**Cursor:**

Diff = 1.90 dB

BWC Factor = 9.47 dB

Location: 12.4, -16.5, 3.7 mm

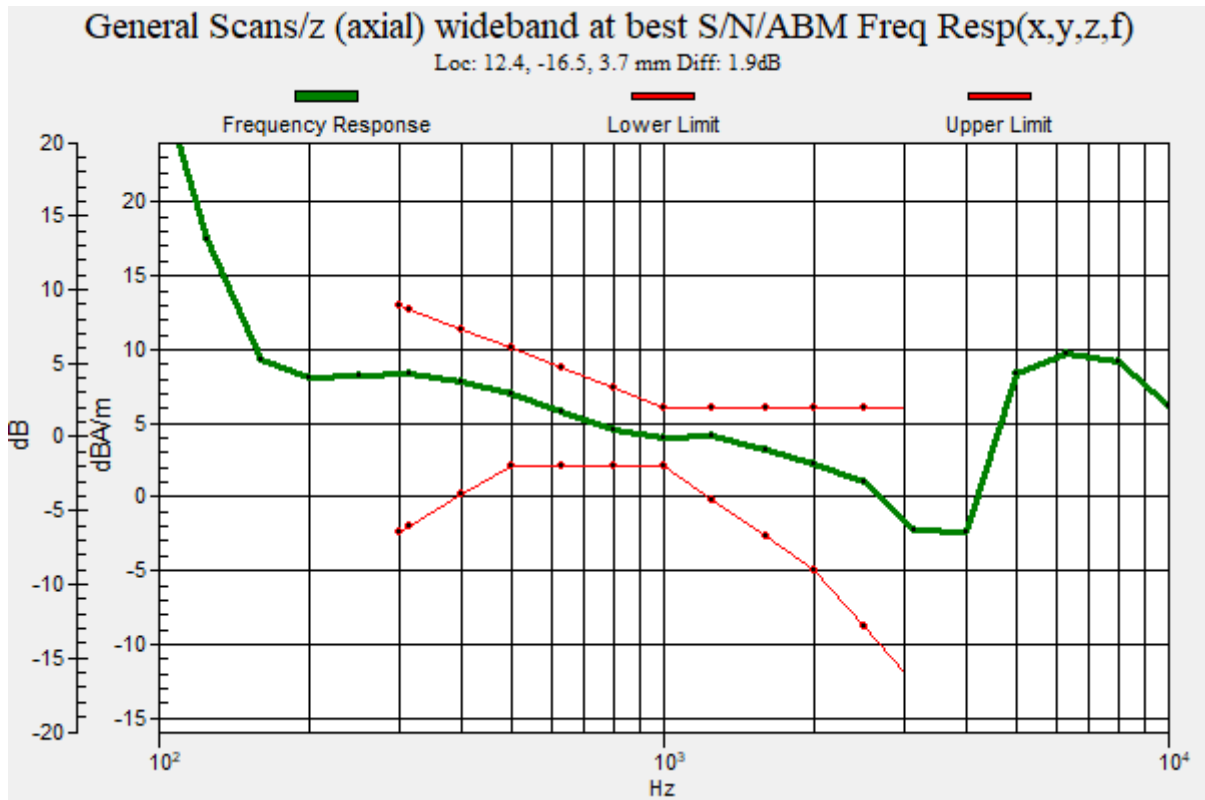

**Plot No.63**

**LTE 48 QPSK EVS wb 5\_9bitrate 20MHz 50RB 49offset 55990ch 6 6 y(transversal)**

**DUT: SM-G991U; Type: Bar**

Communication System: UID 0, LTE 48; Frequency: 3625 MHz;Duty Cycle: 1:1.95209  
Medium parameters used:  $\sigma = 0$  S/m,  $\epsilon_r = 1$ ;  $\rho = 0$  kg/m<sup>3</sup>  
Phantom section: TCoil Section

DASY Configuration:

- Probe: AM1DV2 - 1013; ;
- Sensor-Surface: 0mm (Fix Surface)
- Electronics: DAE4 Sn1629; Calibrated: 2020-08-11
- Phantom: HAC Test Arch with AMCC
- Measurement SW: DASY52, Version 52.10 (4);

**T-Coil scan (scan for ANSI C63.19-2007 & 2011 compliance)/General Scans/y (transversal) 4.2mm 50**

**x 50/ABM Signal(x,y,z) (13x13x1):** Measurement grid: dx=10mm, dy=10mm

Signal Type: Audio File (.wav) 48k\_voice\_1kHz\_1s.wav

Output Gain: 24.41

Measure Window Start: 300ms

Measure Window Length: 1000ms

BWC applied: 0.15 dB

Device Reference Point: 0, 0, -6.3 mm

**Cursor:**

ABM1 comp = -11.69 dBA/m

BWC Factor = 0.15 dB

Location: 0, -20.8, 3.7 mm

**Cursor:**

ABM2 = -44.00 dBA/m

Location: 0, -20.8, 3.7 mm

**Cursor:**

ABM1/ABM2 = 32.31 dB

ABM1 comp = -11.69 dBA/m

BWC Factor = 0.15 dB

Location: 0, -20.8, 3.7 mm

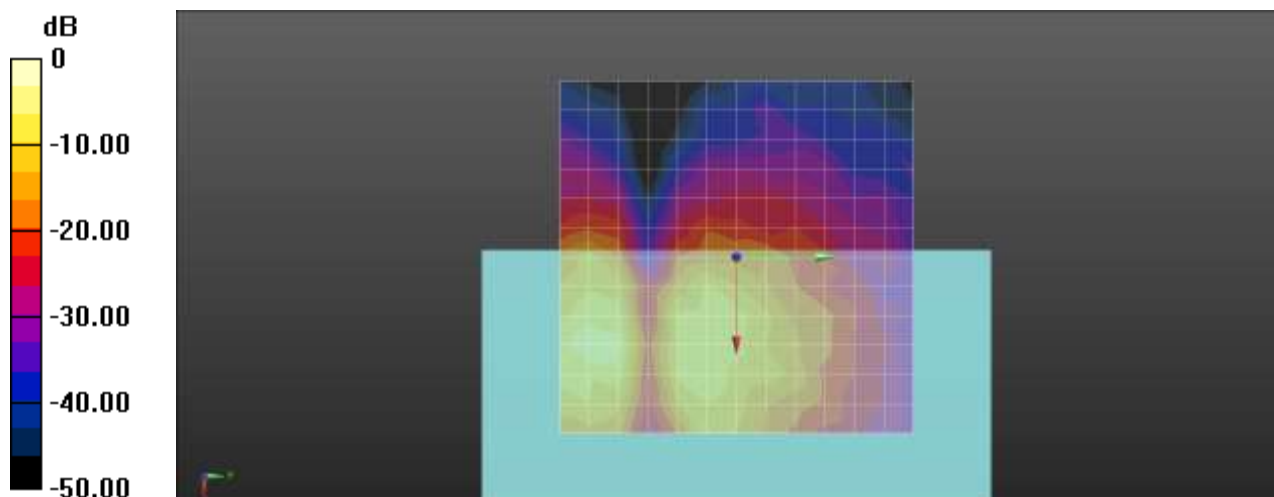

0 dB = 1.000 A/m = 0.00 dBA/m

**Plot No.64**  
**802\_11b 5.5Mbps 6ch EVS WB 5\_9 z(axial)**

**DUT: SM-G991U; Type: Bar**

Communication System: UID 0, 2450MHz FCC (0); Frequency: 2437 MHz;Duty Cycle: 1:1  
Medium parameters used:  $\sigma = 0$  S/m,  $\epsilon_r = 1$ ;  $\rho = 0$  kg/m<sup>3</sup>  
Phantom section: TCoil Section

DASY Configuration:

- Probe: AM1DV2 - 1013; ;
- Sensor-Surface: 0mm (Fix Surface)
- Electronics: DAE4 Sn1629; Calibrated: 2020-08-11
- Phantom: HAC Test Arch with AMCC
- Measurement SW: DASY52, Version 52.10 (4);

**T-Coil scan (scan for ANSI C63.19-2007 & 2011 compliance)/General Scans/z (axial) 4.2mm 50 x 50/ABM Signal(x,y,z) (13x13x1):** Measurement grid: dx=10mm, dy=10mm  
Signal Type: Audio File (.wav) 48k\_voice\_1kHz\_1s.wav  
Output Gain: 15.26  
Measure Window Start: 300ms  
Measure Window Length: 1000ms  
BWC applied: 0.15 dB  
Device Reference Point: 0, 0, -6.3 mm

**Cursor:**  
ABM1 comp = -12.58 dBA/m  
BWC Factor = 0.15 dB  
Location: 0, -8.3, 3.7 mm

**Cursor:**  
ABM2 = -38.91 dBA/m  
Location: 0, -8.3, 3.7 mm

**Cursor:**  
ABM1/ABM2 = 26.33 dB  
ABM1 comp = -12.58 dBA/m  
BWC Factor = 0.15 dB  
Location: 0, -8.3, 3.7 mm

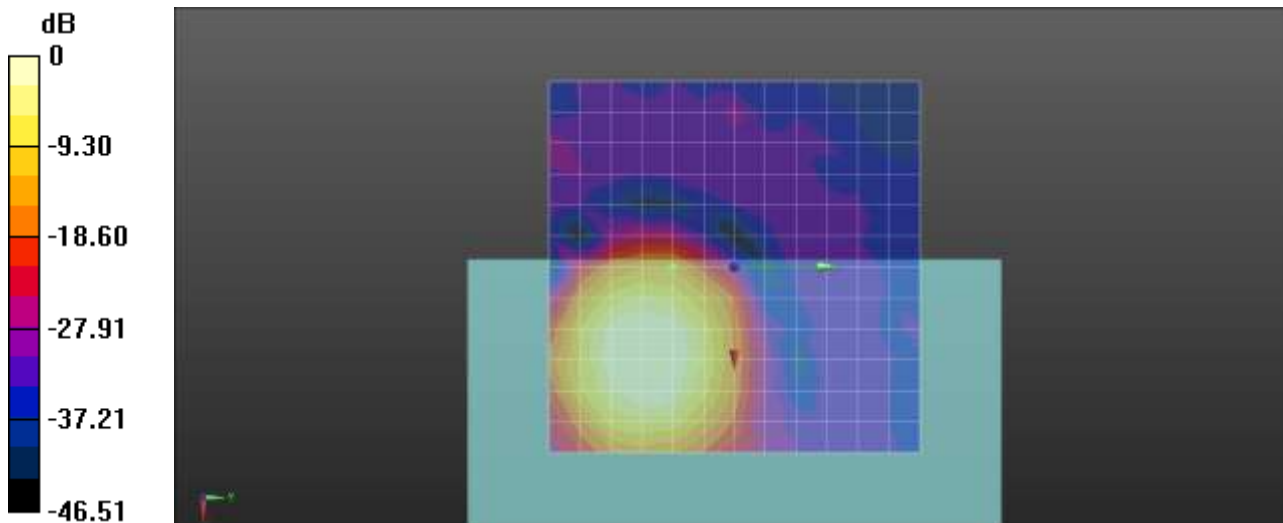

0 dB = 1.000 A/m = 0.00 dBA/m

**Plot No.65**  
**802\_11b 5.5Mbps 6ch EVS WB 5\_9 Freq.Response**

**DUT: SM-G991U; Type: Bar**

Communication System: UID 0, 2450MHz FCC (0); Frequency: 2437 MHz;Duty Cycle: 1:1  
Medium parameters used:  $\sigma = 0$  S/m,  $\epsilon_r = 1$ ;  $\rho = 0$  kg/m<sup>3</sup>  
Phantom section: TCoil Section

**T-Coil scan (scan for ANSI C63.19-2007 & 2011 compliance)/General Scans/z (axial) wideband at best S/N/ABM Freq Resp(x,y,z,f) (1x1x1):** Measurement grid: dx=10mm, dy=10mm  
Signal Type: Audio File (.wav) 48k\_Normal\_51s new.wav  
Output Gain: 46.39  
Measure Window Start: 300ms  
Measure Window Length: 51000ms  
BWC applied: 9.47 dB  
Device Reference Point: 0, 0, -6.3 mm

Category	Telephone parameters WD signal quality [(signal+noise)-to-noise ratio in decibels]
Category T1	0 dB to 10 dB
Category T2	10 dB to 20 dB
Category T3	20 dB to 30 dB
Category T4	> 30 dB

**Cursor:**  
Diff = 2.00 dB  
BWC Factor = 9.47 dB  
Location: 9.8, -15.1, 3.7 mm

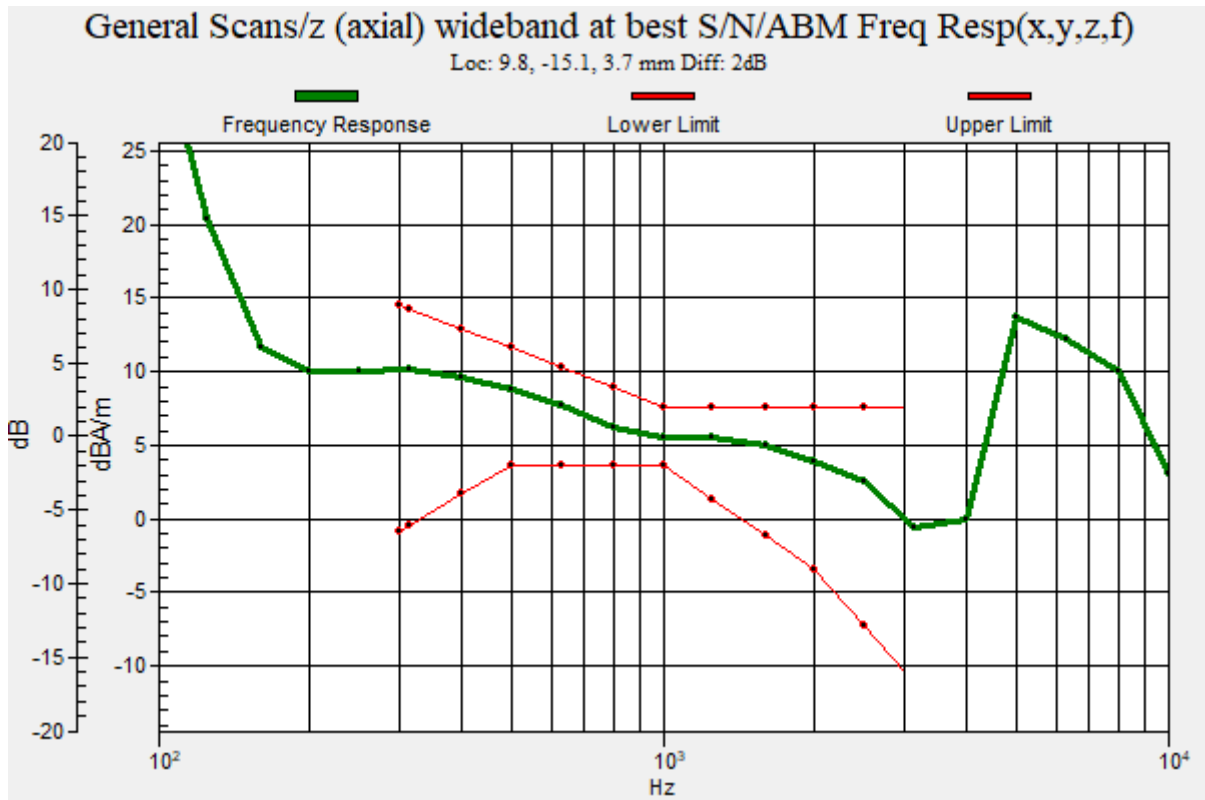

**Plot No.66**

**802\_11b 5.5Mbps 6ch EVS WB 5\_9 y(transversal)**

**DUT: SM-G991U; Type: Bar**

Communication System: UID 0, 2450MHz FCC (0); Frequency: 2437 MHz;Duty Cycle: 1:1  
Medium parameters used:  $\sigma = 0$  S/m,  $\epsilon_r = 1$ ;  $\rho = 0$  kg/m<sup>3</sup>  
Phantom section: TCoil Section

DASY Configuration:

- Probe: AM1DV2 - 1013; ;
- Sensor-Surface: 0mm (Fix Surface)
- Electronics: DAE4 Sn1629; Calibrated: 2020-08-11
- Phantom: HAC Test Arch with AMCC
- Measurement SW: DASY52, Version 52.10 (4);

**T-Coil scan (scan for ANSI C63.19-2007 & 2011 compliance)/General Scans/y (transversal) 4.2mm 50**

**x 50/ABM Signal(x,y,z) (13x13x1):** Measurement grid: dx=10mm, dy=10mm

Signal Type: Audio File (.wav) 48k\_voice\_1kHz\_1s.wav

Output Gain: 15.26

Measure Window Start: 300ms

Measure Window Length: 1000ms

BWC applied: 0.15 dB

Device Reference Point: 0, 0, -6.3 mm

**Cursor:**

ABM1 comp = -2.70 dBA/m

BWC Factor = 0.15 dB

Location: 16.7, -4.2, 3.7 mm

**Cursor:**

ABM2 = -29.96 dBA/m

Location: 16.7, -4.2, 3.7 mm

**Cursor:**

ABM1/ABM2 = 27.27 dB

ABM1 comp = -2.70 dBA/m

BWC Factor = 0.15 dB

Location: 16.7, -4.2, 3.7 mm

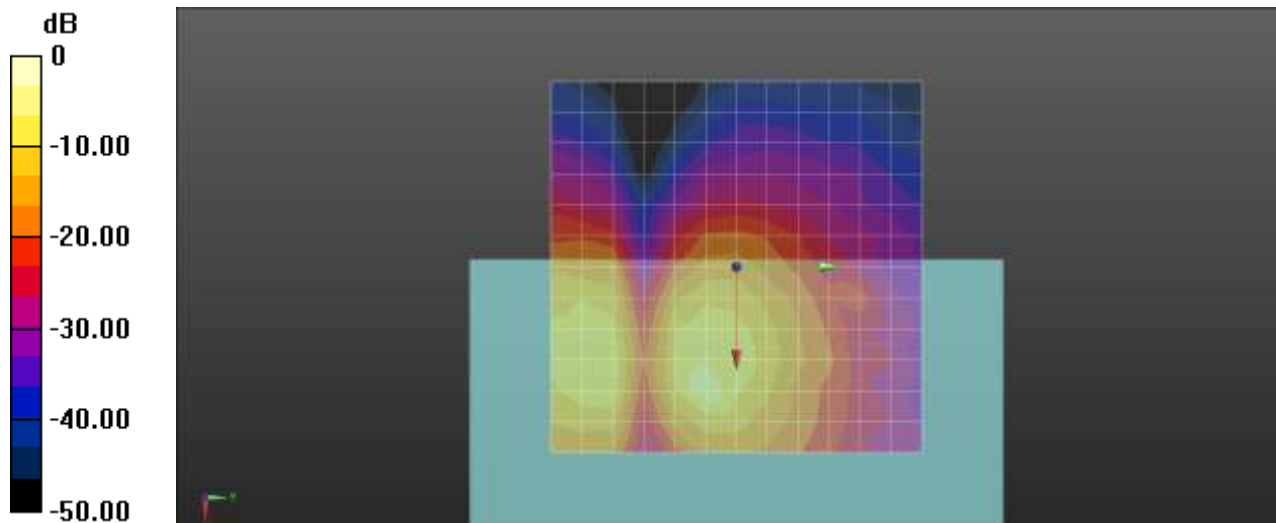

0 dB = 1.000 A/m = 0.00 dBA/m

**Plot No.67**  
**802\_11n20 MCS0 40ch EVS WB 5\_9 z(axial)**

**DUT: SM-G991U; Type: Bar**

Communication System: UID 0, WIFI 5GHz (0); Frequency: 5200 MHz;Duty Cycle: 1:1  
Medium parameters used:  $\sigma = 0$  S/m,  $\epsilon_r = 1$ ;  $\rho = 0$  kg/m<sup>3</sup>  
Phantom section: TCoil Section

DASY Configuration:

- Probe: AM1DV3 - 3049; ;
- Sensor-Surface: 0mm (Fix Surface)
- Electronics: DAE4 Sn466; Calibrated: 2020-04-22
- Phantom: HAC Test Arch with AMCC
- Measurement SW: DASY52, Version 52.10 (4);

**T-Coil scan (scan for ANSI C63.19-2007 & 2011 compliance)/General Scans/z (axial) 4.2mm 50 x 50/ABM Signal(x,y,z) (13x13x1):** Measurement grid: dx=10mm, dy=10mm  
Signal Type: Audio File (.wav) 48k\_voice\_1kHz\_1s.wav  
Output Gain: 15.26  
Measure Window Start: 300ms  
Measure Window Length: 1000ms  
BWC applied: 0.16 dB  
Device Reference Point: 0, 0, -6.3 mm

**Cursor:**  
ABM1 comp = -14.18 dBA/m  
BWC Factor = 0.16 dB  
Location: 0, -8.3, 3.7 mm

**Cursor:**  
ABM2 = -37.41 dBA/m  
Location: 0, -8.3, 3.7 mm

**Cursor:**  
ABM1/ABM2 = 23.23 dB  
ABM1 comp = -14.18 dBA/m  
BWC Factor = 0.16 dB  
Location: 0, -8.3, 3.7 mm

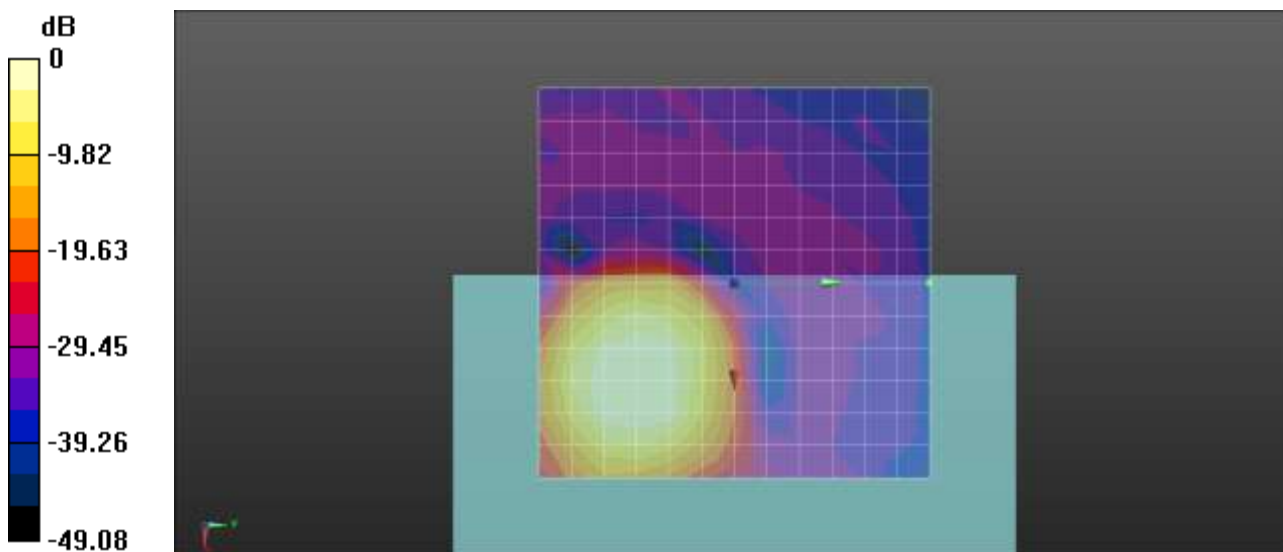

0 dB = 1.000 A/m = 0.00 dBA/m



**Plot No.68**  
**802\_11n20 MCS0 40ch EVS WB 5\_9 Freq.Response**

**DUT: SM-G991U; Type: Bar**

Communication System: UID 0, WIFI 5GHz (0); Frequency: 5200 MHz;Duty Cycle: 1:1  
Medium parameters used:  $\sigma = 0$  S/m,  $\epsilon_r = 1$ ;  $\rho = 0$  kg/m<sup>3</sup>  
Phantom section: TCoil Section

**T-Coil scan (scan for ANSI C63.19-2007 & 2011 compliance)/General Scans/z (axial) wideband at best S/N/ABM Freq Resp(x,y,z,f) (1x1x1):** Measurement grid: dx=10mm, dy=10mm  
Signal Type: Audio File (.wav) 48k\_Normal\_51s new.wav  
Output Gain: 46.24  
Measure Window Start: 300ms  
Measure Window Length: 51000ms  
BWC applied: 9.48 dB  
Device Reference Point: 0, 0, -6.3 mm

Category	Telephone parameters WD signal quality [(signal+noise)-to-noise ratio in decibels]
Category T1	0 dB to 10 dB
Category T2	10 dB to 20 dB
Category T3	20 dB to 30 dB
Category T4	> 30 dB

**Cursor:**  
Diff = 1.93 dB  
BWC Factor = 9.48 dB  
Location: 4.4, -5, 3.7 mm

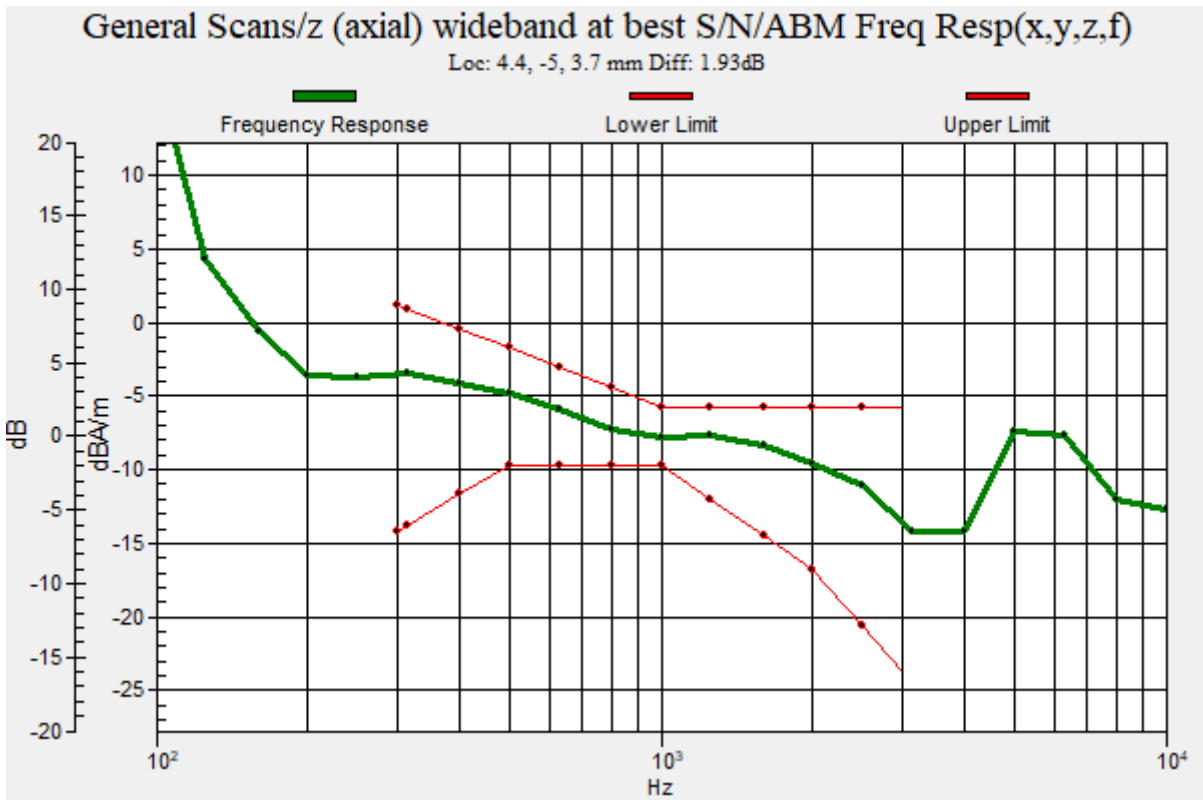

**Plot No.69**  
**802\_11n20 MCS0 40ch EVS WB 5\_9 y(transversal)**

**DUT: SM-G991U; Type: Bar**

Communication System: UID 0, WIFI 5GHz (0); Frequency: 5200 MHz;Duty Cycle: 1:1  
Medium parameters used:  $\sigma = 0$  S/m,  $\epsilon_r = 1$ ;  $\rho = 0$  kg/m<sup>3</sup>  
Phantom section: TCoil Section

DASY Configuration:

- Probe: AM1DV3 - 3049; ;
- Sensor-Surface: 0mm (Fix Surface)
- Electronics: DAE4 Sn466; Calibrated: 2020-04-22
- Phantom: HAC Test Arch with AMCC
- Measurement SW: DASY52, Version 52.10 (4);

**T-Coil scan (scan for ANSI C63.19-2007 & 2011 compliance)/General Scans/y (transversal) 4.2mm 50**

**x 50/ABM Signal(x,y,z) (13x13x1):** Measurement grid: dx=10mm, dy=10mm

Signal Type: Audio File (.wav) 48k\_voice\_1kHz\_1s.wav

Output Gain: 15.26

Measure Window Start: 300ms

Measure Window Length: 1000ms

BWC applied: 0.16 dB

Device Reference Point: 0, 0, -6.3 mm

**Cursor:**

ABM1 comp = -4.40 dBA/m

BWC Factor = 0.16 dB

Location: 8.3, -8.3, 3.7 mm

**Cursor:**

ABM2 = -28.61 dBA/m

Location: 8.3, -8.3, 3.7 mm

**Cursor:**

ABM1/ABM2 = 24.21 dB

ABM1 comp = -4.40 dBA/m

BWC Factor = 0.16 dB

Location: 8.3, -8.3, 3.7 mm

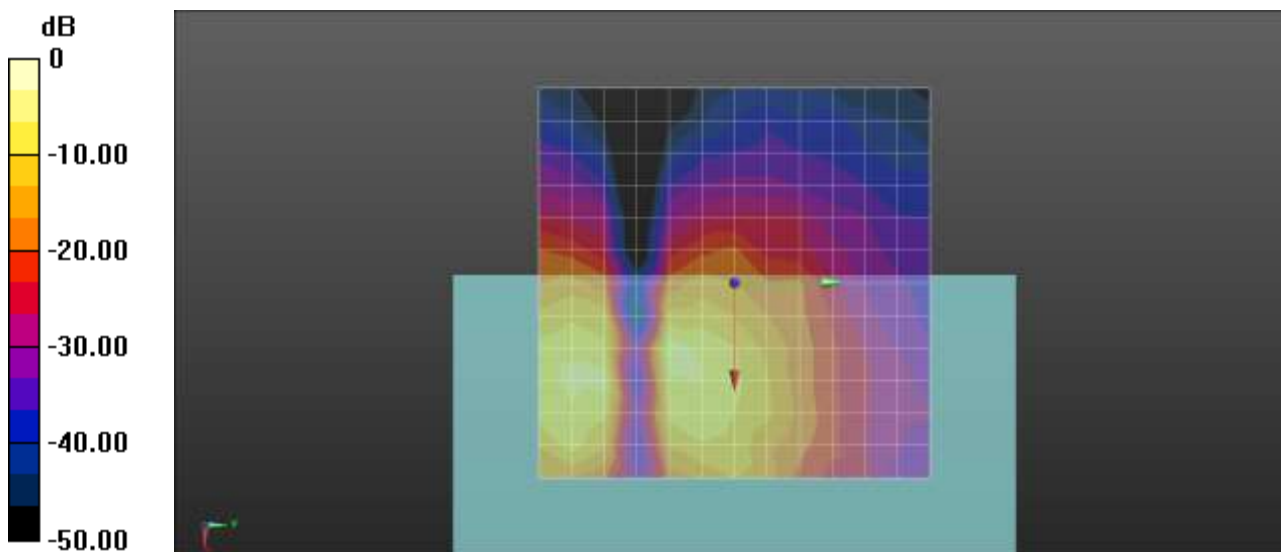

0 dB = 1.000 A/m = 0.00 dBA/m

**Plot No.70**  
**802\_11n20 MCS0 56ch EVS WB 5\_9 z(axial)**

**DUT: SM-G991U; Type: Bar**

Communication System: UID 0, WIFI 5GHz (0); Frequency: 5280 MHz;Duty Cycle: 1:1  
Medium parameters used:  $\sigma = 0$  S/m,  $\epsilon_r = 1$ ;  $\rho = 0$  kg/m<sup>3</sup>  
Phantom section: TCoil Section

DASY Configuration:

- Probe: AM1DV3 - 3049; ;
- Sensor-Surface: 0mm (Fix Surface)
- Electronics: DAE4 Sn466; Calibrated: 2020-04-22
- Phantom: HAC Test Arch with AMCC
- Measurement SW: DASY52, Version 52.10 (4);

**T-Coil scan (scan for ANSI C63.19-2007 & 2011 compliance)/General Scans/z (axial) 4.2mm 50 x 50/ABM Signal(x,y,z) (13x13x1):** Measurement grid: dx=10mm, dy=10mm  
Signal Type: Audio File (.wav) 48k\_voice\_1kHz\_1s.wav  
Output Gain: 15.26  
Measure Window Start: 300ms  
Measure Window Length: 1000ms  
BWC applied: 0.16 dB  
Device Reference Point: 0, 0, -6.3 mm

**Cursor:**  
ABM1 comp = -1.35 dBA/m  
BWC Factor = 0.16 dB  
Location: 4.2, -12.5, 3.7 mm

**Cursor:**  
ABM2 = -25.08 dBA/m  
Location: 4.2, -12.5, 3.7 mm

**Cursor:**  
ABM1/ABM2 = 23.73 dB  
ABM1 comp = -1.35 dBA/m  
BWC Factor = 0.16 dB  
Location: 4.2, -12.5, 3.7 mm

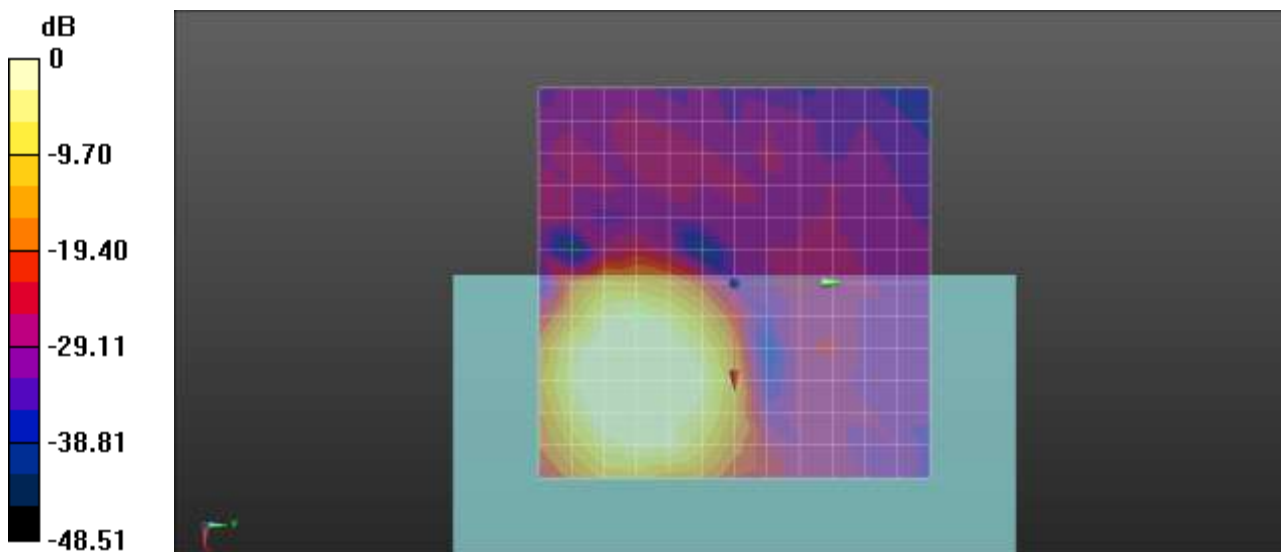

0 dB = 1.000 A/m = 0.00 dBA/m

**Plot No.71**  
**802\_11n20 MCS0 56ch EVS WB 5\_9 Freq.Response**

**DUT: SM-G991U; Type: Bar**

Communication System: UID 0, WIFI 5GHz (0); Frequency: 5280 MHz;Duty Cycle: 1:1  
Medium parameters used:  $\sigma = 0$  S/m,  $\epsilon_r = 1$ ;  $\rho = 0$  kg/m<sup>3</sup>

**T-Coil scan (scan for ANSI C63.19-2007 & 2011 compliance)/General Scans/z (axial) wideband at best S/N/ABM Freq Resp(x,y,z,f) (1x1x1):** Measurement grid: dx=10mm, dy=10mm  
Signal Type: Audio File (.wav) 48k\_Normal\_51s new.wav  
Output Gain: 46.24  
Measure Window Start: 300ms  
Measure Window Length: 51000ms  
BWC applied: 9.48 dB  
Device Reference Point: 0, 0, -6.3 mm

Category	Telephone parameters WD signal quality [(signal+noise)-to-noise ratio in decibels]
Category T1	0 dB to 10 dB
Category T2	10 dB to 20 dB
Category T3	20 dB to 30 dB
Category T4	> 30 dB

**Cursor:**  
Diff = 2.00 dB  
BWC Factor = 9.48 dB  
Location: 5.2, -13.3, 3.7 mm

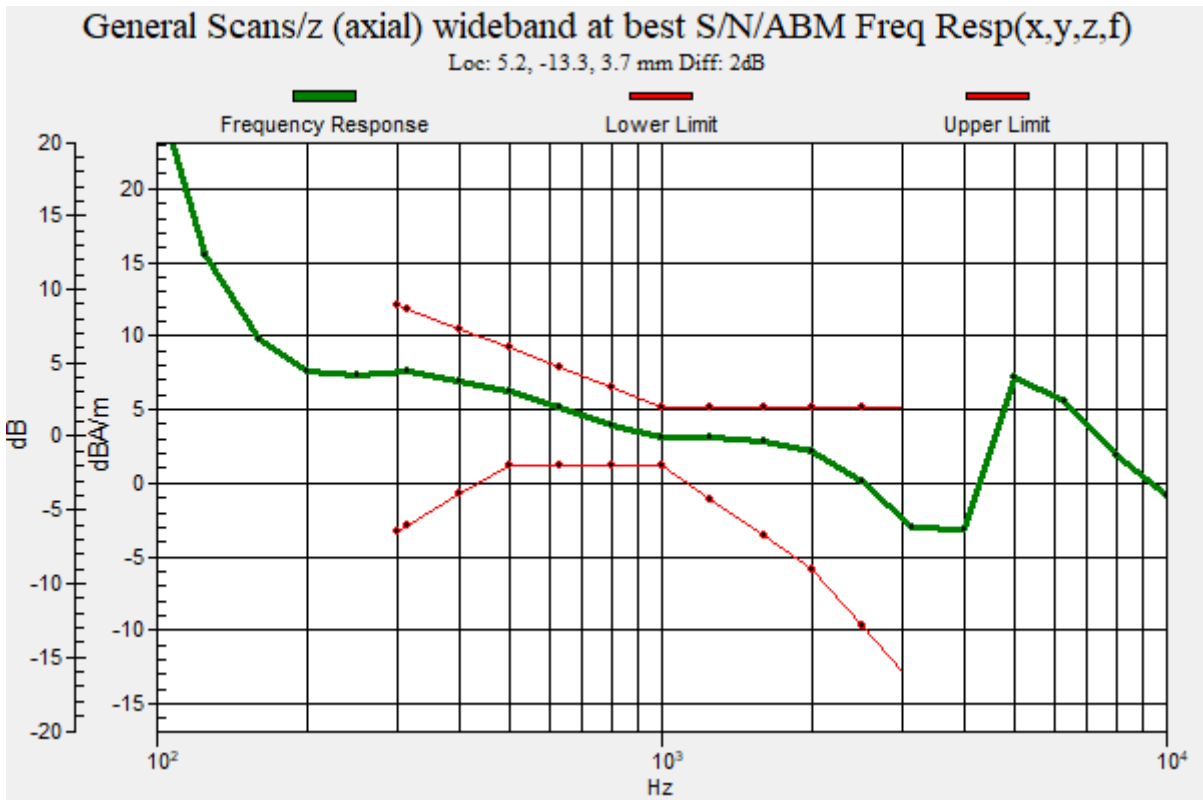

**Plot No.72**

**802\_11n20 MCS0 56ch EVS WB 5\_9 y(transversal)**

**DUT: SM-G991U; Type: Bar**

Communication System: UID 0, WIFI 5GHz (0); Frequency: 5280 MHz;Duty Cycle: 1:1  
Medium parameters used:  $\sigma = 0$  S/m,  $\epsilon_r = 1$ ;  $\rho = 0$  kg/m<sup>3</sup>  
Phantom section: TCoil Section

DASY Configuration:

- Probe: AM1DV3 - 3049; ;
- Sensor-Surface: 0mm (Fix Surface)
- Electronics: DAE4 Sn466; Calibrated: 2020-04-22
- Phantom: HAC Test Arch with AMCC
- Measurement SW: DASY52, Version 52.10 (4);

**T-Coil scan (scan for ANSI C63.19-2007 & 2011 compliance)/General Scans/y (transversal) 4.2mm 50**

**x 50/ABM Signal(x,y,z) (13x13x1):** Measurement grid: dx=10mm, dy=10mm

Signal Type: Audio File (.wav) 48k\_voice\_1kHz\_1s.wav

Output Gain: 15.26

Measure Window Start: 300ms

Measure Window Length: 1000ms

BWC applied: 0.16 dB

Device Reference Point: 0, 0, -6.3 mm

**Cursor:**

ABM1 comp = -4.34 dBA/m

BWC Factor = 0.16 dB

Location: 8.3, 0, 3.7 mm

**Cursor:**

ABM2 = -28.74 dBA/m

Location: 8.3, 0, 3.7 mm

**Cursor:**

ABM1/ABM2 = 24.40 dB

ABM1 comp = -4.34 dBA/m

BWC Factor = 0.16 dB

Location: 8.3, 0, 3.7 mm

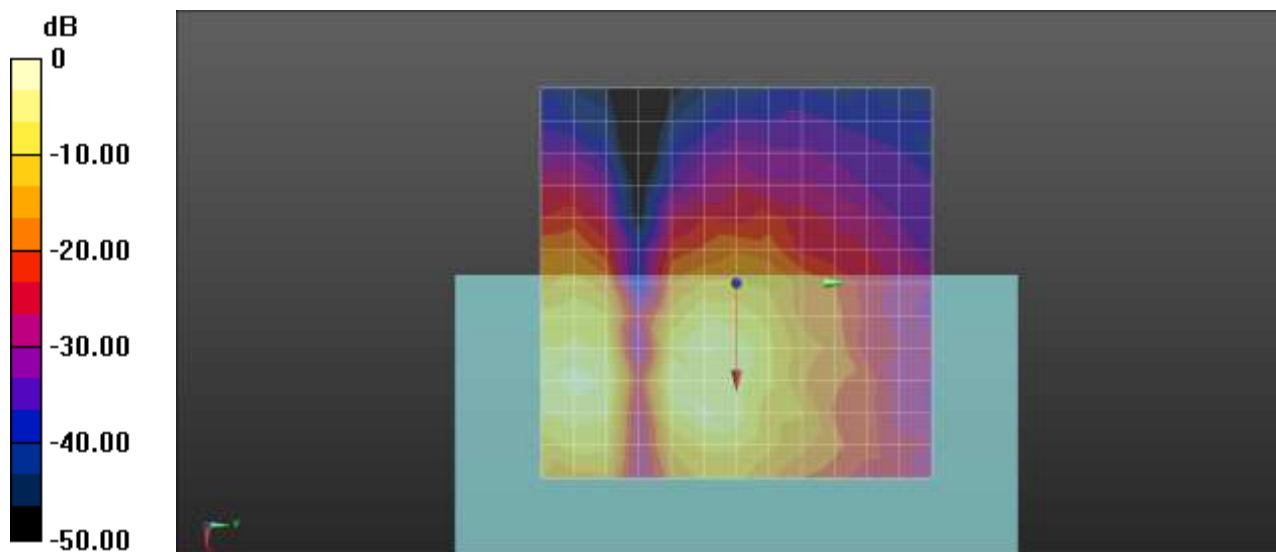

0 dB = 1.000 A/m = 0.00 dBA/m

**Plot No.73**  
**802\_11n20 MCS0 120ch EVS WB 5\_9 z(axial)**

**DUT: SM-G991U; Type: Bar**

Communication System: UID 0, WIFI 5GHz (0); Frequency: 5600 MHz;Duty Cycle: 1:1  
Medium parameters used:  $\sigma = 0$  S/m,  $\epsilon_r = 1$ ;  $\rho = 0$  kg/m<sup>3</sup>  
Phantom section: TCoil Section

DASY Configuration:

- Probe: AM1DV3 - 3049; ;
- Sensor-Surface: 0mm (Fix Surface)
- Electronics: DAE4 Sn466; Calibrated: 2020-04-22
- Phantom: HAC Test Arch with AMCC
- Measurement SW: DASY52, Version 52.10 (4);

**T-Coil scan (scan for ANSI C63.19-2007 & 2011 compliance)/General Scans/z (axial) 4.2mm 50 x 50/ABM Signal(x,y,z) (13x13x1):** Measurement grid: dx=10mm, dy=10mm  
Signal Type: Audio File (.wav) 48k\_voice\_1kHz\_1s.wav  
Output Gain: 15.26  
Measure Window Start: 300ms  
Measure Window Length: 1000ms  
BWC applied: 0.16 dB  
Device Reference Point: 0, 0, -6.3 mm

**Cursor:**  
ABM1 comp = -3.14 dBA/m  
BWC Factor = 0.16 dB  
Location: 8.3, -20.8, 3.7 mm

**Cursor:**  
ABM2 = -27.49 dBA/m  
Location: 8.3, -20.8, 3.7 mm

**Cursor:**  
ABM1/ABM2 = 24.35 dB  
ABM1 comp = -3.14 dBA/m  
BWC Factor = 0.16 dB  
Location: 8.3, -20.8, 3.7 mm

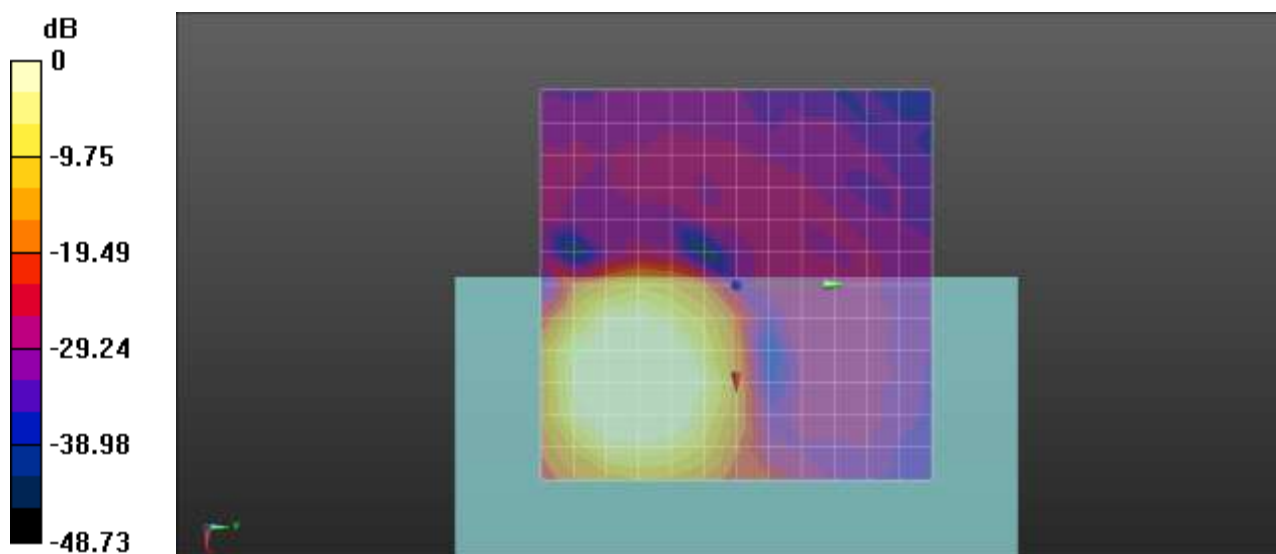

0 dB = 1.000 A/m = 0.00 dBA/m

**Plot No.74**  
**802\_11n20 MCS0 120ch EVS WB 5\_9 Freq.Response**

**DUT: SM-G991U; Type: Bar**

Communication System: UID 0, WIFI 5GHz (0); Frequency: 5600 MHz;Duty Cycle: 1:1  
Medium parameters used:  $\sigma = 0$  S/m,  $\epsilon_r = 1$ ;  $\rho = 0$  kg/m<sup>3</sup>  
Phantom section: TCoil Section

**T-Coil scan (scan for ANSI C63.19-2007 & 2011 compliance)/General Scans/z (axial) wideband at best S/N/ABM Freq Resp(x,y,z,f) (1x1x1):** Measurement grid: dx=10mm, dy=10mm  
Signal Type: Audio File (.wav) 48k\_Normal\_51s new.wav  
Output Gain: 46.24  
Measure Window Start: 300ms  
Measure Window Length: 51000ms  
BWC applied: 9.48 dB  
Device Reference Point: 0, 0, -6.3 mm

Category	Telephone parameters WD signal quality [(signal+noise)-to-noise ratio in decibels]
Category T1	0 dB to 10 dB
Category T2	10 dB to 20 dB
Category T3	20 dB to 30 dB
Category T4	> 30 dB

**Cursor:**  
Diff = 2.00 dB  
BWC Factor = 9.48 dB  
Location: 8.5, -19.9, 3.7 mm

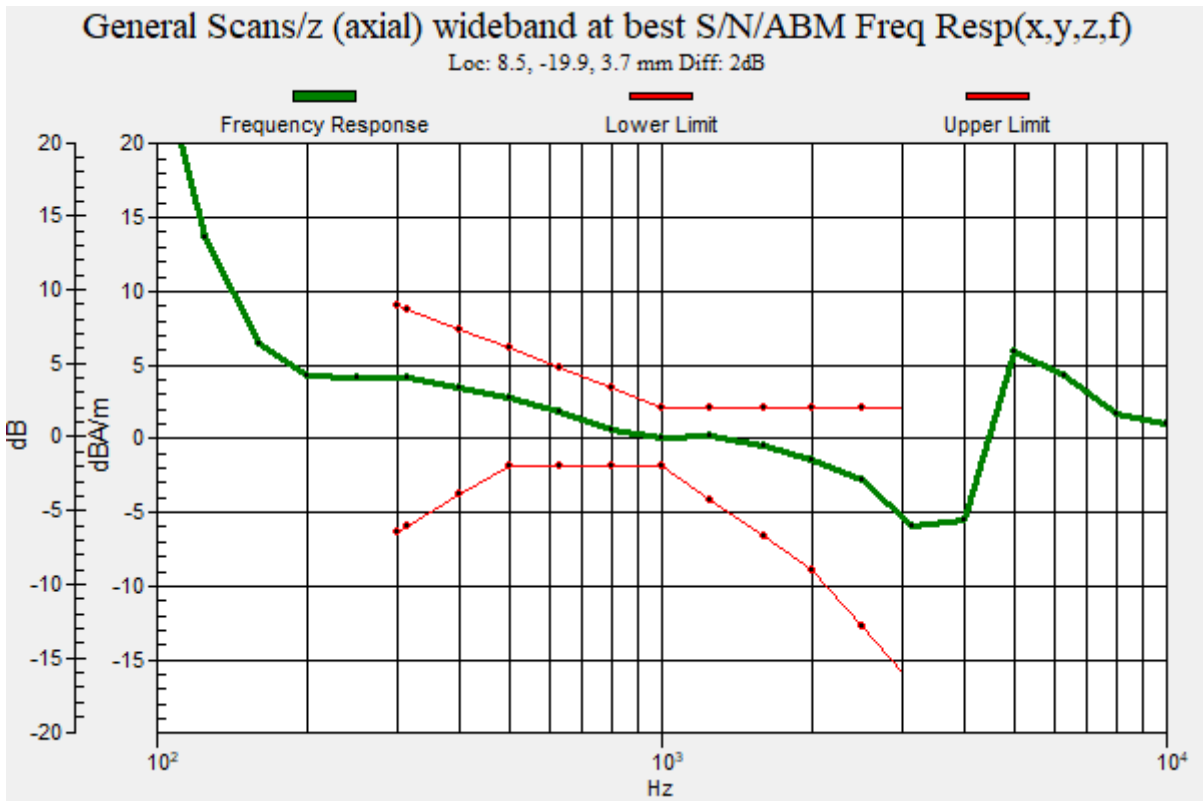

**Plot No.75**

**802\_11n20 MCS0 120ch EVS WB 5\_9 y(transversal)**

**DUT: SM-G991U; Type: Bar**

Communication System: UID 0, WIFI 5GHz (0); Frequency: 5600 MHz;Duty Cycle: 1:1  
Medium parameters used:  $\sigma = 0$  S/m,  $\epsilon_r = 1$ ;  $\rho = 0$  kg/m<sup>3</sup>  
Phantom section: TCoil Section

DASY Configuration:

- Probe: AM1DV3 - 3049; ;
- Sensor-Surface: 0mm (Fix Surface)
- Electronics: DAE4 Sn466; Calibrated: 2020-04-22
- Phantom: HAC Test Arch with AMCC
- Measurement SW: DASY52, Version 52.10 (4);

**T-Coil scan (scan for ANSI C63.19-2007 & 2011 compliance)/General Scans/y (transversal) 4.2mm 50**

**x 50/ABM Signal(x,y,z) (13x13x1):** Measurement grid: dx=10mm, dy=10mm

Signal Type: Audio File (.wav) 48k\_voice\_1kHz\_1s.wav

Output Gain: 15.26

Measure Window Start: 300ms

Measure Window Length: 1000ms

BWC applied: 0.16 dB

Device Reference Point: 0, 0, -6.3 mm

**Cursor:**

ABM1 comp = -13.39 dBA/m

BWC Factor = 0.16 dB

Location: 0, 4.2, 3.7 mm

**Cursor:**

ABM2 = -37.67 dBA/m

Location: 0, 4.2, 3.7 mm

**Cursor:**

ABM1/ABM2 = 24.28 dB

ABM1 comp = -13.39 dBA/m

BWC Factor = 0.16 dB

Location: 0, 4.2, 3.7 mm

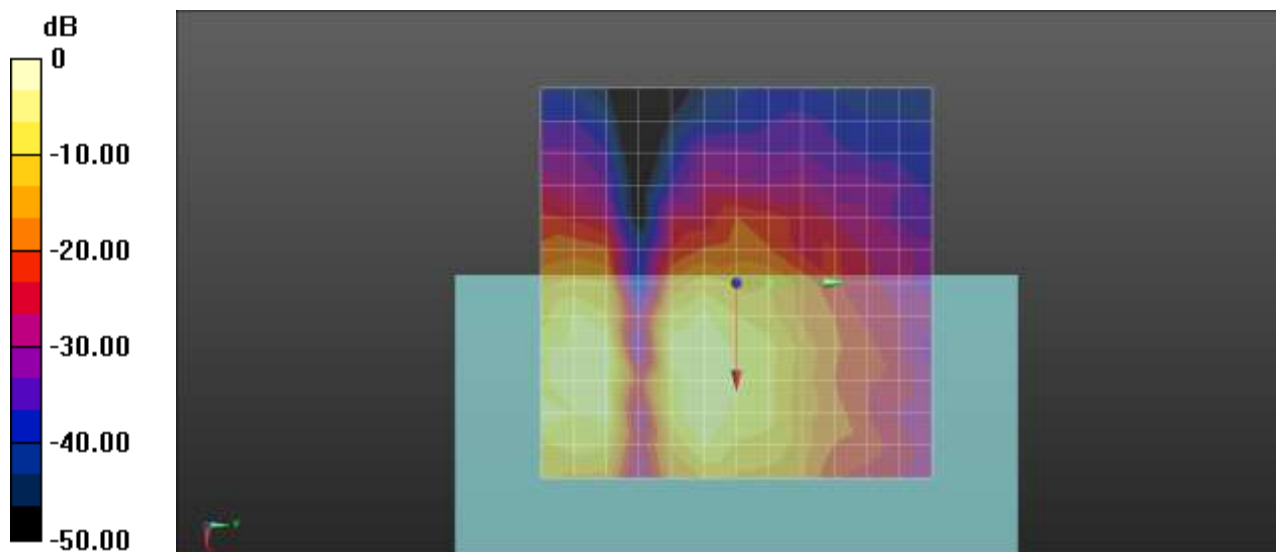

0 dB = 1.000 A/m = 0.00 dBA/m



**Plot No.76**  
**802\_11n20 MCS0 157ch EVS WB 5\_9 z(axial)**

**DUT: SM-G991U; Type: Bar**

Communication System: UID 0, WIFI 5GHz (0); Frequency: 5785 MHz;Duty Cycle: 1:1  
Medium parameters used:  $\sigma = 0$  S/m,  $\epsilon_r = 1$ ;  $\rho = 0$  kg/m<sup>3</sup>  
Phantom section: TCoil Section

DASY Configuration:

- Probe: AM1DV3 - 3049; ;
- Sensor-Surface: 0mm (Fix Surface)
- Electronics: DAE4 Sn466; Calibrated: 2020-04-22
- Phantom: HAC Test Arch with AMCC
- Measurement SW: DASY52, Version 52.10 (4);

**T-Coil scan (scan for ANSI C63.19-2007 & 2011 compliance)/General Scans/z (axial) 4.2mm 50 x 50/ABM Signal(x,y,z) (13x13x1):** Measurement grid: dx=10mm, dy=10mm  
Signal Type: Audio File (.wav) 48k\_voice\_1kHz\_1s.wav  
Output Gain: 15.26  
Measure Window Start: 300ms  
Measure Window Length: 1000ms  
BWC applied: 0.16 dB  
Device Reference Point: 0, 0, -6.3 mm

**Cursor:**  
ABM1 comp = 4.82 dBA/m  
BWC Factor = 0.16 dB  
Location: 16.7, -12.5, 3.7 mm

**Cursor:**  
ABM2 = -18.31 dBA/m  
Location: 16.7, -12.5, 3.7 mm

**Cursor:**  
ABM1/ABM2 = 23.13 dB  
ABM1 comp = 4.82 dBA/m  
BWC Factor = 0.16 dB  
Location: 16.7, -12.5, 3.7 mm

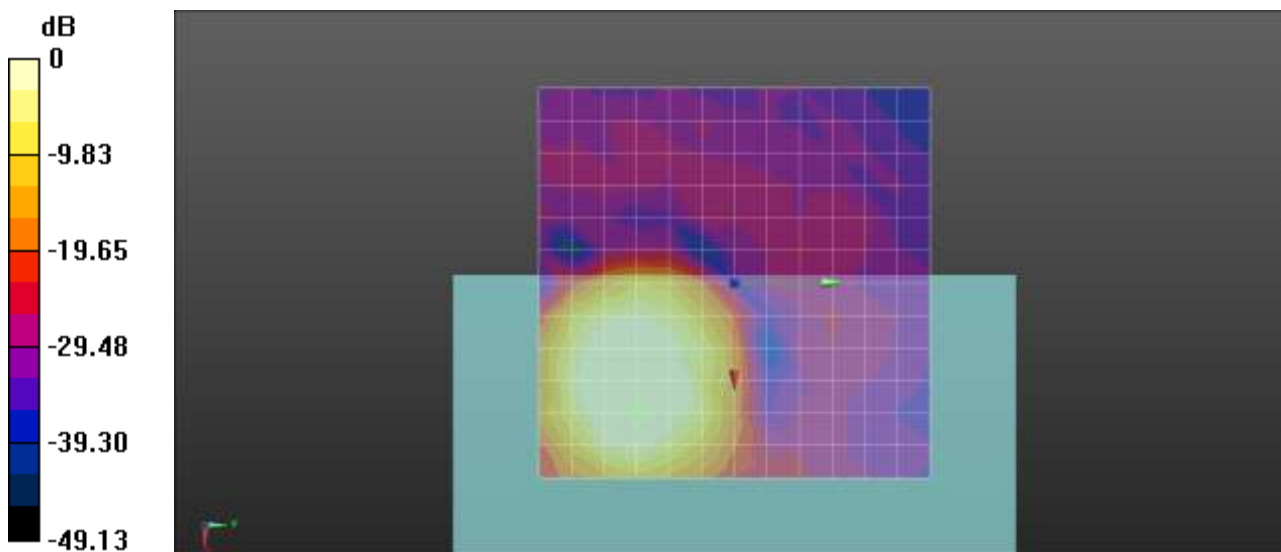

0 dB = 1.000 A/m = 0.00 dBA/m

**Plot No.77**  
**802\_11n20 MCS0 157ch EVS WB 5\_9 Freq.Response**

**DUT: SM-G991U; Type: Bar**

Communication System: UID 0, WIFI 5GHz (0); Frequency: 5785 MHz;Duty Cycle: 1:1  
Medium parameters used:  $\sigma = 0$  S/m,  $\epsilon_r = 1$ ;  $\rho = 0$  kg/m<sup>3</sup>  
Phantom section: TCoil Section

**T-Coil scan (scan for ANSI C63.19-2007 & 2011 compliance)/General Scans/z (axial) wideband at best S/N/ABM Freq Resp(x,y,z,f) (1x1x1):** Measurement grid: dx=10mm, dy=10mm  
Signal Type: Audio File (.wav) 48k\_Normal\_51s new.wav  
Output Gain: 46.24  
Measure Window Start: 300ms  
Measure Window Length: 51000ms  
BWC applied: 9.48 dB  
Device Reference Point: 0, 0, -6.3 mm

Category	Telephone parameters WD signal quality [(signal+noise)-to-noise ratio in decibels]
Category T1	0 dB to 10 dB
Category T2	10 dB to 20 dB
Category T3	20 dB to 30 dB
Category T4	> 30 dB

**Cursor:**  
Diff = 1.68 dB  
BWC Factor = 9.48 dB  
Location: 16.4, -13.4, 3.7 mm

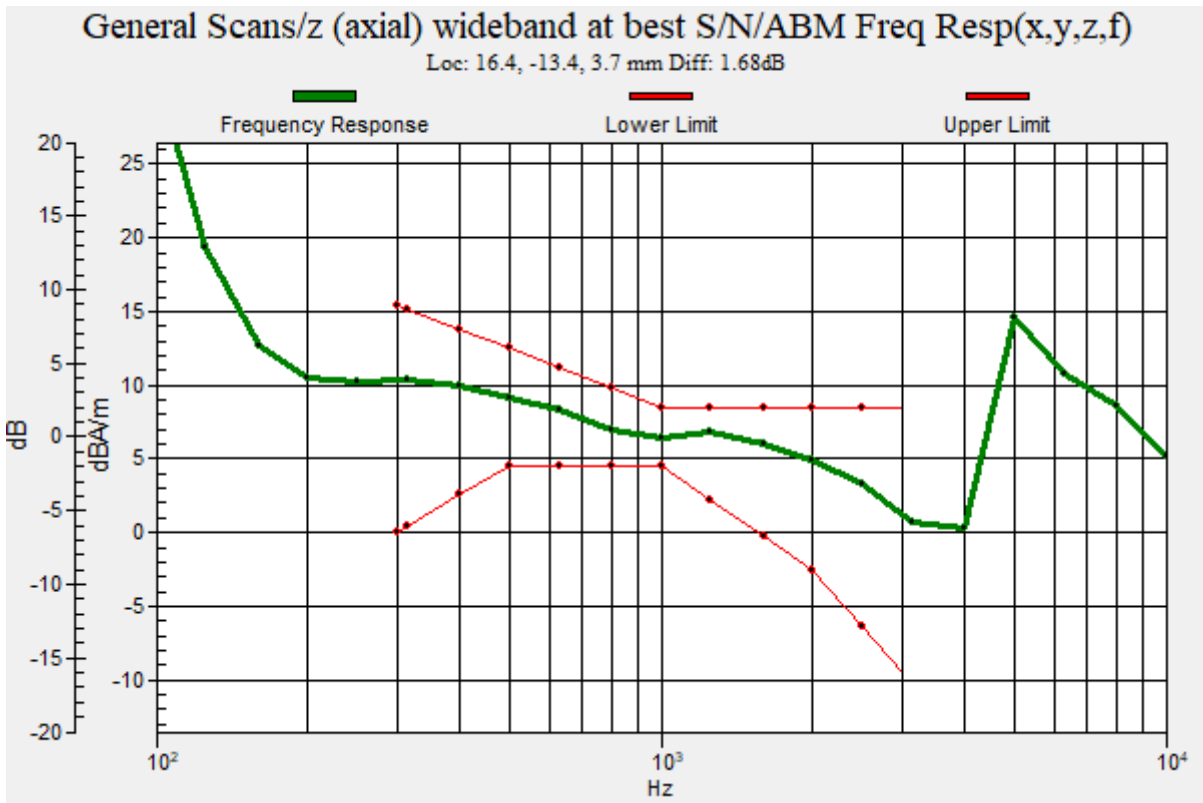

**Plot No.78**  
**802\_11n20 MCS0 157ch EVS WB 5\_9 y(transversal)**

**DUT: SM-G991U; Type: Bar**

Communication System: UID 0, WIFI 5GHz (0); Frequency: 5785 MHz;Duty Cycle: 1:1  
Medium parameters used:  $\sigma = 0$  S/m,  $\epsilon_r = 1$ ;  $\rho = 0$  kg/m<sup>3</sup>  
Phantom section: TCoil Section

DASY Configuration:

- Probe: AM1DV3 - 3049; ;
- Sensor-Surface: 0mm (Fix Surface)
- Electronics: DAE4 Sn466; Calibrated: 2020-04-22
- Phantom: HAC Test Arch with AMCC
- Measurement SW: DASY52, Version 52.10 (4);

**T-Coil scan (scan for ANSI C63.19-2007 & 2011 compliance)/General Scans/y (transversal) 4.2mm 50**

**x 50/ABM Signal(x,y,z) (13x13x1):** Measurement grid: dx=10mm, dy=10mm

Signal Type: Audio File (.wav) 48k\_voice\_1kHz\_1s.wav

Output Gain: 15.26

Measure Window Start: 300ms

Measure Window Length: 1000ms

BWC applied: 0.16 dB

Device Reference Point: 0, 0, -6.3 mm

**Cursor:**

ABM1 comp = -1.59 dBA/m

BWC Factor = 0.16 dB

Location: 12.5, -20.8, 3.7 mm

**Cursor:**

ABM2 = -25.33 dBA/m

Location: 12.5, -20.8, 3.7 mm

**Cursor:**

ABM1/ABM2 = 23.74 dB

ABM1 comp = -1.59 dBA/m

BWC Factor = 0.16 dB

Location: 12.5, -20.8, 3.7 mm

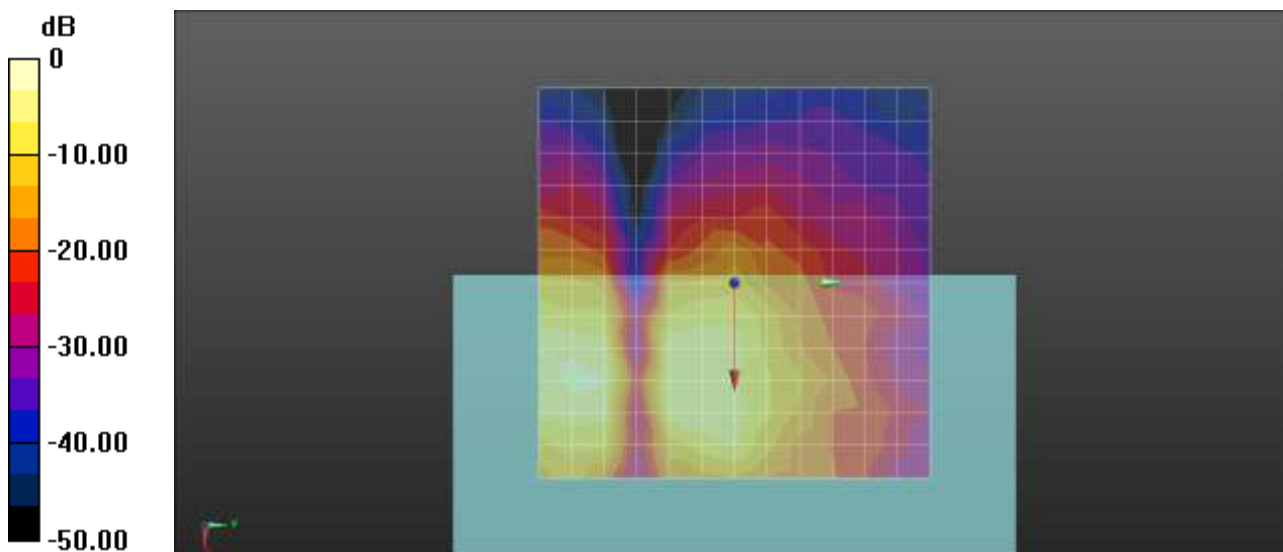

0 dB = 1.000 A/m = 0.00 dBA/m

**Plot No.79**  
**802\_11n20 MCS0 149ch EVS WB 5\_9 z(axial)**

**DUT: SM-G991U; Type: Bar**

Communication System: UID 0, WIFI 5GHz (0); Frequency: 5745 MHz;Duty Cycle: 1:1  
Medium parameters used:  $\sigma = 0$  S/m,  $\epsilon_r = 1$ ;  $\rho = 0$  kg/m<sup>3</sup>  
Phantom section: TCoil Section

DASY Configuration:

- Probe: AM1DV3 - 3049; ;
- Sensor-Surface: 0mm (Fix Surface)
- Electronics: DAE4 Sn466; Calibrated: 2020-04-22
- Phantom: HAC Test Arch with AMCC
- Measurement SW: DASY52, Version 52.10 (4);

**T-Coil scan (scan for ANSI C63.19-2007 & 2011 compliance)/General Scans/z (axial) 4.2mm 50 x 50/ABM Signal(x,y,z) (13x13x1):** Measurement grid: dx=10mm, dy=10mm  
Signal Type: Audio File (.wav) 48k\_voice\_1kHz\_1s.wav  
Output Gain: 15.26  
Measure Window Start: 300ms  
Measure Window Length: 1000ms  
BWC applied: 0.16 dB  
Device Reference Point: 0, 0, -6.3 mm

**Cursor:**  
ABM1 comp = 0.39 dBA/m  
BWC Factor = 0.16 dB  
Location: 4.2, -12.5, 3.7 mm

**Cursor:**  
ABM2 = -24.66 dBA/m  
Location: 4.2, -12.5, 3.7 mm

**Cursor:**  
ABM1/ABM2 = 25.05 dB  
ABM1 comp = 0.39 dBA/m  
BWC Factor = 0.16 dB  
Location: 4.2, -12.5, 3.7 mm

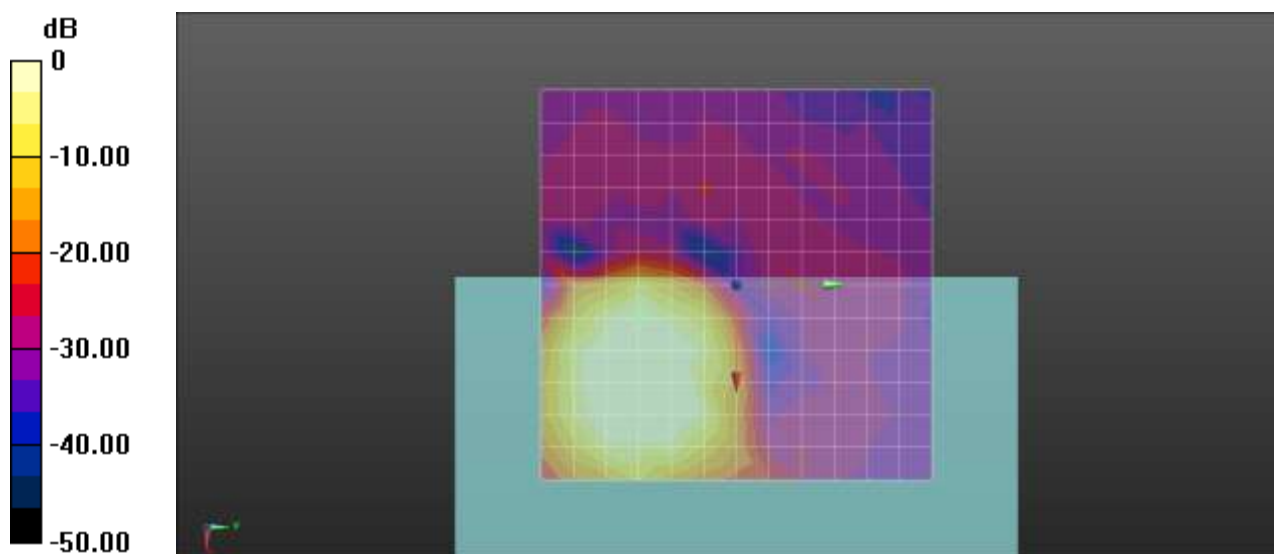

0 dB = 1.000 A/m = 0.00 dBA/m

**Plot No.80**  
**802\_11n20 MCS0 149ch EVS WB 5\_9 Freq.Response**

**DUT: SM-G991U; Type: Bar**

Communication System: UID 0, WIFI 5GHz (0); Frequency: 5745 MHz;Duty Cycle: 1:1  
Medium parameters used:  $\sigma = 0$  S/m,  $\epsilon_r = 1$ ;  $\rho = 0$  kg/m<sup>3</sup>  
Phantom section: TCoil Section

**T-Coil scan (scan for ANSI C63.19-2007 & 2011 compliance)/General Scans/z (axial) wideband at best S/N/ABM Freq Resp(x,y,z,f) (1x1x1):** Measurement grid: dx=10mm, dy=10mm  
Signal Type: Audio File (.wav) 48k\_Normal\_51s new.wav  
Output Gain: 46.24  
Measure Window Start: 300ms  
Measure Window Length: 51000ms  
BWC applied: 9.48 dB  
Device Reference Point: 0, 0, -6.3 mm

Category	Telephone parameters WD signal quality [(signal+noise)-to-noise ratio in decibels]
Category T1	0 dB to 10 dB
Category T2	10 dB to 20 dB
Category T3	20 dB to 30 dB
Category T4	> 30 dB

**Cursor:**  
Diff = 1.76 dB  
BWC Factor = 9.48 dB  
Location: 4.7, -12.6, 3.7 mm

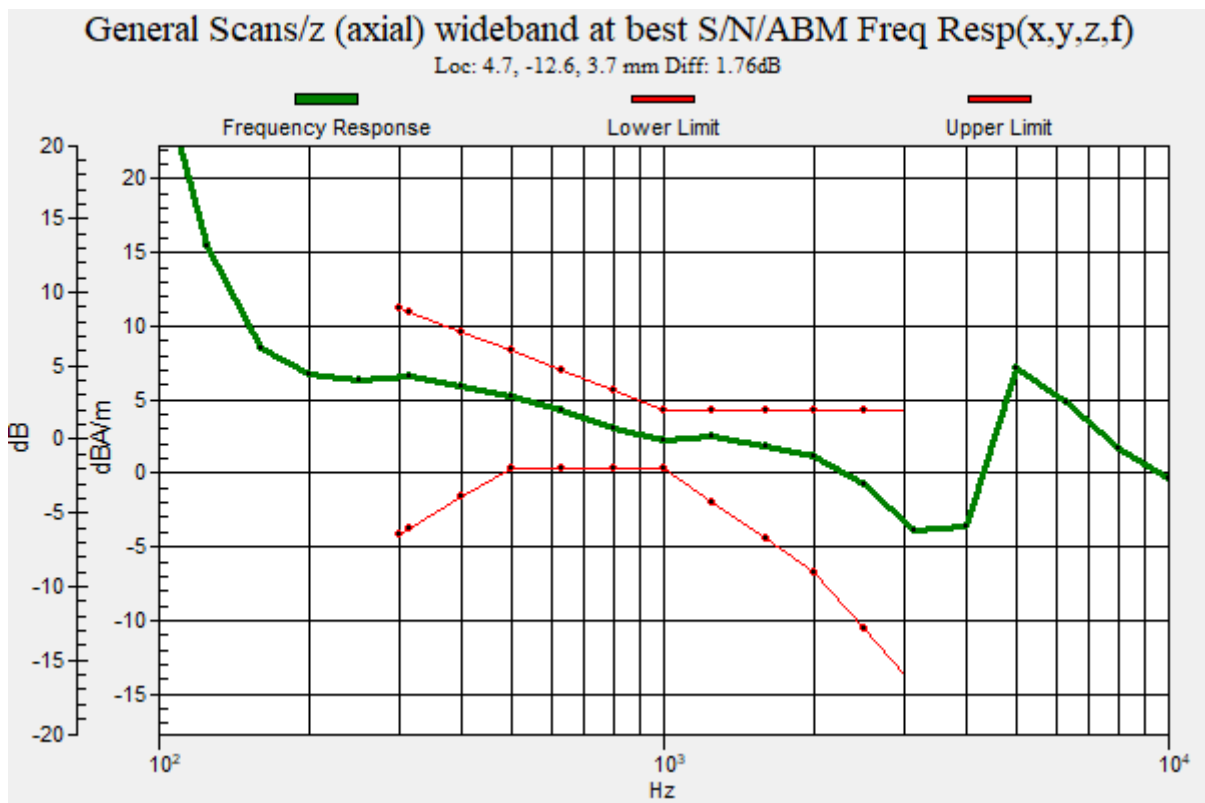

**Plot No.81**  
**802\_11n20 MCS0 149ch EVS WB 5\_9 y(transversal)**

**DUT: SM-G991U; Type: Bar**

Communication System: UID 0, WIFI 5GHz (0); Frequency: 5745 MHz;Duty Cycle: 1:1  
Medium parameters used:  $\sigma = 0$  S/m,  $\epsilon_r = 1$ ;  $\rho = 0$  kg/m<sup>3</sup>  
Phantom section: TCoil Section

DASY Configuration:

- Probe: AM1DV3 - 3049; ;
- Sensor-Surface: 0mm (Fix Surface)
- Electronics: DAE4 Sn466; Calibrated: 2020-04-22
- Phantom: HAC Test Arch with AMCC
- Measurement SW: DASY52, Version 52.10 (4);

**T-Coil scan (scan for ANSI C63.19-2007 & 2011 compliance)/General Scans/y (transversal) 4.2mm 50**

**x 50/ABM Signal(x,y,z) (13x13x1):** Measurement grid: dx=10mm, dy=10mm

Signal Type: Audio File (.wav) 48k\_voice\_1kHz\_1s.wav

Output Gain: 15.26

Measure Window Start: 300ms

Measure Window Length: 1000ms

BWC applied: 0.16 dB

Device Reference Point: 0, 0, -6.3 mm

**Cursor:**

ABM1 comp = -2.66 dBA/m

BWC Factor = 0.16 dB

Location: 12.5, 0, 3.7 mm

**Cursor:**

ABM2 = -30.24 dBA/m

Location: 12.5, 0, 3.7 mm

**Cursor:**

ABM1/ABM2 = 27.58 dB

ABM1 comp = -2.66 dBA/m

BWC Factor = 0.16 dB

Location: 12.5, 0, 3.7 mm

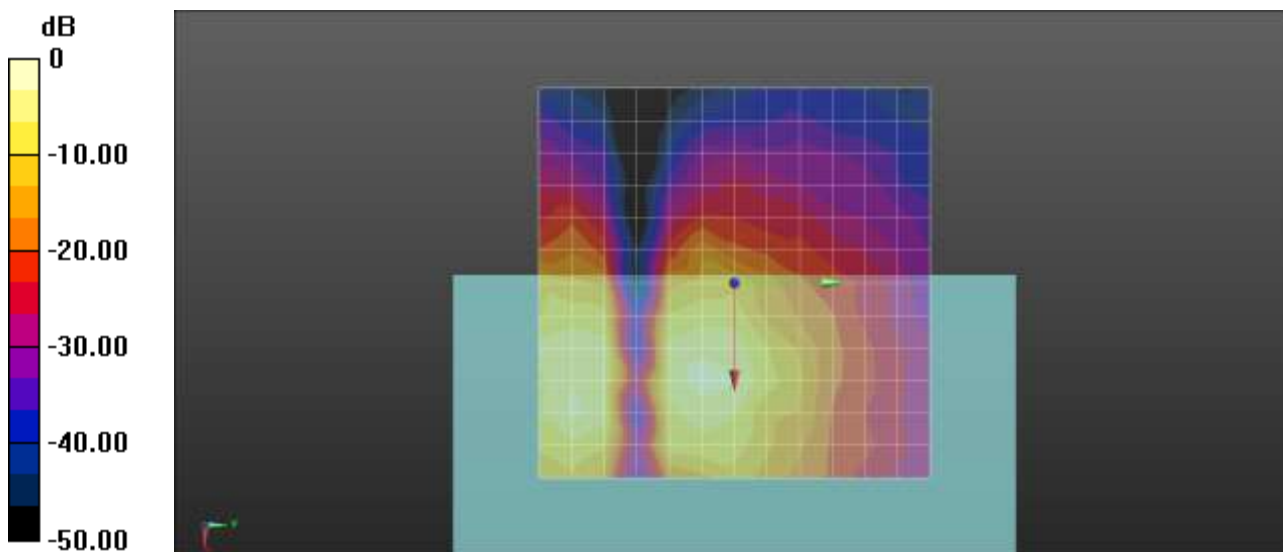

0 dB = 1.000 A/m = 0.00 dBA/m

**Plot No.82**  
**802\_11n20 MCS0 165ch EVS WB 5\_9 z(axial)**

**DUT: SM-G991U; Type: Bar**

Communication System: UID 0, WIFI 5GHz (0); Frequency: 5825 MHz;Duty Cycle: 1:1  
Medium parameters used:  $\sigma = 0$  S/m,  $\epsilon_r = 1$ ;  $\rho = 0$  kg/m<sup>3</sup>  
Phantom section: TCoil Section

DASY Configuration:

- Probe: AM1DV3 - 3049; ;
- Sensor-Surface: 0mm (Fix Surface)
- Electronics: DAE4 Sn466; Calibrated: 2020-04-22
- Phantom: HAC Test Arch with AMCC
- Measurement SW: DASY52, Version 52.10 (4);

**T-Coil scan (scan for ANSI C63.19-2007 & 2011 compliance)/General Scans/z (axial) 4.2mm 50 x 50/ABM Signal(x,y,z) (13x13x1):** Measurement grid: dx=10mm, dy=10mm  
Signal Type: Audio File (.wav) 48k\_voice\_1kHz\_1s.wav  
Output Gain: 15.26  
Measure Window Start: 300ms  
Measure Window Length: 1000ms  
BWC applied: 0.16 dB  
Device Reference Point: 0, 0, -6.3 mm

**Cursor:**  
ABM1 comp = 2.81 dBA/m  
BWC Factor = 0.16 dB  
Location: 8.3, -16.7, 3.7 mm

**Cursor:**  
ABM2 = -21.35 dBA/m  
Location: 8.3, -16.7, 3.7 mm

**Cursor:**  
ABM1/ABM2 = 24.16 dB  
ABM1 comp = 2.81 dBA/m  
BWC Factor = 0.16 dB  
Location: 8.3, -16.7, 3.7 mm

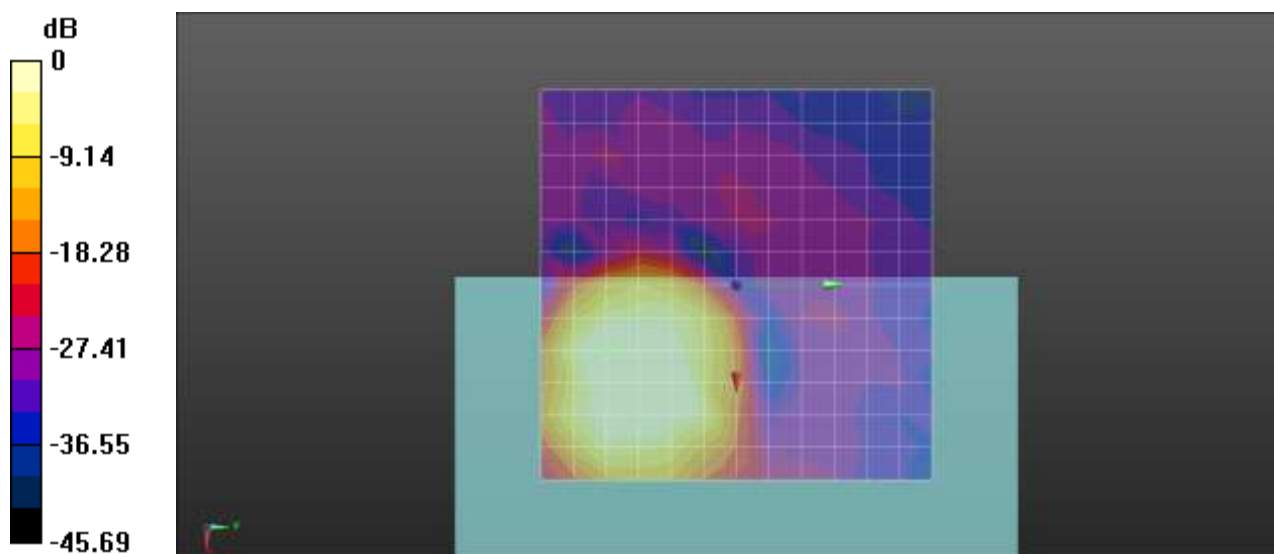

0 dB = 1.000 A/m = 0.00 dBA/m

**Plot No.83**  
**802\_11n20 MCS0 165ch EVS WB 5\_9 Freq.Response**

**DUT: SM-G991U; Type: Bar**

Communication System: UID 0, WIFI 5GHz (0); Frequency: 5825 MHz;Duty Cycle: 1:1  
Medium parameters used:  $\sigma = 0$  S/m,  $\epsilon_r = 1$ ;  $\rho = 0$  kg/m<sup>3</sup>  
Phantom section: TCoil Section

**T-Coil scan (scan for ANSI C63.19-2007 & 2011 compliance)/General Scans/z (axial) wideband at best S/N/ABM Freq Resp(x,y,z,f) (1x1x1):** Measurement grid: dx=10mm, dy=10mm  
Signal Type: Audio File (.wav) 48k\_Normal\_51s new.wav  
Output Gain: 46.24  
Measure Window Start: 300ms  
Measure Window Length: 51000ms  
BWC applied: 9.48 dB  
Device Reference Point: 0, 0, -6.3 mm

Category	Telephone parameters WD signal quality [(signal+noise)-to-noise ratio in decibels]
Category T1	0 dB to 10 dB
Category T2	10 dB to 20 dB
Category T3	20 dB to 30 dB
Category T4	> 30 dB

**Cursor:**  
Diff = 1.82 dB  
BWC Factor = 9.48 dB  
Location: 4.3, -5.1, 3.7 mm

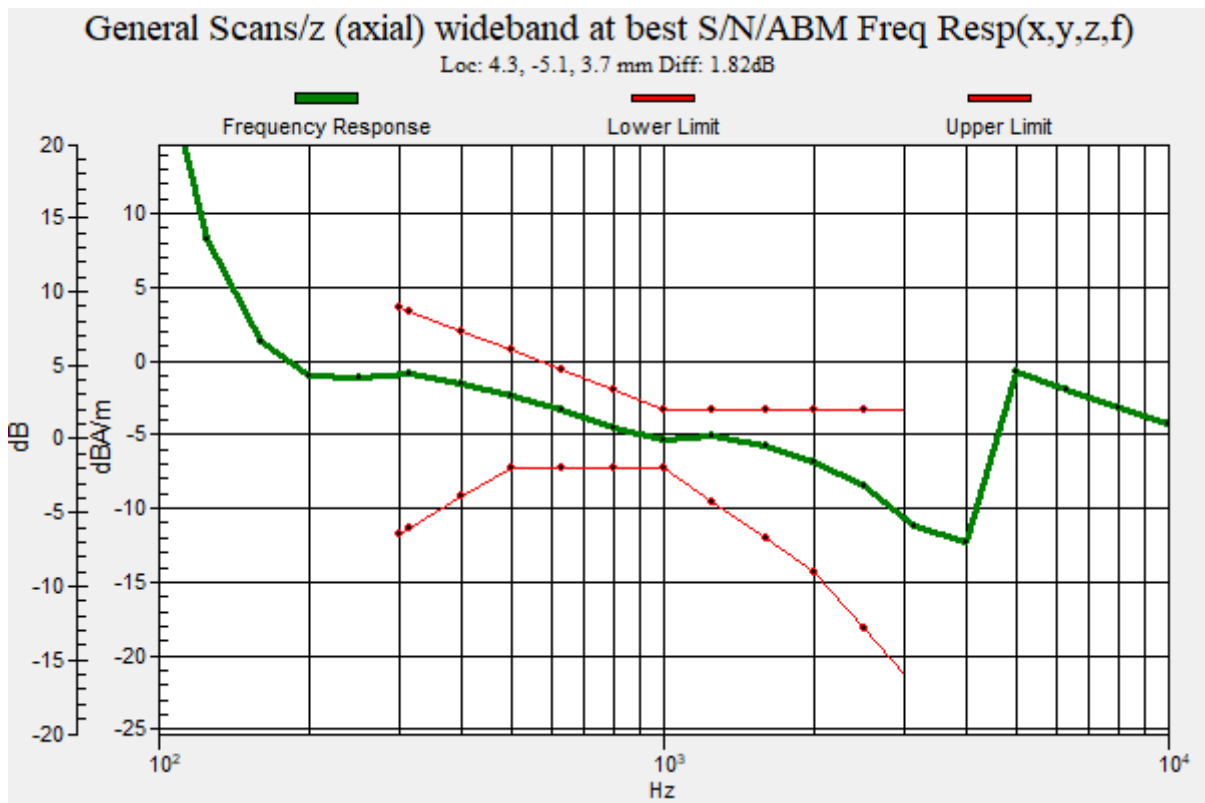



**Plot No.84**  
**802\_11n20 MCS0 165ch EVS WB 5\_9 y(transversal)**

**DUT: SM-G991U; Type: Bar**

Communication System: UID 0, WIFI 5GHz (0); Frequency: 5825 MHz;Duty Cycle: 1:1  
Medium parameters used:  $\sigma = 0$  S/m,  $\epsilon_r = 1$ ;  $\rho = 0$  kg/m<sup>3</sup>  
Phantom section: TCoil Section

DASY Configuration:

- Probe: AM1DV3 - 3049; ;
- Sensor-Surface: 0mm (Fix Surface)
- Electronics: DAE4 Sn466; Calibrated: 2020-04-22
- Phantom: HAC Test Arch with AMCC
- Measurement SW: DASY52, Version 52.10 (4);

**T-Coil scan (scan for ANSI C63.19-2007 & 2011 compliance)/General Scans/y (transversal) 4.2mm 50**

**x 50/ABM Signal(x,y,z) (13x13x1):** Measurement grid: dx=10mm, dy=10mm

Signal Type: Audio File (.wav) 48k\_voice\_1kHz\_1s.wav

Output Gain: 15.26

Measure Window Start: 300ms

Measure Window Length: 1000ms

BWC applied: 0.16 dB

Device Reference Point: 0, 0, -6.3 mm

**Cursor:**

ABM1 comp = -19.96 dBA/m

BWC Factor = 0.16 dB

Location: -8.3, -25, 3.7 mm

**Cursor:**

ABM2 = -44.05 dBA/m

Location: -8.3, -25, 3.7 mm

**Cursor:**

ABM1/ABM2 = 24.10 dB

ABM1 comp = -19.96 dBA/m

BWC Factor = 0.16 dB

Location: -8.3, -25, 3.7 mm

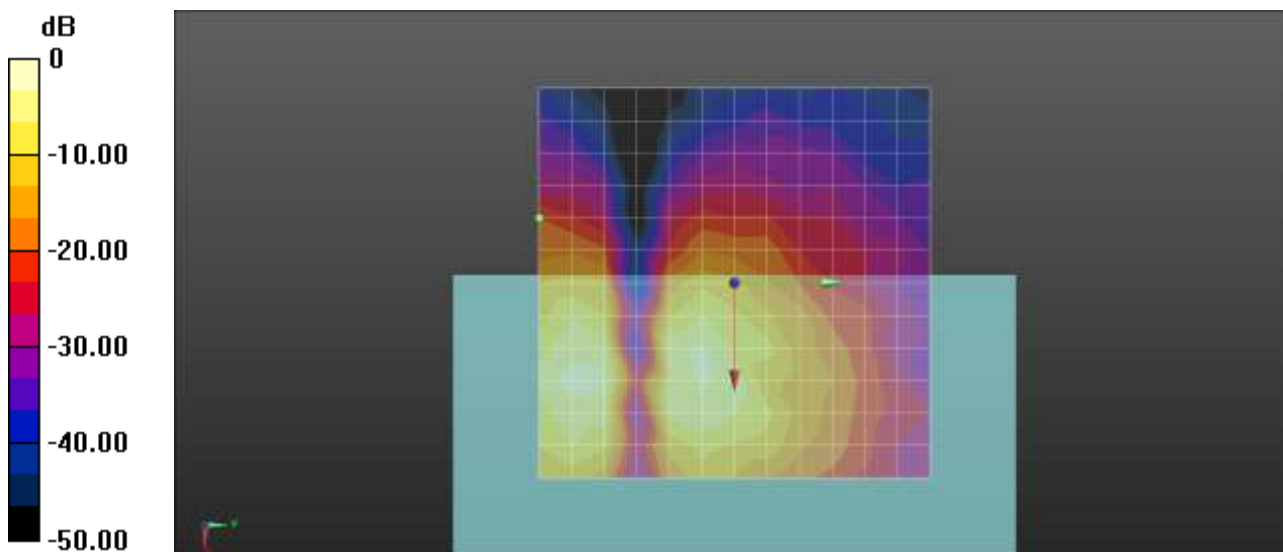

0 dB = 1.000 A/m = 0.00 dBA/m

**Plot No.85**  
**GSM850 Edge 2Tx 190ch Bitrate 6 z(axial)**

**DUT: SM-G991U; Type: Bar**

Communication System: UID 0, GSM850 GPRS 2TX (0); Frequency: 836.6 MHz;Duty Cycle: 1:4.14954  
Medium parameters used:  $\sigma = 0$  S/m,  $\epsilon_r = 1$ ;  $\rho = 0$  kg/m<sup>3</sup>  
Phantom section: TCoil Section

DASY Configuration:

- Probe: AM1DV3 - 3049; ;
- Sensor-Surface: 0mm (Fix Surface)
- Electronics: DAE4 Sn466; Calibrated: 2020-04-22
- Phantom: HAC Test Arch with AMCC
- Measurement SW: DASY52, Version 52.10 (4);

**T-Coil scan (scan for ANSI C63.19-2007 & 2011 compliance)/General Scans/z (axial) 4.2mm 50 x 50/ABM Signal(x,y,z) (13x13x1):** Measurement grid: dx=10mm, dy=10mm

Signal Type: Audio File (.wav) 48k\_voice\_1kHz\_1s.wav

Output Gain: 18.9

Measure Window Start: 300ms

Measure Window Length: 3000ms

BWC applied: 0.15 dB

Device Reference Point: 0, 0, -6.3 mm

**Cursor:**

ABM1 comp = 12.68 dBA/m

BWC Factor = 0.15 dB

Location: 8.3, -12.5, 3.7 mm

**Cursor:**

ABM2 = -30.00 dBA/m

Location: 8.3, -12.5, 3.7 mm

**Cursor:**

ABM1/ABM2 = 42.68 dB

ABM1 comp = 12.68 dBA/m

BWC Factor = 0.15 dB

Location: 8.3, -12.5, 3.7 mm

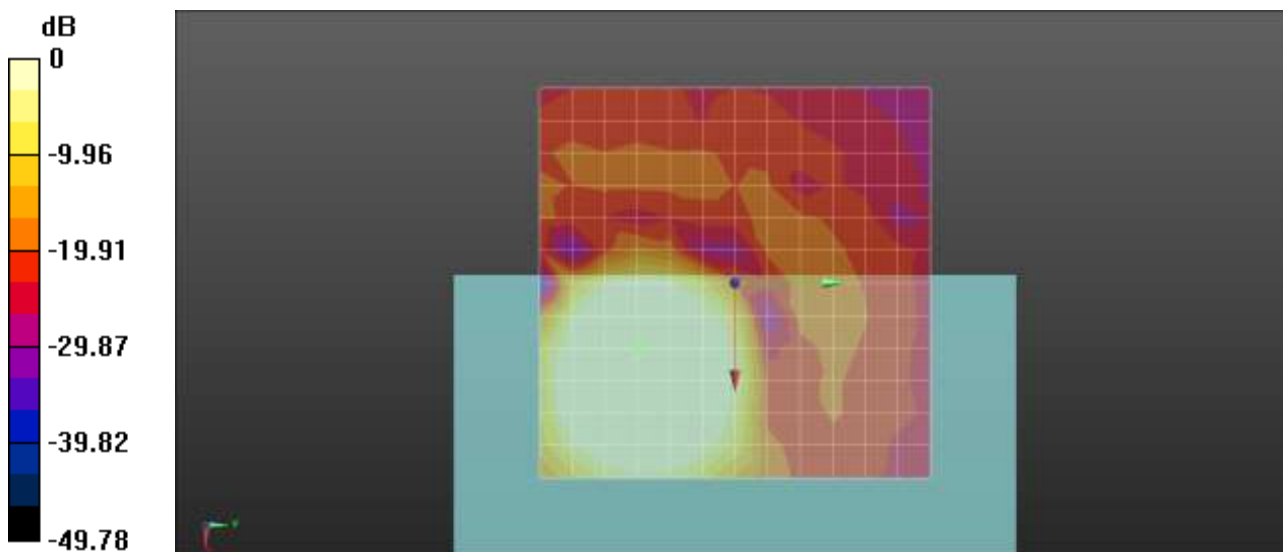

0 dB = 1.000 A/m = 0.00 dBA/m

**Plot No.86**  
**GSM850 Edge 2Tx 190ch Bitrate 6 Freq.Response**

**DUT: SM-G991U; Type: Bar**

Communication System: UID 0, GSM850 GPRS 2TX (0); Frequency: 836.6 MHz;Duty Cycle: 1:4.14954  
Medium parameters used:  $\sigma = 0$  S/m,  $\epsilon_r = 1$ ;  $\rho = 0$  kg/m<sup>3</sup>  
Phantom section: TCoil Section

**T-Coil scan (scan for ANSI C63.19-2007 & 2011 compliance)/General Scans/z (axial) wideband at best S/N/ABM Freq Resp(x,y,z,f) (1x1x1):** Measurement grid: dx=10mm, dy=10mm  
Signal Type: Audio File (.wav) 48k\_Normal\_51s new.wav  
Output Gain: 57.55  
Measure Window Start: 300ms  
Measure Window Length: 51000ms  
BWC applied: 9.47 dB  
Device Reference Point: 0, 0, -6.3 mm

Category	Telephone parameters WD signal quality [(signal+noise)-to-noise ratio in decibels]
Category T1	0 dB to 10 dB
Category T2	10 dB to 20 dB
Category T3	20 dB to 30 dB
Category T4	> 30 dB

**Cursor:**  
Diff = 1.93 dB  
BWC Factor = 9.47 dB  
Location: 8.1, -12.4, 3.7 mm

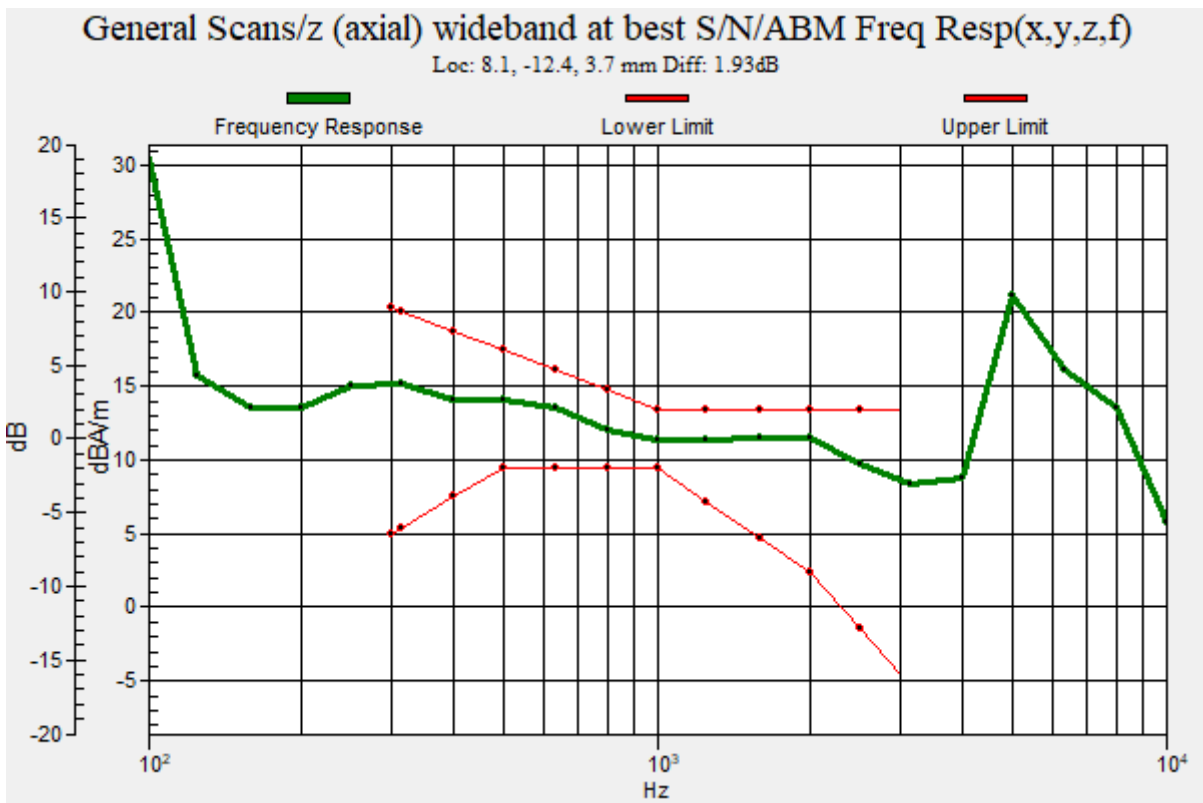

**Plot No.87**  
**GSM850 Edge 2Tx 190ch Bitrate 6 y(transversal)**

**DUT: SM-G991U; Type: Bar**

Communication System: UID 0, GSM850 GPRS 2TX (0); Frequency: 836.6 MHz;Duty Cycle: 1:4.14954  
Medium parameters used:  $\sigma = 0$  S/m,  $\epsilon_r = 1$ ;  $\rho = 0$  kg/m<sup>3</sup>  
Phantom section: TCoil Section

DASY Configuration:

- Probe: AM1DV3 - 3049; ;
- Sensor-Surface: 0mm (Fix Surface)
- Electronics: DAE4 Sn466; Calibrated: 2020-04-22
- Phantom: HAC Test Arch with AMCC
- Measurement SW: DASY52, Version 52.10 (4);

**T-Coil scan (scan for ANSI C63.19-2007 & 2011 compliance)/General Scans/y (transversal) 4.2mm 50**

**x 50/ABM Signal(x,y,z) (13x13x1):** Measurement grid: dx=10mm, dy=10mm  
Signal Type: Audio File (.wav) 48k\_voice\_1kHz\_1s.wav  
Output Gain: 18.9  
Measure Window Start: 300ms  
Measure Window Length: 3000ms  
BWC applied: 0.15 dB  
Device Reference Point: 0, 0, -6.3 mm

**Cursor:**

ABM1 comp = 5.21 dBA/m  
BWC Factor = 0.15 dB  
Location: 8.3, -20.8, 3.7 mm

**Cursor:**

ABM2 = -45.86 dBA/m  
Location: 8.3, -20.8, 3.7 mm

**Cursor:**

ABM1/ABM2 = 51.07 dB  
ABM1 comp = 5.21 dBA/m  
BWC Factor = 0.15 dB  
Location: 8.3, -20.8, 3.7 mm

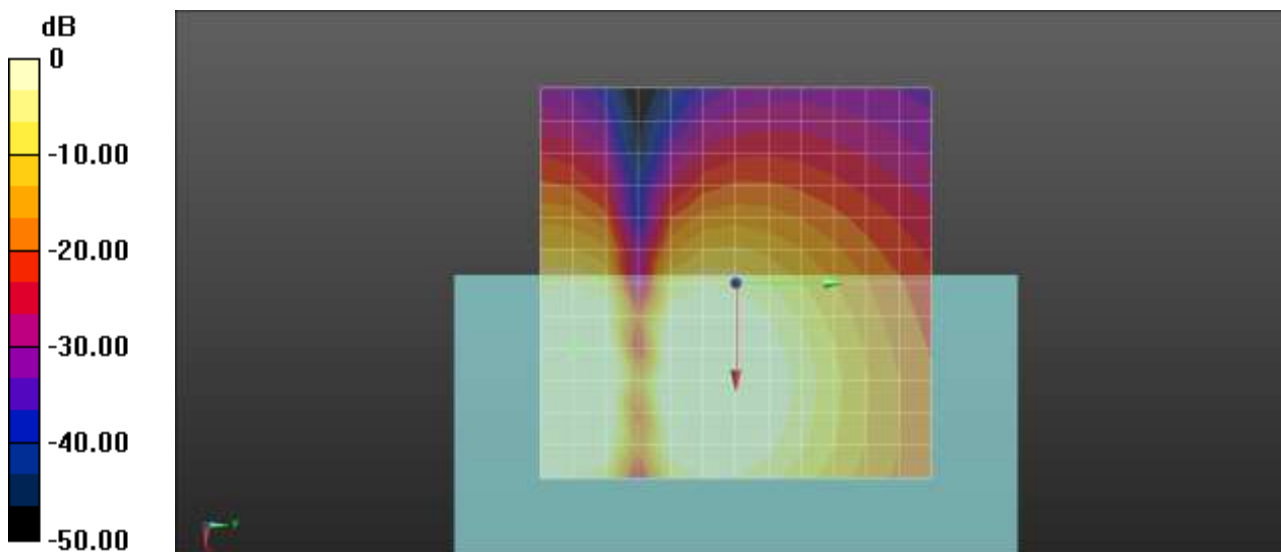

0 dB = 1.000 A/m = 0.00 dBA/m

**Plot No.88**  
**GSM1900 Edge 2Tx 661ch Bitrate 6 z(axial)**

**DUT: SM-G991U; Type: Bar**

Communication System: UID 0, GSM 1900 2TX (0); Frequency: 1880 MHz;Duty Cycle: 1:4.14954  
Medium parameters used:  $\sigma = 0$  S/m,  $\epsilon_r = 1$ ;  $\rho = 0$  kg/m<sup>3</sup>  
Phantom section: TCoil Section

DASY Configuration:

- Probe: AM1DV3 - 3049; ;
- Sensor-Surface: 0mm (Fix Surface)
- Electronics: DAE4 Sn466; Calibrated: 2020-04-22
- Phantom: HAC Test Arch with AMCC
- Measurement SW: DASY52, Version 52.10 (4);

**T-Coil scan (scan for ANSI C63.19-2007 & 2011 compliance)/General Scans/z (axial) 4.2mm 50 x 50/ABM Signal(x,y,z) (13x13x1):** Measurement grid: dx=10mm, dy=10mm

Signal Type: Audio File (.wav) 48k\_voice\_1kHz\_1s.wav

Output Gain: 18.9

Measure Window Start: 300ms

Measure Window Length: 3000ms

BWC applied: 0.16 dB

Device Reference Point: 0, 0, -6.3 mm

**Cursor:**

ABM1 comp = 12.09 dBA/m

BWC Factor = 0.16 dB

Location: 12.5, -8.3, 3.7 mm

**Cursor:**

ABM2 = -33.90 dBA/m

Location: 12.5, -8.3, 3.7 mm

**Cursor:**

ABM1/ABM2 = 45.99 dB

ABM1 comp = 12.09 dBA/m

BWC Factor = 0.16 dB

Location: 12.5, -8.3, 3.7 mm

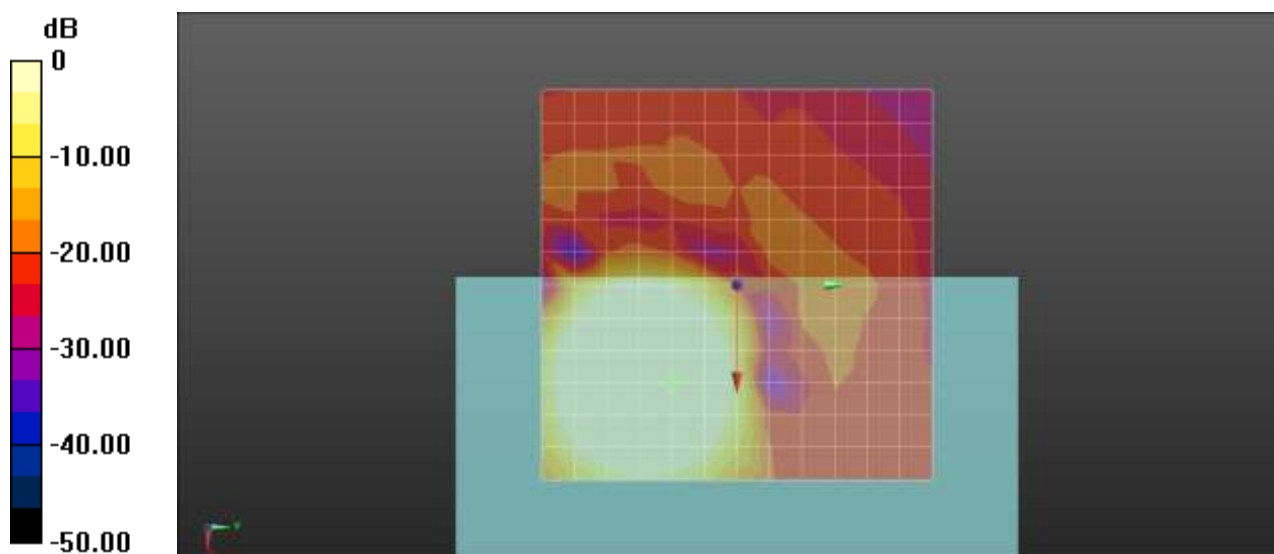

0 dB = 1.000 A/m = 0.00 dBA/m

**Plot No.89**  
**GSM1900 Edge 2Tx 661ch Bitrate 6 Freq.Response**

**DUT: SM-G991U; Type: Bar**

Communication System: UID 0, GSM 1900 2TX (0); Frequency: 1880 MHz;Duty Cycle: 1:4.14954  
Medium parameters used:  $\sigma = 0$  S/m,  $\epsilon_r = 1$ ;  $\rho = 0$  kg/m<sup>3</sup>  
Phantom section: TCoil Section

**T-Coil scan (scan for ANSI C63.19-2007 & 2011 compliance)/General Scans/z (axial) wideband at best S/N/ABM Freq Resp(x,y,z,f) (1x1x1):** Measurement grid: dx=10mm, dy=10mm  
Signal Type: Audio File (.wav) 48k\_Normal\_51s new.wav  
Output Gain: 57.55  
Measure Window Start: 300ms  
Measure Window Length: 51000ms  
BWC applied: 9.48 dB  
Device Reference Point: 0, 0, -6.3 mm

Category	Telephone parameters WD signal quality [(signal+noise)-to-noise ratio in decibels]
Category T1	0 dB to 10 dB
Category T2	10 dB to 20 dB
Category T3	20 dB to 30 dB
Category T4	> 30 dB

**Cursor:**  
Diff = 2.00 dB  
BWC Factor = 9.48 dB  
Location: 12.3, -9.9, 3.7 mm

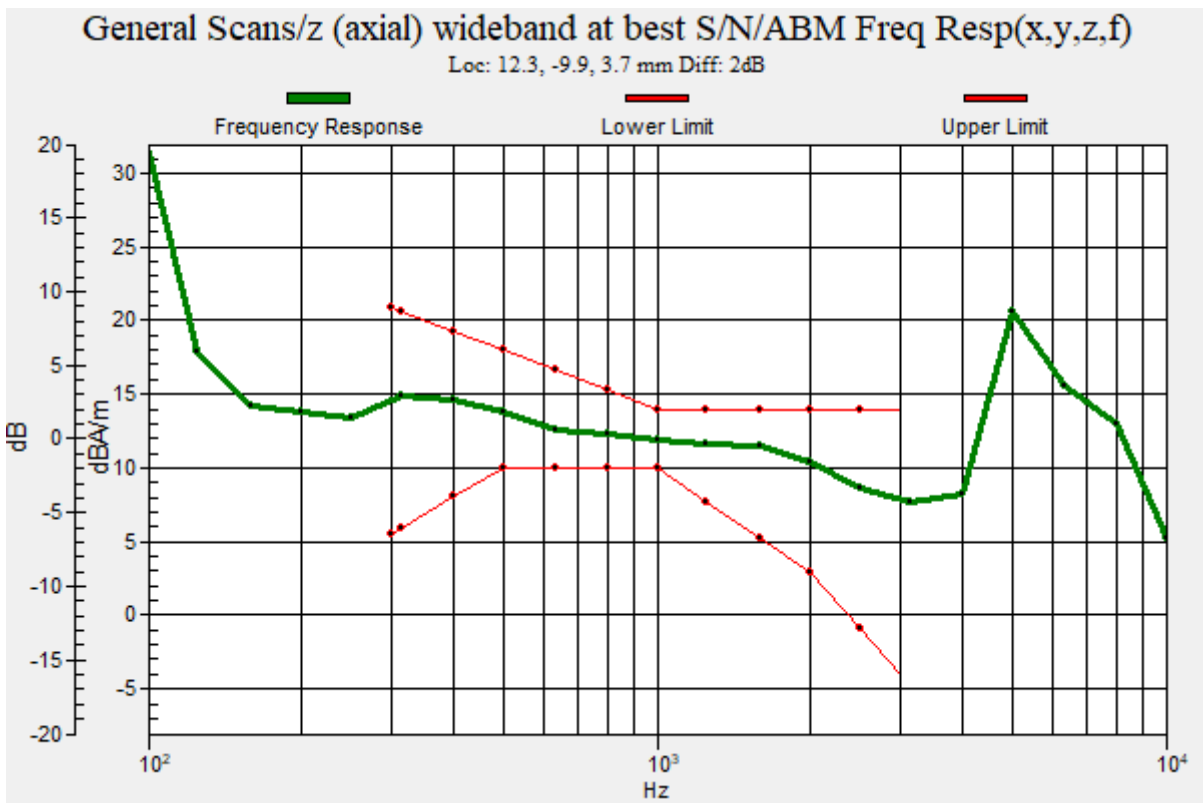

**Plot No.90**  
**GSM1900 Edge 2Tx 661ch Bitrate 6 y(transversal)**

**DUT: SM-G991U; Type: Bar**

Communication System: UID 0, GSM 1900 2TX (0); Frequency: 1880 MHz;Duty Cycle: 1:4.14954  
Medium parameters used:  $\sigma = 0$  S/m,  $\epsilon_r = 1$ ;  $\rho = 0$  kg/m<sup>3</sup>  
Phantom section: TCoil Section

DASY Configuration:

- Probe: AM1DV3 - 3049; ;
- Sensor-Surface: 0mm (Fix Surface)
- Electronics: DAE4 Sn466; Calibrated: 2020-04-22
- Phantom: HAC Test Arch with AMCC
- Measurement SW: DASY52, Version 52.10 (4);

**T-Coil scan (scan for ANSI C63.19-2007 & 2011 compliance)/General Scans/y (transversal) 4.2mm 50**

**x 50/ABM Signal(x,y,z) (13x13x1):** Measurement grid: dx=10mm, dy=10mm

Signal Type: Audio File (.wav) 48k\_voice\_1kHz\_1s.wav

Output Gain: 18.9

Measure Window Start: 300ms

Measure Window Length: 3000ms

BWC applied: 0.16 dB

Device Reference Point: 0, 0, -6.3 mm

**Cursor:**

ABM1 comp = -0.97 dBA/m

BWC Factor = 0.16 dB

Location: 4.2, -25, 3.7 mm

**Cursor:**

ABM2 = -45.02 dBA/m

Location: 4.2, -25, 3.7 mm

**Cursor:**

ABM1/ABM2 = 44.05 dB

ABM1 comp = -0.97 dBA/m

BWC Factor = 0.16 dB

Location: 4.2, -25, 3.7 mm

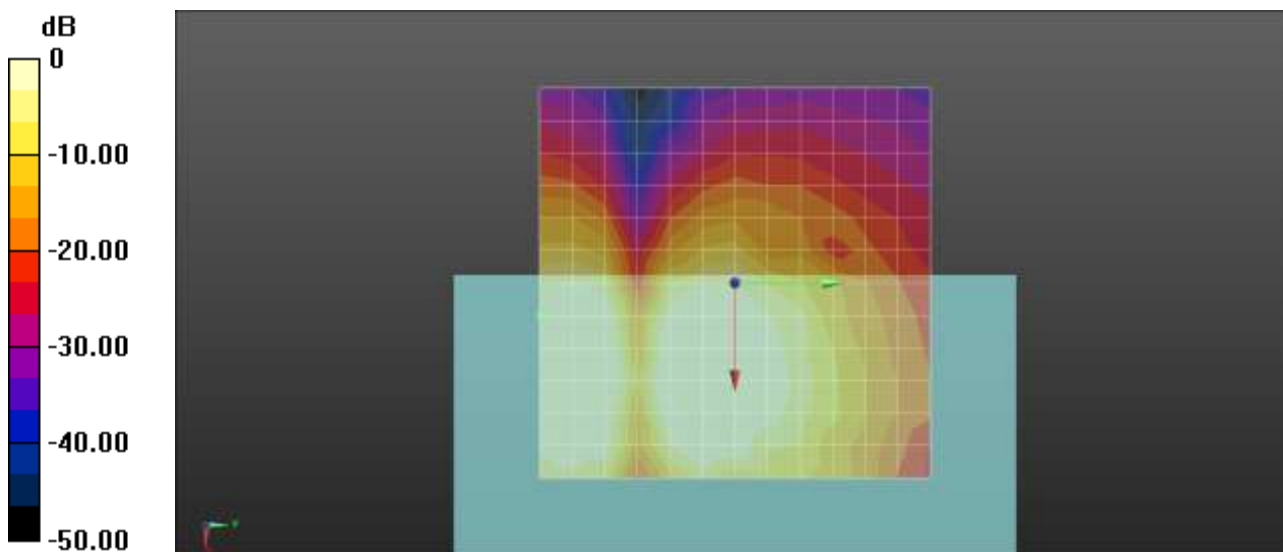

0 dB = 1.000 A/m = 0.00 dBA/m

**Plot No.91**  
**WCDMA Band 2 9262ch Bitrate 75 z(axial)**

**DUT: SM-G991U; Type: Bar**

Communication System: UID 0, WCDMA1900 (0); Frequency: 1852.4 MHz;Duty Cycle: 1:1  
Medium parameters used:  $\sigma = 0$  S/m,  $\epsilon_r = 1$ ;  $\rho = 0$  kg/m<sup>3</sup>  
Phantom section: TCoil Section

DASY Configuration:

- Probe: AM1DV3 - 3049; ;
- Sensor-Surface: 0mm (Fix Surface)
- Electronics: DAE4 Sn466; Calibrated: 2020-04-22
- Phantom: HAC Test Arch with AMCC
- Measurement SW: DASY52, Version 52.10 (4);

**T-Coil scan (scan for ANSI C63.19-2007 & 2011 compliance)/General Scans/z (axial) 4.2mm 50 x 50/ABM Signal(x,y,z) (13x13x1):** Measurement grid: dx=10mm, dy=10mm  
Signal Type: Audio File (.wav) 48k\_voice\_1kHz\_1s.wav  
Output Gain: 18.9  
Measure Window Start: 300ms  
Measure Window Length: 1000ms  
BWC applied: 0.15 dB  
Device Reference Point: 0, 0, -6.3 mm

**Cursor:**  
ABM1 comp = 12.14 dBA/m  
BWC Factor = 0.15 dB  
Location: 8.3, -12.5, 3.7 mm

**Cursor:**  
ABM2 = -36.97 dBA/m  
Location: 8.3, -12.5, 3.7 mm

**Cursor:**  
ABM1/ABM2 = 49.12 dB  
ABM1 comp = 12.14 dBA/m  
BWC Factor = 0.15 dB  
Location: 8.3, -12.5, 3.7 mm

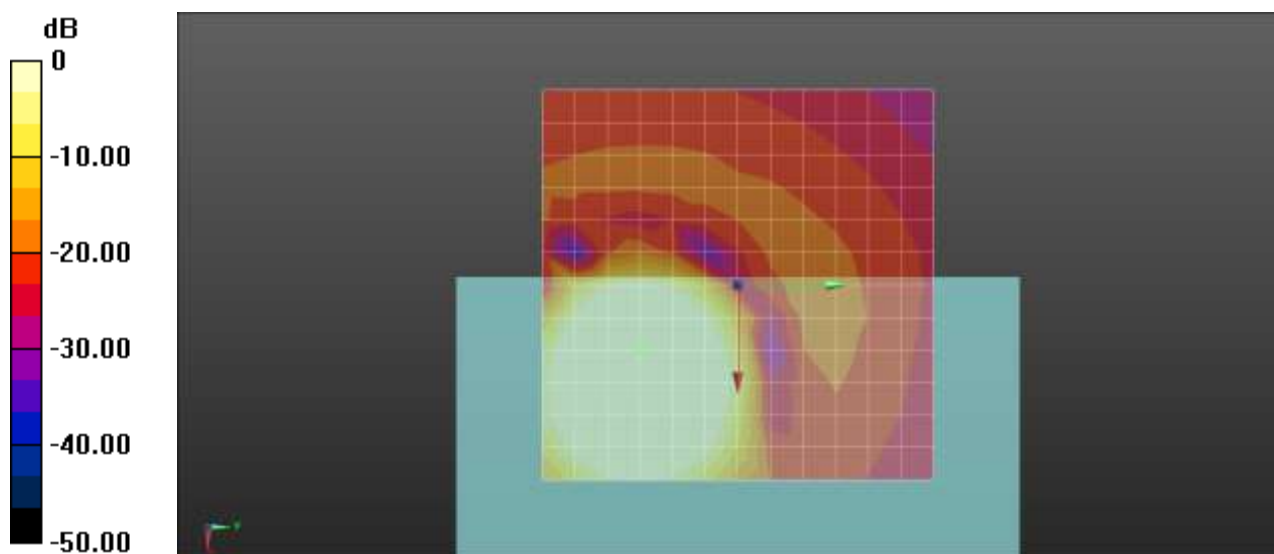

0 dB = 1.000 A/m = 0.00 dBA/m



**Plot No.92**  
**WCDMA Band 2 9262ch Bitrate 75 Freq.Response**

**DUT: SM-G991U; Type: Bar**

Communication System: UID 0, WCDMA1900 (0); Frequency: 1852.4 MHz;Duty Cycle: 1:1  
Medium parameters used:  $\sigma = 0$  S/m,  $\epsilon_r = 1$ ;  $\rho = 0$  kg/m<sup>3</sup>  
Phantom section: TCoil Section

**T-Coil scan (scan for ANSI C63.19-2007 & 2011 compliance)/General Scans/z (axial) wideband at best S/N/ABM Freq Resp(x,y,z,f) (1x1x1):** Measurement grid: dx=10mm, dy=10mm  
Signal Type: Audio File (.wav) 48k\_Normal\_51s new.wav  
Output Gain: 57.55  
Measure Window Start: 300ms  
Measure Window Length: 51000ms  
BWC applied: 9.48 dB  
Device Reference Point: 0, 0, -6.3 mm

Category	Telephone parameters WD signal quality [(signal+noise)-to-noise ratio in decibels]
Category T1	0 dB to 10 dB
Category T2	10 dB to 20 dB
Category T3	20 dB to 30 dB
Category T4	> 30 dB

**Cursor:**  
Diff = 2.00 dB  
BWC Factor = 9.48 dB  
Location: 8.8, -14.3, 3.7 mm

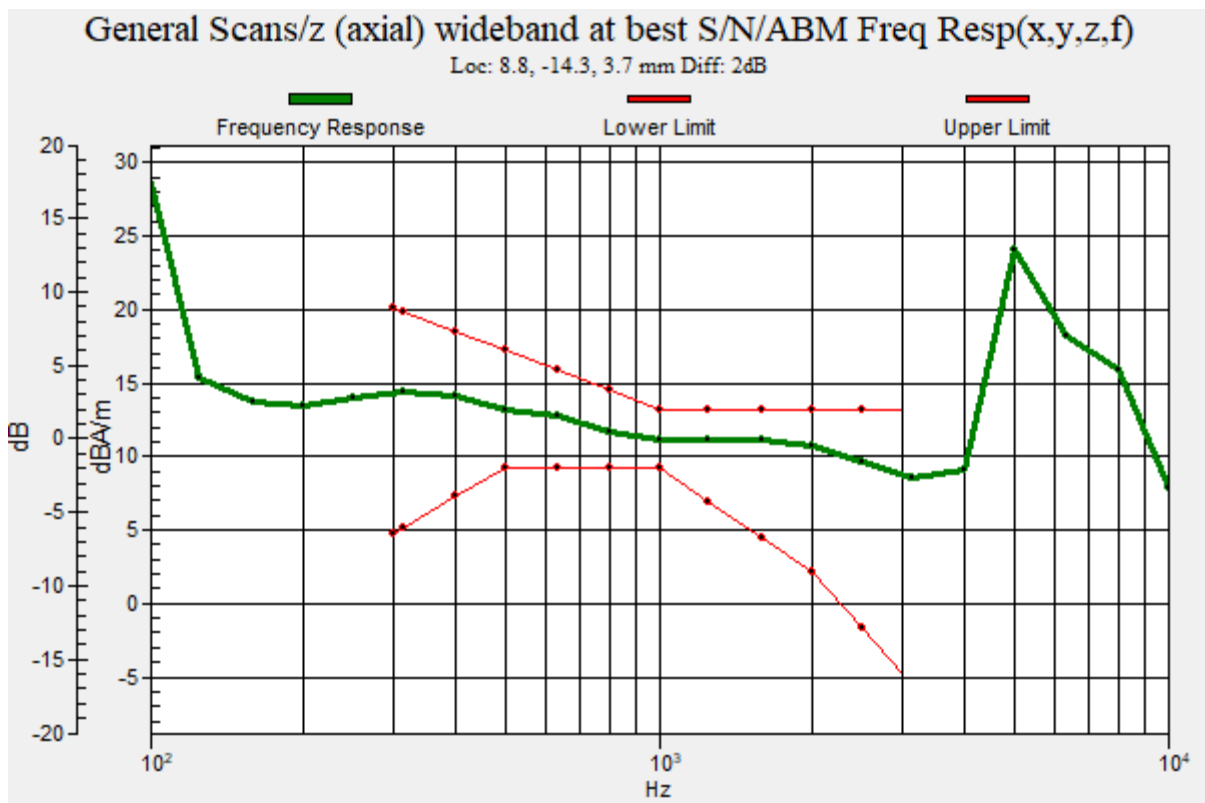

**Plot No.93**  
**WCDMA Band 2 9262ch Bitrate 75 y(transversal)**

**DUT: SM-G991U; Type: Bar**

Communication System: UID 0, WCDMA1900 (0); Frequency: 1852.4 MHz;Duty Cycle: 1:1  
Medium parameters used:  $\sigma = 0$  S/m,  $\epsilon_r = 1$ ;  $\rho = 0$  kg/m<sup>3</sup>  
Phantom section: TCoil Section

DASY Configuration:

- Probe: AM1DV3 - 3049; ;
- Sensor-Surface: 0mm (Fix Surface)
- Electronics: DAE4 Sn466; Calibrated: 2020-04-22
- Phantom: HAC Test Arch with AMCC
- Measurement SW: DASY52, Version 52.10 (4);

**T-Coil scan (scan for ANSI C63.19-2007 & 2011 compliance)/General Scans/y (transversal) 4.2mm 50**

**x 50/ABM Signal(x,y,z) (13x13x1):** Measurement grid: dx=10mm, dy=10mm

Signal Type: Audio File (.wav) 48k\_voice\_1kHz\_1s.wav

Output Gain: 18.9

Measure Window Start: 300ms

Measure Window Length: 1000ms

BWC applied: 0.15 dB

Device Reference Point: 0, 0, -6.3 mm

**Cursor:**

ABM1 comp = 4.62 dBA/m

BWC Factor = 0.15 dB

Location: 8.3, -20.8, 3.7 mm

**Cursor:**

ABM2 = -44.12 dBA/m

Location: 8.3, -20.8, 3.7 mm

**Cursor:**

ABM1/ABM2 = 48.74 dB

ABM1 comp = 4.62 dBA/m

BWC Factor = 0.15 dB

Location: 8.3, -20.8, 3.7 mm

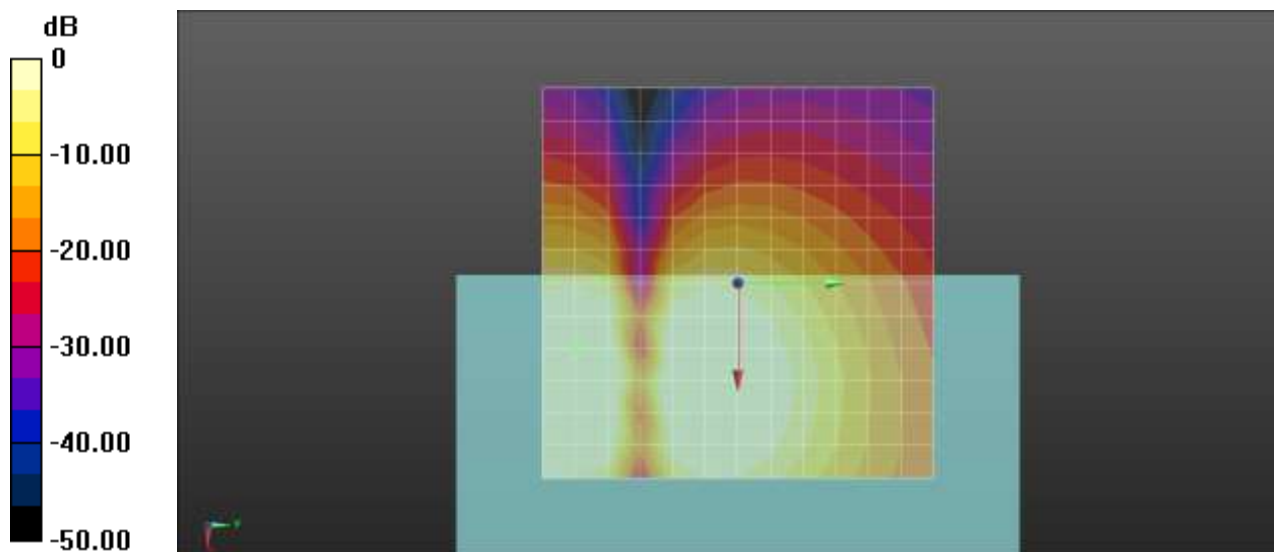

0 dB = 1.000 A/m = 0.00 dBA/m

**Plot No.94**  
**WCDMA Band 4 1412ch Bitrate 75 z(axial)**

**DUT: SM-G991U; Type: Bar**

Communication System: UID 0, WCDMA IV (0); Frequency: 1732.4 MHz;Duty Cycle: 1:1  
Medium parameters used:  $\sigma = 0$  S/m,  $\epsilon_r = 1$ ;  $\rho = 0$  kg/m<sup>3</sup>  
Phantom section: TCoil Section

DASY Configuration:

- Probe: AM1DV3 - 3049; ;
- Sensor-Surface: 0mm (Fix Surface)
- Electronics: DAE4 Sn466; Calibrated: 2020-04-22
- Phantom: HAC Test Arch with AMCC
- Measurement SW: DASY52, Version 52.10 (4);

**T-Coil scan (scan for ANSI C63.19-2007 & 2011 compliance)/General Scans/z (axial) 4.2mm 50 x 50/ABM Signal(x,y,z) (13x13x1):** Measurement grid: dx=10mm, dy=10mm  
Signal Type: Audio File (.wav) 48k\_voice\_1kHz\_1s.wav  
Output Gain: 18.9  
Measure Window Start: 300ms  
Measure Window Length: 1000ms  
BWC applied: 0.15 dB  
Device Reference Point: 0, 0, -6.3 mm

**Cursor:**  
ABM1 comp = 12.29 dBA/m  
BWC Factor = 0.15 dB  
Location: 8.3, -12.5, 3.7 mm

**Cursor:**  
ABM2 = -36.60 dBA/m  
Location: 8.3, -12.5, 3.7 mm

**Cursor:**  
ABM1/ABM2 = 48.89 dB  
ABM1 comp = 12.29 dBA/m  
BWC Factor = 0.15 dB  
Location: 8.3, -12.5, 3.7 mm

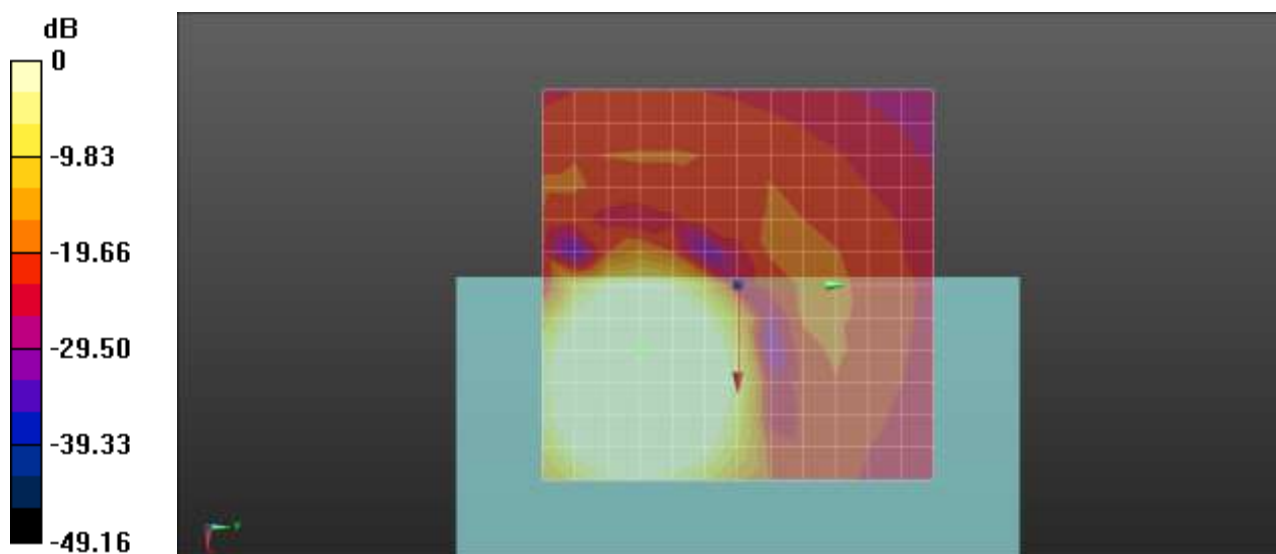

0 dB = 1.000 A/m = 0.00 dBA/m

**Plot No.95**  
**WCDMA Band 4 1412ch Bitrate 75 Freq.Response**

**DUT: SM-G991U; Type: Bar**

Communication System: UID 0, WCDMA IV (0); Frequency: 1732.4 MHz;Duty Cycle: 1:1  
Medium parameters used:  $\sigma = 0$  S/m,  $\epsilon_r = 1$ ;  $\rho = 0$  kg/m<sup>3</sup>  
Phantom section: TCoil Section

**T-Coil scan (scan for ANSI C63.19-2007 & 2011 compliance)/General Scans/z (axial) wideband at best S/N/ABM Freq Resp(x,y,z,f) (1x1x1):** Measurement grid: dx=10mm, dy=10mm  
Signal Type: Audio File (.wav) 48k\_Normal\_51s new.wav  
Output Gain: 57.55  
Measure Window Start: 300ms  
Measure Window Length: 51000ms  
BWC applied: 9.48 dB  
Device Reference Point: 0, 0, -6.3 mm

Category	Telephone parameters WD signal quality [(signal+noise)-to-noise ratio in decibels]
Category T1	0 dB to 10 dB
Category T2	10 dB to 20 dB
Category T3	20 dB to 30 dB
Category T4	> 30 dB

**Cursor:**  
Diff = 2.00 dB  
BWC Factor = 9.48 dB  
Location: 5.9, -12.7, 3.7 mm

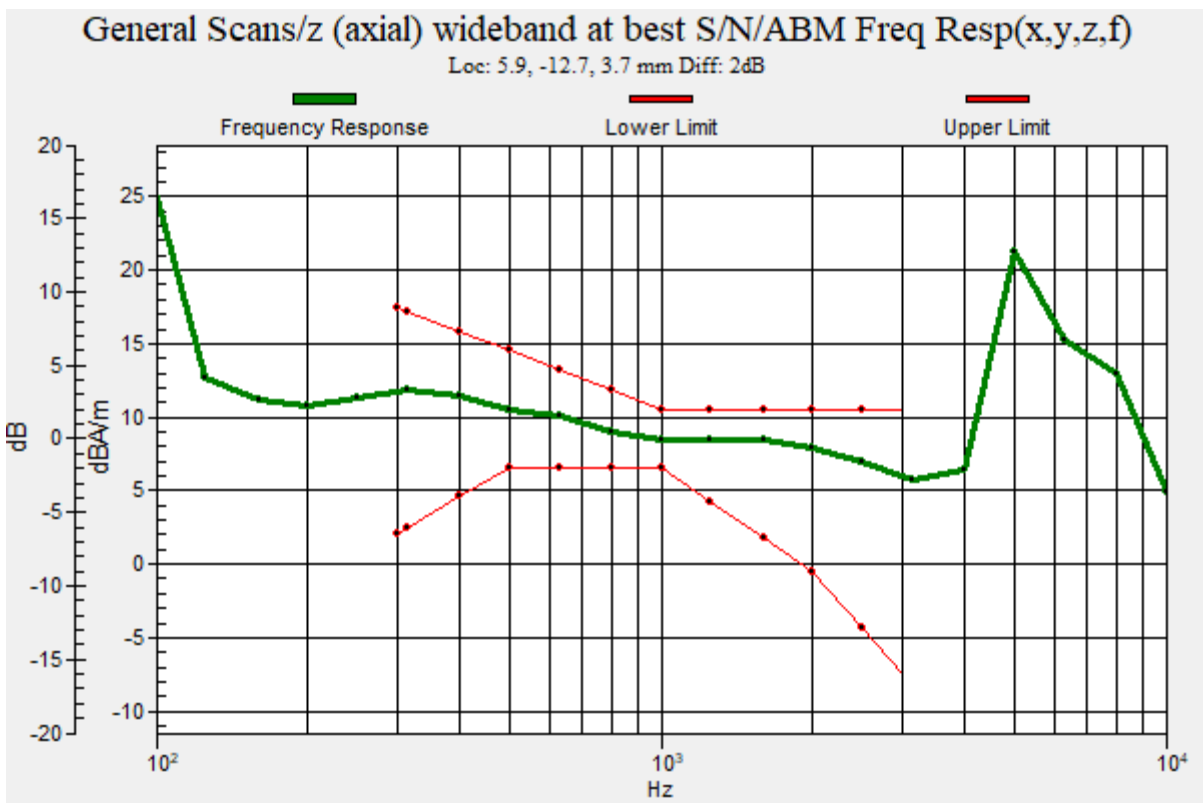

**Plot No.96**  
**WCDMA Band 4 1412ch Bitrate 75 y(transversal)**

**DUT: SM-G991U; Type: Bar**

Communication System: UID 0, WCDMA IV (0); Frequency: 1732.4 MHz;Duty Cycle: 1:1  
Medium parameters used:  $\sigma = 0$  S/m,  $\epsilon_r = 1$ ;  $\rho = 0$  kg/m<sup>3</sup>  
Phantom section: TCoil Section

DASY Configuration:

- Probe: AM1DV3 - 3049; ;
- Sensor-Surface: 0mm (Fix Surface)
- Electronics: DAE4 Sn466; Calibrated: 2020-04-22
- Phantom: HAC Test Arch with AMCC
- Measurement SW: DASY52, Version 52.10 (4);

**T-Coil scan (scan for ANSI C63.19-2007 & 2011 compliance)/General Scans/y (transversal) 4.2mm 50**

**x 50/ABM Signal(x,y,z) (13x13x1):** Measurement grid: dx=10mm, dy=10mm

Signal Type: Audio File (.wav) 48k\_voice\_1kHz\_1s.wav

Output Gain: 18.9

Measure Window Start: 300ms

Measure Window Length: 1000ms

BWC applied: 0.15 dB

Device Reference Point: 0, 0, -6.3 mm

**Cursor:**

ABM1 comp = 4.64 dBA/m

BWC Factor = 0.15 dB

Location: 8.3, -20.8, 3.7 mm

**Cursor:**

ABM2 = -44.15 dBA/m

Location: 8.3, -20.8, 3.7 mm

**Cursor:**

ABM1/ABM2 = 48.80 dB

ABM1 comp = 4.64 dBA/m

BWC Factor = 0.15 dB

Location: 8.3, -20.8, 3.7 mm

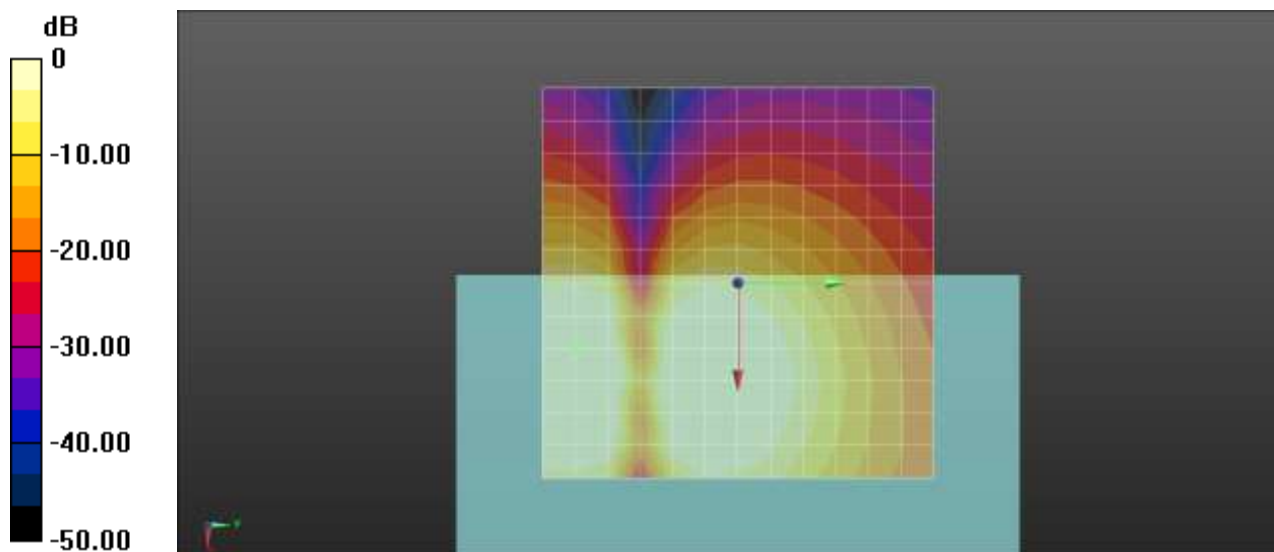

0 dB = 1.000 A/m = 0.00 dBA/m

**Plot No.97**  
**WCDMA Band 5 4183ch Bitrate 75 z(axial)**

**DUT: SM-G991U; Type: Bar**

Communication System: UID 0, WCDMA850 (0); Frequency: 836.6 MHz;Duty Cycle: 1:1  
Medium parameters used:  $\sigma = 0$  S/m,  $\epsilon_r = 1$ ;  $\rho = 0$  kg/m<sup>3</sup>  
Phantom section: TCoil Section

DASY Configuration:

- Probe: AM1DV3 - 3049; ;
- Sensor-Surface: 0mm (Fix Surface)
- Electronics: DAE4 Sn466; Calibrated: 2020-04-22
- Phantom: HAC Test Arch with AMCC
- Measurement SW: DASY52, Version 52.10 (4);

**T-Coil scan (scan for ANSI C63.19-2007 & 2011 compliance)/General Scans/z (axial) 4.2mm 50 x 50/ABM Signal(x,y,z) (13x13x1):** Measurement grid: dx=10mm, dy=10mm

Signal Type: Audio File (.wav) 48k\_voice\_1kHz\_1s.wav

Output Gain: 18.9

Measure Window Start: 300ms

Measure Window Length: 1000ms

BWC applied: 0.15 dB

Device Reference Point: 0, 0, -6.3 mm

**Cursor:**

ABM1 comp = 12.45 dBA/m

BWC Factor = 0.15 dB

Location: 8.3, -12.5, 3.7 mm

**Cursor:**

ABM2 = -36.61 dBA/m

Location: 8.3, -12.5, 3.7 mm

**Cursor:**

ABM1/ABM2 = 49.06 dB

ABM1 comp = 12.45 dBA/m

BWC Factor = 0.15 dB

Location: 8.3, -12.5, 3.7 mm

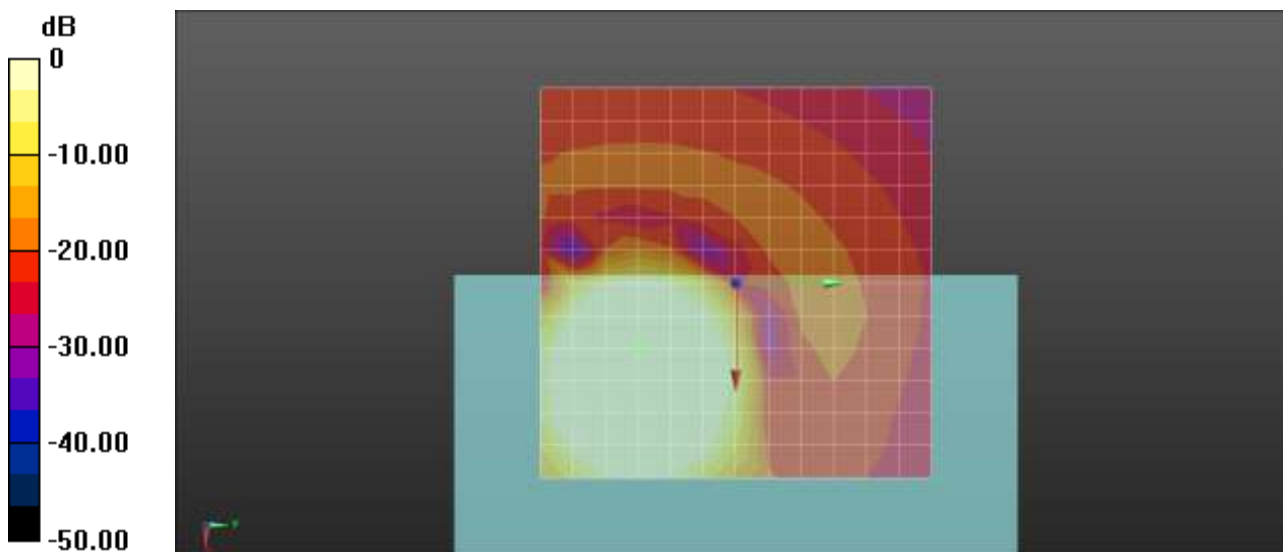

0 dB = 1.000 A/m = 0.00 dBA/m

**Plot No.98**  
**WCDMA Band 5 4183ch Bitrate 75 Freq.Response**

**DUT: SM-G991U; Type: Bar**

Communication System: UID 0, WCDMA850 (0); Frequency: 836.6 MHz;Duty Cycle: 1:1  
Medium parameters used:  $\sigma = 0$  S/m,  $\epsilon_r = 1$ ;  $\rho = 0$  kg/m<sup>3</sup>  
Phantom section: TCoil Section

**T-Coil scan (scan for ANSI C63.19-2007 & 2011 compliance)/General Scans/z (axial) wideband at best S/N/ABM Freq Resp(x,y,z,f) (1x1x1):** Measurement grid: dx=10mm, dy=10mm  
Signal Type: Audio File (.wav) 48k\_Normal\_51s new.wav  
Output Gain: 57.55  
Measure Window Start: 300ms  
Measure Window Length: 51000ms  
BWC applied: 9.48 dB  
Device Reference Point: 0, 0, -6.3 mm

Category	Telephone parameters WD signal quality [(signal+noise)-to-noise ratio in decibels]
Category T1	0 dB to 10 dB
Category T2	10 dB to 20 dB
Category T3	20 dB to 30 dB
Category T4	> 30 dB

**Cursor:**  
Diff = 1.98 dB  
BWC Factor = 9.48 dB  
Location: 7.3, -12.5, 3.7 mm

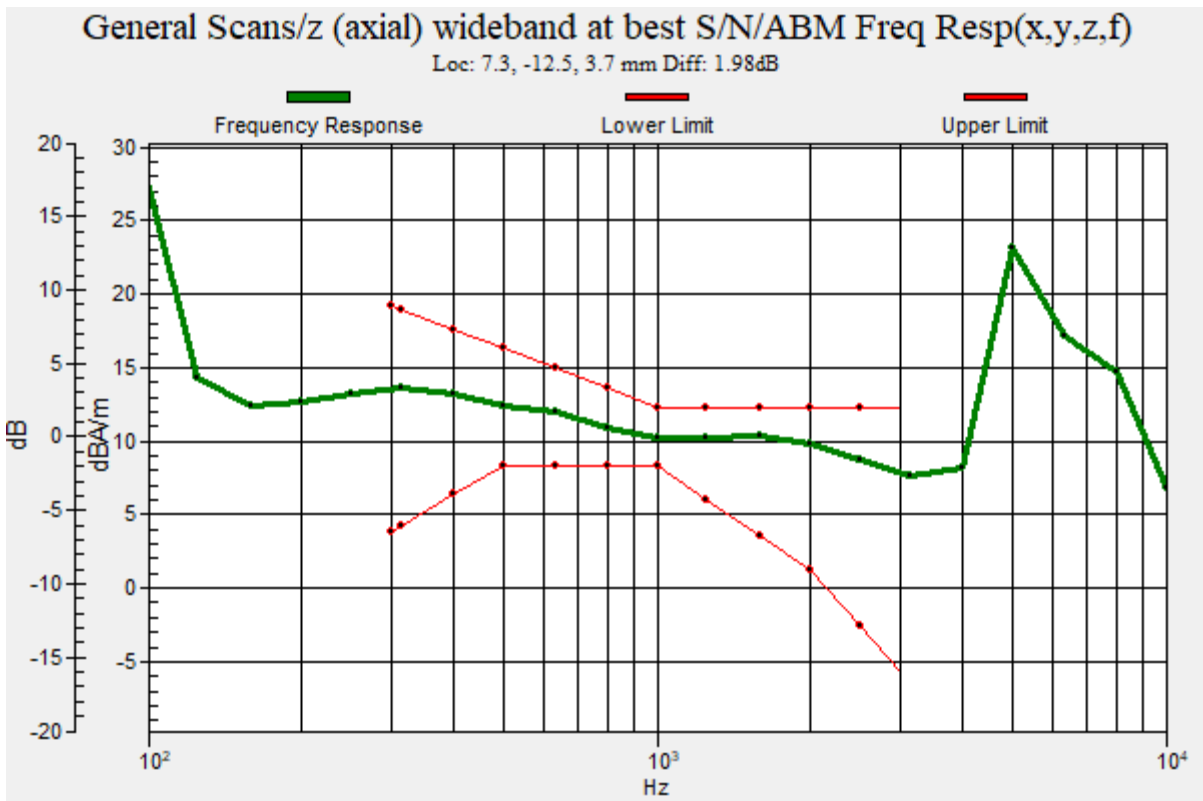

**Plot No.99**  
**WCDMA Band 5 4183ch Bitrate 75 y(transversal)**

**DUT: SM-G991U; Type: Bar**

Communication System: UID 0, WCDMA850 (0); Frequency: 836.6 MHz;Duty Cycle: 1:1  
Medium parameters used:  $\sigma = 0$  S/m,  $\epsilon_r = 1$ ;  $\rho = 0$  kg/m<sup>3</sup>  
Phantom section: TCoil Section

DASY Configuration:

- Probe: AM1DV3 - 3049; ;
- Sensor-Surface: 0mm (Fix Surface)
- Electronics: DAE4 Sn466; Calibrated: 2020-04-22
- Phantom: HAC Test Arch with AMCC
- Measurement SW: DASY52, Version 52.10 (4);

**T-Coil scan (scan for ANSI C63.19-2007 & 2011 compliance)/General Scans/y (transversal) 4.2mm 50**

**x 50/ABM Signal(x,y,z) (13x13x1):** Measurement grid: dx=10mm, dy=10mm

Signal Type: Audio File (.wav) 48k\_voice\_1kHz\_1s.wav

Output Gain: 18.9

Measure Window Start: 300ms

Measure Window Length: 1000ms

BWC applied: 0.15 dB

Device Reference Point: 0, 0, -6.3 mm

**Cursor:**

ABM1 comp = 5.40 dBA/m

BWC Factor = 0.15 dB

Location: 8.3, -4.2, 3.7 mm

**Cursor:**

ABM2 = -43.04 dBA/m

Location: 8.3, -4.2, 3.7 mm

**Cursor:**

ABM1/ABM2 = 48.44 dB

ABM1 comp = 5.40 dBA/m

BWC Factor = 0.15 dB

Location: 8.3, -4.2, 3.7 mm

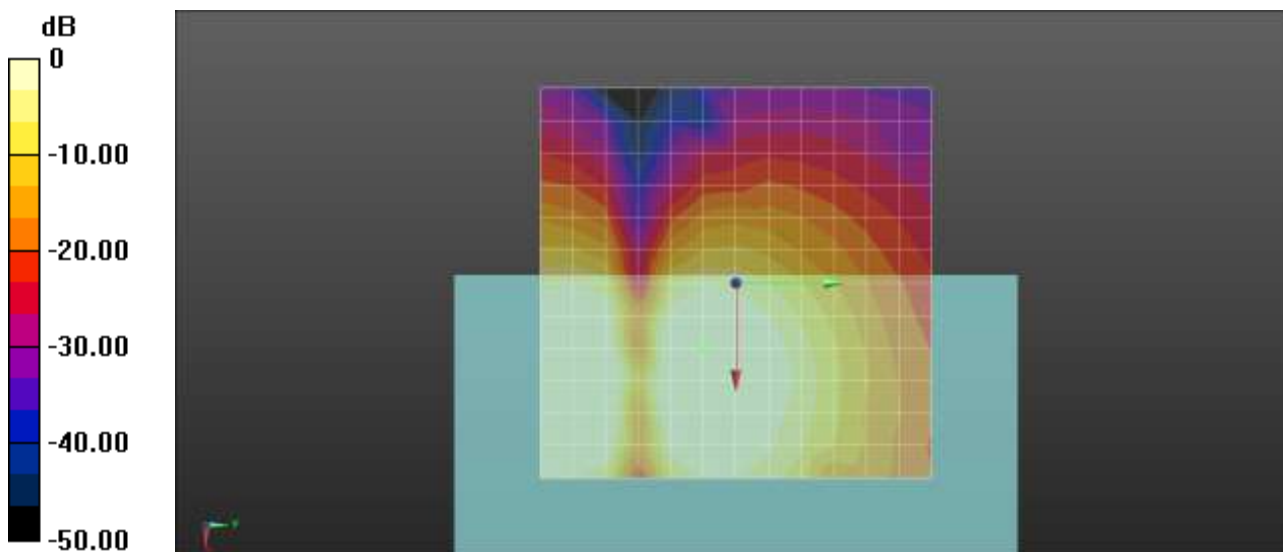

0 dB = 1.000 A/m = 0.00 dBA/m



**Plot No.100**

**LTE 7 64QAM 15MHz 1RB 74offset 21100ch Bit rate 75 z(axial)**

**DUT: SM-G991U; Type: Bar**

Communication System: UID 0, LTE Band 7 (0); Frequency: 2535 MHz;Duty Cycle: 1:1  
Medium parameters used:  $\sigma = 0$  S/m,  $\epsilon_r = 1$ ;  $\rho = 0$  kg/m<sup>3</sup>  
Phantom section: TCoil Section

DASY Configuration:

- Probe: AM1DV3 - 3049; ;
- Sensor-Surface: 0mm (Fix Surface)
- Electronics: DAE4 Sn466; Calibrated: 2020-04-22
- Phantom: HAC Test Arch with AMCC
- Measurement SW: DASY52, Version 52.10 (4);

**T-Coil scan (scan for ANSI C63.19-2007 & 2011 compliance)/General Scans/z (axial) 4.2mm 50 x**

**50/ABM Signal(x,y,z) (13x13x1):** Measurement grid: dx=10mm, dy=10mm

Signal Type: Audio File (.wav) 48k\_voice\_1kHz\_1s.wav

Output Gain: 18.9

Measure Window Start: 300ms

Measure Window Length: 1000ms

BWC applied: 0.16 dB

Device Reference Point: 0, 0, -6.3 mm

**Cursor:**

ABM1 comp = 13.04 dBA/m

BWC Factor = 0.16 dB

Location: 8.3, -12.5, 3.7 mm

**Cursor:**

ABM2 = -36.03 dBA/m

Location: 8.3, -12.5, 3.7 mm

**Cursor:**

ABM1/ABM2 = 49.07 dB

ABM1 comp = 13.04 dBA/m

BWC Factor = 0.16 dB

Location: 8.3, -12.5, 3.7 mm

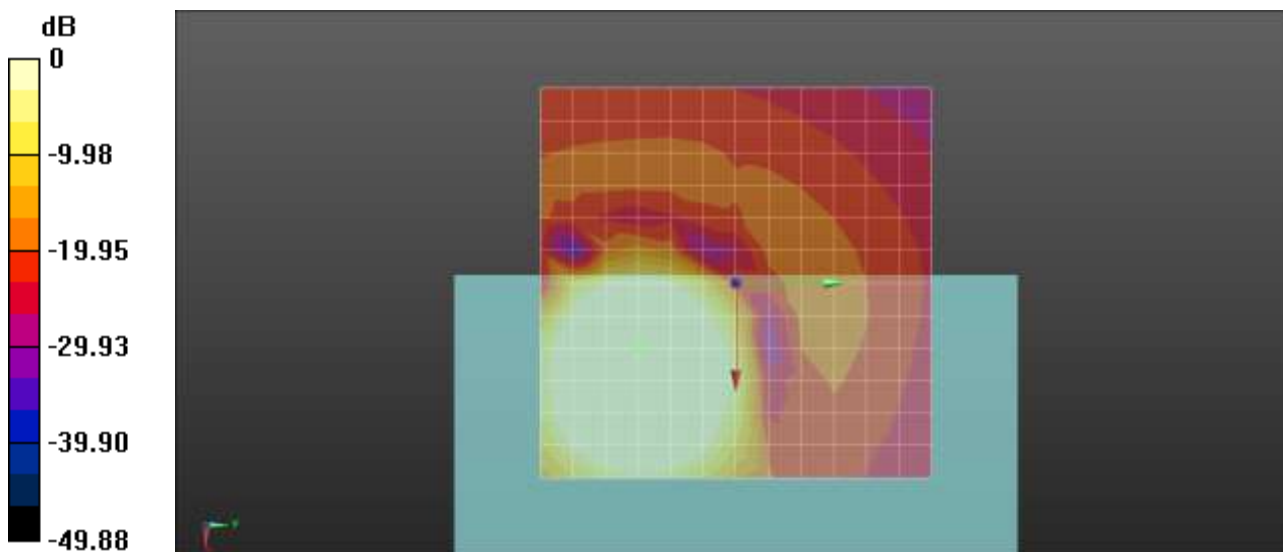

0 dB = 1.000 A/m = 0.00 dBA/m

**Plot No.101**  
**LTE 7 64QAM 15MHz 1RB 74offset 21100ch Bit rate 75 Freq.Response**

**DUT: SM-G991U; Type: Bar**

Communication System: UID 0, LTE Band 7 (0); Frequency: 2535 MHz;Duty Cycle: 1:1  
 Medium parameters used:  $\sigma = 0$  S/m,  $\epsilon_r = 1$ ;  $\rho = 0$  kg/m<sup>3</sup>  
 Phantom section: TCoil Section

**T-Coil scan (scan for ANSI C63.19-2007 & 2011 compliance)/General Scans/z (axial) wideband at best S/N/ABM Freq Resp(x,y,z,f) (1x1x1):** Measurement grid: dx=10mm, dy=10mm  
 Signal Type: Audio File (.wav) 48k\_Normal\_51s new.wav  
 Output Gain: 57.55  
 Measure Window Start: 300ms  
 Measure Window Length: 51000ms  
 BWC applied: 9.48 dB  
 Device Reference Point: 0, 0, -6.3 mm

Category	Telephone parameters WD signal quality [(signal+noise)-to-noise ratio in decibels]
Category T1	0 dB to 10 dB
Category T2	10 dB to 20 dB
Category T3	20 dB to 30 dB
Category T4	> 30 dB

**Cursor:**  
 Diff = 2.00 dB  
 BWC Factor = 9.48 dB  
 Location: 7.9, -11, 3.7 mm

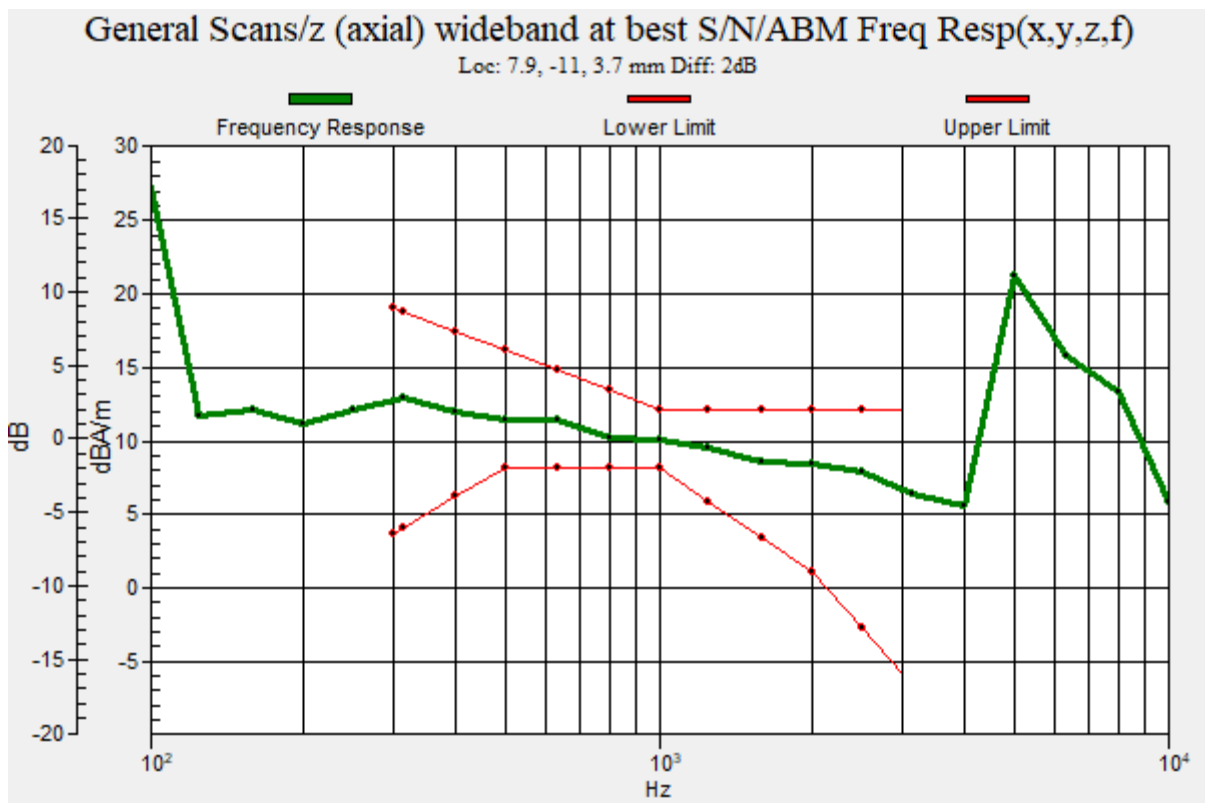

**Plot No.102**

**LTE 7 64QAM 15MHz 1RB 74offset 21100ch Bit rate 75 y(transversal)**

**DUT: SM-G991U; Type: Bar**

Communication System: UID 0, LTE Band 7 (0); Frequency: 2535 MHz;Duty Cycle: 1:1  
Medium parameters used:  $\sigma = 0$  S/m,  $\epsilon_r = 1$ ;  $\rho = 0$  kg/m<sup>3</sup>  
Phantom section: TCoil Section

DASY Configuration:

- Probe: AM1DV3 - 3049; ;
- Sensor-Surface: 0mm (Fix Surface)
- Electronics: DAE4 Sn466; Calibrated: 2020-04-22
- Phantom: HAC Test Arch with AMCC
- Measurement SW: DASY52, Version 52.10 (4);

**T-Coil scan (scan for ANSI C63.19-2007 & 2011 compliance)/General Scans/y (transversal) 4.2mm 50**

**x 50/ABM Signal(x,y,z) (13x13x1):** Measurement grid: dx=10mm, dy=10mm

Signal Type: Audio File (.wav) 48k\_voice\_1kHz\_1s.wav

Output Gain: 18.9

Measure Window Start: 300ms

Measure Window Length: 1000ms

BWC applied: 0.16 dB

Device Reference Point: 0, 0, -6.3 mm

**Cursor:**

ABM1 comp = 5.91 dBA/m

BWC Factor = 0.16 dB

Location: 12.5, -20.8, 3.7 mm

**Cursor:**

ABM2 = -43.40 dBA/m

Location: 12.5, -20.8, 3.7 mm

**Cursor:**

ABM1/ABM2 = 49.31 dB

ABM1 comp = 5.91 dBA/m

BWC Factor = 0.16 dB

Location: 12.5, -20.8, 3.7 mm

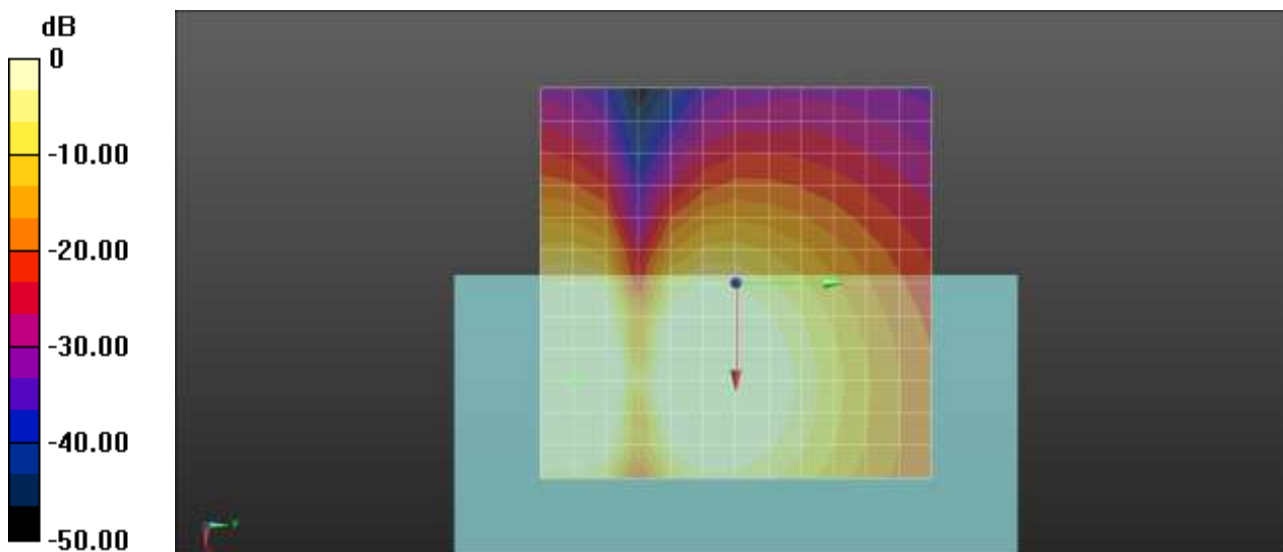

0 dB = 1.000 A/m = 0.00 dBA/m

**Plot No.103**

**LTE 12 64QAM 10MHz 1RB 49offset 23095ch Bit rate 75 z(axial)**

**DUT: SM-G991U; Type: Bar**

Communication System: UID 0, LTE Band12 (0); Frequency: 707.5 MHz;Duty Cycle: 1:1  
Medium parameters used:  $\sigma = 0$  S/m,  $\epsilon_r = 1$ ;  $\rho = 0$  kg/m<sup>3</sup>  
Phantom section: TCoil Section

DASY Configuration:

- Probe: AM1DV3 - 3049; ;
- Sensor-Surface: 0mm (Fix Surface)
- Electronics: DAE4 Sn466; Calibrated: 2020-04-22
- Phantom: HAC Test Arch with AMCC
- Measurement SW: DASY52, Version 52.10 (4);

**T-Coil scan (scan for ANSI C63.19-2007 & 2011 compliance)/General Scans/z (axial) 4.2mm 50 x**

**50/ABM Signal(x,y,z) (13x13x1):** Measurement grid: dx=10mm, dy=10mm

Signal Type: Audio File (.wav) 48k\_voice\_1kHz\_1s.wav

Output Gain: 18.9

Measure Window Start: 300ms

Measure Window Length: 1000ms

BWC applied: 0.16 dB

Device Reference Point: 0, 0, -6.3 mm

**Cursor:**

ABM1 comp = 12.62 dBA/m

BWC Factor = 0.16 dB

Location: 8.3, -12.5, 3.7 mm

**Cursor:**

ABM2 = -36.37 dBA/m

Location: 8.3, -12.5, 3.7 mm

**Cursor:**

ABM1/ABM2 = 48.99 dB

ABM1 comp = 12.62 dBA/m

BWC Factor = 0.16 dB

Location: 8.3, -12.5, 3.7 mm

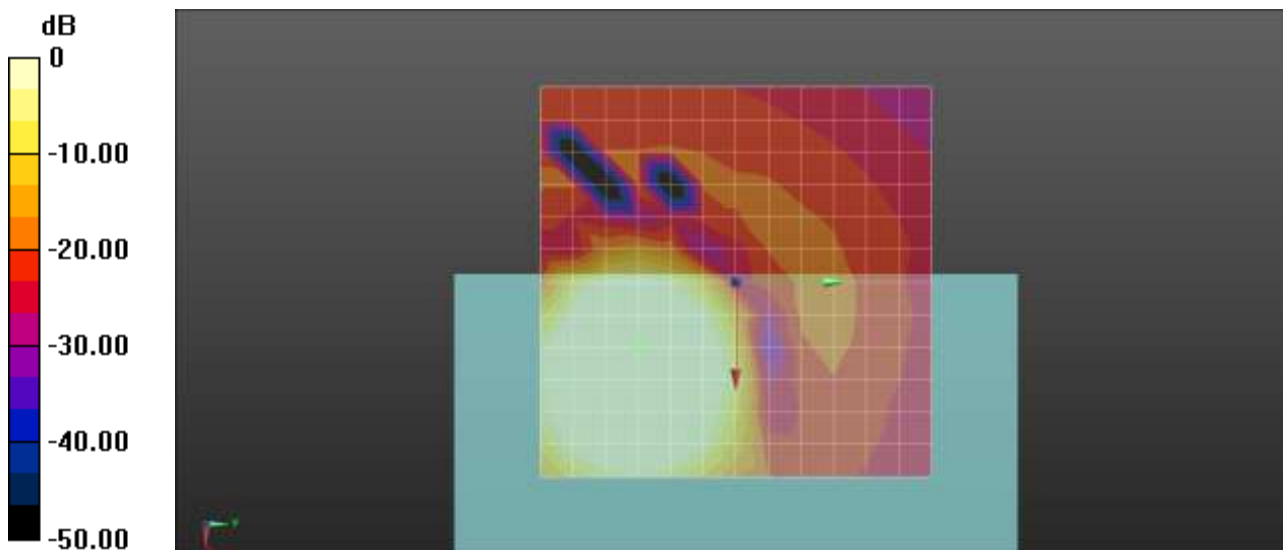

0 dB = 1.000 A/m = 0.00 dBA/m

**Plot No.104**

**LTE 12 64QAM 10MHz 1RB 49offset 23095ch Bit rate 75 Freq.Response**

**DUT: SM-G991U; Type: Bar**

Communication System: UID 0, LTE Band12 (0); Frequency: 707.5 MHz;Duty Cycle: 1:1  
Medium parameters used:  $\sigma = 0$  S/m,  $\epsilon_r = 1$ ;  $\rho = 0$  kg/m<sup>3</sup>  
Phantom section: TCoil Section

**T-Coil scan (scan for ANSI C63.19-2007 & 2011 compliance)/General Scans/z (axial) wideband at best**

**S/N/ABM Freq Resp(x,y,z,f) (1x1x1):** Measurement grid: dx=10mm, dy=10mm

Signal Type: Audio File (.wav) 48k\_Normal\_51s new.wav

Output Gain: 57.55

Measure Window Start: 300ms

Measure Window Length: 51000ms

BWC applied: 9.48 dB

Device Reference Point: 0, 0, -6.3 mm

Category	Telephone parameters WD signal quality [(signal+noise)-to-noise ratio in decibels]
Category T1	0 dB to 10 dB
Category T2	10 dB to 20 dB
Category T3	20 dB to 30 dB
Category T4	> 30 dB

**Cursor:**

Diff = 2.00 dB

BWC Factor = 9.48 dB

Location: 8.3, -14, 3.7 mm

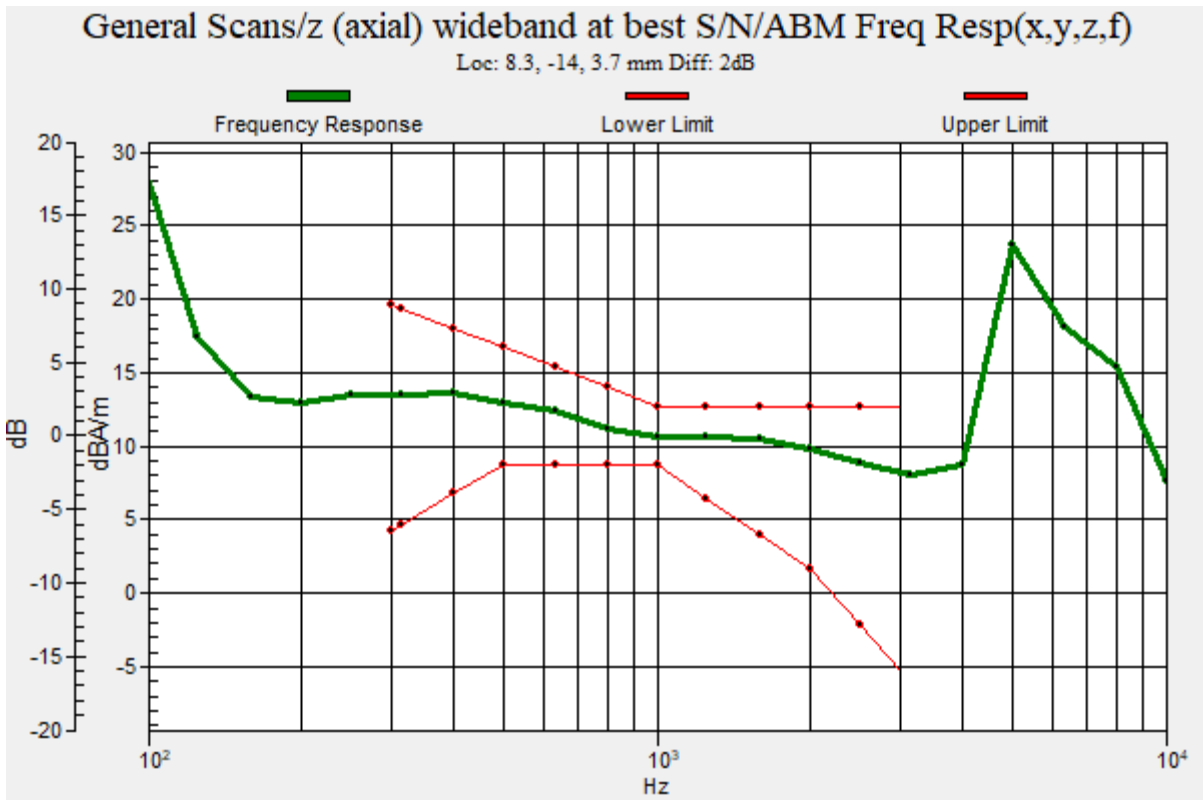

**Plot No.105**

**LTE 12 64QAM 10MHz 1RB 49offset 23095ch Bit rate 75 y(transversal)**

**DUT: SM-G991U; Type: Bar**

Communication System: UID 0, LTE Band12 (0); Frequency: 707.5 MHz;Duty Cycle: 1:1  
Medium parameters used:  $\sigma = 0$  S/m,  $\epsilon_r = 1$ ;  $\rho = 0$  kg/m<sup>3</sup>  
Phantom section: TCoil Section

DASY Configuration:

- Probe: AM1DV3 - 3049; ;
- Sensor-Surface: 0mm (Fix Surface)
- Electronics: DAE4 Sn466; Calibrated: 2020-04-22
- Phantom: HAC Test Arch with AMCC
- Measurement SW: DASY52, Version 52.10 (4);

**T-Coil scan (scan for ANSI C63.19-2007 & 2011 compliance)/General Scans/y (transversal) 4.2mm 50**

**x 50/ABM Signal(x,y,z) (13x13x1):** Measurement grid: dx=10mm, dy=10mm

Signal Type: Audio File (.wav) 48k\_voice\_1kHz\_1s.wav

Output Gain: 18.9

Measure Window Start: 300ms

Measure Window Length: 1000ms

BWC applied: 0.16 dB

Device Reference Point: 0, 0, -6.3 mm

**Cursor:**

ABM1 comp = 2.40 dBA/m

BWC Factor = 0.16 dB

Location: 8.3, -25, 3.7 mm

**Cursor:**

ABM2 = -48.65 dBA/m

Location: 8.3, -25, 3.7 mm

**Cursor:**

ABM1/ABM2 = 51.05 dB

ABM1 comp = 2.40 dBA/m

BWC Factor = 0.16 dB

Location: 8.3, -25, 3.7 mm

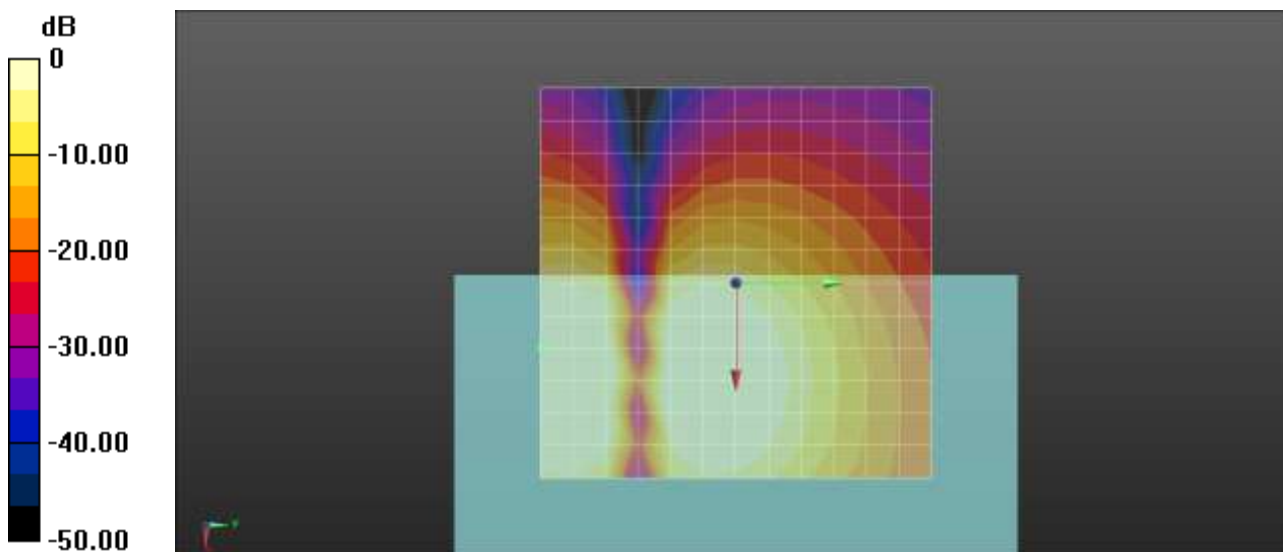

0 dB = 1.000 A/m = 0.00 dBA/m

**Plot No.106**

**LTE 13 64QAM 10MHz 1RB 49offset 23230ch Bit rate 75 z(axial)**

**DUT: SM-G991U; Type: Bar**

Communication System: UID 0, LTE Band 13 (0); Frequency: 782 MHz;Duty Cycle: 1:1  
Medium parameters used:  $\sigma = 0$  S/m,  $\epsilon_r = 1$ ;  $\rho = 0$  kg/m<sup>3</sup>  
Phantom section: TCoil Section

DASY Configuration:

- Probe: AM1DV3 - 3049; ;
- Sensor-Surface: 0mm (Fix Surface)
- Electronics: DAE4 Sn466; Calibrated: 2020-04-22
- Phantom: HAC Test Arch with AMCC
- Measurement SW: DASY52, Version 52.10 (4);

**T-Coil scan (scan for ANSI C63.19-2007 & 2011 compliance)/General Scans/z (axial) 4.2mm 50 x**

**50/ABM Signal(x,y,z) (13x13x1):** Measurement grid: dx=10mm, dy=10mm

Signal Type: Audio File (.wav) 48k\_voice\_1kHz\_1s.wav

Output Gain: 18.9

Measure Window Start: 300ms

Measure Window Length: 1000ms

BWC applied: 0.16 dB

Device Reference Point: 0, 0, -6.3 mm

**Cursor:**

ABM1 comp = 11.81 dBA/m

BWC Factor = 0.16 dB

Location: 8.3, -12.5, 3.7 mm

**Cursor:**

ABM2 = -36.28 dBA/m

Location: 8.3, -12.5, 3.7 mm

**Cursor:**

ABM1/ABM2 = 48.09 dB

ABM1 comp = 11.81 dBA/m

BWC Factor = 0.16 dB

Location: 8.3, -12.5, 3.7 mm

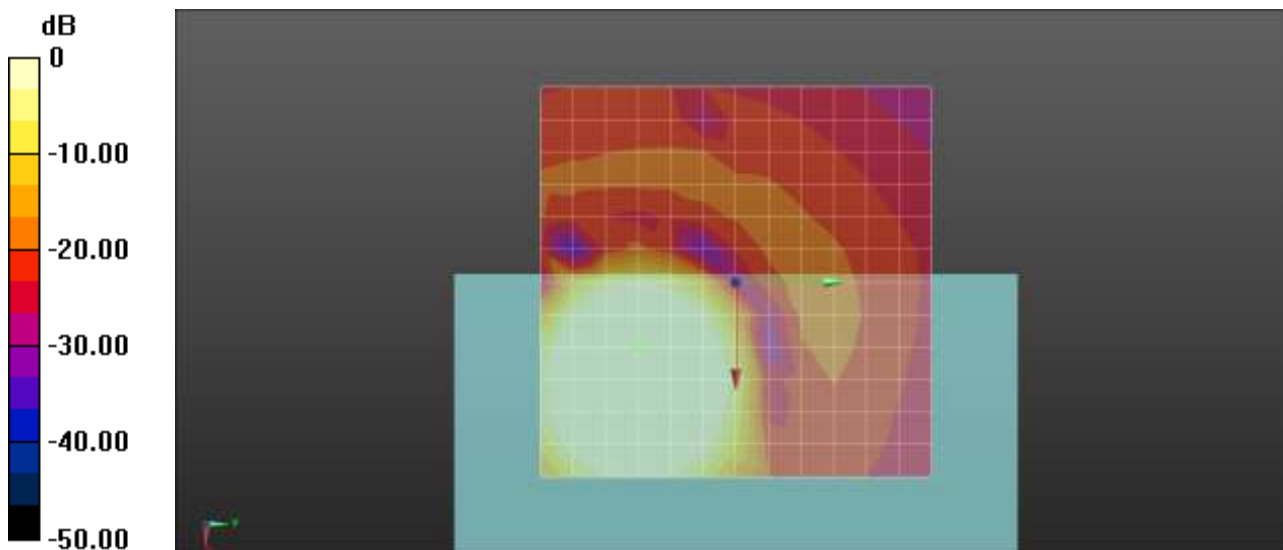

0 dB = 1.000 A/m = 0.00 dBA/m

**Plot No.107**

**LTE 13 64QAM 10MHz 1RB 49offset 23230ch Bit rate 75 Freq.Response**

**DUT: SM-G991U; Type: Bar**

Communication System: UID 0, LTE Band 13 (0); Frequency: 782 MHz;Duty Cycle: 1:1  
Medium parameters used:  $\sigma = 0$  S/m,  $\epsilon_r = 1$ ;  $\rho = 0$  kg/m<sup>3</sup>  
Phantom section: TCoil Section

**T-Coil scan (scan for ANSI C63.19-2007 & 2011 compliance)/General Scans/z (axial) wideband at best S/N/ABM Freq Resp(x,y,z,f) (1x1x1):** Measurement grid: dx=10mm, dy=10mm  
Signal Type: Audio File (.wav) 48k\_Normal\_51s new.wav  
Output Gain: 57.55  
Measure Window Start: 300ms  
Measure Window Length: 51000ms  
BWC applied: 9.48 dB  
Device Reference Point: 0, 0, -6.3 mm

Category	Telephone parameters WD signal quality [(signal+noise)-to-noise ratio in decibels]
Category T1	0 dB to 10 dB
Category T2	10 dB to 20 dB
Category T3	20 dB to 30 dB
Category T4	> 30 dB

**Cursor:**

Diff = 2.00 dB  
BWC Factor = 9.48 dB  
Location: 8.5, -15, 3.7 mm

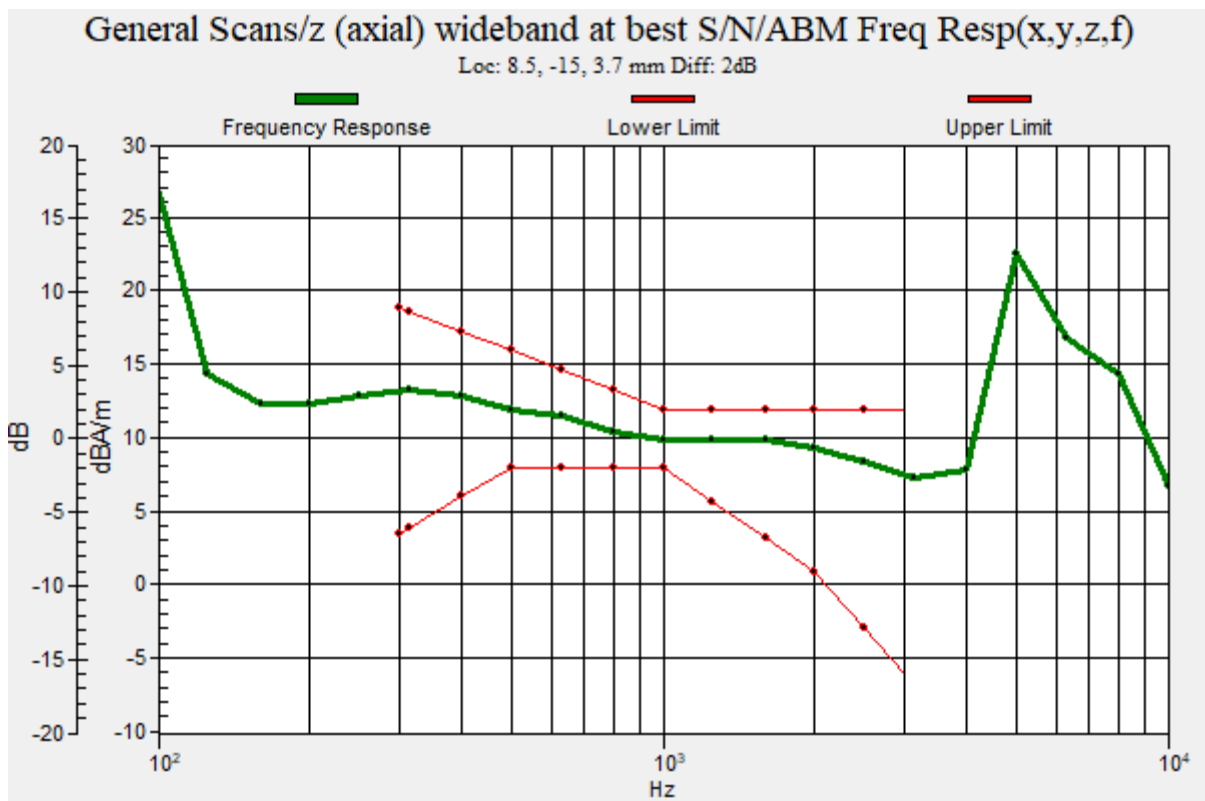



**Plot No.108**

**LTE 13 64QAM 10MHz 1RB 49offset 23230ch Bit rate 75 y(transversal)**

**DUT: SM-G991U; Type: Bar**

Communication System: UID 0, LTE Band 13 (0); Frequency: 782 MHz;Duty Cycle: 1:1  
 Medium parameters used:  $\sigma = 0$  S/m,  $\epsilon_r = 1$ ;  $\rho = 0$  kg/m<sup>3</sup>  
 Phantom section: TCoil Section

DASY Configuration:

- Probe: AM1DV3 - 3049; ;
- Sensor-Surface: 0mm (Fix Surface)
- Electronics: DAE4 Sn466; Calibrated: 2020-04-22
- Phantom: HAC Test Arch with AMCC
- Measurement SW: DASY52, Version 52.10 (4);

**T-Coil scan (scan for ANSI C63.19-2007 & 2011 compliance)/General Scans/y (transversal) 4.2mm 50**

**x 50/ABM Signal(x,y,z) (13x13x1):** Measurement grid: dx=10mm, dy=10mm

Signal Type: Audio File (.wav) 48k\_voice\_1kHz\_1s.wav

Output Gain: 18.9

Measure Window Start: 300ms

Measure Window Length: 1000ms

BWC applied: 0.16 dB

Device Reference Point: 0, 0, -6.3 mm

**Cursor:**

ABM1 comp = 4.04 dBA/m

BWC Factor = 0.16 dB

Location: 8.3, -20.8, 3.7 mm

**Cursor:**

ABM2 = -45.23 dBA/m

Location: 8.3, -20.8, 3.7 mm

**Cursor:**

ABM1/ABM2 = 49.27 dB

ABM1 comp = 4.04 dBA/m

BWC Factor = 0.16 dB

Location: 8.3, -20.8, 3.7 mm

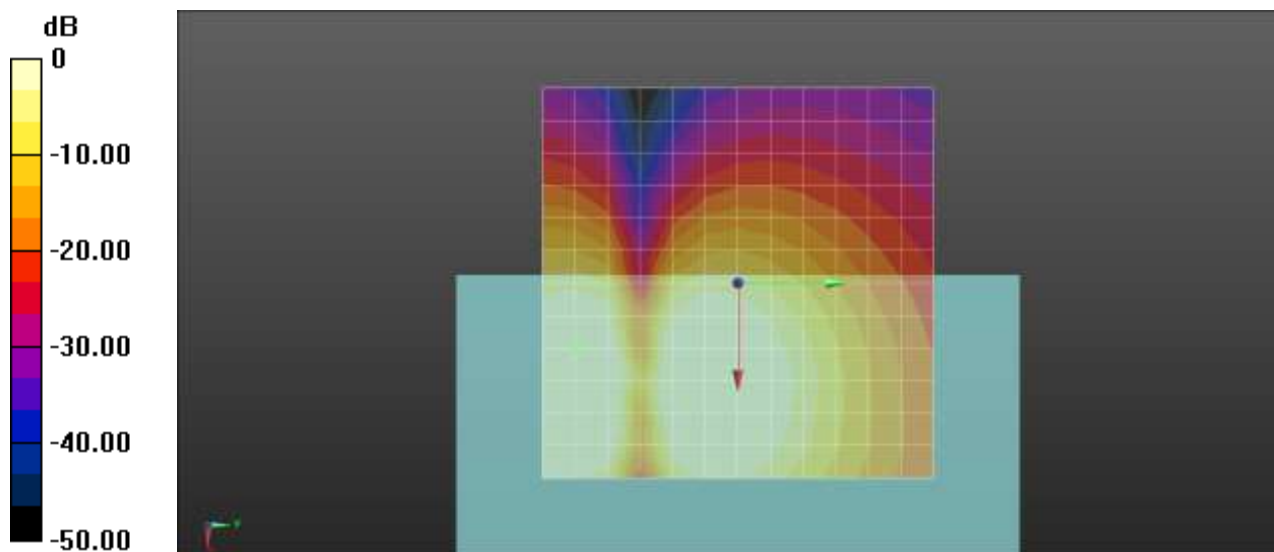

0 dB = 1.000 A/m = 0.00 dBA/m

**Plot No.109**

**LTE 14 64QAM 10MHz 1RB 49offset 23330ch Bit rate 75 z(axial)**

**DUT: SM-G991U; Type: Bar**

Communication System: UID 0, LTE Band 14 (0); Frequency: 793 MHz;Duty Cycle: 1:1  
Medium parameters used:  $\sigma = 0$  S/m,  $\epsilon_r = 1$ ;  $\rho = 0$  kg/m<sup>3</sup>  
Phantom section: TCoil Section

DASY Configuration:

- Probe: AM1DV3 - 3049; ;
- Sensor-Surface: 0mm (Fix Surface)
- Electronics: DAE4 Sn466; Calibrated: 2020-04-22
- Phantom: HAC Test Arch with AMCC
- Measurement SW: DASY52, Version 52.10 (4);

**T-Coil scan (scan for ANSI C63.19-2007 & 2011 compliance)/General Scans/z (axial) 4.2mm 50 x**

**50/ABM Signal(x,y,z) (13x13x1):** Measurement grid: dx=10mm, dy=10mm

Signal Type: Audio File (.wav) 48k\_voice\_1kHz\_1s.wav

Output Gain: 18.9

Measure Window Start: 300ms

Measure Window Length: 1000ms

BWC applied: 0.16 dB

Device Reference Point: 0, 0, -6.3 mm

**Cursor:**

ABM1 comp = 5.54 dBA/m

BWC Factor = 0.16 dB

Location: 4.2, -16.7, 3.7 mm

**Cursor:**

ABM2 = -44.55 dBA/m

Location: 4.2, -16.7, 3.7 mm

**Cursor:**

ABM1/ABM2 = 50.09 dB

ABM1 comp = 5.54 dBA/m

BWC Factor = 0.16 dB

Location: 4.2, -16.7, 3.7 mm

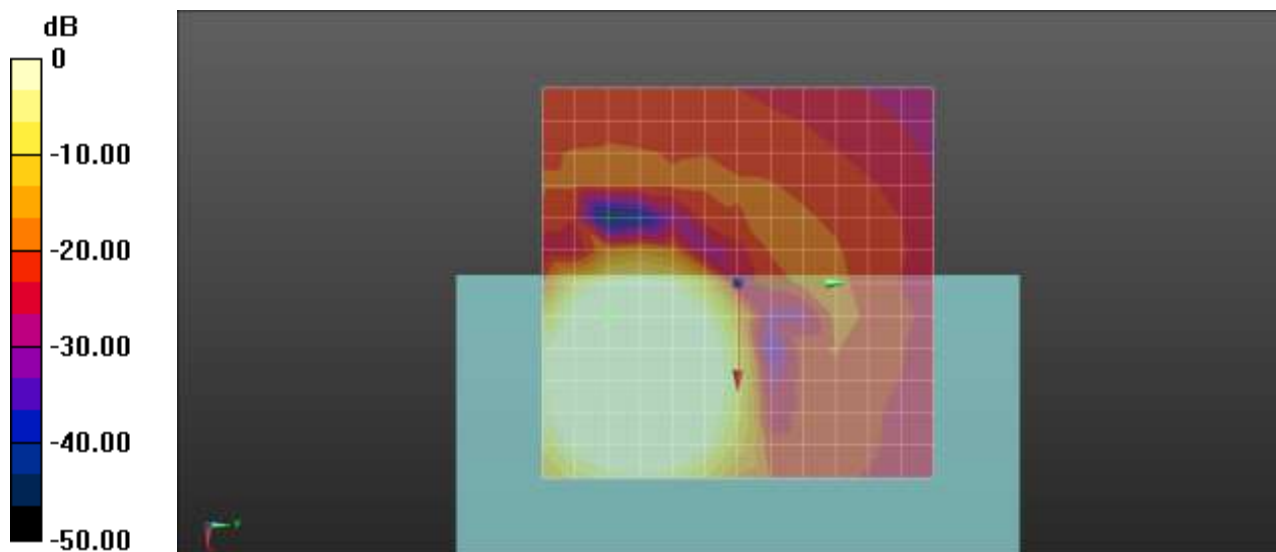

0 dB = 1.000 A/m = 0.00 dBA/m

**Plot No.110**  
**LTE 14 64QAM 10MHz 1RB 49offset 23330ch Bit rate 75 Freq.Response**

**DUT: SM-G991U; Type: Bar**

Communication System: UID 0, LTE Band 14 (0); Frequency: 793 MHz;Duty Cycle: 1:1  
Medium parameters used:  $\sigma = 0$  S/m,  $\epsilon_r = 1$ ;  $\rho = 0$  kg/m<sup>3</sup>  
Phantom section: TCoil Section

**T-Coil scan (scan for ANSI C63.19-2007 & 2011 compliance)/General Scans/z (axial) wideband at best S/N/ABM Freq Resp(x,y,z,f) (1x1x1):** Measurement grid: dx=10mm, dy=10mm  
Signal Type: Audio File (.wav) 48k\_Normal\_51s new.wav  
Output Gain: 57.55  
Measure Window Start: 300ms  
Measure Window Length: 51000ms  
BWC applied: 9.48 dB  
Device Reference Point: 0, 0, -6.3 mm

Category	Telephone parameters WD signal quality [(signal+noise)-to-noise ratio in decibels]
Category T1	0 dB to 10 dB
Category T2	10 dB to 20 dB
Category T3	20 dB to 30 dB
Category T4	> 30 dB

**Cursor:**  
Diff = 1.95 dB  
BWC Factor = 9.48 dB  
Location: 4.4, -16.2, 3.7 mm

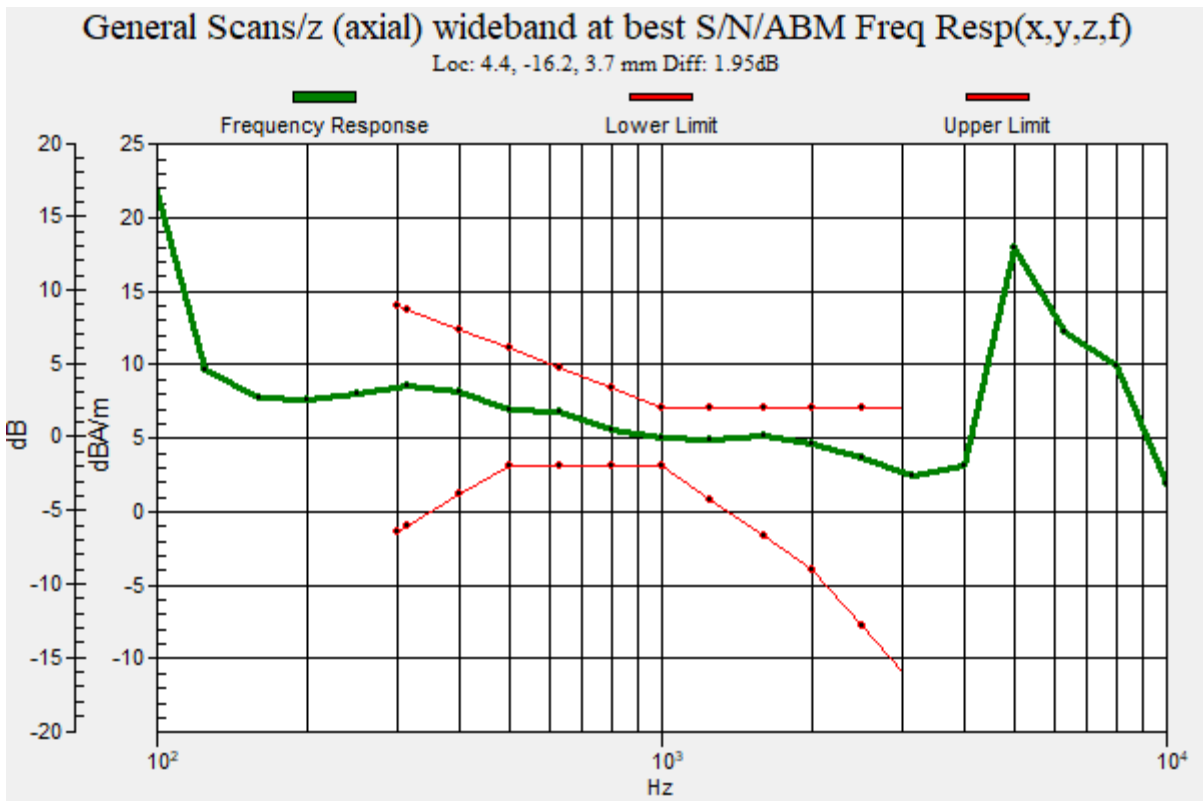

**Plot No.111**

**LTE 14 64QAM 10MHz 1RB 49offset 23330ch Bit rate 75 y(transversal)**

**DUT: SM-G991U; Type: Bar**

Communication System: UID 0, LTE Band 14 (0); Frequency: 793 MHz;Duty Cycle: 1:1  
 Medium parameters used:  $\sigma = 0$  S/m,  $\epsilon_r = 1$ ;  $\rho = 0$  kg/m<sup>3</sup>  
 Phantom section: TCoil Section

DASY Configuration:

- Probe: AM1DV3 - 3049; ;
- Sensor-Surface: 0mm (Fix Surface)
- Electronics: DAE4 Sn466; Calibrated: 2020-04-22
- Phantom: HAC Test Arch with AMCC
- Measurement SW: DASY52, Version 52.10 (4);

**T-Coil scan (scan for ANSI C63.19-2007 & 2011 compliance)/General Scans/y (transversal) 4.2mm 50**

**x 50/ABM Signal(x,y,z) (13x13x1):** Measurement grid: dx=10mm, dy=10mm

Signal Type: Audio File (.wav) 48k\_voice\_1kHz\_1s.wav

Output Gain: 18.9

Measure Window Start: 300ms

Measure Window Length: 1000ms

BWC applied: 0.16 dB

Device Reference Point: 0, 0, -6.3 mm

**Cursor:**

ABM1 comp = 4.24 dBA/m

BWC Factor = 0.16 dB

Location: 8.3, -20.8, 3.7 mm

**Cursor:**

ABM2 = -43.37 dBA/m

Location: 8.3, -20.8, 3.7 mm

**Cursor:**

ABM1/ABM2 = 47.61 dB

ABM1 comp = 4.24 dBA/m

BWC Factor = 0.16 dB

Location: 8.3, -20.8, 3.7 mm

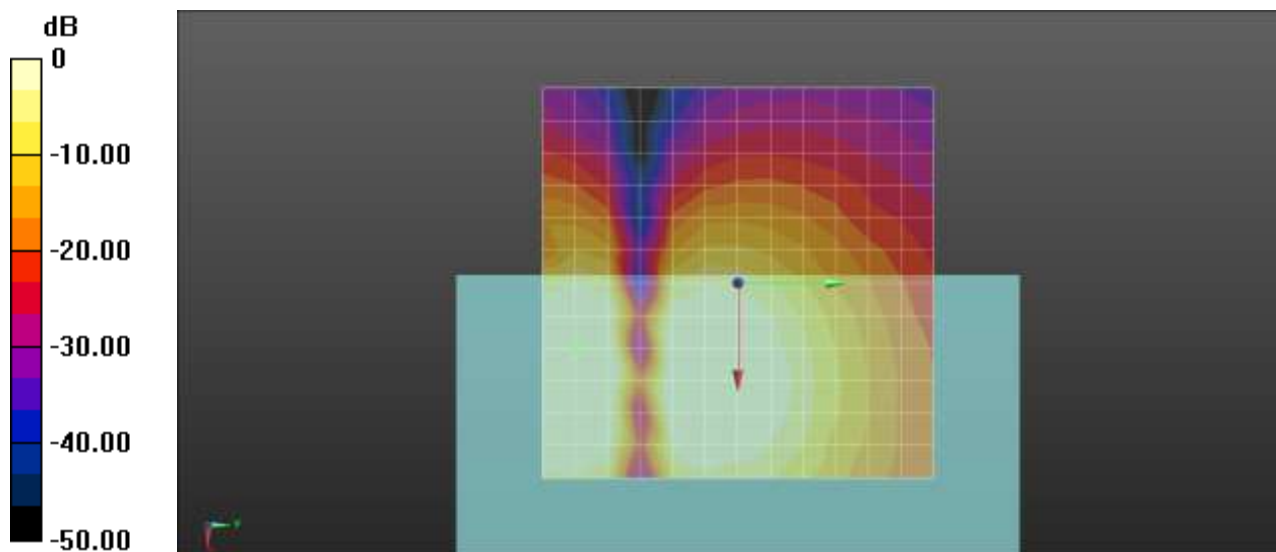

0 dB = 1.000 A/m = 0.00 dBA/m

**Plot No.112**

**LTE 25 64QAM 15MHz 1RB 74offset 26365ch Bitrate 75 z(axial)**

**DUT: SM-G991U; Type: Bar**

Communication System: UID 0, LTE Band 25 (0); Frequency: 1882.5 MHz;Duty Cycle: 1:1  
Medium parameters used:  $\sigma = 0$  S/m,  $\epsilon_r = 1$ ;  $\rho = 0$  kg/m<sup>3</sup>  
Phantom section: TCoil Section

DASY Configuration:

- Probe: AM1DV3 - 3049; ;
- Sensor-Surface: 0mm (Fix Surface)
- Electronics: DAE4 Sn466; Calibrated: 2020-04-22
- Phantom: HAC Test Arch with AMCC
- Measurement SW: DASY52, Version 52.10 (4);

**T-Coil scan (scan for ANSI C63.19-2007 & 2011 compliance)/General Scans/z (axial) 4.2mm 50 x**

**50/ABM Signal(x,y,z) (13x13x1):** Measurement grid: dx=10mm, dy=10mm

Signal Type: Audio File (.wav) 48k\_voice\_1kHz\_1s.wav

Output Gain: 18.9

Measure Window Start: 300ms

Measure Window Length: 1000ms

BWC applied: 0.16 dB

Device Reference Point: 0, 0, -6.3 mm

**Cursor:**

ABM1 comp = 11.99 dBA/m

BWC Factor = 0.16 dB

Location: 8.3, -12.5, 3.7 mm

**Cursor:**

ABM2 = -36.50 dBA/m

Location: 8.3, -12.5, 3.7 mm

**Cursor:**

ABM1/ABM2 = 48.49 dB

ABM1 comp = 11.99 dBA/m

BWC Factor = 0.16 dB

Location: 8.3, -12.5, 3.7 mm

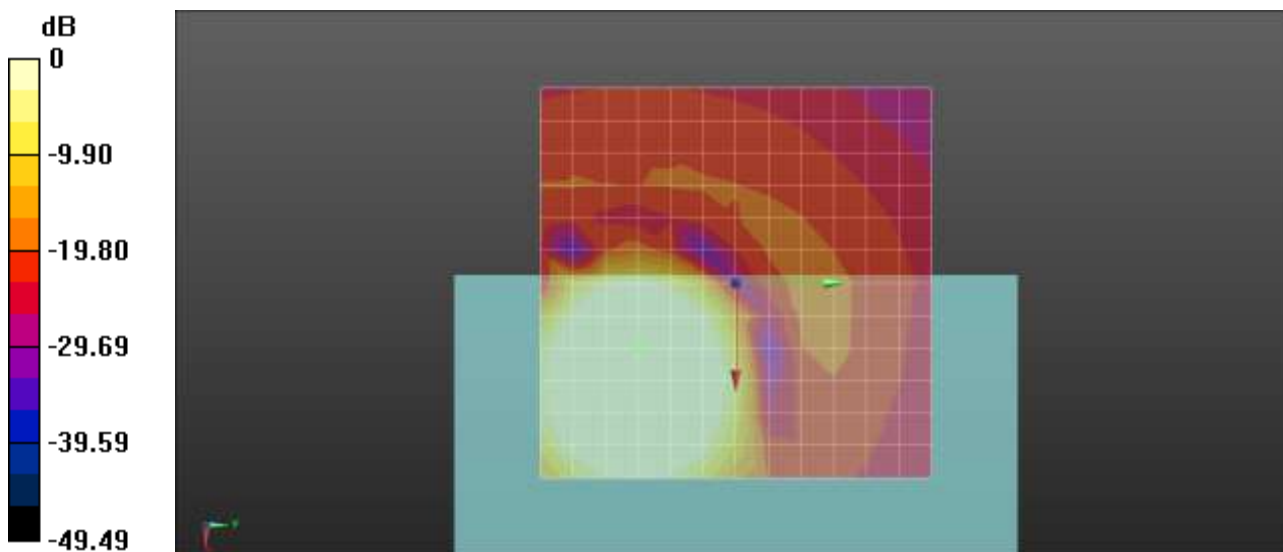

0 dB = 1.000 A/m = 0.00 dBA/m

**Plot No.113**  
**LTE 25 64QAM 15MHz 1RB 74offset 26365ch Bitrate 75 Freq.Response**

**DUT: SM-G991U; Type: Bar**

Communication System: UID 0, LTE Band 25 (0); Frequency: 1882.5 MHz;Duty Cycle: 1:1  
 Medium parameters used:  $\sigma = 0$  S/m,  $\epsilon_r = 1$ ;  $\rho = 0$  kg/m<sup>3</sup>  
 Phantom section: TCoil Section

**T-Coil scan (scan for ANSI C63.19-2007 & 2011 compliance)/General Scans/z (axial) wideband at best S/N/ABM Freq Resp(x,y,z,f) (1x1x1):** Measurement grid: dx=10mm, dy=10mm  
 Signal Type: Audio File (.wav) 48k\_Normal\_51s new.wav  
 Output Gain: 57.55  
 Measure Window Start: 300ms  
 Measure Window Length: 51000ms  
 BWC applied: 9.48 dB  
 Device Reference Point: 0, 0, -6.3 mm

Category	Telephone parameters WD signal quality [(signal+noise)-to-noise ratio in decibels]
Category T1	0 dB to 10 dB
Category T2	10 dB to 20 dB
Category T3	20 dB to 30 dB
Category T4	> 30 dB

**Cursor:**  
 Diff = 2.00 dB  
 BWC Factor = 9.48 dB  
 Location: 8.5, -13.3, 3.7 mm

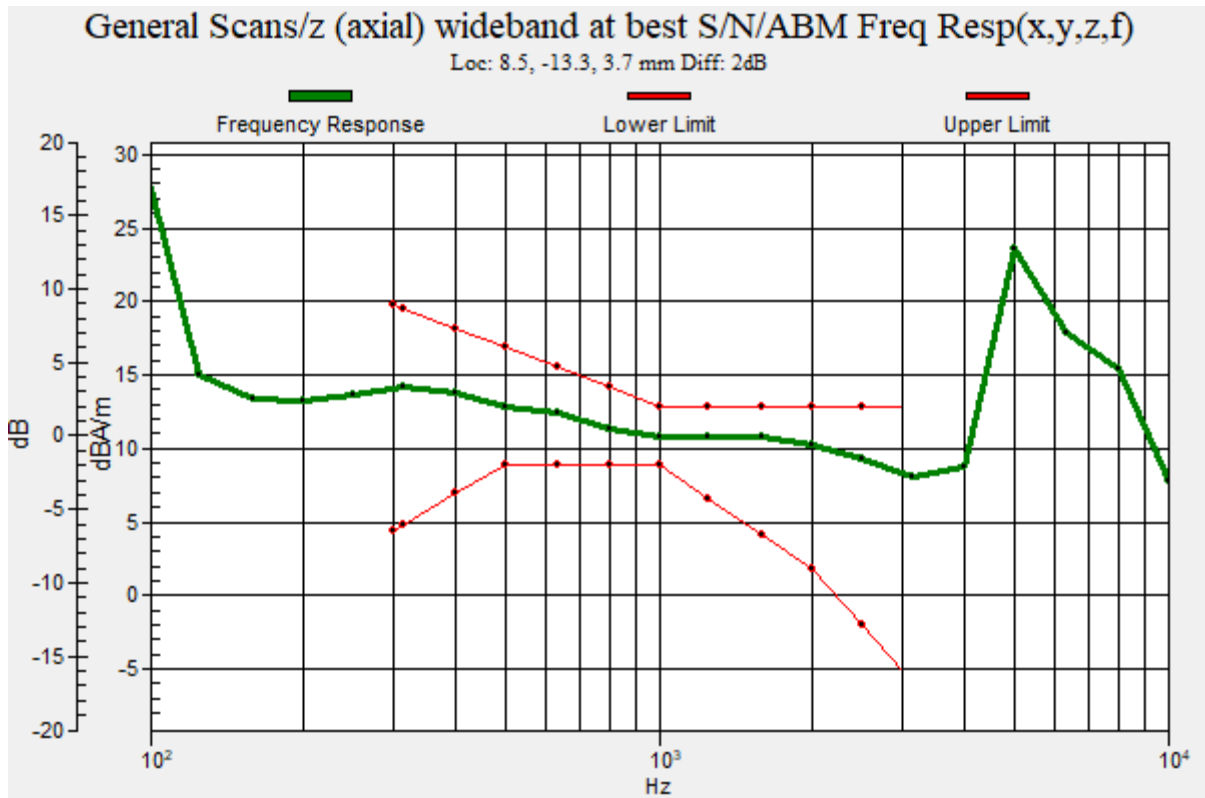

**Plot No.114**

**LTE 25 64QAM 15MHz 1RB 74offset 26365ch Bitrate 75 y(transversal)**

**DUT: SM-G991U; Type: Bar**

Communication System: UID 0, LTE Band 25 (0); Frequency: 1882.5 MHz;Duty Cycle: 1:1  
Medium parameters used:  $\sigma = 0$  S/m,  $\epsilon_r = 1$ ;  $\rho = 0$  kg/m<sup>3</sup>  
Phantom section: TCoil Section

DASY Configuration:

- Probe: AM1DV3 - 3049; ;
- Sensor-Surface: 0mm (Fix Surface)
- Electronics: DAE4 Sn466; Calibrated: 2020-04-22
- Phantom: HAC Test Arch with AMCC
- Measurement SW: DASY52, Version 52.10 (4);

**T-Coil scan (scan for ANSI C63.19-2007 & 2011 compliance)/General Scans/y (transversal) 4.2mm 50**

**x 50/ABM Signal(x,y,z) (13x13x1):** Measurement grid: dx=10mm, dy=10mm

Signal Type: Audio File (.wav) 48k\_voice\_1kHz\_1s.wav

Output Gain: 18.9

Measure Window Start: 300ms

Measure Window Length: 1000ms

BWC applied: 0.16 dB

Device Reference Point: 0, 0, -6.3 mm

**Cursor:**

ABM1 comp = 4.52 dBA/m

BWC Factor = 0.16 dB

Location: 8.3, -20.8, 3.7 mm

**Cursor:**

ABM2 = -44.57 dBA/m

Location: 8.3, -20.8, 3.7 mm

**Cursor:**

ABM1/ABM2 = 49.09 dB

ABM1 comp = 4.52 dBA/m

BWC Factor = 0.16 dB

Location: 8.3, -20.8, 3.7 mm

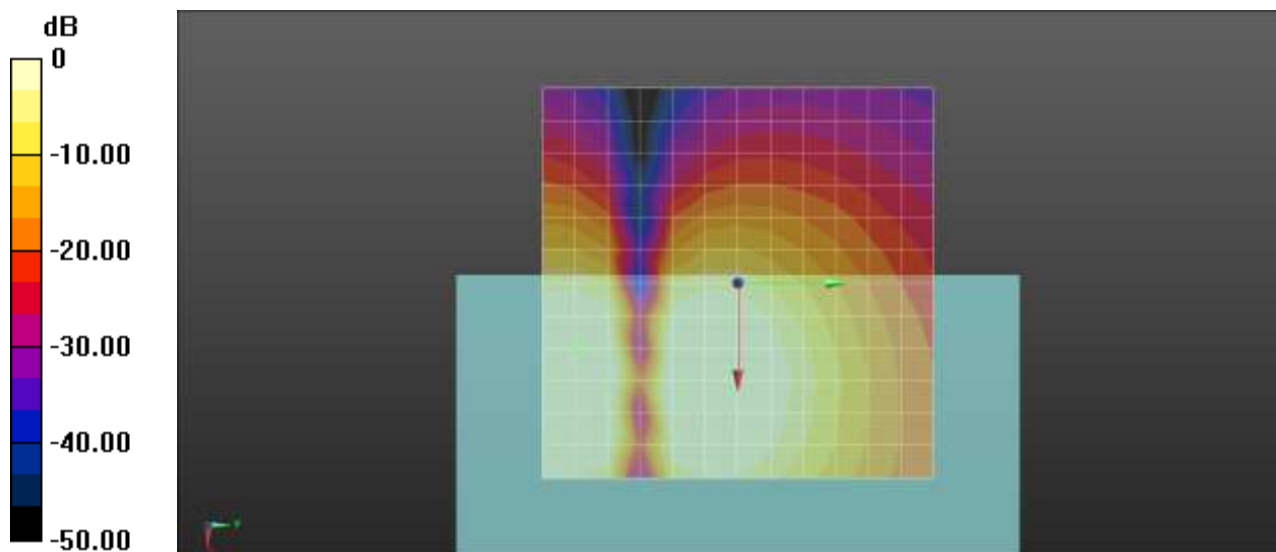

0 dB = 1.000 A/m = 0.00 dBA/m

**Plot No.115**

**LTE 26 64QAM 15MHz 1RB 74offset t 26865ch Bit rate 75 z(axial)**

**DUT: SM-G991U; Type: Bar**

Communication System: UID 0, LTE Band 26 (0); Frequency: 831.5 MHz;Duty Cycle: 1:1  
Medium parameters used:  $\sigma = 0$  S/m,  $\epsilon_r = 1$ ;  $\rho = 0$  kg/m<sup>3</sup>  
Phantom section: TCoil Section

DASY Configuration:

- Probe: AM1DV3 - 3049; ;
- Sensor-Surface: 0mm (Fix Surface)
- Electronics: DAE4 Sn466; Calibrated: 2020-04-22
- Phantom: HAC Test Arch with AMCC
- Measurement SW: DASY52, Version 52.10 (4);

**T-Coil scan (scan for ANSI C63.19-2007 & 2011 compliance)/General Scans/z (axial) 4.2mm 50 x**

**50/ABM Signal(x,y,z) (13x13x1):** Measurement grid: dx=10mm, dy=10mm

Signal Type: Audio File (.wav) 48k\_voice\_1kHz\_1s.wav

Output Gain: 18.9

Measure Window Start: 300ms

Measure Window Length: 1000ms

BWC applied: 0.16 dB

Device Reference Point: 0, 0, -6.3 mm

**Cursor:**

ABM1 comp = 12.97 dBA/m

BWC Factor = 0.16 dB

Location: 8.3, -12.5, 3.7 mm

**Cursor:**

ABM2 = -36.22 dBA/m

Location: 8.3, -12.5, 3.7 mm

**Cursor:**

ABM1/ABM2 = 49.18 dB

ABM1 comp = 12.97 dBA/m

BWC Factor = 0.16 dB

Location: 8.3, -12.5, 3.7 mm

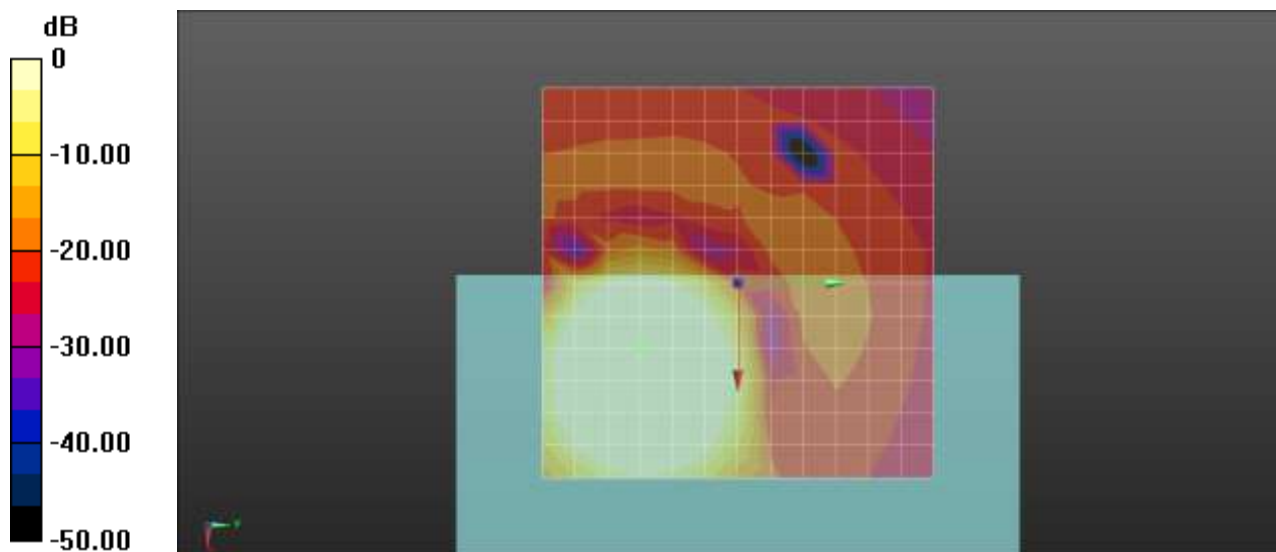

0 dB = 1.000 A/m = 0.00 dBA/m



**Plot No.116**  
**LTE 26 64QAM 15MHz 1RB 74offset 26865ch Bit rate 75 Freq.Response**

**DUT: SM-G991U; Type: Bar**

Communication System: UID 0, LTE Band 26 (0); Frequency: 831.5 MHz;Duty Cycle: 1:1  
Medium parameters used:  $\sigma = 0$  S/m,  $\epsilon_r = 1$ ;  $\rho = 0$  kg/m<sup>3</sup>  
Phantom section: TCoil Section

**T-Coil scan (scan for ANSI C63.19-2007 & 2011 compliance)/General Scans/z (axial) wideband at best S/N/ABM Freq Resp(x,y,z,f) (1x1x1):** Measurement grid: dx=10mm, dy=10mm  
Signal Type: Audio File (.wav) 48k\_Normal\_51s new.wav  
Output Gain: 57.55  
Measure Window Start: 300ms  
Measure Window Length: 51000ms  
BWC applied: 9.48 dB  
Device Reference Point: 0, 0, -6.3 mm

Category	Telephone parameters WD signal quality [(signal+noise)-to-noise ratio in decibels]
Category T1	0 dB to 10 dB
Category T2	10 dB to 20 dB
Category T3	20 dB to 30 dB
Category T4	> 30 dB

**Cursor:**  
Diff = 2.00 dB  
BWC Factor = 9.48 dB  
Location: 8.9, -12.3, 3.7 mm

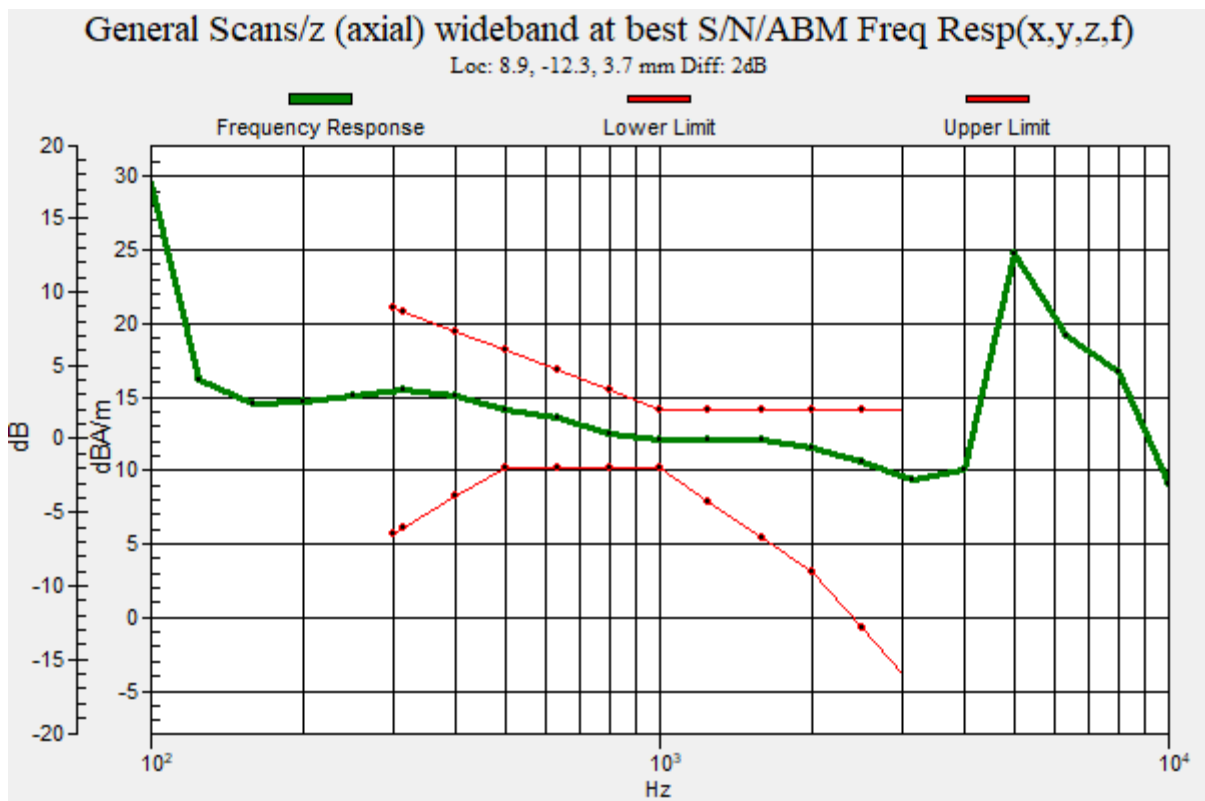

**Plot No.117**

**LTE 26 64QAM 15MHz 1RB 74offset 26865ch Bit rate 75 y(transversal)**

**DUT: SM-G991U; Type: Bar**

Communication System: UID 0, LTE Band 26 (0); Frequency: 831.5 MHz;Duty Cycle: 1:1  
Medium parameters used:  $\sigma = 0$  S/m,  $\epsilon_r = 1$ ;  $\rho = 0$  kg/m<sup>3</sup>  
Phantom section: TCoil Section

DASY Configuration:

- Probe: AM1DV3 - 3049; ;
- Sensor-Surface: 0mm (Fix Surface)
- Electronics: DAE4 Sn466; Calibrated: 2020-04-22
- Phantom: HAC Test Arch with AMCC
- Measurement SW: DASY52, Version 52.10 (4);

**T-Coil scan (scan for ANSI C63.19-2007 & 2011 compliance)/General Scans/y (transversal) 4.2mm 50**

**x 50/ABM Signal(x,y,z) (13x13x1):** Measurement grid: dx=10mm, dy=10mm

Signal Type: Audio File (.wav) 48k\_voice\_1kHz\_1s.wav

Output Gain: 18.9

Measure Window Start: 300ms

Measure Window Length: 1000ms

BWC applied: 0.16 dB

Device Reference Point: 0, 0, -6.3 mm

**Cursor:**

ABM1 comp = 4.78 dBA/m

BWC Factor = 0.16 dB

Location: 8.3, -20.8, 3.7 mm

**Cursor:**

ABM2 = -44.40 dBA/m

Location: 8.3, -20.8, 3.7 mm

**Cursor:**

ABM1/ABM2 = 49.18 dB

ABM1 comp = 4.78 dBA/m

BWC Factor = 0.16 dB

Location: 8.3, -20.8, 3.7 mm

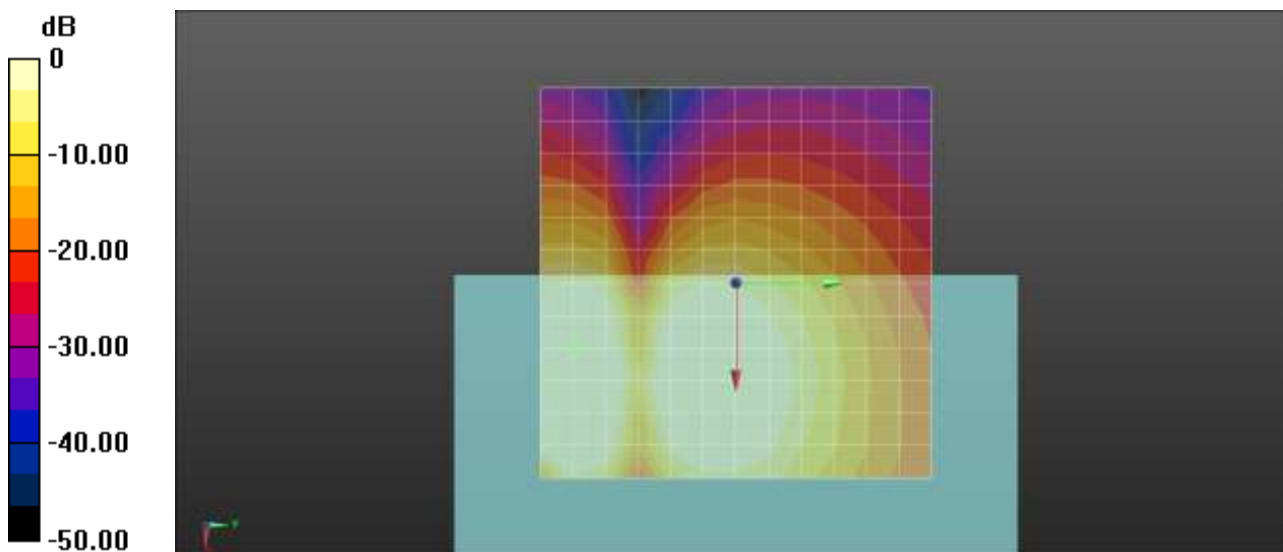

0 dB = 1.000 A/m = 0.00 dBA/m

**Plot No.118**

**LTE 30 64QAM 10MHz 1RB 49offset 27710ch Bit rate 75 z(axial)**

**DUT: SM-G991U; Type: Bar**

Communication System: UID 0, LTE Band30 (0); Frequency: 2310 MHz;Duty Cycle: 1:1  
Medium parameters used:  $\sigma = 0$  S/m,  $\epsilon_r = 1$ ;  $\rho = 0$  kg/m<sup>3</sup>  
Phantom section: TCoil Section

DASY Configuration:

- Probe: AM1DV3 - 3049; ;
- Sensor-Surface: 0mm (Fix Surface)
- Electronics: DAE4 Sn466; Calibrated: 2020-04-22
- Phantom: HAC Test Arch with AMCC
- Measurement SW: DASY52, Version 52.10 (4);

**T-Coil scan (scan for ANSI C63.19-2007 & 2011 compliance)/General Scans/z (axial) 4.2mm 50 x**

**50/ABM Signal(x,y,z) (13x13x1):** Measurement grid: dx=10mm, dy=10mm

Signal Type: Audio File (.wav) 48k\_voice\_1kHz\_1s.wav

Output Gain: 18.9

Measure Window Start: 300ms

Measure Window Length: 1000ms

BWC applied: 0.16 dB

Device Reference Point: 0, 0, -6.3 mm

**Cursor:**

ABM1 comp = 13.04 dBA/m

BWC Factor = 0.16 dB

Location: 8.3, -12.5, 3.7 mm

**Cursor:**

ABM2 = -35.98 dBA/m

Location: 8.3, -12.5, 3.7 mm

**Cursor:**

ABM1/ABM2 = 49.02 dB

ABM1 comp = 13.04 dBA/m

BWC Factor = 0.16 dB

Location: 8.3, -12.5, 3.7 mm

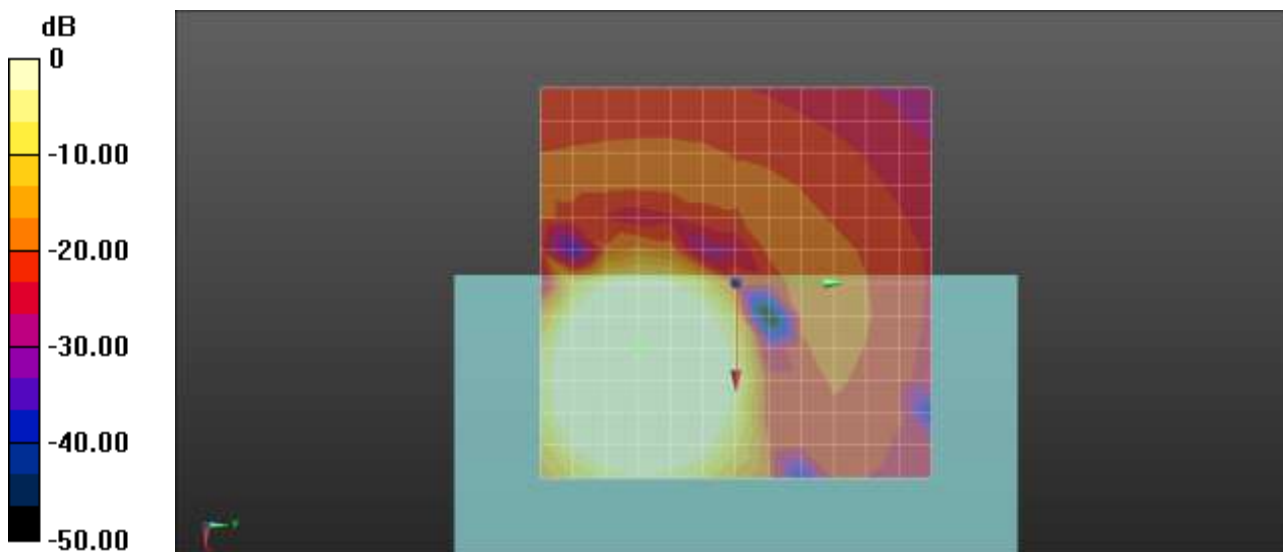

0 dB = 1.000 A/m = 0.00 dBA/m

**Plot No.119**  
**LTE 30 64QAM 10MHz 1RB 49offset 27710ch Bit rate 75 Freq.Response**

**DUT: SM-G991U; Type: Bar**

Communication System: UID 0, LTE Band30 (0); Frequency: 2310 MHz;Duty Cycle: 1:1  
Medium parameters used:  $\sigma = 0$  S/m,  $\epsilon_r = 1$ ;  $\rho = 0$  kg/m<sup>3</sup>  
Phantom section: TCoil Section

**T-Coil scan (scan for ANSI C63.19-2007 & 2011 compliance)/General Scans/z (axial) wideband at best S/N/ABM Freq Resp(x,y,z,f) (1x1x1):** Measurement grid: dx=10mm, dy=10mm  
Signal Type: Audio File (.wav) 48k\_Normal\_51s new.wav  
Output Gain: 57.55  
Measure Window Start: 300ms  
Measure Window Length: 51000ms  
BWC applied: 9.48 dB  
Device Reference Point: 0, 0, -6.3 mm

Category	Telephone parameters WD signal quality [(signal+noise)-to-noise ratio in decibels]
Category T1	0 dB to 10 dB
Category T2	10 dB to 20 dB
Category T3	20 dB to 30 dB
Category T4	> 30 dB

**Cursor:**  
Diff = 2.00 dB  
BWC Factor = 9.48 dB  
Location: 8.8, -12.3, 3.7 mm

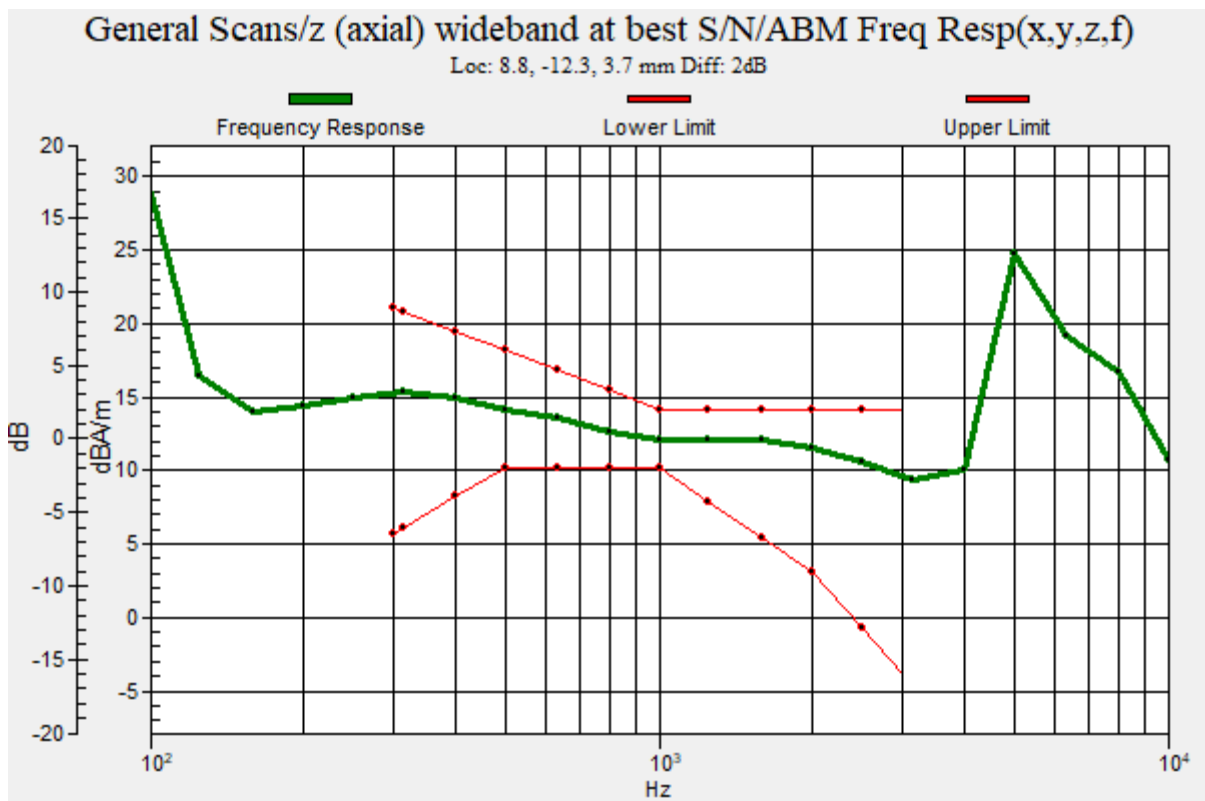

**Plot No.120**

**LTE 30 64QAM 10MHz 1RB 49offset 27710ch Bit rate 75-1 y(transversal)**

**DUT: SM-G991U; Type: Bar**

Communication System: UID 0, LTE Band30 (0); Frequency: 2310 MHz;Duty Cycle: 1:1  
Medium parameters used:  $\sigma = 0$  S/m,  $\epsilon_r = 1$ ;  $\rho = 0$  kg/m<sup>3</sup>  
Phantom section: TCoil Section

DASY Configuration:

- Probe: AM1DV3 - 3049; ;
- Sensor-Surface: 0mm (Fix Surface)
- Electronics: DAE4 Sn466; Calibrated: 2020-04-22
- Phantom: HAC Test Arch with AMCC
- Measurement SW: DASY52, Version 52.10 (4);

**T-Coil scan (scan for ANSI C63.19-2007 & 2011 compliance)/General Scans/y (transversal) 4.2mm 50**

**x 50/ABM Signal(x,y,z) (13x13x1):** Measurement grid: dx=10mm, dy=10mm

Signal Type: Audio File (.wav) 48k\_voice\_1kHz\_1s.wav

Output Gain: 18.9

Measure Window Start: 300ms

Measure Window Length: 1000ms

BWC applied: 0.16 dB

Device Reference Point: 0, 0, -6.3 mm

**Cursor:**

ABM1 comp = -0.60 dBA/m

BWC Factor = 0.16 dB

Location: 4.2, -25, 3.7 mm

**Cursor:**

ABM2 = -47.01 dBA/m

Location: 4.2, -25, 3.7 mm

**Cursor:**

ABM1/ABM2 = 46.41 dB

ABM1 comp = -0.60 dBA/m

BWC Factor = 0.16 dB

Location: 4.2, -25, 3.7 mm

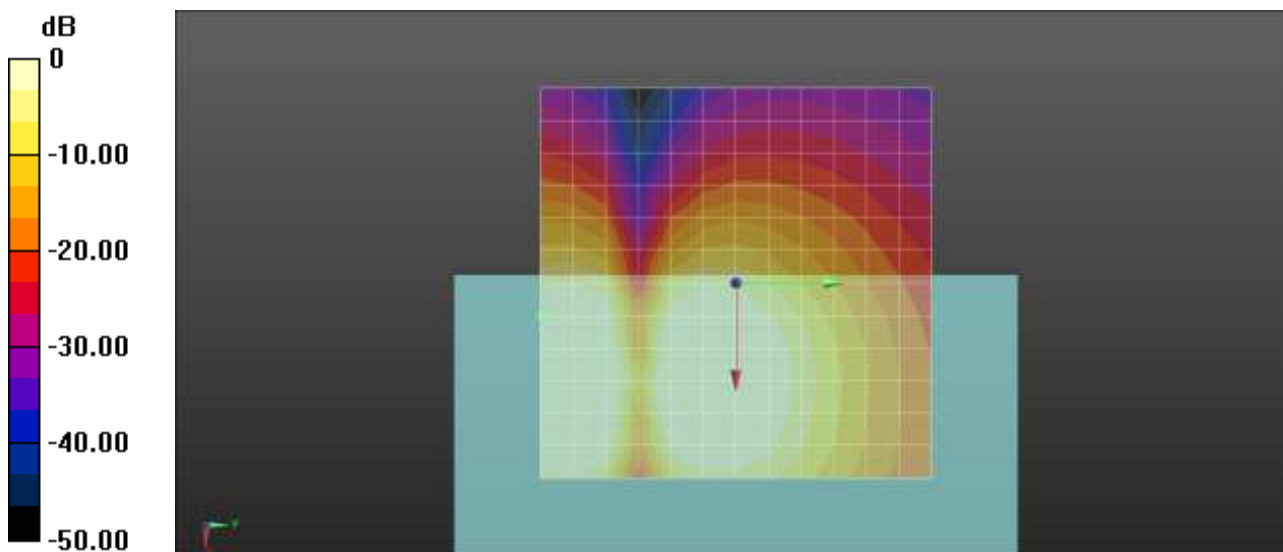

0 dB = 1.000 A/m = 0.00 dBA/m

**Plot No.121**

**LTE 66 64QAM 15MHz 1RB 74offset 132322ch Bit rate 75 z(axial)**

**DUT: SM-G991U; Type: Bar**

Communication System: UID 0, LTE Band66 (0); Frequency: 1745 MHz;Duty Cycle: 1:1  
Medium parameters used:  $\sigma = 0$  S/m,  $\epsilon_r = 1$ ;  $\rho = 0$  kg/m<sup>3</sup>  
Phantom section: TCoil Section

DASY Configuration:

- Probe: AM1DV3 - 3049; ;
- Sensor-Surface: 0mm (Fix Surface)
- Electronics: DAE4 Sn466; Calibrated: 2020-04-22
- Phantom: HAC Test Arch with AMCC
- Measurement SW: DASY52, Version 52.10 (4);

**T-Coil scan (scan for ANSI C63.19-2007 & 2011 compliance)/General Scans/z (axial) 4.2mm 50 x**

**50/ABM Signal(x,y,z) (13x13x1):** Measurement grid: dx=10mm, dy=10mm

Signal Type: Audio File (.wav) 48k\_voice\_1kHz\_1s.wav

Output Gain: 18.9

Measure Window Start: 300ms

Measure Window Length: 1000ms

BWC applied: 0.15 dB

Device Reference Point: 0, 0, -6.3 mm

**Cursor:**

ABM1 comp = 13.83 dBA/m

BWC Factor = 0.15 dB

Location: 12.5, -12.5, 3.7 mm

**Cursor:**

ABM2 = -31.35 dBA/m

Location: 12.5, -12.5, 3.7 mm

**Cursor:**

ABM1/ABM2 = 45.19 dB

ABM1 comp = 13.83 dBA/m

BWC Factor = 0.15 dB

Location: 12.5, -12.5, 3.7 mm

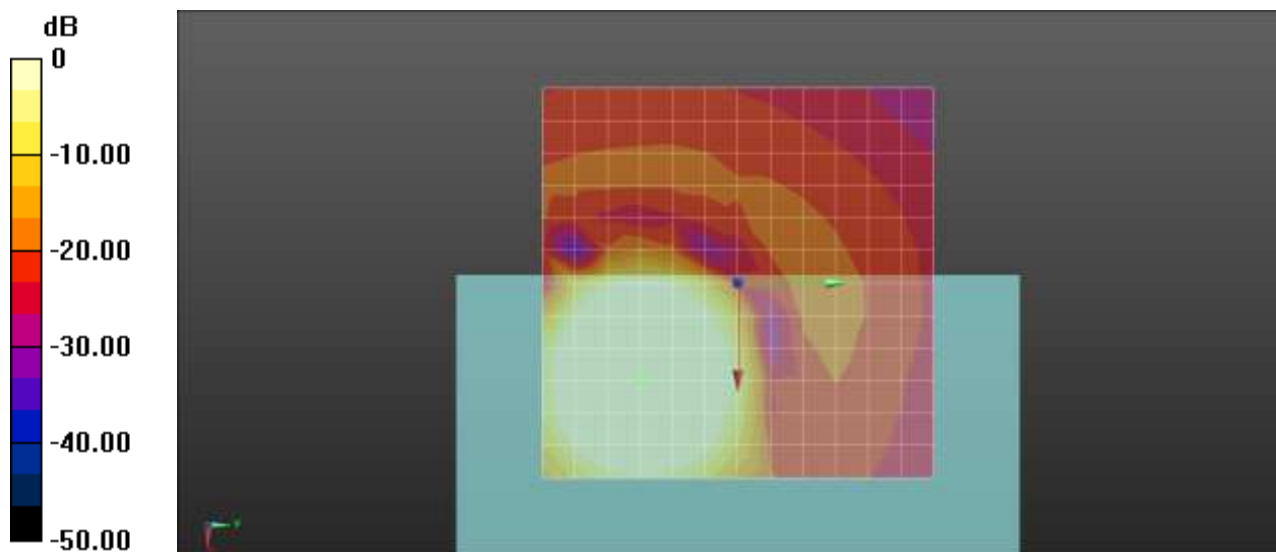

0 dB = 1.000 A/m = 0.00 dBA/m

**Plot No.122**  
**LTE 66 64QAM 15MHz 1RB 74offset 132322ch Bit rate 75 Freq.Response**

**DUT: SM-G991U; Type: Bar**

Communication System: UID 0, LTE Band66 (0); Frequency: 1745 MHz;Duty Cycle: 1:1  
 Medium parameters used:  $\sigma = 0$  S/m,  $\epsilon_r = 1$ ;  $\rho = 0$  kg/m<sup>3</sup>  
 Phantom section: TCoil Section

**T-Coil scan (scan for ANSI C63.19-2007 & 2011 compliance)/General Scans/z (axial) wideband at best S/N/ABM Freq Resp(x,y,z,f) (1x1x1):** Measurement grid: dx=10mm, dy=10mm  
 Signal Type: Audio File (.wav) 48k\_Normal\_51s new.wav  
 Output Gain: 57.55  
 Measure Window Start: 300ms  
 Measure Window Length: 51000ms  
 BWC applied: 9.47 dB  
 Device Reference Point: 0, 0, -6.3 mm

Category	Telephone parameters WD signal quality [(signal+noise)-to-noise ratio in decibels]
Category T1	0 dB to 10 dB
Category T2	10 dB to 20 dB
Category T3	20 dB to 30 dB
Category T4	> 30 dB

**Cursor:**  
 Diff = 2.00 dB  
 BWC Factor = 9.47 dB  
 Location: 11.9, -10.9, 3.7 mm

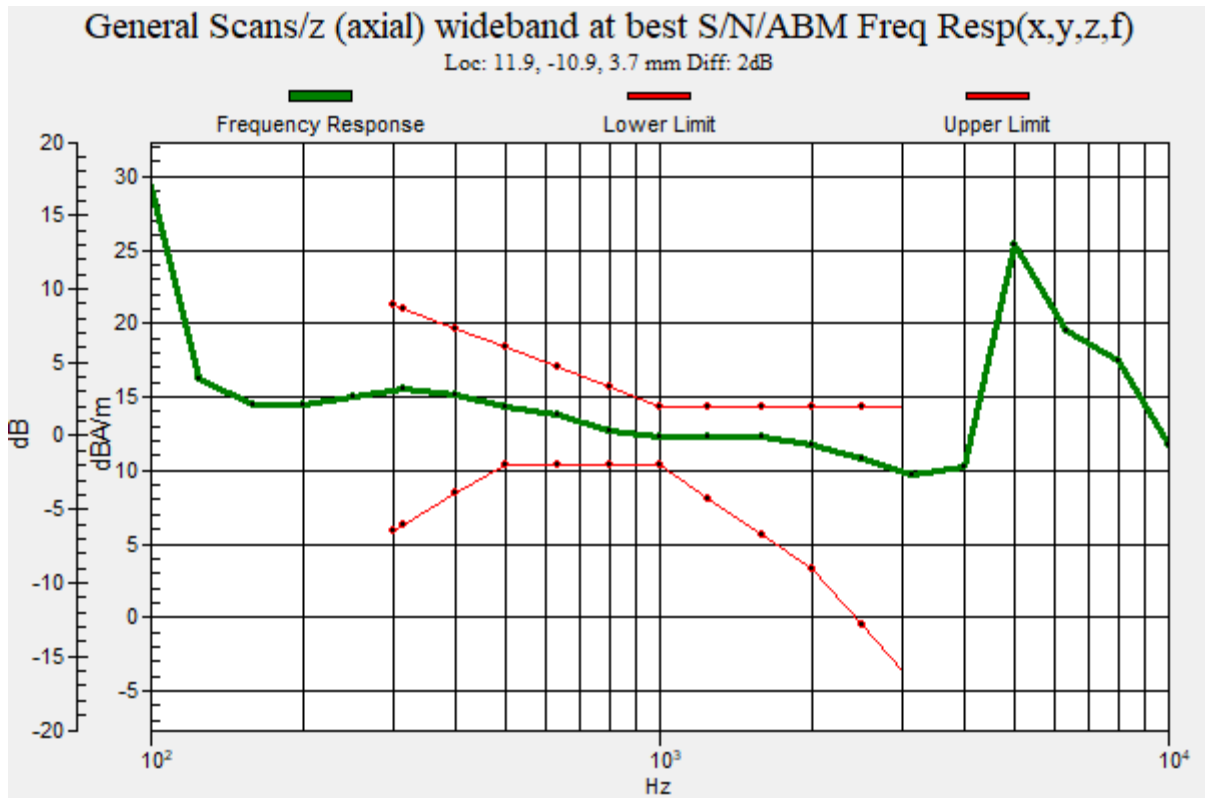

**Plot No.123**

**LTE 66 64QAM 15MHz 1RB 74offset 132322ch Bit rate 75 y(transversal)**

**DUT: SM-G991U; Type: Bar**

Communication System: UID 0, LTE Band66 (0); Frequency: 1745 MHz;Duty Cycle: 1:1  
Medium parameters used:  $\sigma = 0$  S/m,  $\epsilon_r = 1$ ;  $\rho = 0$  kg/m<sup>3</sup>  
Phantom section: TCoil Section

DASY Configuration:

- Probe: AM1DV3 - 3049; ;
- Sensor-Surface: 0mm (Fix Surface)
- Electronics: DAE4 Sn466; Calibrated: 2020-04-22
- Phantom: HAC Test Arch with AMCC
- Measurement SW: DASY52, Version 52.10 (4);

**T-Coil scan (scan for ANSI C63.19-2007 & 2011 compliance)/General Scans/y (transversal) 4.2mm 50**

**x 50/ABM Signal(x,y,z) (13x13x1):** Measurement grid: dx=10mm, dy=10mm

Signal Type: Audio File (.wav) 48k\_voice\_1kHz\_1s.wav

Output Gain: 18.9

Measure Window Start: 300ms

Measure Window Length: 1000ms

BWC applied: 0.15 dB

Device Reference Point: 0, 0, -6.3 mm

**Cursor:**

ABM1 comp = -0.85 dBA/m

BWC Factor = 0.15 dB

Location: 4.2, -25, 3.7 mm

**Cursor:**

ABM2 = -46.58 dBA/m

Location: 4.2, -25, 3.7 mm

**Cursor:**

ABM1/ABM2 = 45.73 dB

ABM1 comp = -0.85 dBA/m

BWC Factor = 0.15 dB

Location: 4.2, -25, 3.7 mm

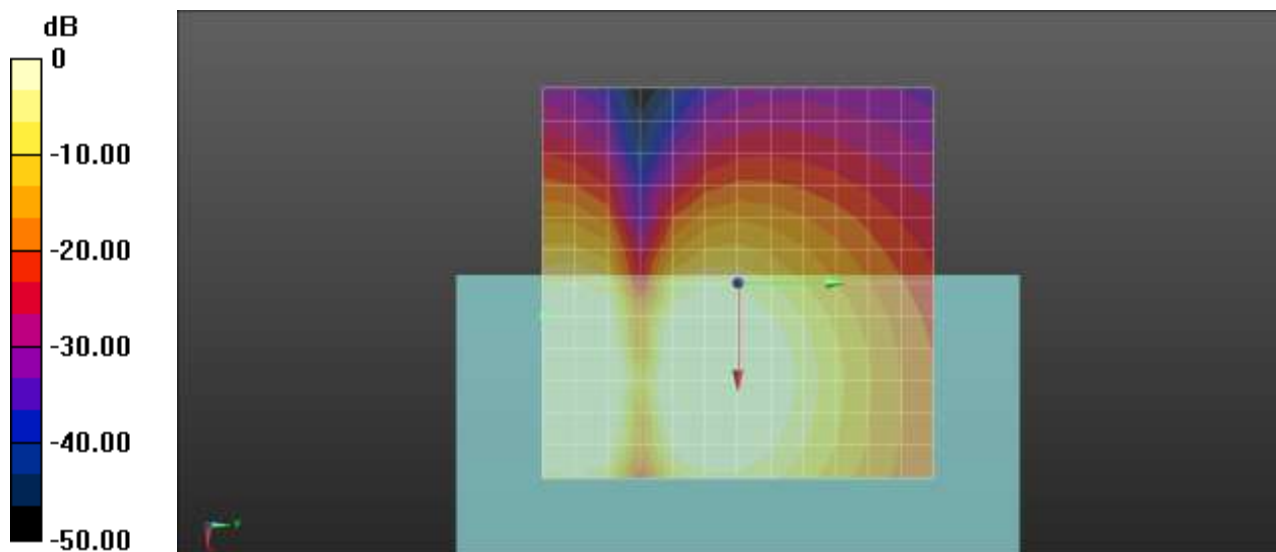

0 dB = 1.000 A/m = 0.00 dBA/m



**Plot No.124**

**LTE 71 64QAM 15MHz 1RB 74offset 133322ch Bit rate 75 z(axial)**

**DUT: SM-G991U; Type: Bar**

Communication System: UID 0, LTE Band 71 (0); Frequency: 683 MHz;Duty Cycle: 1:1  
Medium parameters used:  $\sigma = 0$  S/m,  $\epsilon_r = 1$ ;  $\rho = 0$  kg/m<sup>3</sup>  
Phantom section: TCoil Section

DASY Configuration:

- Probe: AM1DV3 - 3049; ;
- Sensor-Surface: 0mm (Fix Surface)
- Electronics: DAE4 Sn466; Calibrated: 2020-04-22
- Phantom: HAC Test Arch with AMCC
- Measurement SW: DASY52, Version 52.10 (4);

**T-Coil scan (scan for ANSI C63.19-2007 & 2011 compliance)/General Scans/z (axial) 4.2mm 50 x**

**50/ABM Signal(x,y,z) (13x13x1):** Measurement grid: dx=10mm, dy=10mm

Signal Type: Audio File (.wav) 48k\_voice\_1kHz\_1s.wav

Output Gain: 18.9

Measure Window Start: 300ms

Measure Window Length: 1000ms

BWC applied: 0.16 dB

Device Reference Point: 0, 0, -6.3 mm

**Cursor:**

ABM1 comp = 12.79 dBA/m

BWC Factor = 0.16 dB

Location: 8.3, -12.5, 3.7 mm

**Cursor:**

ABM2 = -34.86 dBA/m

Location: 8.3, -12.5, 3.7 mm

**Cursor:**

ABM1/ABM2 = 47.65 dB

ABM1 comp = 12.79 dBA/m

BWC Factor = 0.16 dB

Location: 8.3, -12.5, 3.7 mm

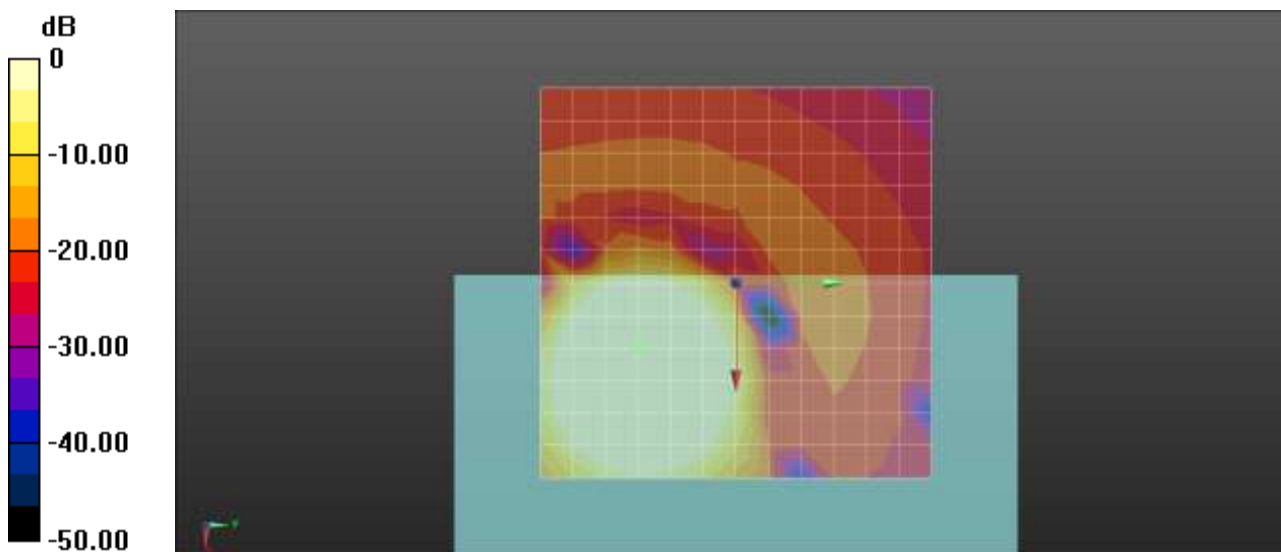

0 dB = 1.000 A/m = 0.00 dBA/m

**Plot No.125**

**LTE 71 64QAM 15MHz 1RB 74offset 133322ch Bit rate 75 Freq.Response**

**DUT: SM-G991U; Type: Bar**

Communication System: UID 0, LTE Band 71 (0); Frequency: 683 MHz;Duty Cycle: 1:1  
Medium parameters used:  $\sigma = 0$  S/m,  $\epsilon_r = 1$ ;  $\rho = 0$  kg/m<sup>3</sup>  
Phantom section: TCoil Section

**T-Coil scan (scan for ANSI C63.19-2007 & 2011 compliance)/General Scans/z (axial) wideband at best**

**S/N/ABM Freq Resp(x,y,z,f) (1x1x1):** Measurement grid: dx=10mm, dy=10mm

Signal Type: Audio File (.wav) 48k\_Normal\_51s new.wav

Output Gain: 57.55

Measure Window Start: 300ms

Measure Window Length: 51000ms

BWC applied: 9.48 dB

Device Reference Point: 0, 0, -6.3 mm

Category	Telephone parameters WD signal quality [(signal+noise)-to-noise ratio in decibels]
Category T1	0 dB to 10 dB
Category T2	10 dB to 20 dB
Category T3	20 dB to 30 dB
Category T4	> 30 dB

**Cursor:**

Diff = 2.00 dB

BWC Factor = 9.48 dB

Location: 11, -10, 3.7 mm

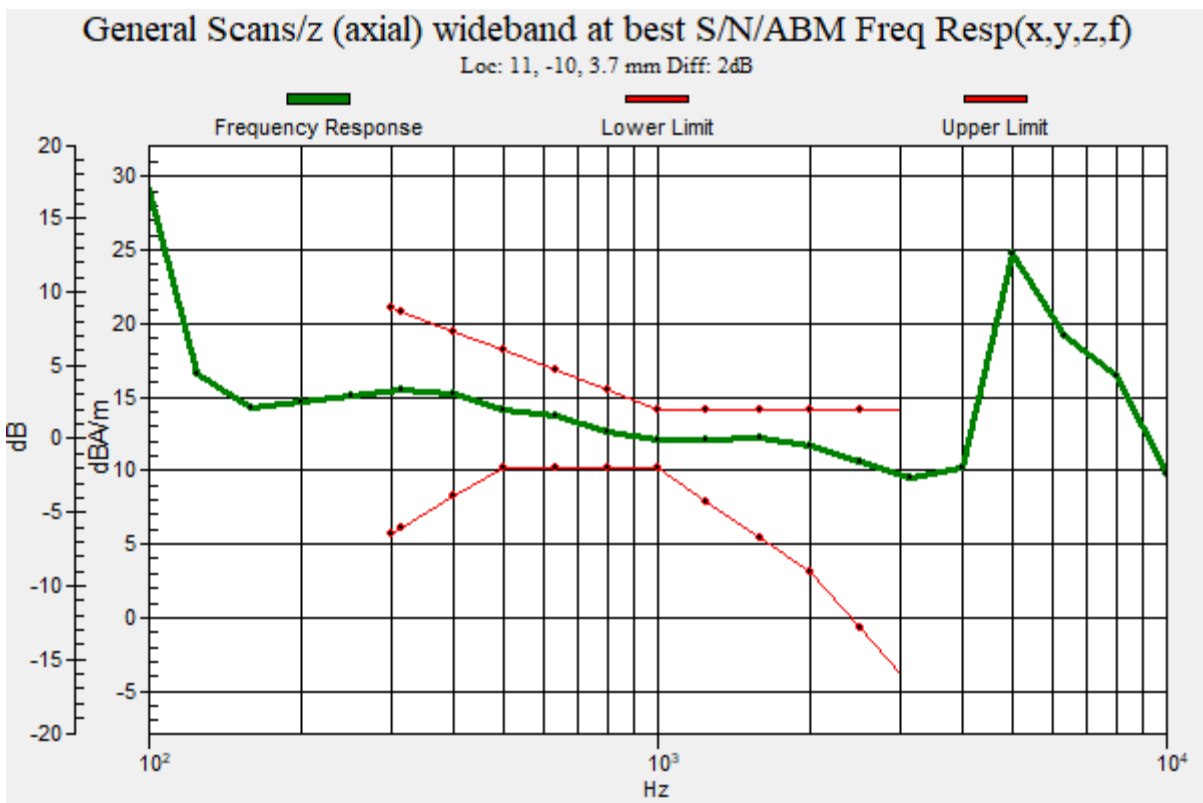

**Plot No.126**

**LTE 71 64QAM 15MHz 1RB 74offset 133322ch Bit rate 75 y(transversal)**

**DUT: SM-G991U; Type: Bar**

Communication System: UID 0, LTE Band 71 (0); Frequency: 683 MHz;Duty Cycle: 1:1  
Medium parameters used:  $\sigma = 0$  S/m,  $\epsilon_r = 1$ ;  $\rho = 0$  kg/m<sup>3</sup>  
Phantom section: TCoil Section

DASY Configuration:

- Probe: AM1DV3 - 3049; ;
- Sensor-Surface: 0mm (Fix Surface)
- Electronics: DAE4 Sn466; Calibrated: 2020-04-22
- Phantom: HAC Test Arch with AMCC
- Measurement SW: DASY52, Version 52.10 (4);

**T-Coil scan (scan for ANSI C63.19-2007 & 2011 compliance)/General Scans/y (transversal) 4.2mm 50**

**x 50/ABM Signal(x,y,z) (13x13x1):** Measurement grid: dx=10mm, dy=10mm

Signal Type: Audio File (.wav) 48k\_voice\_1kHz\_1s.wav

Output Gain: 18.9

Measure Window Start: 300ms

Measure Window Length: 1000ms

BWC applied: 0.16 dB

Device Reference Point: 0, 0, -6.3 mm

**Cursor:**

ABM1 comp = 4.27 dBA/m

BWC Factor = 0.16 dB

Location: 8.3, -16.7, 3.7 mm

**Cursor:**

ABM2 = -43.13 dBA/m

Location: 8.3, -16.7, 3.7 mm

**Cursor:**

ABM1/ABM2 = 47.41 dB

ABM1 comp = 4.27 dBA/m

BWC Factor = 0.16 dB

Location: 8.3, -16.7, 3.7 mm

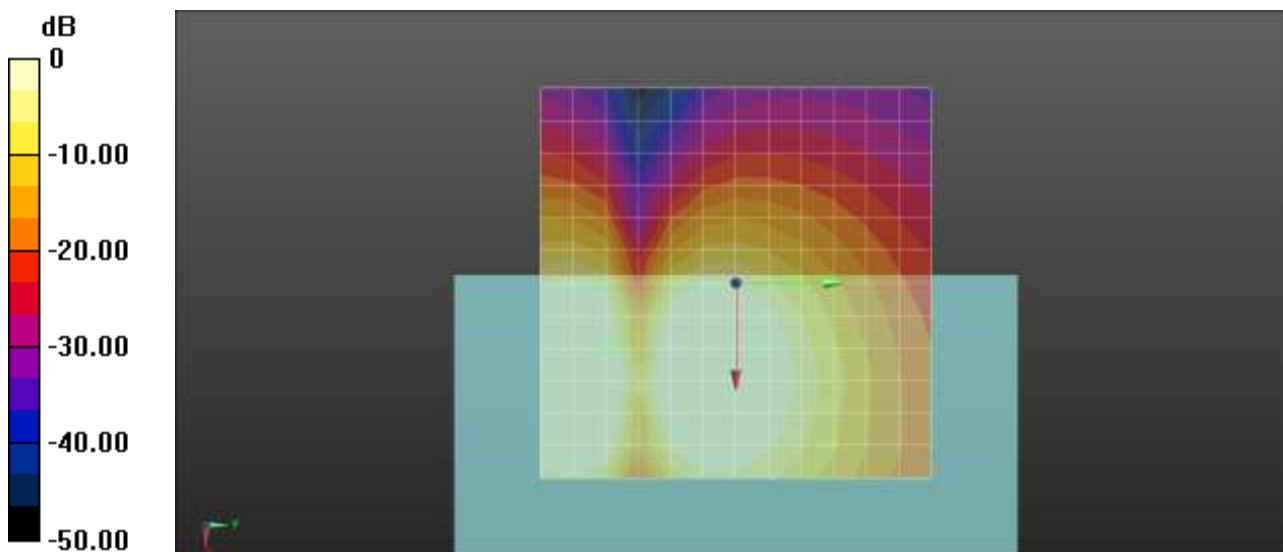

0 dB = 1.000 A/m = 0.00 dBA/m

**Plot No.127**

**LTE 38 QPSK 20MHz 50RB 49offset 38000ch 6 6 Bit rate 75 z(axial)**

**DUT: SM-G991U; Type: Bar**

Communication System: UID 0, LTE38 (0); Frequency: 2595 MHz;Duty Cycle: 1:1.95209

Medium parameters used:  $\sigma = 0$  S/m,  $\epsilon_r = 1$ ;  $\rho = 0$  kg/m<sup>3</sup>

Phantom section: TCoil Section

DASY Configuration:

- Probe: AM1DV3 - 3049; ;
- Sensor-Surface: 0mm (Fix Surface)
- Electronics: DAE4 Sn466; Calibrated: 2020-04-22
- Phantom: HAC Test Arch with AMCC
- Measurement SW: DASY52, Version 52.10 (4);

**T-Coil scan (scan for ANSI C63.19-2007 & 2011 compliance)/General Scans/z (axial) 4.2mm 50 x**

**50/ABM Signal(x,y,z) (13x13x1):** Measurement grid: dx=10mm, dy=10mm

Signal Type: Audio File (.wav) 48k\_voice\_1kHz\_1s.wav

Output Gain: 18.9

Measure Window Start: 300ms

Measure Window Length: 1000ms

BWC applied: 0.15 dB

Device Reference Point: 0, 0, -6.3 mm

**Cursor:**

ABM1 comp = 14.03 dBA/m

BWC Factor = 0.15 dB

Location: 12.5, -12.5, 3.7 mm

**Cursor:**

ABM2 = -31.77 dBA/m

Location: 12.5, -12.5, 3.7 mm

**Cursor:**

ABM1/ABM2 = 45.80 dB

ABM1 comp = 14.03 dBA/m

BWC Factor = 0.15 dB

Location: 12.5, -12.5, 3.7 mm

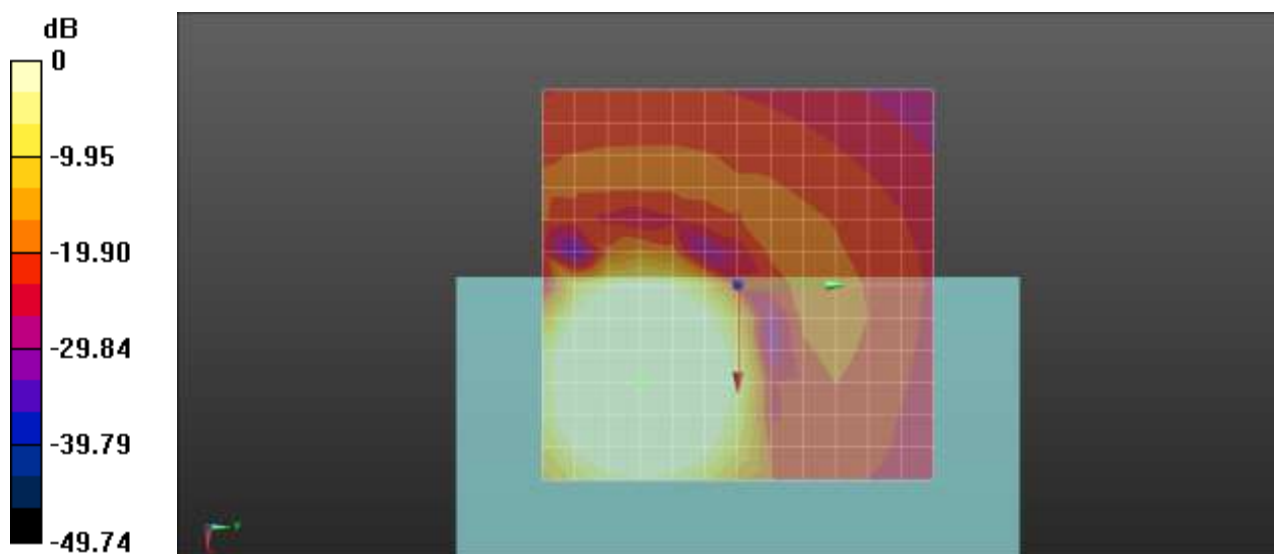

0 dB = 1.000 A/m = 0.00 dBA/m

**Plot No.128**  
**LTE 38 QPSK 20MHz 50RB 49offset 38000ch 6 6 Bit rate 75Freq.Response**

**DUT: SM-G991U; Type: Bar**

Communication System: UID 0, LTE38 (0); Frequency: 2595 MHz;Duty Cycle: 1:1.95209  
Medium parameters used:  $\sigma = 0$  S/m,  $\epsilon_r = 1$ ;  $\rho = 0$  kg/m<sup>3</sup>  
Phantom section: TCoil Section

**T-Coil scan (scan for ANSI C63.19-2007 & 2011 compliance)/General Scans/z (axial) wideband at best S/N/ABM Freq Resp(x,y,z,f) (1x1x1):** Measurement grid: dx=10mm, dy=10mm  
Signal Type: Audio File (.wav) 48k\_Normal\_51s new.wav  
Output Gain: 57.55  
Measure Window Start: 300ms  
Measure Window Length: 51000ms  
BWC applied: 9.48 dB  
Device Reference Point: 0, 0, -6.3 mm

Category	Telephone parameters WD signal quality [(signal+noise)-to-noise ratio in decibels]
Category T1	0 dB to 10 dB
Category T2	10 dB to 20 dB
Category T3	20 dB to 30 dB
Category T4	> 30 dB

**Cursor:**  
Diff = 2.00 dB  
BWC Factor = 9.48 dB  
Location: 12.1, -11, 3.7 mm

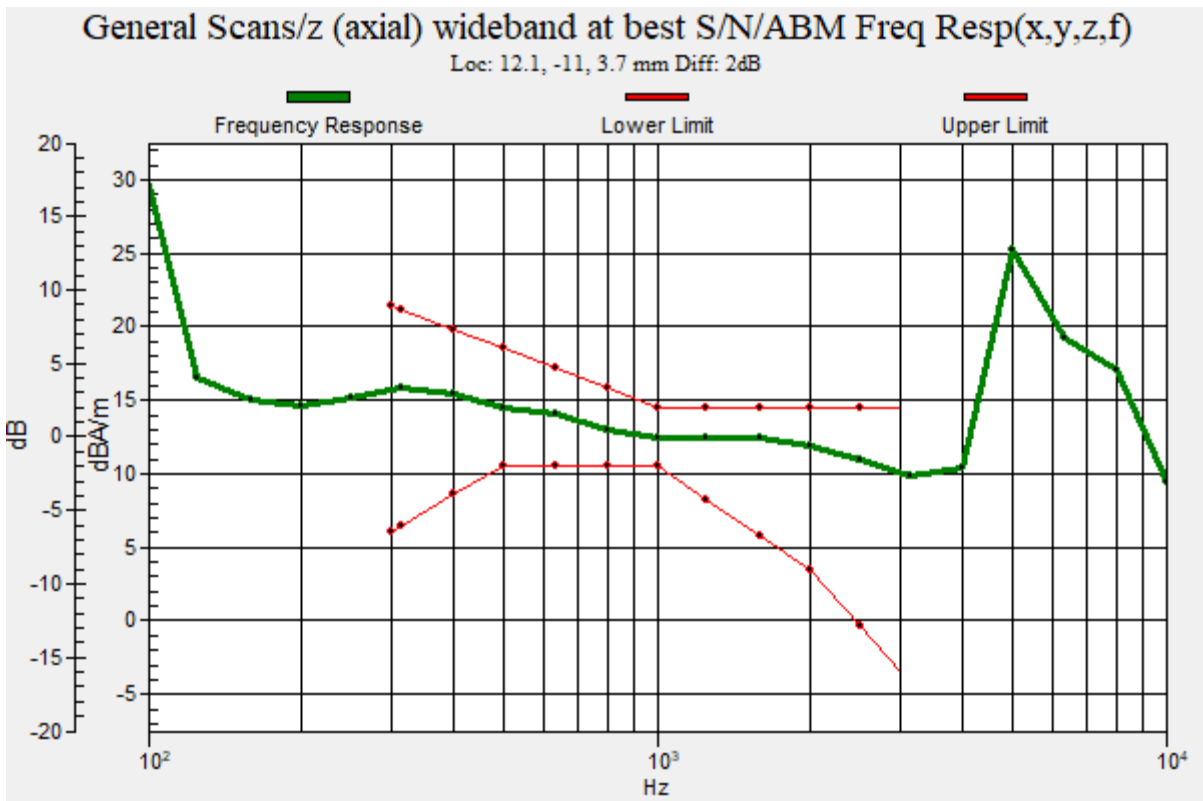

**Plot No.129**

**LTE 38 QPSK 20MHz 50RB 49offset 38000ch 6 6 Bit rate 75 y(transversal)**

**DUT: SM-G991U; Type: Bar**

Communication System: UID 0, LTE38 (0); Frequency: 2595 MHz;Duty Cycle: 1:1.95209

Medium parameters used:  $\sigma = 0$  S/m,  $\epsilon_r = 1$ ;  $\rho = 0$  kg/m<sup>3</sup>

Phantom section: TCoil Section

DASY Configuration:

- Probe: AM1DV3 - 3049; ;
- Sensor-Surface: 0mm (Fix Surface)
- Electronics: DAE4 Sn466; Calibrated: 2020-04-22
- Phantom: HAC Test Arch with AMCC
- Measurement SW: DASY52, Version 52.10 (4);

**T-Coil scan (scan for ANSI C63.19-2007 & 2011 compliance)/General Scans/y (transversal) 4.2mm 50**

**x 50/ABM Signal(x,y,z) (13x13x1):** Measurement grid: dx=10mm, dy=10mm

Signal Type: Audio File (.wav) 48k\_voice\_1kHz\_1s.wav

Output Gain: 18.9

Measure Window Start: 300ms

Measure Window Length: 1000ms

BWC applied: 0.15 dB

Device Reference Point: 0, 0, -6.3 mm

**Cursor:**

ABM1 comp = 2.05 dBA/m

BWC Factor = 0.15 dB

Location: 8.3, -25, 3.7 mm

**Cursor:**

ABM2 = -42.89 dBA/m

Location: 8.3, -25, 3.7 mm

**Cursor:**

ABM1/ABM2 = 44.94 dB

ABM1 comp = 2.05 dBA/m

BWC Factor = 0.15 dB

Location: 8.3, -25, 3.7 mm

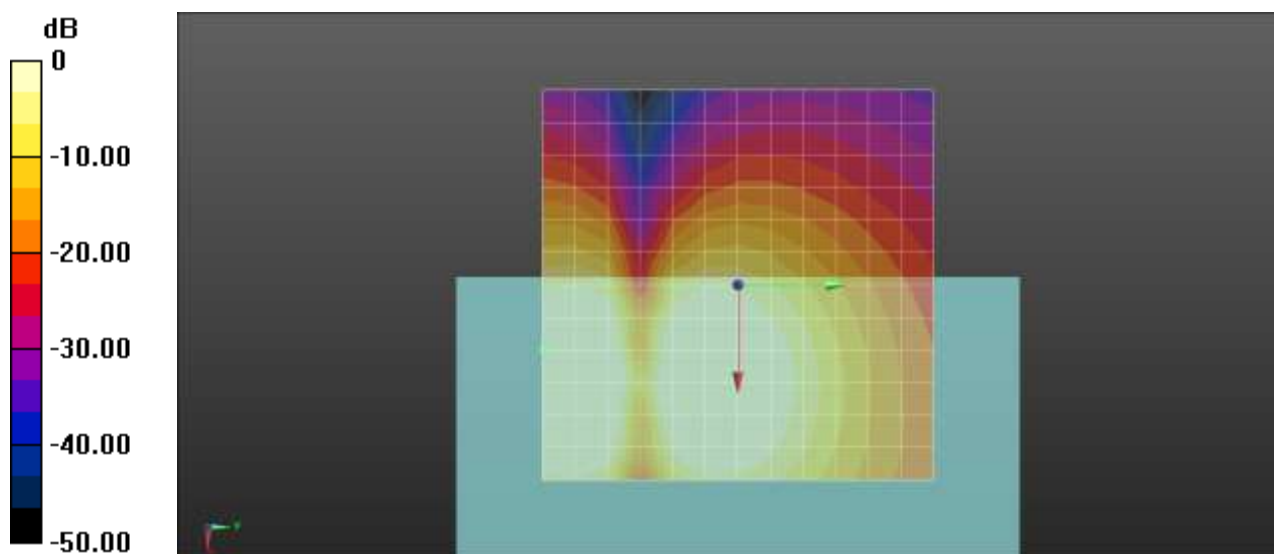

0 dB = 1.000 A/m = 0.00 dBA/m

**Plot No.130**

**LTE 40 QPSK 10MHz 25RB 24offset 38750ch 6 6 Bit rate 75 Lower Band z(axial)**

**DUT: SM-G991U; Type: Bar**

Communication System: UID 0, LTE Band40 (0); Frequency: 2310 MHz;Duty Cycle: 1:1.95209  
Medium parameters used:  $\sigma = 0$  S/m,  $\epsilon_r = 1$ ;  $\rho = 0$  kg/m<sup>3</sup>  
Phantom section: TCoil Section

DASY Configuration:

- Probe: AM1DV3 - 3049; ;
- Sensor-Surface: 0mm (Fix Surface)
- Electronics: DAE4 Sn466; Calibrated: 2020-04-22
- Phantom: HAC Test Arch with AMCC
- Measurement SW: DASY52, Version 52.10 (4);

**T-Coil scan (scan for ANSI C63.19-2007 & 2011 compliance)/General Scans/z (axial) 4.2mm 50 x**

**50/ABM Signal(x,y,z) (13x13x1):** Measurement grid: dx=10mm, dy=10mm

Signal Type: Audio File (.wav) 48k\_voice\_1kHz\_1s.wav

Output Gain: 18.9

Measure Window Start: 300ms

Measure Window Length: 1000ms

BWC applied: 0.15 dB

Device Reference Point: 0, 0, -6.3 mm

**Cursor:**

ABM1 comp = 13.77 dBA/m

BWC Factor = 0.15 dB

Location: 12.5, -12.5, 3.7 mm

**Cursor:**

ABM2 = -31.75 dBA/m

Location: 12.5, -12.5, 3.7 mm

**Cursor:**

ABM1/ABM2 = 45.52 dB

ABM1 comp = 13.77 dBA/m

BWC Factor = 0.15 dB

Location: 12.5, -12.5, 3.7 mm

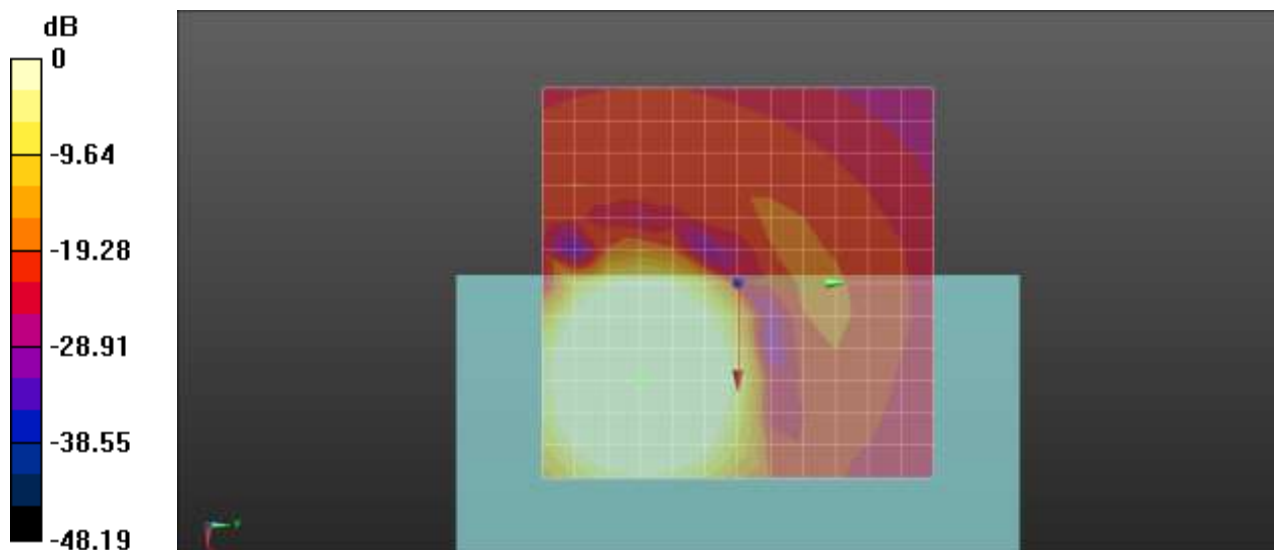

0 dB = 1.000 A/m = 0.00 dBA/m

**Plot No.131**

**LTE 40 QPSK 10MHz 25RB 24offset 38750ch 6 6 Bit rate 75 Lower Band Freq.Response**

**DUT: SM-G991U; Type: Bar**

Communication System: UID 0, LTE Band40 (0); Frequency: 2310 MHz;Duty Cycle: 1:1.95209  
 Medium parameters used:  $\sigma = 0$  S/m,  $\epsilon_r = 1$ ;  $\rho = 0$  kg/m<sup>3</sup>  
 Phantom section: TCoil Section

**T-Coil scan (scan for ANSI C63.19-2007 & 2011 compliance)/General Scans/z (axial) wideband at best**

**S/N/ABM Freq Resp(x,y,z,f) (1x1x1):** Measurement grid: dx=10mm, dy=10mm

Signal Type: Audio File (.wav) 48k\_Normal\_51s new.wav

Output Gain: 57.55

Measure Window Start: 300ms

Measure Window Length: 51000ms

BWC applied: 9.48 dB

Device Reference Point: 0, 0, -6.3 mm

Category	Telephone parameters WD signal quality [(signal+noise)-to-noise ratio in decibels]
Category T1	0 dB to 10 dB
Category T2	10 dB to 20 dB
Category T3	20 dB to 30 dB
Category T4	> 30 dB

**Cursor:**

Diff = 2.00 dB

BWC Factor = 9.48 dB

Location: 11.9, -10.5, 3.7 mm

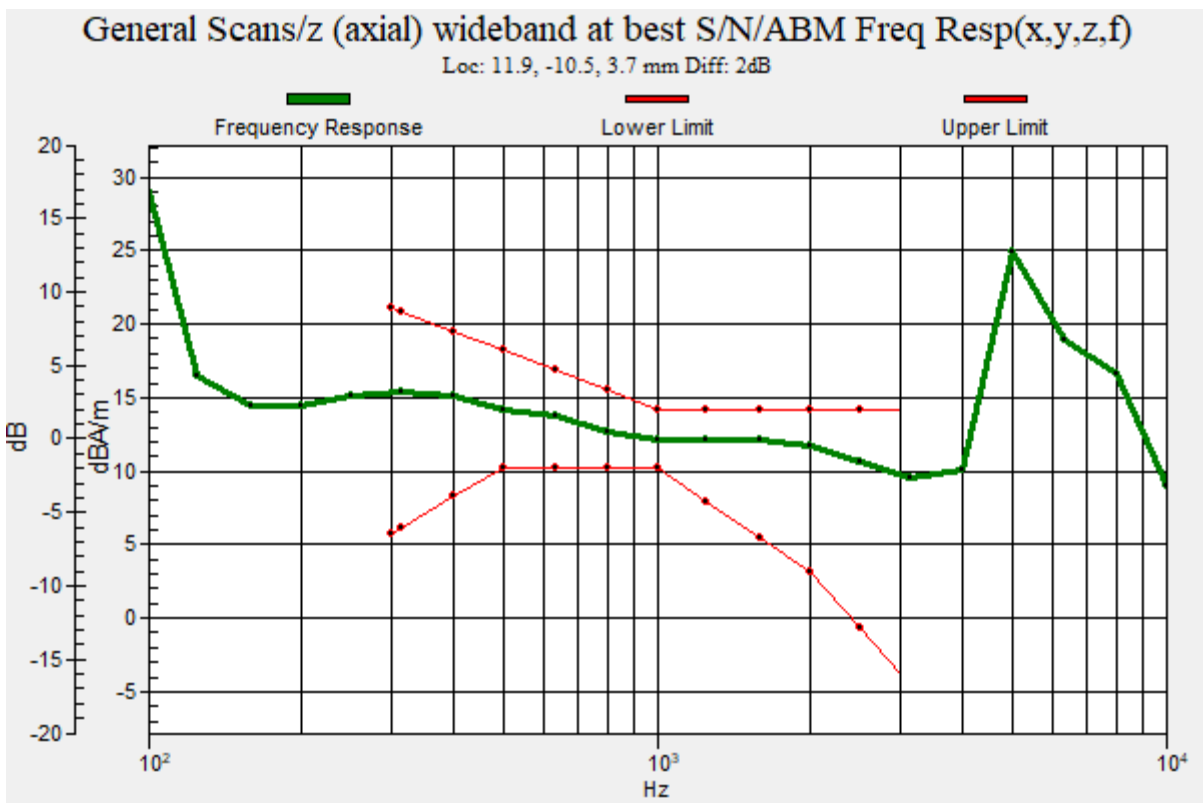



**Plot No.132**

**LTE 40 QPSK 10MHz 25RB 24offset 38750ch 6 6 Bit rate 75 Lower Band y(transversal)**

**DUT: SM-G991U; Type: Bar**

Communication System: UID 0, LTE Band40 (0); Frequency: 2310 MHz;Duty Cycle: 1:1.95209  
Medium parameters used:  $\sigma = 0$  S/m,  $\epsilon_r = 1$ ;  $\rho = 0$  kg/m<sup>3</sup>  
Phantom section: TCoil Section

DASY Configuration:

- Probe: AM1DV3 - 3049; ;
- Sensor-Surface: 0mm (Fix Surface)
- Electronics: DAE4 Sn466; Calibrated: 2020-04-22
- Phantom: HAC Test Arch with AMCC
- Measurement SW: DASY52, Version 52.10 (4);

**T-Coil scan (scan for ANSI C63.19-2007 & 2011 compliance)/General Scans/y (transversal) 4.2mm 50**

**x 50/ABM Signal(x,y,z) (13x13x1):** Measurement grid: dx=10mm, dy=10mm

Signal Type: Audio File (.wav) 48k\_voice\_1kHz\_1s.wav

Output Gain: 18.9

Measure Window Start: 300ms

Measure Window Length: 1000ms

BWC applied: 0.15 dB

Device Reference Point: 0, 0, -6.3 mm

**Cursor:**

ABM1 comp = 1.94 dBA/m

BWC Factor = 0.15 dB

Location: 8.3, -25, 3.7 mm

**Cursor:**

ABM2 = -43.05 dBA/m

Location: 8.3, -25, 3.7 mm

**Cursor:**

ABM1/ABM2 = 44.99 dB

ABM1 comp = 1.94 dBA/m

BWC Factor = 0.15 dB

Location: 8.3, -25, 3.7 mm

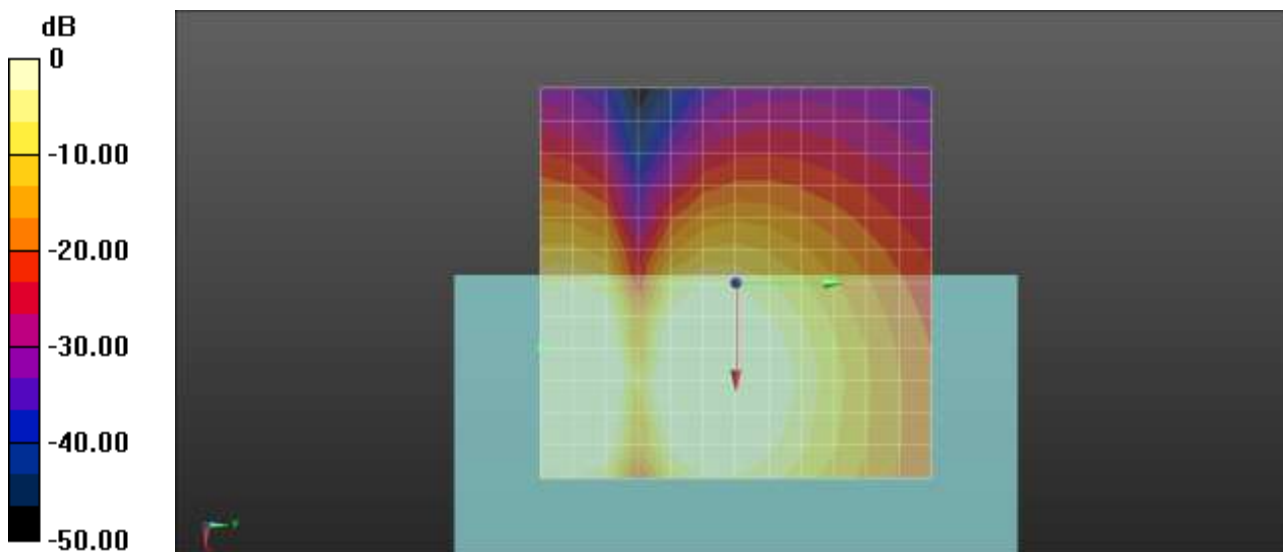

0 dB = 1.000 A/m = 0.00 dBA/m

**Plot No.133**

**LTE 40 QPSK 10MHz 25RB 24offset 39200ch 6 6 Bit rate 75 Upper Band z(axial)**

**DUT: SM-G991U; Type: Bar**

Communication System: UID 0, LTE Band40 (0); Frequency: 2355 MHz;Duty Cycle: 1:1.95209  
Medium parameters used:  $\sigma = 0$  S/m,  $\epsilon_r = 1$ ;  $\rho = 0$  kg/m<sup>3</sup>  
Phantom section: TCoil Section

DASY Configuration:

- Probe: AM1DV3 - 3049; ;
- Sensor-Surface: 0mm (Fix Surface)
- Electronics: DAE4 Sn466; Calibrated: 2020-04-22
- Phantom: HAC Test Arch with AMCC
- Measurement SW: DASY52, Version 52.10 (4);

**T-Coil scan (scan for ANSI C63.19-2007 & 2011 compliance)/General Scans/z (axial) 4.2mm 50 x**

**50/ABM Signal(x,y,z) (13x13x1):** Measurement grid: dx=10mm, dy=10mm

Signal Type: Audio File (.wav) 48k\_voice\_1kHz\_1s.wav

Output Gain: 18.9

Measure Window Start: 300ms

Measure Window Length: 1000ms

BWC applied: 0.15 dB

Device Reference Point: 0, 0, -6.3 mm

**Cursor:**

ABM1 comp = 14.00 dBA/m

BWC Factor = 0.15 dB

Location: 12.5, -12.5, 3.7 mm

**Cursor:**

ABM2 = -32.08 dBA/m

Location: 12.5, -12.5, 3.7 mm

**Cursor:**

ABM1/ABM2 = 46.08 dB

ABM1 comp = 14.00 dBA/m

BWC Factor = 0.15 dB

Location: 12.5, -12.5, 3.7 mm

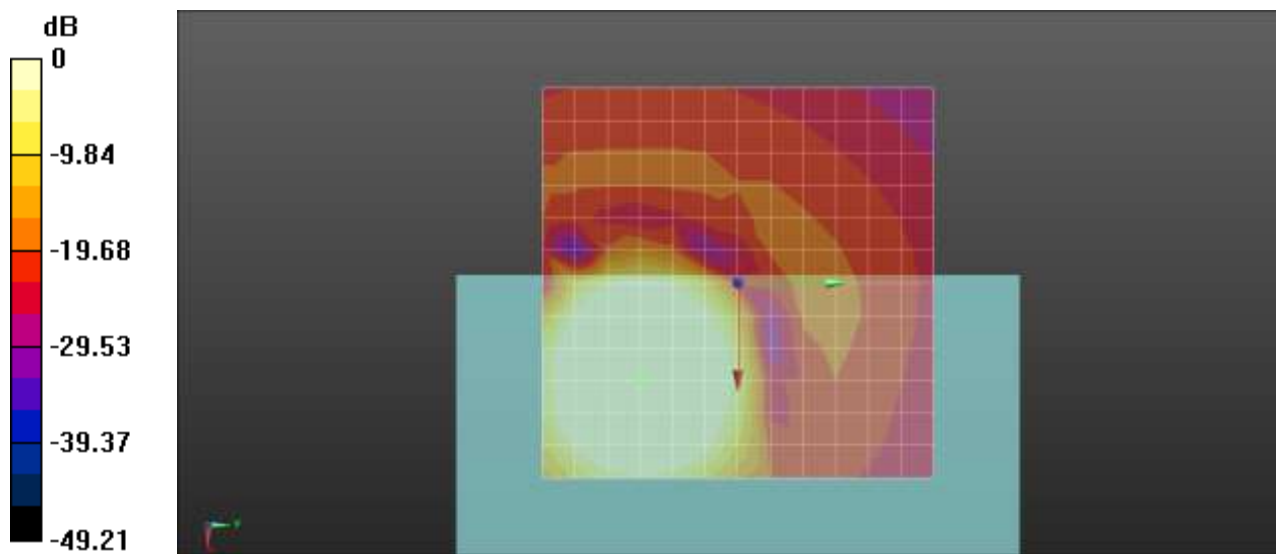

0 dB = 1.000 A/m = 0.00 dBA/m

**Plot No.134**

**LTE 40 QPSK 10MHz 25RB 24offset 39200ch 6 6 Bit rate 75 Upper Band Freq.Response**

**DUT: SM-G991U; Type: Bar**

Communication System: UID 0, LTE Band40 (0); Frequency: 2355 MHz;Duty Cycle: 1:1.95209  
Medium parameters used:  $\sigma = 0$  S/m,  $\epsilon_r = 1$ ;  $\rho = 0$  kg/m<sup>3</sup>  
Phantom section: TCoil Section

**T-Coil scan (scan for ANSI C63.19-2007 & 2011 compliance)/General Scans/z (axial) wideband at best**

**S/N/ABM Freq Resp(x,y,z,f) (1x1x1):** Measurement grid: dx=10mm, dy=10mm

Signal Type: Audio File (.wav) 48k\_Normal\_51s new.wav

Output Gain: 57.55

Measure Window Start: 300ms

Measure Window Length: 51000ms

BWC applied: 9.47 dB

Device Reference Point: 0, 0, -6.3 mm

Category	Telephone parameters WD signal quality [(signal+noise)-to-noise ratio in decibels]
Category T1	0 dB to 10 dB
Category T2	10 dB to 20 dB
Category T3	20 dB to 30 dB
Category T4	> 30 dB

**Cursor:**

Diff = 2.00 dB

BWC Factor = 9.47 dB

Location: 11.5, -10.7, 3.7 mm

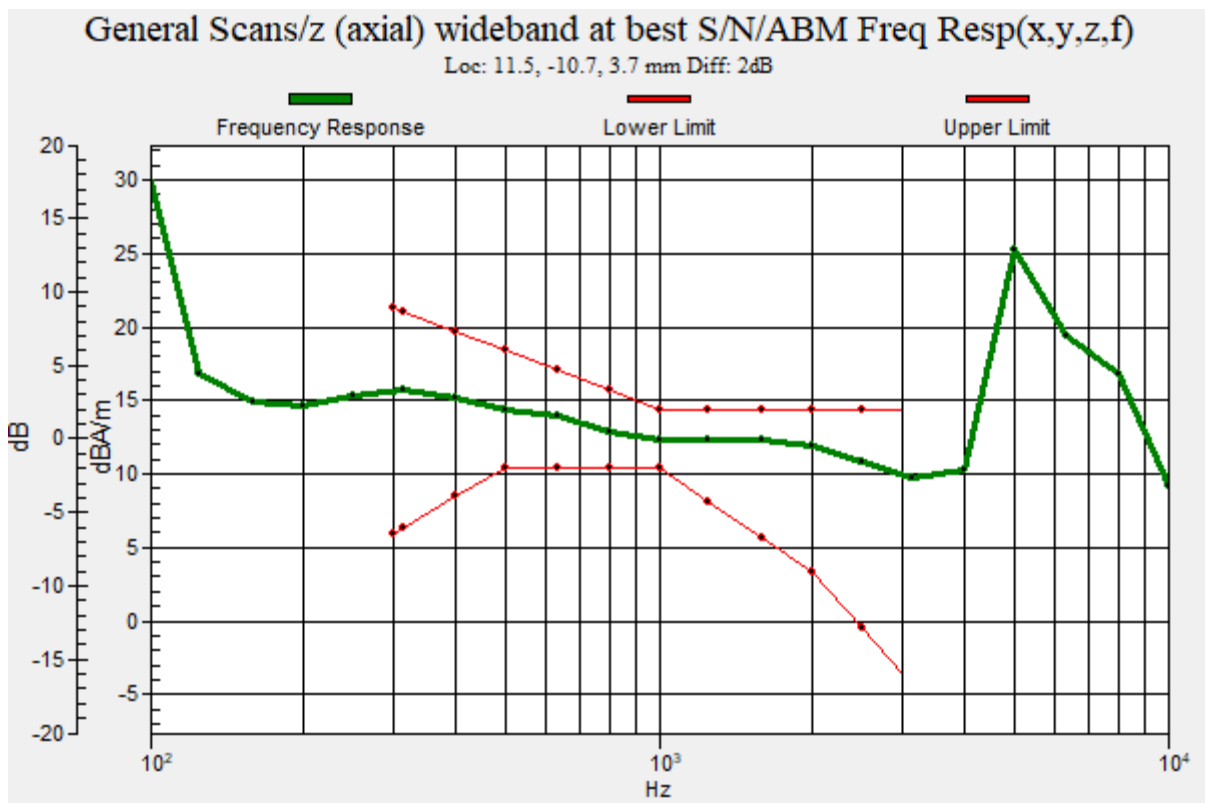

**Plot No.135**

**LTE 40 QPSK 10MHz 25RB 24offset 39200ch 6 6 Bit rate 75 Upper Band y(transversal)**

**DUT: SM-G991U; Type: Bar**

Communication System: UID 0, LTE Band40 (0); Frequency: 2355 MHz;Duty Cycle: 1:1.95209  
Medium parameters used:  $\sigma = 0$  S/m,  $\epsilon_r = 1$ ;  $\rho = 0$  kg/m<sup>3</sup>  
Phantom section: TCoil Section

DASY Configuration:

- Probe: AM1DV3 - 3049; ;
- Sensor-Surface: 0mm (Fix Surface)
- Electronics: DAE4 Sn466; Calibrated: 2020-04-22
- Phantom: HAC Test Arch with AMCC
- Measurement SW: DASY52, Version 52.10 (4);

**T-Coil scan (scan for ANSI C63.19-2007 & 2011 compliance)/General Scans/y (transversal) 4.2mm 50**

**x 50/ABM Signal(x,y,z) (13x13x1):** Measurement grid: dx=10mm, dy=10mm

Signal Type: Audio File (.wav) 48k\_voice\_1kHz\_1s.wav

Output Gain: 18.9

Measure Window Start: 300ms

Measure Window Length: 1000ms

BWC applied: 0.15 dB

Device Reference Point: 0, 0, -6.3 mm

**Cursor:**

ABM1 comp = 2.08 dBA/m

BWC Factor = 0.15 dB

Location: 8.3, -25, 3.7 mm

**Cursor:**

ABM2 = -43.73 dBA/m

Location: 8.3, -25, 3.7 mm

**Cursor:**

ABM1/ABM2 = 45.81 dB

ABM1 comp = 2.08 dBA/m

BWC Factor = 0.15 dB

Location: 8.3, -25, 3.7 mm

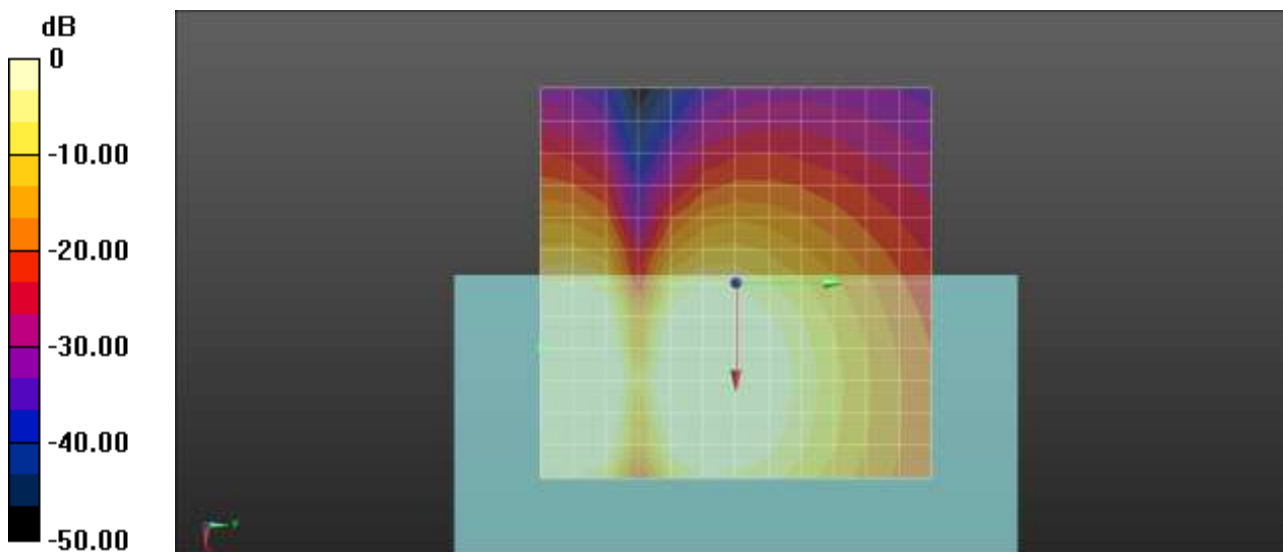

0 dB = 1.000 A/m = 0.00 dBA/m

**Plot No.136**

**LTE 41 QPSK 20MHz 50RB 49offset 40620ch 6 6 Bit rate 75 z(axial)**

**DUT: SM-G991U; Type: Bar**

Communication System: UID 0, LTE Band 41 (0); Frequency: 2593 MHz;Duty Cycle: 1:1.95209  
Medium parameters used:  $\sigma = 0$  S/m,  $\epsilon_r = 1$ ;  $\rho = 0$  kg/m<sup>3</sup>  
Phantom section: TCoil Section

DASY Configuration:

- Probe: AM1DV3 - 3049; ;
- Sensor-Surface: 0mm (Fix Surface)
- Electronics: DAE4 Sn466; Calibrated: 2020-04-22
- Phantom: HAC Test Arch with AMCC
- Measurement SW: DASY52, Version 52.10 (4);

**T-Coil scan (scan for ANSI C63.19-2007 & 2011 compliance)/General Scans/z (axial) 4.2mm 50 x**

**50/ABM Signal(x,y,z) (13x13x1):** Measurement grid: dx=10mm, dy=10mm

Signal Type: Audio File (.wav) 48k\_voice\_1kHz\_1s.wav

Output Gain: 18.9

Measure Window Start: 300ms

Measure Window Length: 1000ms

BWC applied: 0.15 dB

Device Reference Point: 0, 0, -6.3 mm

**Cursor:**

ABM1 comp = 13.97 dBA/m

BWC Factor = 0.15 dB

Location: 12.5, -12.5, 3.7 mm

**Cursor:**

ABM2 = -31.53 dBA/m

Location: 12.5, -12.5, 3.7 mm

**Cursor:**

ABM1/ABM2 = 45.51 dB

ABM1 comp = 13.97 dBA/m

BWC Factor = 0.15 dB

Location: 12.5, -12.5, 3.7 mm

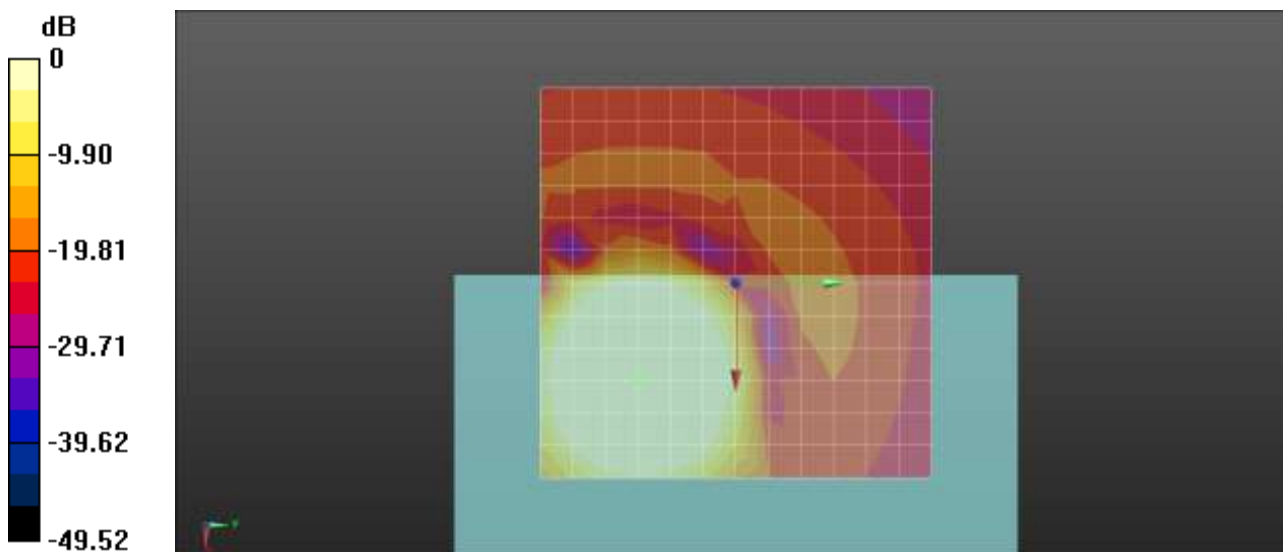

0 dB = 1.000 A/m = 0.00 dBA/m

**Plot No.137**  
**LTE 41 QPSK 20MHz 50RB 49offset 40620ch 6 6 Bit rate 75 Freq.Response**

**DUT: SM-G991U; Type: Bar**

Communication System: UID 0, LTE Band 41 (0); Frequency: 2593 MHz;Duty Cycle: 1:1.95209  
Medium parameters used:  $\sigma = 0$  S/m,  $\epsilon_r = 1$ ;  $\rho = 0$  kg/m<sup>3</sup>  
Phantom section: TCoil Section

**T-Coil scan (scan for ANSI C63.19-2007 & 2011 compliance)/General Scans/z (axial) wideband at best S/N/ABM Freq Resp(x,y,z,f) (1x1x1):** Measurement grid: dx=10mm, dy=10mm  
Signal Type: Audio File (.wav) 48k\_Normal\_51s new.wav  
Output Gain: 57.55  
Measure Window Start: 300ms  
Measure Window Length: 51000ms  
BWC applied: 9.48 dB  
Device Reference Point: 0, 0, -6.3 mm

Category	Telephone parameters WD signal quality [(signal+noise)-to-noise ratio in decibels]
Category T1	0 dB to 10 dB
Category T2	10 dB to 20 dB
Category T3	20 dB to 30 dB
Category T4	> 30 dB

**Cursor:**  
Diff = 2.00 dB  
BWC Factor = 9.48 dB  
Location: 12.2, -11.3, 3.7 mm

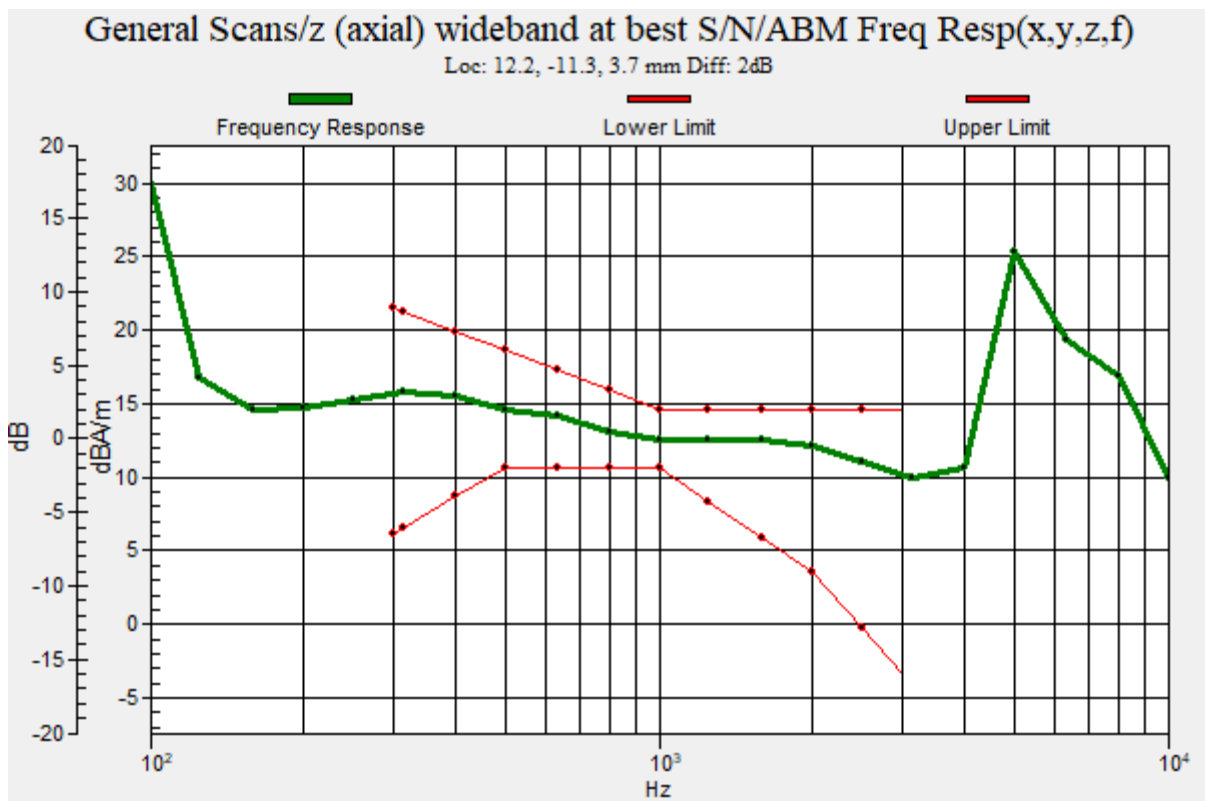

**Plot No.138**

**LTE 41 QPSK 20MHz 50RB 49offset 40620ch 6 6 Bit rate 75 y(transversal)**

**DUT: SM-G991U; Type: Bar**

Communication System: UID 0, LTE Band 41 (0); Frequency: 2593 MHz;Duty Cycle: 1:1.95209  
Medium parameters used:  $\sigma = 0$  S/m,  $\epsilon_r = 1$ ;  $\rho = 0$  kg/m<sup>3</sup>  
Phantom section: TCoil Section

DASY Configuration:

- Probe: AM1DV3 - 3049; ;
- Sensor-Surface: 0mm (Fix Surface)
- Electronics: DAE4 Sn466; Calibrated: 2020-04-22
- Phantom: HAC Test Arch with AMCC
- Measurement SW: DASY52, Version 52.10 (4);

**T-Coil scan (scan for ANSI C63.19-2007 & 2011 compliance)/General Scans/y (transversal) 4.2mm 50**

**x 50/ABM Signal(x,y,z) (13x13x1):** Measurement grid: dx=10mm, dy=10mm

Signal Type: Audio File (.wav) 48k\_voice\_1kHz\_1s.wav

Output Gain: 18.9

Measure Window Start: 300ms

Measure Window Length: 1000ms

BWC applied: 0.15 dB

Device Reference Point: 0, 0, -6.3 mm

**Cursor:**

ABM1 comp = 2.12 dBA/m

BWC Factor = 0.15 dB

Location: 8.3, -25, 3.7 mm

**Cursor:**

ABM2 = -42.17 dBA/m

Location: 8.3, -25, 3.7 mm

**Cursor:**

ABM1/ABM2 = 44.29 dB

ABM1 comp = 2.12 dBA/m

BWC Factor = 0.15 dB

Location: 8.3, -25, 3.7 mm

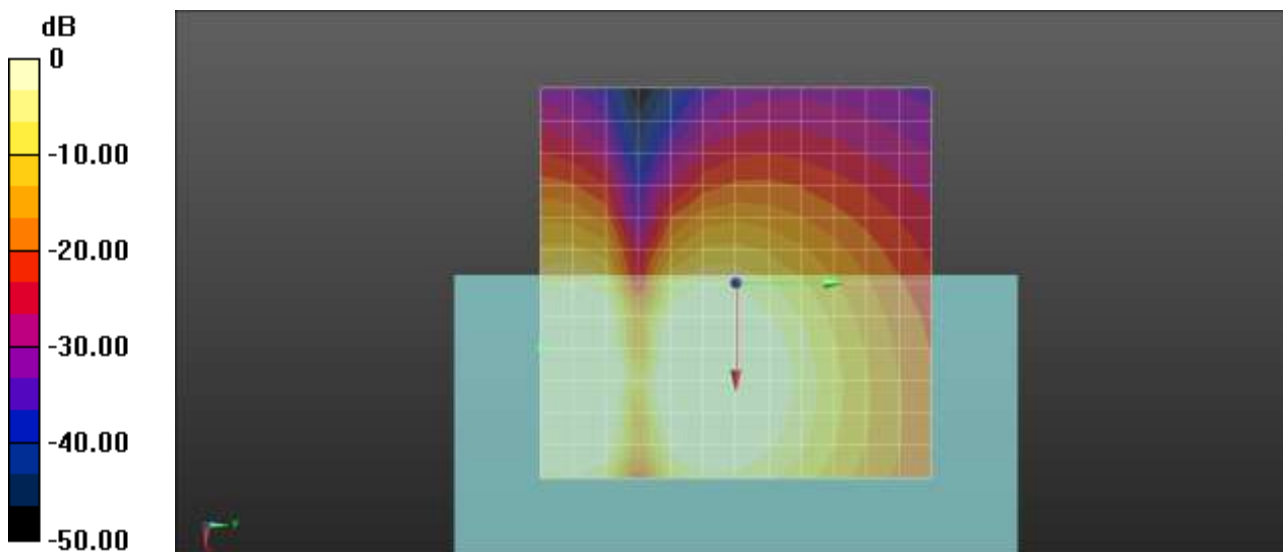

0 dB = 1.000 A/m = 0.00 dBA/m

**Plot No.139**

**LTE 48 QPSK 20MHz 50RB 49offset 55990ch 6 6 Bit rate 75 z(axial)**

**DUT: SM-G991U; Type: Bar**

Communication System: UID 0, LTE 48 (0); Frequency: 3625 MHz;Duty Cycle: 1:1.95209  
Medium parameters used:  $\sigma = 0$  S/m,  $\epsilon_r = 1$ ;  $\rho = 0$  kg/m<sup>3</sup>  
Phantom section: TCoil Section

DASY Configuration:

- Probe: AM1DV3 - 3049; ;
- Sensor-Surface: 0mm (Fix Surface)
- Electronics: DAE4 Sn466; Calibrated: 2020-04-22
- Phantom: HAC Test Arch with AMCC
- Measurement SW: DASY52, Version 52.10 (4);

**T-Coil scan (scan for ANSI C63.19-2007 & 2011 compliance)/General Scans/z (axial) 4.2mm 50 x**

**50/ABM Signal(x,y,z) (13x13x1):** Measurement grid: dx=10mm, dy=10mm

Signal Type: Audio File (.wav) 48k\_voice\_1kHz\_1s.wav

Output Gain: 18.9

Measure Window Start: 300ms

Measure Window Length: 1000ms

BWC applied: 0.15 dB

Device Reference Point: 0, 0, -6.3 mm

**Cursor:**

ABM1 comp = 11.63 dBA/m

BWC Factor = 0.15 dB

Location: 8.3, -12.5, 3.7 mm

**Cursor:**

ABM2 = -38.06 dBA/m

Location: 8.3, -12.5, 3.7 mm

**Cursor:**

ABM1/ABM2 = 49.68 dB

ABM1 comp = 11.63 dBA/m

BWC Factor = 0.15 dB

Location: 8.3, -12.5, 3.7 mm

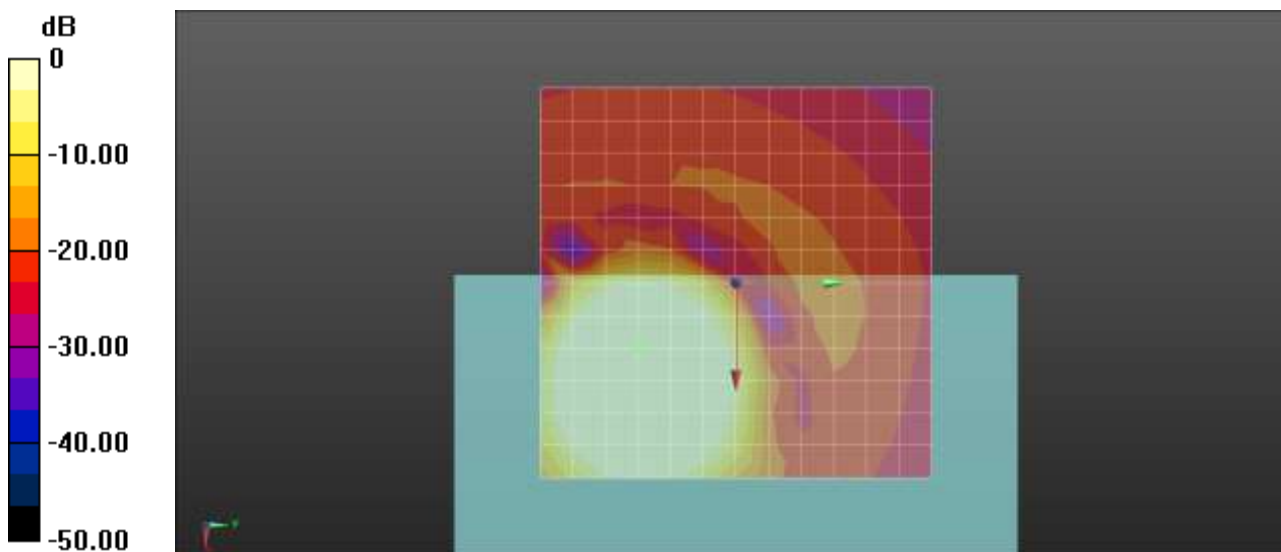

0 dB = 1.000 A/m = 0.00 dBA/m



**Plot No.140**  
**LTE 48 QPSK 20MHz 50RB 49offset 55990ch 6 6 Bit rate 75 Freq.Response**

**DUT: SM-G991U; Type: Bar**

Communication System: UID 0, LTE 48 (0); Frequency: 3625 MHz;Duty Cycle: 1:1.95209  
Medium parameters used:  $\sigma = 0$  S/m,  $\epsilon_r = 1$ ;  $\rho = 0$  kg/m<sup>3</sup>  
Phantom section: TCoil Section

**T-Coil scan (scan for ANSI C63.19-2007 & 2011 compliance)/General Scans/z (axial) wideband at best S/N/ABM Freq Resp(x,y,z,f) (1x1x1):** Measurement grid: dx=10mm, dy=10mm  
Signal Type: Audio File (.wav) 48k\_Normal\_51s new.wav  
Output Gain: 57.55  
Measure Window Start: 300ms  
Measure Window Length: 51000ms  
BWC applied: 9.47 dB  
Device Reference Point: 0, 0, -6.3 mm

Category	Telephone parameters WD signal quality [(signal+noise)-to-noise ratio in decibels]
Category T1	0 dB to 10 dB
Category T2	10 dB to 20 dB
Category T3	20 dB to 30 dB
Category T4	> 30 dB

**Cursor:**  
Diff = 1.97 dB  
BWC Factor = 9.47 dB  
Location: 10.7, -12.2, 3.7 mm

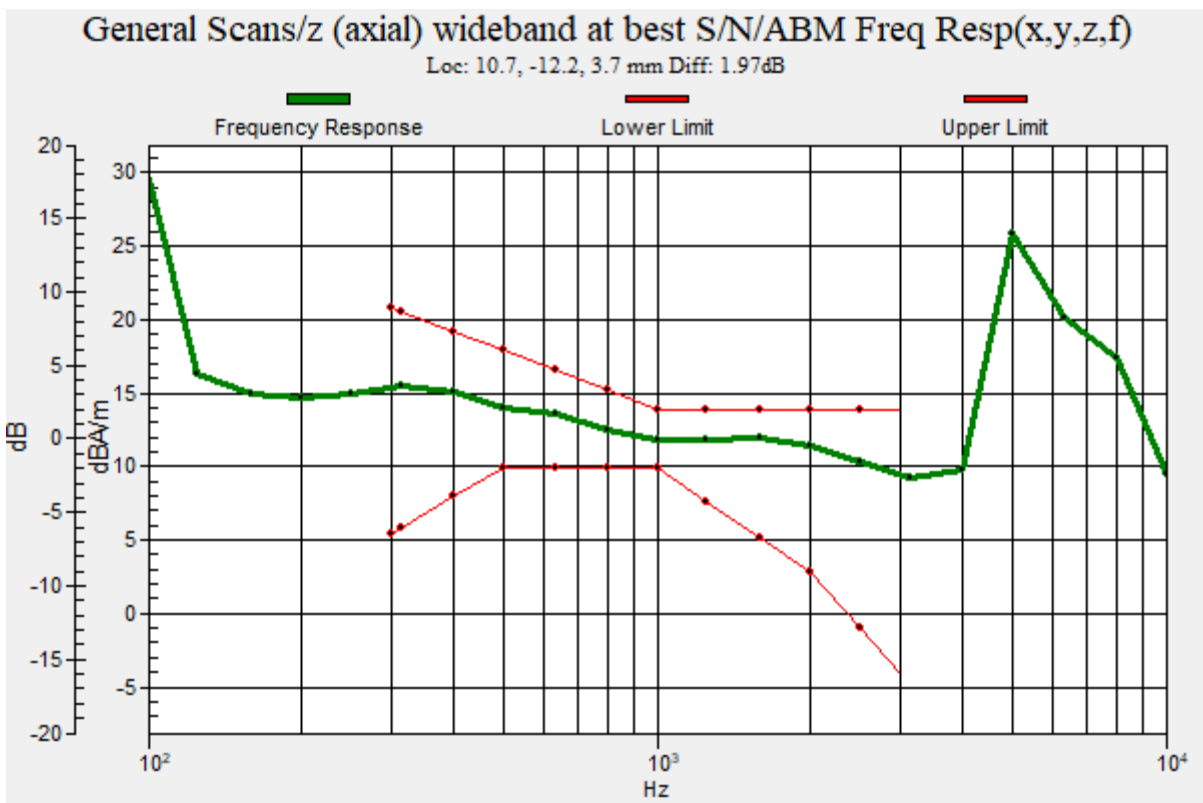

**Plot No.141**

**LTE 48 QPSK 20MHz 50RB 49offset 55990ch 6 6 Bit rate 75 y(transversal)**

**DUT: SM-G991U; Type: Bar**

Communication System: UID 0, LTE 48 (0); Frequency: 3625 MHz;Duty Cycle: 1:1.95209

Medium parameters used:  $\sigma = 0$  S/m,  $\epsilon_r = 1$ ;  $\rho = 0$  kg/m<sup>3</sup>

Phantom section: TCoil Section

DASY Configuration:

- Probe: AM1DV3 - 3049; ;
- Sensor-Surface: 0mm (Fix Surface)
- Electronics: DAE4 Sn466; Calibrated: 2020-04-22
- Phantom: HAC Test Arch with AMCC
- Measurement SW: DASY52, Version 52.10 (4);

**T-Coil scan (scan for ANSI C63.19-2007 & 2011 compliance)/General Scans/y (transversal) 4.2mm 50**

**x 50/ABM Signal(x,y,z) (13x13x1):** Measurement grid: dx=10mm, dy=10mm

Signal Type: Audio File (.wav) 48k\_voice\_1kHz\_1s.wav

Output Gain: 18.9

Measure Window Start: 300ms

Measure Window Length: 1000ms

BWC applied: 0.15 dB

Device Reference Point: 0, 0, -6.3 mm

**Cursor:**

ABM1 comp = 5.12 dBA/m

BWC Factor = 0.15 dB

Location: 8.3, -4.2, 3.7 mm

**Cursor:**

ABM2 = -43.25 dBA/m

Location: 8.3, -4.2, 3.7 mm

**Cursor:**

ABM1/ABM2 = 48.38 dB

ABM1 comp = 5.12 dBA/m

BWC Factor = 0.15 dB

Location: 8.3, -4.2, 3.7 mm

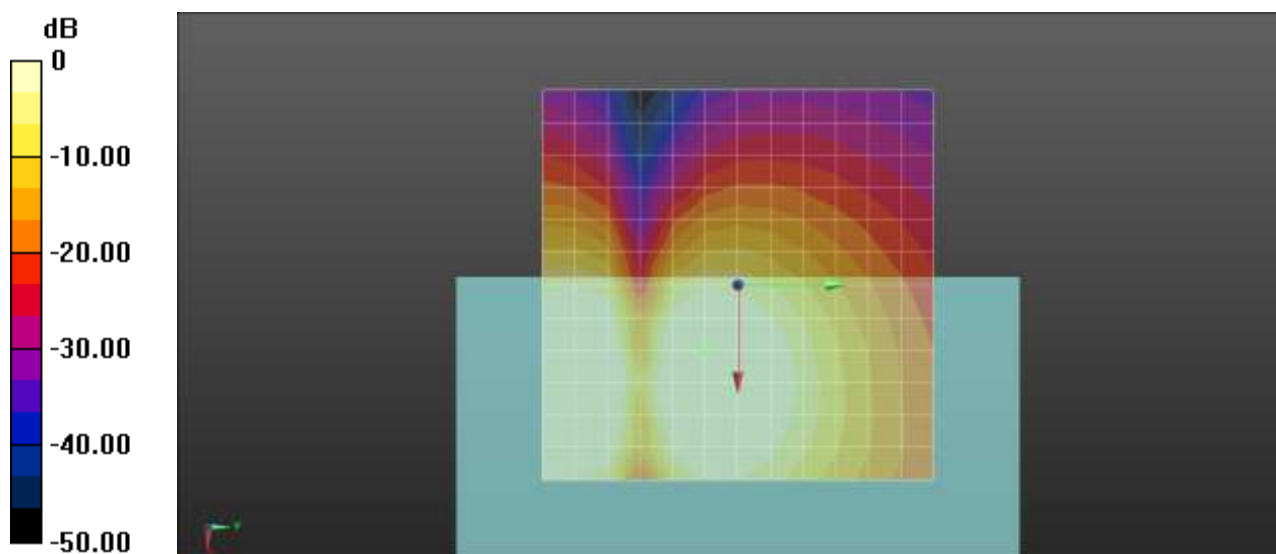

0 dB = 1.000 A/m = 0.00 dBA/m

**Plot No.142**  
**802.11b 5.5.Mpbs 6ch Bit rate 75 z(axial)**

**DUT: SM-G991U; Type: Bar**

Communication System: UID 0, 2450MHz FCC (0); Frequency: 2437 MHz;Duty Cycle: 1:1  
Medium parameters used:  $\sigma = 0$  S/m,  $\epsilon_r = 1$ ;  $\rho = 0$  kg/m<sup>3</sup>  
Phantom section: TCoil Section

DASY Configuration:

- Probe: AM1DV3 - 3049; ;
- Sensor-Surface: 0mm (Fix Surface)
- Electronics: DAE4 Sn466; Calibrated: 2020-04-22
- Phantom: HAC Test Arch with AMCC
- Measurement SW: DASY52, Version 52.10 (4);

**T-Coil scan (scan for ANSI C63.19-2007 & 2011 compliance)/General Scans/z (axial) 4.2mm 50 x 50/ABM Signal(x,y,z) (13x13x1):** Measurement grid: dx=10mm, dy=10mm  
Signal Type: Audio File (.wav) 48k\_voice\_1kHz\_1s.wav  
Output Gain: 18.9  
Measure Window Start: 300ms  
Measure Window Length: 1000ms  
BWC applied: 0.16 dB  
Device Reference Point: 0, 0, -6.3 mm

**Cursor:**

ABM1 comp = 13.87 dBA/m  
BWC Factor = 0.16 dB  
Location: 12.5, -12.5, 3.7 mm

**Cursor:**

ABM2 = -33.23 dBA/m  
Location: 12.5, -12.5, 3.7 mm

**Cursor:**

ABM1/ABM2 = 47.10 dB  
ABM1 comp = 13.87 dBA/m  
BWC Factor = 0.16 dB  
Location: 12.5, -12.5, 3.7 mm

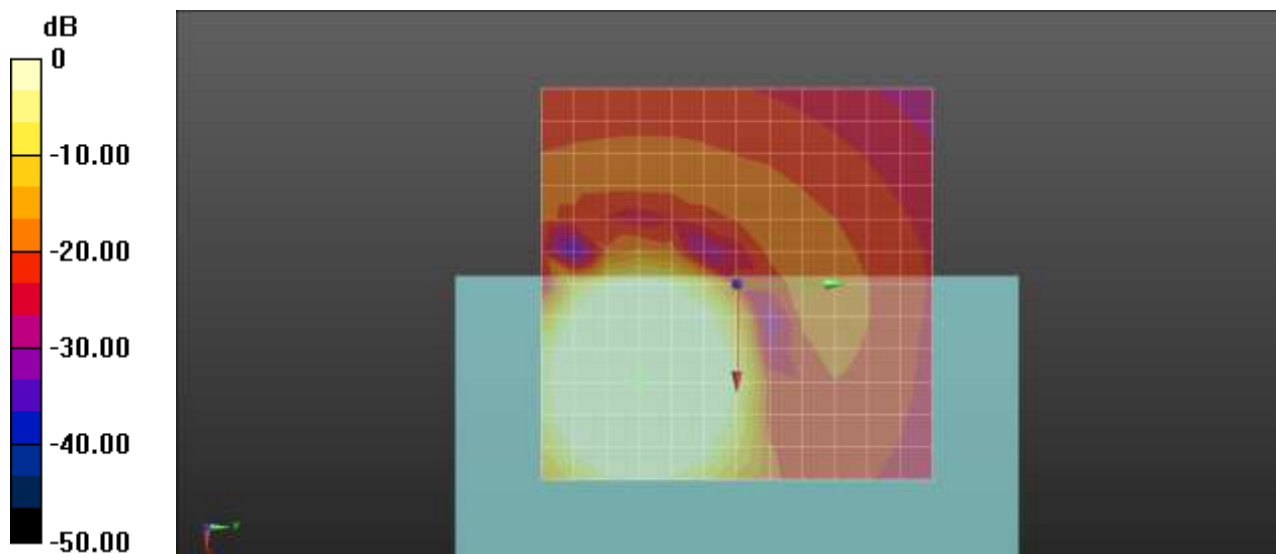

0 dB = 1.000 A/m = 0.00 dBA/m

**Plot No.143**  
**802.11b 5.5.Mpbs 6ch Bit rate 75 Freq.Response**

**DUT: SM-G991U; Type: Bar**

Communication System: UID 0, 2450MHz FCC (0); Frequency: 2437 MHz;Duty Cycle: 1:1  
Medium parameters used:  $\sigma = 0$  S/m,  $\epsilon_r = 1$ ;  $\rho = 0$  kg/m<sup>3</sup>  
Phantom section: TCoil Section

**T-Coil scan (scan for ANSI C63.19-2007 & 2011 compliance)/General Scans/z (axial) wideband at best S/N/ABM Freq Resp(x,y,z,f) (1x1x1):** Measurement grid: dx=10mm, dy=10mm  
Signal Type: Audio File (.wav) 48k\_Normal\_51s new.wav  
Output Gain: 57.55  
Measure Window Start: 300ms  
Measure Window Length: 51000ms  
BWC applied: 9.48 dB  
Device Reference Point: 0, 0, -6.3 mm

Category	Telephone parameters WD signal quality [(signal+noise)-to-noise ratio in decibels]
Category T1	0 dB to 10 dB
Category T2	10 dB to 20 dB
Category T3	20 dB to 30 dB
Category T4	> 30 dB

**Cursor:**  
Diff = 1.96 dB  
BWC Factor = 9.48 dB  
Location: 11.6, -10.5, 3.7 mm

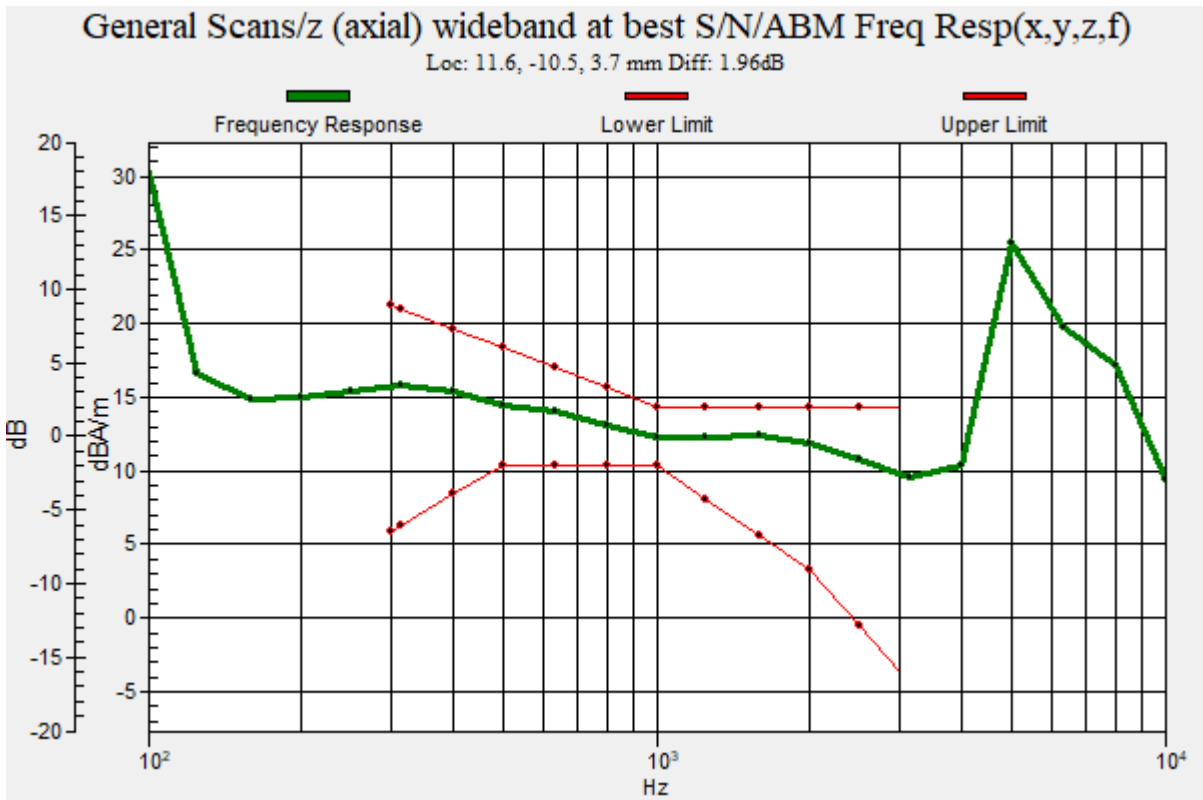

**Plot No.144**  
**802.11b 5.5.Mpbs 6ch Bit rate 75 y(trnavsersal)**

**DUT: SM-G991U; Type: Bar**

Communication System: UID 0, 2450MHz FCC (0); Frequency: 2437 MHz;Duty Cycle: 1:1  
Medium parameters used:  $\sigma = 0$  S/m,  $\epsilon_r = 1$ ;  $\rho = 0$  kg/m<sup>3</sup>  
Phantom section: TCoil Section

DASY Configuration:

- Probe: AM1DV3 - 3049; ;
- Sensor-Surface: 0mm (Fix Surface)
- Electronics: DAE4 Sn466; Calibrated: 2020-04-22
- Phantom: HAC Test Arch with AMCC
- Measurement SW: DASY52, Version 52.10 (4);

**T-Coil scan (scan for ANSI C63.19-2007 & 2011 compliance)/General Scans/y (transversal) 4.2mm 50**

**x 50/ABM Signal(x,y,z) (13x13x1):** Measurement grid: dx=10mm, dy=10mm

Signal Type: Audio File (.wav) 48k\_voice\_1kHz\_1s.wav

Output Gain: 18.9

Measure Window Start: 300ms

Measure Window Length: 1000ms

BWC applied: 0.16 dB

Device Reference Point: 0, 0, -6.3 mm

**Cursor:**

ABM1 comp = 4.64 dBA/m

BWC Factor = 0.16 dB

Location: 8.3, -20.8, 3.7 mm

**Cursor:**

ABM2 = -41.40 dBA/m

Location: 8.3, -20.8, 3.7 mm

**Cursor:**

ABM1/ABM2 = 46.05 dB

ABM1 comp = 4.64 dBA/m

BWC Factor = 0.16 dB

Location: 8.3, -20.8, 3.7 mm

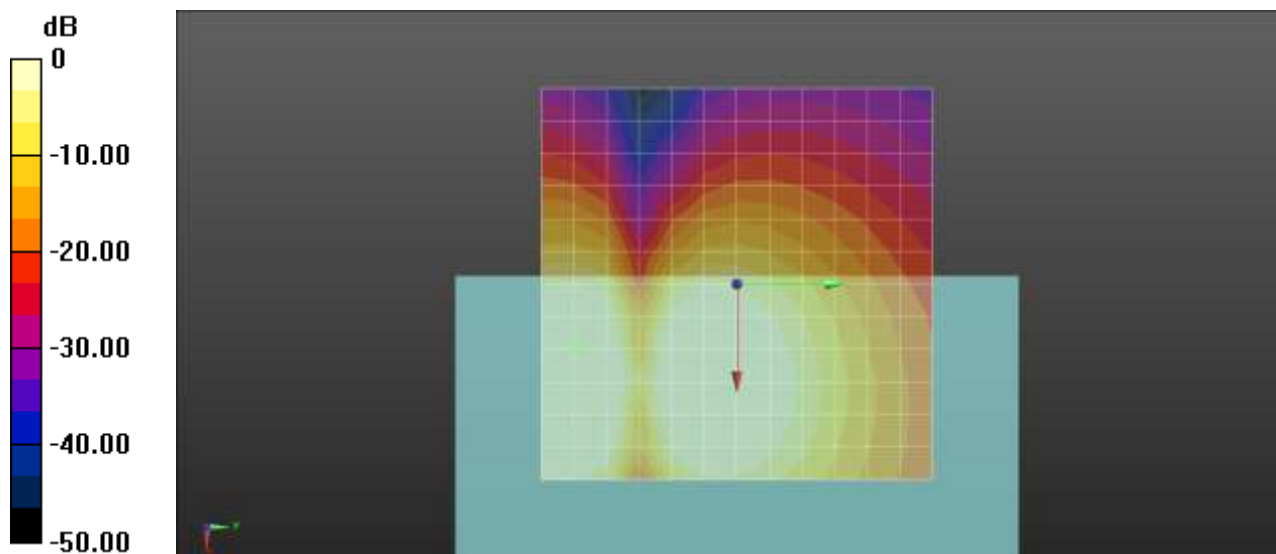

0 dB = 1.000 A/m = 0.00 dBA/m

**Plot No.145**  
**802.11n20 MCS0 40ch Bit rate 75 z(axial)**

**DUT: SM-G991U; Type: Bar**

Communication System: UID 0, WIFI 5GHz (0); Frequency: 5200 MHz;Duty Cycle: 1:1  
Medium parameters used:  $\sigma = 0$  S/m,  $\epsilon_r = 1$ ;  $\rho = 0$  kg/m<sup>3</sup>  
Phantom section: TCoil Section

DASY Configuration:

- Probe: AM1DV3 - 3049; ;
- Sensor-Surface: 0mm (Fix Surface)
- Electronics: DAE4 Sn466; Calibrated: 2020-04-22
- Phantom: HAC Test Arch with AMCC
- Measurement SW: DASY52, Version 52.10 (4);

**T-Coil scan (scan for ANSI C63.19-2007 & 2011 compliance)/General Scans/z (axial) 4.2mm 50 x 50/ABM Signal(x,y,z) (13x13x1):** Measurement grid: dx=10mm, dy=10mm  
Signal Type: Audio File (.wav) 48k\_voice\_1kHz\_1s.wav  
Output Gain: 18.9  
Measure Window Start: 300ms  
Measure Window Length: 1000ms  
BWC applied: 0.16 dB  
Device Reference Point: 0, 0, -6.3 mm

**Cursor:**  
ABM1 comp = 12.35 dBA/m  
BWC Factor = 0.16 dB  
Location: 8.3, -12.5, 3.7 mm

**Cursor:**  
ABM2 = -36.74 dBA/m  
Location: 8.3, -12.5, 3.7 mm

**Cursor:**  
ABM1/ABM2 = 49.09 dB  
ABM1 comp = 12.35 dBA/m  
BWC Factor = 0.16 dB  
Location: 8.3, -12.5, 3.7 mm

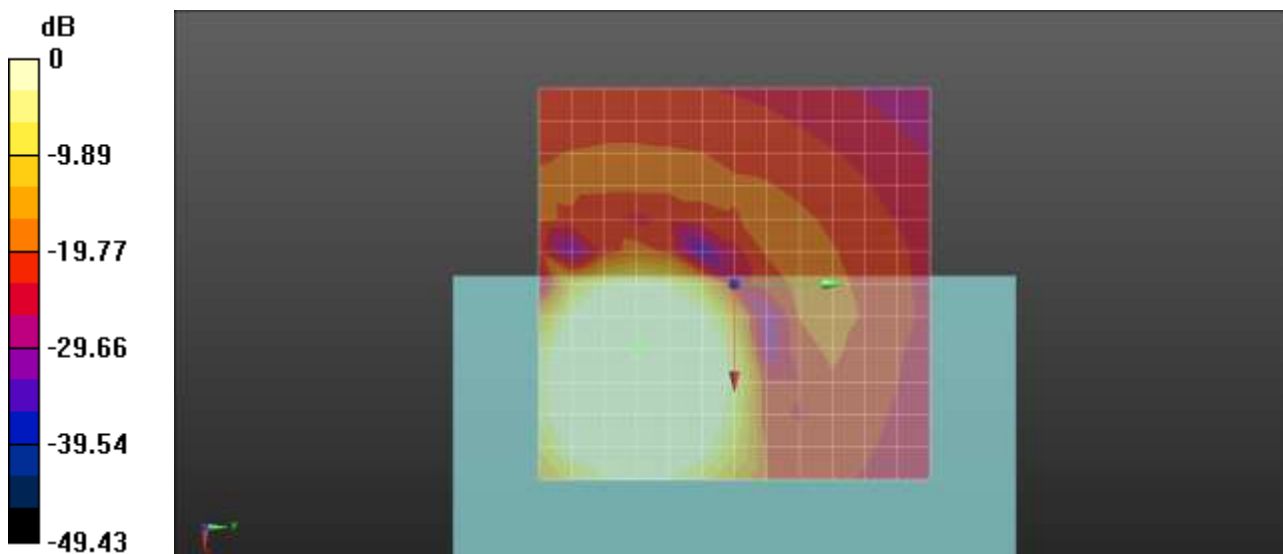

0 dB = 1.000 A/m = 0.00 dBA/m

**Plot No.145**  
**802.11n20 MCS0 40ch Bit rate 75 Freq.Response**

**DUT: SM-G991U; Type: Bar**

Communication System: UID 0, WIFI 5GHz (0); Frequency: 5200 MHz;Duty Cycle: 1:1  
Medium parameters used:  $\sigma = 0$  S/m,  $\epsilon_r = 1$ ;  $\rho = 0$  kg/m<sup>3</sup>  
Phantom section: TCoil Section

**T-Coil scan (scan for ANSI C63.19-2007 & 2011 compliance)/General Scans/z (axial) wideband at best S/N/ABM Freq Resp(x,y,z,f) (1x1x1):** Measurement grid: dx=10mm, dy=10mm  
Signal Type: Audio File (.wav) 48k\_Normal\_51s new.wav  
Output Gain: 57.55  
Measure Window Start: 300ms  
Measure Window Length: 51000ms  
BWC applied: 9.48 dB  
Device Reference Point: 0, 0, -6.3 mm

Category	Telephone parameters WD signal quality [(signal+noise)-to-noise ratio in decibels]
Category T1	0 dB to 10 dB
Category T2	10 dB to 20 dB
Category T3	20 dB to 30 dB
Category T4	> 30 dB

**Cursor:**  
Diff = 2.00 dB  
BWC Factor = 9.48 dB  
Location: 10, -12.2, 3.7 mm

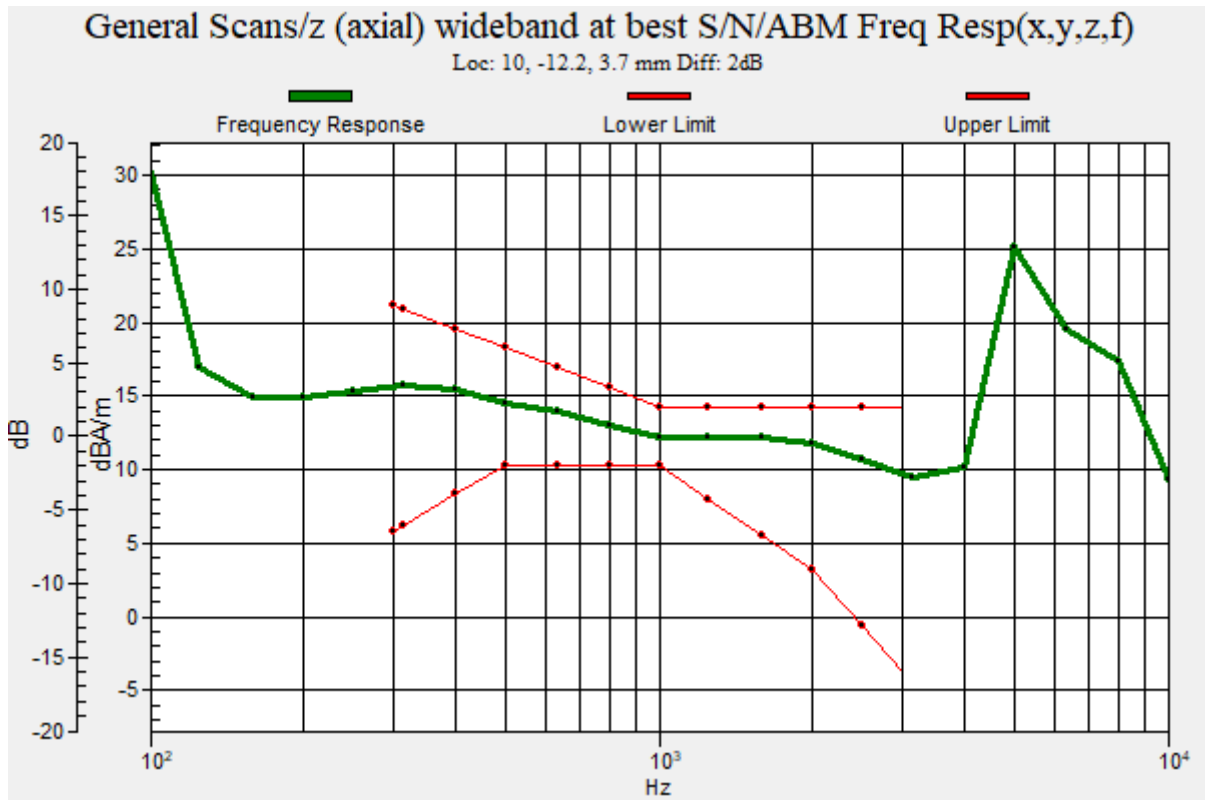

**Plot No.147**  
**802.11n20 MCS0 40ch Bit rate 75 y(transversal)**

**DUT: SM-G991U; Type: Bar**

Communication System: UID 0, WIFI 5GHz (0); Frequency: 5200 MHz;Duty Cycle: 1:1  
Medium parameters used:  $\sigma = 0$  S/m,  $\epsilon_r = 1$ ;  $\rho = 0$  kg/m<sup>3</sup>  
Phantom section: TCoil Section

DASY Configuration:

- Probe: AM1DV3 - 3049; ;
- Sensor-Surface: 0mm (Fix Surface)
- Electronics: DAE4 Sn466; Calibrated: 2020-04-22
- Phantom: HAC Test Arch with AMCC
- Measurement SW: DASY52, Version 52.10 (4);

**T-Coil scan (scan for ANSI C63.19-2007 & 2011 compliance)/General Scans/y (transversal) 4.2mm 50**

**x 50/ABM Signal(x,y,z) (13x13x1):** Measurement grid: dx=10mm, dy=10mm

Signal Type: Audio File (.wav) 48k\_voice\_1kHz\_1s.wav

Output Gain: 18.9

Measure Window Start: 300ms

Measure Window Length: 1000ms

BWC applied: 0.16 dB

Device Reference Point: 0, 0, -6.3 mm

**Cursor:**

ABM1 comp = 3.51 dBA/m

BWC Factor = 0.16 dB

Location: 8.3, -16.7, 3.7 mm

**Cursor:**

ABM2 = -45.13 dBA/m

Location: 8.3, -16.7, 3.7 mm

**Cursor:**

ABM1/ABM2 = 48.63 dB

ABM1 comp = 3.51 dBA/m

BWC Factor = 0.16 dB

Location: 8.3, -16.7, 3.7 mm

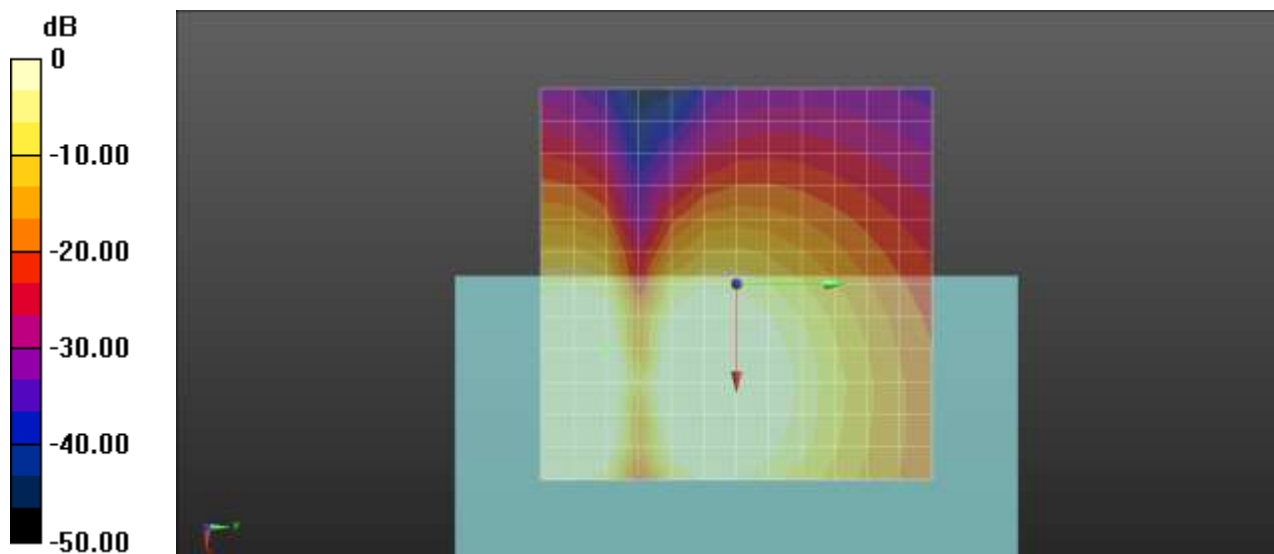

0 dB = 1.000 A/m = 0.00 dBA/m



**Plot No.148**  
**802.11n20 MCS0 56ch Bit rate 75 z(axial)**

**DUT: SM-G991U; Type: Bar**

Communication System: UID 0, WIFI 5GHz (0); Frequency: 5280 MHz;Duty Cycle: 1:1  
Medium parameters used:  $\sigma = 0$  S/m,  $\epsilon_r = 1$ ;  $\rho = 0$  kg/m<sup>3</sup>  
Phantom section: TCoil Section

DASY Configuration:

- Probe: AM1DV3 - 3049; ;
- Sensor-Surface: 0mm (Fix Surface)
- Electronics: DAE4 Sn466; Calibrated: 2020-04-22
- Phantom: HAC Test Arch with AMCC
- Measurement SW: DASY52, Version 52.10 (4);

**T-Coil scan (scan for ANSI C63.19-2007 & 2011 compliance)/General Scans/z (axial) 4.2mm 50 x 50/ABM Signal(x,y,z) (13x13x1):** Measurement grid: dx=10mm, dy=10mm  
Signal Type: Audio File (.wav) 48k\_voice\_1kHz\_1s.wav  
Output Gain: 18.9  
Measure Window Start: 300ms  
Measure Window Length: 1000ms  
BWC applied: 0.16 dB  
Device Reference Point: 0, 0, -6.3 mm

**Cursor:**

ABM1 comp = 12.29 dBA/m  
BWC Factor = 0.16 dB  
Location: 8.3, -12.5, 3.7 mm

**Cursor:**

ABM2 = -36.67 dBA/m  
Location: 8.3, -12.5, 3.7 mm

**Cursor:**

ABM1/ABM2 = 48.95 dB  
ABM1 comp = 12.29 dBA/m  
BWC Factor = 0.16 dB  
Location: 8.3, -12.5, 3.7 mm

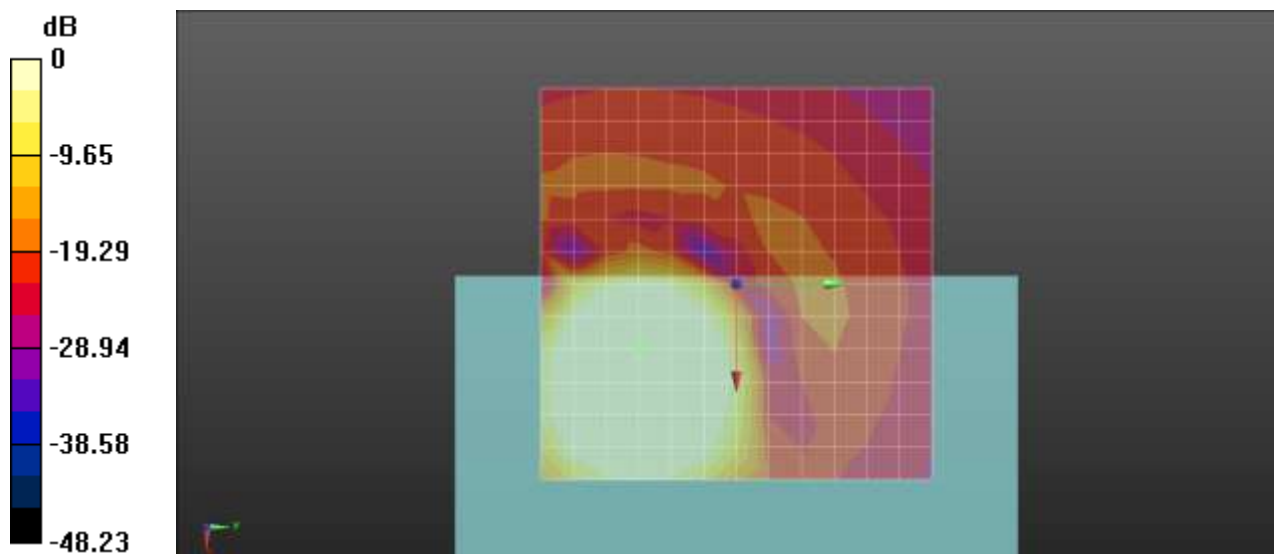

0 dB = 1.000 A/m = 0.00 dBA/m

**Plot No.149**  
**802.11n20 MCS0 56ch Bit rate 75 Freq.Response**

**DUT: SM-G991U; Type: Bar**

Communication System: UID 0, WIFI 5GHz (0); Frequency: 5280 MHz;Duty Cycle: 1:1  
Medium parameters used:  $\sigma = 0$  S/m,  $\epsilon_r = 1$ ;  $\rho = 0$  kg/m<sup>3</sup>  
Phantom section: TCoil Section

**T-Coil scan (scan for ANSI C63.19-2007 & 2011 compliance)/General Scans/z (axial) wideband at best S/N/ABM Freq Resp(x,y,z,f) (1x1x1):** Measurement grid: dx=10mm, dy=10mm  
Signal Type: Audio File (.wav) 48k\_Normal\_51s new.wav  
Output Gain: 57.55  
Measure Window Start: 300ms  
Measure Window Length: 51000ms  
BWC applied: 9.48 dB  
Device Reference Point: 0, 0, -6.3 mm

Category	Telephone parameters WD signal quality [(signal+noise)-to-noise ratio in decibels]
Category T1	0 dB to 10 dB
Category T2	10 dB to 20 dB
Category T3	20 dB to 30 dB
Category T4	> 30 dB

**Cursor:**  
Diff = 2.00 dB  
BWC Factor = 9.48 dB  
Location: 10.3, -12.8, 3.7 mm

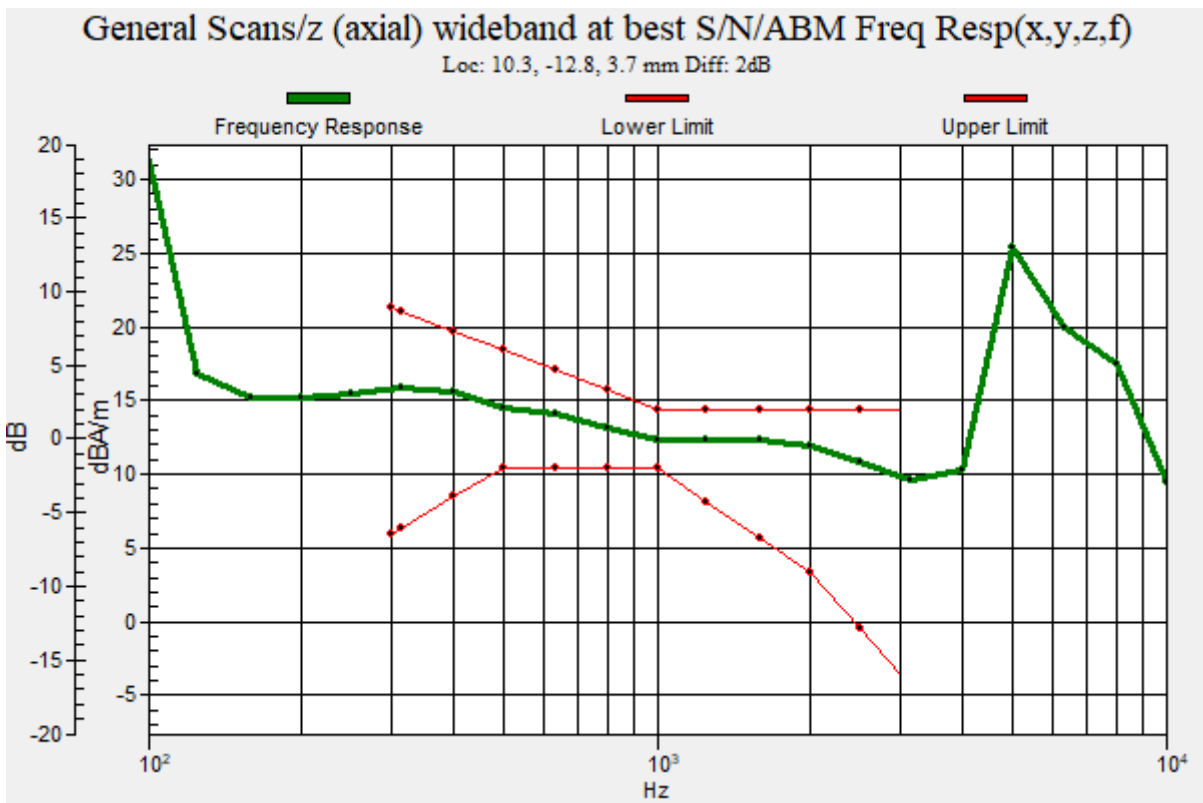

**Plot No.150**  
**802.11n20 MCS0 56ch Bit rate 75 y(transversal)**

**DUT: SM-G991U; Type: Bar**

Communication System: UID 0, WIFI 5GHz (0); Frequency: 5280 MHz;Duty Cycle: 1:1  
Medium parameters used:  $\sigma = 0$  S/m,  $\epsilon_r = 1$ ;  $\rho = 0$  kg/m<sup>3</sup>  
Phantom section: TCoil Section

DASY Configuration:

- Probe: AM1DV3 - 3049; ;
- Sensor-Surface: 0mm (Fix Surface)
- Electronics: DAE4 Sn466; Calibrated: 2020-04-22
- Phantom: HAC Test Arch with AMCC
- Measurement SW: DASY52, Version 52.10 (4);

**T-Coil scan (scan for ANSI C63.19-2007 & 2011 compliance)/General Scans/y (transversal) 4.2mm 50**

**x 50/ABM Signal(x,y,z) (13x13x1):** Measurement grid: dx=10mm, dy=10mm

Signal Type: Audio File (.wav) 48k\_voice\_1kHz\_1s.wav

Output Gain: 18.9

Measure Window Start: 300ms

Measure Window Length: 1000ms

BWC applied: 0.16 dB

Device Reference Point: 0, 0, -6.3 mm

**Cursor:**

ABM1 comp = 4.48 dBA/m

BWC Factor = 0.16 dB

Location: 8.3, -20.8, 3.7 mm

**Cursor:**

ABM2 = -44.25 dBA/m

Location: 8.3, -20.8, 3.7 mm

**Cursor:**

ABM1/ABM2 = 48.73 dB

ABM1 comp = 4.48 dBA/m

BWC Factor = 0.16 dB

Location: 8.3, -20.8, 3.7 mm

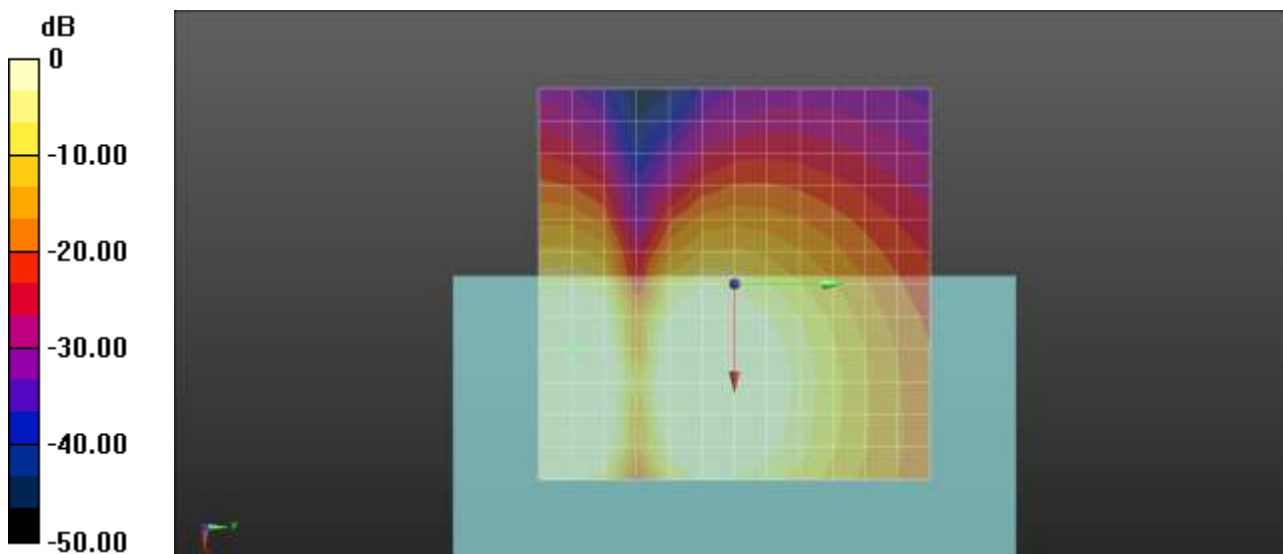

0 dB = 1.000 A/m = 0.00 dBA/m

**Plot No.151**  
**802.11n20 MCS0 120ch Bit rate 75 z(axial)**

**DUT: SM-G991U; Type: Bar**

Communication System: UID 0, WIFI 5GHz (0); Frequency: 5600 MHz;Duty Cycle: 1:1  
Medium parameters used:  $\sigma = 0$  S/m,  $\epsilon_r = 1$ ;  $\rho = 0$  kg/m<sup>3</sup>  
Phantom section: TCoil Section

DASY Configuration:

- Probe: AM1DV3 - 3049; ;
- Sensor-Surface: 0mm (Fix Surface)
- Electronics: DAE4 Sn466; Calibrated: 2020-04-22
- Phantom: HAC Test Arch with AMCC
- Measurement SW: DASY52, Version 52.10 (4);

**T-Coil scan (scan for ANSI C63.19-2007 & 2011 compliance)/General Scans/z (axial) 4.2mm 50 x 50/ABM Signal(x,y,z) (13x13x1):** Measurement grid: dx=10mm, dy=10mm  
Signal Type: Audio File (.wav) 48k\_voice\_1kHz\_1s.wav  
Output Gain: 18.9  
Measure Window Start: 300ms  
Measure Window Length: 1000ms  
BWC applied: 0.16 dB  
Device Reference Point: 0, 0, -6.3 mm

**Cursor:**  
ABM1 comp = 12.29 dBA/m  
BWC Factor = 0.16 dB  
Location: 8.3, -12.5, 3.7 mm

**Cursor:**  
ABM2 = -36.46 dBA/m  
Location: 8.3, -12.5, 3.7 mm

**Cursor:**  
ABM1/ABM2 = 48.76 dB  
ABM1 comp = 12.29 dBA/m  
BWC Factor = 0.16 dB  
Location: 8.3, -12.5, 3.7 mm

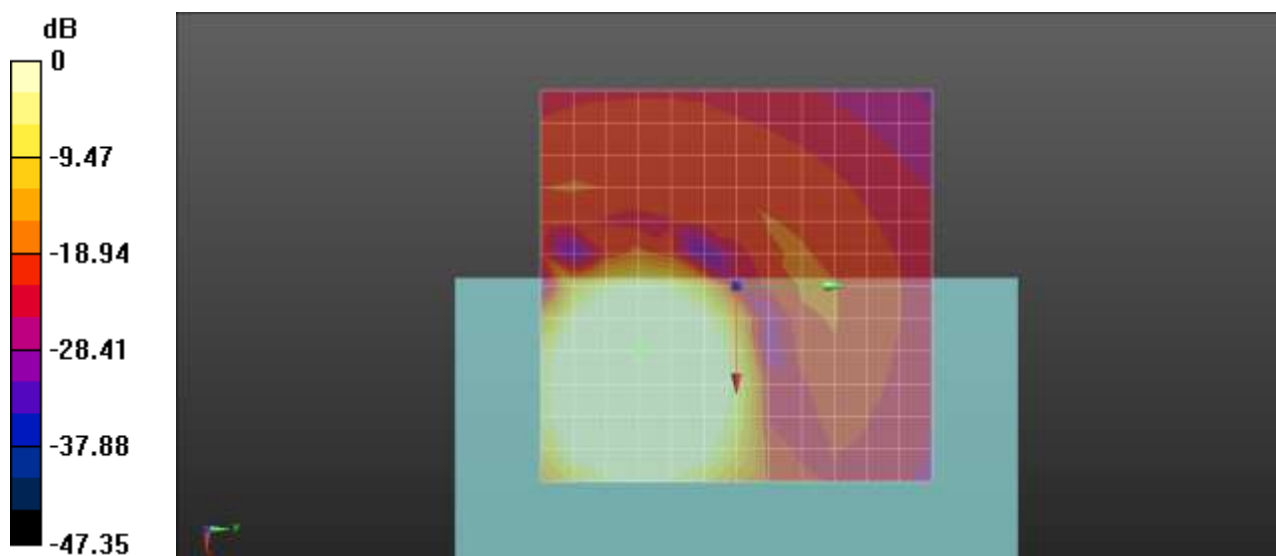

0 dB = 1.000 A/m = 0.00 dBA/m

**Plot No.152**  
**802.11n20 MCS0 120ch Bit rate 75 Freq.Response**

**DUT: SM-G991U; Type: Bar**

Communication System: UID 0, WIFI 5GHz (0); Frequency: 5600 MHz;Duty Cycle: 1:1  
Medium parameters used:  $\sigma = 0$  S/m,  $\epsilon_r = 1$ ;  $\rho = 0$  kg/m<sup>3</sup>  
Phantom section: TCoil Section

**T-Coil scan (scan for ANSI C63.19-2007 & 2011 compliance)/General Scans/z (axial) wideband at best S/N/ABM Freq Resp(x,y,z,f) (1x1x1):** Measurement grid: dx=10mm, dy=10mm  
Signal Type: Audio File (.wav) 48k\_Normal\_51s new.wav  
Output Gain: 57.55  
Measure Window Start: 300ms  
Measure Window Length: 51000ms  
BWC applied: 9.48 dB  
Device Reference Point: 0, 0, -6.3 mm

Category	Telephone parameters WD signal quality [(signal+noise)-to-noise ratio in decibels]
Category T1	0 dB to 10 dB
Category T2	10 dB to 20 dB
Category T3	20 dB to 30 dB
Category T4	> 30 dB

**Cursor:**  
Diff = 1.98 dB  
BWC Factor = 9.48 dB  
Location: 10.5, -11.1, 3.7 mm

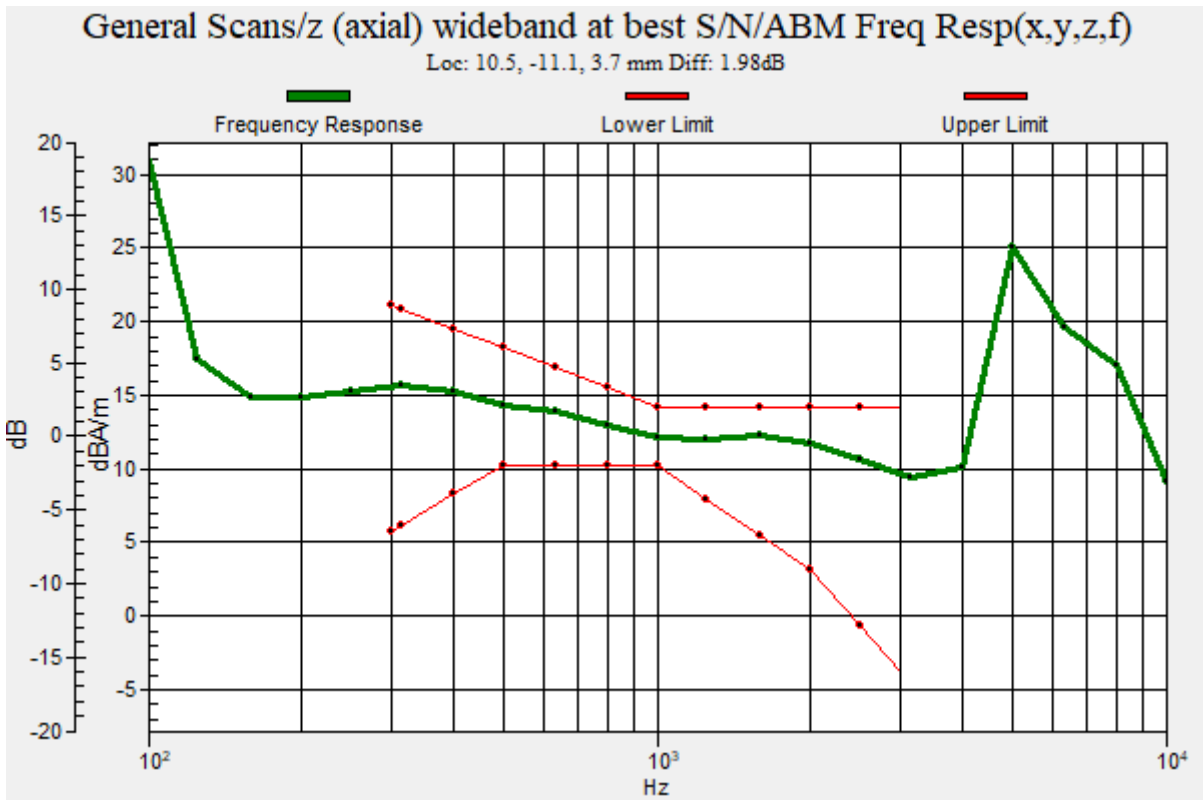

**Plot No.153**  
**802.11n20 MCS0 120ch Bit rate 75 y(transversal)**

**DUT: SM-G991U; Type: Bar**

Communication System: UID 0, WIFI 5GHz (0); Frequency: 5600 MHz;Duty Cycle: 1:1  
Medium parameters used:  $\sigma = 0$  S/m,  $\epsilon_r = 1$ ;  $\rho = 0$  kg/m<sup>3</sup>  
Phantom section: TCoil Section

DASY Configuration:

- Probe: AM1DV3 - 3049; ;
- Sensor-Surface: 0mm (Fix Surface)
- Electronics: DAE4 Sn466; Calibrated: 2020-04-22
- Phantom: HAC Test Arch with AMCC
- Measurement SW: DASY52, Version 52.10 (4);

**T-Coil scan (scan for ANSI C63.19-2007 & 2011 compliance)/General Scans/y (transversal) 4.2mm 50**

**x 50/ABM Signal(x,y,z) (13x13x1):** Measurement grid: dx=10mm, dy=10mm

Signal Type: Audio File (.wav) 48k\_voice\_1kHz\_1s.wav

Output Gain: 18.9

Measure Window Start: 300ms

Measure Window Length: 1000ms

BWC applied: 0.16 dB

Device Reference Point: 0, 0, -6.3 mm

**Cursor:**

ABM1 comp = 4.69 dBA/m

BWC Factor = 0.16 dB

Location: 8.3, -20.8, 3.7 mm

**Cursor:**

ABM2 = -43.97 dBA/m

Location: 8.3, -20.8, 3.7 mm

**Cursor:**

ABM1/ABM2 = 48.66 dB

ABM1 comp = 4.69 dBA/m

BWC Factor = 0.16 dB

Location: 8.3, -20.8, 3.7 mm

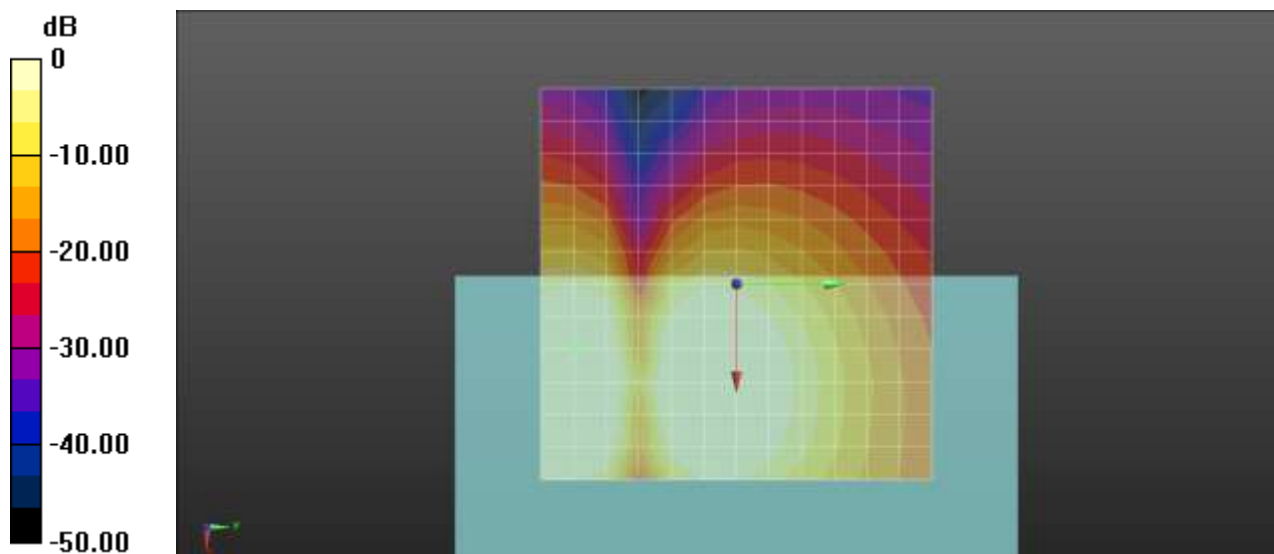

0 dB = 1.000 A/m = 0.00 dBA/m

**Plot No.154**  
**802.11n20 MCS0 157ch Bit rate 75 z(axial)**

**DUT: SM-G991U; Type: Bar**

Communication System: UID 0, WIFI 5GHz (0); Frequency: 5785 MHz;Duty Cycle: 1:1  
Medium parameters used:  $\sigma = 0$  S/m,  $\epsilon_r = 1$ ;  $\rho = 0$  kg/m<sup>3</sup>  
Phantom section: TCoil Section

DASY Configuration:

- Probe: AM1DV3 - 3049; ;
- Sensor-Surface: 0mm (Fix Surface)
- Electronics: DAE4 Sn466; Calibrated: 2020-04-22
- Phantom: HAC Test Arch with AMCC
- Measurement SW: DASY52, Version 52.10 (4);

**T-Coil scan (scan for ANSI C63.19-2007 & 2011 compliance)/General Scans/z (axial) 4.2mm 50 x 50/ABM Signal(x,y,z) (13x13x1):** Measurement grid: dx=10mm, dy=10mm  
Signal Type: Audio File (.wav) 48k\_voice\_1kHz\_1s.wav  
Output Gain: 18.9  
Measure Window Start: 300ms  
Measure Window Length: 1000ms  
BWC applied: 0.16 dB  
Device Reference Point: 0, 0, -6.3 mm

**Cursor:**  
ABM1 comp = 12.36 dBA/m  
BWC Factor = 0.16 dB  
Location: 8.3, -12.5, 3.7 mm

**Cursor:**  
ABM2 = -36.80 dBA/m  
Location: 8.3, -12.5, 3.7 mm

**Cursor:**  
ABM1/ABM2 = 49.16 dB  
ABM1 comp = 12.36 dBA/m  
BWC Factor = 0.16 dB  
Location: 8.3, -12.5, 3.7 mm

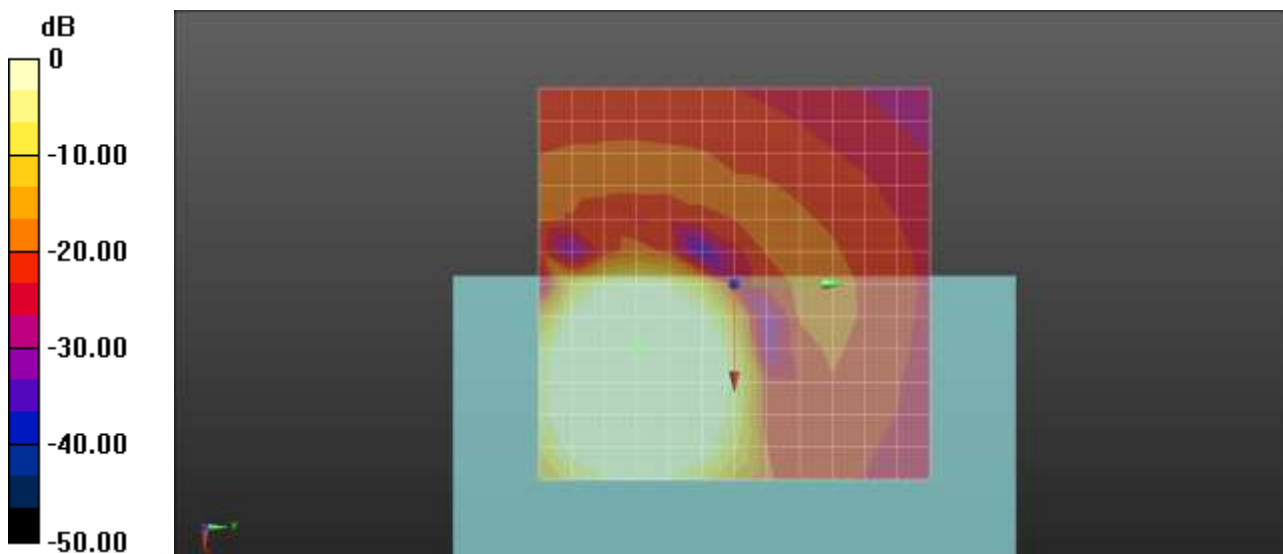

0 dB = 1.000 A/m = 0.00 dBA/m

**Plot No.155**  
**802.11n20 MCS0 157ch Bit rate 75 Freq.Response**

**DUT: SM-G991U; Type: Bar**

Communication System: UID 0, WIFI 5GHz (0); Frequency: 5785 MHz;Duty Cycle: 1:1  
Medium parameters used:  $\sigma = 0$  S/m,  $\epsilon_r = 1$ ;  $\rho = 0$  kg/m<sup>3</sup>  
Phantom section: TCoil Section

**T-Coil scan (scan for ANSI C63.19-2007 & 2011 compliance)/General Scans/z (axial) wideband at best S/N/ABM Freq Resp(x,y,z,f) (1x1x1):** Measurement grid: dx=10mm, dy=10mm  
Signal Type: Audio File (.wav) 48k\_Normal\_51s new.wav  
Output Gain: 57.55  
Measure Window Start: 300ms  
Measure Window Length: 51000ms  
BWC applied: 9.48 dB  
Device Reference Point: 0, 0, -6.3 mm

Category	Telephone parameters WD signal quality [(signal+noise)-to-noise ratio in decibels]
Category T1	0 dB to 10 dB
Category T2	10 dB to 20 dB
Category T3	20 dB to 30 dB
Category T4	> 30 dB

**Cursor:**  
Diff = 1.96 dB  
BWC Factor = 9.48 dB  
Location: 10, -11.9, 3.7 mm

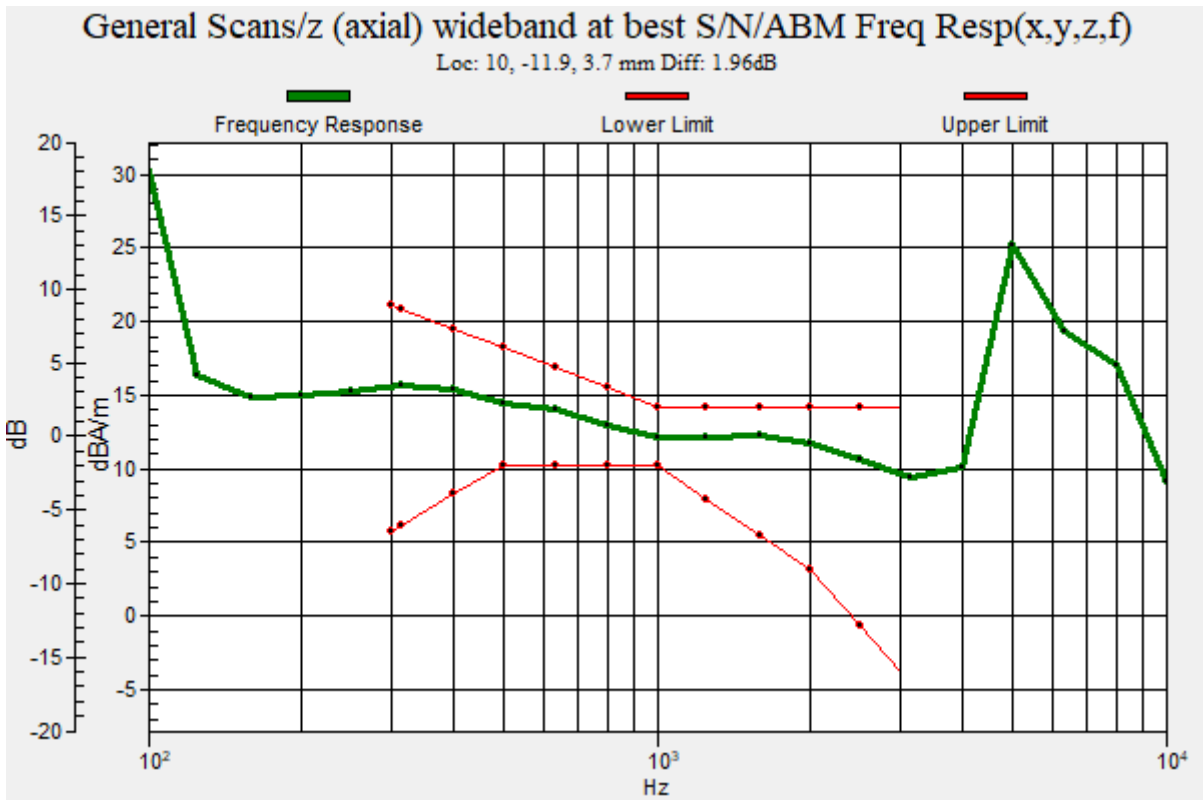



**Plot No.156**  
**802.11n20 MCS0 157ch Bit rate 75 y(transversal)**

**DUT: SM-G991U; Type: Bar**

Communication System: UID 0, WIFI 5GHz (0); Frequency: 5785 MHz;Duty Cycle: 1:1  
Medium parameters used:  $\sigma = 0$  S/m,  $\epsilon_r = 1$ ;  $\rho = 0$  kg/m<sup>3</sup>  
Phantom section: TCoil Section

DASY Configuration:

- Probe: AM1DV3 - 3049; ;
- Sensor-Surface: 0mm (Fix Surface)
- Electronics: DAE4 Sn466; Calibrated: 2020-04-22
- Phantom: HAC Test Arch with AMCC
- Measurement SW: DASY52, Version 52.10 (4);

**T-Coil scan (scan for ANSI C63.19-2007 & 2011 compliance)/General Scans/y (transversal) 4.2mm 50**

**x 50/ABM Signal(x,y,z) (13x13x1):** Measurement grid: dx=10mm, dy=10mm

Signal Type: Audio File (.wav) 48k\_voice\_1kHz\_1s.wav

Output Gain: 18.9

Measure Window Start: 300ms

Measure Window Length: 1000ms

BWC applied: 0.16 dB

Device Reference Point: 0, 0, -6.3 mm

**Cursor:**

ABM1 comp = 3.53 dBA/m

BWC Factor = 0.16 dB

Location: 8.3, -16.7, 3.7 mm

**Cursor:**

ABM2 = -45.34 dBA/m

Location: 8.3, -16.7, 3.7 mm

**Cursor:**

ABM1/ABM2 = 48.87 dB

ABM1 comp = 3.53 dBA/m

BWC Factor = 0.16 dB

Location: 8.3, -16.7, 3.7 mm

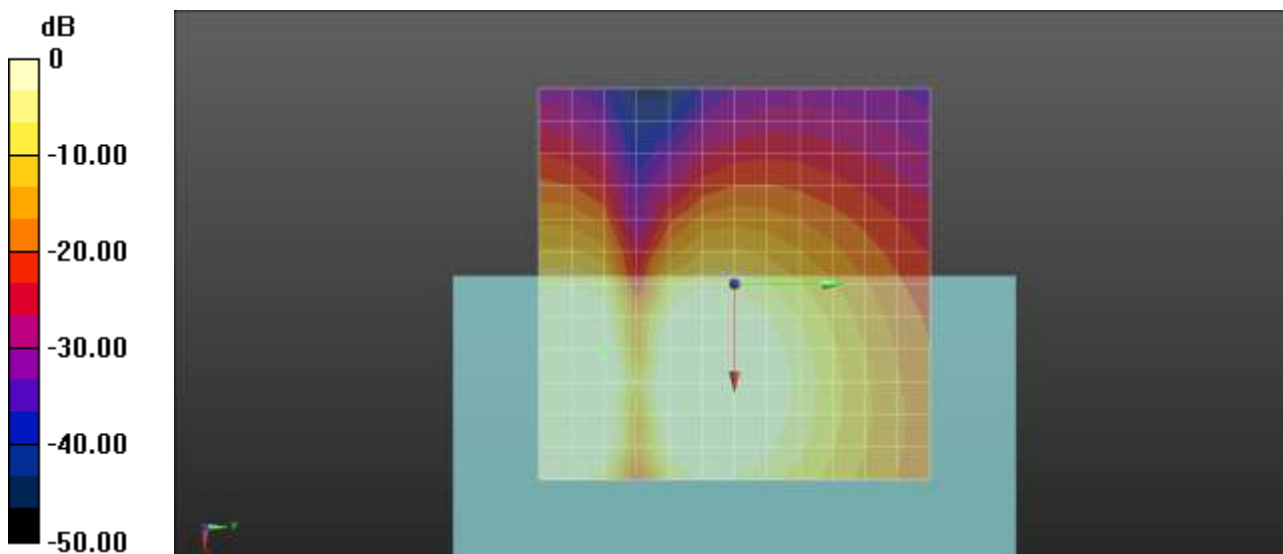

0 dB = 1.000 A/m = 0.00 dBA/m

**Plot No.157**  
**EVDO BC0 Rev.A 384ch Bit rate 75 z(axial)**

**DUT: SM-G991U; Type: Bar**

Communication System: UID 0, CDMA 835MHz FCC (0); Frequency: 836.52 MHz;Duty Cycle: 1:1  
Medium parameters used:  $\sigma = 0$  S/m,  $\epsilon_r = 1$ ;  $\rho = 0$  kg/m<sup>3</sup>  
Phantom section: TCoil Section

DASY Configuration:

- Probe: AM1DV3 - 3049; ;
- Sensor-Surface: 0mm (Fix Surface)
- Electronics: DAE4 Sn466; Calibrated: 2020-04-22
- Phantom: HAC Test Arch with AMCC
- Measurement SW: DASY52, Version 52.10 (4);

**T-Coil scan (scan for ANSI C63.19-2007 & 2011 compliance)/General Scans/z (axial) 4.2mm 50 x 50/ABM Signal(x,y,z) (13x13x1):** Measurement grid: dx=10mm, dy=10mm  
Signal Type: Audio File (.wav) 48k\_voice\_1kHz\_1s.wav  
Output Gain: 18.9  
Measure Window Start: 300ms  
Measure Window Length: 3000ms  
BWC applied: 0.15 dB  
Device Reference Point: 0, 0, -6.3 mm

**Cursor:**  
ABM1 comp = 5.41 dBA/m  
BWC Factor = 0.15 dB  
Location: 4.2, -12.5, 3.7 mm

**Cursor:**  
ABM2 = -42.01 dBA/m  
Location: 4.2, -12.5, 3.7 mm

**Cursor:**  
ABM1/ABM2 = 47.42 dB  
ABM1 comp = 5.41 dBA/m  
BWC Factor = 0.15 dB  
Location: 4.2, -12.5, 3.7 mm

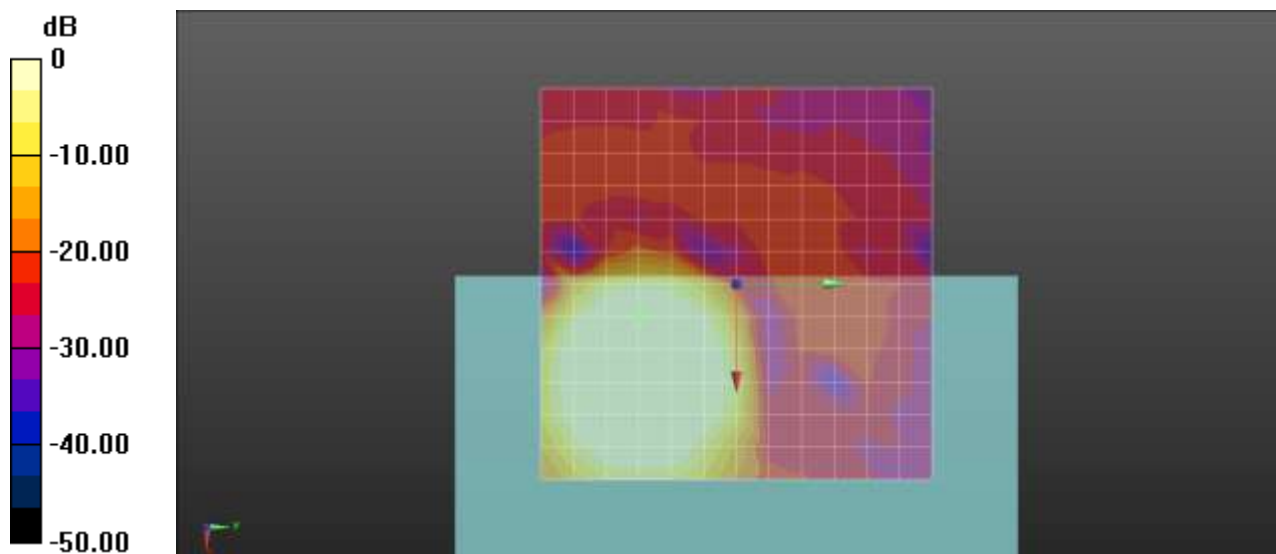

0 dB = 1.000 A/m = 0.00 dBA/m

**Plot No.158**  
**EVDO BC0 Rev.A 384ch Bit rate 75 Freq.Response**

**DUT: SM-G991U; Type: Bar**

Communication System: UID 0, CDMA 835MHz FCC (0); Frequency: 836.52 MHz;Duty Cycle: 1:1  
Medium parameters used:  $\sigma = 0$  S/m,  $\epsilon_r = 1$ ;  $\rho = 0$  kg/m<sup>3</sup>  
Phantom section: TCoil Section

**T-Coil scan (scan for ANSI C63.19-2007 & 2011 compliance)/General Scans/z (axial) wideband at best S/N/ABM Freq Resp(x,y,z,f) (1x1x1):** Measurement grid: dx=10mm, dy=10mm  
Signal Type: Audio File (.wav) 48k\_Normal\_51s new.wav  
Output Gain: 57.55  
Measure Window Start: 300ms  
Measure Window Length: 51000ms  
BWC applied: 9.48 dB  
Device Reference Point: 0, 0, -6.3 mm

Category	Telephone parameters WD signal quality [(signal+noise)-to-noise ratio in decibels]
Category T1	0 dB to 10 dB
Category T2	10 dB to 20 dB
Category T3	20 dB to 30 dB
Category T4	> 30 dB

**Cursor:**  
Diff = 2.00 dB  
BWC Factor = 9.48 dB  
Location: 4.3, -12.2, 3.7 mm

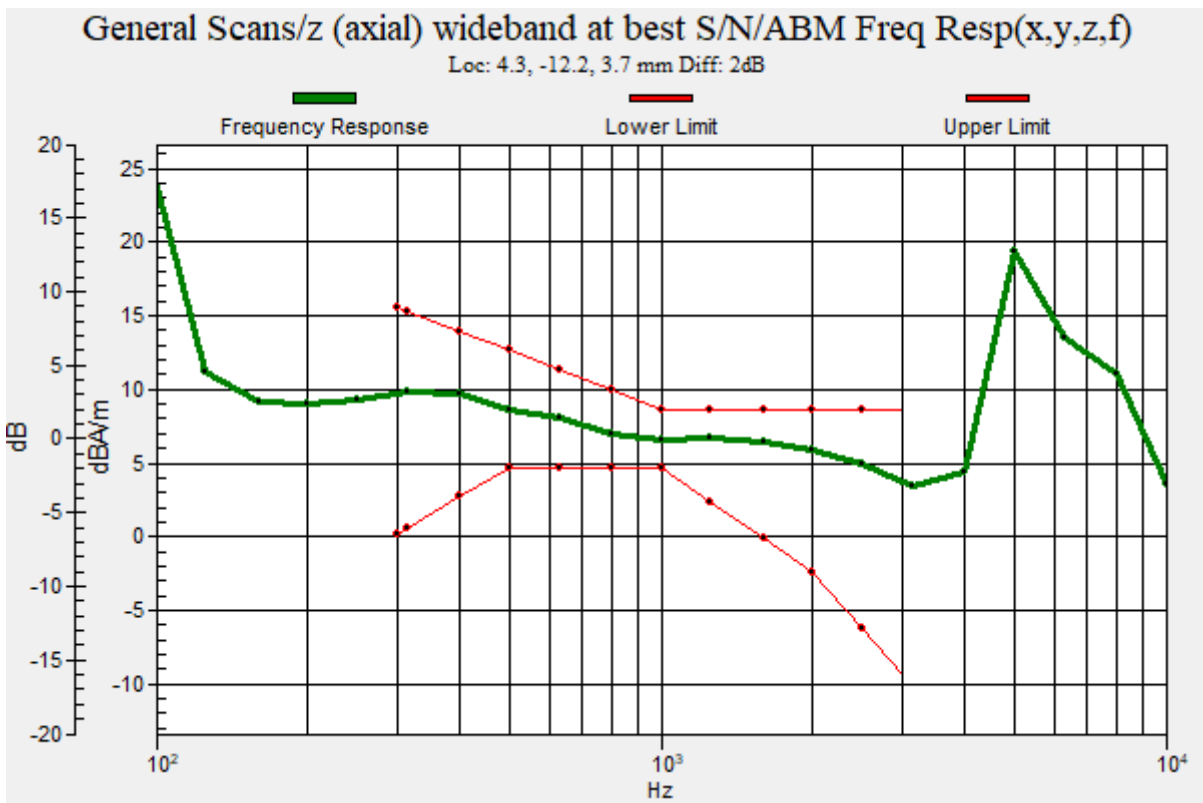

**Plot No.159**  
**EVDO BC0 Rev.A 384ch Bit rate 75 y(transversal)**

**DUT: SM-G991U; Type: Bar**

Communication System: UID 0, CDMA 835MHz FCC (0); Frequency: 836.52 MHz;Duty Cycle: 1:1  
Medium parameters used:  $\sigma = 0$  S/m,  $\epsilon_r = 1$ ;  $\rho = 0$  kg/m<sup>3</sup>  
Phantom section: TCoil Section

DASY Configuration:

- Probe: AM1DV3 - 3049; ;
- Sensor-Surface: 0mm (Fix Surface)
- Electronics: DAE4 Sn466; Calibrated: 2020-04-22
- Phantom: HAC Test Arch with AMCC
- Measurement SW: DASY52, Version 52.10 (4);

**T-Coil scan (scan for ANSI C63.19-2007 & 2011 compliance)/General Scans/y (transversal) 4.2mm 50**

**x 50/ABM Signal(x,y,z) (13x13x1):** Measurement grid: dx=10mm, dy=10mm

Signal Type: Audio File (.wav) 48k\_voice\_1kHz\_1s.wav

Output Gain: 18.9

Measure Window Start: 300ms

Measure Window Length: 3000ms

BWC applied: 0.15 dB

Device Reference Point: 0, 0, -6.3 mm

**Cursor:**

ABM1 comp = 2.72 dBA/m

BWC Factor = 0.15 dB

Location: 8.3, -20.8, 3.7 mm

**Cursor:**

ABM2 = -44.21 dBA/m

Location: 8.3, -20.8, 3.7 mm

**Cursor:**

ABM1/ABM2 = 46.93 dB

ABM1 comp = 2.72 dBA/m

BWC Factor = 0.15 dB

Location: 8.3, -20.8, 3.7 mm

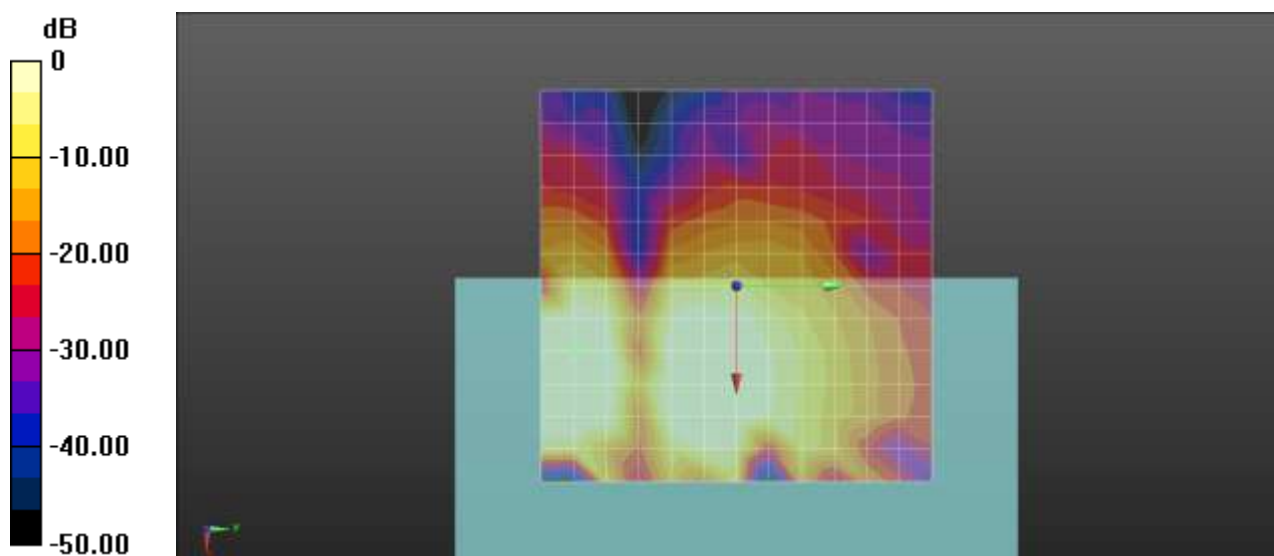

0 dB = 1.000 A/m = 0.00 dBA/m

**Plot No.160**  
**EVDO BC1 Rev.A 600ch Bit rate 75 z(axial)**

**DUT: SM-G991U; Type: Bar**

Communication System: UID 0, CDMA BC1 (0); Frequency: 1880 MHz;Duty Cycle: 1:1  
Medium parameters used:  $\sigma = 0$  S/m,  $\epsilon_r = 1$ ;  $\rho = 0$  kg/m<sup>3</sup>  
Phantom section: TCoil Section

DASY Configuration:

- Probe: AM1DV3 - 3049; ;
- Sensor-Surface: 0mm (Fix Surface)
- Electronics: DAE4 Sn466; Calibrated: 2020-04-22
- Phantom: HAC Test Arch with AMCC
- Measurement SW: DASY52, Version 52.10 (4);

**T-Coil scan (scan for ANSI C63.19-2007 & 2011 compliance)/General Scans/z (axial) 4.2mm 50 x 50/ABM Signal(x,y,z) (13x13x1):** Measurement grid: dx=10mm, dy=10mm  
Signal Type: Audio File (.wav) 48k\_voice\_1kHz\_1s.wav  
Output Gain: 18.9  
Measure Window Start: 300ms  
Measure Window Length: 1000ms  
BWC applied: 0.15 dB  
Device Reference Point: 0, 0, -6.3 mm

**Cursor:**  
ABM1 comp = 12.71 dBA/m  
BWC Factor = 0.15 dB  
Location: 8.3, -12.5, 3.7 mm

**Cursor:**  
ABM2 = -36.72 dBA/m  
Location: 8.3, -12.5, 3.7 mm

**Cursor:**  
ABM1/ABM2 = 49.43 dB  
ABM1 comp = 12.71 dBA/m  
BWC Factor = 0.15 dB  
Location: 8.3, -12.5, 3.7 mm

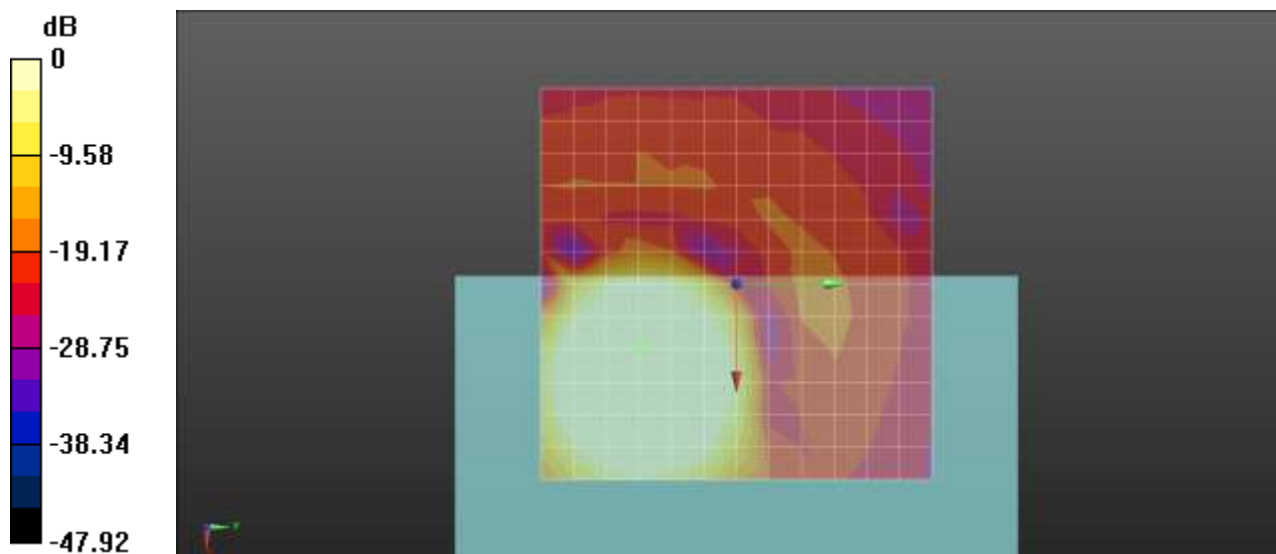

0 dB = 1.000 A/m = 0.00 dBA/m

**Plot No.161**  
**EVDO BC1 Rev.A 600ch Bit rate 75 Freq.Response**

**DUT: SM-G991U; Type: Bar**

Communication System: UID 0, CDMA BC1 (0); Frequency: 1880 MHz;Duty Cycle: 1:1  
Medium parameters used:  $\sigma = 0$  S/m,  $\epsilon_r = 1$ ;  $\rho = 0$  kg/m<sup>3</sup>  
Phantom section: TCoil Section

**T-Coil scan (scan for ANSI C63.19-2007 & 2011 compliance)/General Scans/z (axial) wideband at best S/N/ABM Freq Resp(x,y,z,f) (1x1x1):** Measurement grid: dx=10mm, dy=10mm  
Signal Type: Audio File (.wav) 48k\_Normal\_51s new.wav  
Output Gain: 57.55  
Measure Window Start: 300ms  
Measure Window Length: 51000ms  
BWC applied: 9.48 dB  
Device Reference Point: 0, 0, -6.3 mm

Category	Telephone parameters WD signal quality [(signal+noise)-to-noise ratio in decibels]
Category T1	0 dB to 10 dB
Category T2	10 dB to 20 dB
Category T3	20 dB to 30 dB
Category T4	> 30 dB

**Cursor:**  
Diff = 2.00 dB  
BWC Factor = 9.48 dB  
Location: 8.8, -10.5, 3.7 mm

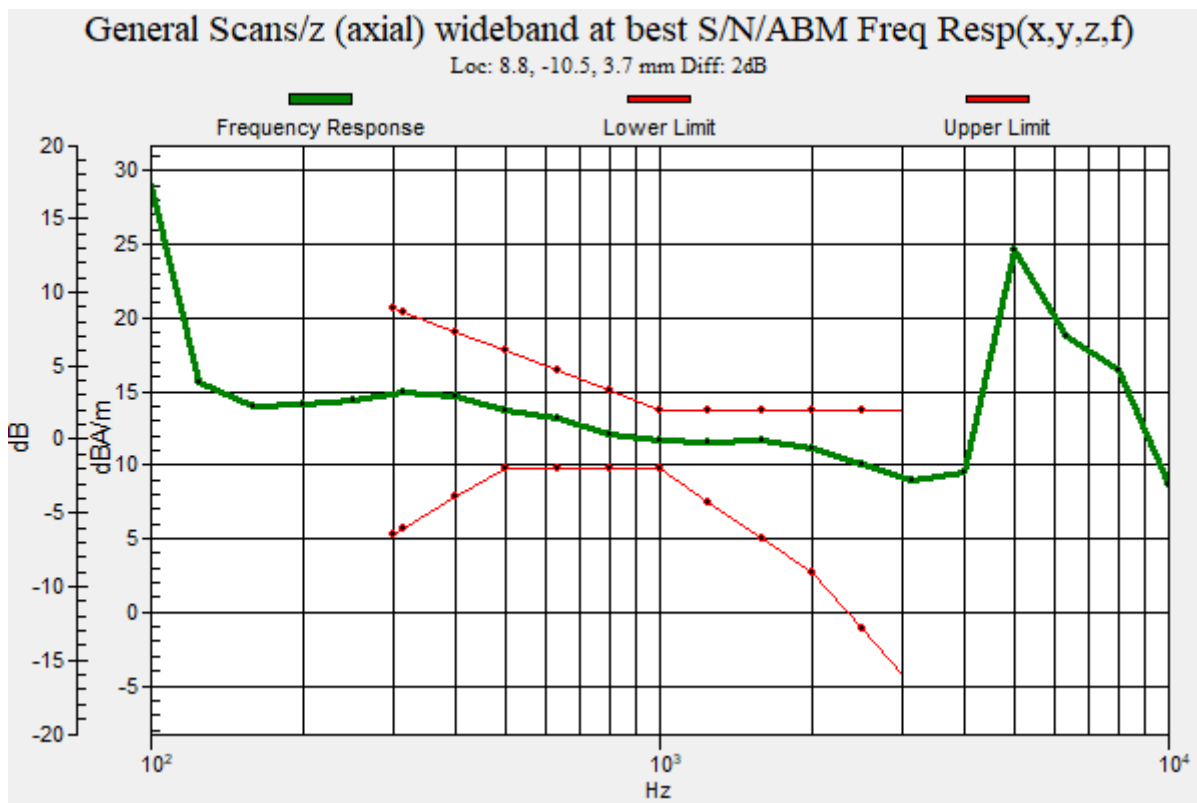

**Plot No.162**  
**EVDO BC1 Rev.A 600ch Bit rate 75 y(transversal)**

**DUT: SM-G991U; Type: Bar**

Communication System: UID 0, CDMA BC1 (0); Frequency: 1880 MHz;Duty Cycle: 1:1  
Medium parameters used:  $\sigma = 0$  S/m,  $\epsilon_r = 1$ ;  $\rho = 0$  kg/m<sup>3</sup>  
Phantom section: TCoil Section

DASY Configuration:

- Probe: AM1DV3 - 3049; ;
- Sensor-Surface: 0mm (Fix Surface)
- Electronics: DAE4 Sn466; Calibrated: 2020-04-22
- Phantom: HAC Test Arch with AMCC
- Measurement SW: DASY52, Version 52.10 (4);

**T-Coil scan (scan for ANSI C63.19-2007 & 2011 compliance)/General Scans/y (transversal) 4.2mm 50**

**x 50/ABM Signal(x,y,z) (13x13x1):** Measurement grid: dx=10mm, dy=10mm

Signal Type: Audio File (.wav) 48k\_voice\_1kHz\_1s.wav

Output Gain: 18.9

Measure Window Start: 300ms

Measure Window Length: 1000ms

BWC applied: 0.15 dB

Device Reference Point: 0, 0, -6.3 mm

**Cursor:**

ABM1 comp = 5.19 dBA/m

BWC Factor = 0.15 dB

Location: 8.3, -20.8, 3.7 mm

**Cursor:**

ABM2 = -44.56 dBA/m

Location: 8.3, -20.8, 3.7 mm

**Cursor:**

ABM1/ABM2 = 49.75 dB

ABM1 comp = 5.19 dBA/m

BWC Factor = 0.15 dB

Location: 8.3, -20.8, 3.7 mm

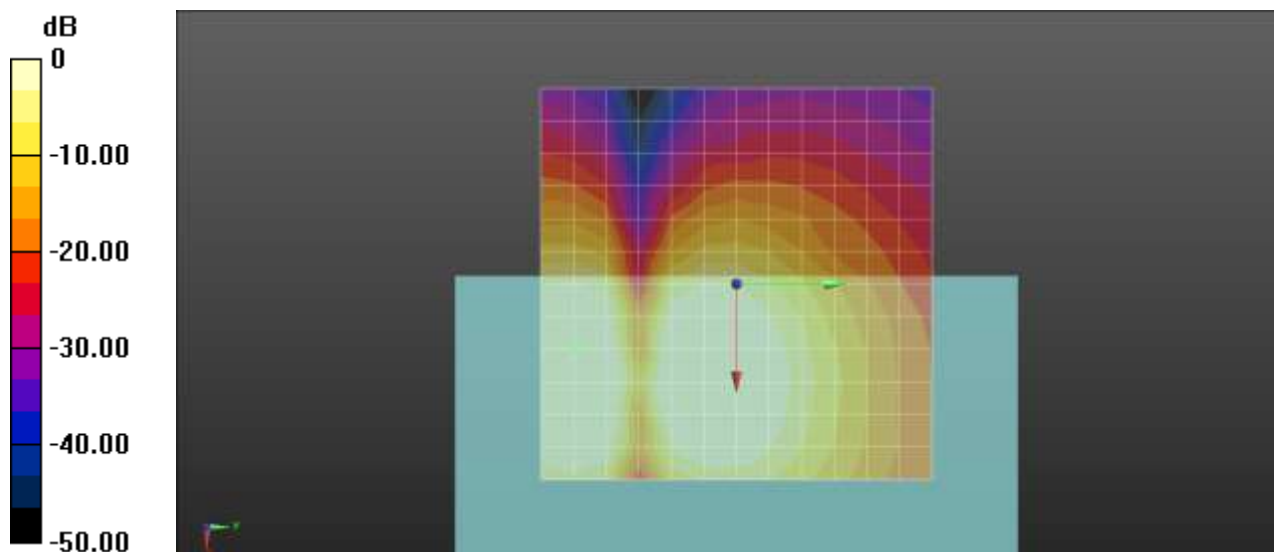

0 dB = 1.000 A/m = 0.00 dBA/m

**Plot No.163**  
**EVDO BC10 Rev.A 560ch Bit rate 75 z(axial)**

**DUT: SM-G991U; Type: Bar**

Communication System: UID 0, BC10 (0); Frequency: 820 MHz;Duty Cycle: 1:1  
Medium parameters used:  $\sigma = 0$  S/m,  $\epsilon_r = 1$ ;  $\rho = 0$  kg/m<sup>3</sup>  
Phantom section: TCoil Section

DASY Configuration:

- Probe: AM1DV3 - 3049; ;
- Sensor-Surface: 0mm (Fix Surface)
- Electronics: DAE4 Sn466; Calibrated: 2020-04-22
- Phantom: HAC Test Arch with AMCC
- Measurement SW: DASY52, Version 52.10 (4);

**T-Coil scan (scan for ANSI C63.19-2007 & 2011 compliance)/General Scans/z (axial) 4.2mm 50 x 50/ABM Signal(x,y,z) (13x13x1):** Measurement grid: dx=10mm, dy=10mm  
Signal Type: Audio File (.wav) 48k\_voice\_1kHz\_1s.wav  
Output Gain: 18.9  
Measure Window Start: 300ms  
Measure Window Length: 3000ms  
BWC applied: 0.15 dB  
Device Reference Point: 0, 0, -6.3 mm

**Cursor:**  
ABM1 comp = 8.42 dBA/m  
BWC Factor = 0.15 dB  
Location: 8.3, -8.3, 3.7 mm

**Cursor:**  
ABM2 = -38.94 dBA/m  
Location: 8.3, -8.3, 3.7 mm

**Cursor:**  
ABM1/ABM2 = 47.37 dB  
ABM1 comp = 8.42 dBA/m  
BWC Factor = 0.15 dB  
Location: 8.3, -8.3, 3.7 mm

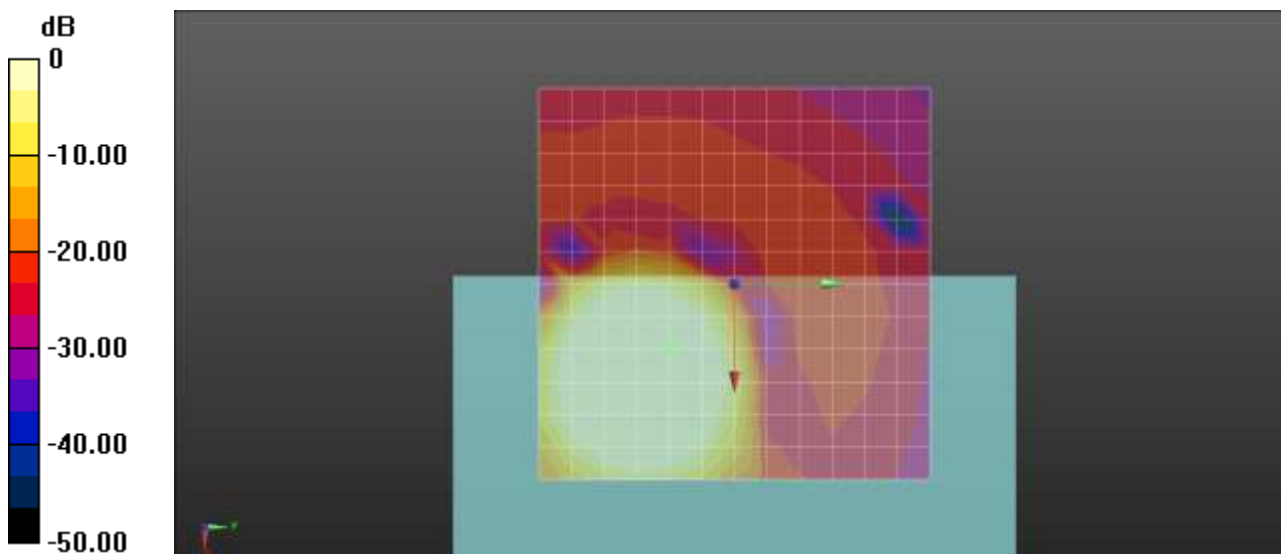

0 dB = 1.000 A/m = 0.00 dBA/m



**Plot No.164**  
**EVDO BC10 Rev.A 560ch Bit rate 75 Freq.Response**

**DUT: SM-G991U; Type: Bar**

Communication System: UID 0, BC10 (0); Frequency: 820 MHz;Duty Cycle: 1:1  
Medium parameters used:  $\sigma = 0$  S/m,  $\epsilon_r = 1$ ;  $\rho = 0$  kg/m<sup>3</sup>  
Phantom section: TCoil Section

**T-Coil scan (scan for ANSI C63.19-2007 & 2011 compliance)/General Scans/z (axial) wideband at best S/N/ABM Freq Resp(x,y,z,f) (1x1x1):** Measurement grid: dx=10mm, dy=10mm  
Signal Type: Audio File (.wav) 48k\_Normal\_51s new.wav  
Output Gain: 57.55  
Measure Window Start: 300ms  
Measure Window Length: 51000ms  
BWC applied: 9.48 dB  
Device Reference Point: 0, 0, -6.3 mm

Category	Telephone parameters WD signal quality [(signal+noise)-to-noise ratio in decibels]
Category T1	0 dB to 10 dB
Category T2	10 dB to 20 dB
Category T3	20 dB to 30 dB
Category T4	> 30 dB

**Cursor:**  
Diff = 2.00 dB  
BWC Factor = 9.48 dB  
Location: 9.5, -9.8, 3.7 mm

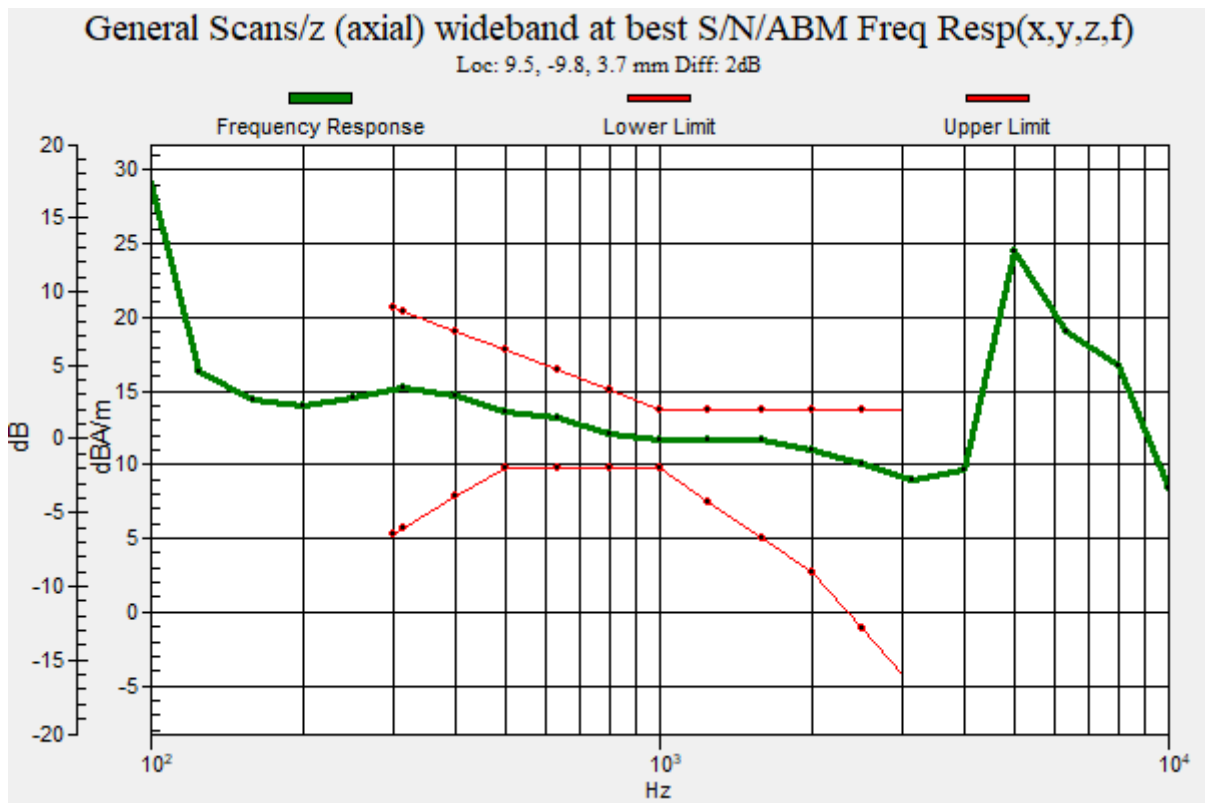

**Plot No.165**  
**EVDO BC10 560ch Bit rate 75 y(transversal)**

**DUT: SM-G991U; Type: Bar**

Communication System: UID 0, BC10 (0); Frequency: 820 MHz;Duty Cycle: 1:1  
Medium parameters used:  $\sigma = 0$  S/m,  $\epsilon_r = 1$ ;  $\rho = 0$  kg/m<sup>3</sup>  
Phantom section: TCoil Section

DASY Configuration:

- Probe: AM1DV3 - 3049; ;
- Sensor-Surface: 0mm (Fix Surface)
- Electronics: DAE4 Sn466; Calibrated: 2020-04-22
- Phantom: HAC Test Arch with AMCC
- Measurement SW: DASY52, Version 52.10 (4);

**T-Coil scan (scan for ANSI C63.19-2007 & 2011 compliance)/General Scans/y (transversal) 4.2mm 50**

**x 50/ABM Signal(x,y,z) (13x13x1):** Measurement grid: dx=10mm, dy=10mm

Signal Type: Audio File (.wav) 48k\_voice\_1kHz\_1s.wav

Output Gain: 18.9

Measure Window Start: 300ms

Measure Window Length: 3000ms

BWC applied: 0.15 dB

Device Reference Point: 0, 0, -6.3 mm

**Cursor:**

ABM1 comp = 3.28 dBA/m

BWC Factor = 0.15 dB

Location: 8.3, -20.8, 3.7 mm

**Cursor:**

ABM2 = -44.04 dBA/m

Location: 8.3, -20.8, 3.7 mm

**Cursor:**

ABM1/ABM2 = 47.32 dB

ABM1 comp = 3.28 dBA/m

BWC Factor = 0.15 dB

Location: 8.3, -20.8, 3.7 mm

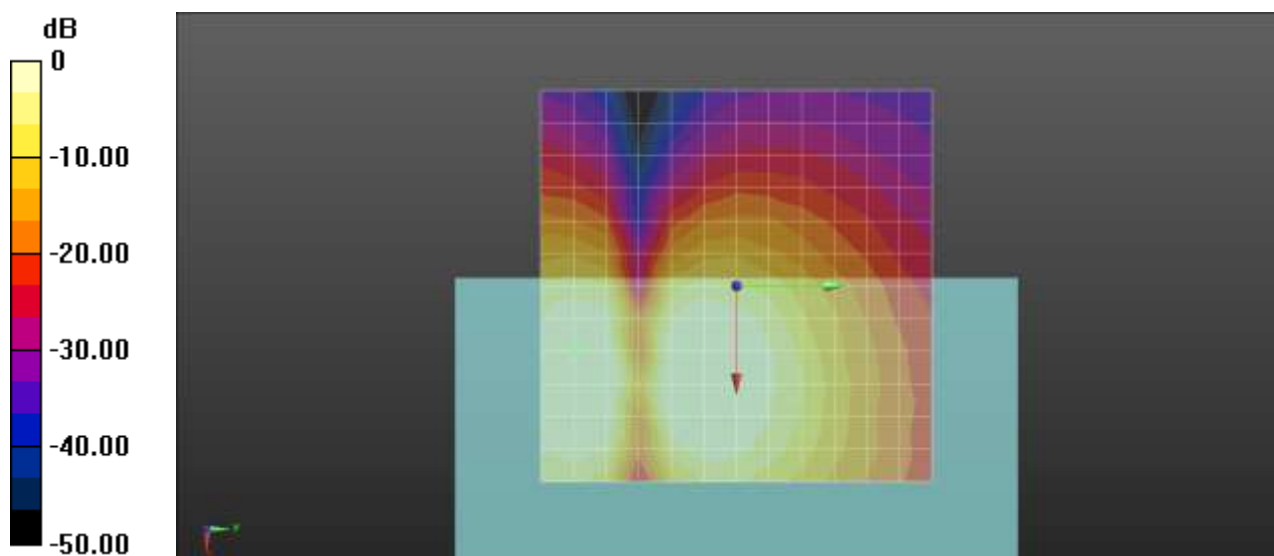

0 dB = 1.000 A/m = 0.00 dBA/m

**Plot No.166**

**NR Band 2 CP-OFDM 16QAM 20MHz 1RB 104offset 376000ch z(axial)**

**DUT: SM-G991U; Type: Bar**

Communication System: UID 0, NR Band 2 (0); Frequency: 1880 MHz;Duty Cycle: 1:1  
Medium parameters used:  $\sigma = 0$  S/m,  $\epsilon_r = 1$ ;  $\rho = 0$  kg/m<sup>3</sup>  
Phantom section: TCoil Section

DASY Configuration:

- Probe: AM1DV3 - 3049; ;
- Sensor-Surface: 0mm (Fix Surface)
- Electronics: DAE4 Sn466; Calibrated: 2020-04-22
- Phantom: HAC Test Arch with AMCC
- Measurement SW: DASY52, Version 52.10 (4);

**T-Coil scan (scan for ANSI C63.19-2007 & 2011 compliance)/General Scans/z (axial) 4.2mm 50 x 50/ABM Noise Spectrum(x,y,z,f) (13x13x1):** Measurement grid: dx=10mm, dy=10mm

Signal Type: Audio File (.wav) 48k\_voice\_1kHz\_1s.wav  
Output Gain: 18.9  
Measure Window Start: 300ms  
Measure Window Length: 1000ms  
Device Reference Point: 0, 0, -6.3 mm

**Cursor:**

ABM = -42.09 dBA/m  
Location: 8.3, -12.5, 3.7 mm

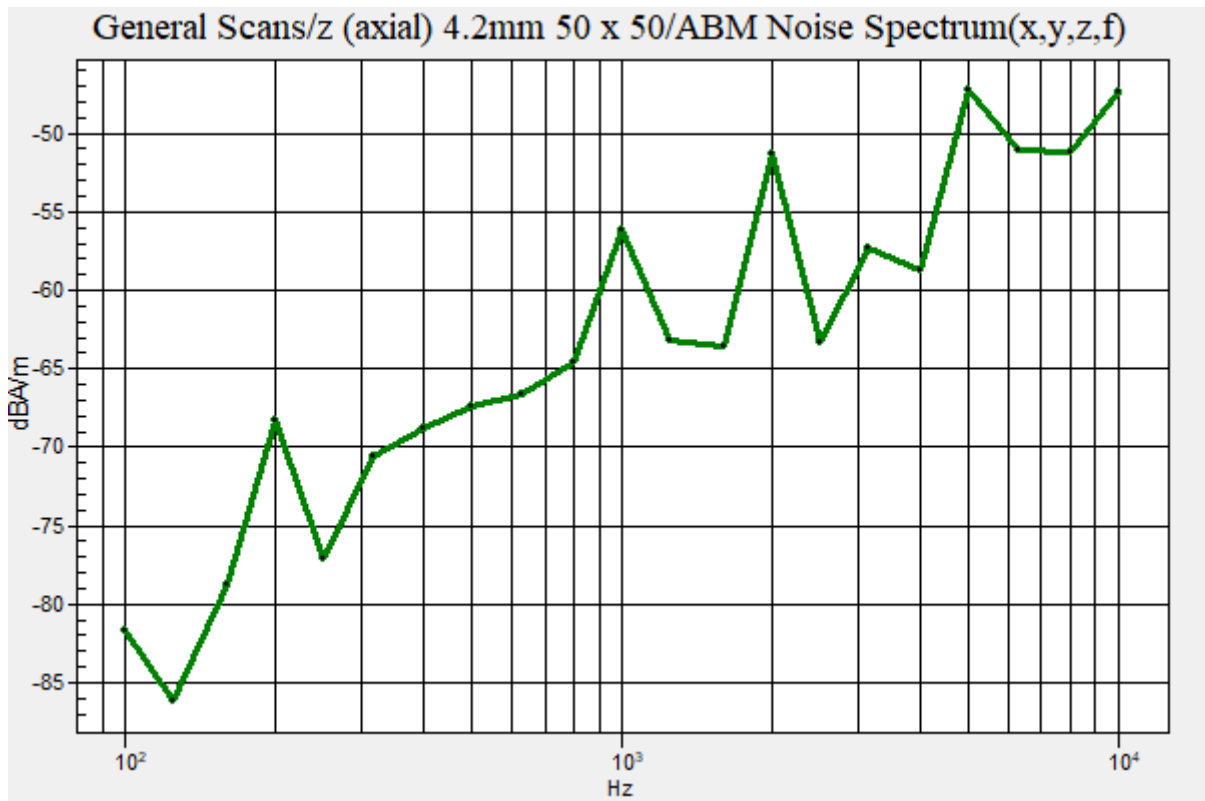

**Plot No.167**

**NR Band 2 CP-OFDM 16QAM 20MHz 1RB 104offset 376000ch y(transversal)**

**DUT: SM-G991U; Type: Bar**

Communication System: UID 0, NR Band 2 (0); Frequency: 1880 MHz;Duty Cycle: 1:1  
Medium parameters used:  $\sigma = 0$  S/m,  $\epsilon_r = 1$ ;  $\rho = 0$  kg/m<sup>3</sup>  
Phantom section: TCoil Section

DASY Configuration:

- Probe: AM1DV3 - 3049; ;
- Sensor-Surface: 0mm (Fix Surface)
- Electronics: DAE4 Sn466; Calibrated: 2020-04-22
- Phantom: HAC Test Arch with AMCC
- Measurement SW: DASY52, Version 52.10 (4);

**T-Coil scan (scan for ANSI C63.19-2007 & 2011 compliance)/General Scans/y (transversal) 4.2mm 50**

**x 50/ABM Noise Spectrum(x,y,z,f) (13x13x1):** Measurement grid: dx=10mm, dy=10mm

Signal Type: Audio File (.wav) 48k\_voice\_1kHz\_1s.wav

Output Gain: 18.9

Measure Window Start: 300ms

Measure Window Length: 1000ms

Device Reference Point: 0, 0, -6.3 mm

**Cursor:**

ABM = -52.78 dBA/m

Location: 8.3, -20.8, 3.7 mm

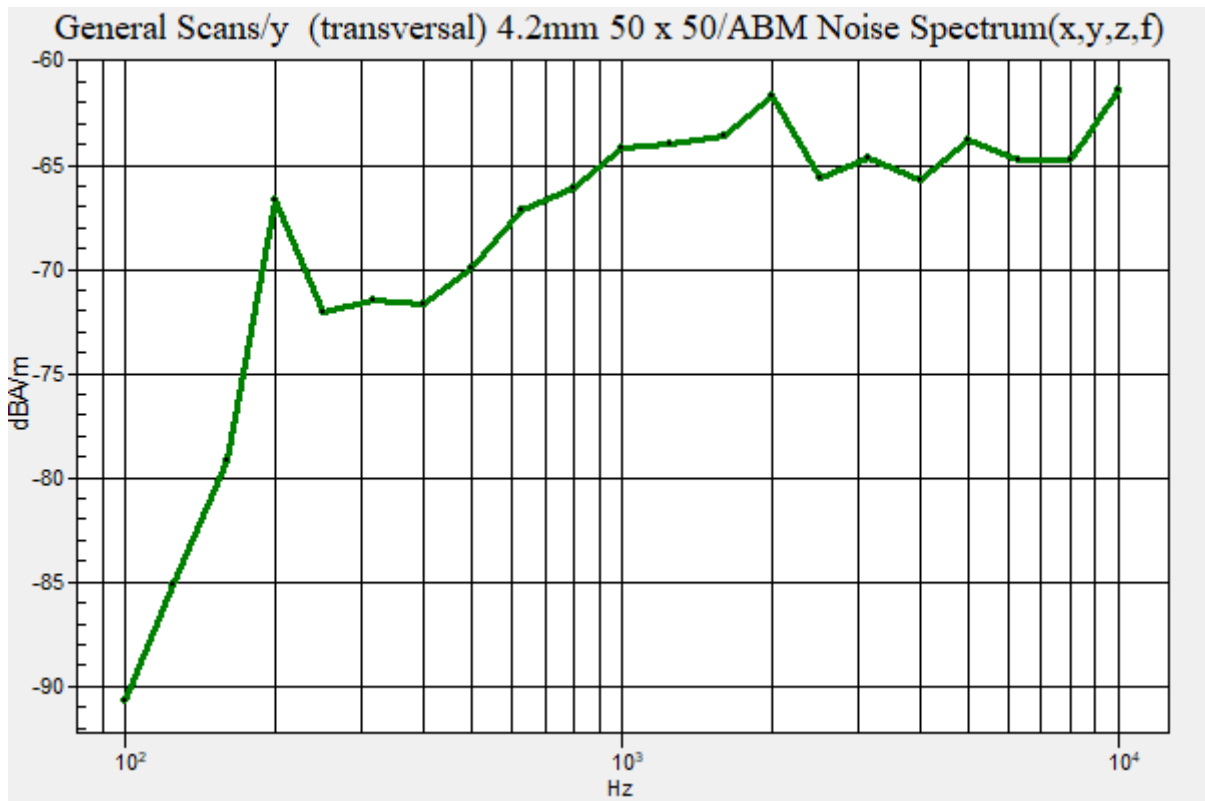

**Plot No.168**

**NR Band 5 CP-OFDM 16QAM 20MHz 1RB 104offset 167300ch z(axial)**

**DUT: SM-G991U; Type: Bar**

Communication System: UID 0, NR Band 5 (0); Frequency: 836.5 MHz;Duty Cycle: 1:1  
Medium parameters used:  $\sigma = 0$  S/m,  $\epsilon_r = 1$ ;  $\rho = 0$  kg/m<sup>3</sup>  
Phantom section: TCoil Section

DASY Configuration:

- Probe: AM1DV3 - 3049; ;
- Sensor-Surface: 0mm (Fix Surface)
- Electronics: DAE4 Sn466; Calibrated: 2020-04-22
- Phantom: HAC Test Arch with AMCC
- Measurement SW: DASY52, Version 52.10 (4);

**T-Coil scan (scan for ANSI C63.19-2007 & 2011 compliance)/General Scans/z (axial) 4.2mm 50 x 50/ABM Noise Spectrum(x,y,z,f) (13x13x1):** Measurement grid: dx=10mm, dy=10mm

Signal Type: Audio File (.wav) 48k\_voice\_1kHz\_1s.wav  
Output Gain: 18.9  
Measure Window Start: 300ms  
Measure Window Length: 1000ms  
Device Reference Point: 0, 0, -6.3 mm

**Cursor:**

ABM = -46.81 dBA/m  
Location: 8.3, -12.5, 3.7 mm

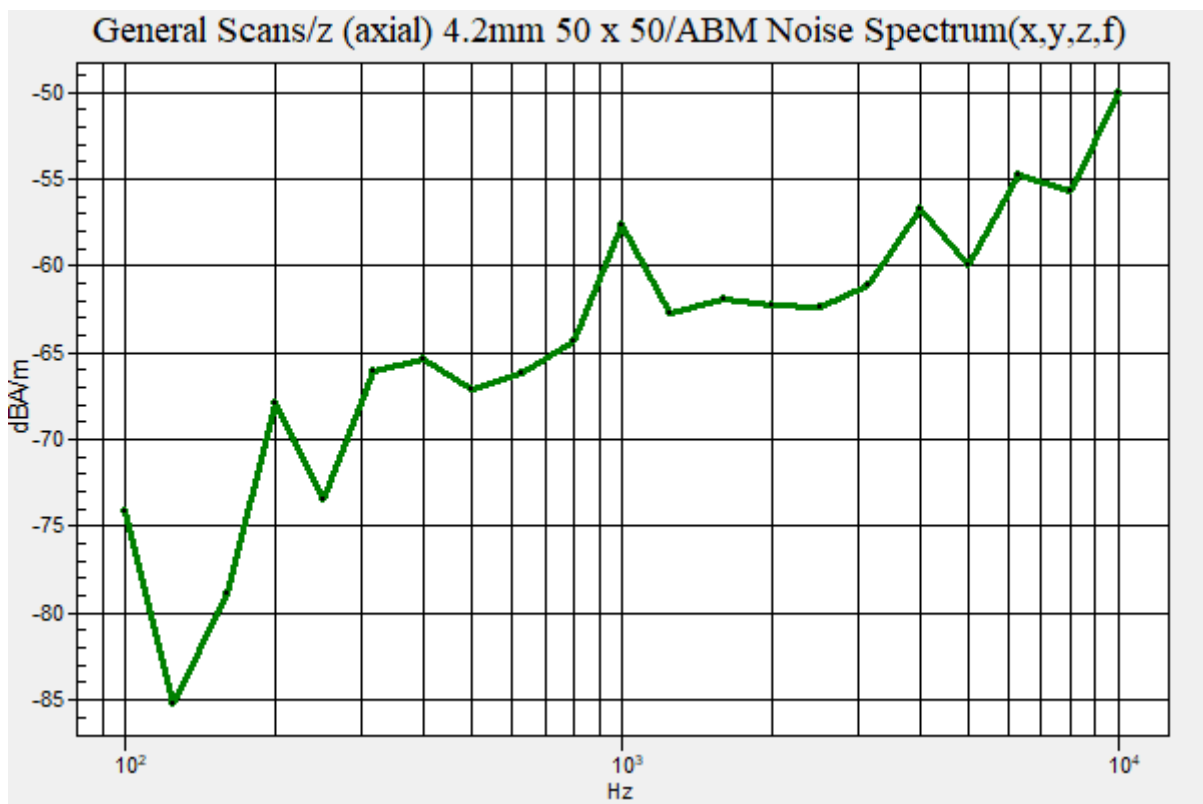

**Plot No.169**

**NR Band 5 CP-OFDM 16QAM 20MHz 1RB 104offset 167300ch y(transversal)**

**DUT: SM-G991U; Type: Bar**

Communication System: UID 0, NR Band 5 (0); Frequency: 836.5 MHz;Duty Cycle: 1:1  
Medium parameters used:  $\sigma = 0$  S/m,  $\epsilon_r = 1$ ;  $\rho = 0$  kg/m<sup>3</sup>  
Phantom section: TCoil Section

DASY Configuration:

- Probe: AM1DV3 - 3049; ;
- Sensor-Surface: 0mm (Fix Surface)
- Electronics: DAE4 Sn466; Calibrated: 2020-04-22
- Phantom: HAC Test Arch with AMCC
- Measurement SW: DASY52, Version 52.10 (4);

**T-Coil scan (scan for ANSI C63.19-2007 & 2011 compliance)/General Scans/y (transversal) 4.2mm 50**

**x 50/ABM Noise Spectrum(x,y,z,f) (13x13x1):** Measurement grid: dx=10mm, dy=10mm

Signal Type: Audio File (.wav) 48k\_voice\_1kHz\_1s.wav

Output Gain: 18.9

Measure Window Start: 300ms

Measure Window Length: 1000ms

Device Reference Point: 0, 0, -6.3 mm

**Cursor:**

ABM = -52.77 dBA/m

Location: 8.3, -20.8, 3.7 mm

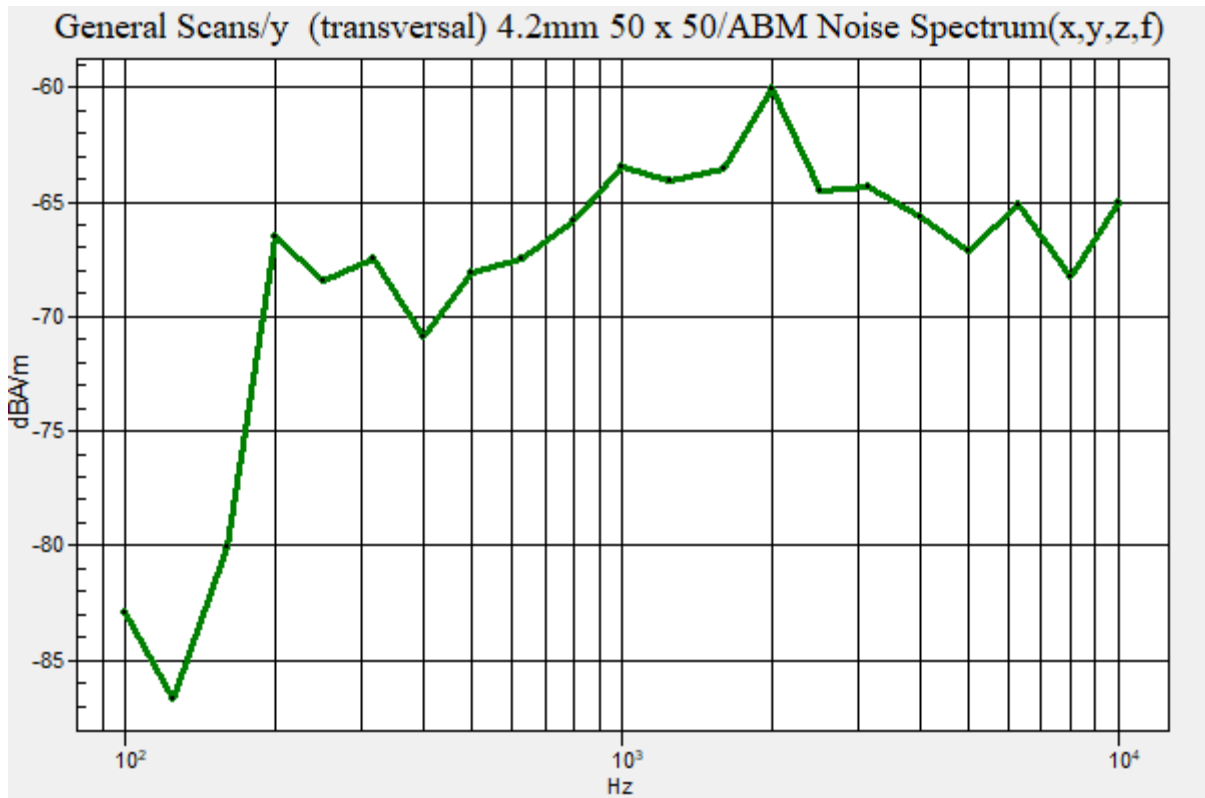

**Plot No.170**  
NR Band 12 CP-OFDM 16QAM 15MHz 1RB 77offset 141500ch z(axial)

**DUT: SM-G991U; Type: Bar**

Communication System: UID 0, NR Band 12 (0); Frequency: 707.5 MHz;Duty Cycle: 1:1  
Medium parameters used:  $\sigma = 0$  S/m,  $\epsilon_r = 1$ ;  $\rho = 0$  kg/m<sup>3</sup>  
Phantom section: TCoil Section

DASY Configuration:

- Probe: AM1DV3 - 3049; ;
- Sensor-Surface: 0mm (Fix Surface)
- Electronics: DAE4 Sn466; Calibrated: 2020-04-22
- Phantom: HAC Test Arch with AMCC
- Measurement SW: DASY52, Version 52.10 (4);

**T-Coil scan (scan for ANSI C63.19-2007 & 2011 compliance)/General Scans/z (axial) 4.2mm 50 x 50/ABM Noise Spectrum(x,y,z,f) (13x13x1):** Measurement grid: dx=10mm, dy=10mm  
Signal Type: Audio File (.wav) 48k\_voice\_1kHz\_1s.wav  
Output Gain: 18.9  
Measure Window Start: 300ms  
Measure Window Length: 1000ms  
Device Reference Point: 0, 0, -6.3 mm

**Cursor:**  
ABM = -48.43 dBA/m  
Location: 8.3, -12.5, 3.7 mm

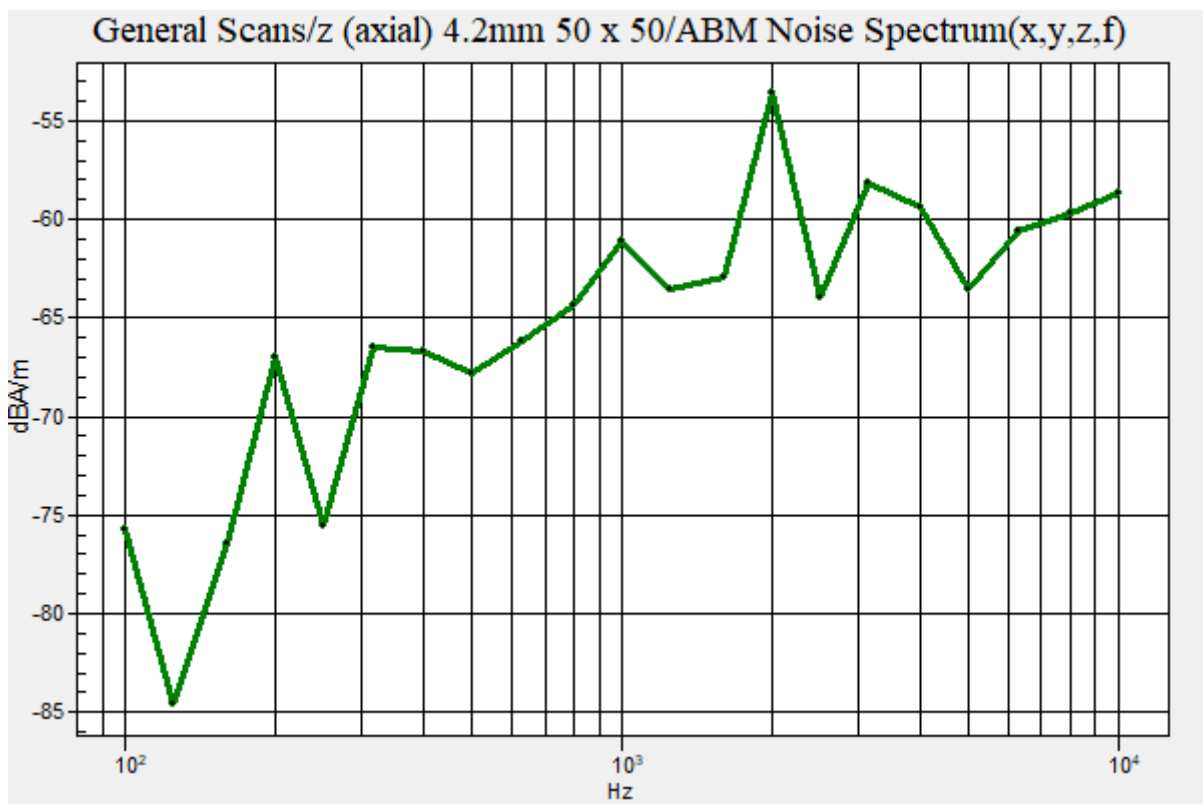

**Plot No.171**  
**NR Band 12 CP-OFDM 16QAM 15MHz 1RB 77offset 141500ch y(transversal)**

**DUT: SM-G991U; Type: Bar**

Communication System: UID 0, NR Band 12 (0); Frequency: 707.5 MHz;Duty Cycle: 1:1  
Medium parameters used:  $\sigma = 0$  S/m,  $\epsilon_r = 1$ ;  $\rho = 0$  kg/m<sup>3</sup>  
Phantom section: TCoil Section

DASY Configuration:

- Probe: AM1DV3 - 3049; ;
- Sensor-Surface: 0mm (Fix Surface)
- Electronics: DAE4 Sn466; Calibrated: 2020-04-22
- Phantom: HAC Test Arch with AMCC
- Measurement SW: DASY52, Version 52.10 (4);

**T-Coil scan (scan for ANSI C63.19-2007 & 2011 compliance)/General Scans/y (transversal) 4.2mm 50 x 50/ABM Noise Spectrum(x,y,z,f) (13x13x1):** Measurement grid: dx=10mm, dy=10mm  
Signal Type: Audio File (.wav) 48k\_voice\_1kHz\_1s.wav  
Output Gain: 18.9  
Measure Window Start: 300ms  
Measure Window Length: 1000ms  
Device Reference Point: 0, 0, -6.3 mm

**Cursor:**  
ABM = -50.80 dBA/m  
Location: 8.3, -25, 3.7 mm

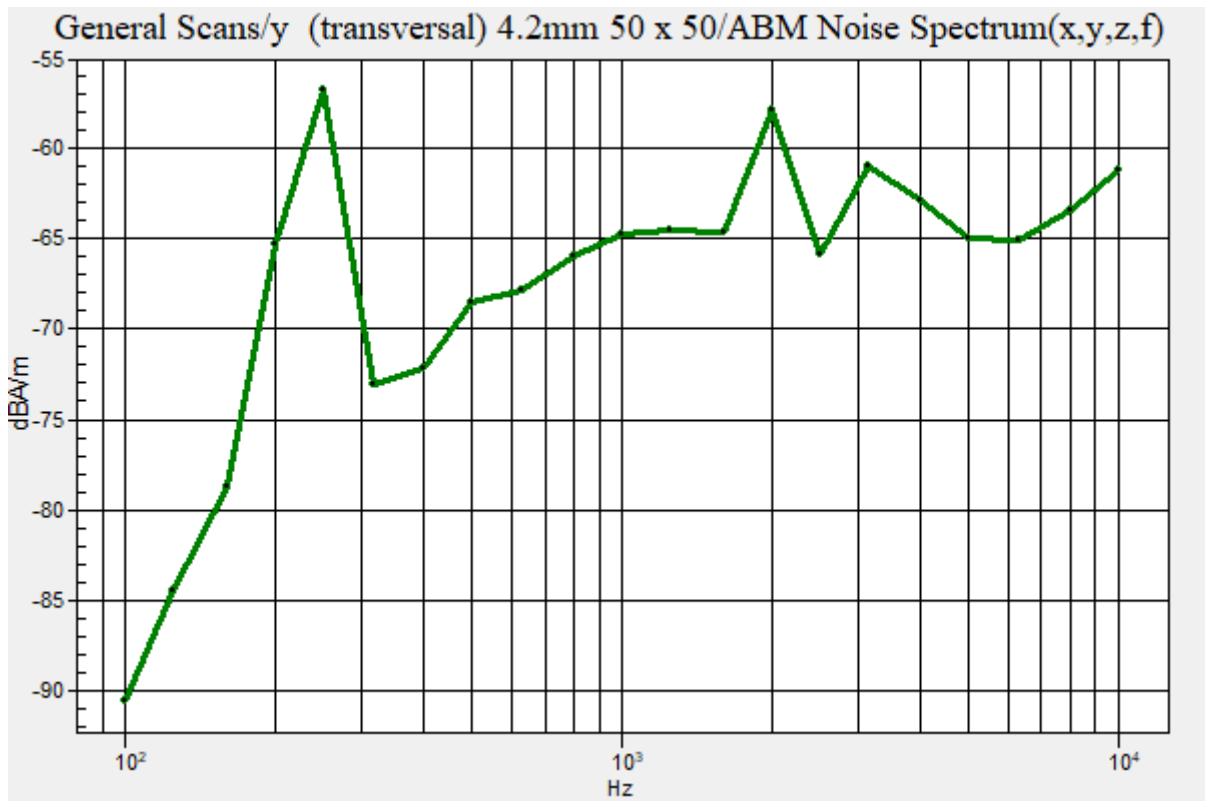



**Plot No.172**  
**NR Band 25 CP-OFDM 16QAM 40MHz 1RB 214offset 376500ch z(axial)**

**DUT: SM-G991U; Type: Bar**

Communication System: UID 0, NR n25 (0); Frequency: 1882.5 MHz;Duty Cycle: 1:1  
Medium parameters used:  $\sigma = 0$  S/m,  $\epsilon_r = 1$ ;  $\rho = 0$  kg/m<sup>3</sup>  
Phantom section: TCoil Section

DASY Configuration:

- Probe: AM1DV3 - 3049; ;
- Sensor-Surface: 0mm (Fix Surface)
- Electronics: DAE4 Sn466; Calibrated: 2020-04-22
- Phantom: HAC Test Arch with AMCC
- Measurement SW: DASY52, Version 52.10 (4);

**T-Coil scan (scan for ANSI C63.19-2007 & 2011 compliance)/General Scans/z (axial) 4.2mm 50 x 50/ABM Noise Spectrum(x,y,z,f) (13x13x1):** Measurement grid: dx=10mm, dy=10mm  
Signal Type: Audio File (.wav) 48k\_voice\_1kHz\_1s.wav  
Output Gain: 18.9  
Measure Window Start: 300ms  
Measure Window Length: 1000ms  
Device Reference Point: 0, 0, -6.3 mm

**Cursor:**  
ABM = -42.74 dBA/m  
Location: 8.3, -12.5, 3.7 mm

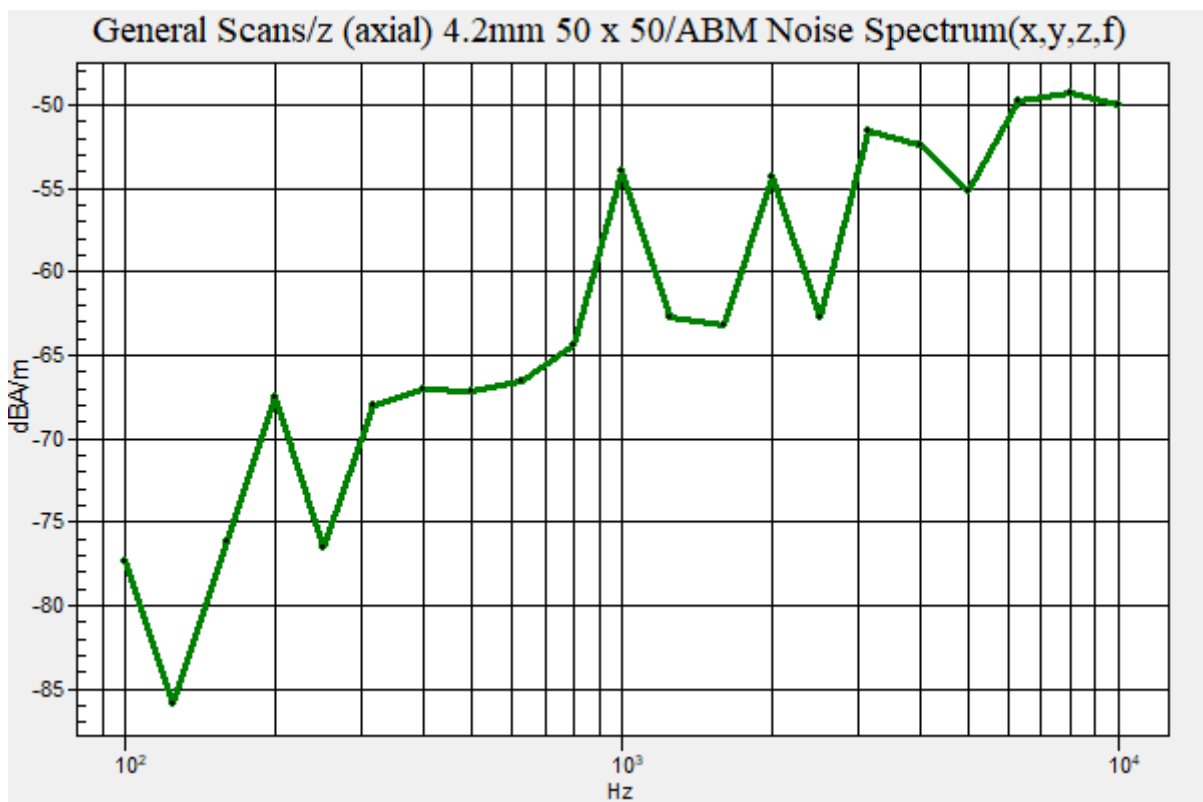

**Plot No.173**

**NR Band 25 CP-OFDM 16QAM 40MHz 1RB 214offset 376500ch y(transversal)**

**DUT: SM-G991U; Type: Bar**

Communication System: UID 0, NR n25 (0); Frequency: 1882.5 MHz;Duty Cycle: 1:1  
Medium parameters used:  $\sigma = 0$  S/m,  $\epsilon_r = 1$ ;  $\rho = 0$  kg/m<sup>3</sup>  
Phantom section: TCoil Section

DASY Configuration:

- Probe: AM1DV3 - 3049; ;
- Sensor-Surface: 0mm (Fix Surface)
- Electronics: DAE4 Sn466; Calibrated: 2020-04-22
- Phantom: HAC Test Arch with AMCC
- Measurement SW: DASY52, Version 52.10 (4);

**T-Coil scan (scan for ANSI C63.19-2007 & 2011 compliance)/General Scans/y (transversal) 4.2mm 50 x 50/ABM Noise Spectrum(x,y,z,f) (13x13x1):**

Measurement grid: dx=10mm, dy=10mm

Signal Type: Audio File (.wav) 48k\_voice\_1kHz\_1s.wav

Output Gain: 18.9

Measure Window Start: 300ms

Measure Window Length: 1000ms

Device Reference Point: 0, 0, -6.3 mm

**Cursor:**

ABM = -52.31 dBA/m

Location: 8.3, -20.8, 3.7 mm

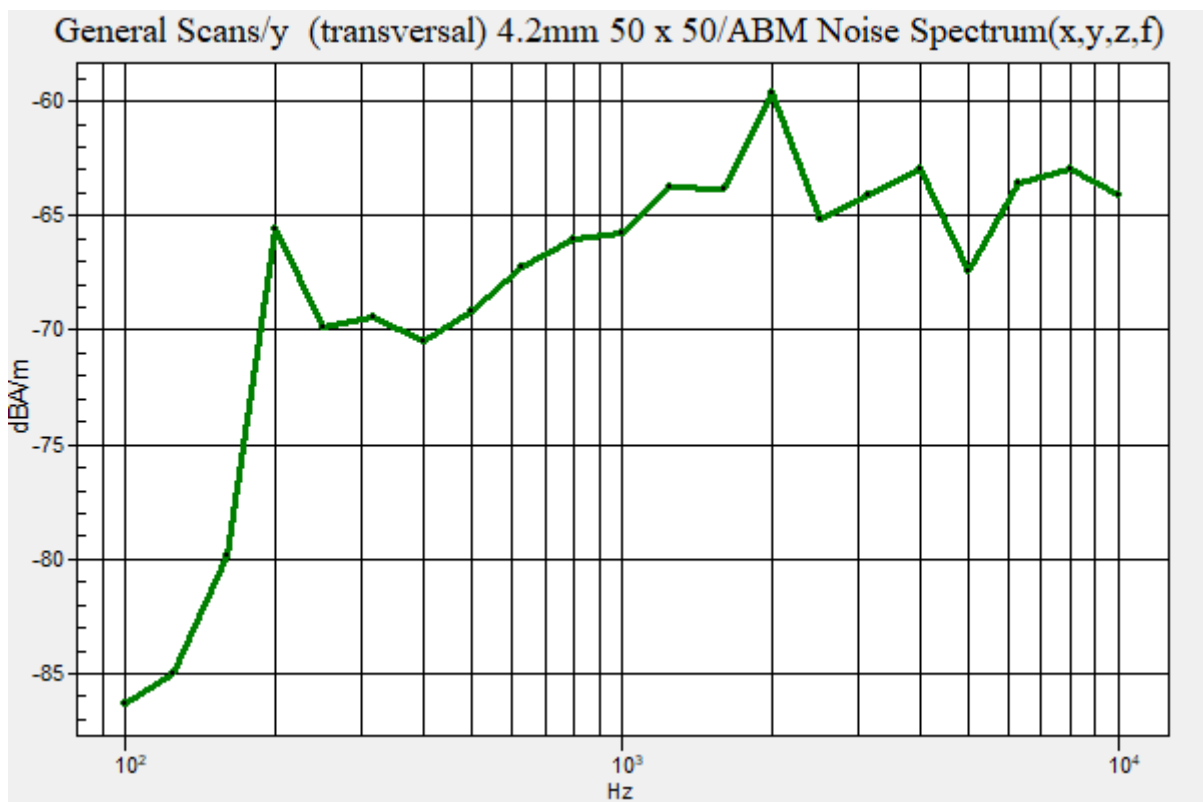

**Plot No.174**  
**NR Band 30 CP-OFDM 16QAM 10MHz 1RB 50offset 462000ch z(axial)**

**DUT: SM-G991U; Type: Bar**

Communication System: UID 0, NR n30 (0); Frequency: 2310 MHz;Duty Cycle: 1:1  
Medium parameters used:  $\sigma = 0$  S/m,  $\epsilon_r = 1$ ;  $\rho = 0$  kg/m<sup>3</sup>  
Phantom section: TCoil Section

DASY Configuration:

- Probe: AM1DV3 - 3049; ;
- Sensor-Surface: 0mm (Fix Surface)
- Electronics: DAE4 Sn466; Calibrated: 2020-04-22
- Phantom: HAC Test Arch with AMCC
- Measurement SW: DASY52, Version 52.10 (4);

**T-Coil scan (scan for ANSI C63.19-2007 & 2011 compliance)/General Scans/z (axial) 4.2mm 50 x 50/ABM Noise Spectrum(x,y,z,f) (13x13x1):** Measurement grid: dx=10mm, dy=10mm  
Signal Type: Audio File (.wav) 48k\_voice\_1kHz\_1s.wav  
Output Gain: 18.9  
Measure Window Start: 300ms  
Measure Window Length: 1000ms  
Device Reference Point: 0, 0, -6.3 mm

**Cursor:**  
ABM = -45.12 dBA/m  
Location: 8.3, -12.5, 3.7 mm

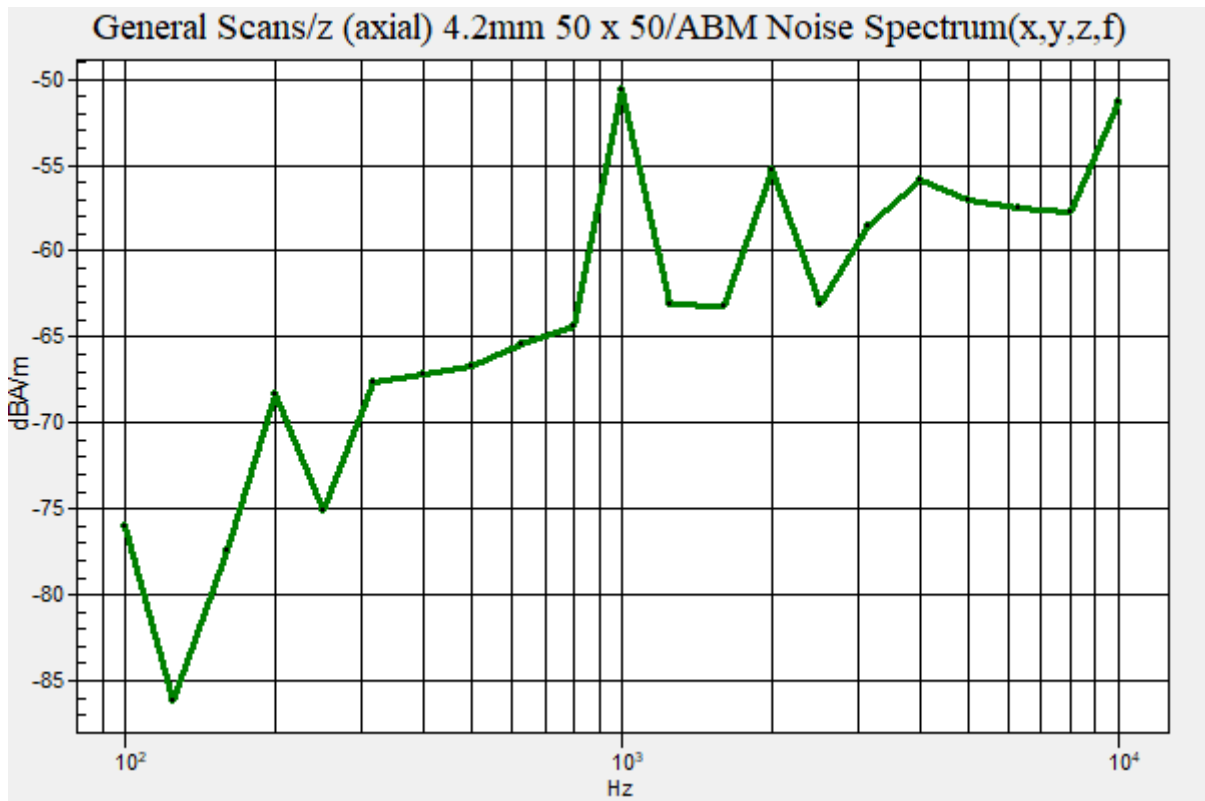

**Plot No.175**  
**NR Band 30 CP-OFDM 16QAM 10MHz 1RB 50offset 462000ch y(transversal)**

**DUT: SM-G991U; Type: Bar**

Communication System: UID 0, NR n30 (0); Frequency: 2310 MHz;Duty Cycle: 1:1  
Medium parameters used:  $\sigma = 0$  S/m,  $\epsilon_r = 1$ ;  $\rho = 0$  kg/m<sup>3</sup>  
Phantom section: TCoil Section

DASY Configuration:

- Probe: AM1DV3 - 3049; ;
- Sensor-Surface: 0mm (Fix Surface)
- Electronics: DAE4 Sn466; Calibrated: 2020-04-22
- Phantom: HAC Test Arch with AMCC
- Measurement SW: DASY52, Version 52.10 (4);

**T-Coil scan (scan for ANSI C63.19-2007 & 2011 compliance)/General Scans/y (transversal) 4.2mm 50 x 50/ABM Noise Spectrum(x,y,z,f) (13x13x1):** Measurement grid: dx=10mm, dy=10mm  
Signal Type: Audio File (.wav) 48k\_voice\_1kHz\_1s.wav  
Output Gain: 18.9  
Measure Window Start: 300ms  
Measure Window Length: 1000ms  
Device Reference Point: 0, 0, -6.3 mm

**Cursor:**  
ABM = -53.73 dBA/m  
Location: 4.2, -25, 3.7 mm

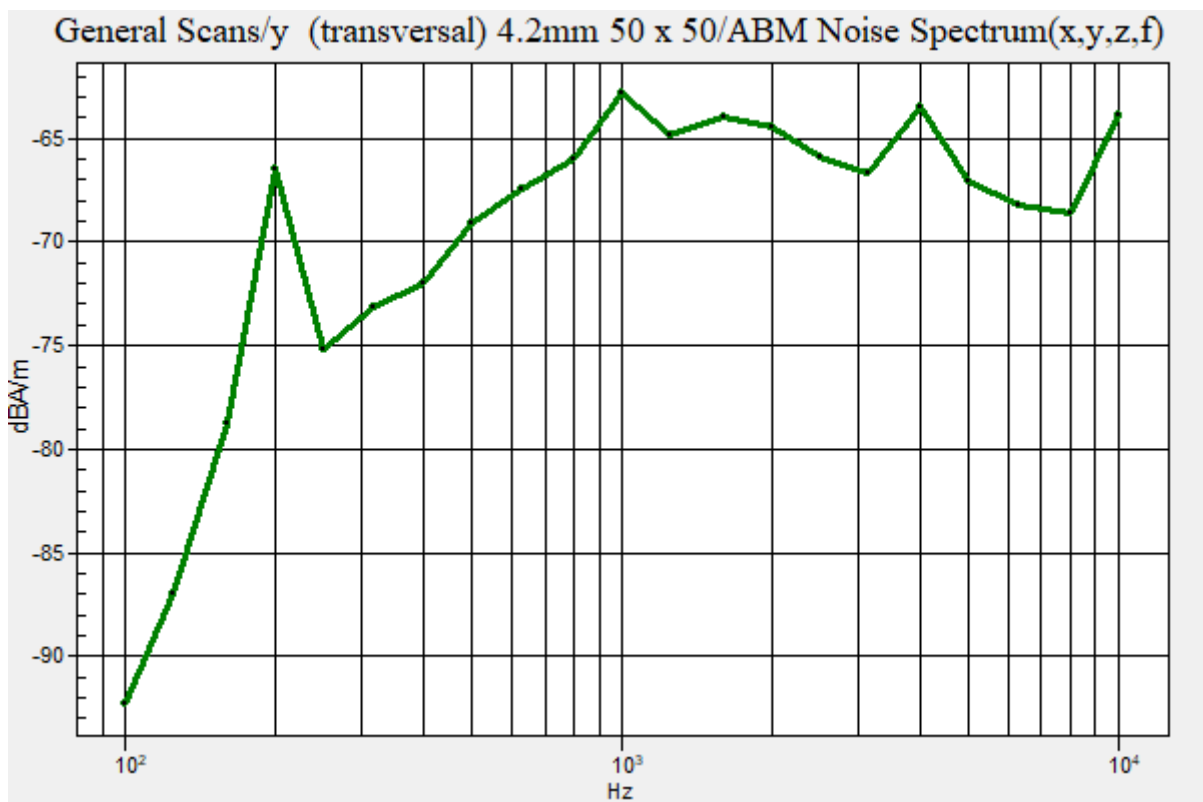

**Plot No.176**  
**NR Band 66 CP-OFDM 16QAM 40MHz 1RB 214offset 349000ch z(axial)**

**DUT: SM-G991U; Type: Bar**

Communication System: UID 0, NR Band 66 (0); Frequency: 1745 MHz;Duty Cycle: 1:1  
Medium parameters used:  $\sigma = 0$  S/m,  $\epsilon_r = 1$ ;  $\rho = 0$  kg/m<sup>3</sup>  
Phantom section: TCoil Section

DASY Configuration:

- Probe: AM1DV3 - 3049; ;
- Sensor-Surface: 0mm (Fix Surface)
- Electronics: DAE4 Sn466; Calibrated: 2020-04-22
- Phantom: HAC Test Arch with AMCC
- Measurement SW: DASY52, Version 52.10 (4);

**T-Coil scan (scan for ANSI C63.19-2007 & 2011 compliance)/General Scans/z (axial) 4.2mm 50 x 50/ABM Noise Spectrum(x,y,z,f) (13x13x1):** Measurement grid: dx=10mm, dy=10mm  
Signal Type: Audio File (.wav) 48k\_voice\_1kHz\_1s.wav  
Output Gain: 18.9  
Measure Window Start: 300ms  
Measure Window Length: 1000ms  
Device Reference Point: 0, 0, -6.3 mm

**Cursor:**  
ABM = -37.31 dBA/m  
Location: 12.5, -12.5, 3.7 mm

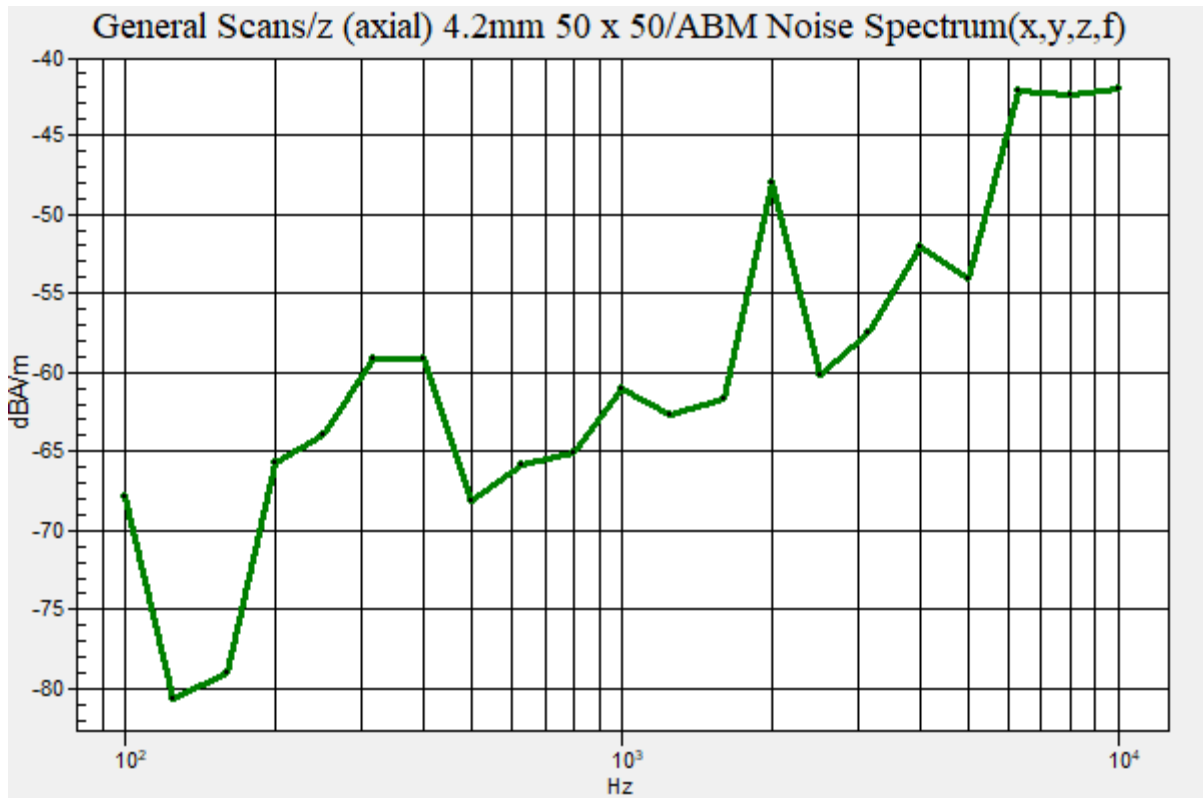

**Plot No.177**

**NR Band 66 CP-OFDM 16QAM 40MHz 1RB 214offset 349000ch y(transversal)**

**DUT: SM-G991U; Type: Bar**

Communication System: UID 0, NR Band 66 (0); Frequency: 1745 MHz;Duty Cycle: 1:1  
Medium parameters used:  $\sigma = 0$  S/m,  $\epsilon_r = 1$ ;  $\rho = 0$  kg/m<sup>3</sup>  
Phantom section: TCoil Section

DASY Configuration:

- Probe: AM1DV3 - 3049; ;
- Sensor-Surface: 0mm (Fix Surface)
- Electronics: DAE4 Sn466; Calibrated: 2020-04-22
- Phantom: HAC Test Arch with AMCC
- Measurement SW: DASY52, Version 52.10 (4);

**T-Coil scan (scan for ANSI C63.19-2007 & 2011 compliance)/General Scans/y (transversal) 4.2mm 50**

**x 50/ABM Noise Spectrum(x,y,z,f) (13x13x1):** Measurement grid: dx=10mm, dy=10mm

Signal Type: Audio File (.wav) 48k\_voice\_1kHz\_1s.wav

Output Gain: 18.9

Measure Window Start: 300ms

Measure Window Length: 1000ms

Device Reference Point: 0, 0, -6.3 mm

**Cursor:**

ABM = -47.40 dBA/m

Location: 4.2, -25, 3.7 mm

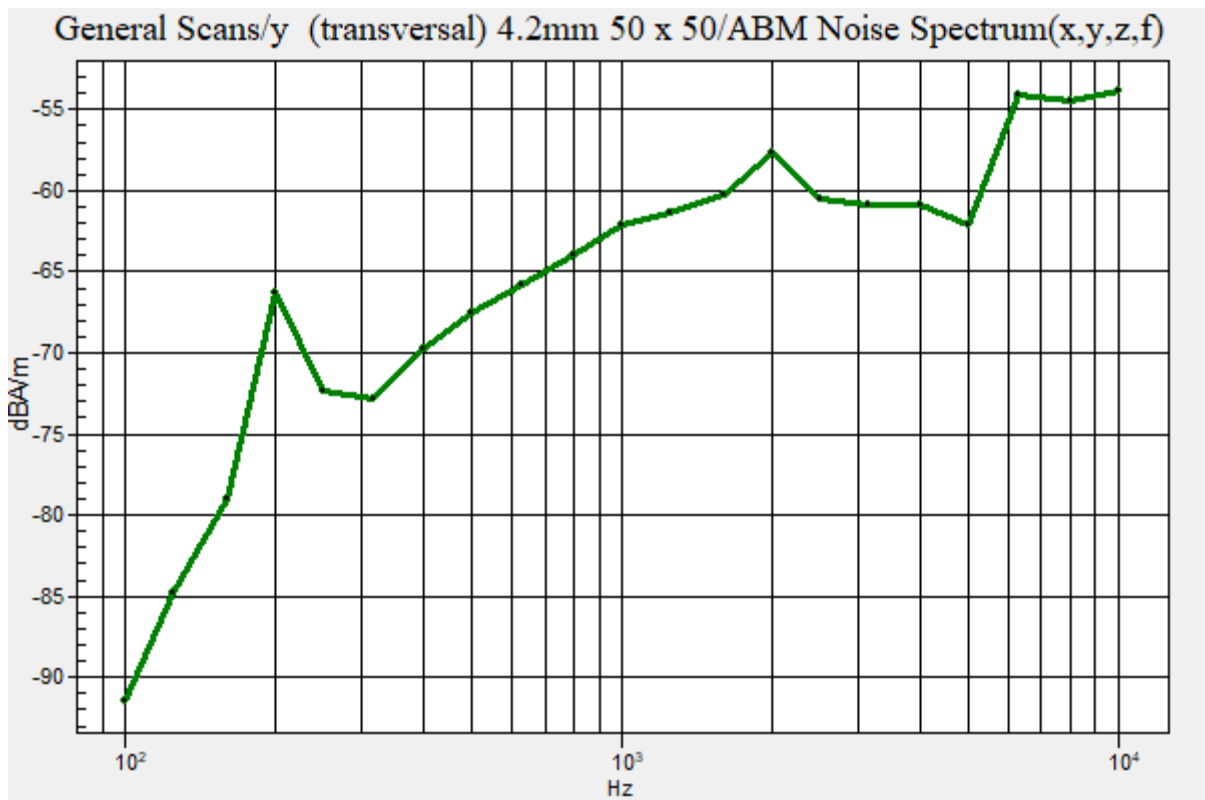

**Plot No.178**  
**NR Band 71 CP-OFDM 16QAM 20MHz 1RB 104offset 136100ch z(axial)**

**DUT: SM-G991U; Type: Bar**

Communication System: UID 0, NR Band 71 (0); Frequency: 680.5 MHz;Duty Cycle: 1:1  
Medium parameters used:  $\sigma = 0$  S/m,  $\epsilon_r = 1$ ;  $\rho = 0$  kg/m<sup>3</sup>  
Phantom section: TCoil Section

DASY Configuration:

- Probe: AM1DV3 - 3049; ;
- Sensor-Surface: 0mm (Fix Surface)
- Electronics: DAE4 Sn466; Calibrated: 2020-04-22
- Phantom: HAC Test Arch with AMCC
- Measurement SW: DASY52, Version 52.10 (4);

**T-Coil scan (scan for ANSI C63.19-2007 & 2011 compliance)/General Scans/z (axial) 4.2mm 50 x 50/ABM Noise Spectrum(x,y,z,f) (13x13x1):** Measurement grid: dx=10mm, dy=10mm  
Signal Type: Audio File (.wav) 48k\_voice\_1kHz\_1s.wav  
Output Gain: 18.9  
Measure Window Start: 300ms  
Measure Window Length: 1000ms  
Device Reference Point: 0, 0, -6.3 mm

**Cursor:**

ABM = -48.46 dBA/m  
Location: 8.3, -12.5, 3.7 mm

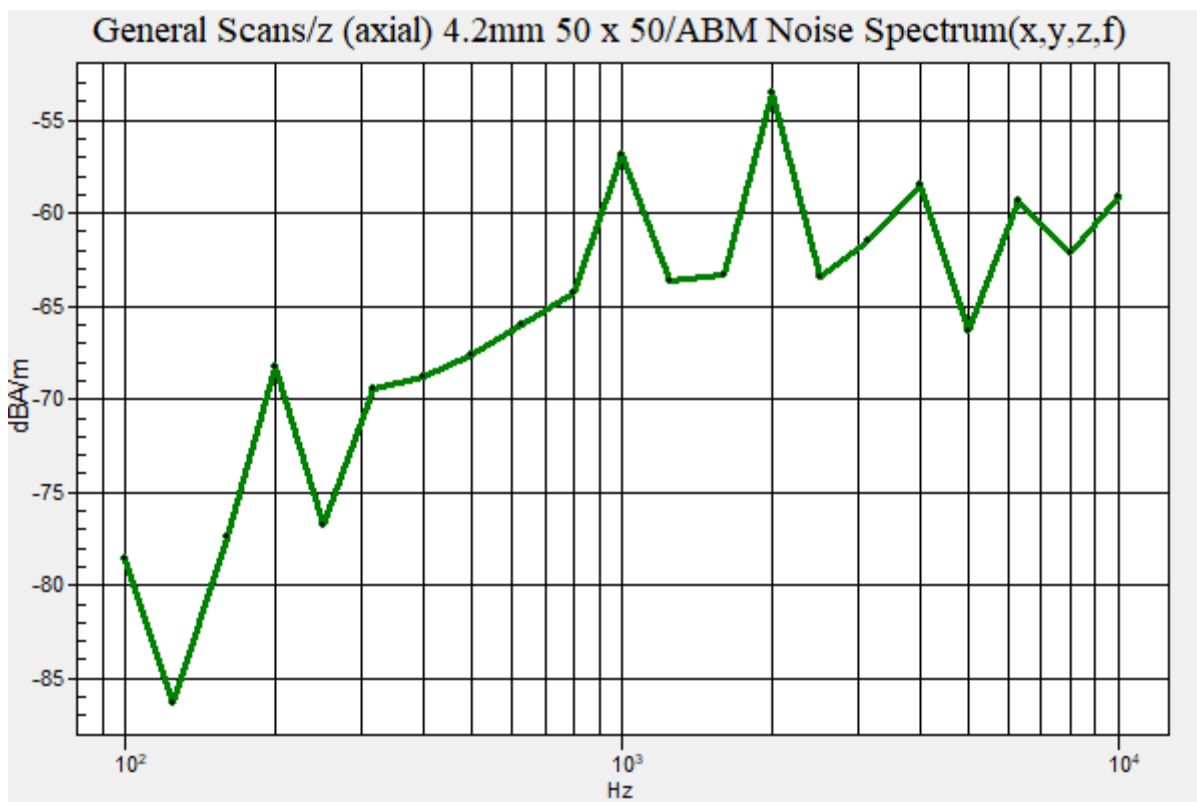

**Plot No.179**

**NR Band 71 CP-OFDM 16QAM 20MHz 1RB 104offset 136100ch y(transversal)**

**DUT: SM-G991U; Type: Bar**

Communication System: UID 0, NR Band 71 (0); Frequency: 680.5 MHz;Duty Cycle: 1:1  
 Medium parameters used:  $\sigma = 0$  S/m,  $\epsilon_r = 1$ ;  $\rho = 0$  kg/m<sup>3</sup>  
 Phantom section: TCoil Section

DASY Configuration:

- Probe: AM1DV3 - 3049; ;
- Sensor-Surface: 0mm (Fix Surface)
- Electronics: DAE4 Sn466; Calibrated: 2020-04-22
- Phantom: HAC Test Arch with AMCC
- Measurement SW: DASY52, Version 52.10 (4);

**T-Coil scan (scan for ANSI C63.19-2007 & 2011 compliance)/General Scans/y (transversal) 4.2mm 50**

**x 50/ABM Noise Spectrum(x,y,z,f) (13x13x1):** Measurement grid: dx=10mm, dy=10mm

Signal Type: Audio File (.wav) 48k\_voice\_1kHz\_1s.wav

Output Gain: 18.9

Measure Window Start: 300ms

Measure Window Length: 1000ms

Device Reference Point: 0, 0, -6.3 mm

**Cursor:**

ABM = -48.22 dBA/m

Location: 8.3, -16.7, 3.7 mm

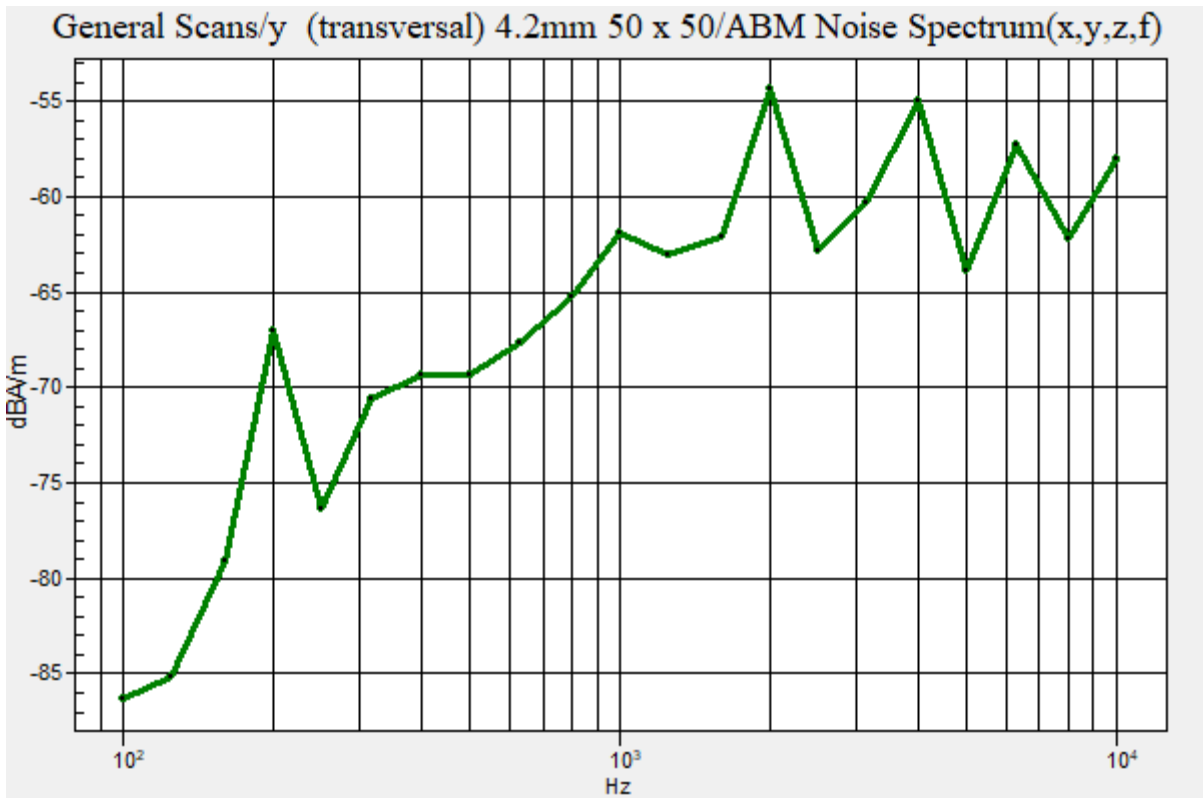



**Plot No.180**  
**NR Band 66 CP-OFDM 16QAM 20MHz 1RB 104offset 349000ch z(axial)**

**DUT: SM-G991U; Type: Bar**

Communication System: UID 0, NR Band 66 (0); Frequency: 1745 MHz;Duty Cycle: 1:1  
Medium parameters used:  $\sigma = 0$  S/m,  $\epsilon_r = 1$ ;  $\rho = 0$  kg/m<sup>3</sup>  
Phantom section: TCoil Section

DASY Configuration:

- Probe: AM1DV3 - 3049; ;
- Sensor-Surface: 0mm (Fix Surface)
- Electronics: DAE4 Sn466; Calibrated: 2020-04-22
- Phantom: HAC Test Arch with AMCC
- Measurement SW: DASY52, Version 52.10 (4);

**T-Coil scan (scan for ANSI C63.19-2007 & 2011 compliance)/General Scans/z (axial) 4.2mm 50 x 50/ABM Noise Spectrum(x,y,z,f) (13x13x1):** Measurement grid: dx=10mm, dy=10mm  
Signal Type: Audio File (.wav) 48k\_voice\_1kHz\_1s.wav  
Output Gain: 18.9  
Measure Window Start: 300ms  
Measure Window Length: 1000ms  
Device Reference Point: 0, 0, -6.3 mm

**Cursor:**  
ABM = -40.32 dBA/m  
Location: 12.5, -12.5, 3.7 mm

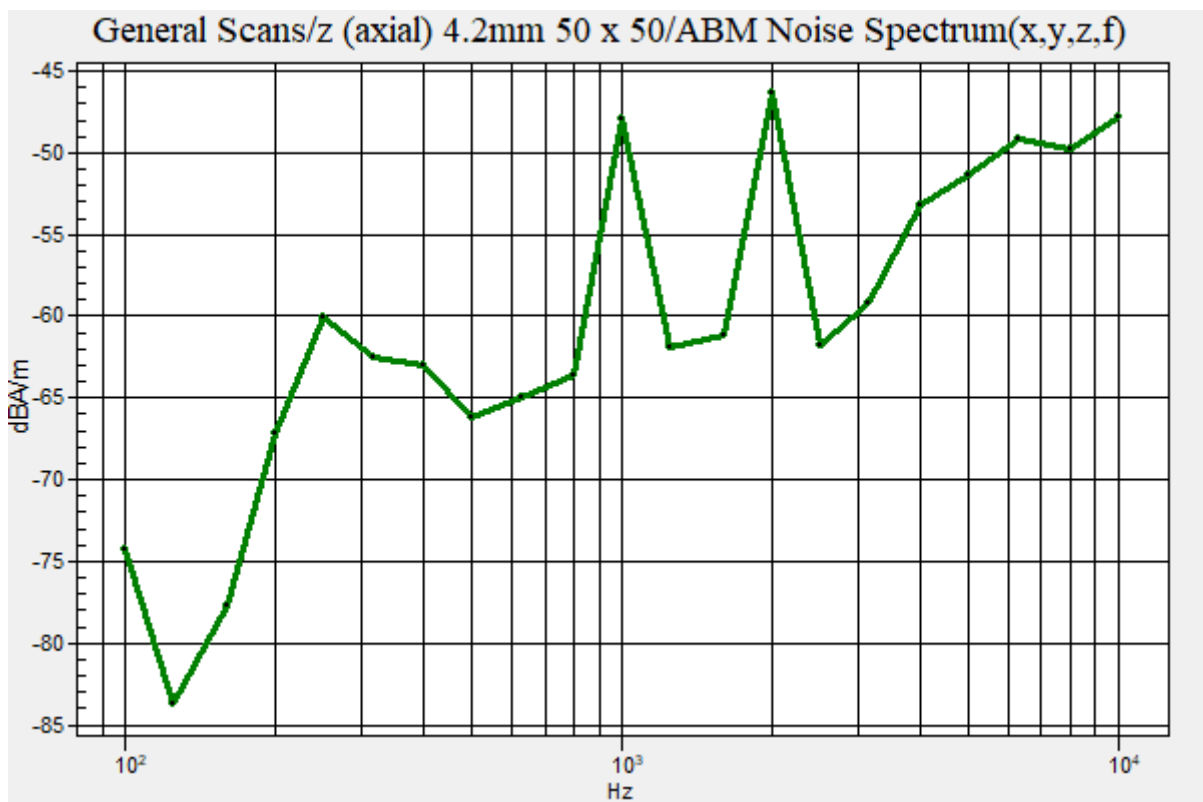

**Plot No.181**  
**NR Band 66 CP-OFDM 16QAM 20MHz 1RB 104offset 349000ch y(transversal)**

**DUT: SM-G991U; Type: Bar**

Communication System: UID 0, NR Band 66 (0); Frequency: 1745 MHz;Duty Cycle: 1:1  
Medium parameters used:  $\sigma = 0$  S/m,  $\epsilon_r = 1$ ;  $\rho = 0$  kg/m<sup>3</sup>  
Phantom section: TCoil Section

DASY Configuration:

- Probe: AM1DV3 - 3049; ;
- Sensor-Surface: 0mm (Fix Surface)
- Electronics: DAE4 Sn466; Calibrated: 2020-04-22
- Phantom: HAC Test Arch with AMCC
- Measurement SW: DASY52, Version 52.10 (4);

**T-Coil scan (scan for ANSI C63.19-2007 & 2011 compliance)/General Scans/y (transversal) 4.2mm 50 x 50/ABM Noise Spectrum(x,y,z,f) (13x13x1):** Measurement grid: dx=10mm, dy=10mm  
Signal Type: Audio File (.wav) 48k\_voice\_1kHz\_1s.wav  
Output Gain: 18.9  
Measure Window Start: 300ms  
Measure Window Length: 1000ms  
Device Reference Point: 0, 0, -6.3 mm

**Cursor:**  
ABM = -52.41 dBA/m  
Location: 4.2, -25, 3.7 mm

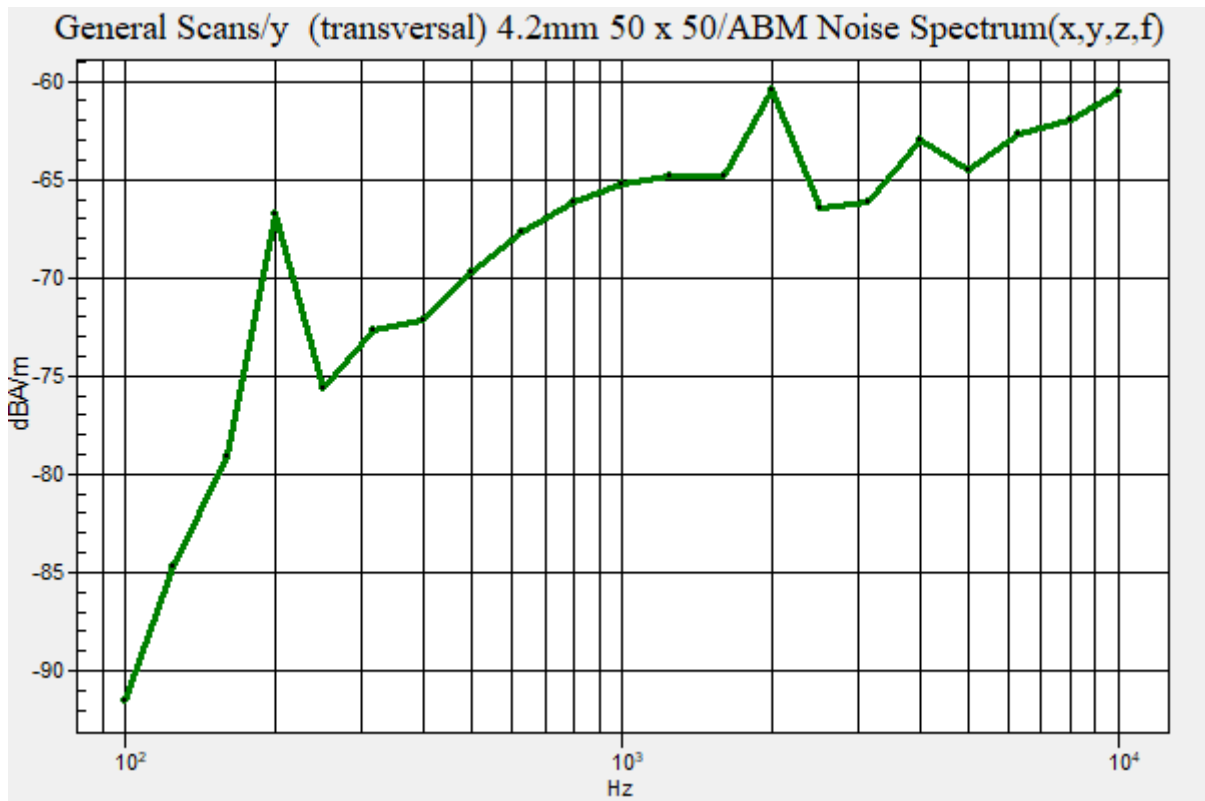

**Plot No.182**  
**NR Band 66 CP-OFDM 16QAM 15MHz 1RB 77offset 349000ch z(axial)**

**DUT: SM-G991U; Type: Bar**

Communication System: UID 0, NR Band 66 (0); Frequency: 1745 MHz;Duty Cycle: 1:1  
Medium parameters used:  $\sigma = 0$  S/m,  $\epsilon_r = 1$ ;  $\rho = 0$  kg/m<sup>3</sup>  
Phantom section: TCoil Section

DASY Configuration:

- Probe: AM1DV3 - 3049; ;
- Sensor-Surface: 0mm (Fix Surface)
- Electronics: DAE4 Sn466; Calibrated: 2020-04-22
- Phantom: HAC Test Arch with AMCC
- Measurement SW: DASY52, Version 52.10 (4);

**T-Coil scan (scan for ANSI C63.19-2007 & 2011 compliance)/General Scans/z (axial) 4.2mm 50 x 50/ABM Noise Spectrum(x,y,z,f) (13x13x1):** Measurement grid: dx=10mm, dy=10mm  
Signal Type: Audio File (.wav) 48k\_voice\_1kHz\_1s.wav  
Output Gain: 18.9  
Measure Window Start: 300ms  
Measure Window Length: 1000ms  
Device Reference Point: 0, 0, -6.3 mm

**Cursor:**  
ABM = -40.72 dBA/m  
Location: 12.5, -12.5, 3.7 mm

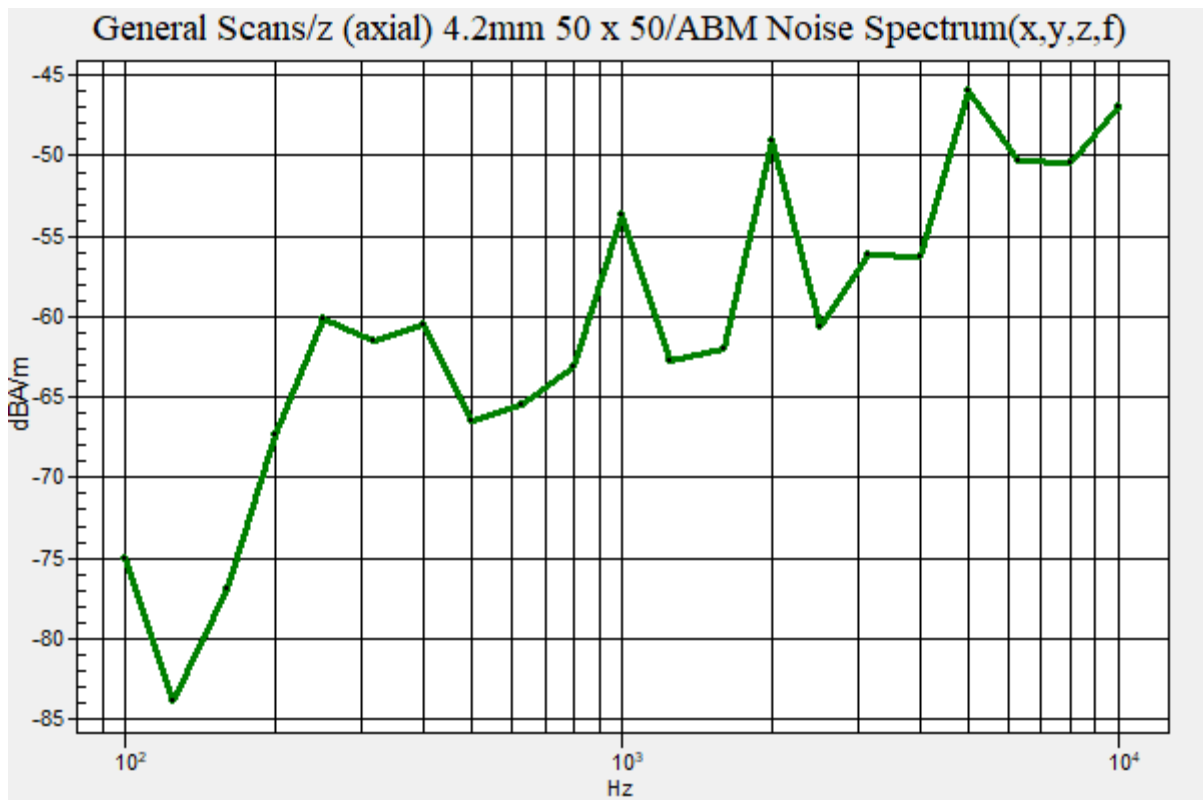

**Plot No.183**  
**NR Band 66 CP-OFDM 16QAM 15MHz 1RB 77offset 349000ch y(transversal)**

**DUT: SM-G991U; Type: Bar**

Communication System: UID 0, NR Band 66 (0); Frequency: 1745 MHz;Duty Cycle: 1:1  
Medium parameters used:  $\sigma = 0$  S/m,  $\epsilon_r = 1$ ;  $\rho = 0$  kg/m<sup>3</sup>  
Phantom section: TCoil Section

DASY Configuration:

- Probe: AM1DV3 - 3049; ;
- Sensor-Surface: 0mm (Fix Surface)
- Electronics: DAE4 Sn466; Calibrated: 2020-04-22
- Phantom: HAC Test Arch with AMCC
- Measurement SW: DASY52, Version 52.10 (4);

**T-Coil scan (scan for ANSI C63.19-2007 & 2011 compliance)/General Scans/y (transversal) 4.2mm 50 x 50/ABM Noise Spectrum(x,y,z,f) (13x13x1):** Measurement grid: dx=10mm, dy=10mm  
Signal Type: Audio File (.wav) 48k\_voice\_1kHz\_1s.wav  
Output Gain: 18.9  
Measure Window Start: 300ms  
Measure Window Length: 1000ms  
Device Reference Point: 0, 0, -6.3 mm

**Cursor:**  
ABM = -52.33 dBA/m  
Location: 4.2, -25, 3.7 mm

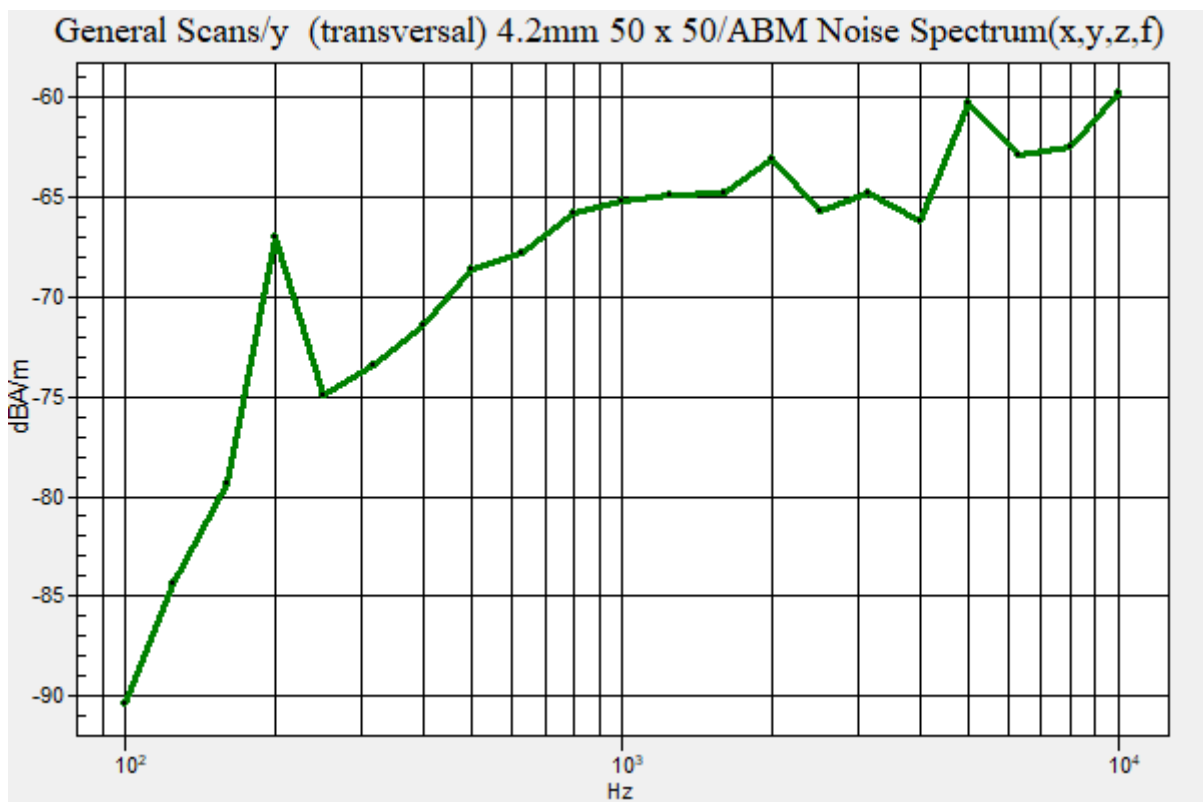

**Plot No.184**

**NR Band 66 CP-OFDM 16QAM 10MHz 1RB 50offset 349000ch z(axial)**

**DUT: SM-G991U; Type: Bar**

Communication System: UID 0, NR Band 66 (0); Frequency: 1745 MHz;Duty Cycle: 1:1  
 Medium parameters used:  $\sigma = 0$  S/m,  $\epsilon_r = 1$ ;  $\rho = 0$  kg/m<sup>3</sup>  
 Phantom section: TCoil Section

DASY Configuration:

- Probe: AM1DV3 - 3049; ;
- Sensor-Surface: 0mm (Fix Surface)
- Electronics: DAE4 Sn466; Calibrated: 2020-04-22
- Phantom: HAC Test Arch with AMCC
- Measurement SW: DASY52, Version 52.10 (4);

**T-Coil scan (scan for ANSI C63.19-2007 & 2011 compliance)/General Scans/z (axial) 4.2mm 50 x 50/ABM Noise Spectrum(x,y,z,f) (13x13x1):** Measurement grid: dx=10mm, dy=10mm

Signal Type: Audio File (.wav) 48k\_voice\_1kHz\_1s.wav  
 Output Gain: 18.9  
 Measure Window Start: 300ms  
 Measure Window Length: 1000ms  
 Device Reference Point: 0, 0, -6.3 mm

**Cursor:**

ABM = -44.17 dBA/m  
 Location: 12.5, -12.5, 3.7 mm

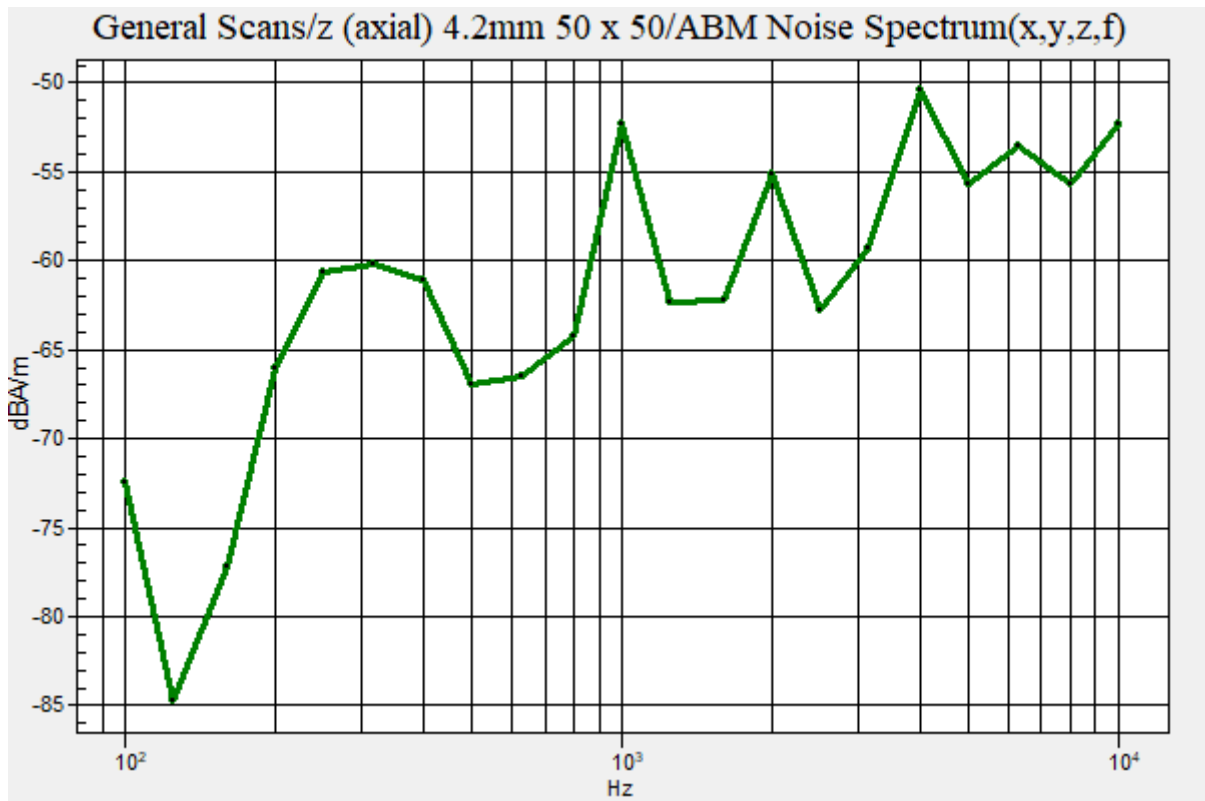

**Plot No.185**  
**NR Band 66 CP-OFDM 16QAM 10MHz 1RB 50offset 349000ch y(transversal)**

**DUT: SM-G991U; Type: Bar**

Communication System: UID 0, NR Band 66 (0); Frequency: 1745 MHz;Duty Cycle: 1:1  
Medium parameters used:  $\sigma = 0$  S/m,  $\epsilon_r = 1$ ;  $\rho = 0$  kg/m<sup>3</sup>  
Phantom section: TCoil Section

DASY Configuration:

- Probe: AM1DV3 - 3049; ;
- Sensor-Surface: 0mm (Fix Surface)
- Electronics: DAE4 Sn466; Calibrated: 2020-04-22
- Phantom: HAC Test Arch with AMCC
- Measurement SW: DASY52, Version 52.10 (4);

**T-Coil scan (scan for ANSI C63.19-2007 & 2011 compliance)/General Scans/y (transversal) 4.2mm 50**

**x 50/ABM Noise Spectrum(x,y,z,f) (13x13x1):** Measurement grid: dx=10mm, dy=10mm

Signal Type: Audio File (.wav) 48k\_voice\_1kHz\_1s.wav

Output Gain: 18.9

Measure Window Start: 300ms

Measure Window Length: 1000ms

Device Reference Point: 0, 0, -6.3 mm

**Cursor:**

ABM = -54.18 dBA/m

Location: 4.2, -25, 3.7 mm

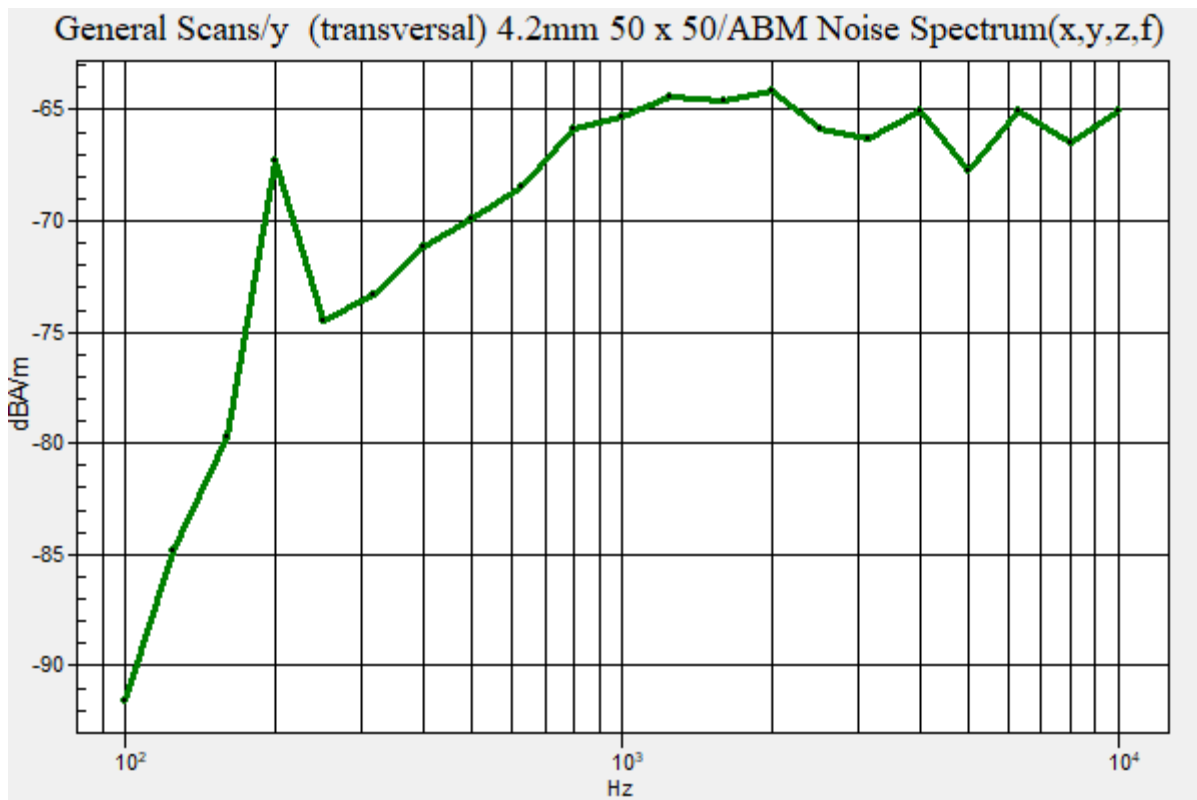

**Plot No.186**  
NR Band 66 CP-OFDM 16QAM 5MHz 1RB 23offset 349000ch z(axial)

**DUT: SM-G991U; Type: Bar**

Communication System: UID 0, NR Band 66 (0); Frequency: 1745 MHz;Duty Cycle: 1:1  
Medium parameters used:  $\sigma = 0$  S/m,  $\epsilon_r = 1$ ;  $\rho = 0$  kg/m<sup>3</sup>  
Phantom section: TCoil Section

DASY Configuration:

- Probe: AM1DV3 - 3049; ;
- Sensor-Surface: 0mm (Fix Surface)
- Electronics: DAE4 Sn466; Calibrated: 2020-04-22
- Phantom: HAC Test Arch with AMCC
- Measurement SW: DASY52, Version 52.10 (4);

**T-Coil scan (scan for ANSI C63.19-2007 & 2011 compliance)/General Scans/z (axial) 4.2mm 50 x 50/ABM Noise Spectrum(x,y,z,f) (13x13x1):** Measurement grid: dx=10mm, dy=10mm  
Signal Type: Audio File (.wav) 48k\_voice\_1kHz\_1s.wav  
Output Gain: 18.9  
Measure Window Start: 300ms  
Measure Window Length: 1000ms  
Device Reference Point: 0, 0, -6.3 mm

**Cursor:**  
ABM = -44.11 dBA/m  
Location: 12.5, -12.5, 3.7 mm

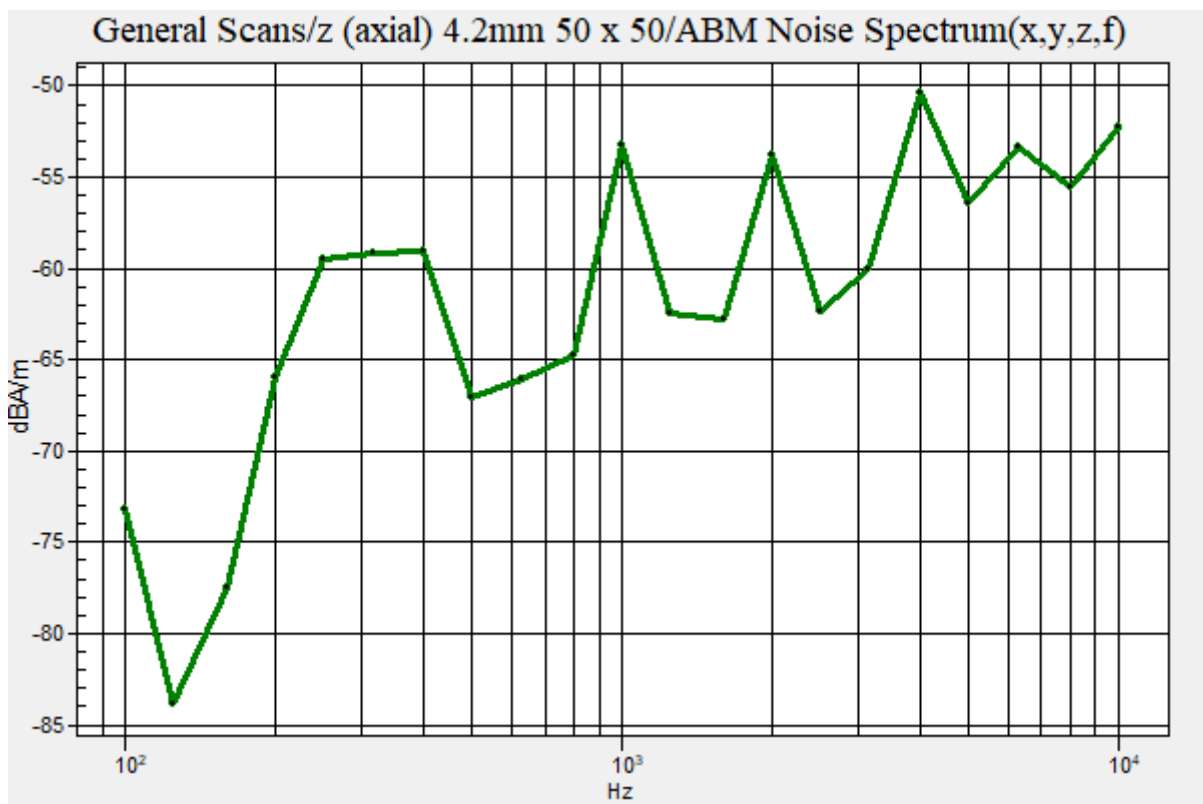

**Plot No.187**  
**NR Band 66 CP-OFDM 16QAM 5MHz 1RB 23offset 349000ch y(transversal)**

**DUT: SM-G991U; Type: Bar**

Communication System: UID 0, NR Band 66 (0); Frequency: 1745 MHz;Duty Cycle: 1:1  
Medium parameters used:  $\sigma = 0$  S/m,  $\epsilon_r = 1$ ;  $\rho = 0$  kg/m<sup>3</sup>  
Phantom section: TCoil Section

DASY Configuration:

- Probe: AM1DV3 - 3049; ;
- Sensor-Surface: 0mm (Fix Surface)
- Electronics: DAE4 Sn466; Calibrated: 2020-04-22
- Phantom: HAC Test Arch with AMCC
- Measurement SW: DASY52, Version 52.10 (4);

**T-Coil scan (scan for ANSI C63.19-2007 & 2011 compliance)/General Scans/y (transversal) 4.2mm 50**

**x 50/ABM Noise Spectrum(x,y,z,f) (13x13x1):** Measurement grid: dx=10mm, dy=10mm

Signal Type: Audio File (.wav) 48k\_voice\_1kHz\_1s.wav

Output Gain: 18.9

Measure Window Start: 300ms

Measure Window Length: 1000ms

Device Reference Point: 0, 0, -6.3 mm

**Cursor:**

ABM = -54.19 dBA/m

Location: 4.2, -25, 3.7 mm

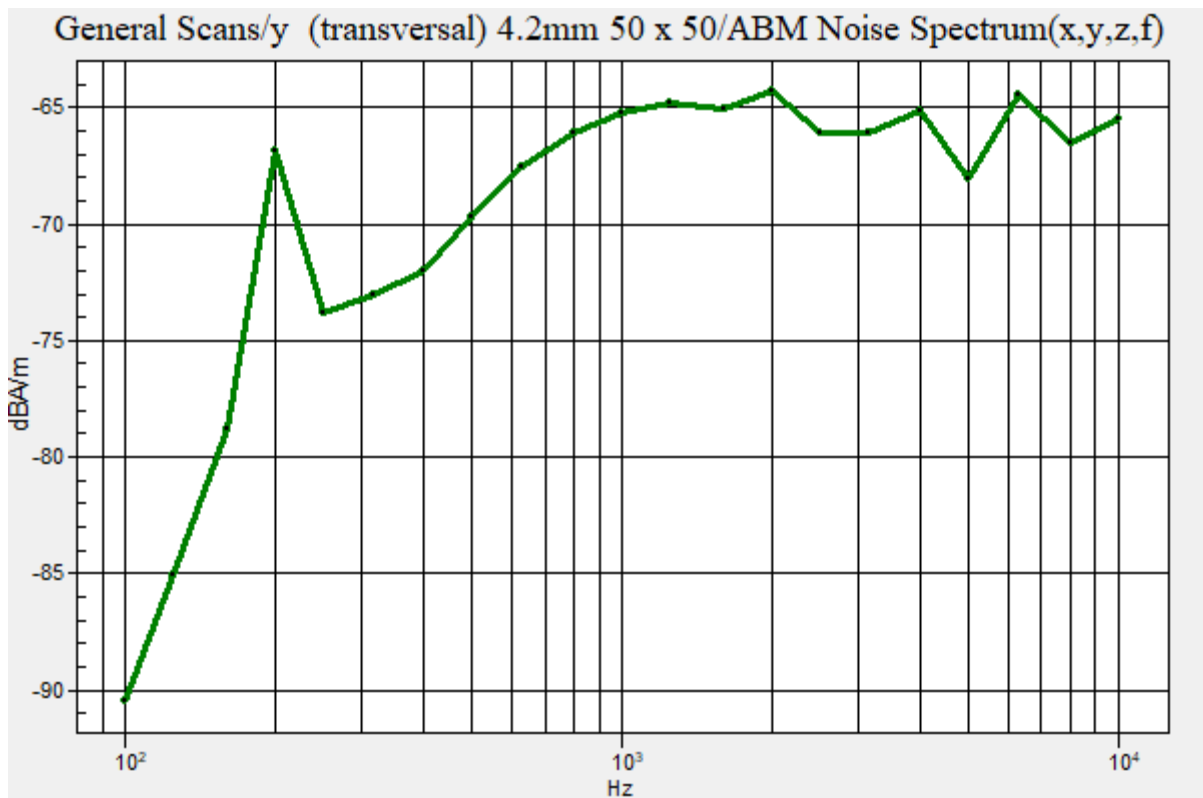



**Plot No.188**  
NR Band 66 CP-OFDM 16QAM 30MHz 1RB 158offset 349000ch z(axial)

**DUT: SM-G991U; Type: Bar**

Communication System: UID 0, NR Band 66 (0); Frequency: 1745 MHz;Duty Cycle: 1:1  
Medium parameters used:  $\sigma = 0$  S/m,  $\epsilon_r = 1$ ;  $\rho = 0$  kg/m<sup>3</sup>  
Phantom section: TCoil Section

DASY Configuration:

- Probe: AM1DV3 - 3049; ;
- Sensor-Surface: 0mm (Fix Surface)
- Electronics: DAE4 Sn466; Calibrated: 2020-04-22
- Phantom: HAC Test Arch with AMCC
- Measurement SW: DASY52, Version 52.10 (4);

**T-Coil scan (scan for ANSI C63.19-2007 & 2011 compliance)/General Scans/z (axial) 4.2mm 50 x 50/ABM Noise Spectrum(x,y,z,f) (13x13x1):** Measurement grid: dx=10mm, dy=10mm  
Signal Type: Audio File (.wav) 48k\_voice\_1kHz\_1s.wav  
Output Gain: 18.9  
Measure Window Start: 300ms  
Measure Window Length: 1000ms  
Device Reference Point: 0, 0, -6.3 mm

**Cursor:**  
ABM = -40.20 dBA/m  
Location: 12.5, -12.5, 3.7 mm

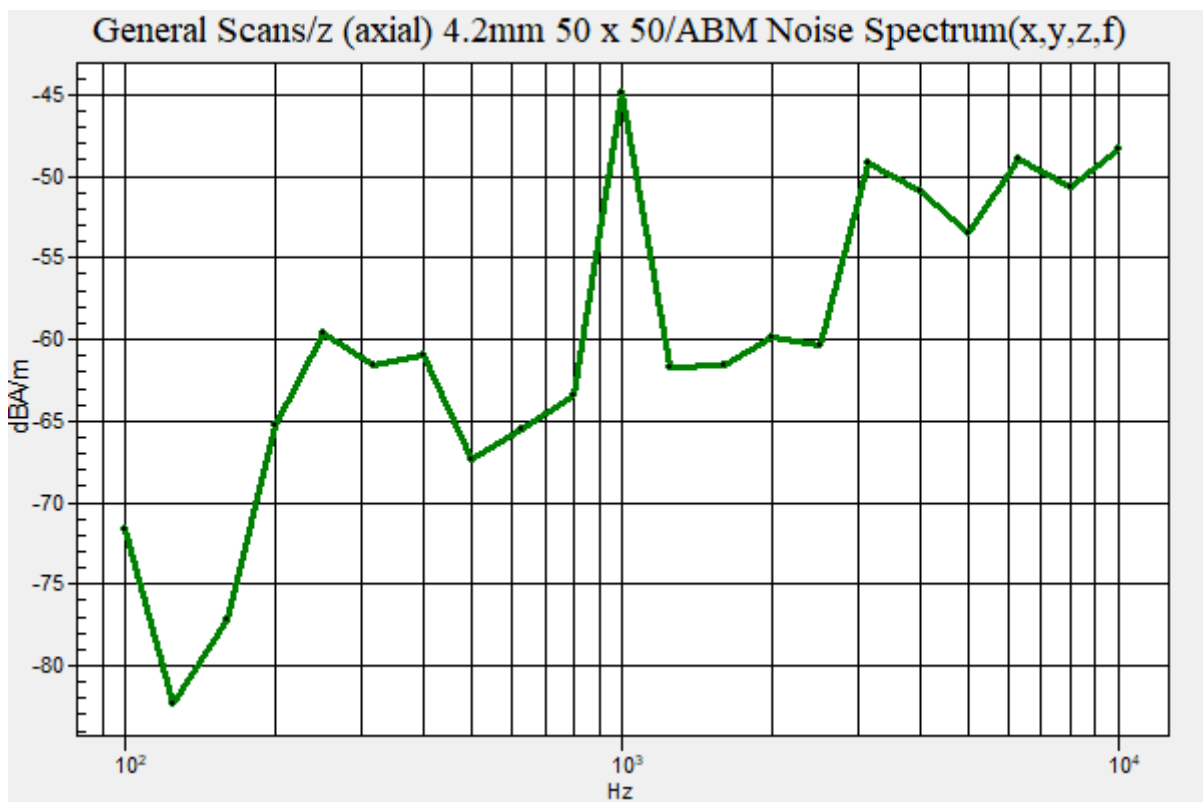

**Plot No.189**

**NR Band 66 CP-OFDM 16QAM 30MHz 1RB 158offset 349000ch y(transversal)**

**DUT: SM-G991U; Type: Bar**

Communication System: UID 0, NR Band 66 (0); Frequency: 1745 MHz;Duty Cycle: 1:1  
Medium parameters used:  $\sigma = 0$  S/m,  $\epsilon_r = 1$ ;  $\rho = 0$  kg/m<sup>3</sup>  
Phantom section: TCoil Section

DASY Configuration:

- Probe: AM1DV3 - 3049; ;
- Sensor-Surface: 0mm (Fix Surface)
- Electronics: DAE4 Sn466; Calibrated: 2020-04-22
- Phantom: HAC Test Arch with AMCC
- Measurement SW: DASY52, Version 52.10 (4);

**T-Coil scan (scan for ANSI C63.19-2007 & 2011 compliance)/General Scans/y (transversal) 4.2mm 50 x 50/ABM Noise Spectrum(x,y,z,f) (13x13x1):** Measurement grid: dx=10mm, dy=10mm

Signal Type: Audio File (.wav) 48k\_voice\_1kHz\_1s.wav  
Output Gain: 18.9  
Measure Window Start: 300ms  
Measure Window Length: 1000ms  
Device Reference Point: 0, 0, -6.3 mm

**Cursor:**

ABM = -52.90 dBA/m  
Location: 4.2, -25, 3.7 mm

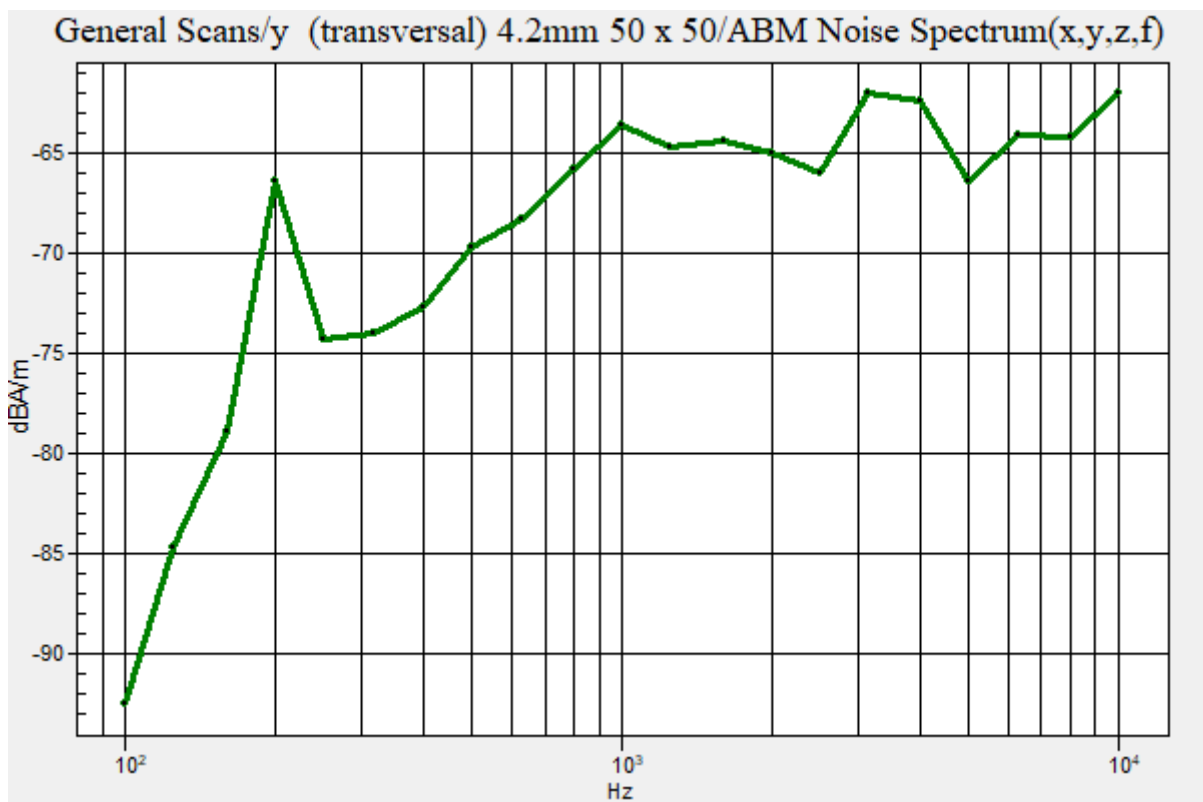

**Plot No.190**

**NR Band 66 CP-OFDM 16QAM 40MHz 1RB 214offset 349000ch z(axial)**

**DUT: SM-G991U; Type: Bar**

Communication System: UID 0, NR Band 66 (0); Frequency: 1745 MHz;Duty Cycle: 1:1  
Medium parameters used:  $\sigma = 0$  S/m,  $\epsilon_r = 1$ ;  $\rho = 0$  kg/m<sup>3</sup>  
Phantom section: TCoil Section

DASY5 Configuration:

- Probe: AM1DV3 - 3049; ; Calibrated: 5/26/2020
- Sensor-Surface: 0mm (Fix Surface)
- Electronics: DAE4 Sn466; Calibrated: 4/22/2020
- Phantom: HAC Test Arch with AMCC
- Measurement SW: DASY52, Version 52.10 (4); SEMCAD X Version 14.6.14 (7483)

**T-Coil scan (scan for ANSI C63.19-2007 & 2011 compliance)/General Scans/z (axial) 4.2mm 50 x 50/ABM Noise Spectrum(x,y,z,f) (13x13x1):** Measurement grid: dx=10mm, dy=10mm

Signal Type: Audio File (.wav) 48k\_voice\_1kHz\_1s.wav

Output Gain: 18.9

Measure Window Start: 300ms

Measure Window Length: 1000ms

Device Reference Point: 0, 0, -6.3 mm

**Cursor:**

ABM = -44.26 dBA/m

Location: 12.5, -12.5, 3.7 mm

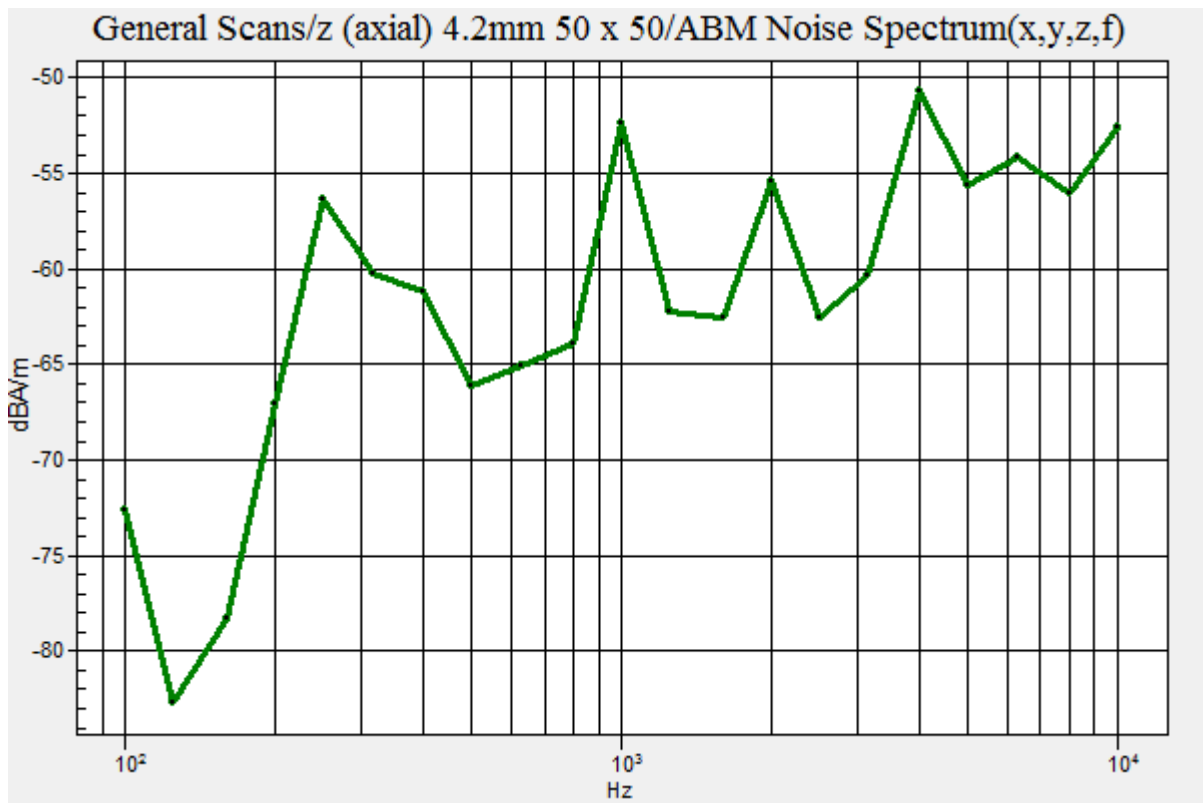

**Plot No.191**

**NR Band 66 CP-OFDM 16QAM 15MHz 1RB 77offset 349000ch y(transversal)**

**DUT: SM-G991U; Type: Bar**

Communication System: UID 0, NR Band 66 (0); Frequency: 1755 MHz;Duty Cycle: 1:1  
 Medium parameters used:  $\sigma = 0$  S/m,  $\epsilon_r = 1$ ;  $\rho = 0$  kg/m<sup>3</sup>  
 Phantom section: TCoil Section

DASY5 Configuration:

- Probe: AM1DV3 - 3049; ; Calibrated: 5/26/2020
- Sensor-Surface: 0mm (Fix Surface)
- Electronics: DAE4 Sn466; Calibrated: 4/22/2020
- Phantom: HAC Test Arch with AMCC
- Measurement SW: DASY52, Version 52.10 (4); SEMCAD X Version 14.6.14 (7483)

**T-Coil scan (scan for ANSI C63.19-2007 & 2011 compliance)/General Scans/y (transversal) 4.2mm 50**

**x 50/ABM Noise Spectrum(x,y,z,f) (13x13x1):** Measurement grid: dx=10mm, dy=10mm

Signal Type: Audio File (.wav) 48k\_voice\_1kHz\_1s.wav

Output Gain: 18.9

Measure Window Start: 300ms

Measure Window Length: 1000ms

Device Reference Point: 0, 0, -6.3 mm

**Cursor:**

ABM = -54.25 dBA/m

Location: 4.2, -25, 3.7 mm

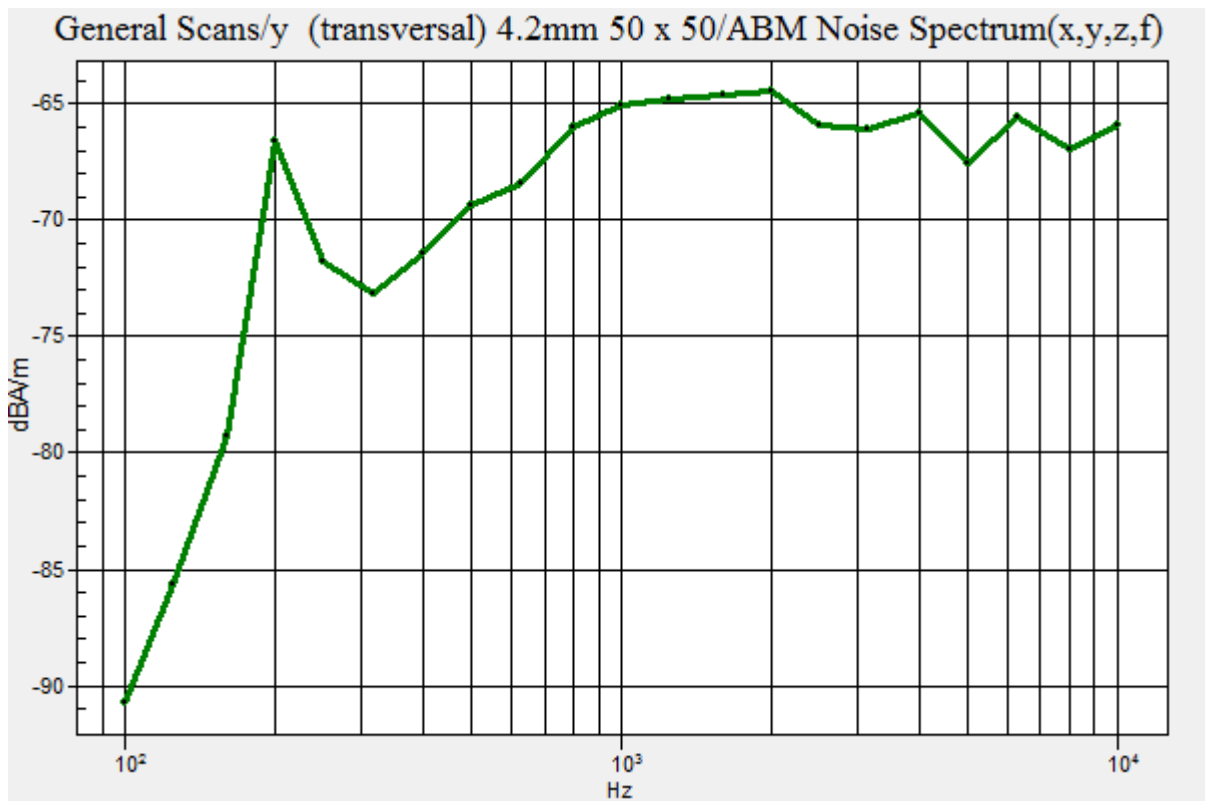

**Plot No.192**  
**NR Band 66 CP-OFDM 16QAM 15MHz 1RB 77offset 343500ch z(axial)**

**DUT: SM-G991U; Type: Bar**

Communication System: UID 0, NR Band 66 (0); Frequency: 1717.5 MHz;Duty Cycle: 1:1  
Medium parameters used:  $\sigma = 0$  S/m,  $\epsilon_r = 1$ ;  $\rho = 0$  kg/m<sup>3</sup>  
Phantom section: TCoil Section

DASY Configuration:

- Probe: AM1DV3 - 3049; ;
- Sensor-Surface: 0mm (Fix Surface)
- Electronics: DAE4 Sn466; Calibrated: 2020-04-22
- Phantom: HAC Test Arch with AMCC
- Measurement SW: DASY52, Version 52.10 (4);

**T-Coil scan (scan for ANSI C63.19-2007 & 2011 compliance)/General Scans/z (axial) 4.2mm 50 x 50/ABM Noise Spectrum(x,y,z,f) (13x13x1):** Measurement grid: dx=10mm, dy=10mm  
Signal Type: Audio File (.wav) 48k\_voice\_1kHz\_1s.wav  
Output Gain: 18.9  
Measure Window Start: 300ms  
Measure Window Length: 1000ms  
Device Reference Point: 0, 0, -6.3 mm

**Cursor:**

ABM = -41.09 dBA/m  
Location: 12.5, -12.5, 3.7 mm

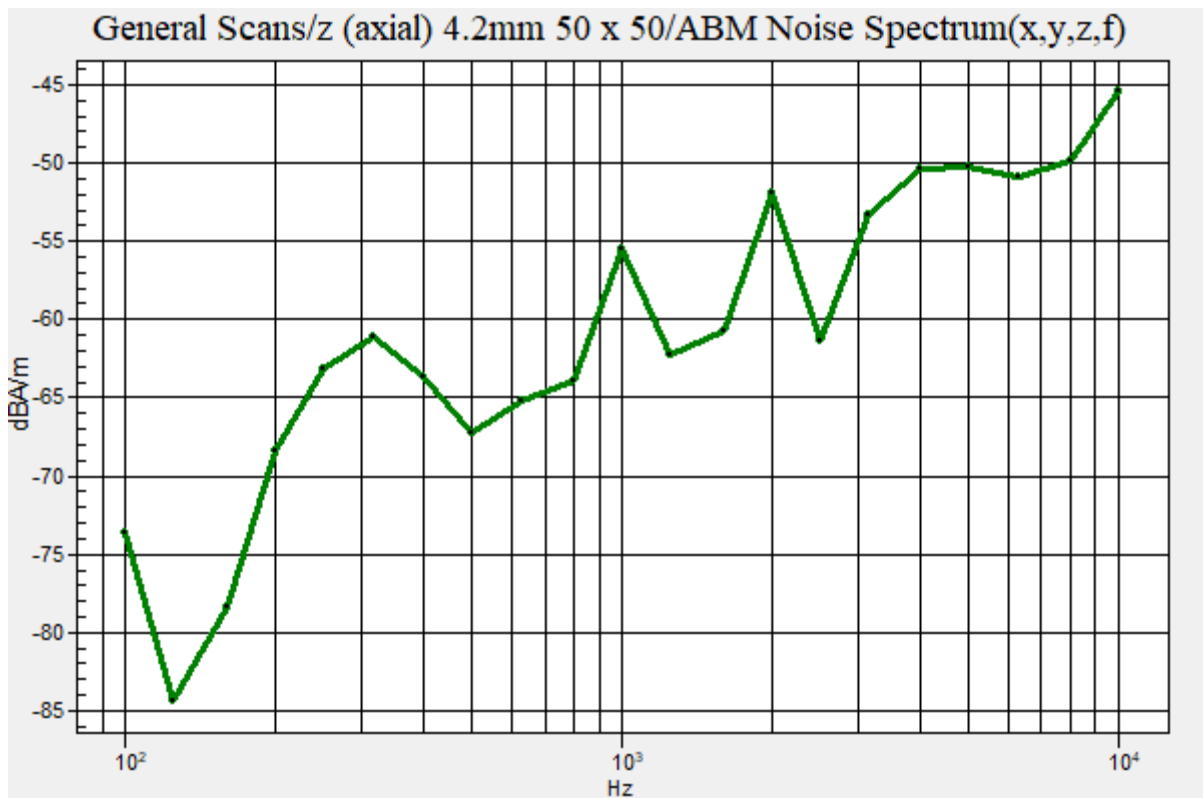

**Plot No.193**  
**NR Band 66 CP-OFDM 16QAM 15MHz 1RB 77offset 343500ch y(transversal)**

**DUT: SM-G991U; Type: Bar**

Communication System: UID 0, NR Band 66 (0); Frequency: 1717.5 MHz;Duty Cycle: 1:1  
Medium parameters used:  $\sigma = 0$  S/m,  $\epsilon_r = 1$ ;  $\rho = 0$  kg/m<sup>3</sup>  
Phantom section: TCoil Section

DASY Configuration:

- Probe: AM1DV3 - 3049; ;
- Sensor-Surface: 0mm (Fix Surface)
- Electronics: DAE4 Sn466; Calibrated: 2020-04-22
- Phantom: HAC Test Arch with AMCC
- Measurement SW: DASY52, Version 52.10 (4);

**T-Coil scan (scan for ANSI C63.19-2007 & 2011 compliance)/General Scans/y (transversal) 4.2mm 50 x 50/ABM Noise Spectrum(x,y,z,f) (13x13x1):** Measurement grid: dx=10mm, dy=10mm  
Signal Type: Audio File (.wav) 48k\_voice\_1kHz\_1s.wav  
Output Gain: 18.9  
Measure Window Start: 300ms  
Measure Window Length: 1000ms  
Device Reference Point: 0, 0, -6.3 mm

**Cursor:**  
ABM = -52.41 dBA/m  
Location: 4.2, -25, 3.7 mm

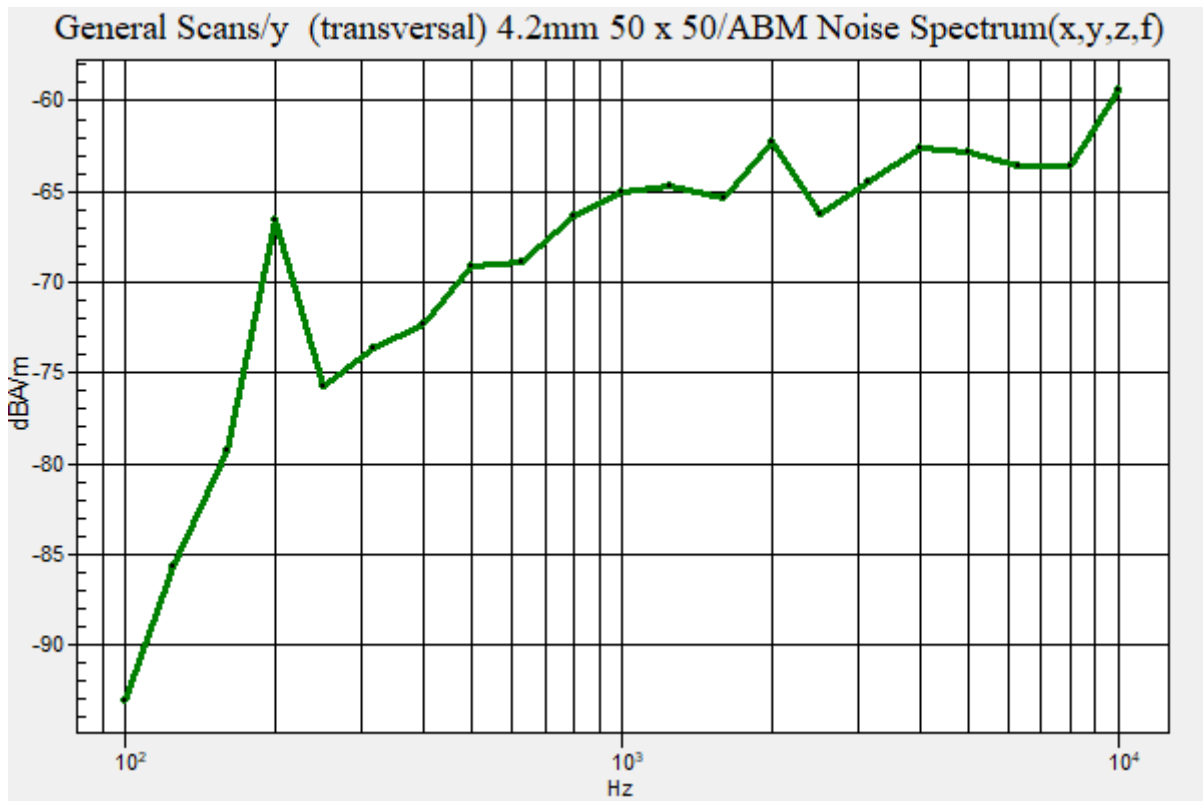

**Plot No.194**

**NR Band 66 CP-OFDM 16QAM 15MHz 1RB 77offset 354500ch z(axial)**

**DUT: SM-G991U; Type: Bar**

Communication System: UID 0, NR Band 66 (0); Frequency: 1772.5 MHz;Duty Cycle: 1:1  
Medium parameters used:  $\sigma = 0$  S/m,  $\epsilon_r = 1$ ;  $\rho = 0$  kg/m<sup>3</sup>  
Phantom section: TCoil Section

DASY Configuration:

- Probe: AM1DV3 - 3049; ;
- Sensor-Surface: 0mm (Fix Surface)
- Electronics: DAE4 Sn466; Calibrated: 2020-04-22
- Phantom: HAC Test Arch with AMCC
- Measurement SW: DASY52, Version 52.10 (4);

**T-Coil scan (scan for ANSI C63.19-2007 & 2011 compliance)/General Scans/z (axial) 4.2mm 50 x 50/ABM Noise Spectrum(x,y,z,f) (13x13x1):** Measurement grid: dx=10mm, dy=10mm

Signal Type: Audio File (.wav) 48k\_voice\_1kHz\_1s.wav

Output Gain: 18.9

Measure Window Start: 300ms

Measure Window Length: 1000ms

Device Reference Point: 0, 0, -6.3 mm

**Cursor:**

ABM = -42.52 dBA/m

Location: 12.5, -12.5, 3.7 mm

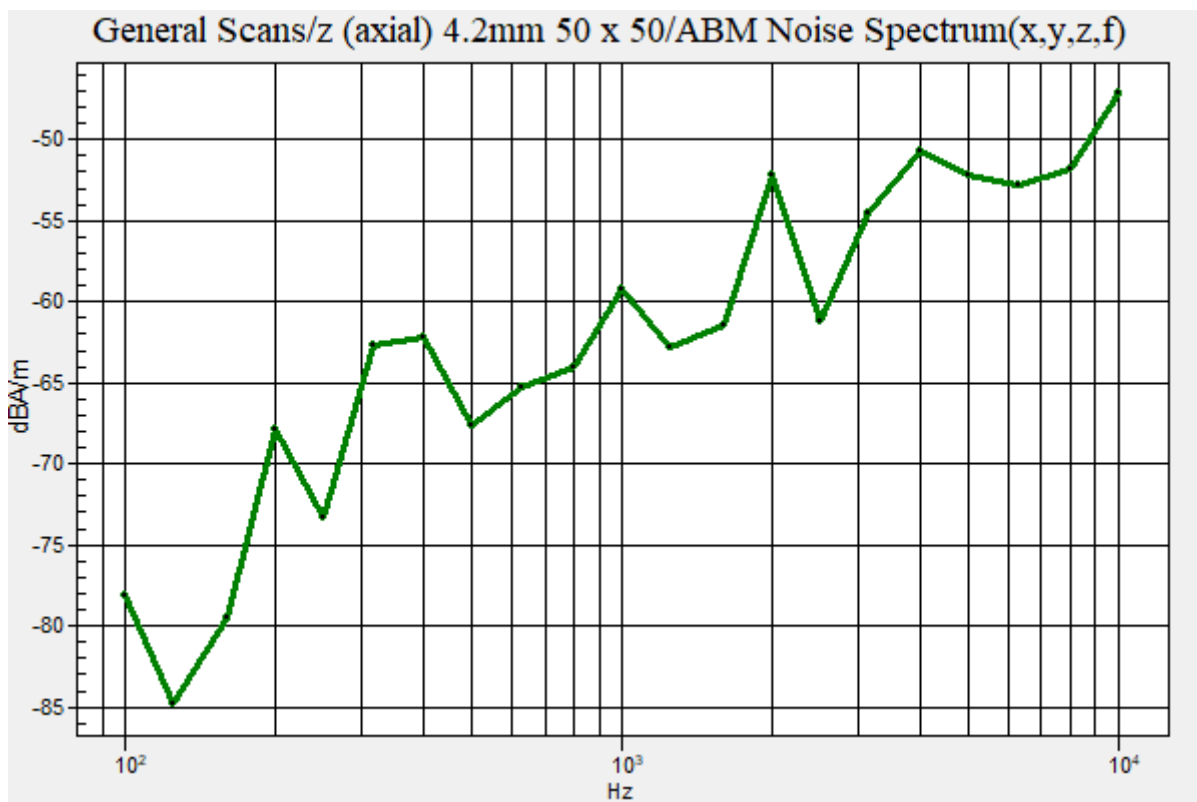

**Plot No.195**  
**NR Band 66 CP-OFDM 16QAM 15MHz 1RB 77offset 354500ch y(trnasversal)**

**DUT: SM-G991U; Type: Bar**

Communication System: UID 0, NR Band 66 (0); Frequency: 1772.5 MHz;Duty Cycle: 1:1  
Medium parameters used:  $\sigma = 0$  S/m,  $\epsilon_r = 1$ ;  $\rho = 0$  kg/m<sup>3</sup>  
Phantom section: TCoil Section

DASY Configuration:

- Probe: AM1DV3 - 3049; ;
- Sensor-Surface: 0mm (Fix Surface)
- Electronics: DAE4 Sn466; Calibrated: 2020-04-22
- Phantom: HAC Test Arch with AMCC
- Measurement SW: DASY52, Version 52.10 (4);

**T-Coil scan (scan for ANSI C63.19-2007 & 2011 compliance)/General Scans/y (transversal) 4.2mm 50 x 50/ABM Noise Spectrum(x,y,z,f) (13x13x1):** Measurement grid: dx=10mm, dy=10mm  
Signal Type: Audio File (.wav) 48k\_voice\_1kHz\_1s.wav  
Output Gain: 18.9  
Measure Window Start: 300ms  
Measure Window Length: 1000ms  
Device Reference Point: 0, 0, -6.3 mm

**Cursor:**  
ABM = -53.10 dBA/m  
Location: 4.2, -25, 3.7 mm

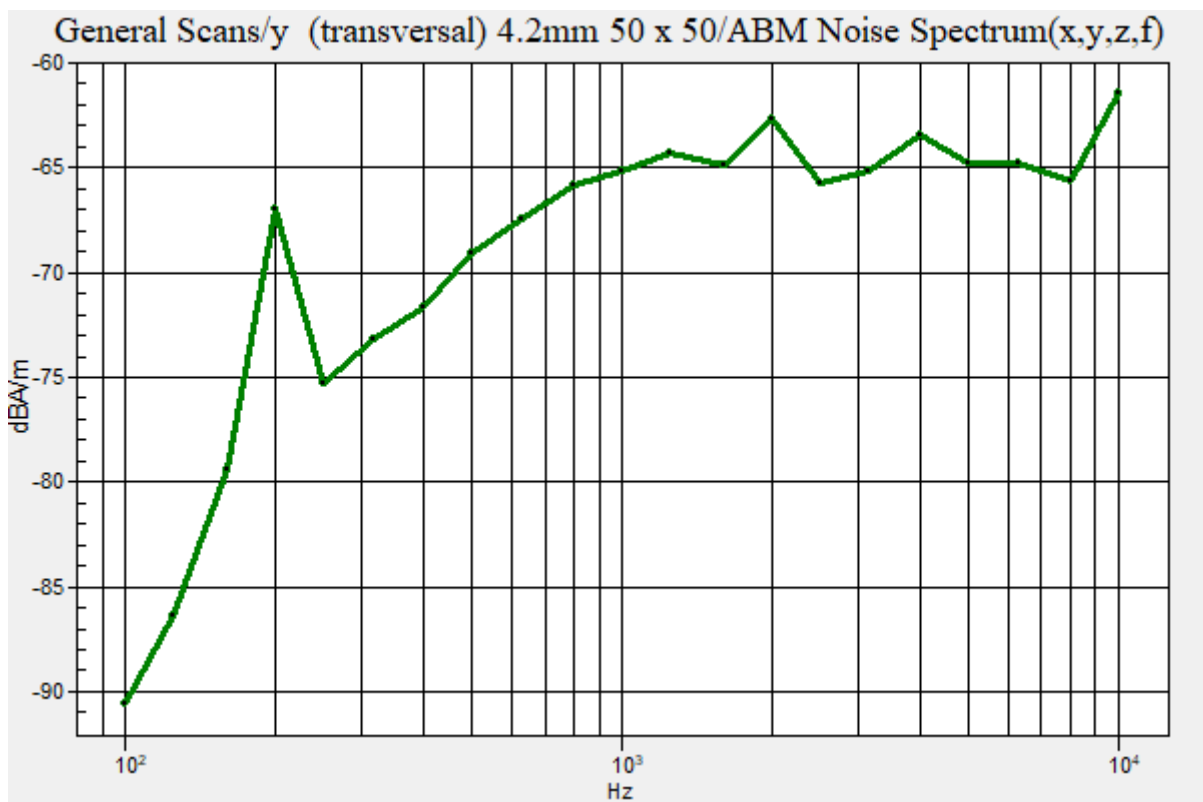



**Plot No.196**  
**NR Band 41 CP-OFDM 16QAM 20MHz 1RB 49offset 518598ch z(axial)**

**DUT: SM-G991U; Type: Bar**

Communication System: UID 0, n41 (0); Frequency: 2592.99 MHz;Duty Cycle: 1:1  
Medium parameters used:  $\sigma = 0$  S/m,  $\epsilon_r = 1$ ;  $\rho = 0$  kg/m<sup>3</sup>  
Phantom section: TCoil Section

DASY Configuration:

- Probe: AM1DV3 - 3049; ;
- Sensor-Surface: 0mm (Fix Surface)
- Electronics: DAE4 Sn466; Calibrated: 2020-04-22
- Phantom: HAC Test Arch with AMCC
- Measurement SW: DASY52, Version 52.10 (4);

**T-Coil scan (scan for ANSI C63.19-2007 & 2011 compliance)/General Scans/z (axial) 4.2mm 50 x 50/ABM Noise Spectrum(x,y,z,f) (13x13x1):** Measurement grid: dx=10mm, dy=10mm  
Signal Type: Audio File (.wav) 48k\_voice\_1kHz\_1s.wav  
Output Gain: 18.9  
Measure Window Start: 300ms  
Measure Window Length: 1000ms  
Device Reference Point: 0, 0, -6.3 mm

**Cursor:**  
ABM = -46.44 dBA/m  
Location: 12.5, -12.5, 3.7 mm

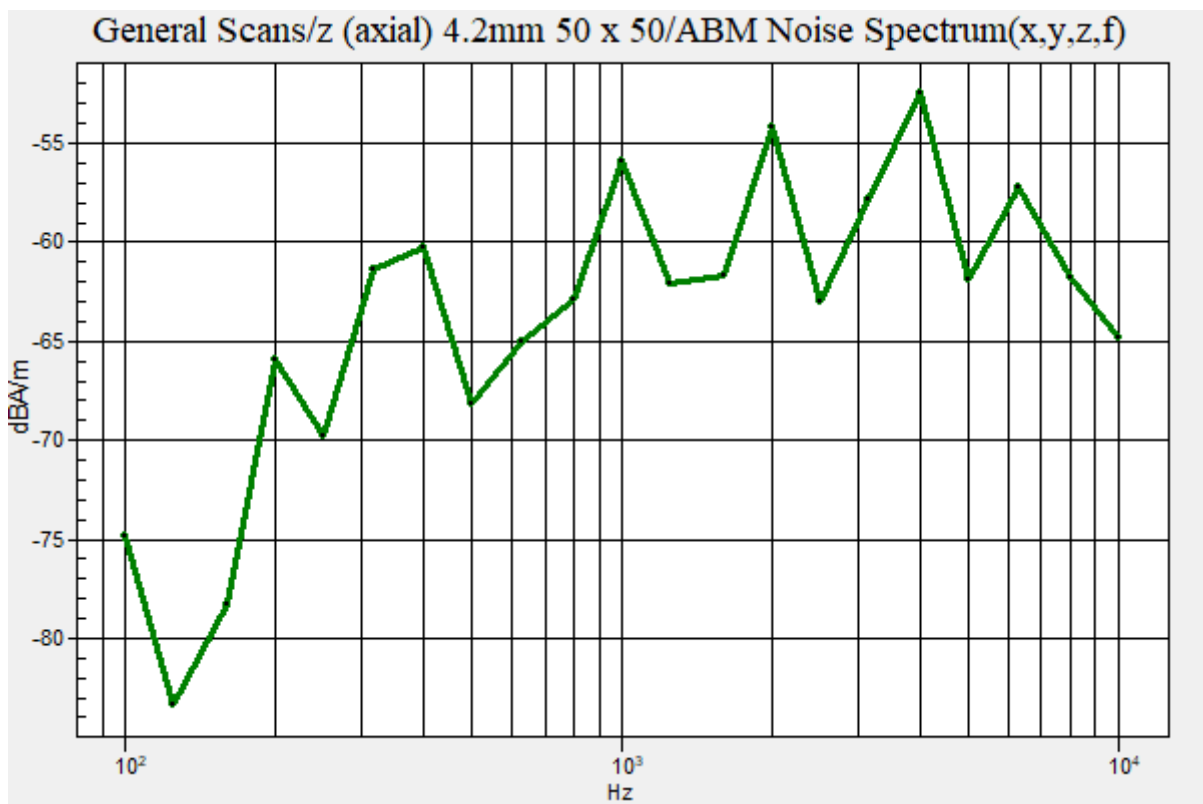

**Plot No.197**  
**NR Band 41 CP-OFDM 16QAM 20MHz 1RB 49offset 518598ch y(transversal)**

**DUT: SM-G991U; Type: Bar**

Communication System: UID 0, n41 (0); Frequency: 2592.99 MHz;Duty Cycle: 1:1  
Medium parameters used:  $\sigma = 0$  S/m,  $\epsilon_r = 1$ ;  $\rho = 0$  kg/m<sup>3</sup>  
Phantom section: TCoil Section

DASY Configuration:

- Probe: AM1DV3 - 3049; ;
- Sensor-Surface: 0mm (Fix Surface)
- Electronics: DAE4 Sn466; Calibrated: 2020-04-22
- Phantom: HAC Test Arch with AMCC
- Measurement SW: DASY52, Version 52.10 (4);

**T-Coil scan (scan for ANSI C63.19-2007 & 2011 compliance)/General Scans/y (transversal) 4.2mm 50 x 50/ABM Noise Spectrum(x,y,z,f) (13x13x1):** Measurement grid: dx=10mm, dy=10mm  
Signal Type: Audio File (.wav) 48k\_voice\_1kHz\_1s.wav  
Output Gain: 18.9  
Measure Window Start: 300ms  
Measure Window Length: 1000ms  
Device Reference Point: 0, 0, -6.3 mm

**Cursor:**  
ABM = -53.44 dBA/m  
Location: 8.3, -25, 3.7 mm

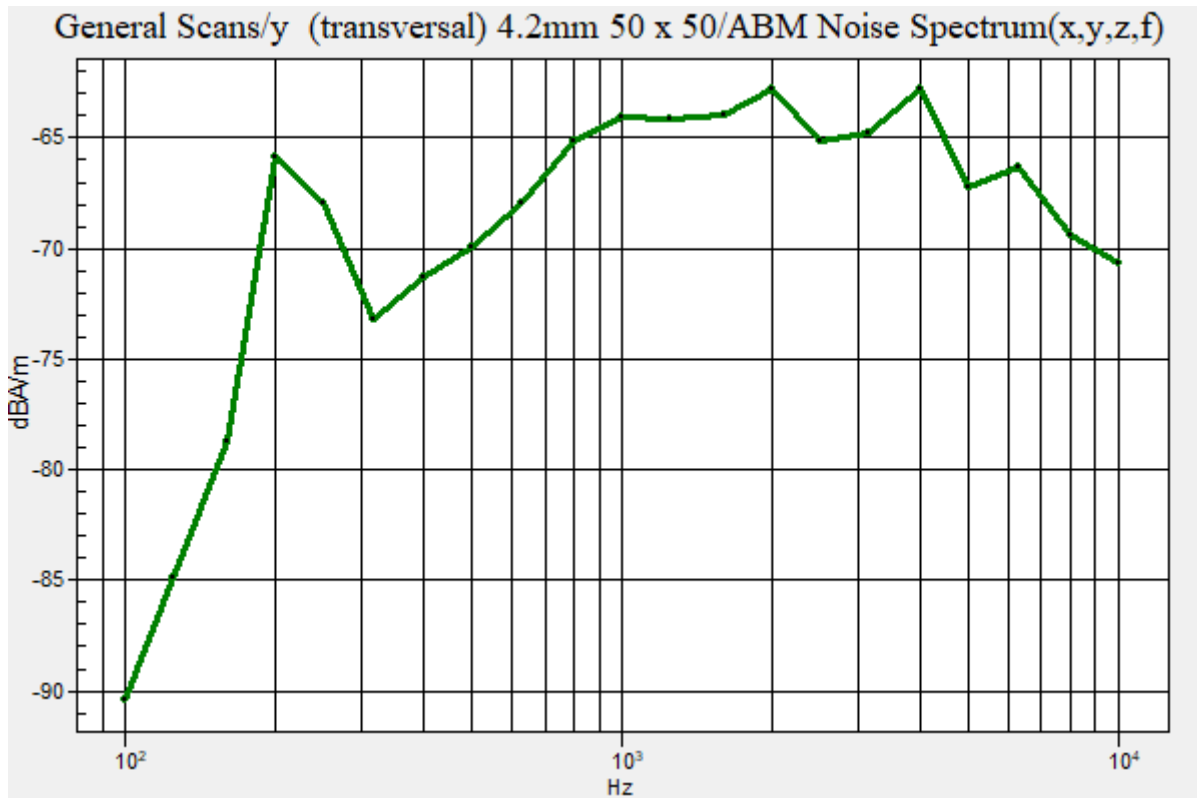

**Plot No.198**  
**NR Band 41 CP-OFDM 16QAM 40MHz 1RB 104offset 518598ch z(axial)**

**DUT: SM-G991U; Type: Bar**

Communication System: UID 0, n41 (0); Frequency: 2592.99 MHz;Duty Cycle: 1:1  
Medium parameters used:  $\sigma = 0$  S/m,  $\epsilon_r = 1$ ;  $\rho = 0$  kg/m<sup>3</sup>  
Phantom section: TCoil Section

DASY Configuration:

- Probe: AM1DV3 - 3049; ;
- Sensor-Surface: 0mm (Fix Surface)
- Electronics: DAE4 Sn466; Calibrated: 2020-04-22
- Phantom: HAC Test Arch with AMCC
- Measurement SW: DASY52, Version 52.10 (4);

**T-Coil scan (scan for ANSI C63.19-2007 & 2011 compliance)/General Scans/z (axial) 4.2mm 50 x 50/ABM Noise Spectrum(x,y,z,f) (13x13x1):** Measurement grid: dx=10mm, dy=10mm  
Signal Type: Audio File (.wav) 48k\_voice\_1kHz\_1s.wav  
Output Gain: 18.9  
Measure Window Start: 300ms  
Measure Window Length: 1000ms  
Device Reference Point: 0, 0, -6.3 mm

**Cursor:**  
ABM = -45.89 dBA/m  
Location: 12.5, -12.5, 3.7 mm

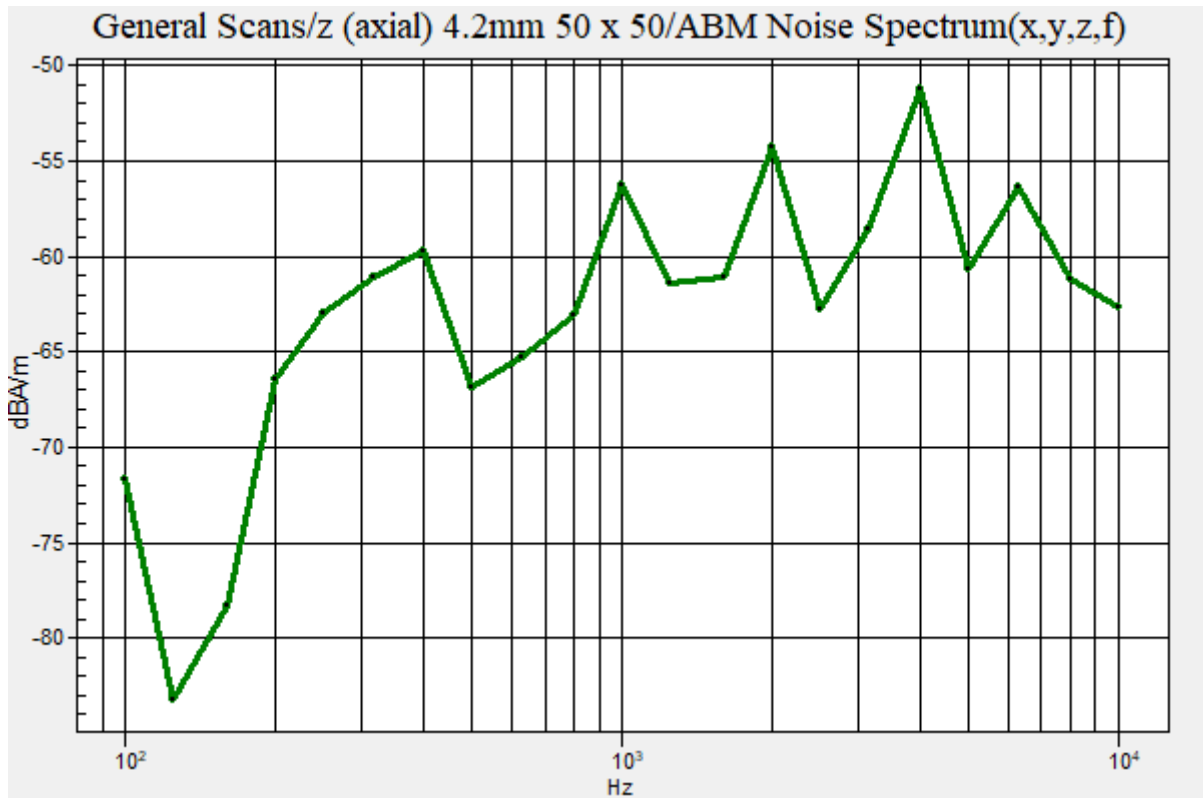

**Plot No.199**

**NR Band 41 CP-OFDM 16QAM 40MHz 1RB 104offset 518598ch y(transversal)**

**DUT: SM-G991U; Type: Bar**

Communication System: UID 0, n41 (0); Frequency: 2592.99 MHz;Duty Cycle: 1:1  
Medium parameters used:  $\sigma = 0$  S/m,  $\epsilon_r = 1$ ;  $\rho = 0$  kg/m<sup>3</sup>  
Phantom section: TCoil Section

DASY Configuration:

- Probe: AM1DV3 - 3049; ;
- Sensor-Surface: 0mm (Fix Surface)
- Electronics: DAE4 Sn466; Calibrated: 2020-04-22
- Phantom: HAC Test Arch with AMCC
- Measurement SW: DASY52, Version 52.10 (4);

**T-Coil scan (scan for ANSI C63.19-2007 & 2011 compliance)/General Scans/y (transversal) 4.2mm 50 x 50/ABM Noise Spectrum(x,y,z,f) (13x13x1):**

Measurement grid: dx=10mm, dy=10mm

Signal Type: Audio File (.wav) 48k\_voice\_1kHz\_1s.wav

Output Gain: 18.9

Measure Window Start: 300ms

Measure Window Length: 1000ms

Device Reference Point: 0, 0, -6.3 mm

**Cursor:**

ABM = -53.16 dBA/m

Location: 8.3, -25, 3.7 mm

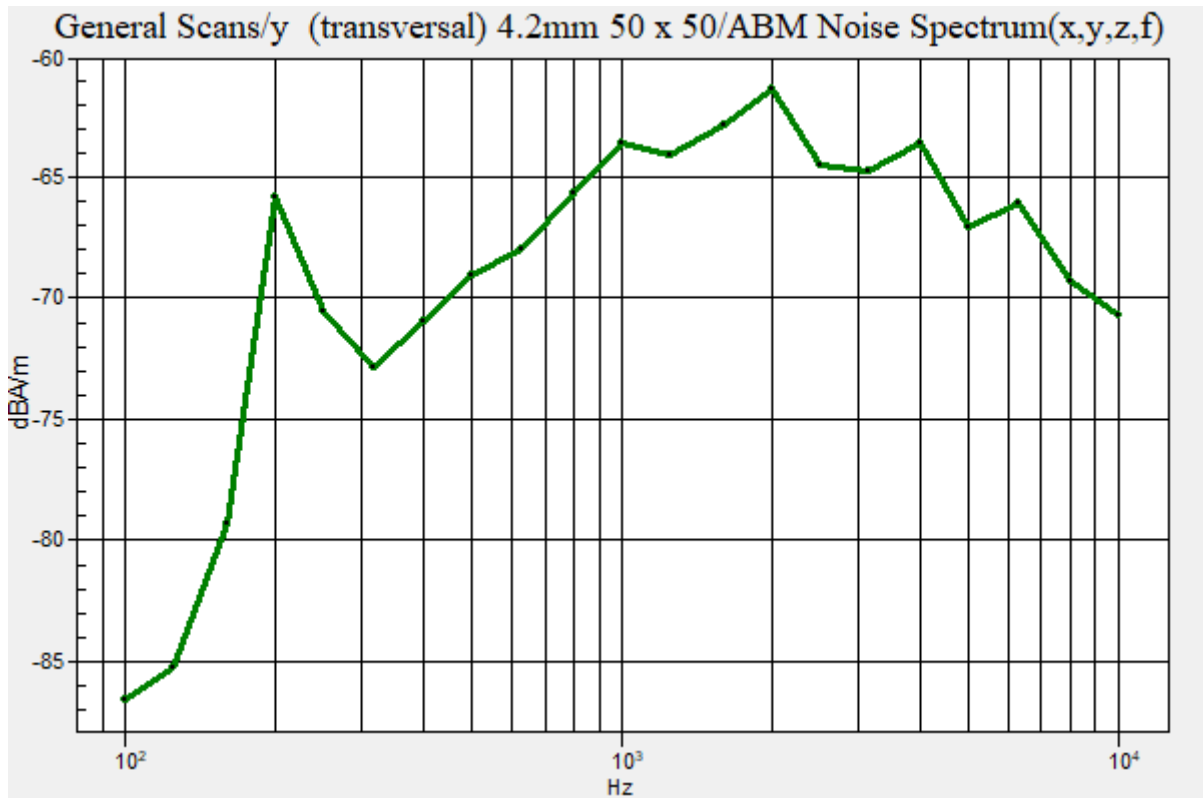

**Plot No.200**  
NR Band 41 CP-OFDM 16QAM 50MHz 1RB 131offset 518598ch z(axial)

**DUT: SM-G991U; Type: Bar**

Communication System: UID 0, n41 (0); Frequency: 2592.99 MHz;Duty Cycle: 1:1  
Medium parameters used:  $\sigma = 0$  S/m,  $\epsilon_r = 1$ ;  $\rho = 0$  kg/m<sup>3</sup>  
Phantom section: TCoil Section

DASY Configuration:

- Probe: AM1DV3 - 3049; ;
- Sensor-Surface: 0mm (Fix Surface)
- Electronics: DAE4 Sn466; Calibrated: 2020-04-22
- Phantom: HAC Test Arch with AMCC
- Measurement SW: DASY52, Version 52.10 (4);

**T-Coil scan (scan for ANSI C63.19-2007 & 2011 compliance)/General Scans/z (axial) 4.2mm 50 x 50/ABM Noise Spectrum(x,y,z,f) (13x13x1):** Measurement grid: dx=10mm, dy=10mm  
Signal Type: Audio File (.wav) 48k\_voice\_1kHz\_1s.wav  
Output Gain: 18.9  
Measure Window Start: 300ms  
Measure Window Length: 1000ms  
Device Reference Point: 0, 0, -6.3 mm

**Cursor:**  
ABM = -45.30 dBA/m  
Location: 12.5, -12.5, 3.7 mm

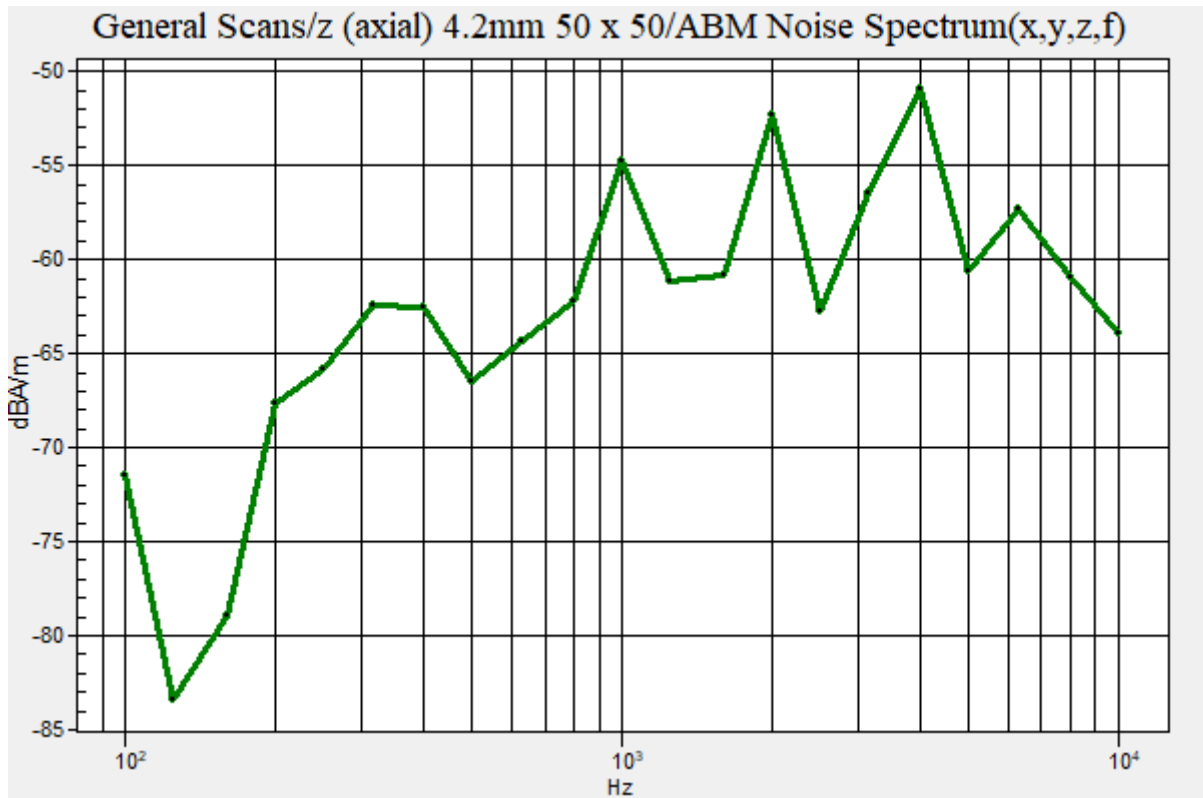

**Plot No.201**

**NR Band 41 CP-OFDM 16QAM 50MHz 1RB 131offset 518598ch y(transversal)**

**DUT: SM-G991U; Type: Bar**

Communication System: UID 0, n41 (0); Frequency: 2592.99 MHz;Duty Cycle: 1:1  
Medium parameters used:  $\sigma = 0$  S/m,  $\epsilon_r = 1$ ;  $\rho = 0$  kg/m<sup>3</sup>  
Phantom section: TCoil Section

DASY Configuration:

- Probe: AM1DV3 - 3049; ;
- Sensor-Surface: 0mm (Fix Surface)
- Electronics: DAE4 Sn466; Calibrated: 2020-04-22
- Phantom: HAC Test Arch with AMCC
- Measurement SW: DASY52, Version 52.10 (4);

**T-Coil scan (scan for ANSI C63.19-2007 & 2011 compliance)/General Scans/y (transversal) 4.2mm 50 x 50/ABM Noise Spectrum(x,y,z,f) (13x13x1):**

Measurement grid: dx=10mm, dy=10mm

Signal Type: Audio File (.wav) 48k\_voice\_1kHz\_1s.wav

Output Gain: 18.9

Measure Window Start: 300ms

Measure Window Length: 1000ms

Device Reference Point: 0, 0, -6.3 mm

**Cursor:**

ABM = -53.27 dBA/m

Location: 8.3, -25, 3.7 mm

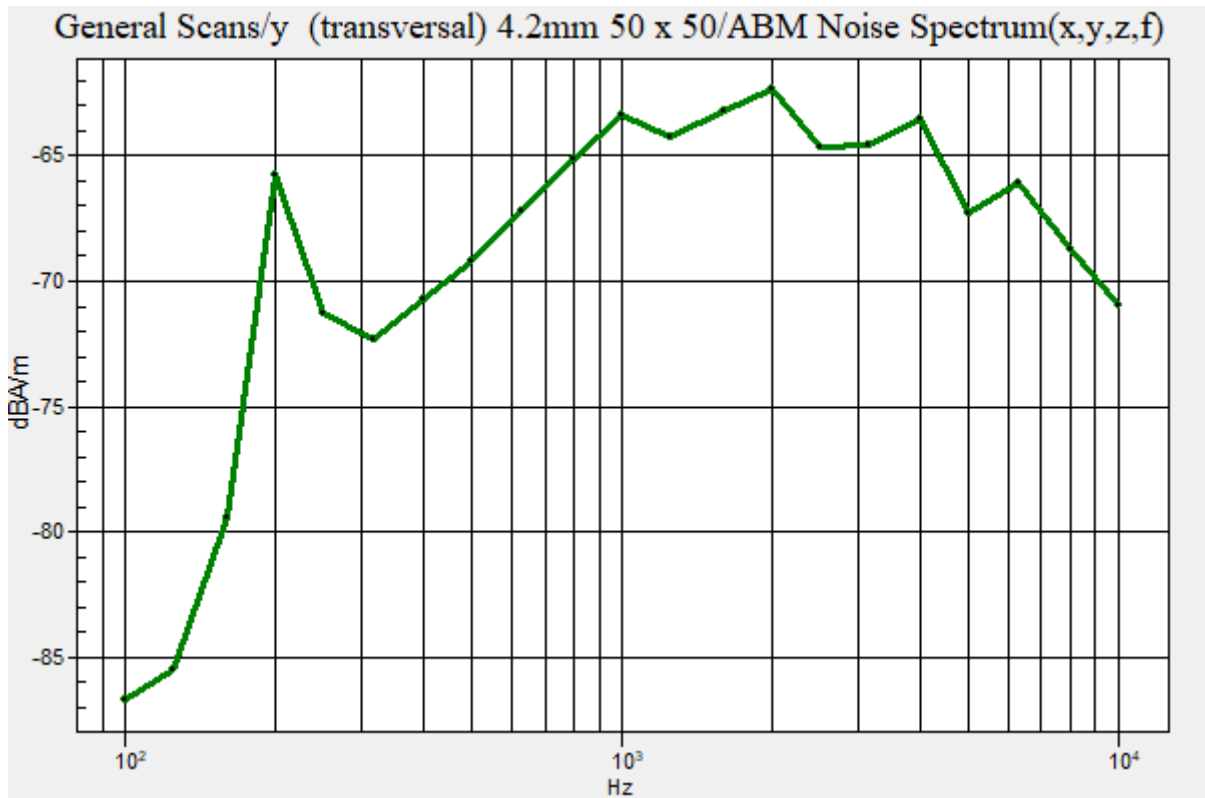

**Plot No.202**  
**NR Band 41 CP-OFDM 16QAM 60MHz 1RB 160offset 518598ch z(axial)**

**DUT: SM-G991U; Type: Bar**

Communication System: UID 0, n41 (0); Frequency: 2592.99 MHz;Duty Cycle: 1:1  
Medium parameters used:  $\sigma = 0$  S/m,  $\epsilon_r = 1$ ;  $\rho = 0$  kg/m<sup>3</sup>  
Phantom section: TCoil Section

DASY Configuration:

- Probe: AM1DV3 - 3049; ;
- Sensor-Surface: 0mm (Fix Surface)
- Electronics: DAE4 Sn466; Calibrated: 2020-04-22
- Phantom: HAC Test Arch with AMCC
- Measurement SW: DASY52, Version 52.10 (4);

**T-Coil scan (scan for ANSI C63.19-2007 & 2011 compliance)/General Scans/z (axial) 4.2mm 50 x 50/ABM Noise Spectrum(x,y,z,f) (13x13x1):** Measurement grid: dx=10mm, dy=10mm  
Signal Type: Audio File (.wav) 48k\_voice\_1kHz\_1s.wav  
Output Gain: 18.9  
Measure Window Start: 300ms  
Measure Window Length: 1000ms  
Device Reference Point: 0, 0, -6.3 mm

**Cursor:**  
ABM = -46.96 dBA/m  
Location: 12.5, -12.5, 3.7 mm

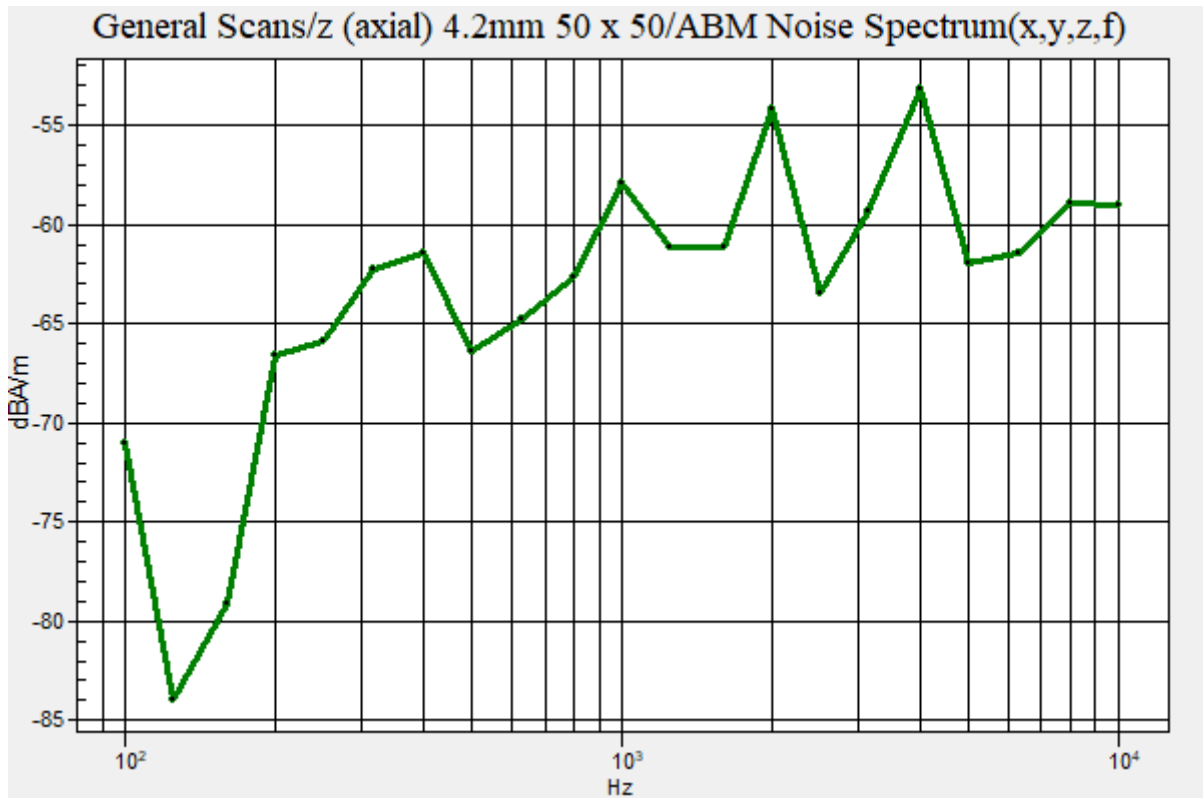

**Plot No.203**

**NR Band 41 CP-OFDM 16QAM 60MHz 1RB 160offset 518598ch y(transversal)**

**DUT: SM-G991U; Type: Bar**

Communication System: UID 0, n41 (0); Frequency: 2592.99 MHz;Duty Cycle: 1:1  
Medium parameters used:  $\sigma = 0$  S/m,  $\epsilon_r = 1$ ;  $\rho = 0$  kg/m<sup>3</sup>  
Phantom section: TCoil Section

DASY Configuration:

- Probe: AM1DV3 - 3049; ;
- Sensor-Surface: 0mm (Fix Surface)
- Electronics: DAE4 Sn466; Calibrated: 2020-04-22
- Phantom: HAC Test Arch with AMCC
- Measurement SW: DASY52, Version 52.10 (4);

**T-Coil scan (scan for ANSI C63.19-2007 & 2011 compliance)/General Scans/y (transversal) 4.2mm 50 x 50/ABM Noise Spectrum(x,y,z,f) (13x13x1):**

Measurement grid: dx=10mm, dy=10mm

Signal Type: Audio File (.wav) 48k\_voice\_1kHz\_1s.wav

Output Gain: 18.9

Measure Window Start: 300ms

Measure Window Length: 1000ms

Device Reference Point: 0, 0, -6.3 mm

**Cursor:**

ABM = -53.01 dBA/m

Location: 8.3, -25, 3.7 mm

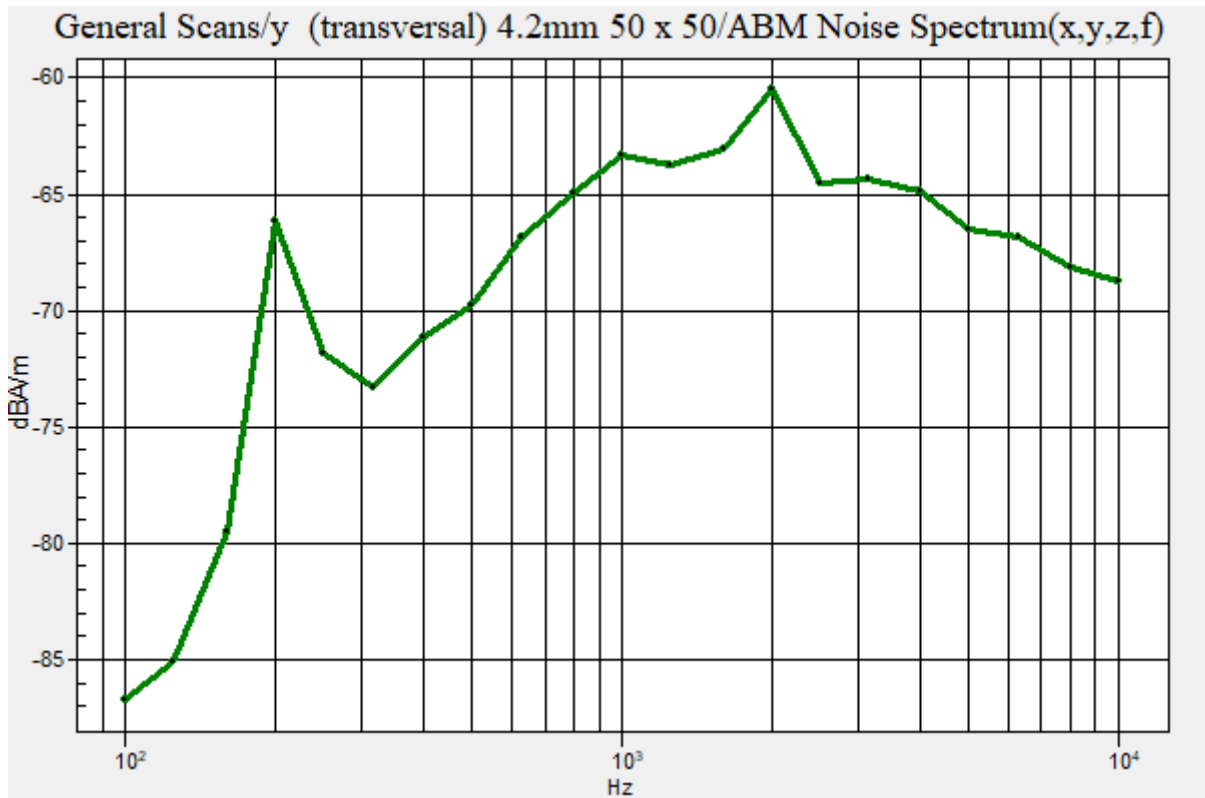



**Plot No.204**  
**NR Band 41 CP-OFDM 16QAM 80MHz 1RB 215offset 518598ch z(axial)**

**DUT: SM-G991U; Type: Bar**

Communication System: UID 0, n41 (0); Frequency: 2592.99 MHz;Duty Cycle: 1:1  
Medium parameters used:  $\sigma = 0$  S/m,  $\epsilon_r = 1$ ;  $\rho = 0$  kg/m<sup>3</sup>  
Phantom section: TCoil Section

DASY Configuration:

- Probe: AM1DV3 - 3049; ;
- Sensor-Surface: 0mm (Fix Surface)
- Electronics: DAE4 Sn466; Calibrated: 2020-04-22
- Phantom: HAC Test Arch with AMCC
- Measurement SW: DASY52, Version 52.10 (4);

**T-Coil scan (scan for ANSI C63.19-2007 & 2011 compliance)/General Scans/z (axial) 4.2mm 50 x 50/ABM Noise Spectrum(x,y,z,f) (13x13x1):** Measurement grid: dx=10mm, dy=10mm  
Signal Type: Audio File (.wav) 48k\_voice\_1kHz\_1s.wav  
Output Gain: 18.9  
Measure Window Start: 300ms  
Measure Window Length: 1000ms  
Device Reference Point: 0, 0, -6.3 mm

**Cursor:**  
ABM = -45.64 dBA/m  
Location: 12.5, -12.5, 3.7 mm

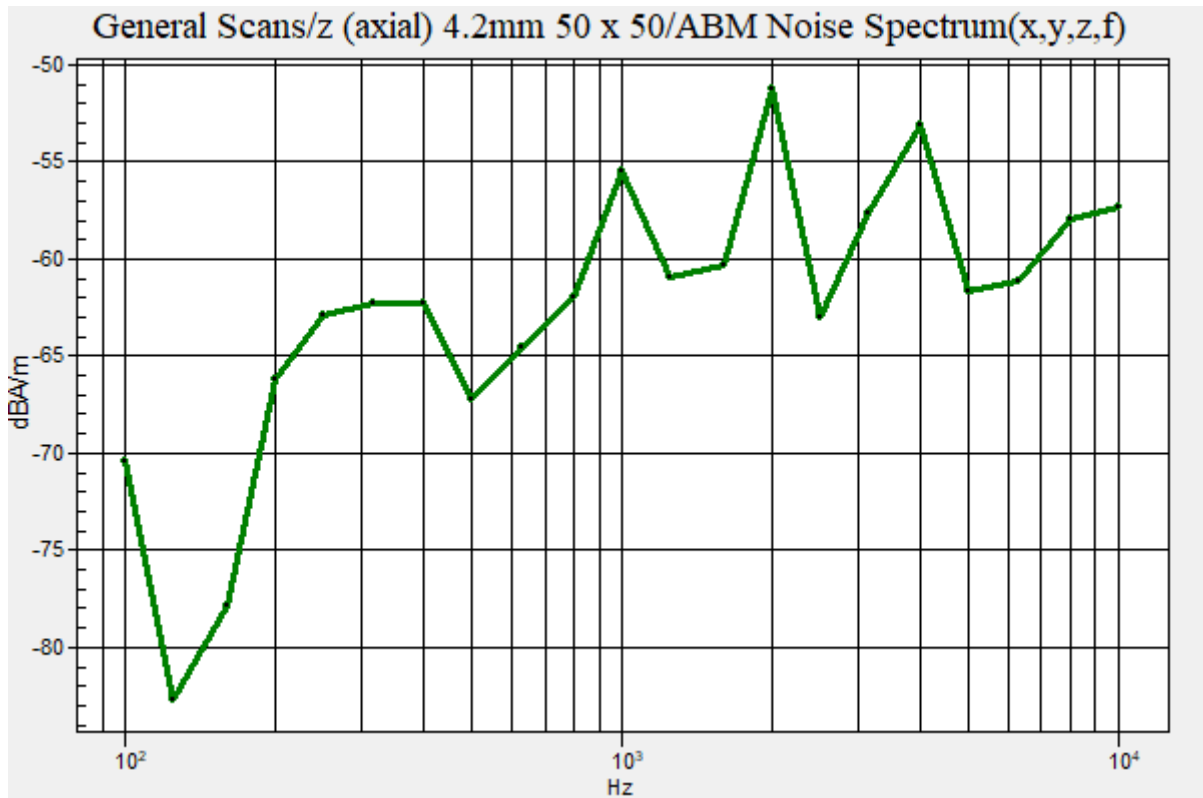

**Plot No.205**

**NR Band 41 CP-OFDM 16QAM 80MHz 1RB 215offset 518598ch y(transversal)**

**DUT: SM-G991U; Type: Bar**

Communication System: UID 0, n41 (0); Frequency: 2592.99 MHz;Duty Cycle: 1:1  
Medium parameters used:  $\sigma = 0$  S/m,  $\epsilon_r = 1$ ;  $\rho = 0$  kg/m<sup>3</sup>  
Phantom section: TCoil Section

DASY Configuration:

- Probe: AM1DV3 - 3049; ;
- Sensor-Surface: 0mm (Fix Surface)
- Electronics: DAE4 Sn466; Calibrated: 2020-04-22
- Phantom: HAC Test Arch with AMCC
- Measurement SW: DASY52, Version 52.10 (4);

**T-Coil scan (scan for ANSI C63.19-2007 & 2011 compliance)/General Scans/y (transversal) 4.2mm 50**

**x 50/ABM Noise Spectrum(x,y,z,f) (13x13x1):** Measurement grid: dx=10mm, dy=10mm

Signal Type: Audio File (.wav) 48k\_voice\_1kHz\_1s.wav

Output Gain: 18.9

Measure Window Start: 300ms

Measure Window Length: 1000ms

Device Reference Point: 0, 0, -6.3 mm

**Cursor:**

ABM = -52.62 dBA/m

Location: 8.3, -25, 3.7 mm

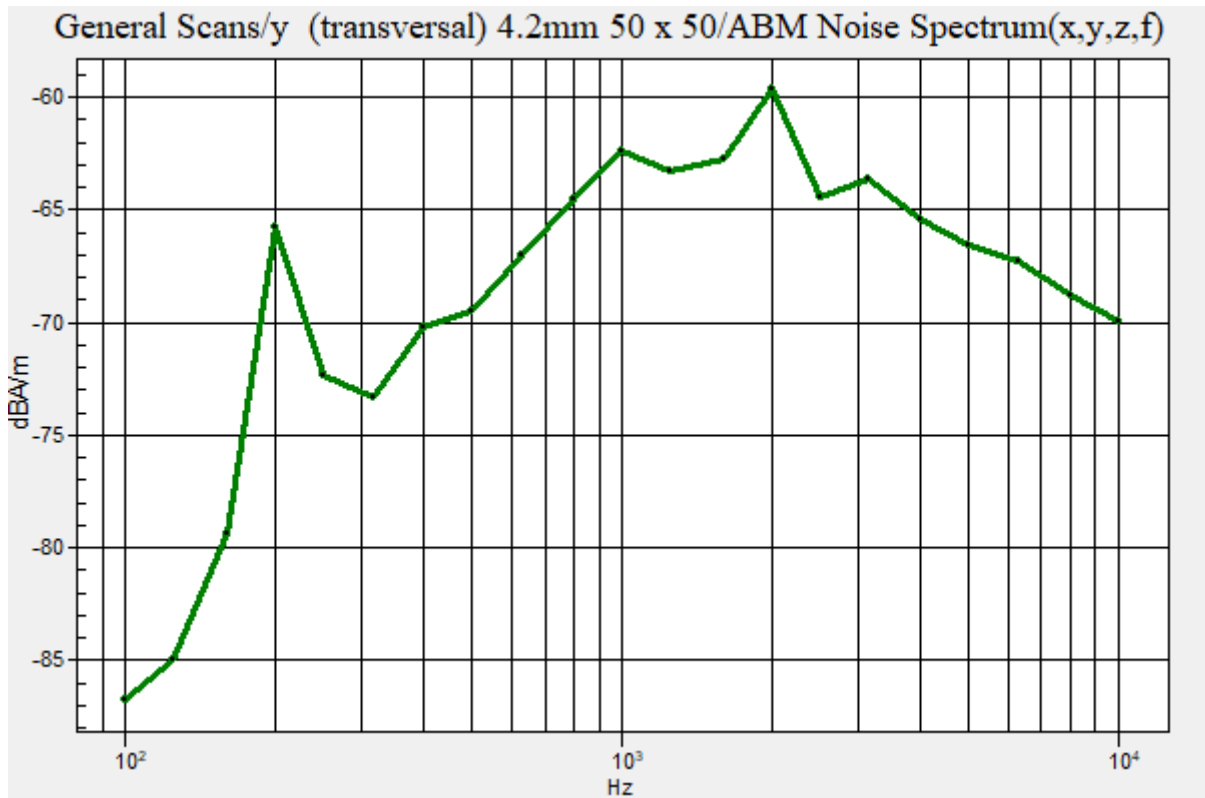

**Plot No.206**  
NR Band 41 CP-OFDM 16QAM 90MHz 1RB 243offset 518598ch z(axial)

**DUT: SM-G991U; Type: Bar**

Communication System: UID 0, n41 (0); Frequency: 2592.99 MHz;Duty Cycle: 1:1  
Medium parameters used:  $\sigma = 0$  S/m,  $\epsilon_r = 1$ ;  $\rho = 0$  kg/m<sup>3</sup>  
Phantom section: TCoil Section

DASY Configuration:

- Probe: AM1DV3 - 3049; ;
- Sensor-Surface: 0mm (Fix Surface)
- Electronics: DAE4 Sn466; Calibrated: 2020-04-22
- Phantom: HAC Test Arch with AMCC
- Measurement SW: DASY52, Version 52.10 (4);

**T-Coil scan (scan for ANSI C63.19-2007 & 2011 compliance)/General Scans/z (axial) 4.2mm 50 x 50/ABM Noise Spectrum(x,y,z,f) (13x13x1):** Measurement grid: dx=10mm, dy=10mm  
Signal Type: Audio File (.wav) 48k\_voice\_1kHz\_1s.wav  
Output Gain: 18.9  
Measure Window Start: 300ms  
Measure Window Length: 1000ms  
Device Reference Point: 0, 0, -6.3 mm

**Cursor:**  
ABM = -46.50 dBA/m  
Location: 12.5, -12.5, 3.7 mm

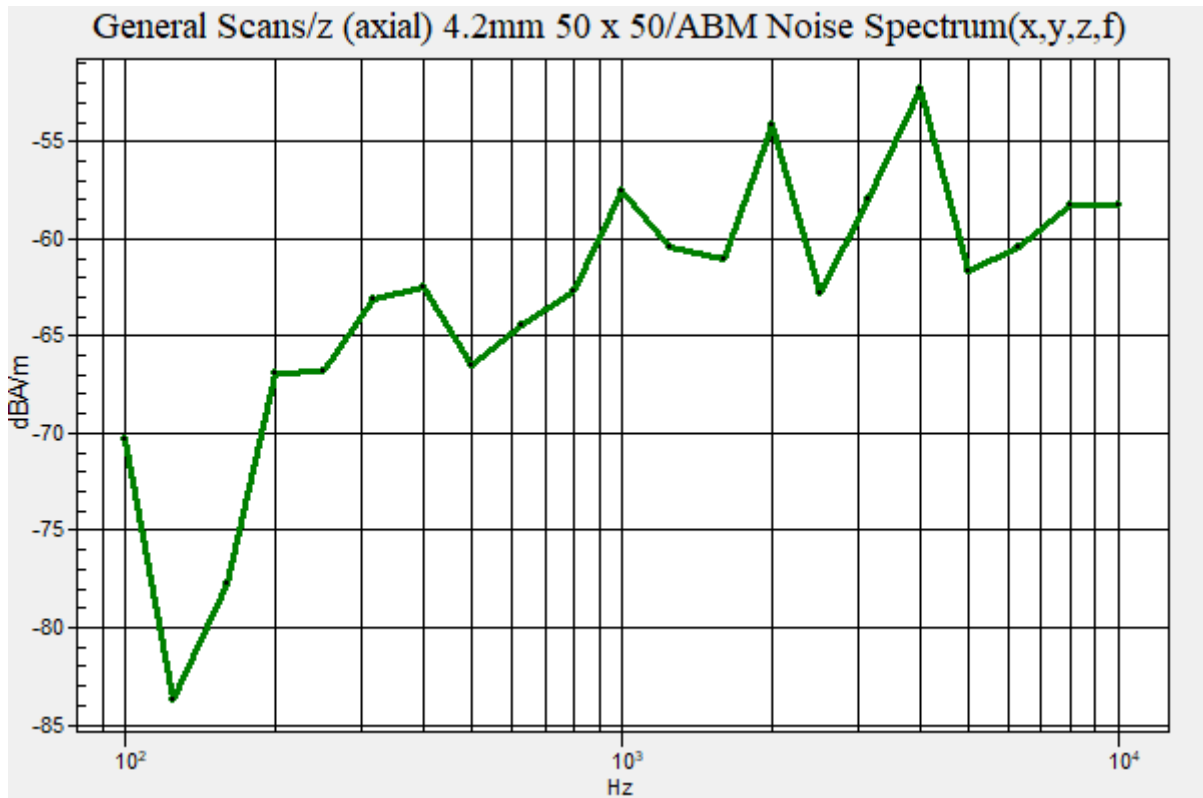

**Plot No.207**

**NR Band 41 CP-OFDM 16QAM 90MHz 1RB 243offset 518598ch y(transversal)**

**DUT: SM-G991U; Type: Bar**

Communication System: UID 0, n41 (0); Frequency: 2592.99 MHz;Duty Cycle: 1:1  
Medium parameters used:  $\sigma = 0$  S/m,  $\epsilon_r = 1$ ;  $\rho = 0$  kg/m<sup>3</sup>  
Phantom section: TCoil Section

DASY Configuration:

- Probe: AM1DV3 - 3049; ;
- Sensor-Surface: 0mm (Fix Surface)
- Electronics: DAE4 Sn466; Calibrated: 2020-04-22
- Phantom: HAC Test Arch with AMCC
- Measurement SW: DASY52, Version 52.10 (4);

**T-Coil scan (scan for ANSI C63.19-2007 & 2011 compliance)/General Scans/y (transversal) 4.2mm 50 x 50/ABM Noise Spectrum(x,y,z,f) (13x13x1):** Measurement grid: dx=10mm, dy=10mm

Signal Type: Audio File (.wav) 48k\_voice\_1kHz\_1s.wav  
Output Gain: 18.9  
Measure Window Start: 300ms  
Measure Window Length: 1000ms  
Device Reference Point: 0, 0, -6.3 mm

**Cursor:**

ABM = -52.95 dBA/m  
Location: 8.3, -25, 3.7 mm

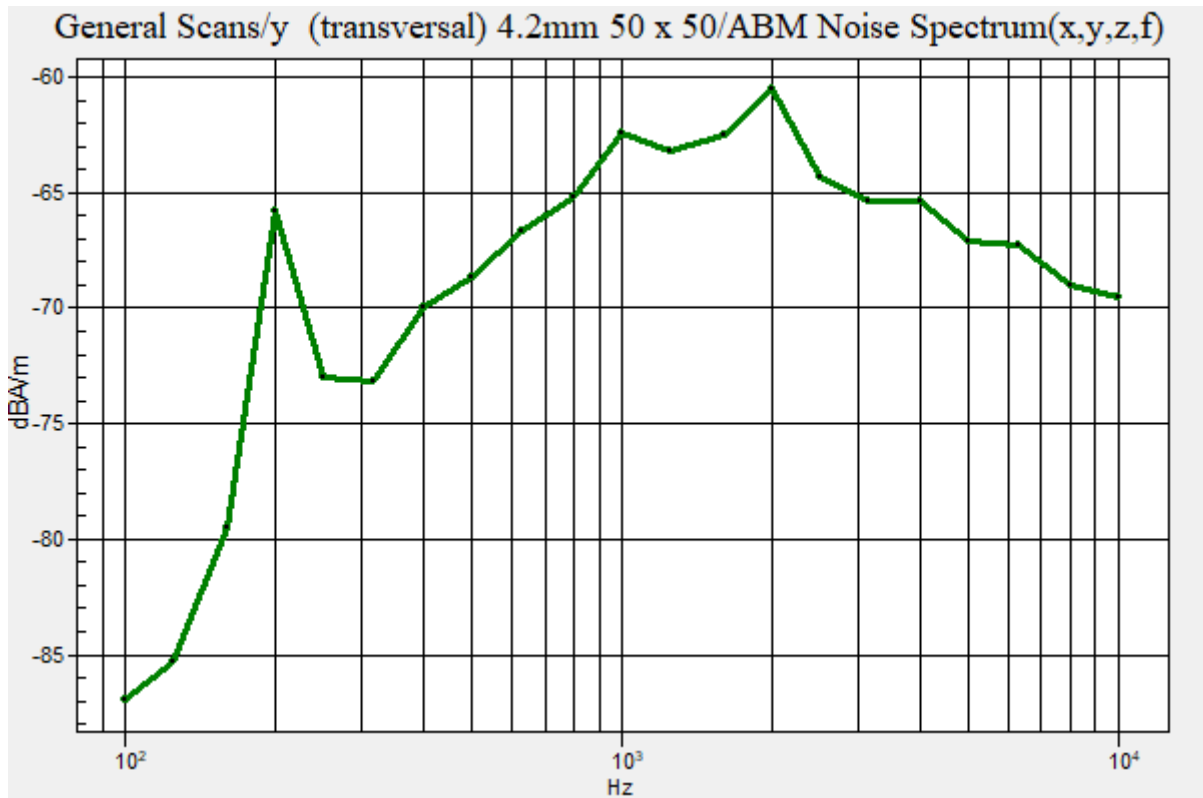

**Plot No.208**

**NR Band 41 CP-OFDM 16QAM 100MHz 1RB 271offset 518598ch z(axial)**

**DUT: SM-G991U; Type: Bar**

Communication System: UID 0, n41 (0); Frequency: 2592.99 MHz;Duty Cycle: 1:1  
Medium parameters used:  $\sigma = 0$  S/m,  $\epsilon_r = 1$ ;  $\rho = 0$  kg/m<sup>3</sup>  
Phantom section: TCoil Section

DASY Configuration:

- Probe: AM1DV3 - 3049; ;
- Sensor-Surface: 0mm (Fix Surface)
- Electronics: DAE4 Sn466; Calibrated: 2020-04-22
- Phantom: HAC Test Arch with AMCC
- Measurement SW: DASY52, Version 52.10 (4);

**T-Coil scan (scan for ANSI C63.19-2007 & 2011 compliance)/General Scans/z (axial) 4.2mm 50 x 50/ABM Noise Spectrum(x,y,z,f) (13x13x1):** Measurement grid: dx=10mm, dy=10mm

Signal Type: Audio File (.wav) 48k\_voice\_1kHz\_1s.wav  
Output Gain: 18.9  
Measure Window Start: 300ms  
Measure Window Length: 1000ms  
Device Reference Point: 0, 0, -6.3 mm

**Cursor:**

ABM = -44.43 dBA/m  
Location: 12.5, -12.5, 3.7 mm

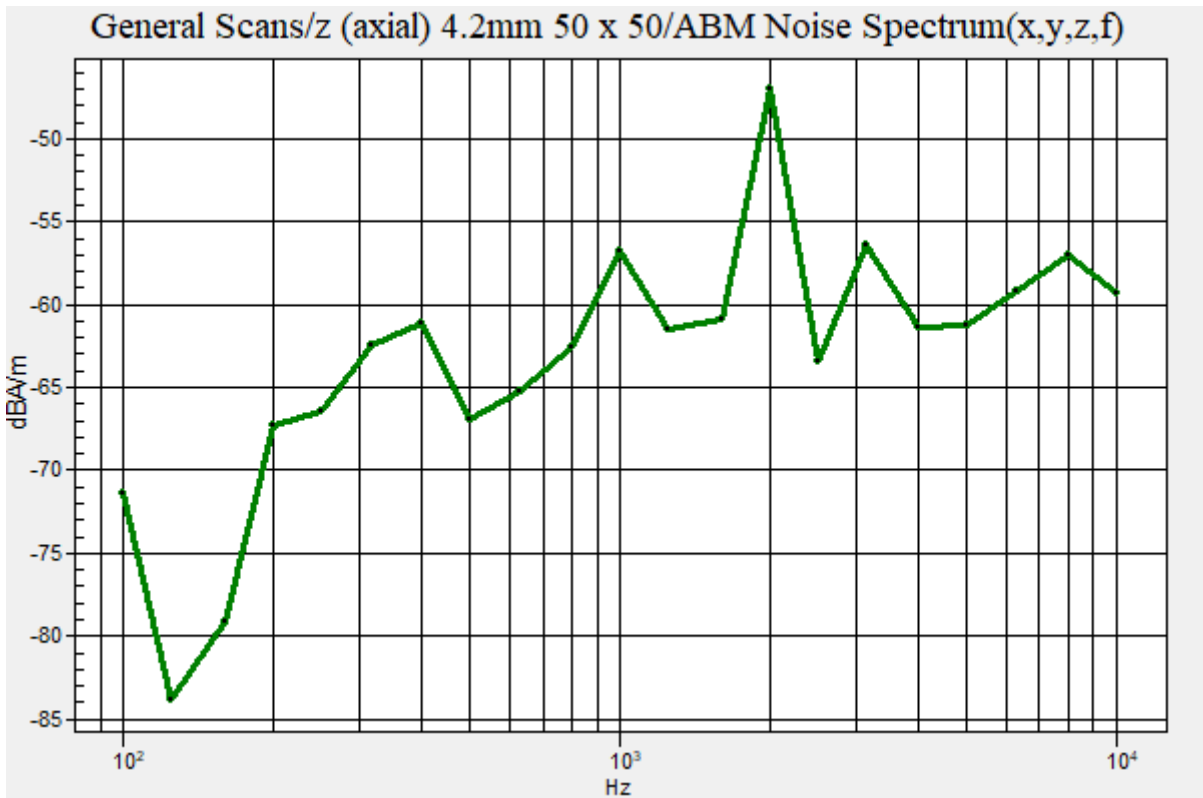

**Plot No.209**

**NR Band 41 CP-OFDM 16QAM 100MHz 1RB 271offset 518598ch y(transversal)**

**DUT: SM-G991U; Type: Bar**

Communication System: UID 0, n41 (0); Frequency: 2592.99 MHz;Duty Cycle: 1:1  
Medium parameters used:  $\sigma = 0$  S/m,  $\epsilon_r = 1$ ;  $\rho = 0$  kg/m<sup>3</sup>  
Phantom section: TCoil Section

DASY Configuration:

- Probe: AM1DV3 - 3049; ;
- Sensor-Surface: 0mm (Fix Surface)
- Electronics: DAE4 Sn466; Calibrated: 2020-04-22
- Phantom: HAC Test Arch with AMCC
- Measurement SW: DASY52, Version 52.10 (4);

**T-Coil scan (scan for ANSI C63.19-2007 & 2011 compliance)/General Scans/y (transversal) 4.2mm 50 x 50/ABM Noise Spectrum(x,y,z,f) (13x13x1):**

Measurement grid: dx=10mm, dy=10mm

Signal Type: Audio File (.wav) 48k\_voice\_1kHz\_1s.wav

Output Gain: 18.9

Measure Window Start: 300ms

Measure Window Length: 1000ms

Device Reference Point: 0, 0, -6.3 mm

**Cursor:**

ABM = -51.54 dBA/m

Location: 8.3, -25, 3.7 mm

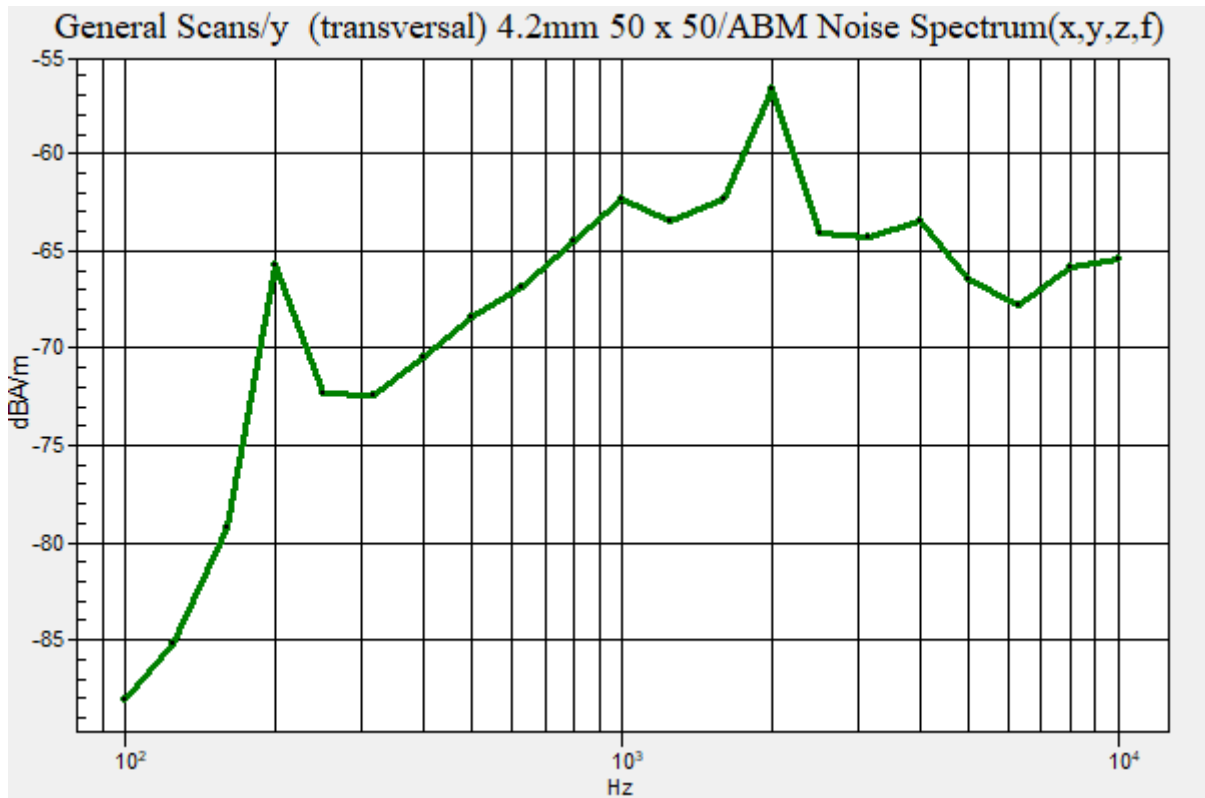

**Plot No.212**

**NR Band 77 CP-OFDM 16QAM 100MHz 1RB 271offset 656000ch z(axial)**

**DUT: SM-G991U; Type: Bar**

Communication System: UID 0, NR Band 77 (0); Frequency: 3840 MHz;Duty Cycle: 1:1  
Medium parameters used:  $\sigma = 0$  S/m,  $\epsilon_r = 1$ ;  $\rho = 0$  kg/m<sup>3</sup>  
Phantom section: TCoil Section

DASY Configuration:

- Probe: AM1DV3 - 3049; ;
- Sensor-Surface: 0mm (Fix Surface)
- Electronics: DAE4 Sn466; Calibrated: 2020-04-22
- Phantom: HAC Test Arch with AMCC
- Measurement SW: DASY52, Version 52.10 (4);

**T-Coil scan (scan for ANSI C63.19-2007 & 2011 compliance)/General Scans/z (axial) 4.2mm 50 x 50/ABM Noise Spectrum(x,y,z,f) (13x13x1):** Measurement grid: dx=10mm, dy=10mm

Signal Type: Audio File (.wav) 48k\_voice\_1kHz\_1s.wav  
Output Gain: 18.9  
Measure Window Start: 300ms  
Measure Window Length: 1000ms  
Device Reference Point: 0, 0, -6.3 mm

**Cursor:**

ABM = -48.81 dBA/m  
Location: 12.5, -12.5, 3.7 mm

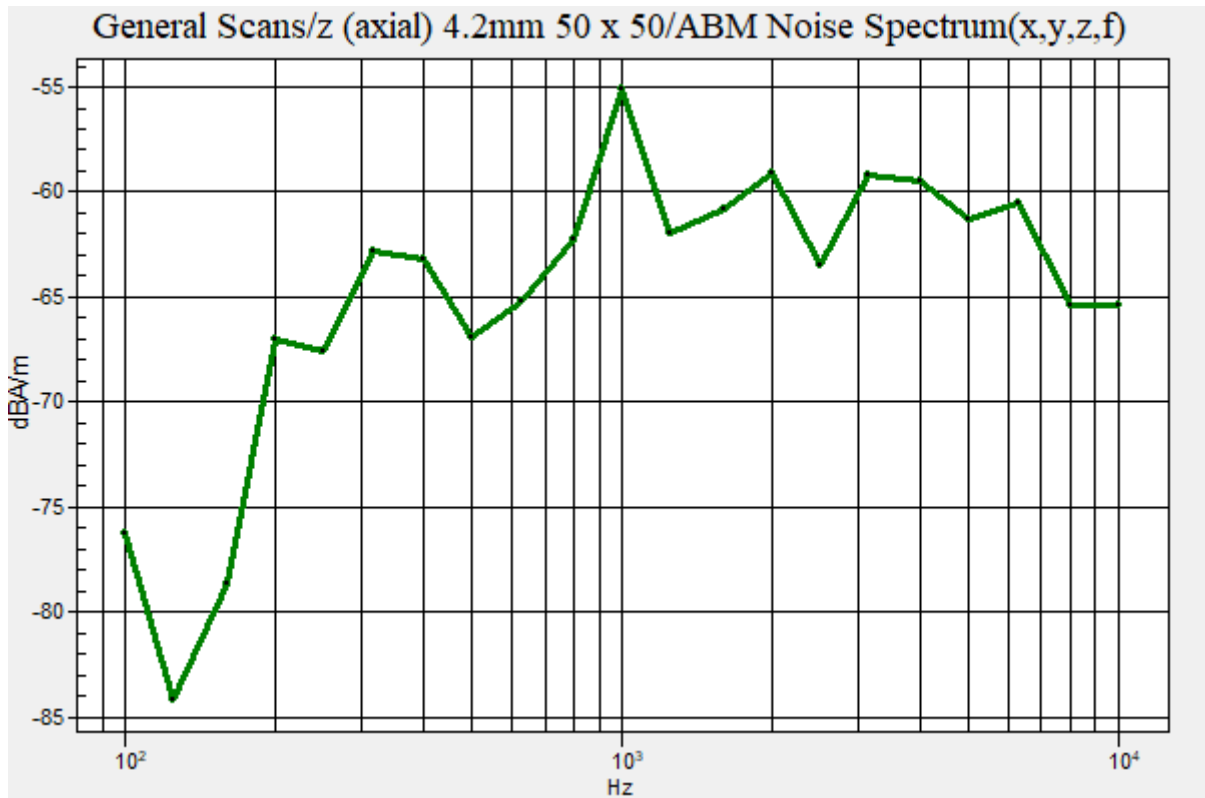

**Plot No.213**

**NR Band 77 CP-OFDM 16QAM 100MHz 1RB 271offset 656000ch y(transversal)**

**DUT: SM-G991U; Type: Bar**

Communication System: UID 0, NR Band 77 (0); Frequency: 3840 MHz;Duty Cycle: 1:1  
Medium parameters used:  $\sigma = 0$  S/m,  $\epsilon_r = 1$ ;  $\rho = 0$  kg/m<sup>3</sup>  
Phantom section: TCoil Section

DASY Configuration:

- Probe: AM1DV3 - 3049; ;
- Sensor-Surface: 0mm (Fix Surface)
- Electronics: DAE4 Sn466; Calibrated: 2020-04-22
- Phantom: HAC Test Arch with AMCC
- Measurement SW: DASY52, Version 52.10 (4);

**T-Coil scan (scan for ANSI C63.19-2007 & 2011 compliance)/General Scans/y (transversal) 4.2mm 50**

**x 50/ABM Noise Spectrum(x,y,z,f) (13x13x1):** Measurement grid: dx=10mm, dy=10mm

Signal Type: Audio File (.wav) 48k\_voice\_1kHz\_1s.wav

Output Gain: 18.9

Measure Window Start: 300ms

Measure Window Length: 1000ms

Device Reference Point: 0, 0, -6.3 mm

**Cursor:**

ABM = -52.18 dBA/m

Location: 8.3, -25, 3.7 mm

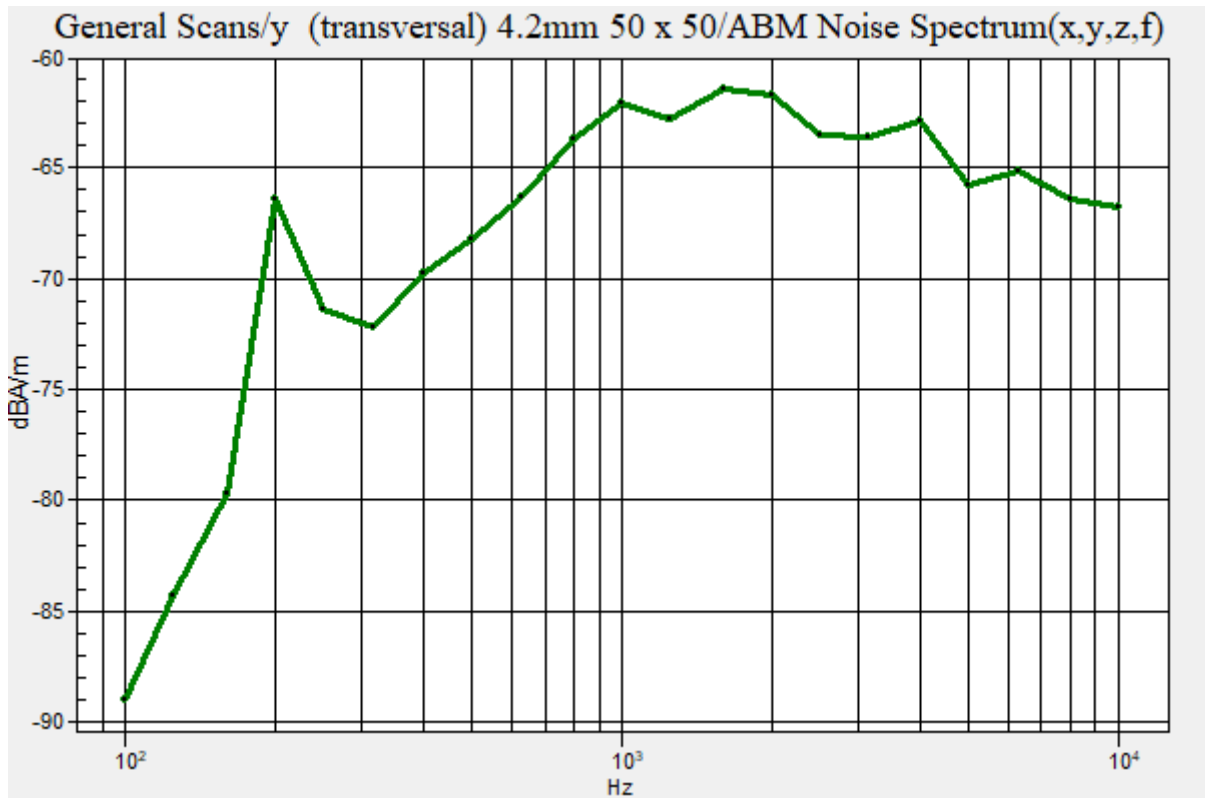



**Plot No.214**

**NR Band 41 CP-OFDM 16QAM 100MHz 1RB 271offset 509202ch z(axial)**

**DUT: SM-G991U; Type: Bar**

Communication System: UID 0, n41 (0); Frequency: 2546.01 MHz;Duty Cycle: 1:1  
Medium parameters used:  $\sigma = 0$  S/m,  $\epsilon_r = 1$ ;  $\rho = 0$  kg/m<sup>3</sup>  
Phantom section: TCoil Section

DASY Configuration:

- Probe: AM1DV3 - 3049; ;
- Sensor-Surface: 0mm (Fix Surface)
- Electronics: DAE4 Sn466; Calibrated: 2020-04-22
- Phantom: HAC Test Arch with AMCC
- Measurement SW: DASY52, Version 52.10 (4);

**T-Coil scan (scan for ANSI C63.19-2007 & 2011 compliance)/General Scans/z (axial) 4.2mm 50 x 50/ABM Noise Spectrum(x,y,z,f) (13x13x1):** Measurement grid: dx=10mm, dy=10mm

Signal Type: Audio File (.wav) 48k\_voice\_1kHz\_1s.wav  
Output Gain: 18.9  
Measure Window Start: 300ms  
Measure Window Length: 1000ms  
Device Reference Point: 0, 0, -6.3 mm

**Cursor:**

ABM = -45.79 dBA/m  
Location: 12.5, -12.5, 3.7 mm

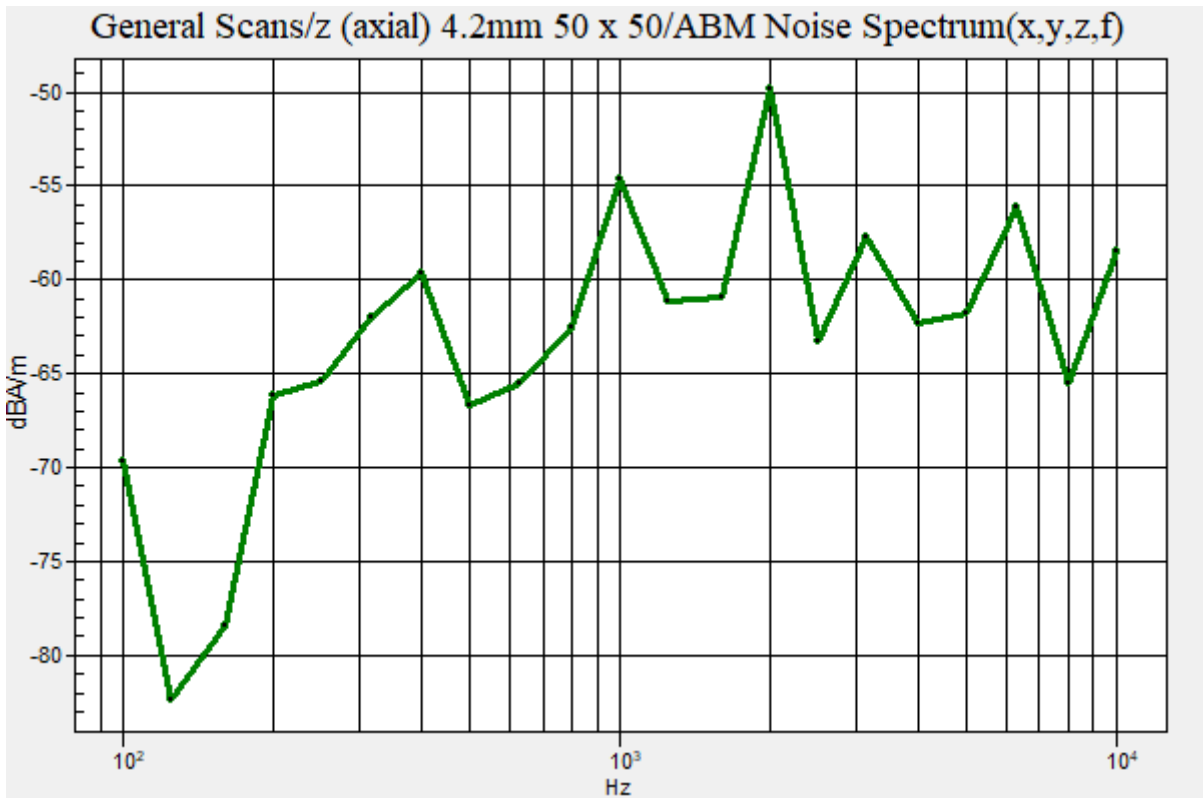

**Plot No.215**

**NR Band 41 CP-OFDM 16QAM 100MHz 1RB 271offset 509202ch y(transversal)**

**DUT: SM-G991U; Type: Bar**

Communication System: UID 0, n41 (0); Frequency: 2546.01 MHz;Duty Cycle: 1:1  
Medium parameters used:  $\sigma = 0$  S/m,  $\epsilon_r = 1$ ;  $\rho = 0$  kg/m<sup>3</sup>  
Phantom section: TCoil Section

DASY Configuration:

- Probe: AM1DV3 - 3049; ;
- Sensor-Surface: 0mm (Fix Surface)
- Electronics: DAE4 Sn466; Calibrated: 2020-04-22
- Phantom: HAC Test Arch with AMCC
- Measurement SW: DASY52, Version 52.10 (4);

**T-Coil scan (scan for ANSI C63.19-2007 & 2011 compliance)/General Scans/y (transversal) 4.2mm 50 x 50/ABM Noise Spectrum(x,y,z,f) (13x13x1):**

Measurement grid: dx=10mm, dy=10mm

Signal Type: Audio File (.wav) 48k\_voice\_1kHz\_1s.wav

Output Gain: 18.9

Measure Window Start: 300ms

Measure Window Length: 1000ms

Device Reference Point: 0, 0, -6.3 mm

**Cursor:**

ABM = -52.22 dBA/m

Location: 8.3, -25, 3.7 mm

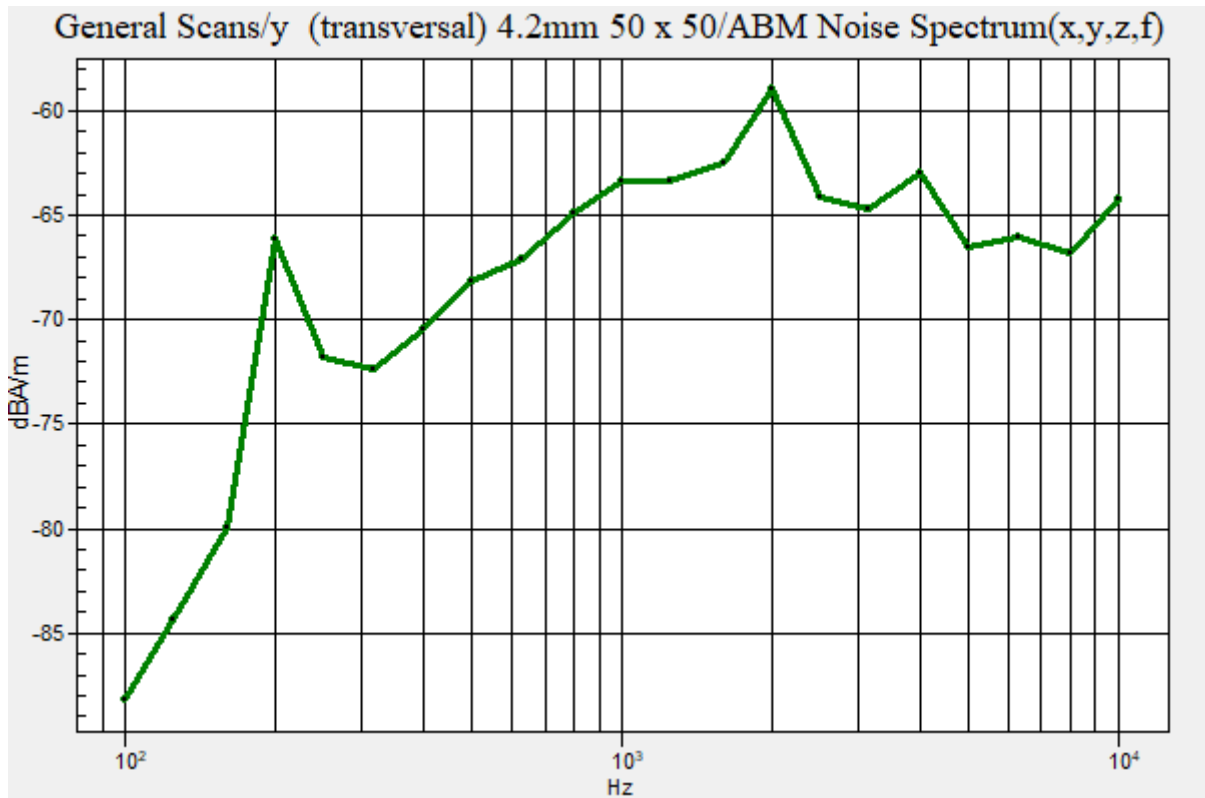

**Plot No.216**  
NR Band 41 CP-OFDM 16QAM 100MHz 1RB 271offset 513900ch z(axial)

**DUT: SM-G991U; Type: Bar**

Communication System: UID 0, n41 (0); Frequency: 2569.5 MHz;Duty Cycle: 1:1  
Medium parameters used:  $\sigma = 0$  S/m,  $\epsilon_r = 1$ ;  $\rho = 0$  kg/m<sup>3</sup>  
Phantom section: TCoil Section

DASY Configuration:

- Probe: AM1DV3 - 3049; ;
- Sensor-Surface: 0mm (Fix Surface)
- Electronics: DAE4 Sn466; Calibrated: 2020-04-22
- Phantom: HAC Test Arch with AMCC
- Measurement SW: DASY52, Version 52.10 (4);

**T-Coil scan (scan for ANSI C63.19-2007 & 2011 compliance)/General Scans/z (axial) 4.2mm 50 x 50/ABM Noise Spectrum(x,y,z,f) (13x13x1):** Measurement grid: dx=10mm, dy=10mm  
Signal Type: Audio File (.wav) 48k\_voice\_1kHz\_1s.wav  
Output Gain: 18.9  
Measure Window Start: 300ms  
Measure Window Length: 1000ms  
Device Reference Point: 0, 0, -6.3 mm

**Cursor:**  
ABM = -46.84 dBA/m  
Location: 12.5, -12.5, 3.7 mm

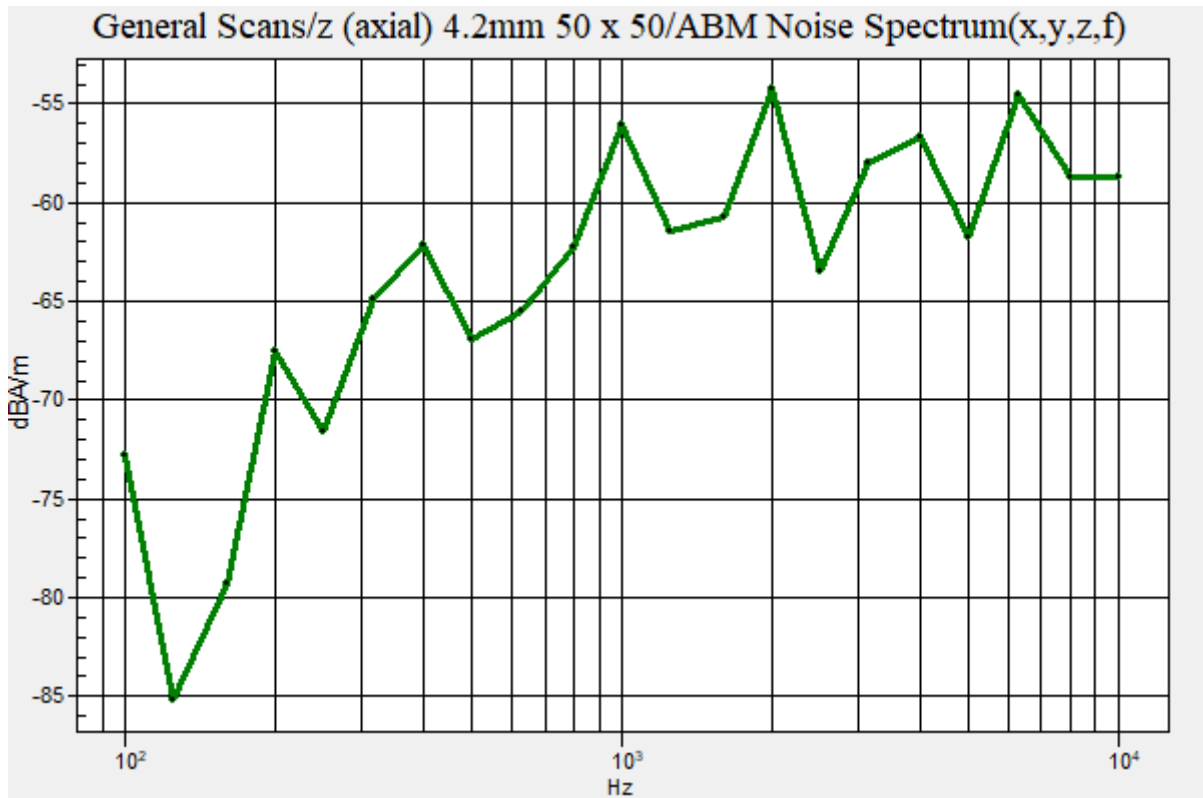

**Plot No.217**

**NR Band 41 CP-OFDM 16QAM 100MHz 1RB 271offset 513900ch y(transversal)**

**DUT: SM-G991U; Type: Bar**

Communication System: UID 0, n41 (0); Frequency: 2569.5 MHz;Duty Cycle: 1:1  
Medium parameters used:  $\sigma = 0$  S/m,  $\epsilon_r = 1$ ;  $\rho = 0$  kg/m<sup>3</sup>  
Phantom section: TCoil Section

DASY Configuration:

- Probe: AM1DV3 - 3049; ;
- Sensor-Surface: 0mm (Fix Surface)
- Electronics: DAE4 Sn466; Calibrated: 2020-04-22
- Phantom: HAC Test Arch with AMCC
- Measurement SW: DASY52, Version 52.10 (4);

**T-Coil scan (scan for ANSI C63.19-2007 & 2011 compliance)/General Scans/y (transversal) 4.2mm 50**

**x 50/ABM Noise Spectrum(x,y,z,f) (13x13x1):** Measurement grid: dx=10mm, dy=10mm

Signal Type: Audio File (.wav) 48k\_voice\_1kHz\_1s.wav

Output Gain: 18.9

Measure Window Start: 300ms

Measure Window Length: 1000ms

Device Reference Point: 0, 0, -6.3 mm

**Cursor:**

ABM = -53.13 dBA/m

Location: 8.3, -25, 3.7 mm

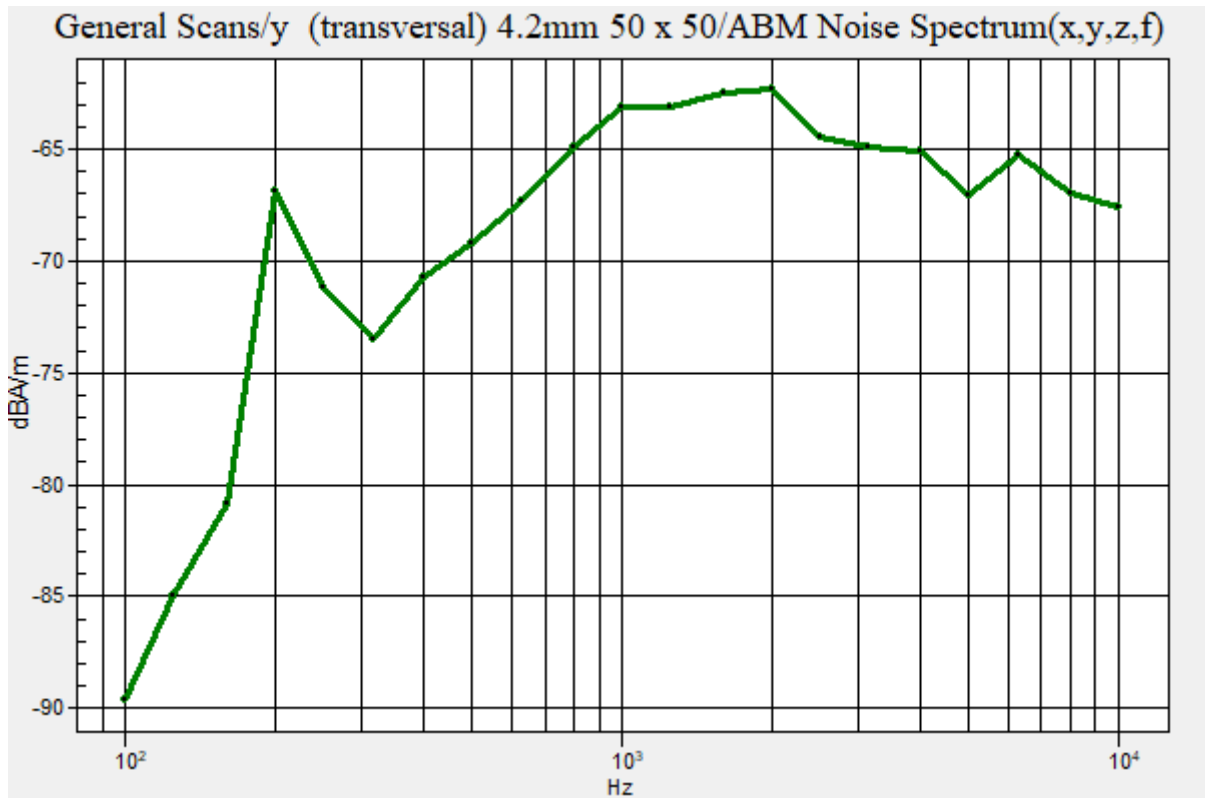

**Plot No.218**

**NR Band 71 CP-OFDM 16QAM 100MHz 1RB 271offset 523302ch z(axial)**

**DUT: SM-G991U; Type: Bar**

Communication System: UID 0, n41 (0); Frequency: 2616.51 MHz;Duty Cycle: 1:1  
Medium parameters used:  $\sigma = 0$  S/m,  $\epsilon_r = 1$ ;  $\rho = 0$  kg/m<sup>3</sup>  
Phantom section: TCoil Section

DASY Configuration:

- Probe: AM1DV3 - 3049; ;
- Sensor-Surface: 0mm (Fix Surface)
- Electronics: DAE4 Sn466; Calibrated: 2020-04-22
- Phantom: HAC Test Arch with AMCC
- Measurement SW: DASY52, Version 52.10 (4);

**T-Coil scan (scan for ANSI C63.19-2007 & 2011 compliance)/General Scans/z (axial) 4.2mm 50 x 50/ABM Noise Spectrum(x,y,z,f) (13x13x1):** Measurement grid: dx=10mm, dy=10mm

Signal Type: Audio File (.wav) 48k\_voice\_1kHz\_1s.wav  
Output Gain: 18.9  
Measure Window Start: 300ms  
Measure Window Length: 1000ms  
Device Reference Point: 0, 0, -6.3 mm

**Cursor:**

ABM = -47.10 dBA/m  
Location: 12.5, -12.5, 3.7 mm

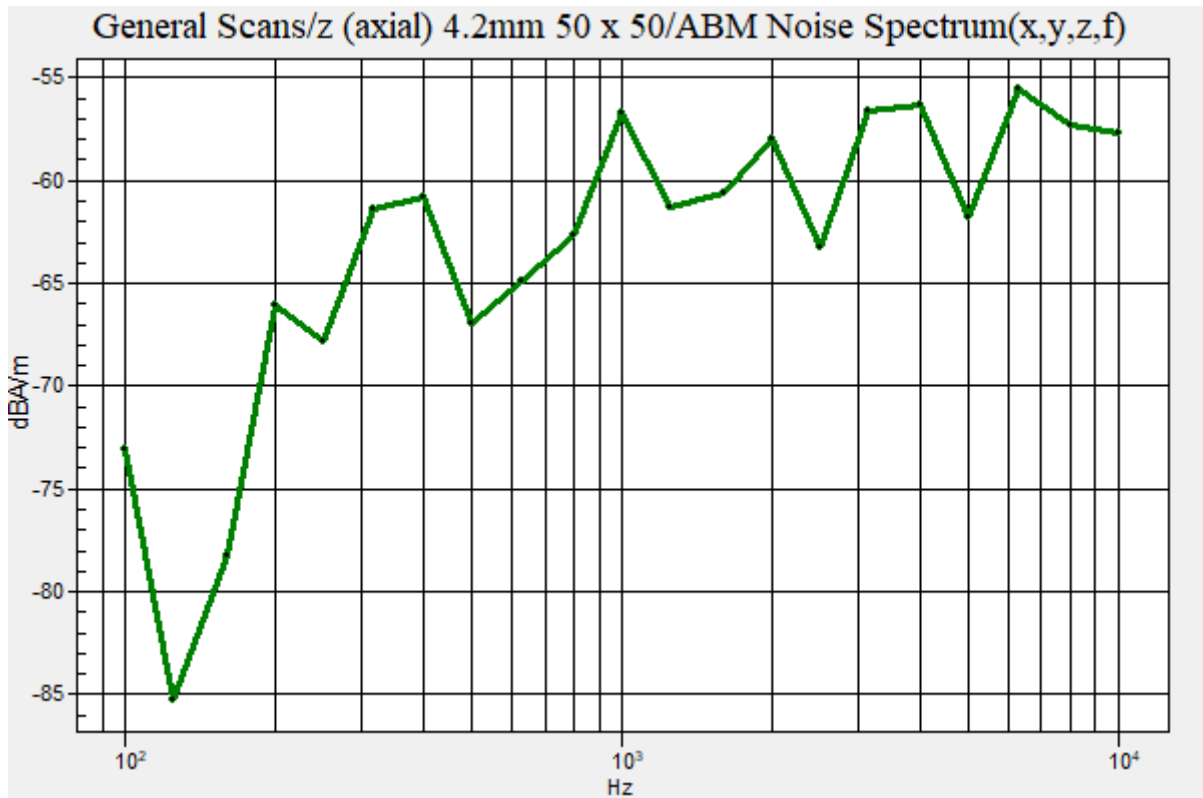

**Plot No.219**

**NR Band 41 CP-OFDM 16QAM 100MHz 1RB 271offset 523302ch y(transversal)**

**DUT: SM-G991U; Type: Bar**

Communication System: UID 0, n41 (0); Frequency: 2616.51 MHz;Duty Cycle: 1:1  
Medium parameters used:  $\sigma = 0$  S/m,  $\epsilon_r = 1$ ;  $\rho = 0$  kg/m<sup>3</sup>  
Phantom section: TCoil Section

DASY Configuration:

- Probe: AM1DV3 - 3049; ;
- Sensor-Surface: 0mm (Fix Surface)
- Electronics: DAE4 Sn466; Calibrated: 2020-04-22
- Phantom: HAC Test Arch with AMCC
- Measurement SW: DASY52, Version 52.10 (4);

**T-Coil scan (scan for ANSI C63.19-2007 & 2011 compliance)/General Scans/y (transversal) 4.2mm 50**

**x 50/ABM Noise Spectrum(x,y,z,f) (13x13x1):** Measurement grid: dx=10mm, dy=10mm

Signal Type: Audio File (.wav) 48k\_voice\_1kHz\_1s.wav

Output Gain: 18.9

Measure Window Start: 300ms

Measure Window Length: 1000ms

Device Reference Point: 0, 0, -6.3 mm

**Cursor:**

ABM = -52.96 dBA/m

Location: 8.3, -25, 3.7 mm

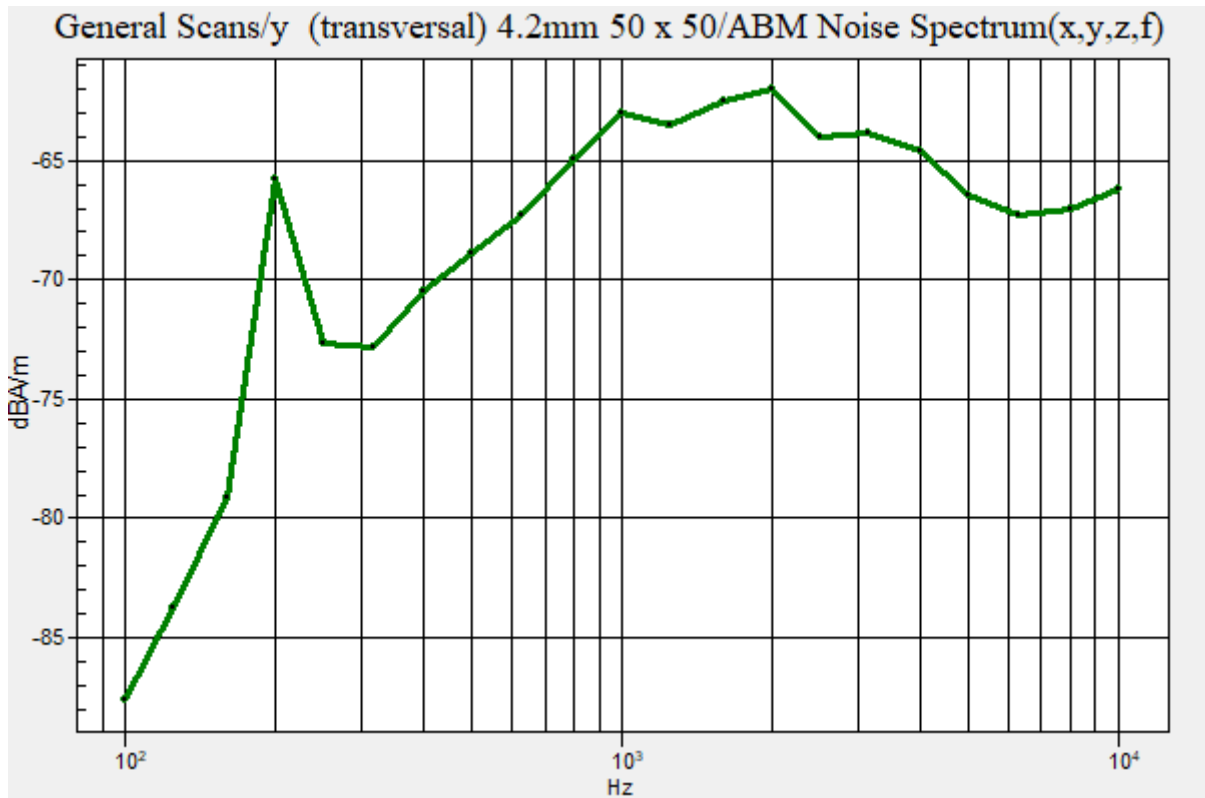

**Plot No.220**

**NR Band 41 CP-OFDM 16QAM 100MHz 1RB 271offset 528000ch z(axial)**

**DUT: SM-G991U; Type: Bar**

Communication System: UID 0, n41 (0); Frequency: 2640 MHz;Duty Cycle: 1:1  
Medium parameters used:  $\sigma = 0$  S/m,  $\epsilon_r = 1$ ;  $\rho = 0$  kg/m<sup>3</sup>  
Phantom section: TCoil Section

DASY Configuration:

- Probe: AM1DV3 - 3049; ;
- Sensor-Surface: 0mm (Fix Surface)
- Electronics: DAE4 Sn466; Calibrated: 2020-04-22
- Phantom: HAC Test Arch with AMCC
- Measurement SW: DASY52, Version 52.10 (4);

**T-Coil scan (scan for ANSI C63.19-2007 & 2011 compliance)/General Scans/z (axial) 4.2mm 50 x 50/ABM Noise Spectrum(x,y,z,f) (13x13x1):** Measurement grid: dx=10mm, dy=10mm

Signal Type: Audio File (.wav) 48k\_voice\_1kHz\_1s.wav  
Output Gain: 18.9  
Measure Window Start: 300ms  
Measure Window Length: 1000ms  
Device Reference Point: 0, 0, -6.3 mm

**Cursor:**

ABM = -46.97 dBA/m  
Location: 12.5, -12.5, 3.7 mm

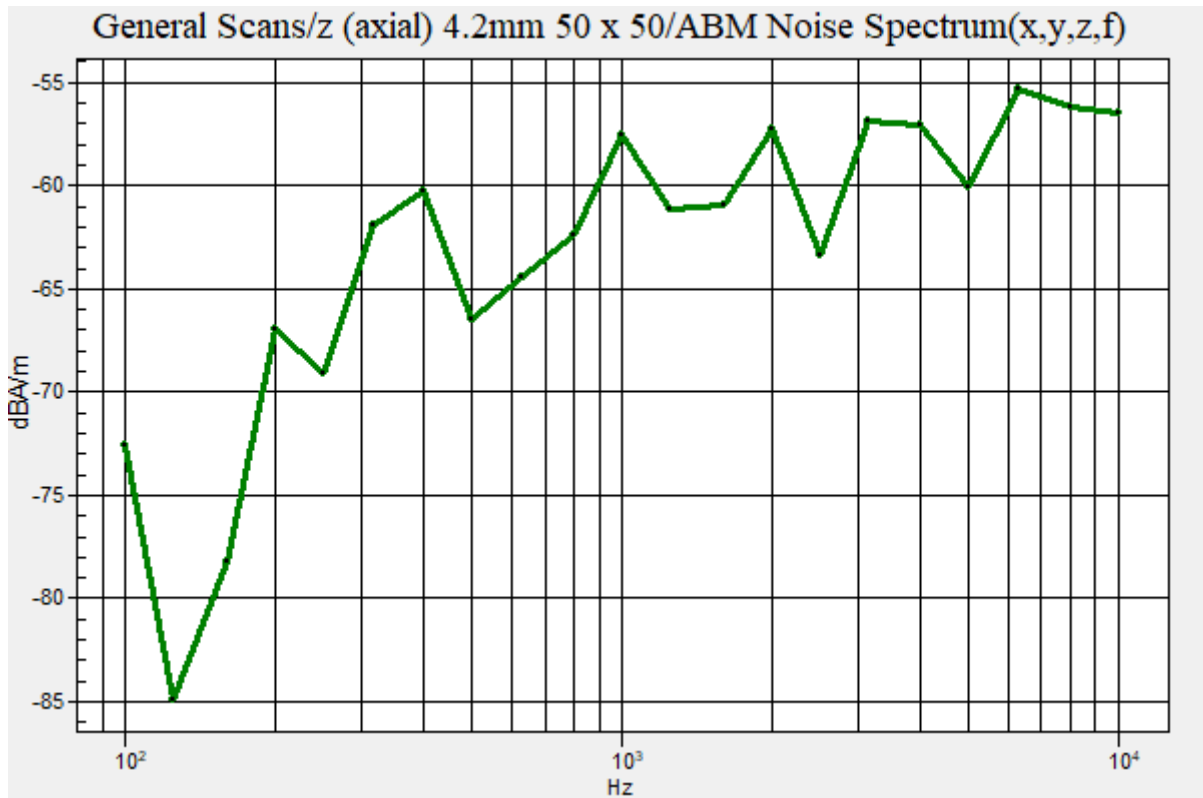

**Plot No.221**

**NR Band 41 CP-OFDM 16QAM 100MHz 1RB 271offset 528000ch y(transversal)**

**DUT: SM-G991U; Type: Bar**

Communication System: UID 0, n41 (0); Frequency: 2640 MHz;Duty Cycle: 1:1  
Medium parameters used:  $\sigma = 0$  S/m,  $\epsilon_r = 1$ ;  $\rho = 0$  kg/m<sup>3</sup>  
Phantom section: TCoil Section

DASY Configuration:

- Probe: AM1DV3 - 3049; ;
- Sensor-Surface: 0mm (Fix Surface)
- Electronics: DAE4 Sn466; Calibrated: 2020-04-22
- Phantom: HAC Test Arch with AMCC
- Measurement SW: DASY52, Version 52.10 (4);

**T-Coil scan (scan for ANSI C63.19-2007 & 2011 compliance)/General Scans/y (transversal) 4.2mm 50 x 50/ABM Noise Spectrum(x,y,z,f) (13x13x1):** Measurement grid: dx=10mm, dy=10mm

Signal Type: Audio File (.wav) 48k\_voice\_1kHz\_1s.wav  
Output Gain: 18.9  
Measure Window Start: 300ms  
Measure Window Length: 1000ms  
Device Reference Point: 0, 0, -6.3 mm

**Cursor:**

ABM = -53.04 dBA/m  
Location: 8.3, -25, 3.7 mm

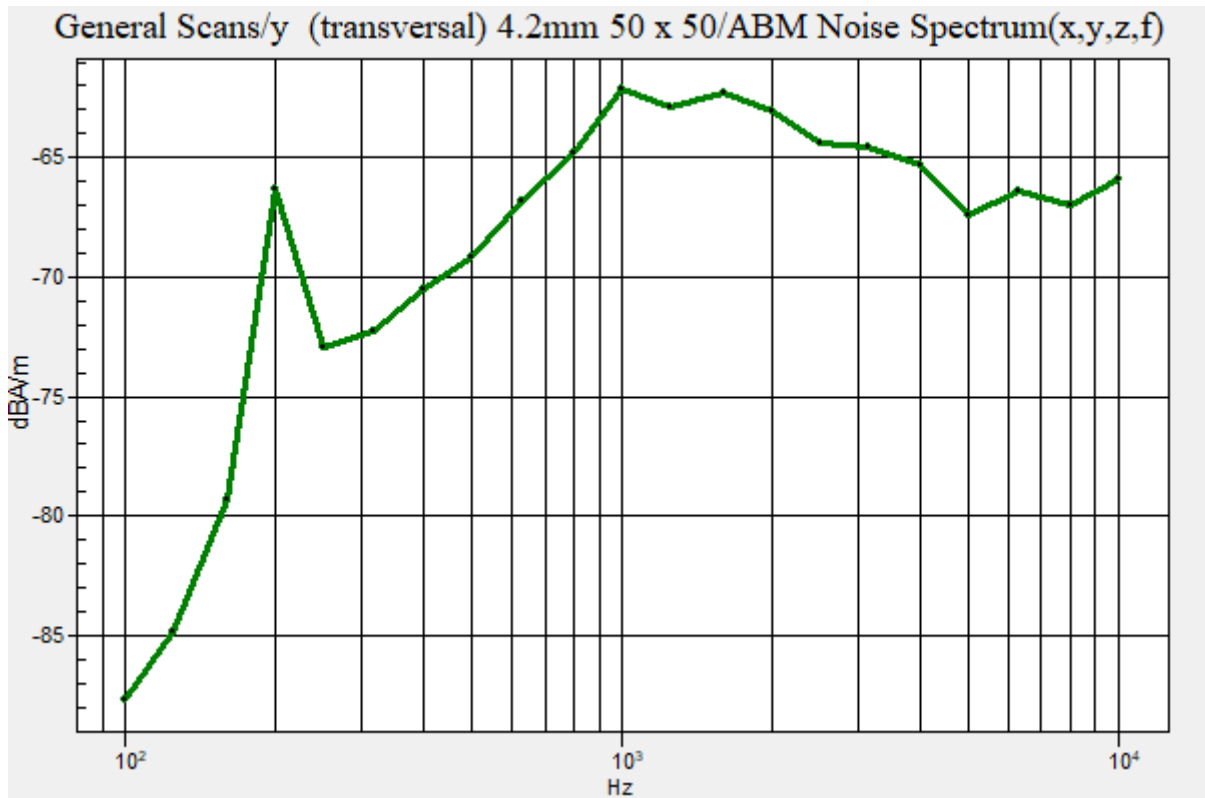



## Attachment 2. HAC T-Coil Probe Certificates

**Calibration Laboratory of  
Schmid & Partner  
Engineering AG**  
Zeughausstrasse 43, 8004 Zurich, Switzerland



**S** Schweizerischer Kalibrierdienst  
**S** Service suisse d'étalonnage  
**C** Servizio svizzero di taratura  
**S** Swiss Calibration Service

Accredited by the Swiss Accreditation Service (SAS)  
The Swiss Accreditation Service is one of the signatories to the EA  
Multilateral Agreement for the recognition of calibration certificates

Accreditation No.: **SCS 0108**

Client **HCT (Dymstec)**

Certificate No: **AM1DV2-1013\_Apr20**

**CALIBRATION CERTIFICATE**

Object: **AM1DV2 - SN: 1013**

Calibration procedure(s): **QA CAL-24.v4  
Calibration procedure for AM1D magnetic field probes and TMFS in the audio range**

Calibration date: **April 23, 2020**

결	담당자	확인자
재	<i>[Signature]</i>	<i>[Signature]</i>
직위/성명	SW 김민정	검사 이희영
일 자	2020. 4. 23	2020. 4. 23

This calibration certificate documents the traceability to national standards, which realize the physical units of measurements (SI).  
The measurements and the uncertainties with confidence probability are given on the following pages and are part of the certificate.

All calibrations have been conducted in the closed laboratory facility: environment temperature (22 ± 3)°C and humidity < 70%.

Calibration Equipment used (M&TE critical for calibration)

Primary Standards	ID #	Cal Date (Certificate No.)	Scheduled Calibration
Kelthley Multimeter Type 2001	SN: 0810278	03-Sep-19 (No. 25949)	Sep-20
Reference Probe AM1DV2	SN: 100B	10-Dec-19 (No. AM1DV2-1008_Dec19)	Dec-20
DAE4	SN: 781	27-Dec-19 (No. DAE4-781_Dec19)	Dec-20
Secondary Standards	ID #	Check Date (in house)	Scheduled Check
AMCC	SN: 1050	01-Oct-13 (in house check Oct-17)	Oct-20
AMMI Audio Measuring Instrument	SN: 1062	26-Sep-12 (in house check Oct-17)	Oct-20

Calibrated by: **Leif Klynsner** (Laboratory Technician) *[Signature]*

Approved by: **Katja Pokovic** (Technical Manager) *[Signature]*

Issued: April 24, 2020

This calibration certificate shall not be reproduced except in full without written approval of the laboratory.

**References**

- [1] ANSI-C63.19-2007  
American National Standard for Methods of Measurement of Compatibility between Wireless Communications Devices and Hearing Aids.
- [2] ANSI-C63.19-2011  
American National Standard, Methods of Measurement of Compatibility between Wireless Communications Devices and Hearing Aids.
- [3] DASY5 manual, Chapter: Hearing Aid Compatibility (HAC) T-Coil Extension

**Description of the AM1D probe**

The AM1D Audio Magnetic Field Probe is a fully shielded magnetic field probe for the frequency range from 100 Hz to 20 kHz. The pickup coil is compliant with the dimensional requirements of [1+2]. The probe includes a symmetric low noise amplifier for the signal available at the shielded 3 pin connector at the side. Power is supplied via the same connector (phantom power supply) and monitored via the LED near the connector. The 7 pin connector at the end of the probe does not carry any signals, but determines the angle of the sensor when mounted on the DAE. The probe supports mechanical detection of the surface.

The single sensor in the probe is arranged in a tilt angle allowing measurement of 3 orthogonal field components when rotating the probe by 120° around its axis. It is aligned with the perpendicular component of the field, if the probe axis is tilted nominally 35.3° above the measurement plane, using the connector rotation and sensor angle stated below.

The probe is fully RF shielded when operated with the matching signal cable (shielded) and allows measurement of audio magnetic fields in the close vicinity of RF emitting wireless devices according to [1+2] without additional shielding.

**Handling of the item**

The probe is manufactured from stainless steel. In order to maintain the performance and calibration of the probe, it must not be opened. The probe is designed for operation in air and shall not be exposed to humidity or liquids. For proper operation of the surface detection and emergency stop functions in a DASY system, the probe must be operated with the special probe cup provided (larger diameter).

**Methods Applied and Interpretation of Parameters**

- *Coordinate System:* The AM1D probe is mounted in the DASY system for operation with a HAC Test Arch phantom with AMCC Helmholtz calibration coil according to [3], with the tip pointing to "southwest" orientation.
- *Functional Test:* The functional test preceding calibration includes test of Noise level RF immunity (1kHz AM modulated signal). The shield of the probe cable must be well connected. Frequency response verification from 100 Hz to 10 kHz.
- *Connector Rotation:* The connector at the end of the probe does not carry any signals and is used for fixation to the DAE only. The probe is operated in the center of the AMCC Helmholtz coil using a 1 kHz magnetic field signal. Its angle is determined from the two minima at nominally +120° and -120° rotation, so the sensor in the tip of the probe is aligned to the vertical plane in z-direction, corresponding to the field maximum in the AMCC Helmholtz calibration coil.
- *Sensor Angle:* The sensor tilting in the vertical plane from the ideal vertical direction is determined from the two minima at nominally +120° and -120°. DASY system uses this angle to align the sensor for radial measurements to the x and y axis in the horizontal plane.
- *Sensitivity:* With the probe sensor aligned to the z-field in the AMCC, the output of the probe is compared to the magnetic field in the AMCC at 1 kHz. The field in the AMCC Helmholtz coil is given by the geometry and the current through the coil, which is monitored on the precision shunt resistor of the coil.

**AM1D probe identification and configuration data**

Item	<b>AM1DV2</b> Audio Magnetic 1D Field Probe
Type No	SP AM1 001 AC
Serial No	<b>1013</b>

Overall length	296 mm
Tip diameter	6.0 mm (at the tip)
Sensor offset	3.0 mm (centre of sensor from tip)
Internal Amplifier	40 dB

Manufacturer / Origin	Schmid & Partner Engineering AG, Zurich, Switzerland
-----------------------	--

**Calibration data**

Connector rotation angle	(in DASY system)	<b>279.5°</b>	+/- 3.6 ° (k=2)
Sensor angle	(in DASY system)	<b>3.45 °</b>	+/- 0.5 ° (k=2)
Sensitivity at 1 kHz	(in DASY system)	<b>0.0657 V/(A/m)</b>	+/- 2.2 % (k=2)

The reported uncertainty of measurement is stated as the standard uncertainty of measurement multiplied by the coverage factor k=2, which for a normal distribution corresponds to a coverage probability of approximately 95%.

**Calibration Laboratory of  
Schmid & Partner  
Engineering AG**  
Zeughausstrasse 43, 8004 Zurich, Switzerland



**S** Schweizerischer Kalibrierdienst  
**C** Service suisse d'étalonnage  
**S** Servizio svizzero di taratura  
**S** Swiss Calibration Service

Accredited by the Swiss Accreditation Service (SAS)  
The Swiss Accreditation Service is one of the signatories to the EA  
Multilateral Agreement for the recognition of calibration certificates

Accreditation No.: **SCS 0108**

Client **HCT (Dymstec)**

Certificate No: **AM1DV3-3049\_May20**

**CALIBRATION CERTIFICATE**

Object: **AM1DV3 - SN: 3049**

Calibration procedure(s): **QA CAL-24.v4  
Calibration procedure for AM1D magnetic field probes and TMFS in the audio range**

Calibration date: **May 26, 2020**

결	담당자	확인자
제	<i>[Signature]</i>	<i>[Signature]</i>
직원/성명	SW 12.019	KS 1.229
일 자	2020. 6. 16	2020. 6. 16

This calibration certificate documents the traceability to national standards, which realize the physical units of measurements (SI).  
The measurements and the uncertainties with confidence probability are given on the following pages and are part of the certificate.

All calibrations have been conducted in the closed laboratory facility: environment temperature (22 ± 3)°C and humidity < 70%.

Calibration Equipment used (M&TE critical for calibration)

Primary Standards	ID #	Cal Date (Certificate No.)	Scheduled Calibration
Keithley Multimeter Type 2001	SN: 0810278	03-Sep-19 (No. 25949)	Sep-20
Reference Probe AM1DV2	SN: 1008	10-Dec-19 (No. AM1DV2-1008_Dec19)	Dec-20
DAE4	SN: 781	27-Dec-19 (No. DAE4-781_Dec19)	Dec-20
Secondary Standards	ID #	Check Date (in house)	Scheduled Check
AMCC	SN: 1050	01-Oct-13 (in house check Oct-17)	Oct-20
AMMI Audio Measuring Instrument	SN: 1062	26-Sep-12 (in house check Oct-17)	Oct-20

	Name	Function	Signature
Calibrated by:	Leif Klysner	Laboratory Technician	<i>[Signature]</i>
Approved by:	Katja Pokovic	Technical Manager	<i>[Signature]</i>

Issued: May 27, 2020

This calibration certificate shall not be reproduced except in full without written approval of the laboratory.

**References**

- [1] ANSI-C63.19-2007  
American National Standard for Methods of Measurement of Compatibility between Wireless Communications Devices and Hearing Aids.
- [2] ANSI-C63.19-2011  
American National Standard, Methods of Measurement of Compatibility between Wireless Communications Devices and Hearing Aids.
- [3] DASY5 manual, Chapter: Hearing Aid Compatibility (HAC) T-Coil Extension

**Description of the AM1D probe**

The AM1D Audio Magnetic Field Probe is a fully shielded magnetic field probe for the frequency range from 100 Hz to 20 kHz. The pickup coil is compliant with the dimensional requirements of [1+2]. The probe includes a symmetric low noise amplifier for the signal available at the shielded 3 pin connector at the side. Power is supplied via the same connector (phantom power supply) and monitored via the LED near the connector. The 7 pin connector at the end of the probe does not carry any signals, but determines the angle of the sensor when mounted on the DAE. The probe supports mechanical detection of the surface.

The single sensor in the probe is arranged in a tilt angle allowing measurement of 3 orthogonal field components when rotating the probe by 120° around its axis. It is aligned with the perpendicular component of the field, if the probe axis is tilted nominally 35.3° above the measurement plane, using the connector rotation and sensor angle stated below.

The probe is fully RF shielded when operated with the matching signal cable (shielded) and allows measurement of audio magnetic fields in the close vicinity of RF emitting wireless devices according to [1+2] without additional shielding.

**Handling of the item**

The probe is manufactured from stainless steel. In order to maintain the performance and calibration of the probe, it must not be opened. The probe is designed for operation in air and shall not be exposed to humidity or liquids. For proper operation of the surface detection and emergency stop functions in a DASY system, the probe must be operated with the special probe cup provided (larger diameter).

**Methods Applied and Interpretation of Parameters**

- *Coordinate System:* The AM1D probe is mounted in the DASY system for operation with a HAC Test Arch phantom with AMCC Helmholtz calibration coil according to [3], with the tip pointing to "southwest" orientation.
- *Functional Test:* The functional test preceding calibration includes test of Noise level RF immunity (1kHz AM modulated signal). The shield of the probe cable must be well connected. Frequency response verification from 100 Hz to 10 kHz.
- *Connector Rotation:* The connector at the end of the probe does not carry any signals and is used for fixation to the DAE only. The probe is operated in the center of the AMCC Helmholtz coil using a 1 kHz magnetic field signal. Its angle is determined from the two minima at nominally +120° and -120° rotation, so the sensor in the tip of the probe is aligned to the vertical plane in z-direction, corresponding to the field maximum in the AMCC Helmholtz calibration coil.
- *Sensor Angle:* The sensor tilting in the vertical plane from the ideal vertical direction is determined from the two minima at nominally +120° and -120°. DASY system uses this angle to align the sensor for radial measurements to the x and y axis in the horizontal plane.
- *Sensitivity:* With the probe sensor aligned to the z-field in the AMCC, the output of the probe is compared to the magnetic field in the AMCC at 1 kHz. The field in the AMCC Helmholtz coil is given by the geometry and the current through the coil, which is monitored on the precision shunt resistor of the coil.

**AM1D probe identification and configuration data**

Item	<b>AM1DV3</b> Audio Magnetic 1D Field Probe
Type No	SP AM1 001 BA
Serial No	<b>3049</b>

Overall length	296 mm
Tip diameter	6.0 mm (at the tip)
Sensor offset	3.0 mm (centre of sensor from tip)
Internal Amplifier	20 dB

Manufacturer / Origin	Schmid & Partner Engineering AG, Zurich, Switzerland
-----------------------	--

**Calibration data**

Connector rotation angle	(in DASY system)	<b>279.8 °</b>	+/- 3.6 ° (k=2)
Sensor angle	(in DASY system)	<b>-0.49 °</b>	+/- 0.5 ° (k=2)
Sensitivity at 1 kHz	(in DASY system)	<b>0.00746 V/(A/m)</b>	+/- 2.2 % (k=2)

The reported uncertainty of measurement is stated as the standard uncertainty of measurement multiplied by the coverage factor k=2, which for a normal distribution corresponds to a coverage probability of approximately 95%.