



HCT Co., Ltd.

74, Seoicheon-ro 578beon-gil, Majang-myeon, Icheon-si, Gyeonggi-do, 17383 KOREA

Tel. +82 31 645 6300 Fax. +82 31 645 6401

HAC T-COIL Test Report

Applicant Name:

SAMSUNG Electronics Co., Ltd.

129, Samsung-ro, Yeongtong-gu, Suwon-Si, Gyeonggi-do,
16677 Rep. of Korea

Date of Issue: Jul. 14, 2022

Test Report No.: HCT-SR-2207-FC017

Test Site: HCT CO., LTD.

FCC ID

A3LSMG990U2

Equipment Type:

Mobile Phone

Application Type

Class II Permissive Change

FCC Rule Part(s):

CFR §20.19 , ANSI C63.19-2011

Model Name:

SM-G990U2

Additional Model Name:

SM-G990U3/DS

Date of Test:

Apr. 20, 2022

**C63.19-2011
HAC Category**

T4 (T-COIL CATEGORY, NR n48 Only)

This wireless portable device has been shown to be hearing-aid compatible under the above rated category, specified in ANSI/IEEE Std. C63.19-2011 and had been tested in accordance with the specified measurement procedures. Hearing-Aid Compatibility is based on the assumption that all production units will be designed electrically identical to the device tested in this report.

I attest to the accuracy of data. All measurements reported herein were performed by me or were made under my supervision and are correct to the best of my knowledge and belief. I assume full responsibility for the completeness of these measurements and vouch for the qualifications of all persons taking them.

Tested By

**Jee-ill Lee
Test Engineer
SAR Team
Certification Division**

Reviewed By

**Yun-jeang, Heo
Technical Manager
SAR Team
Certification Division**

This report only responds to the tested sample and may not be reproduced, except in full, without written approval of the HCT Co., Ltd.

REVISION HISTORY

The revision history for this test report is shown in table.

Revision No.	Date of Issue	Description
0	Jul. 14, 2022	Initial Release

This test results were applied only to the test methods required by the standard.

The above Test Report is not related to the accredited test result by (KS Q) ISO/IEC 17025 and KOLAS(Korea Laboratory Accreditation Scheme), which signed the ILAC-MRA.

Table of Contents

1. Test Regulations	4
2. ATTESTATION OF TEST RESULT OF DEVICE UNDER TEST	5
3. DEVICE UNDER TEST DESCRIPTION.....	6
4. Test Methodology	7
5. Measuring Instrument Calibraion	8
6. Measurement Uncertainty.....	9
7. Test Procedures for all Technologies	10
8. Audio Level and Gain Measurements.....	14
9 T-coil Measurement Criteria	15
10. Device Under Test.....	17
11. Air Interfaces and Operating Mode	18
12. HAC (T-coil) Test Results	19
Attachment 1. HAC T-COIL Test Plots	21
Attachment 2. HAC T-Coil Probe Certificates	25

1. Test Regulations

The tests were performed according to the following regulations:

Test Standard	FCC 47 CFR §20.19 ANSI C63.19-2011
Test Method	<ul style="list-style-type: none">• FCC CFR47 Part 20.19• ANSI C63.19 2011-version• FCC KDB 285076 D01 HAC Guidance v06• FCC KDB 285076 D02 T Coil testing v04• FCC KDB 285076 D03 HAC FAQ v01r05

2. ATTESTATION OF TEST RESULT OF DEVICE UNDER TEST

Test Laboratory	
Company Name:	HCT Co., LTD
Address:	74, Seoicheon-ro 578beon-gil, Majang-myeon, Icheon-si, Gyeonggi-do, 17383, Rep. of Korea
Telephone:	+82 31 645 6300
Fax.:	+82 31 645 6401

Attestation of SAR test result	
Applicant Name:	SAMSUNG Electronics Co., Ltd.
Model Name:	SM-G990U2
Additional Model Name:	SM-G990U3/DS
EUT Type:	Mobile Phone
Application Type:	Class II Permissive Change

2.1 Test Methodology

The Tests document in this report were performed in accordance with ANSI C63.19-2011 method of Measurement of Compatibility between Wireless Communication Devices and Hearing Aids, FCC published KDB 285076 D01 HAC Guidance v06, FCC published KDB 285076 D02 HAC T-Coil Testing v04, FCC Published KDB285076 D03 HAC FAQ v01r05 and TCB Workshop updates .

3. DEVICE UNDER TEST DESCRIPTION

3.1 DUT specification

Device Wireless specification overview		
Band & Mode	Operating Mode	Tx Frequency
CDMA/EVDO BC10	Voice / Data	817.90 MHz ~ 823.10 MHz
CDMA/EVDO BC0	Voice / Data	824.70 MHz ~ 848.31 MHz
CDMA/EVDO BC1	Voice / Data	1 851.25 MHz ~ 1 908.75 MHz
GSM850	Voice / Data	824.2 MHz ~ 848.8 MHz
GSM1900	Voice / Data	1 850.2 MHz ~ 1 909.8 MHz
UMTS 850	Voice / Data	826.4 MHz ~ 846.6 MHz
UMTS 1700	Voice / Data	1 712.4 MHz ~ 1 752.6 MHz
UMTS 1900	Voice / Data	1 852.4 MHz ~ 1 907.6 MHz
LTE Band 2 (PCS)	Voice / Data	1 850.7 MHz ~ 1 909.3 MHz
LTE Band 4 (AWS)	Voice / Data	1 710.7 MHz ~ 1 754.3 MHz
LTE Band 5 (Cell)	Voice / Data	824.7 MHz ~ 848.3 MHz
LTE Band 7	Voice / Data	2 502.5 MHz ~ 2 567.5 MHz
LTE Band 12	Voice / Data	699.7 MHz ~ 715.3 MHz
LTE Band 13	Voice / Data	779.5 MHz ~ 784.5 MHz
LTE Band 14	Voice / Data	790.5 MHz ~ 795.5 MHz
LTE Band 25	Voice / Data	1 850.7 MHz ~ 1 914.3 MHz
LTE Band 26	Voice / Data	814.7 MHz ~ 848.3 MHz
LTE Band 30	Voice / Data	2 307.5 MHz ~ 2 312.5 MHz
LTE TDD Band 38	Voice / Data	2 572.5 MHz ~ 2 617.5 MHz
LTE TDD Band 40	Voice / Data	2 302.5 MHz ~ 2 397.5 MHz
LTE TDD Band 41	Voice / Data	2 498.5 MHz ~ 2 687.5 MHz
LTE TDD Band 48	Voice / Data	3 552.5 MHz ~ 3 697.5 MHz
LTE Band 66 (AWS)	Voice / Data	1 710.7 MHz ~ 1 779.3 MHz
LTE Band 71	Voice / Data	665.5 MHz ~ 695.5 MHz
NR Band n2 (PCS)	Data	1 852.5 MHz ~ 1 907.5 MHz
NR Band n5 (Cell)	Data	826.5 MHz ~ 846.5 MHz
NR Band n12	Data	701.5 MHz ~ 713.5 MHz
NR Band n25	Data	1852.5 MHz ~ 1912.5 MHz
NR Band n30	Data	2 307.5 MHz ~ 2 312.5 MHz
NR Band n41	Data	2 506.02 MHz ~ 2 679.99 MHz
NR Band n48	Data	3 555 MHz ~ 3 694.98 MHz
NR Band n66	Data	1 712.5 MHz ~ 1 777.5 MHz
NR Band n71	Data	665.5 MHz - 695.5 MHz
NR Band n77	Data	3 710 MHz ~ 3 969.99 MHz
NR Band n77 (DoD)	Data	3 460.02 MHz ~ 3 540 MHz
NR Band n260	Data	37000 - 40000 MHz
NR Band n261	Data	27500 - 28350 MHz
U-NII-1	Voice / Data	5 180 MHz ~ 5 240 MHz
U-NII-2A	Voice / Data	5 260 MHz ~ 5 320 MHz
U-NII-2C	Voice / Data	5 500 MHz ~ 5 720 MHz
U-NII-3	Voice / Data	5 745 MHz ~ 5 825 MHz
2.4 GHz WLAN	Voice / Data	2 412 MHz ~ 2 462 MHz
Bluetooth / LE 5.0	Data	2 402 MHz ~ 2 480 MHz
NFC	Data	13.56 MHz

4. Test Methodology

The tests documented in this report were performed in accordance with ANSI C63.19-2011 Methods of Measurement of Compatibility between Wireless Communications Devices and Hearing Aids and FCC published procedure

KDB 285076 D01 HAC Guidance v06

KDB 285076 D03 HAC FAQ v01r05

TCB workshop updates

KDB 285076 D02 T-Coil testing v04

5. Measuring Instrument Calibraion

The measuring equipment used to perform the tests documented in this report has been calibrated in accordance with the manufacturers' recommendations and is traceable to recognized national standards.

Name of Equipment	Manufacturer	Type/Model	Serial No.	Cal. Due Date
ABM Probe	SPEAG	AM1DV3	3050	11/23/2022
Data Acquisition Electronics	SPEAG	DAE4	1417	02/24/2023
DAC	Sound Devices	USBPre 2	HB1318341009	N/A
Radio Communication Tester	R & S	CMW 500	167916	10/22/2022
USB Audio Module	KEYSIGHT	U8903B-UAM	101006	N/A
UXM 5G Wireless Test Set	KEYSIGHT	E7515B	MY58460166	08/11/2022

6. Measurement Uncertainty

Measurement Uncertainty for Audio Band Magnetic Measurement

Error Description	Uncertainty values (±%)	Probe Dist.	Div.	C _i ABM1	C _i ABM2	Std. Unc.	
						ABM1 (±%)	ABM2 (±%)
Probe Sensitivity							
ReFereNce Level	3.00	N	1	1	1	3.00	3.00
AMCC Geometry	0.40	R	1.73	1	1	0.23	0.23
AMCC Current	1.00	R	1.73	1	1	0.58	0.58
Porbe Positioning during Calibr.	0.10	R	1.73	1	1	0.06	0.06
Noise Contribution	0.70	R	1.73	0.0143	1	0.01	0.40
Frequency Slope	5.90	R	1.73	0.1	1	0.34	3.41
Probe System							
Repeatability / Drift	1.00	R	1.73	1	1	0.58	0.58
Linearity / Dynamic Range	0.60	R	1.73	1	1	0.35	0.35
Acoustic Noise	1.00	R	1.73	0.1	1	0.06	0.58
Probe Angle	2.30	R	1.73	1	1	1.33	1.33
Spectral Processing	0.90	R	1.73	1	1	0.52	0.52
Integration Time	0.60	N	1.00	1	5	0.60	3.00
Field Disturbation	0.20	R	1.73	1	1	0.12	0.12
Test Signal							
Ref. Signal Spectral Response	0.60	R	1.73	0	1	0.00	0.35
Positioning							
Probe Positioning	1.90	R	1.73	1	1	1.10	1.10
Phantom Thickness	0.90	R	1.73	1	1	0.52	0.52
DUT Positioning	1.90	R	1.73	1	1	1.10	1.10
External Contributions							
RF Interference	0.00	R	1.73	1	0.3	0.00	0.00
Test Signal Variation	2.00	R	1.73	1	1	1.2	1.2
Combined Std. Uncertainty (ABM field)						4.1	6.1
Expanded Std. Uncertainty (%)						8.1	12.3
Notes for table N - Nomal R - Rectangular Div. - Divisor used to obtain standard uncertainty							

7. Test Procedures for all Technologies

7.1 General Procedures C63.19-2011, Section 7

ANSI C63.19-2011, Section 7

This document describes the procedures used to measure the ABM (T-Coil) performance of the WD.

In addition to measuring the absolute signal levels, the A-weighted magnitude of the unintended signal shall also be determined. In order to assure that the required signal quality is measured, the measurement of the intended signal and the measurement of the unintended signal must be made at the same location for all measurement positions. In addition, the RF field strength at each measurement location must be at or below that required for the assigned category.

Measurements shall not include undesired properties from the WD's RF field; therefore, use of a coaxial connection to a base station simulator or non-radiating load may be necessary. However, even then with a coaxial connection to a base station simulator or non-radiating load there may still be RF leakage from the WD, which may interfere with the desired measurement. Pre-measurement checks should be made to avoid this possibility. All measurements shall be done with the WD operating on battery power with an appropriate normal speech audio signal input level given in Table 7.1. If the device display can be turned off during a phone call then that may be done during the measurement as well.

Measurements shall be performed at two locations specified in A.3, with the correct probe orientation for a particular location, in a multistage sequence by first measuring the field intensity of the desired T-Coil signal (ABM1) that is useful to a hearing aid T-Coil. The undesired magnetic components (ABM2) must be measured at the same location as the desired ABM or T-Coil signal (ABM1), and the ratio of desired to undesired ABM signals must be calculated. For the perpendicular field location, only the ABM1 frequency response shall be determined in a third measurement stage. The flow chart in Figure 7.3 illustrates this three-stage, two orientation process.

The following steps summarize the basic test flow for determining ABM1 and ABM2. These steps assume that a sine wave or narrowband 1/3 octave signal can be used for the measurement of ABM1.

A validation of the test setup and instrumentation may be performed using a TMFS or Helmholtz coil. Measure the emissions and confirm that they are within the specified tolerance.

Position the WD in the test setup and connect the WD RF connector to a base station simulator or a non-radiating load as shown in Figure 7.1 or Figure 7.2. Confirm that equipment that requires calibration has been calibrated, and that the noise level meets the requirements given in 7.3.1.

The drive level to the WD is set such that the reference input level specified in Table 7.1 is input to the base station simulator (or manufacturer's test mode equivalent) in the 1 kHz, 1/3 octave band. This drive level shall be used for the T-Coil signal test (ABM1) at $f = 1$ kHz. Either a sine wave at 1025 Hz or a voice-like signal, band-limited to the 1 kHz 1/3 octave, as defined in 7.4.2, shall be used for the reference audio signal.

If interference is found at 1025 Hz an alternative nearby reference audio signal frequency may be used.

The same drive level will be used for the ABM1 frequency response measurements at each 1/3 octave band center frequency. The WD volume control may be set at any level up to maximum, provided that a signal at any frequency at maximum modulation would not result in clipping or signal overload.

Determine the magnetic measurement locations for the WD device (A.3), if not already specified by the manufacturer, as described in 7.4.4.1.1 and 7.4.4.2.

At each measurement location, measure and record the desired T-Coil magnetic signals (ABM1 at f_i) as described in 7.4.4.2 in each individual ISO 266-1975 R10 standard 1/3 octave band. The desired audio band input frequency (f_i) shall be centered in each 1/3 octave band maintaining the same drive level as determined in item c) and the reading taken for that band.

Equivalent methods of determining the frequency response may also be employed, such as fast Fourier transform (FFT) analysis using noise excitation or input-output comparison using simulated speech.

The full-band integrated or half-band integrated probe output, as specified in D.9, may be used, as long as the appropriate calibration curve is applied to the measured result, so as to yield an accurate measurement of the field magnitude. (The resulting measurement shall be an accurate measurement in dB A/m.)

All measurements of the desired signal shall be shown to be of the desired signal and not of an undesired signal. This may be shown by turning the desired signal ON and OFF with the probe measuring the same location. If the scanning method is used the scans shall show that all measurement points selected for the ABM1 measurement meet the ambient and test system noise criteria in 7.3.1.

At the measurement location for each orientation, measure and record the undesired broadband audio magnetic signal (ABM2) as specified in 7.4.4.4 with no audio signal applied (or digital zero applied, if appropriate) using A-weighting and the half-band integrator. Calculate the ratio of the desired to undesired signal strength (i.e., signal quality).

Obtain the data from the postprocessor, SEMCAD, and determine the category that properly classifies the signal quality based on Table 8.5.

Test Setup Diagram

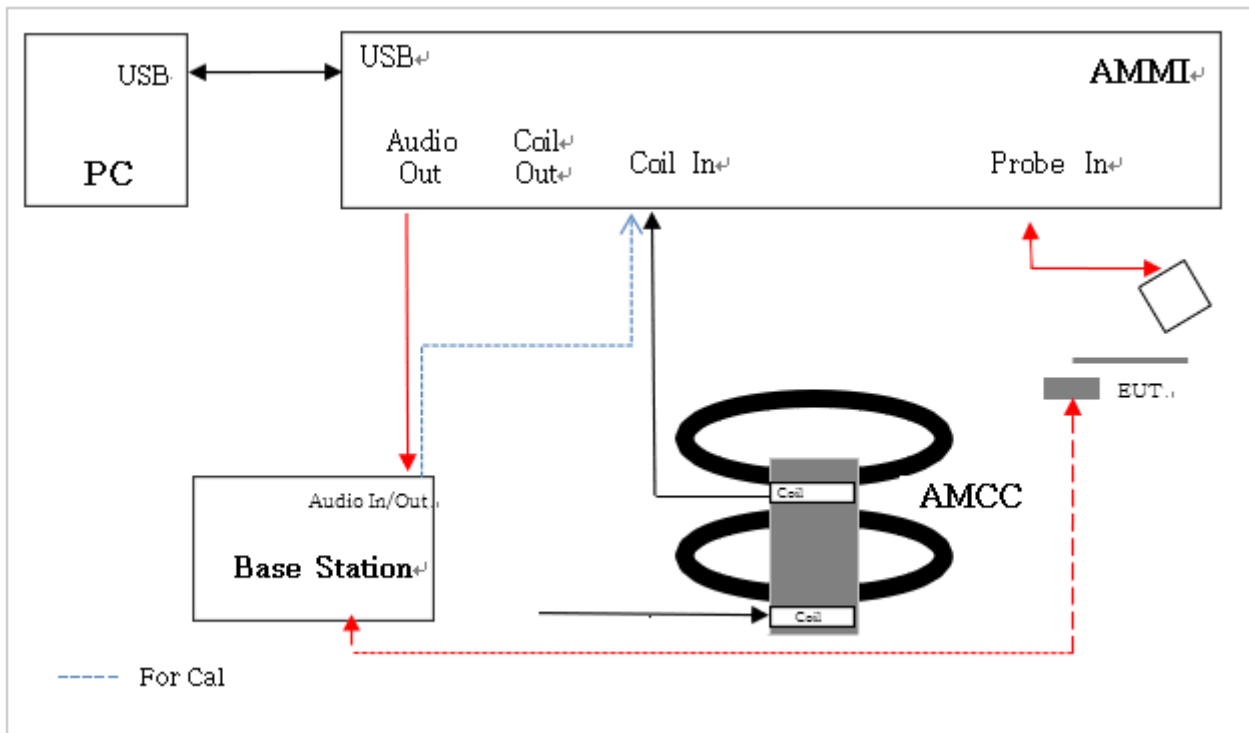

7.2 Over the Top(OTT)

This device supports VoIP via a preinstalled application that uses the Google Duo service, using OPUS as its only codec (refer to §11 for air interface details and §12.1 for codec bit rates). VoIP capabilities require HAC assessment when voice calls are supported over the cellular data connection via pre-installed VoIP applications.

The equipment is set up as shown below with a support device used to originate the call using the IP transport. The support device connects to the cloud-based Google Duo service via Wi-Fi access point and router, or RJ45. The DUT connects to the VoIP service via a cellular/unlicensed air interface to the call box and an Ethernet connection from call box to Internet. The various codec bit rate and air interface configurations are evaluated to determine the worst-case configuration (refer to §12.1).

Test Setup configuration for OTT calls

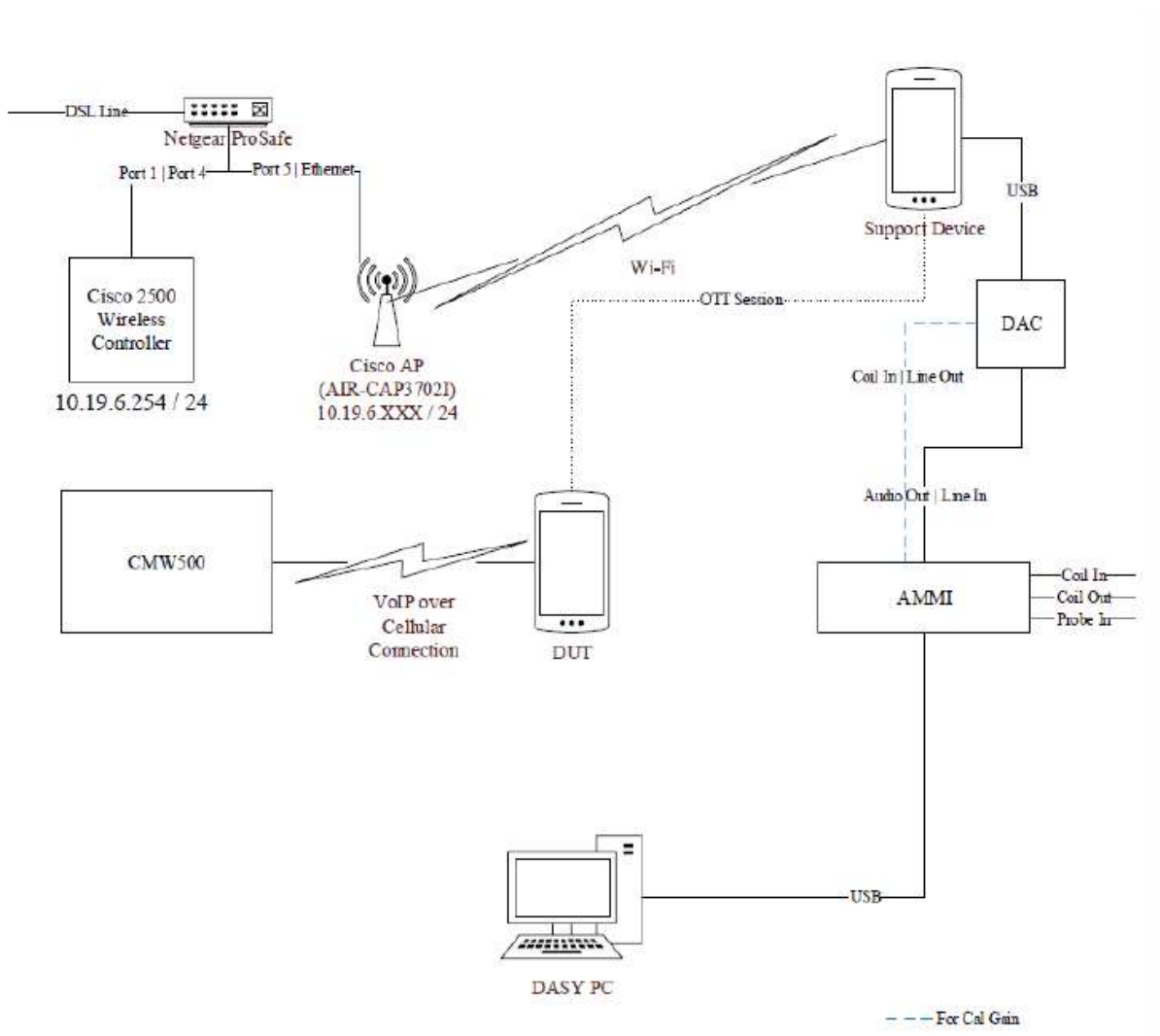

For the OTT call, the calibrated audio card within the CMW500 cannot be used so the AMMI is connected to an external Digital-Analog Converter (DAC) and the DAC is connected to the Support Device via USB. The test signal is sent from the DASY PC to the AMMI, from the AMMI to the DAC, from the DAC to the Support Device, and, via the VoIP call, to the DUT.

As this test set up uses an external DAC between the AMMI's audio output and support device, the appropriate gain factor for the OTT call needs be determined. This is done by connecting the DAC between the AMMI Audio output and Coil input as shown below.

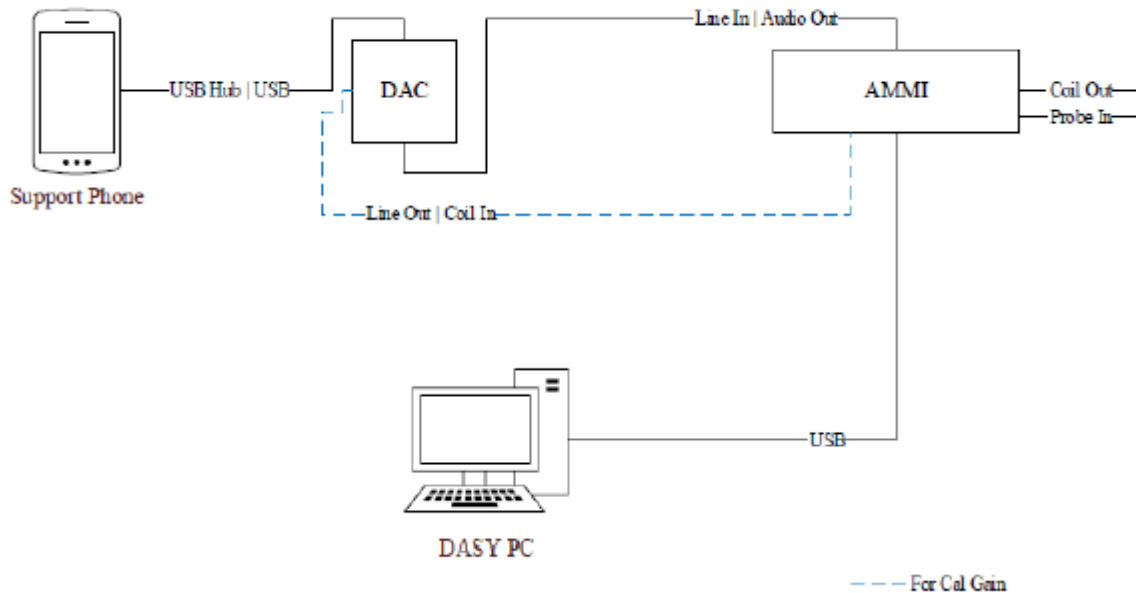

Using the metering function on the DAC, the DAC gain is adjusted until the volume reaches 0 dBFS (3.14 dBm0 based on TIA/EIA 810-A). SPEAG's "TN-LK-05042018-C-T-Coil_Levels" document (Appendix E) steps E through H are then followed to determine the adjusted gain values as detailed in §8.5 so that the reference level is set to 23.14dB below full scale, i.e. at -20dBm0. A verification of the DAC's output is performed prior to testing

8. Audio Level and Gain Measurements

8.1 Over the Top(OTT)

For EDGE, HSPA, LTE, NR and Wi-Fi the linear gain levels listed below were used. The results below are based on a reference input level of -20 dBm.

To calibrate the DAC (refer §7.3), three. Way audio files (sine wave, 1 kHz voice, and 300 to 3 kHz voice) are sent from the DASY5 PC to the AMMI, then to the DAC. The Helmholtz resonator measures the field strength, which represents the AMMI to DAC input sensitivity. After determining the input sensitivity, the adjusted linear gain values can then be calculated.

Signal Type	Audio Level [dBm]	Gain [dB]	Gain [linear]
Voice 1 kHz	-20	25.75	19.31
Voice 300-3 kHz	-20	35.46	58.74

9 T-coil Measurement Criteria

9.1 Frequency Responses

The frequency response of the axial component of the magnetic field, measured in 1/3 octave bands, shall follow the response curve, over the frequency range 300 Hz to 3000 Hz.

Figure 8.1 and Figure 8.2 provide the boundaries for the specified frequency. These response curves are for true field strength measurements of the T-Coil signal. Thus the 6 dB/octave probe response has been **corrected from the raw readings.**

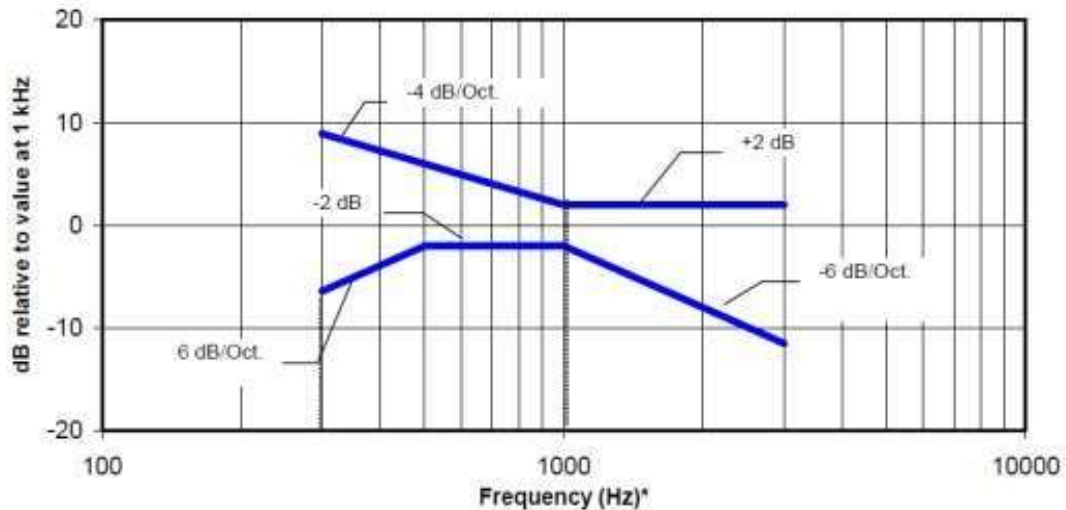

NOTE—The frequency response is between 300 Hz and 3000 Hz.

Figure 8.1—Magnetic field frequency response for WDs with field strength ≤ -15 dB (A/m) at 1 kHz

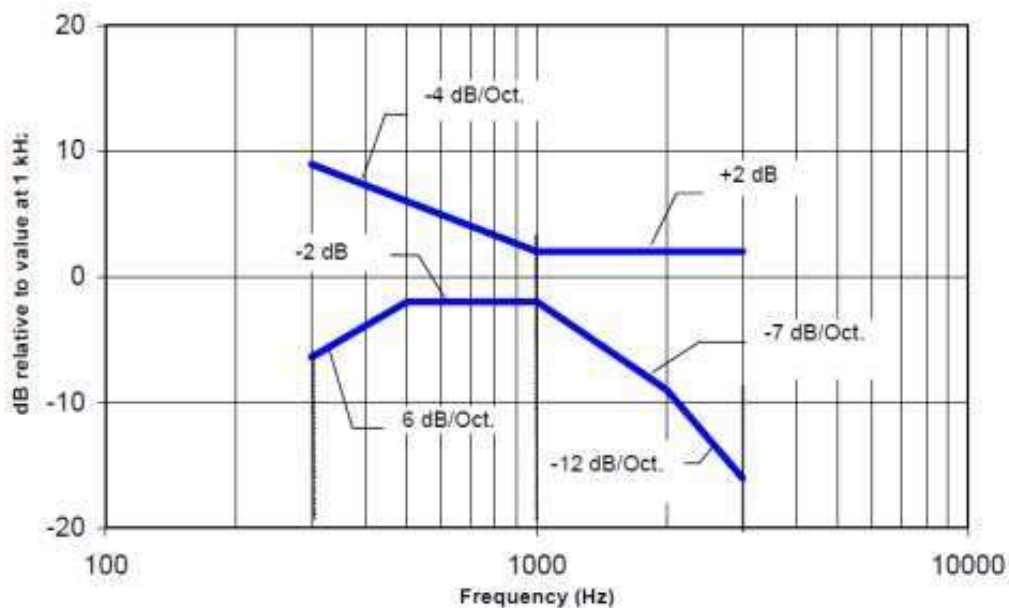

NOTE—The frequency response is between 300 Hz and 3000 Hz.

Figure 8.2—Magnetic field frequency response for WDs with a field that exceeds -15 dB(A/m) at 1 kHz

9.2 Signal to Noise

This specifies the signal-to-noise quality requirement for the intended T-Coil signal from a WD. The worst signal to noise of the two T-Coil signal measurements, as determined in Clause 7, shall be used to determine the T-Coil mode category per Table 8.5.

Only the RF immunity of the hearing aid is measured in T-Coil mode. It is assumed that a hearing aid can have no immunity to an interference signal in the audio band, which is the intended reception band for this mode. So, the only criterion that can be measured is the RF immunity in T-Coil Mode. This is measured using the same procedure as for the audio coupling mode and at the same levels as specified in 6.4.

Category	Telephone parameters WD signal quality [(signal+noise)-to-noise ratio in decibels]
Category T1	0 dB to 10 dB
Category T2	10 dB to 20 dB
Category T3	20 dB to 30 dB
Category T4	> 30 dB

Table 8.5- T-Coil signal-to-noise categories

Measurement locations and reference plane to be used for the T-coil measurements.

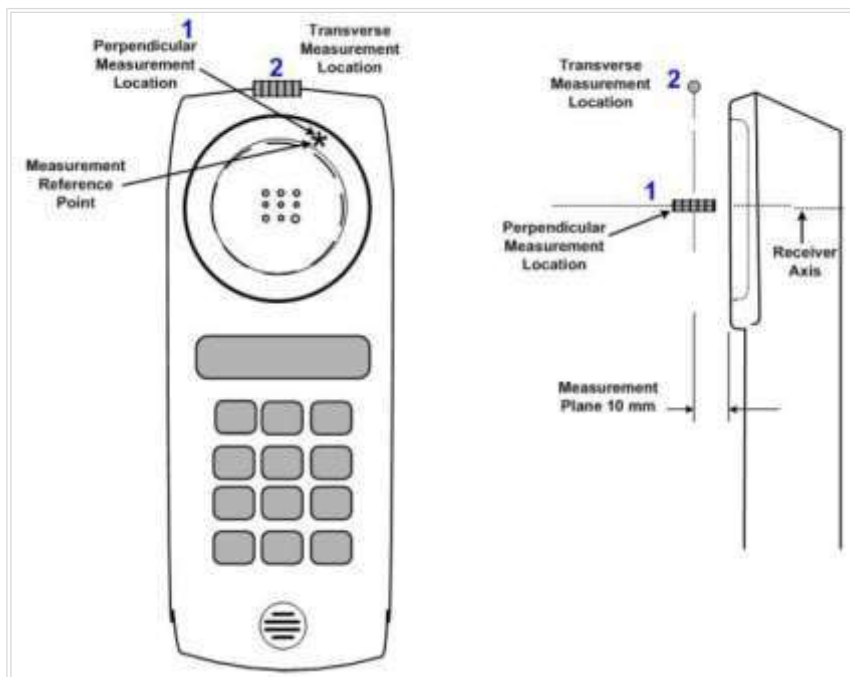

10. Device Under Test

Normal operation	Held to head	
Back Cover	The Back Cover is not removable	
Test sample information	S/N VD10403M	Notes T-coil Test

11. Air Interfaces and Operating Mode

Air Interface	Bands (MHz)	Type	C63.19 Tested	Simultaneous Transmitter	Audio Codecs Evaluated
GSM	850	VO	No	Wi-Fi, BT	EFR
	1900				
	GPRS/EDGE	VD	No	Wi-Fi, BT	OPUS ²
W-CDMA (UMTS)	850	VO	No	Wi-Fi, BT	AMR-NB & AMR-WB
	1700				
	1900				
	HSPA	VD	No	Wi-Fi, BT	OPUS ²
CDMA	800	VO	No	Wi-Fi, BT	EVRC-B & 8k-EVRC
	850	VO	No	Wi-Fi, BT	
	1900	VO	No	Wi-Fi, BT	
	1xEVDO	VD	No	Wi-Fi, BT	OPUS ²
LTE - FDD	680(B71)	VD	No	Wi-Fi, BT	(AMR-NB, AMR- WB, EVS-NB, EVS-WB) ¹ & OPUS ²
	700 (B12/13/14)				
	850 (B5/26)				
	1700 (B4/66)				
	1900 (B2/25)				
	2300 (B30)				
	2500 (B7)				
LTE – TDD	2600 (B41)	VD	No	Wi-Fi, BT	(AMR-NB, AMR- WB, EVS-NB, EVS-WB) ¹ & OPUS ²
	3600 (B48)				
	2600 (B38)				
	2300 (B40)				
NR -FDD	700(B12)	VD	No	Wi-Fi, BT	OPUS ²
	680(B71)				
	850(B5)				
	1700(B66)				
	1900(B2, B25)				
	2300(B30)				
NR -TDD	2600(B41)	VD	No	Wi-Fi, BT	OPUS ²
	3500(B48)		Yes		
	3800(B77)		No		
	28000 (n261)		No ³		
	39000 (n260)		No ³		
Wi-Fi	2450	VD	Yes	WWAN, Wifi 5GHz	AMR-NB, AMR- WB, EVS-NB, EVS-WB & OPUS ²
	5200 (U-NII-1)			WWAN and Wifi 2.4GHz, BT	
	5300 (U-NII-2A)				
	5500 (U-NII-2C)				
	5800 (U-NII-3)				
BT	2450	DT	NA	WWAN and Wifi 5GHz	N/A
Type: VO: Legacy Cellular Voice Service DT: Digital Transport only (no voice) CMRS: Commercial Mobile Radio Service VD: IP Voice service over Digital Transport				Note: 1. Ref Lev in accordance with the July 2012 VoLTE interpretation 2. Ref Lev -20 dBm0 3. n260,n261 are currently outside the scope of ANSI C63.19 and FCC HAC regulations. This DUT dose not support VOmmWave for n260,n261 This report pertains to NR n48 only. For full data, please refer to original test report (Test Report : HCT-SR-2205-FC005-R3)	

12. HAC (T-coil) Test Results

12.1 Codec Investigation

12.1.1 OTT Codec Investigation

The DUT's nested OTT application supports range of codec bit rate 6 – 75 kbit/s, thus an investigation between the various codec configurations (6/75 as Low/High bit rates) and specific parameters are documented (ABM1, ABM2, S+N/N, frequency response) to determine the worst-case bit rates for each service type.

The table below compares the varying codec configurations.

Codec Investigation					
Codec State	codec bit rate (kbit/s)			Orientation	Band/ BandWidth/ Channel
	6	40	75		
ABM1 (dB/m)	8.68	10.50	8.82	z (Axial)	NR Band 77 100 MHz DFT-s QPSK 135RB 69offset CH.656000 3840 MHz
ABM2 (dBA/m)	-33.85	-37.48	-33.73		
S+N/N (dB)	42.53	47.98	42.55		
Freq.Resposne (dB)	1.36	1.68	1.71		
ABM1 (dB/m)	-4.56	-4.39	-4.25	y(Transversal)	
ABM2 (dBA/m)	-46.8	-46.47	-46.67		
S+N/N (dB)	42.24	42.09	42.42		

12.8 OTT Air Interface Investigation

Mode	Ch. Freq.	BW	Waveform	BW/ Modulation	RB Config.	Orientation	ABM1 dB(A/m)	ABM2 dB(A/m)	Ambient Noise dB(A/m)	Freq. Response (dB)	ABM SNR (dB)	T-Rating	Plot No.
NR Band n48 Google Duo Codec: 40 kbit/s	CH. 641666 3624.99 MHz	40 MHz	DFTs	QPSK	50/28	z(Axial)	8.71	-35.47	-55.44	1.70	44.18	T4	1/2
						y(Transversal)	-4.18	-48.65	-54.99		44.47	T4	3

Attachment 1. HAC T-COIL Test Plots

Plot No.1

NR Band 48 DFTs QPSK 40MHz 50RB 28offset 641666ch 40kbit/s z(axial)

Communication System: UID 0, NR TDD Duty 1:4 (0); Frequency: 3624.99 MHz;Duty Cycle: 1:4.00037
Medium parameters used: $\sigma = 0$ S/m, $\epsilon_r = 1$; $\rho = 0$ kg/m³
Phantom section: TCoil Section

DASY5 Configuration:

- Probe: AM1DV3 - 3050; ; Calibrated: 2021-11-23
- Sensor-Surface: 0mm (Fix Surface)
- Electronics: DAE4 Sn1417; Calibrated: 2022-02-24
- Phantom: HAC Test Arch with AMCC
- Measurement SW: DASY52, Version 52.10 (4)

T-Coil scan (scan for ANSI C63.19-2007 & 2011 compliance)/General Scans/z (axial) 4.2mm 50 x

50/ABM Signal(x,y,z) (13x13x1): Measurement grid: dx=10mm, dy=10mm
Signal Type: Audio File (.wav) 48k_voice_1kHz_1s.wav
Output Gain: 19.31
Measure Window Start: 300ms
Measure Window Length: 1000ms
BWC applied: 0.15 dB
Device Reference Point: 0, 0, -6.3 mm

Cursor:

ABM1 comp = 8.71 dBA/m
BWC Factor = 0.15 dB
Location: 12.5, -8.3, 3.7 mm

Cursor:

ABM2 = -35.47 dBA/m
Location: 12.5, -8.3, 3.7 mm

Cursor:

ABM1/ABM2 = 44.18 dB
ABM1 comp = 8.71 dBA/m
BWC Factor = 0.15 dB
Location: 12.5, -8.3, 3.7 mm

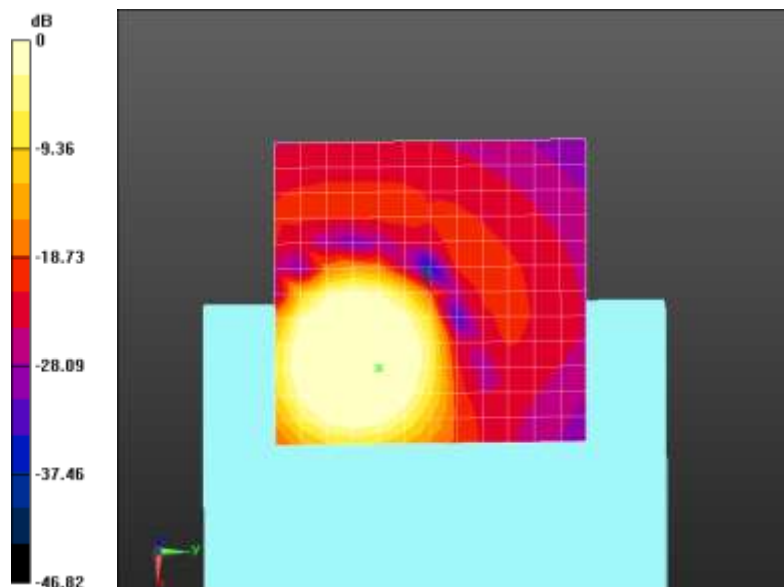

0 dB = 1.000 A/m = 0.00 dBA/m

Plot No.2

NR Band 48 DFTs QPSK 40MHz 50RB 28offset 641666ch 40kbit/s Freq.Response

Communication System: UID 0, NR TDD Duty 1:4 (0); Frequency: 3624.99 MHz;Duty Cycle: 1:4.00037
Medium parameters used: $\sigma = 0$ S/m, $\epsilon_r = 1$; $\rho = 0$ kg/m³
Phantom section: TCoil Section

DASY5 Configuration:

- Probe: AM1DV3 - 3050; ; Calibrated: 2021-11-23
- Sensor-Surface: 0mm (Fix Surface)
- Electronics: DAE4 Sn1417; Calibrated: 2022-02-24
- Phantom: HAC Test Arch with AMCC
- Measurement SW: DASY52, Version 52.10 (4)

T-Coil scan (scan for ANSI C63.19-2007 & 2011 compliance)/General Scans/z (axial) wideband at best S/N/ABM Freq Resp(x,y,z,f) (1x1x1): Measurement grid: dx=10mm, dy=10mm

Signal Type: Audio File (.wav) 48k_Normal_51s new.wav
Output Gain: 58.74
Measure Window Start: 300ms
Measure Window Length: 51000ms
BWC applied: 9.47 dB
Device Reference Point: 0, 0, -6.3 mm

Cursor:

Diff = 1.70 dB
BWC Factor = 9.47 dB
Location: 12.3, -10, 3.7 mm

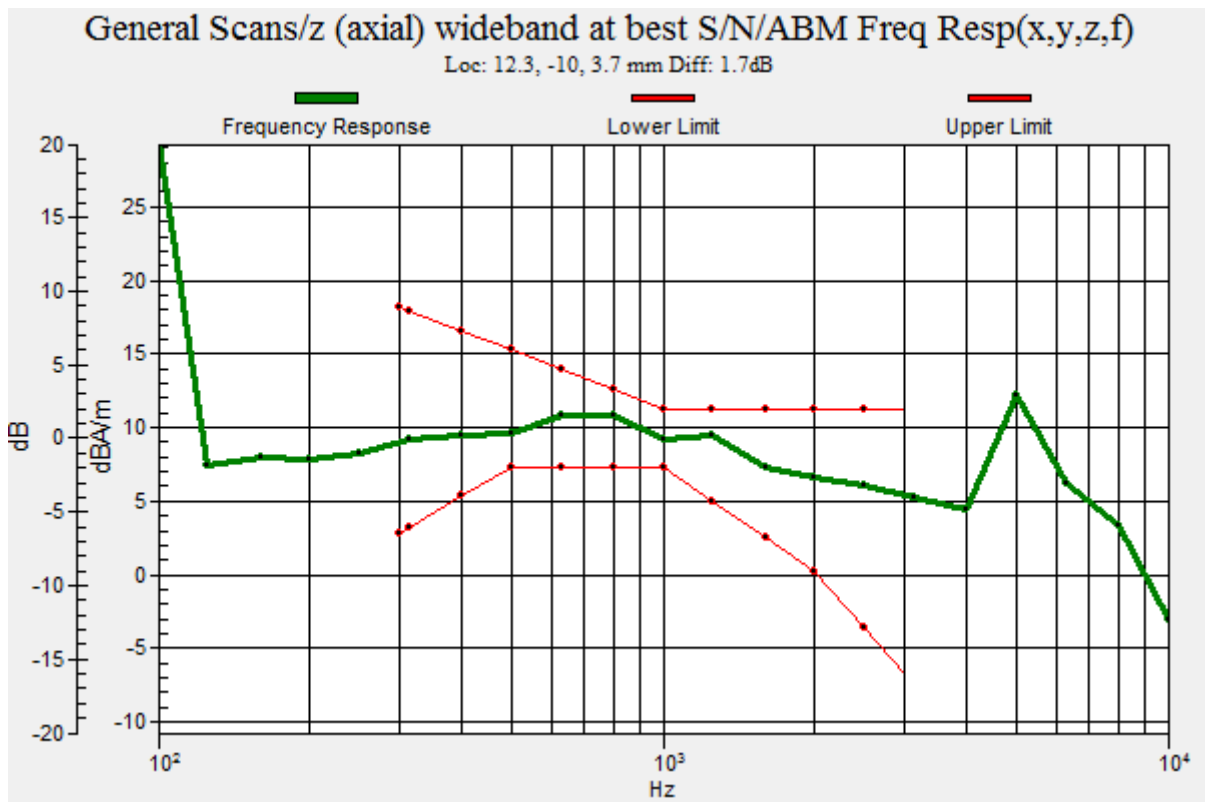

Plot No.3

NR Band 48 DFTs QPSK 40MHz 50RB 28offset 641666ch 40kbit/s y(transversal)

Communication System: UID 0, NR TDD Duty 1:4 (0); Frequency: 3624.99 MHz;Duty Cycle: 1:4.00037
Medium parameters used: $\sigma = 0$ S/m, $\epsilon_r = 1$; $\rho = 0$ kg/m³
Phantom section: TCoil Section

DASY5 Configuration:

- Probe: AM1DV3 - 3050; ; Calibrated: 2021-11-23
- Sensor-Surface: 0mm (Fix Surface)
- Electronics: DAE4 Sn1417; Calibrated: 2022-02-24
- Phantom: HAC Test Arch with AMCC
- Measurement SW: DASY52, Version 52.10 (4)

T-Coil scan (scan for ANSI C63.19-2007 & 2011 compliance)/General Scans/y (transversal) 4.2mm 50

x 50/ABM Signal(x,y,z) (13x13x1): Measurement grid: dx=10mm, dy=10mm
Signal Type: Audio File (.wav) 48k_voice_1kHz_1s.wav
Output Gain: 19.31
Measure Window Start: 300ms
Measure Window Length: 1000ms
BWC applied: 0.15 dB
Device Reference Point: 0, 0, -6.3 mm

Cursor:

ABM1 comp = -4.18 dBA/m
BWC Factor = 0.15 dB
Location: 4.2, 4.2, 3.7 mm

Cursor:

ABM2 = -48.65 dBA/m
Location: 4.2, 4.2, 3.7 mm

Cursor:

ABM1/ABM2 = 44.47 dB
ABM1 comp = -4.18 dBA/m
BWC Factor = 0.15 dB
Location: 4.2, 4.2, 3.7 mm

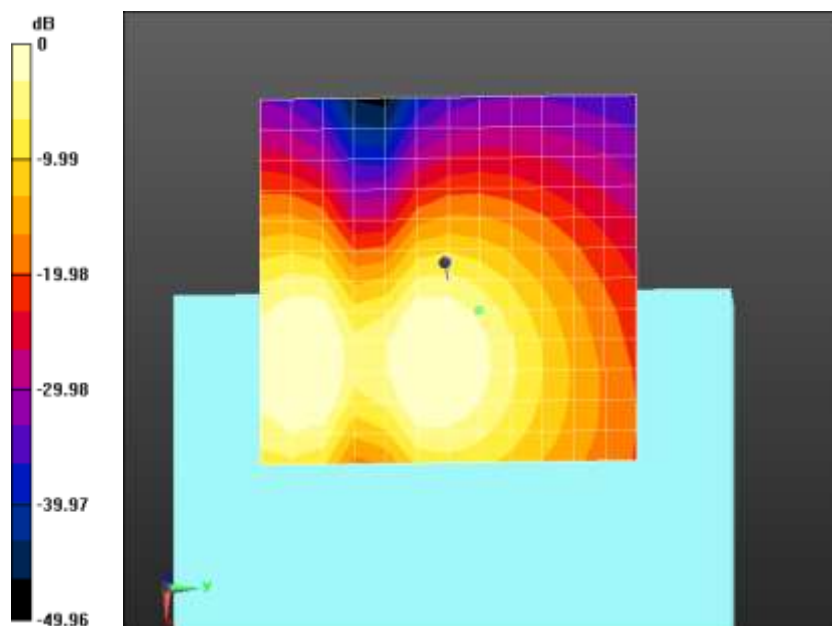

0 dB = 1.000 A/m = 0.00 dBA/m

Attachment 2. HAC T-Coil Probe Certificates

**Calibration Laboratory of
Schmid & Partner
Engineering AG**
Zeughausstrasse 43, 8004 Zurich, Switzerland



S Schweizerischer Kalibrierdienst
C Service suisse d'étalonnage
S Servizio svizzero di taratura
S Swiss Calibration Service

Accredited by the Swiss Accreditation Service (SAS)
The Swiss Accreditation Service is one of the signatories to the EA
Multilateral Agreement for the recognition of calibration certificates

Accreditation No.: **SCS 0108**

Client **HCT (Dymstec)**

Certificate No: **AM1DV3-3050_Nov21**

CALIBRATION CERTIFICATE

Object	AM1DV3 - SN: 3050
Calibration procedure(s)	QA CAL-24.v4 Calibration procedure for AM1D magnetic field probes and TMFS in the audio range
Calibration date:	November 23, 2021

This calibration certificate documents the traceability to national standards, which realize the physical units of measurements (SI).
The measurements and the uncertainties with confidence probability are given on the following pages and are part of the certificate.

All calibrations have been conducted in the closed laboratory facility: environment temperature (22 ± 3)°C and humidity < 70%.

Calibration Equipment used (M&TE critical for calibration)

Primary Standards	ID #	Cal Date (Certificate No.)	Scheduled Calibration
Kaithley Multimeter Type 2001	SN: 0810278	31-Aug-21 (No. 31368)	Aug-22
Reference Probe AM1DV2	SN: 1008	15-Dec-20 (No. AM1DV2-1008_Dec20)	Dec-21
DAE4	SN: 781	23-Dec-20 (No. DAE4-781_Dec20)	Dec-21

Secondary Standards	ID #	Check Date (in house)	Scheduled Check
AMCC	SN: 1050	01-Oct-13 (in house check Oct-20)	Oct-23
AMMI Audio Measuring Instrument	SN: 1062	26-Sep-12 (in house check Oct-20)	Oct-23

Calibrated by:	Name Leaf Klysner	Function Laboratory Technician	Signature
Approved by:	Name Niels Kuster	Quality Manager	

Issued: November 24, 2021

This calibration certificate shall not be reproduced except in full without written approval of the laboratory.

결 재	담 당 자	확 인 자
DL 박성호 2021.12.09		CS 최영준 2021.12.09

References

- [1] ANSI-C63.19-2007
American National Standard for Methods of Measurement of Compatibility between Wireless Communications Devices and Hearing Aids.
- [2] ANSI-C63.19-2019 (ANSI-C63.19-2011)
American National Standard, Methods of Measurement of Compatibility between Wireless Communications Devices and Hearing Aids.
- [3] DASY5 manual, Chapter: Hearing Aid Compatibility (HAC) T-Coil Extension

Description of the AM1D probe

The AM1D Audio Magnetic Field Probe is a fully shielded magnetic field probe for the frequency range from 100 Hz to 20 kHz. The pickup coil is compliant with the dimensional requirements of [1+2]. The probe includes a symmetric low noise amplifier for the signal available at the shielded 3 pin connector at the side. Power is supplied via the same connector (phantom power supply) and monitored via the LED near the connector. The 7 pin connector at the end of the probe does not carry any signals, but determines the angle of the sensor when mounted on the DAE. The probe supports mechanical detection of the surface.

The single sensor in the probe is arranged in a tilt angle allowing measurement of 3 orthogonal field components when rotating the probe by 120° around its axis. It is aligned with the perpendicular component of the field, if the probe axis is tilted nominally 35.3° above the measurement plane, using the connector rotation and sensor angle stated below.

The probe is fully RF shielded when operated with the matching signal cable (shielded) and allows measurement of audio magnetic fields in the close vicinity of RF emitting wireless devices according to [1+2] without additional shielding.

Handling of the item

The probe is manufactured from stainless steel. In order to maintain the performance and calibration of the probe, it must not be opened. The probe is designed for operation in air and shall not be exposed to humidity or liquids. For proper operation of the surface detection and emergency stop functions in a DASY system, the probe must be operated with the special probe cup provided (larger diameter).

Methods Applied and Interpretation of Parameters

- *Coordinate System:* The AM1D probe is mounted in the DASY system for operation with a HAC Test Arch phantom with AMCC Helmholtz calibration coil according to [3], with the tip pointing to "southwest" orientation.
- *Functional Test:* The functional test preceding calibration includes test of Noise level RF immunity (1kHz AM modulated signal). The shield of the probe cable must be well connected. Frequency response verification from 100 Hz to 10 kHz.
- *Connector Rotation:* The connector at the end of the probe does not carry any signals and is used for fixation to the DAE only. The probe is operated in the center of the AMCC Helmholtz coil using a 1 kHz magnetic field signal. Its angle is determined from the two minima at nominally +120° and -120° rotation, so the sensor in the tip of the probe is aligned to the vertical plane in z-direction, corresponding to the field maximum in the AMCC Helmholtz calibration coil.
- *Sensor Angle:* The sensor tilting in the vertical plane from the ideal vertical direction is determined from the two minima at nominally +120° and -120°. DASY system uses this angle to align the sensor for radial measurements to the x and y axis in the horizontal plane.
- *Sensitivity:* With the probe sensor aligned to the z-field in the AMCC, the output of the probe is compared to the magnetic field in the AMCC at 1 kHz. The field in the AMCC Helmholtz coil is given by the geometry and the current through the coil, which is monitored on the precision shunt resistor of the coil.

AM1D probe identification and configuration data

Item	AM1DV3 Audio Magnetic 1D Field Probe
Type No	SP AM1 001 BA
Serial No	3050

Overall length	296 mm
Tip diameter	6.0 mm (at the tip)
Sensor offset	3.0 mm (centre of sensor from tip)
Internal Amplifier	20 dB

Manufacturer / Origin	Schmid & Partner Engineering AG, Zurich, Switzerland
-----------------------	--

Calibration data

Connector rotation angle	(in DASYS system)	213.5 °	+/- 3.6 ° (k=2)
Sensor angle	(in DASYS system)	0.17 °	+/- 0.5 ° (k=2)
Sensitivity at 1 kHz	(in DASYS system)	0.00752 V/(A/m)	+/- 2.2 % (k=2)

The reported uncertainty of measurement is stated as the standard uncertainty of measurement multiplied by the coverage factor k=2, which for a normal distribution corresponds to a coverage probability of approximately 95%.