

EMI TEST REPORT

FCC CERTIFICATION

Applicant:

SAMSUNG Electronics Co., Ltd.
129, Samsung-ro, Yeongtong-gu, Suwon-si,
Gyeonggi-do, 16677, Korea

Date of Issue: May 18, 2022

Test Report No. HCT-EM-2205-FC002-R1

Test Site: HCT CO., LTD.

FCC ID :

A3LSMG990U2

Rule Part(s) / Standard(s) : 47 CFR PART 15 Subpart B Class B
ANSI C63.4-2014

Product Name : Mobile Phone

Model Name : SM-G990U2

Series Model Name : SM-G990U3/DS

Date of Test : May 10, 2022 to May 12, 2022

The device bearing the trade name and model specified above, has been shown to comply with the applicable technical standards as indicated in the measurement report and was tested in accordance with the measurement procedures specified in ANSI C63.4-2014. (See Test Report if any modifications were made for compliance)

I attest to the accuracy of data. All measurements reported herein were performed by me or were made under my supervision and are correct to the best of my knowledge and belief. I assume full responsibility for the completeness of these measurements and vouch for the qualifications of all persons taking them.

Tested By

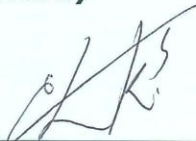

Wook Yi
Test Engineer
EMC Team
Certification Division

Reviewed



Jeong-Hyun Choi
Technical Manager
EMC Team
Certification Division

This report only responds to the tested sample and may not be reproduced, except in full, without written approval of the HCT Co., Ltd.



REVISION HISTORY

The revision history for this document is shown in table.

Rev No.	Issue Date	Information About Changes
0	May 13, 2022	Initial Release
1	May 18, 2022	Revised the Series Model Name

The above Test Report is not related to the accredited test result by (KS Q) ISO/IEC 17025 and KOLAS (Korea Laboratory Accreditation Scheme), which signed the ILAC-MRA.

If this report is required to confirmation of authenticity, please contact to www.hct.co.kr



TABLE OF CONTENTS

	PAGE
1. GENERAL INFORMATION	4
1.1 Description of EUT	4
1.2 Tested System Details	4
1.3 Cable Description	5
1.4 Noise Suppression Parts on Cable. (I/O Cable).....	5
1.5 Test Facility	6
1.6 Calibration of Measuring Instrument	6
1.7 Measurement Uncertainty	6
2. LIST OF TEST EQUIPMENT.....	7
3. DESCRIPTION OF TEST	8
3.1 Measurement of Conducted Emission.....	8
3.2 Measurement of Radiated Emission.....	9
3.3 Configuration of Tested System	10
4. OPERATION OF THE EUT.....	11
4.1 Conducted Emission.....	11
4.2 Radiated Emission.....	12
5. EMI TEST SUMMARY	13
5.1 Conducted Emission.....	13
5.1.1 Test Condition.....	13
5.1.2 Measuring Data.....	13
5.2 Radiated Emission Below 1 GHz	13
5.2.1 Test Condition.....	14
5.2.2 Measuring Data.....	15
5.3 Radiated Emission Above 1 GHz	18
5.3.1 Test Condition.....	21
5.3.2 Measuring Data.....	22
6. CONCLUSION.....	24
7. APPENDIX A. TEST SETUP PHOTO.....	27



1. GENERAL INFORMATION

1.1 Description of EUT

FCC ID	A3LSMG990U2
Model Name	SM-G990U2
Series Model Name	SM-G990U3/DS
Product Name	Mobile Phone
Frequency Band	CDMA BC0/1/10, GSM 850/1900, WCDMA B2/4/5, LTE B2/4/5/7/12/13/14/25/26/30/38/40/41/48/66/71, (Rx only: B29/46), 5G NR n2/5/12/25/30/41/66/71/77, NR n260/261 BT BDR/EDR/LE, Wi-Fi a/b/g/n/ac/ax (MIMO/RSDB), NFC, AIT, WPT
Power Supply	Travel adapter: Input: 100 to 240 V, 50 to 60 Hz, 0.7 A Output: (PDO)5.0 V, 3.0 A or 9.0 V, 2.77 A (PPS)3.3 to 5.9 V, 3.0 A or 3.3 to 11.0 V, 2.25 A
	Battery: Low: 3.65 V / Normal: 3.88 V / High: 4.47 V Type: Li-ion Battery

1.2 Tested System Details

All equipment descriptions used in the tested system (including inserted cards) are:

Device Type	Model Name	Serial Number	Manufacturer
Mobile Phone	SM-G990U2	-	SAMSUNG
TA	EP-TA800	-	SOLUM
Data Cable	EP-DN980	-	RF TECH
Earphone	YBD-19HS	-	BUJEON



1.3 Cable Description

Product Name	Port	Power Cord Shielded (Y/N)	I/O Cable Shielded (Y/N)	Length (m)
EUT	Data Cable (USB Type C)	Y	N/A	(P) 1.0
	Earphone (USB Type C)	N/A	N	(D) 1.3

"(D)" Data Cable and "(P)" Power Cable.

1.4 Noise Suppression Parts on Cable. (I/O Cable)

Product Name	Port	Ferrite Bead (Y/N)	Location	Metal Hood (Y/N)	Location
EUT	Data Cable (USB Type C)	N	N/A	Y	Both End
	Earphone (USB Type C)	N	N/A	Y	EUT End



1.5 Test Facility

Test site is located at 74, Seoicheon-ro 578beon-gil, Majang-myeon, Icheon-si, Gyeonggi-do, Korea. Those measurement facilities are constructed in conformance with the requirements of ANSI C63.4-2014. The Normalized site attenuations (30 MHz to 1 GHz) and Site validation (1 GHz to 18 GHz) were performed in accordance with the standard in ANSI C63.4-2014 and ANSI C63.4a-2017. Our laboratories are accredited and designated in accordance with the provisions of Radio Waves ACT and International Standard ISO/IEC 17025:2017. (National Radio Research Agency, CABID No. KR0032)

1.6 Calibration of Measuring Instrument

The measuring equipment, which was utilized in performing the tests documented herein, has been calibrated in accordance with the manufacturers recommendations for utilizing calibration equipment, which is traceable to recognized national standards.

Especially, all antenna for measurement is calibrated in accordance with the requirements of C63.5:2017.

1.7 Measurement Uncertainty

The measurement uncertainties shown below were calculated in accordance with the requirements of ANSI C63.4-2014.

All measurement uncertainty values are shown with a coverage factor of $k = 2$ to indicate a 95 % level of confidence. The measurement data shown herein meets or exceeds the U_{CISPR} measurement uncertainty values specified in CISPR 16-4-2 and, thus, can be compared directly to specified limits to determine compliance.

Test Item	Test Site (Chamber)	Expanded Uncertainty
Radiated Emission (30 MHz to 1 GHz)	3 m Semi Anechoic Chamber #1	5.8 dB
Radiated Emission (1 GHz to 18 GHz)	3 m Semi Anechoic Chamber #1	4.8 dB
Radiated Emission (18 GHz to 40 GHz)	3 m Semi Anechoic Chamber #1	5.8 dB



2. LIST OF TEST EQUIPMENT

<u>Type</u>	<u>Model Name</u>	<u>Manufacturer</u>	<u>Serial Number</u>	<u>Calibration Cycle</u>	<u>Calibration Date</u>
Conducted Emission					
<input type="checkbox"/> EMI Test Receiver	ESR7	Rohde & Schwarz	101910	1 year	06.17.2021
<input type="checkbox"/> LISN	ENV216	Rohde & Schwarz	102245	1 year	08.23.2021
<input type="checkbox"/> Radio communication analyzer	MT8821C	ANRITSU	6262192376	1 year	10.19.2021
<input type="checkbox"/> Antenna (for Communication)	HyperLOG7060	Aaronia	66450	-	-
<input type="checkbox"/> Antenna (for Communication)	HyperLOG7060	Aaronia	66451	-	-
<input type="checkbox"/> Software	EMC32	Rohde & Schwarz	-	-	-
Radiated Emission					
-For measurement below 1 GHz					
<input checked="" type="checkbox"/> EMI Test Receiver	ESU40	Rohde & Schwarz	100524	1 year	05.10.2022
<input checked="" type="checkbox"/> Bi-Log Antenna	VULB9168	Schwarzbeck	255	2 year	03.15.2021
<input checked="" type="checkbox"/> Antenna master	MA4640-XP-ET	INNCO SYSTEM	-	N/A	-
<input checked="" type="checkbox"/> Antenna master controller	CO3000	INNCO SYSTEM	CO3000/870/ 35990515/L	N/A	-
<input checked="" type="checkbox"/> Turn Table	1060	INNCO SYSTEM	-	N/A	-
<input checked="" type="checkbox"/> Turn Table controller	CO2000	INNCO SYSTEM	CO2000/095/ 7590304/L	N/A	-
<input checked="" type="checkbox"/> UNIVERSAL RADIO COMMUNICATION TESTER	CMU200	Rohde & Schwarz	107488	1 year	08.31.2021
<input checked="" type="checkbox"/> Radio communication analyzer	MT8821C	ANRITSU	6262192376	1 year	10.19.2021
<input checked="" type="checkbox"/> Antenna (for Communication)	HyperLOG7060	Aaronia	66450	-	-
<input checked="" type="checkbox"/> Radio communication analyzer	MT8000A	ANRITSU	6262208294	1 year	12.22.2021
<input checked="" type="checkbox"/> Antenna (for Communication)	HyperLOG7060	Aaronia	66451	-	-
<input checked="" type="checkbox"/> Software	EMC32	Rohde & Schwarz	-	-	-
-For measurement above 1 GHz					
<input checked="" type="checkbox"/> EMI Test Receiver	ESU40	Rohde & Schwarz	100524	1 year	05.10.2022
<input checked="" type="checkbox"/> Antenna master	MA4640-XP-ET	INNCO SYSTEM	-	N/A	-
<input checked="" type="checkbox"/> Antenna master controller	CO3000	INNCO SYSTEM	CO3000/870/ 35990515/L	N/A	-
<input checked="" type="checkbox"/> Turn Table	1060	INNCO SYSTEM	-	N/A	-
<input checked="" type="checkbox"/> Turn Table controller	CO2000	INNCO SYSTEM	CO2000/095/ 7590304/L	N/A	-
<input checked="" type="checkbox"/> Low Noise Amplifier	TK-PA18H	TESTEK	170034-L	1 year	02.24.2022
<input checked="" type="checkbox"/> Low Noise Amplifier	TK-PA1840H	TESTEK	170030-L	1 year	02.24.2022
<input checked="" type="checkbox"/> Horn Antenna	BBHA 9120D	Schwarzbeck	01836	1 year	07.20.2021
<input checked="" type="checkbox"/> Horn Antenna	BBHA 9170	Schwarzbeck	BBHA 9170 #786	1 year	11.16.2021
<input checked="" type="checkbox"/> Radio communication analyzer	MT8821C	ANRITSU	6262192376	1 year	10.19.2021
<input checked="" type="checkbox"/> Antenna (for Communication)	HyperLOG7060	Aaronia	66450	-	-
<input checked="" type="checkbox"/> Radio communication analyzer	MT8000A	ANRITSU	6262208294	1 year	12.22.2021
<input checked="" type="checkbox"/> Antenna (for Communication)	HyperLOG7060	Aaronia	66451	-	-
<input checked="" type="checkbox"/> Software	EMC32	Rohde & Schwarz	-	-	-



3. DESCRIPTION OF TEST

3.1 Measurement of Conducted Emission

The test procedure was in accordance with ANSI C63.4-2014, Clause 7.3

- a. The EUT was placed 0.4 meters from the conducting wall of the shielded room with EUT being connected to the power mains through a line impedance stabilization network (LISN).
If the EUT is connected to the PC through USB, the AC power-line adapter of the PC is directly connected to a line impedance stabilization network (LISN).
Other support units were connected to the power mains through another LISN. The two LISNs provide 50 Ohm/50uH of coupling impedance for the measuring instrument.
- b. Both conducted lines are measured in Quasi-Peak and Average mode, including the worst-case data points for each tested configuration.
- c. The frequency ranges from 150 kHz to 30 MHz was searched.

[Conducted Emission Limits]

Frequency (MHz)	Resolution Bandwidth (kHz)	Quasi-Peak (dB(μ V))	Average (dB(μ V))
0.15 to 0.5	9	66 to 56*	56 to 46*
0.5 to 5	9	56	46
5 to 30	9	60	50

**Decreases with the logarithm of the frequency.*



3.2 Measurement of Radiated Emission

The test procedure was in accordance with ANSI C63.4-2014, Clause 8.3

- The EUT was placed on the top of a turn table 0.8 meters above the ground at a semi-anechoic chamber. The table was rotated 360 degrees to determine the position of the highest radiation.
- The EUT was set 3 m away from the interference-receiving antenna, which was mounted on the top of a variable-height antenna tower.
- The antenna height is varied from 1 m to 4 m above the ground to determine the maximum value of the field strength. Both horizontal and vertical polarizations of the antenna are set to make the measurement.
- For each suspected emission, the EUT was arranged to its worst case and then the antenna was tuned to heights from 1 m to 4 m and the turn table was turned from 0 degrees to 360 degrees to find the maximum reading.
- The test-receiver system was set to Quasi-Peak detect function and specified bandwidth with maximum hold mode when the test frequency is below 1 GHz.
- The test-receiver system was set to Peak and Average detect function and specified bandwidth with maximum hold mode when the test frequency is above 1 GHz.
- Place the measurement antenna away from each area of the EUT determined to be a source of emissions at the specified measurement distance, while keeping the measurement antenna aimed at the source of emissions at each frequency of significant emissions, with polarization oriented for maximum response. (1 GHz to 40 GHz)

[Radiated Emission Limits]

Frequency (MHz)	Antenna Distance (m)	Field Strength ($\mu\text{V}/\text{m}$)	Quasi-Peak (dB $\mu\text{V}/\text{m}$)
30 to 88	3	100	40.0
88 to 216	3	150	43.5
216 to 960	3	200	46.0
Above 960	3	500	54.0

Frequency (MHz)	Antenna Distance (m)	Peak (dB $\mu\text{V}/\text{m}$)	Average (dB $\mu\text{V}/\text{m}$)
Above 1 000	3	74	54



3.2.1 Frequency Range of Radiated Measurements

An unintentional radiator, including a digital device, the spectrum shall be investigated from the lowest radio frequency signal generated or used in the device, without going below the lowest frequency for which a Radiated Emission limit is specified, up to the frequency shown in the following table.

Highest frequency generated or used in the device or on which the device operates or tunes (MHz)	Upper frequency of measurement range (MHz)
Below 1.705	30
1.705 to 108	1 000
108 to 500	2 000
500 to 1 000	5 000
Above 1 000	5 th harmonic of the highest frequency or 40 GHz, whichever is lower

3.3 Configuration of Tested System

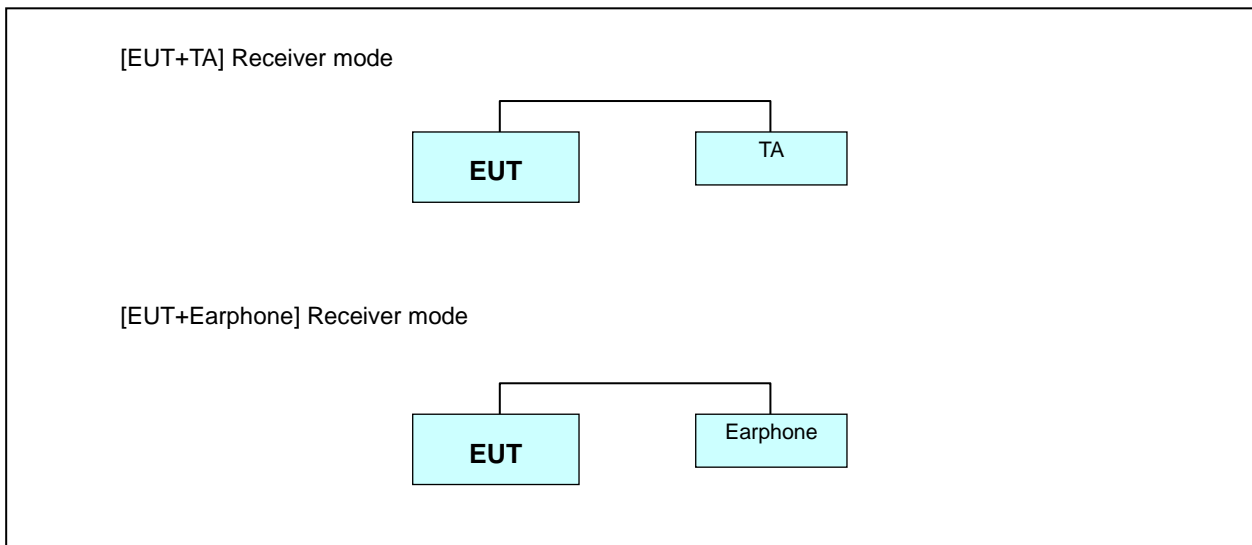

Non-Conductive Table



4. OPERATION OF THE EUT

During preliminary tests, the following operating mode was investigated.

Receiver mode(CDMA BC0 Low/Middle/High ch Idle)
Receiver mode(CDMA BC10 Low/Middle/High ch Idle)
Receiver mode(GSM 850 Low/Middle/High ch Idle)
Receiver mode(WCDMA B5 Low/Middle/High ch Idle)
Receiver mode(LTE B5_Low/Middle/High ch)
Receiver mode(LTE B12_Low/Middle/High ch)
Receiver mode(LTE B13_Low/Middle/High ch)
Receiver mode(LTE B14_Low/Middle/High ch)
Receiver mode(LTE B26_Low/Middle/High ch)
Receiver mode(LTE B29_Low/Middle/High ch)
Receiver mode(LTE B71_Low/Middle/High ch)
Receiver mode(5G NR n5_Low/Middle/High ch)
Receiver mode(5G NR n12_Low/Middle/High ch)
Receiver mode(5G NR n71_Low/Middle/High ch)

NOTE. The worst case is tested.

4.1 Conducted Emission (Not Applicable)

It was final tested the following operating mode, after connecting all peripheral devices.

Operating Mode: Not applicable



4.2 Radiated Emission

It was final tested the following operating mode, after connecting all peripheral devices.

Operating Mode:

Radiated Emission below 1 GHz:

[EUT+TA]

LTE B26(B5)+5G NR n5 Low ch Idle
 LTE B26(B5)+5G NR n5 Middle ch Idle *
 LTE B26(B5)+5G NR n5 High ch Idle
 LTE B12+B13+5G NR n12 Low ch Idle*
 LTE B12+B13+5G NR n12 Middle ch Idle
 LTE B12+B13+5G NR n12 High ch Idle
 LTE B14 Low ch Idle
 LTE B14 Middle ch Idle*
 LTE B14 High ch Idle
 LTE B29 Low ch Idle
 LTE B29 Middle ch Idle*
 LTE B29 High ch Idle
 LTE B71+5G NR n71 Low ch Idle*
 LTE B71+5G NR n71 Middle ch Idle
 LTE B71+5G NR n71 High ch Idle

[EUT+Earphone]

LTE B14 Middle ch Idle*

Radiated Emission above 1 GHz:

[EUT+TA]

LTE B26(B5)+5G NR n5 Middle ch Idle
 LTE B12+B13+5G NR n12 Low ch Idle
 LTE B14 Middle ch Idle*
 LTE B29 Middle ch Idle
 LTE B71+5G NR n71 Low ch Idle

[EUT+Earphone]

LTE B14 Middle ch Idle*

NOTE.

1. Three orientations have been investigated and the worst case orientation (x-axis: The display of EUT placed on the table is facing upwards) is reported.
2. The worst case of operating mode is reported. [*].



5. EMI TEST SUMMARY

5.1 Conducted Emission

5.1.1 Test Condition

The test results of conducted emission at mains ports provide the following information:

Used Test Standard	47 CFR PART 15 Subpart B Class B ANSI C63.4-2014
Frequency Range	150 kHz to 30 MHz
Detector	Quasi-Peak, CISPR-Average
Bandwidth	9 kHz (6 dB)
Operating Mode	-
Test Site	EMI Shield Room
Temperature	min. - °C, max. - °C
Humidity	min. - % R.H., max. - % R.H.
Test Date	-

Calculation Formula:

1. Conductor L1 = Hot, Conductor N = Neutral
2. Corr. = LISN Factor+Cable Loss
3. QuasiPeak or CAverage= Receiver Reading+Corr.
4. Margin = Limit – QuasiPeak or CAverage

5.1.2 Measuring Data

Not applicable



5.2 Radiated Emission Below 1 GHz

5.2.1 Test Condition

The test results of radiated emission provide the following information:

Used Test Standard	47 CFR PART 15 Subpart B Class B ANSI C63.4-2014
Frequency Range	30 MHz to 1 000 MHz
Detector / Bandwidth	Quasi-Peak / Bandwidth: 120 kHz (6 dB)
Operating Mode of Worst case	[EUT+TA] LTE B26(B5)+5G NR n5 Middle ch Idle LTE B12+B13+5G NR n12 Low ch Idle LTE B14 Middle ch Idle LTE B29 Middle ch Idle LTE B71+5G NR n71 LoW ch Idle [EUT+Earphone] LTE B14 Middle ch Idle
Measurement Distance	3 m
Antenna Measurement Height	1 m to 4 m
Test Site	3 m Semi Anechoic Chamber #1
Temperature	min. 23.3 °C, max. 24.9 °C
Humidity	min. 34.5 % R.H., max. 37.9 % R.H.
Test Date	May 10, 2022 – May 11, 2022

Calculation Formula:

1. POL. H = Horizontal, POL. V = Vertical
2. QuasiPeak = Reading (Receiver Reading)+Corr.
3. Corr. (Correction Factor) = Antenna Factor+Cable Loss
4. Margin = Limit - QuasiPeak



5.2.2 Measuring Data

Figure 1: Radiated Emission (30 to 1 000) MHz, [EUT+TA] LTE B26(B5)+5G NR n5 Middle ch Idle

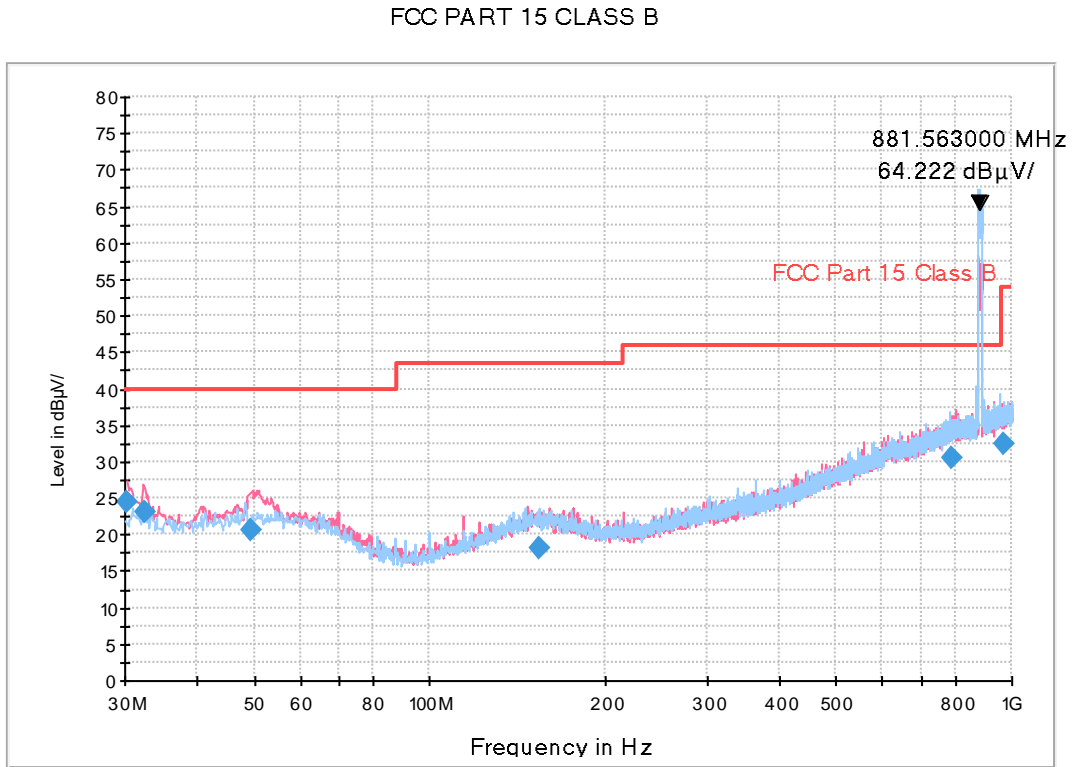

NOTE. 1. Carrier Frequency: RX 881.563 MHz
 2. These are signals for fundamental frequency from the base station

Frequency (MHz)	Quasi Peak (dBµV/m)	Antenna Height (cm)	POL. (H/V)	Azimuth (deg)	Corr. (dB)	Margin (dB)	Limit (dBµV/m)
30.1480	24.6	116.8	V	332.0	18.5	15.4	40.0
32.5511	23.1	116.7	V	316.0	18.7	16.9	40.0
49.5920	20.6	100.0	V	193.0	20.0	19.4	40.0
154.9751	18.0	125.1	H	237.0	19.6	25.5	43.5
788.6192	30.6	225.1	V	319.0	30.4	15.4	46.0
969.5610	32.5	125.3	H	226.0	32.3	21.5	54.0



Figure 2: Radiated Emission (30 to 1 000) MHz, [EUT+TA] LTE B12+B13+5G NR n12 Low ch Idle

FCC PART 15 CLASS B

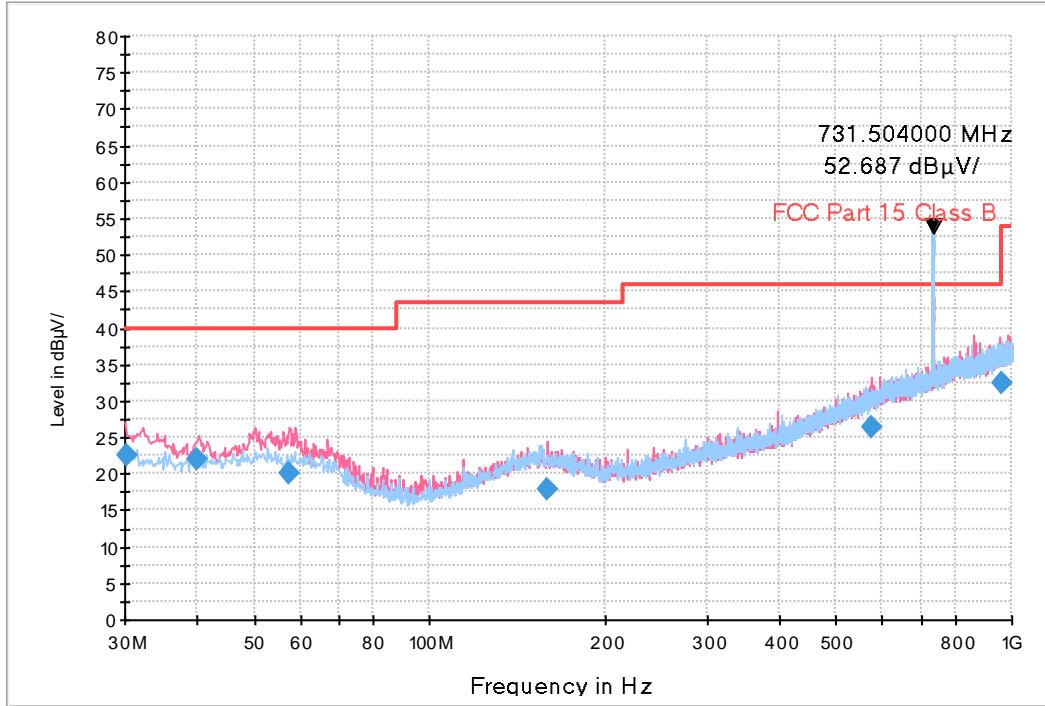

- NOTE. 1. Carrier Frequency: RX 731.504 MHz
 2. These are signals for fundamental frequency from the base station

Frequency (MHz)	Quasi Peak (dBµV/m)	Antenna Height (cm)	POL. (H/V)	Azimuth (deg)	Corr. (dB)	Margin (dB)	Limit (dBµV/m)
30.2262	22.6	207.8	V	276.0	18.5	17.4	40.0
39.8115	22.0	125.0	V	125.0	19.3	18.0	40.0
57.3193	20.1	116.7	V	222.0	19.7	19.9	40.0
159.3636	18.0	100.0	V	324.0	19.7	25.5	43.5
572.4582	26.4	116.9	V	0.0	26.9	19.6	46.0
963.3540	32.4	225.1	H	84.0	32.2	21.6	54.0



Figure 3: Radiated Emission (30 to 1 000) MHz, [EUT+TA] LTE B14 Middle ch Idle

FCC PART 15 CLASS B

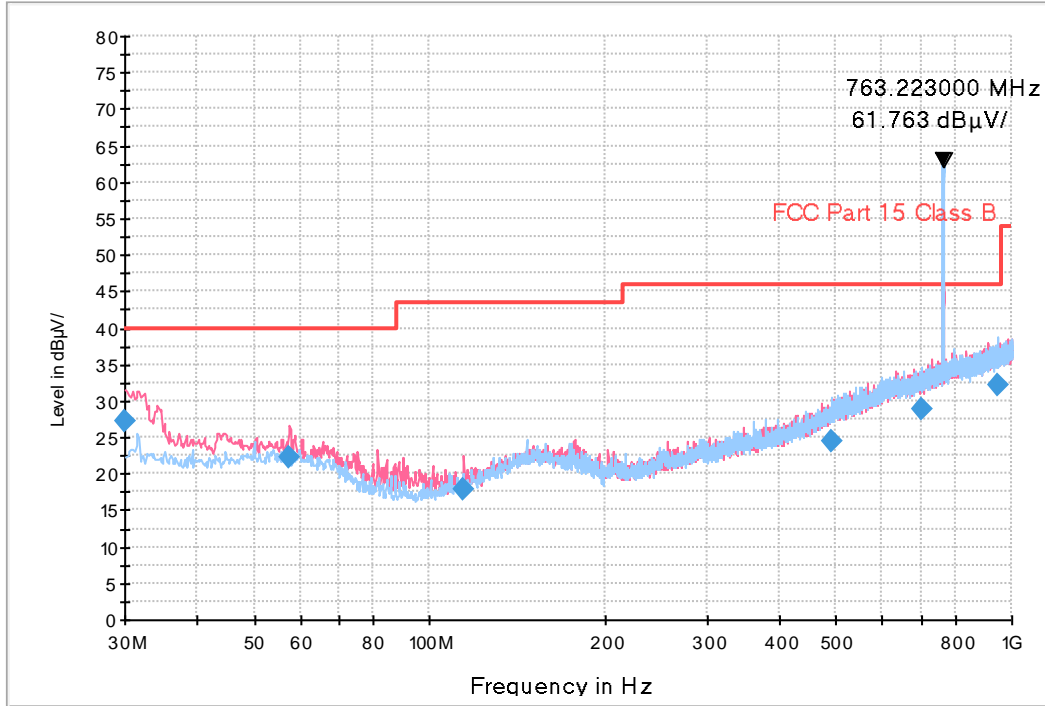

- NOTE. 1. Carrier Frequency: RX 763.223 MHz
 2. These are signals for fundamental frequency from the base station

Frequency (MHz)	Quasi Peak (dBµV/m)	Antenna Height (cm)	POL. (H/V)	Azimuth (deg)	Corr. (dB)	Margin (dB)	Limit (dBµV/m)
30.0159	27.1	108.7	V	350.0	18.5	12.9	40.0
57.4896	22.4	125.0	V	162.0	19.7	17.6	40.0
114.5110	17.8	185.5	V	69.0	16.5	25.7	43.5
491.6194	24.4	100.0	H	306.0	25.3	21.6	46.0
698.2817	28.8	173.3	H	188.0	28.8	17.2	46.0
949.4243	32.3	224.7	H	357.0	32.1	13.7	46.0



Figure 4: Radiated Emission (30 to 1 000) MHz, [EUT+TA] LTE B29 Middle ch Idle

FCC PART 15 CLASS B

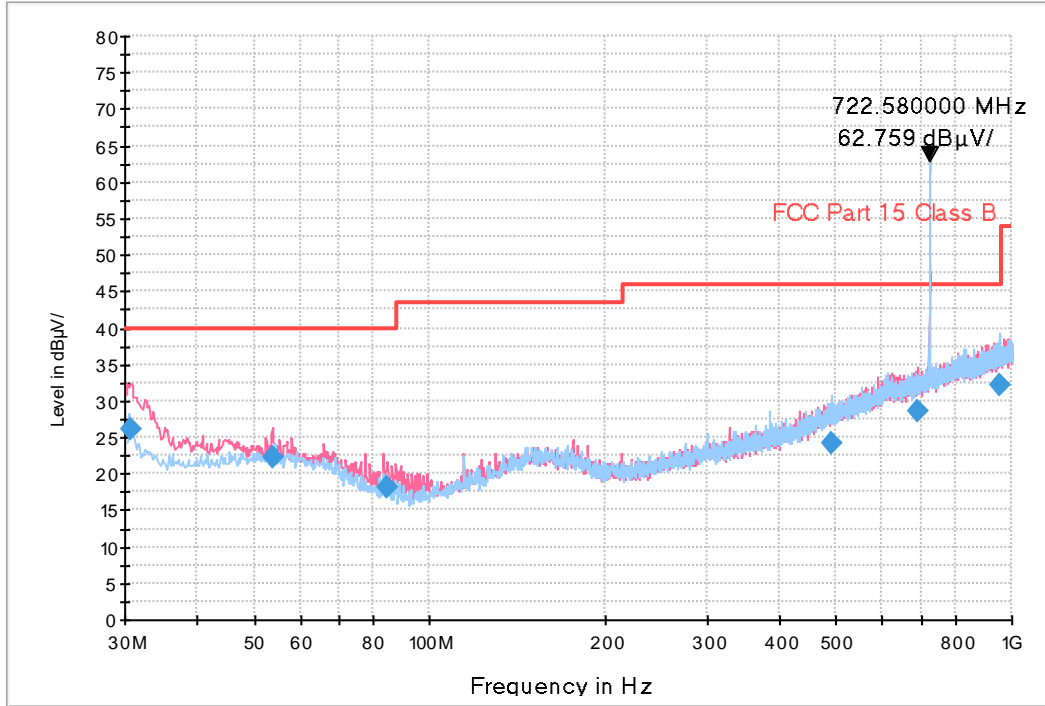

- NOTE. 1. Carrier Frequency: RX 722.580 MHz
 2. These are signals for fundamental frequency from the base station

Frequency (MHz)	Quasi Peak (dBµV/m)	Antenna Height (cm)	POL. (H/V)	Azimuth (deg)	Corr. (dB)	Margin (dB)	Limit (dBµV/m)
30.8186	26.1	125.2	V	311.0	18.5	13.9	40.0
53.7908	22.3	116.8	V	143.0	19.9	17.7	40.0
84.7218	18.2	116.8	V	355.0	15.0	21.8	40.0
491.1122	24.3	100.0	H	68.0	25.3	21.7	46.0
689.3514	28.5	125.2	V	134.0	28.7	17.5	46.0
955.7820	32.3	100.0	H	246.0	32.2	13.7	46.0



Figure 5: Radiated Emission (30 to 1 000) MHz, [EUT+TA] LTE B71+5G NR n71 Low ch Idle

FCC PART 15 CLASS B

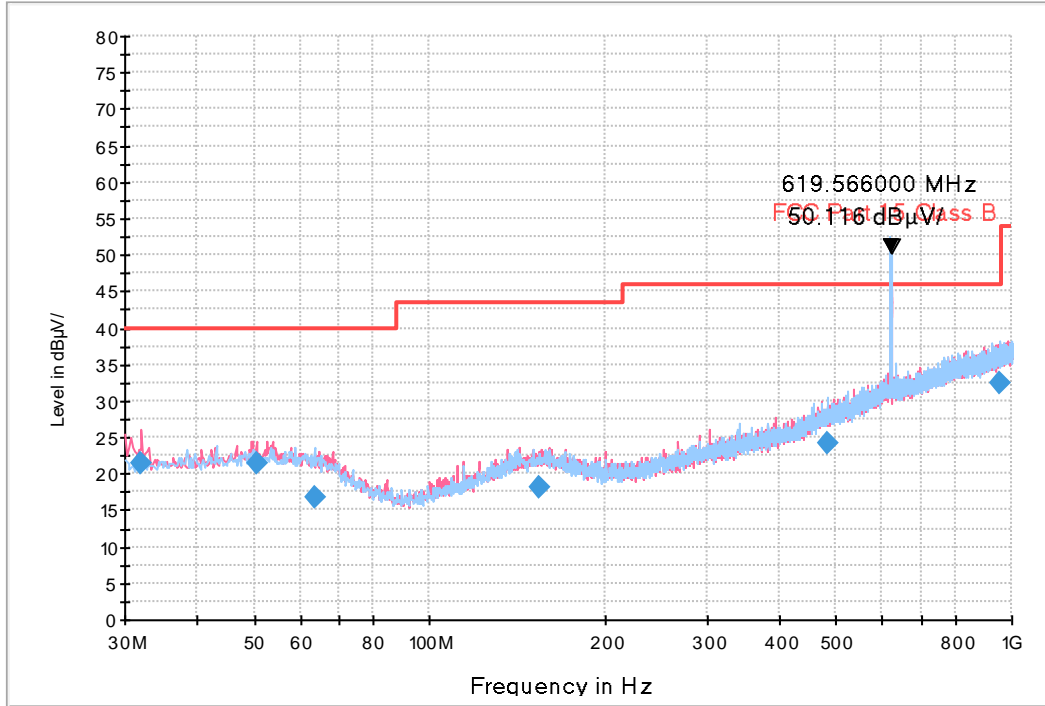

- NOTE. 1. Carrier Frequency: RX 619.566 MHz
 2. These are signals for fundamental frequency from the base station

Frequency (MHz)	Quasi Peak (dBµV/m)	Antenna Height (cm)	POL. (H/V)	Azimuth (deg)	Corr. (dB)	Margin (dB)	Limit (dBµV/m)
32.0119	21.6	116.9	V	282.0	18.6	18.4	40.0
50.5828	21.4	100.0	V	293.0	20.0	18.6	40.0
63.5100	16.9	125.0	H	152.0	19.2	23.1	40.0
154.0093	18.2	125.2	V	13.0	19.6	25.3	43.5
482.4579	24.2	100.0	H	212.0	25.0	21.8	46.0
951.5498	32.3	225.2	H	117.0	32.1	13.7	46.0



Figure 6: Radiated Emission (30 to 1 000) MHz, [EUT+Earphone] LTE B14 Middle ch Idle

FCC PART 15 CLASS B

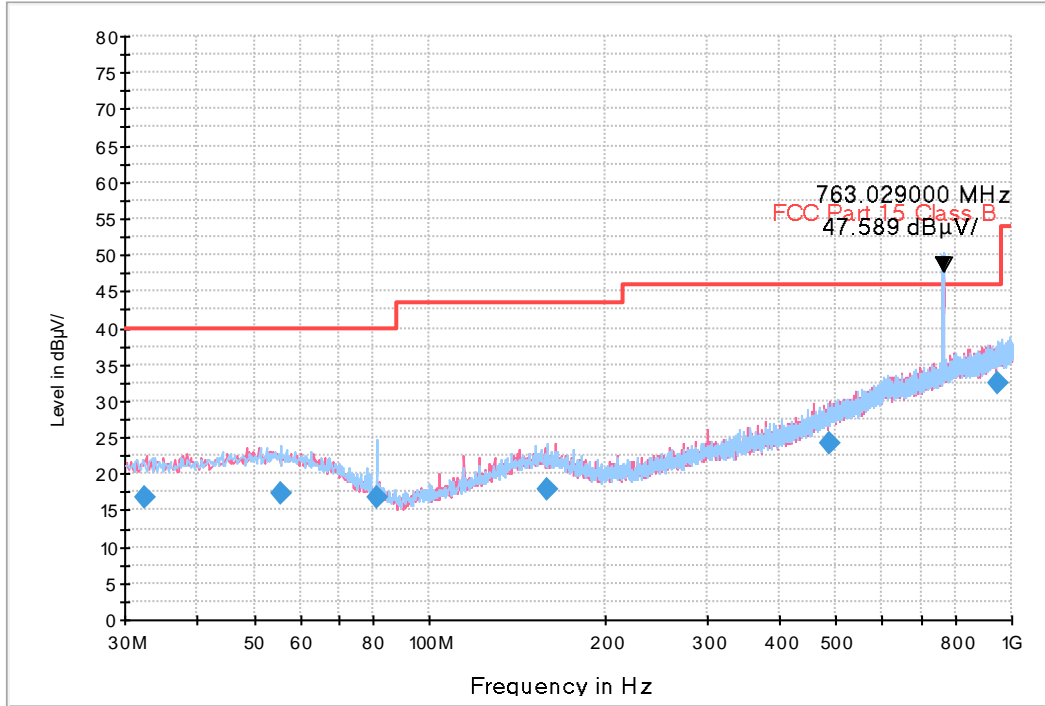

- NOTE. 1. Carrier Frequency: RX 763.029 MHz
- 2. These are signals for fundamental frequency from the base station

Frequency (MHz)	Quasi Peak (dBµV/m)	Antenna Height (cm)	POL. (H/V)	Azimuth (deg)	Corr. (dB)	Margin (dB)	Limit (dBµV/m)
32.3514	16.7	116.8	V	0.0	18.7	23.3	40.0
55.4925	17.3	199.8	H	294.0	19.8	22.7	40.0
81.2904	16.7	225.1	H	0.0	15.5	23.3	40.0
159.3041	18.0	225.1	H	198.0	19.7	25.5	43.5
486.8342	24.2	100.0	V	105.0	25.2	21.8	46.0
947.6680	32.3	199.7	H	0.0	32.1	13.7	46.0



5.3 Radiated Emission Above 1 GHz

5.3.1 Test Condition

The test results of radiated emission provide the following information:

Used Test Standard	47 CFR PART 15 Subpart B Class B ANSI C63.4-2014
Detector / Bandwidth	Peak / Bandwidth: 1 MHz CISPR-Average / Bandwidth: 1 MHz
Operating Mode of Worst case	[EUT+TA] LTE B14 Middle ch Idle [EUT+Earphone] LTE B14 Middle ch Idle
Highest Frequency	40 GHz
Tested Frequency Range	1 GHz to 40 GHz
Measurement Distance	3 m
Antenna Measurement Height	1 m to 4 m
Test Site	3 m Semi Anechoic Chamber #1
Temperature	min. 23.4 °C, max. 24.7 °C
Humidity	min. 35.3 % R.H., max. 37.4 % R.H.
Test Date	May 12, 2022

Calculation Formula:

1. POL. H = Horizontal, POL. V = Vertical
2. Peak or CAverage = Reading (Receiver Reading)+Corr.
3. Corr. (Correction Factor) = Antenna Factor+ Cable Loss –Amplifier Gain
4. Margin = Limit - Peak or CAverage



5.3.2 Measuring Data

Figure 7: Radiated Emission (1 to 40) GHz, [EUT+TA] LTE B14 Middle ch Idle

Tilting of GHz FCC PART 15 CLASS B

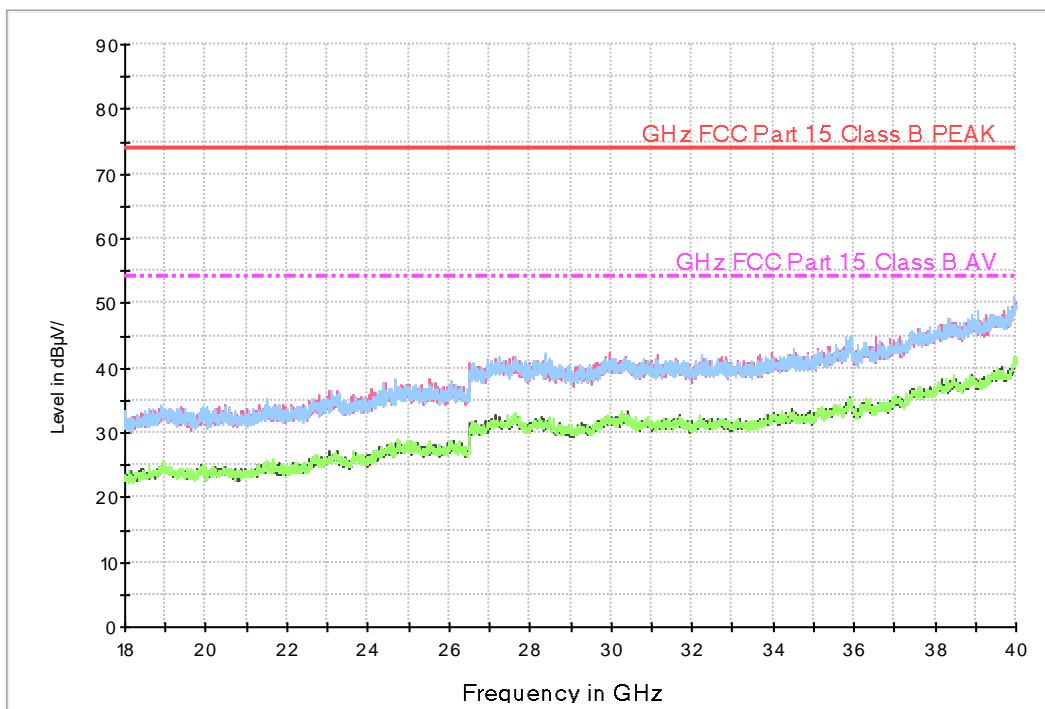
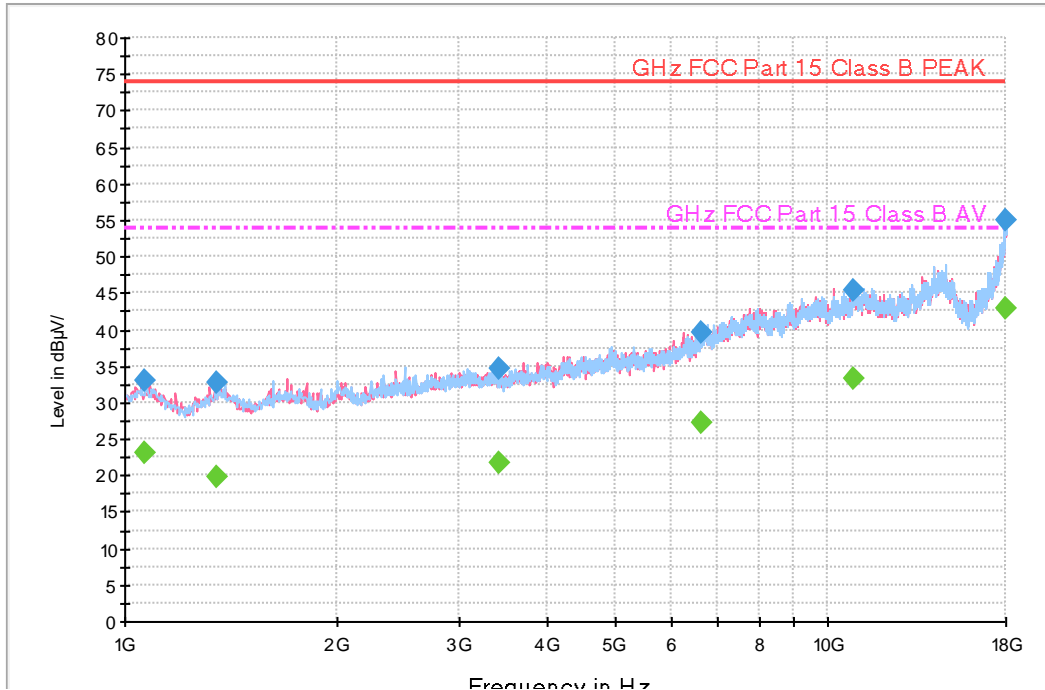



Frequency (MHz)	Peak (dB μ V/m)	Antenna Height (cm)	POL. (H/V)	Azimuth (deg)	Corr. (dB)	Margin (dB)	Limit (dB μ V/m)
1066.0800	32.9	249.8	V	116.0	-27.4	41.1	74.0
1356.1000	32.6	100.0	H	218.0	-26.5	41.4	74.0
3416.8250	34.7	149.8	V	227.0	-20.0	39.3	74.0
6614.2750	39.5	149.4	V	54.0	-11.9	34.5	74.0
10920.8200	45.5	149.5	H	166.0	-3.5	28.5	74.0
17945.4050	55.1	149.6	H	225.0	9.7	18.9	74.0

Frequency (MHz)	CAverage (dB μ V/m)	Antenna Height (cm)	POL. (H/V)	Azimuth (deg)	Corr. (dB)	Margin (dB)	Limit (dB μ V/m)
1066.0800	23.0	249.8	V	116.0	-27.4	31.0	54.0
1356.1000	19.9	100.0	H	218.0	-26.5	34.1	54.0
3416.8250	21.6	149.8	V	227.0	-20.0	32.4	54.0
6614.2750	27.3	149.4	V	54.0	-11.9	26.7	54.0
10920.8200	33.3	149.5	H	166.0	-3.5	20.7	54.0
17945.4050	42.8	149.6	H	225.0	9.7	11.2	54.0



Figure 8: Radiated Emission (1 to 40) GHz, [EUT+Earphone] LTE B14 Middle ch Idle

Tilting of GHz FCC PART 15 CLASS B

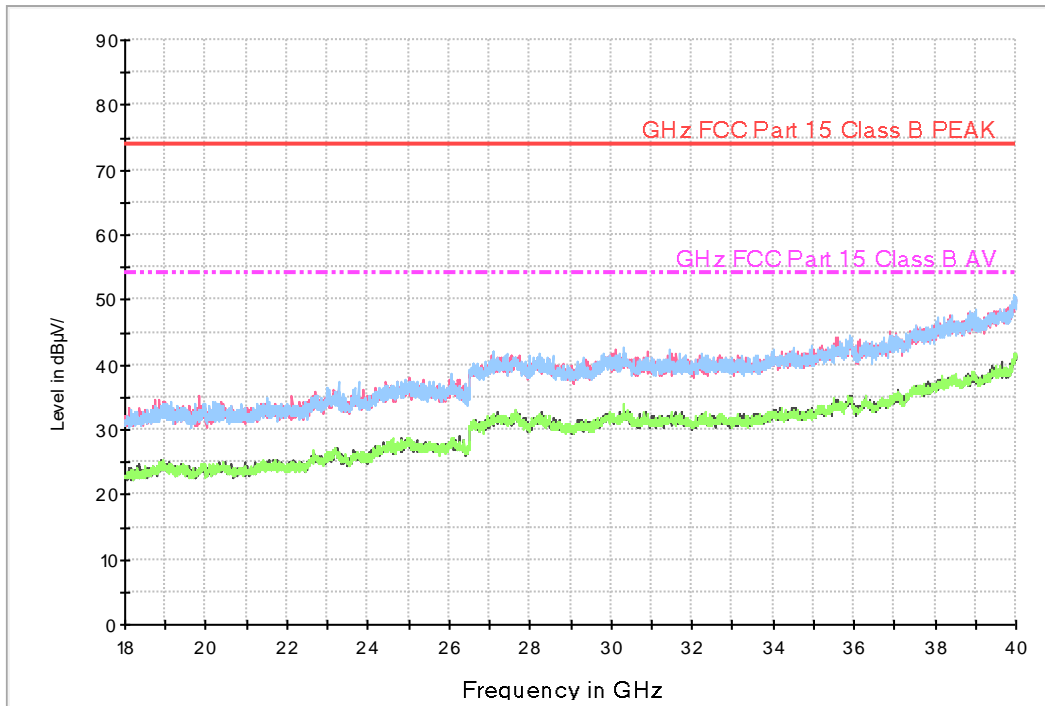
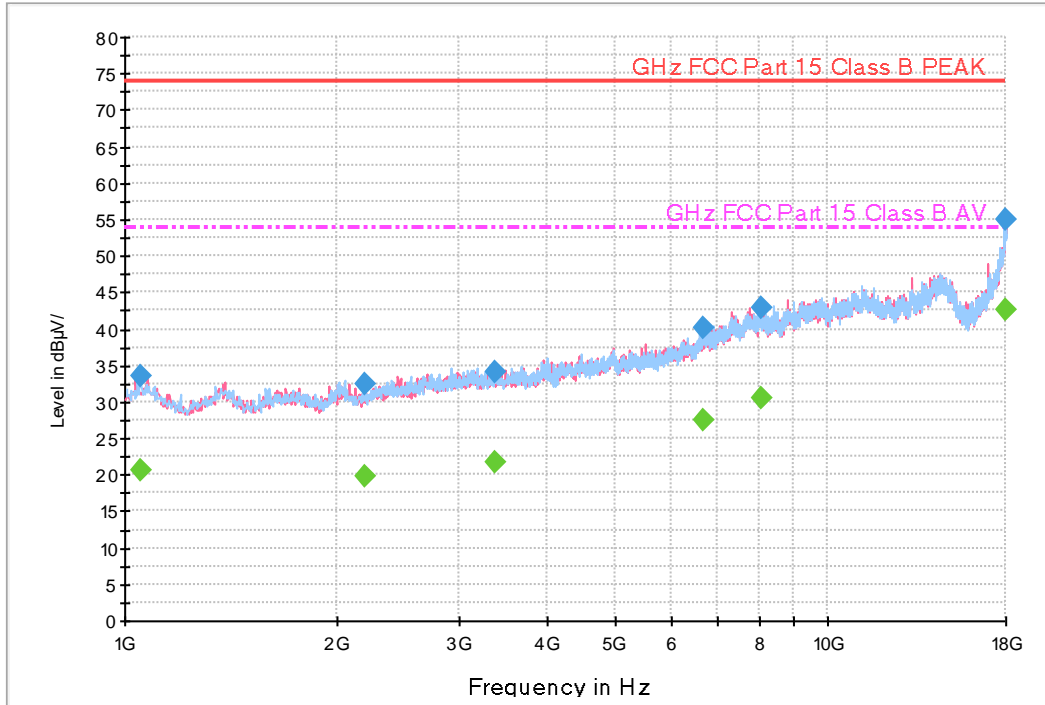



Frequency (MHz)	Peak (dB μ V/m)	Antenna Height (cm)	POL. (H/V)	Azimuth (deg)	Corr. (dB)	Margin (dB)	Limit (dB μ V/m)
1057.1750	33.5	100.1	V	256.0	-27.4	40.5	74.0
2200.9300	32.5	134.7	V	184.0	-23.8	41.5	74.0
3374.5450	34.2	149.8	V	342.0	-20.1	39.8	74.0
6694.8900	40.2	238.5	V	163.0	-11.7	33.8	74.0
8086.8750	42.9	134.5	V	108.0	-8.9	31.1	74.0
17970.6850	55.0	249.8	H	100.0	10.0	19.0	74.0

Frequency (MHz)	CAverage (dB μ V/m)	Antenna Height (cm)	POL. (H/V)	Azimuth (deg)	Corr. (dB)	Margin (dB)	Limit (dB μ V/m)
1057.1750	20.5	100.1	V	256.0	-27.4	33.5	54.0
2200.9300	19.7	134.7	V	184.0	-23.8	34.3	54.0
3374.5450	21.8	149.8	V	342.0	-20.1	32.2	54.0
6694.8900	27.5	238.5	V	163.0	-11.7	26.5	54.0
8086.8750	30.5	134.5	V	108.0	-8.9	23.5	54.0
17970.6850	42.7	249.8	H	100.0	10.0	11.3	54.0



6. CONCLUSION

The data collected shows that the **Product Name: Mobile Phone and Model Name: SM-G990U2** complies with §15.107 and §15.109 of the FCC rules.



7. APPENDIX A. TEST SETUP PHOTO

Please refer to EMI Test Setup Photo and test setup photo file no. as follows;

Rev. No.	Issue Date	File No.
0	May 13, 2022	HCT-EM-2205-FC002-P

End of report