

1.4.5

LTE Band 14 as PCC

Table 18 Maximum Output Powers

Table with columns: Combination, PCC Band, PCC BW [MHz], PCC [UL] Ch., PCC [DL] Freq. [MHz], Mod., PCC UL RB, PCC UL RB Offset, PCC [DL] Ch., PCC [DL] Freq. [MHz], DL Ant. Config., SCC Band, SCC BW [MHz], SCC [DL] Ch., SCC [DL] Freq. [MHz], DL Ant. Config., SCC Band, SCC BW [MHz], SCC [DL] Ch., SCC [DL] Freq. [MHz], DL Ant. Config., SCC Band, SCC BW [MHz], SCC [DL] Ch., SCC [DL] Freq. [MHz], DL Ant. Config., LTE Tx Power with DL CA Enabled [dBm], LTE Single Carrier Tx Power [dBm].

1.4.6

LTE Band 26 as PCC

Table 19 Maximum Output Powers

Table with columns: Combination, PCC Band, PCC BW [MHz], PCC [UL] Ch., PCC [UL] Freq. [MHz], Mod., PCC UL RB, PCC UL RB Offset, PCC [DL] Ch., PCC [DL] Freq. [MHz], DL Ant. Config., SCC Band, SCC BW [MHz], SCC [DL] Ch., SCC [DL] Freq. [MHz], DL Ant. Config., SCC Band, SCC BW [MHz], SCC [DL] Ch., SCC [DL] Freq. [MHz], DL Ant. Config., LTE Tx Power with DL CA Enabled [dBm], LTE Single Carrier Tx Power [dBm].

Table with 3 columns: FCC ID: A3L5MG988U, Test Dates: 11/18/19 – 01/23/20, DUT Type: Portable Handset, SAR EVALUATION REPORT, Samsung logo, Reviewed by: Quality Manager, APPENDIX F: Page 10 of 18.

1.4.8

LTE Band 66 as PCC

Table 21 Maximum Output Powers

Table with columns: Combination, PCC Band, PCC BW [MHz], PCC UL Ch, PCC UL Freq [MHz], Mod., PCC UL RB Offset, PCC UL RB, PCC UL Ch, PCC UL Freq [MHz], DL Ant. Config., SCC Band, SCC BW [MHz], SCC UL Ch, SCC UL Freq [MHz], DL Ant. Config., SCC Band, SCC BW [MHz], SCC UL Ch, SCC UL Freq [MHz], DL Ant. Config., SCC Band, SCC BW [MHz], SCC UL Ch, SCC UL Freq [MHz], DL Ant. Config., SCC Band, SCC BW [MHz], SCC UL Ch, SCC UL Freq [MHz], DL Ant. Config., LTE Tx Power with DL CA Enabled [dBm], LTE Single Carrier Tx Power [dBm].

FCC ID: A3LSMG988U
Test Dates: 11/18/19 - 01/23/20

PCTEST SAR EVALUATION REPORT
DUT Type: Portable Handset

SAMSUNG
Reviewed by: Quality Manager
APPENDIX F: Page 12 of 18

1.4.10

LTE Band 30 as PCC

Table 23
Maximum Output Powers

Combination	PCC Band	PCC BW [MHz]	PCC Freq [MHz]	PCC MCS	Mod.	PCC				S-CC Band	SCC 1				SCC 2				SCC 3				SCC 4				LTE Tx Power with DRB CA Enabled [dBm]	LTE Single Carrier Tx Power [dBm]					
						PCC UL RB [MHz]	PCC UL RB [MHz]	PCC DL Ch [MHz]	PCC (DL) Freq [MHz]		DL Ant. Config.	SCC Band	SCC BW [MHz]	SCC Freq [MHz]	DL Ant. Config.	SCC Band	SCC BW [MHz]	SCC Freq [MHz]	DL Ant. Config.	SCC Band	SCC BW [MHz]	SCC Freq [MHz]	DL Ant. Config.	SCC Band	SCC BW [MHz]	SCC Freq [MHz]			DL Ant. Config.				
CA 2A-3A-30A	LTE-B30	10	2770	2310	QPSK	1	0	9820	2350	444	LTE-B2	20	900	1960	262	LTE-B4	20	2170	2133.5	262	-	-	-	-	-	-	-	-	-	-	-	23.82	23.82
CA 2A-3A-30A	LTE-B30	10	2770	2310	QPSK	1	0	9820	2350	444	LTE-B2	20	900	1960	262	LTE-B2	20	900	1960	262	-	-	-	-	-	-	-	-	-	-	-	-	-

FCC ID: A3LSMG988U
Test Dates:
11/18/19 – 01/23/20

PCTEST
DUT Type:
Portable Handset

SAR EVALUATION REPORT

Reviewed by:
Quality Manager
APPENDIX F:
Page 15 of 18

1.4.11

LTE Band 7 as PCC

Table 24
Maximum Output Powers

Table with columns: Combination, PCC Band, PCC BW, PCC (UL) Ch, PCC (DL) Freq, Mod., PCC UL RB, PCC UL RB Offset, PCC (DL) Ch, PCC (DL) Freq, DL Ant. Config., SCC Band, SCC BW, SCC (UL) Ch, SCC (DL) Freq, DL Ant. Config., SCC Band, SCC BW, SCC (UL) Ch, SCC (DL) Freq, DL Ant. Config., SCC Band, SCC BW, SCC (UL) Ch, SCC (DL) Freq, DL Ant. Config., SCC Band, SCC BW, SCC (UL) Ch, SCC (DL) Freq, DL Ant. Config., LTE Tx Power, LTE Single Carrier Tx Power.

1.4.12

LTE Band 48 as PCC

Table 25
Maximum Output Powers

Table with columns: Combination, PCC Band, PCC BW, PCC (UL) Ch, PCC (DL) Freq, Mod., PCC UL RB, PCC UL RB Offset, PCC (DL) Ch, PCC (DL) Freq, DL Ant. Config., SCC Band, SCC BW, SCC (UL) Ch, SCC (DL) Freq, DL Ant. Config., SCC Band, SCC BW, SCC (UL) Ch, SCC (DL) Freq, DL Ant. Config., SCC Band, SCC BW, SCC (UL) Ch, SCC (DL) Freq, DL Ant. Config., SCC Band, SCC BW, SCC (UL) Ch, SCC (DL) Freq, DL Ant. Config., LTE Tx Power, LTE Single Carrier Tx Power.

1.4.13

LTE Band 41 PC3 as PCC

Table 26
Maximum Output Powers

Table with columns: Combination, PCC Band, PCC BW, PCC (UL) Ch, PCC (DL) Freq, Mod., PCC UL RB, PCC UL RB Offset, PCC (DL) Ch, PCC (DL) Freq, DL Ant. Config., SCC Band, SCC BW, SCC (UL) Ch, SCC (DL) Freq, DL Ant. Config., SCC Band, SCC BW, SCC (UL) Ch, SCC (DL) Freq, DL Ant. Config., SCC Band, SCC BW, SCC (UL) Ch, SCC (DL) Freq, DL Ant. Config., SCC Band, SCC BW, SCC (UL) Ch, SCC (DL) Freq, DL Ant. Config., LTE Tx Power, LTE Single Carrier Tx Power.

FCC ID: A3LSMG988U

Test Dates: 11/18/19 - 01/23/20



SAR EVALUATION REPORT

DUT Type: Portable Handset



Reviewed by: Quality Manager
APPENDIX F: Page 16 of 18

1.5.2

DL Carrier Aggregation with DL 4x4 MIMO RF Conducted Powers

Note: 4x4 DL MIMO is only operating in the downlink. Uplink transmission is limited to a single output stream for each component carrier of ULCA.

**Table 29
Maximum Output Powers**

Combination	PCC											SCC											Power										
	PCC Band	PCC Bandwidth [MHz]	PCC (UL) Channel	PCC (UL) Frequency [MHz]	Modulation	PCC UL RB	PCC UL RB Offset	PCC (DL) Channel	PCC (DL) Frequency [MHz]	DL Ant. Config.	SCC Band	SCC Bandwidth [MHz]	SCC (UL) Channel	SCC (UL) Frequency [MHz]	Modulation	SCC UL RB	SCC UL RB Offset	SCC (DL) Channel	SCC (DL) Frequency [MHz]	DL Ant. Config.	SCC Band	SCC Bandwidth [MHz]	SCC (UL) Channel	SCC (UL) Frequency [MHz]	Modulation	SCC UL RB	SCC UL RB Offset	SCC (DL) Channel	SCC (DL) Frequency [MHz]	DL Ant. Config.	ulca with dca active Power	ULCA power	
CA [66B]	LTE B66	10	132022	1715	QPSK	1	0	49	66486	2115	4x4	LTE B66	10	132121	1724.9	QPSK	1	0	66585	2124.9	4x4	LTE B66	10	132374	1750.2	QPSK	1	99	66838	2150.2	4x4	23.92	23.93
CA [66C]	LTE B66	20	132572	1770	QPSK	1	0	67036	2170	4x4	LTE B66	20	132671	1780	QPSK	1	99	67284	2180	4x4	LTE B66	20	132924	1805.2	QPSK	1	99	67537	2135.2	4x4	24.97	24.94	
CA [141C]	LTE B41	20	40620	2593	QPSK	1	0	40620	2593	4x4	LTE B41	20	40422	2573.2	QPSK	1	99	40422	2573.2	4x4	LTE B41	20	40422	2573.2	QPSK	1	99	40422	2573.2	4x4	27.87	27.99	

APPENDIX G POWER REDUCTION VERIFICATION

Per the May 2017 TCBC Workshop Notes, demonstration of proper functioning of the power reduction mechanisms is required to support the corresponding SAR configurations. The verification process was divided into two parts: (1) evaluation of output power levels for individual or multiple triggering mechanisms and (2) evaluation of the triggering distances for proximity-based sensors.

G.1 Power Verification Procedure



The power verification was performed according to the following procedure:

1. A base station simulator was used to establish a conducted RF connection and the output power was monitored. The power measurements were confirmed to be within expected tolerances for all states before and after a power reduction mechanism was triggered. For licensed modes, the device state index as displayed on the device UI was recorded before and after the mechanism was triggered.
2. Step 1 was repeated for all relevant modes and frequency bands for the mechanism being investigated.
3. Steps 1 and 2 were repeated for all individual power reduction mechanisms and combinations thereof. For the combination cases, one mechanism was switched to a 'triggered' state at a time; powers were confirmed to be within tolerances after each additional mechanism was activated.

G.2 Distance Verification Procedure

The distance verification procedure was performed according to the following procedure:

1. A base station simulator was used to establish an RF connection and to monitor the power levels. The device being tested was placed below the relevant section of the phantom with the relevant side or edge of the device facing toward the phantom. For licensed modes, the device state index on the device UI was monitored to determine the triggering state.
2. The device was moved toward and away from the phantom to determine the distance at which the mechanism triggers and the output power is reduced, per KDB Publication 616217 D04v01r02 and FCC Guidance. Each applicable test position was evaluated. The distances were confirmed to be the same or larger (more conservative) than the minimum distances provided by the manufacturer.
3. Steps 1 and 2 were repeated for low, mid, and high bands, as appropriate (see note below Table G-2 for more details).
4. Steps 1 through 3 were repeated for all distance-based power reduction mechanisms.

FCC ID: A3LSMG988U	 SAR EVALUATION REPORT		Reviewed by: Quality Manager
Test Dates: 11/18/19 – 01/23/20	DUT Type: Portable Handset		APPENDIX G: Page 1 of 5

G.3 Main Antenna Verification Summary

**Table G-1
Power Measurement Verification for Main Antenna**

Mechanism(s)		Mode/Band	Device State Index		
1st	2nd		Un-triggered (Max)	Mechanism #1 (Reduced)	Mechanism #2 (Reduced)
Hotspot On		PCS CDMA	0	3	
Grip		PCS CDMA	0	1	
Hotspot On	Grip	PCS CDMA	0	3	3
Grip	Hotspot On	PCS CDMA	0	1	3
Hotspot On		GPRS 1900 1 Tx Slot	0	3	
Grip		GPRS 1900 1 Tx Slot	0	1	
Hotspot On	Grip	GPRS 1900 1 Tx Slot	0	3	3
Grip	Hotspot On	GPRS 1900 1 Tx Slot	0	1	3
Hotspot On		UMTS 1750	0	3	
Grip		UMTS 1750	0	1	
Hotspot On	Grip	UMTS 1750	0	3	3
Grip	Hotspot On	UMTS 1750	0	1	3
Hotspot On		UMTS 1900	0	3	
Grip		UMTS 1900	0	1	
Hotspot On	Grip	UMTS 1900	0	3	3
Grip	Hotspot On	UMTS 1900	0	1	3
Hotspot On		LTE FDD Band 66	0	3	
Grip		LTE FDD Band 66	0	1	
Hotspot On	Grip	LTE FDD Band 66	0	3	3
Grip	Hotspot On	LTE FDD Band 66	0	1	3
Hotspot On		LTE FDD Band 4	0	3	
Grip		LTE FDD Band 4	0	1	
Hotspot On	Grip	LTE FDD Band 4	0	3	3
Grip	Hotspot On	LTE FDD Band 4	0	1	3
Hotspot On		LTE FDD Band 25	0	3	
Grip		LTE FDD Band 25	0	1	
Hotspot On	Grip	LTE FDD Band 25	0	3	3
Grip	Hotspot On	LTE FDD Band 25	0	1	3
Hotspot On		LTE FDD Band 2	0	3	
Grip		LTE FDD Band 2	0	1	
Hotspot On	Grip	LTE FDD Band 2	0	3	3
Grip	Hotspot On	LTE FDD Band 2	0	1	3
Hotspot On		LTE FDD Band 30	0	3	
Grip		LTE FDD Band 30	0	1	
Hotspot On	Grip	LTE FDD Band 30	0	3	3
Grip	Hotspot On	LTE FDD Band 30	0	1	3
Hotspot On		LTE FDD Band 7	0	3	
Grip		LTE FDD Band 7	0	1	
Hotspot On	Grip	LTE FDD Band 7	0	3	3
Grip	Hotspot On	LTE FDD Band 7	0	1	3
Hotspot On		LTE TDD Band 38	0	3	
Grip		LTE TDD Band 38	0	1	
Hotspot On	Grip	LTE TDD Band 38	0	3	3
Grip	Hotspot On	LTE TDD Band 38	0	1	3
Hotspot On		LTE TDD Band 41 (PC3)	0	3	
Grip		LTE TDD Band 41 (PC3)	0	1	
Hotspot On	Grip	LTE TDD Band 41 (PC3)	0	3	3
Grip	Hotspot On	LTE TDD Band 41 (PC3)	0	1	3
Hotspot On		LTE TDD Band 41 (PC2)	0	3	
Grip		LTE TDD Band 41 (PC2)	0	1	
Hotspot On	Grip	LTE TDD Band 41 (PC2)	0	3	3
Grip	Hotspot On	LTE TDD Band 41 (PC2)	0	1	3
Held-to-Ear		LTE TDD Band 48	0	2	

Mechanism(s)		Mode/Band	Device State Index		
1st	2nd		Un-triggered (Max)	Mechanism #1 (Reduced)	Mechanism #2 (Reduced)
Hotspot On		NR Band n66	0	3	
Grip		NR Band n66	0	1	
Hotspot On	Grip	NR Band n66	0	3	3
Grip	Hotspot On	NR Band n66	0	1	3
Hotspot On		NR Band n2	0	3	
Grip		NR Band n2	0	1	
Hotspot On	Grip	NR Band n2	0	3	3
Grip	Hotspot On	NR Band n2	0	1	3

*Note: This device uses different Device State Indices (DSI) to configure different time averaged power levels based on certain exposure scenarios. For this device, DSI = 1 represents the case when the grip sensor is active, DSI = 2 represents the case where the device is held to ear, and DSI = 3 represents the case when hotspot mode is active. DSI = 0 is configured at max power when the device cannot detect the use condition.



FCC ID: A3LSMG988U	 SAR EVALUATION REPORT		Reviewed by: Quality Manager
Test Dates: 11/18/19 – 01/23/20	DUT Type: Portable Handset		APPENDIX G: Page 2 of 5

Table G-2
Power Measurement Verification for Main Antenna with NR Active



	Mechanism(s)		Mode/Band	Device State Index		
	1st	2nd		Un-triggered (Max)	Mechanism #1 (Reduced)	Mechanism #2 (Reduced)
mmWave Active	Hotspot On		LTE FDD Band 66	0	3	
	Grip			0	1	
	Hotspot On	Grip		0	3	3
	Grip	Hotspot On		0	1	3
	Hotspot On		LTE FDD Band 4	0	3	
	Grip			0	1	
	Hotspot On	Grip		0	3	3
	Grip	Hotspot On		0	1	3
	Hotspot On		LTE FDD Band 2	0	3	
	Grip			0	1	
	Hotspot On	Grip		0	3	3
	Grip	Hotspot On		0	1	3
	Hotspot On		LTE FDD Band 30 (n260 only)	0	3	
	Grip			0	1	
	Hotspot On	Grip		0	3	3
	Grip	Hotspot On		0	1	3

*Note: This device uses different Device State Indices (DSI) to configure different time averaged power levels based on certain exposure scenarios. For this device, DSI = 1 represents the case when the grip sensor is active and DSI = 3 represents the case when hotspot mode is active. DSI = 0 is configured at max power when the device cannot detect the use condition.

Table G-3
Distance Measurement Verification for Main Antenna

Mechanism(s)	Test Condition	Band	Distance Measurements (mm)		Minimum Distance per Manufacturer (mm)
			Moving Toward	Moving Away	
Grip	Phablet - Back Side	Mid	9	14	9
Grip	Phablet - Back Side	High	9	14	9
Grip	Phablet - Front Side	Mid	9	12	8
Grip	Phablet - Front Side	High	9	12	8
Grip	Phablet - Bottom Edge	Mid	13	16	13
Grip	Phablet - Bottom Edge	High	13	16	13

*Note: Mid band refers to: CDMA BC1, GSM1900, UMTS B2/4, LTE B2/4/25/66, NR n2/n66; High band refers to: LTE B7/30/38/41 PC3/41 PC2

FCC ID: A3LSMG988U	 SAR EVALUATION REPORT		Reviewed by: Quality Manager
Test Dates: 11/18/19 – 01/23/20	DUT Type: Portable Handset		APPENDIX G: Page 3 of 5

G.4 WIFI Verification Summary

**Table G-4
Power Measurement Verification WIFI – Antenna 1**



Mechanism(s)	Mode/Band	Conducted Power (dBm)	
		Un-triggered (Max)	Mechanism #1 (Reduced)
1st			
Held-to-Ear	802.11b	19.52	16.00
Held-to-Ear	802.11g	17.01	16.97
Held-to-Ear	802.11n (2.4GHz)	17.34	17.00
Held-to-Ear	802.11a	16.86	12.92
Held-to-Ear	802.11n (5GHz, 20MHz BW)	16.93	13.10
Held-to-Ear	802.11ac (20MHz BW)	16.51	12.31
Held-to-Ear	802.11n (5GHz, 40MHz BW)	15.95	12.04
Held-to-Ear	802.11ac (40MHz BW)	15.51	12.65
Held-to-Ear	802.11ac (80MHz BW)	14.51	12.45

*Note: MIMO and 802.11ax WIFI modes were not evaluated due to equipment limitations.

**Table G-5
Power Measurement Verification WIFI – Antenna 2**

Mechanism(s)	Mode/Band	Conducted Power (dBm)	
		Un-triggered (Max)	Mechanism #1 (Reduced)
1st			
Held-to-Ear	802.11b	20.93	15.86
Held-to-Ear	802.11g	18.48	16.77
Held-to-Ear	802.11n (2.4GHz)	18.50	17.00
Held-to-Ear	802.11a	17.54	12.98
Held-to-Ear	802.11n (5GHz, 20MHz BW)	17.50	13.48
Held-to-Ear	802.11ac (20MHz BW)	17.58	13.42
Held-to-Ear	802.11n (5GHz, 40MHz BW)	16.88	13.22
Held-to-Ear	802.11ac (40MHz BW)	16.54	13.18
Held-to-Ear	802.11ac (80MHz BW)	14.82	12.61

*Note: MIMO and 802.11ax WIFI modes were not evaluated due to equipment limitations.

FCC ID: A3LSMG988U	 SAR EVALUATION REPORT		Reviewed by: Quality Manager
Test Dates: 11/18/19 – 01/23/20	DUT Type: Portable Handset		APPENDIX G: Page 4 of 5

**Table G-6
Power Measurement Verification WIFI with NR Active – Antenna 1**



Mode/Band	Conducted Power (dBm)		
	Un-triggered (Max)	Mechanism #1 NR Active (Reduced)	Mechanism #2 RCV Active (Reduced)
802.11b	19.87	16.11	13.24
802.11g	17.92	16.42	13.16
802.11n (2.4GHz)	17.76	16.28	13.07
802.11a	17.21	12.77	12.65
802.11n (5GHz, 20MHz BW)	17.33	12.59	12.71
802.11ac (20MHz BW)	17.38	12.72	12.69
802.11n (5GHz, 40MHz BW)	16.33	12.89	12.78
802.11ac (40MHz BW)	16.21	12.7	12.91
802.11ac (80MHz BW)	15.11	12.69	12.72

*Note: MIMO and 802.11ax WIFI modes were not evaluated due to equipment limitations.

**Table G-7
Power Measurement Verification WIFI with NR Active – Antenna 2**

Mode/Band	Conducted Power (dBm)		
	Un-triggered (Max)	Mechanism #1 NR Active (Reduced)	Mechanism #2 RCV Active (Reduced)
802.11b	20.11	15.92	12.97
802.11g	17.69	16.02	13.05
802.11n (2.4GHz)	17.55	15.77	13.11
802.11a	17.65	13.21	13.1
802.11n (5GHz, 20MHz BW)	17.58	13.18	13.25
802.11ac (20MHz BW)	17.61	13.36	13.17
802.11n (5GHz, 40MHz BW)	16.71	13.24	13.32
802.11ac (40MHz BW)	16.66	13.1	13.24
802.11ac (80MHz BW)	15.7	13.29	13.52

*Note: MIMO and 802.11ax WIFI modes were not evaluated due to equipment limitations.

FCC ID: A3LSMG988U	 SAR EVALUATION REPORT		Reviewed by: Quality Manager
Test Dates: 11/18/19 – 01/23/20	DUT Type: Portable Handset		APPENDIX G: Page 5 of 5

APPENDIX H: IEEE 802.11AX RU SAR EXCLUSION

1.1 IEEE 802.11ax RU SAR Exclusion



To make the most efficient use of the additional available subcarriers (data tones), IEEE 802.11ax can utilize Orthogonal Frequency-Division Multiple Access (OFDMA) which divides the existing 802.11 channels into smaller subchannels called Resource Units (RUs). Possible RU sizes are: 26T, 52T, 106T, 242T, 484T and 996T.

Per April 2019 TCB Workshop Notes, 802.11ax was considered a higher order 802.11 mode when compared to a/b/g/n/ac to apply KDB Publication 248227 D01v02r02 for OFDM mode selection. Therefore, SAR tests were not required for 802.11ax based on the maximum allowed output powers of OFDM modes and the reported SAR values. Per FCC Guidance, maximum conducted powers were performed for each RU size to demonstrate that the output powers would not be higher than the other OFDM 802.11 modes.

1.2 IEEE 802.11ax RU Target Powers

1.2.1 Maximum 802.11ax RU WLAN Output Power

Tones		SISO (ANT1/2) /in dBm				MIMO (ALL) /in dBm			
		2.4GHz	5GHz/20MHz	5GHz/40MHz	5GHz/80MHz	2.4GHz	5GHz/20MHz	5GHz/40MHz	5GHz/80MHz
26T	Maximum	14	11	11	11	14	11	11	11
	Nominal	13	10	10	10	13	10	10	10
52T	Maximum	16	13	13	13	16	13	13	13
	Nominal	15	12	12	12	15	12	12	12
106T	Maximum	18	15	15	15	18	15	15	15
	Nominal	17	14	14	14	17	14	14	14
242T	Maximum	18 ch. 11: 16.0	18 ch. 36: 15 ch. 64: 14 ch. 100: 16.5	17	16	18 ch. 11: 16.0	18 ch. 36: 15 ch. 64: 14 ch. 100: 16.5	17	16
	Nominal	17 ch. 11: 15.0	17 ch. 36: 14.0 ch. 64: 13.0 ch. 100: 15.5	16	15	17 ch. 11: 15.0	17 ch. 36: 14.0 ch. 64: 13.0 ch. 100: 15.5	16	15
484T	Maximum			17 ch. 38: 12.5 ch. 62: 12.5 ch. 102: 13.5	16 ch. 42: 14.0 ch. 58: 14.0			17 ch. 38: 12.5 ch. 62: 12.5 ch. 102: 13.5	16 ch. 42: 14.0 ch. 58: 14.0
	Nominal			16 ch. 38: 11.5 ch. 62: 11.5 ch. 102: 12.5	15 ch. 42: 13.0 ch. 58: 13.0			16 ch. 38: 11.5 ch. 62: 11.5 ch. 102: 12.5	15 ch. 42: 13.0 ch. 58: 13.0
996T	Maximum				16 ch. 42: 12.5 ch. 58: 12.0 ch. 106: 12.5				16 ch. 42: 12.5 ch. 58: 12.0 ch. 106: 12.5
	Nominal				15 ch. 42: 11.5 ch. 58: 11.0 ch. 106: 11.5				15 ch. 42: 11.5 ch. 58: 11.0 ch. 106: 11.5



FCC ID: A3LSMG988U	 SAR EVALUATION REPORT		Reviewed by: Quality Manager
Test Dates: 11/18/19 – 01/23/20	DUT Type: Portable Handset		APPENDIX H: Page 1 of 9

1.2.2 Reduced 802.11ax RU WLAN Output Power

Applicable for conditions:

- RCV Active
- Simultaneous conditions with 2.4 GHz WLAN and 5 GHz WLAN
- Simultaneous conditions with 5G NR and 2.4 GHz WLAN and/or 5 GHz WLAN

Tones		SISO (ANT1/2) /in dBm				MIMO (ALL) /in dBm			
		2.4GHz	5GHz/20MHz	5GHz/40MHz	5GHz/80MHz	2.4GHz	5GHz/20MHz	5GHz/40MHz	5GHz/80MHz
26T	Maximum	14	11	11	11	14	11	11	11
	Nominal	13	10	10	10	13	10	10	10
52T	Maximum	16	13	13	13	16	13	13	13
	Nominal	15	12	12	12	15	12	12	12
106T	Maximum	17	14	14	14	18	15	15	15
	Nominal	16	13	13	13	17	14	14	14
242T	Maximum	17 ch. 11: 16.0	14	14	14	18 ch. 11: 16.0	17 ch. 36: 15 ch. 64: 14 ch.100 16.5	17	16
	Nominal	16 ch. 11: 15.0	13	13	13	17 ch. 11: 15.0	16 ch. 36: 14.0 ch. 64: 13.0 ch.100 15.5	16	15
484T	Maximum			14 ch. 38: 12.5 ch. 62: 12.5 ch.100: 13.5	14			17 ch. 38: 12.5 ch. 62: 12.5 ch.100: 13.5	16 ch. 42: 14.0 ch. 58: 14.0
	Nominal			13 ch. 38: 11.5 ch. 62: 11.5 ch.100: 12.5	13			16 ch. 38: 11.5 ch. 62: 11.5 ch.100: 12.5	15 ch. 42: 13.0 ch. 58: 13.0
996T	Maximum				14 ch. 42: 12.5 ch. 58: 12.0 ch. 106: 12.5				16 ch. 42: 12.5 ch. 58: 12.0 ch. 106: 12.5
	Nominal				13 ch. 42: 11.5 ch. 58: 11.0 ch. 106: 11.5				15 ch. 42: 11.5 ch. 58: 11.0 ch. 106: 11.5



FCC ID: A3LSMG988U	 SAR EVALUATION REPORT 	Reviewed by: Quality Manager
Test Dates: 11/18/19 – 01/23/20	DUT Type: Portable Handset	APPENDIX H: Page 2 of 9

1.2.3 Reduced 802.11ax RU WLAN Output Power

Applicable for conditions:

- RCV Active during simultaneous conditions with 2.4 GHz WLAN and 5 GHz WLAN
- RCV Active during simultaneous conditions with 5G NR and 2.4 GHz WLAN and/or 5 GHz WLAN

Tones		SISO (ANT1/2) /in dBm				MIMO (ALL) /in dBm			
		2.4GHz	5GHz/20MHz	5GHz/40MHz	5GHz/80MHz	2.4GHz	5GHz/20MHz	5GHz/40MHz	5GHz/80MHz
26T	Maximum	14	11	11	11	14	11	11	11
	Nominal	13	10	10	10	13	10	10	10
52T	Maximum	14	13	13	13	16	13	13	13
	Nominal	13	12	12	12	15	12	12	12
106T	Maximum	14	14	14	14	17	15	15	15
	Nominal	13	13	13	13	16	14	14	14
242T	Maximum	14	14	14	14	ch. 11: 16.0	ch. 36: 15 ch. 64: 14 ch.100 16.5		
	Nominal	13	13	13	13	ch. 11: 15.0	ch. 36: 14.0 ch. 64: 13.0 ch.100 15.5		
484T	Maximum			14 ch. 38: 12.5 ch. 62: 12.5 ch.100: 13.5	14			17 ch. 38: 12.5 ch. 62: 12.5 ch.100: 13.5	16 ch. 42: 14.0 ch. 58: 14.0
	Nominal			13 ch. 38: 11.5 ch. 62: 11.5 ch.100: 12.5	13			16 ch. 38: 11.5 ch. 62: 11.5 ch.100: 12.5	15 ch. 42: 13.0 ch. 58: 13.0
996T	Maximum				14 ch. 42: 12.5 ch. 58: 12.0 ch. 106: 12.5				16 ch. 42: 12.5 ch. 58: 12.0 ch. 106: 12.5
	Nominal				13 ch. 42: 11.5 ch. 58: 11.0 ch. 106: 11.5				15 ch. 42: 11.5 ch. 58: 11.0 ch. 106: 11.5

FCC ID: A3LSMG988U	 SAR EVALUATION REPORT		Reviewed by: Quality Manager
Test Dates: 11/18/19 – 01/23/20	DUT Type: Portable Handset		APPENDIX H: Page 3 of 9

1.3 IEEE 802.11ax Measured Powers

Table 1
Maximum 2.4 GHz 802.11ax RU Output Power – Ant 1

Freq [MHz]	Channel	Tones	RU Index	Avg Conducted Powers (dBm)	Freq [MHz]	Channel	Tones	RU Index	Avg Conducted Powers (dBm)
2412	1	26T	0	13.01	2412	1	52T	37	15.78
			4	13.97				38	15.14
			8	13.70				40	15.03
2437	6	26T	0	13.51	2437	6	52T	37	15.01
			4	13.48				38	15.49
			8	13.52				40	15.03
2462	11	26T	0	13.50	2462	11	52T	37	14.69
			4	13.29				38	15.19
			8	13.66				40	15.02

Freq [MHz]	Channel	Tones	RU Index	Avg Conducted Powers (dBm)	Freq [MHz]	Channel	Tones	RU Index	Avg Conducted Powers (dBm)
2412	1	106T	53	17.69	2412	1	242T	61	17.60
			54	17.98					
2437	6	106T	53	16.69	2437	6	242T	61	16.64
			54	16.72					
2462	11	106T	53	17.94	2462	11	242T	61	15.93
			54	17.99					



FCC ID: A3LSMG988U	 SAR EVALUATION REPORT		Reviewed by: Quality Manager
Test Dates: 11/18/19 – 01/23/20	DUT Type: Portable Handset		APPENDIX H: Page 4 of 9

Table 2
Maximum 2.4 GHz 802.11ax RU Output Power – Ant 2

Freq [MHz]	Channel	Tones	RU Index	Avg Conducted Powers (dBm)	Freq [MHz]	Channel	Tones	RU Index	Avg Conducted Powers (dBm)
2412	1	26T	0	13.01	2412	1	52T	37	15.17
			4	13.19				38	15.34
			8	13.35				40	15.29
2437	6	26T	0	13.59	2437	6	52T	37	15.86
			4	13.14				38	15.98
			8	13.39				40	15.36
2462	11	26T	0	13.07	2462	11	52T	37	15.01
			4	13.87				38	15.43
			8	13.61				40	15.22
Freq [MHz]	Channel	Tones	RU Index	Avg Conducted Powers (dBm)					
2412	1	106T	53	17.33	Freq [MHz]	Channel	Tones	RU Index	Avg Conducted Powers (dBm)
			54	17.07	2412	1	242T	61	17.02
2437	6	106T	53	17.65					
			54	17.31	2462	11	242T	61	15.91
2462	11	106T	53	17.77					
			54	17.25					



FCC ID: A3LSMG988U	 SAR EVALUATION REPORT		Reviewed by: Quality Manager
Test Dates: 11/18/19 – 01/23/20	DUT Type: Portable Handset	APPENDIX H: Page 5 of 9	



Table 3
Maximum 5 GHz 802.11ax RU Output Power – Ant 1

20MHz BW	Band	Freq [MHz]	Channel	Tones	Avg Conducted Power (dBm)			20MHz BW	Band	Freq [MHz]	Channel	Tones	Avg Conducted Power (dBm)		
					RU Index								RU Index		
					0	4	8						37	39	40
1	1	5180	36	26T	10.40	10.77	10.69	1	1	5180	36	52T	12.33	12.65	12.64
		5200	40	26T	10.42	10.77	10.69			5200	40	52T	12.50	12.77	12.68
		5240	48	26T	10.54	10.90	10.92			5240	48	52T	12.55	12.86	12.88
2A	2A	5260	52	26T	10.62	10.89	10.65	2A	2A	5260	52	52T	12.52	12.87	12.67
		5280	56	26T	10.61	10.89	10.82			5280	56	52T	12.67	12.97	12.83
		5320	64	26T	10.73	10.98	10.68			5320	64	52T	12.84	12.02	12.89
2C	2C	5500	100	26T	10.84	10.15	10.89	2C	2C	5500	100	52T	12.87	12.06	12.88
		5600	120	26T	10.91	10.39	10.88			5600	120	52T	12.99	12.17	12.92
		5720	144	26T	10.88	10.24	10.86			5720	144	52T	12.82	12.97	12.84
3	3	5745	149	26T	10.58	10.73	10.48	3	3	5745	149	52T	12.45	12.51	12.23
		5785	157	26T	10.41	10.74	10.44			5785	157	52T	12.22	12.56	12.28
		5825	165	26T	10.03	10.25	10.02			5825	165	52T	12.76	12.97	12.89

20MHz BW	Band	Freq [MHz]	Channel	Tones	Avg Conducted Power (dBm)		20MHz BW	Band	Freq [MHz]	Channel	Tones	Avg Conducted Power (dBm)
					RU Index							RU Index
					53	54						61
1	1	5180	36	106T	14.56	14.68	1	1	5180	36	242T	14.75
		5200	40	106T	14.71	14.78			5200	40	242T	17.63
		5240	48	106T	14.75	14.91			5240	48	242T	17.74
2A	2A	5260	52	106T	14.72	14.73	2A	2A	5260	52	242T	17.37
		5280	56	106T	14.69	14.86			5280	56	242T	17.47
		5320	64	106T	14.92	14.89			5320	64	242T	13.42
2C	2C	5500	100	106T	14.82	14.70	2C	2C	5500	100	242T	16.46
		5600	120	106T	14.72	14.78			5600	120	242T	17.19
		5720	144	106T	14.62	14.64			5720	144	242T	17.07
3	3	5745	149	106T	14.58	14.44	3	3	5745	149	242T	17.20
		5785	157	106T	14.45	14.42			5785	157	242T	17.08
		5825	165	106T	14.92	14.94			5825	165	242T	17.87

40MHz BW	Band	Freq [MHz]	Channel	Tones	Avg Conducted Power (dBm)			40MHz BW	Band	Freq [MHz]	Channel	Tones	Avg Conducted Power (dBm)		
					RU Index								RU Index		
					0	8	17						37	40	44
1	1	5190	38	26T	10.05	10.39	10.16	1	1	5190	38	52T	12.06	12.22	12.28
		5230	46	26T	10.14	10.40	10.27			5230	46	52T	12.17	12.24	12.31
2A	2A	5270	54	26T	10.09	10.18	10.11	2A	2A	5270	54	52T	12.32	12.23	12.37
		5310	62	26T	10.17	10.30	10.12			5310	62	52T	12.34	12.29	12.34
2C	2C	5510	102	26T	10.33	10.57	10.63	2C	2C	5510	102	52T	12.47	12.34	12.74
		5590	118	26T	10.37	10.61	10.46			5590	118	52T	12.50	12.31	12.56
		5710	142	26T	10.47	10.61	10.41			5710	142	52T	12.48	12.40	12.40
3	3	5755	151	26T	10.21	10.26	10.26	3	3	5755	151	52T	12.17	12.98	12.18
		5795	159	26T	10.48	10.98	10.34			5795	159	52T	12.48	12.75	12.44

40MHz BW	Band	Freq [MHz]	Channel	Tones	Avg Conducted Power (dBm)			40MHz BW	Band	Freq [MHz]	Channel	Tones	Avg Conducted Power (dBm)	
					RU Index								RU Index	
					53	54	56						61	62
1	1	5190	38	106T	14.30	14.25	14.43	1	1	5190	38	242T	16.44	16.47
		5230	46	106T	14.38	14.23	14.47			5230	46	242T	16.63	16.55
2A	2A	5270	54	106T	14.43	14.05	14.38	2A	2A	5270	54	242T	16.44	16.52
		5310	62	106T	14.44	14.10	14.32			5310	62	242T	16.41	16.45
2C	2C	5510	102	106T	14.29	14.17	14.67	2C	2C	5510	102	242T	16.38	16.53
		5590	118	106T	14.35	14.17	14.42			5590	118	242T	16.32	16.34
		5710	142	106T	14.36	14.07	14.36			5710	142	242T	16.23	16.25
3	3	5755	151	106T	14.24	14.79	14.23	3	3	5755	151	242T	16.46	16.46
		5795	159	106T	14.76	14.62	14.71			5795	159	242T	16.01	16.11

FCC ID: A3LSMG988U	 SAR EVALUATION REPORT		Reviewed by: Quality Manager
Test Dates: 11/18/19 – 01/23/20	DUT Type: Portable Handset		APPENDIX H: Page 6 of 9

40MHz BW	Band	Freq [MHz]	Channel	Tones	Avg Conducted	80MHz BW	Band	Freq [MHz]	Channel	Tones	Avg Conducted Power (dBm)		
					RU Index						RU Index		
					65						0	18	36
1	5190	38	484T	12.03	1	5210	42	26T	10.85	10.70	10.91		
	5230	46	484T	16.40		5290	58	26T	10.72	10.48	10.82		
2A	5270	54	484T	16.29		2C	5530	106	26T	10.23	10.99	10.27	
	5310	62	484T	12.14			5610	122	26T	10.15	10.86	10.14	
5510	102	484T	13.22	5690			138	26T	10.24	10.91	10.20		
2C	5590	118	484T	16.29		3	5775	155	26T	10.90	10.47	10.63	
	5710	142	484T	16.30									
3	5755	151	484T	16.20									
	5795	159	484T	16.94									

80MHz BW	Band	Freq [MHz]	Channel	Tones	Avg Conducted Power (dBm)		
					RU Index		
					37	44	52
1	5210	42	52T	12.96	12.38	12.03	
	5290	58	52T	12.76	12.47	12.89	
2C	5530	106	52T	12.30	12.57	12.29	
	5610	122	52T	12.24	12.50	12.24	
	5690	138	52T	12.25	12.62	12.13	
3	5775	155	52T	12.71	12.26	12.53	

80MHz BW	Band	Freq [MHz]	Channel	Tones	Avg Conducted Power (dBm)		
					RU Index		
					53	56	60
1	5210	42	106T	14.87	14.34	14.96	
	5290	58	106T	14.84	14.28	14.87	
2C	5530	106	106T	14.07	14.25	14.03	
	5610	122	106T	14.01	14.24	14.01	
	5690	138	106T	14.99	14.21	14.92	
3	5775	155	106T	14.91	14.18	14.71	

80MHz BW	Band	Freq [MHz]	Channel	Tones	Avg Conducted Power (dBm)		
					RU Index		
					61	62	64
1	5210	42	242T	15.98	15.51	15.21	
	5290	58	242T	15.09	15.46	15.16	
2C	5530	106	242T	15.33	15.53	15.30	
	5610	122	242T	15.20	15.30	15.24	
	5690	138	242T	15.25	15.32	15.18	
3	5775	155	242T	15.13	15.16	15.85	

80MHz BW	Band	Freq [MHz]	Channel	Tones	Avg Conducted Power (dBm)		80MHz BW	Band	Freq [MHz]	Channel	Tones	Avg Conducted
					RU Index							RU Index
					65	66						67
1	5210	42	484T	13.73	13.91	1	5210	42	996T	11.96		
	5290	58	484T	13.79	13.94		5290	58	996T	11.97		
2C	5530	106	484T	15.13	15.21		2C	5530	106	996T	12.21	
	5610	122	484T	15.88	15.98			5610	122	996T	15.81	
	5690	138	484T	15.98	15.91			5690	138	996T	15.80	
3	5775	155	484T	15.81	15.78		3	5775	155	996T	15.66	



FCC ID: A3LSMG988U	 SAR EVALUATION REPORT		Reviewed by: Quality Manager
Test Dates: 11/18/19 – 01/23/20	DUT Type: Portable Handset	APPENDIX H: Page 7 of 9	



Table 4
Maximum 5 GHz 802.11ax RU Output Power – Ant 2

20MHz BW	Band	Freq [MHz]	Channel	Tones	Avg Conducted Power (dBm)			20MHz BW	Band	Freq [MHz]	Channel	Tones	Avg Conducted Power (dBm)		
					RU Index								RU Index		
					0	4	8						37	39	40
20MHz BW	1	5180	36	26T	10.66	10.96	10.99	20MHz BW	1	5180	36	52T	12.59	12.83	12.71
		5200	40	26T	10.78	10.94	10.87			5200	40	52T	12.65	12.81	12.70
		5240	48	26T	10.86	10.23	10.97			5240	48	52T	12.67	12.88	12.83
	2A	5260	52	26T	10.54	10.78	10.65		2A	5260	52	52T	12.47	12.71	12.68
		5280	56	26T	10.57	10.89	10.66			5280	56	52T	12.48	12.80	12.70
		5320	64	26T	10.65	10.92	10.87			5320	64	52T	12.69	12.87	12.72
	2C	5500	100	26T	10.57	10.67	10.45		2C	5500	100	52T	12.45	12.64	12.40
		5600	120	26T	10.77	10.95	10.68			5600	120	52T	12.82	12.74	12.65
		5720	144	26T	10.99	10.16	10.94			5720	144	52T	12.95	12.94	12.82
	3	5745	149	26T	10.46	10.62	10.24		3	5745	149	52T	12.20	12.27	12.09
		5785	157	26T	10.42	10.67	10.34			5785	157	52T	12.32	12.42	12.12
		5825	165	26T	10.20	10.49	10.15			5825	165	52T	12.11	12.16	12.02

20MHz BW	Band	Freq [MHz]	Channel	Tones	Avg Conducted Power (dBm)		20MHz BW	Band	Freq [MHz]	Channel	Tones	Avg Conducted Power (dBm)	
					RU Index							RU Index	
					53	54						61	61
20MHz BW	1	5180	36	106T	14.58	14.70	20MHz BW	1	5180	36	242T	14.96	14.96
		5200	40	106T	14.61	14.78			5200	40	242T	17.56	17.56
		5240	48	106T	14.81	14.80			5240	48	242T	17.55	17.55
	2A	5260	52	106T	14.51	14.58		2A	5260	52	242T	17.42	17.42
		5280	56	106T	14.65	14.73			5280	56	242T	17.50	17.50
		5320	64	106T	14.66	14.73			5320	64	242T	13.41	13.41
	2C	5500	100	106T	14.60	14.47		2C	5500	100	242T	16.04	16.04
		5600	120	106T	14.73	14.65			5600	120	242T	17.43	17.43
		5720	144	106T	14.84	14.78			5720	144	242T	17.55	17.55
	3	5745	149	106T	14.19	14.97		3	5745	149	242T	17.66	17.66
		5785	157	106T	14.15	14.05			5785	157	242T	17.89	17.89
		5825	165	106T	14.95	14.84			5825	165	242T	17.68	17.68

40MHz BW	Band	Freq [MHz]	Channel	Tones	Avg Conducted Power (dBm)			40MHz BW	Band	Freq [MHz]	Channel	Tones	Avg Conducted Power (dBm)		
					RU Index								RU Index		
					0	8	17						37	40	44
40MHz BW	1	5190	38	26T	10.05	10.14	10.03	40MHz BW	1	5190	38	52T	12.06	12.16	12.18
		5230	46	26T	10.08	10.38	10.27			5230	46	52T	12.23	12.30	12.32
	2A	5270	54	26T	10.84	10.95	10.92		2A	5270	54	52T	12.02	12.84	12.01
		5310	62	26T	10.93	10.91	10.80			5310	62	52T	12.08	12.97	12.07
	2C	5510	102	26T	10.88	10.73	10.93		2C	5510	102	52T	12.06	12.82	12.10
		5590	118	26T	10.93	10.83	10.70			5590	118	52T	12.07	12.73	12.02
	3	5710	142	26T	10.30	10.14	10.26		3	5710	142	52T	12.34	12.98	12.33
		5755	151	26T	10.77	10.61	10.78			5755	151	52T	12.93	12.60	12.80
		5795	159	26T	10.32	10.71	10.24			5795	159	52T	12.38	12.61	12.40

40MHz BW	Band	Freq [MHz]	Channel	Tones	Avg Conducted Power (dBm)			40MHz BW	Band	Freq [MHz]	Channel	Tones	Avg Conducted Power (dBm)	
					RU Index								RU Index	
					53	54	56						61	62
40MHz BW	1	5190	38	106T	14.30	14.20	14.41	40MHz BW	1	5190	38	242T	16.57	16.59
		5230	46	106T	14.48	14.28	14.55			5230	46	242T	16.61	16.60
	2A	5270	54	106T	14.28	14.87	14.27		2A	5270	54	242T	16.37	16.43
		5310	62	106T	14.38	14.95	14.31			5310	62	242T	16.66	16.44
	2C	5510	102	106T	14.25	14.71	14.25		2C	5510	102	242T	16.14	16.35
		5590	118	106T	14.26	14.67	14.80			5590	118	242T	16.12	16.29
	3	5710	142	106T	14.54	14.93	14.56		3	5710	142	242T	16.43	16.47
		5755	151	106T	14.96	14.30	14.90			5755	151	242T	16.66	16.93
		5795	159	106T	14.61	14.22	14.64			5795	159	242T	16.56	16.65

FCC ID: A3LSMG988U	 SAR EVALUATION REPORT		Reviewed by: Quality Manager
Test Dates: 11/18/19 – 01/23/20	DUT Type: Portable Handset		APPENDIX H: Page 8 of 9



40MHz BW	Band	Freq [MHz]	Channel	Tones	Avg Conducted	80MHz BW	Band	Freq [MHz]	Channel	Tones	Avg Conducted Power (dBm)		
					RU Index						RU Index		
					65						0	18	36
					1						5190	38	484T
	5230	46	484T	16.57									
2A	5270	54	484T	16.43	2A	5290	58	26T	10.71	10.47	10.85		
	5310	62	484T	12.16									
2C	5510	102	484T	13.24	2C	5530	106	26T	10.94	10.35	10.79		
	5590	118	484T	16.14									
	5710	142	484T	16.30									
3	5755	151	484T	16.70	3	5690	138	26T	10.98	10.60	10.90		
	5795	159	484T	16.57			5775	155	26T	10.56	10.32	10.57	

80MHz BW	Band	Freq [MHz]	Channel	Tones	Avg Conducted Power (dBm)		
					RU Index		
					37	44	52
					1	5210	42
2A	5290	58	52T	12.94	12.38	12.97	
2C	5530	106	52T	12.91	12.17	12.78	
	5610	122	52T	12.82	12.14	12.81	
	5690	138	52T	12.98	12.33	12.92	
3	5775	155	52T	12.69	12.86	12.57	

80MHz BW	Band	Freq [MHz]	Channel	Tones	Avg Conducted Power (dBm)		
					RU Index		
					53	56	60
					1	5210	42
2A	5290	58	106T	14.03	14.43	14.11	
2C	5530	106	106T	14.04	14.24	14.04	
	5610	122	106T	14.15	14.27	14.12	
	5690	138	106T	14.31	14.41	14.19	
3	5775	155	106T	14.67	14.88	14.77	

80MHz BW	Band	Freq [MHz]	Channel	Tones	Avg Conducted Power (dBm)		
					RU Index		
					61	62	64
					1	5210	42
2A	5290	58	242T	15.38	15.63	15.35	
2C	5530	106	242T	15.12	15.45	15.08	
	5610	122	242T	15.13	15.43	15.20	
	5690	138	242T	15.26	15.53	15.38	
3	5775	155	242T	15.64	15.98	15.77	

80MHz BW	Band	Freq [MHz]	Channel	Tones	Avg Conducted Power (dBm)		80MHz BW	Band	Freq [MHz]	Channel	Tones	Avg Conducted
					RU Index							RU Index
					65	66						67
					1	5210						42
2A	5290	58	484T	13.83	13.96	2A	5290	58	996T	11.98		
2C	5530	106	484T	15.10	15.25	2C	5530	106	996T	12.23		
	5610	122	484T	15.04	15.21			5610	122	996T	15.42	
	5690	138	484T	15.23	15.37			5690	138	996T	15.50	
3	5775	155	484T	15.68	15.86	3	5775	155	996T	15.92		

FCC ID: A3LSMG988U	 SAR EVALUATION REPORT		Reviewed by: Quality Manager
Test Dates: 11/18/19 – 01/23/20	DUT Type: Portable Handset		APPENDIX H: Page 9 of 9

APPENDIX I: PROBE CALIBRATION



Accredited by the Swiss Accreditation Service (SAS)
The Swiss Accreditation Service is one of the signatories to the EA
Multilateral Agreement for the recognition of calibration certificates

Accreditation No.: SCS 0108

Client **PC Test**

Certificate No: **D5GHzV2-1191_Sep19**

CALIBRATION CERTIFICATE

Object **D5GHzV2 - SN:1191**

Calibration procedure(s) **QA CAL-22.v4
Calibration Procedure for SAR Validation Sources between 3-6 GHz**

*BN ✓
09/26/2019*

Calibration date: **September 17, 2019**

This calibration certificate documents the traceability to national standards, which realize the physical units of measurements (SI).
The measurements and the uncertainties with confidence probability are given on the following pages and are part of the certificate.

All calibrations have been conducted in the closed laboratory facility: environment temperature (22 ± 3)°C and humidity < 70%.

Calibration Equipment used (M&TE critical for calibration)

Primary Standards	ID #	Cal Date (Certificate No.)	Scheduled Calibration
Power meter NRP	SN: 104778	03-Apr-19 (No. 217-02892/02893)	Apr-20
Power sensor NRP-Z91	SN: 103244	03-Apr-19 (No. 217-02892)	Apr-20
Power sensor NRP-Z91	SN: 103245	03-Apr-19 (No. 217-02893)	Apr-20
Reference 20 dB Attenuator	SN: 5058 (20k)	04-Apr-19 (No. 217-02894)	Apr-20
Type-N mismatch combination	SN: 5047.2 / 06327	04-Apr-19 (No. 217-02895)	Apr-20
Reference Probe EX3DV4	SN: 3503	25-Mar-19 (No. EX3-3503_Mar19)	Mar-20
DAE4	SN: 601	30-Apr-19 (No. DAE4-601_Apr19)	Apr-20

Secondary Standards	ID #	Check Date (in house)	Scheduled Check
Power meter E4419B	SN: GB39512475	30-Oct-14 (in house check Feb-19)	In house check: Oct-20
Power sensor HP 8481A	SN: US37292783	07-Oct-15 (in house check Oct-18)	In house check: Oct-20
Power sensor HP 8481A	SN: MY41092317	07-Oct-15 (in house check Oct-18)	In house check: Oct-20
RF generator R&S SMT-06	SN: 100972	15-Jun-15 (in house check Oct-18)	In house check: Oct-20
Network Analyzer Agilent E8358A	SN: US41080477	31-Mar-14 (in house check Oct-18)	In house check: Oct-19

	Name	Function	Signature
Calibrated by:	Manu Seitz	Laboratory Technician	
Approved by:	Katja Pokovic	Technical Manager	

Issued: September 18, 2019

This calibration certificate shall not be reproduced except in full without written approval of the laboratory.



Accredited by the Swiss Accreditation Service (SAS)
The Swiss Accreditation Service is one of the signatories to the EA
Multilateral Agreement for the recognition of calibration certificates

Accreditation No.: **SCS 0108**

Glossary:

TSL	tissue simulating liquid
ConvF	sensitivity in TSL / NORM x,y,z
N/A	not applicable or not measured

Calibration is Performed According to the Following Standards:

- a) IEEE Std 1528-2013, "IEEE Recommended Practice for Determining the Peak Spatial-Averaged Specific Absorption Rate (SAR) in the Human Head from Wireless Communications Devices: Measurement Techniques", June 2013
- b) IEC 62209-1, "Measurement procedure for the assessment of Specific Absorption Rate (SAR) from hand-held and body-mounted devices used next to the ear (frequency range of 300 MHz to 6 GHz)", July 2016
- c) IEC 62209-2, "Procedure to determine the Specific Absorption Rate (SAR) for wireless communication devices used in close proximity to the human body (frequency range of 30 MHz to 6 GHz)", March 2010
- d) KDB 865664, "SAR Measurement Requirements for 100 MHz to 6 GHz"

Additional Documentation:

- e) DASY4/5 System Handbook

Methods Applied and Interpretation of Parameters:

- *Measurement Conditions:* Further details are available from the Validation Report at the end of the certificate. All figures stated in the certificate are valid at the frequency indicated.
- *Antenna Parameters with TSL:* The dipole is mounted with the spacer to position its feed point exactly below the center marking of the flat phantom section, with the arms oriented parallel to the body axis.
- *Feed Point Impedance and Return Loss:* These parameters are measured with the dipole positioned under the liquid filled phantom. The impedance stated is transformed from the measurement at the SMA connector to the feed point. The Return Loss ensures low reflected power. No uncertainty required.
- *Electrical Delay:* One-way delay between the SMA connector and the antenna feed point. No uncertainty required.
- *SAR measured:* SAR measured at the stated antenna input power.
- *SAR normalized:* SAR as measured, normalized to an input power of 1 W at the antenna connector.
- *SAR for nominal TSL parameters:* The measured TSL parameters are used to calculate the nominal SAR result.

The reported uncertainty of measurement is stated as the standard uncertainty of measurement multiplied by the coverage factor $k=2$, which for a normal distribution corresponds to a coverage probability of approximately 95%.

Measurement Conditions

DASY system configuration, as far as not given on page 1.

DASY Version	DASY5	V52.10.2
Extrapolation	Advanced Extrapolation	
Phantom	Modular Flat Phantom V5.0	
Distance Dipole Center - TSL	10 mm	with Spacer
Zoom Scan Resolution	dx, dy = 4.0 mm, dz = 1.4 mm	Graded Ratio = 1.4 (Z direction)
Frequency	5200 MHz ± 1 MHz 5250 MHz ± 1 MHz 5600 MHz ± 1 MHz 5750 MHz ± 1 MHz 5800 MHz ± 1 MHz	

Head TSL parameters at 5250 MHz

The following parameters and calculations were applied.

	Temperature	Permittivity	Conductivity
Nominal Head TSL parameters	22.0 °C	35.9	4.71 mho/m
Measured Head TSL parameters	(22.0 ± 0.2) °C	35.1 ± 6 %	4.53 mho/m ± 6 %
Head TSL temperature change during test	< 0.5 °C	----	----

SAR result with Head TSL at 5250 MHz

SAR averaged over 1 cm³ (1 g) of Head TSL	Condition	
SAR measured	100 mW input power	8.13 W/kg
SAR for nominal Head TSL parameters	normalized to 1W	80.8 W/kg ± 19.9 % (k=2)

SAR averaged over 10 cm³ (10 g) of Head TSL	condition	
SAR measured	100 mW input power	2.32 W/kg
SAR for nominal Head TSL parameters	normalized to 1W	23.0 W/kg ± 19.5 % (k=2)

Head TSL parameters at 5600 MHz

The following parameters and calculations were applied.

	Temperature	Permittivity	Conductivity
Nominal Head TSL parameters	22.0 °C	35.5	5.07 mho/m
Measured Head TSL parameters	(22.0 ± 0.2) °C	34.6 ± 6 %	4.88 mho/m ± 6 %
Head TSL temperature change during test	< 0.5 °C	----	----

SAR result with Head TSL at 5600 MHz

SAR averaged over 1 cm ³ (1 g) of Head TSL	Condition	
SAR measured	100 mW input power	8.33 W/kg
SAR for nominal Head TSL parameters	normalized to 1W	82.7 W/kg ± 19.9 % (k=2)

SAR averaged over 10 cm ³ (10 g) of Head TSL	condition	
SAR measured	100 mW input power	2.36 W/kg
SAR for nominal Head TSL parameters	normalized to 1W	23.4 W/kg ± 19.5 % (k=2)

Head TSL parameters at 5750 MHz

The following parameters and calculations were applied.

	Temperature	Permittivity	Conductivity
Nominal Head TSL parameters	22.0 °C	35.4	5.22 mho/m
Measured Head TSL parameters	(22.0 ± 0.2) °C	34.4 ± 6 %	5.03 mho/m ± 6 %
Head TSL temperature change during test	< 0.5 °C	----	----

SAR result with Head TSL at 5750 MHz

SAR averaged over 1 cm ³ (1 g) of Head TSL	Condition	
SAR measured	100 mW input power	8.08 W/kg
SAR for nominal Head TSL parameters	normalized to 1W	80.2 W/kg ± 19.9 % (k=2)

SAR averaged over 10 cm ³ (10 g) of Head TSL	condition	
SAR measured	100 mW input power	2.29 W/kg
SAR for nominal Head TSL parameters	normalized to 1W	22.7 W/kg ± 19.5 % (k=2)

Body TSL parameters at 5200 MHz

The following parameters and calculations were applied.

	Temperature	Permittivity	Conductivity
Nominal Body TSL parameters	22.0 °C	49.0	5.30 mho/m
Measured Body TSL parameters	(22.0 ± 0.2) °C	46.9 ± 6 %	5.44 mho/m ± 6 %
Body TSL temperature change during test	< 0.5 °C	----	----

SAR result with Body TSL at 5200 MHz

SAR averaged over 1 cm ³ (1 g) of Body TSL	Condition	
SAR measured	100 mW input power	7.55 W/kg
SAR for nominal Body TSL parameters	normalized to 1W	74.9 W/kg ± 19.9 % (k=2)

SAR averaged over 10 cm ³ (10 g) of Body TSL	condition	
SAR measured	100 mW input power	2.11 W/kg
SAR for nominal Body TSL parameters	normalized to 1W	20.9 W/kg ± 19.5 % (k=2)

Body TSL parameters at 5250 MHz

The following parameters and calculations were applied.

	Temperature	Permittivity	Conductivity
Nominal Body TSL parameters	22.0 °C	48.9	5.36 mho/m
Measured Body TSL parameters	(22.0 ± 0.2) °C	46.9 ± 6 %	5.51 mho/m ± 6 %
Body TSL temperature change during test	< 0.5 °C	----	----

SAR result with Body TSL at 5250 MHz

SAR averaged over 1 cm ³ (1 g) of Body TSL	Condition	
SAR measured	100 mW input power	7.76 W/kg
SAR for nominal Body TSL parameters	normalized to 1W	77.0 W/kg ± 19.9 % (k=2)

SAR averaged over 10 cm ³ (10 g) of Body TSL	condition	
SAR measured	100 mW input power	2.16 W/kg
SAR for nominal Body TSL parameters	normalized to 1W	21.4 W/kg ± 19.5 % (k=2)

Body TSL parameters at 5600 MHz

The following parameters and calculations were applied.

	Temperature	Permittivity	Conductivity
Nominal Body TSL parameters	22.0 °C	48.5	5.77 mho/m
Measured Body TSL parameters	(22.0 ± 0.2) °C	46.2 ± 6 %	5.98 mho/m ± 6 %
Body TSL temperature change during test	< 0.5 °C	----	----

SAR result with Body TSL at 5600 MHz

SAR averaged over 1 cm ³ (1 g) of Body TSL	Condition	
SAR measured	100 mW input power	7.93 W/kg
SAR for nominal Body TSL parameters	normalized to 1W	78.6 W/kg ± 19.9 % (k=2)

SAR averaged over 10 cm ³ (10 g) of Body TSL	condition	
SAR measured	100 mW input power	2.22 W/kg
SAR for nominal Body TSL parameters	normalized to 1W	21.9 W/kg ± 19.5 % (k=2)

Body TSL parameters at 5750 MHz

The following parameters and calculations were applied.

	Temperature	Permittivity	Conductivity
Nominal Body TSL parameters	22.0 °C	48.3	5.94 mho/m
Measured Body TSL parameters	(22.0 ± 0.2) °C	46.0 ± 6 %	6.19 mho/m ± 6 %
Body TSL temperature change during test	< 0.5 °C	----	----

SAR result with Body TSL at 5750 MHz

SAR averaged over 1 cm ³ (1 g) of Body TSL	Condition	
SAR measured	100 mW input power	7.75 W/kg
SAR for nominal Body TSL parameters	normalized to 1W	76.9 W/kg ± 19.9 % (k=2)

SAR averaged over 10 cm ³ (10 g) of Body TSL	condition	
SAR measured	100 mW input power	2.15 W/kg
SAR for nominal Body TSL parameters	normalized to 1W	21.3 W/kg ± 19.5 % (k=2)

Body TSL parameters at 5800 MHz

The following parameters and calculations were applied.

	Temperature	Permittivity	Conductivity
Nominal Body TSL parameters	22.0 °C	48.2	6.00 mho/m
Measured Body TSL parameters	(22.0 ± 0.2) °C	45.9 ± 6 %	6.26 mho/m ± 6 %
Body TSL temperature change during test	< 0.5 °C	----	----

SAR result with Body TSL at 5800 MHz

SAR averaged over 1 cm ³ (1 g) of Body TSL	Condition	
SAR measured	100 mW input power	7.66 W/kg
SAR for nominal Body TSL parameters	normalized to 1W	76.0 W/kg ± 19.9 % (k=2)

SAR averaged over 10 cm ³ (10 g) of Body TSL	condition	
SAR measured	100 mW input power	2.12 W/kg
SAR for nominal Body TSL parameters	normalized to 1W	21.0 W/kg ± 19.5 % (k=2)

Appendix (Additional assessments outside the scope of SCS 0108)

Antenna Parameters with Head TSL at 5250 MHz

Impedance, transformed to feed point	53.5 Ω - 6.2 j Ω
Return Loss	- 23.2 dB

Antenna Parameters with Head TSL at 5600 MHz

Impedance, transformed to feed point	56.4 Ω - 4.3 j Ω
Return Loss	- 22.8 dB

Antenna Parameters with Head TSL at 5750 MHz

Impedance, transformed to feed point	59.1 Ω + 1.9 j Ω
Return Loss	- 21.4 dB

Antenna Parameters with Body TSL at 5200 MHz

Impedance, transformed to feed point	50.9 Ω - 8.6 j Ω
Return Loss	- 21.3 dB

Antenna Parameters with Body TSL at 5250 MHz

Impedance, transformed to feed point	53.2 Ω - 4.1 j Ω
Return Loss	- 26.0 dB

Antenna Parameters with Body TSL at 5600 MHz

Impedance, transformed to feed point	58.1 Ω - 4.2 j Ω
Return Loss	- 21.4 dB

Antenna Parameters with Body TSL at 5750 MHz

Impedance, transformed to feed point	60.3 Ω + 2.3 j Ω
Return Loss	- 20.4 dB

Antenna Parameters with Body TSL at 5800 MHz

Impedance, transformed to feed point	57.5 Ω + 2.3 j Ω
Return Loss	- 22.7 dB

General Antenna Parameters and Design

Electrical Delay (one direction)	1.202 ns
----------------------------------	----------

After long term use with 100W radiated power, only a slight warming of the dipole near the feedpoint can be measured.

The dipole is made of standard semirigid coaxial cable. The center conductor of the feeding line is directly connected to the second arm of the dipole. The antenna is therefore short-circuited for DC-signals. On some of the dipoles, small end caps are added to the dipole arms in order to improve matching when loaded according to the position as explained in the "Measurement Conditions" paragraph. The SAR data are not affected by this change. The overall dipole length is still according to the Standard.

No excessive force must be applied to the dipole arms, because they might bend or the soldered connections near the feedpoint may be damaged.

Additional EUT Data

Manufactured by	SPEAG
-----------------	-------

Appendix (Additional assessments outside the scope of SCS 0108)

Measurement Conditions (f=5200 MHz)

DASY system configuration, as far as not given on page 1 and 3.

Phantom	SAM Head Phantom	For usage with cSAR3DV2-R/L
---------	------------------	-----------------------------

SAR result with SAM Head (Top)

SAR averaged over 1 cm ³ (1 g) of Head TSL	Condition	
SAR measured	100 mW input power	8.04 W/kg
SAR for nominal Head TSL parameters	normalized to 1W	80.4 W/kg ± 20.3 % (k=2)

SAR averaged over 10 cm ³ (10 g) of Head TSL	condition	
SAR measured	100 mW input power	2.34 W/kg
SAR for nominal Head TSL parameters	normalized to 1W	23.4 W/kg ± 19.9 % (k=2)

SAR result with SAM Head (Mouth)

SAR averaged over 1 cm ³ (1 g) of Head TSL	Condition	
SAR measured	100 mW input power	8.37 W/kg
SAR for nominal Head TSL parameters	normalized to 1W	83.8 W/kg ± 20.3 % (k=2)

SAR averaged over 10 cm ³ (10 g) of Head TSL	condition	
SAR measured	100 mW input power	2.36 W/kg
SAR for nominal Head TSL parameters	normalized to 1W	23.6 W/kg ± 19.9 % (k=2)

SAR result with SAM Head (Neck)

SAR averaged over 1 cm ³ (1 g) of Head TSL	Condition	
SAR measured	100 mW input power	8.04 W/kg
SAR for nominal Head TSL parameters	normalized to 1W	80.4 W/kg ± 20.3 % (k=2)

SAR averaged over 10 cm ³ (10 g) of Head TSL	condition	
SAR measured	100 mW input power	2.36 W/kg
SAR for nominal Head TSL parameters	normalized to 1W	23.6W/kg ± 19.9 % (k=2)

SAR result with SAM Head (Ear)

SAR averaged over 1 cm ³ (1 g) of Head TSL	Condition	
SAR measured	100 mW input power	5.11 W/kg
SAR for nominal Head TSL parameters	normalized to 1W	51.1 W/kg ± 20.3 % (k=2)

SAR averaged over 10 cm ³ (10 g) of Head TSL	condition	
SAR measured	100 mW input power	1.78 W/kg
SAR for nominal Head TSL parameters	normalized to 1W	17.8 W/kg ± 19.9 % (k=2)

Appendix (Additional assessments outside the scope of SCS 0108)

Measurement Conditions (f=5800 MHz)

DASY system configuration, as far as not given on page 1 and 3.

Phantom	SAM Head Phantom	For usage with cSAR3DV2-R/L
---------	------------------	-----------------------------

SAR result with SAM Head (Top)

SAR averaged over 1 cm ³ (1 g) of Head TSL	Condition	
SAR measured	100 mW input power	8.18 W/kg
SAR for nominal Head TSL parameters	normalized to 1W	81.7 W/kg ± 20.3 % (k=2)

SAR averaged over 10 cm ³ (10 g) of Head TSL	condition	
SAR measured	100 mW input power	2.33 W/kg
SAR for nominal Head TSL parameters	normalized to 1W	23.3 W/kg ± 19.9 % (k=2)

SAR result with SAM Head (Mouth)

SAR averaged over 1 cm ³ (1 g) of Head TSL	Condition	
SAR measured	100 mW input power	8.56 W/kg
SAR for nominal Head TSL parameters	normalized to 1W	85.5 W/kg ± 20.3 % (k=2)

SAR averaged over 10 cm ³ (10 g) of Head TSL	condition	
SAR measured	100 mW input power	2.37 W/kg
SAR for nominal Head TSL parameters	normalized to 1W	23.6 W/kg ± 19.9 % (k=2)

SAR result with SAM Head (Neck)

SAR averaged over 1 cm ³ (1 g) of Head TSL	Condition	
SAR measured	100 mW input power	7.91 W/kg
SAR for nominal Head TSL parameters	normalized to 1W	78.9 W/kg ± 20.3 % (k=2)

SAR averaged over 10 cm ³ (10 g) of Head TSL	condition	
SAR measured	100 mW input power	2.26 W/kg
SAR for nominal Head TSL parameters	normalized to 1W	22.5 W/kg ± 19.9 % (k=2)

SAR result with SAM Head (Ear)

SAR averaged over 1 cm ³ (1 g) of Head TSL	Condition	
SAR measured	100 mW input power	5.60 W/kg
SAR for nominal Head TSL parameters	normalized to 1W	55.9 W/kg ± 20.3 % (k=2)

SAR averaged over 10 cm ³ (10 g) of Head TSL	condition	
SAR measured	100 mW input power	1.92 W/kg
SAR for nominal Head TSL parameters	normalized to 1W	19.1 W/kg ± 19.9 % (k=2)

DASY5 Validation Report for Head TSL

Date: 13.09.2019

Test Laboratory: SPEAG, Zurich, Switzerland

DUT: Dipole D5GHzV2; Type: D5GHzV2; Serial: D5GHzV2 - SN:1191

Communication System: UID 0 - CW; Frequency: 5250 MHz, Frequency: 5600 MHz, Frequency: 5750 MHz
Medium parameters used: $f = 5250$ MHz; $\sigma = 4.53$ S/m; $\epsilon_r = 35.1$; $\rho = 1000$ kg/m³,
Medium parameters used: $f = 5600$ MHz; $\sigma = 4.88$ S/m; $\epsilon_r = 34.6$; $\rho = 1000$ kg/m³,
Medium parameters used: $f = 5750$ MHz; $\sigma = 5.03$ S/m; $\epsilon_r = 34.4$; $\rho = 1000$ kg/m³
Phantom section: Flat Section
Measurement Standard: DASY5 (IEEE/IEC/ANSI C63.19-2011)

DASY52 Configuration:

- Probe: EX3DV4 - SN3503; ConvF(5.4, 5.4, 5.4) @ 5250 MHz, ConvF(4.95, 4.95, 4.95) @ 5600 MHz, ConvF(4.98, 4.98, 4.98) @ 5750 MHz; Calibrated: 25.03.2019
- Sensor-Surface: 1.4mm (Mechanical Surface Detection)
- Electronics: DAE4 Sn601; Calibrated: 30.04.2019
- Phantom: Flat Phantom 5.0 (front); Type: QD 000 P50 AA; Serial: 1001
- DASY52 52.10.2(1504); SEMCAD X 14.6.12(7470)

Dipole Calibration for Head Tissue/Pin=100mW, dist=10mm, f=5250 MHz/Zoom Scan, dist=1.4mm (8x8x7)/Cube 0: Measurement grid: dx=4mm, dy=4mm, dz=1.4mm

Reference Value = 76.95 V/m; Power Drift = 0.02 dB

Peak SAR (extrapolated) = 28.0 W/kg

SAR(1 g) = 8.13 W/kg; SAR(10 g) = 2.32 W/kg

Maximum value of SAR (measured) = 18.2 W/kg

Dipole Calibration for Head Tissue/Pin=100mW, dist=10mm, f=5600 MHz/Zoom Scan, dist=1.4mm (8x8x7)/Cube 0: Measurement grid: dx=4mm, dy=4mm, dz=1.4mm

Reference Value = 76.89 V/m; Power Drift = 0.02 dB

Peak SAR (extrapolated) = 30.9 W/kg

SAR(1 g) = 8.33 W/kg; SAR(10 g) = 2.36 W/kg

Maximum value of SAR (measured) = 19.2 W/kg

Dipole Calibration for Head Tissue/Pin=100mW, dist=10mm, f=5750 MHz/Zoom Scan, dist=1.4mm (8x8x7)/Cube 0: Measurement grid: dx=4mm, dy=4mm, dz=1.4mm

Reference Value = 74.20 V/m; Power Drift = 0.01 dB

Peak SAR (extrapolated) = 31.6 W/kg

SAR(1 g) = 8.08 W/kg; SAR(10 g) = 2.29 W/kg

Maximum value of SAR (measured) = 18.9 W/kg

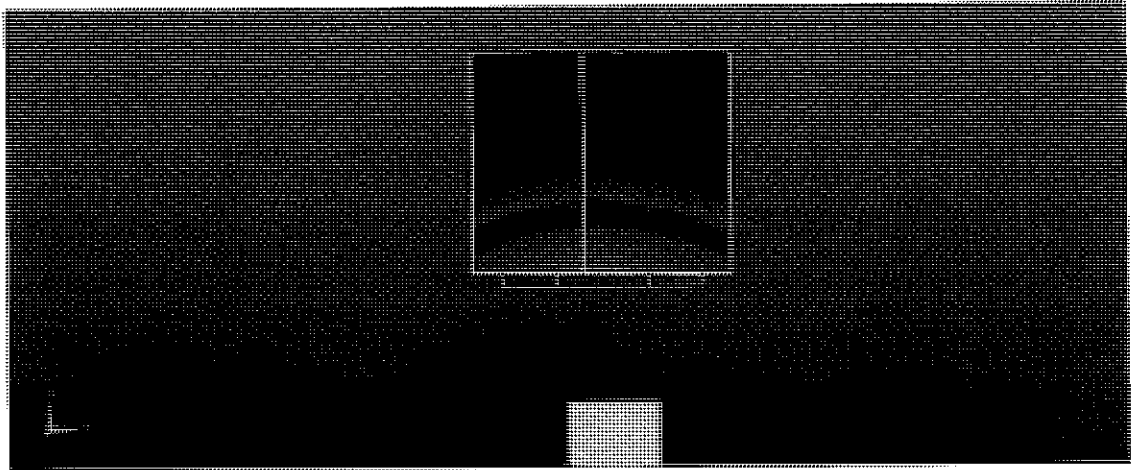

0 dB = 18.9 W/kg = 12.76 dBW/kg

Impedance Measurement Plot for Head TSL

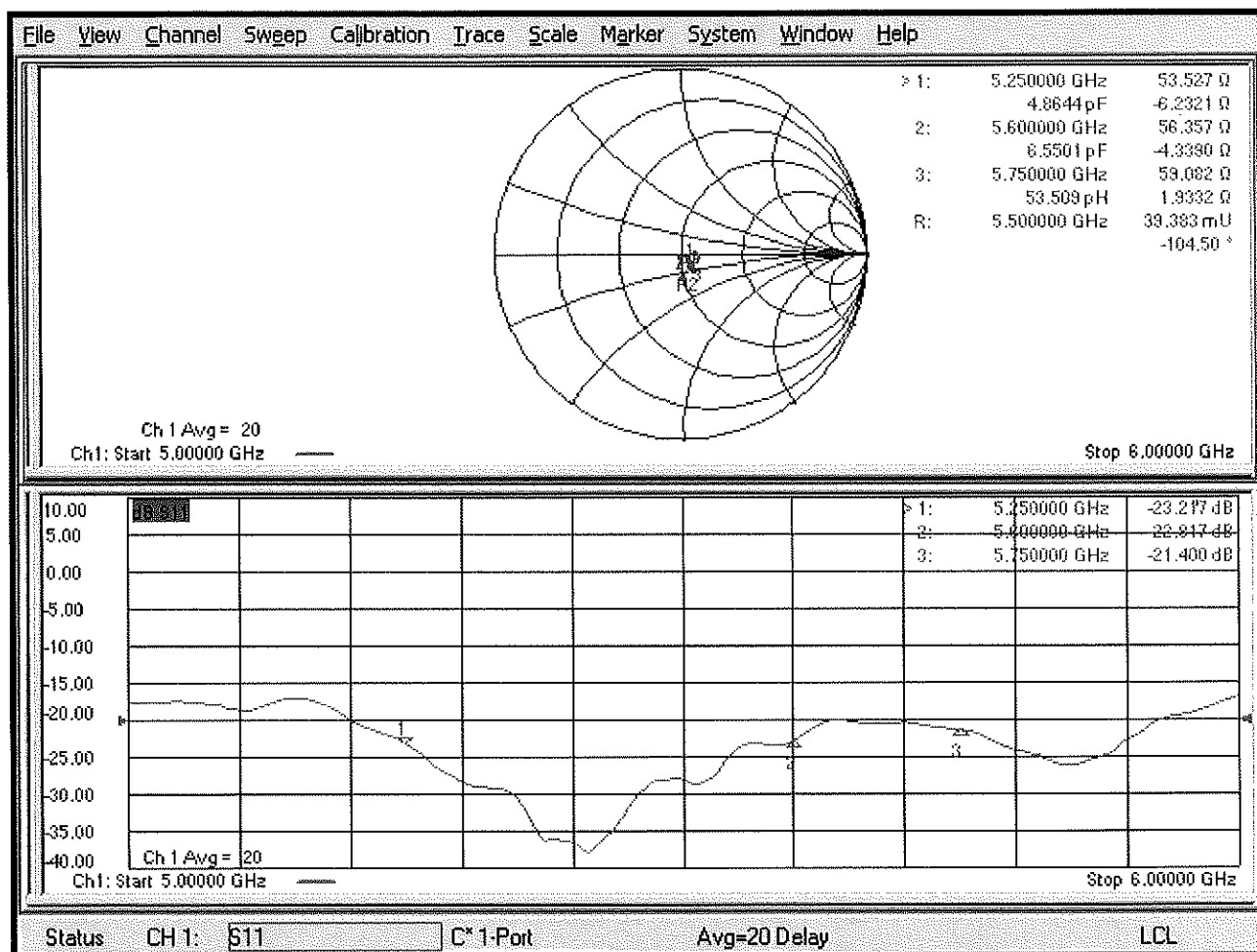

DASY5 Validation Report for Body TSL

Date: 16.09.2019

Test Laboratory: SPEAG, Zurich, Switzerland

DUT: Dipole D5GHzV2; Type: D5GHzV2; Serial: D5GHzV2 - SN:1191

Communication System: UID 0 - CW; Frequency: 5200 MHz, Frequency: 5250 MHz, Frequency: 5600 MHz, Frequency: 5750 MHz, Frequency: 5800 MHz

Medium parameters used: $f = 5200$ MHz; $\sigma = 5.44$ S/m; $\epsilon_r = 46.9$; $\rho = 1000$ kg/m³,

Medium parameters used: $f = 5250$ MHz; $\sigma = 5.51$ S/m; $\epsilon_r = 46.9$; $\rho = 1000$ kg/m³,

Medium parameters used: $f = 5600$ MHz; $\sigma = 5.98$ S/m; $\epsilon_r = 46.2$; $\rho = 1000$ kg/m³,

Medium parameters used: $f = 5750$ MHz; $\sigma = 6.19$ S/m; $\epsilon_r = 46$; $\rho = 1000$ kg/m³,

Medium parameters used: $f = 5800$ MHz; $\sigma = 6.26$ S/m; $\epsilon_r = 45.9$; $\rho = 1000$ kg/m³

Phantom section: Flat Section

Measurement Standard: DASY5 (IEEE/IEC/ANSI C63.19-2011)

DASY52 Configuration:

- Probe: EX3DV4 - SN3503; ConvF(5.14, 5.14, 5.14) @ 5200 MHz, ConvF(5.26, 5.26, 5.26) @ 5250 MHz, ConvF(4.74, 4.74, 4.74) @ 5600 MHz, ConvF(4.62, 4.62, 4.62) @ 5750 MHz, ConvF(4.62, 4.62, 4.62) @ 5800 MHz; Calibrated: 25.03.2019
- Sensor-Surface: 1.4mm (Mechanical Surface Detection)
- Electronics: DAE4 Sn601; Calibrated: 30.04.2019
- Phantom: Flat Phantom 5.0 (back); Type: QD 000 P50 AA; Serial: 1002
- DASY52 52.10.2(1504); SEMCAD X 14.6.12(7470)

Dipole Calibration for Body Tissue/Pin=100mW, dist=10mm, f=5200 MHz/Zoom Scan, dist=1.4mm (8x8x7)/Cube 0: Measurement grid: dx=4mm, dy=4mm, dz=1.4mm

Reference Value = 68.78 V/m; Power Drift = -0.07 dB

Peak SAR (extrapolated) = 28.7 W/kg

SAR(1 g) = 7.55 W/kg; SAR(10 g) = 2.11 W/kg

Maximum value of SAR (measured) = 17.3 W/kg

Dipole Calibration for Body Tissue/Pin=100mW, dist=10mm, f=5250 MHz/Zoom Scan, dist=1.4mm (8x8x7)/Cube 0: Measurement grid: dx=4mm, dy=4mm, dz=1.4mm

Reference Value = 69.09 V/m; Power Drift = -0.09 dB

Peak SAR (extrapolated) = 30.3 W/kg

SAR(1 g) = 7.76 W/kg; SAR(10 g) = 2.16 W/kg

Maximum value of SAR (measured) = 18.1 W/kg

Dipole Calibration for Body Tissue/Pin=100mW, dist=10mm, f=5600 MHz/Zoom Scan, dist=1.4mm (8x8x7)/Cube 0: Measurement grid: dx=4mm, dy=4mm, dz=1.4mm
Reference Value = 68.19 V/m; Power Drift = -0.07 dB
Peak SAR (extrapolated) = 34.3 W/kg
SAR(1 g) = 7.93 W/kg; SAR(10 g) = 2.22 W/kg
Maximum value of SAR (measured) = 19.0 W/kg

Dipole Calibration for Body Tissue/Pin=100mW, dist=10mm, f=5750 MHz/Zoom Scan, dist=1.4mm (8x8x7)/Cube 0: Measurement grid: dx=4mm, dy=4mm, dz=1.4mm
Reference Value = 66.80 V/m; Power Drift = -0.08 dB
Peak SAR (extrapolated) = 35.1 W/kg
SAR(1 g) = 7.75 W/kg; SAR(10 g) = 2.15 W/kg
Maximum value of SAR (measured) = 18.9 W/kg

Dipole Calibration for Body Tissue/Pin=100mW, dist=10mm, f=5800 MHz/Zoom Scan, dist=1.4mm (8x8x7)/Cube 0: Measurement grid: dx=4mm, dy=4mm, dz=1.4mm
Reference Value = 67.13 V/m; Power Drift = -0.08 dB
Peak SAR (extrapolated) = 33.8 W/kg
SAR(1 g) = 7.66 W/kg; SAR(10 g) = 2.12 W/kg
Maximum value of SAR (measured) = 18.5 W/kg

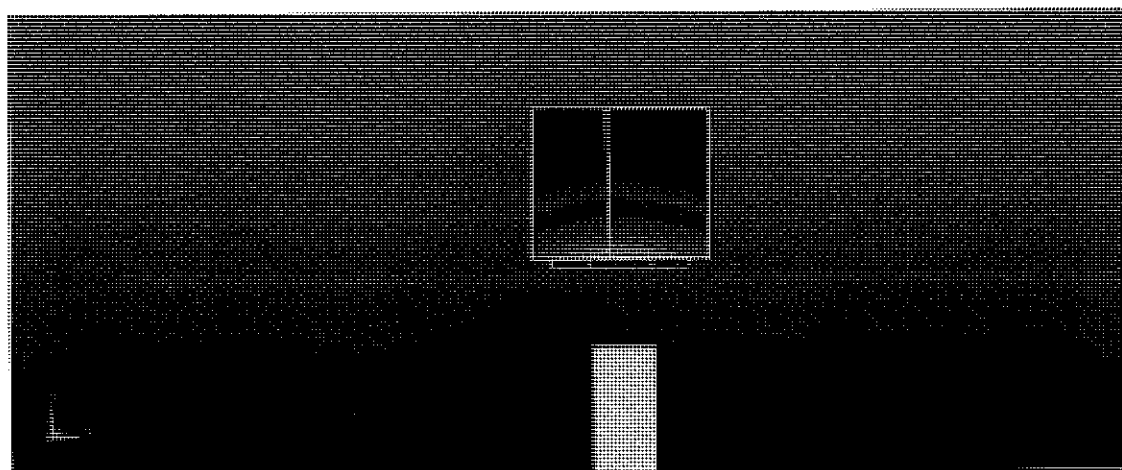
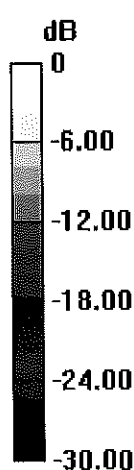

0 dB = 18.5 W/kg = 12.67 dBW/kg

Impedance Measurement Plot for Body TSL

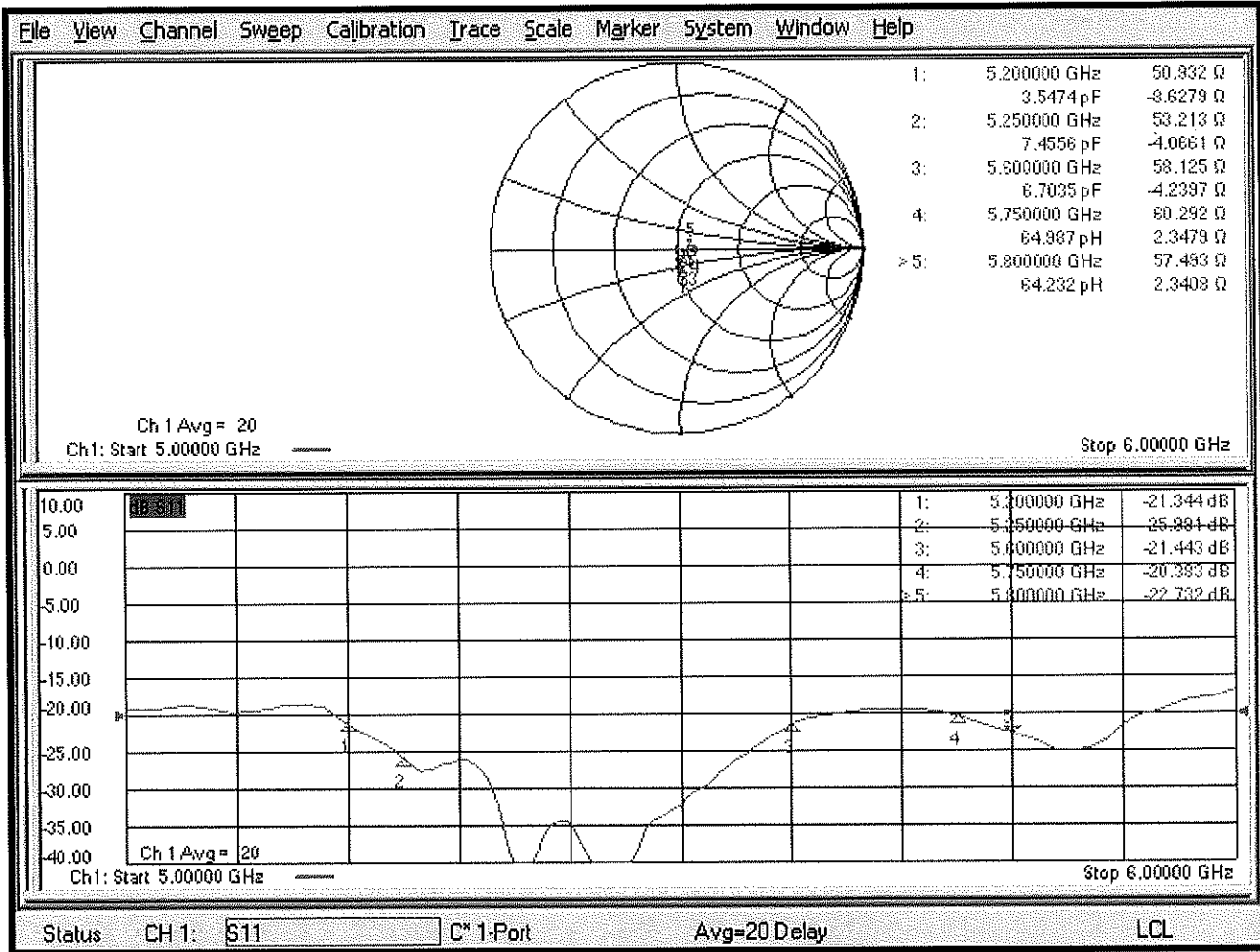

DASY5 Validation Report for SAM Head

Date: 17.09.2019

Test Laboratory: SPEAG, Zurich, Switzerland

DUT: Dipole 5GHz; Type: D5GHzV2; Serial: D5GHzV2 - SN:1191

Communication System: UID 0 - CW; Frequency: 5200 MHz, Frequency: 5800 MHz
Medium parameters used: $f = 5200$ MHz; $\sigma = 4.55$ S/m; $\epsilon_r = 36.2$; $\rho = 1000$ kg/m³,
Medium parameters used: $f = 5800$ MHz; $\sigma = 5.28$ S/m; $\epsilon_r = 34.9$; $\rho = 1000$ kg/m³
Measurement Standard: DASY5 (IEEE/IEC/ANSI C63.19-2011)

DASY52 Configuration:

- Probe: EX3DV4 - SN3503; ConvF(5.64, 5.64, 5.64) @ 5200 MHz, ConvF(4.96, 4.96, 4.96) @ 5800 MHz; Calibrated: 25.03.2019
- Sensor-Surface: 1.4mm (Mechanical Surface Detection)
- Electronics: DAE4 Sn601; Calibrated: 30.04.2019
- Phantom: SAM Head
- DASY52 52.10.2(1504); SEMCAD X 14.6.12(7470)

SAM/Head/Top - 5200/Zoom Scan (8x8x7)/Cube 0: Measurement grid: dx=4mm, dy=4mm, dz=1.4mm

Reference Value = 74.84 V/m; Power Drift = -0.01 dB
Peak SAR (extrapolated) = 27.5 W/kg
SAR(1 g) = 8.04 W/kg; SAR(10 g) = 2.34 W/kg
Maximum value of SAR (measured) = 18.5 W/kg

SAM/Head/Top - 5800/Zoom Scan (8x8x7)/Cube 0: Measurement grid: dx=4mm, dy=4mm, dz=1.4mm

Reference Value = 70.45 V/m; Power Drift = 0.03 dB
Peak SAR (extrapolated) = 32.3 W/kg
SAR(1 g) = 8.18 W/kg; SAR(10 g) = 2.33 W/kg
Maximum value of SAR (measured) = 20.2 W/kg

SAM/Head/Mouth - 5200/Zoom Scan (8x8x7)/Cube 0: Measurement grid: dx=4mm, dy=4mm, dz=1.4mm

Reference Value = 76.86 V/m; Power Drift = 0.02 dB
Peak SAR (extrapolated) = 29.3 W/kg
SAR(1 g) = 8.37 W/kg; SAR(10 g) = 2.36 W/kg
Maximum value of SAR (measured) = 19.8 W/kg

SAM/Head/Mouth - 5800/Zoom Scan (8x8x7)/Cube 0: Measurement grid: dx=4mm, dy=4mm, dz=1.4mm

Reference Value = 71.46 V/m; Power Drift = 0.02 dB
Peak SAR (extrapolated) = 34.0 W/kg
SAR(1 g) = 8.56 W/kg; SAR(10 g) = 2.37 W/kg
Maximum value of SAR (measured) = 21.3 W/kg

SAM/Head/Neck - 5200/Zoom Scan (8x8x7)/Cube 0: Measurement grid: dx=4mm, dy=4mm, dz=1.4mm

Reference Value = 74.71 V/m; Power Drift = 0.09 dB

Peak SAR (extrapolated) = 28.8 W/kg

SAR(1 g) = 8.04 W/kg; SAR(10 g) = 2.36 W/kg

Maximum value of SAR (measured) = 19.2 W/kg

SAM/Head/Neck - 5800/Zoom Scan (8x8x7)/Cube 0: Measurement grid: dx=4mm, dy=4mm, dz=1.4mm

Reference Value = 71.62 V/m; Power Drift = -0.01 dB

Peak SAR (extrapolated) = 32.1 W/kg

SAR(1 g) = 7.91 W/kg; SAR(10 g) = 2.26 W/kg

Maximum value of SAR (measured) = 20.2 W/kg

SAM/Head/Ear - 5200/Zoom Scan (8x8x7)/Cube 0: Measurement grid: dx=4mm, dy=4mm, dz=1.4mm

Reference Value = 57.89 V/m; Power Drift = 0.03 dB

Peak SAR (extrapolated) = 16.7 W/kg

SAR(1 g) = 5.11 W/kg; SAR(10 g) = 1.78 W/kg

Maximum value of SAR (measured) = 11.4 W/kg

SAM/Head/Ear - 5800/Zoom Scan (8x8x7)/Cube 0: Measurement grid: dx=4mm, dy=4mm, dz=1.4mm

Reference Value = 58.22 V/m; Power Drift = 0.03 dB

Peak SAR (extrapolated) = 21.0 W/kg

SAR(1 g) = 5.6 W/kg; SAR(10 g) = 1.92 W/kg

Maximum value of SAR (measured) = 13.4 W/kg

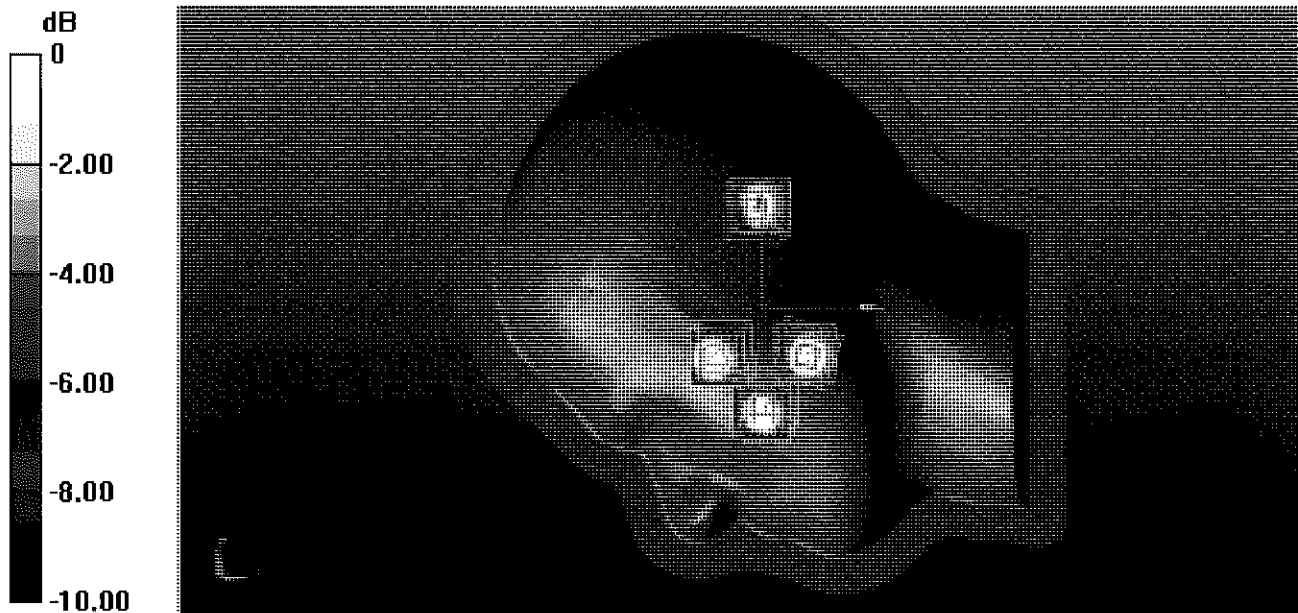

0 dB = 11.4 W/kg = 10.57 dBW/kg



Accredited by the Swiss Accreditation Service (SAS)
The Swiss Accreditation Service is one of the signatories to the EA
Multilateral Agreement for the recognition of calibration certificates

Accreditation No.: **SCS 0108**

Client **PC Test**

Certificate No: **D750V3-1054_Mar19/2**

CALIBRATION CERTIFICATE (Replacement of No:D750V3-1154_Mar19)

Object **D750V3 - SN:1054**

Calibration procedure(s) **QA CAL-05.v11
Calibration Procedure for SAR Validation Sources between 0.7-3 GHz**

*BNV
4-29-2019*

Calibration date: **March 18, 2019**

This calibration certificate documents the traceability to national standards, which realize the physical units of measurements (SI).
The measurements and the uncertainties with confidence probability are given on the following pages and are part of the certificate.

All calibrations have been conducted in the closed laboratory facility: environment temperature (22 ± 3)°C and humidity < 70%.

Calibration Equipment used (M&TE critical for calibration)

Primary Standards	ID #	Cal Date (Certificate No.)	Scheduled Calibration
Power meter NRP	SN: 104778	04-Apr-18 (No. 217-02672/02673)	Apr-19
Power sensor NRP-Z91	SN: 103244	04-Apr-18 (No. 217-02672)	Apr-19
Power sensor NRP-Z91	SN: 103245	04-Apr-18 (No. 217-02673)	Apr-19
Reference 20 dB Attenuator	SN: 5058 (20k)	04-Apr-18 (No. 217-02682)	Apr-19
Type-N mismatch combination	SN: 5047.2 / 06327	04-Apr-18 (No. 217-02683)	Apr-19
Reference Probe EX3DV4	SN: 7349	31-Dec-18 (No. EX3-7349_Dec18)	Dec-19
DAE4	SN: 601	04-Oct-18 (No. DAE4-601_Oct18)	Oct-19
Secondary Standards	ID #	Check Date (in house)	Scheduled Check
Power meter E4419B	SN: GB39512475	07-Oct-15 (in house check Feb-19)	In house check: Oct-20
Power sensor HP 8481A	SN: US37292783	07-Oct-15 (in house check Oct-18)	In house check: Oct-20
Power sensor HP 8481A	SN: MY41092317	07-Oct-15 (in house check Oct-18)	In house check: Oct-20
RF generator R&S SMT-06	SN: 100972	15-Jun-15 (in house check Oct-18)	In house check: Oct-20
Network Analyzer Agilent E8358A	SN: US41080477	31-Mar-14 (in house check Oct-18)	In house check: Oct-19

Calibrated by: **Manu Seitz** **Manu Seitz** **Manu Seitz**
Name Function Signature
Laboratory Technician

Approved by: **Katja Pokovic** **Katja Pokovic**
Technical Manager

Issued: April 12, 2019

This calibration certificate shall not be reproduced except in full without written approval of the laboratory.



Accredited by the Swiss Accreditation Service (SAS)

The Swiss Accreditation Service is one of the signatories to the EA
Multilateral Agreement for the recognition of calibration certificates

Accreditation No.: **SCS 0108**

Glossary:

TSL	tissue simulating liquid
ConvF	sensitivity in TSL / NORM x,y,z
N/A	not applicable or not measured

Calibration is Performed According to the Following Standards:

- IEEE Std 1528-2013, "IEEE Recommended Practice for Determining the Peak Spatial-Averaged Specific Absorption Rate (SAR) in the Human Head from Wireless Communications Devices: Measurement Techniques", June 2013
- IEC 62209-1, "Measurement procedure for the assessment of Specific Absorption Rate (SAR) from hand-held and body-mounted devices used next to the ear (frequency range of 300 MHz to 6 GHz)", July 2016
- IEC 62209-2, "Procedure to determine the Specific Absorption Rate (SAR) for wireless communication devices used in close proximity to the human body (frequency range of 30 MHz to 6 GHz)", March 2010
- KDB 865664, "SAR Measurement Requirements for 100 MHz to 6 GHz"

Additional Documentation:

- DASY4/5 System Handbook

Methods Applied and Interpretation of Parameters:

- Measurement Conditions:** Further details are available from the Validation Report at the end of the certificate. All figures stated in the certificate are valid at the frequency indicated.
- Antenna Parameters with TSL:** The dipole is mounted with the spacer to position its feed point exactly below the center marking of the flat phantom section, with the arms oriented parallel to the body axis.
- Feed Point Impedance and Return Loss:** These parameters are measured with the dipole positioned under the liquid filled phantom. The impedance stated is transformed from the measurement at the SMA connector to the feed point. The Return Loss ensures low reflected power. No uncertainty required.
- Electrical Delay:** One-way delay between the SMA connector and the antenna feed point. No uncertainty required.
- SAR measured:** SAR measured at the stated antenna input power.
- SAR normalized:** SAR as measured, normalized to an input power of 1 W at the antenna connector.
- SAR for nominal TSL parameters:** The measured TSL parameters are used to calculate the nominal SAR result.

The reported uncertainty of measurement is stated as the standard uncertainty of measurement multiplied by the coverage factor $k=2$, which for a normal distribution corresponds to a coverage probability of approximately 95%.

Measurement Conditions

DASY system configuration, as far as not given on page 1.

DASY Version	DASY5	V52.10.2
Extrapolation	Advanced Extrapolation	
Phantom	Modular Flat Phantom	
Distance Dipole Center - TSL	15 mm	with Spacer
Zoom Scan Resolution	dx, dy, dz = 5.0 mm	
Frequency	750 MHz ± 1 MHz	

Head TSL parameters

The following parameters and calculations were applied.

	Temperature	Permittivity	Conductivity
Nominal Head TSL parameters	22.0 °C	41.9	0.89 mho/m
Measured Head TSL parameters	(22.0 ± 0.2) °C	42.1 ± 6 %	0.89 mho/m ± 6 %
Head TSL temperature change during test	< 0.5 °C	----	----

SAR result with Head TSL

SAR averaged over 1 cm³ (1 g) of Head TSL	Condition	
SAR measured	250 mW input power	2.07 W/kg
SAR for nominal Head TSL parameters	normalized to 1W	8.29 W/kg ± 17.0 % (k=2)

SAR averaged over 10 cm³ (10 g) of Head TSL	condition	
SAR measured	250 mW input power	1.37 W/kg
SAR for nominal Head TSL parameters	normalized to 1W	5.48 W/kg ± 16.5 % (k=2)

Body TSL parameters

The following parameters and calculations were applied.

	Temperature	Permittivity	Conductivity
Nominal Body TSL parameters	22.0 °C	55.5	0.96 mho/m
Measured Body TSL parameters	(22.0 ± 0.2) °C	54.5 ± 6 %	0.98 mho/m ± 6 %
Body TSL temperature change during test	< 0.5 °C	----	----

SAR result with Body TSL

SAR averaged over 1 cm³ (1 g) of Body TSL	Condition	
SAR measured	250 mW input power	2.18 W/kg
SAR for nominal Body TSL parameters	normalized to 1W	8.55 W/kg ± 17.0 % (k=2)

SAR averaged over 10 cm³ (10 g) of Body TSL	condition	
SAR measured	250 mW input power	1.44 W/kg
SAR for nominal Body TSL parameters	normalized to 1W	5.67 W/kg ± 16.5 % (k=2)

Appendix (Additional assessments outside the scope of SCS 0108)

Antenna Parameters with Head TSL

Impedance, transformed to feed point	54.5 Ω - 0.3 j Ω
Return Loss	- 27.2 dB

Antenna Parameters with Body TSL

Impedance, transformed to feed point	50.2 Ω - 3.0 j Ω
Return Loss	- 30.3 dB

General Antenna Parameters and Design

Electrical Delay (one direction)	1.035 ns
----------------------------------	----------

After long term use with 100W radiated power, only a slight warming of the dipole near the feedpoint can be measured.

The dipole is made of standard semirigid coaxial cable. The center conductor of the feeding line is directly connected to the second arm of the dipole. The antenna is therefore short-circuited for DC-signals. On some of the dipoles, small end caps are added to the dipole arms in order to improve matching when loaded according to the position as explained in the "Measurement Conditions" paragraph. The SAR data are not affected by this change. The overall dipole length is still according to the Standard.

No excessive force must be applied to the dipole arms, because they might bend or the soldered connections near the feedpoint may be damaged.

Additional EUT Data

Manufactured by	SPEAG
-----------------	-------

Appendix (Additional assessments outside the scope of SCS 0108)

Measurement Conditions

DASY system configuration, as far as not given on page 1 and 3.

Phantom	SAM Head Phantom	For usage with cSAR3DV2-R/L
---------	------------------	-----------------------------

SAR result with SAM Head (Top)

SAR averaged over 1 cm ³ (1 g) of Head TSL	Condition	
SAR measured	250 mW input power	1.93 W/kg
SAR for nominal Head TSL parameters	normalized to 1W	7.72 W/kg ± 17.5 % (k=2)

SAR averaged over 10 cm ³ (10 g) of Head TSL	condition	
SAR measured	250 mW input power	1.31 W/kg
SAR for nominal Head TSL parameters	normalized to 1W	5.23 W/kg ± 16.9 % (k=2)

SAR result with SAM Head (Mouth)

SAR averaged over 1 cm ³ (1 g) of Head TSL	Condition	
SAR measured	250 mW input power	2.05 W/kg
SAR for nominal Head TSL parameters	normalized to 1W	8.20 W/kg ± 17.5 % (k=2)

SAR averaged over 10 cm ³ (10 g) of Head TSL	condition	
SAR measured	250 mW input power	1.39 W/kg
SAR for nominal Head TSL parameters	normalized to 1W	5.55 W/kg ± 16.9 % (k=2)

SAR result with SAM Head (Neck)

SAR averaged over 1 cm ³ (1 g) of Head TSL	Condition	
SAR measured	250 mW input power	2.00 W/kg
SAR for nominal Head TSL parameters	normalized to 1W	8.00 W/kg ± 17.5 % (k=2)

SAR averaged over 10 cm ³ (10 g) of Head TSL	condition	
SAR measured	250 mW input power	1.38 W/kg
SAR for nominal Head TSL parameters	normalized to 1W	5.51 W/kg ± 16.9 % (k=2)

SAR result with SAM Head (Ear)

SAR averaged over 1 cm ³ (1 g) of Head TSL	Condition	
SAR measured	250 mW input power	1.66 W/kg
SAR for nominal Head TSL parameters	normalized to 1W	6.64 W/kg ± 17.5 % (k=2)

SAR averaged over 10 cm ³ (10 g) of Head TSL	condition	
SAR measured	250 mW input power	1.14 W/kg
SAR for nominal Head TSL parameters	normalized to 1W	4.55 W/kg ± 16.9 % (k=2)

DASY5 Validation Report for Head TSL

Date: 13.03.2019

Test Laboratory: SPEAG, Zurich, Switzerland

DUT: Dipole 750 MHz; Type: D750V3; Serial: D750V3 - SN:1054

Communication System: UID 0 - CW; Frequency: 750 MHz

Medium parameters used: $f = 750$ MHz; $\sigma = 0.89$ S/m; $\epsilon_r = 42.1$; $\rho = 1000$ kg/m³

Phantom section: Flat Section

Measurement Standard: DASY5 (IEEE/IEC/ANSI C63.19-2011)

DASY52 Configuration:

- Probe: EX3DV4 - SN7349; ConvF(10.32, 10.32, 10.32) @ 750 MHz; Calibrated: 31.12.2018
- Sensor-Surface: 1.4mm (Mechanical Surface Detection)
- Electronics: DAE4 Sn601; Calibrated: 04.10.2018
- Phantom: Flat Phantom 4.9 (front); Type: QD 00L P49 AA; Serial: 1001
- DASY52 52.10.2(1495); SEMCAD X 14.6.12(7450)

Dipole Calibration for Head Tissue/Pin=250 mW, d=15mm/Zoom Scan (7x7x7)/Cube 0:

Measurement grid: dx=5mm, dy=5mm, dz=5mm

Reference Value = 58.96 V/m; Power Drift = 0.00 dB

Peak SAR (extrapolated) = 3.06 W/kg

SAR(1 g) = 2.07 W/kg; SAR(10 g) = 1.37 W/kg

Maximum value of SAR (measured) = 2.73 W/kg

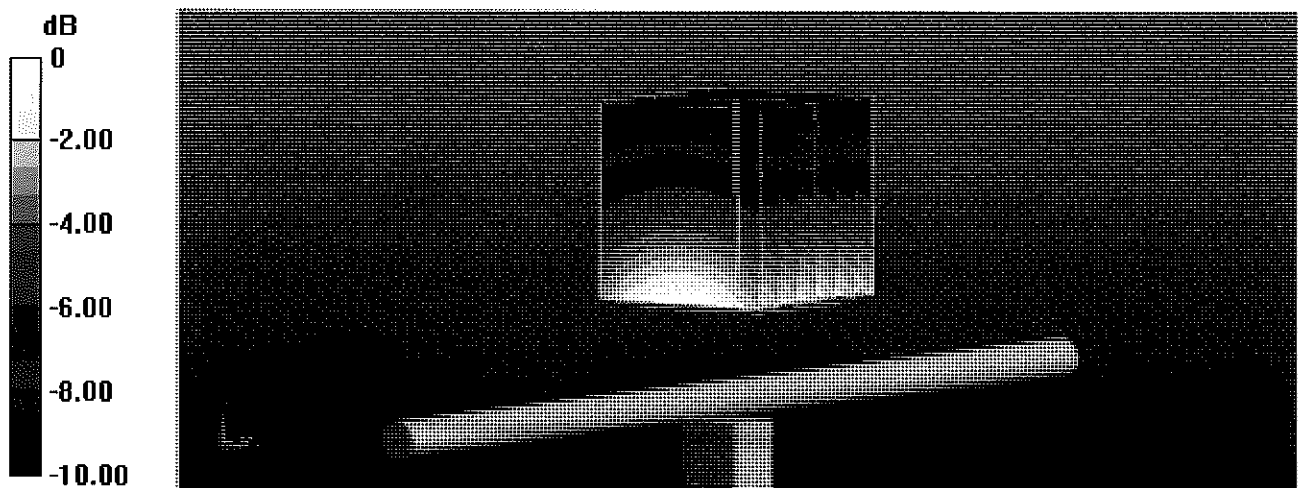

0 dB = 2.73 W/kg = 4.36 dBW/kg

Impedance Measurement Plot for Head TSL

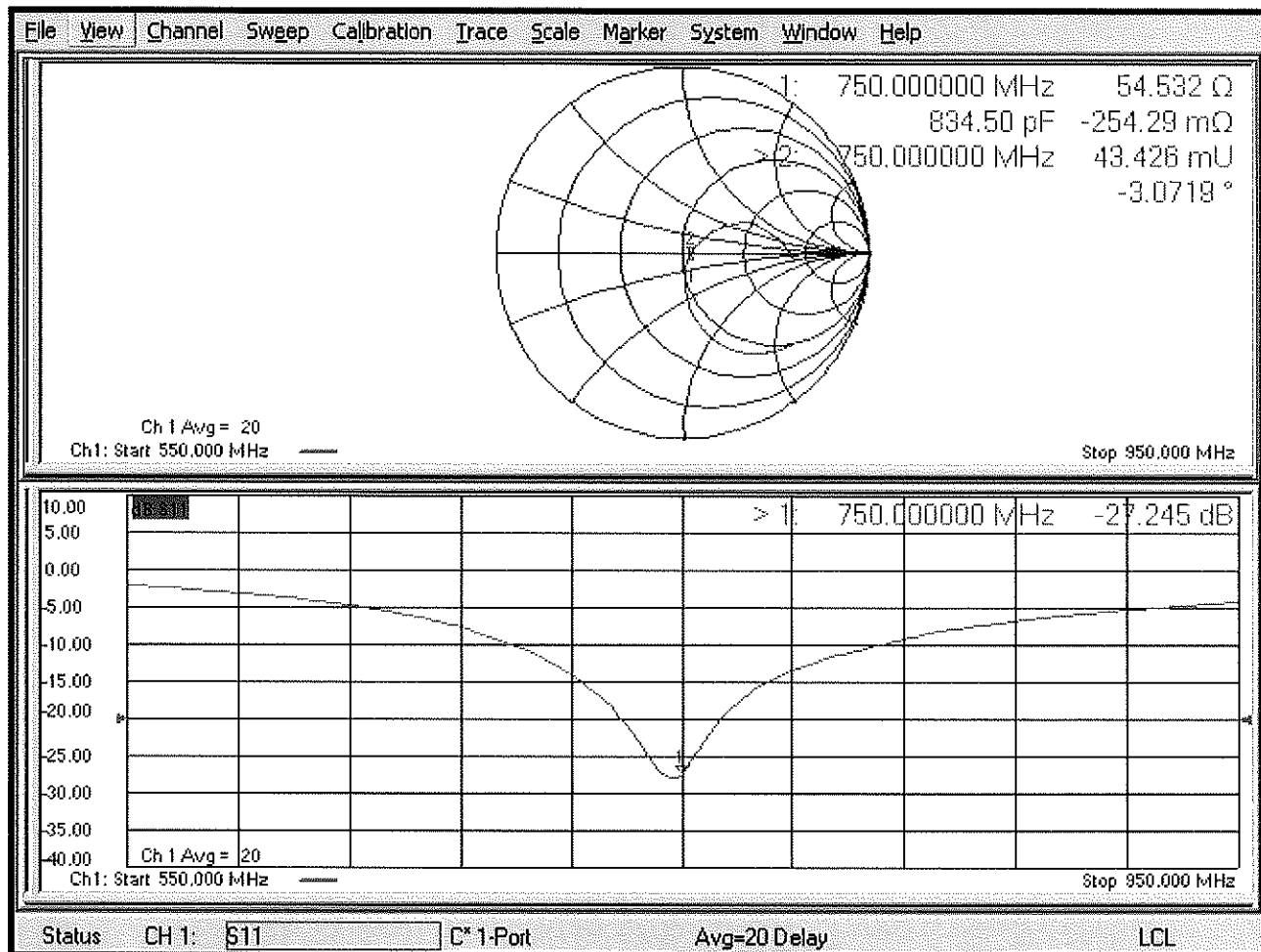

DASY5 Validation Report for Body TSL

Date: 13.03.2019

Test Laboratory: SPEAG, Zurich, Switzerland

DUT: Dipole 750 MHz; Type: D750V3; Serial: D750V3 - SN:1054

Communication System: UID 0 - CW; Frequency: 750 MHz

Medium parameters used: $f = 750 \text{ MHz}$; $\sigma = 0.98 \text{ S/m}$; $\epsilon_r = 54.5$; $\rho = 1000 \text{ kg/m}^3$

Phantom section: Flat Section

Measurement Standard: DASY5 (IEEE/IEC/ANSI C63.19-2011)

DASY52 Configuration:

- Probe: EX3DV4 - SN7349; ConvF(10.29, 10.29, 10.29) @ 750 MHz; Calibrated: 31.12.2018
- Sensor-Surface: 1.4mm (Mechanical Surface Detection)
- Electronics: DAE4 Sn601; Calibrated: 04.10.2018
- Phantom: Flat Phantom 4.9 (Back); Type: QD 00R P49 AA; Serial: 1005
- DASY52 52.10.2(1495); SEMCAD X 14.6.12(7450)

Dipole Calibration for Body Tissue/Pin=250 mW, d=15mm/Zoom Scan (7x7x7)/Cube 0:

Measurement grid: $dx=5\text{mm}$, $dy=5\text{mm}$, $dz=5\text{mm}$

Reference Value = 57.37 V/m; Power Drift = -0.01 dB

Peak SAR (extrapolated) = 3.19 W/kg

SAR(1 g) = 2.18 W/kg; SAR(10 g) = 1.44 W/kg

Maximum value of SAR (measured) = 2.87 W/kg

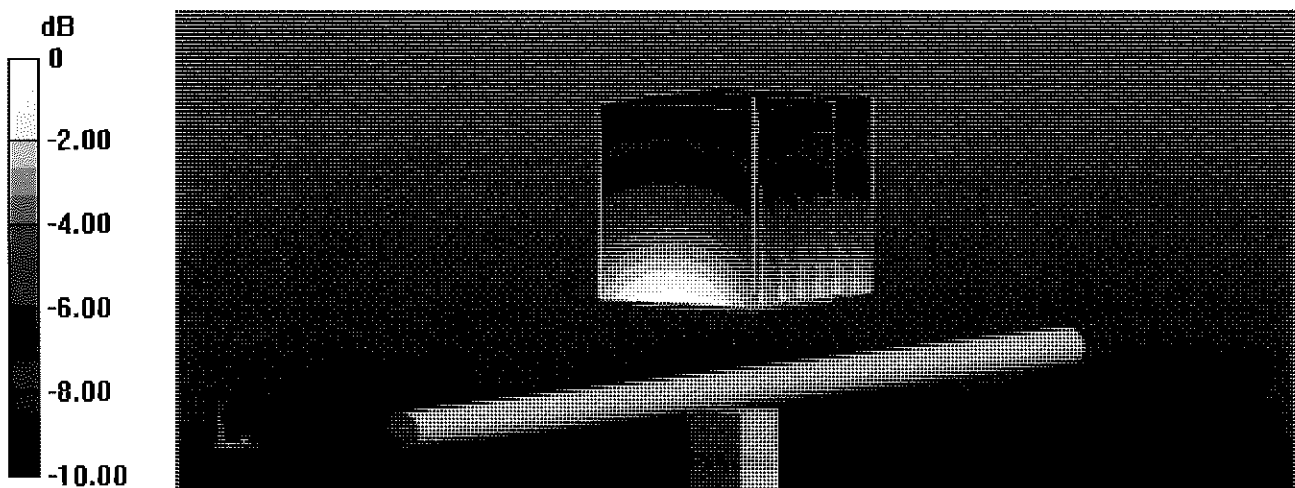

0 dB = 2.87 W/kg = 4.58 dBW/kg

Impedance Measurement Plot for Body TSL

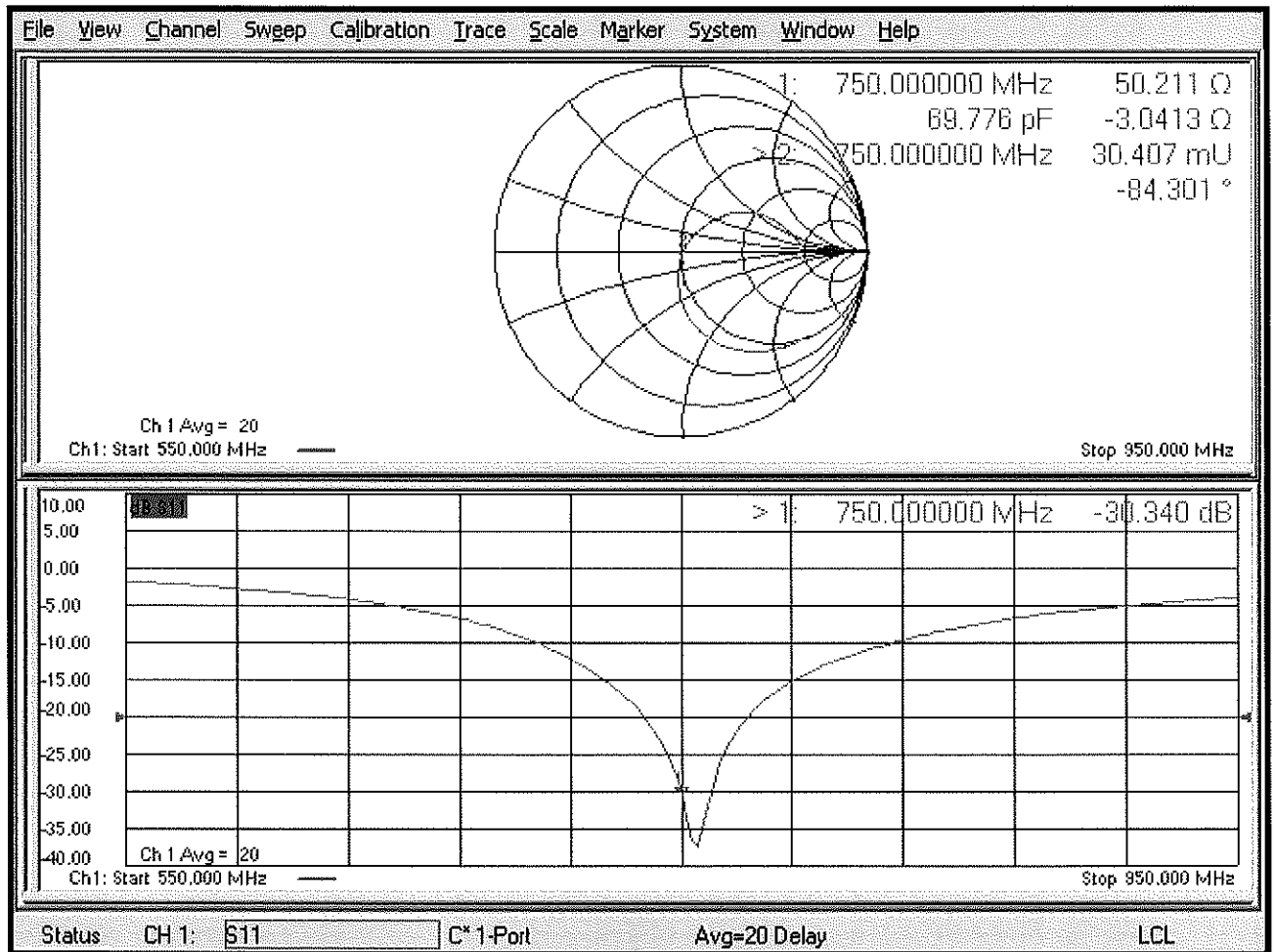

DASY5 Validation Report for SAM Head

Date: 18.03.2019

Test Laboratory: SPEAG, Zurich, Switzerland

DUT: Dipole 750 MHz; Type: D750V3; Serial: D750V3 - SN:1054

Communication System: UID 0 - CW; Frequency: 750 MHz

Medium parameters used: $f = 750$ MHz; $\sigma = 0.904$ S/m; $\epsilon_r = 44.22$; $\rho = 1000$ kg/m³

Measurement Standard: DASY5 (IEEE/IEC/ANSI C63.19-2011)

DASY52 Configuration:

- Probe: EX3DV4 - SN7349; ConvF(10.32, 10.32, 10.32) @ 750 MHz; Calibrated: 31.12.2018
- Sensor-Surface: 1.4mm (Mechanical Surface Detection)
- Electronics: DAE4 Sn601; Calibrated: 04.10.2018
- Phantom: SAM Head
- DASY52 52.10.2(1495); SEMCAD X 14.6.12(7450)

SAM Right/Head/Top/Zoom Scan (7x7x7)/Cube 0: Measurement grid: dx=5mm, dy=5mm, dz=5mm

Reference Value = 55.66 V/m; Power Drift = -0.02 dB

Peak SAR (extrapolated) = 2.80 W/kg

SAR(1 g) = 1.93 W/kg; SAR(10 g) = 1.31 W/kg

Maximum value of SAR (measured) = 2.52 W/kg

SAM Right/Head/Mouth/Zoom Scan (7x7x7)/Cube 0: Measurement grid: dx=5mm, dy=5mm, dz=5mm

Reference Value = 57.68 V/m; Power Drift = 0.03 dB

Peak SAR (extrapolated) = 2.98 W/kg

SAR(1 g) = 2.05 W/kg; SAR(10 g) = 1.39 W/kg

Maximum value of SAR (measured) = 2.68 W/kg

SAM Right/Head/Neck/Zoom Scan (7x7x7)/Cube 0: Measurement grid: dx=5mm, dy=5mm, dz=5mm

Reference Value = 56.23 V/m; Power Drift = -0.04 dB

Peak SAR (extrapolated) = 2.82 W/kg

SAR(1 g) = 2 W/kg; SAR(10 g) = 1.38 W/kg

Maximum value of SAR (measured) = 2.56 W/kg

SAM Right/Head/Ear/Zoom Scan (8x7x7)/Cube 0: Measurement grid: dx=5mm, dy=5mm, dz=5mm

Reference Value = 50.76 V/m; Power Drift = -0.02 dB

Peak SAR (extrapolated) = 2.32 W/kg

SAR(1 g) = 1.66 W/kg; SAR(10 g) = 1.14 W/kg

Maximum value of SAR (measured) = 2.11 W/kg

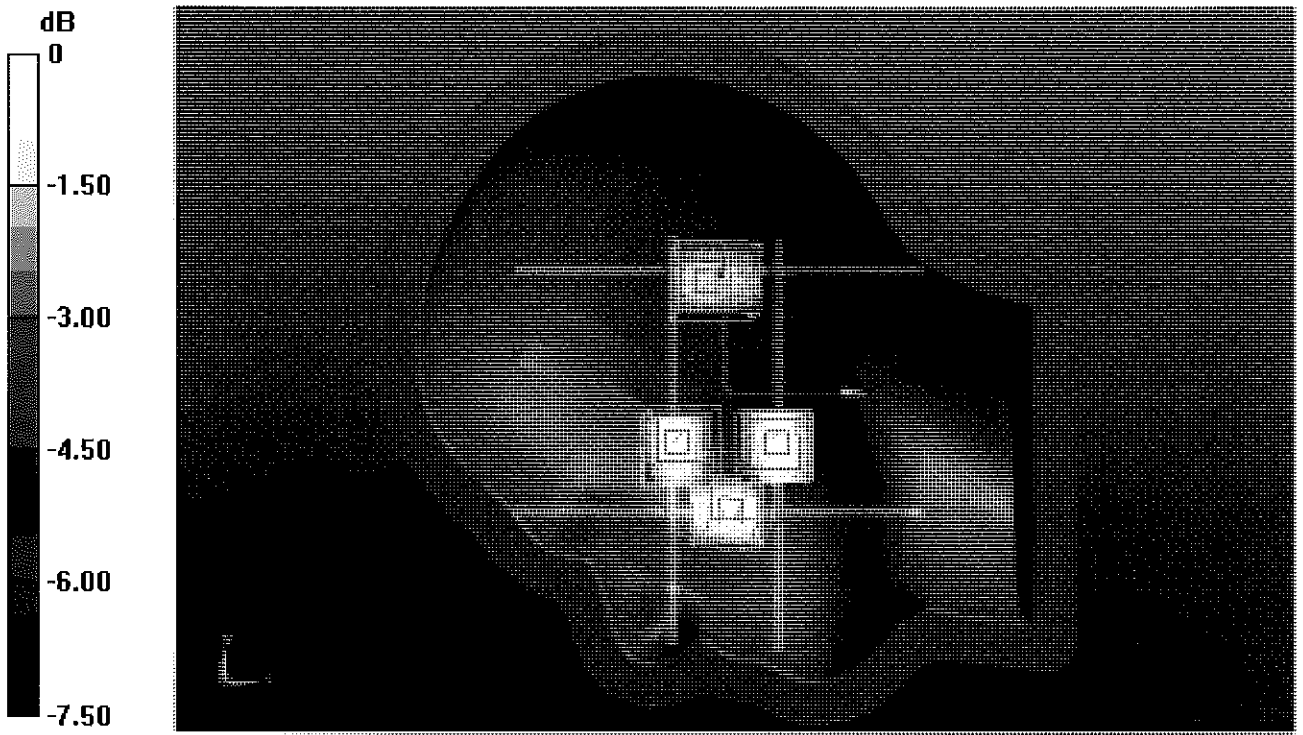

0 dB = 2.11 W/kg = 3.24 dBW/kg



Accredited by the Swiss Accreditation Service (SAS)
The Swiss Accreditation Service is one of the signatories to the EA
Multilateral Agreement for the recognition of calibration certificates

Accreditation No.: **SCS 0108**

Client **PC Test**

Certificate No: **D750V3-1161_Oct18**

CALIBRATION CERTIFICATE

Object **D750V3 - SN:1161**

Calibration procedure(s) **QA CAL-05.v10
Calibration procedure for dipole validation kits above 700 MHz**

Calibration date: **October 19, 2018**

*BN ✓
10-30-2018
BN ✓
10-20-2019*

This calibration certificate documents the traceability to national standards, which realize the physical units of measurements (SI). The measurements and the uncertainties with confidence probability are given on the following pages and are part of the certificate.

All calibrations have been conducted in the closed laboratory facility: environment temperature (22 ± 3)°C and humidity < 70%.

Calibration Equipment used (M&TE critical for calibration)

Primary Standards	ID #	Cal Date (Certificate No.)	Scheduled Calibration
Power meter NRP	SN: 104778	04-Apr-18 (No. 217-02672/02673)	Apr-19
Power sensor NRP-Z91	SN: 103244	04-Apr-18 (No. 217-02672)	Apr-19
Power sensor NRP-Z91	SN: 103245	04-Apr-18 (No. 217-02673)	Apr-19
Reference 20 dB Attenuator	SN: 5058 (20k)	04-Apr-18 (No. 217-02682)	Apr-19
Type-N mismatch combination	SN: 5047.2 / 05327	04-Apr-18 (No. 217-02683)	Apr-19
Reference Probe EX3DV4	SN: 7349	30-Dec-17 (No. EX3-7349_Dec17)	Dec-18
DAE4	SN: 601	04-Oct-18 (No. DAE4-601_Oct18)	Oct-19

Secondary Standards	ID #	Check Date (in house)	Scheduled Check
Power meter EPM-442A	SN: GB37480704	07-Oct-15 (in house check Oct-18)	In house check: Oct-20
Power sensor HP 8481A	SN: US37292783	07-Oct-15 (in house check Oct-18)	In house check: Oct-20
Power sensor HP 8481A	SN: MY41092317	07-Oct-15 (in house check Oct-18)	In house check: Oct-20
RF generator R&S SMT-06	SN: 100972	15-Jun-15 (in house check Oct-18)	In house check: Oct-20
Network Analyzer Agilent E8358A	SN: US41080477	31-Mar-14 (in house check Oct-18)	In house check: Oct-19

Calibrated by: **Manu Seitz** (Laboratory Technician) *[Signature]*
Approved by: **Katja Pokovic** (Technical Manager) *[Signature]*

Issued: October 22, 2018

This calibration certificate shall not be reproduced except in full without written approval of the laboratory.



Accredited by the Swiss Accreditation Service (SAS)

The Swiss Accreditation Service is one of the signatories to the EA
Multilateral Agreement for the recognition of calibration certificates

Accreditation No.: **SCS 0108**

Glossary:

TSL	tissue simulating liquid
ConvF	sensitivity in TSL / NORM x,y,z
N/A	not applicable or not measured

Calibration is Performed According to the Following Standards:

- IEEE Std 1528-2013, "IEEE Recommended Practice for Determining the Peak Spatial-Averaged Specific Absorption Rate (SAR) in the Human Head from Wireless Communications Devices: Measurement Techniques", June 2013
- IEC 62209-1, "Measurement procedure for the assessment of Specific Absorption Rate (SAR) from hand-held and body-mounted devices used next to the ear (frequency range of 300 MHz to 6 GHz)", July 2016
- IEC 62209-2, "Procedure to determine the Specific Absorption Rate (SAR) for wireless communication devices used in close proximity to the human body (frequency range of 30 MHz to 6 GHz)", March 2010
- KDB 865664, "SAR Measurement Requirements for 100 MHz to 6 GHz"

Additional Documentation:

- DASY4/5 System Handbook

Methods Applied and Interpretation of Parameters:

- Measurement Conditions:** Further details are available from the Validation Report at the end of the certificate. All figures stated in the certificate are valid at the frequency indicated.
- Antenna Parameters with TSL:** The dipole is mounted with the spacer to position its feed point exactly below the center marking of the flat phantom section, with the arms oriented parallel to the body axis.
- Feed Point Impedance and Return Loss:** These parameters are measured with the dipole positioned under the liquid filled phantom. The impedance stated is transformed from the measurement at the SMA connector to the feed point. The Return Loss ensures low reflected power. No uncertainty required.
- Electrical Delay:** One-way delay between the SMA connector and the antenna feed point. No uncertainty required.
- SAR measured:** SAR measured at the stated antenna input power.
- SAR normalized:** SAR as measured, normalized to an input power of 1 W at the antenna connector.
- SAR for nominal TSL parameters:** The measured TSL parameters are used to calculate the nominal SAR result.

The reported uncertainty of measurement is stated as the standard uncertainty of measurement multiplied by the coverage factor $k=2$, which for a normal distribution corresponds to a coverage probability of approximately 95%.

Measurement Conditions

DASY system configuration, as far as not given on page 1.

DASY Version	DASY5	V52.10.2
Extrapolation	Advanced Extrapolation	
Phantom	Modular Flat Phantom	
Distance Dipole Center - TSL	15 mm	with Spacer
Zoom Scan Resolution	dx, dy, dz = 5 mm	
Frequency	750 MHz \pm 1 MHz	

Head TSL parameters

The following parameters and calculations were applied.

	Temperature	Permittivity	Conductivity
Nominal Head TSL parameters	22.0 °C	41.9	0.89 mho/m
Measured Head TSL parameters	(22.0 \pm 0.2) °C	40.8 \pm 6 %	0.89 mho/m \pm 6 %
Head TSL temperature change during test	< 0.5 °C	----	----

SAR result with Head TSL

SAR averaged over 1 cm³ (1 g) of Head TSL	Condition	
SAR measured	250 mW input power	2.02 W/kg
SAR for nominal Head TSL parameters	normalized to 1W	8.03 W/kg \pm 17.0 % (k=2)

SAR averaged over 10 cm³ (10 g) of Head TSL	condition	
SAR measured	250 mW input power	1.32 W/kg
SAR for nominal Head TSL parameters	normalized to 1W	5.26 W/kg \pm 16.5 % (k=2)

Body TSL parameters

The following parameters and calculations were applied.

	Temperature	Permittivity	Conductivity
Nominal Body TSL parameters	22.0 °C	55.5	0.96 mho/m
Measured Body TSL parameters	(22.0 \pm 0.2) °C	55.1 \pm 6 %	0.96 mho/m \pm 6 %
Body TSL temperature change during test	< 0.5 °C	----	----

SAR result with Body TSL

SAR averaged over 1 cm³ (1 g) of Body TSL	Condition	
SAR measured	250 mW input power	2.11 W/kg
SAR for nominal Body TSL parameters	normalized to 1W	8.43 W/kg \pm 17.0 % (k=2)

SAR averaged over 10 cm³ (10 g) of Body TSL	condition	
SAR measured	250 mW input power	1.39 W/kg
SAR for nominal Body TSL parameters	normalized to 1W	5.55 W/kg \pm 16.5 % (k=2)

Appendix (Additional assessments outside the scope of SCS 0108)

Antenna Parameters with Head TSL

Impedance, transformed to feed point	55.6 Ω - 1.9 j Ω
Return Loss	- 25.0 dB

Antenna Parameters with Body TSL

Impedance, transformed to feed point	50.6 Ω - 4.2 j Ω
Return Loss	- 27.6 dB

General Antenna Parameters and Design

Electrical Delay (one direction)	1.032 ns
----------------------------------	----------

After long term use with 100W radiated power, only a slight warming of the dipole near the feedpoint can be measured.

The dipole is made of standard semirigid coaxial cable. The center conductor of the feeding line is directly connected to the second arm of the dipole. The antenna is therefore short-circuited for DC-signals. On some of the dipoles, small end caps are added to the dipole arms in order to improve matching when loaded according to the position as explained in the "Measurement Conditions" paragraph. The SAR data are not affected by this change. The overall dipole length is still according to the Standard.

No excessive force must be applied to the dipole arms, because they might bend or the soldered connections near the feedpoint may be damaged.

Additional EUT Data

Manufactured by	SPEAG
Manufactured on	November 19, 2015

DASY5 Validation Report for Head TSL

Date: 19.10.2018

Test Laboratory: SPEAG, Zurich, Switzerland

DUT: Dipole 750 MHz; Type: D750V3; Serial: D750V3 - SN:1161

Communication System: UID 0 - CW; Frequency: 750 MHz

Medium parameters used: $f = 750$ MHz; $\sigma = 0.89$ S/m; $\epsilon_r = 40.8$; $\rho = 1000$ kg/m³

Phantom section: Flat Section

Measurement Standard: DASY5 (IEEE/IEC/ANSI C63.19-2011)

DASY52 Configuration:

- Probe: EX3DV4 - SN7349; ConvF(10.22, 10.22, 10.22) @ 750 MHz; Calibrated: 30.12.2017
- Sensor-Surface: 1.4mm (Mechanical Surface Detection)
- Electronics: DAE4 Sn601; Calibrated: 04.10.2018
- Phantom: Flat Phantom 4.9 (front); Type: QD 00L P49 AA; Serial: 1001
- DASY52 52.10.2(1495); SEMCAD X 14.6.12(7450)

Dipole Calibration for Head Tissue/Pin=250 mW, d=15mm/Zoom Scan (7x7x7)/Cube 0:

Measurement grid: dx=5mm, dy=5mm, dz=5mm

Reference Value = 58.51 V/m; Power Drift = -0.04 dB

Peak SAR (extrapolated) = 3.04 W/kg

SAR(1 g) = 2.02 W/kg; SAR(10 g) = 1.32 W/kg

Maximum value of SAR (measured) = 2.70 W/kg

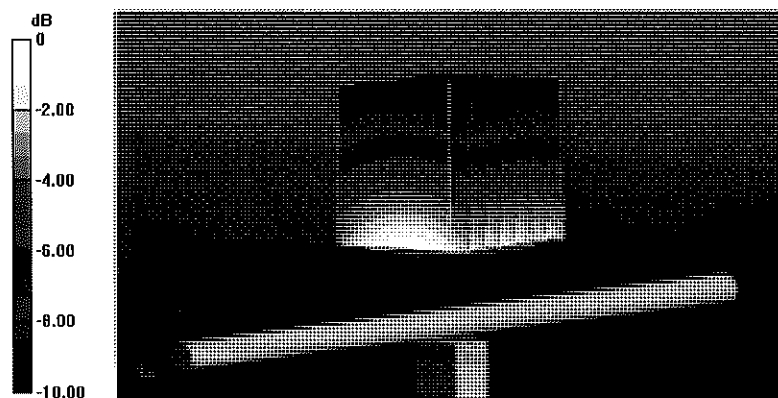

0 dB = 2.70 W/kg = 4.31 dBW/kg

Impedance Measurement Plot for Head TSL

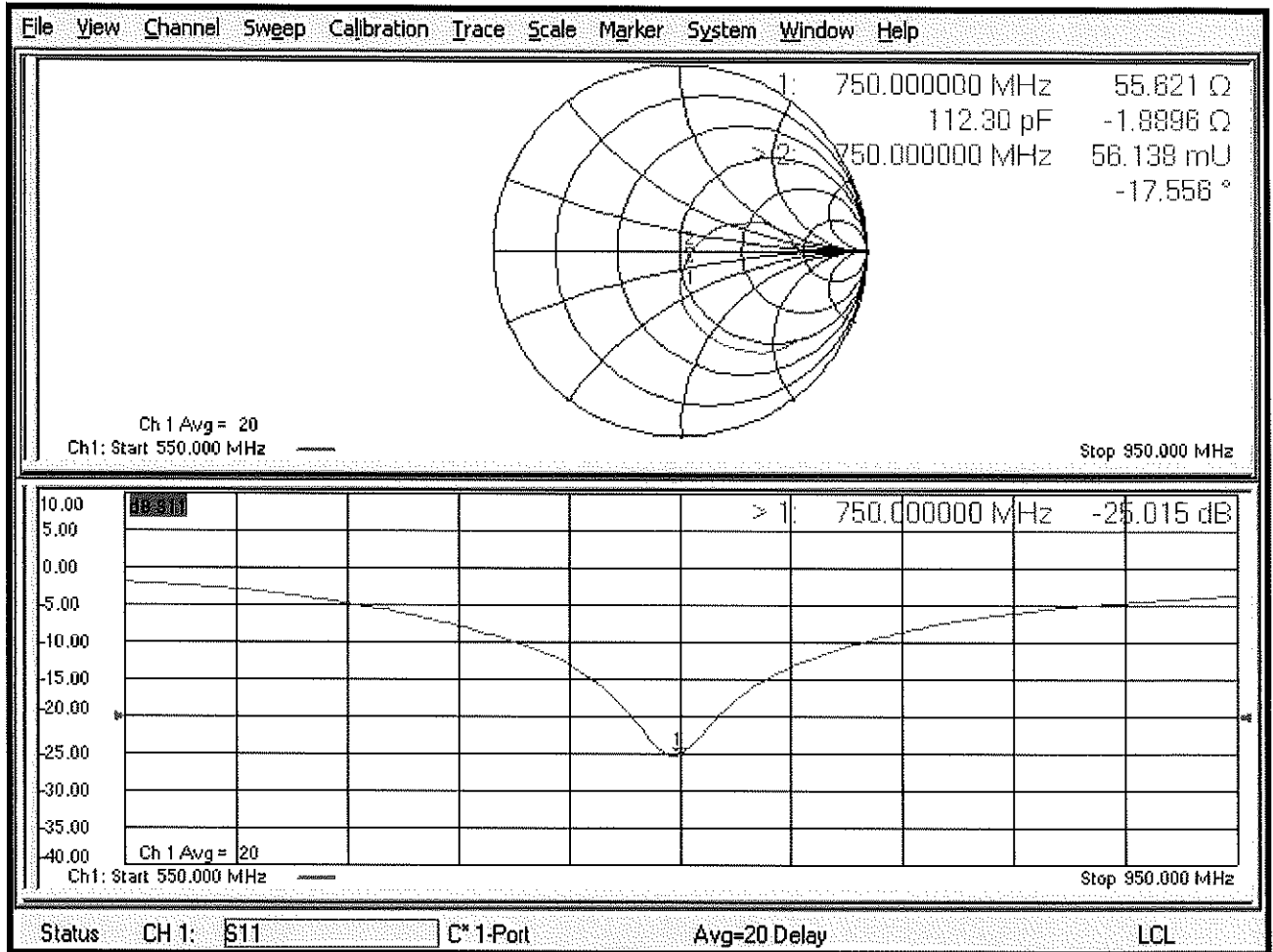

DASY5 Validation Report for Body TSL

Date: 19.10.2018

Test Laboratory: SPEAG, Zurich, Switzerland

DUT: Dipole 750 MHz; Type: D750V3; Serial: D750V3 - SN:1161

Communication System: UID 0 - CW; Frequency: 750 MHz

Medium parameters used: $f = 750$ MHz; $\sigma = 0.96$ S/m; $\epsilon_r = 55.1$; $\rho = 1000$ kg/m³

Phantom section: Flat Section

Measurement Standard: DASY5 (IEEE/IEC/ANSI C63.19-2011)

DASY52 Configuration:

- Probe: EX3DV4 - SN7349; ConvF(10.19, 10.19, 10.19) @ 750 MHz; Calibrated: 30.12.2017
- Sensor-Surface: 1.4mm (Mechanical Surface Detection)
- Electronics: DAE4 Sn601; Calibrated: 04.10.2018
- Phantom: Flat Phantom 4.9 (Back); Type: QD 00R P49 AA; Serial: 1005
- DASY52 52.10.2(1495); SEMCAD X 14.6.12(7450)

Dipole Calibration for Body Tissue/Pin=250 mW, d=15mm/Zoom Scan (7x7x7)/Cube 0:

Measurement grid: dx=5mm, dy=5mm, dz=5mm

Reference Value = 57.57 V/m; Power Drift = -0.02 dB

Peak SAR (extrapolated) = 3.18 W/kg

SAR(1 g) = 2.11 W/kg; SAR(10 g) = 1.39 W/kg

Maximum value of SAR (measured) = 2.83 W/kg

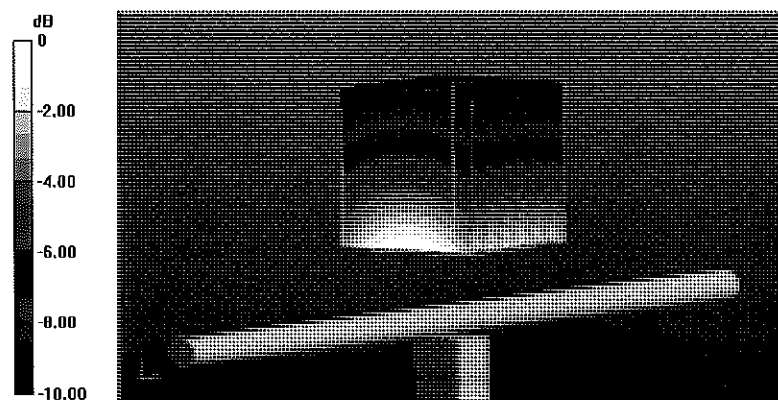

0 dB = 2.83 W/kg = 4.52 dBW/kg

Impedance Measurement Plot for Body TSL

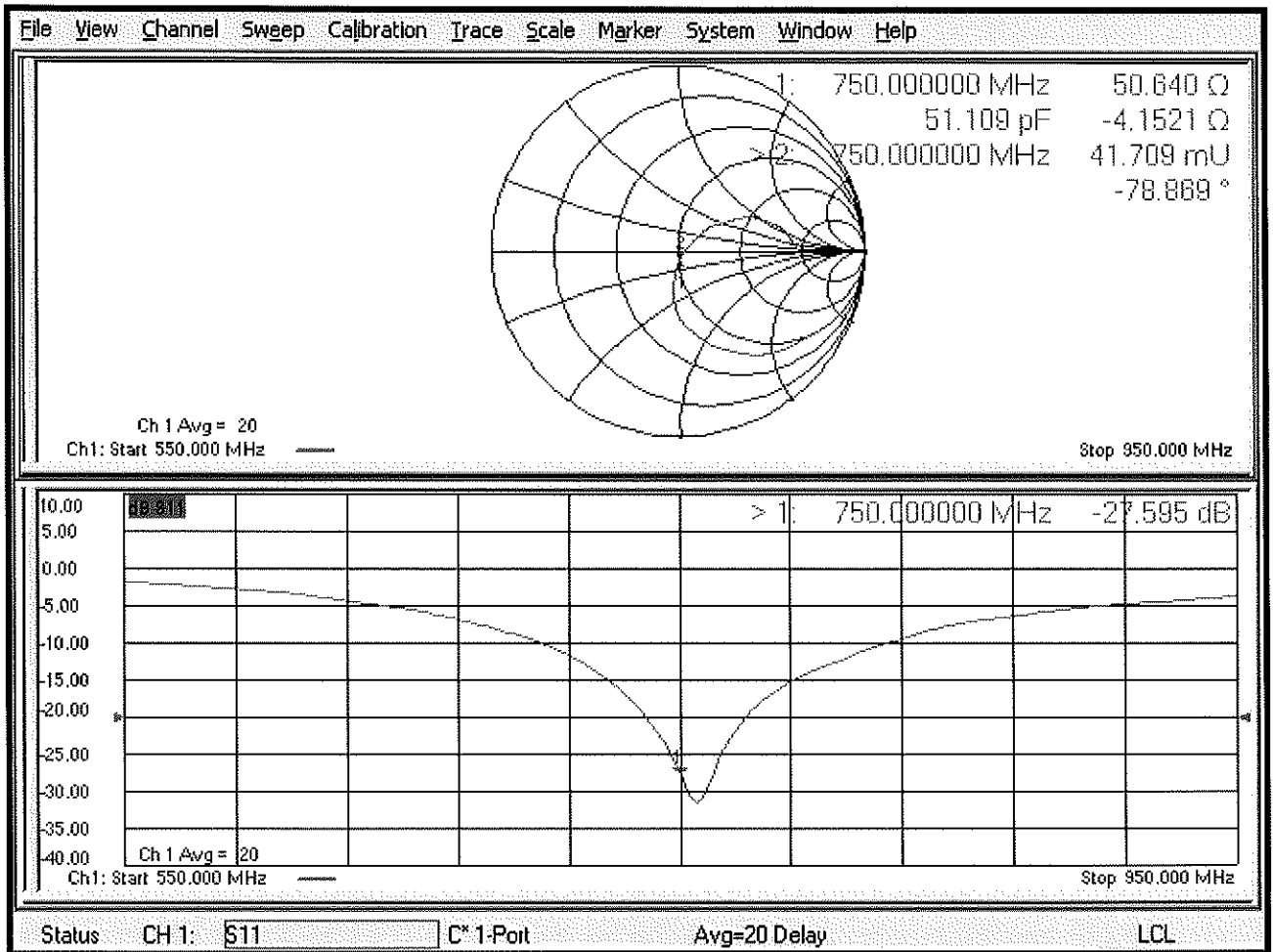

Certification of Calibration

Object D750V3 – SN:1161

Calibration procedure(s) Procedure for Calibration Extension for SAR Dipoles.

Extended Calibration date: October 18, 2019

Description: SAR Validation Dipole at 750 MHz.

Calibration Equipment used:

Manufacturer	Model	Description	Cal Date	Cal Interval	Cal Due	Serial Number
Control Company	4040	Therm./Clock/Humidity Monitor	6/29/2019	Biennial	6/29/2021	192291470
Control Company	4352	Ultra Long Stem Thermometer	8/2/2018	Biennial	8/2/2020	181334684
Amplifier Research	15S1G6	Amplifier	CBT	N/A	CBT	433971
Narda	4772-3	Attenuator (3dB)	CBT	N/A	CBT	9406
Keysight Technologies	85033E	Standard Mechanical Calibration Kit (DC to 9GHz, 3.5mm)	7/2/2019	Annual	7/2/2020	MY53401181
Rohde & Schwarz	ZNLE6	Vector Network Analyzer	10/11/2019	Annual	10/11/2020	101307
Mini-Circuits	BW-N20W5+	DC to 18 GHz Precision Fixed 20 dB Attenuator	CBT	N/A	CBT	N/A
SPEAG	DAKS-3.5	Portable Dielectric Assessment Kit	8/13/2019	Annual	8/13/2020	1041
Anritsu	MA2411B	Pulse Power Sensor	8/14/2019	Annual	8/14/2020	1315051
Anritsu	MA2411B	Pulse Power Sensor	8/8/2019	Annual	8/8/2020	1339008
Anritsu	ML2495A	Power Meter	11/20/2018	Annual	11/20/2019	1039008
Agilent	N5182A	MXG Vector Signal Generator	8/19/2019	Annual	8/19/2020	MY47420837
Seekonk	NC-100	Torque Wrench	5/9/2018	Biennial	5/9/2020	22217
Mini-Circuits	NLP-2950+	Low Pass Filter DC to 2700 MHz	CBT	N/A	CBT	N/A
MiniCircuits	ZHDC-16-63-S+	Bidirectional Coupler	CBT	N/A	CBT	N/A
MiniCircuits	VLF-6000+	Low Pass Filter	CBT	N/A	CBT	N/A
SPEAG	EX3DV4	SAR Probe	4/24/2019	Annual	4/24/2020	7357
SPEAG	EX3DV4	SAR Probe	7/16/2019	Annual	7/16/2020	7410
SPEAG	DAE4	Dasy Data Acquisition Electronics	7/11/2019	Annual	7/11/2020	1322
SPEAG	DAE4	Dasy Data Acquisition Electronics	4/18/2019	Annual	4/18/2020	1407

Note: CBT (Calibrated Before Testing). Prior to testing, the measurement paths containing a cable, amplifier, attenuator, coupler or filter were connected to a calibrated source (i.e. a signal generator) to determine the losses of the measurement path.

Measurement Uncertainty = $\pm 23\%$ (k=2)

	Name	Function	Signature
Calibrated By:	Brodie Halfoster	Team Lead Engineer	<i>BRODIE HALFOSTER</i>
Approved By:	Kaitlin O'Keefe	Senior Technical Manager	<i>KOK</i>

DIPOLE CALIBRATION EXTENSION

Per KDB 865664 D01, calibration intervals of up to three years may be considered for reference dipoles when it is demonstrated that the SAR target, impedance and return loss of a dipole have remained stable according to the following requirements:

1. The measured SAR does not deviate more than 10% from the target on the calibration certificate.
2. The return-loss does not deviate more than 20% from the previous measurement and meets the required 20dB minimum return-loss requirement.
3. The measurement of real or imaginary parts of impedance does not deviate more than 5Ω from the previous measurement.

The following dipole was checked to pass the above 3 requirements to have 2-year calibration period from the calibration date:

Calibration Date	Extension Date	Certificate Electrical Delay (ns)	Certificate SAR Target Head (1g) W/kg @ 23.0 dBm	Measured Head SAR (1g) W/kg @ 23.0 dBm	Deviation 1g (%)	Certificate SAR Target Head (10g) W/kg @ 23.0 dBm	Measured Head SAR (10g) W/kg @ 23.0 dBm	Deviation 10g (%)	Certificate Impedance Head (Ohm) Real	Measured Impedance Head (Ohm) Real	Difference (Ohm) Real	Certificate Impedance Head (Ohm) Imaginary	Measured Impedance Head (Ohm) Imaginary	Difference (Ohm) Imaginary	Certificate Return Loss Head (dB)	Measured Return Loss Head (dB)	Deviation (%)	PASS/FAIL
10/19/2018	10/18/2019	1.032	1.61	1.64	2.12%	1.05	1.08	2.86%	55.6	53.2	2.4	-1.9	-3.4	1.5	-25	-26.8	-7.30%	PASS
Calibration Date	Extension Date	Certificate Electrical Delay (ns)	Certificate SAR Target Body (1g) W/kg @ 23.0 dBm	Measured Body SAR (1g) W/kg @ 23.0 dBm	Deviation 1g (%)	Certificate SAR Target Body (10g) W/kg @ 23.0 dBm	Measured Body SAR (10g) W/kg @ 23.0 dBm	Deviation 10g (%)	Certificate Impedance Body (Ohm) Real	Measured Impedance Body (Ohm) Real	Difference (Ohm) Real	Certificate Impedance Body (Ohm) Imaginary	Measured Impedance Body (Ohm) Imaginary	Difference (Ohm) Imaginary	Certificate Return Loss Body (dB)	Measured Return Loss Body (dB)	Deviation (%)	PASS/FAIL
10/19/2018	10/18/2019	1.032	1.69	1.76	4.39%	1.11	1.17	5.41%	50.6	50	0.6	-4.2	-4	0.2	-27.6	-28.1	-1.80%	PASS

Impedance & Return-Loss Measurement Plot for Head TSL

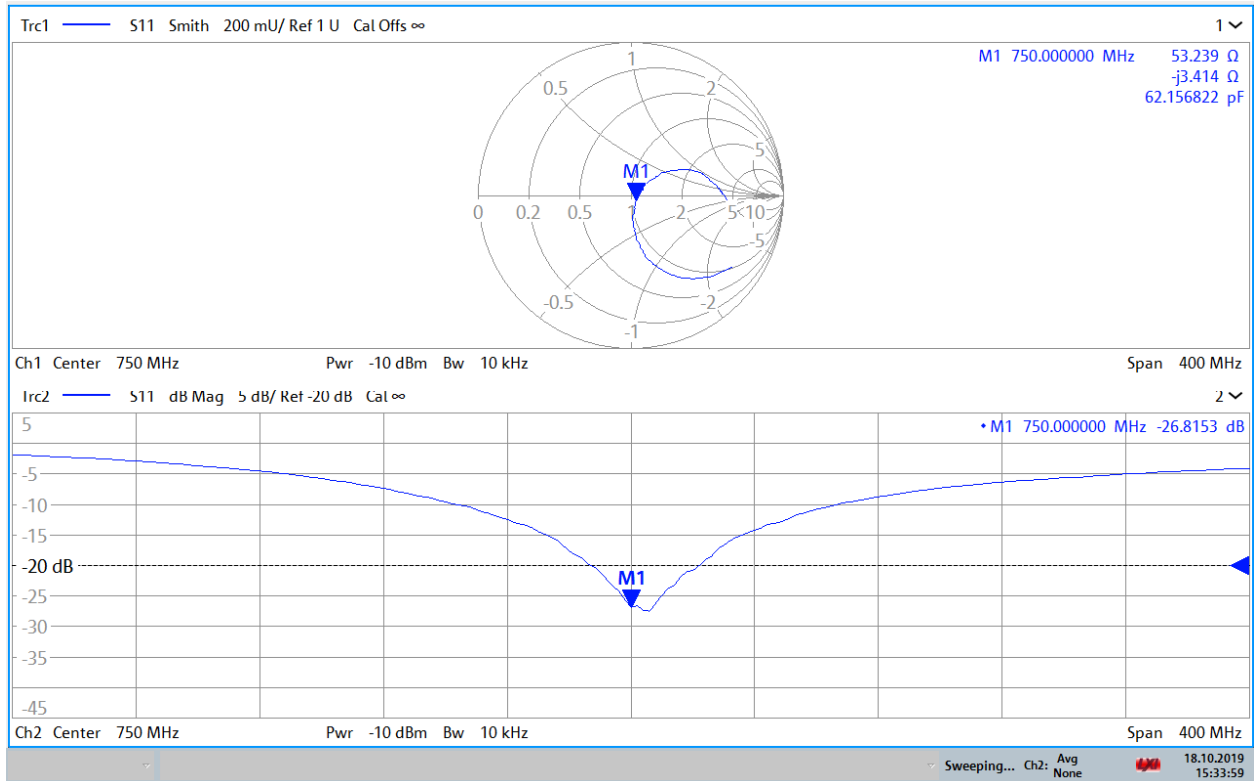

15:34:00 18.10.2019

Impedance & Return-Loss Measurement Plot for Body TSL

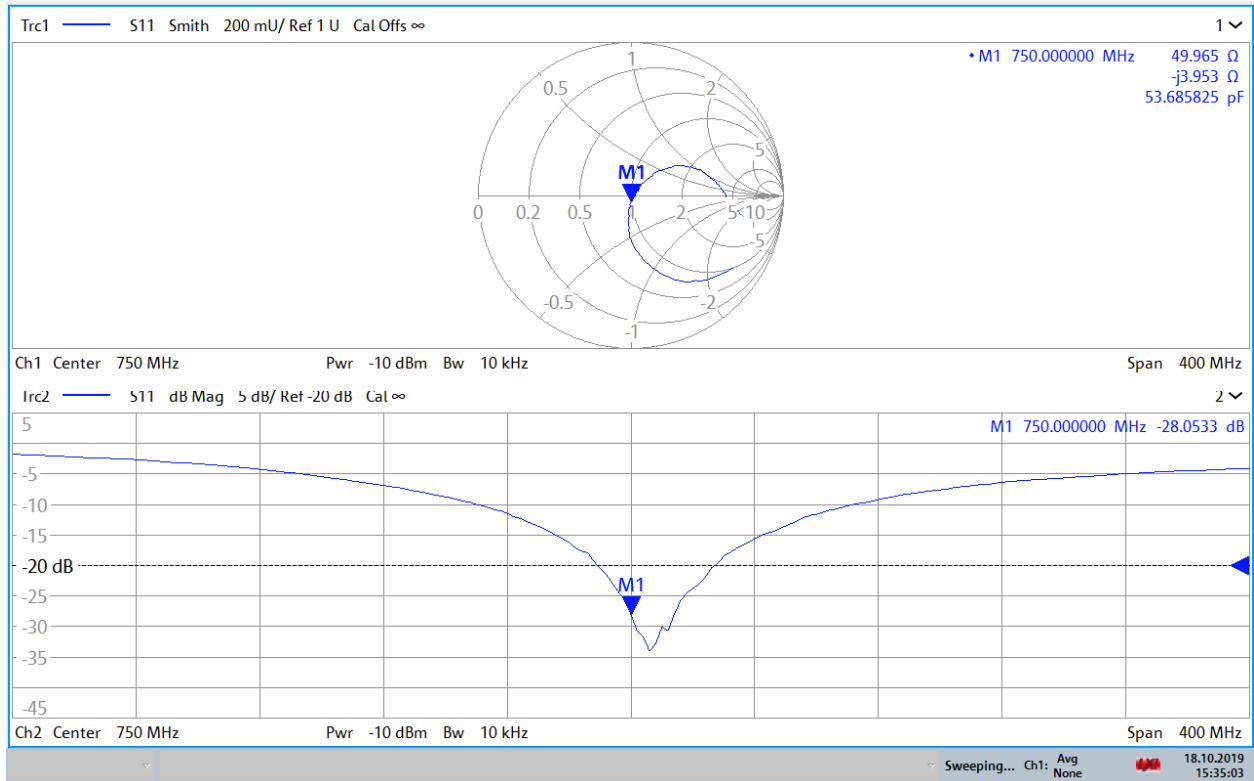

15:35:04 18.10.2019



Accredited by the Swiss Accreditation Service (SAS)
The Swiss Accreditation Service is one of the signatories to the EA
Multilateral Agreement for the recognition of calibration certificates

Accreditation No.: **SCS 0108**

Client **PC Test**

Certificate No: **D835V2-4d047_Mar19**

CALIBRATION CERTIFICATE

Object **D835V2 - SN:4d047**

Calibration procedure(s) **QA CAL-05.v11
Calibration Procedure for SAR Validation Sources between 0.7-3 GHz**

Calibration date: **March 13, 2019**

BN ✓
04-12-2019

This calibration certificate documents the traceability to national standards, which realize the physical units of measurements (SI).
The measurements and the uncertainties with confidence probability are given on the following pages and are part of the certificate.

All calibrations have been conducted in the closed laboratory facility: environment temperature (22 ± 3)°C and humidity < 70%.

Calibration Equipment used (M&TE critical for calibration)

Primary Standards	ID #	Cal Date (Certificate No.)	Scheduled Calibration
Power meter NRP	SN: 104778	04-Apr-18 (No. 217-02672/02673)	Apr-19
Power sensor NRP-Z91	SN: 103244	04-Apr-18 (No. 217-02672)	Apr-19
Power sensor NRP-Z91	SN: 103245	04-Apr-18 (No. 217-02673)	Apr-19
Reference 20 dB Attenuator	SN: 5058 (20k)	04-Apr-18 (No. 217-02682)	Apr-19
Type-N mismatch combination	SN: 5047.2 / 06327	04-Apr-18 (No. 217-02683)	Apr-19
Reference Probe EX3DV4	SN: 7349	31-Dec-18 (No. EX3-7349_Dec18)	Dec-19
DAE4	SN: 601	04-Oct-18 (No. DAE4-601_Oct18)	Oct-19

Secondary Standards	ID #	Check Date (in house)	Scheduled Check
Power meter E4419B	SN: GB39512475	07-Oct-15 (in house check Feb-19)	In house check: Oct-20
Power sensor HP 8481A	SN: US37292783	07-Oct-15 (in house check Oct-18)	In house check: Oct-20
Power sensor HP 8481A	SN: MY41092317	07-Oct-15 (in house check Oct-18)	In house check: Oct-20
RF generator R&S SMT-06	SN: 100972	15-Jun-15 (in house check Oct-18)	In house check: Oct-20
Network Analyzer Agilent E8358A	SN: US41080477	31-Mar-14 (in house check Oct-18)	In house check: Oct-19

Calibrated by:	Name Manu Seitz	Function Laboratory Technician	Signature
Approved by:	Name Katja Pokovic	Technical Manager	

Issued: March 13, 2019

This calibration certificate shall not be reproduced except in full without written approval of the laboratory.



Accredited by the Swiss Accreditation Service (SAS)

The Swiss Accreditation Service is one of the signatories to the EA
Multilateral Agreement for the recognition of calibration certificates

Accreditation No.: **SCS 0108**

Glossary:

TSL	tissue simulating liquid
ConvF	sensitivity in TSL / NORM x,y,z
N/A	not applicable or not measured

Calibration is Performed According to the Following Standards:

- IEEE Std 1528-2013, "IEEE Recommended Practice for Determining the Peak Spatial-Averaged Specific Absorption Rate (SAR) in the Human Head from Wireless Communications Devices: Measurement Techniques", June 2013
- IEC 62209-1, "Measurement procedure for the assessment of Specific Absorption Rate (SAR) from hand-held and body-mounted devices used next to the ear (frequency range of 300 MHz to 6 GHz)", July 2016
- IEC 62209-2, "Procedure to determine the Specific Absorption Rate (SAR) for wireless communication devices used in close proximity to the human body (frequency range of 30 MHz to 6 GHz)", March 2010
- KDB 865664, "SAR Measurement Requirements for 100 MHz to 6 GHz"

Additional Documentation:

- DASY4/5 System Handbook

Methods Applied and Interpretation of Parameters:

- Measurement Conditions:** Further details are available from the Validation Report at the end of the certificate. All figures stated in the certificate are valid at the frequency indicated.
- Antenna Parameters with TSL:** The dipole is mounted with the spacer to position its feed point exactly below the center marking of the flat phantom section, with the arms oriented parallel to the body axis.
- Feed Point Impedance and Return Loss:** These parameters are measured with the dipole positioned under the liquid filled phantom. The impedance stated is transformed from the measurement at the SMA connector to the feed point. The Return Loss ensures low reflected power. No uncertainty required.
- Electrical Delay:** One-way delay between the SMA connector and the antenna feed point. No uncertainty required.
- SAR measured:** SAR measured at the stated antenna input power.
- SAR normalized:** SAR as measured, normalized to an input power of 1 W at the antenna connector.
- SAR for nominal TSL parameters:** The measured TSL parameters are used to calculate the nominal SAR result.

The reported uncertainty of measurement is stated as the standard uncertainty of measurement multiplied by the coverage factor $k=2$, which for a normal distribution corresponds to a coverage probability of approximately 95%.

Measurement Conditions

DASY system configuration, as far as not given on page 1.

DASY Version	DASY5	V52.10.2
Extrapolation	Advanced Extrapolation	
Phantom	Modular Flat Phantom	
Distance Dipole Center - TSL	15 mm	with Spacer
Zoom Scan Resolution	dx, dy, dz = 5 mm	
Frequency	835 MHz \pm 1 MHz	

Head TSL parameters

The following parameters and calculations were applied.

	Temperature	Permittivity	Conductivity
Nominal Head TSL parameters	22.0 °C	41.5	0.90 mho/m
Measured Head TSL parameters	(22.0 \pm 0.2) °C	41.9 \pm 6 %	0.91 mho/m \pm 6 %
Head TSL temperature change during test	< 0.5 °C	----	----

SAR result with Head TSL

SAR averaged over 1 cm³ (1 g) of Head TSL	Condition	
SAR measured	250 mW input power	2.37 W/kg
SAR for nominal Head TSL parameters	normalized to 1W	9.42 W/kg \pm 17.0 % (k=2)

SAR averaged over 10 cm³ (10 g) of Head TSL	condition	
SAR measured	250 mW input power	1.54 W/kg
SAR for nominal Head TSL parameters	normalized to 1W	6.13 W/kg \pm 16.5 % (k=2)

Body TSL parameters

The following parameters and calculations were applied.

	Temperature	Permittivity	Conductivity
Nominal Body TSL parameters	22.0 °C	55.2	0.97 mho/m
Measured Body TSL parameters	(22.0 \pm 0.2) °C	54.3 \pm 6 %	1.01 mho/m \pm 6 %
Body TSL temperature change during test	< 0.5 °C	----	----

SAR result with Body TSL

SAR averaged over 1 cm³ (1 g) of Body TSL	Condition	
SAR measured	250 mW input power	2.45 W/kg
SAR for nominal Body TSL parameters	normalized to 1W	9.47 W/kg \pm 17.0 % (k=2)

SAR averaged over 10 cm³ (10 g) of Body TSL	condition	
SAR measured	250 mW input power	1.61 W/kg
SAR for nominal Body TSL parameters	normalized to 1W	6.27 W/kg \pm 16.5 % (k=2)

Appendix (Additional assessments outside the scope of SCS 0108)

Antenna Parameters with Head TSL

Impedance, transformed to feed point	51.4 Ω - 2.6 j Ω
Return Loss	- 30.7 dB

Antenna Parameters with Body TSL

Impedance, transformed to feed point	46.8 Ω - 6.1 j Ω
Return Loss	- 22.9 dB

General Antenna Parameters and Design

Electrical Delay (one direction)	1.387 ns
----------------------------------	----------

After long term use with 100W radiated power, only a slight warming of the dipole near the feedpoint can be measured.

The dipole is made of standard semirigid coaxial cable. The center conductor of the feeding line is directly connected to the second arm of the dipole. The antenna is therefore short-circuited for DC-signals. On some of the dipoles, small end caps are added to the dipole arms in order to improve matching when loaded according to the position as explained in the "Measurement Conditions" paragraph. The SAR data are not affected by this change. The overall dipole length is still according to the Standard.

No excessive force must be applied to the dipole arms, because they might bend or the soldered connections near the feedpoint may be damaged.

Additional EUT Data

Manufactured by	SPEAG
-----------------	-------

DASY5 Validation Report for Head TSL

Date: 13.03.2019

Test Laboratory: SPEAG, Zurich, Switzerland

DUT: Dipole 835 MHz; Type: D835V2; Serial: D835V2 - SN:4d047

Communication System: UID 0 - CW; Frequency: 835 MHz

Medium parameters used: $f = 835$ MHz; $\sigma = 0.91$ S/m; $\epsilon_r = 41.9$; $\rho = 1000$ kg/m³

Phantom section: Flat Section

Measurement Standard: DASY5 (IEEE/IEC/ANSI C63.19-2011)

DASY52 Configuration:

- Probe: EX3DV4 - SN7349; ConvF(10, 10, 10) @ 835 MHz; Calibrated: 31.12.2018
- Sensor-Surface: 1.4mm (Mechanical Surface Detection)
- Electronics: DAE4 Sn601; Calibrated: 04.10.2018
- Phantom: Flat Phantom 4.9 (front); Type: QD 00L P49 AA; Serial: 1001
- DASY52 52.10.2(1495); SEMCAD X 14.6.12(7450)

Dipole Calibration for Head Tissue/Pin=250 mW, d=15mm/Zoom Scan (7x7x7)/Cube 0:

Measurement grid: dx=5mm, dy=5mm, dz=5mm

Reference Value = 62.48 V/m; Power Drift = -0.08 dB

Peak SAR (extrapolated) = 3.60 W/kg

SAR(1 g) = 2.37 W/kg; SAR(10 g) = 1.54 W/kg

Maximum value of SAR (measured) = 3.18 W/kg

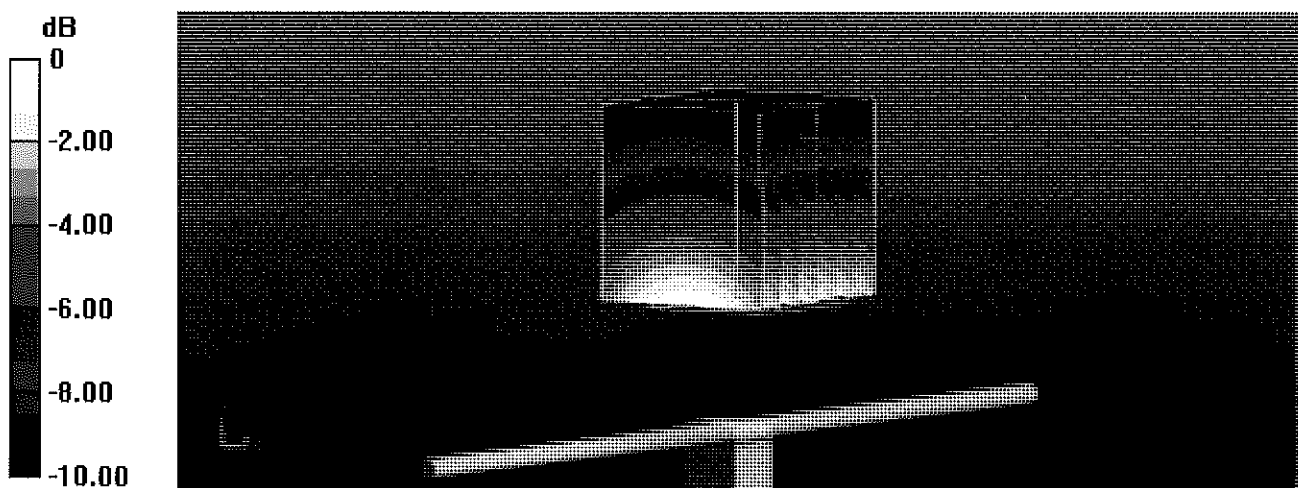

0 dB = 3.18 W/kg = 5.02 dBW/kg

Impedance Measurement Plot for Head TSL

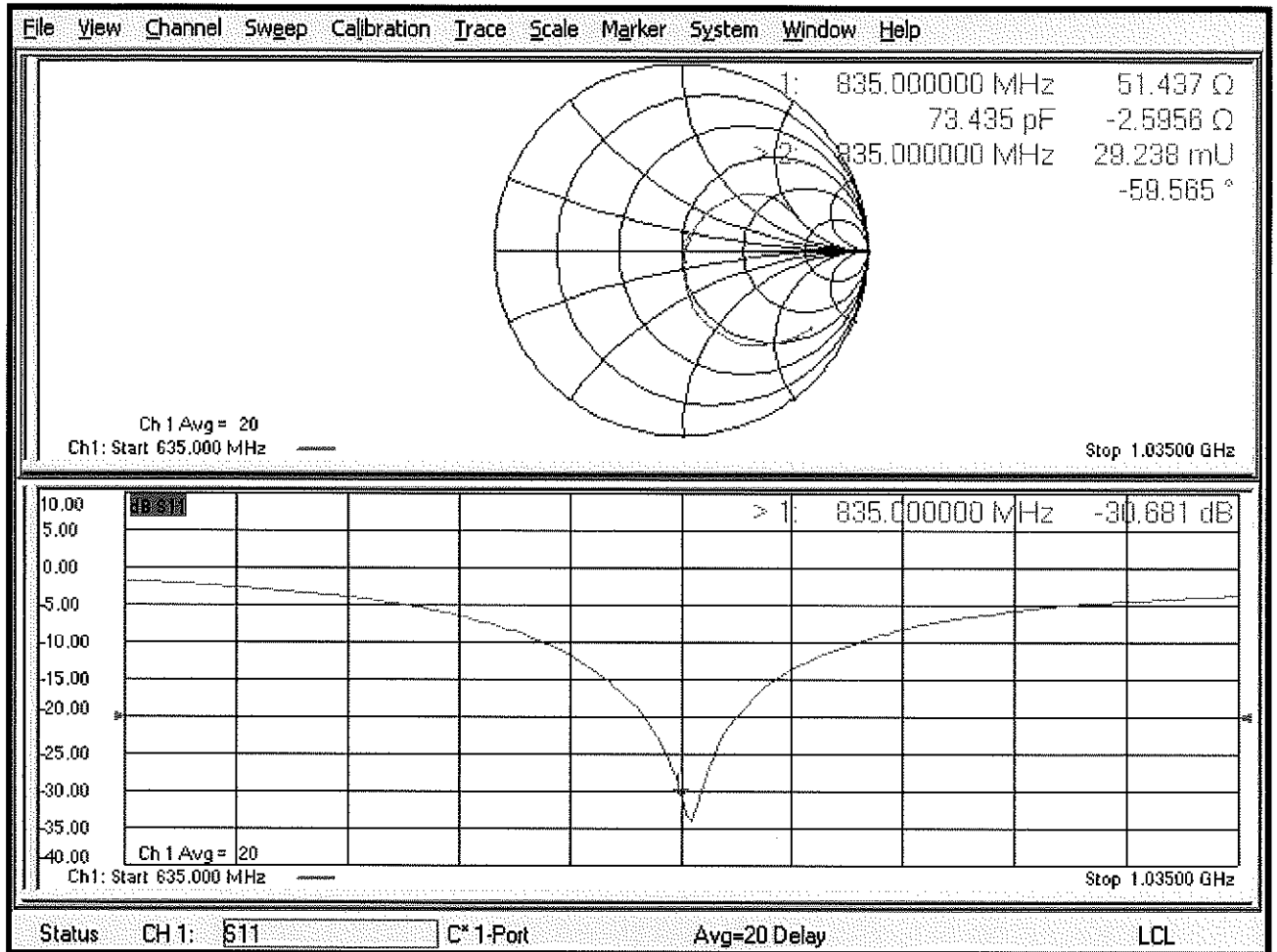

DASY5 Validation Report for Body TSL

Date: 13.03.2019

Test Laboratory: SPEAG, Zurich, Switzerland

DUT: Dipole 835 MHz; Type: D835V2; Serial: D835V2 - SN:4d047

Communication System: UID 0 - CW; Frequency: 835 MHz

Medium parameters used: $f = 835 \text{ MHz}$; $\sigma = 1.01 \text{ S/m}$; $\epsilon_r = 54.3$; $\rho = 1000 \text{ kg/m}^3$

Phantom section: Flat Section

Measurement Standard: DASY5 (IEEE/IEC/ANSI C63.19-2011)

DASY52 Configuration:

- Probe: EX3DV4 - SN7349; ConvF(10.15, 10.15, 10.15) @ 835 MHz; Calibrated: 31.12.2018
- Sensor-Surface: 1.4mm (Mechanical Surface Detection)
- Electronics: DAE4 Sn601; Calibrated: 04.10.2018
- Phantom: Flat Phantom 4.9 (Back); Type: QD 00R P49 AA; Serial: 1005
- DASY52 52.10.2(1495); SEMCAD X 14.6.12(7450)

Dipole Calibration for Body Tissue/Pin=250 mW, d=15mm/Zoom Scan (7x7x7)/Cube 0:

Measurement grid: $dx=5\text{mm}$, $dy=5\text{mm}$, $dz=5\text{mm}$

Reference Value = 60.49 V/m; Power Drift = -0.02 dB

Peak SAR (extrapolated) = 3.58 W/kg

SAR(1 g) = 2.45 W/kg; SAR(10 g) = 1.61 W/kg

Maximum value of SAR (measured) = 3.23 W/kg

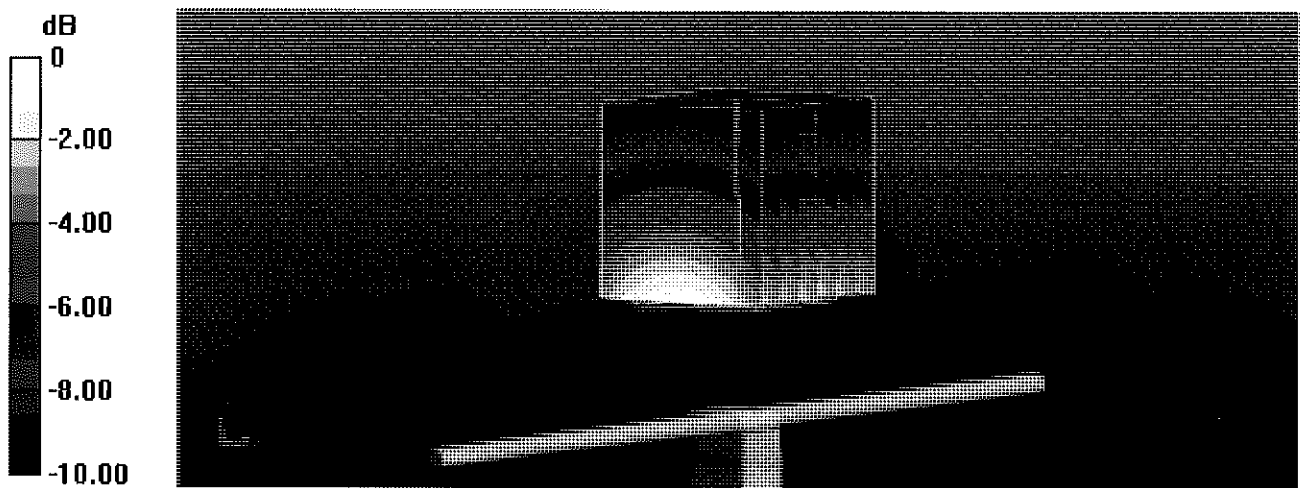

Impedance Measurement Plot for Body TSL

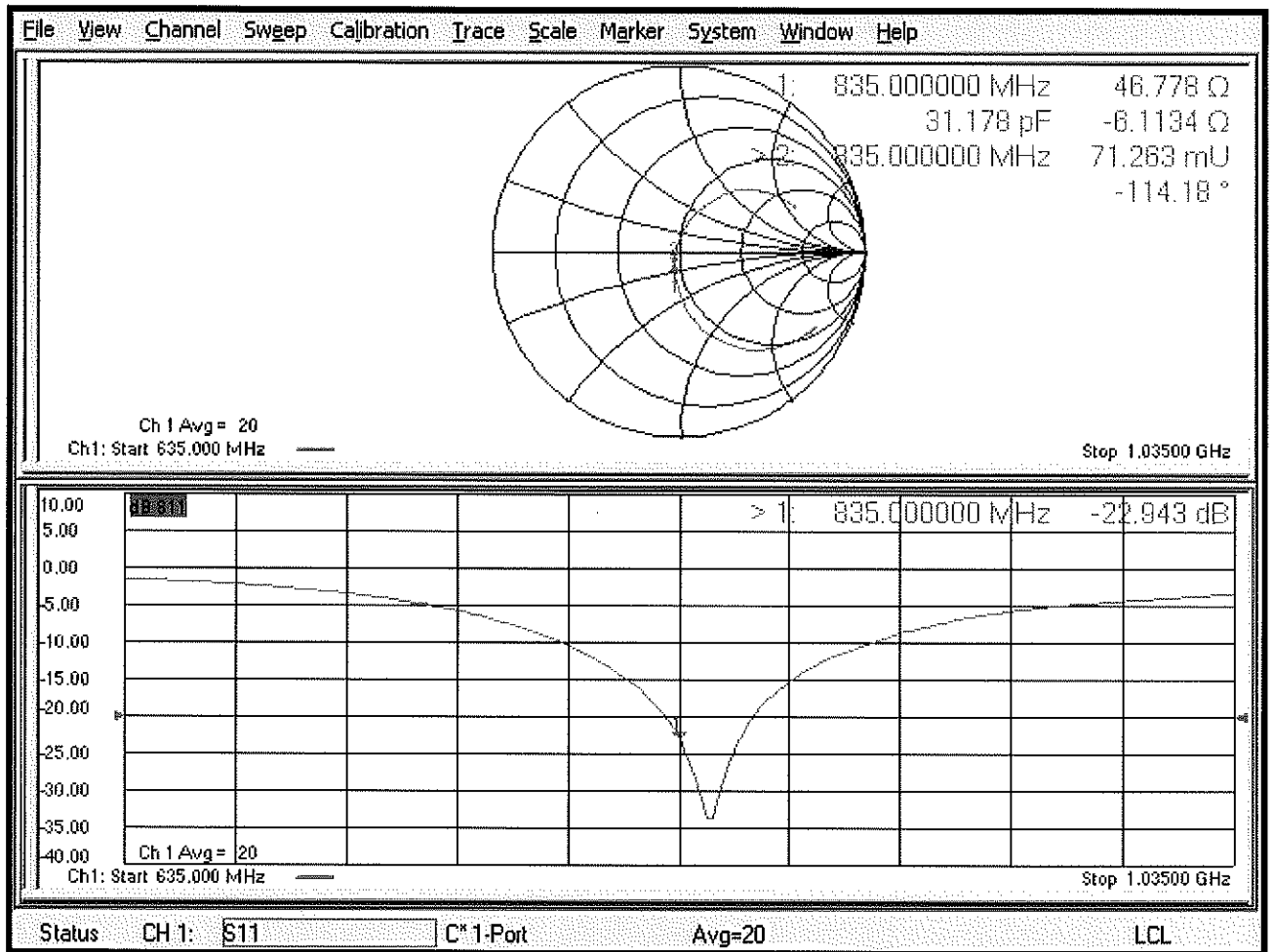



Accredited by the Swiss Accreditation Service (SAS)
The Swiss Accreditation Service is one of the signatories to the EA
Multilateral Agreement for the recognition of calibration certificates

Accreditation No.: **SCS 0108**

Client **PC Test**

Certificate No: **D835V2-4d133_Oct18**

CALIBRATION CERTIFICATE

Object **D835V2 - SN:4d133**

Calibration procedure(s) **QA CAL-05.v10
Calibration procedure for dipole validation kits above 700 MHz**

*BN ✓
10/30/2018
BN ✓
10-20-2019*

Calibration date: **October 19, 2018**

This calibration certificate documents the traceability to national standards, which realize the physical units of measurements (SI).
The measurements and the uncertainties with confidence probability are given on the following pages and are part of the certificate.

All calibrations have been conducted in the closed laboratory facility: environment temperature (22 ± 3)°C and humidity < 70%.

Calibration Equipment used (M&TE critical for calibration)

Primary Standards	ID #	Cal Date (Certificate No.)	Scheduled Calibration
Power meter NRP	SN: 104778	04-Apr-18 (No. 217-02672/02673)	Apr-19
Power sensor NRP-Z91	SN: 103244	04-Apr-18 (No. 217-02672)	Apr-19
Power sensor NRP-Z91	SN: 103245	04-Apr-18 (No. 217-02673)	Apr-19
Reference 20 dB Attenuator	SN: 5058 (20k)	04-Apr-18 (No. 217-02682)	Apr-19
Type-N mismatch combination	SN: 5047.2 / 06327	04-Apr-18 (No. 217-02683)	Apr-19
Reference Probe EX3DV4	SN: 7349	30-Dec-17 (No. EX3-7349_Dec17)	Dec-18
DAE4	SN: 601	04-Oct-18 (No. DAE4-601_Oct18)	Oct-19

Secondary Standards	ID #	Check Date (In house)	Scheduled Check
Power meter EPM-442A	SN: GB37480704	07-Oct-15 (in house check Oct-18)	In house check: Oct-20
Power sensor HP 8481A	SN: US37292783	07-Oct-15 (in house check Oct-18)	In house check: Oct-20
Power sensor HP 8481A	SN: MY41092317	07-Oct-15 (in house check Oct-18)	In house check: Oct-20
RF generator R&S SMT-06	SN: 100972	15-Jun-15 (in house check Oct-18)	In house check: Oct-20
Network Analyzer Agilent E8358A	SN: US41080477	31-Mar-14 (in house check Oct-18)	In house check: Oct-19

	Name	Function	Signature
Calibrated by:	Manu Seitz	Laboratory Technician	
Approved by:	Kolja Pokovic	Technical Manager	

Issued: October 22, 2018

This calibration certificate shall not be reproduced except in full without written approval of the laboratory.



Accredited by the Swiss Accreditation Service (SAS)

The Swiss Accreditation Service is one of the signatories to the EA Multilateral Agreement for the recognition of calibration certificates

Accreditation No.: **SCS 0108**

Glossary:

TSL	tissue simulating liquid
ConvF	sensitivity in TSL / NORM x,y,z
N/A	not applicable or not measured

Calibration is Performed According to the Following Standards:

- IEEE Std 1528-2013, "IEEE Recommended Practice for Determining the Peak Spatial-Averaged Specific Absorption Rate (SAR) in the Human Head from Wireless Communications Devices: Measurement Techniques", June 2013
- IEC 62209-1, "Measurement procedure for the assessment of Specific Absorption Rate (SAR) from hand-held and body-mounted devices used next to the ear (frequency range of 300 MHz to 6 GHz)", July 2016
- IEC 62209-2, "Procedure to determine the Specific Absorption Rate (SAR) for wireless communication devices used in close proximity to the human body (frequency range of 30 MHz to 6 GHz)", March 2010
- KDB 865664, "SAR Measurement Requirements for 100 MHz to 6 GHz"

Additional Documentation:

- DASY4/5 System Handbook

Methods Applied and Interpretation of Parameters:

- Measurement Conditions:** Further details are available from the Validation Report at the end of the certificate. All figures stated in the certificate are valid at the frequency indicated.
- Antenna Parameters with TSL:** The dipole is mounted with the spacer to position its feed point exactly below the center marking of the flat phantom section, with the arms oriented parallel to the body axis.
- Feed Point Impedance and Return Loss:** These parameters are measured with the dipole positioned under the liquid filled phantom. The impedance stated is transformed from the measurement at the SMA connector to the feed point. The Return Loss ensures low reflected power. No uncertainty required.
- Electrical Delay:** One-way delay between the SMA connector and the antenna feed point. No uncertainty required.
- SAR measured:** SAR measured at the stated antenna input power.
- SAR normalized:** SAR as measured, normalized to an input power of 1 W at the antenna connector.
- SAR for nominal TSL parameters:** The measured TSL parameters are used to calculate the nominal SAR result.

The reported uncertainty of measurement is stated as the standard uncertainty of measurement multiplied by the coverage factor $k=2$, which for a normal distribution corresponds to a coverage probability of approximately 95%.

Measurement Conditions

DASY system configuration, as far as not given on page 1.

DASY Version	DASY5	V52.10.2
Extrapolation	Advanced Extrapolation	
Phantom	Modular Flat Phantom	
Distance Dipole Center - TSL	15 mm	with Spacer
Zoom Scan Resolution	dx, dy, dz = 5 mm	
Frequency	835 MHz \pm 1 MHz	

Head TSL parameters

The following parameters and calculations were applied.

	Temperature	Permittivity	Conductivity
Nominal Head TSL parameters	22.0 °C	41.5	0.90 mho/m
Measured Head TSL parameters	(22.0 \pm 0.2) °C	40.6 \pm 6 %	0.91 mho/m \pm 6 %
Head TSL temperature change during test	< 0.5 °C	----	----

SAR result with Head TSL

SAR averaged over 1 cm³ (1 g) of Head TSL	Condition	
SAR measured	250 mW input power	2.39 W/kg
SAR for nominal Head TSL parameters	normalized to 1W	9.43 W/kg \pm 17.0 % (k=2)

SAR averaged over 10 cm³ (10 g) of Head TSL	condition	
SAR measured	250 mW input power	1.54 W/kg
SAR for nominal Head TSL parameters	normalized to 1W	6.10 W/kg \pm 16.5 % (k=2)

Body TSL parameters

The following parameters and calculations were applied.

	Temperature	Permittivity	Conductivity
Nominal Body TSL parameters	22.0 °C	55.2	0.97 mho/m
Measured Body TSL parameters	(22.0 \pm 0.2) °C	54.9 \pm 6 %	0.98 mho/m \pm 6 %
Body TSL temperature change during test	< 0.5 °C	----	----

SAR result with Body TSL

SAR averaged over 1 cm³ (1 g) of Body TSL	Condition	
SAR measured	250 mW input power	2.46 W/kg
SAR for nominal Body TSL parameters	normalized to 1W	9.75 W/kg \pm 17.0 % (k=2)

SAR averaged over 10 cm³ (10 g) of Body TSL	condition	
SAR measured	250 mW input power	1.61 W/kg
SAR for nominal Body TSL parameters	normalized to 1W	6.40 W/kg \pm 16.5 % (k=2)

Appendix (Additional assessments outside the scope of SCS 0108)

Antenna Parameters with Head TSL

Impedance, transformed to feed point	50.6 Ω - 2.4 j Ω
Return Loss	- 32.2 dB

Antenna Parameters with Body TSL

Impedance, transformed to feed point	45.0 Ω - 6.7 j Ω
Return Loss	- 21.1 dB

General Antenna Parameters and Design

Electrical Delay (one direction)	1.397 ns
----------------------------------	----------

After long term use with 100W radiated power, only a slight warming of the dipole near the feedpoint can be measured.

The dipole is made of standard semirigid coaxial cable. The center conductor of the feeding line is directly connected to the second arm of the dipole. The antenna is therefore short-circuited for DC-signals. On some of the dipoles, small end caps are added to the dipole arms in order to improve matching when loaded according to the position as explained in the "Measurement Conditions" paragraph. The SAR data are not affected by this change. The overall dipole length is still according to the Standard.

No excessive force must be applied to the dipole arms, because they might bend or the soldered connections near the feedpoint may be damaged.

Additional EUT Data

Manufactured by	SPEAG
Manufactured on	July 22, 2011

DASY5 Validation Report for Head TSL

Date: 19.10.2018

Test Laboratory: The name of your organization

DUT: Dipole 835 MHz; Type: D835V2; Serial: D835V2 - SN:4d133

Communication System: UID 0 - CW; Frequency: 835 MHz

Medium parameters used: $f = 835$ MHz; $\sigma = 0.91$ S/m; $\epsilon_r = 40.6$; $\rho = 1000$ kg/m³

Phantom section: Flat Section

Measurement Standard: DASY5 (IEEE/IEC/ANSI C63.19-2011)

DASY52 Configuration:

- Probe: EX3DV4 - SN7349; ConvF(9.9, 9.9, 9.9) @ 835 MHz; Calibrated: 30.12.2017
- Sensor-Surface: 1.4mm (Mechanical Surface Detection)
- Electronics: DAE4 Sn601; Calibrated: 04.10.2018
- Phantom: Flat Phantom 4.9 (front); Type: QD 00L P49 AA; Serial: 1001
- DASY52 52.10.2(1495); SEMCAD X 14.6.12(7450)

Dipole Calibration for Head Tissue/Pin=250 mW, d=15mm/Zoom Scan (7x7x7)/Cube 0:

Measurement grid: dx=5mm, dy=5mm, dz=5mm

Reference Value = 63.02 V/m; Power Drift = -0.02 dB

Peak SAR (extrapolated) = 3.68 W/kg

SAR(1 g) = 2.39 W/kg; SAR(10 g) = 1.54 W/kg

Maximum value of SAR (measured) = 3.24 W/kg

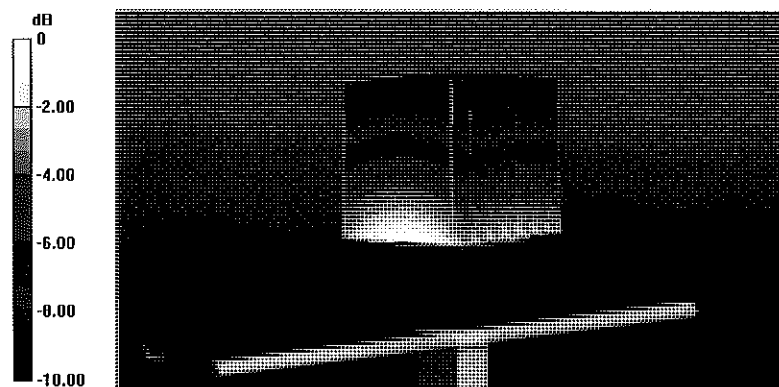

0 dB = 3.24 W/kg = 5.11 dBW/kg

Impedance Measurement Plot for Head TSL

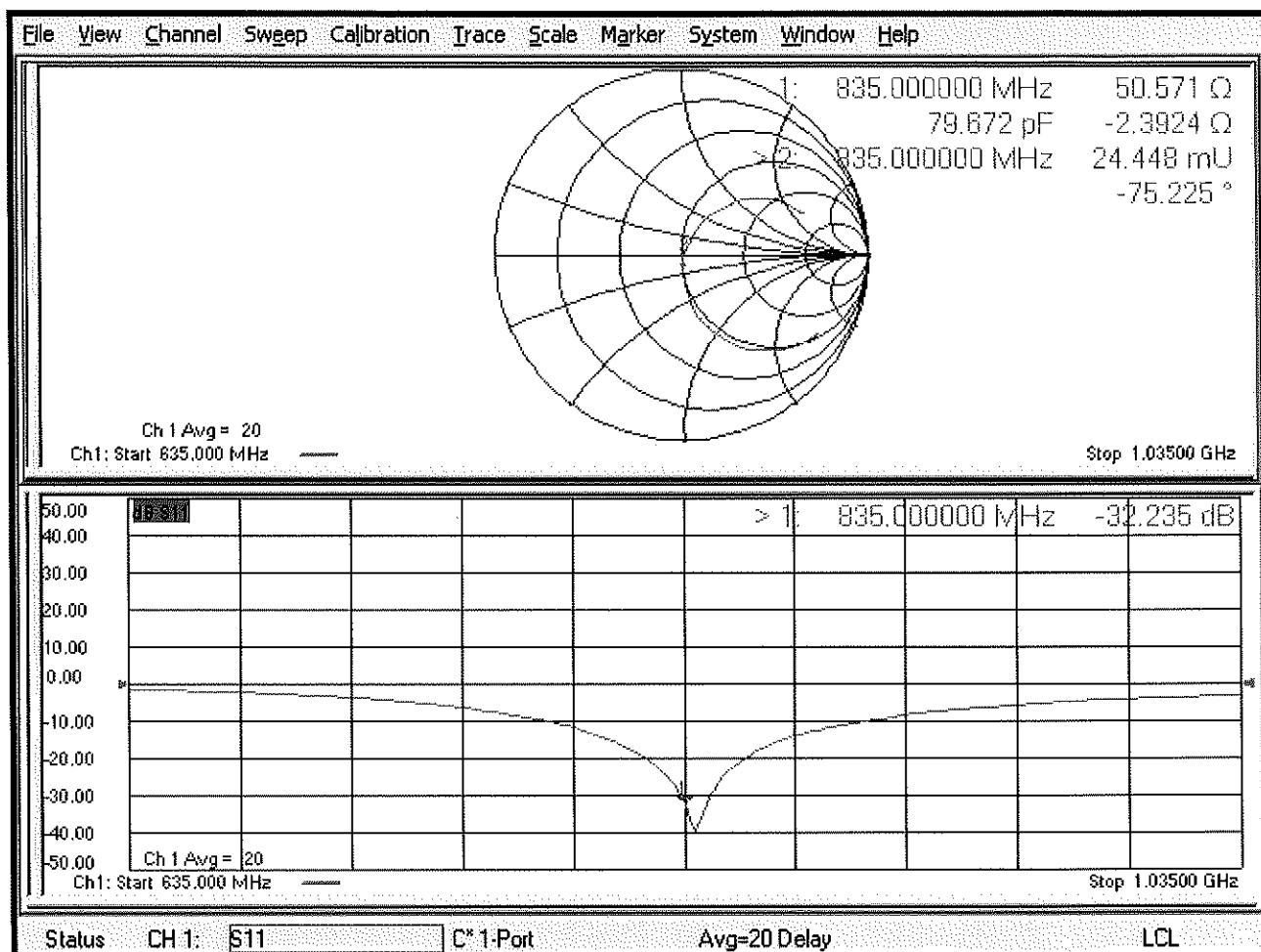

DASY5 Validation Report for Body TSL

Date: 19.10.2018

Test Laboratory: SPEAG, Zurich, Switzerland

DUT: Dipole 835 MHz; Type: D835V2; Serial: D835V2 - SN:4d133

Communication System: UID 0 - CW; Frequency: 835 MHz

Medium parameters used: $f = 835$ MHz; $\sigma = 0.98$ S/m; $\epsilon_r = 54.9$; $\rho = 1000$ kg/m³

Phantom section: Flat Section

Measurement Standard: DASY5 (IEEE/IEC/ANSI C63.19-2011)

DASY52 Configuration:

- Probe: EX3DV4 - SN7349; ConvF(10.05, 10.05, 10.05) @ 835 MHz; Calibrated: 30.12.2017
- Sensor-Surface: 1.4mm (Mechanical Surface Detection)
- Electronics: DAE4 Sn601; Calibrated: 04.10.2018
- Phantom: Flat Phantom 4.9 (Back); Type: QD 00R P49 AA; Serial: 1005
- DASY52 52.10.2(1495); SEMCAD X 14.6.12(7450)

Dipole Calibration for Body Tissue/Pin=250 mW, d=15mm/Zoom Scan (7x7x7)/Cube 0:

Measurement grid: dx=5mm, dy=5mm, dz=5mm

Reference Value = 61.61 V/m; Power Drift = -0.02 dB

Peak SAR (extrapolated) = 3.69 W/kg

SAR(1 g) = 2.46 W/kg; SAR(10 g) = 1.61 W/kg

Maximum value of SAR (measured) = 3.28 W/kg

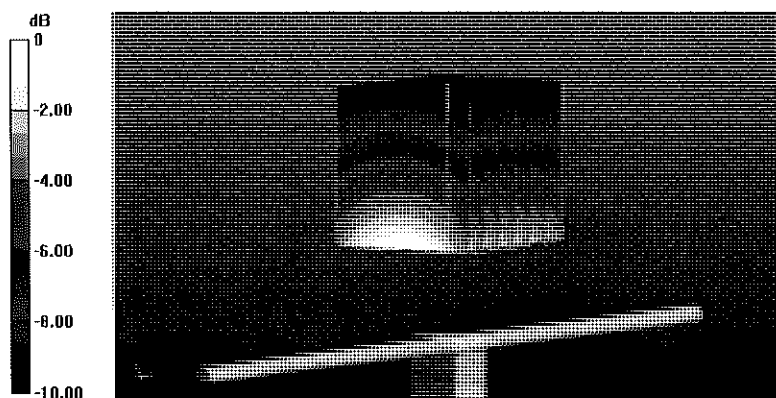

0 dB = 3.28 W/kg = 5.16 dBW/kg

Impedance Measurement Plot for Body TSL

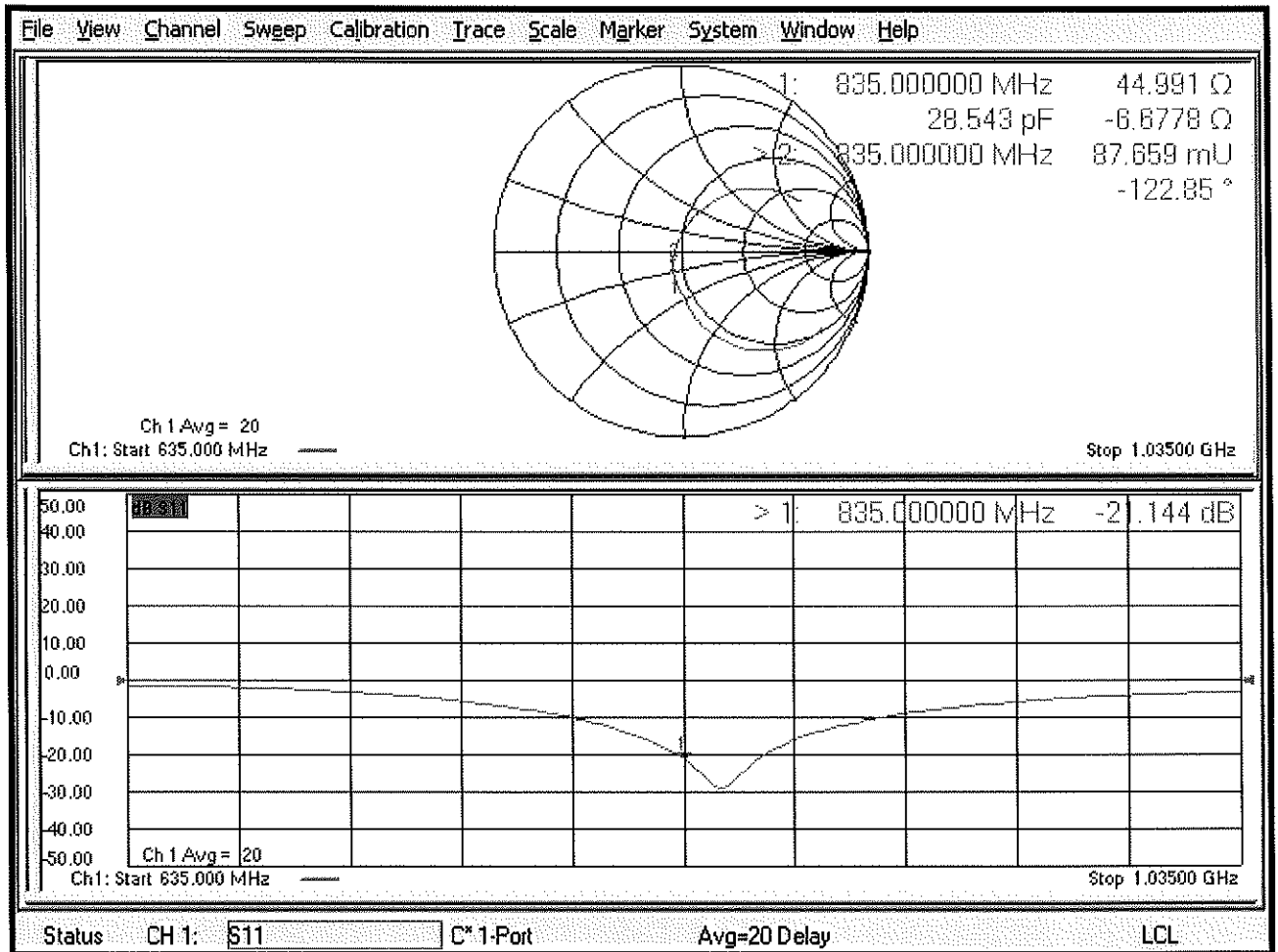

Certification of Calibration

Object D835V2 – SN:4d133

Calibration procedure(s) Procedure for Calibration Extension for SAR Dipoles.

Extended Calibration date: October 18, 2019

Description: SAR Validation Dipole at 835 MHz.

Calibration Equipment used:

Manufacturer	Model	Description	Cal Date	Cal Interval	Cal Due	Serial Number
Control Company	4040	Therm./Clock/Humidity Monitor	6/29/2019	Biennial	6/29/2021	192291470
Control Company	4352	Ultra Long Stem Thermometer	8/2/2018	Biennial	8/2/2020	181334684
Amplifier Research	15S1G6	Amplifier	CBT	N/A	CBT	433971
Narda	4772-3	Attenuator (3dB)	CBT	N/A	CBT	9406
Keysight Technologies	85033E	Standard Mechanical Calibration Kit (DC to 9GHz, 3.5mm)	7/2/2019	Annual	7/2/2020	MY53401181
Rohde & Schwarz	ZNLE6	Vector Network Analyzer	10/11/2019	Annual	10/11/2020	101307
Mini-Circuits	BW-N20W5+	DC to 18 GHz Precision Fixed 20 dB Attenuator	CBT	N/A	CBT	N/A
SPEAG	DAKS-3.5	Portable Dielectric Assessment Kit	8/13/2019	Annual	8/13/2020	1041
Anritsu	MA2411B	Pulse Power Sensor	8/14/2019	Annual	8/14/2020	1315051
Anritsu	MA2411B	Pulse Power Sensor	8/8/2019	Annual	8/8/2020	1339008
Anritsu	ML2495A	Power Meter	11/20/2018	Annual	11/20/2019	1039008
Agilent	N5182A	MXG Vector Signal Generator	8/19/2019	Annual	8/19/2020	MY47420837
Seekonk	NC-100	Torque Wrench	5/9/2018	Biennial	5/9/2020	22217
Mini-Circuits	NLP-2950+	Low Pass Filter DC to 2700 MHz	CBT	N/A	CBT	N/A
MiniCircuits	ZHDC-16-63-S+	Bidirectional Coupler	CBT	N/A	CBT	N/A
MiniCircuits	VLF-6000+	Low Pass Filter	CBT	N/A	CBT	N/A
SPEAG	EX3DV4	SAR Probe	9/19/2019	Annual	9/19/2020	7551
SPEAG	EX3DV4	SAR Probe	4/24/2019	Annual	4/24/2020	7357
SPEAG	DAE4	Dasy Data Acquisition Electronics	9/17/2019	Annual	9/17/2020	1333
SPEAG	DAE4	Dasy Data Acquisition Electronics	4/18/2019	Annual	4/18/2020	1407

Note: CBT (Calibrated Before Testing). Prior to testing, the measurement paths containing a cable, amplifier, attenuator, coupler or filter were connected to a calibrated source (i.e. a signal generator) to determine the losses of the measurement path.

Measurement Uncertainty = $\pm 23\%$ (k=2)

	Name	Function	Signature
Calibrated By:	Brodie Halfoster	Team Lead Engineer	<i>BRODIE HALFOSTER</i>
Approved By:	Kaitlin O'Keefe	Senior Technical Manager	<i>KOK</i>

DIPOLE CALIBRATION EXTENSION

Per KDB 865664 D01, calibration intervals of up to three years may be considered for reference dipoles when it is demonstrated that the SAR target, impedance and return loss of a dipole have remained stable according to the following requirements:

1. The measured SAR does not deviate more than 10% from the target on the calibration certificate.
2. The return-loss does not deviate more than 20% from the previous measurement and meets the required 20dB minimum return-loss requirement.
3. The measurement of real or imaginary parts of impedance does not deviate more than 5Ω from the previous measurement.

The following dipole was checked to pass the above 3 requirements to have 2-year calibration period from the calibration date:

Calibration Date	Extension Date	Certificate Electrical Delay (ns)	Certificate SAR Target Head (1g) W/kg @ 23.0 dBm	Measured Head SAR (1g) W/kg @ 23.0 dBm	Deviation 1g (%)	Certificate SAR Target Head (10g) W/kg @ 23.0 dBm	Measured Head SAR (10g) W/kg @ 23.0 dBm	Deviation 10g (%)	Certificate Impedance Head (Ohm) Real	Measured Impedance Head (Ohm) Real	Difference (Ohm) Real	Certificate Impedance Head (Ohm) Imaginary	Measured Impedance Head (Ohm) Imaginary	Difference (Ohm) Imaginary	Certificate Return Loss Head (dB)	Measured Return Loss Head (dB)	Deviation (%)	PASS/FAIL
10/19/2018	10/18/2019	1.397	1.886	2.03	7.64%	1.22	1.32	8.20%	50.6	49.5	1.1	-2.4	-3.2	0.8	-32.2	-29.8	7.50%	PASS
Calibration Date	Extension Date	Certificate Electrical Delay (ns)	Certificate SAR Target Body (1g) W/kg @ 23.0 dBm	Measured Body SAR (1g) W/kg @ 23.0 dBm	Deviation 1g (%)	Certificate SAR Target Body (10g) W/kg @ 23.0 dBm	Measured Body SAR (10g) W/kg @ 23.0 dBm	Deviation 10g (%)	Certificate Impedance Body (Ohm) Real	Measured Impedance Body (Ohm) Real	Difference (Ohm) Real	Certificate Impedance Body (Ohm) Imaginary	Measured Impedance Body (Ohm) Imaginary	Difference (Ohm) Imaginary	Certificate Return Loss Body (dB)	Measured Return Loss Body (dB)	Deviation (%)	PASS/FAIL
10/19/2018	10/18/2019	1.397	1.96	2.07	6.15%	1.28	1.36	6.25%	45	45.1	0.1	-6.7	-5.1	1.6	-21.1	-22.6	-6.90%	PASS

Impedance & Return-Loss Measurement Plot for Head TSL

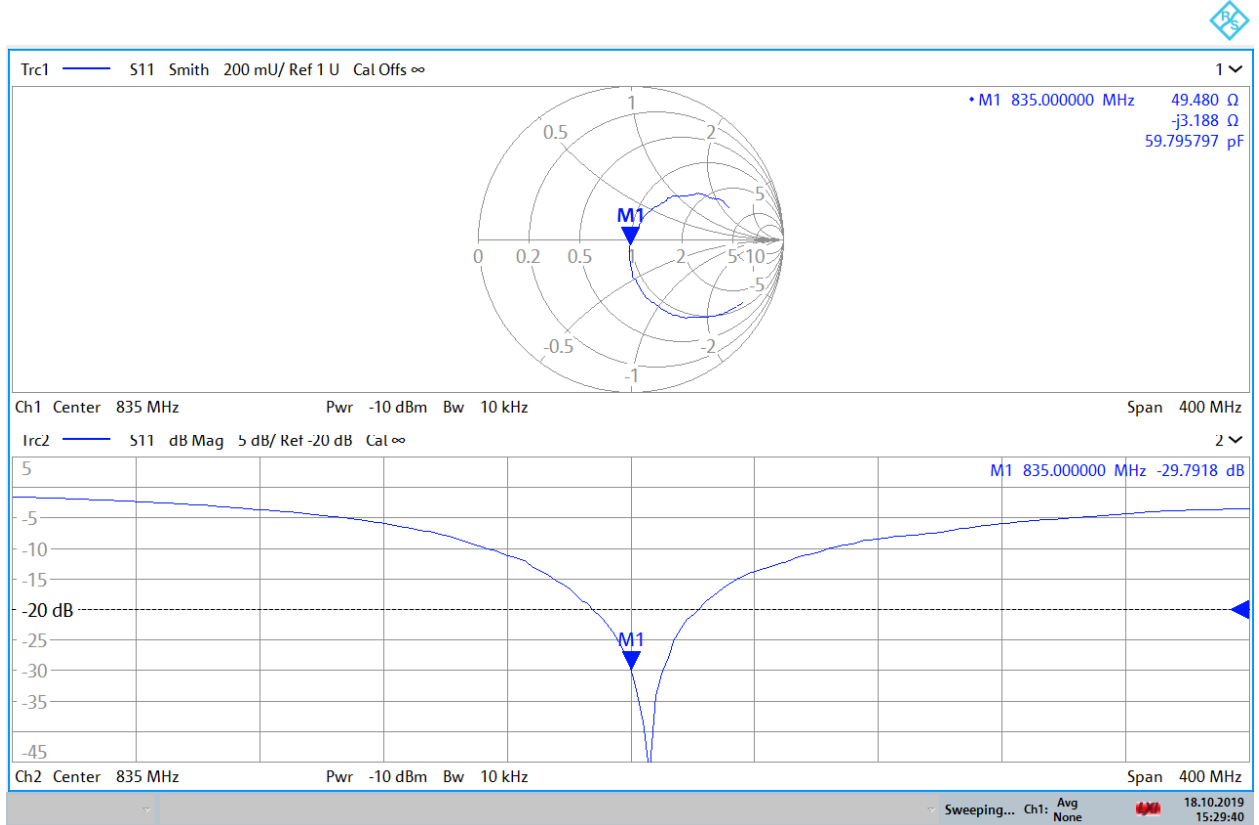

15:29:41 18.10.2019

Impedance & Return-Loss Measurement Plot for Body TSL

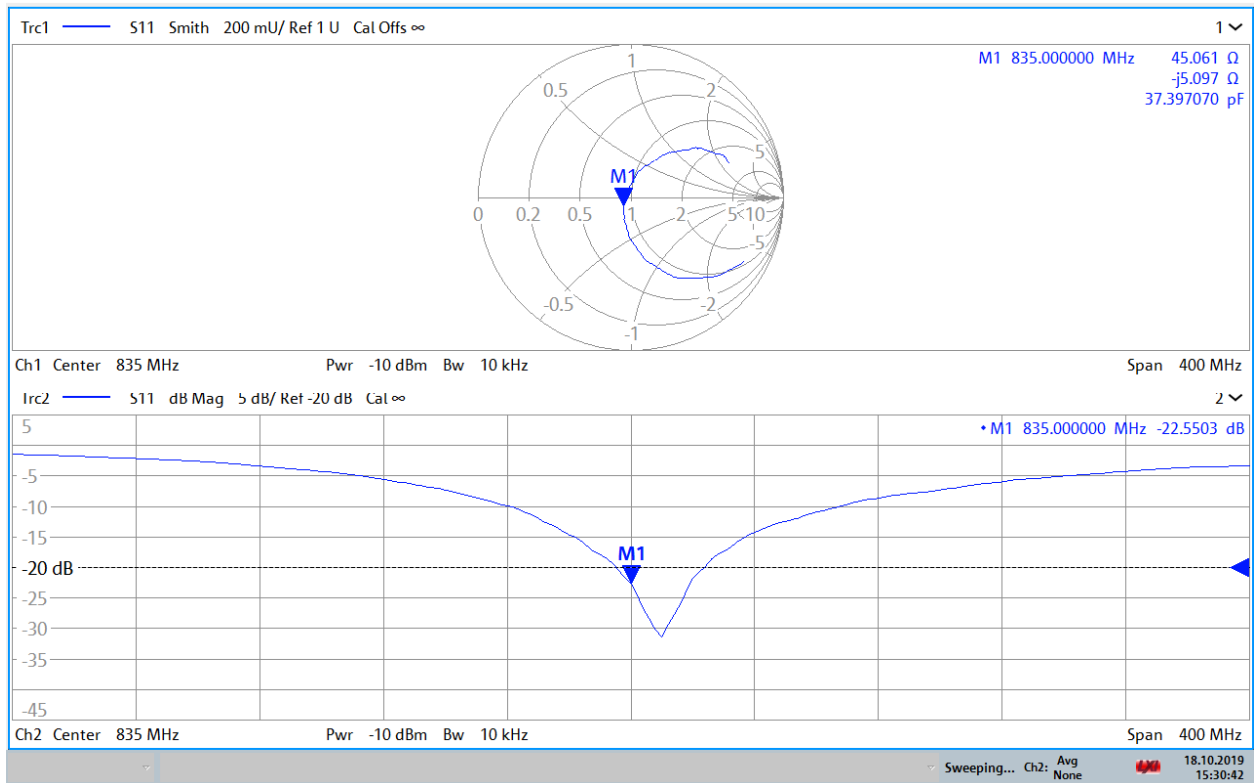

15:30:43 18.10.2019



Accredited by the Swiss Accreditation Service (SAS)
The Swiss Accreditation Service is one of the signatories to the EA
Multilateral Agreement for the recognition of calibration certificates

Accreditation No.: **SCS 0108**

Client **PC Test**

Certificate No: **D1750V2-1148_May19**

CALIBRATION CERTIFICATE

Object **D1750V2 - SN:1148**

Calibration procedure(s) **QA CAL-05.v11
Calibration Procedure for SAR Validation Sources between 0.7-3 GHz**

Calibration date: **May 15, 2019**

BNW
05-23-2019

This calibration certificate documents the traceability to national standards, which realize the physical units of measurements (SI).
The measurements and the uncertainties with confidence probability are given on the following pages and are part of the certificate.

All calibrations have been conducted in the closed laboratory facility: environment temperature (22 ± 3)°C and humidity < 70%.

Calibration Equipment used (M&TE critical for calibration)

Primary Standards	ID #	Cal Date (Certificate No.)	Scheduled Calibration
Power meter NRP	SN: 104778	03-Apr-19 (No. 217-02892/02893)	Apr-20
Power sensor NRP-Z91	SN: 103244	03-Apr-19 (No. 217-02892)	Apr-20
Power sensor NRP-Z91	SN: 103245	03-Apr-19 (No. 217-02893)	Apr-20
Reference 20 dB Attenuator	SN: 5058 (20k)	04-Apr-19 (No. 217-02894)	Apr-20
Type-N mismatch combination	SN: 5047.2 / 06327	04-Apr-19 (No. 217-02895)	Apr-20
Reference Probe EX3DV4	SN: 7349	31-Dec-18 (No. EX3-7349_Dec18)	Dec-19
DAE4	SN: 601	30-Apr-19 (No. DAE4-601_Apr19)	Apr-20

Secondary Standards	ID #	Check Date (in house)	Scheduled Check
Power meter E4419B	SN: GB39512475	30-Oct-14 (in house check Feb-19)	In house check: Oct-20
Power sensor HP 8481A	SN: US37292783	07-Oct-15 (in house check Oct-18)	In house check: Oct-20
Power sensor HP 8481A	SN: MY41092317	07-Oct-15 (in house check Oct-18)	In house check: Oct-20
RF generator R&S SMT-06	SN: 100972	15-Jun-15 (in house check Oct-18)	In house check: Oct-20
Network Analyzer Agilent E8358A	SN: US41080477	31-Mar-14 (in house check Oct-18)	In house check: Oct-19

Calibrated by:	Name	Function	Signature
	Leif Klysner	Laboratory Technician	<i>Leif Klysner</i>

Approved by:	Name	Function
	Katja Pokovic	Technical Manager

Katja Pokovic

Issued: May 15, 2019

This calibration certificate shall not be reproduced except in full without written approval of the laboratory.



Accredited by the Swiss Accreditation Service (SAS)
The Swiss Accreditation Service is one of the signatories to the EA
Multilateral Agreement for the recognition of calibration certificates

Accreditation No.: **SCS 0108**

Glossary:

TSL	tissue simulating liquid
ConvF	sensitivity in TSL / NORM x,y,z
N/A	not applicable or not measured

Calibration is Performed According to the Following Standards:

- a) IEEE Std 1528-2013, "IEEE Recommended Practice for Determining the Peak Spatial-Averaged Specific Absorption Rate (SAR) in the Human Head from Wireless Communications Devices: Measurement Techniques", June 2013
- b) IEC 62209-1, "Measurement procedure for the assessment of Specific Absorption Rate (SAR) from hand-held and body-mounted devices used next to the ear (frequency range of 300 MHz to 6 GHz)", July 2016
- c) IEC 62209-2, "Procedure to determine the Specific Absorption Rate (SAR) for wireless communication devices used in close proximity to the human body (frequency range of 30 MHz to 6 GHz)", March 2010
- d) KDB 865664, "SAR Measurement Requirements for 100 MHz to 6 GHz"

Additional Documentation:

- e) DASY4/5 System Handbook

Methods Applied and Interpretation of Parameters:

- *Measurement Conditions:* Further details are available from the Validation Report at the end of the certificate. All figures stated in the certificate are valid at the frequency indicated.
- *Antenna Parameters with TSL:* The dipole is mounted with the spacer to position its feed point exactly below the center marking of the flat phantom section, with the arms oriented parallel to the body axis.
- *Feed Point Impedance and Return Loss:* These parameters are measured with the dipole positioned under the liquid filled phantom. The impedance stated is transformed from the measurement at the SMA connector to the feed point. The Return Loss ensures low reflected power. No uncertainty required.
- *Electrical Delay:* One-way delay between the SMA connector and the antenna feed point. No uncertainty required.
- *SAR measured:* SAR measured at the stated antenna input power.
- *SAR normalized:* SAR as measured, normalized to an input power of 1 W at the antenna connector.
- *SAR for nominal TSL parameters:* The measured TSL parameters are used to calculate the nominal SAR result.

The reported uncertainty of measurement is stated as the standard uncertainty of measurement multiplied by the coverage factor $k=2$, which for a normal distribution corresponds to a coverage probability of approximately 95%.

Measurement Conditions

DASY system configuration, as far as not given on page 1.

DASY Version	DASY5	V52.10.2
Extrapolation	Advanced Extrapolation	
Phantom	Modular Flat Phantom	
Distance Dipole Center - TSL	10 mm	with Spacer
Zoom Scan Resolution	dx, dy, dz = 5.0 mm	
Frequency	1750 MHz \pm 1 MHz	

Head TSL parameters

The following parameters and calculations were applied.

	Temperature	Permittivity	Conductivity
Nominal Head TSL parameters	22.0 °C	40.1	1.37 mho/m
Measured Head TSL parameters	(22.0 \pm 0.2) °C	40.0 \pm 6 %	1.34 mho/m \pm 6 %
Head TSL temperature change during test	< 0.5 °C	---	----

SAR result with Head TSL

SAR averaged over 1 cm³ (1 g) of Head TSL	Condition	
SAR measured	250 mW input power	9.13 W/kg
SAR for nominal Head TSL parameters	normalized to 1W	37.0 W/kg \pm 17.0 % (k=2)

SAR averaged over 10 cm³ (10 g) of Head TSL	condition	
SAR measured	250 mW input power	4.83 W/kg
SAR for nominal Head TSL parameters	normalized to 1W	19.5 W/kg \pm 16.5 % (k=2)

Body TSL parameters

The following parameters and calculations were applied.

	Temperature	Permittivity	Conductivity
Nominal Body TSL parameters	22.0 °C	53.4	1.49 mho/m
Measured Body TSL parameters	(22.0 \pm 0.2) °C	53.5 \pm 6 %	1.47 mho/m \pm 6 %
Body TSL temperature change during test	< 0.5 °C	---	----

SAR result with Body TSL

SAR averaged over 1 cm³ (1 g) of Body TSL	Condition	
SAR measured	250 mW input power	9.35 W/kg
SAR for nominal Body TSL parameters	normalized to 1W	37.7 W/kg \pm 17.0 % (k=2)

SAR averaged over 10 cm³ (10 g) of Body TSL	condition	
SAR measured	250 mW input power	4.93 W/kg
SAR for nominal Body TSL parameters	normalized to 1W	19.8 W/kg \pm 16.5 % (k=2)

Appendix (Additional assessments outside the scope of SCS 0108)

Antenna Parameters with Head TSL

Impedance, transformed to feed point	51.4 Ω - 0.2 j Ω
Return Loss	- 37.0 dB

Antenna Parameters with Body TSL

Impedance, transformed to feed point	47.4 Ω - 0.5 j Ω
Return Loss	- 31.4 dB

General Antenna Parameters and Design

Electrical Delay (one direction)	1.222 ns
----------------------------------	----------

After long term use with 100W radiated power, only a slight warming of the dipole near the feedpoint can be measured.

The dipole is made of standard semirigid coaxial cable. The center conductor of the feeding line is directly connected to the second arm of the dipole. The antenna is therefore short-circuited for DC-signals. On some of the dipoles, small end caps are added to the dipole arms in order to improve matching when loaded according to the position as explained in the "Measurement Conditions" paragraph. The SAR data are not affected by this change. The overall dipole length is still according to the Standard.

No excessive force must be applied to the dipole arms, because they might bend or the soldered connections near the feedpoint may be damaged.

Additional EUT Data

Manufactured by	SPEAG
-----------------	-------

Appendix (Additional assessments outside the scope of SCS 0108)

Measurement Conditions

DASY system configuration, as far as not given on page 1 and 3.

Phantom	SAM Head Phantom	For usage with cSAR3DV2-R/L
---------	------------------	-----------------------------

SAR result with SAM Head (Top)

SAR averaged over 1 cm ³ (1 g) of Head TSL	Condition	
SAR measured	250 mW input power	9.38 W/kg
SAR for nominal Head TSL parameters	normalized to 1W	37.9 W/kg ± 17.5 % (k=2)

SAR averaged over 10 cm ³ (10 g) of Head TSL	condition	
SAR measured	250 mW input power	5.04 W/kg
SAR for nominal Head TSL parameters	normalized to 1W	20.3 W/kg ± 16.9 % (k=2)

SAR result with SAM Head (Mouth)

SAR averaged over 1 cm ³ (1 g) of Head TSL	Condition	
SAR measured	250 mW input power	9.34 W/kg
SAR for nominal Head TSL parameters	normalized to 1W	37.8 W/kg ± 17.5 % (k=2)

SAR averaged over 10 cm ³ (10 g) of Head TSL	condition	
SAR measured	250 mW input power	5.04 W/kg
SAR for nominal Head TSL parameters	normalized to 1W	20.3 W/kg ± 16.9 % (k=2)

SAR result with SAM Head (Neck)

SAR averaged over 1 cm ³ (1 g) of Head TSL	Condition	
SAR measured	250 mW input power	9.06 W/kg
SAR for nominal Head TSL parameters	normalized to 1W	36.6 W/kg ± 17.5 % (k=2)

SAR averaged over 10 cm ³ (10 g) of Head TSL	condition	
SAR measured	250 mW input power	4.95 W/kg
SAR for nominal Head TSL parameters	normalized to 1W	19.9 W/kg ± 16.9 % (k=2)

SAR result with SAM Head (Ear)

SAR averaged over 1 cm ³ (1 g) of Head TSL	Condition	
SAR measured	250 mW input power	7.11 W/kg
SAR for nominal Head TSL parameters	normalized to 1W	28.7 W/kg ± 17.5 % (k=2)

SAR averaged over 10 cm ³ (10 g) of Head TSL	condition	
SAR measured	250 mW input power	3.98 W/kg
SAR for nominal Head TSL parameters	normalized to 1W	16.0 W/kg ± 16.9 % (k=2)

DASY5 Validation Report for Head TSL

Date: 08.05.2019

Test Laboratory: SPEAG, Zurich, Switzerland

DUT: Dipole 1750 MHz; Type: D1750V2; Serial: D1750V2 - SN:1148

Communication System: UID 0 - CW; Frequency: 1750 MHz

Medium parameters used: $f = 1750$ MHz; $\sigma = 1.34$ S/m; $\epsilon_r = 40$; $\rho = 1000$ kg/m³

Phantom section: Flat Section

Measurement Standard: DASY5 (IEEE/IEC/ANSI C63.19-2011)

DASY52 Configuration:

- Probe: EX3DV4 - SN7349; ConvF(8.59, 8.59, 8.59) @ 1750 MHz; Calibrated: 31.12.2018
- Sensor-Surface: 1.4mm (Mechanical Surface Detection)
- Electronics: DAE4 Sn601; Calibrated: 30.04.2019
- Phantom: Flat Phantom 5.0 (front); Type: QD 000 P50 AA; Serial: 1001
- DASY52 52.10.2(1495); SEMCAD X 14.6.12(7450)

Dipole Calibration for Head Tissue/Pin=250 mW, d=10mm/Zoom Scan (7x7x7)/Cube 0:

Measurement grid: dx=5mm, dy=5mm, dz=5mm

Reference Value = 107.8 V/m; Power Drift = -0.01 dB

Peak SAR (extrapolated) = 16.7 W/kg

SAR(1 g) = 9.13 W/kg; SAR(10 g) = 4.83 W/kg

Maximum value of SAR (measured) = 14.1 W/kg

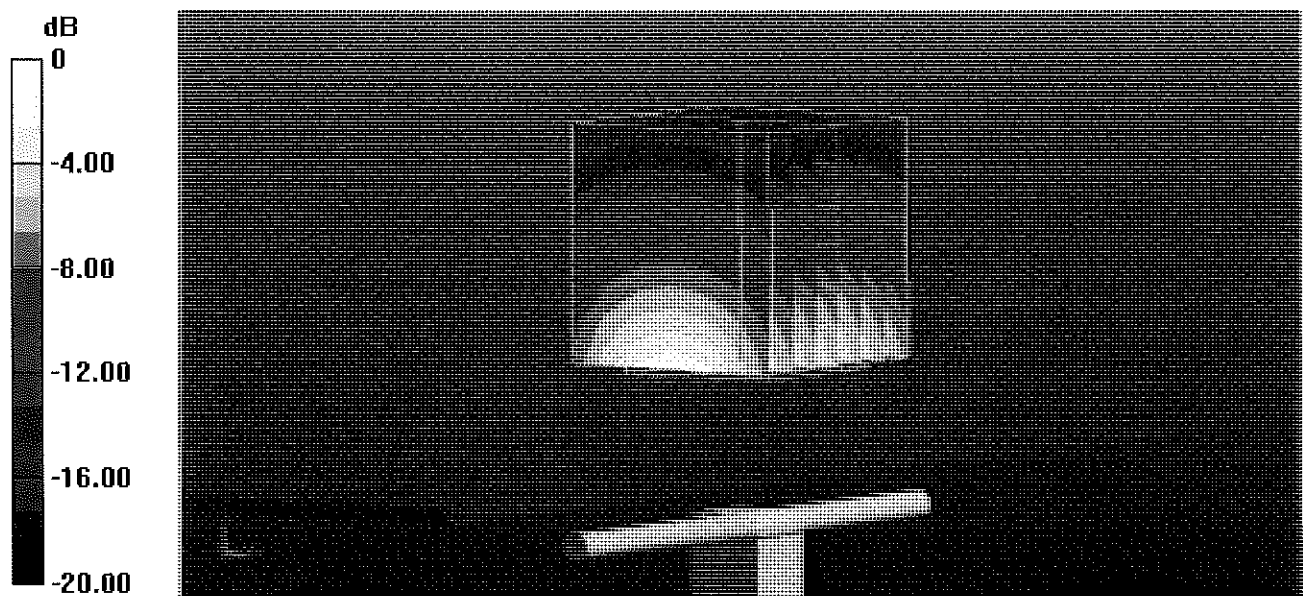

0 dB = 14.1 W/kg = 11.49 dBW/kg

Impedance Measurement Plot for Head TSL

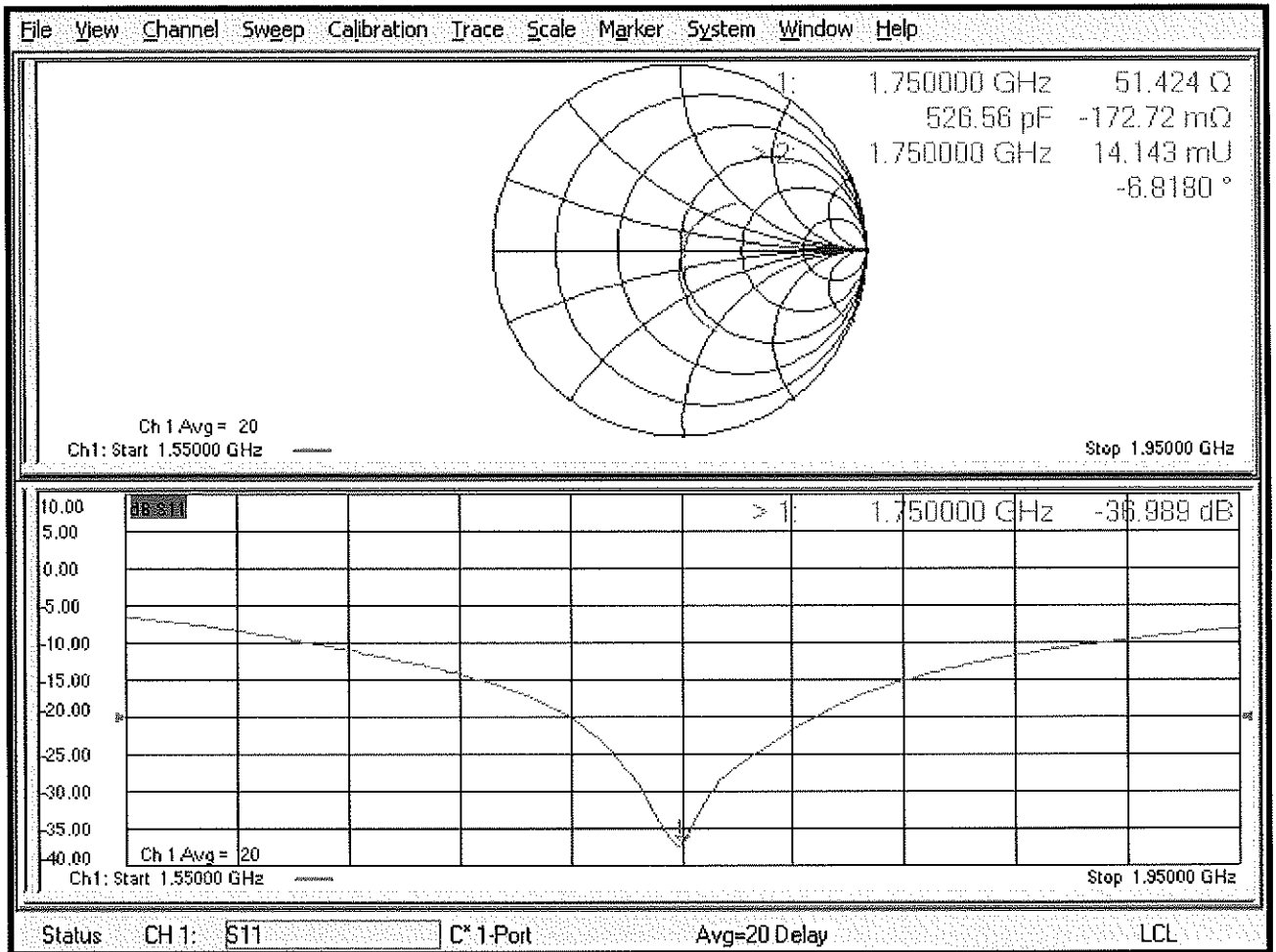

DASY5 Validation Report for Body TSL

Date: 08.05.2019

Test Laboratory: SPEAG, Zurich, Switzerland

DUT: Dipole 1750 MHz; Type: D1750V2; Serial: D1750V2 - SN:1148

Communication System: UID 0 - CW; Frequency: 1750 MHz

Medium parameters used: $f = 1750$ MHz; $\sigma = 1.47$ S/m; $\epsilon_r = 53.5$; $\rho = 1000$ kg/m³

Phantom section: Flat Section

Measurement Standard: DASY5 (IEEE/IEC/ANSI C63.19-2011)

DASY52 Configuration:

- Probe: EX3DV4 - SN7349; ConvF(8.43, 8.43, 8.43) @ 1750 MHz; Calibrated: 31.12.2018
- Sensor-Surface: 1.4mm (Mechanical Surface Detection)
- Electronics: DAE4 Sn601; Calibrated: 30.04.2019
- Phantom: Flat Phantom 5.0 (back); Type: QD 000 P50 AA; Serial: 1002
- DASY52 52.10.2(1495); SEMCAD X 14.6.12(7450)

Dipole Calibration for Body Tissue/Pin=250 mW, d=10mm/Zoom Scan (7x7x7)/Cube 0:

Measurement grid: dx=5mm, dy=5mm, dz=5mm

Reference Value = 103.1 V/m; Power Drift = -0.04 dB

Peak SAR (extrapolated) = 17.2 W/kg

SAR(1 g) = 9.35 W/kg; SAR(10 g) = 4.93 W/kg

Maximum value of SAR (measured) = 14.4 W/kg

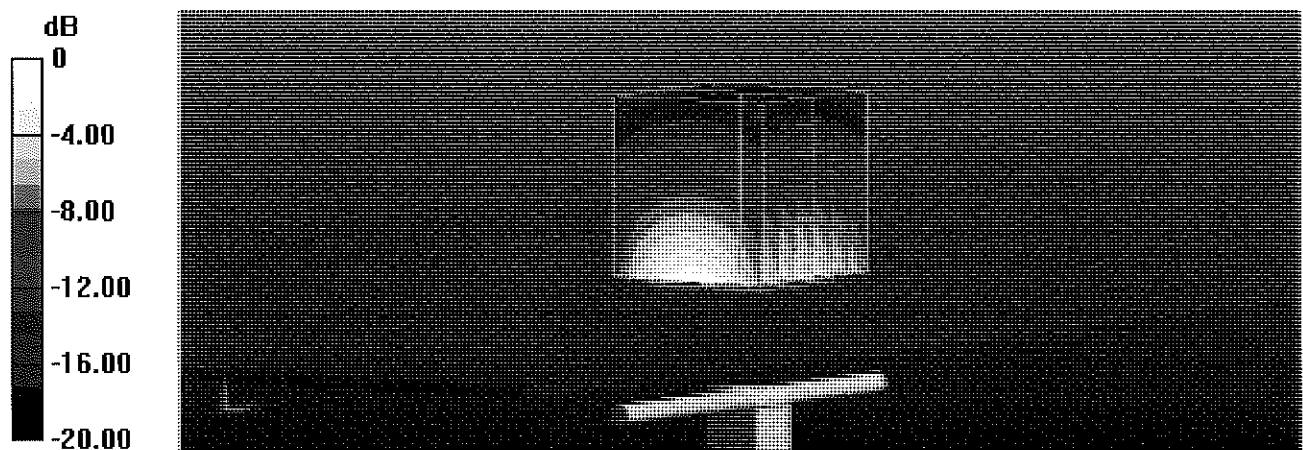

0 dB = 14.4 W/kg = 11.58 dBW/kg

Impedance Measurement Plot for Body TSL

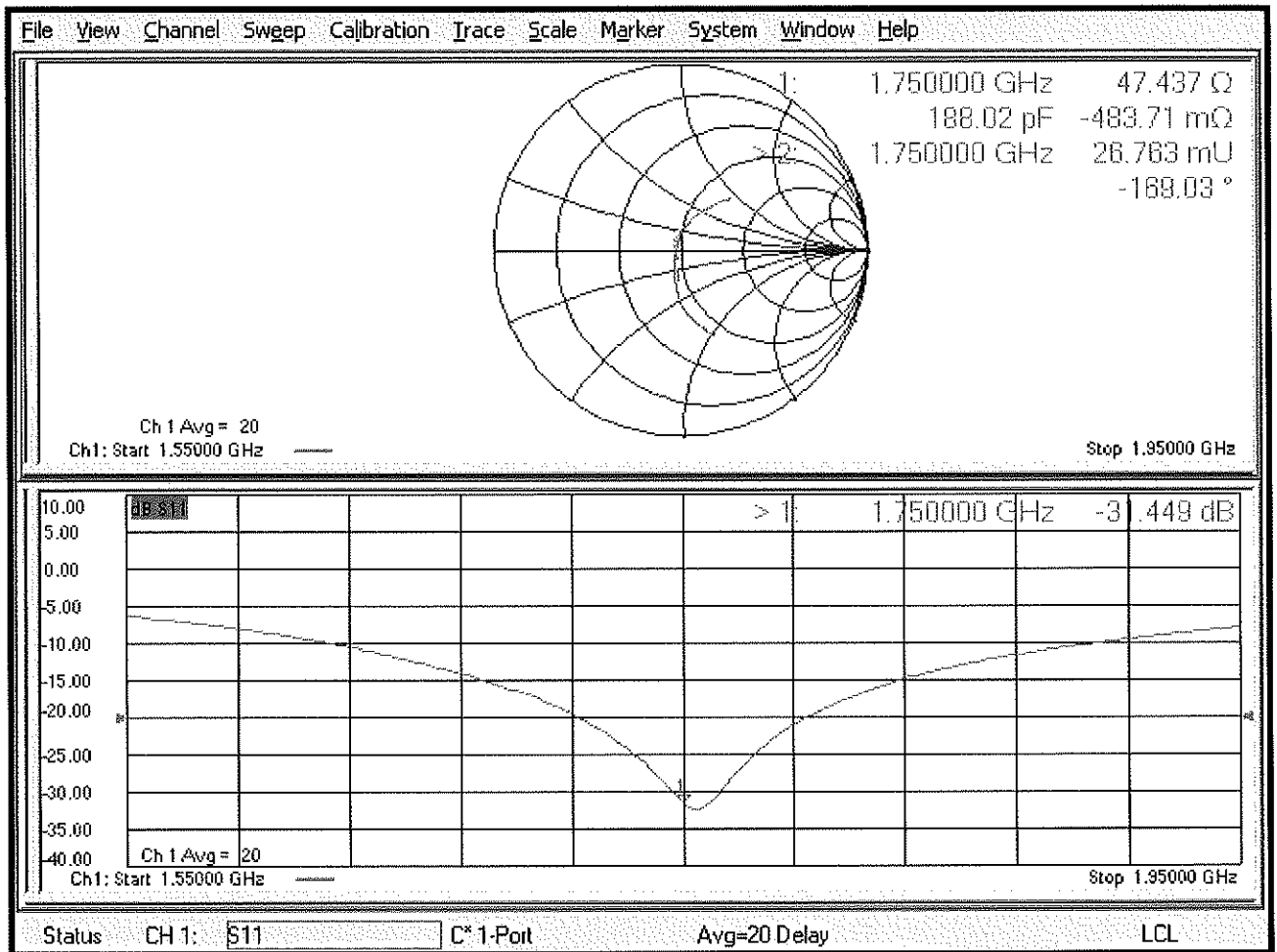

DASY5 Validation Report for SAM Head

Date: 15.05.2019

Test Laboratory: SPEAG, Zurich, Switzerland

DUT: Dipole 1750 MHz; Type: D1750V2; Serial: D1750V2 - SN:1148

Communication System: UID 0 - CW; Frequency: 1750 MHz

Medium parameters used: $f = 1750$ MHz; $\sigma = 1.37$ S/m; $\epsilon_r = 42.1$; $\rho = 1000$ kg/m³

Measurement Standard: DASY5 (IEEE/IEC/ANSI C63.19-2011)

DASY52 Configuration:

- Probe: EX3DV4 - SN7349; ConvF(8.59, 8.59, 8.59) @ 1750 MHz; Calibrated: 31.12.2018
- Sensor-Surface: 1.4mm (Mechanical Surface Detection)
- Electronics: DAE4 Sn601; Calibrated: 30.04.2019
- Phantom: SAM Head
- DASY52 52.10.2(1495); SEMCAD X 14.6.12(7450)

SAM Head/Top/Zoom Scan (7x7x7)/Cube 0: Measurement grid: dx=5mm, dy=5mm, dz=5mm

Reference Value = 107.2 V/m; Power Drift = 0.01 dB

Peak SAR (extrapolated) = 16.6 W/kg

SAR(1 g) = 9.38 W/kg; SAR(10 g) = 5.04 W/kg

Maximum value of SAR (measured) = 14.2 W/kg

SAM Head/Mouth/Zoom Scan (7x7x7)/Cube 0: Measurement grid: dx=5mm, dy=5mm, dz=5mm

Reference Value = 104.7 V/m; Power Drift = 0.02 dB

Peak SAR (extrapolated) = 16.5 W/kg

SAR(1 g) = 9.34 W/kg; SAR(10 g) = 5.04 W/kg

Maximum value of SAR (measured) = 13.9 W/kg

SAM Head/Neck/Zoom Scan (7x7x7)/Cube 0: Measurement grid: dx=5mm, dy=5mm, dz=5mm

Reference Value = 103.3 V/m; Power Drift = 0.01 dB

Peak SAR (extrapolated) = 15.5 W/kg

SAR(1 g) = 9.06 W/kg; SAR(10 g) = 4.95 W/kg

Maximum value of SAR (measured) = 13.1 W/kg

SAM Head/Ear/Zoom Scan (7x7x7)/Cube 0: Measurement grid: dx=5mm, dy=5mm, dz=5mm

Reference Value = 90.82 V/m; Power Drift = 0.02 dB

Peak SAR (extrapolated) = 12.0 W/kg

SAR(1 g) = 7.11 W/kg; SAR(10 g) = 3.98 W/kg

Maximum value of SAR (measured) = 10.2 W/kg

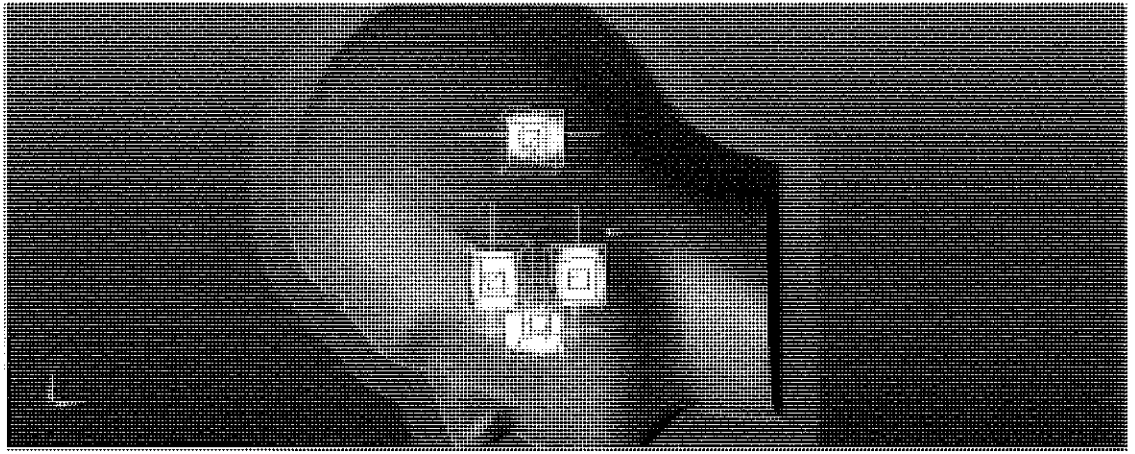
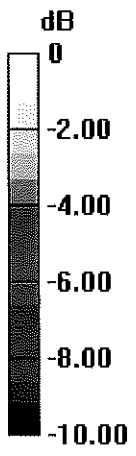

0 dB = 10.2 W/kg = 10.09 dBW/kg



Accredited by the Swiss Accreditation Service (SAS)
The Swiss Accreditation Service is one of the signatories to the EA
Multilateral Agreement for the recognition of calibration certificates

Accreditation No.: **SCS 0108**

Client **PC Test**

Certificate No.: **D1750V2-1150_Oct18**

CALIBRATION CERTIFICATE

Object **D1750V2 - SN:1150**

Calibration procedure(s) **QA CAL-05.v10
Calibration procedure for dipole validation kits above 700 MHz**

Calibration date: **October 22, 2018**

*BNW
10/30/2018
BNW
10-20-2019*

This calibration certificate documents the traceability to national standards, which realize the physical units of measurements (SI).
The measurements and the uncertainties with confidence probability are given on the following pages and are part of the certificate.

All calibrations have been conducted in the closed laboratory facility: environment temperature (22 ± 3)°C and humidity < 70%.

Calibration Equipment used (M&TE critical for calibration)

Primary Standards	ID #	Cal Date (Certificate No.)	Scheduled Calibration
Power meter NRP	SN: 104778	04-Apr-18 (No. 217-02672/02673)	Apr-19
Power sensor NRP-Z91	SN: 103244	04-Apr-18 (No. 217-02672)	Apr-19
Power sensor NRP-Z91	SN: 103245	04-Apr-18 (No. 217-02673)	Apr-19
Reference 20 dB Attenuator	SN: 5058 (20k)	04-Apr-18 (No. 217-02682)	Apr-19
Type-N mismatch combination	SN: 5047.2 / 06327	04-Apr-18 (No. 217-02683)	Apr-19
Reference Probe EX3DV4	SN: 7349	30-Dec-17 (No. EX3-7349_Dec17)	Dec-18
DAE4	SN: 601	04-Oct-18 (No. DAE4-601_Oct18)	Oct-19

Secondary Standards	ID #	Check Date (in house)	Scheduled Check
Power meter EPM-442A	SN: GB37480704	07-Oct-15 (in house check Oct-18)	In house check: Oct-20
Power sensor HP 8481A	SN: US37292783	07-Oct-15 (in house check Oct-18)	In house check: Oct-20
Power sensor HP 8481A	SN: MY41092317	07-Oct-15 (in house check Oct-18)	In house check: Oct-20
RF generator R&S SMT-06	SN: 100972	15-Jun-15 (in house check Oct-18)	In house check: Oct-20
Network Analyzer Agilent E8358A	SN: US41080477	31-Mar-14 (in house check Oct-18)	In house check: Oct-19

Calibrated by: **Michael Weber** (Name) / **Laboratory Technician** (Function) / *M. Weber* (Signature)

Approved by: **Katja Pokovic** (Name) / **Technical Manager** (Function) / *K. Pokovic* (Signature)

Issued: October 22, 2018

This calibration certificate shall not be reproduced except in full without written approval of the laboratory.



Accredited by the Swiss Accreditation Service (SAS)
The Swiss Accreditation Service is one of the signatories to the EA
Multilateral Agreement for the recognition of calibration certificates

Accreditation No.: **SCS 0108**

Glossary:

TSL	tissue simulating liquid
ConvF	sensitivity in TSL / NORM x,y,z
N/A	not applicable or not measured

Calibration is Performed According to the Following Standards:

- IEEE Std 1528-2013, "IEEE Recommended Practice for Determining the Peak Spatial-Averaged Specific Absorption Rate (SAR) in the Human Head from Wireless Communications Devices: Measurement Techniques", June 2013
- IEC 62209-1, "Measurement procedure for the assessment of Specific Absorption Rate (SAR) from hand-held and body-mounted devices used next to the ear (frequency range of 300 MHz to 6 GHz)", July 2016
- IEC 62209-2, "Procedure to determine the Specific Absorption Rate (SAR) for wireless communication devices used in close proximity to the human body (frequency range of 30 MHz to 6 GHz)", March 2010
- KDB 865664, "SAR Measurement Requirements for 100 MHz to 6 GHz"

Additional Documentation:

- DASY4/5 System Handbook

Methods Applied and Interpretation of Parameters:

- Measurement Conditions:** Further details are available from the Validation Report at the end of the certificate. All figures stated in the certificate are valid at the frequency indicated.
- Antenna Parameters with TSL:** The dipole is mounted with the spacer to position its feed point exactly below the center marking of the flat phantom section, with the arms oriented parallel to the body axis.
- Feed Point Impedance and Return Loss:** These parameters are measured with the dipole positioned under the liquid filled phantom. The impedance stated is transformed from the measurement at the SMA connector to the feed point. The Return Loss ensures low reflected power. No uncertainty required.
- Electrical Delay:** One-way delay between the SMA connector and the antenna feed point. No uncertainty required.
- SAR measured:** SAR measured at the stated antenna input power.
- SAR normalized:** SAR as measured, normalized to an input power of 1 W at the antenna connector.
- SAR for nominal TSL parameters:** The measured TSL parameters are used to calculate the nominal SAR result.

The reported uncertainty of measurement is stated as the standard uncertainty of measurement multiplied by the coverage factor $k=2$, which for a normal distribution corresponds to a coverage probability of approximately 95%.

Measurement Conditions

DASY system configuration, as far as not given on page 1.

DASY Version	DASY5	V52.10.2
Extrapolation	Advanced Extrapolation	
Phantom	Modular Flat Phantom	
Distance Dipole Center - TSL	10 mm	with Spacer
Zoom Scan Resolution	dx, dy, dz = 5 mm	
Frequency	1750 MHz \pm 1 MHz	

Head TSL parameters

The following parameters and calculations were applied.

	Temperature	Permittivity	Conductivity
Nominal Head TSL parameters	22.0 °C	40.1	1.37 mho/m
Measured Head TSL parameters	(22.0 \pm 0.2) °C	38.8 \pm 6 %	1.33 mho/m \pm 6 %
Head TSL temperature change during test	< 0.5 °C	----	----

SAR result with Head TSL

SAR averaged over 1 cm³ (1 g) of Head TSL	Condition	
SAR measured	250 mW input power	9.02 W/kg
SAR for nominal Head TSL parameters	normalized to 1W	36.5 W/kg \pm 17.0 % (k=2)

SAR averaged over 10 cm³ (10 g) of Head TSL	condition	
SAR measured	250 mW input power	4.76 W/kg
SAR for nominal Head TSL parameters	normalized to 1W	19.2 W/kg \pm 16.5 % (k=2)

Body TSL parameters

The following parameters and calculations were applied.

	Temperature	Permittivity	Conductivity
Nominal Body TSL parameters	22.0 °C	53.4	1.49 mho/m
Measured Body TSL parameters	(22.0 \pm 0.2) °C	53.5 \pm 6 %	1.46 mho/m \pm 6 %
Body TSL temperature change during test	< 0.5 °C	----	----

SAR result with Body TSL

SAR averaged over 1 cm³ (1 g) of Body TSL	Condition	
SAR measured	250 mW input power	9.04 W/kg
SAR for nominal Body TSL parameters	normalized to 1W	36.6 W/kg \pm 17.0 % (k=2)

SAR averaged over 10 cm³ (10 g) of Body TSL	condition	
SAR measured	250 mW input power	4.82 W/kg
SAR for nominal Body TSL parameters	normalized to 1W	19.4 W/kg \pm 16.5 % (k=2)

Appendix (Additional assessments outside the scope of SCS 0108)

Antenna Parameters with Head TSL

Impedance, transformed to feed point	50.9 Ω - 0.4 j Ω
Return Loss	- 40.1 dB

Antenna Parameters with Body TSL

Impedance, transformed to feed point	46.6 Ω - 0.1 j Ω
Return Loss	- 29.2 dB

General Antenna Parameters and Design

Electrical Delay (one direction)	1.217 ns
----------------------------------	----------

After long term use with 100W radiated power, only a slight warming of the dipole near the feedpoint can be measured.

The dipole is made of standard semirigid coaxial cable. The center conductor of the feeding line is directly connected to the second arm of the dipole. The antenna is therefore short-circuited for DC-signals. On some of the dipoles, small end caps are added to the dipole arms in order to improve matching when loaded according to the position as explained in the "Measurement Conditions" paragraph. The SAR data are not affected by this change. The overall dipole length is still according to the Standard.

No excessive force must be applied to the dipole arms, because they might bend or the soldered connections near the feedpoint may be damaged.

Additional EUT Data

Manufactured by	SPEAG
Manufactured on	April 10, 2015

DASY5 Validation Report for Head TSL

Date: 22.10.2018

Test Laboratory: SPEAG, Zurich, Switzerland

DUT: Dipole 1750 MHz; Type: D1750V2; Serial: D1750V2 - SN:1150

Communication System: UID 0 - CW; Frequency: 1750 MHz

Medium parameters used: $f = 1750$ MHz; $\sigma = 1.33$ S/m; $\epsilon_r = 38.8$; $\rho = 1000$ kg/m³

Phantom section: Flat Section

Measurement Standard: DASY5 (IEEE/IEC/ANSI C63.19-2011)

DASY52 Configuration:

- Probe: EX3DV4 - SN7349; ConvF(8.5, 8.5, 8.5) @ 1750 MHz; Calibrated: 30.12.2017
- Sensor-Surface: 1.4mm (Mechanical Surface Detection)
- Electronics: DAE4 Sn601; Calibrated: 04.10.2018
- Phantom: Flat Phantom 5.0 (front); Type: QD 000 P50 AA; Serial: 1001
- DASY52 52.10.2(1495); SEMCAD X 14.6.12(7450)

Dipole Calibration for Head Tissue/Pin=250 mW, d=10mm/Zoom Scan (7x7x7)/Cube 0:

Measurement grid: dx=5mm, dy=5mm, dz=5mm

Reference Value = 108.1 V/m; Power Drift = -0.09 dB

Peak SAR (extrapolated) = 16.7 W/kg

SAR(1 g) = 9.02 W/kg; SAR(10 g) = 4.76 W/kg

Maximum value of SAR (measured) = 14.0 W/kg

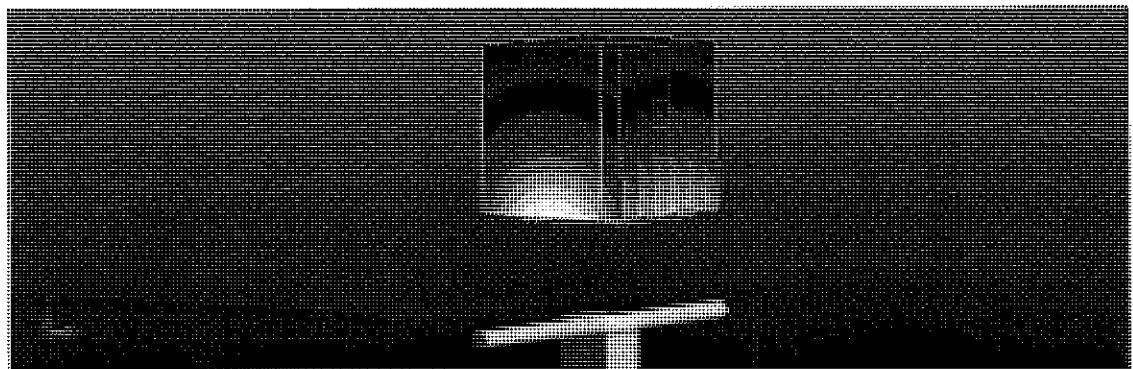
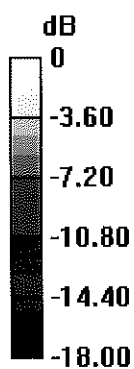

0 dB = 14.0 W/kg = 11.46 dBW/kg

Impedance Measurement Plot for Head TSL

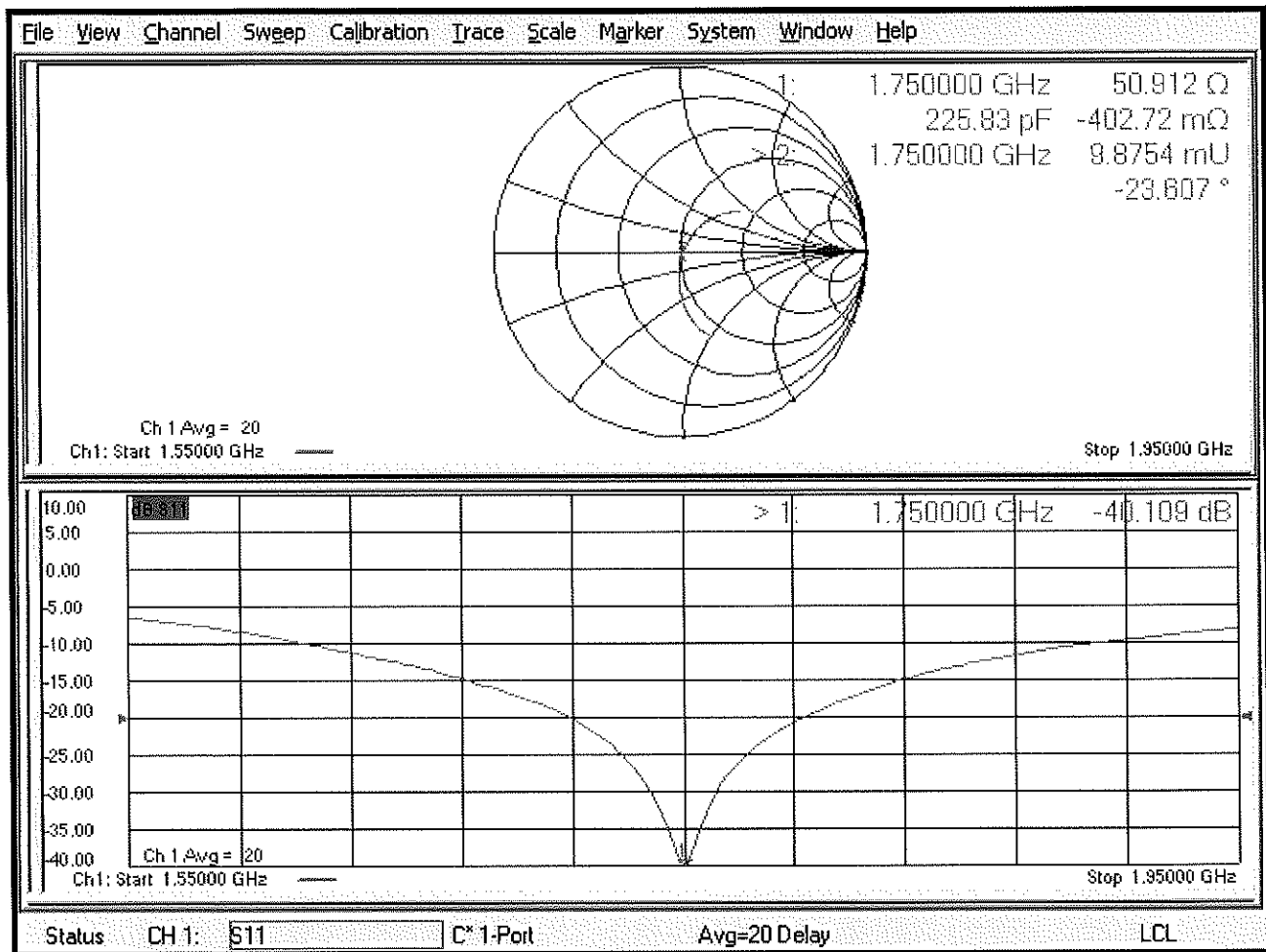

DASY5 Validation Report for Body TSL

Date: 22.10.2018

Test Laboratory: SPEAG, Zurich, Switzerland

DUT: Dipole 1750 MHz; Type: D1750V2; Serial: D1750V2 - SN:1150

Communication System: UID 0 - CW; Frequency: 1750 MHz

Medium parameters used: $f = 1750$ MHz; $\sigma = 1.46$ S/m; $\epsilon_r = 53.5$; $\rho = 1000$ kg/m³

Phantom section: Flat Section

Measurement Standard: DASY5 (IEEE/IEC/ANSI C63.19-2011)

DASY52 Configuration:

- Probe: EX3DV4 - SN7349; ConvF(8.35, 8.35, 8.35) @ 1750 MHz; Calibrated: 30.12.2017
- Sensor-Surface: 1.4mm (Mechanical Surface Detection)
- Electronics: DAE4 Sn601; Calibrated: 04.10.2018
- Phantom: Flat Phantom 5.0 (back); Type: QD 000 P50 AA; Serial: 1002
- DASY52 52.10.2(1495); SEMCAD X 14.6.12(7450)

Dipole Calibration for Body Tissue/Pin=250 mW, d=10mm/Zoom Scan (7x7x7)/Cube 0:

Measurement grid: dx=5mm, dy=5mm, dz=5mm

Reference Value = 102.1 V/m; Power Drift = -0.09 dB

Peak SAR (extrapolated) = 16.0 W/kg

SAR(1 g) = 9.04 W/kg; SAR(10 g) = 4.82 W/kg

Maximum value of SAR (measured) = 13.6 W/kg

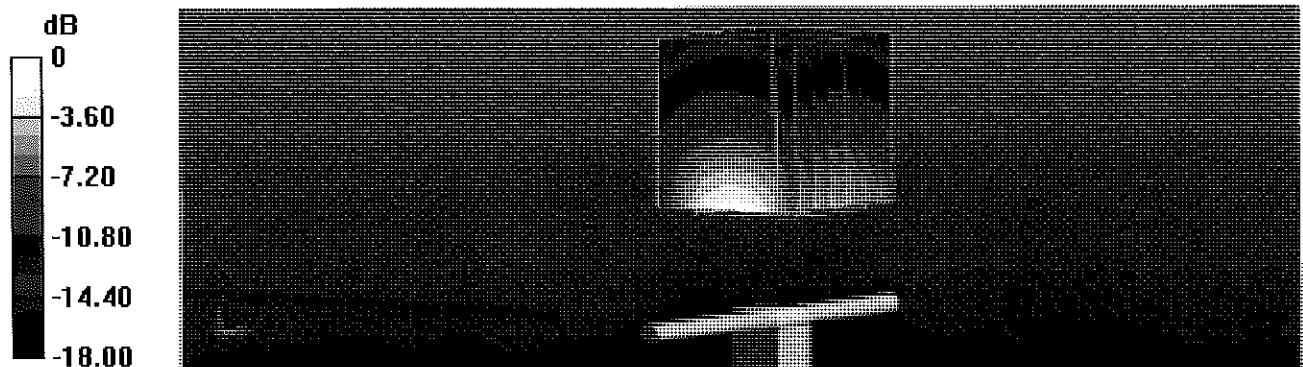

0 dB = 13.6 W/kg = 11.34 dBW/kg

Impedance Measurement Plot for Body TSL

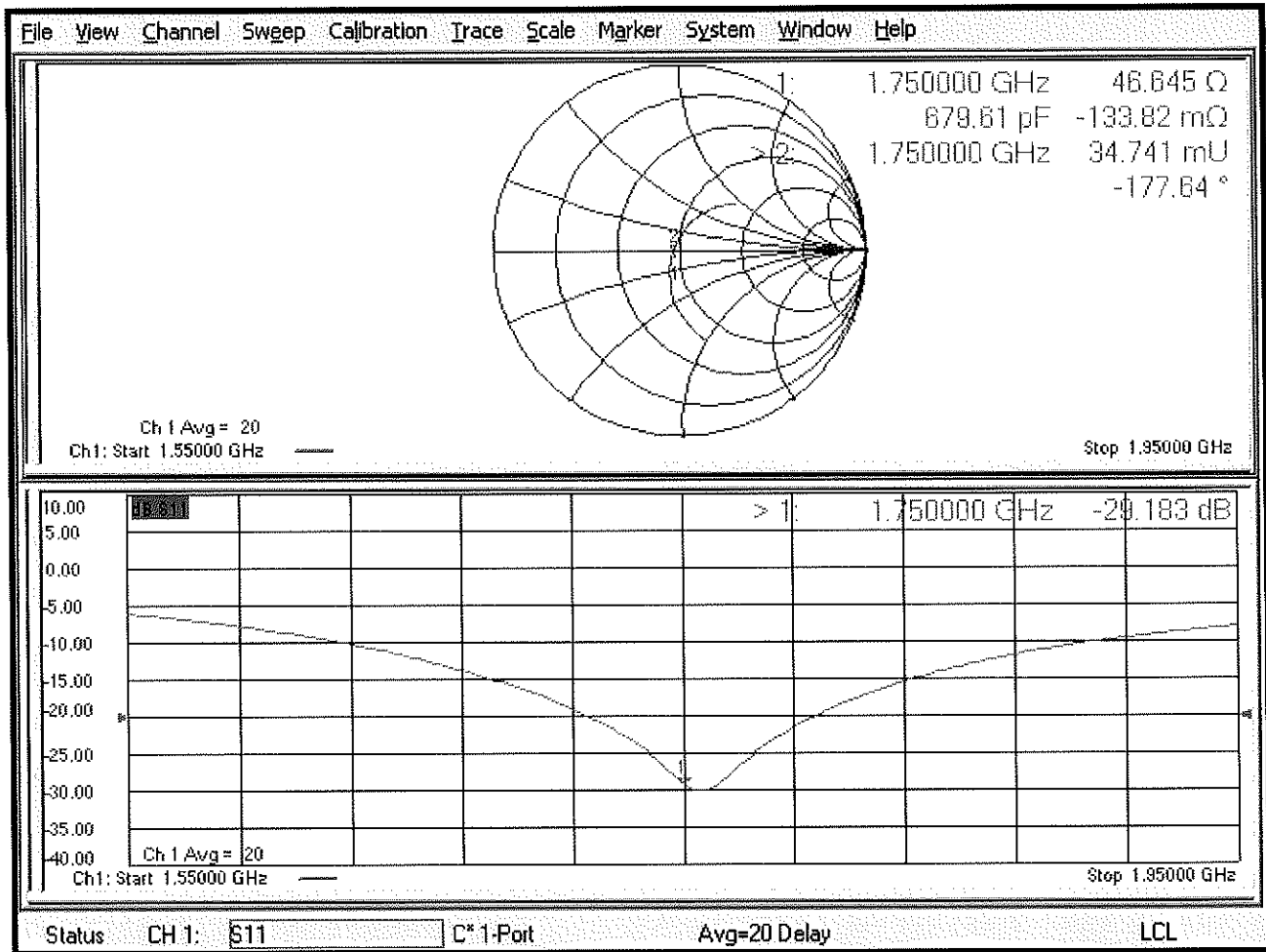

Certification of Calibration

Object D1750V2 – SN:1150

Calibration procedure(s) Procedure for Calibration Extension for SAR Dipoles.

Extended Calibration date: October 18, 2019

Description: SAR Validation Dipole at 1750 MHz.

Calibration Equipment used:

Manufacturer	Model	Description	Cal Date	Cal Interval	Cal Due	Serial Number
Control Company	4040	Therm./Clock/Humidity Monitor	6/29/2019	Biennial	6/29/2021	192291470
Control Company	4352	Ultra Long Stem Thermometer	8/2/2018	Biennial	8/2/2020	181334684
Amplifier Research	15S1G6	Amplifier	CBT	N/A	CBT	433971
Narda	4772-3	Attenuator (3dB)	CBT	N/A	CBT	9406
Keysight Technologies	85033E	Standard Mechanical Calibration Kit (DC to 9GHz, 3.5mm)	7/2/2019	Annual	7/2/2020	MY53401181
Rohde & Schwarz	ZNLE6	Vector Network Analyzer	10/11/2019	Annual	10/11/2020	101307
Mini-Circuits	BW-N20W5+	DC to 18 GHz Precision Fixed 20 dB Attenuator	CBT	N/A	CBT	N/A
SPEAG	DAK5-3.5	Portable Dielectric Assessment Kit	8/13/2019	Annual	8/13/2020	1041
Anritsu	MA2411B	Pulse Power Sensor	8/14/2019	Annual	8/14/2020	1315051
Anritsu	MA2411B	Pulse Power Sensor	8/8/2019	Annual	8/8/2020	1339008
Anritsu	ML2495A	Power Meter	11/20/2018	Annual	11/20/2019	1039008
Agilent	N5182A	MXG Vector Signal Generator	8/19/2019	Annual	8/19/2020	MY47420837
Seekonk	NC-100	Torque Wrench	5/9/2018	Biennial	5/9/2020	22217
Mini-Circuits	NLP-2950+	Low Pass Filter DC to 2700 MHz	CBT	N/A	CBT	N/A
MiniCircuits	ZHDC-16-63-S+	Bidirectional Coupler	CBT	N/A	CBT	N/A
MiniCircuits	VLF-6000+	Low Pass Filter	CBT	N/A	CBT	N/A
SPEAG	EX3DV4	SAR Probe	8/16/2019	Annual	8/16/2020	7308
SPEAG	EX3DV4	SAR Probe	4/24/2019	Annual	4/24/2020	7357
SPEAG	DAE4	Dasy Data Acquisition Electronics	4/18/2019	Annual	4/18/2020	1407
SPEAG	DAE4	Dasy Data Acquisition Electronics	8/14/2019	Annual	8/14/2020	1450

Note: CBT (Calibrated Before Testing). Prior to testing, the measurement paths containing a cable, amplifier, attenuator, coupler or filter were connected to a calibrated source (i.e. a signal generator) to determine the losses of the measurement path.

Measurement Uncertainty = $\pm 23\%$ (k=2)

	Name	Function	Signature
Calibrated By:	Brodie Halfoster	Team Lead Engineer	<i>BRODIE HALBFOSTER</i>
Approved By:	Kaitlin O'Keefe	Senior Technical Manager	<i>KOK</i>

DIPOLE CALIBRATION EXTENSION

Per KDB 865664 D01, calibration intervals of up to three years may be considered for reference dipoles when it is demonstrated that the SAR target, impedance and return loss of a dipole have remained stable according to the following requirements:

1. The measured SAR does not deviate more than 10% from the target on the calibration certificate.
2. The return-loss does not deviate more than 20% from the previous measurement and meets the required 20dB minimum return-loss requirement.
3. The measurement of real or imaginary parts of impedance does not deviate more than 5Ω from the previous measurement.

The following dipole was checked to pass the above 3 requirements to have 2-year calibration period from the calibration date:

Calibration Date	Extension Date	Certificate Electrical Delay (ms)	Certificate SAR Target Head (1g) W/kg @ 20.0 dBm	Measured Head SAR (1g) W/kg @ 20.0 dBm	Deviation 1g (%)	Certificate SAR Target Head (10g) W/kg @ 20.0 dBm	Measured Head SAR (10g) W/kg @ 20.0 dBm	Deviation 10g (%)	Certificate Impedance Head (Ohm) Real	Measured Impedance Head (Ohm) Real	Difference (Ohm) Real	Certificate Impedance Head (Ohm) Imaginary	Measured Impedance Head (Ohm) Imaginary	Difference (Ohm) Imaginary	Certificate Return Loss Head (dB)	Measured Return Loss Head (dB)	Deviation (%)	PASS/FAIL
10/22/2018	10/18/2019	1.217	3.65	3.8	4.11%	1.92	2	4.17%	50.9	49.3	1.6	0.4	-0.7	1.1	-40.1	-40.2	-0.20%	PASS
Calibration Date	Extension Date	Certificate Electrical Delay (ms)	Certificate SAR Target Body (1g) W/kg @ 20.0 dBm	Measured Body SAR (1g) W/kg @ 20.0 dBm	Deviation 1g (%)	Certificate SAR Target Body (10g) W/kg @ 20.0 dBm	Measured Body SAR (10g) W/kg @ 20.0 dBm	Deviation 10g (%)	Certificate Impedance Body (Ohm) Real	Measured Impedance Body (Ohm) Real	Difference (Ohm) Real	Certificate Impedance Body (Ohm) Imaginary	Measured Impedance Body (Ohm) Imaginary	Difference (Ohm) Imaginary	Certificate Return Loss Body (dB)	Measured Return Loss Body (dB)	Deviation (%)	PASS/FAIL
10/22/2018	10/18/2019	1.217	3.66	3.82	4.37%	1.94	2.02	4.12%	46.6	44.7	1.9	-0.1	-0.8	0.7	-29.2	-25	14.40%	PASS

Impedance & Return-Loss Measurement Plot for Head TSL

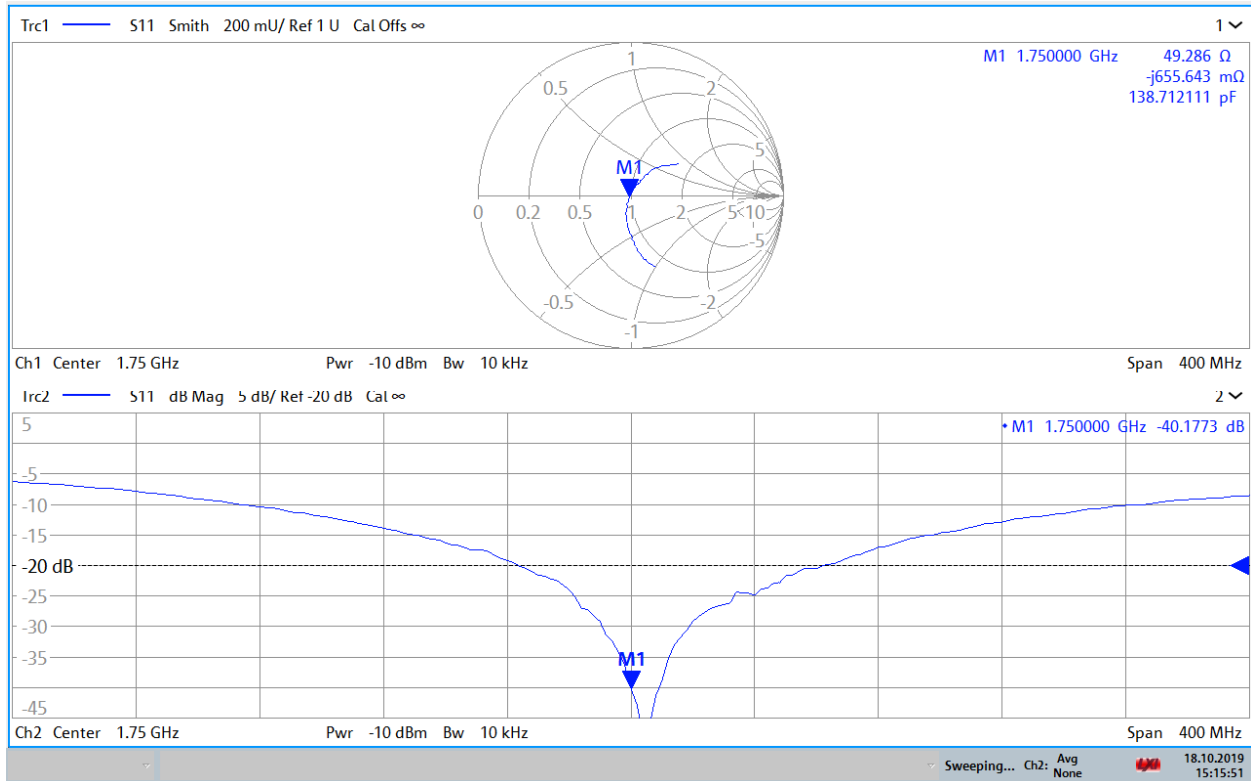

15:15:52 18.10.2019

Impedance & Return-Loss Measurement Plot for Body TSL

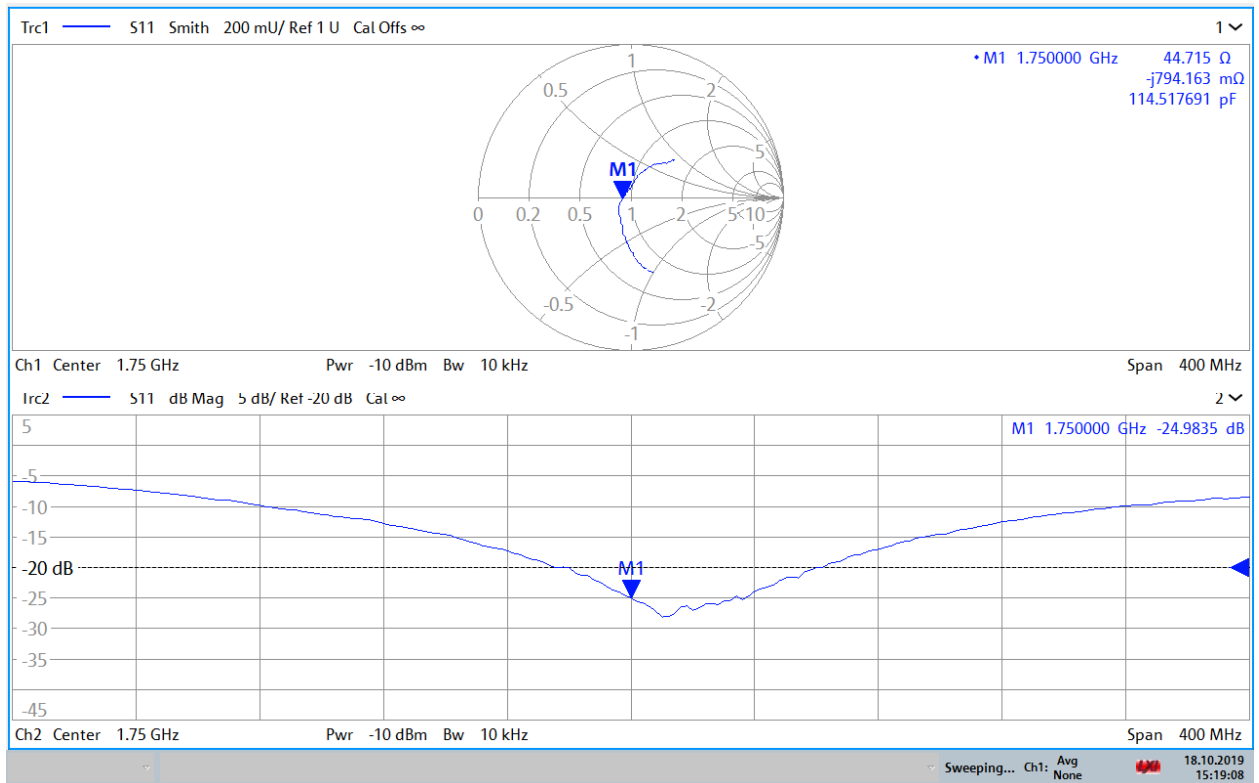

15:19:09 18.10.2019



Accredited by the Swiss Accreditation Service (SAS)
 The Swiss Accreditation Service is one of the signatories to the EA
 Multilateral Agreement for the recognition of calibration certificates

Accreditation No.: **SCS 0108**

Client **PC Test**

Certificate No: **D1765V2-1008_May18**

CALIBRATION CERTIFICATE

Object **D1765V2 - SN:1008**

Calibration procedure(s) **QA CAL-05.v10**
Calibration procedure for dipole validation kits above 700 MHz

Calibration date: **May 23, 2018**

BN ✓
 7/16/2018
 BN ✓
 05/20/2019

This calibration certificate documents the traceability to national standards, which realize the physical units of measurements (SI).
 The measurements and the uncertainties with confidence probability are given on the following pages and are part of the certificate.

All calibrations have been conducted in the closed laboratory facility: environment temperature (22 ± 3)°C and humidity < 70%.

Calibration Equipment used (M&TE critical for calibration)

Primary Standards	ID #	Cal Date (Certificate No.)	Scheduled Calibration
Power meter NRP	SN: 104778	04-Apr-18 (No. 217-02672/02673)	Apr-19
Power sensor NRP-Z91	SN: 103244	04-Apr-18 (No. 217-02672)	Apr-19
Power sensor NRP-Z91	SN: 103245	04-Apr-18 (No. 217-02673)	Apr-19
Reference 20 dB Attenuator	SN: 5058 (20k)	04-Apr-18 (No. 217-02682)	Apr-19
Type-N mismatch combination	SN: 5047.2 / 06327	04-Apr-18 (No. 217-02683)	Apr-19
Reference Probe EX3DV4	SN: 7349	30-Dec-17 (No. EX3-7349_Dec17)	Dec-18
DAE4	SN: 601	26-Oct-17 (No. DAE4-601_Oct17)	Oct-18

Secondary Standards	ID #	Check Date (in house)	Scheduled Check
Power meter EPM-442A	SN: GB37480704	07-Oct-15 (in house check Oct-16)	In house check: Oct-18
Power sensor HP 8481A	SN: US37292783	07-Oct-15 (in house check Oct-16)	In house check: Oct-18
Power sensor HP 8481A	SN: MY41092317	07-Oct-15 (in house check Oct-16)	In house check: Oct-18
RF generator R&S SMT-06	SN: 100972	15-Jun-15 (in house check Oct-16)	In house check: Oct-18
Network Analyzer HP 8753E	SN: US37390585	18-Oct-01 (in house check Oct-17)	In house check: Oct-18

Calibrated by: **Manu Seitz** Name: **Manu Seitz** Function: **Laboratory Technician** Signature: *[Signature]*

Approved by: **Katja Pokovic** Name: **Katja Pokovic** Function: **Technical Manager** Signature: *[Signature]*

Issued: May 23, 2018

This calibration certificate shall not be reproduced except in full without written approval of the laboratory.



Accredited by the Swiss Accreditation Service (SAS)

The Swiss Accreditation Service is one of the signatories to the EA
Multilateral Agreement for the recognition of calibration certificates

Accreditation No.: **SCS 0108**

Glossary:

TSL	tissue simulating liquid
ConvF	sensitivity in TSL / NORM x,y,z
N/A	not applicable or not measured

Calibration is Performed According to the Following Standards:

- IEEE Std 1528-2013, "IEEE Recommended Practice for Determining the Peak Spatial-Averaged Specific Absorption Rate (SAR) in the Human Head from Wireless Communications Devices: Measurement Techniques", June 2013
- IEC 62209-1, "Measurement procedure for the assessment of Specific Absorption Rate (SAR) from hand-held and body-mounted devices used next to the ear (frequency range of 300 MHz to 6 GHz)", July 2016
- IEC 62209-2, "Procedure to determine the Specific Absorption Rate (SAR) for wireless communication devices used in close proximity to the human body (frequency range of 30 MHz to 6 GHz)", March 2010
- KDB 865664, "SAR Measurement Requirements for 100 MHz to 6 GHz"

Additional Documentation:

- DASY4/5 System Handbook

Methods Applied and Interpretation of Parameters:

- Measurement Conditions:** Further details are available from the Validation Report at the end of the certificate. All figures stated in the certificate are valid at the frequency indicated.
- Antenna Parameters with TSL:** The dipole is mounted with the spacer to position its feed point exactly below the center marking of the flat phantom section, with the arms oriented parallel to the body axis.
- Feed Point Impedance and Return Loss:** These parameters are measured with the dipole positioned under the liquid filled phantom. The impedance stated is transformed from the measurement at the SMA connector to the feed point. The Return Loss ensures low reflected power. No uncertainty required.
- Electrical Delay:** One-way delay between the SMA connector and the antenna feed point. No uncertainty required.
- SAR measured:** SAR measured at the stated antenna input power.
- SAR normalized:** SAR as measured, normalized to an input power of 1 W at the antenna connector.
- SAR for nominal TSL parameters:** The measured TSL parameters are used to calculate the nominal SAR result.

The reported uncertainty of measurement is stated as the standard uncertainty of measurement multiplied by the coverage factor $k=2$, which for a normal distribution corresponds to a coverage probability of approximately 95%.

Measurement Conditions

DASY system configuration, as far as not given on page 1.

DASY Version	DASY5	V52.10.1
Extrapolation	Advanced Extrapolation	
Phantom	Modular Flat Phantom	
Distance Dipole Center - TSL	10 mm	with Spacer
Zoom Scan Resolution	dx, dy, dz = 5.0 mm	
Frequency	1750 MHz \pm 1 MHz	

Head TSL parameters

The following parameters and calculations were applied.

	Temperature	Permittivity	Conductivity
Nominal Head TSL parameters	22.0 °C	40.1	1.37 mho/m
Measured Head TSL parameters	(22.0 \pm 0.2) °C	39.0 \pm 6 %	1.34 mho/m \pm 6 %
Head TSL temperature change during test	< 0.5 °C	----	----

SAR result with Head TSL

SAR averaged over 1 cm³ (1 g) of Head TSL	Condition	
SAR measured	250 mW input power	8.94 W/kg
SAR for nominal Head TSL parameters	normalized to 1W	36.2 W/kg \pm 17.0 % (k=2)

SAR averaged over 10 cm³ (10 g) of Head TSL	condition	
SAR measured	250 mW input power	4.71 W/kg
SAR for nominal Head TSL parameters	normalized to 1W	19.0 W/kg \pm 16.5 % (k=2)

Body TSL parameters

The following parameters and calculations were applied.

	Temperature	Permittivity	Conductivity
Nominal Body TSL parameters	22.0 °C	53.4	1.49 mho/m
Measured Body TSL parameters	(22.0 \pm 0.2) °C	53.2 \pm 6 %	1.46 mho/m \pm 6 %
Body TSL temperature change during test	< 0.5 °C	----	----

SAR result with Body TSL

SAR averaged over 1 cm³ (1 g) of Body TSL	Condition	
SAR measured	250 mW input power	9.21 W/kg
SAR for nominal Body TSL parameters	normalized to 1W	37.4 W/kg \pm 17.0 % (k=2)

SAR averaged over 10 cm³ (10 g) of Body TSL	condition	
SAR measured	250 mW input power	4.92 W/kg
SAR for nominal Body TSL parameters	normalized to 1W	19.9 W/kg \pm 16.5 % (k=2)

Appendix (Additional assessments outside the scope of SCS 0108)

Antenna Parameters with Head TSL

Impedance, transformed to feed point	47.7 Ω - 6.5 j Ω
Return Loss	- 23.0 dB

Antenna Parameters with Body TSL

Impedance, transformed to feed point	43.3 Ω - 6.0 j Ω
Return Loss	- 20.3 dB

General Antenna Parameters and Design

Electrical Delay (one direction)	1.210 ns
----------------------------------	----------

After long term use with 100W radiated power, only a slight warming of the dipole near the feedpoint can be measured.

The dipole is made of standard semirigid coaxial cable. The center conductor of the feeding line is directly connected to the second arm of the dipole. The antenna is therefore short-circuited for DC-signals. On some of the dipoles, small end caps are added to the dipole arms in order to improve matching when loaded according to the position as explained in the "Measurement Conditions" paragraph. The SAR data are not affected by this change. The overall dipole length is still according to the Standard.

No excessive force must be applied to the dipole arms, because they might bend or the soldered connections near the feedpoint may be damaged.

Additional EUT Data

Manufactured by	SPEAG
Manufactured on	October 06, 2005

Appendix (Additional assessments outside the scope of SCS 0108)

Measurement Conditions

DASY system configuration, as far as not given on page 1 and 3.

Phantom	SAM Head Phantom	For usage with cSAR3DV2-R/L
---------	------------------	-----------------------------

SAR result with SAM Head (Top)

SAR averaged over 1 cm ³ (1 g) of Head TSL	Condition	
SAR measured	250 mW input power	9.26 W/kg
SAR for nominal Head TSL parameters	normalized to 1W	37.4 W/kg ± 17.5 % (k=2)

SAR averaged over 10 cm ³ (10 g) of Head TSL	condition	
SAR measured	250 mW input power	4.95 W/kg
SAR for nominal Head TSL parameters	normalized to 1W	19.9 W/kg ± 16.9 % (k=2)

SAR result with SAM Head (Mouth)

SAR averaged over 1 cm ³ (1 g) of Head TSL	Condition	
SAR measured	250 mW input power	9.47 W/kg
SAR for nominal Head TSL parameters	normalized to 1W	38.2 W/kg ± 17.5 % (k=2)

SAR averaged over 10 cm ³ (10 g) of Head TSL	condition	
SAR measured	250 mW input power	5.06 W/kg
SAR for nominal Head TSL parameters	normalized to 1W	20.4 W/kg ± 16.9 % (k=2)

SAR result with SAM Head (Neck)

SAR averaged over 1 cm ³ (1 g) of Head TSL	Condition	
SAR measured	250 mW input power	9.26 W/kg
SAR for nominal Head TSL parameters	normalized to 1W	37.4 W/kg ± 17.5 % (k=2)

SAR averaged over 10 cm ³ (10 g) of Head TSL	condition	
SAR measured	250 mW input power	5.02 W/kg
SAR for nominal Head TSL parameters	normalized to 1W	20.2 W/kg ± 16.9 % (k=2)

SAR result with SAM Head (Ear)

SAR averaged over 1 cm ³ (1 g) of Head TSL	Condition	
SAR measured	250 mW input power	7.12 W/kg
SAR for nominal Head TSL parameters	normalized to 1W	28.7 W/kg ± 17.5 % (k=2)

SAR averaged over 10 cm ³ (10 g) of Head TSL	condition	
SAR measured	250 mW input power	4.01 W/kg
SAR for nominal Head TSL parameters	normalized to 1W	16.1 W/kg ± 16.9 % (k=2)

DASY5 Validation Report for Head TSL

Date: 15.05.2018

Test Laboratory: SPEAG, Zurich, Switzerland

DUT: Dipole 1765 MHz; Type: D1765V2; Serial: D1765V2 - SN:1008

Communication System: UID 0 - CW; Frequency: 1750 MHz

Medium parameters used: $f = 1750$ MHz; $\sigma = 1.34$ S/m; $\epsilon_r = 39$; $\rho = 1000$ kg/m³

Phantom section: Flat Section

Measurement Standard: DASY5 (IEEE/IEC/ANSI C63.19-2011)

DASY52 Configuration:

- Probe: EX3DV4 - SN7349; ConvF(8.5, 8.5, 8.5) @ 1750 MHz; Calibrated: 30.12.2017
- Sensor-Surface: 1.4mm (Mechanical Surface Detection)
- Electronics: DAE4 Sn601; Calibrated: 26.10.2017
- Phantom: Flat Phantom 5.0 (front); Type: QD 000 P50 AA; Serial: 1001
- DASY52 52.10.1(1476); SEMCAD X 14.6.11(7439)

Dipole Calibration for Head Tissue/Pin=250 mW, d=10mm/Zoom Scan (7x7x7)/Cube 0:

Measurement grid: dx=5mm, dy=5mm, dz=5mm

Reference Value = 106.6 V/m; Power Drift = -0.02 dB

Peak SAR (extrapolated) = 16.4 W/kg

SAR(1 g) = 8.94 W/kg; SAR(10 g) = 4.71 W/kg

Maximum value of SAR (measured) = 13.8 W/kg

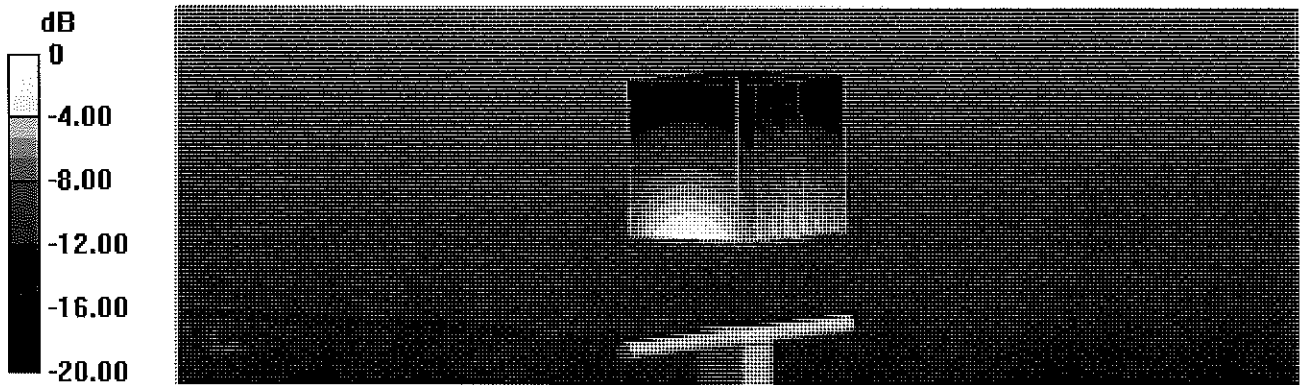

0 dB = 13.8 W/kg = 11.40 dBW/kg

Impedance Measurement Plot for Head TSL

15 May 2018 11:19:20

CH1 S11 1 U FS 1: 47.658 Ω -6.5039 Ω 13.983 pF 1 750.000 000 MHz

*
De1
CA
Avg
16
H1d

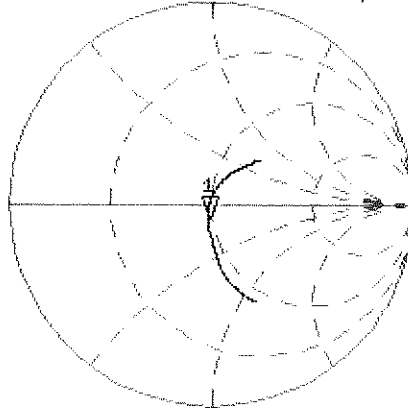

CH2 S11 LOG 5 dB/REF -20 dB 1:-23.017 dB 1 750.000 000 MHz

CA
Avg
16
H1d

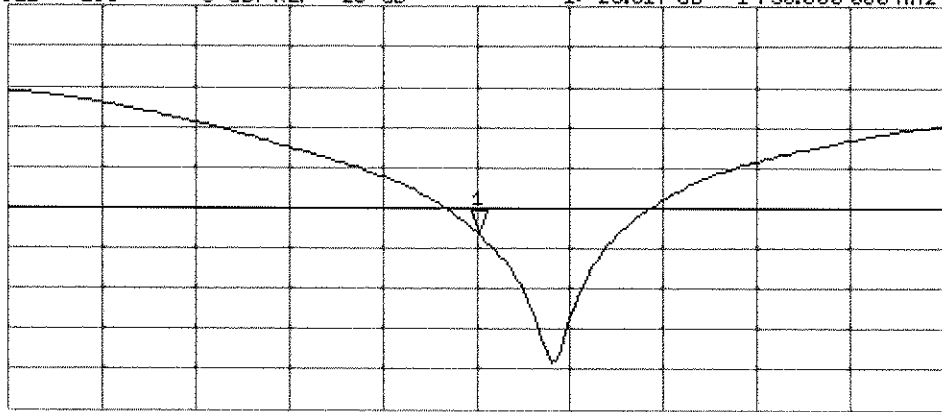

START 1 550.000 000 MHz

STOP 1 950.000 000 MHz

DASY5 Validation Report for Body TSL

Date: 15.05.2018

Test Laboratory: SPEAG, Zurich, Switzerland

DUT: Dipole 1765 MHz; Type: D1765V2; Serial: D1765V2 - SN:1008

Communication System: UID 0 - CW; Frequency: 1750 MHz

Medium parameters used: $f = 1750$ MHz; $\sigma = 1.46$ S/m; $\epsilon_r = 53.2$; $\rho = 1000$ kg/m³

Phantom section: Flat Section

Measurement Standard: DASY5 (IEEE/IEC/ANSI C63.19-2011)

DASY52 Configuration:

- Probe: EX3DV4 - SN7349; ConvF(8.35, 8.35, 8.35) @ 1750 MHz; Calibrated: 30.12.2017
- Sensor-Surface: 1.4mm (Mechanical Surface Detection)
- Electronics: DAE4 Sn601; Calibrated: 26.10.2017
- Phantom: Flat Phantom 5.0 (back); Type: QD 000 P50 AA; Serial: 1002
- DASY52 52.10.1(1476); SEMCAD X 14.6.11(7439)

Dipole Calibration for Body Tissue/Pin=250 mW, d=10mm/Zoom Scan (7x7x7)/Cube 0:

Measurement grid: dx=5mm, dy=5mm, dz=5mm

Reference Value = 102.4 V/m; Power Drift = -0.06 dB

Peak SAR (extrapolated) = 16.1 W/kg

SAR(1 g) = 9.21 W/kg; SAR(10 g) = 4.92 W/kg

Maximum value of SAR (measured) = 13.7 W/kg

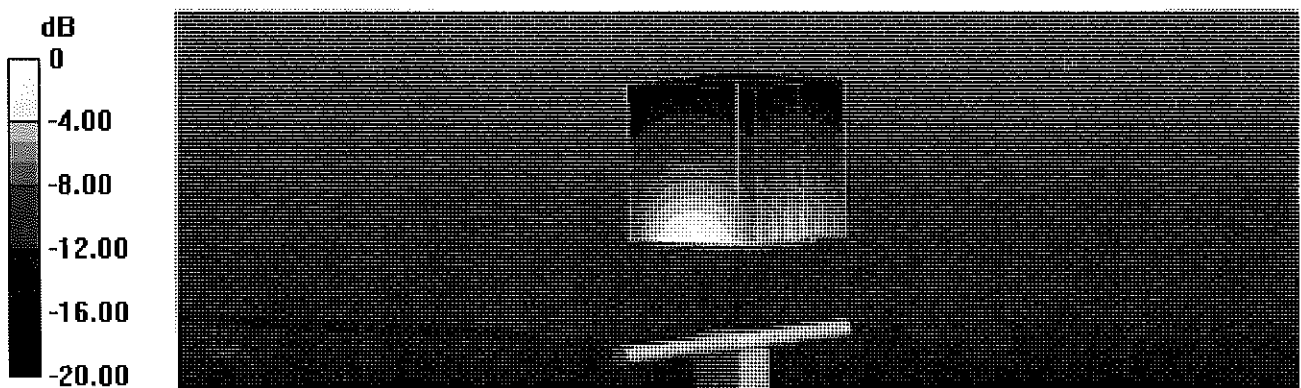

Impedance Measurement Plot for Body TSL

15 May 2018 11:18:17

CH1 S11 1 U FS 1: 43.322 Ω -6.0117 Ω 15.128 pF 1 750.000 000 MHz

*
De1

CA

Avg
16

HI d

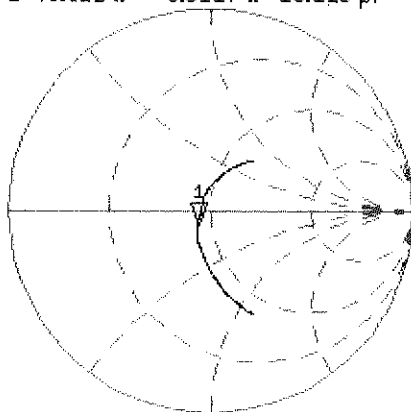

CH2 S11 LOG 5 dB/REF -20 dB 1:-20.349 dB 1 750.000 000 MHz

CA

Avg
16

HI d

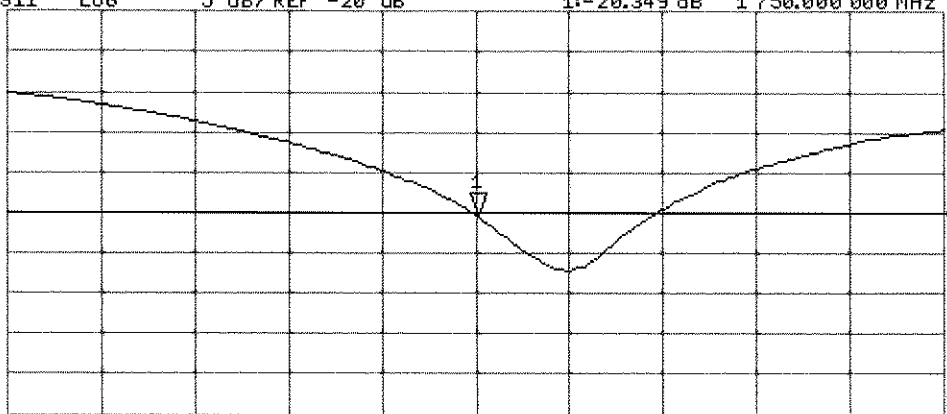

START 1 550.000 000 MHz

STOP 1 950.000 000 MHz

DASY5 Validation Report for SAM Head

Date: 23.05.2018

Test Laboratory: SPEAG, Zurich, Switzerland

DUT: Dipole 1765 MHz; Type: D1765V2; Serial: D1765V2 - SN:1008

Communication System: UID 0 - CW; Frequency: 1750 MHz

Medium parameters used: $f = 1750$ MHz; $\sigma = 1.37$ S/m; $\epsilon_r = 41.8$; $\rho = 1000$ kg/m³

Measurement Standard: DASY5 (IEEE/IEC/ANSI C63.19-2011)

DASY52 Configuration:

- Probe: EX3DV4 - SN7349; ConvF(8.5, 8.5, 8.5) @ 1750 MHz; Calibrated: 30.12.2017
- Sensor-Surface: 1.4mm (Mechanical Surface Detection)
- Electronics: DAE4 Sn601; Calibrated: 26.10.2017
- Phantom: SAM Head
- DASY52 52.10.1(1476); SEMCAD X 14.6.11(7439)

SAM/Head/Top/Zoom Scan (7x7x7)/Cube 0: Measurement grid: dx=5mm, dy=5mm, dz=5mm

Reference Value = 105.8 V/m; Power Drift = 0.02 dB

Peak SAR (extrapolated) = 16.4 W/kg

SAR(1 g) = 9.26 W/kg; SAR(10 g) = 4.95 W/kg

Maximum value of SAR (measured) = 13.9 W/kg

SAM/Head/Mouth/Zoom Scan (7x7x7)/Cube 0: Measurement grid: dx=5mm, dy=5mm, dz=5mm

Reference Value = 104.2 V/m; Power Drift = -0.04 dB

Peak SAR (extrapolated) = 16.6 W/kg

SAR(1 g) = 9.47 W/kg; SAR(10 g) = 5.06 W/kg

Maximum value of SAR (measured) = 13.7 W/kg

SAM/Head/Neck/Zoom Scan (7x7x7)/Cube 0: Measurement grid: dx=5mm, dy=5mm, dz=5mm

Reference Value = 104.7 V/m; Power Drift = 0.02 dB

Peak SAR (extrapolated) = 15.8 W/kg

SAR(1 g) = 9.26 W/kg; SAR(10 g) = 5.02 W/kg

Maximum value of SAR (measured) = 13.8 W/kg

SAM/Head/Ear/Zoom Scan (7x7x7)/Cube 0: Measurement grid: dx=5mm, dy=5mm, dz=5mm

Reference Value = 90.46 V/m; Power Drift = -0.02 dB

Peak SAR (extrapolated) = 11.8 W/kg

SAR(1 g) = 7.12 W/kg; SAR(10 g) = 4.01 W/kg

Maximum value of SAR (measured) = 10.3 W/kg

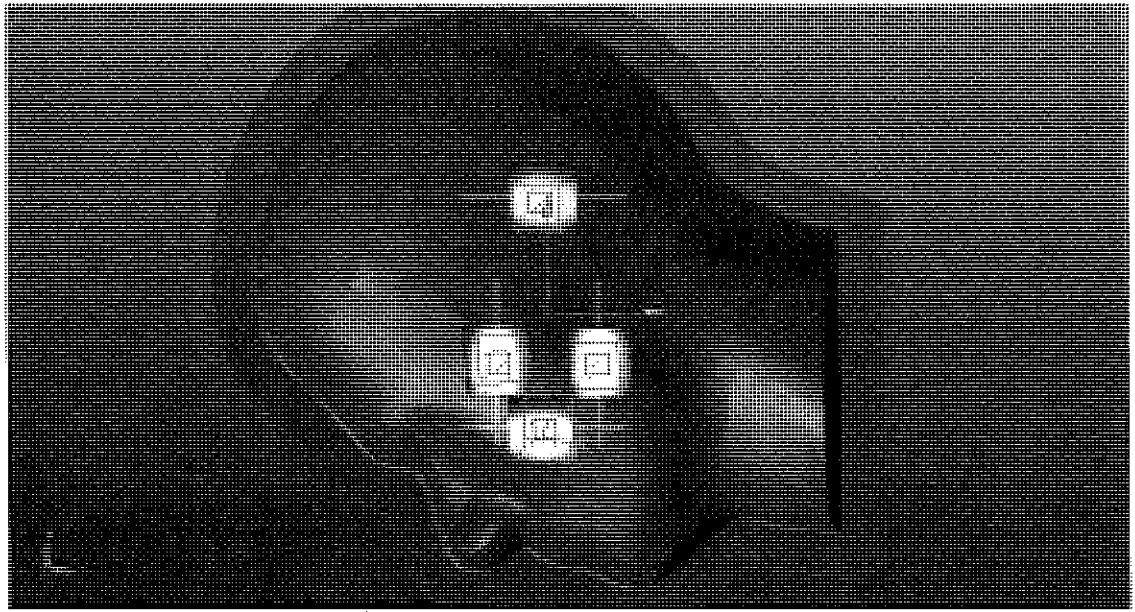
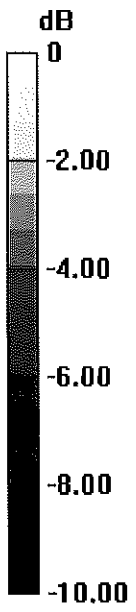

0 dB = 10.3 W/kg = 10.13 dBW/kg

Certification of Calibration

Object: D1765V2 – SN: 1008

Calibration procedure(s): Procedure for Calibration Extension for SAR Dipoles.

Extension Calibration date: 5/17/2019

Description: SAR Validation Dipole at 1750 MHz.

Calibration Equipment used:

Manufacturer	Model	Description	Cal Date	Cal Interval	Cal Due	Serial Number
Agilent	8753ES	S-Parameter Network Analyzer	3/11/2019	Annual	3/11/2020	US39170122
Agilent	N5182A	MXG Vector Signal Generator	11/28/2018	Annual	11/28/2019	MY47420603
Amplifier Research	15S1G6	Amplifier	CBT	N/A	CBT	433971
Anritsu	MA2411B	Pulse Power Sensor	11/20/2018	Annual	11/20/2019	1027293
Anritsu	MA2411B	Pulse Power Sensor	10/30/2018	Annual	10/30/2019	1126066
Anritsu	ML2495A	Power Meter	10/21/2018	Annual	10/21/2019	941001
Control Company	4040	Therm./ Clock/ Humidity Monitor	10/9/2018	Biennial	10/9/2020	181647811
Control Company	4352	Ultra Long Stem Thermometer	6/6/2018	Biennial	6/6/2020	181334678
Keysight	772D	Dual Directional Coupler	CBT	N/A	CBT	MY52180215
Keysight Technologies	85033E	Standard Mechanical Calibration Kit (DC to 9GHz, 3.5mm)	6/4/2018	Annual	6/4/2019	MY53401181
MiniCircuits	VLF-6000+	Low Pass Filter	CBT	N/A	CBT	N/A
Mini-Circuits	BW-N20W5+	DC to 18 GHz Precision Fixed 20 dB Attenuator	CBT	N/A	CBT	N/A
Narda	4772-3	Attenuator (3dB)	CBT	N/A	CBT	9406
Pasternack	PE2209-10	Bidirectional Coupler	CBT	N/A	CBT	N/A
Seekonk	NC-100	Torque Wrench	7/11/2018	Annual	7/11/2019	N/A
SPEAG	EX3DV4	SAR Probe	6/25/2018	Annual	6/25/2019	7409
SPEAG	DAE4	Dasy Data Acquisition Electronics	6/18/2018	Annual	6/18/2019	1334
SPEAG	EX3DV4	SAR Probe	2/19/2019	Annual	2/19/2020	3914
SPEAG	DAE4	Dasy Data Acquisition Electronics	2/14/2019	Annual	2/14/2020	1272
SPEAG	DAK-3.5	Dielectric Assessment Kit	9/11/2018	Annual	9/11/2019	1091

Measurement Uncertainty = $\pm 23\%$ (k=2)

	Name	Function	Signature
Calibrated By:	Brodie Halfoster	Test Engineer	<i>BRODIE HALFOSTER</i>
Approved By:	Kaitlin O'Keefe	Senior Technical Manager	<i>KOK</i>

DIPOLE CALIBRATION EXTENSION

Per KDB 865664 D01, calibration intervals of up to three years may be considered for reference dipoles when it is demonstrated that the SAR target, impedance and return loss of a dipole have remained stable according to the following requirements:

1. The measured SAR does not deviate more than 10% from the target on the calibration certificate.
2. The return-loss does not deviate more than 20% from the previous measurement and meets the required 20dB minimum return-loss requirement.
3. The measurement of real or imaginary parts of impedance does not deviate more than 5Ω from the previous measurement.

The following dipole was checked to pass the above 3 requirements to have 2-year calibration period from the calibration date:

Calibration Date	Extension Date	Certificate Electrical Delay (ns)	Certificate SAR Target Head (1g) W/kg @ 20.0 dBm	Measured Head SAR (1g) W/kg @ 20.0 dBm	Deviation 1g (%)	Certificate SAR Target Head (10g) W/kg @ 20.0 dBm	Measured Head SAR (10g) W/kg @ 20.0 dBm	Deviation 10g (%)	Certificate Impedance Head (Ohm) Real	Measured Impedance Head (Ohm) Real	Difference (Ohm) Real	Certificate Impedance Head (Ohm) Imaginary	Measured Impedance Head (Ohm) Imaginary	Difference (Ohm) Imaginary	Certificate Return Loss Head (dB)	Measured Return Loss Head (dB)	Deviation (%)	PASS/FAIL
5/23/2019	5/17/2019	1.21	3.62	3.63	0.28%	1.9	1.92	1.05%	47.7	47	0.7	-6.5	-6	0.5	-23	-23.3	-1.20%	PASS
Calibration Date	Extension Date	Certificate Electrical Delay (ns)	Certificate SAR Target Body (1g) W/kg @ 20.0 dBm	Measured Body SAR (1g) W/kg @ 20.0 dBm	Deviation 1g (%)	Certificate SAR Target Body (10g) W/kg @ 20.0 dBm	Measured Body SAR (10g) W/kg @ 20.0 dBm	Deviation 10g (%)	Certificate Impedance Body (Ohm) Real	Measured Impedance Body (Ohm) Real	Difference (Ohm) Real	Certificate Impedance Body (Ohm) Imaginary	Measured Impedance Body (Ohm) Imaginary	Difference (Ohm) Imaginary	Certificate Return Loss Body (dB)	Measured Return Loss Body (dB)	Deviation (%)	PASS/FAIL
5/23/2019	5/17/2019	1.21	3.74	3.95	5.61%	1.99	2.08	4.52%	43.3	44.6	1.3	-6	-7	1	-20.3	-20.5	-0.90%	PASS

Impedance & Return-Loss Measurement Plot for Head TSL

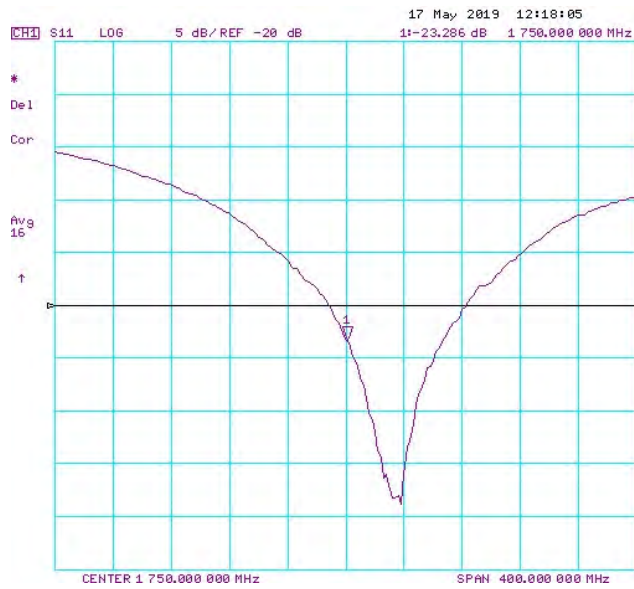
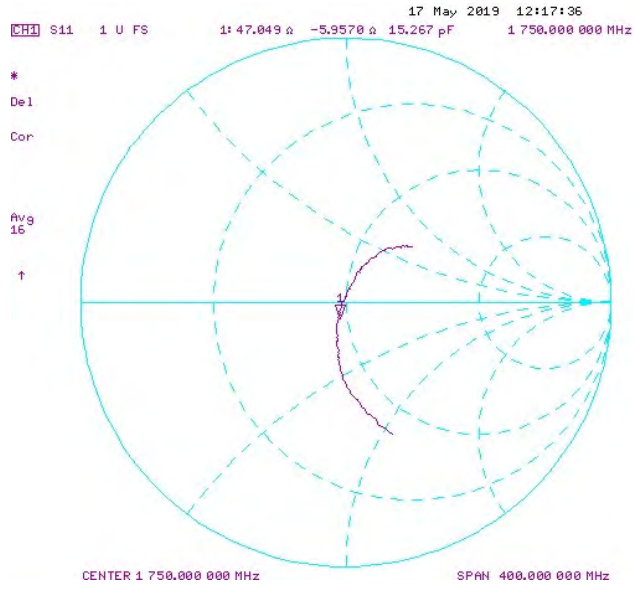

Impedance & Return-Loss Measurement Plot for Body TSL

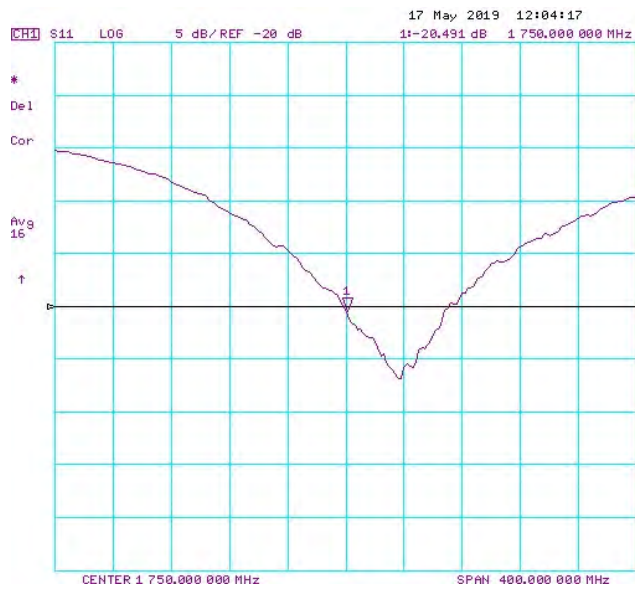
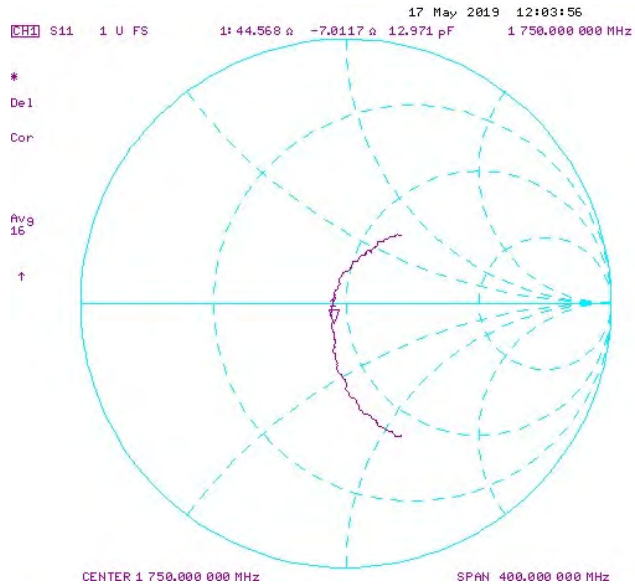



Accredited by the Swiss Accreditation Service (SAS)
The Swiss Accreditation Service is one of the signatories to the EA
Multilateral Agreement for the recognition of calibration certificates

Accreditation No.: **SCS 0108**

Client **PC Test**

Certificate No: **D1900V2-5d080_Oct18**

CALIBRATION CERTIFICATE

Object **D1900V2 - SN:5d080**

Calibration procedure(s) **QA CAL-05 v10
Calibration procedure for dipole validation kits above 700 MHz**

Calibration date: **October 23, 2018**

*BN ✓
10-30-2018
BN ✓
10-20-2019*

This calibration certificate documents the traceability to national standards, which realize the physical units of measurements (SI).
The measurements and the uncertainties with confidence probability are given on the following pages and are part of the certificate.

All calibrations have been conducted in the closed laboratory facility: environment temperature (22 ± 3)°C and humidity < 70%.

Calibration Equipment used (M&TE critical for calibration)

Primary Standards	ID #	Cal Date (Certificate No.)	Scheduled Calibration
Power meter NRP	SN: 104778	04-Apr-18 (No. 217-02672/02673)	Apr-19
Power sensor NRP-Z91	SN: 103244	04-Apr-18 (No. 217-02672)	Apr-19
Power sensor NRP-Z91	SN: 103245	04-Apr-18 (No. 217-02673)	Apr-19
Reference 20 dB Attenuator	SN: 5058 (20k)	04-Apr-18 (No. 217-02682)	Apr-19
Type-N mismatch combination	SN: 5047.2 / 06327	04-Apr-18 (No. 217-02683)	Apr-19
Reference Probe EX3DV4	SN: 7349	30-Dec-17 (No. EX3-7349_Dec17)	Dec-18
DAE4	SN: 601	04-Oct-18 (No. DAE4-601_Oct18)	Oct-19

Secondary Standards	ID #	Check Date (in house)	Scheduled Check
Power meter EPM-442A	SN: GB37480704	07-Oct-15 (in house check Oct-18)	In house check: Oct-20
Power sensor HP 8481A	SN: US37292783	07-Oct-15 (in house check Oct-18)	In house check: Oct-20
Power sensor HP 8481A	SN: MY41092317	07-Oct-15 (in house check Oct-18)	In house check: Oct-20
RF generator R&S SMT-06	SN: 100972	15-Jun-15 (in house check Oct-18)	In house check: Oct-20
Network Analyzer Agilent E8358A	SN: US41080477	31-Mar-14 (in house check Oct-18)	In house check: Oct-19

Calibrated by: **Jeton Kastrati** (Name) **Laboratory Technician** (Function) *[Signature]* (Signature)

Approved by: **Katja Pokovic** (Name) **Technical Manager** (Function) *[Signature]* (Signature)

Issued: October 23, 2018

This calibration certificate shall not be reproduced except in full without written approval of the laboratory.



Accredited by the Swiss Accreditation Service (SAS)
The Swiss Accreditation Service is one of the signatories to the EA
Multilateral Agreement for the recognition of calibration certificates

Accreditation No.: **SCS 0108**

Glossary:

TSL	tissue simulating liquid
ConvF	sensitivity in TSL / NORM x,y,z
N/A	not applicable or not measured

Calibration is Performed According to the Following Standards:

- IEEE Std 1528-2013, "IEEE Recommended Practice for Determining the Peak Spatial-Averaged Specific Absorption Rate (SAR) in the Human Head from Wireless Communications Devices: Measurement Techniques", June 2013
- IEC 62209-1, "Measurement procedure for the assessment of Specific Absorption Rate (SAR) from hand-held and body-mounted devices used next to the ear (frequency range of 300 MHz to 6 GHz)", July 2016
- IEC 62209-2, "Procedure to determine the Specific Absorption Rate (SAR) for wireless communication devices used in close proximity to the human body (frequency range of 30 MHz to 6 GHz)", March 2010
- KDB 865664, "SAR Measurement Requirements for 100 MHz to 6 GHz"

Additional Documentation:

- DASY4/5 System Handbook

Methods Applied and Interpretation of Parameters:

- Measurement Conditions:** Further details are available from the Validation Report at the end of the certificate. All figures stated in the certificate are valid at the frequency indicated.
- Antenna Parameters with TSL:** The dipole is mounted with the spacer to position its feed point exactly below the center marking of the flat phantom section, with the arms oriented parallel to the body axis.
- Feed Point Impedance and Return Loss:** These parameters are measured with the dipole positioned under the liquid filled phantom. The impedance stated is transformed from the measurement at the SMA connector to the feed point. The Return Loss ensures low reflected power. No uncertainty required.
- Electrical Delay:** One-way delay between the SMA connector and the antenna feed point. No uncertainty required.
- SAR measured:** SAR measured at the stated antenna input power.
- SAR normalized:** SAR as measured, normalized to an input power of 1 W at the antenna connector.
- SAR for nominal TSL parameters:** The measured TSL parameters are used to calculate the nominal SAR result.

The reported uncertainty of measurement is stated as the standard uncertainty of measurement multiplied by the coverage factor $k=2$, which for a normal distribution corresponds to a coverage probability of approximately 95%.

Measurement Conditions

DASY system configuration, as far as not given on page 1.

DASY Version	DASY5	V52.10.2
Extrapolation	Advanced Extrapolation	
Phantom	Modular Flat Phantom	
Distance Dipole Center - TSL	10 mm	with Spacer
Zoom Scan Resolution	dx, dy, dz = 5 mm	
Frequency	1900 MHz \pm 1 MHz	

Head TSL parameters

The following parameters and calculations were applied.

	Temperature	Permittivity	Conductivity
Nominal Head TSL parameters	22.0 °C	40.0	1.40 mho/m
Measured Head TSL parameters	(22.0 \pm 0.2) °C	40.3 \pm 6 %	1.40 mho/m \pm 6 %
Head TSL temperature change during test	< 0.5 °C	----	----

SAR result with Head TSL

SAR averaged over 1 cm ³ (1 g) of Head TSL	Condition	
SAR measured	250 mW input power	9.93 W/kg
SAR for nominal Head TSL parameters	normalized to 1W	39.8 W/kg \pm 17.0 % (k=2)

SAR averaged over 10 cm ³ (10 g) of Head TSL	condition	
SAR measured	250 mW input power	5.18 W/kg
SAR for nominal Head TSL parameters	normalized to 1W	20.7 W/kg \pm 16.5 % (k=2)

Body TSL parameters

The following parameters and calculations were applied.

	Temperature	Permittivity	Conductivity
Nominal Body TSL parameters	22.0 °C	53.3	1.52 mho/m
Measured Body TSL parameters	(22.0 \pm 0.2) °C	52.9 \pm 6 %	1.47 mho/m \pm 6 %
Body TSL temperature change during test	< 0.5 °C	----	----

SAR result with Body TSL

SAR averaged over 1 cm ³ (1 g) of Body TSL	Condition	
SAR measured	250 mW input power	9.62 W/kg
SAR for nominal Body TSL parameters	normalized to 1W	39.2 W/kg \pm 17.0 % (k=2)

SAR averaged over 10 cm ³ (10 g) of Body TSL	condition	
SAR measured	250 mW input power	5.09 W/kg
SAR for nominal Body TSL parameters	normalized to 1W	20.6 W/kg \pm 16.5 % (k=2)

Appendix (Additional assessments outside the scope of SCS 0108)

Antenna Parameters with Head TSL

Impedance, transformed to feed point	$52.5 \Omega + 7.9 j\Omega$
Return Loss	- 21.8 dB

Antenna Parameters with Body TSL

Impedance, transformed to feed point	$48.1 \Omega + 8.1 j\Omega$
Return Loss	- 21.5 dB

General Antenna Parameters and Design

Electrical Delay (one direction)	1.193 ns
----------------------------------	----------

After long term use with 100W radiated power, only a slight warming of the dipole near the feedpoint can be measured.

The dipole is made of standard semirigid coaxial cable. The center conductor of the feeding line is directly connected to the second arm of the dipole. The antenna is therefore short-circuited for DC-signals. On some of the dipoles, small end caps are added to the dipole arms in order to improve matching when loaded according to the position as explained in the "Measurement Conditions" paragraph. The SAR data are not affected by this change. The overall dipole length is still according to the Standard.

No excessive force must be applied to the dipole arms, because they might bend or the soldered connections near the feedpoint may be damaged.

Additional EUT Data

Manufactured by	SPEAG
Manufactured on	June 28, 2006

DASY5 Validation Report for Head TSL

Date: 23.10.2018

Test Laboratory: SPEAG, Zurich, Switzerland

DUT: Dipole 1900 MHz; Type: D1900V2; Serial: D1900V2 - SN:5d080

Communication System: UID 0 - CW; Frequency: 1900 MHz

Medium parameters used: $f = 1900$ MHz; $\sigma = 1.4$ S/m; $\epsilon_r = 40.3$; $\rho = 1000$ kg/m³

Phantom section: Flat Section

Measurement Standard: DASY5 (IEEE/IEC/ANSI C63.19-2011)

DASY52 Configuration:

- Probe: EX3DV4 - SN7349; ConvF(8.18, 8.18, 8.18) @ 1900 MHz; Calibrated: 30.12.2017
- Sensor-Surface: 1.4mm (Mechanical Surface Detection)
- Electronics: DAE4 Sn601; Calibrated: 04.10.2018
- Phantom: Flat Phantom 5.0 (front); Type: QD 000 P50 AA; Serial: 1001
- DASY52 52.10.2(1495); SEMCAD X 14.6.12(7450)

Dipole Calibration for Head Tissue/Pin=250 mW, d=10mm/Zoom Scan (7x7x7)/Cube 0:

Measurement grid: dx=5mm, dy=5mm, dz=5mm

Reference Value = 110.0 V/m; Power Drift = -0.05 dB

Peak SAR (extrapolated) = 18.7 W/kg

SAR(1 g) = 9.93 W/kg; SAR(10 g) = 5.18 W/kg

Maximum value of SAR (measured) = 15.6 W/kg

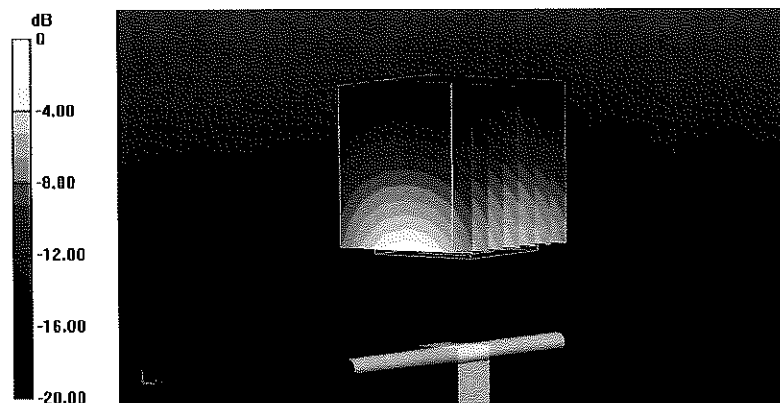

0 dB = 15.6 W/kg = 11.93 dBW/kg

Impedance Measurement Plot for Head TSL

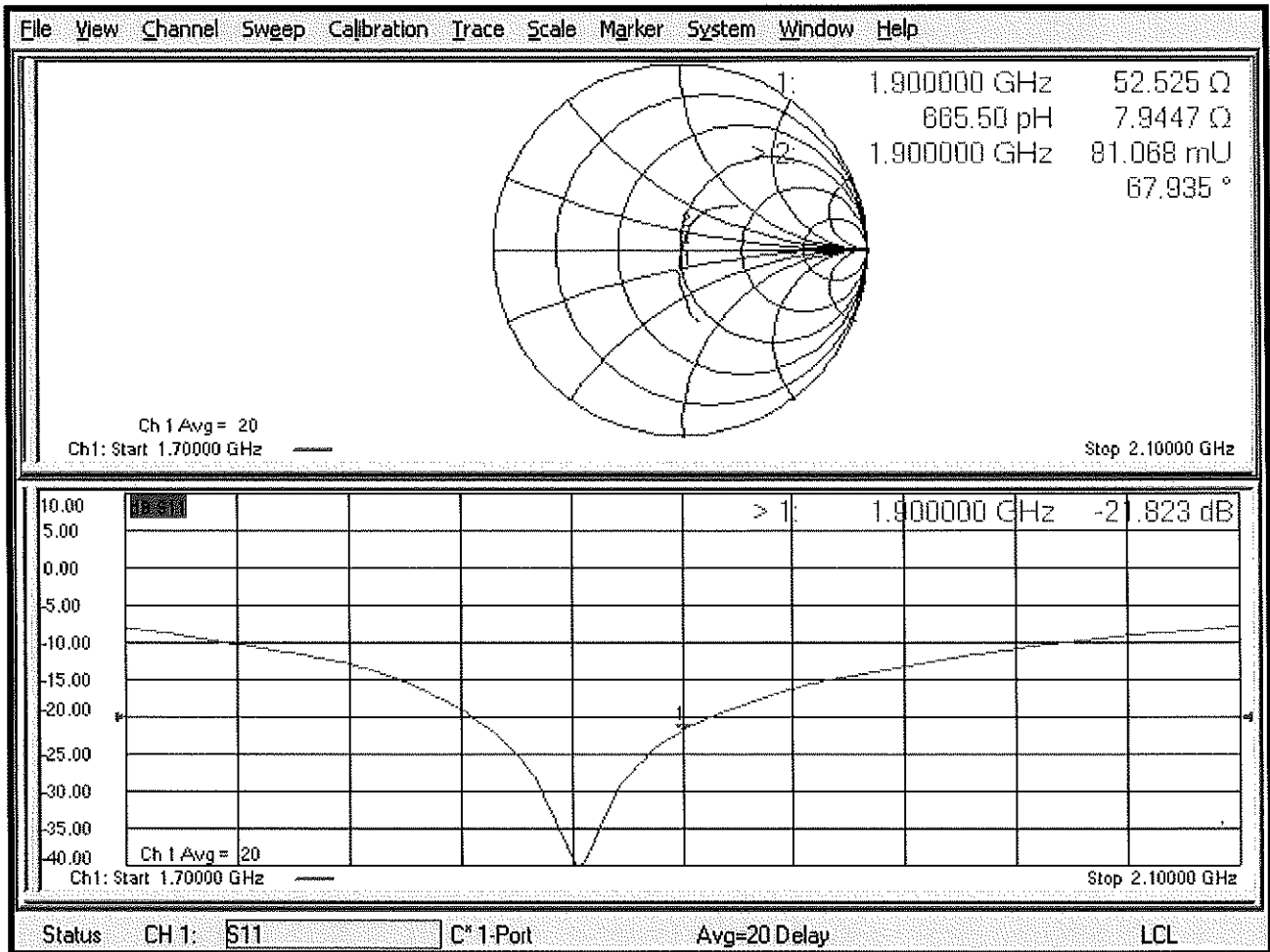

DASY5 Validation Report for Body TSL

Date: 23.10.2018

Test Laboratory: SPEAG, Zurich, Switzerland

DUT: Dipole 1900 MHz; Type: D1900V2; Serial: D1900V2 - SN:5d080

Communication System: UID 0 - CW; Frequency: 1900 MHz

Medium parameters used: $f = 1900$ MHz; $\sigma = 1.47$ S/m; $\epsilon_r = 52.9$; $\rho = 1000$ kg/m³

Phantom section: Flat Section

Measurement Standard: DASY5 (IEEE/IEC/ANSI C63.19-2011)

DASY52 Configuration:

- Probe: EX3DV4 - SN7349; ConvF(8.15, 8.15, 8.15) @ 1900 MHz; Calibrated: 30.12.2017
- Sensor-Surface: 1.4mm (Mechanical Surface Detection)
- Electronics: DAE4 Sn601; Calibrated: 04.10.2018
- Phantom: Flat Phantom 5.0 (back); Type: QD 000 P50 AA; Serial: 1002
- DASY52 52.10.2(1495); SEMCAD X 14.6.12(7450)

Dipole Calibration for Body Tissue/Pin=250 mW, d=10mm/Zoom Scan (7x7x7)/Cube 0:

Measurement grid: dx=5mm, dy=5mm, dz=5mm

Reference Value = 99.86 V/m; Power Drift = 0.00 dB

Peak SAR (extrapolated) = 17.3 W/kg

SAR(1 g) = 9.62 W/kg; SAR(10 g) = 5.09 W/kg

Maximum value of SAR (measured) = 14.1 W/kg

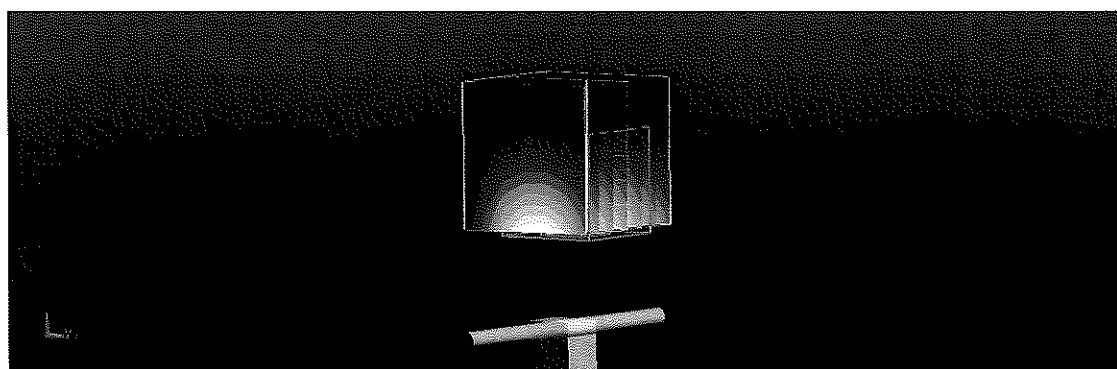
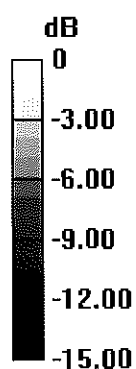

0 dB = 14.1 W/kg = 11.49 dBW/kg

Impedance Measurement Plot for Body TSL

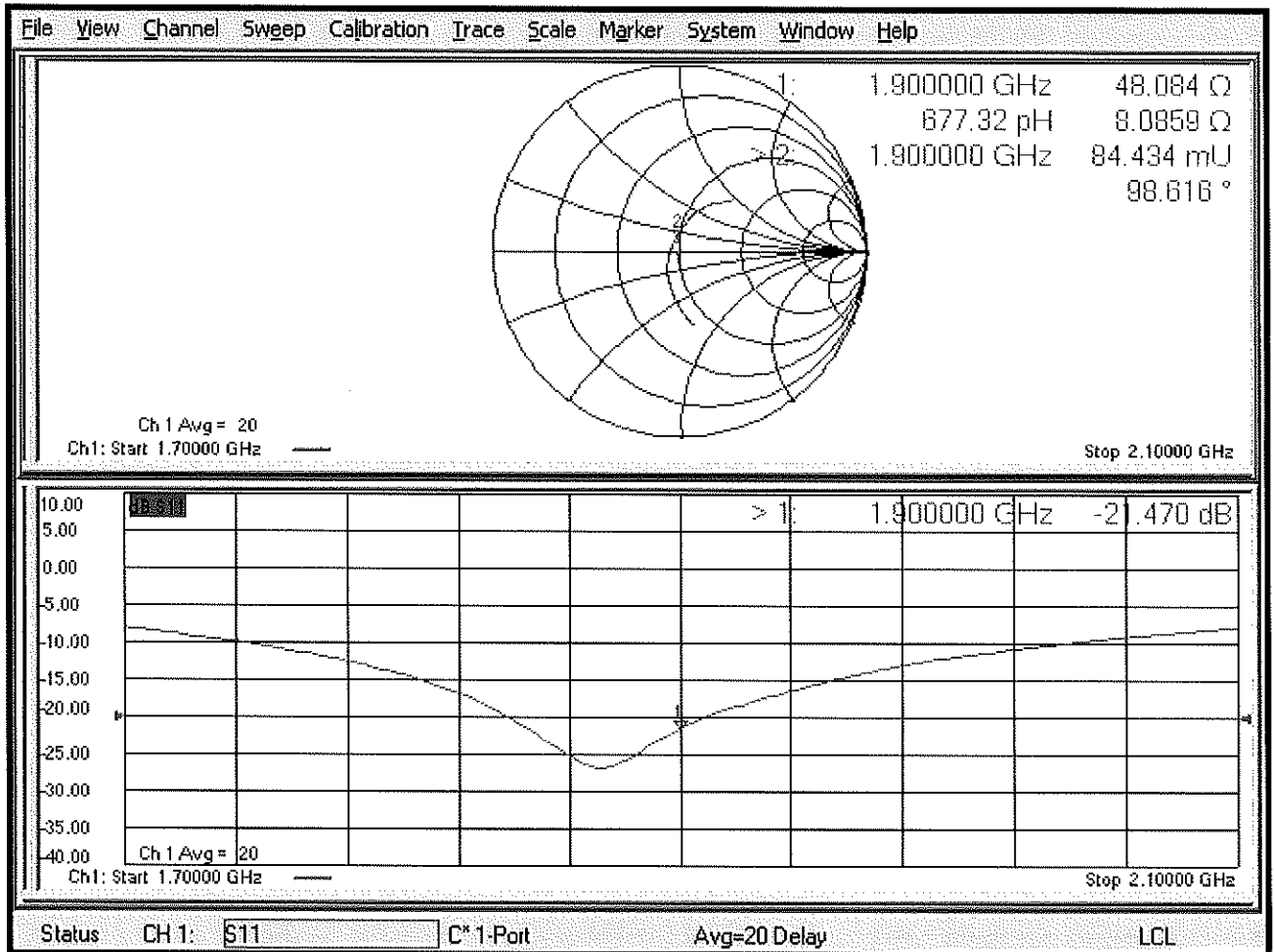

Certification of Calibration

Object: D1900V2 – SN:5d080

Calibration procedure(s): Procedure for Calibration Extension for SAR Dipoles.

Extended Calibration date: October 18, 2019

Description: SAR Validation Dipole at 1900 MHz.

Calibration Equipment used:

Manufacturer	Model	Description	Cal Date	Cal Interval	Cal Due	Serial Number
Control Company	4040	Therm./Clock/Humidity Monitor	6/29/2019	Biennial	6/29/2021	192291470
Control Company	4352	Ultra Long Stem Thermometer	8/2/2018	Biennial	8/2/2020	181334684
Amplifier Research	15S1G6	Amplifier	CBT	N/A	CBT	433971
Narda	4772-3	Attenuator (3dB)	CBT	N/A	CBT	9406
Keysight Technologies	85033E	Standard Mechanical Calibration Kit (DC to 9GHz, 3.5mm)	7/2/2019	Annual	7/2/2020	MY53401181
Rohde & Schwarz	ZNLE6	Vector Network Analyzer	10/11/2019	Annual	10/11/2020	101307
Mini-Circuits	BW-N20W5+	DC to 18 GHz Precision Fixed 20 dB Attenuator	CBT	N/A	CBT	N/A
SPEAG	DAKS-3.5	Portable Dielectric Assessment Kit	8/13/2019	Annual	8/13/2020	1041
Anritsu	MA2411B	Pulse Power Sensor	8/14/2019	Annual	8/14/2020	1315051
Anritsu	MA2411B	Pulse Power Sensor	8/8/2019	Annual	8/8/2020	1339008
Anritsu	ML2495A	Power Meter	11/20/2018	Annual	11/20/2019	1039008
Agilent	N5182A	MXG Vector Signal Generator	8/19/2019	Annual	8/19/2020	MY47420837
Seekonk	NC-100	Torque Wrench	5/9/2018	Biennial	5/9/2020	22217
Mini-Circuits	NLP-2950+	Low Pass Filter DC to 2700 MHz	CBT	N/A	CBT	N/A
MiniCircuits	ZHDC-16-63-S+	Bidirectional Coupler	CBT	N/A	CBT	N/A
MiniCircuits	VLF-6000+	Low Pass Filter	CBT	N/A	CBT	N/A
SPEAG	EX3DV4	SAR Probe	2/19/2019	Annual	2/19/2020	3914
SPEAG	EX3DV4	SAR Probe	5/16/2019	Annual	5/16/2020	7406
SPEAG	DAE4	Dasy Data Acquisition Electronics	5/8/2019	Annual	5/8/2020	859
SPEAG	DAE4	Dasy Data Acquisition Electronics	2/14/2019	Annual	2/14/2020	1272

Note: CBT (Calibrated Before Testing). Prior to testing, the measurement paths containing a cable, amplifier, attenuator, coupler or filter were connected to a calibrated source (i.e. a signal generator) to determine the losses of the measurement path.

Measurement Uncertainty = $\pm 23\%$ (k=2)

	Name	Function	Signature
Calibrated By:	Brodie Halfoster	Team Lead Engineer	<i>BRODIE HALBFOSTER</i>
Approved By:	Kaitlin O'Keefe	Senior Technical Manager	<i>KOK</i>

DIPOLE CALIBRATION EXTENSION

Per KDB 865664 D01, calibration intervals of up to three years may be considered for reference dipoles when it is demonstrated that the SAR target, impedance and return loss of a dipole have remained stable according to the following requirements:

1. The measured SAR does not deviate more than 10% from the target on the calibration certificate.
2. The return-loss does not deviate more than 20% from the previous measurement and meets the required 20dB minimum return-loss requirement.
3. The measurement of real or imaginary parts of impedance does not deviate more than 5Ω from the previous measurement.

The following dipole was checked to pass the above 3 requirements to have 2-year calibration period from the calibration date:

Calibration Date	Extension Date	Certificate Electrical Delay (ms)	Certificate SAR Target Head (1g) W/kg @ 20.0 dBm	Measured Head SAR (1g) W/kg @ 20.0 dBm	Deviation 1g (%)	Certificate SAR Target Head (10g) W/kg @ 20.0 dBm	Measured Head SAR (10g) W/kg @ 20.0 dBm	Deviation 10g (%)	Certificate Impedance Head (Ohm) Real	Measured Impedance Head (Ohm) Real	Difference (Ohm) Real	Certificate Impedance Head (Ohm) Imaginary	Measured Impedance Head (Ohm) Imaginary	Difference (Ohm) Imaginary	Certificate Return Loss Head (dB)	Measured Return Loss Head (dB)	Deviation (%)	PASS/FAIL
10/23/2018	10/18/2019	1.193	3.98	4.16	4.52%	2.07	2.13	2.90%	52.5	50.4	2.1	7.9	6.2	1.7	-21.8	-24.2	-10.90%	PASS
Calibration Date	Extension Date	Certificate Electrical Delay (ms)	Certificate SAR Target Body (1g) W/kg @ 20.0 dBm	Measured Body SAR (1g) W/kg @ 20.0 dBm	Deviation 1g (%)	Certificate SAR Target Body (10g) W/kg @ 20.0 dBm	Measured Body SAR (10g) W/kg @ 20.0 dBm	Deviation 10g (%)	Certificate Impedance Body (Ohm) Real	Measured Impedance Body (Ohm) Real	Difference (Ohm) Real	Certificate Impedance Body (Ohm) Imaginary	Measured Impedance Body (Ohm) Imaginary	Difference (Ohm) Imaginary	Certificate Return Loss Body (dB)	Measured Return Loss Body (dB)	Deviation (%)	PASS/FAIL
10/23/2018	10/18/2019	1.193	3.92	4.21	7.40%	2.06	2.16	4.85%	48.1	46.5	1.6	8.1	6.6	1.5	-21.5	-22.2	-3.40%	PASS

Impedance & Return-Loss Measurement Plot for Head TSL

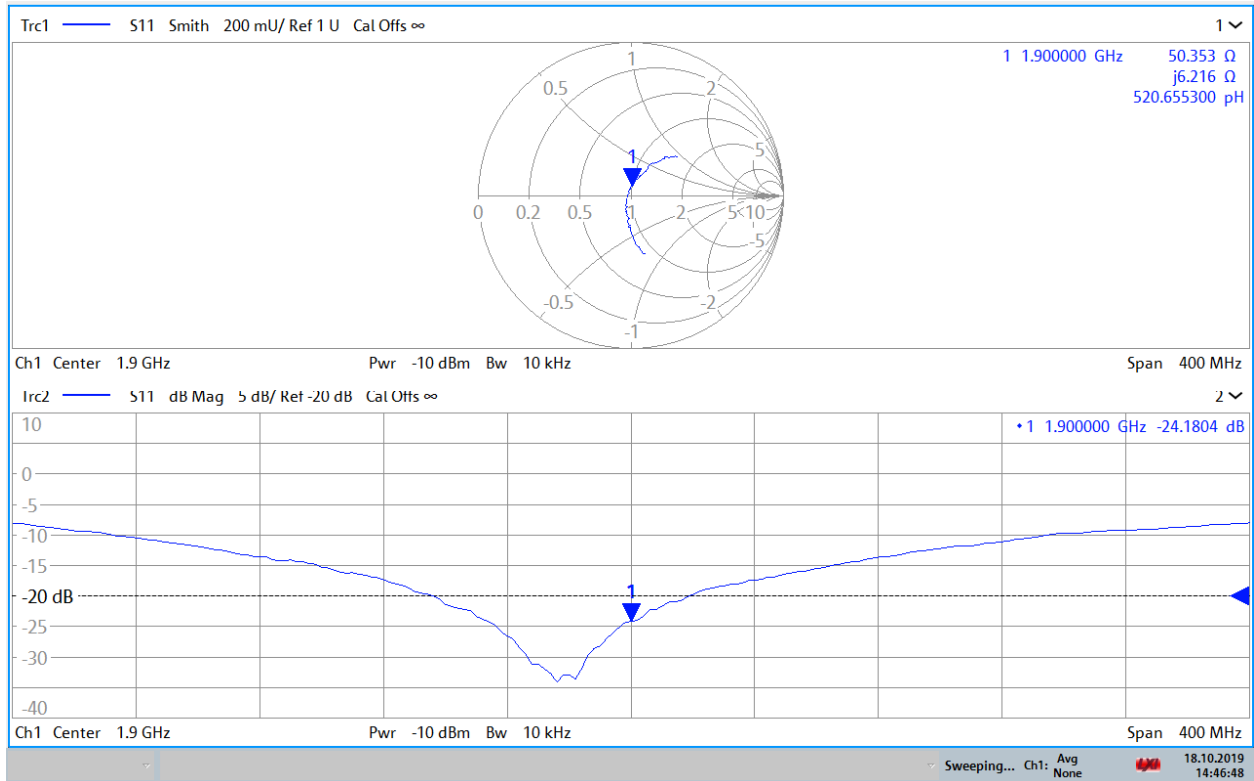

14:46:49 18.10.2019

Impedance & Return-Loss Measurement Plot for Body TSL

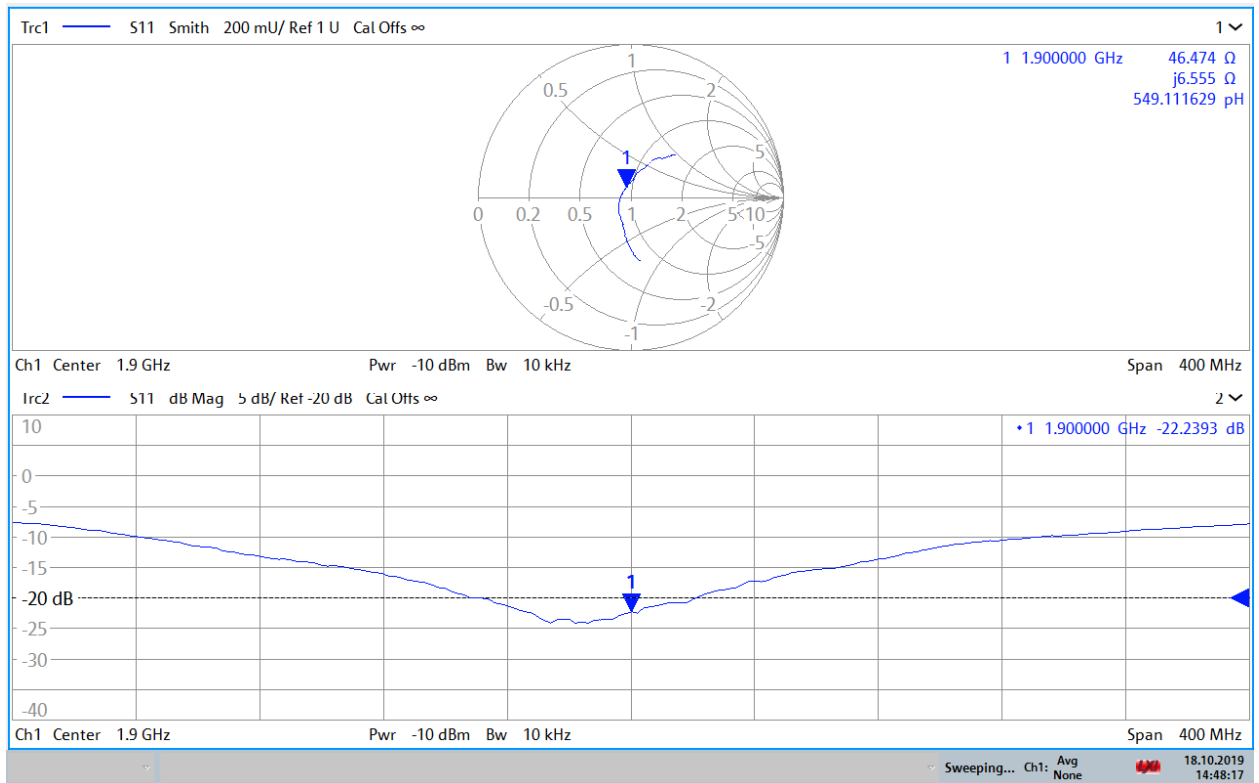

14:48:18 18.10.2019



Accredited by the Swiss Accreditation Service (SAS)
The Swiss Accreditation Service is one of the signatories to the EA
Multilateral Agreement for the recognition of calibration certificates

Accreditation No.: **SCS 0108**

Client **PC Test**

Certificate No: **D1900V2-5d148_Feb19**

CALIBRATION CERTIFICATE

Object **D1900V2 - SN:5d148**

Calibration procedure(s) **QA CAL-05.v11
Calibration Procedure for SAR Validation Sources between 0.7-3 GHz**

Calibration date: **February 21, 2019**

*BNV
03-01-19*

This calibration certificate documents the traceability to national standards, which realize the physical units of measurements (SI).
The measurements and the uncertainties with confidence probability are given on the following pages and are part of the certificate.

All calibrations have been conducted in the closed laboratory facility: environment temperature (22 ± 3)°C and humidity < 70%.

Calibration Equipment used (M&TE critical for calibration)

Primary Standards	ID #	Cal Date (Certificate No.)	Scheduled Calibration
Power meter NRP	SN: 104778	04-Apr-18 (No. 217-02672/02673)	Apr-19
Power sensor NRP-Z91	SN: 103244	04-Apr-18 (No. 217-02672)	Apr-19
Power sensor NRP-Z91	SN: 103245	04-Apr-18 (No. 217-02673)	Apr-19
Reference 20 dB Attenuator	SN: 5058 (20k)	04-Apr-18 (No. 217-02682)	Apr-19
Type-N mismatch combination	SN: 5047.2 / 06327	04-Apr-18 (No. 217-02683)	Apr-19
Reference Probe EX3DV4	SN: 7349	31-Dec-18 (No. EX3-7349_Dec18)	Dec-19
DAE4	SN: 601	04-Oct-18 (No. DAE4-601_Oct18)	Oct-19

Secondary Standards	ID #	Check Date (in house)	Scheduled Check
Power meter E4419B	SN: GB39512475	07-Oct-15 (in house check Feb-19)	In house check: Oct-20
Power sensor HP 8481A	SN: US37292783	07-Oct-15 (in house check Oct-18)	In house check: Oct-20
Power sensor HP 8481A	SN: MY41092317	07-Oct-15 (in house check Oct-18)	In house check: Oct-20
RF generator R&S SMT-06	SN: 100972	15-Jun-15 (in house check Oct-18)	In house check: Oct-20
Network Analyzer Agilent E8358A	SN: US41080477	31-Mar-14 (in house check Oct-18)	In house check: Oct-19

Calibrated by: **Manu Seitz** Name: **Manu Seitz** Function: **Laboratory Technician** Signature:

Approved by: **Katja Pokovic** Name: **Katja Pokovic** Technical Manager Signature:

Issued: February 21, 2019

This calibration certificate shall not be reproduced except in full without written approval of the laboratory.



Accredited by the Swiss Accreditation Service (SAS)
The Swiss Accreditation Service is one of the signatories to the EA
Multilateral Agreement for the recognition of calibration certificates

Accreditation No.: **SCS 0108**

Glossary:

TSL	tissue simulating liquid
ConvF	sensitivity in TSL / NORM x,y,z
N/A	not applicable or not measured

Calibration is Performed According to the Following Standards:

- IEEE Std 1528-2013, "IEEE Recommended Practice for Determining the Peak Spatial-Averaged Specific Absorption Rate (SAR) in the Human Head from Wireless Communications Devices: Measurement Techniques", June 2013
- IEC 62209-1, "Measurement procedure for the assessment of Specific Absorption Rate (SAR) from hand-held and body-mounted devices used next to the ear (frequency range of 300 MHz to 6 GHz)", July 2016
- IEC 62209-2, "Procedure to determine the Specific Absorption Rate (SAR) for wireless communication devices used in close proximity to the human body (frequency range of 30 MHz to 6 GHz)", March 2010
- KDB 865664, "SAR Measurement Requirements for 100 MHz to 6 GHz"

Additional Documentation:

- DASY4/5 System Handbook

Methods Applied and Interpretation of Parameters:

- Measurement Conditions:** Further details are available from the Validation Report at the end of the certificate. All figures stated in the certificate are valid at the frequency indicated.
- Antenna Parameters with TSL:** The dipole is mounted with the spacer to position its feed point exactly below the center marking of the flat phantom section, with the arms oriented parallel to the body axis.
- Feed Point Impedance and Return Loss:** These parameters are measured with the dipole positioned under the liquid filled phantom. The impedance stated is transformed from the measurement at the SMA connector to the feed point. The Return Loss ensures low reflected power. No uncertainty required.
- Electrical Delay:** One-way delay between the SMA connector and the antenna feed point. No uncertainty required.
- SAR measured:** SAR measured at the stated antenna input power.
- SAR normalized:** SAR as measured, normalized to an input power of 1 W at the antenna connector.
- SAR for nominal TSL parameters:** The measured TSL parameters are used to calculate the nominal SAR result.

The reported uncertainty of measurement is stated as the standard uncertainty of measurement multiplied by the coverage factor $k=2$, which for a normal distribution corresponds to a coverage probability of approximately 95%.

Measurement Conditions

DASY system configuration, as far as not given on page 1.

DASY Version	DASY5	V52.10.2
Extrapolation	Advanced Extrapolation	
Phantom	Modular Flat Phantom	
Distance Dipole Center - TSL	10 mm	with Spacer
Zoom Scan Resolution	dx, dy, dz = 5 mm	
Frequency	1900 MHz ± 1 MHz	

Head TSL parameters

The following parameters and calculations were applied.

	Temperature	Permittivity	Conductivity
Nominal Head TSL parameters	22.0 °C	40.0	1.40 mho/m
Measured Head TSL parameters	(22.0 ± 0.2) °C	40.9 ± 6 %	1.38 mho/m ± 6 %
Head TSL temperature change during test	< 0.5 °C	----	----

SAR result with Head TSL

SAR averaged over 1 cm³ (1 g) of Head TSL	Condition	
SAR measured	250 mW input power	9.65 W/kg
SAR for nominal Head TSL parameters	normalized to 1W	39.1 W/kg ± 17.0 % (k=2)

SAR averaged over 10 cm³ (10 g) of Head TSL	condition	
SAR measured	250 mW input power	5.05 W/kg
SAR for nominal Head TSL parameters	normalized to 1W	20.4 W/kg ± 16.5 % (k=2)

Body TSL parameters

The following parameters and calculations were applied.

	Temperature	Permittivity	Conductivity
Nominal Body TSL parameters	22.0 °C	53.3	1.52 mho/m
Measured Body TSL parameters	(22.0 ± 0.2) °C	53.6 ± 6 %	1.47 mho/m ± 6 %
Body TSL temperature change during test	< 0.5 °C	----	----

SAR result with Body TSL

SAR averaged over 1 cm³ (1 g) of Body TSL	Condition	
SAR measured	250 mW input power	9.56 W/kg
SAR for nominal Body TSL parameters	normalized to 1W	39.1 W/kg ± 17.0 % (k=2)

SAR averaged over 10 cm³ (10 g) of Body TSL	condition	
SAR measured	250 mW input power	5.05 W/kg
SAR for nominal Body TSL parameters	normalized to 1W	20.5 W/kg ± 16.5 % (k=2)

Appendix (Additional assessments outside the scope of SCS 0108)

Antenna Parameters with Head TSL

Impedance, transformed to feed point	$51.8 \Omega + 6.8 j\Omega$
Return Loss	- 23.2 dB

Antenna Parameters with Body TSL

Impedance, transformed to feed point	$48.4 \Omega + 7.8 j\Omega$
Return Loss	- 21.9 dB

General Antenna Parameters and Design

Electrical Delay (one direction)	1.170 ns
----------------------------------	----------

After long term use with 100W radiated power, only a slight warming of the dipole near the feedpoint can be measured.

The dipole is made of standard semirigid coaxial cable. The center conductor of the feeding line is directly connected to the second arm of the dipole. The antenna is therefore short-circuited for DC-signals. On some of the dipoles, small end caps are added to the dipole arms in order to improve matching when loaded according to the position as explained in the "Measurement Conditions" paragraph. The SAR data are not affected by this change. The overall dipole length is still according to the Standard.

No excessive force must be applied to the dipole arms, because they might bend or the soldered connections near the feedpoint may be damaged.

Additional EUT Data

Manufactured by	SPEAG
-----------------	-------

DASY5 Validation Report for Head TSL

Date: 21.02.2019

Test Laboratory: SPEAG, Zurich, Switzerland

DUT: Dipole 1900 MHz; Type: D1900V2; Serial: D1900V2 - SN:5d148

Communication System: UID 0 - CW; Frequency: 1900 MHz

Medium parameters used: $f = 1900$ MHz; $\sigma = 1.38$ S/m; $\epsilon_r = 40.9$; $\rho = 1000$ kg/m³

Phantom section: Flat Section

Measurement Standard: DASY5 (IEEE/IEC/ANSI C63.19-2011)

DASY52 Configuration:

- Probe: EX3DV4 - SN7349; ConvF(8.26, 8.26, 8.26) @ 1900 MHz; Calibrated: 31.12.2018
- Sensor-Surface: 1.4mm (Mechanical Surface Detection)
- Electronics: DAE4 Sn601; Calibrated: 04.10.2018
- Phantom: Flat Phantom 5.0 (front); Type: QD 000 P50 AA; Serial: 1001
- DASY52 52.10.2(1495); SEMCAD X 14.6.12(7450)

Dipole Calibration for Head Tissue/Pin=250 mW, d=10mm/Zoom Scan (7x7x7)/Cube 0:

Measurement grid: dx=5mm, dy=5mm, dz=5mm

Reference Value = 109.4 V/m; Power Drift = 0.01 dB

Peak SAR (extrapolated) = 17.8 W/kg

SAR(1 g) = 9.65 W/kg; SAR(10 g) = 5.05 W/kg

Maximum value of SAR (measured) = 15.0 W/kg

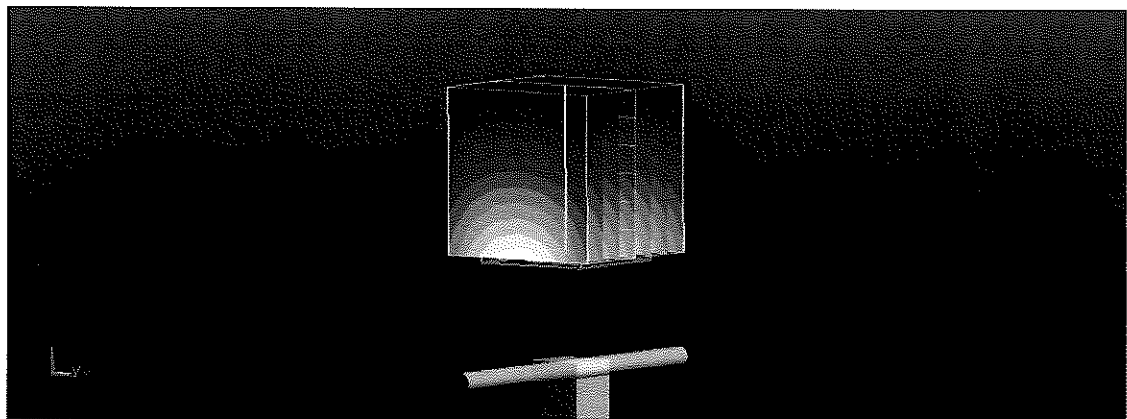
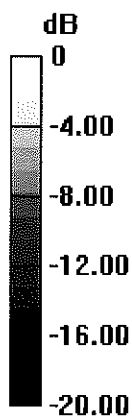

0 dB = 15.0 W/kg = 11.76 dBW/kg

Impedance Measurement Plot for Head TSL

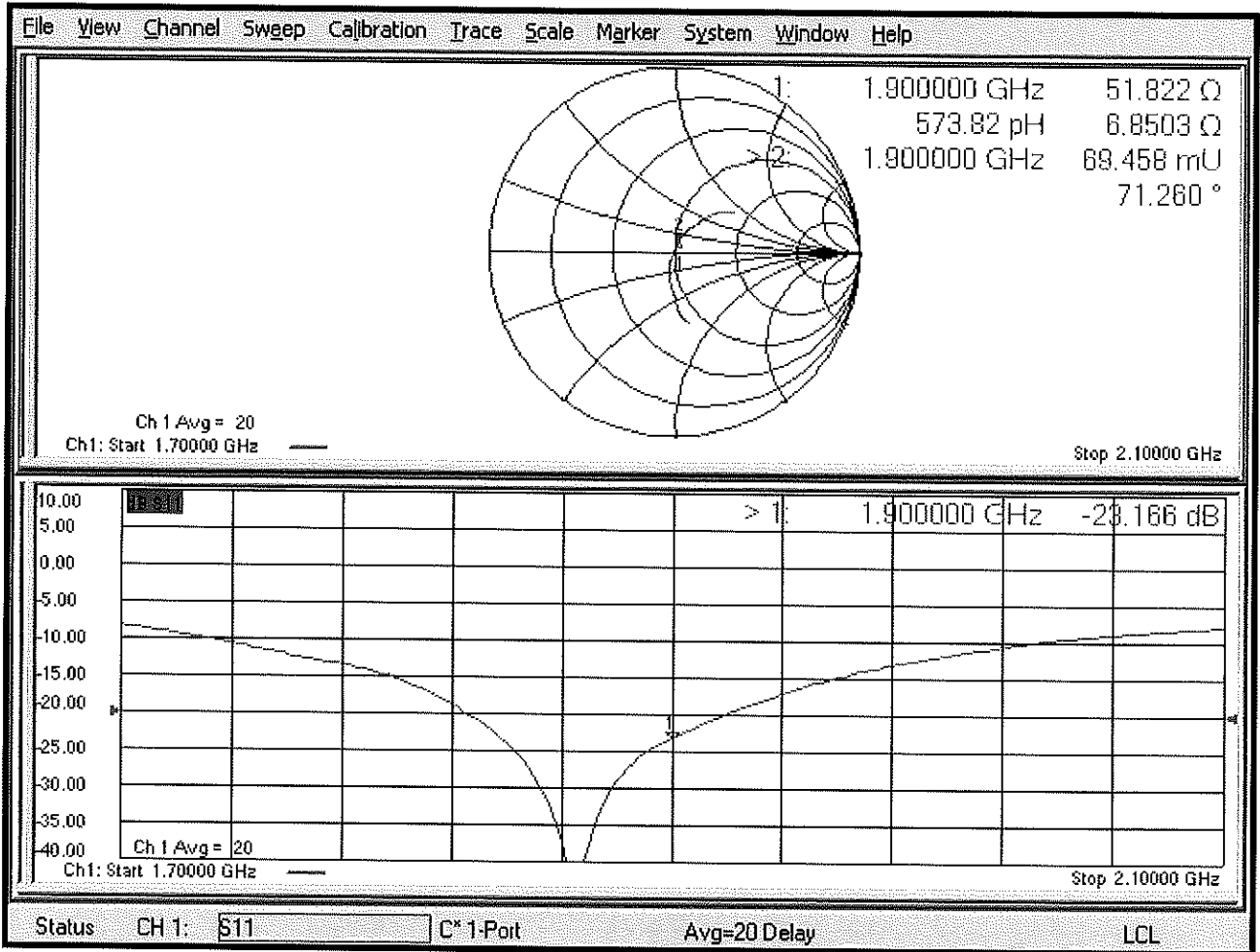

DASY5 Validation Report for Body TSL

Date: 21.02.2019

Test Laboratory: SPEAG, Zurich, Switzerland

DUT: Dipole 1900 MHz; Type: D1900V2; Serial: D1900V2 - SN:5d148

Communication System: UID 0 - CW; Frequency: 1900 MHz

Medium parameters used: $f = 1900$ MHz; $\sigma = 1.47$ S/m; $\epsilon_r = 53.6$; $\rho = 1000$ kg/m³

Phantom section: Flat Section

Measurement Standard: DASY5 (IEEE/IEC/ANSI C63.19-2011)

DASY52 Configuration:

- Probe: EX3DV4 - SN7349; ConvF(8.23, 8.23, 8.23) @ 1900 MHz; Calibrated: 31.12.2018
- Sensor-Surface: 1.4mm (Mechanical Surface Detection)
- Electronics: DAE4 Sn601; Calibrated: 04.10.2018
- Phantom: Flat Phantom 5.0 (back); Type: QD 000 P50 AA; Serial: 1002
- DASY52 52.10.2(1495); SEMCAD X 14.6.12(7450)

Dipole Calibration for Body Tissue/Pin=250 mW, d=10mm/Zoom Scan (7x7x7)/Cube 0:

Measurement grid: dx=5mm, dy=5mm, dz=5mm

Reference Value = 103.7 V/m; Power Drift = -0.03 dB

Peak SAR (extrapolated) = 17.0 W/kg

SAR(1 g) = 9.56 W/kg; SAR(10 g) = 5.05 W/kg

Maximum value of SAR (measured) = 14.4 W/kg

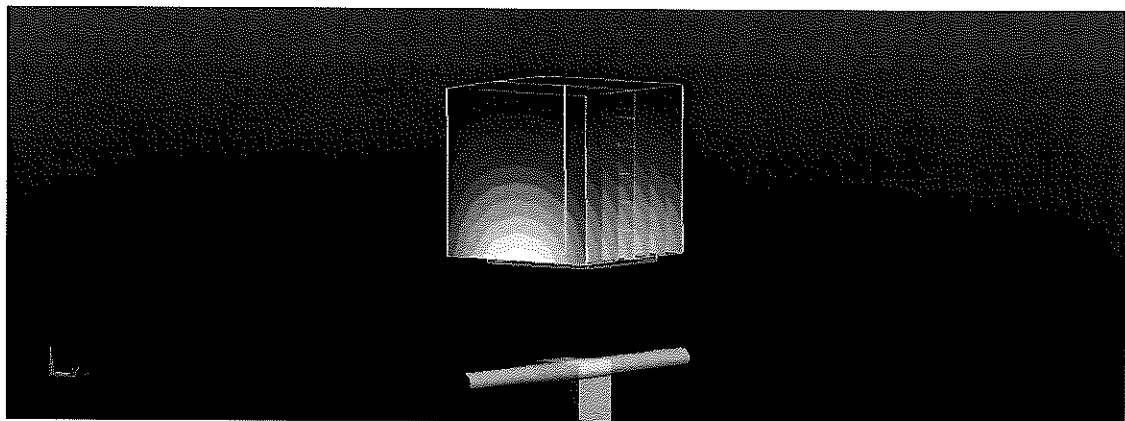
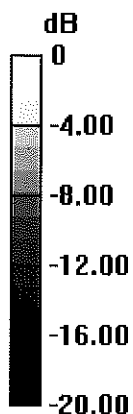

0 dB = 14.4 W/kg = 11.58 dBW/kg

Impedance Measurement Plot for Body TSL

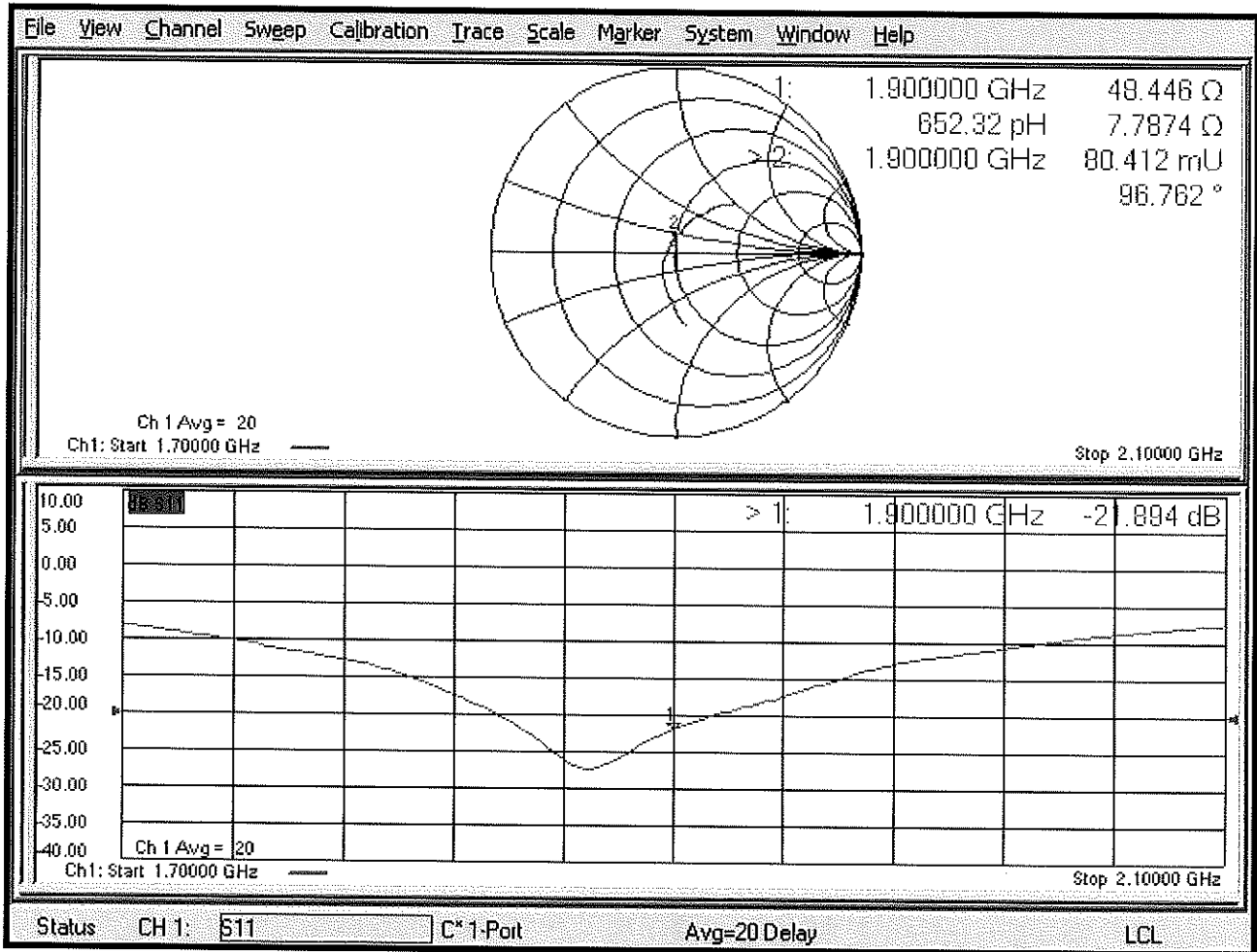



Accredited by the Swiss Accreditation Service (SAS)
The Swiss Accreditation Service is one of the signatories to the EA
Multilateral Agreement for the recognition of calibration certificates

Accreditation No.: **SCS 0108**

Client **PC Test**

Certificate No: **D1900V2-5d149_Oct18**

CALIBRATION CERTIFICATE

Object **D1900V2 - SN:5d149**

Calibration procedure(s) **QA CAL-05.v10
Calibration procedure for dipole validation kits above 700 MHz**

Calibration date: **October 23, 2018**

*BNV
10-30-2018
BNV
10-20-2018*

This calibration certificate documents the traceability to national standards, which realize the physical units of measurements (SI).
The measurements and the uncertainties with confidence probability are given on the following pages and are part of the certificate.

All calibrations have been conducted in the closed laboratory facility: environment temperature (22 ± 3)°C and humidity < 70%.

Calibration Equipment used (M&TE critical for calibration)

Primary Standards	ID #	Cal Date (Certificate No.)	Scheduled Calibration
Power meter NRP	SN: 104778	04-Apr-18 (No. 217-02672/02673)	Apr-19
Power sensor NRP-Z91	SN: 103244	04-Apr-18 (No. 217-02672)	Apr-19
Power sensor NRP-Z91	SN: 103245	04-Apr-18 (No. 217-02673)	Apr-19
Reference 20 dB Attenuator	SN: 5058 (20k)	04-Apr-18 (No. 217-02682)	Apr-19
Type-N mismatch combination	SN: 5047.2 / 06327	04-Apr-18 (No. 217-02683)	Apr-19
Reference Probe EX3DV4	SN: 7349	30-Dec-17 (No. EX3-7349_Dec17)	Dec-18
DAE4	SN: 601	04-Oct-18 (No. DAE4-601_Oct18)	Oct-19
Secondary Standards	ID #	Check Date (in house)	Scheduled Check
Power meter EPM-442A	SN: GB37480704	07-Oct-15 (in house check Oct-18)	In house check: Oct-20
Power sensor HP 8481A	SN: US37292783	07-Oct-15 (in house check Oct-18)	In house check: Oct-20
Power sensor HP 8481A	SN: MY41092317	07-Oct-15 (in house check Oct-18)	In house check: Oct-20
RF generator R&S SMT-06	SN: 100972	15-Jun-15 (in house check Oct-18)	In house check: Oct-20
Network Analyzer Agilent E8358A	SN: US41080477	31-Mar-14 (in house check Oct-18)	In house check: Oct-19

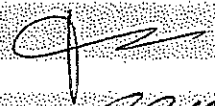
Calibrated by: **Jeton Kastrati** (Name) **Laboratory Technician** (Function)  (Signature)

Approved by: **Katja Pokovic** (Name) **Technical Manager** (Function)  (Signature)

Issued: October 23, 2018

This calibration certificate shall not be reproduced except in full without written approval of the laboratory.



Accredited by the Swiss Accreditation Service (SAS)

The Swiss Accreditation Service is one of the signatories to the EA
Multilateral Agreement for the recognition of calibration certificates

Accreditation No.: **SCS 0108**

Glossary:

TSL	tissue simulating liquid
ConvF	sensitivity in TSL / NORM x,y,z
N/A	not applicable or not measured

Calibration is Performed According to the Following Standards:

- IEEE Std 1528-2013, "IEEE Recommended Practice for Determining the Peak Spatial-Averaged Specific Absorption Rate (SAR) in the Human Head from Wireless Communications Devices: Measurement Techniques", June 2013
- IEC 62209-1, "Measurement procedure for the assessment of Specific Absorption Rate (SAR) from hand-held and body-mounted devices used next to the ear (frequency range of 300 MHz to 6 GHz)", July 2016
- IEC 62209-2, "Procedure to determine the Specific Absorption Rate (SAR) for wireless communication devices used in close proximity to the human body (frequency range of 30 MHz to 6 GHz)", March 2010
- KDB 865664, "SAR Measurement Requirements for 100 MHz to 6 GHz"

Additional Documentation:

- DASY4/5 System Handbook

Methods Applied and Interpretation of Parameters:

- Measurement Conditions:** Further details are available from the Validation Report at the end of the certificate. All figures stated in the certificate are valid at the frequency indicated.
- Antenna Parameters with TSL:** The dipole is mounted with the spacer to position its feed point exactly below the center marking of the flat phantom section, with the arms oriented parallel to the body axis.
- Feed Point Impedance and Return Loss:** These parameters are measured with the dipole positioned under the liquid filled phantom. The impedance stated is transformed from the measurement at the SMA connector to the feed point. The Return Loss ensures low reflected power. No uncertainty required.
- Electrical Delay:** One-way delay between the SMA connector and the antenna feed point. No uncertainty required.
- SAR measured:** SAR measured at the stated antenna input power.
- SAR normalized:** SAR as measured, normalized to an input power of 1 W at the antenna connector.
- SAR for nominal TSL parameters:** The measured TSL parameters are used to calculate the nominal SAR result.

The reported uncertainty of measurement is stated as the standard uncertainty of measurement multiplied by the coverage factor $k=2$, which for a normal distribution corresponds to a coverage probability of approximately 95%.

Measurement Conditions

DASY system configuration, as far as not given on page 1.

DASY Version	DASY5	V52.10.2
Extrapolation	Advanced Extrapolation	
Phantom	Modular Flat Phantom	
Distance Dipole Center - TSL	10 mm	with Spacer
Zoom Scan Resolution	dx, dy, dz = 5 mm	
Frequency	1900 MHz ± 1 MHz	

Head TSL parameters

The following parameters and calculations were applied.

	Temperature	Permittivity	Conductivity
Nominal Head TSL parameters	22.0 °C	40.0	1.40 mho/m
Measured Head TSL parameters	(22.0 ± 0.2) °C	40.3 ± 6 %	1.40 mho/m ± 6 %
Head TSL temperature change during test	< 0.5 °C	----	----

SAR result with Head TSL

SAR averaged over 1 cm³ (1 g) of Head TSL	Condition	
SAR measured	250 mW input power	9.80 W/kg
SAR for nominal Head TSL parameters	normalized to 1W	39.3 W/kg ± 17.0 % (k=2)

SAR averaged over 10 cm³ (10 g) of Head TSL	condition	
SAR measured	250 mW input power	5.11 W/kg
SAR for nominal Head TSL parameters	normalized to 1W	20.5 W/kg ± 16.5 % (k=2)

Body TSL parameters

The following parameters and calculations were applied.

	Temperature	Permittivity	Conductivity
Nominal Body TSL parameters	22.0 °C	53.3	1.52 mho/m
Measured Body TSL parameters	(22.0 ± 0.2) °C	52.9 ± 6 %	1.47 mho/m ± 6 %
Body TSL temperature change during test	< 0.5 °C	----	----

SAR result with Body TSL

SAR averaged over 1 cm³ (1 g) of Body TSL	Condition	
SAR measured	250 mW input power	9.68 W/kg
SAR for nominal Body TSL parameters	normalized to 1W	39.4 W/kg ± 17.0 % (k=2)

SAR averaged over 10 cm³ (10 g) of Body TSL	condition	
SAR measured	250 mW input power	5.11 W/kg
SAR for nominal Body TSL parameters	normalized to 1W	20.7 W/kg ± 16.5 % (k=2)

Appendix (Additional assessments outside the scope of SCS 0108)

Antenna Parameters with Head TSL

Impedance, transformed to feed point	$52.9 \Omega + 6.3 j\Omega$
Return Loss	- 23.4 dB

Antenna Parameters with Body TSL

Impedance, transformed to feed point	$48.5 \Omega + 8.2 j\Omega$
Return Loss	- 21.5 dB

General Antenna Parameters and Design

Electrical Delay (one direction)	1.193 ns
----------------------------------	----------

After long term use with 100W radiated power, only a slight warming of the dipole near the feedpoint can be measured.

The dipole is made of standard semirigid coaxial cable. The center conductor of the feeding line is directly connected to the second arm of the dipole. The antenna is therefore short-circuited for DC-signals. On some of the dipoles, small end caps are added to the dipole arms in order to improve matching when loaded according to the position as explained in the "Measurement Conditions" paragraph. The SAR data are not affected by this change. The overall dipole length is still according to the Standard.

No excessive force must be applied to the dipole arms, because they might bend or the soldered connections near the feedpoint may be damaged.

Additional EUT Data

Manufactured by	SPEAG
Manufactured on	March 11, 2011

DASY5 Validation Report for Head TSL

Date: 23.10.2018

Test Laboratory: SPEAG, Zurich, Switzerland

DUT: Dipole 1900 MHz; Type: D1900V2; Serial: D1900V2 - SN:5d149

Communication System: UID 0 - CW; Frequency: 1900 MHz

Medium parameters used: $f = 1900$ MHz; $\sigma = 1.4$ S/m; $\epsilon_r = 40.3$; $\rho = 1000$ kg/m³

Phantom section: Flat Section

Measurement Standard: DASY5 (IEEE/IEC/ANSI C63.19-2011)

DASY52 Configuration:

- Probe: EX3DV4 - SN7349; ConvF(8.18, 8.18, 8.18) @ 1900 MHz; Calibrated: 30.12.2017
- Sensor-Surface: 1.4mm (Mechanical Surface Detection)
- Electronics: DAE4 Sn601; Calibrated: 04.10.2018
- Phantom: Flat Phantom 5.0 (front); Type: QD 000 P50 AA; Serial: 1001
- DASY52 52.10.2(1495); SEMCAD X 14.6.12(7450)

Dipole Calibration for Head Tissue/Pin=250 mW, d=10mm/Zoom Scan (7x7x7)/Cube 0:

Measurement grid: dx=5mm, dy=5mm, dz=5mm

Reference Value = 110.0 V/m; Power Drift = -0.03 dB

Peak SAR (extrapolated) = 18.5 W/kg

SAR(1 g) = 9.8 W/kg; SAR(10 g) = 5.11 W/kg

Maximum value of SAR (measured) = 15.4 W/kg

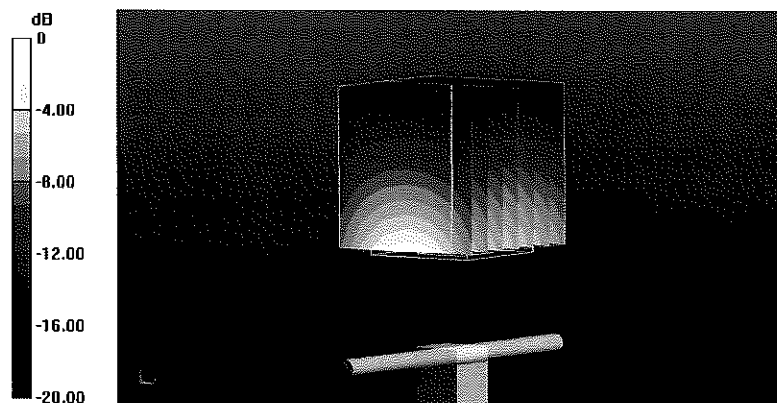

0 dB = 15.4 W/kg = 11.88 dBW/kg

Impedance Measurement Plot for Head TSL

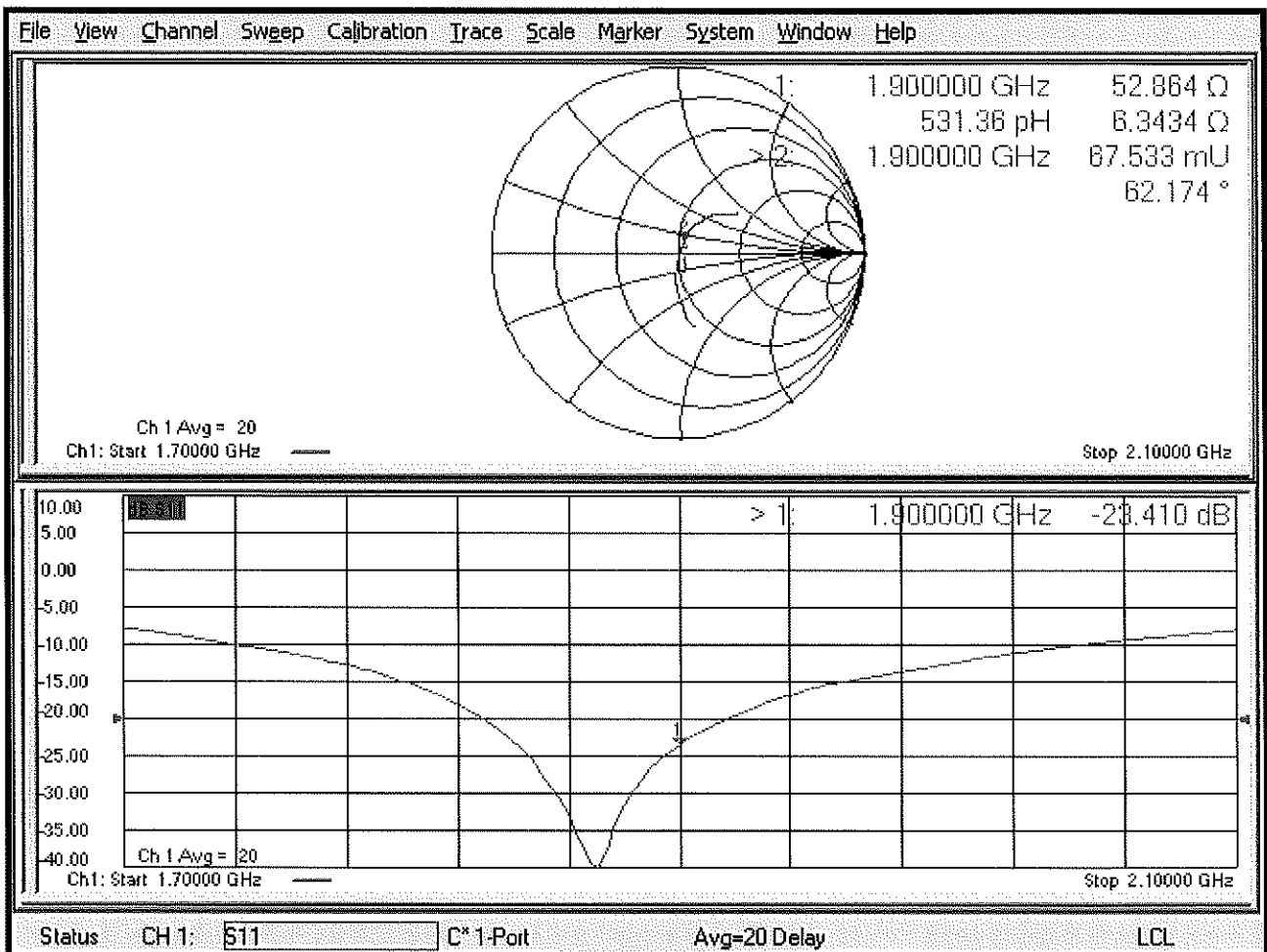

DASY5 Validation Report for Body TSL

Date: 23.10.2018

Test Laboratory: SPEAG, Zurich, Switzerland

DUT: Dipole 1900 MHz; Type: D1900V2; Serial: D1900V2 - SN:5d149

Communication System: UID 0 - CW; Frequency: 1900 MHz

Medium parameters used: $f = 1900$ MHz; $\sigma = 1.47$ S/m; $\epsilon_r = 52.9$; $\rho = 1000$ kg/m³

Phantom section: Flat Section

Measurement Standard: DASY5 (IEEE/IEC/ANSI C63.19-2011)

DASY52 Configuration:

- Probe: EX3DV4 - SN7349; ConvF(8.15, 8.15, 8.15) @ 1900 MHz; Calibrated: 30.12.2017
- Sensor-Surface: 1.4mm (Mechanical Surface Detection)
- Electronics: DAE4 Sn601; Calibrated: 04.10.2018
- Phantom: Flat Phantom 5.0 (back); Type: QD 000 P50 AA; Serial: 1002
- DASY52 52.10.2(1495); SEMCAD X 14.6.12(7450)

Dipole Calibration for Body Tissue/Pin=250 mW, d=10mm/Zoom Scan (7x7x7)/Cube 0:

Measurement grid: dx=5mm, dy=5mm, dz=5mm

Reference Value = 103.1 V/m; Power Drift = -0.03 dB

Peak SAR (extrapolated) = 17.5 W/kg

SAR(1 g) = 9.68 W/kg; SAR(10 g) = 5.11 W/kg

Maximum value of SAR (measured) = 14.2 W/kg

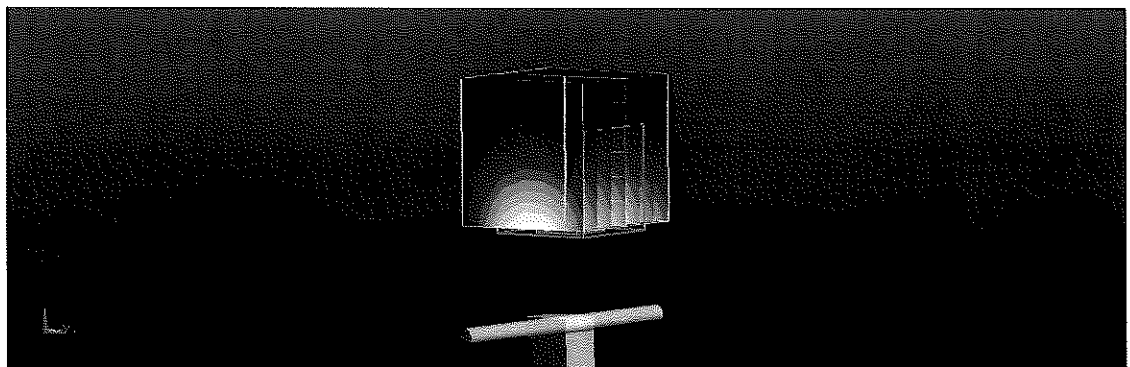
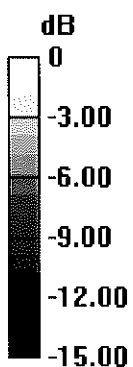

0 dB = 14.2 W/kg = 11.52 dBW/kg

Impedance Measurement Plot for Body TSL

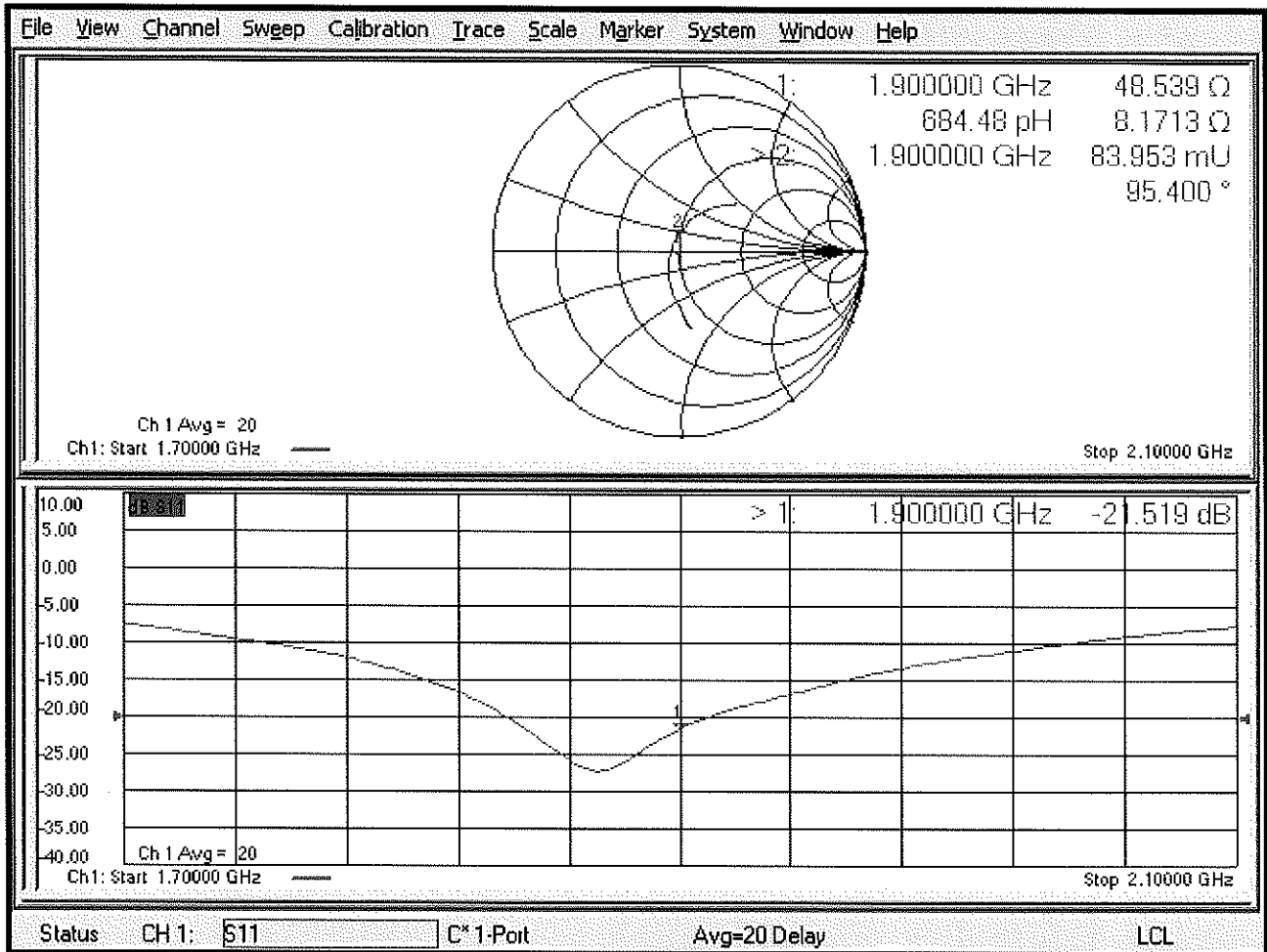

Certification of Calibration

Object D1900V2 – SN:5d149

Calibration procedure(s) Procedure for Calibration Extension for SAR Dipoles.

Extended Calibration date: October 18, 2019

Description: SAR Validation Dipole at 1900 MHz.

Calibration Equipment used:

Manufacturer	Model	Description	Cal Date	Cal Interval	Cal Due	Serial Number
Control Company	4040	Therm./Clock/Humidity Monitor	6/29/2019	Biennial	6/29/2021	192291470
Control Company	4352	Ultra Long Stem Thermometer	8/2/2018	Biennial	8/2/2020	181334684
Amplifier Research	15S1G6	Amplifier	CBT	N/A	CBT	433971
Narda	4772-3	Attenuator (3dB)	CBT	N/A	CBT	9406
Keysight Technologies	85033E	Standard Mechanical Calibration Kit (DC to 9GHz, 3.5mm)	7/2/2019	Annual	7/2/2020	MY53401181
Rohde & Schwarz	ZNLE6	Vector Network Analyzer	10/11/2019	Annual	10/11/2020	101307
Mini-Circuits	BW-N20W5+	DC to 18 GHz Precision Fixed 20 dB Attenuator	CBT	N/A	CBT	N/A
SPEAG	DAKS-3.5	Portable Dielectric Assessment Kit	8/13/2019	Annual	8/13/2020	1041
Anritsu	MA2411B	Pulse Power Sensor	8/14/2019	Annual	8/14/2020	1315051
Anritsu	MA2411B	Pulse Power Sensor	8/8/2019	Annual	8/8/2020	1339008
Anritsu	ML2495A	Power Meter	11/20/2018	Annual	11/20/2019	1039008
Agilent	N5182A	MXG Vector Signal Generator	8/19/2019	Annual	8/19/2020	MY47420837
Seekonk	NC-100	Torque Wrench	5/9/2018	Biennial	5/9/2020	22217
Mini-Circuits	NLP-2950+	Low Pass Filter DC to 2700 MHz	CBT	N/A	CBT	N/A
MiniCircuits	ZHDC-16-63-S+	Bidirectional Coupler	CBT	N/A	CBT	N/A
MiniCircuits	VLF-6000+	Low Pass Filter	CBT	N/A	CBT	N/A
SPEAG	EX3DV4	SAR Probe	2/19/2019	Annual	2/19/2020	3914
SPEAG	EX3DV4	SAR Probe	5/16/2019	Annual	5/16/2020	7406
SPEAG	DAE4	Dasy Data Acquisition Electronics	5/8/2019	Annual	5/8/2020	859
SPEAG	DAE4	Dasy Data Acquisition Electronics	2/14/2019	Annual	2/14/2020	1272

Note: CBT (Calibrated Before Testing). Prior to testing, the measurement paths containing a cable, amplifier, attenuator, coupler or filter were connected to a calibrated source (i.e. a signal generator) to determine the losses of the measurement path.

Measurement Uncertainty = $\pm 23\%$ (k=2)

	Name	Function	Signature
Calibrated By:	Brodie Halfoster	Team Lead Engineer	<i>BRODIE HALFOSTER</i>
Approved By:	Kaitlin O'Keefe	Senior Technical Manager	<i>KOK</i>

DIPOLE CALIBRATION EXTENSION

Per KDB 865664 D01, calibration intervals of up to three years may be considered for reference dipoles when it is demonstrated that the SAR target, impedance and return loss of a dipole have remained stable according to the following requirements:

1. The measured SAR does not deviate more than 10% from the target on the calibration certificate.
2. The return-loss does not deviate more than 20% from the previous measurement and meets the required 20dB minimum return-loss requirement.
3. The measurement of real or imaginary parts of impedance does not deviate more than 5Ω from the previous measurement.

The following dipole was checked to pass the above 3 requirements to have 2-year calibration period from the calibration date:

Calibration Date	Extension Date	Certificate Electrical Delay (ns)	Certificate SAR Target Head (1g) W/kg @ 20.0 dBm	Measured Head SAR (1g) W/kg @ 20.0 dBm	Deviation 1g (%)	Certificate SAR Target Head (10g) W/kg @ 20.0 dBm	Measured Head SAR (10g) W/kg @ 20.0 dBm	Deviation 10g (%)	Certificate Impedance Head (Ohm) Real	Measured Impedance Head (Ohm) Real	Difference (Ohm) Real	Certificate Impedance Head (Ohm) Imaginary	Measured Impedance Head (Ohm) Imaginary	Difference (Ohm) Imaginary	Certificate Return Loss Head (dB)	Measured Return Loss Head (dB)	Deviation (%)	PASS/FAIL
10/23/2018	10/18/2019	1.193	3.93	4.24	7.89%	2.05	2.18	6.34%	52.9	51.8	1.1	6.3	6.4	0.1	-23.4	-23.8	-1.80%	Pass
Calibration Date	Extension Date	Certificate Electrical Delay (ns)	Certificate SAR Target Body (1g) W/kg @ 20.0 dBm	Measured Body SAR (1g) W/kg @ 20.0 dBm	Deviation 1g (%)	Certificate SAR Target Body (10g) W/kg @ 20.0 dBm	Measured Body SAR (10g) W/kg @ 20.0 dBm	Deviation 10g (%)	Certificate Impedance Body (Ohm) Real	Measured Impedance Body (Ohm) Real	Difference (Ohm) Real	Certificate Impedance Body (Ohm) Imaginary	Measured Impedance Body (Ohm) Imaginary	Difference (Ohm) Imaginary	Certificate Return Loss Body (dB)	Measured Return Loss Body (dB)	Deviation (%)	PASS/FAIL
10/23/2018	10/18/2019	1.193	3.94	4.2	6.60%	2.07	2.15	3.96%	48.5	48.4	0.1	8.2	7.6	0.6	-21.5	-22.1	-2.60%	PASS

Impedance & Return-Loss Measurement Plot for Head TSL

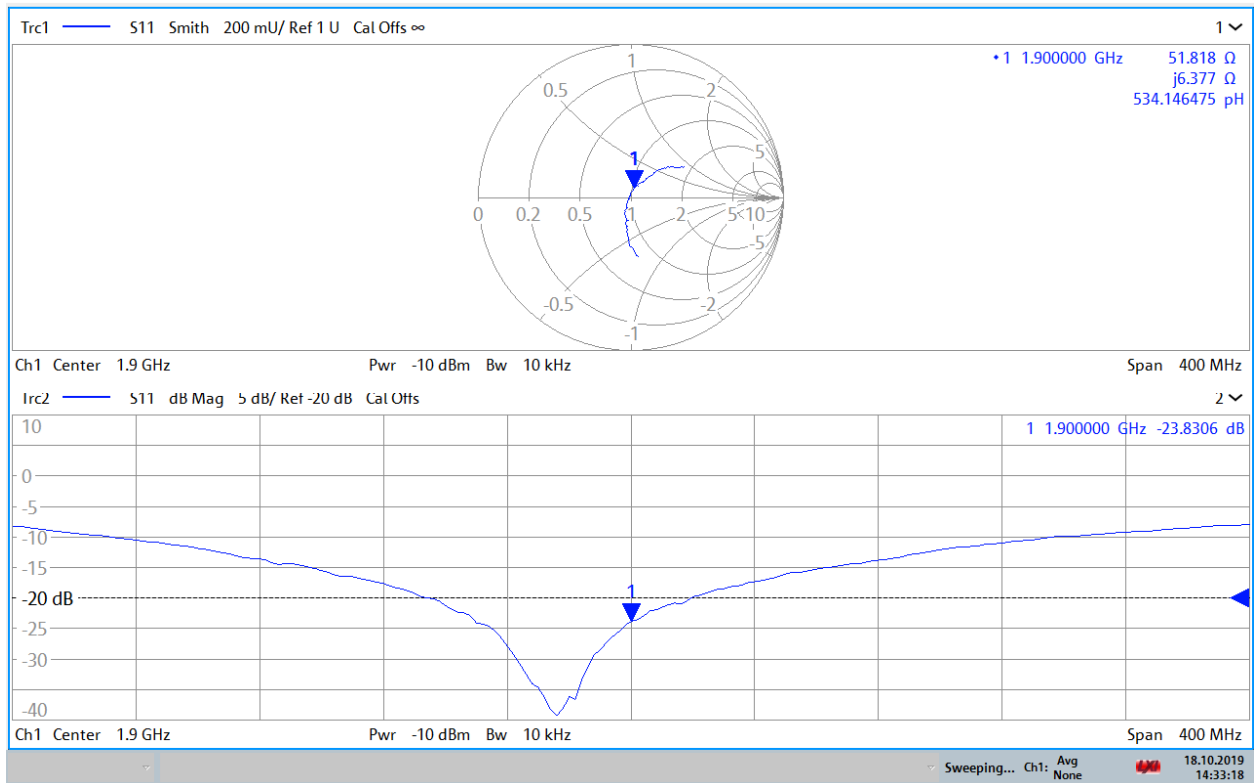

14:33:19 18.10.2019

Impedance & Return-Loss Measurement Plot for Body TSL

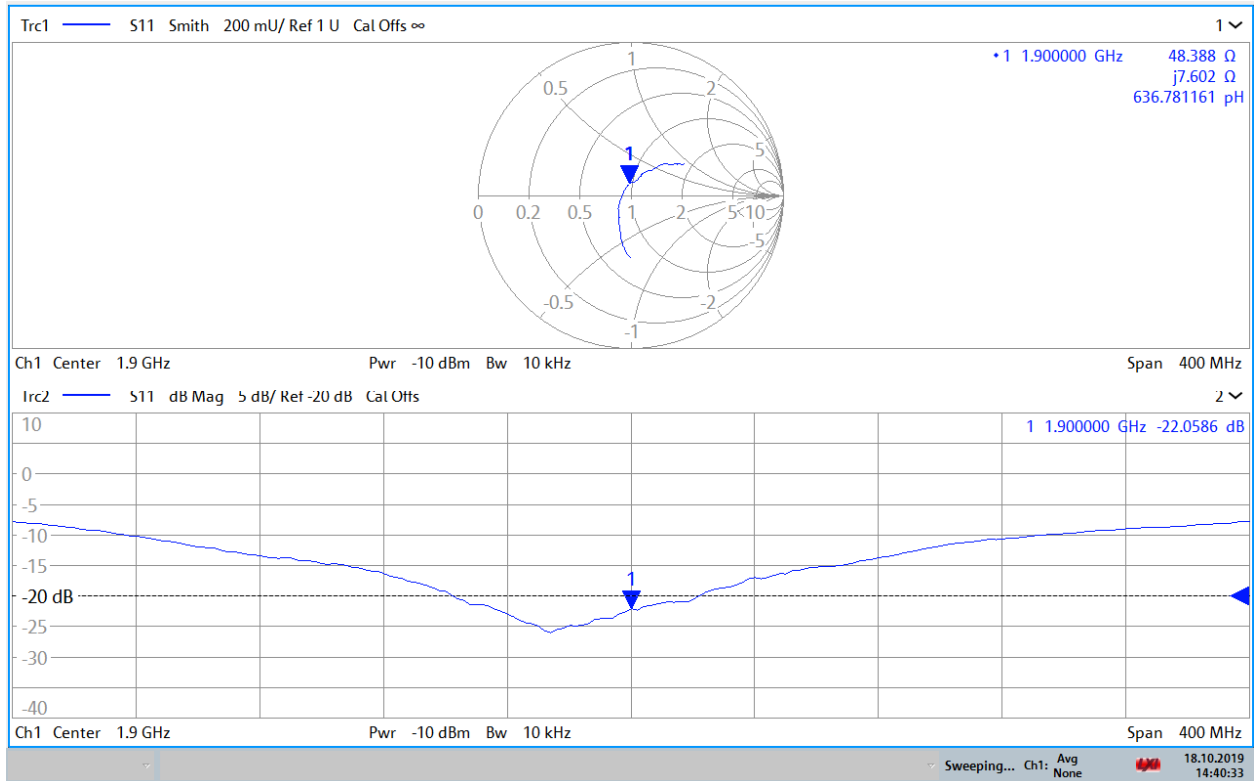

14:40:34 18.10.2019



Accredited by the Swiss Accreditation Service (SAS)
The Swiss Accreditation Service is one of the signatories to the EA
Multilateral Agreement for the recognition of calibration certificates

Accreditation No.: **SCS 0108**

Client **PC Test**

Certificate No: **D2300V2-1073_Aug18**

CALIBRATION CERTIFICATE

Object **D2300V2 - SN:1073**

Calibration procedure(s) **QA CAL-05.v10**
Calibration procedure for dipole validation kits above 700 MHz

Calibration date: **August 13, 2018**

BNV
09-06-2018
BNV
08/10/2019

This calibration certificate documents the traceability to national standards, which realize the physical units of measurements (SI).
The measurements and the uncertainties with confidence probability are given on the following pages and are part of the certificate.

All calibrations have been conducted in the closed laboratory facility: environment temperature (22 ± 3)°C and humidity < 70%.

Calibration Equipment used (M&TE critical for calibration)

Primary Standards	ID #	Cal Date (Certificate No.)	Scheduled Calibration
Power meter NRP	SN: 104778	04-Apr-18 (No. 217-02672/02673)	Apr-19
Power sensor NRP-Z91	SN: 103244	04-Apr-18 (No. 217-02672)	Apr-19
Power sensor NRP-Z91	SN: 103245	04-Apr-18 (No. 217-02673)	Apr-19
Reference 20 dB Attenuator	SN: 5058 (20k)	04-Apr-18 (No. 217-02682)	Apr-19
Type-N mismatch combination	SN: 5047.2 / 06327	04-Apr-18 (No. 217-02683)	Apr-19
Reference Probe EX3DV4	SN: 7349	30-Dec-17 (No. EX3-7349_Dec17)	Dec-18
DAE4	SN: 601	26-Oct-17 (No. DAE4-601_Oct17)	Oct-18

Secondary Standards	ID #	Check Date (in house)	Scheduled Check
Power meter EPM-442A	SN: GB37480704	07-Oct-15 (in house check Oct-16)	In house check: Oct-18
Power sensor HP 8481A	SN: US37292783	07-Oct-15 (in house check Oct-16)	In house check: Oct-18
Power sensor HP 8481A	SN: MY41092317	07-Oct-15 (in house check Oct-16)	In house check: Oct-18
RF generator R&S SMT-06	SN: 100972	15-Jun-15 (in house check Oct-16)	In house check: Oct-18
Network Analyzer Agilent E8358A	SN: US41080477	31-Mar-14 (in house check Oct-17)	In house check: Oct-18

Calibrated by: **Michael Weber** Name: **Michael Weber** Function: **Laboratory Technician**

Approved by: **Katja Pokovic** Name: **Katja Pokovic** Technical Manager

Signature
M. Weber
K. Pokovic

Issued: August 13, 2018

This calibration certificate shall not be reproduced except in full without written approval of the laboratory.



Accredited by the Swiss Accreditation Service (SAS)

The Swiss Accreditation Service is one of the signatories to the EA
Multilateral Agreement for the recognition of calibration certificates

Accreditation No.: **SCS 0108**

Glossary:

TSL	tissue simulating liquid
ConvF	sensitivity in TSL / NORM x,y,z
N/A	not applicable or not measured

Calibration is Performed According to the Following Standards:

- IEEE Std 1528-2013, "IEEE Recommended Practice for Determining the Peak Spatial-Averaged Specific Absorption Rate (SAR) in the Human Head from Wireless Communications Devices: Measurement Techniques", June 2013
- IEC 62209-1, "Measurement procedure for the assessment of Specific Absorption Rate (SAR) from hand-held and body-mounted devices used next to the ear (frequency range of 300 MHz to 6 GHz)", July 2016
- IEC 62209-2, "Procedure to determine the Specific Absorption Rate (SAR) for wireless communication devices used in close proximity to the human body (frequency range of 30 MHz to 6 GHz)", March 2010
- KDB 865664, "SAR Measurement Requirements for 100 MHz to 6 GHz"

Additional Documentation:

- DASY4/5 System Handbook

Methods Applied and Interpretation of Parameters:

- Measurement Conditions:** Further details are available from the Validation Report at the end of the certificate. All figures stated in the certificate are valid at the frequency indicated.
- Antenna Parameters with TSL:** The dipole is mounted with the spacer to position its feed point exactly below the center marking of the flat phantom section, with the arms oriented parallel to the body axis.
- Feed Point Impedance and Return Loss:** These parameters are measured with the dipole positioned under the liquid filled phantom. The impedance stated is transformed from the measurement at the SMA connector to the feed point. The Return Loss ensures low reflected power. No uncertainty required.
- Electrical Delay:** One-way delay between the SMA connector and the antenna feed point. No uncertainty required.
- SAR measured:** SAR measured at the stated antenna input power.
- SAR normalized:** SAR as measured, normalized to an input power of 1 W at the antenna connector.
- SAR for nominal TSL parameters:** The measured TSL parameters are used to calculate the nominal SAR result.

The reported uncertainty of measurement is stated as the standard uncertainty of measurement multiplied by the coverage factor $k=2$, which for a normal distribution corresponds to a coverage probability of approximately 95%.

Measurement Conditions

DASY system configuration, as far as not given on page 1.

DASY Version	DASY5	V52.10.1
Extrapolation	Advanced Extrapolation	
Phantom	Modular Flat Phantom	
Distance Dipole Center - TSL	10 mm	with Spacer
Zoom Scan Resolution	dx, dy, dz = 5 mm	
Frequency	2300 MHz ± 1 MHz	

Head TSL parameters

The following parameters and calculations were applied.

	Temperature	Permittivity	Conductivity
Nominal Head TSL parameters	22.0 °C	39.5	1.67 mho/m
Measured Head TSL parameters	(22.0 ± 0.2) °C	38.2 ± 6 %	1.70 mho/m ± 6 %
Head TSL temperature change during test	< 0.5 °C	----	----

SAR result with Head TSL

SAR averaged over 1 cm³ (1 g) of Head TSL	Condition	
SAR measured	250 mW input power	12.5 W/kg
SAR for nominal Head TSL parameters	normalized to 1W	49.2 W/kg ± 17.0 % (k=2)

SAR averaged over 10 cm³ (10 g) of Head TSL	condition	
SAR measured	250 mW input power	6.02 W/kg
SAR for nominal Head TSL parameters	normalized to 1W	23.8 W/kg ± 16.5 % (k=2)

Body TSL parameters

The following parameters and calculations were applied.

	Temperature	Permittivity	Conductivity
Nominal Body TSL parameters	22.0 °C	52.9	1.81 mho/m
Measured Body TSL parameters	(22.0 ± 0.2) °C	52.2 ± 6 %	1.85 mho/m ± 6 %
Body TSL temperature change during test	< 0.5 °C	----	----

SAR result with Body TSL

SAR averaged over 1 cm³ (1 g) of Body TSL	Condition	
SAR measured	250 mW input power	12.1 W/kg
SAR for nominal Body TSL parameters	normalized to 1W	47.7 W/kg ± 17.0 % (k=2)

SAR averaged over 10 cm³ (10 g) of Body TSL	condition	
SAR measured	250 mW input power	5.86 W/kg
SAR for nominal Body TSL parameters	normalized to 1W	23.2 W/kg ± 16.5 % (k=2)

Appendix (Additional assessments outside the scope of SCS 0108)

Antenna Parameters with Head TSL

Impedance, transformed to feed point	50.1 Ω - 5.2 j Ω
Return Loss	- 25.7 dB

Antenna Parameters with Body TSL

Impedance, transformed to feed point	45.5 Ω - 4.1 j Ω
Return Loss	- 23.9 dB

General Antenna Parameters and Design

Electrical Delay (one direction)	1.171 ns
----------------------------------	----------

After long term use with 100W radiated power, only a slight warming of the dipole near the feedpoint can be measured.

The dipole is made of standard semirigid coaxial cable. The center conductor of the feeding line is directly connected to the second arm of the dipole. The antenna is therefore short-circuited for DC-signals. On some of the dipoles, small end caps are added to the dipole arms in order to improve matching when loaded according to the position as explained in the "Measurement Conditions" paragraph. The SAR data are not affected by this change. The overall dipole length is still according to the Standard.

No excessive force must be applied to the dipole arms, because they might bend or the soldered connections near the feedpoint may be damaged.

Additional EUT Data

Manufactured by	SPEAG
Manufactured on	November 16, 2015

DASY5 Validation Report for Head TSL

Date: 13.08.2018

Test Laboratory: SPEAG, Zurich, Switzerland

DUT: Dipole 2300 MHz; Type: D2300V2; Serial: D2300V2 - SN: 1073

Communication System: UID 0 - CW; Frequency: 2300 MHz

Medium parameters used: $f = 2300$ MHz; $\sigma = 1.7$ S/m; $\epsilon_r = 38.2$; $\rho = 1000$ kg/m³

Phantom section: Flat Section

Measurement Standard: DASY5 (IEEE/IEC/ANSI C63.19-2011)

DASY52 Configuration:

- Probe: EX3DV4 - SN7349; ConvF(8.08, 8.08, 8.08) @ 2300 MHz; Calibrated: 30.12.2017
- Sensor-Surface: 1.4mm (Mechanical Surface Detection)
- Electronics: DAE4 Sn601; Calibrated: 26.10.2017
- Phantom: Flat Phantom 5.0 (front); Type: QD 000 P50 AA; Serial: 1001
- DASY52 52.10.1(1476); SEMCAD X 14.6.11(7439)

Dipole Calibration for Head Tissue/Pin=250 mW, d=10mm/Zoom Scan (7x7x7)/Cube 0:

Measurement grid: $dx=5$ mm, $dy=5$ mm, $dz=5$ mm

Reference Value = 115.9 V/m; Power Drift = -0.05 dB

Peak SAR (extrapolated) = 24.1 W/kg

SAR(1 g) = 12.5 W/kg; SAR(10 g) = 6.02 W/kg

Maximum value of SAR (measured) = 20.2 W/kg



0 dB = 20.2 W/kg = 13.05 dBW/kg

Impedance Measurement Plot for Head TSL

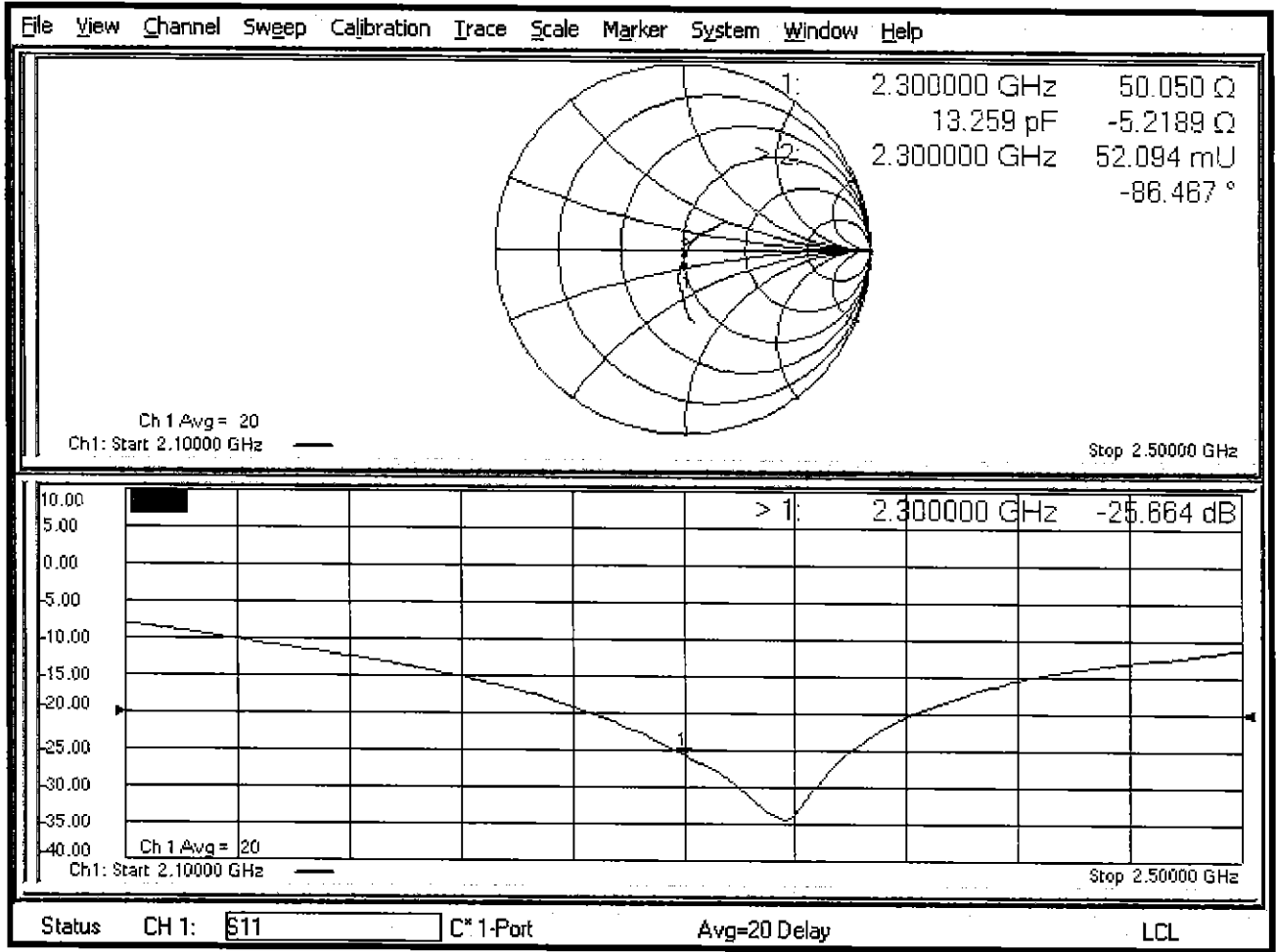

DASY5 Validation Report for Body TSL

Date: 13.08.2018

Test Laboratory: SPEAG, Zurich, Switzerland

DUT: Dipole 2300 MHz; Type: D2300V2; Serial: D2300V2 - SN: 1073

Communication System: UID 0 - CW; Frequency: 2300 MHz

Medium parameters used: $f = 2300$ MHz; $\sigma = 1.85$ S/m; $\epsilon_r = 52.2$; $\rho = 1000$ kg/m³

Phantom section: Flat Section

Measurement Standard: DASY5 (IEEE/IEC/ANSI C63.19-2011)

DASY52 Configuration:

- Probe: EX3DV4 - SN7349; ConvF(8.08, 8.08, 8.08) @ 2300 MHz; Calibrated: 30.12.2017
- Sensor-Surface: 1.4mm (Mechanical Surface Detection)
- Electronics: DAE4 Sn601; Calibrated: 26.10.2017
- Phantom: Flat Phantom 5.0 (back); Type: QD 000 P50 AA; Serial: 1002
- DASY52 52.10.1(1476); SEMCAD X 14.6.11(7439)

Dipole Calibration for Body Tissue/Pin=250 mW, d=10mm/Zoom Scan (7x7x7)/Cube 0:

Measurement grid: dx=5mm, dy=5mm, dz=5mm

Reference Value = 107.5 V/m; Power Drift = -0.08 dB

Peak SAR (extrapolated) = 22.9 W/kg

SAR(1 g) = 12.1 W/kg; SAR(10 g) = 5.86 W/kg

Maximum value of SAR (measured) = 19.1 W/kg

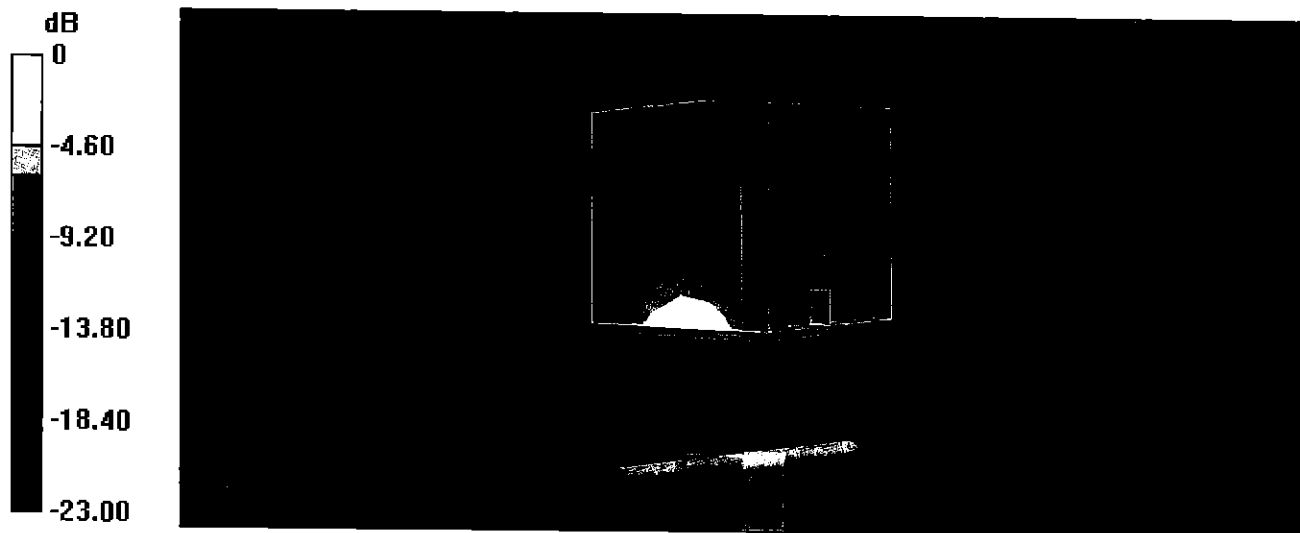

Impedance Measurement Plot for Body TSL

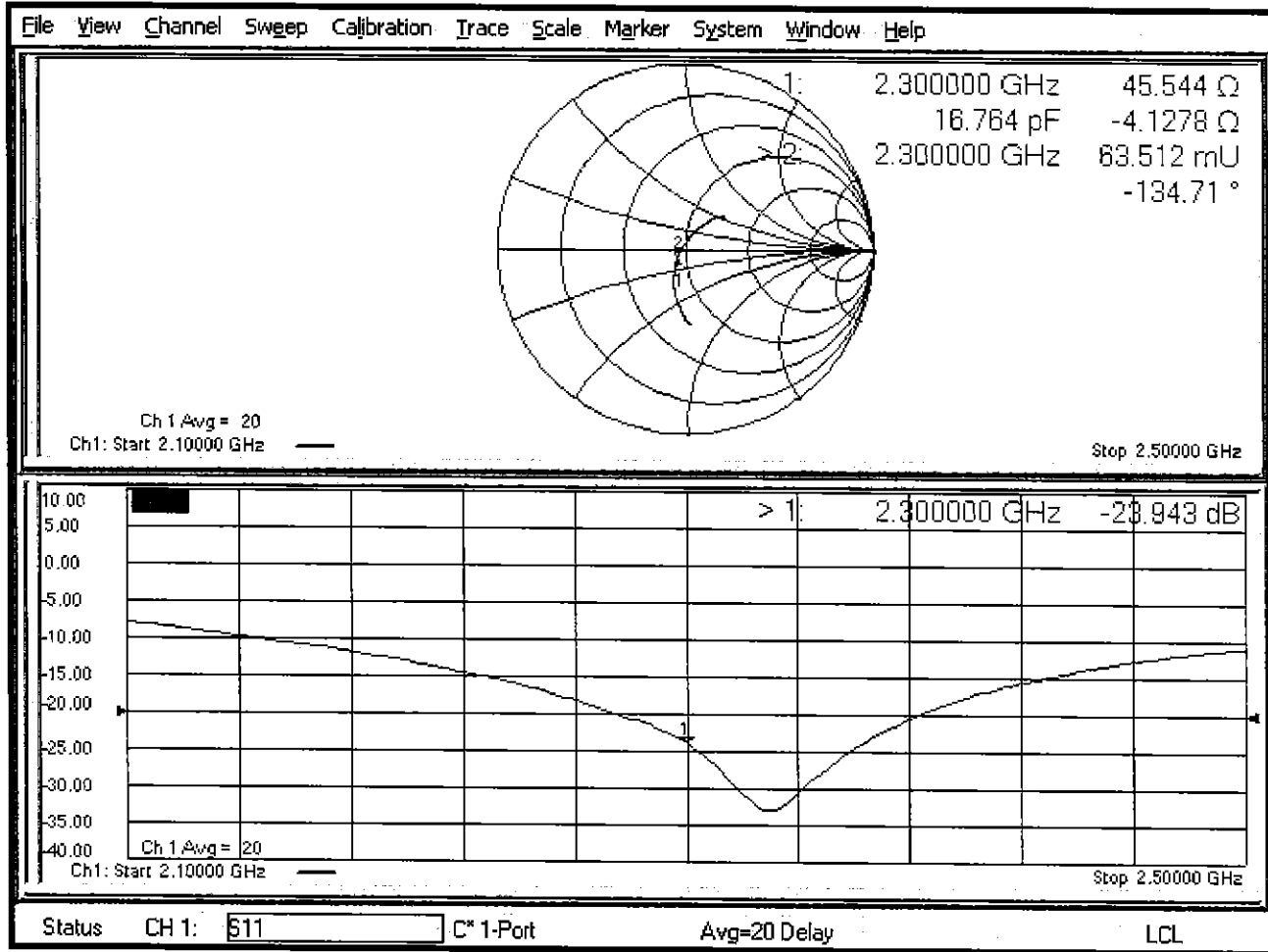

Certification of Calibration

Object: D2300V2 – SN: 1073

Calibration procedure(s): Procedure for Calibration Extension for SAR Dipoles.

Calibration date: 08/09/2019

Description: SAR Validation Dipole at 2300 MHz.

Calibration Equipment used:

Manufacturer	Model	Description	Cal Date	Cal Interval	Cal Due	Serial Number
Agilent	8753ES	S-Parameter Network Analyzer	10/2/2018	Annual	10/2/2019	US39170118
Agilent	N5182A	MXG Vector Signal Generator	6/27/2019	Annual	6/27/2020	US46240505
Amplifier Research	15S1G6	Amplifier	CBT	N/A	CBT	343972
Anritsu	ML2495A	Power Meter	10/21/2018	Annual	10/21/2019	941001
Anritsu	MA2411B	Pulse Power Sensor	10/30/2018	Annual	10/30/2019	1207470
Anritsu	MA2411B	Pulse Power Sensor	11/20/2018	Annual	11/20/2019	1339007
Control Company	4040	Temperature / Humidity Monitor	2/28/2018	Biennial	2/28/2020	150761911
Control Company	4352	Ultra Long Stem Thermometer	2/28/2018	Biennial	2/28/2020	170330160
Keysight	772D	Dual Directional Coupler	CBT	N/A	CBT	MY52180215
Keysight Technologies	85033E	Standard Mechanical Calibration Kit (DC to 9GHz, 3.5mm)	7/2/2019	Annual	7/2/2020	MY53401181
Mini-Circuits	BW-N20W5+	DC to 18 GHz Precision Fixed 20 dB Attenuator	CBT	N/A	CBT	N/A
Mini-Circuits	NLP-2950+	Low Pass Filter DC to 2700 MHz	CBT	N/A	CBT	N/A
Narda	4772-3	Attenuator (3dB)	CBT	N/A	CBT	9406
Pasternack	PE2209-10	Bidirectional Coupler	CBT	N/A	CBT	N/A
Pasternack	NC-100	Torque Wrench	5/23/2018	Biennial	5/23/2020	N/A
SPEAG	EX3DV4	SAR Probe	2/19/2019	Annual	2/19/2020	7417
SPEAG	DAE4	Dasy Data Acquisition Electronics	2/13/2019	Annual	2/13/2020	665
SPEAG	EX3DV4	SAR Probe	7/15/2019	Annual	7/15/2020	7547
SPEAG	DAE4	Dasy Data Acquisition Electronics	7/11/2019	Annual	7/11/2020	1323
SPEAG	DAK-3.5	Dielectric Assessment Kit	9/11/2018	Annual	9/11/2019	1091

Measurement Uncertainty = $\pm 23\%$ (k=2)

	Name	Function	Signature
Calibrated By:	Brodie Halfoster	Test Engineer	<i>BRODIE HALFOSTER</i>
Approved By:	Kaitlin O'Keefe	Senior Technical Manager	<i>KOK</i>

DIPOLE CALIBRATION EXTENSION

Per KDB 865664 D01, calibration intervals of up to three years may be considered for reference dipoles when it is demonstrated that the SAR target, impedance and return loss of a dipole have remained stable according to the following requirements:

1. The measured SAR does not deviate more than 10% from the target on the calibration certificate.
2. The return-loss does not deviate more than 20% from the previous measurement and meets the required 20dB minimum return-loss requirement.
3. The measurement of real or imaginary parts of impedance does not deviate more than 5Ω from the previous measurement.

The following dipole was checked to pass the above 3 requirements to have 2-year calibration period from the calibration date:

Calibration Date	Extension Date	Certificate Electrical Delay (ns)	Certificate SAR Target Head (1g) W/kg @ 20.0 dBm	Measured Head SAR (1g) W/kg @ 20.0 dBm	Deviation 1g (%)	Certificate SAR Target Head (10g) W/kg @ 20.0 dBm	Measured Head SAR (10g) W/kg @ 20.0 dBm	Deviation 10g (%)	Certificate Impedance Head (Ohm) Real	Measured Impedance Head (Ohm) Real	Difference (Ohm) Real	Certificate Impedance Head (Ohm) Imaginary	Measured Impedance Head (Ohm) Imaginary	Difference (Ohm) Imaginary	Certificate Return Loss Head (dB)	Measured Return Loss Head (dB)	Deviation (%)	PASS/FAIL
8/13/2018	8/9/2019	1.171	4.82	5.21	5.89%	2.38	2.49	4.62%	50.1	47.5	2.6	-5.2	-4.2	1	-25.7	-26.1	-1.60%	PASS
Calibration Date	Extension Date	Certificate Electrical Delay (ns)	Certificate SAR Target Body (1g) W/kg @ 20.0 dBm	Measured Body SAR (1g) W/kg @ 20.0 dBm	Deviation 1g (%)	Certificate SAR Target Body (10g) W/kg @ 20.0 dBm	Measured Body SAR (10g) W/kg @ 20.0 dBm	Deviation 10g (%)	Certificate Impedance Body (Ohm) Real	Measured Impedance Body (Ohm) Real	Difference (Ohm) Real	Certificate Impedance Body (Ohm) Imaginary	Measured Impedance Body (Ohm) Imaginary	Difference (Ohm) Imaginary	Certificate Return Loss Body (dB)	Measured Return Loss Body (dB)	Deviation (%)	PASS/FAIL
8/13/2018	8/9/2019	1.171	4.77	5.05	5.87%	2.32	2.4	3.45%	45.5	44.4	1.1	-4.1	-3.3	0.8	-23.9	-23.2	2.80%	PASS

Impedance & Return-Loss Measurement Plot for Head TSL

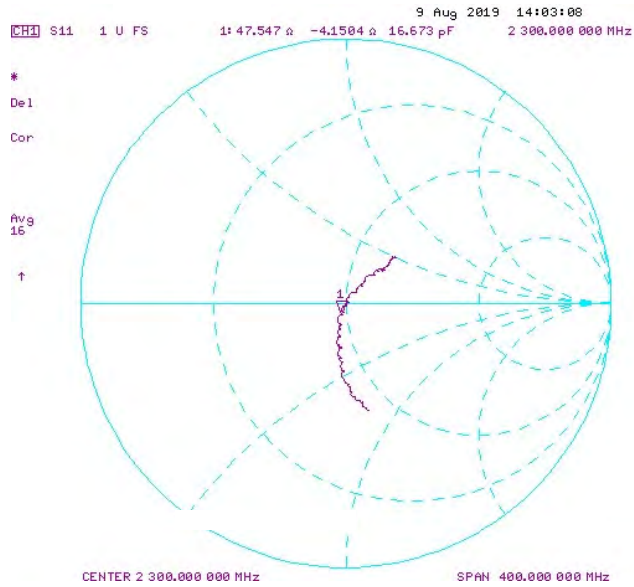

Impedance & Return-Loss Measurement Plot for Body TSL

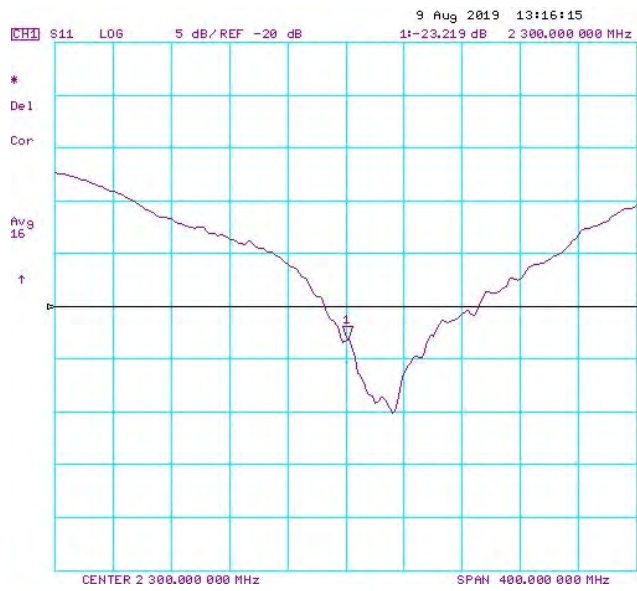
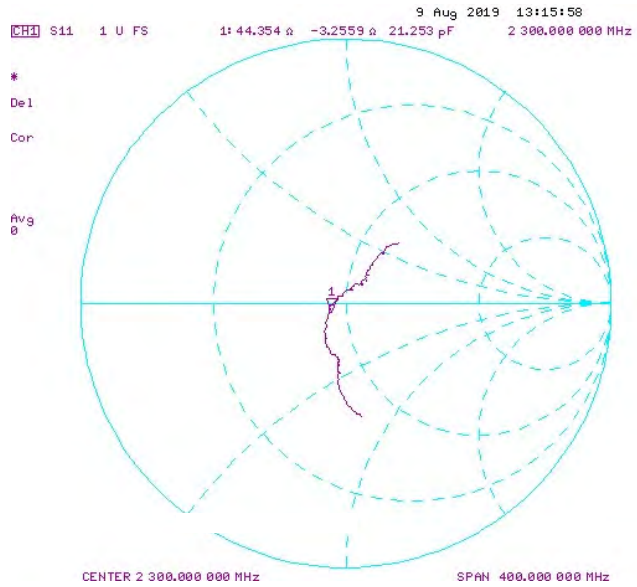



Accredited by the Swiss Accreditation Service (SAS)
The Swiss Accreditation Service is one of the signatories to the EA
Multilateral Agreement for the recognition of calibration certificates

Accreditation No.: **SCS 0108**

Client **PC Test**

Certificate No: **D2450V2-719_Aug19**

CALIBRATION CERTIFICATE

Object **D2450V2 - SN:719**

Calibration procedure(s) **QA CAL-05.v11
Calibration Procedure for SAR Validation Sources between 0.7-3 GHz**

Calibration date: **August 14, 2019**

*BNW
08/30/2019*

This calibration certificate documents the traceability to national standards, which realize the physical units of measurements (SI).
The measurements and the uncertainties with confidence probability are given on the following pages and are part of the certificate.

All calibrations have been conducted in the closed laboratory facility: environment temperature (22 ± 3)°C and humidity < 70%.

Calibration Equipment used (M&TE critical for calibration)

Primary Standards	ID #	Cal Date (Certificate No.)	Scheduled Calibration
Power meter NRP	SN: 104778	03-Apr-19 (No. 217-02892/02893)	Apr-20
Power sensor NRP-Z91	SN: 103244	03-Apr-19 (No. 217-02892)	Apr-20
Power sensor NRP-Z91	SN: 103245	03-Apr-19 (No. 217-02893)	Apr-20
Reference 20 dB Attenuator	SN: 5058 (20k)	04-Apr-19 (No. 217-02894)	Apr-20
Type-N mismatch combination	SN: 5047.2 / 06327	04-Apr-19 (No. 217-02895)	Apr-20
Reference Probe EX3DV4	SN: 7349	29-May-19 (No. EX3-7349_May19)	May-20
DAE4	SN: 601	30-Apr-19 (No. DAE4-601_Apr19)	Apr-20
Secondary Standards	ID #	Check Date (in house)	Scheduled Check
Power meter E4419B	SN: GB39512475	30-Oct-14 (in house check Feb-19)	In house check: Oct-20
Power sensor HP 8481A	SN: US37292783	07-Oct-15 (in house check Oct-18)	In house check: Oct-20
Power sensor HP 8481A	SN: MY41092317	07-Oct-15 (in house check Oct-18)	In house check: Oct-20
RF generator R&S SMT-06	SN: 100972	15-Jun-15 (in house check Oct-18)	In house check: Oct-20
Network Analyzer Agilent E8358A	SN: US41080477	31-Mar-14 (in house check Oct-18)	In house check: Oct-19

Calibrated by: **Claudio Leubler** **Laboratory Technician**

Signature

Approved by: **Katja Pokovic** **Technical Manager**

Issued: August 15, 2019

This calibration certificate shall not be reproduced except in full without written approval of the laboratory.



Accredited by the Swiss Accreditation Service (SAS)

Accreditation No.: **SCS 0108**

The Swiss Accreditation Service is one of the signatories to the EA
Multilateral Agreement for the recognition of calibration certificates

Glossary:

TSL	tissue simulating liquid
ConvF	sensitivity in TSL / NORM x,y,z
N/A	not applicable or not measured

Calibration is Performed According to the Following Standards:

- IEEE Std 1528-2013, "IEEE Recommended Practice for Determining the Peak Spatial-Averaged Specific Absorption Rate (SAR) in the Human Head from Wireless Communications Devices: Measurement Techniques", June 2013
- IEC 62209-1, "Measurement procedure for the assessment of Specific Absorption Rate (SAR) from hand-held and body-mounted devices used next to the ear (frequency range of 300 MHz to 6 GHz)", July 2016
- IEC 62209-2, "Procedure to determine the Specific Absorption Rate (SAR) for wireless communication devices used in close proximity to the human body (frequency range of 30 MHz to 6 GHz)", March 2010
- KDB 865664, "SAR Measurement Requirements for 100 MHz to 6 GHz"

Additional Documentation:

- DASY4/5 System Handbook

Methods Applied and Interpretation of Parameters:

- Measurement Conditions:** Further details are available from the Validation Report at the end of the certificate. All figures stated in the certificate are valid at the frequency indicated.
- Antenna Parameters with TSL:** The dipole is mounted with the spacer to position its feed point exactly below the center marking of the flat phantom section, with the arms oriented parallel to the body axis.
- Feed Point Impedance and Return Loss:** These parameters are measured with the dipole positioned under the liquid filled phantom. The impedance stated is transformed from the measurement at the SMA connector to the feed point. The Return Loss ensures low reflected power. No uncertainty required.
- Electrical Delay:** One-way delay between the SMA connector and the antenna feed point. No uncertainty required.
- SAR measured:** SAR measured at the stated antenna input power.
- SAR normalized:** SAR as measured, normalized to an input power of 1 W at the antenna connector.
- SAR for nominal TSL parameters:** The measured TSL parameters are used to calculate the nominal SAR result.

The reported uncertainty of measurement is stated as the standard uncertainty of measurement multiplied by the coverage factor $k=2$, which for a normal distribution corresponds to a coverage probability of approximately 95%.

Measurement Conditions

DASY system configuration, as far as not given on page 1.

DASY Version	DASY5	V52.10.2
Extrapolation	Advanced Extrapolation	
Phantom	Modular Flat Phantom	
Distance Dipole Center - TSL	10 mm	with Spacer
Zoom Scan Resolution	dx, dy, dz = 5 mm	
Frequency	2450 MHz \pm 1 MHz	

Head TSL parameters

The following parameters and calculations were applied.

	Temperature	Permittivity	Conductivity
Nominal Head TSL parameters	22.0 °C	39.2	1.80 mho/m
Measured Head TSL parameters	(22.0 \pm 0.2) °C	37.8 \pm 6 %	1.83 mho/m \pm 6 %
Head TSL temperature change during test	< 0.5 °C	----	----

SAR result with Head TSL

SAR averaged over 1 cm³ (1 g) of Head TSL	Condition	
SAR measured	250 mW input power	13.5 W/kg
SAR for nominal Head TSL parameters	normalized to 1W	53.1 W/kg \pm 17.0 % (k=2)

SAR averaged over 10 cm³ (10 g) of Head TSL	condition	
SAR measured	250 mW input power	6.25 W/kg
SAR for nominal Head TSL parameters	normalized to 1W	24.7 W/kg \pm 16.5 % (k=2)

Body TSL parameters

The following parameters and calculations were applied.

	Temperature	Permittivity	Conductivity
Nominal Body TSL parameters	22.0 °C	52.7	1.95 mho/m
Measured Body TSL parameters	(22.0 \pm 0.2) °C	50.8 \pm 6 %	2.01 mho/m \pm 6 %
Body TSL temperature change during test	< 0.5 °C	----	----

SAR result with Body TSL

SAR averaged over 1 cm³ (1 g) of Body TSL	Condition	
SAR measured	250 mW input power	13.0 W/kg
SAR for nominal Body TSL parameters	normalized to 1W	50.8 W/kg \pm 17.0 % (k=2)

SAR averaged over 10 cm³ (10 g) of Body TSL	condition	
SAR measured	250 mW input power	6.09 W/kg
SAR for nominal Body TSL parameters	normalized to 1W	24.0 W/kg \pm 16.5 % (k=2)

Appendix (Additional assessments outside the scope of SCS 0108)

Antenna Parameters with Head TSL

Impedance, transformed to feed point	54.6 Ω + 5.6 j Ω
Return Loss	- 23.2 dB

Antenna Parameters with Body TSL

Impedance, transformed to feed point	51.0 Ω + 8.4 j Ω
Return Loss	- 21.6 dB

General Antenna Parameters and Design

Electrical Delay (one direction)	1.150 ns
----------------------------------	----------

After long term use with 100W radiated power, only a slight warming of the dipole near the feedpoint can be measured.

The dipole is made of standard semirigid coaxial cable. The center conductor of the feeding line is directly connected to the second arm of the dipole. The antenna is therefore short-circuited for DC-signals. On some of the dipoles, small end caps are added to the dipole arms in order to improve matching when loaded according to the position as explained in the "Measurement Conditions" paragraph. The SAR data are not affected by this change. The overall dipole length is still according to the Standard.

No excessive force must be applied to the dipole arms, because they might bend or the soldered connections near the feedpoint may be damaged.

Additional EUT Data

Manufactured by	SPEAG
-----------------	-------

DASY5 Validation Report for Head TSL

Date: 14.08.2019

Test Laboratory: SPEAG, Zurich, Switzerland

DUT: Dipole 2450 MHz; Type: D2450V2; Serial: D2450V2 - SN:719

Communication System: UID 0 - CW; Frequency: 2450 MHz

Medium parameters used: $f = 2450$ MHz; $\sigma = 1.83$ S/m; $\epsilon_r = 37.8$; $\rho = 1000$ kg/m³

Phantom section: Flat Section

Measurement Standard: DASY5 (IEEE/IEC/ANSI C63.19-2011)

DASY52 Configuration:

- Probe: EX3DV4 - SN7349; ConvF(7.9, 7.9, 7.9) @ 2450 MHz; Calibrated: 29.05.2019
- Sensor-Surface: 1.4mm (Mechanical Surface Detection)
- Electronics: DAE4 Sn601; Calibrated: 30.04.2019
- Phantom: Flat Phantom 5.0 (front); Type: QD 000 P50 AA; Serial: 1001
- DASY52 52.10.2(1504); SEMCAD X 14.6.12(7470)

Dipole Calibration for Head Tissue/Pin=250 mW, d=10mm/Zoom Scan (7x7x7)/Cube 0:

Measurement grid: dx=5mm, dy=5mm, dz=5mm

Reference Value = 117.1 V/m; Power Drift = 0.07 dB

Peak SAR (extrapolated) = 26.6 W/kg

SAR(1 g) = 13.5 W/kg; SAR(10 g) = 6.25 W/kg

Maximum value of SAR (measured) = 21.8 W/kg

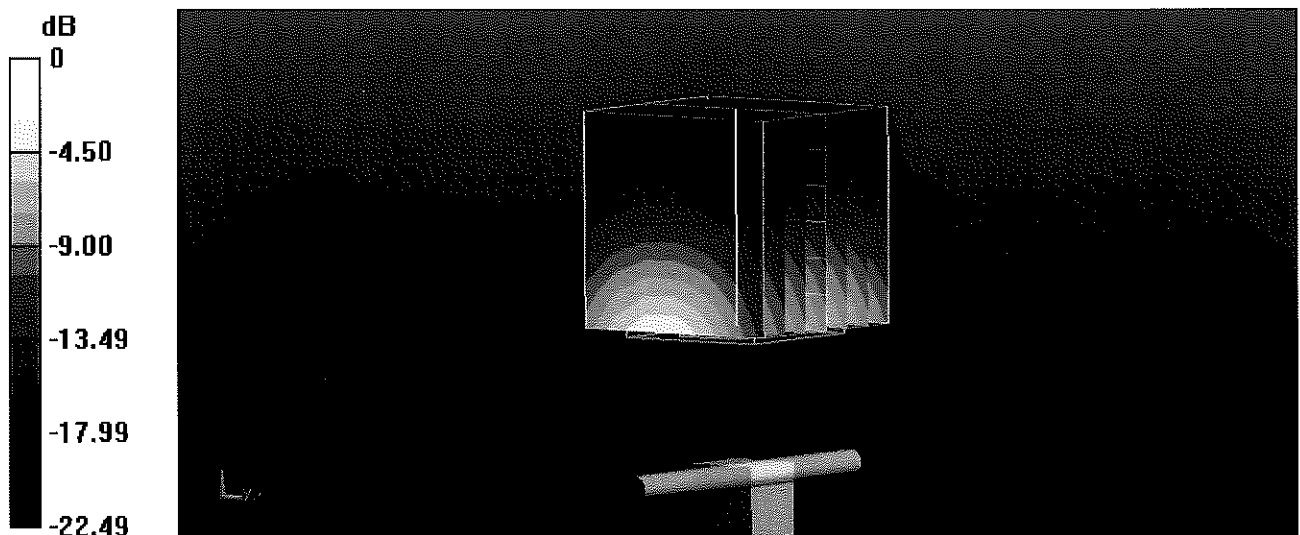

0 dB = 21.8 W/kg = 13.38 dBW/kg

Impedance Measurement Plot for Head TSL

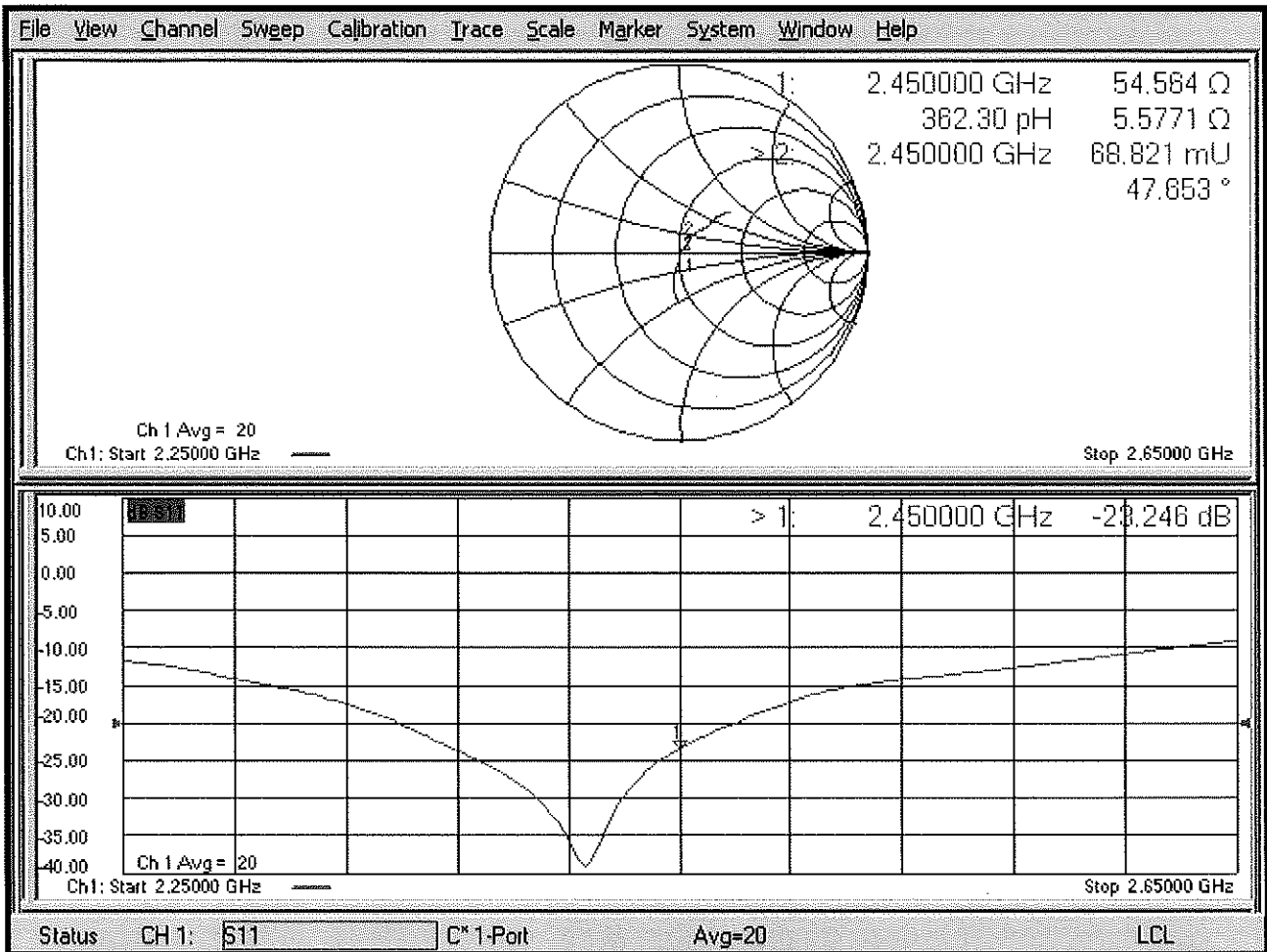

DASY5 Validation Report for Body TSL

Date: 14.08.2019

Test Laboratory: SPEAG, Zurich, Switzerland

DUT: Dipole 2450 MHz; Type: D2450V2; Serial: D2450V2 - SN:719

Communication System: UID 0 - CW; Frequency: 2450 MHz

Medium parameters used: $f = 2450$ MHz; $\sigma = 2.01$ S/m; $\epsilon_r = 50.8$; $\rho = 1000$ kg/m³

Phantom section: Flat Section

Measurement Standard: DASY5 (IEEE/IEC/ANSI C63.19-2011)

DASY52 Configuration:

- Probe: EX3DV4 - SN7349; ConvF(7.94, 7.94, 7.94) @ 2450 MHz; Calibrated: 29.05.2019
- Sensor-Surface: 1.4mm (Mechanical Surface Detection)
- Electronics: DAE4 Sn601; Calibrated: 30.04.2019
- Phantom: Flat Phantom 5.0 (back); Type: QD 000 P50 AA; Serial: 1002
- DASY52 52.10.2(1504); SEMCAD X 14.6.12(7470)

Dipole Calibration for Body Tissue/Pin=250 mW, d=10mm/Zoom Scan (7x7x7)/Cube 0:

Measurement grid: dx=5mm, dy=5mm, dz=5mm

Reference Value = 105.2 V/m; Power Drift = 0.03 dB

Peak SAR (extrapolated) = 25.6 W/kg

SAR(1 g) = 13 W/kg; SAR(10 g) = 6.09 W/kg

Maximum value of SAR (measured) = 20.0 W/kg

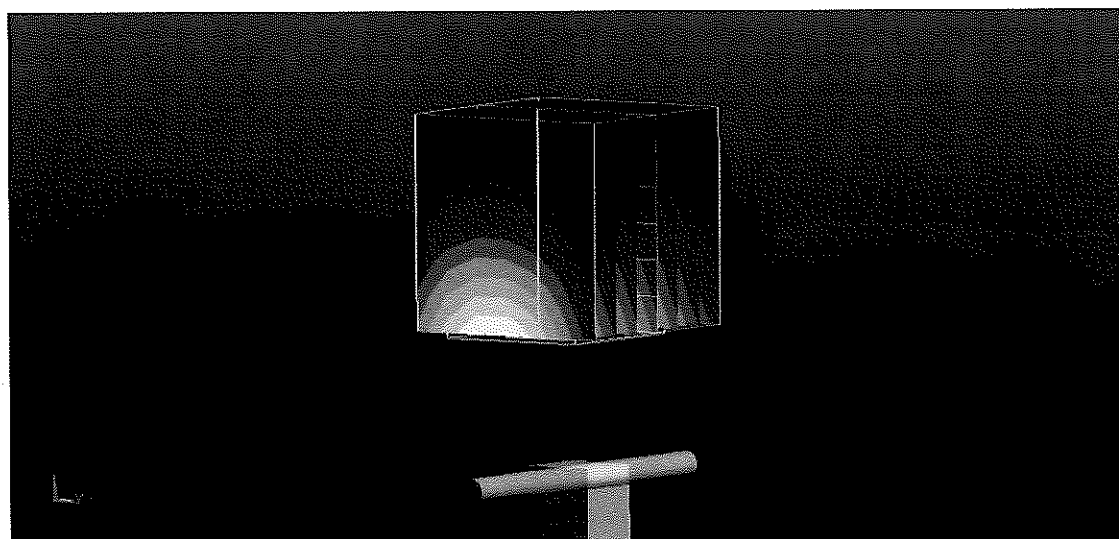
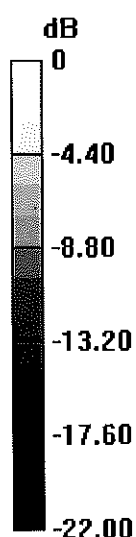

0 dB = 20.0 W/kg = 13.01 dBW/kg

Impedance Measurement Plot for Body TSL

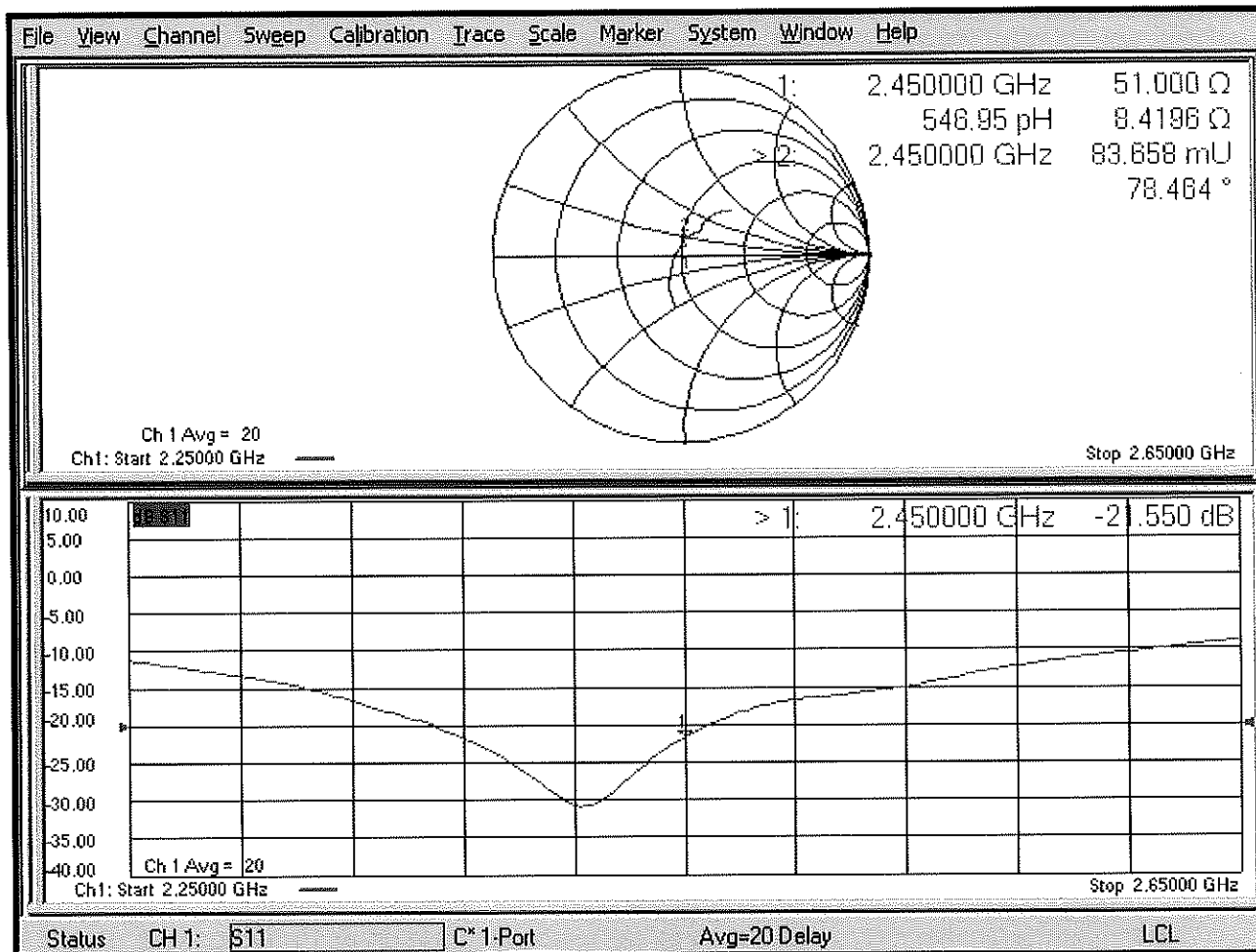

**Calibration Laboratory of
Schmid & Partner
Engineering AG**
Zeughausstrasse 43, 8004 Zurich, Switzerland



S Schweizerischer Kalibrierdienst
C Service suisse d'étalonnage
S Servizio svizzero di taratura
S Swiss Calibration Service

Accredited by the Swiss Accreditation Service (SAS)
The Swiss Accreditation Service is one of the signatories to the EA
Multilateral Agreement for the recognition of calibration certificates

Accreditation No.: **SCS 0108**

Client **PC Test**

Certificate No: **D2450V2-797_Sep17**

CALIBRATION CERTIFICATE

Object **D2450V2 - SN:797**

Calibration procedure(s) **QA CAL-05.v9**
Calibration procedure for dipole validation kits above 700 MHz

SCS
10/03/2019

Calibration date: **September 11, 2017**

Extended PMV
9/20/2018

This calibration certificate documents the traceability to national standards, which realize the physical units of measurements (SI).
The measurements and the uncertainties with confidence probability are given on the following pages and are part of the certificate.

BNV
09/20/2019

All calibrations have been conducted in the closed laboratory facility: environment temperature (22 ± 3)°C and humidity < 70%.

Calibration Equipment used (M&TE critical for calibration)

Primary Standards	ID #	Cal Date (Certificate No.)	Scheduled Calibration
Power meter NRP	SN: 104778	04-Apr-17 (No. 217-02521/02522)	Apr-18
Power sensor NRP-Z91	SN: 103244	04-Apr-17 (No. 217-02521)	Apr-18
Power sensor NRP-Z91	SN: 103245	04-Apr-17 (No. 217-02522)	Apr-18
Reference 20 dB Attenuator	SN: 5058 (20k)	07-Apr-17 (No. 217-02528)	Apr-18
Type-N mismatch combination	SN: 5047.2 / 06327	07-Apr-17 (No. 217-02529)	Apr-18
Reference Probe EX3DV4	SN: 7349	31-May-17 (No. EX3-7349_May17)	May-18
DAE4	SN: 601	28-Mar-17 (No. DAE4-601_Mar17)	Mar-18
Secondary Standards	ID #	Check Date (in house)	Scheduled Check
Power meter EPM-442A	SN: GB37480704	07-Oct-15 (in house check Oct-16)	In house check: Oct-18
Power sensor HP 8481A	SN: US37292783	07-Oct-15 (in house check Oct-16)	In house check: Oct-18
Power sensor HP 8481A	SN: MY41092317	07-Oct-15 (in house check Oct-16)	In house check: Oct-18
RF generator R&S SMT-06	SN: 100972	15-Jun-15 (in house check Oct-16)	In house check: Oct-18
Network Analyzer HP 8753E	SN: US37390585	18-Oct-01 (in house check Oct-16)	In house check: Oct-17

Calibrated by: **Michael Weber** Name: Michael Weber Function: Laboratory Technician

Signature
M. Weber

Approved by: **Katja Pokovic** Name: Katja Pokovic Function: Technical Manager

Signature
K. Pokovic

Issued: September 11, 2017

This calibration certificate shall not be reproduced except in full without written approval of the laboratory.

**Calibration Laboratory of
Schmid & Partner
Engineering AG**
Zeughausstrasse 43, 8004 Zurich, Switzerland



S Schweizerischer Kalibrierdienst
C Service suisse d'étalonnage
S Servizio svizzero di taratura
S Swiss Calibration Service

Accredited by the Swiss Accreditation Service (SAS)
The Swiss Accreditation Service is one of the signatories to the EA
Multilateral Agreement for the recognition of calibration certificates

Accreditation No.: **SCS 0108**

Glossary:

TSL tissue simulating liquid
ConvF sensitivity in TSL / NORM x,y,z
N/A not applicable or not measured

Calibration is Performed According to the Following Standards:

- a) IEEE Std 1528-2013, "IEEE Recommended Practice for Determining the Peak Spatial-Averaged Specific Absorption Rate (SAR) in the Human Head from Wireless Communications Devices: Measurement Techniques", June 2013
- b) IEC 62209-1, "Measurement procedure for the assessment of Specific Absorption Rate (SAR) from hand-held and body-mounted devices used next to the ear (frequency range of 300 MHz to 6 GHz)", July 2016
- c) IEC 62209-2, "Procedure to determine the Specific Absorption Rate (SAR) for wireless communication devices used in close proximity to the human body (frequency range of 30 MHz to 6 GHz)", March 2010
- d) KDB 865664, "SAR Measurement Requirements for 100 MHz to 6 GHz"

Additional Documentation:

- e) DASY4/5 System Handbook

Methods Applied and Interpretation of Parameters:

- *Measurement Conditions:* Further details are available from the Validation Report at the end of the certificate. All figures stated in the certificate are valid at the frequency indicated.
- *Antenna Parameters with TSL:* The dipole is mounted with the spacer to position its feed point exactly below the center marking of the flat phantom section, with the arms oriented parallel to the body axis.
- *Feed Point Impedance and Return Loss:* These parameters are measured with the dipole positioned under the liquid filled phantom. The impedance stated is transformed from the measurement at the SMA connector to the feed point. The Return Loss ensures low reflected power. No uncertainty required.
- *Electrical Delay:* One-way delay between the SMA connector and the antenna feed point. No uncertainty required.
- *SAR measured:* SAR measured at the stated antenna input power.
- *SAR normalized:* SAR as measured, normalized to an input power of 1 W at the antenna connector.
- *SAR for nominal TSL parameters:* The measured TSL parameters are used to calculate the nominal SAR result.

The reported uncertainty of measurement is stated as the standard uncertainty of measurement multiplied by the coverage factor $k=2$, which for a normal distribution corresponds to a coverage probability of approximately 95%.

Measurement Conditions

DASY system configuration, as far as not given on page 1.

DASY Version	DASY5	V52.10.0
Extrapolation	Advanced Extrapolation	
Phantom	Modular Flat Phantom	
Distance Dipole Center - TSL	10 mm	with Spacer
Zoom Scan Resolution	dx, dy, dz = 5 mm	
Frequency	2450 MHz ± 1 MHz	

Head TSL parameters

The following parameters and calculations were applied.

	Temperature	Permittivity	Conductivity
Nominal Head TSL parameters	22.0 °C	39.2	1.80 mho/m
Measured Head TSL parameters	(22.0 ± 0.2) °C	37.8 ± 6 %	1.86 mho/m ± 6 %
Head TSL temperature change during test	< 0.5 °C	---	---

SAR result with Head TSL

SAR averaged over 1 cm ³ (1 g) of Head TSL	Condition	
SAR measured	250 mW input power	13.5 W/kg
SAR for nominal Head TSL parameters	normalized to 1W	52.7 W/kg ± 17.0 % (k=2)

SAR averaged over 10 cm ³ (10 g) of Head TSL	condition	
SAR measured	250 mW input power	6.28 W/kg
SAR for nominal Head TSL parameters	normalized to 1W	24.8 W/kg ± 16.5 % (k=2)

Body TSL parameters

The following parameters and calculations were applied.

	Temperature	Permittivity	Conductivity
Nominal Body TSL parameters	22.0 °C	52.7	1.95 mho/m
Measured Body TSL parameters	(22.0 ± 0.2) °C	51.9 ± 6 %	2.04 mho/m ± 6 %
Body TSL temperature change during test	< 0.5 °C	----	----

SAR result with Body TSL

SAR averaged over 1 cm ³ (1 g) of Body TSL	Condition	
SAR measured	250 mW input power	13.1 W/kg
SAR for nominal Body TSL parameters	normalized to 1W	51.1 W/kg ± 17.0 % (k=2)

SAR averaged over 10 cm ³ (10 g) of Body TSL	condition	
SAR measured	250 mW input power	6.14 W/kg
SAR for nominal Body TSL parameters	normalized to 1W	24.2 W/kg ± 16.5 % (k=2)

Appendix (Additional assessments outside the scope of SCS 0108)

Antenna Parameters with Head TSL

Impedance, transformed to feed point	53.8 Ω + 7.4 j Ω
Return Loss	- 21.9 dB

Antenna Parameters with Body TSL

Impedance, transformed to feed point	49.7 Ω + 9.1 j Ω
Return Loss	- 20.9 dB

General Antenna Parameters and Design

Electrical Delay (one direction)	1.152 ns
----------------------------------	----------

After long term use with 100W radiated power, only a slight warming of the dipole near the feedpoint can be measured.

The dipole is made of standard semirigid coaxial cable. The center conductor of the feeding line is directly connected to the second arm of the dipole. The antenna is therefore short-circuited for DC-signals. On some of the dipoles, small end caps are added to the dipole arms in order to improve matching when loaded according to the position as explained in the "Measurement Conditions" paragraph. The SAR data are not affected by this change. The overall dipole length is still according to the Standard.

No excessive force must be applied to the dipole arms, because they might bend or the soldered connections near the feedpoint may be damaged.

Additional EUT Data

Manufactured by	SPEAG
Manufactured on	January 24, 2006

DASY5 Validation Report for Head TSL

Date: 11.09.2017

Test Laboratory: SPEAG, Zurich, Switzerland

DUT: Dipole 2450 MHz; Type: D2450V2; Serial: D2450V2 - SN: 797

Communication System: UID 0 - CW; Frequency: 2450 MHz

Medium parameters used: $f = 2450$ MHz; $\sigma = 1.86$ S/m; $\epsilon_r = 37.8$; $\rho = 1000$ kg/m³

Phantom section: Flat Section

Measurement Standard: DASY5 (IEEE/IEC/ANSI C63.19-2011)

DASY52 Configuration:

- Probe: EX3DV4 - SN7349; ConvF(8.12, 8.12, 8.12); Calibrated: 31.05.2017;
- Sensor-Surface: 1.4mm (Mechanical Surface Detection)
- Electronics: DAE4 Sn601; Calibrated: 28.03.2017
- Phantom: Flat Phantom 5.0 (front); Type: QD 000 P50 AA; Serial: 1001
- DASY52 52.10.0(1446); SEMCAD X 14.6.10(7417)

Dipole Calibration for Head Tissue/ $P_{in}=250$ mW, $d=10$ mm/Zoom Scan (7x7x7)/Cube 0:

Measurement grid: $dx=5$ mm, $dy=5$ mm, $dz=5$ mm

Reference Value = 113.5 V/m; Power Drift = -0.08 dB

Peak SAR (extrapolated) = 26.9 W/kg

SAR(1 g) = 13.5 W/kg; SAR(10 g) = 6.28 W/kg

Maximum value of SAR (measured) = 21.6 W/kg

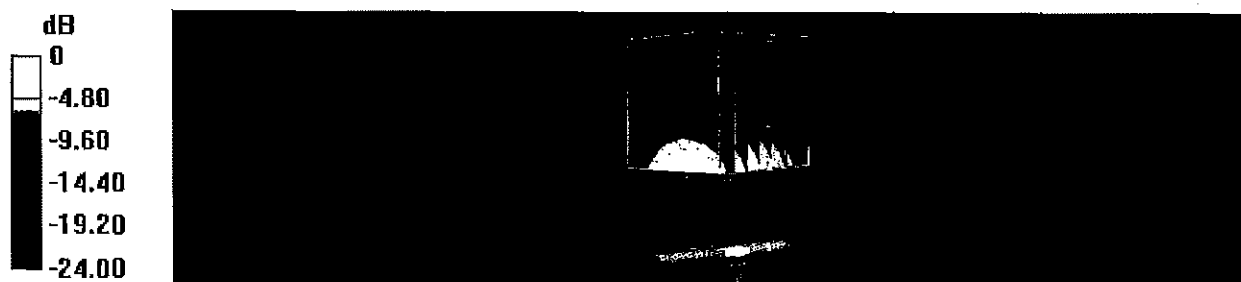

0 dB = 21.6 W/kg = 13.34 dBW/kg

Impedance Measurement Plot for Head TSL

11 Sep 2017 11:52:57

CH1 S11 1 U FS 1: 53.777 Ω 7.4395 Ω 483.28 μ H 2 450.000 000 MHz

*
DeI
CA

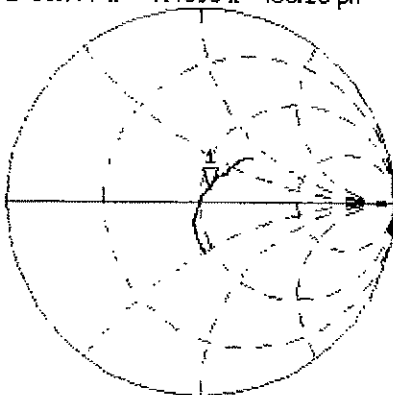

Avg
16

H1d

CH2 S11 LOG 5 dB/REF -20 dB 1: -21.911 dB 2 450.000 000 MHz

CA

Avg
16

H1d

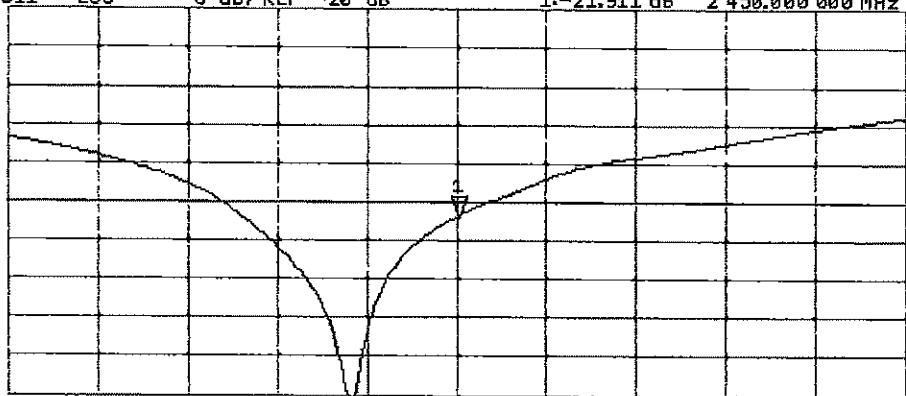

START 2 250.000 000 MHz

STOP 2 650.000 000 MHz

DASY5 Validation Report for Body TSL

Date: 11.09.2017

Test Laboratory: SPEAG, Zurich, Switzerland

DUT: Dipole 2450 MHz; Type: D2450V2; Serial: D2450V2 - SN: 797

Communication System: UID 0 - CW; Frequency: 2450 MHz

Medium parameters used: $f = 2450$ MHz; $\sigma = 2.04$ S/m; $\epsilon_r = 51.9$; $\rho = 1000$ kg/m³

Phantom section: Flat Section

Measurement Standard: DASY5 (IEEE/IEC/ANSI C63.19-2011)

DASY52 Configuration:

- Probe: EX3DV4 - SN7349; ConvF(8.1, 8.1, 8.1); Calibrated: 31.05.2017;
- Sensor-Surface: 1.4mm (Mechanical Surface Detection)
- Electronics: DAB4 Sn601; Calibrated: 28.03.2017
- Phantom: Flat Phantom 5.0 (back); Type: QD 000 P50 AA; Serial: 1002
- DASY52 52.10.0(1446); SEMCAD X 14.6.10(7417)

Dipole Calibration for Body Tissue/Pin=250 mW, d=10mm/Zoom Scan (7x7x7)/Cube 0:

Measurement grid: dx=5mm, dy=5mm, dz=5mm

Reference Value = 105.4 V/m; Power Drift = -0.08 dB

Peak SAR (extrapolated) = 25.6 W/kg

SAR(1 g) = 13.1 W/kg; SAR(10 g) = 6.14 W/kg

Maximum value of SAR (measured) = 20.3 W/kg

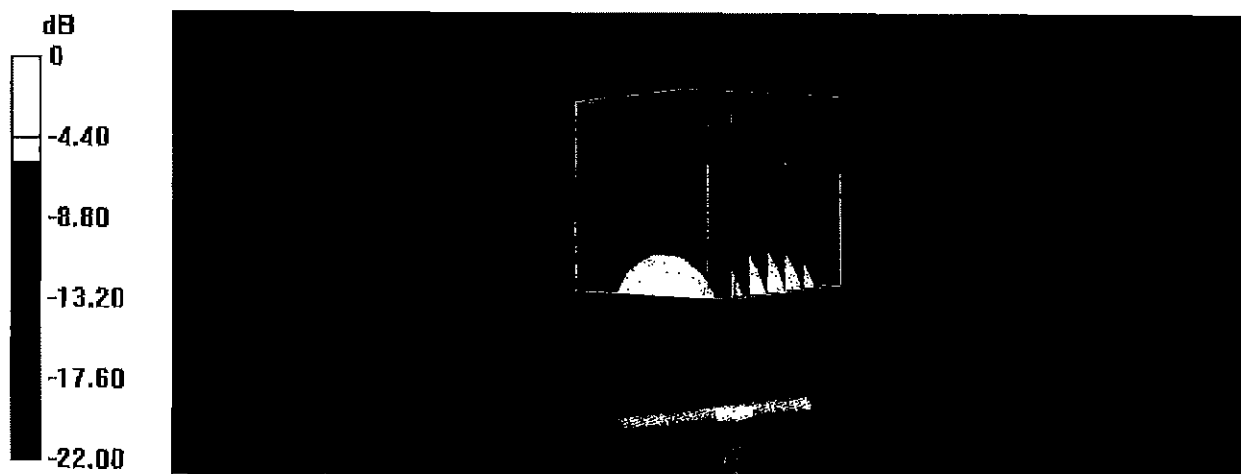

0 dB = 20.3 W/kg = 13.07 dBW/kg

Impedance Measurement Plot for Body TSL

11 Sep 2017 11:52:10

CH1 S11 1 U FS 1: 49.725 Ω 9.0703 Ω 589.22 pF 2 450.000 000 MHz

De1
CA

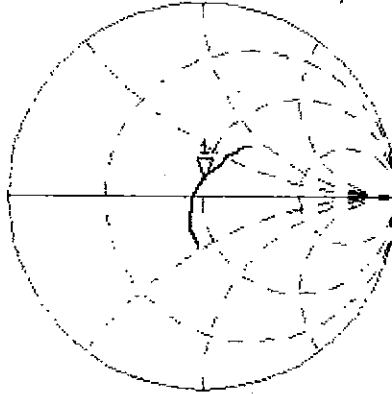

Avg
16

H1d

CH2 S11 LOG 5 dB/REF -20 dB 1: -20.854 dB 2 450.000 000 MHz

CA

Avg
16

H1d

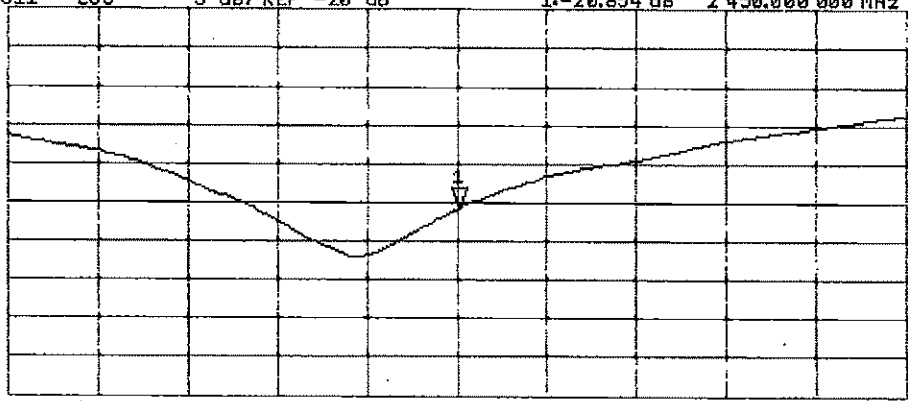

START 2 250.000 000 MHz

STOP 2 650.000 000 MHz

Certification of Calibration

Object: D2450V2 – SN: 797

Calibration procedure(s): Procedure for Calibration Extension for SAR Dipoles.

Extended Calibration date: September 11, 2018

Description: SAR Validation Dipole at 2450 MHz.

Calibration Equipment used:

Manufacturer	Model	Description	Cal Date	Cal Interval	Cal Due	Serial Number
Control Company	4040	Therm./Clock/Humidity Monitor	3/31/2017	Biennial	3/31/2019	170232394
Control Company	4352	Ultra Long Stem Thermometer	5/2/2017	Biennial	5/2/2019	170330156
Amplifier Research	15S1G6	Amplifier	CBT	N/A	CBT	433971
Narda	4772-3	Attenuator (3dB)	CBT	N/A	CBT	9406
Keysight	772D	Dual Directional Coupler	CBT	N/A	CBT	MY52180215
Keysight Technologies	85033E	Standard Mechanical Calibration Kit (DC to 9GHz, 3.5mm)	6/4/2018	Annual	6/4/2019	MY53401181
Agilent	8753ES	S-Parameter Vector Network Analyzer	8/30/2018	Annual	8/30/2019	MY40003841
Mini-Circuits	BW-N20W5+	DC to 18 GHz Precision Fixed 20 dB Attenuator	CBT	N/A	CBT	N/A
SPEAG	DAK-3.5	Dielectric Assessment Kit	5/15/2018	Annual	5/15/2019	1070
SPEAG	EX3DV4	SAR Probe	7/20/2018	Annual	7/20/2019	7410
SPEAG	DAE4	Dasy Data Acquisition Electronics	7/11/2018	Annual	7/11/2019	1322
SPEAG	ES3DV3	SAR Probe	3/13/2018	Annual	3/13/2019	3319
SPEAG	DAE4	Dasy Data Acquisition Electronics	3/7/2018	Annual	3/7/2019	1368
Anritsu	MA2411B	Pulse Power Sensor	3/2/2018	Annual	3/2/2019	1207364
Anritsu	MA2411B	Pulse Power Sensor	3/2/2018	Annual	3/2/2019	1339018
Anritsu	ML2495A	Power Meter	10/22/2017	Annual	10/22/2018	1328004
Agilent	NS182A	MXG Vector Signal Generator	4/18/2018	Annual	4/18/2019	MY47420800
Seekonk	NC-100	Torque Wrench	7/11/2018	Annual	7/11/2019	N/A
MiniCircuits	VLF-6000+	Low Pass Filter	CBT	N/A	CBT	N/A
Narda	4014C-6	4 - 8 GHz SMA 6 dB Directional Coupler	CBT	N/A	CBT	N/A

Note: CBT (Calibrated Before Testing). Prior to testing, the measurement paths containing a cable, amplifier, attenuator, coupler or filter were connected to a calibrated source (i.e. a signal generator) to determine the losses of the measurement path.

Measurement Uncertainty = $\pm 23\%$ (k=2)

	Name	Function	Signature
Calibrated By:	Brodie Halfoster	Team Lead Engineer	<i>BRODIE HALFOSTER</i>
Approved By:	Kaitlin O'Keefe	Senior Technical Manager	<i>KOK</i>

DIPOLE CALIBRATION EXTENSION

Per KDB 865664 D01, calibration intervals of up to three years may be considered for reference dipoles when it is demonstrated that the SAR target, impedance and return loss of a dipole have remained stable according to the following requirements:

1. The measured SAR does not deviate more than 10% from the target on the calibration certificate.
2. The return-loss does not deviate more than 20% from the previous measurement and meets the required 20dB minimum return-loss requirement.
3. The measurement of real or imaginary parts of impedance does not deviate more than 5Ω from the previous measurement.

The following dipole was checked to pass the above 3 requirements to have 2-year calibration period from the calibration date:

Calibration Date	Extension Date	Certificate Electrical Delay (ns)	Certificate SAR Target Head (1g) W/kg @ 20.0 dBm	Measured Head SAR (1g) W/kg @ 20.0 dBm	Deviation 1g (%)	Certificate SAR Target Head (10g) W/kg @ 20.0 dBm	Measured Head SAR (10g) W/kg @ 20.0 dBm	Deviation 10g (%)	Certificate Impedance Head (Ohm) Real	Measured Impedance Head (Ohm) Real	Difference (Ohm) Real	Certificate Impedance Head (Ohm) Imaginary	Measured Impedance Head (Ohm) Imaginary	Difference (Ohm) Imaginary	Certificate Return Loss Head (dB)	Measured Return Loss Head (dB)	Deviation (%)	PASS/FAIL
9/11/2017	9/11/2018	1.152	5.27	5.52	4.74%	2.48	2.54	2.42%	53.8	49.8	4	7.4	7.1	0.3	-21.9	-23	-4.80%	PASS

Calibration Date	Extension Date	Certificate Electrical Delay (ns)	Certificate SAR Target Body (1g) W/kg @ 20.0 dBm	Measured Body SAR (1g) W/kg @ 20.0 dBm	Deviation 1g (%)	Certificate SAR Target Body (10g) W/kg @ 20.0 dBm	Measured Body SAR (10g) W/kg @ 20.0 dBm	Deviation 10g (%)	Certificate Impedance Body (Ohm) Real	Measured Impedance Body (Ohm) Real	Difference (Ohm) Real	Certificate Impedance Body (Ohm) Imaginary	Measured Impedance Body (Ohm) Imaginary	Difference (Ohm) Imaginary	Certificate Return Loss Body (dB)	Measured Return Loss Body (dB)	Deviation (%)	PASS/FAIL
9/11/2017	9/11/2018	1.152	5.11	5.17	1.17%	2.42	2.37	-2.07%	49.7	49.8	0.1	9.1	7.2	1.9	-20.9	-22.6	-8.20%	PASS

Impedance & Return-Loss Measurement Plot for Head TSL

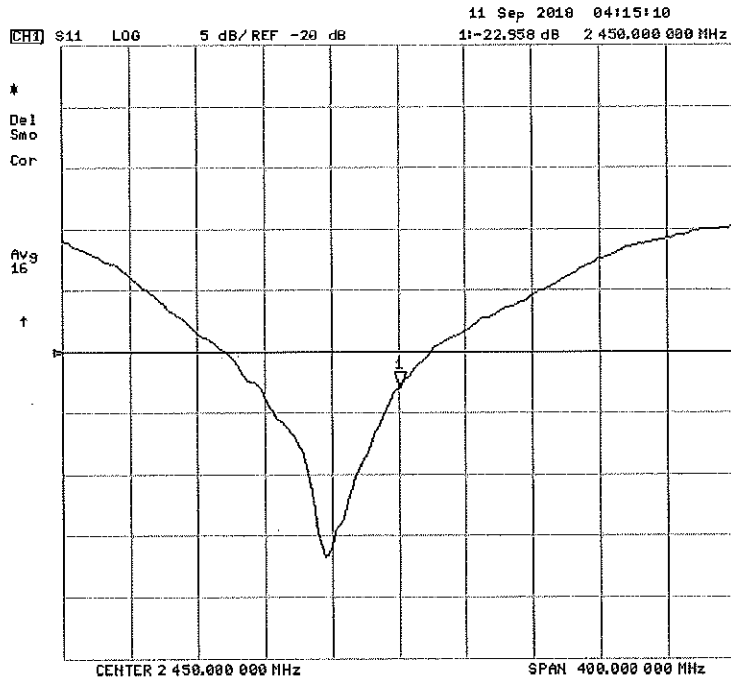
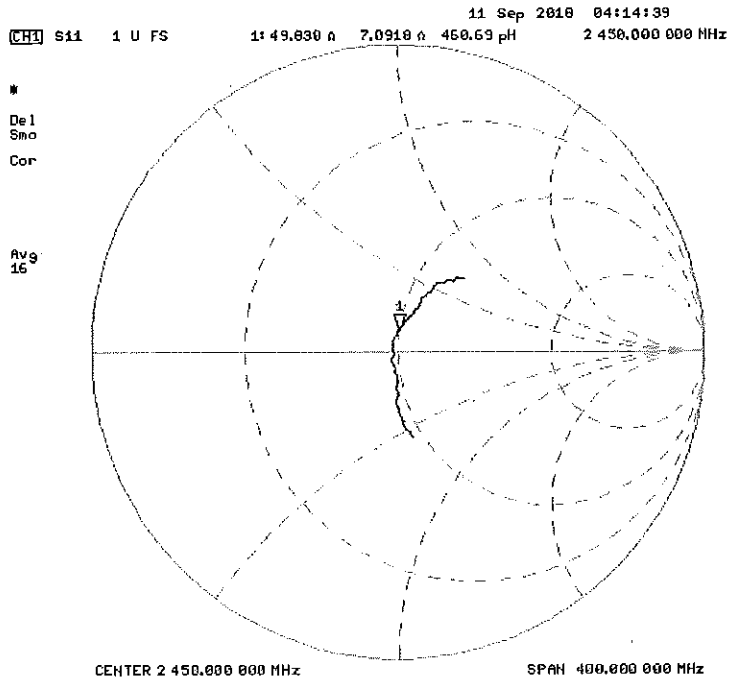

Object:

D2450V2 -- SN: 797

Date Issued:

09/11/2018

Page 3 of 4

Impedance & Return-Loss Measurement Plot for Body TSL

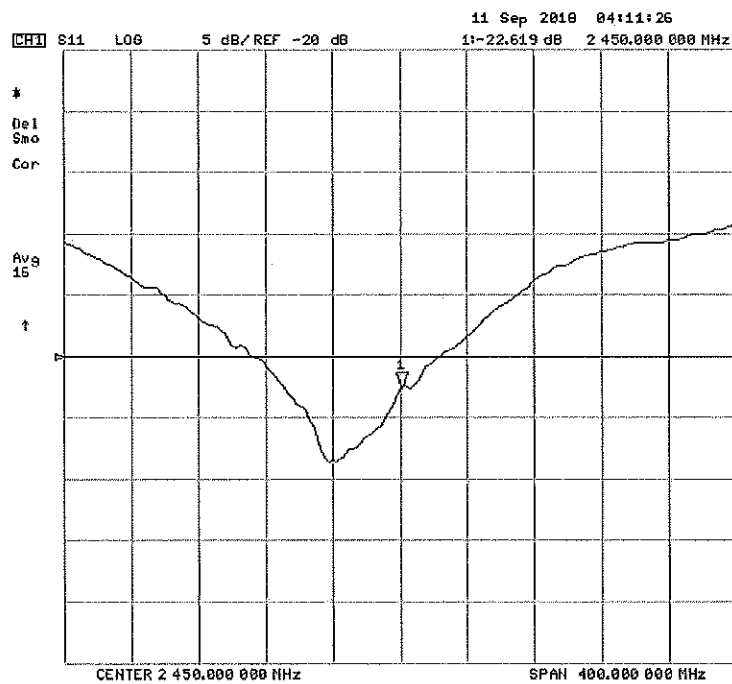
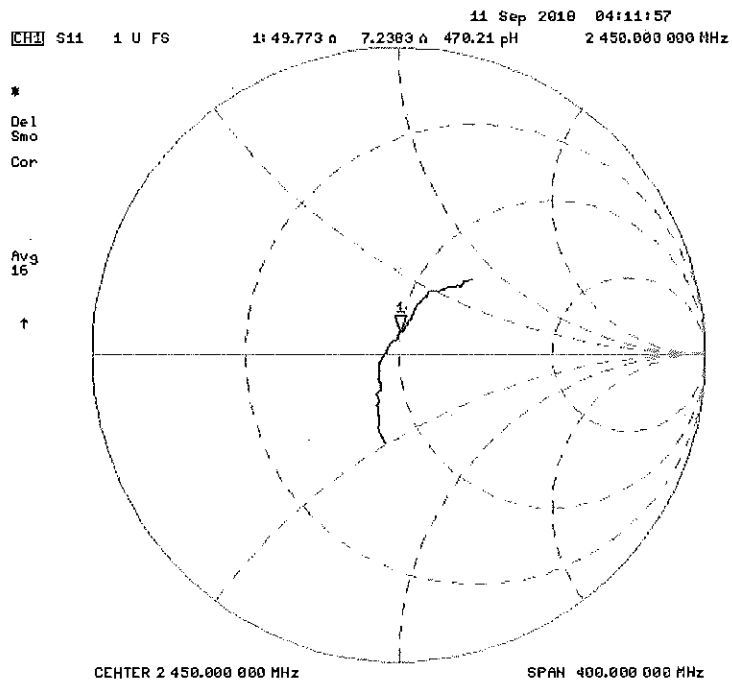

Certification of Calibration

Object: D2450V2 – SN: 797

Calibration procedure(s): Procedure for Calibration Extension for SAR Dipoles.

Extended Calibration date: September 9, 2019

Description: SAR Validation Dipole at 2450 MHz.

Calibration Equipment used:

Manufacturer	Model	Description	Cal Date	Cal Interval	Cal Due	Serial Number
Agilent	8753ES	S-Parameter Network Analyzer	10/2/2018	Annual	10/2/2019	US39170118
Agilent	N5182A	MXG Vector Signal Generator	6/27/2019	Annual	6/27/2020	US46240505
Amplifier Research	15S1G6	Amplifier	CBT	N/A	CBT	343972
Anritsu	ML2495A	Power Meter	10/21/2018	Annual	10/21/2019	941001
Anritsu	MA2411B	Pulse Power Sensor	10/30/2018	Annual	10/30/2019	1207470
Anritsu	MA2411B	Pulse Power Sensor	11/20/2018	Annual	11/20/2019	1339007
Control Company	4040	Temperature / Humidity Monitor	2/28/2018	Biennial	2/28/2020	150761911
Control Company	4352	Ultra Long Stem Thermometer	2/28/2018	Biennial	2/28/2020	170330160
Keysight	772D	Dual Directional Coupler	CBT	N/A	CBT	MY52180215
Keysight Technologies	85033E	Standard Mechanical Calibration Kit (DC to 9GHz, 3.5mm)	7/2/2019	Annual	7/2/2020	MY53401181
Mini-Circuits	BW-N20W5+	DC to 18 GHz Precision Fixed 20 dB Attenuator	CBT	N/A	CBT	N/A
Mini-Circuits	NLP-2950+	Low Pass Filter DC to 2700 MHz	CBT	N/A	CBT	N/A
Narda	4772-3	Attenuator (3dB)	CBT	N/A	CBT	9406
Pasternack	PE2209-10	Bidirectional Coupler	CBT	N/A	CBT	N/A
Pasternack	NC-100	Torque Wrench	5/23/2018	Biennial	5/23/2020	N/A
SPEAG	EX3DV4	SAR Probe	2/19/2019	Annual	2/19/2020	7417
SPEAG	DAE4	Dasy Data Acquisition Electronics	2/13/2019	Annual	2/13/2020	665
SPEAG	EX3DV4	SAR Probe	7/15/2019	Annual	7/15/2020	7547
SPEAG	DAE4	Dasy Data Acquisition Electronics	7/11/2019	Annual	7/11/2020	1323
SPEAG	DAK-3.5	Dielectric Assessment Kit	9/11/2018	Annual	9/11/2019	1091

Note: CBT (Calibrated Before Testing). Prior to testing, the measurement paths containing a cable, amplifier, attenuator, coupler or filter were connected to a calibrated source (i.e. a signal generator) to determine the losses of the measurement path.

Measurement Uncertainty = $\pm 23\%$ (k=2)

	Name	Function	Signature
Calibrated By:	Brodie Halfoster	Team Lead Engineer	<i>BRODIE HALFOSTER</i>
Approved By:	Kaitlin O'Keefe	Senior Technical Manager	<i>KOK</i>

DIPOLE CALIBRATION EXTENSION

Per KDB 865664 D01, calibration intervals of up to three years may be considered for reference dipoles when it is demonstrated that the SAR target, impedance and return loss of a dipole have remained stable according to the following requirements:

1. The measured SAR does not deviate more than 10% from the target on the calibration certificate.
2. The return-loss does not deviate more than 20% from the previous measurement and meets the required 20dB minimum return-loss requirement.
3. The measurement of real or imaginary parts of impedance does not deviate more than 5Ω from the previous measurement.

The following dipole was checked to pass the above 3 requirements to have 3-year calibration period from the calibration date:

Calibration Date	Extension Date	Certificate Electrical Delay (ms)	Certificate SAR Target Head (1g) W/kg @ 20.0 dBm	Measured Head SAR (1g) W/kg @ 20.0 dBm	Deviation 1g (%)	Certificate SAR Target Head (10g) W/kg @ 20.0 dBm	Measured Head SAR (10g) W/kg @ 20.0 dBm	Deviation 10g (%)	Certificate Impedance Head (Ohm) Real	Measured Impedance Head (Ohm) Real	Difference (Ohm) Real	Certificate Impedance Head (Ohm) Imaginary	Measured Impedance Head (Ohm) Imaginary	Difference (Ohm) Imaginary	Certificate Return Loss Head (dB)	Measured Return Loss Head (dB)	Deviation (%)	PASS/FAIL
9/11/2017	9/9/2019	1.152	5.27	5.19	-1.52%	2.48	2.41	-2.82%	53.8	51.1	2.7	7.4	6.6	0.6	-21.9	-23.4	-6.70%	PASS
Calibration Date	Extension Date	Certificate Electrical Delay (ms)	Certificate SAR Target Body (1g) W/kg @ 20.0 dBm	Measured Body SAR (1g) W/kg @ 20.0 dBm	Deviation 1g (%)	Certificate SAR Target Body (10g) W/kg @ 20.0 dBm	Measured Body SAR (10g) W/kg @ 20.0 dBm	Deviation 10g (%)	Certificate Impedance Body (Ohm) Real	Measured Impedance Body (Ohm) Real	Difference (Ohm) Real	Certificate Impedance Body (Ohm) Imaginary	Measured Impedance Body (Ohm) Imaginary	Difference (Ohm) Imaginary	Certificate Return Loss Body (dB)	Measured Return Loss Body (dB)	Deviation (%)	PASS/FAIL
9/11/2017	9/9/2019	1.152	5.11	5.17	1.17%	2.42	2.38	-1.65%	49.7	46	3.7	9.1	5.5	3.6	-20.9	-23.5	-12.40%	PASS

Impedance & Return-Loss Measurement Plot for Head TSL

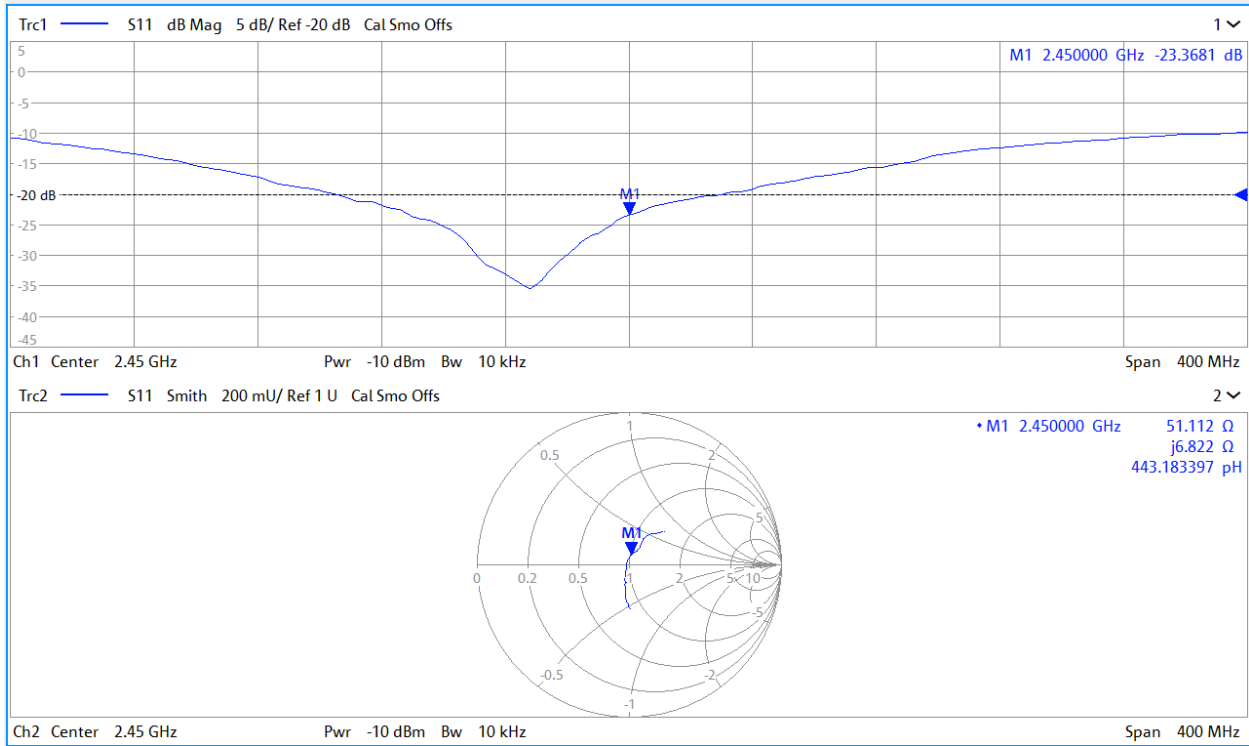

Impedance & Return-Loss Measurement Plot for Body TSL

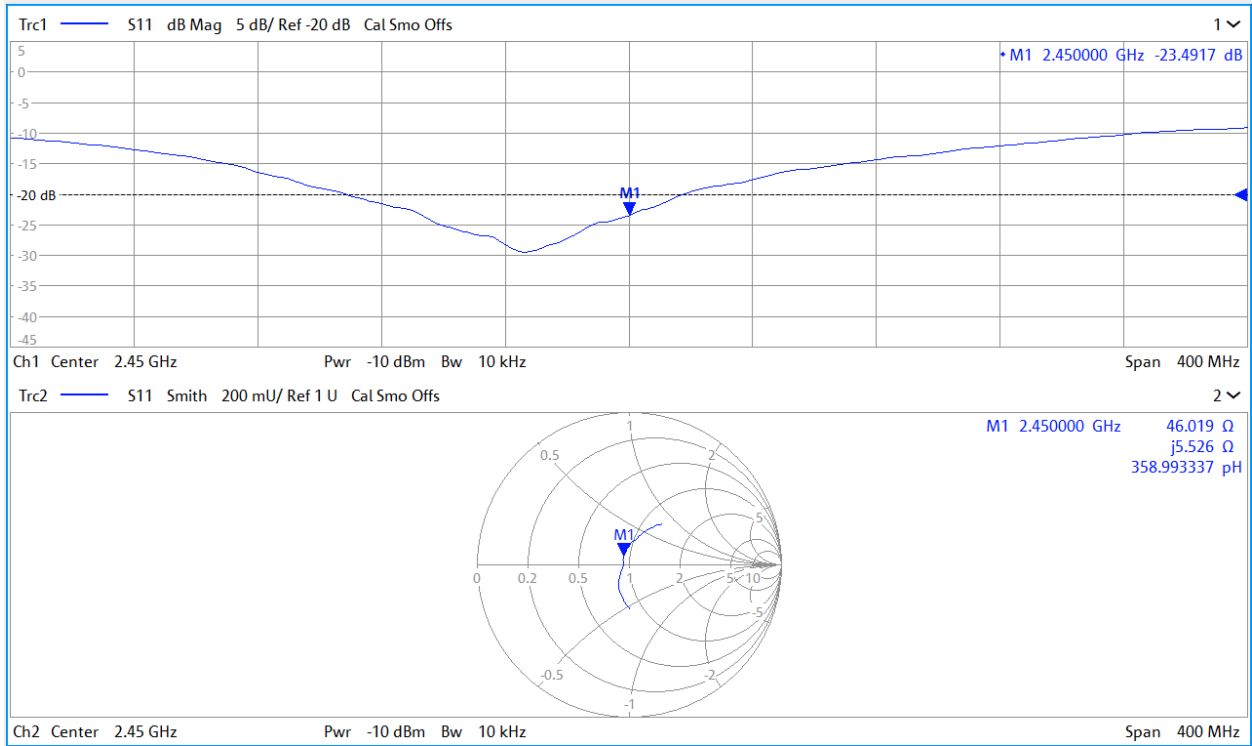



Accredited by the Swiss Accreditation Service (SAS)
The Swiss Accreditation Service is one of the signatories to the EA
Multilateral Agreement for the recognition of calibration certificates

Accreditation No.: **SCS 0108**

Client **PC Test**

Certificate No: **D2450V2-981_Aug18**

CALIBRATION CERTIFICATE

Object **D2450V2 - SN:981**

Calibration procedure(s) **QA CAL-05.v10**
Calibration procedure for dipole validation kits above 700 MHz

Calibration date: **August 16, 2018**

BNV
09-26/2018
BNV
08/10/2019

This calibration certificate documents the traceability to national standards, which realize the physical units of measurements (SI).
The measurements and the uncertainties with confidence probability are given on the following pages and are part of the certificate.

All calibrations have been conducted in the closed laboratory facility: environment temperature (22 ± 3)°C and humidity < 70%.

Calibration Equipment used (M&TE critical for calibration)

Primary Standards	ID #	Cal Date (Certificate No.)	Scheduled Calibration
Power meter NRP	SN: 104778	04-Apr-18 (No. 217-02672/02673)	Apr-19
Power sensor NRP-Z91	SN: 103244	04-Apr-18 (No. 217-02672)	Apr-19
Power sensor NRP-Z91	SN: 103245	04-Apr-18 (No. 217-02673)	Apr-19
Reference 20 dB Attenuator	SN: 5058 (20k)	04-Apr-18 (No. 217-02682)	Apr-19
Type-N mismatch combination	SN: 5047.2 / 06327	04-Apr-18 (No. 217-02683)	Apr-19
Reference Probe EX3DV4	SN: 7349	30-Dec-17 (No. EX3-7349_Dec17)	Dec-18
DAE4	SN: 601	26-Oct-17 (No. DAE4-601_Oct17)	Oct-18

Secondary Standards	ID #	Check Date (in house)	Scheduled Check
Power meter EPM-442A	SN: GB37480704	07-Oct-15 (in house check Oct-16)	In house check: Oct-18
Power sensor HP 8481A	SN: US37292783	07-Oct-15 (in house check Oct-16)	In house check: Oct-18
Power sensor HP 8481A	SN: MY41092317	07-Oct-15 (in house check Oct-16)	In house check: Oct-18
RF generator R&S SMT-06	SN: 100972	15-Jun-15 (in house check Oct-16)	In house check: Oct-18
Network Analyzer Agilent E8358A	SN: US41080477	31-Mar-14 (in house check Oct-17)	In house check: Oct-18

Calibrated by: **Leif Klysner** Name: **Leif Klysner** Function: **Laboratory Technician**

Signature

Approved by: **Katja Pokovic** Name: **Katja Pokovic** Function: **Technical Manager**

Issued: August 23, 2018

This calibration certificate shall not be reproduced except in full without written approval of the laboratory.



Accredited by the Swiss Accreditation Service (SAS)
The Swiss Accreditation Service is one of the signatories to the EA
Multilateral Agreement for the recognition of calibration certificates

Accreditation No.: **SCS 0108**

Glossary:

TSL	tissue simulating liquid
ConvF	sensitivity in TSL / NORM x,y,z
N/A	not applicable or not measured

Calibration is Performed According to the Following Standards:

- IEEE Std 1528-2013, "IEEE Recommended Practice for Determining the Peak Spatial-Averaged Specific Absorption Rate (SAR) in the Human Head from Wireless Communications Devices: Measurement Techniques", June 2013
- IEC 62209-1, "Measurement procedure for the assessment of Specific Absorption Rate (SAR) from hand-held and body-mounted devices used next to the ear (frequency range of 300 MHz to 6 GHz)", July 2016
- IEC 62209-2, "Procedure to determine the Specific Absorption Rate (SAR) for wireless communication devices used in close proximity to the human body (frequency range of 30 MHz to 6 GHz)", March 2010
- KDB 865664, "SAR Measurement Requirements for 100 MHz to 6 GHz"

Additional Documentation:

- DASY4/5 System Handbook

Methods Applied and Interpretation of Parameters:

- Measurement Conditions:** Further details are available from the Validation Report at the end of the certificate. All figures stated in the certificate are valid at the frequency indicated.
- Antenna Parameters with TSL:** The dipole is mounted with the spacer to position its feed point exactly below the center marking of the flat phantom section, with the arms oriented parallel to the body axis.
- Feed Point Impedance and Return Loss:** These parameters are measured with the dipole positioned under the liquid filled phantom. The impedance stated is transformed from the measurement at the SMA connector to the feed point. The Return Loss ensures low reflected power. No uncertainty required.
- Electrical Delay:** One-way delay between the SMA connector and the antenna feed point. No uncertainty required.
- SAR measured:** SAR measured at the stated antenna input power.
- SAR normalized:** SAR as measured, normalized to an input power of 1 W at the antenna connector.
- SAR for nominal TSL parameters:** The measured TSL parameters are used to calculate the nominal SAR result.

The reported uncertainty of measurement is stated as the standard uncertainty of measurement multiplied by the coverage factor $k=2$, which for a normal distribution corresponds to a coverage probability of approximately 95%.

Measurement Conditions

DASY system configuration, as far as not given on page 1.

DASY Version	DASY5	V52.10.1
Extrapolation	Advanced Extrapolation	
Phantom	Modular Flat Phantom	
Distance Dipole Center - TSL	10 mm	with Spacer
Zoom Scan Resolution	dx, dy, dz = 5.0 mm	
Frequency	2450 MHz ± 1 MHz	

Head TSL parameters

The following parameters and calculations were applied.

	Temperature	Permittivity	Conductivity
Nominal Head TSL parameters	22.0 °C	39.2	1.80 mho/m
Measured Head TSL parameters	(22.0 ± 0.2) °C	37.7 ± 6 %	1.86 mho/m ± 6 %
Head TSL temperature change during test	< 0.5 °C	----	----

SAR result with Head TSL

SAR averaged over 1 cm³ (1 g) of Head TSL	Condition	
SAR measured	250 mW input power	13.4 W/kg
SAR for nominal Head TSL parameters	normalized to 1W	52.3 W/kg ± 17.0 % (k=2)

SAR averaged over 10 cm³ (10 g) of Head TSL	condition	
SAR measured	250 mW input power	6.20 W/kg
SAR for nominal Head TSL parameters	normalized to 1W	24.4 W/kg ± 16.5 % (k=2)

Body TSL parameters

The following parameters and calculations were applied.

	Temperature	Permittivity	Conductivity
Nominal Body TSL parameters	22.0 °C	52.7	1.95 mho/m
Measured Body TSL parameters	(22.0 ± 0.2) °C	51.8 ± 6 %	2.02 mho/m ± 6 %
Body TSL temperature change during test	< 0.5 °C	----	----

SAR result with Body TSL

SAR averaged over 1 cm³ (1 g) of Body TSL	Condition	
SAR measured	250 mW input power	13.0 W/kg
SAR for nominal Body TSL parameters	normalized to 1W	50.9 W/kg ± 17.0 % (k=2)

SAR averaged over 10 cm³ (10 g) of Body TSL	condition	
SAR measured	250 mW input power	6.11 W/kg
SAR for nominal Body TSL parameters	normalized to 1W	24.2 W/kg ± 16.5 % (k=2)

Appendix (Additional assessments outside the scope of SCS 0108)

Antenna Parameters with Head TSL

Impedance, transformed to feed point	55.0 Ω + 2.3 j Ω
Return Loss	- 25.6 dB

Antenna Parameters with Body TSL

Impedance, transformed to feed point	50.2 Ω + 4.7 j Ω
Return Loss	- 26.6 dB

General Antenna Parameters and Design

Electrical Delay (one direction)	1.162 ns
----------------------------------	----------

After long term use with 100W radiated power, only a slight warming of the dipole near the feedpoint can be measured.

The dipole is made of standard semirigid coaxial cable. The center conductor of the feeding line is directly connected to the second arm of the dipole. The antenna is therefore short-circuited for DC-signals. On some of the dipoles, small end caps are added to the dipole arms in order to improve matching when loaded according to the position as explained in the "Measurement Conditions" paragraph. The SAR data are not affected by this change. The overall dipole length is still according to the Standard.

No excessive force must be applied to the dipole arms, because they might bend or the soldered connections near the feedpoint may be damaged.

Additional EUT Data

Manufactured by	SPEAG
Manufactured on	December 30, 2014

Appendix (Additional assessments outside the scope of SCS 0108)

Measurement Conditions

DASY system configuration, as far as not given on page 1 and 3.

Phantom	SAM Head Phantom	For usage with cSAR3DV2-R/L
---------	------------------	-----------------------------

SAR result with SAM Head (Top)

SAR averaged over 1 cm ³ (1 g) of Head TSL	Condition	
SAR measured	250 mW input power	13.6 W/kg
SAR for nominal Head TSL parameters	normalized to 1W	54.0 W/kg ± 17.5 % (k=2)

SAR averaged over 10 cm ³ (10 g) of Head TSL	condition	
SAR measured	250 mW input power	6.33 W/kg
SAR for nominal Head TSL parameters	normalized to 1W	25.2 W/kg ± 16.9 % (k=2)

SAR result with SAM Head (Mouth)

SAR averaged over 1 cm ³ (1 g) of Head TSL	Condition	
SAR measured	250 mW input power	13.6 W/kg
SAR for nominal Head TSL parameters	normalized to 1W	54.0 W/kg ± 17.5 % (k=2)

SAR averaged over 10 cm ³ (10 g) of Head TSL	condition	
SAR measured	250 mW input power	6.35 W/kg
SAR for nominal Head TSL parameters	normalized to 1W	25.3 W/kg ± 16.9 % (k=2)

SAR result with SAM Head (Neck)

SAR averaged over 1 cm ³ (1 g) of Head TSL	Condition	
SAR measured	250 mW input power	12.9 W/kg
SAR for nominal Head TSL parameters	normalized to 1W	51.2 W/kg ± 17.5 % (k=2)

SAR averaged over 10 cm ³ (10 g) of Head TSL	condition	
SAR measured	250 mW input power	6.11 W/kg
SAR for nominal Head TSL parameters	normalized to 1W	24.4 W/kg ± 16.9 % (k=2)

SAR result with SAM Head (Ear)

SAR averaged over 1 cm ³ (1 g) of Head TSL	Condition	
SAR measured	250 mW input power	8.74 W/kg
SAR for nominal Head TSL parameters	normalized to 1W	34.7 W/kg ± 17.5 % (k=2)

SAR averaged over 10 cm ³ (10 g) of Head TSL	condition	
SAR measured	250 mW input power	4.40 W/kg
SAR for nominal Head TSL parameters	normalized to 1W	17.5 W/kg ± 16.9 % (k=2)

DASY5 Validation Report for Head TSL

Date: 13.08.2018

Test Laboratory: SPEAG, Zurich, Switzerland

DUT: Dipole 2450 MHz; Type: D2450V2; Serial: D2450V2 - SN:981

Communication System: UID 0 - CW; Frequency: 2450 MHz

Medium parameters used: $f = 2450$ MHz; $\sigma = 1.86$ S/m; $\epsilon_r = 37.7$; $\rho = 1000$ kg/m³

Phantom section: Flat Section

Measurement Standard: DASY5 (IEEE/IEC/ANSI C63.19-2011)

DASY52 Configuration:

- Probe: EX3DV4 - SN7349; ConvF(7.88, 7.88, 7.88) @ 2450 MHz; Calibrated: 30.12.2017
- Sensor-Surface: 1.4mm (Mechanical Surface Detection)
- Electronics: DAE4 Sn601; Calibrated: 26.10.2017
- Phantom: Flat Phantom 5.0 (front); Type: QD 000 P50 AA; Serial: 1001
- DASY52 52.10.1(1476); SEMCAD X 14.6.11(7439)

Dipole Calibration for Head Tissue/Pin=250 mW, d=10mm/Zoom Scan (7x7x7)/Cube 0:

Measurement grid: dx=5mm, dy=5mm, dz=5mm

Reference Value = 116.6 V/m; Power Drift = -0.03 dB

Peak SAR (extrapolated) = 26.7 W/kg

SAR(1 g) = 13.4 W/kg; SAR(10 g) = 6.2 W/kg

Maximum value of SAR (measured) = 22.1 W/kg



0 dB = 22.1 W/kg = 13.44 dBW/kg

Impedance Measurement Plot for Head TSL

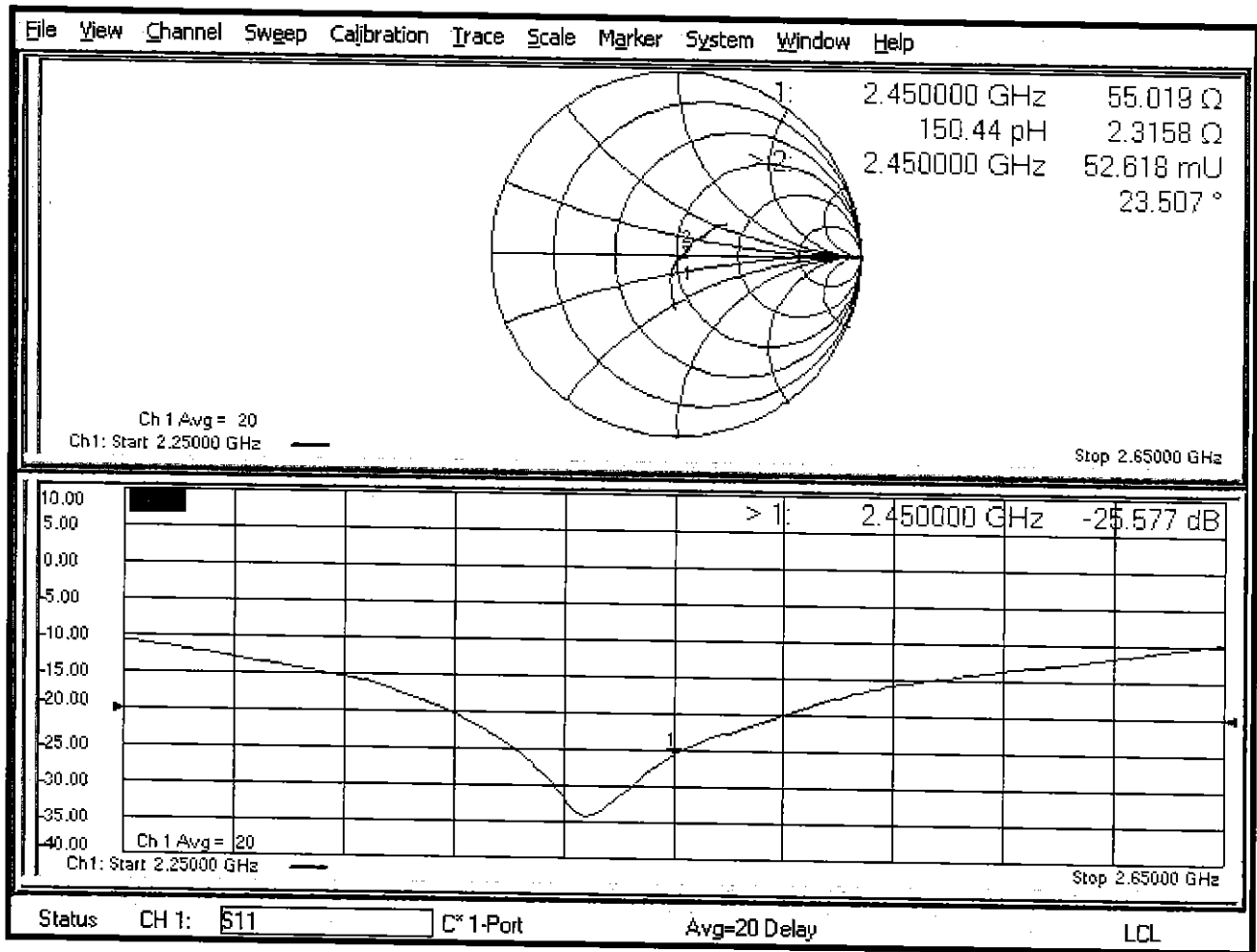

DASY5 Validation Report for Body TSL

Date: 13.08.2018

Test Laboratory: SPEAG, Zurich, Switzerland

DUT: Dipole 2450 MHz; Type: D2450V2; Serial: D2450V2 - SN:981

Communication System: UID 0 - CW; Frequency: 2450 MHz

Medium parameters used: $f = 2450$ MHz; $\sigma = 2.02$ S/m; $\epsilon_r = 51.8$; $\rho = 1000$ kg/m³

Phantom section: Flat Section

Measurement Standard: DASY5 (IEEE/IEC/ANSI C63.19-2011)

DASY52 Configuration:

- Probe: EX3DV4 - SN7349; ConvF(8.01, 8.01, 8.01) @ 2450 MHz; Calibrated: 30.12.2017
- Sensor-Surface: 1.4mm (Mechanical Surface Detection)
- Electronics: DAE4 Sn601; Calibrated: 26.10.2017
- Phantom: Flat Phantom 5.0 (back); Type: QD 000 P50 AA; Serial: 1002
- DASY52 52.10.1(1476); SEMCAD X 14.6.11(7439)

Dipole Calibration for Body Tissue/Pin=250 mW, d=10mm/Zoom Scan (7x7x7)/Cube 0:

Measurement grid: dx=5mm, dy=5mm, dz=5mm

Reference Value = 107.0 V/m; Power Drift = -0.08 dB

Peak SAR (extrapolated) = 25.3 W/kg

SAR(1 g) = 13 W/kg; SAR(10 g) = 6.11 W/kg

Maximum value of SAR (measured) = 20.7 W/kg



0 dB = 20.7 W/kg = 13.16 dBW/kg

Impedance Measurement Plot for Body TSL

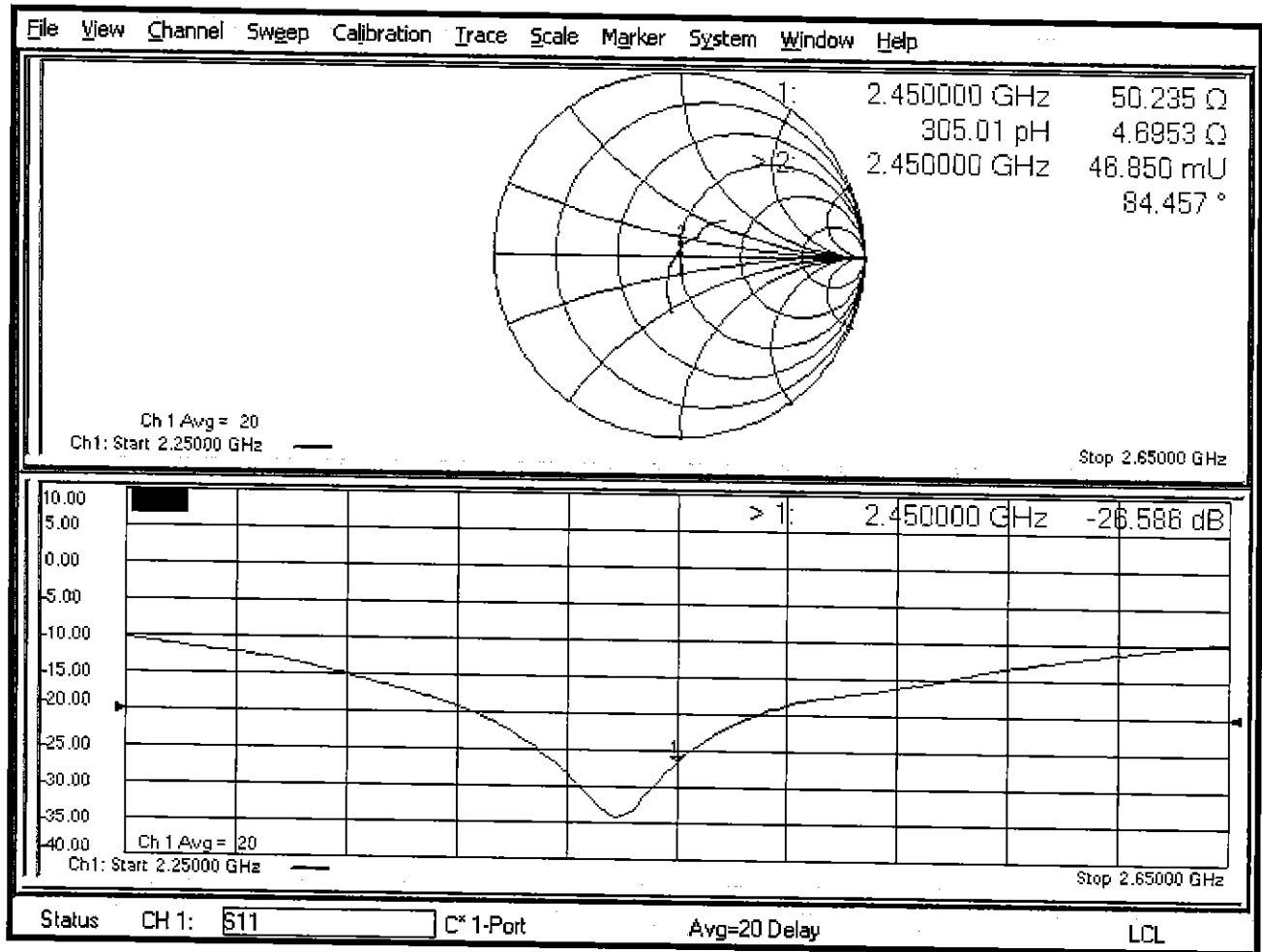

DASY5 Validation Report for SAM Head

Date: 16.08.2018

Test Laboratory: SPEAG, Zurich, Switzerland

DUT: Dipole 2450 MHz; Type: D2450V2; Serial: D2450V2 - SN:981

Communication System: UID 0 - CW ; Frequency: 2450 MHz

Medium parameters used: $f = 2450$ MHz; $\sigma = 1.85$ S/m; $\epsilon_r = 40.2$; $\rho = 1000$ kg/m³

Measurement Standard: DASY5 (IEEE/IEC/ANSI C63.19-2011)

DASY52 Configuration:

- Probe: EX3DV4 - SN7349; ConvF(7.88, 7.88, 7.88) @ 2450 MHz; Calibrated: 30.12.2017
- Sensor-Surface: 1.4mm (Mechanical Surface Detection)
- Electronics: DAE4 Sn601; Calibrated: 26.10.2017
- Phantom: SAM Head
- DASY52 52.10.1(1476); SEMCAD X 14.6.11(7439)

SAM Head Top/Zoom Scan (7x7x7)/Cube 0: Measurement grid: dx=5mm, dy=5mm, dz=5mm

Reference Value = 116.2 V/m; Power Drift = 0.00 dB

Peak SAR (extrapolated) = 26.4 W/kg

SAR(1 g) = 13.6 W/kg; SAR(10 g) = 6.33 W/kg

Maximum value of SAR (measured) = 22.0 W/kg

SAM Head Mouth/Zoom Scan (7x7x7)/Cube 0: Measurement grid: dx=5mm, dy=5mm, dz=5mm

Reference Value = 116.9 V/m; Power Drift = 0.01 dB

Peak SAR (extrapolated) = 26.3 W/kg

SAR(1 g) = 13.6 W/kg; SAR(10 g) = 6.35 W/kg

Maximum value of SAR (measured) = 21.7 W/kg

SAM Head Neck/Zoom Scan (7x7x7)/Cube 0: Measurement grid: dx=5mm, dy=5mm, dz=5mm

Reference Value = 112.0 V/m; Power Drift = 0.03 dB

Peak SAR (extrapolated) = 24.1 W/kg

SAR(1 g) = 12.9 W/kg; SAR(10 g) = 6.11 W/kg

Maximum value of SAR (measured) = 20.5 W/kg

SAM Head Ear/Zoom Scan (7x7x7)/Cube 0: Measurement grid: dx=5mm, dy=5mm, dz=5mm

Reference Value = 91.03 V/m; Power Drift = -0.01 dB

Peak SAR (extrapolated) = 15.8 W/kg

SAR(1 g) = 8.74 W/kg; SAR(10 g) = 4.4 W/kg

Maximum value of SAR (measured) = 13.5 W/kg

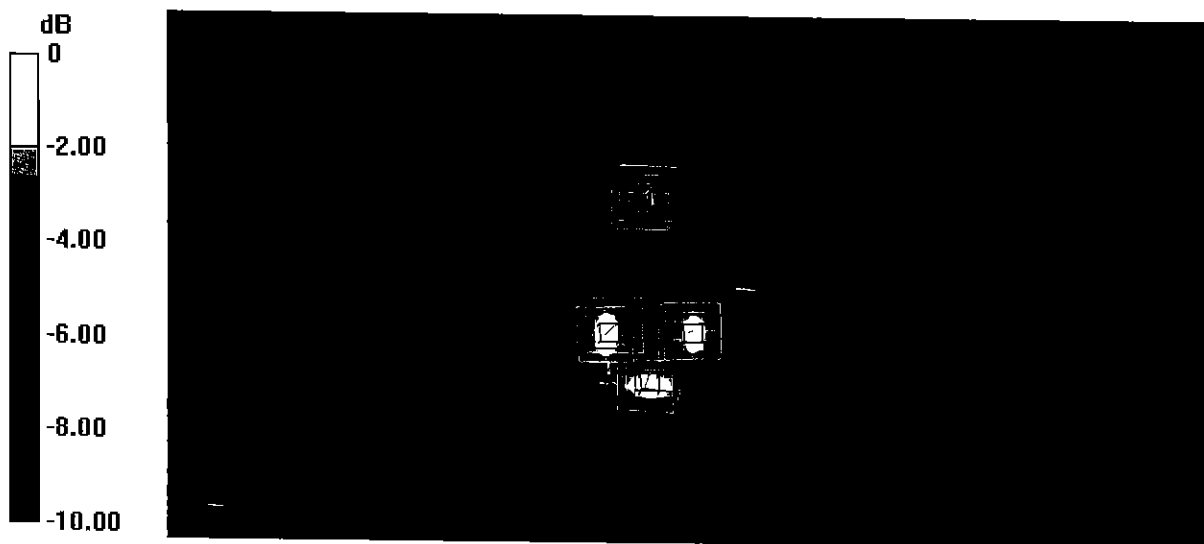

0 dB = 22.0 W/kg = 13.42 dBW/kg

Certification of Calibration

Object: D2450V2 – SN: 981

Calibration procedure(s): Procedure for Calibration Extension for SAR Dipoles.

Calibration date: 08/09/2019

Description: SAR Validation Dipole at 2450 MHz.

Calibration Equipment used:

Manufacturer	Model	Description	Cal Date	Cal Interval	Cal Due	Serial Number
Agilent	8753ES	S-Parameter Network Analyzer	10/2/2018	Annual	10/2/2019	US39170118
Agilent	N5182A	MXG Vector Signal Generator	6/27/2019	Annual	6/27/2020	US46240505
Amplifier Research	15S1G6	Amplifier	CBT	N/A	CBT	343972
Anritsu	ML2495A	Power Meter	10/21/2018	Annual	10/21/2019	941001
Anritsu	MA2411B	Pulse Power Sensor	10/30/2018	Annual	10/30/2019	1207470
Anritsu	MA2411B	Pulse Power Sensor	11/20/2018	Annual	11/20/2019	1339007
Control Company	4040	Temperature / Humidity Monitor	2/28/2018	Biennial	2/28/2020	150761911
Control Company	4352	Ultra Long Stem Thermometer	2/28/2018	Biennial	2/28/2020	170330160
Keysight	772D	Dual Directional Coupler	CBT	N/A	CBT	MY52180215
Keysight Technologies	85033E	Standard Mechanical Calibration Kit (DC to 9GHz, 3.5mm)	7/2/2019	Annual	7/2/2020	MY53401181
Mini-Circuits	BW-N20W5+	DC to 18 GHz Precision Fixed 20 dB Attenuator	CBT	N/A	CBT	N/A
Mini-Circuits	NLP-2950+	Low Pass Filter DC to 2700 MHz	CBT	N/A	CBT	N/A
Narda	4772-3	Attenuator (3dB)	CBT	N/A	CBT	9406
Pasternack	PE2209-10	Bidirectional Coupler	CBT	N/A	CBT	N/A
Pasternack	NC-100	Torque Wrench	5/23/2018	Biennial	5/23/2020	N/A
SPEAG	EX3DV4	SAR Probe	2/19/2019	Annual	2/19/2020	7417
SPEAG	DAE4	Dasy Data Acquisition Electronics	2/13/2019	Annual	2/13/2020	665
SPEAG	EX3DV4	SAR Probe	7/15/2019	Annual	7/15/2020	7547
SPEAG	DAE4	Dasy Data Acquisition Electronics	7/11/2019	Annual	7/11/2020	1323
SPEAG	DAK-3.5	Dielectric Assessment Kit	9/11/2018	Annual	9/11/2019	1091

Measurement Uncertainty = $\pm 23\%$ (k=2)

	Name	Function	Signature
Calibrated By:	Brodie Halfoster	Test Engineer	<i>BRODIE HALFOSTER</i>
Approved By:	Kaitlin O'Keefe	Senior Technical Manager	<i>KOK</i>

DIPOLE CALIBRATION EXTENSION

Per KDB 865664 D01, calibration intervals of up to three years may be considered for reference dipoles when it is demonstrated that the SAR target, impedance and return loss of a dipole have remained stable according to the following requirements:

1. The measured SAR does not deviate more than 10% from the target on the calibration certificate.
2. The return-loss does not deviate more than 20% from the previous measurement and meets the required 20dB minimum return-loss requirement.
3. The measurement of real or imaginary parts of impedance does not deviate more than 5Ω from the previous measurement.

The following dipole was checked to pass the above 3 requirements to have 2-year calibration period from the calibration date:

Calibration Date	Extension Date	Certificate Electrical Delay (ns)	Certificate SAR Target Head (1g) W/kg @ 20.0 dBm	Measured Head SAR (1g) W/kg @ 20.0 dBm	Deviation 1g (%)	Certificate SAR Target Head (10g) W/kg @ 20.0 dBm	Measured Head SAR (10g) W/kg @ 20.0 dBm	Deviation 10g (%)	Certificate Impedance Head (Ohm) Real	Measured Impedance Head (Ohm) Real	Difference (Ohm) Real	Certificate Impedance Head (Ohm) Imaginary	Measured Impedance Head (Ohm) Imaginary	Difference (Ohm) Imaginary	Certificate Return Loss Head (dB)	Measured Return Loss Head (dB)	Deviation (%)	PASS/FAIL
8/16/2018	8/9/2019	1.162	5.23	5.53	5.74%	2.44	2.56	4.92%	55	53.5	1.5	2.3	1.1	1.2	-25.6	-28.5	-11.30%	PASS
Calibration Date	Extension Date	Certificate Electrical Delay (ns)	Certificate SAR Target Body (1g) W/kg @ 20.0 dBm	Measured Body SAR (1g) W/kg @ 20.0 dBm	Deviation 1g (%)	Certificate SAR Target Body (10g) W/kg @ 20.0 dBm	Measured Body SAR (10g) W/kg @ 20.0 dBm	Deviation 10g (%)	Certificate Impedance Body (Ohm) Real	Measured Impedance Body (Ohm) Real	Difference (Ohm) Real	Certificate Impedance Body (Ohm) Imaginary	Measured Impedance Body (Ohm) Imaginary	Difference (Ohm) Imaginary	Certificate Return Loss Body (dB)	Measured Return Loss Body (dB)	Deviation (%)	PASS/FAIL
8/16/2018	8/9/2019	1.162	5.09	4.98	-2.16%	2.42	2.28	-5.79%	50.2	47.8	2.4	4.7	1.1	3.6	-26.6	-31.8	-19.60%	PASS

Impedance & Return-Loss Measurement Plot for Head TSL

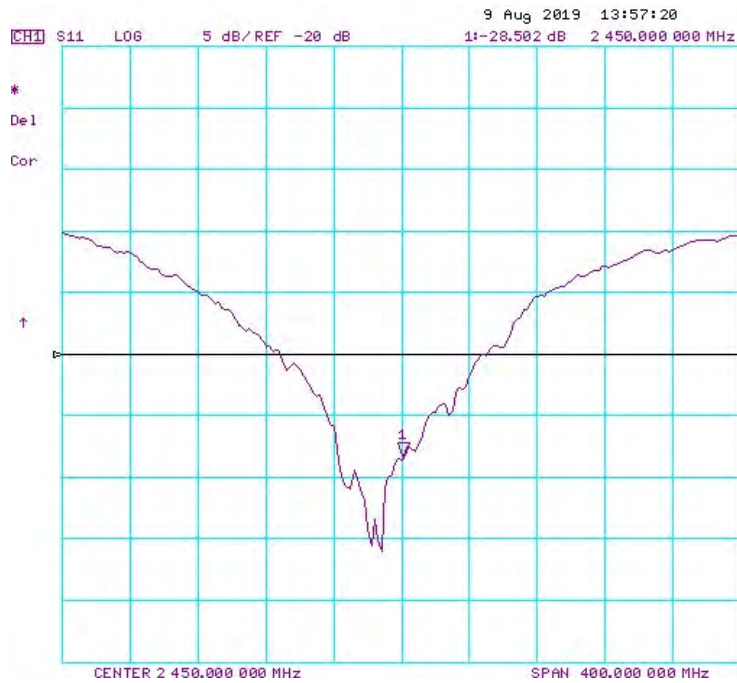
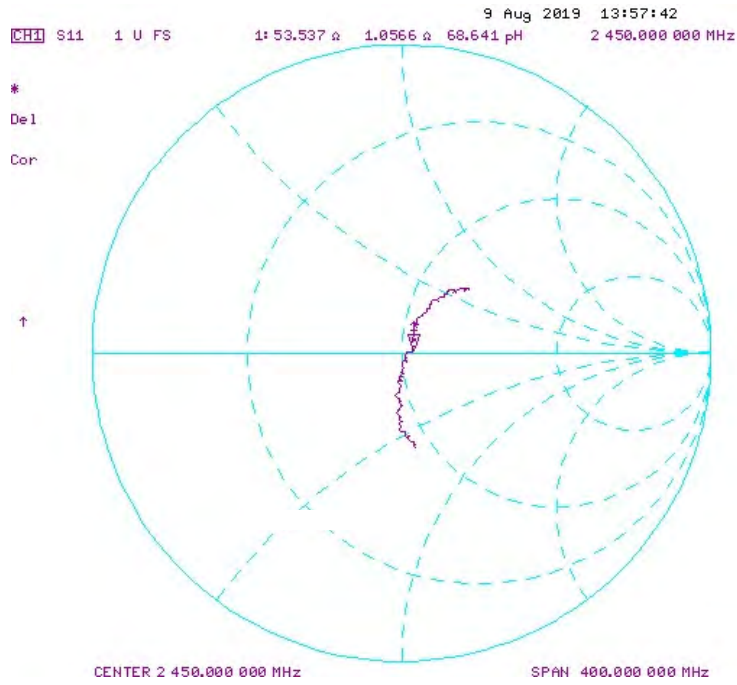

Impedance & Return-Loss Measurement Plot for Body TSL

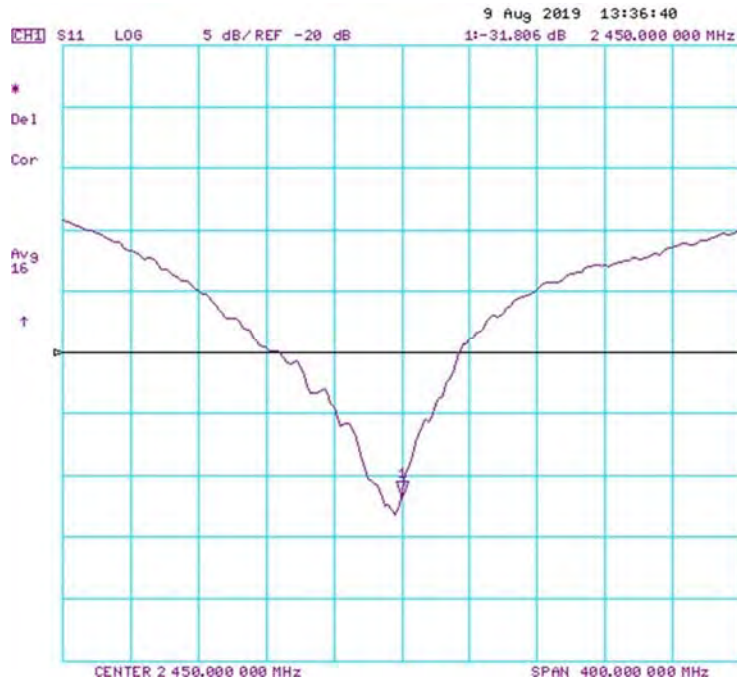
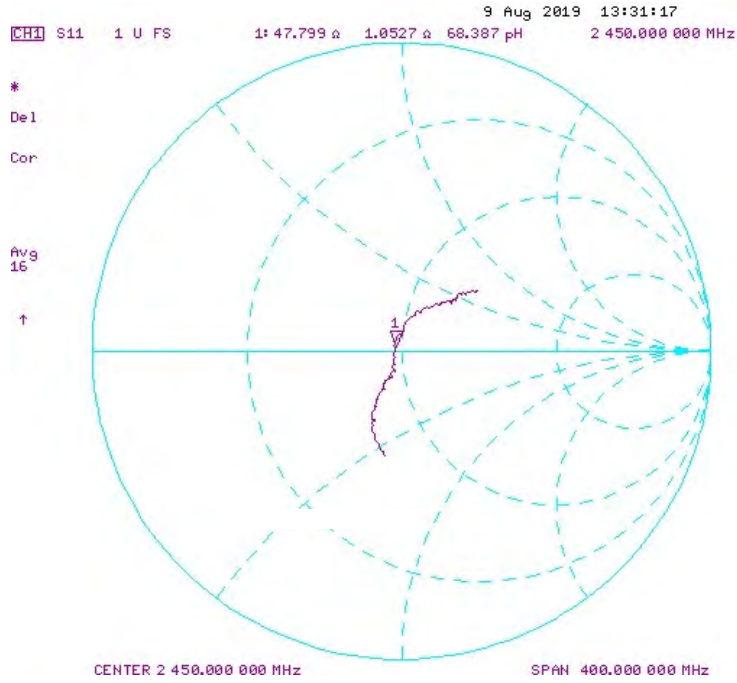



Accredited by the Swiss Accreditation Service (SAS)
The Swiss Accreditation Service is one of the signatories to the EA
Multilateral Agreement for the recognition of calibration certificates

Accreditation No.: **SCS 0108**

Client **PC Test**

Certificate No: **D2600V2-1004_Apr18**

CALIBRATION CERTIFICATE

Object **D2600V2 - SN:1004**

Calibration procedure(s) **OPTICAL BEAM
Calibration procedure for power evaluation with power 100 MHz**

Calibration date: **April 11, 2018**

*BN ✓
04-20-2019
Extended*

This calibration certificate documents the traceability to national standards, which realize the physical units of measurements (SI).
The measurements and the uncertainties with confidence probability are given on the following pages and are part of the certificate.

All calibrations have been conducted in the closed laboratory facility: environment temperature (22 ± 3)°C and humidity < 70%.

Calibration Equipment used (M&TE critical for calibration)

Primary Standards	ID #	Cal Date (Certificate No.)	Scheduled Calibration
Power meter NRP	SN: 104778	04-Apr-18 (No. 217-02672/02673)	Apr-19
Power sensor NRP-Z91	SN: 103244	04-Apr-18 (No. 217-02672)	Apr-19
Power sensor NRP-Z91	SN: 103245	04-Apr-18 (No. 217-02673)	Apr-19
Reference 20 dB Attenuator	SN: 5058 (20k)	04-Apr-18 (No. 217-02682)	Apr-19
Type-N mismatch combination	SN: 5047.2 / 06327	04-Apr-18 (No. 217-02683)	Apr-19
Reference Probe EX3DV4	SN: 7349	30-Dec-17 (No. EX3-7349_Dec17)	Dec-18
DAE4	SN: 601	26-Oct-17 (No. DAE4-601_Oct17)	Oct-18
Secondary Standards	ID #	Check Date (in house)	Scheduled Check
Power meter EPM-442A	SN: GB37480704	07-Oct-15 (in house check Oct-16)	In house check: Oct-18
Power sensor HP 8481A	SN: US37292783	07-Oct-15 (in house check Oct-16)	In house check: Oct-18
Power sensor HP 8481A	SN: MY41092317	07-Oct-15 (in house check Oct-16)	In house check: Oct-18
RF generator R&S SMT-06	SN: 100972	15-Jun-15 (in house check Oct-16)	In house check: Oct-18
Network Analyzer HP 8753E	SN: US37390585	18-Oct-01 (in house check Oct-17)	In house check: Oct-18

Calibrated by: **Michael Weber** (Name), **Laboratory Technician** (Function), *[Signature]* (Signature)

Approved by: **Katja Pokovic** (Name), **Technical Manager** (Function), *[Signature]* (Signature)

Issued: April 12, 2018

This calibration certificate shall not be reproduced except in full without written approval of the laboratory.



Accredited by the Swiss Accreditation Service (SAS)

Accreditation No.: **SCS 0108**

The Swiss Accreditation Service is one of the signatories to the EA Multilateral Agreement for the recognition of calibration certificates

Glossary:

TSL	tissue simulating liquid
ConvF	sensitivity in TSL / NORM x,y,z
N/A	not applicable or not measured

Calibration is Performed According to the Following Standards:

- IEEE Std 1528-2013, "IEEE Recommended Practice for Determining the Peak Spatial-Averaged Specific Absorption Rate (SAR) in the Human Head from Wireless Communications Devices: Measurement Techniques", June 2013
- IEC 62209-1, "Measurement procedure for the assessment of Specific Absorption Rate (SAR) from hand-held and body-mounted devices used next to the ear (frequency range of 300 MHz to 6 GHz)", July 2016
- IEC 62209-2, "Procedure to determine the Specific Absorption Rate (SAR) for wireless communication devices used in close proximity to the human body (frequency range of 30 MHz to 6 GHz)", March 2010
- KDB 865664, "SAR Measurement Requirements for 100 MHz to 6 GHz"

Additional Documentation:

- DASY4/5 System Handbook

Methods Applied and Interpretation of Parameters:

- Measurement Conditions:** Further details are available from the Validation Report at the end of the certificate. All figures stated in the certificate are valid at the frequency indicated.
- Antenna Parameters with TSL:** The dipole is mounted with the spacer to position its feed point exactly below the center marking of the flat phantom section, with the arms oriented parallel to the body axis.
- Feed Point Impedance and Return Loss:** These parameters are measured with the dipole positioned under the liquid filled phantom. The impedance stated is transformed from the measurement at the SMA connector to the feed point. The Return Loss ensures low reflected power. No uncertainty required.
- Electrical Delay:** One-way delay between the SMA connector and the antenna feed point. No uncertainty required.
- SAR measured:** SAR measured at the stated antenna input power.
- SAR normalized:** SAR as measured, normalized to an input power of 1 W at the antenna connector.
- SAR for nominal TSL parameters:** The measured TSL parameters are used to calculate the nominal SAR result.

The reported uncertainty of measurement is stated as the standard uncertainty of measurement multiplied by the coverage factor $k=2$, which for a normal distribution corresponds to a coverage probability of approximately 95%.

Measurement Conditions

DASY system configuration, as far as not given on page 1.

DASY Version	DASY5	V52.10.0
Extrapolation	Advanced Extrapolation	
Phantom	Modular Flat Phantom	
Distance Dipole Center - TSL	10 mm	with Spacer
Zoom Scan Resolution	dx, dy, dz = 5 mm	
Frequency	2600 MHz \pm 1 MHz	

Head TSL parameters

The following parameters and calculations were applied.

	Temperature	Permittivity	Conductivity
Nominal Head TSL parameters	22.0 °C	39.0	1.96 mho/m
Measured Head TSL parameters	(22.0 \pm 0.2) °C	37.8 \pm 6 %	2.03 mho/m \pm 6 %
Head TSL temperature change during test	< 0.5 °C	----	----

SAR result with Head TSL

SAR averaged over 1 cm³ (1 g) of Head TSL	Condition	
SAR measured	250 mW input power	14.3 W/kg
SAR for nominal Head TSL parameters	normalized to 1W	55.9 W/kg \pm 17.0 % (k=2)

SAR averaged over 10 cm³ (10 g) of Head TSL	condition	
SAR measured	250 mW input power	6.35 W/kg
SAR for nominal Head TSL parameters	normalized to 1W	25.1 W/kg \pm 16.5 % (k=2)

Body TSL parameters

The following parameters and calculations were applied.

	Temperature	Permittivity	Conductivity
Nominal Body TSL parameters	22.0 °C	52.5	2.16 mho/m
Measured Body TSL parameters	(22.0 \pm 0.2) °C	52.1 \pm 6 %	2.19 mho/m \pm 6 %
Body TSL temperature change during test	< 0.5 °C	----	----

SAR result with Body TSL

SAR averaged over 1 cm³ (1 g) of Body TSL	Condition	
SAR measured	250 mW input power	13.8 W/kg
SAR for nominal Body TSL parameters	normalized to 1W	54.8 W/kg \pm 17.0 % (k=2)

SAR averaged over 10 cm³ (10 g) of Body TSL	condition	
SAR measured	250 mW input power	6.20 W/kg
SAR for nominal Body TSL parameters	normalized to 1W	24.7 W/kg \pm 16.5 % (k=2)

Appendix (Additional assessments outside the scope of SCS 0108)

Antenna Parameters with Head TSL

Impedance, transformed to feed point	47.7 Ω - 5.7 j Ω
Return Loss	- 24.1 dB

Antenna Parameters with Body TSL

Impedance, transformed to feed point	46.0 Ω - 3.8 j Ω
Return Loss	- 24.9 dB

General Antenna Parameters and Design

Electrical Delay (one direction)	1.149 ns
----------------------------------	----------

After long term use with 100W radiated power, only a slight warming of the dipole near the feedpoint can be measured.

The dipole is made of standard semirigid coaxial cable. The center conductor of the feeding line is directly connected to the second arm of the dipole. The antenna is therefore short-circuited for DC-signals. On some of the dipoles, small end caps are added to the dipole arms in order to improve matching when loaded according to the position as explained in the "Measurement Conditions" paragraph. The SAR data are not affected by this change. The overall dipole length is still according to the Standard.

No excessive force must be applied to the dipole arms, because they might bend or the soldered connections near the feedpoint may be damaged.

Additional EUT Data

Manufactured by	SPEAG
Manufactured on	December 23, 2006

DASY5 Validation Report for Head TSL

Date: 11.04.2018

Test Laboratory: SPEAG, Zurich, Switzerland

DUT: Dipole 2600 MHz; Type: D2600V2; Serial: D2600V2 - SN: 1004

Communication System: UID 0 - CW; Frequency: 2600 MHz

Medium parameters used: $f = 2600$ MHz; $\sigma = 2.03$ S/m; $\epsilon_r = 37.8$; $\rho = 1000$ kg/m³

Phantom section: Flat Section

Measurement Standard: DASY5 (IEEE/IEC/ANSI C63.19-2011)

DASY52 Configuration:

- Probe: EX3DV4 - SN7349; ConvF(7.7, 7.7, 7.7); Calibrated: 30.12.2017;
- Sensor-Surface: 1.4mm (Mechanical Surface Detection)
- Electronics: DAE4 Sn601; Calibrated: 26.10.2017
- Phantom: Flat Phantom 5.0 (front); Type: QD 000 P50 AA; Serial: 1001
- DASY52 52.10.0(1446); SEMCAD X 14.6.10(7417)

Dipole Calibration for Head Tissue/Pin=250 mW, d=10mm/Zoom Scan (7x7x7)/Cube 0:

Measurement grid: dx=5mm, dy=5mm, dz=5mm

Reference Value = 118.5 V/m; Power Drift = -0.04 dB

Peak SAR (extrapolated) = 28.6 W/kg

SAR(1 g) = 14.3 W/kg; SAR(10 g) = 6.35 W/kg

Maximum value of SAR (measured) = 23.9 W/kg

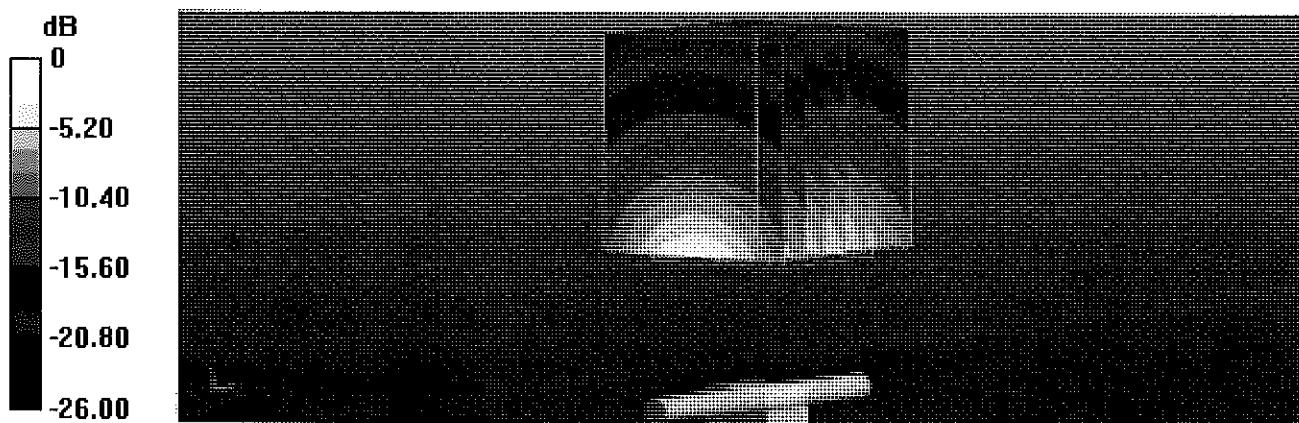

0 dB = 23.9 W/kg = 13.78 dBW/kg

Impedance Measurement Plot for Head TSL

11 Apr 2018 11:25:16

[CH1] S11 1 U FS 1: 47.721 Ω -5.6836 Ω 10.770 pF 2 500.000 000 MHz

*

De1

CA

Avg
16

H1 d

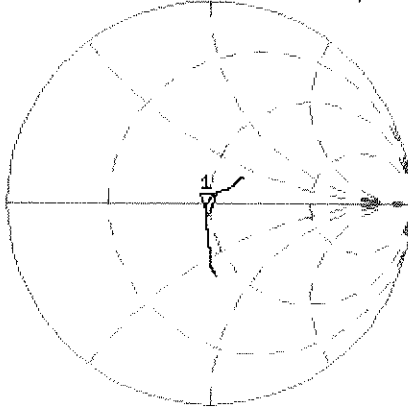

CH2 S11 LOG 5 dB/REF -20 dB 1: -24.073 dB 2 500.000 000 MHz

CA

Avg
16

H1 d

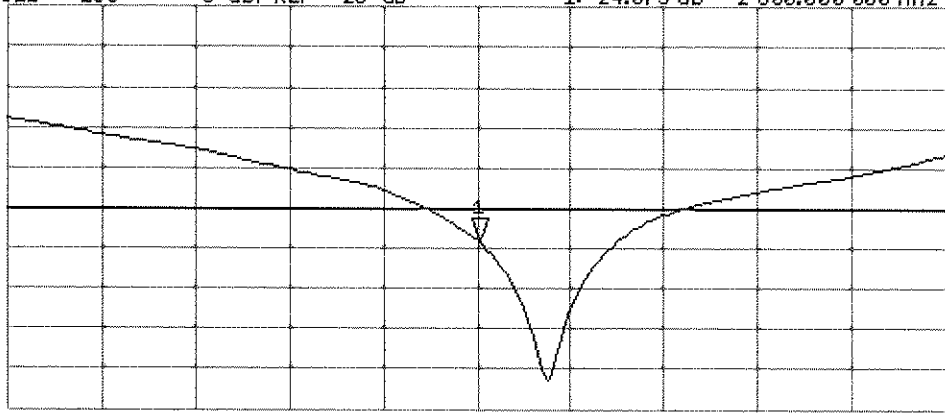

START 2 400.000 000 MHz

STOP 2 800.000 000 MHz

DASY5 Validation Report for Body TSL

Date: 11.04.2018

Test Laboratory: SPEAG, Zurich, Switzerland

DUT: Dipole 2600 MHz; Type: D2600V2; Serial: D2600V2 - SN: 1004

Communication System: UID 0 - CW; Frequency: 2600 MHz

Medium parameters used: $f = 2600$ MHz; $\sigma = 2.19$ S/m; $\epsilon_r = 52.1$; $\rho = 1000$ kg/m³

Phantom section: Flat Section

Measurement Standard: DASY5 (IEEE/IEC/ANSI C63.19-2011)

DASY52 Configuration:

- Probe: EX3DV4 - SN7349; ConvF(7.81, 7.81, 7.81); Calibrated: 30.12.2017;
- Sensor-Surface: 1.4mm (Mechanical Surface Detection)
- Electronics: DAE4 Sn601; Calibrated: 26.10.2017
- Phantom: Flat Phantom 5.0 (back); Type: QD 000 P50 AA; Serial: 1002
- DASY52 52.10.0(1446); SEMCAD X 14.6.10(7417)

Dipole Calibration for Body Tissue/ $P_{in}=250$ mW, $d=10$ mm/Zoom Scan (7x7x7)/Cube 0:

Measurement grid: $dx=5$ mm, $dy=5$ mm, $dz=5$ mm

Reference Value = 108.5 V/m; Power Drift = -0.09 dB

Peak SAR (extrapolated) = 28.3 W/kg

SAR(1 g) = 13.8 W/kg; SAR(10 g) = 6.2 W/kg

Maximum value of SAR (measured) = 22.9 W/kg

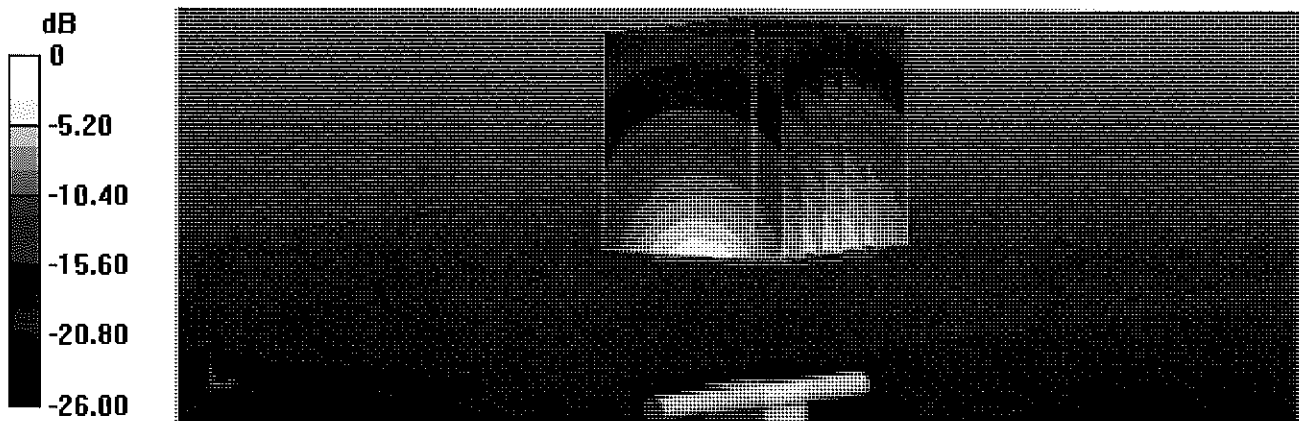

0 dB = 22.9 W/kg = 13.60 dBW/kg

Impedance Measurement Plot for Body TSL

11 Apr 2018 11:24:36

CH1 S11 1 U FS

1: 46.039 Ω -3.7520 Ω 16.315 pF

2 600.000 000 MHz

*
De1
Ca

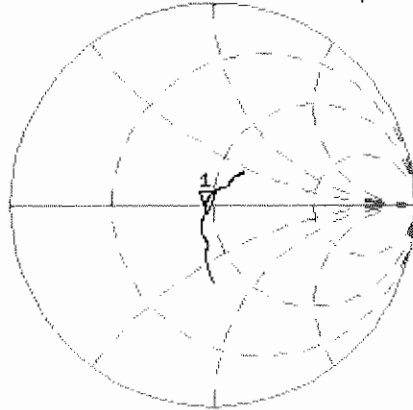

Avg
16
H1 d

CH2 S11 LOG 5 dB/REF -20 dB 1:-24.921 dB 2 600.000 000 MHz

Ca
Avg
16
H1 d

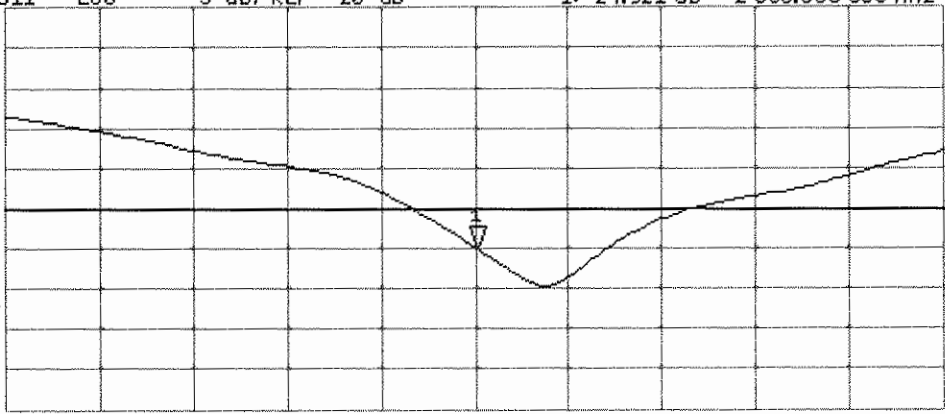

START 2 400.000 000 MHz

STOP 2 800.000 000 MHz

Certification of Calibration

Object: D2600V2 – SN: 1004

Calibration procedure(s): Procedure for Calibration Extension for SAR Dipoles.

Extension Calibration date: 4/11/2019

Description: SAR Validation Dipole at 2600 MHz.

Calibration Equipment used:

Manufacturer	Model	Description	Cal Date	Cal Interval	Cal Due	Serial Number
Agilent	8753ES	S-Parameter Network Analyzer	3/11/2019	Annual	3/11/2020	US39170122
Agilent	N5182A	MXG Vector Signal Generator	4/18/2018	Annual	4/18/2019	MY47420800
Amplifier Research	15S1G6	Amplifier	CBT	N/A	CBT	433971
Anritsu	MA2411B	Pulse Power Sensor	11/20/2018	Annual	11/20/2019	1027293
Anritsu	MA2411B	Pulse Power Sensor	10/30/2018	Annual	10/30/2019	1126066
Anritsu	ML2495A	Power Meter	10/21/2018	Annual	10/21/2019	941001
Control Company	4040	Therm./ Clock/ Humidity Monitor	10/9/2018	Biennial	10/9/2020	181647811
Control Company	4352	Ultra Long Stem Thermometer	5/2/2017	Biennial	5/2/2019	170330156
Keysight	772D	Dual Directional Coupler	CBT	N/A	CBT	MY52180215
Keysight Technologies	85033E	Standard Mechanical Calibration Kit (DC to 9GHz, 3.5mm)	6/4/2018	Annual	6/4/2019	MY53401181
MiniCircuits	VLF-6000+	Low Pass Filter	CBT	N/A	CBT	N/A
Mini-Circuits	BW-N20W5+	DC to 18 GHz Precision Fixed 20 dB Attenuator	CBT	N/A	CBT	N/A
Narda	4772-3	Attenuator (3dB)	CBT	N/A	CBT	9406
Pasternack	PE2209-10	Bidirectional Coupler	CBT	N/A	CBT	N/A
Seekonk	NC-100	Torque Wrench	7/11/2018	Annual	7/11/2019	N/A
SPEAG	EX3DV4	SAR Probe	6/25/2018	Annual	6/25/2019	7409
SPEAG	DAE4	Dasy Data Acquisition Electronics	6/18/2018	Annual	6/18/2019	1334
SPEAG	DAE4	Dasy Data Acquisition Electronics	2/13/2019	Annual	2/13/2020	665
SPEAG	EX3DV4	SAR Probe	2/19/2019	Annual	2/19/2020	7417
SPEAG	DAK-3.5	Dielectric Assessment Kit	9/11/2018	Annual	9/11/2019	1091

Measurement Uncertainty = $\pm 23\%$ (k=2)

	Name	Function	Signature
Calibrated By:	Brodie Halfoster	Test Engineer	<i>BRODIE HALFOSTER</i>
Approved By:	Kaitlin O'Keefe	Senior Technical Manager	<i>KOK</i>

DIPOLE CALIBRATION EXTENSION

Per KDB 865664 D01, calibration intervals of up to three years may be considered for reference dipoles when it is demonstrated that the SAR target, impedance and return loss of a dipole have remained stable according to the following requirements:

1. The measured SAR does not deviate more than 10% from the target on the calibration certificate.
2. The return-loss does not deviate more than 20% from the previous measurement and meets the required 20dB minimum return-loss requirement.
3. The measurement of real or imaginary parts of impedance does not deviate more than 5Ω from the previous measurement.

The following dipole was checked to pass the above 3 requirements to have 2-year calibration period from the calibration date:

Calibration Date	Extension Date	Certificate Electrical Delay (ns)	Certificate SAR Target Head (1g) W/kg @ 20.0 dBm	Measured Head SAR (1g) W/kg @ 20.0 dBm	Deviation 1g (%)	Certificate SAR Target Head (10g) W/kg @ 20.0 dBm	Measured Head SAR (10g) W/kg @ 20.0 dBm	Deviation 10g (%)	Certificate Impedance Head (Ohm) Real	Measured Impedance Head (Ohm) Real	Difference (Ohm) Real	Certificate Impedance Head (Ohm) Imaginary	Measured Impedance Head (Ohm) Imaginary	Difference (Ohm) Imaginary	Certificate Return Loss Head (dB)	Measured Return Loss Head (dB)	Deviation (%)	PASS/FAIL
4/11/2018	4/11/2019	1.140	5.59	5.51	-1.43%	2.51	2.47	-1.59%	47.7	48.5	0.8	-5.7	-5.1	0.6	-24.1	-25.6	-6.30%	PASS
Calibration Date	Extension Date	Certificate Electrical Delay (ns)	Certificate SAR Target Body (1g) W/kg @ 20.0 dBm	Measured Body SAR (1g) W/kg @ 20.0 dBm	Deviation 1g (%)	Certificate SAR Target Body (10g) W/kg @ 20.0 dBm	Measured Body SAR (10g) W/kg @ 20.0 dBm	Deviation 10g (%)	Certificate Impedance Body (Ohm) Real	Measured Impedance Body (Ohm) Real	Difference (Ohm) Real	Certificate Impedance Body (Ohm) Imaginary	Measured Impedance Body (Ohm) Imaginary	Difference (Ohm) Imaginary	Certificate Return Loss Body (dB)	Measured Return Loss Body (dB)	Deviation (%)	PASS/FAIL
4/11/2018	4/11/2019	1.140	5.48	5.65	3.10%	2.47	2.48	0.40%	46	46.6	0.6	-3.8	-4.7	0.9	-24.9	-24.5	1.80%	PASS

Impedance & Return-Loss Measurement Plot for Head TSL

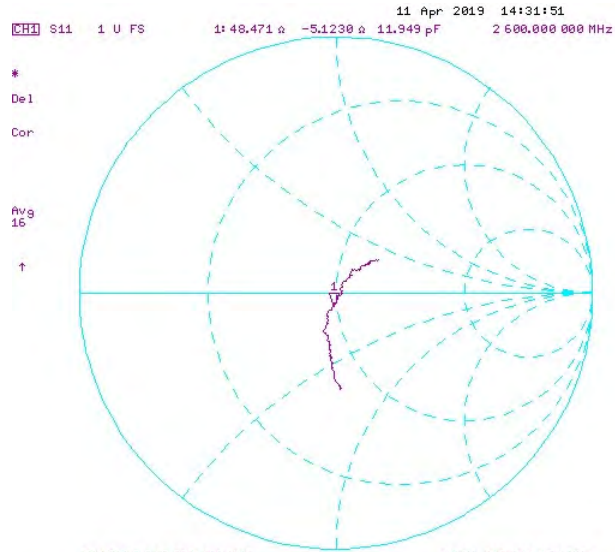

Impedance & Return-Loss Measurement Plot for Body TSL

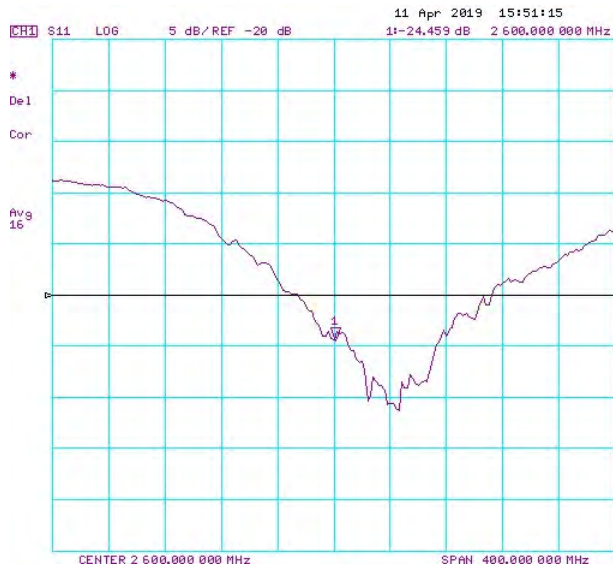
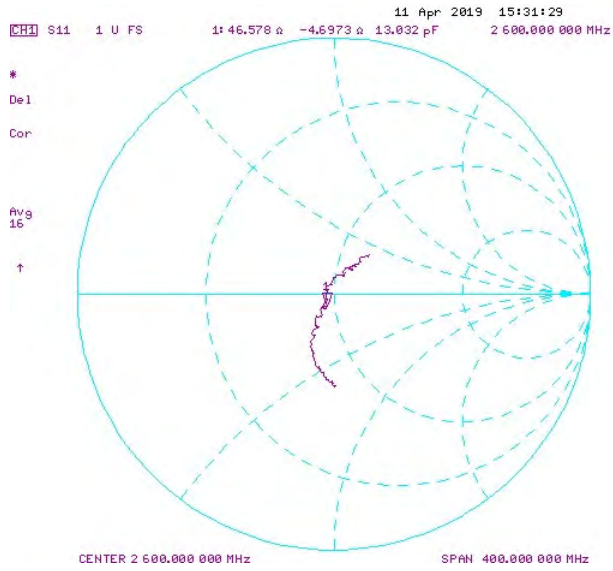



Accredited by the Swiss Accreditation Service (SAS)
The Swiss Accreditation Service is one of the signatories to the EA
Multilateral Agreement for the recognition of calibration certificates

Accreditation No.: **SCS 0108**

Client **PC Test**

Certificate No: **D2600V2-1064_Jun19**

CALIBRATION CERTIFICATE

Object **D2600V2 - SN:1064**

Calibration procedure(s) **QA CAL-05.v11
Calibration Procedure for SAR Validation Sources between 0.7-3 GHz**

*BNV
07/31/2019*

Calibration date: **June 14, 2019**

This calibration certificate documents the traceability to national standards, which realize the physical units of measurements (SI).
The measurements and the uncertainties with confidence probability are given on the following pages and are part of the certificate.

All calibrations have been conducted in the closed laboratory facility: environment temperature (22 ± 3)°C and humidity < 70%.

Calibration Equipment used (M&TE critical for calibration)

Primary Standards	ID #	Cal Date (Certificate No.)	Scheduled Calibration
Power meter NRP	SN: 104778	03-Apr-19 (No. 217-02892/02893)	Apr-20
Power sensor NRP-Z91	SN: 103244	03-Apr-19 (No. 217-02892)	Apr-20
Power sensor NRP-Z91	SN: 103245	03-Apr-19 (No. 217-02893)	Apr-20
Reference 20 dB Attenuator	SN: 5058 (20k)	04-Apr-19 (No. 217-02894)	Apr-20
Type-N mismatch combination	SN: 5047.2 / 06327	04-Apr-19 (No. 217-02895)	Apr-20
Reference Probe EX3DV4	SN: 7349	29-May-19 (No. EX3-7349_May19)	May-20
DAE4	SN: 601	30-Apr-19 (No. DAE4-601_Apr19)	Apr-20

Secondary Standards	ID #	Check Date (in house)	Scheduled Check
Power meter E4419B	SN: GB39512475	30-Oct-14 (in house check Feb-19)	In house check: Oct-20
Power sensor HP 8481A	SN: US37292783	07-Oct-15 (in house check Oct-18)	In house check: Oct-20
Power sensor HP 8481A	SN: MY41092317	07-Oct-15 (in house check Oct-18)	In house check: Oct-20
RF generator R&S SMT-06	SN: 100972	15-Jun-15 (in house check Oct-18)	In house check: Oct-20
Network Analyzer Agilent E8358A	SN: US41080477	31-Mar-14 (in house check Oct-18)	In house check: Oct-19

Calibrated by:	Name Michael Weber	Function Laboratory Technician	Signature
Approved by:	Name Katja Pokovic	Function Technical Manager	

Issued: June 20, 2019

This calibration certificate shall not be reproduced except in full without written approval of the laboratory.