

Measurement Certificate / Material Test

Item Name	Body Tissue Simulating Liquid (MBBL600-6000V6)
Product No.	SL AAM U16 BC (Batch: 181029-1)
Manufacturer	SPEAG

Measurement Method

TSL dielectric parameters measured using calibrated DAK probe.

Target Parameters

Target parameters as defined in the KDB 865664 compliance standard.

Test Condition

Ambient Condition 22°C ; 30% humidity
 TSL Temperature 22°C
 Test Date 30-Oct-18
 Operator CL

Additional Information

TSL Density
 TSL Heat-capacity

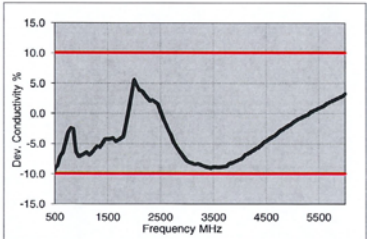
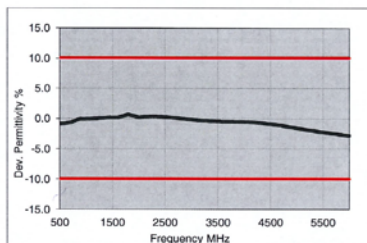

Results

f [MHz]	Measured			Target		Diff.to Target [%]	
	e'	e''	sigma	eps	sigma	Δ-eps	Δ-sigma
800	55.1	21.3	0.95	55.3	0.97	-0.4	-2.1
825	55.1	20.8	0.98	55.2	0.98	-0.3	-2.0
835	55.1	20.6	0.96	55.1	0.99	0.0	-2.5
850	55.1	20.4	0.96	55.2	0.99	-0.1	-3.0
900	55.0	19.7	0.98	55.0	1.05	0.0	-6.7
1400	54.2	15.6	1.22	54.1	1.28	0.2	-4.7
1450	54.1	15.4	1.24	54.0	1.30	0.2	-4.6
1500	54.1	15.3	1.27	53.9	1.33	0.3	-4.5
1550	54.0	15.1	1.30	53.9	1.36	0.2	-4.4
1600	53.9	15.0	1.33	53.8	1.39	0.2	-4.3
1625	53.9	14.9	1.35	53.8	1.41	0.3	-4.3
1640	53.9	14.9	1.36	53.7	1.42	0.3	-4.2
1650	53.8	14.9	1.36	53.7	1.43	0.2	-4.9
1700	53.8	14.8	1.40	53.6	1.46	0.4	-4.1
1750	53.7	14.7	1.43	53.4	1.49	0.5	-4.0
1800	53.7	14.6	1.46	53.3	1.52	0.8	-3.9
1810	53.7	14.6	1.47	53.3	1.52	0.8	-3.3
1825	53.7	14.6	1.48	53.3	1.52	0.8	-2.6
1850	53.6	14.5	1.50	53.3	1.52	0.6	-1.3
1900	53.5	14.5	1.53	53.3	1.52	0.4	0.7
1950	53.5	14.5	1.57	53.3	1.52	0.4	3.3
2000	53.4	14.4	1.60	53.3	1.52	0.2	5.3
2050	53.4	14.4	1.64	53.2	1.57	0.3	4.5
2100	53.3	14.4	1.68	53.2	1.62	0.2	3.7
2150	53.3	14.4	1.72	53.1	1.68	0.4	3.6
2200	53.2	14.4	1.76	53.0	1.71	0.3	2.9
2250	53.1	14.4	1.81	53.0	1.76	0.2	2.8
2300	53.1	14.4	1.85	52.9	1.81	0.4	2.2
2350	53.0	14.5	1.89	52.8	1.85	0.3	2.2
2400	52.9	14.5	1.94	52.8	1.90	0.2	2.1
2450	52.9	14.5	1.98	52.7	1.95	0.4	1.5
2500	52.8	14.6	2.03	52.6	2.02	0.3	0.5
2550	52.7	14.6	2.07	52.6	2.09	0.2	-1.0
2600	52.6	14.7	2.12	52.5	2.16	0.2	-1.9



3500	51.1	15.5	3.02	51.3	3.31	-0.4	-8.8
3700	50.8	15.7	3.24	51.1	3.55	-0.5	-8.8
5200	48.1	18.2	5.27	49.0	5.30	-1.8	-0.6
5250	48.0	18.3	5.34	49.0	5.36	-1.9	-0.4
5300	47.9	18.4	5.41	48.9	5.42	-2.0	-0.2
5500	47.5	18.6	5.70	48.6	5.65	-2.2	0.8
5600	47.3	18.8	5.84	48.5	5.77	-2.3	1.3
5700	47.1	18.9	5.99	48.3	5.88	-2.5	1.8
5800	47.0	19.0	6.14	48.2	6.00	-2.6	2.3

Figure C-2
600 – 5800 MHz Body Tissue Equivalent Matter

FCC ID: A3LSMG986U		SAR EVALUATION REPORT		Approved by: Quality Manager
Test Dates: 10/21/19 – 01/01/20	DUT Type: Portable Handset			APPENDIX C: Page 2 of 3

Measurement Certificate / Material Test

Item Name	Head Tissue Simulating Liquid (HBBL600-10000V6)
Product No.	SL AAH U16 BC (Batch: 181031-2)
Manufacturer	SPEAG

Measurement Method

TSL dielectric parameters measured using calibrated DAK probe.

Target Parameters

Target parameters as defined in the IEEE 1528 and IEC 62209 compliance standards.

Test Condition

Ambient Condition 22°C ; 30% humidity
 TSL Temperature 22°C
 Test Date 31-Oct-18
 Operator CL

Additional Information

TSL Density
 TSL Heat-capacity

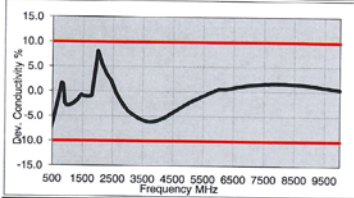
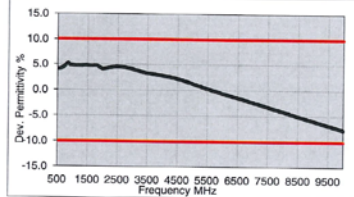

Results

f [MHz]	Measured			Target		Diff.to Target [%]	
	e'	e''	sigma	eps	sigma	Δ-eps	Δ-sigma
800	43.8	20.5	0.91	41.7	0.90	5.1	1.4
825	43.8	20.1	0.92	41.6	0.91	5.3	1.5
835	43.8	19.9	0.93	41.5	0.91	5.4	2.0
850	43.7	19.7	0.93	41.5	0.92	5.3	1.5
900	43.5	18.9	0.95	41.5	0.97	4.8	-2.1
1400	42.5	15.0	1.17	40.6	1.18	4.7	-0.8
1450	42.5	14.8	1.19	40.5	1.20	4.9	-0.8
1600	42.2	14.3	1.27	40.3	1.28	4.7	-1.1
1625	42.2	14.2	1.29	40.3	1.30	4.8	-0.7
1640	42.2	14.2	1.30	40.3	1.31	4.8	-0.5
1650	42.1	14.2	1.30	40.2	1.31	4.6	-1.0
1700	42.1	14.0	1.33	40.2	1.34	4.8	-0.9
1750	42.0	13.9	1.36	40.1	1.37	4.8	-0.8
1800	41.9	13.9	1.39	40.0	1.40	4.7	-0.7
1810	41.9	13.8	1.40	40.0	1.40	4.7	0.0
1825	41.9	13.8	1.41	40.0	1.40	4.7	0.7
1850	41.8	13.8	1.42	40.0	1.40	4.5	1.4
1900	41.8	13.7	1.45	40.0	1.40	4.5	3.6
1950	41.7	13.7	1.48	40.0	1.40	4.3	5.7
2000	41.6	13.6	1.51	40.0	1.40	4.0	7.9
2050	41.6	13.6	1.55	39.9	1.44	4.2	7.3
2100	41.5	13.5	1.58	39.8	1.49	4.2	6.1
2150	41.4	13.5	1.62	39.7	1.53	4.2	5.7
2200	41.4	13.5	1.65	39.6	1.58	4.4	4.6
2250	41.3	13.5	1.69	39.6	1.62	4.4	4.2
2300	41.2	13.5	1.72	39.5	1.67	4.4	3.2
2350	41.1	13.5	1.76	39.4	1.71	4.4	2.9
2400	41.1	13.5	1.80	39.3	1.76	4.6	2.5
2450	41.0	13.5	1.84	39.2	1.80	4.6	2.2
2500	40.9	13.5	1.88	39.1	1.85	4.5	1.4
2550	40.8	13.5	1.92	39.1	1.91	4.4	0.6
2600	40.8	13.6	1.96	39.0	1.96	4.6	-0.2
3500	39.2	14.1	2.74	37.9	2.91	3.3	-5.8
3700	38.9	14.2	2.93	37.7	3.12	3.1	-6.1



5200	36.3	15.8	4.57	36.0	4.66	0.9	-1.7
5250	36.2	15.9	4.63	35.9	4.71	0.8	-1.6
5300	36.1	15.9	4.69	35.9	4.76	0.7	-1.4
5500	35.8	16.1	4.92	35.6	4.96	0.3	-0.9
5600	35.6	16.2	5.04	35.5	5.07	0.1	-0.6
5700	35.4	16.2	5.15	35.4	5.17	0.0	-0.3
5800	35.2	16.3	5.27	35.3	5.27	-0.2	0.0
6000	34.9	16.5	5.50	35.1	5.48	-0.6	0.5
6500	34.0	16.9	6.12	34.5	6.07	-1.4	0.9
7000	33.1	17.3	6.74	33.9	6.65	-2.3	1.3
7500	32.2	17.6	7.36	33.3	7.24	-3.2	1.6
8000	31.4	17.9	7.97	32.7	7.84	-4.1	1.7
8500	30.5	18.2	8.59	32.1	8.45	-5.0	1.6
9000	29.7	18.4	9.20	31.5	9.08	-5.9	1.3
9500	28.9	18.5	9.80	31.0	9.71	-6.8	0.9
10000	28.1	18.7	10.40	30.4	10.36	-7.6	0.4

Figure C-3
600 – 5800 MHz Head Tissue Equivalent Matter

FCC ID: A3LSMG986U		SAR EVALUATION REPORT		Approved by: Quality Manager
Test Dates: 10/21/19 – 01/01/20	DUT Type: Portable Handset			APPENDIX C: Page 3 of 3



APPENDIX D: SAR SYSTEM VALIDATION

Per FCC KDB Publication 865664 D02v01r02, SAR system validation status should be documented to confirm measurement accuracy. The SAR systems (including SAR probes, system components and software versions) used for this device were validated against its performance specifications prior to the SAR measurements. Reference dipoles were used with the required tissue- equivalent media for system validation, according to the procedures outlined in FCC KDB Publication 865664 D01v01r04 and IEEE 1528-2013. Since SAR probe calibrations are frequency dependent, each probe calibration point was validated at a frequency within the valid frequency range of the probe calibration point, using the system that normally operates with the probe for routine SAR measurements and according to the required tissue-equivalent media.

A tabulated summary of the system validation status including the validation date(s), measurement frequencies, SAR probes and tissue dielectric parameters has been included.

Table D-1
SAR System Validation Summary – 1g



SAR System	Freq. (MHz)	Date	Probe SN	Probe Cal Point		Cond. (σ)	Perm. (εr)	CW VALIDATION			MOD. VALIDATION		
								SENSITIVITY	PROBE LINEARITY	PROBE ISOTROPY	MOD. TYPE	DUTY FACTOR	PAR
P	750	10/1/2019	7551	750	Head	0.904	41.462	PASS	PASS	PASS	N/A	N/A	N/A
P	835	10/1/2019	7551	835	Head	0.918	41.180	PASS	PASS	PASS	GMSK	PASS	N/A
D	1750	5/24/2019	3914	1750	Head	1.366	41.075	PASS	PASS	PASS	N/A	N/A	N/A
P	1750	10/2/2019	7551	1750	Head	1.346	39.450	PASS	PASS	PASS	N/A	N/A	N/A
D	1900	5/20/2019	3914	1900	Head	1.454	40.608	PASS	PASS	PASS	GMSK	PASS	N/A
P	1900	10/2/2019	7551	1900	Head	1.444	39.260	PASS	PASS	PASS	GMSK	PASS	N/A
E	2300	9/6/2019	7417	2300	Head	1.737	39.748	PASS	PASS	PASS	N/A	N/A	N/A
E	2450	9/5/2019	7417	2450	Head	1.855	39.542	PASS	PASS	PASS	OFDM/TDD	PASS	PASS
E	2600	9/5/2019	7417	2600	Head	1.979	39.302	PASS	PASS	PASS	TDD	PASS	N/A
H	3500	9/17/2019	3589	3500	Head	2.796	38.091	PASS	PASS	PASS	TDD	PASS	N/A
H	3500	12/5/2019	3589	3500	Head	2.778	39.596	PASS	PASS	PASS	TDD	PASS	N/A
H	3700	9/17/2019	3589	3700	Head	2.983	37.722	PASS	PASS	PASS	TDD	PASS	N/A
H	3700	12/5/2019	3589	3700	Head	2.973	39.247	PASS	PASS	PASS	TDD	PASS	N/A
H	5250	12/7/2019	7406	5250	Head	4.709	35.885	PASS	PASS	PASS	OFDM	N/A	PASS
H	5600	12/7/2019	7406	5600	Head	5.120	35.211	PASS	PASS	PASS	OFDM	N/A	PASS
H	5750	12/7/2019	7406	5750	Head	5.309	34.961	PASS	PASS	PASS	OFDM	N/A	PASS
L	750	8/20/2019	7410	750	Body	0.941	54.921	PASS	PASS	PASS	N/A	N/A	N/A
I	835	10/8/2019	7357	835	Body	0.957	54.363	PASS	PASS	PASS	GMSK	PASS	N/A
J	1750	2/7/2019	7488	1750	Body	1.509	51.017	PASS	PASS	PASS	N/A	N/A	N/A
I	1750	5/21/2019	7357	1750	Body	1.442	55.384	PASS	PASS	PASS	N/A	N/A	N/A
H	1900	10/2/2019	7406	1900	Body	1.577	52.464	PASS	PASS	PASS	GMSK	PASS	N/A
J	1900	10/7/2019	7488	1900	Body	1.555	51.080	PASS	PASS	PASS	GMSK	PASS	N/A
P	1900	10/8/2019	7551	1900	Body	1.542	51.760	PASS	PASS	PASS	GMSK	PASS	N/A
J	1900	1/1/2020	7571	1900	Body	1.579	51.919	PASS	PASS	PASS	GMSK	PASS	N/A
K	2300	9/5/2019	7547	2300	Body	1.893	52.450	PASS	PASS	PASS	N/A	N/A	N/A
K	2450	9/6/2019	7547	2450	Body	1.996	51.898	PASS	PASS	PASS	OFDM/TDD	PASS	PASS
M	2450	10/10/2019	7308	2450	Body	1.962	51.230	PASS	PASS	PASS	OFDM/TDD	PASS	PASS
K	2600	9/5/2019	7547	2600	Body	2.716	52.040	PASS	PASS	PASS	TDD	PASS	N/A
M	2600	10/16/2019	7308	2600	Body	2.138	52.938	PASS	PASS	PASS	TDD	PASS	N/A
D	3500	6/12/2019	3914	3500	Body	3.377	51.090	PASS	PASS	PASS	TDD	PASS	N/A
D	3700	6/12/2019	3914	3700	Body	3.593	50.776	PASS	PASS	PASS	TDD	PASS	N/A
G	5250	10/4/2019	7409	5250	Body	5.223	47.070	PASS	PASS	PASS	OFDM	N/A	PASS
G	5600	10/7/2019	7409	5600	Body	5.884	47.080	PASS	PASS	PASS	OFDM	N/A	PASS
G	5750	10/7/2019	7409	5750	Body	6.111	46.780	PASS	PASS	PASS	OFDM	N/A	PASS

FCC ID: A3LSMG986U	 PCTEST <small>PROFESSIONAL COMMUNICATIONS TESTING, INC.</small>	SAR EVALUATION REPORT		Approved by: Quality Manager
Test Dates: 10/21/19 – 01/01/20	DUT Type: Portable Handset			APPENDIX D: Page 1 of 2

**Table D-2
SAR System Validation Summary – 10g**

SAR System	Freq. (MHz)	Date	Probe SN	Probe Cal Point		Cond. (σ)	Perm. (ϵ_r)	CW VALIDATION			MOD. VALIDATION		
								SENSITIVITY	PROBE LINEARITY	PROBE ISOTROPY	MOD. TYPE	DUTY FACTOR	PAR
I	1750	5/21/2019	7357	1750	Body	1.442	55.384	PASS	PASS	PASS	N/A	N/A	N/A
J	1900	10/7/2019	7488	1900	Body	1.555	51.08	PASS	PASS	PASS	GMSK	PASS	N/A
P	1900	10/8/2019	7551	1900	Body	1.542	51.76	PASS	PASS	PASS	GMSK	PASS	N/A
J	1900	1/1/2020	7571	1900	Body	1.579	51.919	PASS	PASS	PASS	GMSK	PASS	N/A
K	2300	9/5/2019	7547	2300	Body	1.893	52.45	PASS	PASS	PASS	N/A	N/A	N/A
K	2450	9/6/2019	7547	2450	Body	1.996	51.898	PASS	PASS	PASS	OFDM/TDD	PASS	PASS
M	2450	10/10/2019	7308	2450	Body	1.962	51.23	PASS	PASS	PASS	OFDM/TDD	PASS	PASS
M	2600	10/16/2019	7308	2600	Body	2.138	52.938	PASS	PASS	PASS	TDD	PASS	N/A
G	5250	10/4/2019	7409	5250	Body	5.223	47.07	PASS	PASS	PASS	OFDM	N/A	PASS
G	5600	10/7/2019	7409	5600	Body	5.884	47.08	PASS	PASS	PASS	OFDM	N/A	PASS
G	5750	10/7/2019	7409	5750	Body	6.111	46.78	PASS	PASS	PASS	OFDM	N/A	PASS

NOTE: While the probes have been calibrated for both CW and modulated signals, all measurements were performed using communication systems calibrated for CW signals only. Modulations in the table above represent test configurations for which the measurement system has been validated per FCC KDB Publication 865664 D01v01r04 for scenarios when CW probe calibrations are used with other signal types. SAR systems were validated for modulated signals with a periodic duty cycle, such as GMSK, or with a high peak to average ratio (>5 dB), such as OFDM according to FCC KDB Publication 865664 D01v01r04.

FCC ID: A3LSMG986U		SAR EVALUATION REPORT		Approved by: Quality Manager
Test Dates: 10/21/19 – 01/01/20	DUT Type: Portable Handset			APPENDIX D: Page 2 of 2

1.2 LTE Downlink Only Carrier Aggregation Test Selection and Setup

SAR test exclusion for LTE downlink Carrier Aggregation is determined by power measurements according to the number component carriers (CCs) supported by the product implementation. For those configurations required by April 2018 TCBC Workshop Notes, conducted power measurements with LTE Carrier Aggregation (CA) (downlink only) active are made in accordance to KDB Publication 941225 D05Av01r02. The RRC connection is only handled by one cell, the primary component carrier (PCC) for downlink and uplink communications. After making a data connection to the PCC, the UE device adds secondary component carrier(s) (SCC) on the downlink only. All uplink communications and acknowledgements remain identical to specifications when downlink carrier aggregation is inactive on the PCC. Additional conducted output powers are measured with the downlink carrier aggregation active for the configuration with highest measured maximum conducted power with downlink carrier aggregation inactive measured among the channel bandwidth, modulation, and RB combinations in each frequency band.

This device supports LAA with downlink carrier aggregation only. It uses carrier aggregation in the downlink to combine LTE in the unlicensed spectrum (i.e. LTE Band 46) with LTE in the licensed band (served as PCC). All uplink communications and acknowledgements on the PCC remain identical to specifications when downlink carrier aggregation is inactive.

Per FCC KDB Publication 941225 D05Av01r02, no SAR measurements are required for carrier aggregation configurations when the maximum average output power with downlink only carrier aggregation active is not more than 0.25 dB higher than the average output power with downlink only carrier aggregation inactive. All bands required for SAR testing per FCC KDB procedures were considered. Based on the measured maximum powers below, no additional SAR tests were required for DLCA SAR configurations.

General PCC and SCC configuration selection procedure

- PCC uplink channel, channel bandwidth, modulation and RB configurations were selected based on section C)3)b)ii) of KDB 941225 D05 V01r02. The downlink PCC channel was paired with the selected PCC uplink channel according to normal configurations without carrier aggregation.
- To maximize aggregated bandwidth, highest channel bandwidth available for that CA combination was selected for SCC. For inter-band CA, the SCC downlink channels were selected near the middle of their transmission bands. For contiguous intra-band CA, the downlink channel spacing between the component carriers was set to multiple of 300 kHz less than the nominal channel spacing defined in section 5.4.1A of 3GPP TS 36.521. For non-contiguous intra-band CA, the downlink channel spacing between the component carriers was set to be larger than the nominal channel spacing and provided maximum separation between the component carriers.
- All selected PCC and SCC(s) remained fully within the uplink/downlink transmission band of the respective component carrier.

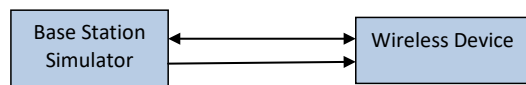



Figure 1
DL CA Power Measurement Setup

FCC ID: A3LSMG986U	 SAR EVALUATION REPORT	Reviewed by: Quality Manager
Test Dates: 10/21/19 – 01/01/20	DUT Type: Portable Handset	APPENDIX F: Page 2 of 25

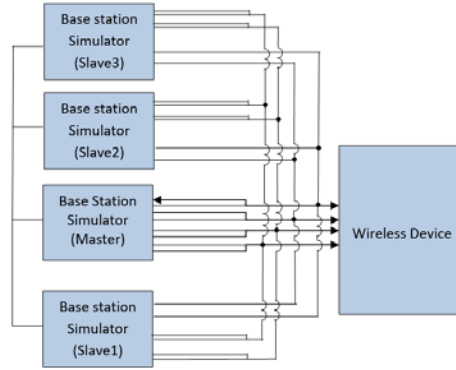

Figure 2
DL CA with DL 4x4 MIMO Power Measurement Setup

1.3 Downlink Carrier Aggregation RF Conducted Powers

1.3.1 LTE Band 71 as PCC

Table 1
Maximum Output Powers

Combination	PCC Band	PCC BW [MHz]	PCC (UL) Ch.	PCC (UL) Freq. [MHz]	Mod.	PCC				SCC 1			SCC 2			SCC 3			Power							
						PCC UL/RB	PCC UL RB Offset	PCC (DL) Channel	PCC (DL) Freq. [MHz]	SCC Band	SCC BW [MHz]	SCC (DL) Channel	SCC (DL) Freq. [MHz]	SCC Band	SCC BW [MHz]	SCC (DL) Channel	SCC (DL) Freq. [MHz]	SCC Band	SCC BW [MHz]	SCC (DL) Channel	SCC (DL) Freq. [MHz]	LTE Tx Power with DL CA Enabled (dBm)	LTE Single Carrier Tx Power (dBm)			
CA_4A-4A-71A	LTE B71	5	133147	665.5	QPSK	1	12	68611	619.5	LTE B4	20	2175	2132.5	LTE B4	10	2350	2150	-	-	-	-	-	-	24.89	24.91	
CA_4B4-4B4-71A	LTE B71	5	133147	665.5	QPSK	1	12	68611	619.5	LTE B4B	20	55990	3625	LTE B4B	20	58640	3690	-	-	-	-	-	-	-	24.88	24.91
CA_4B4-71A	LTE B71	5	133147	665.5	QPSK	1	12	68611	619.5	LTE B4B	20	55990	3625	LTE B4B	20	58188	3644.8	-	-	-	-	-	-	-	24.92	24.91
CA_2A-2A-4A-71A	LTE B71	5	133147	665.5	QPSK	1	12	68611	619.5	LTE B2	20	900	1960	LTE B2	20	700	1940	LTE B4	20	2175	2132.5	-	-	-	24.79	24.91
CA_2A-2A-66A-71A	LTE B71	5	133147	665.5	QPSK	1	12	68611	619.5	LTE B2	20	900	1960	LTE B2	20	700	1940	LTE B6B	20	66786	2145	66786	2145	24.83	24.91	
CA_2A-66A-66A-71A	LTE B71	5	133147	665.5	QPSK	1	12	68611	619.5	LTE B2	20	900	1960	LTE B6B	20	66786	2145	LTE B6B	20	67236	2190	67236	2190	24.92	24.91	
CA_2A-66C-71A	LTE B71	5	133147	665.5	QPSK	1	12	68611	619.5	LTE B2	20	900	1960	LTE B6B	20	66786	2145	LTE B6B	20	66984	2164.8	66984	2164.8	24.93	24.91	

1.3.2 LTE Band 12 as PCC

Table 2
Maximum Output Powers

Combination	PCC Band	PCC BW [MHz]	PCC (UL) Ch.	PCC (UL) Freq. [MHz]	Mod.	PCC				SCC 1			SCC 2			SCC 3			Power								
						PCC UL/RB	PCC UL RB Offset	PCC (DL) Channel	PCC (DL) Freq. [MHz]	SCC Band	SCC BW [MHz]	SCC (DL) Channel	SCC (DL) Freq. [MHz]	SCC Band	SCC BW [MHz]	SCC (DL) Channel	SCC (DL) Freq. [MHz]	SCC Band	SCC BW [MHz]	SCC (DL) Channel	SCC (DL) Freq. [MHz]	LTE Tx Power with DL CA Enabled (dBm)	LTE Single Carrier Tx Power (dBm)				
CA_2A-12A (1)	LTE B12	10	23095	707.5	QPSK	1	0	5095	737.5	LTE B2	20	900	1960	-	-	-	-	-	-	-	-	-	-	-	24.96	24.92	
CA_4A-12A (1)	LTE B12	10	23095	707.5	QPSK	1	0	5095	737.5	LTE B4	20	2175	2132.5	-	-	-	-	-	-	-	-	-	-	-	-	24.89	24.92
CA_4A-12A (2)	LTE B12	10	23095	707.5	QPSK	1	0	5095	737.5	LTE B4	20	2175	2132.5	-	-	-	-	-	-	-	-	-	-	-	-	24.89	24.92
CA_12A-66A (1)	LTE B12	10	23095	707.5	QPSK	1	0	5095	737.5	LTE B6B	20	66786	2145	-	-	-	-	-	-	-	-	-	-	-	-	24.94	24.92
CA_12A-66A (2)	LTE B12	10	23095	707.5	QPSK	1	0	5095	737.5	LTE B6B	20	66786	2145	-	-	-	-	-	-	-	-	-	-	-	-	24.94	24.92
CA_12A-46A	LTE B12	10	23095	707.5	QPSK	1	0	5095	737.5	LTE B4B	20	50665	5537.5	-	-	-	-	-	-	-	-	-	-	-	-	24.98	24.92
CA_4A-4A-12A	LTE B12	10	23095	707.5	QPSK	1	0	5095	737.5	LTE B4	20	2175	2132.5	LTE B4	10	2350	2150	-	-	-	-	-	-	-	-	24.89	24.92
CA_12A-46C	LTE B12	10	23095	707.5	QPSK	1	0	5095	737.5	LTE B4B	20	50665	5537.5	LTE B4B	20	50467	5517.7	-	-	-	-	-	-	-	-	25.04	24.92
CA_2A-2A-4A-12A	LTE B12	10	23095	707.5	QPSK	1	0	5095	737.5	LTE B2	20	900	1960	LTE B2	20	700	1940	LTE B4	20	2175	2132.5	-	-	-	-	25.03	24.92
CA_2A-2A-7A-12A	LTE B12	10	23095	707.5	QPSK	1	0	5095	737.5	LTE B2	20	900	1960	LTE B2	20	700	1940	LTE B7	20	3100	2655	-	-	-	-	24.89	24.91
CA_2A-2A-12B	LTE B12	5	23035	701.5	QPSK	1	0	5035	731.5	LTE B12	10	5107	738.7	LTE B2	20	900	1960	LTE B2	20	700	1940	-	-	-	-	24.90	24.91
CA_2A-2A-12A-30A	LTE B12	10	23095	707.5	QPSK	1	0	5095	737.5	LTE B2	20	900	1960	LTE B2	20	700	1940	LTE B30	10	9820	2355	-	-	-	-	25.02	24.92
CA_2A-2A-12A-66A	LTE B12	10	23095	707.5	QPSK	1	0	5095	737.5	LTE B2	20	900	1960	LTE B2	20	700	1940	LTE B6B	20	66786	2145	66786	2145	25.02	24.92		
CA_2A-7A-12B	LTE B12	5	23035	701.5	QPSK	1	0	5035	731.5	LTE B12	10	5107	738.7	LTE B2	20	900	1960	LTE B7	20	3100	2655	-	-	-	-	24.84	24.91
CA_2A-12A-66A-66A	LTE B12	10	23095	707.5	QPSK	1	0	5095	737.5	LTE B2	20	900	1960	LTE B6B	20	66786	2145	LTE B6B	20	67236	2190	67236	2190	24.96	24.92		
CA_2A-12A-66C	LTE B12	10	23095	707.5	QPSK	1	0	5095	737.5	LTE B2	20	900	1960	LTE B6B	20	66786	2145	LTE B6B	20	66984	2164.8	66984	2164.8	24.98	24.92		
CA_12A-46D	LTE B12	10	23095	707.5	QPSK	1	0	5095	737.5	LTE B4B	20	50665	5537.5	LTE B4B	20	50467	5517.7	LTE B4B	20	50863	5557.3	50863	5557.3	24.89	24.92		

FCC ID: A3LSMG986U	PCTEST ENGINEERING LABORATORY, INC.	SAR EVALUATION REPORT	Reviewed by: Quality Manager
Test Dates: 10/21/19 – 01/01/20	DUT Type: Portable Handset		APPENDIX F: Page 3 of 25

1.3.14

LTE Band 41 PC2 as PCC

Table 14
Maximum Output Powers

Combination	PCC Band	PCC								SCC 1			SCC 2			SCC 3			SCC 4			Power						
		PCC BW [MHz]	PCC (UL) Ch.	PCC (UL) Freq. [MHz]	Mod.	PCC UL RB	PCC UL RB Offset	PCC (DL) Channel	PCC (DL) Freq. [MHz]	SCC Band	SCC BW [MHz]	SCC (DL) Channel	SCC (DL) Freq. [MHz]	SCC Band	SCC BW [MHz]	SCC (DL) Channel	SCC (DL) Freq. [MHz]	SCC Band	SCC BW [MHz]	SCC (DL) Channel	SCC (DL) Freq. [MHz]	SCC Band	SCC BW [MHz]	SCC (DL) Channel	SCC (DL) Freq. [MHz]	LTE Tx Power with DL CA Enabled [dBm]	LTE Single Carrier Tx Power [dBm]	
CA_41A-41A (1)	LTE B41 PC2	20	40185	2549.5	QPSK	1	0	40185	2549.5	LTE B41 PC2	20	41490	2680	-	-	-	-	-	-	-	-	-	-	-	-	-	27.37	27.34
CA_41A-41C	LTE B41 PC2	20	40185	2549.5	QPSK	1	0	40185	2549.5	LTE B41 PC2	20	41202	2660.2	LTE B41 PC2	20	41490	2680	-	-	-	-	-	-	-	-	-	27.37	27.34
CA_41C-41A	LTE B41 PC2	20	40185	2549.5	QPSK	1	0	40185	2549.5	LTE B41 PC2	20	40383	2569.3	LTE B41 PC2	20	41490	2680	-	-	-	-	-	-	-	-	-	27.12	27.34
CA_41A-41D	LTE B41 PC2	20	40185	2549.5	QPSK	1	0	40185	2549.5	LTE B41 PC2	20	41094	2640.4	LTE B41 PC2	20	41202	2660.2	LTE B41 PC2	20	41490	2680	-	-	-	-	-	27.25	27.34
CA_41D-41A	LTE B41 PC2	20	40185	2549.5	QPSK	1	0	40185	2549.5	LTE B41 PC2	20	40383	2569.3	LTE B41 PC2	20	40681	2589.1	LTE B41 PC2	20	41490	2680	-	-	-	-	-	27.21	27.34
CA_41C-41C	LTE B41 PC2	20	40185	2549.5	QPSK	1	0	40185	2549.5	LTE B41 PC2	20	40383	2569.3	LTE B41 PC2	20	41202	2660.2	LTE B41 PC2	20	41490	2680	-	-	-	-	-	27.19	27.34
CA_41E	LTE B41 PC2	20	40185	2549.5	QPSK	1	0	40185	2549.5	LTE B41 PC2	20	40383	2569.3	LTE B41 PC2	20	40581	2589.1	LTE B41 PC2	20	40779	2608.9	-	-	-	-	-	27.19	27.34
CA_41C-41D	LTE B41 PC2	20	40385	2548.5	QPSK	1	0	40385	2548.5	LTE B41 PC2	20	40383	2569.3	LTE B41 PC2	20	40394	2640.4	LTE B41 PC2	20	41292	2660.2	LTE B41 PC2	20	41490	2680	27.25	27.34	
CA_41D-41C	LTE B41 PC2	20	40385	2548.5	QPSK	1	0	40385	2548.5	LTE B41 PC2	20	40383	2569.3	LTE B41 PC2	20	40581	2589.1	LTE B41 PC2	20	41292	2660.2	LTE B41 PC2	20	41490	2680	27.20	27.34	

FCC ID: A3LSMG986U	 PCTEST ENGINEERING LABORATORY, INC.	SAR EVALUATION REPORT	Reviewed by: Quality Manager
Test Dates: 10/21/19 – 01/01/20	DUT Type: Portable Handset		APPENDIX F: Page 8 of 25

1.4 DL CA with DL 4x4 MIMO RF Conduction Powers

This device supports downlink 4x4 MIMO operations for some LTE bands. Uplink transmission is limited to a single output stream. When carrier aggregation was applicable, the general test selection and setup procedures described in Section 1.2 were applied.

Per May 2017 TCB Workshop Notes, SAR for 4x4 DL MIMO was not needed since the maximum average output power in 4x4 DL MIMO mode was not more than 0.25 dB higher than the maximum output power with 4x4 DL MIMO inactive. Additionally, SAR for 4x4 MIMO Downlink Carrier Aggregation was not needed since the maximum average output power in 4x4 MIMO Downlink Carrier Aggregation mode was not more than 0.25 dB higher than the maximum output power with 4x4 MIMO Downlink and downlink carrier aggregation inactive.

1.4.1 LTE 4x4 MIMO DL Standalone Powers

Table 15
Maximum Output Powers

LTE Band	Bandwidth [MHz]	Channel	Frequency [MHz]	Modulation	RB Size	RB Offset	4x4 DL MIMO Tx. Power [dBm]	Single Antenna Tx. Power [dBm]	Target Power [dBm]
66	15	132597	1772.5	QPSK	1	36	24.25	24.20	24.0
2	20	19100	1900	QPSK	1	99	23.95	23.89	23.5
25	20	26365	1882.5	QPSK	1	99	24.03	24.01	23.5
7	15	21100	2535	QPSK	1	74	23.37	23.58	23.0
30	5	27710	2310	QPSK	1	12	22.55	22.51	22.0
41 PC3	15	40185	2549.5	QPSK	1	36	24.91	24.87	24.0
41 PC2	20	40185	2549.5	QPSK	1	0	27.23	27.24	26.7
48	10	56690	3695	QPSK	1	25	23.94	24.00	23.0

1.4.2 LTE Band 71 as PCC

Table 16
Maximum Output Powers

Combination	PCC										SCC1				SCC2				SCC3				Power						
	PCC Band	PCC BW [MHz]	PCC [DU] Ch.	PCC [DU] Freq. [MHz]	Mod.	PCC UL RB	PCC UL RB Offset	PCC [DU] Ch.	PCC [DU] Freq. [MHz]	DL Ant. Config.	SCC Band	SCC BW [MHz]	SCC [DU] Ch.	SCC [DU] Freq. [MHz]	DL Ant. Config.	SCC Band	SCC BW [MHz]	SCC [DU] Ch.	SCC [DU] Freq. [MHz]	DL Ant. Config.	SCC Band	SCC BW [MHz]	SCC [DU] Ch.	SCC [DU] Freq. [MHz]	DL Ant. Config.	LTE Tx. Power with DL CA Enabled	LTE Single Carrier Tx Power [dBm]		
CA_1A1-4A-71A	LTE B71	5	133147	665.5	QPSK	1	12	68611	619.5	2x2	LTE B4	20	2175	2132.5	4x4	LTE B4	10	2350	2150	2x2	-	-	-	-	-	-	-	24.92	24.91
CA_1A1-4A-71A	LTE B71	5	133147	665.5	QPSK	1	12	68611	619.5	2x2	LTE B4	20	2175	2132.5	4x4	LTE B4	10	2350	2150	4x4	-	-	-	-	-	-	-	24.85	24.91
CA_2A-2A-4A-71A	LTE B71	5	133147	665.5	QPSK	1	12	68611	619.5	2x2	LTE B2	20	900	1960	2x2	LTE B2	20	700	1940	2x2	LTE B4	20	2175	2132.5	4x4	24.93	24.91	24.91	24.91
CA_2A-2A-4A-71A	LTE B71	5	133147	665.5	QPSK	1	12	68611	619.5	2x2	LTE B2	20	900	1960	4x4	LTE B2	20	700	1940	2x2	LTE B4	20	2175	2132.5	2x2	24.83	24.91	24.91	24.91
CA_2A-2A-14A-71A	LTE B71	5	133147	665.5	QPSK	1	12	68611	619.5	2x2	LTE B2	20	900	1960	4x4	LTE B2	20	700	1940	2x2	LTE B4	20	2175	2132.5	4x4	25.01	24.91	24.91	24.91
CA_2A-2A-14A-71A	LTE B71	5	133147	665.5	QPSK	1	12	68611	619.5	2x2	LTE B2	20	900	1960	4x4	LTE B2	20	700	1940	4x4	LTE B4	20	2175	2132.5	2x2	24.94	24.91	24.91	24.91
CA_2A-2A-14A-71A	LTE B71	5	133147	665.5	QPSK	1	12	68611	619.5	2x2	LTE B2	20	900	1960	4x4	LTE B2	20	700	1940	4x4	LTE B4	20	2175	2132.5	4x4	24.97	24.91	24.91	24.91
CA_2A-2A-66A-71A	LTE B71	5	133147	665.5	QPSK	1	12	68611	619.5	2x2	LTE B2	20	900	1960	2x2	LTE B2	20	700	1940	2x2	LTE B66	20	66786	2145	4x4	24.97	24.91	24.91	24.91
CA_2A-2A-66A-71A	LTE B71	5	133147	665.5	QPSK	1	12	68611	619.5	2x2	LTE B2	20	900	1960	4x4	LTE B2	20	700	1940	2x2	LTE B66	20	66786	2145	2x2	24.97	24.91	24.91	24.91
CA_2A-2A-66A-71A	LTE B71	5	133147	665.5	QPSK	1	12	68611	619.5	2x2	LTE B2	20	900	1960	4x4	LTE B2	20	700	1940	2x2	LTE B66	20	66786	2145	4x4	24.99	24.91	24.91	24.91
CA_2A-2A-66A-71A	LTE B71	5	133147	665.5	QPSK	1	12	68611	619.5	2x2	LTE B2	20	900	1960	4x4	LTE B2	20	700	1940	4x4	LTE B66	20	66786	2145	2x2	24.91	24.91	24.91	24.91
CA_2A-2A-66A-71A	LTE B71	5	133147	665.5	QPSK	1	12	68611	619.5	2x2	LTE B2	20	900	1960	4x4	LTE B2	20	700	1940	4x4	LTE B66	20	66786	2145	4x4	24.98	24.91	24.91	24.91
CA_2A-2A-66A-71A	LTE B71	5	133147	665.5	QPSK	1	12	68611	619.5	2x2	LTE B2	20	900	1960	4x4	LTE B2	20	700	1940	2x2	LTE B66	20	66786	2145	2x2	24.99	24.91	24.91	24.91
CA_2A-2A-66A-71A	LTE B71	5	133147	665.5	QPSK	1	12	68611	619.5	2x2	LTE B2	20	900	1960	2x2	LTE B66	20	66786	2145	4x4	LTE B66	20	66786	2145	2x2	24.94	24.91	24.91	24.91
CA_2A-2A-66A-71A	LTE B71	5	133147	665.5	QPSK	1	12	68611	619.5	2x2	LTE B2	20	900	1960	4x4	LTE B66	20	66786	2145	4x4	LTE B66	20	66786	2145	4x4	24.97	24.91	24.91	24.91
CA_2A-2A-66A-71A	LTE B71	5	133147	665.5	QPSK	1	12	68611	619.5	2x2	LTE B2	20	900	1960	4x4	LTE B66	20	66786	2145	4x4	LTE B66	20	66786	2145	4x4	24.90	24.91	24.91	24.91
CA_2A-66C-71A	LTE B71	5	133147	665.5	QPSK	1	12	68611	619.5	2x2	LTE B2	20	900	1960	2x2	LTE B66	20	66786	2145	4x4	LTE B66	20	66984	2164.8	4x4	24.95	24.91	24.91	24.91
CA_2A-66C-71A	LTE B71	5	133147	665.5	QPSK	1	12	68611	619.5	2x2	LTE B2	20	900	1960	4x4	LTE B66	20	66786	2145	2x2	LTE B66	20	66984	2164.8	2x2	25.00	24.91	24.91	24.91
CA_2A-66C-71A	LTE B71	5	133147	665.5	QPSK	1	12	68611	619.5	2x2	LTE B2	20	900	1960	4x4	LTE B66	20	66786	2145	4x4	LTE B66	20	66984	2164.8	4x4	24.98	24.91	24.91	24.91

FCC ID: A3LSMG986U	 PCTEST ENGINEERING LABORATORY, INC.	SAR EVALUATION REPORT	Reviewed by: Quality Manager
Test Dates: 10/21/19 – 01/01/20	DUT Type: Portable Handset		APPENDIX F: Page 9 of 25

1.5 Downlink Carrier Aggregation with CA_41C Uplink Carrier Aggregation enabled

This device supports uplink carrier aggregation (ULCA) with additional Carrier Aggregation configurations active in the downlink. Power measurements were performed with ULCA active and additional CA configurations active in the downlink for the configuration per Fall 2017 TCB Workshop Notes.

Per FCC Guidance, additional SAR measurements for these configurations were not required since their maximum output power was not more than 0.25 dB higher than the maximum output power for with only ULCA active.

1.5.1 DL Carrier Aggregation RF Conducted Powers

Table 30
Maximum Output Powers – LTE Band 41 Power Class 3

Combination	PCC Band	PCC BW [MHz]	PCC [U] Ch.	PCC				PCC [DL] Freq. [MHz]	SCC Band	SCC BW [MHz]	SCC 1				SCC 2				SCC 3				SCC 4				ULCA Tx Power with add'l CA Config. active	ULCA Tx Power [dBm]							
				Mod.	PCC UL RB	PCC UL RB Offset	PCC [DL] Channel				PCC [UL] Ch.	PCC [UL] Freq. [MHz]	Mod.	PCC UL RB	PCC UL RB Offset	SCC [DL] Channel	SCC [DL] Freq. [MHz]	SCC Band	SCC BW [MHz]	SCC [DL] Channel	SCC [DL] Freq. [MHz]	SCC Band	SCC BW [MHz]	SCC [DL] Channel	SCC [DL] Freq. [MHz]	SCC Band			SCC BW [MHz]	SCC [DL] Channel	SCC [DL] Freq. [MHz]				
CA_41C-41A	LTE B41	20	40620	2593	QPSK	1	0	40620	2593	LTE B41	20	40422	2573.2	QPSK	1	99	40422	2573.2	LTE B41	20	41490	2680	-	-	-	-	-	-	-	-	-	-	24.52	24.50	
CA_41D	LTE B41	20	40620	2593	QPSK	1	0	40620	2593	LTE B41	20	40422	2573.2	QPSK	1	99	40422	2573.2	LTE B41	20	40818	2612.8	-	-	-	-	-	-	-	-	-	-	24.48	24.50	
CA_41D-41A	LTE B41	20	40620	2593	QPSK	1	0	40620	2593	LTE B41	20	40422	2573.2	QPSK	1	99	40422	2573.2	LTE B41	20	40818	2612.8	LTE B41	20	41490	2680	-	-	-	-	-	-	24.52	24.50	
CA_41C-41C	LTE B41	20	40620	2593	QPSK	1	0	40620	2593	LTE B41	20	40422	2573.2	QPSK	1	99	40422	2573.2	LTE B41	20	41394	2642.4	LTE B41	20	41490	2680	-	-	-	-	-	-	24.45	24.48	
CA_41E	LTE B41	20	40620	2593	QPSK	1	0	40620	2593	LTE B41	20	40422	2573.2	QPSK	1	99	40422	2573.2	LTE B41	20	40818	2612.8	LTE B41	20	41016	2632.6	-	-	-	-	-	-	24.30	24.50	
CA_41C-41D	LTE B41	20	40620	2593	QPSK	1	0	40620	2593	LTE B41	20	40422	2573.2	QPSK	1	99	40422	2573.2	LTE B41	20	41094	2642.4	LTE B41	20	41092	2632.2	LTE B41	20	41490	2680	-	-	-	24.55	24.50
CA_41D-41C	LTE B41	20	40620	2593	QPSK	1	0	40620	2593	LTE B41	20	40422	2573.2	QPSK	1	99	40422	2573.2	LTE B41	20	40818	2612.8	LTE B41	20	41092	2632.2	LTE B41	20	41490	2680	-	-	-	24.50	24.50

Table 31
Maximum Output Powers – LTE Band 41 Power Class 2

Combination	PCC Band	PCC BW [MHz]	PCC [U] Ch.	PCC				PCC [DL] Freq. [MHz]	SCC Band	SCC BW [MHz]	SCC 1				SCC 2				SCC 3				SCC 4				ULCA Tx Power with add'l CA Config. active	ULCA Tx Power [dBm]							
				Mod.	PCC UL RB	PCC UL RB Offset	PCC [DL] Channel				PCC [UL] Ch.	PCC [UL] Freq. [MHz]	Mod.	PCC UL RB	PCC UL RB Offset	SCC [DL] Channel	SCC [DL] Freq. [MHz]	SCC Band	SCC BW [MHz]	SCC [DL] Channel	SCC [DL] Freq. [MHz]	SCC Band	SCC BW [MHz]	SCC [DL] Channel	SCC [DL] Freq. [MHz]	SCC Band			SCC BW [MHz]	SCC [DL] Channel	SCC [DL] Freq. [MHz]				
CA_41C-41A	LTE B41 PCC	20	40620	2593	QPSK	1	0	40620	2593	LTE B41 PCC	20	40422	2573.2	QPSK	1	99	40422	2573.2	LTE B41 PCC	20	39790	2506	-	-	-	-	-	-	-	-	-	-	27.45	27.45	
CA_41D	LTE B41 PCC	20	40620	2593	QPSK	1	0	40620	2593	LTE B41 PCC	20	40422	2573.2	QPSK	1	99	40422	2573.2	LTE B41 PCC	20	40818	2612.8	-	-	-	-	-	-	-	-	-	-	27.38	27.45	
CA_41D-41A	LTE B41 PCC	20	40620	2593	QPSK	1	0	40620	2593	LTE B41 PCC	20	40422	2573.2	QPSK	1	99	40422	2573.2	LTE B41 PCC	20	40818	2612.8	LTE B41 PCC	20	41490	2680	-	-	-	-	-	-	27.32	27.45	
CA_41C-41C	LTE B41 PCC	20	40620	2593	QPSK	1	0	40620	2593	LTE B41 PCC	20	40422	2573.2	QPSK	1	99	40422	2573.2	LTE B41 PCC	20	41392	2642.2	LTE B41 PCC	20	41490	2680	-	-	-	-	-	-	27.35	27.45	
CA_41E	LTE B41 PCC	20	40620	2593	QPSK	1	0	40620	2593	LTE B41 PCC	20	40422	2573.2	QPSK	1	99	40422	2573.2	LTE B41 PCC	20	40818	2612.8	LTE B41 PCC	20	41016	2632.6	-	-	-	-	-	-	27.33	27.45	
CA_41C-41D	LTE B41 PCC	20	40620	2593	QPSK	1	0	40620	2593	LTE B41 PCC	20	40422	2573.2	QPSK	1	99	40422	2573.2	LTE B41 PCC	20	41094	2642.4	LTE B41 PCC	20	41092	2632.2	LTE B41 PCC	20	41490	2680	-	-	-	27.35	27.45
CA_41D-41C	LTE B41 PCC	20	40620	2593	QPSK	1	0	40620	2593	LTE B41 PCC	20	40422	2573.2	QPSK	1	99	40422	2573.2	LTE B41 PCC	20	40818	2612.8	LTE B41 PCC	20	41092	2632.2	LTE B41 PCC	20	41490	2680	-	-	-	27.45	27.45

FCC ID: A3LSMG986U	 PCTEST ENGINEERING LABORATORY, INC.	SAR EVALUATION REPORT	Reviewed by: Quality Manager
Test Dates: 10/21/19 – 01/01/20	DUT Type: Portable Handset		APPENDIX F: Page 24 of 25

APPENDIX G POWER REDUCTION VERIFICATION

Per the May 2017 TCBC Workshop Notes, demonstration of proper functioning of the power reduction mechanisms is required to support the corresponding SAR configurations. The verification process was divided into two parts: (1) evaluation of output power levels for individual or multiple triggering mechanisms and (2) evaluation of the triggering distances for proximity-based sensors.

G.1 Power Verification Procedure



The power verification was performed according to the following procedure:

1. A base station simulator was used to establish a conducted RF connection and the output power was monitored. The power measurements were confirmed to be within expected tolerances for all states before and after a power reduction mechanism was triggered. For licensed modes, the device state index as displayed on the device UI was recorded before and after the mechanism was triggered.
2. Step 1 was repeated for all relevant modes and frequency bands for the mechanism being investigated.
3. Steps 1 and 2 were repeated for all individual power reduction mechanisms and combinations thereof. For the combination cases, one mechanism was switched to a 'triggered' state at a time; powers were confirmed to be within tolerances after each additional mechanism was activated.

G.2 Distance Verification Procedure

The distance verification procedure was performed according to the following procedure:

1. A base station simulator was used to establish an RF connection and to monitor the power levels. The device being tested was placed below the relevant section of the phantom with the relevant side or edge of the device facing toward the phantom. For licensed modes, the device state index on the device UI was monitored to determine the triggering state.
2. The device was moved toward and away from the phantom to determine the distance at which the mechanism triggers and the output power is reduced, per KDB Publication 616217 D04v01r02 and FCC Guidance. Each applicable test position was evaluated. The distances were confirmed to be the same or larger (more conservative) than the minimum distances provided by the manufacturer.
3. Steps 1 and 2 were repeated for low, mid, and high bands, as appropriate (see note below Table G-2 for more details).
4. Steps 1 through 3 were repeated for all distance-based power reduction mechanisms.

FCC ID: A3LSMG986U	 SAR EVALUATION REPORT		Reviewed by: Quality Manager
Test Dates: 10/21/19 – 01/01/20	DUT Type: Portable Handset		APPENDIX G: Page 1 of 5

G.3 Main Antenna Verification Summary

**Table G-1
Power Measurement Verification for Main Antenna**

Mechanism(s)		Mode/Band	Device System Index		
1st	2nd		Un-triggered (Max)	Mechanism #1 (Reduced)	Mechanism #2 (Reduced)
Hotspot On		GPRS 1900 1 Tx Slot	0	3	
Grip		GPRS 1900 1 Tx Slot	0	1	
Hotspot On	Grip	GPRS 1900 1 Tx Slot	0	3	3
Grip	Hotspot On	GPRS 1900 1 Tx Slot	0	1	3
Hotspot On		UMTS 1750	0	3	
Grip		UMTS 1750	0	1	
Hotspot On	Grip	UMTS 1750	0	3	3
Grip	Hotspot On	UMTS 1750	0	1	3
Hotspot On		UMTS 1900	0	3	
Grip		UMTS 1900	0	1	
Hotspot On	Grip	UMTS 1900	0	3	3
Grip	Hotspot On	UMTS 1900	0	1	3
Hotspot On		PCS EVDO	0	3	
Grip		PCS EVDO	0	1	
Hotspot On	Grip	PCS EVDO	0	3	3
Grip	Hotspot On	PCS EVDO	0	1	3
Hotspot On		LTE FDD Band 4	0	3	
Grip		LTE FDD Band 4	0	1	
Hotspot On	Grip	LTE FDD Band 4	0	3	3
Grip	Hotspot On	LTE FDD Band 4	0	1	3
Hotspot On		LTE FDD Band 66	0	3	
Grip		LTE FDD Band 66	0	1	
Hotspot On	Grip	LTE FDD Band 66	0	3	3
Grip	Hotspot On	LTE FDD Band 66	0	1	3
Hotspot On		LTE FDD Band 25	0	3	
Grip		LTE FDD Band 25	0	1	
Hotspot On	Grip	LTE FDD Band 25	0	3	3
Grip	Hotspot On	LTE FDD Band 25	0	1	3
Hotspot On		LTE FDD Band 2	0	3	
Grip		LTE FDD Band 2	0	1	
Hotspot On	Grip	LTE FDD Band 2	0	3	3
Grip	Hotspot On	LTE FDD Band 2	0	1	3
Hotspot On		LTE FDD Band 30	0	3	
Grip		LTE FDD Band 30	0	1	
Hotspot On	Grip	LTE FDD Band 30	0	3	3
Grip	Hotspot On	LTE FDD Band 30	0	1	3
Hotspot On		LTE FDD Band 7	0	3	
Grip		LTE FDD Band 7	0	1	
Hotspot On	Grip	LTE FDD Band 7	0	3	3
Grip	Hotspot On	LTE FDD Band 7	0	1	3
Hotspot On		LTE TDD Band 38	0	3	
Grip		LTE TDD Band 38	0	1	
Hotspot On	Grip	LTE TDD Band 38	0	3	3
Grip	Hotspot On	LTE TDD Band 38	0	1	3
Hotspot On		LTE TDD Band 41 (PC3)	0	3	
Grip		LTE TDD Band 41 (PC3)	0	1	
Hotspot On	Grip	LTE TDD Band 41 (PC3)	0	3	3
Grip	Hotspot On	LTE TDD Band 41 (PC3)	0	1	3
Hotspot On		LTE TDD Band 41 (PC2)	0	3	
Grip		LTE TDD Band 41 (PC2)	0	1	
Hotspot On	Grip	LTE TDD Band 41 (PC2)	0	3	3
Grip	Hotspot On	LTE TDD Band 41 (PC2)	0	1	3
Held-to-Ear		LTE TDD Band 48	0	2	
Hotspot On		NR Band n66	0	3	
Grip		NR Band n66	0	1	
Hotspot On	Grip	NR Band n66	0	3	3
Grip	Hotspot On	NR Band n66	0	1	3
Hotspot On		NR Band n2	0	3	
Grip		NR Band n2	0	1	
Hotspot On	Grip	NR Band n2	0	3	3
Grip	Hotspot On	NR Band n2	0	1	3

*Note: This device uses different Device State Indices (DSI) to configure different time averaged power levels based on certain exposure scenarios. For this device, DSI = 1 represents the case when the grip sensor is active, DSI = 2 represents the case where the device is held to ear, and DSI = 3 represents the case when hotspot mode is active. DSI = 0 is configured at max power when the device cannot detect the use condition.



FCC ID: A3LSMG986U	 SAR EVALUATION REPORT		Reviewed by: Quality Manager
Test Dates: 10/21/19 – 01/01/20	DUT Type: Portable Handset		APPENDIX G: Page 2 of 5

Table G-2
Power Measurement Verification for Main Antenna with NR Active



	Mechanism(s)		Mode/Band	Device State Index		
	1st	2nd		Un-triggered (Max)	Mechanism #1 (Reduced)	Mechanism #2 (Reduced)
mmWave Active	Hotspot On		LTE FDD Band 2	0	3	
	Hotspot On	Grip		0	3	3
	Grip			0	1	
	Grip	Hotspot On		0	1	3
	Hotspot On		LTE FDD Band 4	0	3	
	Hotspot On	Grip		0	3	3
	Grip			0	1	
	Grip	Hotspot On		0	1	3
	Hotspot On		LTE FDD Band 30 (N260 Only)	0	3	
	Hotspot On	Grip		0	3	3
	Grip			0	1	
	Grip	Hotspot On		0	1	3
	Hotspot On		LTE FDD Band 66	0	3	
	Hotspot On	Grip		0	3	3
	Grip			0	1	
	Grip	Hotspot On		0	1	3

*Note: This device uses different Device State Indices (DSI) to configure different time averaged power levels based on certain exposure scenarios. For this device, DSI = 1 represents the case when the grip sensor is active and DSI = 3 represents the case when hotspot mode is active. DSI = 0 is configured at max power when the device cannot detect the use condition.

Table G-3
Distance Measurement Verification for Main Antenna

Mechanism(s)	Test Condition	Band	Distance Measurements (mm)		Minimum Distance per Manufacturer (mm)
			Moving Toward	Moving Away	
Grip	Phablet - Back Side	Mid	11	13	9
Grip	Phablet - Back Side	High	11	13	9
Grip	Phablet - Front Side	Mid	8	9	7
Grip	Phablet - Front Side	High	8	9	7
Grip	Phablet - Bottom Edge	Mid	12	14	12
Grip	Phablet - Bottom Edge	High	12	14	12

*Note: Mid band refers to: CDMA BC1, GSM1900, UMTS B2/4, LTE B2/4/25/66, NR n2/n66; High band refers to: LTE B7/30/38/41 PC3/41 PC2

FCC ID: A3LSMG986U	 SAR EVALUATION REPORT 	Reviewed by: Quality Manager
Test Dates: 10/21/19 – 01/01/20	DUT Type: Portable Handset	APPENDIX G: Page 3 of 5

G.4 WIFI Verification Summary

**Table G-4
Power Measurement Verification WIFI – Antenna 1**

Mechanism(s)	Mode/Band	Conducted Power (dBm)	
1st		Un-triggered (Max)	Mechanism #1 (Reduced)
Held-to-Ear	802.11b	20.55	16.83
Held-to-Ear	802.11g	17.38	16.32
Held-to-Ear	802.11n (2.4GHz)	17.48	16.77
Held-to-Ear	802.11a	16.53	12.45
Held-to-Ear	802.11n (5GHz, 20MHz BW)	17.23	12.56
Held-to-Ear	802.11ac (20MHz BW)	16.91	13.45
Held-to-Ear	802.11n (5GHz, 40MHz BW)	16.03	12.97
Held-to-Ear	802.11ac (40MHz BW)	15.96	13.22
Held-to-Ear	802.11ac (80MHz BW)	14.41	12.04

*Note: MIMO and 802.11ax WIFI modes were not evaluated due to equipment limitations.

**Table G-5
Power Measurement Verification WIFI – Antenna 2**

Mechanism(s)	Mode/Band	Conducted Power (dBm)	
1st		Un-triggered (Max)	Mechanism #1 (Reduced)
Held-to-Ear	802.11b	20.45	16.24
Held-to-Ear	802.11g	16.88	16.09
Held-to-Ear	802.11n (2.4GHz)	17.02	16.24
Held-to-Ear	802.11a	15.68	11.58
Held-to-Ear	802.11n (5GHz, 20MHz BW)	15.64	11.55
Held-to-Ear	802.11ac (20MHz BW)	15.56	11.69
Held-to-Ear	802.11n (5GHz, 40MHz BW)	14.04	11.61
Held-to-Ear	802.11ac (40MHz BW)	14.11	11.11
Held-to-Ear	802.11ac (80MHz BW)	12.30	10.12

*Note: MIMO and 802.11ax WIFI modes were not evaluated due to equipment limitations.



FCC ID: A3LSMG986U	 SAR EVALUATION REPORT 	Reviewed by: Quality Manager
Test Dates: 10/21/19 – 01/01/20	DUT Type: Portable Handset	APPENDIX G: Page 4 of 5

Table G-6
Power Measurement Verification WIFI with NR Active – Antenna 1



Mode/Band	Conducted Power (dBm)		
	Un-triggered (Max)	Mechanism #1 NR Active (Reduced)	Mechanism #2 RCV and NR Active (Reduced)
802.11b	20.32	15.41	13.06
802.11g	16.79	15.94	12.86
802.11n (2.4GHz)	17.03	16.08	13.04
802.11a	16.83	12.71	12.67
802.11n (5GHz, 20MHz BW)	16.94	13.10	13.09
802.11ac (20MHz BW)	16.76	13.08	13.16
802.11n (5GHz, 40MHz BW)	16.37	12.83	12.77
802.11ac (40MHz BW)	16.11	12.91	13.00
802.11ac (80MHz BW)	14.25	12.40	12.59

*Note: MIMO and 802.11ax WIFI modes were not evaluated due to equipment limitations.

Table G-7
Power Measurement Verification WIFI with NR Active – Antenna 2

Mode/Band	Conducted Power (dBm)		
	Un-triggered (Max)	Mechanism #1 NR Active (Reduced)	Mechanism #2 RCV and NR Active (Reduced)
802.11b	20.43	15.34	13.45
802.11g	17.65	16.43	13.56
802.11n (2.4GHz)	17.43	16.73	13.29
802.11a	17.45	13.43	13.31
802.11n (5GHz, 20MHz BW)	17.39	13.41	13.50
802.11ac (20MHz BW)	17.22	13.27	13.24
802.11n (5GHz, 40MHz BW)	16.67	13.23	13.30
802.11ac (40MHz BW)	16.83	13.03	13.14
802.11ac (80MHz BW)	15.44	12.87	13.16

*Note: MIMO and 802.11ax WIFI modes were not evaluated due to equipment limitations.

FCC ID: A3LSMG986U	 SAR EVALUATION REPORT 	Reviewed by: Quality Manager
Test Dates: 10/21/19 – 01/01/20	DUT Type: Portable Handset	APPENDIX G: Page 5 of 5

APPENDIX H: IEEE 802.11AX RU SAR EXCLUSION

1.1 IEEE 802.11ax RU SAR Exclusion

To make the most efficient use of the additional available subcarriers (data tones), IEEE 802.11ax can utilize Orthogonal Frequency-Division Multiple Access (OFDMA) which divides the existing 802.11 channels into smaller subchannels called Resource Units (RUs). Possible RU sizes are: 26T, 52T, 106T, 242T, 484T and 996T.

Per April 2019 TCB Workshop Notes, 802.11ax was considered a higher order 802.11 mode when compared to a/b/g/n/ac to apply KDB Publication 248227 D01v02r02 for OFDM mode selection. Therefore, SAR tests were not required for 802.11ax based on the maximum allowed output powers of OFDM modes and the reported SAR values. Per FCC Guidance, maximum conducted powers were performed for each RU size to demonstrate that the output powers would not be higher than the other OFDM 802.11 modes.



1.2 IEEE 802.11ax RU Target Powers

1.2.1 Maximum 802.11ax RU WLAN Output Power

Tones		SISO (ANT1/2) /in dBm				MIMO (ALL) /in dBm			
		2.4GHz	5GHz/20MHz	5GHz/40MHz	5GHz/80MHz	2.4GHz	5GHz/20MHz	5GHz/40MHz	5GHz/80MHz
26T	Maximum	14	11	11	11	14	11	11	11
	Nominal	13	10	10	10	13	10	10	10
52T	Maximum	15	13	12	11	15	13	12	11
	Nominal	14	12	11	10	14	12	11	10
106T	Maximum	16	15	13	12	16	15	13	12
	Nominal	15	14	12	11	15	14	12	11
242T	Maximum	17	16	14	13	17	16	14	13
		ch. 11: 14.5		ch. 38: 13.5		ch. 11: 14.5		ch. 38: 13.5	
	Nominal	16	15	13	12	16	15	13	12
484T	Maximum			14	13			14	13
				ch. 38: 13.5				ch. 38: 13.5	
	Nominal			13	12			13	12
996T	Maximum				13				13
	Nominal				12				12

1.2.2 Reduced 802.11ax RU WLAN Output Power – Receiver Active

Tones		SISO (ANT1/2) /in dBm				MIMO (ALL) /in dBm			
		2.4GHz	5GHz/20MHz	5GHz/40MHz	5GHz/80MHz	2.4GHz	5GHz/20MHz	5GHz/40MHz	5GHz/80MHz
26T	Maximum	14	11	11	11	14	11	11	11
	Nominal	13	10	10	10	13	10	10	10
52T	Maximum	15	13	12	11	15	13	12	11
	Nominal	14	12	11	10	14	12	11	10
106T	Maximum	16	14	13	12	16	15	13	12
	Nominal	15	13	12	11	15	14	12	11
242T	Maximum	17	14	14	13	17	16	14	13
		ch. 11: 14.5		ch. 38: 13.5		ch. 11: 14.5		ch. 38: 13.5	
	Nominal	16	13	13	12	16	15	13	12
484T	Maximum			14	13			14	13
				ch. 38: 13.5				ch. 38: 13.5	
	Nominal			13	12			13	12
996T	Maximum				13				13
	Nominal				12				12



FCC ID: A3LSMG986U	 SAR EVALUATION REPORT		Reviewed by: Quality Manager
Test Dates: 10/21/19 – 01/01/20	DUT Type: Portable Handset		APPENDIX H: Page 1 of 8

1.2.3 Maximum 802.11ax RU WLAN Output Power During Conditions with Simultaneous 2.4 GHz WLAN and 5 GHz WLAN or NR Active

Tones		SISO (ANT1/2) /in dBm				MIMO (ALL) /in dBm			
		2.4GHz	5GHz/20MHz	5GHz/40MHz	5GHz/80MHz	2.4GHz	5GHz/20MHz	5GHz/40MHz	5GHz/80MHz
26T	Maximum	14	11	11	11	14	11	11	11
	Nominal	13	10	10	10	13	10	10	10
52T	Maximum	15	13	12	11	15	13	12	11
	Nominal	14	12	11	10	14	12	11	10
106T	Maximum	16	14	13	12	16	15	13	12
	Nominal	15	13	12	11	15	14	12	11
242T	Maximum	17 ch. 11: 14.5	14	14 ch. 38: 13.5	13	17 ch. 11: 14.5	16	14 ch. 38: 13.5	13
	Nominal	16 ch. 11: 13.5	13	13 ch. 38: 12.5	12	16 ch. 11: 13.5	15	13 ch. 38: 12.5	12
484T	Maximum			14 ch. 38: 13.5	13			14 ch. 38: 13.5	13
	Nominal			13 ch. 38: 12.5	12			13 ch. 38: 12.5	12
996T	Maximum				13				13
	Nominal				12				12

1.2.4 Reduced 802.11ax RU WLAN Output Power During Conditions with Receiver Active and Simultaneous 2.4 GHz WLAN and 5 GHz WLAN and/or NR Active

Tones		SISO (ANT1/2) /in dBm				MIMO (ALL) /in dBm			
		2.4GHz	5GHz/20MHz	5GHz/40MHz	5GHz/80MHz	2.4GHz	5GHz/20MHz	5GHz/40MHz	5GHz/80MHz
26T	Maximum	14	11	11	11	14	11	11	11
	Nominal	13	10	10	10	13	10	10	10
52T	Maximum	14	13	12	11	15	13	12	11
	Nominal	13	12	11	10	14	12	11	10
106T	Maximum	14	14	13	12	16 ch. 11: 15.0	15	13	12
	Nominal	13	13	12	11	15 ch. 11: 14.0	14	12	11
242T	Maximum	14	14	14 ch. 38: 13.5	13	17 ch. 11: 14.5	16	14 ch. 38: 13.5	13
	Nominal	13	13	13 ch. 38: 12.5	12	16 ch. 11: 13.5	15	13 ch. 38: 12.5	12
484T	Maximum			14 ch. 38: 13.5	13			14 ch. 38: 13.5	13
	Nominal			13 ch. 38: 12.5	12			13 ch. 38: 12.5	12
996T	Maximum				13				13
	Nominal				12				12

FCC ID: A3LSMG986U	 SAR EVALUATION REPORT 	Reviewed by: Quality Manager
Test Dates: 10/21/19 – 01/01/20	DUT Type: Portable Handset	APPENDIX H: Page 2 of 8

1.3 IEEE 802.11ax Measured Powers

Table 1
Maximum 2.4 GHz 802.11ax RU Output Power – Ant 1

Freq [MHz]	Channel	Tones	RU Index	Avg Conducted Powers (dBm)	Freq [MHz]	Channel	Tones	RU Index	Avg Conducted Powers (dBm)
2412	1	26T	0	13.40	2412	1	52T	37	14.76
			4	13.90				38	14.74
			8	13.12				40	14.49
2437	6	26T	0	13.46	2437	6	52T	37	14.75
			4	13.78				38	14.07
			8	13.53				40	14.06
2462	11	26T	0	13.79	2462	11	52T	37	14.72
			4	13.18				38	14.35
			8	13.06				40	14.38

Freq [MHz]	Channel	Tones	RU Index	Avg Conducted Powers (dBm)	Freq [MHz]	Channel	Tones	RU Index	Avg Conducted Powers (dBm)
2412	1	106T	53	15.82	2412	1	242T	61	16.09
			54	15.59					
2437	6	106T	53	15.38	2437	6	242T	61	16.27
			54	15.17					
2462	11	106T	53	15.55	2457	10	242T	61	16.46
			54	15.51					



FCC ID: A3LSMG986U	 PCTEST ENGINEERING LABORATORY, INC.	SAR EVALUATION REPORT		Reviewed by: Quality Manager
Test Dates: 10/21/19 – 01/01/20	DUT Type: Portable Handset			APPENDIX H: Page 3 of 8

Table 2
Maximum 2.4 GHz 802.11ax RU Output Power – Ant 2

Freq [MHz]	Channel	Tones	RU Index	Avg Conducted Powers (dBm)	Freq [MHz]	Channel	Tones	RU Index	Avg Conducted Powers (dBm)
2412	1	26T	0	13.51	2412	1	52T	37	14.24
			4	13.27				38	14.46
			8	13.12				40	14.30
2437	6	26T	0	13.92	2437	6	52T	37	14.79
			4	13.68				38	14.44
			8	13.61				40	14.29
2462	11	26T	0	13.39	2462	11	52T	37	14.97
			4	13.32				38	14.20
			8	13.54				40	14.98

Freq [MHz]	Channel	Tones	RU Index	Avg Conducted Powers (dBm)	Freq [MHz]	Channel	Tones	RU Index	Avg Conducted Powers (dBm)
2412	1	106T	53	15.97	2412	1	242T	61	16.83
			54	15.50					
2437	6	106T	53	15.46	2437	6	242T	61	16.73
			54	15.72					
2462	11	106T	53	15.44	2457	10	242T	61	16.77
			54	15.09					
					2462	11	242T	61	14.13



FCC ID: A3LSMG986U	 PCTEST ENGINEERING LABORATORY, INC.	SAR EVALUATION REPORT		Reviewed by: Quality Manager
Test Dates: 10/21/19 – 01/01/20	DUT Type: Portable Handset			APPENDIX H: Page 4 of 8



Table 3
Maximum 5 GHz 802.11ax RU Output Power – Ant 1

20MHz BW	Band	Freq [MHz]	Channel	Tones	Avg Conducted Power (dBm)			20MHz BW	Band	Freq [MHz]	Channel	Tones	Avg Conducted Power (dBm)			
					RU Index								RU Index			
					0	4	8						37	39	40	
20MHz BW	1	5180	36	26T	10.48	10.76	10.55	20MHz BW	1	5180	36	52T	12.46	12.60	12.48	
		5200	40	26T	10.41	10.65	10.40			5200	40	52T	12.36	12.53	12.41	
		5240	48	26T	10.35	10.62	10.36			5240	48	52T	12.29	12.44	12.31	
	2A	5260	52	26T	10.28	10.42	10.12		20MHz BW	2A	5260	52	52T	12.38	12.41	12.31
		5280	56	26T	10.14	10.44	10.30				5280	56	52T	12.29	12.44	12.27
		5320	64	26T	10.27	10.52	10.26				5320	64	52T	12.43	12.47	12.32
	2C	5500	100	26T	10.34	10.60	10.37		20MHz BW	2C	5500	100	52T	12.47	12.52	12.32
		5600	120	26T	10.77	10.97	10.64				5600	120	52T	12.58	12.75	12.59
		5720	144	26T	10.18	10.36	10.07				5720	144	52T	12.93	12.97	12.96
3	5745	149	26T	10.04	10.05	10.87	20MHz BW	3	5745	149	52T	12.96	12.92	12.75		
	5785	157	26T	10.08	10.38	10.13			5785	157	52T	12.96	12.33	12.96		
	5825	165	26T	10.96	10.33	10.90			5825	165	52T	12.90	12.28	12.95		

20MHz BW	Band	Freq [MHz]	Channel	Tones	Avg Conducted Power (dBm)			20MHz BW	Band	Freq [MHz]	Channel	Tones	Avg Conducted Power (dBm)			
					RU Index								RU Index			
					53	54	N/A						61	N/A	N/A	
20MHz BW	1	5180	36	106T	14.57	14.67		20MHz BW	1	5180	36	242T	15.63			
		5200	40	106T	14.52	14.52				5200	40	242T	15.54			
		5240	48	106T	14.48	14.49				5240	48	242T	15.50			
	2A	5260	52	106T	14.56	14.39			20MHz BW	2A	5260	52	242T	15.20		
		5280	56	106T	14.50	14.57					5280	56	242T	15.29		
		5320	64	106T	14.49	14.48					5320	64	242T	15.26		
	2C	5500	100	106T	14.50	14.45			20MHz BW	2C	5500	100	242T	15.22		
		5600	120	106T	14.71	14.73					5600	120	242T	15.48		
		5720	144	106T	14.88	14.88					5720	144	242T	15.50		
3	5745	149	106T	14.94	14.84		20MHz BW	3	5745	149	242T	15.76				
	5785	157	106T	14.99	14.95				5785	157	242T	15.96				
	5825	165	106T	14.91	14.90				5825	165	242T	15.82				

40MHz BW	Band	Freq [MHz]	Channel	Tones	Avg Conducted Power (dBm)			40MHz BW	Band	Freq [MHz]	Channel	Tones	Avg Conducted Power (dBm)			
					RU Index								RU Index			
					0	8	17						37	40	44	
40MHz BW	1	5190	38	26T	10.98	10.99	10.88	40MHz BW	1	5190	38	52T	11.20	11.94	11.08	
		5230	46	26T	10.90	10.98	10.76			5230	46	52T	11.08	11.99	11.95	
		5270	54	26T	10.88	10.69	10.69			5270	54	52T	11.94	11.85	11.88	
	2A	5310	62	26T	10.77	10.76	10.69		40MHz BW	2A	5310	62	52T	11.97	11.79	11.85
		5510	102	26T	10.84	10.84	10.98				5510	102	52T	11.99	11.85	11.26
		5590	118	26T	10.98	10.97	10.98				5590	118	52T	11.17	11.95	11.16
	2C	5710	142	26T	10.42	10.41	10.45		40MHz BW	2C	5710	142	52T	11.61	11.47	11.69
		5755	151	26T	10.51	10.47	10.66				5755	151	52T	11.76	11.53	11.74
		5795	159	26T	10.17	10.73	10.28				5795	159	52T	11.22	11.68	11.45

40MHz BW	Band	Freq [MHz]	Channel	Tones	Avg Conducted Power (dBm)			40MHz BW	Band	Freq [MHz]	Channel	Tones	Avg Conducted Power (dBm)			
					RU Index								RU Index			
					53	54	56						61	62	N/A	
40MHz BW	1	5190	38	106T	12.35	12.98	12.26	40MHz BW	1	5190	38	242T	13.16	13.42		
		5230	46	106T	12.33	12.91	12.13			5230	46	242T	13.37	13.31		
		5270	54	106T	12.20	12.74	12.19			5270	54	242T	13.32	13.35		
	2A	5310	62	106T	12.22	12.77	12.03		40MHz BW	2A	5310	62	242T	13.35	13.25	
		5510	102	106T	12.24	12.79	12.42				5510	102	242T	13.45	13.72	
		5590	118	106T	12.34	12.91	12.36				5590	118	242T	13.64	13.62	
	2C	5710	142	106T	12.78	12.41	12.81		40MHz BW	2C	5710	142	242T	13.97	13.96	
		5755	151	106T	12.92	12.42	12.93				5755	151	242T	13.91	13.99	
		5795	159	106T	12.52	12.53	12.74				5795	159	242T	13.73	13.94	

FCC ID: A3LSMG986U	 SAR EVALUATION REPORT		Reviewed by: Quality Manager
Test Dates: 10/21/19 – 01/01/20	DUT Type: Portable Handset		APPENDIX H: Page 5 of 8

40MHz BW	Band	Freq [MHz]	Channel	Tones	Avg Conducted Power (dBm)		
					RU Index		
					65	N/A	N/A
1	5190	38	484T	13.26			
	5230	46	484T	13.18			
2A	5270	54	484T	13.20			
	5310	62	484T	13.88			
2C	5510	102	484T	13.40			
	5590	118	484T	13.39			
3	5710	142	484T	13.70			
	5755	151	484T	13.75			
	5795	159	484T	13.61			

80MHz BW	Band	Freq [MHz]	Channel	Tones	Avg Conducted Power (dBm)			80MHz BW	Band	Freq [MHz]	Channel	Tones	Avg Conducted Power (dBm)		
					RU Index								RU Index		
					0	18	36						37	44	52
1	5210	42	26T	10.97	10.51	10.72	1	5210	42	52T	10.18	10.41	10.87		
2A	5290	58	26T	10.72	10.26	10.58	2A	5290	58	52T	10.81	10.16	10.73		
2C	5530	106	26T	10.85	10.71	10.90	2C	5530	106	52T	10.95	10.37	10.94		
	5610	122	26T	10.95	10.73	10.98		5610	122	52T	10.14	10.45	10.20		
	5690	138	26T	10.32	10.93	10.27		5690	138	52T	10.34	10.72	10.46		
3	5775	155	26T	10.34	10.95	10.76	3	5775	155	52T	10.53	10.98	10.81		

80MHz BW	Band	Freq [MHz]	Channel	Tones	Avg Conducted Power (dBm)			80MHz BW	Band	Freq [MHz]	Channel	Tones	Avg Conducted Power (dBm)		
					RU Index								RU Index		
					53	56	60						61	62	64
1	5210	42	106T	11.25	11.43	11.05	1	5210	42	242T	12.51	12.67	12.32		
2A	5290	58	106T	11.98	11.31	11.86	2A	5290	58	242T	12.17	12.39	12.15		
2C	5530	106	106T	11.20	11.46	11.20	2C	5530	106	242T	12.41	12.56	12.49		
	5610	122	106T	11.21	11.61	11.35		5610	122	242T	12.38	12.73	12.64		
	5690	138	106T	11.44	11.80	11.63		5690	138	242T	12.74	12.92	12.73		
3	5775	155	106T	11.63	11.96	11.82	3	5775	155	242T	12.86	12.97	12.83		

80MHz BW	Band	Freq [MHz]	Channel	Tones	Avg Conducted Power (dBm)			80MHz BW	Band	Freq [MHz]	Channel	Tones	Avg Conducted Power (dBm)		
					RU Index								RU Index		
					65	66	N/A						67	N/A	N/A
1	5210	42	484T	12.27	12.12		1	5210	42	996T	12.15				
2A	5290	58	484T	12.94	12.88		2A	5290	58	996T	12.98				
2C	5530	106	484T	12.28	12.41		2C	5530	106	996T	12.18				
	5610	122	484T	12.31	12.53			5610	122	996T	12.20				
	5690	138	484T	12.60	12.69			5690	138	996T	12.50				
3	5775	155	484T	12.57	12.73		3	5775	155	996T	12.61				



FCC ID: A3LSMG986U	 PCTEST ENGINEERING LABORATORY, INC.	SAR EVALUATION REPORT		Reviewed by: Quality Manager
Test Dates: 10/21/19 – 01/01/20	DUT Type: Portable Handset			APPENDIX H: Page 6 of 8



Table 4
Maximum 5 GHz 802.11ax RU Output Power – Ant 2

20MHz BW	Band	Freq [MHz]	Channel	Tones	Avg Conducted Power (dBm)			20MHz BW	Band	Freq [MHz]	Channel	Tones	Avg Conducted Power (dBm)			
					RU Index								RU Index			
					0	4	8						37	39	40	
20MHz BW	1	5180	36	26T	10.61	10.97	10.94	20MHz BW	1	5180	36	52T	12.80	12.98	12.90	
		5200	40	26T	10.59	10.85	10.72			5200	40	52T	12.87	12.94	12.92	
		5240	48	26T	10.59	10.97	10.75			5240	48	52T	12.94	12.90	12.97	
	2A	5260	52	26T	10.72	10.87	10.61		20MHz BW	2A	5260	52	52T	12.04	12.17	12.02
		5280	56	26T	10.66	10.98	10.71				5280	56	52T	12.15	12.33	12.25
		5320	64	26T	10.93	10.96	10.78				5320	64	52T	12.34	12.48	12.33
	2C	5500	100	26T	10.47	10.61	10.42		20MHz BW	2C	5500	100	52T	12.21	12.40	12.20
		5600	120	26T	10.92	10.93	10.49				5600	120	52T	12.70	12.65	12.46
		5720	144	26T	10.91	10.97	10.63				5720	144	52T	12.77	12.96	12.79
3	5745	149	26T	10.53	10.55	10.07	20MHz BW	3	5745	149	52T	12.48	12.38	12.10		
	5785	157	26T	10.40	10.47	10.25			5785	157	52T	12.46	12.58	12.26		
	5825	165	26T	10.25	10.46	10.05			5825	165	52T	12.09	12.34	12.04		

20MHz BW	Band	Freq [MHz]	Channel	Tones	Avg Conducted Power (dBm)			20MHz BW	Band	Freq [MHz]	Channel	Tones	Avg Conducted Power (dBm)			
					RU Index								RU Index			
					53	54	N/A						61	N/A	N/A	
20MHz BW	1	5180	36	106T	14.90	14.95		20MHz BW	1	5180	36	242T	15.91			
		5200	40	106T	14.03	14.11				5200	40	242T	15.94			
		5240	48	106T	14.13	14.14				5240	48	242T	15.93			
	2A	5260	52	106T	14.09	14.12			20MHz BW	2A	5260	52	242T	15.11		
		5280	56	106T	14.21	14.17					5280	56	242T	15.26		
		5320	64	106T	14.36	14.32					5320	64	242T	15.35		
	2C	5500	100	106T	14.35	14.29			20MHz BW	2C	5500	100	242T	15.38		
		5600	120	106T	14.72	14.52					5600	120	242T	15.57		
		5720	144	106T	14.80	14.68					5720	144	242T	15.73		
3	5745	149	106T	14.13	14.06		20MHz BW	3	5745	149	242T	15.90				
	5785	157	106T	14.17	14.08				5785	157	242T	15.97				
	5825	165	106T	14.84	14.78				5825	165	242T	15.79				

40MHz BW	Band	Freq [MHz]	Channel	Tones	Avg Conducted Power (dBm)			40MHz BW	Band	Freq [MHz]	Channel	Tones	Avg Conducted Power (dBm)			
					RU Index								RU Index			
					0	8	17						37	40	44	
40MHz BW	1	5190	38	26T	10.46	10.54	10.40	40MHz BW	1	5190	38	52T	11.56	11.57	11.62	
		5230	46	26T	10.47	10.57	10.45			5230	46	52T	11.61	11.48	11.61	
		5270	54	26T	10.40	10.30	10.37			5270	54	52T	11.50	11.44	11.43	
	2A	5310	62	26T	10.53	10.44	10.37		40MHz BW	2A	5310	62	52T	11.62	11.52	11.43
		5510	102	26T	10.33	10.29	10.31				5510	102	52T	11.56	11.22	11.62
		5590	118	26T	10.41	10.40	10.25				5590	118	52T	11.59	11.28	11.39
	2C	5710	142	26T	10.40	10.18	10.17		40MHz BW	2C	5710	142	52T	11.58	11.29	11.45
		5755	151	26T	10.94	10.80	10.87				5755	151	52T	11.70	11.68	11.84
		5795	159	26T	10.39	10.85	10.21				5795	159	52T	11.38	11.65	11.30

40MHz BW	Band	Freq [MHz]	Channel	Tones	Avg Conducted Power (dBm)			40MHz BW	Band	Freq [MHz]	Channel	Tones	Avg Conducted Power (dBm)			
					RU Index								RU Index			
					53	54	56						61	62	N/A	
40MHz BW	1	5190	38	106T	12.93	12.61	12.81	40MHz BW	1	5190	38	242T	13.25	13.29		
		5230	46	106T	12.90	12.54	12.85			5230	46	242T	13.86	13.65		
		5270	54	106T	12.78	12.32	12.79			5270	54	242T	13.80	13.70		
	2A	5310	62	106T	12.94	12.41	12.83		40MHz BW	2A	5310	62	242T	13.96	13.69	
		5510	102	106T	12.64	12.29	12.80				5510	102	242T	13.67	13.97	
		5590	118	106T	12.72	12.23	12.64				5590	118	242T	13.65	13.59	
	2C	5710	142	106T	12.74	12.16	12.56		40MHz BW	2C	5710	142	242T	13.74	13.55	
		5755	151	106T	12.37	12.85	12.23				5755	151	242T	13.91	13.96	
		5795	159	106T	12.91	12.69	12.63				5795	159	242T	13.79	13.82	



FCC ID: A3LSMG986U	 PCTEST ENGINEERING LABORATORY, INC.	SAR EVALUATION REPORT		Reviewed by: Quality Manager
Test Dates: 10/21/19 – 01/01/20	DUT Type: Portable Handset			APPENDIX H: Page 7 of 8

40MHz BW	Band	Freq [MHz]	Channel	Tones	Avg Conducted Power (dBm)		
					RU Index		
					65	N/A	N/A
1	5190	38	484T	13.05			
	5230	46	484T	13.68			
2A	5270	54	484T	13.65			
	5310	62	484T	13.44			
2C	5510	102	484T	13.51			
	5590	118	484T	13.32			
3	5710	142	484T	13.42			
	5755	151	484T	13.95			
	5795	159	484T	13.85			

80MHz BW	Band	Freq [MHz]	Channel	Tones	Avg Conducted Power (dBm)			80MHz BW	Band	Freq [MHz]	Channel	Tones	Avg Conducted Power (dBm)		
					RU Index								RU Index		
					0	18	36						37	44	52
1	5210	42	26T	10.22	10.85	10.11	1	5210	42	52T	10.30	10.67	10.30		
2A	5290	58	26T	10.02	10.65	10.90	2A	5290	58	52T	10.14	10.55	10.10		
	5530	106	26T	10.08	10.75	10.87	2C	5530	106	52T	10.17	10.25	10.06		
2C	5610	122	26T	10.03	10.52	10.78		5610	122	52T	10.14	10.26	10.97		
	5690	138	26T	10.11	10.52	10.72	5690	138	52T	10.29	10.34	10.96			
3	5775	155	26T	10.64	10.27	10.39	3	5775	155	52T	10.83	10.98	10.60		

80MHz BW	Band	Freq [MHz]	Channel	Tones	Avg Conducted Power (dBm)			80MHz BW	Band	Freq [MHz]	Channel	Tones	Avg Conducted Power (dBm)		
					RU Index								RU Index		
					53	56	60						61	62	64
1	5210	42	106T	11.46	11.69	11.41	1	5210	42	242T	12.62	12.94	12.62		
2A	5290	58	106T	11.18	11.52	11.17	2A	5290	58	242T	12.51	12.76	12.47		
	5530	106	106T	11.33	11.44	11.27	2C	5530	106	242T	12.45	12.61	12.48		
2C	5610	122	106T	11.25	11.42	11.11		5610	122	242T	12.42	12.55	12.36		
	5690	138	106T	11.39	11.39	11.14	5690	138	242T	12.39	12.42	12.40			
3	5775	155	106T	11.77	11.95	11.61	3	5775	155	242T	12.79	12.98	12.85		

80MHz BW	Band	Freq [MHz]	Channel	Tones	Avg Conducted Power (dBm)			80MHz BW	Band	Freq [MHz]	Channel	Tones	Avg Conducted Power (dBm)		
					RU Index								RU Index		
					65	66	N/A						67	N/A	N/A
1	5210	42	484T	12.46	12.45		1	5210	42	996T	12.29				
2A	5290	58	484T	12.22	12.36		2A	5290	58	996T	12.95				
	5530	106	484T	12.23	12.49		2C	5530	106	996T	12.76				
2C	5610	122	484T	12.23	12.32			5610	122	996T	12.65				
	5690	138	484T	12.33	12.45		5690	138	996T	12.66					
3	5775	155	484T	12.67	12.90		3	5775	155	996T	12.28				

FCC ID: A3LSMG986U	 PCTEST ENGINEERING LABORATORY, INC.	SAR EVALUATION REPORT		Reviewed by: Quality Manager
Test Dates: 10/21/19 – 01/01/20	DUT Type: Portable Handset			APPENDIX H: Page 8 of 8

APPENDIX I: PROBE CALIBRATION



Accredited by the Swiss Accreditation Service (SAS)
 The Swiss Accreditation Service is one of the signatories to the EA
 Multilateral Agreement for the recognition of calibration certificates

Accreditation No.: **SCS 0108**

Client **PC Test**

Certificate No: **D2300V2-1064_Nov19**

CALIBRATION CERTIFICATE

✓ ATM
 12/11/19

Object **D2300V2 - SN:1064**

Calibration procedure(s) **QA CAL-05.v11
 Calibration Procedure for SAR Validation Sources between 0.7-3 GHz**

Calibration date: **November 12, 2019**

This calibration certificate documents the traceability to national standards, which realize the physical units of measurements (SI).
 The measurements and the uncertainties with confidence probability are given on the following pages and are part of the certificate.

All calibrations have been conducted in the closed laboratory facility: environment temperature (22 ± 3)°C and humidity < 70%.

Calibration Equipment used (M&TE critical for calibration)

Primary Standards	ID #	Cal Date (Certificate No.)	Scheduled Calibration
Power meter NRP	SN: 104778	03-Apr-19 (No. 217-02892/02893)	Apr-20
Power sensor NRP-Z91	SN: 103244	03-Apr-19 (No. 217-02892)	Apr-20
Power sensor NRP-Z91	SN: 103245	03-Apr-19 (No. 217-02893)	Apr-20
Reference 20 dB Attenuator	SN: 5058 (20k)	04-Apr-19 (No. 217-02894)	Apr-20
Type-N mismatch combination	SN: 5047.2 / 06327	04-Apr-19 (No. 217-02895)	Apr-20
Reference Probe EX3DV4	SN: 7349	29-May-19 (No. EX3-7349_May19)	May-20
DAE4	SN: 601	30-Apr-19 (No. DAE4-601_Apr19)	Apr-20

Secondary Standards	ID #	Check Date (in house)	Scheduled Check
Power meter E4419B	SN: GB39512475	30-Oct-14 (in house check Feb-19)	In house check: Oct-20
Power sensor HP 8481A	SN: US37292783	07-Oct-15 (in house check Oct-18)	In house check: Oct-20
Power sensor HP 8481A	SN: MY41092317	07-Oct-15 (in house check Oct-18)	In house check: Oct-20
RF generator R&S SMT-06	SN: 100972	15-Jun-15 (in house check Oct-18)	In house check: Oct-20
Network Analyzer Agilent E8358A	SN: US41080477	31-Mar-14 (in house check Oct-19)	In house check: Oct-20

	Name	Function	Signature
Calibrated by:	Jeton Kastrali	Laboratory Technician	
Approved by:	Katja Pokovic	Technical Manager	

Issued: November 12, 2019

This calibration certificate shall not be reproduced except in full without written approval of the laboratory.



Accredited by the Swiss Accreditation Service (SAS)
The Swiss Accreditation Service is one of the signatories to the EA
Multilateral Agreement for the recognition of calibration certificates

Accreditation No.: **SCS 0108**

Glossary:

TSL	tissue simulating liquid
ConvF	sensitivity in TSL / NORM x,y,z
N/A	not applicable or not measured

Calibration is Performed According to the Following Standards:

- IEEE Std 1528-2013, "IEEE Recommended Practice for Determining the Peak Spatial-Averaged Specific Absorption Rate (SAR) in the Human Head from Wireless Communications Devices: Measurement Techniques", June 2013
- IEC 62209-1, "Measurement procedure for the assessment of Specific Absorption Rate (SAR) from hand-held and body-mounted devices used next to the ear (frequency range of 300 MHz to 6 GHz)", July 2016
- IEC 62209-2, "Procedure to determine the Specific Absorption Rate (SAR) for wireless communication devices used in close proximity to the human body (frequency range of 30 MHz to 6 GHz)", March 2010
- KDB 865664, "SAR Measurement Requirements for 100 MHz to 6 GHz"

Additional Documentation:

- DASY4/5 System Handbook

Methods Applied and Interpretation of Parameters:

- Measurement Conditions:* Further details are available from the Validation Report at the end of the certificate. All figures stated in the certificate are valid at the frequency indicated.
- Antenna Parameters with TSL:* The dipole is mounted with the spacer to position its feed point exactly below the center marking of the flat phantom section, with the arms oriented parallel to the body axis.
- Feed Point Impedance and Return Loss:* These parameters are measured with the dipole positioned under the liquid filled phantom. The impedance stated is transformed from the measurement at the SMA connector to the feed point. The Return Loss ensures low reflected power. No uncertainty required.
- Electrical Delay:* One-way delay between the SMA connector and the antenna feed point. No uncertainty required.
- SAR measured:* SAR measured at the stated antenna input power.
- SAR normalized:* SAR as measured, normalized to an input power of 1 W at the antenna connector.
- SAR for nominal TSL parameters:* The measured TSL parameters are used to calculate the nominal SAR result.

The reported uncertainty of measurement is stated as the standard uncertainty of measurement multiplied by the coverage factor $k=2$, which for a normal distribution corresponds to a coverage probability of approximately 95%.

Measurement Conditions

DASY system configuration, as far as not given on page 1.

DASY Version	DASY5	V52.10.3
Extrapolation	Advanced Extrapolation	
Phantom	Modular Flat Phantom	
Distance Dipole Center - TSL	10 mm	with Spacer
Zoom Scan Resolution	dx, dy, dz = 5 mm	
Frequency	2300 MHz \pm 1 MHz	

Head TSL parameters

The following parameters and calculations were applied.

	Temperature	Permittivity	Conductivity
Nominal Head TSL parameters	22.0 °C	39.5	1.67 mho/m
Measured Head TSL parameters	(22.0 \pm 0.2) °C	38.7 \pm 6 %	1.68 mho/m \pm 6 %
Head TSL temperature change during test	< 0.5 °C	----	----

SAR result with Head TSL

SAR averaged over 1 cm³ (1 g) of Head TSL	Condition	
SAR measured	250 mW input power	12.0 W/kg
SAR for nominal Head TSL parameters	normalized to 1W	47.6 W/kg \pm 17.0 % (k=2)

SAR averaged over 10 cm³ (10 g) of Head TSL	condition	
SAR measured	250 mW input power	5.71 W/kg
SAR for nominal Head TSL parameters	normalized to 1W	22.7 W/kg \pm 16.5 % (k=2)

Body TSL parameters

The following parameters and calculations were applied.

	Temperature	Permittivity	Conductivity
Nominal Body TSL parameters	22.0 °C	52.9	1.81 mho/m
Measured Body TSL parameters	(22.0 \pm 0.2) °C	51.2 \pm 6 %	1.84 mho/m \pm 6 %
Body TSL temperature change during test	< 0.5 °C	----	----

SAR result with Body TSL

SAR averaged over 1 cm³ (1 g) of Body TSL	Condition	
SAR measured	250 mW input power	12.1 W/kg
SAR for nominal Body TSL parameters	normalized to 1W	47.6 W/kg \pm 17.0 % (k=2)

SAR averaged over 10 cm³ (10 g) of Body TSL	condition	
SAR measured	250 mW input power	5.78 W/kg
SAR for nominal Body TSL parameters	normalized to 1W	22.9 W/kg \pm 16.5 % (k=2)

Appendix (Additional assessments outside the scope of SCS 0108)

Antenna Parameters with Head TSL

Impedance, transformed to feed point	48.5 Ω - 5.4 j Ω
Return Loss	- 24.9 dB

Antenna Parameters with Body TSL

Impedance, transformed to feed point	45.8 Ω - 3.8 j Ω
Return Loss	- 24.5 dB

General Antenna Parameters and Design

Electrical Delay (one direction)	1.167 ns
----------------------------------	----------

After long term use with 100W radiated power, only a slight warming of the dipole near the feedpoint can be measured.

The dipole is made of standard semirigid coaxial cable. The center conductor of the feeding line is directly connected to the second arm of the dipole. The antenna is therefore short-circuited for DC-signals. On some of the dipoles, small end caps are added to the dipole arms in order to improve matching when loaded according to the position as explained in the "Measurement Conditions" paragraph. The SAR data are not affected by this change. The overall dipole length is still according to the Standard.

No excessive force must be applied to the dipole arms, because they might bend or the soldered connections near the feedpoint may be damaged.

Additional EUT Data

Manufactured by	SPEAG
-----------------	-------

DASY5 Validation Report for Head TSL

Date: 12.11.2019

Test Laboratory: SPEAG, Zurich, Switzerland

DUT: Dipole 2300 MHz; Type: D2300V2; Serial: D2300V2 - SN:1064

Communication System: UID 0 - CW; Frequency: 2300 MHz

Medium parameters used: $f = 2300$ MHz; $\sigma = 1.68$ S/m; $\epsilon_r = 38.7$; $\rho = 1000$ kg/m³

Phantom section: Flat Section

Measurement Standard: DASY5 (IEEE/IEC/ANSI C63.19-2011)

DASY52 Configuration:

- Probe: EX3DV4 - SN7349; ConvF(8.15, 8.15, 8.15) @ 2300 MHz; Calibrated: 29.05.2019
- Sensor-Surface: 1.4mm (Mechanical Surface Detection)
- Electronics: DAE4 Sn601; Calibrated: 30.04.2019
- Phantom: Flat Phantom 5.0 (front); Type: QD 000 P50 AA; Serial: 1001
- DASY52 52.10.3(1513); SEMCAD X 14.6.13(7474)

Dipole Calibration for Head Tissue/Pin=250 mW, d=10mm/Zoom Scan (7x7x7)/Cube 0:

Measurement grid: dx=5mm, dy=5mm, dz=5mm

Reference Value = 114.2 V/m; Power Drift = 0.03 dB

Peak SAR (extrapolated) = 23.0 W/kg

SAR(1 g) = 12 W/kg; SAR(10 g) = 5.71 W/kg

Smallest distance from peaks to all points 3 dB below = 9 mm

Ratio of SAR at M2 to SAR at M1 = 52.5%

Maximum value of SAR (measured) = 19.2 W/kg

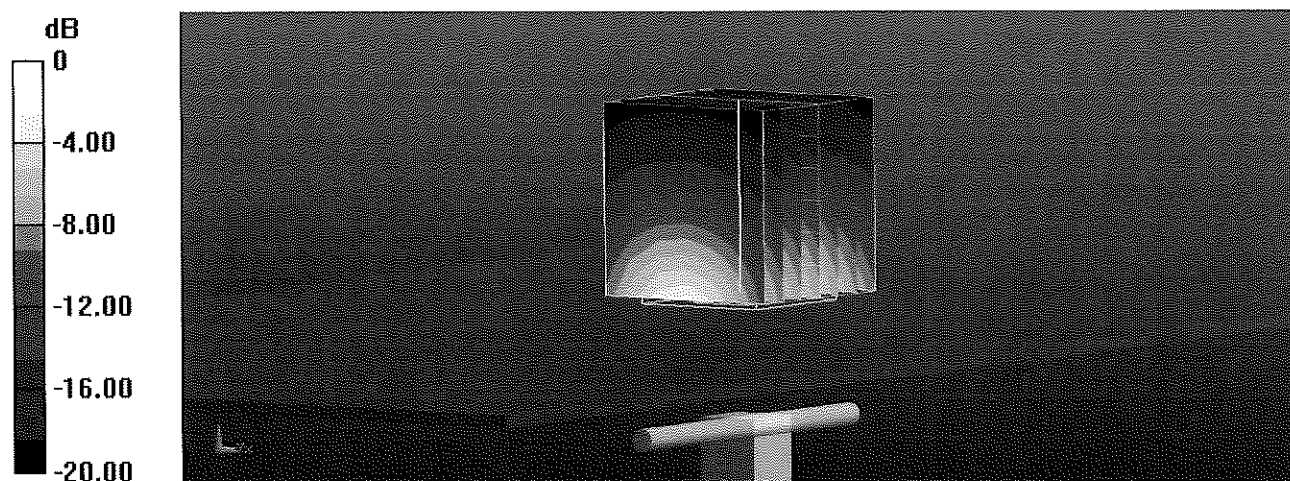

0 dB = 19.2 W/kg = 12.83 dBW/kg

Impedance Measurement Plot for Head TSL

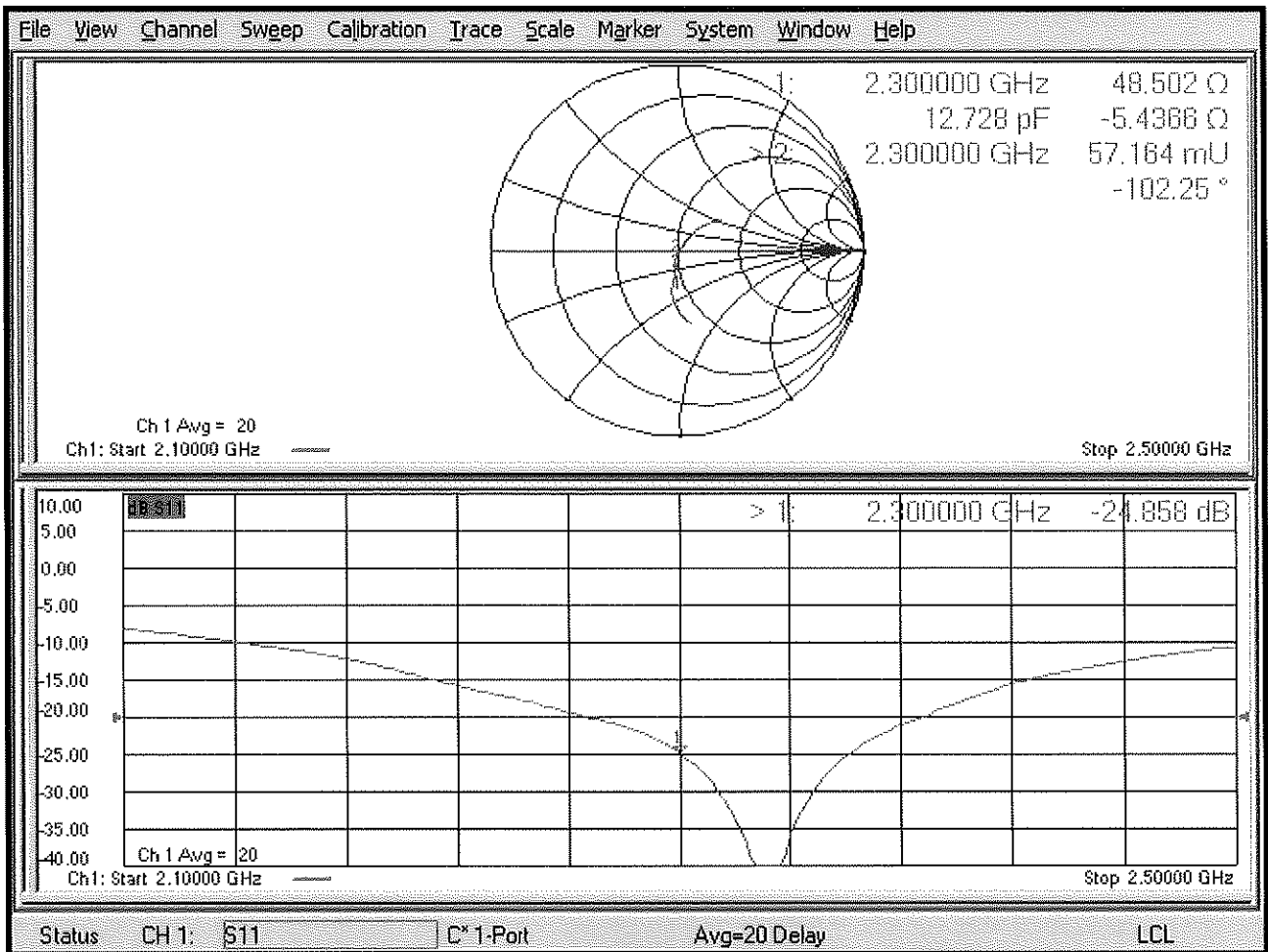

DASY5 Validation Report for Body TSL

Date: 12.11.2019

Test Laboratory: SPEAG, Zurich, Switzerland

DUT: Dipole 2300 MHz; Type: D2300V2; Serial: D2300V2 - SN:1064

Communication System: UID 0 - CW; Frequency: 2300 MHz

Medium parameters used: $f = 2300$ MHz; $\sigma = 1.84$ S/m; $\epsilon_r = 51.2$; $\rho = 1000$ kg/m³

Phantom section: Flat Section

Measurement Standard: DASY5 (IEEE/IEC/ANSI C63.19-2011)

DASY52 Configuration:

- Probe: EX3DV4 - SN7349; ConvF(8.18, 8.18, 8.18) @ 2300 MHz; Calibrated: 29.05.2019
- Sensor-Surface: 1.4mm (Mechanical Surface Detection)
- Electronics: DAE4 Sn601; Calibrated: 30.04.2019
- Phantom: Flat Phantom 5.0 (back); Type: QD 000 P50 AA; Serial: 1002
- DASY52 52.10.3(1513); SEMCAD X 14.6.13(7474)

Dipole Calibration for Body Tissue/Pin=250 mW, d=10mm/Zoom Scan (7x7x7)/Cube 0:

Measurement grid: dx=5mm, dy=5mm, dz=5mm

Reference Value = 109.3 V/m; Power Drift = -0.03 dB

Peak SAR (extrapolated) = 23.2 W/kg

SAR(1 g) = 12.1 W/kg; SAR(10 g) = 5.78 W/kg

Smallest distance from peaks to all points 3 dB below = 8.5 mm

Ratio of SAR at M2 to SAR at M1 = 52.9%

Maximum value of SAR (measured) = 19.5 W/kg

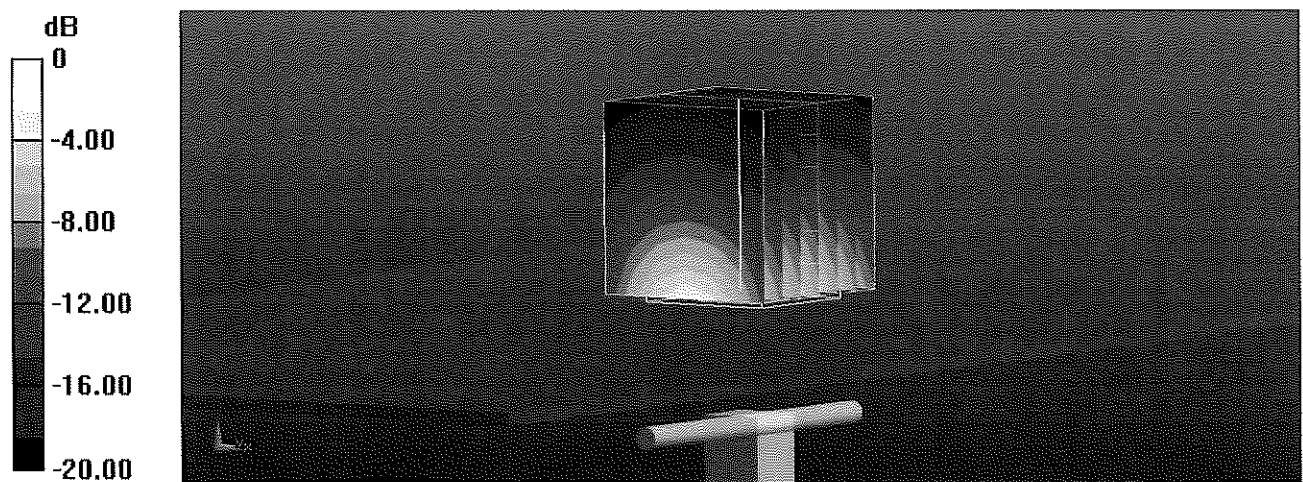

0 dB = 19.5 W/kg = 12.90 dBW/kg

Impedance Measurement Plot for Body TSL

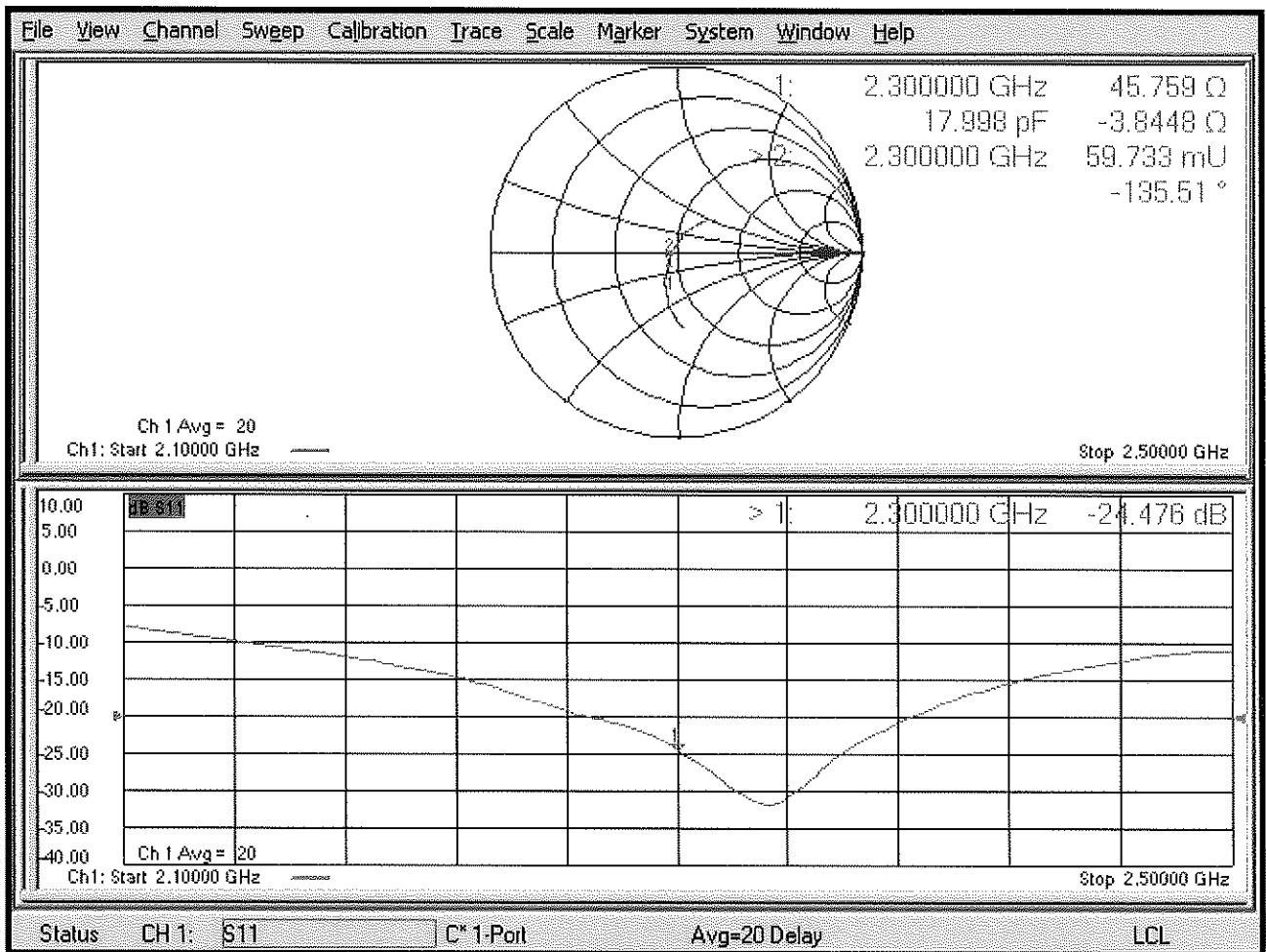



Accredited by the Swiss Accreditation Service (SAS)
The Swiss Accreditation Service is one of the signatories to the EA
Multilateral Agreement for the recognition of calibration certificates

Accreditation No.: **SCS 0108**

Client **PC Test**

Certificate No: **D2600V2-1064_Jun19**

CALIBRATION CERTIFICATE

Object **D2600V2 - SN:1064**

Calibration procedure(s) **QA CAL-05.v11
Calibration Procedure for SAR Validation Sources between 0.7-3 GHz**

*BNW
07/31/2019*

Calibration date: **June 14, 2019**

This calibration certificate documents the traceability to national standards, which realize the physical units of measurements (SI).
The measurements and the uncertainties with confidence probability are given on the following pages and are part of the certificate.

All calibrations have been conducted in the closed laboratory facility: environment temperature (22 ± 3)°C and humidity < 70%.

Calibration Equipment used (M&TE critical for calibration)

Primary Standards	ID #	Cal Date (Certificate No.)	Scheduled Calibration
Power meter NRP	SN: 104778	03-Apr-19 (No. 217-02892/02893)	Apr-20
Power sensor NRP-Z91	SN: 103244	03-Apr-19 (No. 217-02892)	Apr-20
Power sensor NRP-Z91	SN: 103245	03-Apr-19 (No. 217-02893)	Apr-20
Reference 20 dB Attenuator	SN: 5058 (20k)	04-Apr-19 (No. 217-02894)	Apr-20
Type-N mismatch combination	SN: 5047.2 / 06327	04-Apr-19 (No. 217-02895)	Apr-20
Reference Probe EX3DV4	SN: 7349	29-May-19 (No. EX3-7349_May19)	May-20
DAE4	SN: 601	30-Apr-19 (No. DAE4-601_Apr19)	Apr-20
Secondary Standards	ID #	Check Date (in house)	Scheduled Check
Power meter E4419B	SN: GB39512475	30-Oct-14 (in house check Feb-19)	In house check: Oct-20
Power sensor HP 8481A	SN: US37292783	07-Oct-15 (in house check Oct-18)	In house check: Oct-20
Power sensor HP 8481A	SN: MY41092317	07-Oct-15 (in house check Oct-18)	In house check: Oct-20
RF generator R&S SMT-06	SN: 100972	15-Jun-15 (in house check Oct-18)	In house check: Oct-20
Network Analyzer Agilent E8358A	SN: US41080477	31-Mar-14 (in house check Oct-18)	In house check: Oct-19

Calibrated by:	Name Michael Weber	Function Laboratory Technician	Signature
Approved by:	Name Katja Pokovic	Function Technical Manager	

Issued: June 20, 2019

This calibration certificate shall not be reproduced except in full without written approval of the laboratory.



Accredited by the Swiss Accreditation Service (SAS)

Accreditation No.: **SCS 0108**

The Swiss Accreditation Service is one of the signatories to the EA Multilateral Agreement for the recognition of calibration certificates

Glossary:

TSL	tissue simulating liquid
ConvF	sensitivity in TSL / NORM x,y,z
N/A	not applicable or not measured

Calibration is Performed According to the Following Standards:

- IEEE Std 1528-2013, "IEEE Recommended Practice for Determining the Peak Spatial-Averaged Specific Absorption Rate (SAR) in the Human Head from Wireless Communications Devices: Measurement Techniques", June 2013
- IEC 62209-1, "Measurement procedure for the assessment of Specific Absorption Rate (SAR) from hand-held and body-mounted devices used next to the ear (frequency range of 300 MHz to 6 GHz)", July 2016
- IEC 62209-2, "Procedure to determine the Specific Absorption Rate (SAR) for wireless communication devices used in close proximity to the human body (frequency range of 30 MHz to 6 GHz)", March 2010
- KDB 865664, "SAR Measurement Requirements for 100 MHz to 6 GHz"

Additional Documentation:

- DASY4/5 System Handbook

Methods Applied and Interpretation of Parameters:

- Measurement Conditions:** Further details are available from the Validation Report at the end of the certificate. All figures stated in the certificate are valid at the frequency indicated.
- Antenna Parameters with TSL:** The dipole is mounted with the spacer to position its feed point exactly below the center marking of the flat phantom section, with the arms oriented parallel to the body axis.
- Feed Point Impedance and Return Loss:** These parameters are measured with the dipole positioned under the liquid filled phantom. The impedance stated is transformed from the measurement at the SMA connector to the feed point. The Return Loss ensures low reflected power. No uncertainty required.
- Electrical Delay:** One-way delay between the SMA connector and the antenna feed point. No uncertainty required.
- SAR measured:** SAR measured at the stated antenna input power.
- SAR normalized:** SAR as measured, normalized to an input power of 1 W at the antenna connector.
- SAR for nominal TSL parameters:** The measured TSL parameters are used to calculate the nominal SAR result.

The reported uncertainty of measurement is stated as the standard uncertainty of measurement multiplied by the coverage factor $k=2$, which for a normal distribution corresponds to a coverage probability of approximately 95%.

Measurement Conditions

DASY system configuration, as far as not given on page 1.

DASY Version	DASY5	V52.10.2
Extrapolation	Advanced Extrapolation	
Phantom	Modular Flat Phantom	
Distance Dipole Center - TSL	10 mm	with Spacer
Zoom Scan Resolution	dx, dy, dz = 5 mm	
Frequency	2600 MHz ± 1 MHz	

Head TSL parameters

The following parameters and calculations were applied.

	Temperature	Permittivity	Conductivity
Nominal Head TSL parameters	22.0 °C	39.0	1.96 mho/m
Measured Head TSL parameters	(22.0 ± 0.2) °C	37.3 ± 6 %	2.03 mho/m ± 6 %
Head TSL temperature change during test	< 0.5 °C	---	---

SAR result with Head TSL

SAR averaged over 1 cm³ (1 g) of Head TSL	Condition	
SAR measured	250 mW input power	14.9 W/kg
SAR for nominal Head TSL parameters	normalized to 1W	58.1 W/kg ± 17.0 % (k=2)

SAR averaged over 10 cm³ (10 g) of Head TSL	condition	
SAR measured	250 mW input power	6.59 W/kg
SAR for nominal Head TSL parameters	normalized to 1W	26.0 W/kg ± 16.5 % (k=2)

Body TSL parameters

The following parameters and calculations were applied.

	Temperature	Permittivity	Conductivity
Nominal Body TSL parameters	22.0 °C	52.5	2.16 mho/m
Measured Body TSL parameters	(22.0 ± 0.2) °C	50.5 ± 6 %	2.22 mho/m ± 6 %
Body TSL temperature change during test	< 0.5 °C	---	---

SAR result with Body TSL

SAR averaged over 1 cm³ (1 g) of Body TSL	Condition	
SAR measured	250 mW input power	14.2 W/kg
SAR for nominal Body TSL parameters	normalized to 1W	55.6 W/kg ± 17.0 % (k=2)

SAR averaged over 10 cm³ (10 g) of Body TSL	condition	
SAR measured	250 mW input power	6.33 W/kg
SAR for nominal Body TSL parameters	normalized to 1W	25.0 W/kg ± 16.5 % (k=2)

Appendix (Additional assessments outside the scope of SCS 0108)

Antenna Parameters with Head TSL

Impedance, transformed to feed point	49.8 Ω - 6.9 j Ω
Return Loss	- 23.2 dB

Antenna Parameters with Body TSL

Impedance, transformed to feed point	46.6 Ω - 4.4 j Ω
Return Loss	- 24.9 dB

General Antenna Parameters and Design

Electrical Delay (one direction)	1.151 ns
----------------------------------	----------

After long term use with 100W radiated power, only a slight warming of the dipole near the feedpoint can be measured.

The dipole is made of standard semirigid coaxial cable. The center conductor of the feeding line is directly connected to the second arm of the dipole. The antenna is therefore short-circuited for DC-signals. On some of the dipoles, small end caps are added to the dipole arms in order to improve matching when loaded according to the position as explained in the "Measurement Conditions" paragraph. The SAR data are not affected by this change. The overall dipole length is still according to the Standard.

No excessive force must be applied to the dipole arms, because they might bend or the soldered connections near the feedpoint may be damaged.

Additional EUT Data

Manufactured by	SPEAG
-----------------	-------

DASY5 Validation Report for Head TSL

Date: 14.06.2019

Test Laboratory: SPEAG, Zurich, Switzerland

DUT: Dipole 2600 MHz; Type: D2600V2; Serial: D2600V2 - SN:1064

Communication System: UID 0 - CW; Frequency: 2600 MHz

Medium parameters used: $f = 2600$ MHz; $\sigma = 2.03$ S/m; $\epsilon_r = 37.3$; $\rho = 1000$ kg/m³

Phantom section: Flat Section

Measurement Standard: DASY5 (IEEE/IEC/ANSI C63.19-2011)

DASY52 Configuration:

- Probe: EX3DV4 - SN7349; ConvF(7.69, 7.69, 7.69) @ 2600 MHz; Calibrated: 29.05.2019
- Sensor-Surface: 1.4mm (Mechanical Surface Detection)
- Electronics: DAE4 Sn601; Calibrated: 30.04.2019
- Phantom: Flat Phantom 5.0 (front); Type: QD 000 P50 AA; Serial: 1001
- DASY52 52.10.2(1504); SEMCAD X 14.6.12(7470)

Dipole Calibration for Head Tissue/Pin=250 mW, d=10mm/Zoom Scan (7x7x7)/Cube 0:

Measurement grid: dx=5mm, dy=5mm, dz=5mm

Reference Value = 120.9 V/m; Power Drift = 0.01 dB

Peak SAR (extrapolated) = 30.2 W/kg

SAR(1 g) = 14.9 W/kg; SAR(10 g) = 6.59 W/kg

Maximum value of SAR (measured) = 25.1 W/kg

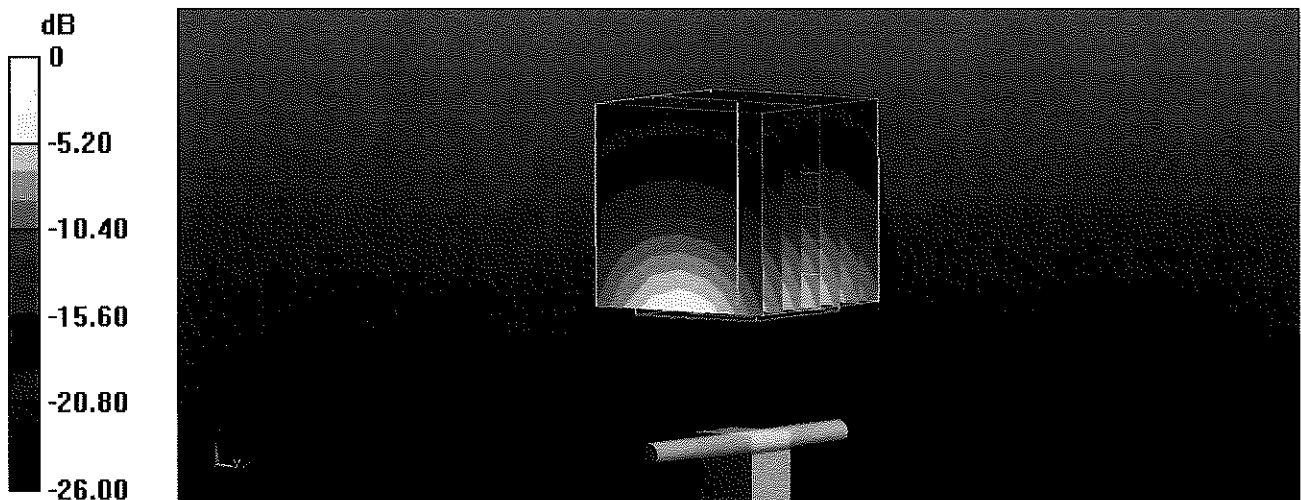

0 dB = 25.1 W/kg = 14.00 dBW/kg

Impedance Measurement Plot for Head TSL

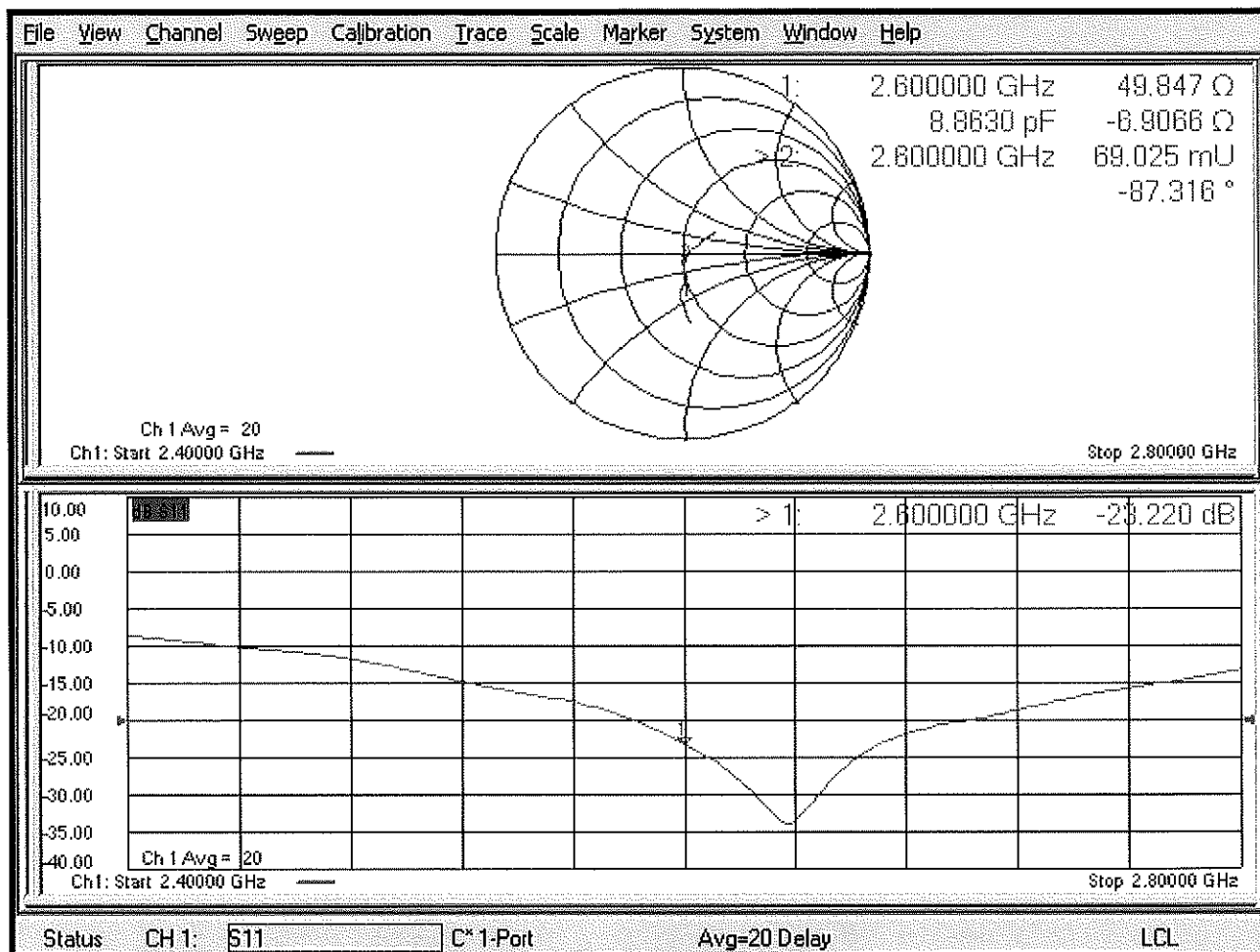

DASY5 Validation Report for Body TSL

Date: 14.06.2019

Test Laboratory: SPEAG, Zurich, Switzerland

DUT: Dipole 2600 MHz; Type: D2600V2; Serial: D2600V2 - SN:1064

Communication System: UID 0 - CW; Frequency: 2600 MHz

Medium parameters used: $f = 2600$ MHz; $\sigma = 2.22$ S/m; $\epsilon_r = 50.5$; $\rho = 1000$ kg/m³

Phantom section: Flat Section

Measurement Standard: DASY5 (IEEE/IEC/ANSI C63.19-2011)

DASY52 Configuration:

- Probe: EX3DV4 - SN7349; ConvF(7.8, 7.8, 7.8) @ 2600 MHz; Calibrated: 29.05.2019
- Sensor-Surface: 1.4mm (Mechanical Surface Detection)
- Electronics: DAE4 Sn601; Calibrated: 30.04.2019
- Phantom: Flat Phantom 5.0 (back); Type: QD 000 P50 AA; Serial: 1002
- DASY52 52.10.2(1504); SEMCAD X 14.6.12(7470)

Dipole Calibration for Body Tissue/Pin=250 mW, d=10mm/Zoom Scan (7x7x7)/Cube 0:

Measurement grid: dx=5mm, dy=5mm, dz=5mm

Reference Value = 110.6 V/m; Power Drift = -0.05 dB

Peak SAR (extrapolated) = 28.9 W/kg

SAR(1 g) = 14.2 W/kg; SAR(10 g) = 6.33 W/kg

Maximum value of SAR (measured) = 23.6 W/kg

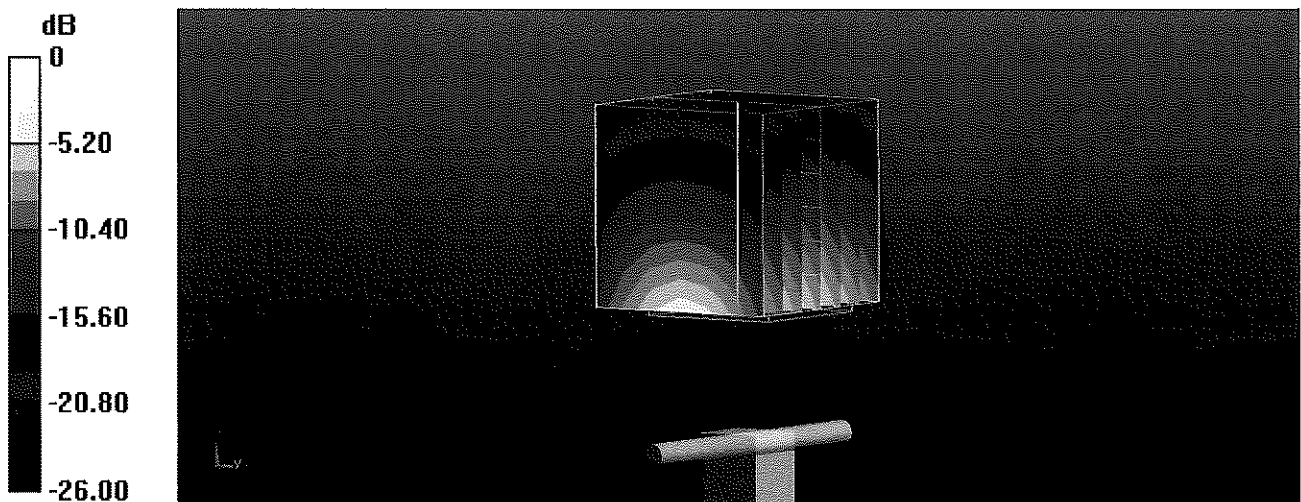

0 dB = 23.6 W/kg = 13.73 dBW/kg

Impedance Measurement Plot for Body TSL

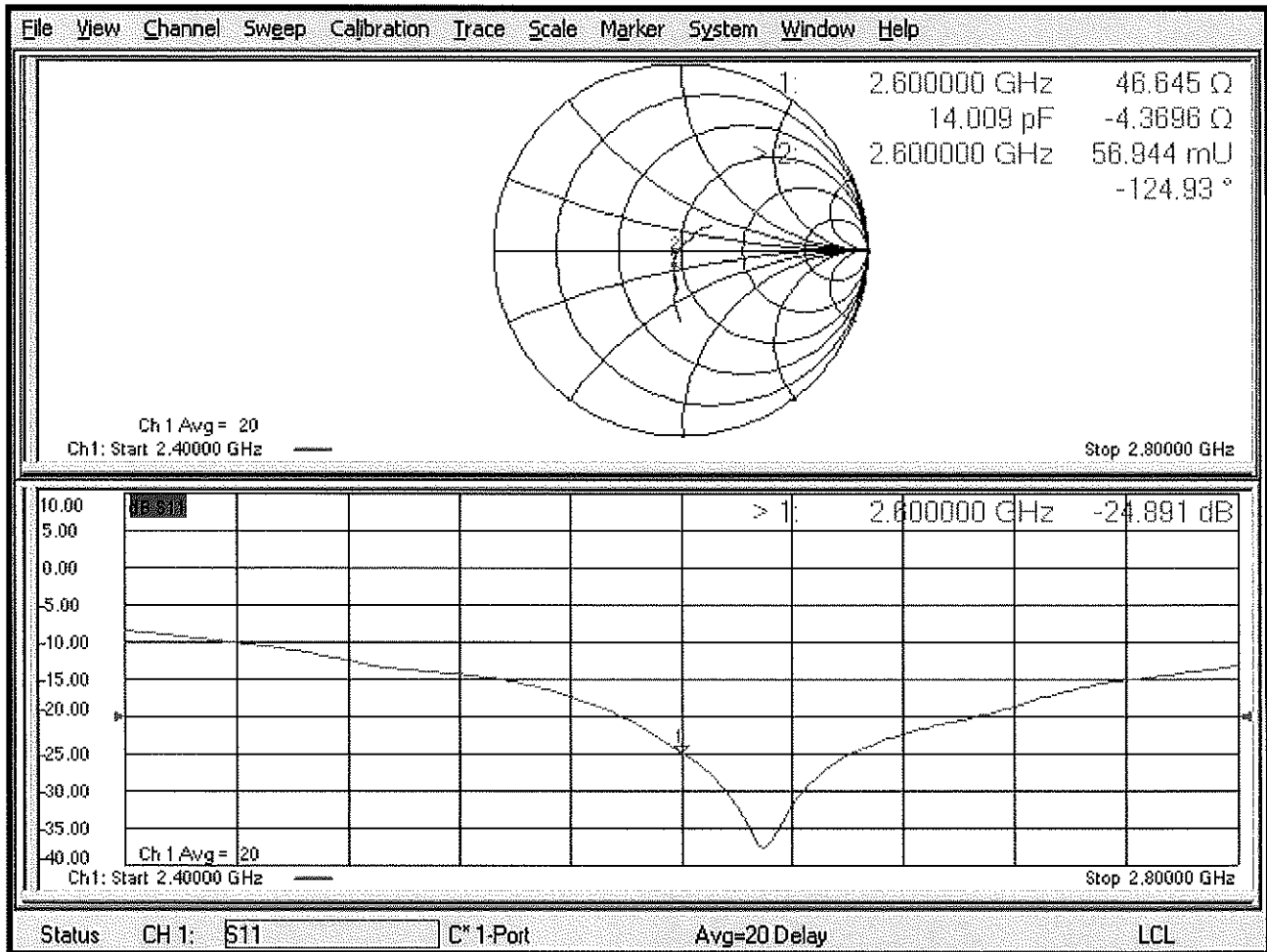

**Calibration Laboratory of
Schmid & Partner
Engineering AG**
Zeughausstrasse 43, 8004 Zurich, Switzerland



S Schweizerischer Kalibrierdienst
C Service suisse d'étalonnage
S Servizio svizzero di taratura
S Swiss Calibration Service

Accredited by the Swiss Accreditation Service (SAS)
The Swiss Accreditation Service is one of the signatories to the EA
Multilateral Agreement for the recognition of calibration certificates

Accreditation No.: **SCS 0108**

Client **PC Test**

Certificate No: **D2450V2-797_Sep17**

CALIBRATION CERTIFICATE

Object **D2450V2 - SN:797**

Calibration procedure(s) **QA CAL-05.v9**
Calibration procedure for dipole validation kits above 700 MHz

SCS
10/03/2019

Calibration date: **September 11, 2017**

Extended PMV
9/20/2018

This calibration certificate documents the traceability to national standards, which realize the physical units of measurements (SI).
The measurements and the uncertainties with confidence probability are given on the following pages and are part of the certificate.

BNV
09/20/2019

All calibrations have been conducted in the closed laboratory facility: environment temperature (22 ± 3)°C and humidity < 70%.

Calibration Equipment used (M&TE critical for calibration)

Primary Standards	ID #	Cal Date (Certificate No.)	Scheduled Calibration
Power meter NRP	SN: 104778	04-Apr-17 (No. 217-02521/02522)	Apr-18
Power sensor NRP-Z91	SN: 103244	04-Apr-17 (No. 217-02521)	Apr-18
Power sensor NRP-Z91	SN: 103245	04-Apr-17 (No. 217-02522)	Apr-18
Reference 20 dB Attenuator	SN: 5058 (20k)	07-Apr-17 (No. 217-02528)	Apr-18
Type-N mismatch combination	SN: 5047.2 / 06327	07-Apr-17 (No. 217-02529)	Apr-18
Reference Probe EX3DV4	SN: 7349	31-May-17 (No. EX3-7349_May17)	May-18
DAE4	SN: 601	28-Mar-17 (No. DAE4-601_Mar17)	Mar-18
Secondary Standards	ID #	Check Date (in house)	Scheduled Check
Power meter EPM-442A	SN: GB37480704	07-Oct-15 (in house check Oct-16)	In house check: Oct-18
Power sensor HP 8481A	SN: US37292783	07-Oct-15 (in house check Oct-16)	In house check: Oct-18
Power sensor HP 8481A	SN: MY41092317	07-Oct-15 (in house check Oct-16)	In house check: Oct-18
RF generator R&S SMT-06	SN: 100972	15-Jun-15 (in house check Oct-16)	In house check: Oct-18
Network Analyzer HP 8753E	SN: US37390585	18-Oct-01 (in house check Oct-16)	In house check: Oct-17

Calibrated by: **Michael Weber** Name: Michael Weber Function: Laboratory Technician

Signature
[Signature]

Approved by: **Katja Pokovic** Name: Katja Pokovic Function: Technical Manager

[Signature]

Issued: September 11, 2017

This calibration certificate shall not be reproduced except in full without written approval of the laboratory.

**Calibration Laboratory of
Schmid & Partner
Engineering AG**
Zeughausstrasse 43, 8004 Zurich, Switzerland



S Schweizerischer Kalibrierdienst
C Service suisse d'étalonnage
S Servizio svizzero di taratura
S Swiss Calibration Service

Accredited by the Swiss Accreditation Service (SAS)
The Swiss Accreditation Service is one of the signatories to the EA
Multilateral Agreement for the recognition of calibration certificates

Accreditation No.: **SCS 0108**

Glossary:

TSL tissue simulating liquid
ConvF sensitivity in TSL / NORM x,y,z
N/A not applicable or not measured

Calibration is Performed According to the Following Standards:

- a) IEEE Std 1528-2013, "IEEE Recommended Practice for Determining the Peak Spatial-Averaged Specific Absorption Rate (SAR) in the Human Head from Wireless Communications Devices: Measurement Techniques", June 2013
- b) IEC 62209-1, "Measurement procedure for the assessment of Specific Absorption Rate (SAR) from hand-held and body-mounted devices used next to the ear (frequency range of 300 MHz to 6 GHz)", July 2016
- c) IEC 62209-2, "Procedure to determine the Specific Absorption Rate (SAR) for wireless communication devices used in close proximity to the human body (frequency range of 30 MHz to 6 GHz)", March 2010
- d) KDB 865664, "SAR Measurement Requirements for 100 MHz to 6 GHz"

Additional Documentation:

- e) DASY4/5 System Handbook

Methods Applied and Interpretation of Parameters:

- *Measurement Conditions:* Further details are available from the Validation Report at the end of the certificate. All figures stated in the certificate are valid at the frequency indicated.
- *Antenna Parameters with TSL:* The dipole is mounted with the spacer to position its feed point exactly below the center marking of the flat phantom section, with the arms oriented parallel to the body axis.
- *Feed Point Impedance and Return Loss:* These parameters are measured with the dipole positioned under the liquid filled phantom. The impedance stated is transformed from the measurement at the SMA connector to the feed point. The Return Loss ensures low reflected power. No uncertainty required.
- *Electrical Delay:* One-way delay between the SMA connector and the antenna feed point. No uncertainty required.
- *SAR measured:* SAR measured at the stated antenna input power.
- *SAR normalized:* SAR as measured, normalized to an input power of 1 W at the antenna connector.
- *SAR for nominal TSL parameters:* The measured TSL parameters are used to calculate the nominal SAR result.

The reported uncertainty of measurement is stated as the standard uncertainty of measurement multiplied by the coverage factor $k=2$, which for a normal distribution corresponds to a coverage probability of approximately 95%.

Measurement Conditions

DASY system configuration, as far as not given on page 1.

DASY Version	DASY5	V52.10.0
Extrapolation	Advanced Extrapolation	
Phantom	Modular Flat Phantom	
Distance Dipole Center - TSL	10 mm	with Spacer
Zoom Scan Resolution	dx, dy, dz = 5 mm	
Frequency	2450 MHz \pm 1 MHz	

Head TSL parameters

The following parameters and calculations were applied.

	Temperature	Permittivity	Conductivity
Nominal Head TSL parameters	22.0 °C	39.2	1.80 mho/m
Measured Head TSL parameters	(22.0 \pm 0.2) °C	37.8 \pm 6 %	1.86 mho/m \pm 6 %
Head TSL temperature change during test	< 0.5 °C	---	---

SAR result with Head TSL

SAR averaged over 1 cm ³ (1 g) of Head TSL	Condition	
SAR measured	250 mW input power	13.5 W/kg
SAR for nominal Head TSL parameters	normalized to 1W	52.7 W/kg \pm 17.0 % (k=2)

SAR averaged over 10 cm ³ (10 g) of Head TSL	condition	
SAR measured	250 mW input power	6.28 W/kg
SAR for nominal Head TSL parameters	normalized to 1W	24.8 W/kg \pm 16.5 % (k=2)

Body TSL parameters

The following parameters and calculations were applied.

	Temperature	Permittivity	Conductivity
Nominal Body TSL parameters	22.0 °C	52.7	1.95 mho/m
Measured Body TSL parameters	(22.0 \pm 0.2) °C	51.9 \pm 6 %	2.04 mho/m \pm 6 %
Body TSL temperature change during test	< 0.5 °C	----	----

SAR result with Body TSL

SAR averaged over 1 cm ³ (1 g) of Body TSL	Condition	
SAR measured	250 mW input power	13.1 W/kg
SAR for nominal Body TSL parameters	normalized to 1W	51.1 W/kg \pm 17.0 % (k=2)

SAR averaged over 10 cm ³ (10 g) of Body TSL	condition	
SAR measured	250 mW input power	6.14 W/kg
SAR for nominal Body TSL parameters	normalized to 1W	24.2 W/kg \pm 16.5 % (k=2)

Appendix (Additional assessments outside the scope of SCS 0108)

Antenna Parameters with Head TSL

Impedance, transformed to feed point	53.8 Ω + 7.4 j Ω
Return Loss	- 21.9 dB

Antenna Parameters with Body TSL

Impedance, transformed to feed point	49.7 Ω + 9.1 j Ω
Return Loss	- 20.9 dB

General Antenna Parameters and Design

Electrical Delay (one direction)	1.152 ns
----------------------------------	----------

After long term use with 100W radiated power, only a slight warming of the dipole near the feedpoint can be measured.

The dipole is made of standard semirigid coaxial cable. The center conductor of the feeding line is directly connected to the second arm of the dipole. The antenna is therefore short-circuited for DC-signals. On some of the dipoles, small end caps are added to the dipole arms in order to improve matching when loaded according to the position as explained in the "Measurement Conditions" paragraph. The SAR data are not affected by this change. The overall dipole length is still according to the Standard.

No excessive force must be applied to the dipole arms, because they might bend or the soldered connections near the feedpoint may be damaged.

Additional EUT Data

Manufactured by	SPEAG
Manufactured on	January 24, 2006

DASY5 Validation Report for Head TSL

Date: 11.09.2017

Test Laboratory: SPEAG, Zurich, Switzerland

DUT: Dipole 2450 MHz; Type: D2450V2; Serial: D2450V2 - SN: 797

Communication System: UID 0 - CW; Frequency: 2450 MHz

Medium parameters used: $f = 2450$ MHz; $\sigma = 1.86$ S/m; $\epsilon_r = 37.8$; $\rho = 1000$ kg/m³

Phantom section: Flat Section

Measurement Standard: DASY5 (IEEE/IEC/ANSI C63.19-2011)

DASY52 Configuration:

- Probe: EX3DV4 - SN7349; ConvF(8.12, 8.12, 8.12); Calibrated: 31.05.2017;
- Sensor-Surface: 1.4mm (Mechanical Surface Detection)
- Electronics: DAE4 Sn601; Calibrated: 28.03.2017
- Phantom: Flat Phantom 5.0 (front); Type: QD 000 P50 AA; Serial: 1001
- DASY52 52.10.0(1446); SEMCAD X 14.6.10(7417)

Dipole Calibration for Head Tissue/ $P_{in}=250$ mW, $d=10$ mm/Zoom Scan (7x7x7)/Cube 0:

Measurement grid: $dx=5$ mm, $dy=5$ mm, $dz=5$ mm

Reference Value = 113.5 V/m; Power Drift = -0.08 dB

Peak SAR (extrapolated) = 26.9 W/kg

SAR(1 g) = 13.5 W/kg; SAR(10 g) = 6.28 W/kg

Maximum value of SAR (measured) = 21.6 W/kg



0 dB = 21.6 W/kg = 13.34 dBW/kg

Impedance Measurement Plot for Head TSL

11 Sep 2017 11:52:57

CH1 S11 1 U FS 1: 53.777 Ω 7.4395 Ω 483.28 μ H 2 450.000 000 MHz

*
De I
CA
Avg
16
H1 d

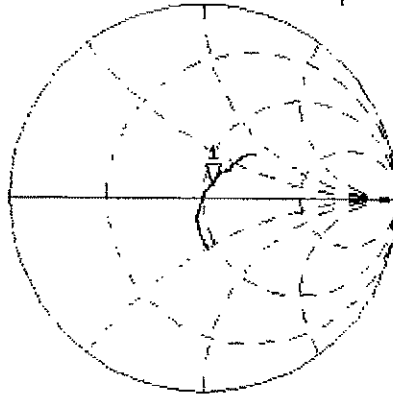

CH2 S11 LOG 5 dB/REF -20 dB 1: -21.911 dB 2 450.000 000 MHz

CA
Avg
16
H1 d

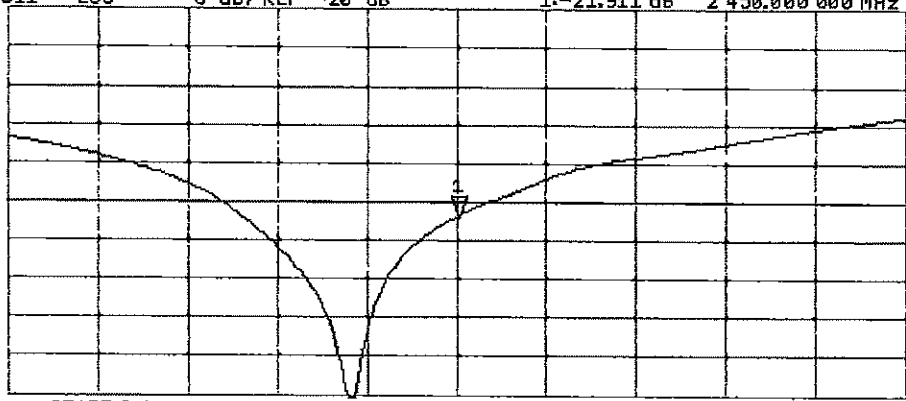

START 2 250.000 000 MHz STOP 2 650.000 000 MHz

DASY5 Validation Report for Body TSL

Date: 11.09.2017

Test Laboratory: SPEAG, Zurich, Switzerland

DUT: Dipole 2450 MHz; Type: D2450V2; Serial: D2450V2 - SN: 797

Communication System: UID 0 - CW; Frequency: 2450 MHz

Medium parameters used: $f = 2450$ MHz; $\sigma = 2.04$ S/m; $\epsilon_r = 51.9$; $\rho = 1000$ kg/m³

Phantom section: Flat Section

Measurement Standard: DASY5 (IEEE/IEC/ANSI C63.19-2011)

DASY52 Configuration:

- Probe: EX3DV4 - SN7349; ConvF(8.1, 8.1, 8.1); Calibrated: 31.05.2017;
- Sensor-Surface: 1.4mm (Mechanical Surface Detection)
- Electronics: DAB4 Sn601; Calibrated: 28.03.2017
- Phantom: Flat Phantom 5.0 (back); Type: QD 000 P50 AA; Serial: 1002
- DASY52 52.10.0(1446); SEMCAD X 14.6.10(7417)

Dipole Calibration for Body Tissue/Pin=250 mW, d=10mm/Zoom Scan (7x7x7)/Cube 0:

Measurement grid: dx=5mm, dy=5mm, dz=5mm

Reference Value = 105.4 V/m; Power Drift = -0.08 dB

Peak SAR (extrapolated) = 25.6 W/kg

SAR(1 g) = 13.1 W/kg; SAR(10 g) = 6.14 W/kg

Maximum value of SAR (measured) = 20.3 W/kg

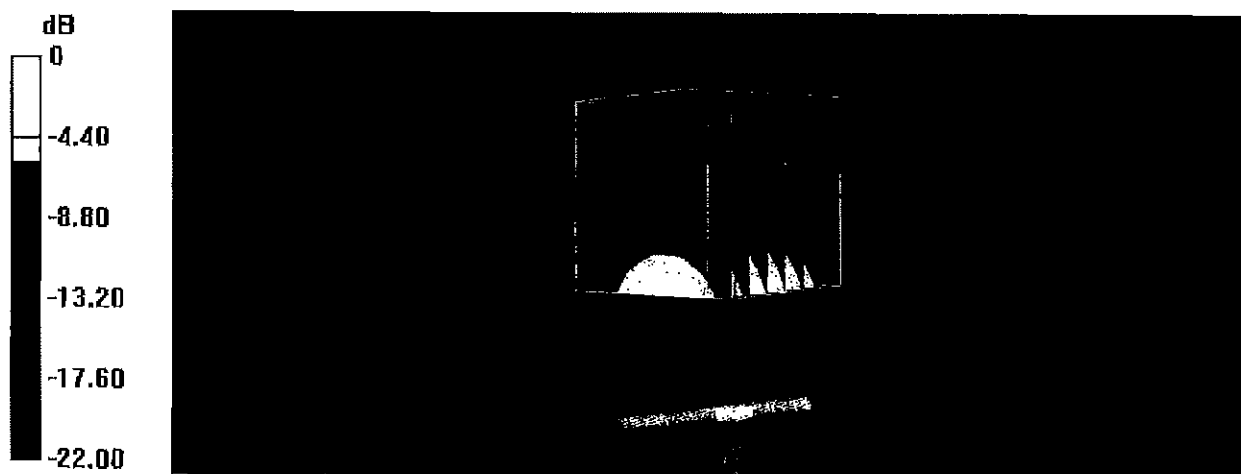

0 dB = 20.3 W/kg = 13.07 dBW/kg

Impedance Measurement Plot for Body TSL

11 Sep 2017 11:52:10

CH1 S11 1 U FS 1: 49.725 Ω 9.0703 Ω 589.22 pF 2 450.000 000 MHz

De1
CA

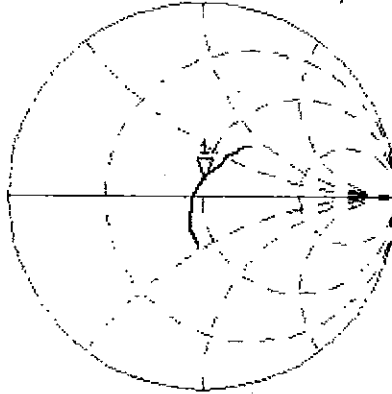

Avg
16

H1d

CH2 S11 LOG 5 dB/REF -20 dB 1: -20.854 dB 2 450.000 000 MHz

CA

Avg
16

H1d

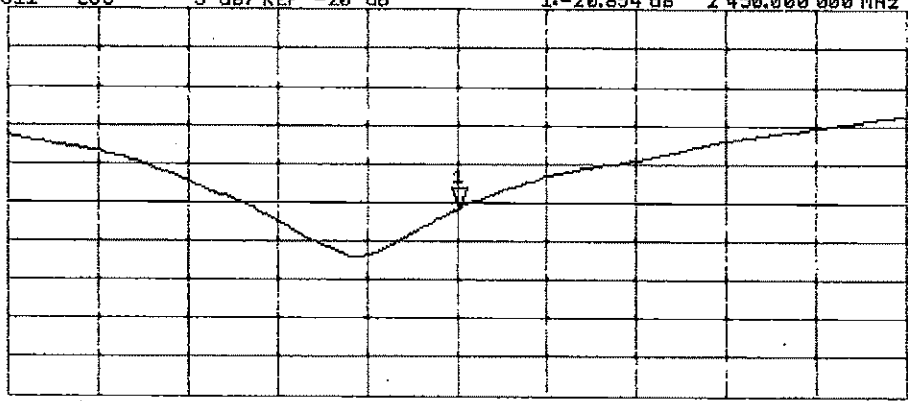

START 2 250.000 000 MHz

STOP 2 650.000 000 MHz

Certification of Calibration

Object: D2450V2 – SN: 797
 Calibration procedure(s): Procedure for Calibration Extension for SAR Dipoles.
 Extended Calibration date: September 11, 2018
 Description: SAR Validation Dipole at 2450 MHz.

Calibration Equipment used:

Manufacturer	Model	Description	Cal Date	Cal Interval	Cal Due	Serial Number
Control Company	4040	Therm./Clock/Humidity Monitor	3/31/2017	Biennial	3/31/2019	170232394
Control Company	4352	Ultra Long Stem Thermometer	5/2/2017	Biennial	5/2/2019	170330156
Amplifier Research	15S1G6	Amplifier	CBT	N/A	CBT	433971
Narda	4772-3	Attenuator (3dB)	CBT	N/A	CBT	9406
Keysight	772D	Dual Directional Coupler	CBT	N/A	CBT	MY52180215
Keysight Technologies	85033E	Standard Mechanical Calibration Kit (DC to 9GHz, 3.5mm)	6/4/2018	Annual	6/4/2019	MY53401181
Agilent	8753ES	S-Parameter Vector Network Analyzer	8/30/2018	Annual	8/30/2019	MY40003841
Mini-Circuits	BW-N20W5+	DC to 18 GHz Precision Fixed 20 dB Attenuator	CBT	N/A	CBT	N/A
SPEAG	DAK-3.5	Dielectric Assessment Kit	5/15/2018	Annual	5/15/2019	1070
SPEAG	EX3DV4	SAR Probe	7/20/2018	Annual	7/20/2019	7410
SPEAG	DAE4	Dasy Data Acquisition Electronics	7/11/2018	Annual	7/11/2019	1322
SPEAG	ES3DV3	SAR Probe	3/13/2018	Annual	3/13/2019	3319
SPEAG	DAE4	Dasy Data Acquisition Electronics	3/7/2018	Annual	3/7/2019	1368
Anritsu	MA2411B	Pulse Power Sensor	3/2/2018	Annual	3/2/2019	1207364
Anritsu	MA2411B	Pulse Power Sensor	3/2/2018	Annual	3/2/2019	1339018
Anritsu	ML2495A	Power Meter	10/22/2017	Annual	10/22/2018	1328004
Agilent	NS182A	MXG Vector Signal Generator	4/18/2018	Annual	4/18/2019	MY47420800
Seekonk	NC-100	Torque Wrench	7/11/2018	Annual	7/11/2019	N/A
MiniCircuits	VLF-6000+	Low Pass Filter	CBT	N/A	CBT	N/A
Narda	4014C-6	4 - 8 GHz SMA 6 dB Directional Coupler	CBT	N/A	CBT	N/A

Note: CBT (Calibrated Before Testing). Prior to testing, the measurement paths containing a cable, amplifier, attenuator, coupler or filter were connected to a calibrated source (i.e. a signal generator) to determine the losses of the measurement path.

Measurement Uncertainty = $\pm 23\%$ (k=2)

	Name	Function	Signature
Calibrated By:	Brodie Halfoster	Team Lead Engineer	<i>BRODIE HALFOSTER</i>
Approved By:	Kaitlin O'Keefe	Senior Technical Manager	<i>KOK</i>

DIPOLE CALIBRATION EXTENSION

Per KDB 865664 D01, calibration intervals of up to three years may be considered for reference dipoles when it is demonstrated that the SAR target, impedance and return loss of a dipole have remained stable according to the following requirements:

1. The measured SAR does not deviate more than 10% from the target on the calibration certificate.
2. The return-loss does not deviate more than 20% from the previous measurement and meets the required 20dB minimum return-loss requirement.
3. The measurement of real or imaginary parts of impedance does not deviate more than 5Ω from the previous measurement.

The following dipole was checked to pass the above 3 requirements to have 2-year calibration period from the calibration date:

Calibration Date	Extension Date	Certificate Electrical Delay (ns)	Certificate SAR Target Head (1g) W/kg @ 20.0 dBm	Measured Head SAR (1g) W/kg @ 20.0 dBm	Deviation 1g (%)	Certificate SAR Target Head (10g) W/kg @ 20.0 dBm	Measured Head SAR (10g) W/kg @ 20.0 dBm	Deviation 10g (%)	Certificate Impedance Head (Ohm) Real	Measured Impedance Head (Ohm) Real	Difference (Ohm) Real	Certificate Impedance Head (Ohm) Imaginary	Measured Impedance Head (Ohm) Imaginary	Difference (Ohm) Imaginary	Certificate Return Loss Head (dB)	Measured Return Loss Head (dB)	Deviation (%)	PASS/FAIL
9/11/2017	9/11/2018	1.152	5.27	5.52	4.74%	2.48	2.54	2.42%	53.8	49.8	4	7.4	7.1	0.3	-21.9	-23	-4.80%	PASS

Calibration Date	Extension Date	Certificate Electrical Delay (ns)	Certificate SAR Target Body (1g) W/kg @ 20.0 dBm	Measured Body SAR (1g) W/kg @ 20.0 dBm	Deviation 1g (%)	Certificate SAR Target Body (10g) W/kg @ 20.0 dBm	Measured Body SAR (10g) W/kg @ 20.0 dBm	Deviation 10g (%)	Certificate Impedance Body (Ohm) Real	Measured Impedance Body (Ohm) Real	Difference (Ohm) Real	Certificate Impedance Body (Ohm) Imaginary	Measured Impedance Body (Ohm) Imaginary	Difference (Ohm) Imaginary	Certificate Return Loss Body (dB)	Measured Return Loss Body (dB)	Deviation (%)	PASS/FAIL
9/11/2017	9/11/2018	1.152	5.11	5.17	1.17%	2.42	2.37	-2.07%	49.7	49.8	0.1	9.1	7.2	1.9	-20.9	-22.6	-8.20%	PASS

Impedance & Return-Loss Measurement Plot for Head TSL

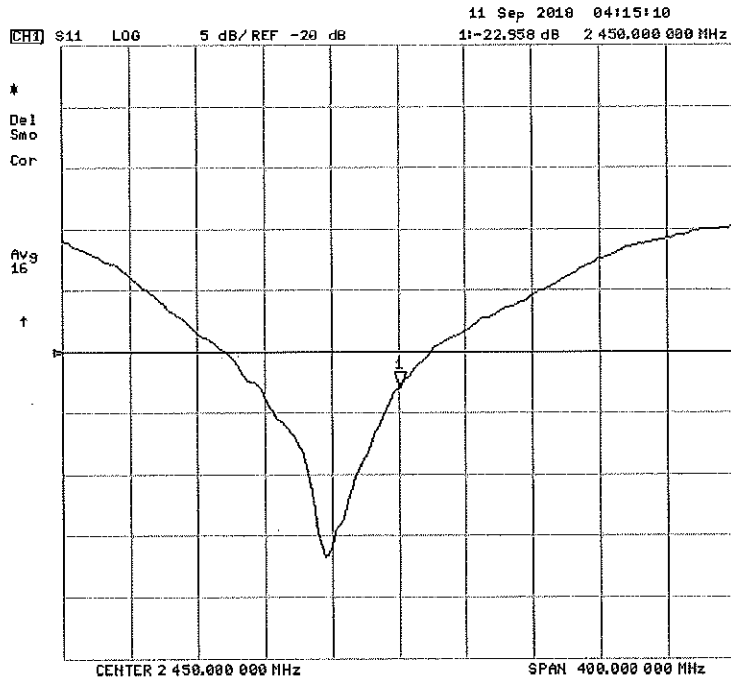
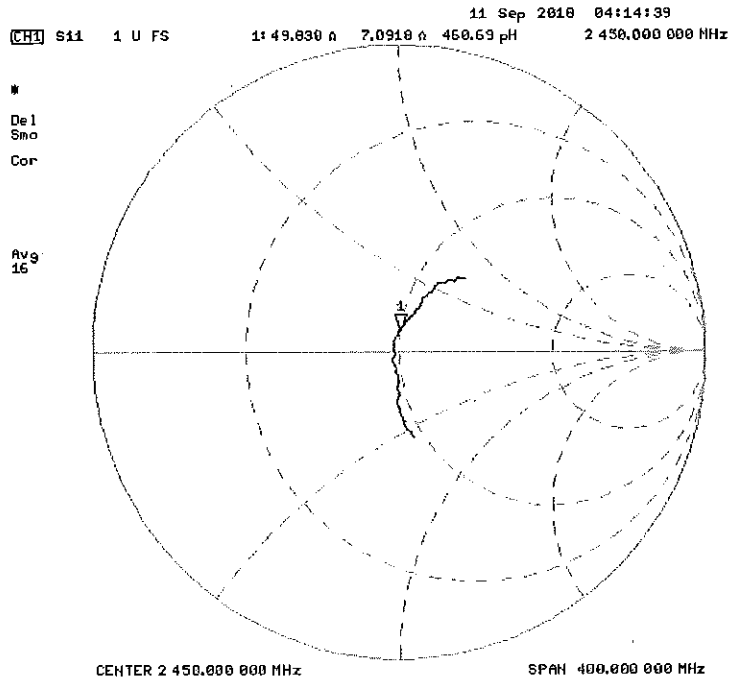

Impedance & Return-Loss Measurement Plot for Body TSL

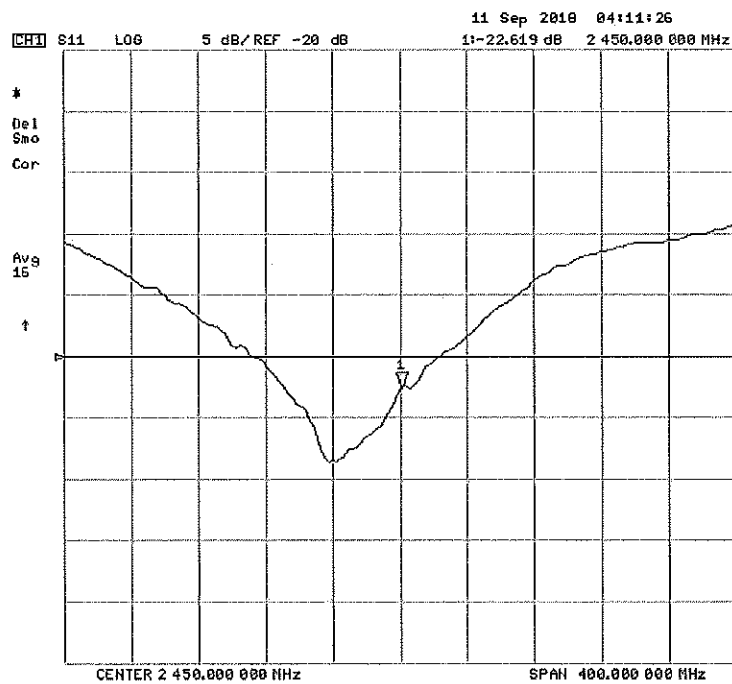
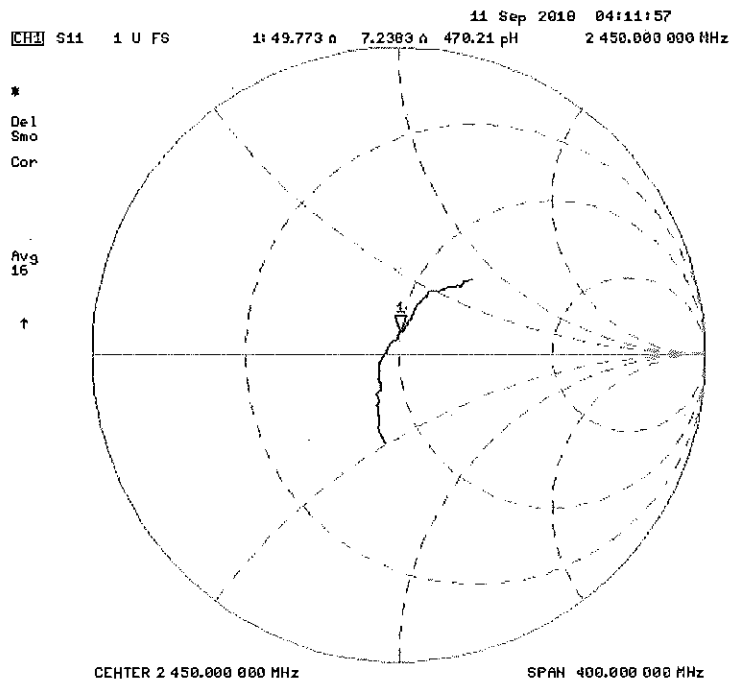

Certification of Calibration

Object: D2450V2 – SN: 797

Calibration procedure(s): Procedure for Calibration Extension for SAR Dipoles.

Extended Calibration date: September 9, 2019

Description: SAR Validation Dipole at 2450 MHz.

Calibration Equipment used:

Manufacturer	Model	Description	Cal Date	Cal Interval	Cal Due	Serial Number
Agilent	8753ES	S-Parameter Network Analyzer	10/2/2018	Annual	10/2/2019	US39170118
Agilent	N5182A	MXG Vector Signal Generator	6/27/2019	Annual	6/27/2020	US46240505
Amplifier Research	15S1G6	Amplifier	CBT	N/A	CBT	343972
Anritsu	ML2495A	Power Meter	10/21/2018	Annual	10/21/2019	941001
Anritsu	MA2411B	Pulse Power Sensor	10/30/2018	Annual	10/30/2019	1207470
Anritsu	MA2411B	Pulse Power Sensor	11/20/2018	Annual	11/20/2019	1339007
Control Company	4040	Temperature / Humidity Monitor	2/28/2018	Biennial	2/28/2020	150761911
Control Company	4352	Ultra Long Stem Thermometer	2/28/2018	Biennial	2/28/2020	170330160
Keysight	772D	Dual Directional Coupler	CBT	N/A	CBT	MY52180215
Keysight Technologies	85033E	Standard Mechanical Calibration Kit (DC to 9GHz, 3.5mm)	7/2/2019	Annual	7/2/2020	MY53401181
Mini-Circuits	BW-N20W5+	DC to 18 GHz Precision Fixed 20 dB Attenuator	CBT	N/A	CBT	N/A
Mini-Circuits	NLP-2950+	Low Pass Filter DC to 2700 MHz	CBT	N/A	CBT	N/A
Narda	4772-3	Attenuator (3dB)	CBT	N/A	CBT	9406
Pasternack	PE2209-10	Bidirectional Coupler	CBT	N/A	CBT	N/A
Pasternack	NC-100	Torque Wrench	5/23/2018	Biennial	5/23/2020	N/A
SPEAG	EX3DV4	SAR Probe	2/19/2019	Annual	2/19/2020	7417
SPEAG	DAE4	Dasy Data Acquisition Electronics	2/13/2019	Annual	2/13/2020	665
SPEAG	EX3DV4	SAR Probe	7/15/2019	Annual	7/15/2020	7547
SPEAG	DAE4	Dasy Data Acquisition Electronics	7/11/2019	Annual	7/11/2020	1323
SPEAG	DAK-3.5	Dielectric Assessment Kit	9/11/2018	Annual	9/11/2019	1091

Note: CBT (Calibrated Before Testing). Prior to testing, the measurement paths containing a cable, amplifier, attenuator, coupler or filter were connected to a calibrated source (i.e. a signal generator) to determine the losses of the measurement path.

Measurement Uncertainty = $\pm 23\%$ (k=2)

	Name	Function	Signature
Calibrated By:	Brodie Halfoster	Team Lead Engineer	<i>BRODIE HALFOSTER</i>
Approved By:	Kaitlin O'Keefe	Senior Technical Manager	<i>KOK</i>

DIPOLE CALIBRATION EXTENSION

Per KDB 865664 D01, calibration intervals of up to three years may be considered for reference dipoles when it is demonstrated that the SAR target, impedance and return loss of a dipole have remained stable according to the following requirements:

1. The measured SAR does not deviate more than 10% from the target on the calibration certificate.
2. The return-loss does not deviate more than 20% from the previous measurement and meets the required 20dB minimum return-loss requirement.
3. The measurement of real or imaginary parts of impedance does not deviate more than 5Ω from the previous measurement.

The following dipole was checked to pass the above 3 requirements to have 3-year calibration period from the calibration date:

Calibration Date	Extension Date	Certificate Electrical Delay (ms)	Certificate SAR Target Head (1g) W/kg @ 20.0 dBm	Measured Head SAR (1g) W/kg @ 20.0 dBm	Deviation 1g (%)	Certificate SAR Target Head (10g) W/kg @ 20.0 dBm	Measured Head SAR (10g) W/kg @ 20.0 dBm	Deviation 10g (%)	Certificate Impedance Head (Ohm) Real	Measured Impedance Head (Ohm) Real	Difference (Ohm) Real	Certificate Impedance Head (Ohm) Imaginary	Measured Impedance Head (Ohm) Imaginary	Difference (Ohm) Imaginary	Certificate Return Loss Head (dB)	Measured Return Loss Head (dB)	Deviation (%)	PASS/FAIL
9/11/2017	9/9/2019	1.152	5.27	5.19	-1.52%	2.48	2.41	-2.82%	53.8	51.1	2.7	7.4	6.6	0.6	-21.9	-23.4	-6.70%	PASS
Calibration Date	Extension Date	Certificate Electrical Delay (ms)	Certificate SAR Target Body (1g) W/kg @ 20.0 dBm	Measured Body SAR (1g) W/kg @ 20.0 dBm	Deviation 1g (%)	Certificate SAR Target Body (10g) W/kg @ 20.0 dBm	Measured Body SAR (10g) W/kg @ 20.0 dBm	Deviation 10g (%)	Certificate Impedance Body (Ohm) Real	Measured Impedance Body (Ohm) Real	Difference (Ohm) Real	Certificate Impedance Body (Ohm) Imaginary	Measured Impedance Body (Ohm) Imaginary	Difference (Ohm) Imaginary	Certificate Return Loss Body (dB)	Measured Return Loss Body (dB)	Deviation (%)	PASS/FAIL
9/11/2017	9/9/2019	1.152	5.11	5.17	1.17%	2.42	2.38	-1.65%	49.7	46	3.7	9.1	5.5	3.6	-20.9	-23.5	-12.40%	PASS

Impedance & Return-Loss Measurement Plot for Head TSL

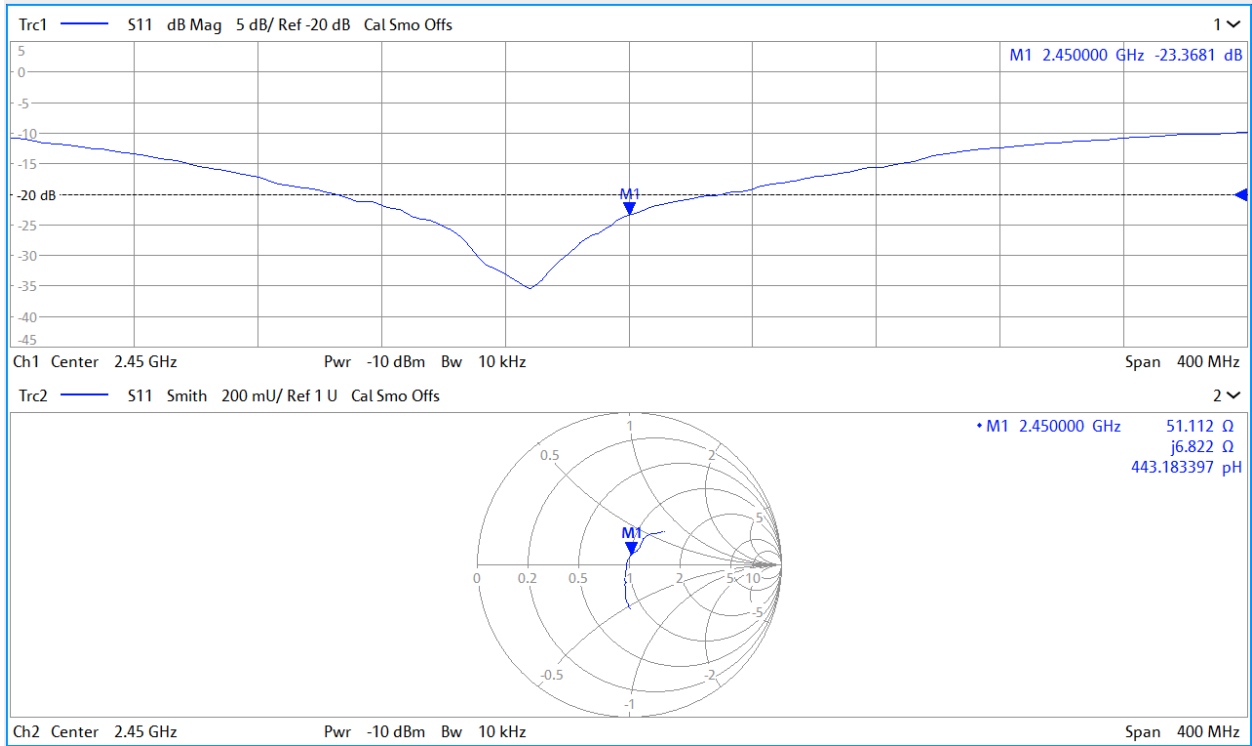

Impedance & Return-Loss Measurement Plot for Body TSL

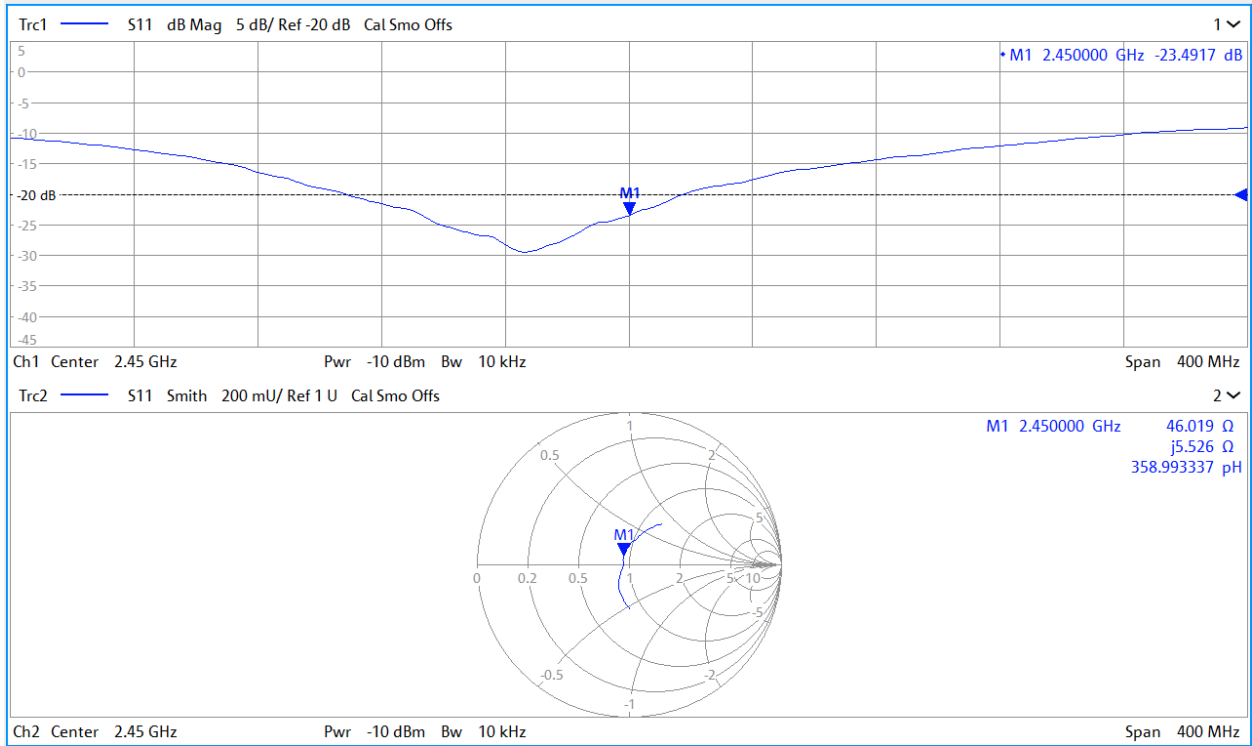



Accredited by the Swiss Accreditation Service (SAS)
The Swiss Accreditation Service is one of the signatories to the EA
Multilateral Agreement for the recognition of calibration certificates

Accreditation No.: **SCS 0108**

Client **PC Test**

Certificate No: **D2450V2-981_Aug18**

CALIBRATION CERTIFICATE

Object **D2450V2 - SN:981**

Calibration procedure(s) **QA CAL-05.v10**
Calibration procedure for dipole validation kits above 700 MHz

Calibration date: **August 16, 2018**

BNV
09-26/2018
BNV
08/10/2019

This calibration certificate documents the traceability to national standards, which realize the physical units of measurements (SI).
The measurements and the uncertainties with confidence probability are given on the following pages and are part of the certificate.

All calibrations have been conducted in the closed laboratory facility: environment temperature (22 ± 3)°C and humidity < 70%.

Calibration Equipment used (M&TE critical for calibration)

Primary Standards	ID #	Cal Date (Certificate No.)	Scheduled Calibration
Power meter NRP	SN: 104778	04-Apr-18 (No. 217-02672/02673)	Apr-19
Power sensor NRP-Z91	SN: 103244	04-Apr-18 (No. 217-02672)	Apr-19
Power sensor NRP-Z91	SN: 103245	04-Apr-18 (No. 217-02673)	Apr-19
Reference 20 dB Attenuator	SN: 5058 (20k)	04-Apr-18 (No. 217-02682)	Apr-19
Type-N mismatch combination	SN: 5047.2 / 06327	04-Apr-18 (No. 217-02683)	Apr-19
Reference Probe EX3DV4	SN: 7349	30-Dec-17 (No. EX3-7349_Dec17)	Dec-18
DAE4	SN: 601	26-Oct-17 (No. DAE4-601_Oct17)	Oct-18
Secondary Standards	ID #	Check Date (in house)	Scheduled Check
Power meter EPM-442A	SN: GB37480704	07-Oct-15 (in house check Oct-16)	In house check: Oct-18
Power sensor HP 8481A	SN: US37292783	07-Oct-15 (in house check Oct-16)	In house check: Oct-18
Power sensor HP 8481A	SN: MY41092317	07-Oct-15 (in house check Oct-16)	In house check: Oct-18
RF generator R&S SMT-06	SN: 100972	15-Jun-15 (in house check Oct-16)	In house check: Oct-18
Network Analyzer Agilent E8358A	SN: US41080477	31-Mar-14 (in house check Oct-17)	In house check: Oct-18

Calibrated by: **Leif Klysner** Name: **Leif Klysner** Function: **Laboratory Technician**

Signature

Approved by: **Katja Pokovic** Name: **Katja Pokovic** Function: **Technical Manager**

Issued: August 23, 2018

This calibration certificate shall not be reproduced except in full without written approval of the laboratory.



Accredited by the Swiss Accreditation Service (SAS)
The Swiss Accreditation Service is one of the signatories to the EA
Multilateral Agreement for the recognition of calibration certificates

Accreditation No.: **SCS 0108**

Glossary:

TSL	tissue simulating liquid
ConvF	sensitivity in TSL / NORM x,y,z
N/A	not applicable or not measured

Calibration is Performed According to the Following Standards:

- IEEE Std 1528-2013, "IEEE Recommended Practice for Determining the Peak Spatial-Averaged Specific Absorption Rate (SAR) in the Human Head from Wireless Communications Devices: Measurement Techniques", June 2013
- IEC 62209-1, "Measurement procedure for the assessment of Specific Absorption Rate (SAR) from hand-held and body-mounted devices used next to the ear (frequency range of 300 MHz to 6 GHz)", July 2016
- IEC 62209-2, "Procedure to determine the Specific Absorption Rate (SAR) for wireless communication devices used in close proximity to the human body (frequency range of 30 MHz to 6 GHz)", March 2010
- KDB 865664, "SAR Measurement Requirements for 100 MHz to 6 GHz"

Additional Documentation:

- DASY4/5 System Handbook

Methods Applied and Interpretation of Parameters:

- Measurement Conditions:** Further details are available from the Validation Report at the end of the certificate. All figures stated in the certificate are valid at the frequency indicated.
- Antenna Parameters with TSL:** The dipole is mounted with the spacer to position its feed point exactly below the center marking of the flat phantom section, with the arms oriented parallel to the body axis.
- Feed Point Impedance and Return Loss:** These parameters are measured with the dipole positioned under the liquid filled phantom. The impedance stated is transformed from the measurement at the SMA connector to the feed point. The Return Loss ensures low reflected power. No uncertainty required.
- Electrical Delay:** One-way delay between the SMA connector and the antenna feed point. No uncertainty required.
- SAR measured:** SAR measured at the stated antenna input power.
- SAR normalized:** SAR as measured, normalized to an input power of 1 W at the antenna connector.
- SAR for nominal TSL parameters:** The measured TSL parameters are used to calculate the nominal SAR result.

The reported uncertainty of measurement is stated as the standard uncertainty of measurement multiplied by the coverage factor $k=2$, which for a normal distribution corresponds to a coverage probability of approximately 95%.

Measurement Conditions

DASY system configuration, as far as not given on page 1.

DASY Version	DASY5	V52.10.1
Extrapolation	Advanced Extrapolation	
Phantom	Modular Flat Phantom	
Distance Dipole Center - TSL	10 mm	with Spacer
Zoom Scan Resolution	dx, dy, dz = 5.0 mm	
Frequency	2450 MHz \pm 1 MHz	

Head TSL parameters

The following parameters and calculations were applied.

	Temperature	Permittivity	Conductivity
Nominal Head TSL parameters	22.0 °C	39.2	1.80 mho/m
Measured Head TSL parameters	(22.0 \pm 0.2) °C	37.7 \pm 6 %	1.86 mho/m \pm 6 %
Head TSL temperature change during test	< 0.5 °C	----	----

SAR result with Head TSL

SAR averaged over 1 cm ³ (1 g) of Head TSL	Condition	
SAR measured	250 mW input power	13.4 W/kg
SAR for nominal Head TSL parameters	normalized to 1W	52.3 W/kg \pm 17.0 % (k=2)

SAR averaged over 10 cm ³ (10 g) of Head TSL	condition	
SAR measured	250 mW input power	6.20 W/kg
SAR for nominal Head TSL parameters	normalized to 1W	24.4 W/kg \pm 16.5 % (k=2)

Body TSL parameters

The following parameters and calculations were applied.

	Temperature	Permittivity	Conductivity
Nominal Body TSL parameters	22.0 °C	52.7	1.95 mho/m
Measured Body TSL parameters	(22.0 \pm 0.2) °C	51.8 \pm 6 %	2.02 mho/m \pm 6 %
Body TSL temperature change during test	< 0.5 °C	----	----

SAR result with Body TSL

SAR averaged over 1 cm ³ (1 g) of Body TSL	Condition	
SAR measured	250 mW input power	13.0 W/kg
SAR for nominal Body TSL parameters	normalized to 1W	50.9 W/kg \pm 17.0 % (k=2)

SAR averaged over 10 cm ³ (10 g) of Body TSL	condition	
SAR measured	250 mW input power	6.11 W/kg
SAR for nominal Body TSL parameters	normalized to 1W	24.2 W/kg \pm 16.5 % (k=2)

Appendix (Additional assessments outside the scope of SCS 0108)

Antenna Parameters with Head TSL

Impedance, transformed to feed point	55.0 Ω + 2.3 j Ω
Return Loss	- 25.6 dB

Antenna Parameters with Body TSL

Impedance, transformed to feed point	50.2 Ω + 4.7 j Ω
Return Loss	- 26.6 dB

General Antenna Parameters and Design

Electrical Delay (one direction)	1.162 ns
----------------------------------	----------

After long term use with 100W radiated power, only a slight warming of the dipole near the feedpoint can be measured.

The dipole is made of standard semirigid coaxial cable. The center conductor of the feeding line is directly connected to the second arm of the dipole. The antenna is therefore short-circuited for DC-signals. On some of the dipoles, small end caps are added to the dipole arms in order to improve matching when loaded according to the position as explained in the "Measurement Conditions" paragraph. The SAR data are not affected by this change. The overall dipole length is still according to the Standard.

No excessive force must be applied to the dipole arms, because they might bend or the soldered connections near the feedpoint may be damaged.

Additional EUT Data

Manufactured by	SPEAG
Manufactured on	December 30, 2014

Appendix (Additional assessments outside the scope of SCS 0108)

Measurement Conditions

DASY system configuration, as far as not given on page 1 and 3.

Phantom	SAM Head Phantom	For usage with cSAR3DV2-R/L
---------	------------------	-----------------------------

SAR result with SAM Head (Top)

SAR averaged over 1 cm ³ (1 g) of Head TSL	Condition	
SAR measured	250 mW input power	13.6 W/kg
SAR for nominal Head TSL parameters	normalized to 1W	54.0 W/kg ± 17.5 % (k=2)

SAR averaged over 10 cm ³ (10 g) of Head TSL	condition	
SAR measured	250 mW input power	6.33 W/kg
SAR for nominal Head TSL parameters	normalized to 1W	25.2 W/kg ± 16.9 % (k=2)

SAR result with SAM Head (Mouth)

SAR averaged over 1 cm ³ (1 g) of Head TSL	Condition	
SAR measured	250 mW input power	13.6 W/kg
SAR for nominal Head TSL parameters	normalized to 1W	54.0 W/kg ± 17.5 % (k=2)

SAR averaged over 10 cm ³ (10 g) of Head TSL	condition	
SAR measured	250 mW input power	6.35 W/kg
SAR for nominal Head TSL parameters	normalized to 1W	25.3 W/kg ± 16.9 % (k=2)

SAR result with SAM Head (Neck)

SAR averaged over 1 cm ³ (1 g) of Head TSL	Condition	
SAR measured	250 mW input power	12.9 W/kg
SAR for nominal Head TSL parameters	normalized to 1W	51.2 W/kg ± 17.5 % (k=2)

SAR averaged over 10 cm ³ (10 g) of Head TSL	condition	
SAR measured	250 mW input power	6.11 W/kg
SAR for nominal Head TSL parameters	normalized to 1W	24.4 W/kg ± 16.9 % (k=2)

SAR result with SAM Head (Ear)

SAR averaged over 1 cm ³ (1 g) of Head TSL	Condition	
SAR measured	250 mW input power	8.74 W/kg
SAR for nominal Head TSL parameters	normalized to 1W	34.7 W/kg ± 17.5 % (k=2)

SAR averaged over 10 cm ³ (10 g) of Head TSL	condition	
SAR measured	250 mW input power	4.40 W/kg
SAR for nominal Head TSL parameters	normalized to 1W	17.5 W/kg ± 16.9 % (k=2)

DASY5 Validation Report for Head TSL

Date: 13.08.2018

Test Laboratory: SPEAG, Zurich, Switzerland

DUT: Dipole 2450 MHz; Type: D2450V2; Serial: D2450V2 - SN:981

Communication System: UID 0 - CW; Frequency: 2450 MHz

Medium parameters used: $f = 2450$ MHz; $\sigma = 1.86$ S/m; $\epsilon_r = 37.7$; $\rho = 1000$ kg/m³

Phantom section: Flat Section

Measurement Standard: DASY5 (IEEE/IEC/ANSI C63.19-2011)

DASY52 Configuration:

- Probe: EX3DV4 - SN7349; ConvF(7.88, 7.88, 7.88) @ 2450 MHz; Calibrated: 30.12.2017
- Sensor-Surface: 1.4mm (Mechanical Surface Detection)
- Electronics: DAE4 Sn601; Calibrated: 26.10.2017
- Phantom: Flat Phantom 5.0 (front); Type: QD 000 P50 AA; Serial: 1001
- DASY52 52.10.1(1476); SEMCAD X 14.6.11(7439)

Dipole Calibration for Head Tissue/Pin=250 mW, d=10mm/Zoom Scan (7x7x7)/Cube 0:

Measurement grid: dx=5mm, dy=5mm, dz=5mm

Reference Value = 116.6 V/m; Power Drift = -0.03 dB

Peak SAR (extrapolated) = 26.7 W/kg

SAR(1 g) = 13.4 W/kg; SAR(10 g) = 6.2 W/kg

Maximum value of SAR (measured) = 22.1 W/kg



Impedance Measurement Plot for Head TSL

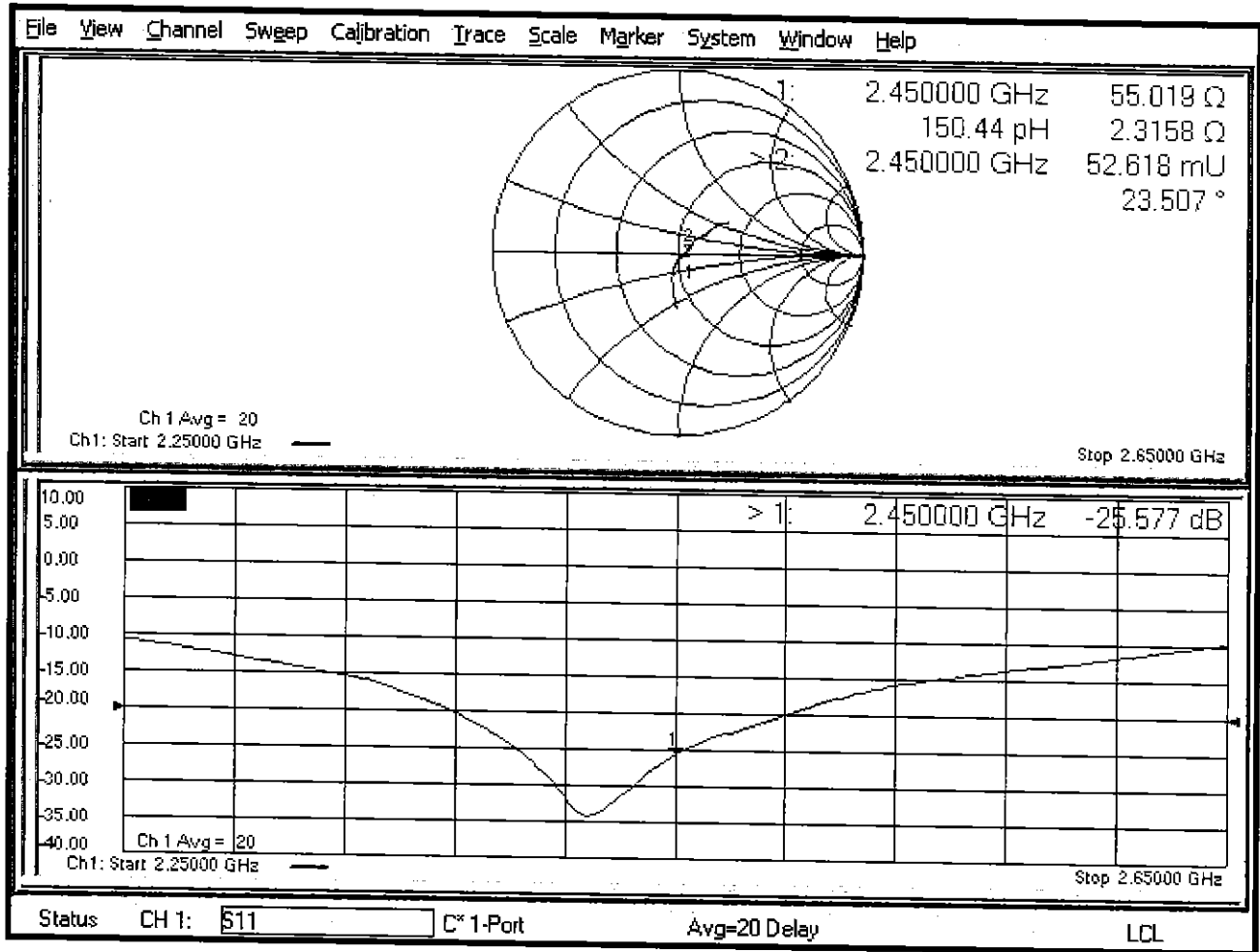

DASY5 Validation Report for Body TSL

Date: 13.08.2018

Test Laboratory: SPEAG, Zurich, Switzerland

DUT: Dipole 2450 MHz; Type: D2450V2; Serial: D2450V2 - SN:981

Communication System: UID 0 - CW; Frequency: 2450 MHz

Medium parameters used: $f = 2450$ MHz; $\sigma = 2.02$ S/m; $\epsilon_r = 51.8$; $\rho = 1000$ kg/m³

Phantom section: Flat Section

Measurement Standard: DASY5 (IEEE/IEC/ANSI C63.19-2011)

DASY52 Configuration:

- Probe: EX3DV4 - SN7349; ConvF(8.01, 8.01, 8.01) @ 2450 MHz; Calibrated: 30.12.2017
- Sensor-Surface: 1.4mm (Mechanical Surface Detection)
- Electronics: DAE4 Sn601; Calibrated: 26.10.2017
- Phantom: Flat Phantom 5.0 (back); Type: QD 000 P50 AA; Serial: 1002
- DASY52 52.10.1(1476); SEMCAD X 14.6.11(7439)

Dipole Calibration for Body Tissue/Pin=250 mW, d=10mm/Zoom Scan (7x7x7)/Cube 0:

Measurement grid: dx=5mm, dy=5mm, dz=5mm

Reference Value = 107.0 V/m; Power Drift = -0.08 dB

Peak SAR (extrapolated) = 25.3 W/kg

SAR(1 g) = 13 W/kg; SAR(10 g) = 6.11 W/kg

Maximum value of SAR (measured) = 20.7 W/kg



0 dB = 20.7 W/kg = 13.16 dBW/kg

Impedance Measurement Plot for Body TSL

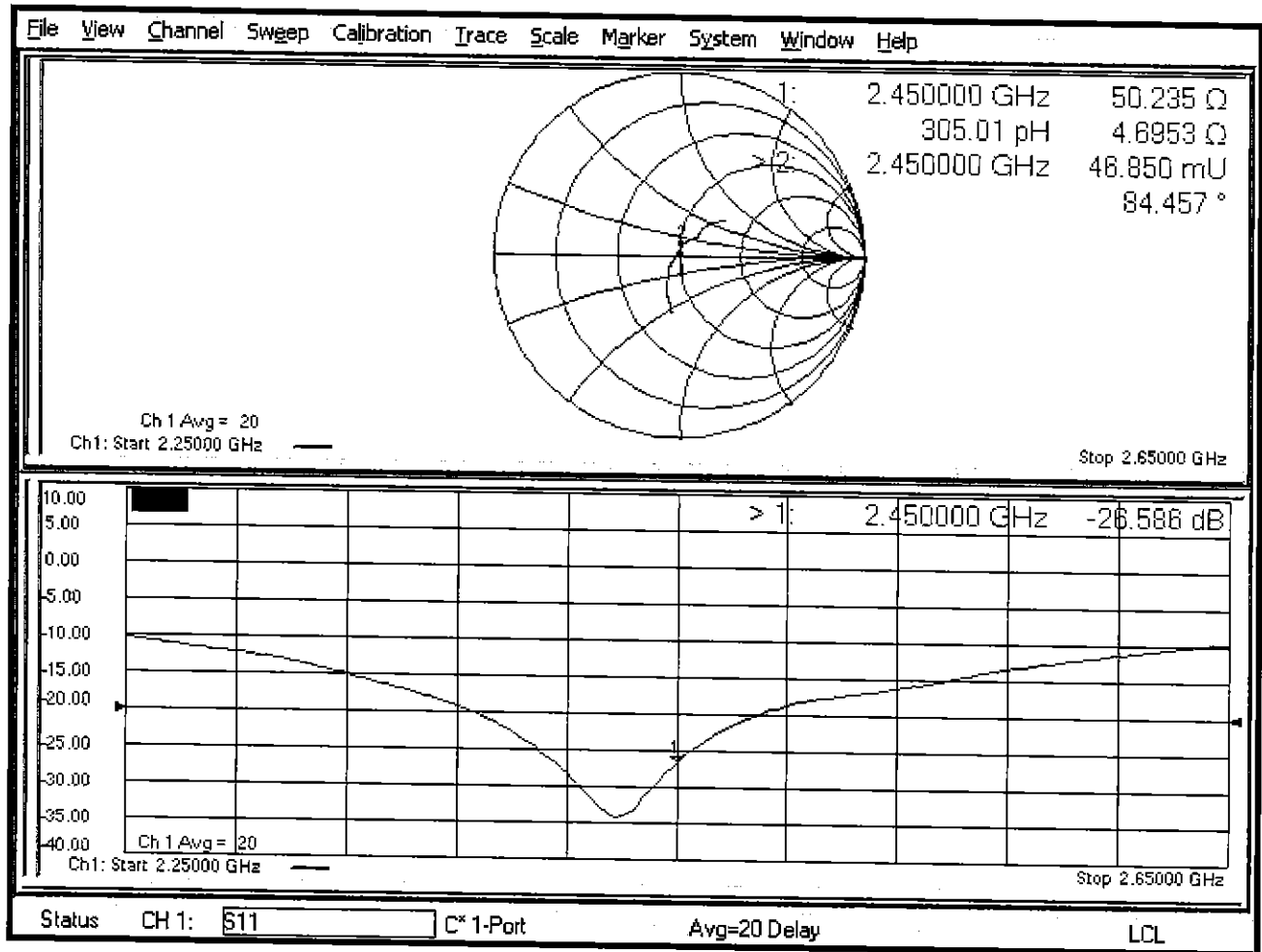

DASY5 Validation Report for SAM Head

Date: 16.08.2018

Test Laboratory: SPEAG, Zurich, Switzerland

DUT: Dipole 2450 MHz; Type: D2450V2; Serial: D2450V2 - SN:981

Communication System: UID 0 - CW ; Frequency: 2450 MHz

Medium parameters used: $f = 2450$ MHz; $\sigma = 1.85$ S/m; $\epsilon_r = 40.2$; $\rho = 1000$ kg/m³

Measurement Standard: DASY5 (IEEE/IEC/ANSI C63.19-2011)

DASY52 Configuration:

- Probe: EX3DV4 - SN7349; ConvF(7.88, 7.88, 7.88) @ 2450 MHz; Calibrated: 30.12.2017
- Sensor-Surface: 1.4mm (Mechanical Surface Detection)
- Electronics: DAE4 Sn601; Calibrated: 26.10.2017
- Phantom: SAM Head
- DASY52 52.10.1(1476); SEMCAD X 14.6.11(7439)

SAM Head Top/Zoom Scan (7x7x7)/Cube 0: Measurement grid: dx=5mm, dy=5mm, dz=5mm

Reference Value = 116.2 V/m; Power Drift = 0.00 dB

Peak SAR (extrapolated) = 26.4 W/kg

SAR(1 g) = 13.6 W/kg; SAR(10 g) = 6.33 W/kg

Maximum value of SAR (measured) = 22.0 W/kg

SAM Head Mouth/Zoom Scan (7x7x7)/Cube 0: Measurement grid: dx=5mm, dy=5mm, dz=5mm

Reference Value = 116.9 V/m; Power Drift = 0.01 dB

Peak SAR (extrapolated) = 26.3 W/kg

SAR(1 g) = 13.6 W/kg; SAR(10 g) = 6.35 W/kg

Maximum value of SAR (measured) = 21.7 W/kg

SAM Head Neck/Zoom Scan (7x7x7)/Cube 0: Measurement grid: dx=5mm, dy=5mm, dz=5mm

Reference Value = 112.0 V/m; Power Drift = 0.03 dB

Peak SAR (extrapolated) = 24.1 W/kg

SAR(1 g) = 12.9 W/kg; SAR(10 g) = 6.11 W/kg

Maximum value of SAR (measured) = 20.5 W/kg

SAM Head Ear/Zoom Scan (7x7x7)/Cube 0: Measurement grid: dx=5mm, dy=5mm, dz=5mm

Reference Value = 91.03 V/m; Power Drift = -0.01 dB

Peak SAR (extrapolated) = 15.8 W/kg

SAR(1 g) = 8.74 W/kg; SAR(10 g) = 4.4 W/kg

Maximum value of SAR (measured) = 13.5 W/kg

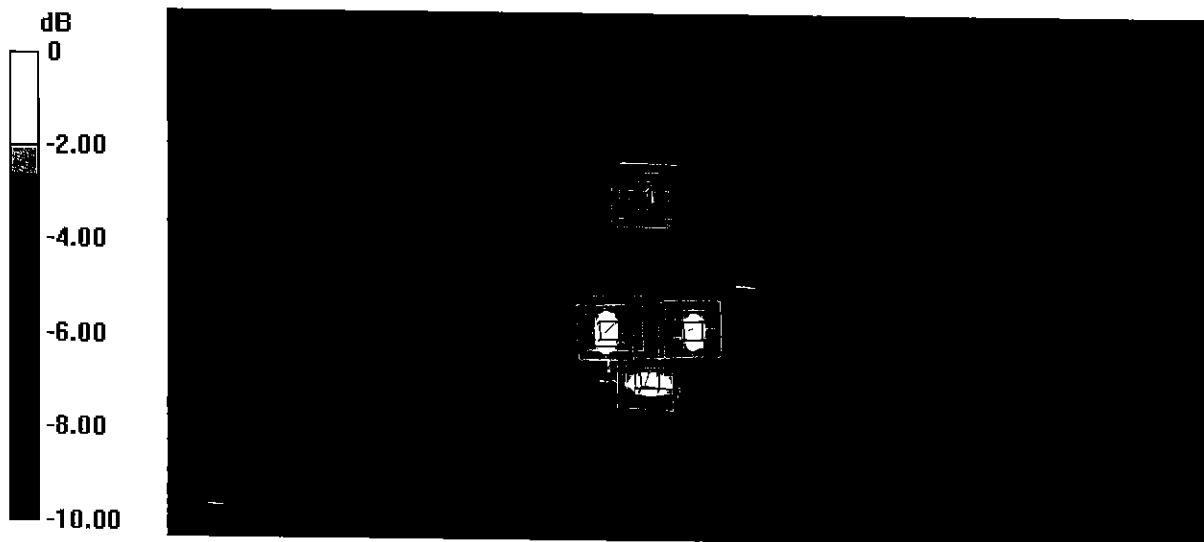

0 dB = 22.0 W/kg = 13.42 dBW/kg

Certification of Calibration

Object: D2450V2 – SN: 981

Calibration procedure(s): Procedure for Calibration Extension for SAR Dipoles.

Calibration date: 08/09/2019

Description: SAR Validation Dipole at 2450 MHz.

Calibration Equipment used:

Manufacturer	Model	Description	Cal Date	Cal Interval	Cal Due	Serial Number
Agilent	8753ES	S-Parameter Network Analyzer	10/2/2018	Annual	10/2/2019	US39170118
Agilent	N5182A	MXG Vector Signal Generator	6/27/2019	Annual	6/27/2020	US46240505
Amplifier Research	15S1G6	Amplifier	CBT	N/A	CBT	343972
Anritsu	ML2495A	Power Meter	10/21/2018	Annual	10/21/2019	941001
Anritsu	MA2411B	Pulse Power Sensor	10/30/2018	Annual	10/30/2019	1207470
Anritsu	MA2411B	Pulse Power Sensor	11/20/2018	Annual	11/20/2019	1339007
Control Company	4040	Temperature / Humidity Monitor	2/28/2018	Biennial	2/28/2020	150761911
Control Company	4352	Ultra Long Stem Thermometer	2/28/2018	Biennial	2/28/2020	170330160
Keysight	772D	Dual Directional Coupler	CBT	N/A	CBT	MY52180215
Keysight Technologies	85033E	Standard Mechanical Calibration Kit (DC to 9GHz, 3.5mm)	7/2/2019	Annual	7/2/2020	MY53401181
Mini-Circuits	BW-N20W5+	DC to 18 GHz Precision Fixed 20 dB Attenuator	CBT	N/A	CBT	N/A
Mini-Circuits	NLP-2950+	Low Pass Filter DC to 2700 MHz	CBT	N/A	CBT	N/A
Narda	4772-3	Attenuator (3dB)	CBT	N/A	CBT	9406
Pasternack	PE2209-10	Bidirectional Coupler	CBT	N/A	CBT	N/A
Pasternack	NC-100	Torque Wrench	5/23/2018	Biennial	5/23/2020	N/A
SPEAG	EX3DV4	SAR Probe	2/19/2019	Annual	2/19/2020	7417
SPEAG	DAE4	Dasy Data Acquisition Electronics	2/13/2019	Annual	2/13/2020	665
SPEAG	EX3DV4	SAR Probe	7/15/2019	Annual	7/15/2020	7547
SPEAG	DAE4	Dasy Data Acquisition Electronics	7/11/2019	Annual	7/11/2020	1323
SPEAG	DAK-3.5	Dielectric Assessment Kit	9/11/2018	Annual	9/11/2019	1091

Measurement Uncertainty = $\pm 23\%$ (k=2)

	Name	Function	Signature
Calibrated By:	Brodie Halfoster	Test Engineer	<i>BRODIE HALFOSTER</i>
Approved By:	Kaitlin O'Keefe	Senior Technical Manager	<i>KOK</i>

DIPOLE CALIBRATION EXTENSION

Per KDB 865664 D01, calibration intervals of up to three years may be considered for reference dipoles when it is demonstrated that the SAR target, impedance and return loss of a dipole have remained stable according to the following requirements:

1. The measured SAR does not deviate more than 10% from the target on the calibration certificate.
2. The return-loss does not deviate more than 20% from the previous measurement and meets the required 20dB minimum return-loss requirement.
3. The measurement of real or imaginary parts of impedance does not deviate more than 5Ω from the previous measurement.

The following dipole was checked to pass the above 3 requirements to have 2-year calibration period from the calibration date:

Calibration Date	Extension Date	Certificate Electrical Delay (ns)	Certificate SAR Target Head (1g) W/kg @ 20.0 dBm	Measured Head SAR (1g) W/kg @ 20.0 dBm	Deviation 1g (%)	Certificate SAR Target Head (10g) W/kg @ 20.0 dBm	Measured Head SAR (10g) W/kg @ 20.0 dBm	Deviation 10g (%)	Certificate Impedance Head (Ohm) Real	Measured Impedance Head (Ohm) Real	Difference (Ohm) Real	Certificate Impedance Head (Ohm) Imaginary	Measured Impedance Head (Ohm) Imaginary	Difference (Ohm) Imaginary	Certificate Return Loss Head (dB)	Measured Return Loss Head (dB)	Deviation (%)	PASS/FAIL
8/16/2018	8/9/2019	1.162	5.23	5.53	5.74%	2.44	2.56	4.92%	55	53.5	1.5	2.3	1.1	1.2	-25.6	-28.5	-11.30%	PASS
Calibration Date	Extension Date	Certificate Electrical Delay (ns)	Certificate SAR Target Body (1g) W/kg @ 20.0 dBm	Measured Body SAR (1g) W/kg @ 20.0 dBm	Deviation 1g (%)	Certificate SAR Target Body (10g) W/kg @ 20.0 dBm	Measured Body SAR (10g) W/kg @ 20.0 dBm	Deviation 10g (%)	Certificate Impedance Body (Ohm) Real	Measured Impedance Body (Ohm) Real	Difference (Ohm) Real	Certificate Impedance Body (Ohm) Imaginary	Measured Impedance Body (Ohm) Imaginary	Difference (Ohm) Imaginary	Certificate Return Loss Body (dB)	Measured Return Loss Body (dB)	Deviation (%)	PASS/FAIL
8/16/2018	8/9/2019	1.162	5.09	4.98	-2.16%	2.42	2.28	-5.79%	50.2	47.8	2.4	4.7	1.1	3.6	-26.6	-31.8	-19.60%	PASS

Impedance & Return-Loss Measurement Plot for Head TSL

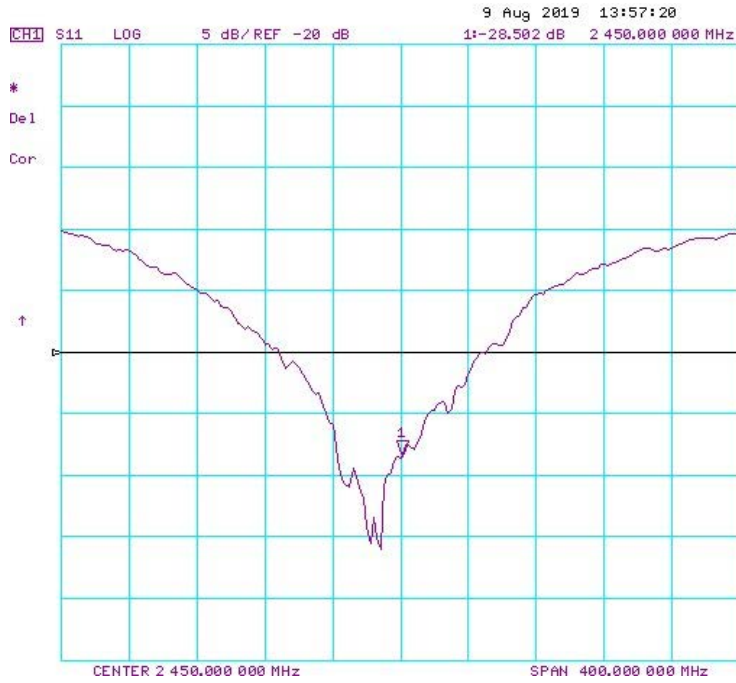
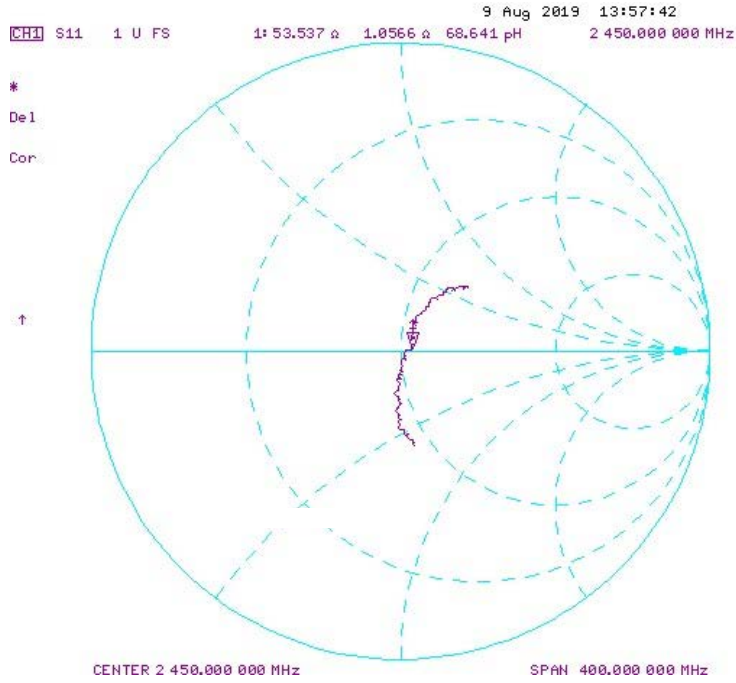

Impedance & Return-Loss Measurement Plot for Body TSL

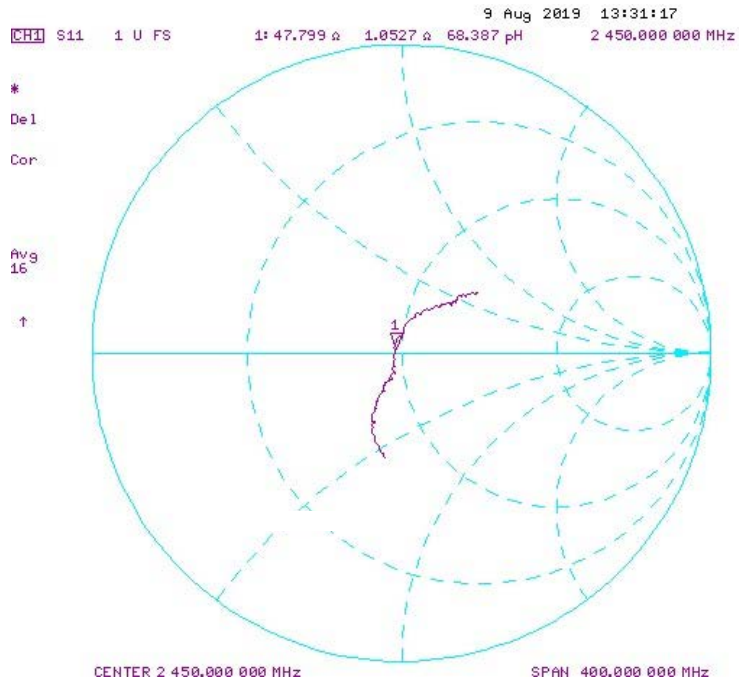



Accredited by the Swiss Accreditation Service (SAS)
The Swiss Accreditation Service is one of the signatories to the EA
Multilateral Agreement for the recognition of calibration certificates

Accreditation No.: **SCS 0108**

Client **PC Test**

Certificate No: **D2600V2-1004_Apr18**

CALIBRATION CERTIFICATE

Object **D2600V2 - SN:1004**

Calibration procedure(s) **QA-CAL-05.v10
Calibration procedure for dipole validation kits above 700 MHz**

Calibration date: **April 11, 2018**

*BN ✓
05-01-2018
BN ✓
04-20-2019
Extended*

This calibration certificate documents the traceability to national standards, which realize the physical units of measurements (SI).
The measurements and the uncertainties with confidence probability are given on the following pages and are part of the certificate.

All calibrations have been conducted in the closed laboratory facility: environment temperature (22 ± 3)°C and humidity < 70%.

Calibration Equipment used (M&TE critical for calibration)

Primary Standards	ID #	Cal Date (Certificate No.)	Scheduled Calibration
Power meter NRP	SN: 104778	04-Apr-18 (No. 217-02672/02673)	Apr-19
Power sensor NRP-Z91	SN: 103244	04-Apr-18 (No. 217-02672)	Apr-19
Power sensor NRP-Z91	SN: 103245	04-Apr-18 (No. 217-02673)	Apr-19
Reference 20 dB Attenuator	SN: 5058 (20k)	04-Apr-18 (No. 217-02682)	Apr-19
Type-N mismatch combination	SN: 5047.2 / 06327	04-Apr-18 (No. 217-02683)	Apr-19
Reference Probe EX3DV4	SN: 7349	30-Dec-17 (No. EX3-7349_Dec17)	Dec-18
DAE4	SN: 601	26-Oct-17 (No. DAE4-601_Oct17)	Oct-18

Secondary Standards	ID #	Check Date (in house)	Scheduled Check
Power meter EPM-442A	SN: GB37480704	07-Oct-15 (in house check Oct-16)	In house check: Oct-18
Power sensor HP 8481A	SN: US37292783	07-Oct-15 (in house check Oct-16)	In house check: Oct-18
Power sensor HP 8481A	SN: MY41092317	07-Oct-15 (in house check Oct-16)	In house check: Oct-18
RF generator R&S SMT-06	SN: 100972	15-Jun-15 (in house check Oct-16)	In house check: Oct-18
Network Analyzer HP 8753E	SN: US37390585	18-Oct-01 (in house check Oct-17)	In house check: Oct-18

Calibrated by:	Name Michael Weber	Function Laboratory Technician	Signature <i>M. Weber</i>
Approved by:	Name Katja Pokovic	Technical Manager	<i>K. Pokovic</i>

Issued: April 12, 2018

This calibration certificate shall not be reproduced except in full without written approval of the laboratory.



Accredited by the Swiss Accreditation Service (SAS)

Accreditation No.: **SCS 0108**

The Swiss Accreditation Service is one of the signatories to the EA Multilateral Agreement for the recognition of calibration certificates

Glossary:

TSL	tissue simulating liquid
ConvF	sensitivity in TSL / NORM x,y,z
N/A	not applicable or not measured

Calibration is Performed According to the Following Standards:

- IEEE Std 1528-2013, "IEEE Recommended Practice for Determining the Peak Spatial-Averaged Specific Absorption Rate (SAR) in the Human Head from Wireless Communications Devices: Measurement Techniques", June 2013
- IEC 62209-1, "Measurement procedure for the assessment of Specific Absorption Rate (SAR) from hand-held and body-mounted devices used next to the ear (frequency range of 300 MHz to 6 GHz)", July 2016
- IEC 62209-2, "Procedure to determine the Specific Absorption Rate (SAR) for wireless communication devices used in close proximity to the human body (frequency range of 30 MHz to 6 GHz)", March 2010
- KDB 865664, "SAR Measurement Requirements for 100 MHz to 6 GHz"

Additional Documentation:

- DASY4/5 System Handbook

Methods Applied and Interpretation of Parameters:

- Measurement Conditions:** Further details are available from the Validation Report at the end of the certificate. All figures stated in the certificate are valid at the frequency indicated.
- Antenna Parameters with TSL:** The dipole is mounted with the spacer to position its feed point exactly below the center marking of the flat phantom section, with the arms oriented parallel to the body axis.
- Feed Point Impedance and Return Loss:** These parameters are measured with the dipole positioned under the liquid filled phantom. The impedance stated is transformed from the measurement at the SMA connector to the feed point. The Return Loss ensures low reflected power. No uncertainty required.
- Electrical Delay:** One-way delay between the SMA connector and the antenna feed point. No uncertainty required.
- SAR measured:** SAR measured at the stated antenna input power.
- SAR normalized:** SAR as measured, normalized to an input power of 1 W at the antenna connector.
- SAR for nominal TSL parameters:** The measured TSL parameters are used to calculate the nominal SAR result.

The reported uncertainty of measurement is stated as the standard uncertainty of measurement multiplied by the coverage factor $k=2$, which for a normal distribution corresponds to a coverage probability of approximately 95%.

Measurement Conditions

DASY system configuration, as far as not given on page 1.

DASY Version	DASY5	V52.10.0
Extrapolation	Advanced Extrapolation	
Phantom	Modular Flat Phantom	
Distance Dipole Center - TSL	10 mm	with Spacer
Zoom Scan Resolution	dx, dy, dz = 5 mm	
Frequency	2600 MHz \pm 1 MHz	

Head TSL parameters

The following parameters and calculations were applied.

	Temperature	Permittivity	Conductivity
Nominal Head TSL parameters	22.0 °C	39.0	1.96 mho/m
Measured Head TSL parameters	(22.0 \pm 0.2) °C	37.8 \pm 6 %	2.03 mho/m \pm 6 %
Head TSL temperature change during test	< 0.5 °C	----	----

SAR result with Head TSL

SAR averaged over 1 cm³ (1 g) of Head TSL	Condition	
SAR measured	250 mW input power	14.3 W/kg
SAR for nominal Head TSL parameters	normalized to 1W	55.9 W/kg \pm 17.0 % (k=2)

SAR averaged over 10 cm³ (10 g) of Head TSL	condition	
SAR measured	250 mW input power	6.35 W/kg
SAR for nominal Head TSL parameters	normalized to 1W	25.1 W/kg \pm 16.5 % (k=2)

Body TSL parameters

The following parameters and calculations were applied.

	Temperature	Permittivity	Conductivity
Nominal Body TSL parameters	22.0 °C	52.5	2.16 mho/m
Measured Body TSL parameters	(22.0 \pm 0.2) °C	52.1 \pm 6 %	2.19 mho/m \pm 6 %
Body TSL temperature change during test	< 0.5 °C	----	----

SAR result with Body TSL

SAR averaged over 1 cm³ (1 g) of Body TSL	Condition	
SAR measured	250 mW input power	13.8 W/kg
SAR for nominal Body TSL parameters	normalized to 1W	54.8 W/kg \pm 17.0 % (k=2)

SAR averaged over 10 cm³ (10 g) of Body TSL	condition	
SAR measured	250 mW input power	6.20 W/kg
SAR for nominal Body TSL parameters	normalized to 1W	24.7 W/kg \pm 16.5 % (k=2)

Appendix (Additional assessments outside the scope of SCS 0108)

Antenna Parameters with Head TSL

Impedance, transformed to feed point	47.7 Ω - 5.7 j Ω
Return Loss	- 24.1 dB

Antenna Parameters with Body TSL

Impedance, transformed to feed point	46.0 Ω - 3.8 j Ω
Return Loss	- 24.9 dB

General Antenna Parameters and Design

Electrical Delay (one direction)	1.149 ns
----------------------------------	----------

After long term use with 100W radiated power, only a slight warming of the dipole near the feedpoint can be measured.

The dipole is made of standard semirigid coaxial cable. The center conductor of the feeding line is directly connected to the second arm of the dipole. The antenna is therefore short-circuited for DC-signals. On some of the dipoles, small end caps are added to the dipole arms in order to improve matching when loaded according to the position as explained in the "Measurement Conditions" paragraph. The SAR data are not affected by this change. The overall dipole length is still according to the Standard.

No excessive force must be applied to the dipole arms, because they might bend or the soldered connections near the feedpoint may be damaged.

Additional EUT Data

Manufactured by	SPEAG
Manufactured on	December 23, 2006

DASY5 Validation Report for Head TSL

Date: 11.04.2018

Test Laboratory: SPEAG, Zurich, Switzerland

DUT: Dipole 2600 MHz; Type: D2600V2; Serial: D2600V2 - SN: 1004

Communication System: UID 0 - CW; Frequency: 2600 MHz

Medium parameters used: $f = 2600$ MHz; $\sigma = 2.03$ S/m; $\epsilon_r = 37.8$; $\rho = 1000$ kg/m³

Phantom section: Flat Section

Measurement Standard: DASY5 (IEEE/IEC/ANSI C63.19-2011)

DASY52 Configuration:

- Probe: EX3DV4 - SN7349; ConvF(7.7, 7.7, 7.7); Calibrated: 30.12.2017;
- Sensor-Surface: 1.4mm (Mechanical Surface Detection)
- Electronics: DAE4 Sn601; Calibrated: 26.10.2017
- Phantom: Flat Phantom 5.0 (front); Type: QD 000 P50 AA; Serial: 1001
- DASY52 52.10.0(1446); SEMCAD X 14.6.10(7417)

Dipole Calibration for Head Tissue/Pin=250 mW, d=10mm/Zoom Scan (7x7x7)/Cube 0:

Measurement grid: dx=5mm, dy=5mm, dz=5mm

Reference Value = 118.5 V/m; Power Drift = -0.04 dB

Peak SAR (extrapolated) = 28.6 W/kg

SAR(1 g) = 14.3 W/kg; SAR(10 g) = 6.35 W/kg

Maximum value of SAR (measured) = 23.9 W/kg

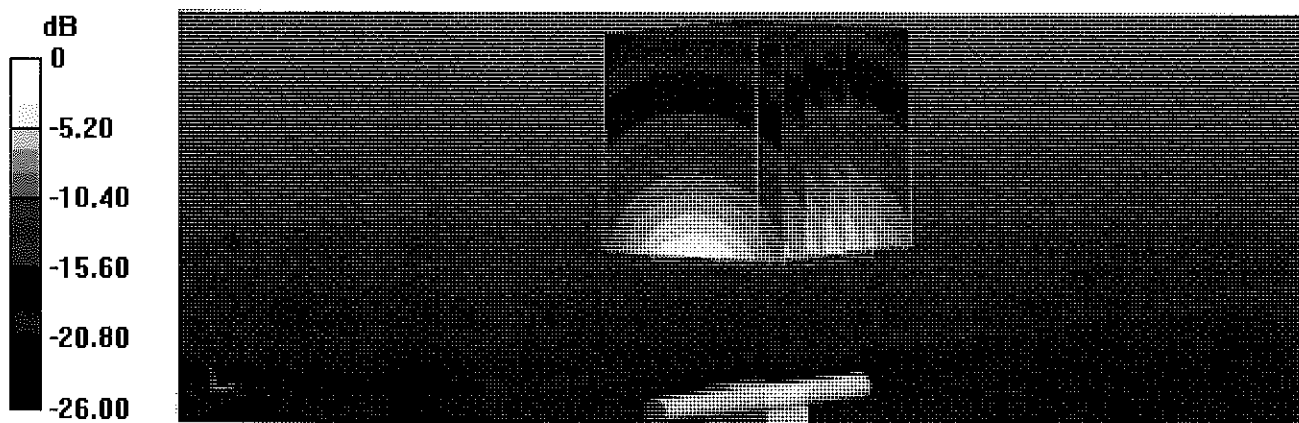

Impedance Measurement Plot for Head TSL

11 Apr 2018 11:25:16

[CH1] S11 1 U FS 1: 47.721 Ω -5.6836 Ω 10.770 pF 2 500.000 000 MHz

*
De1

CA

Avg
16

H1 d

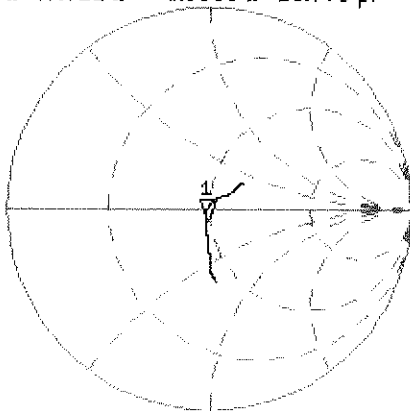

CH2 S11 LOG 5 dB/REF -20 dB 1:-24.073 dB 2 500.000 000 MHz

CA

Avg
16

H1 d

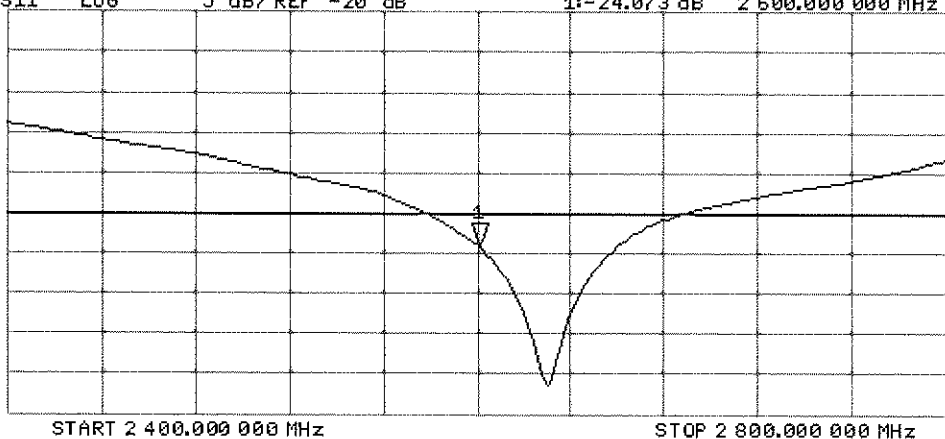

DASY5 Validation Report for Body TSL

Date: 11.04.2018

Test Laboratory: SPEAG, Zurich, Switzerland

DUT: Dipole 2600 MHz; Type: D2600V2; Serial: D2600V2 - SN: 1004

Communication System: UID 0 - CW; Frequency: 2600 MHz

Medium parameters used: $f = 2600$ MHz; $\sigma = 2.19$ S/m; $\epsilon_r = 52.1$; $\rho = 1000$ kg/m³

Phantom section: Flat Section

Measurement Standard: DASY5 (IEEE/IEC/ANSI C63.19-2011)

DASY52 Configuration:

- Probe: EX3DV4 - SN7349; ConvF(7.81, 7.81, 7.81); Calibrated: 30.12.2017;
- Sensor-Surface: 1.4mm (Mechanical Surface Detection)
- Electronics: DAE4 Sn601; Calibrated: 26.10.2017
- Phantom: Flat Phantom 5.0 (back); Type: QD 000 P50 AA; Serial: 1002
- DASY52 52.10.0(1446); SEMCAD X 14.6.10(7417)

Dipole Calibration for Body Tissue/ $P_{in}=250$ mW, $d=10$ mm/Zoom Scan (7x7x7)/Cube 0:

Measurement grid: $dx=5$ mm, $dy=5$ mm, $dz=5$ mm

Reference Value = 108.5 V/m; Power Drift = -0.09 dB

Peak SAR (extrapolated) = 28.3 W/kg

SAR(1 g) = 13.8 W/kg; SAR(10 g) = 6.2 W/kg

Maximum value of SAR (measured) = 22.9 W/kg

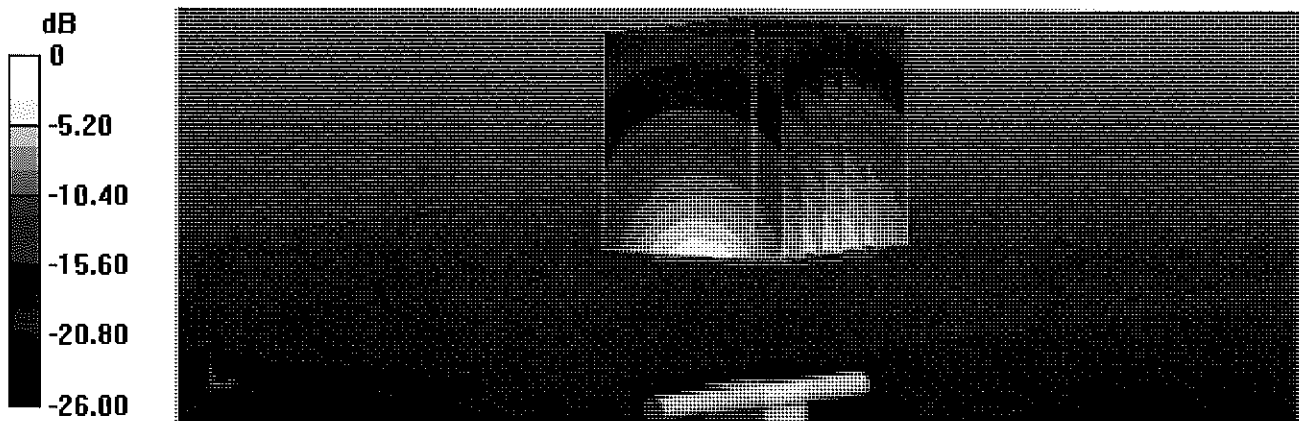

0 dB = 22.9 W/kg = 13.60 dBW/kg

Impedance Measurement Plot for Body TSL

11 Apr 2018 11:24:36

CH1 S11 1 U FS 1: 46.039 Ω -3.7520 Ω 16.315 pF 2 600.000 000 MHz

*
De1
Ca
Avg
16
H1d

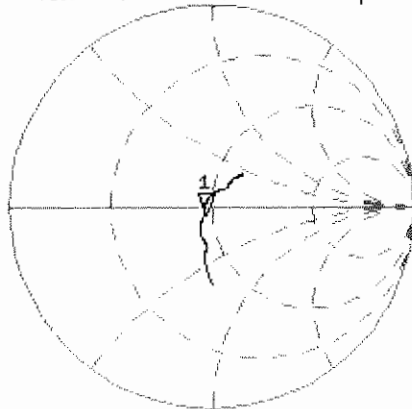

CH2 S11 LOG 5 dB/REF -20 dB 1:-24.921 dB 2 600.000 000 MHz

Ca
Avg
16
H1d

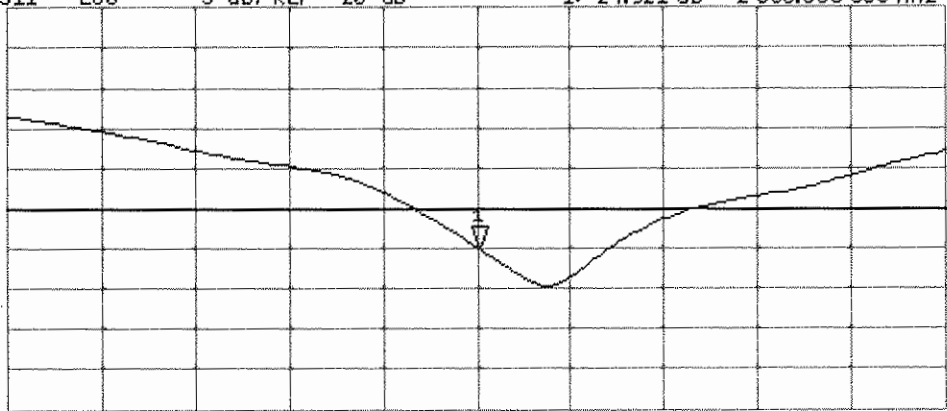

START 2 400.000 000 MHz

STOP 2 800.000 000 MHz

Certification of Calibration

Object: D2600V2 – SN: 1004

Calibration procedure(s): Procedure for Calibration Extension for SAR Dipoles.

Extension Calibration date: 4/11/2019

Description: SAR Validation Dipole at 2600 MHz.

Calibration Equipment used:

Manufacturer	Model	Description	Cal Date	Cal Interval	Cal Due	Serial Number
Agilent	8753ES	S-Parameter Network Analyzer	3/11/2019	Annual	3/11/2020	US39170122
Agilent	N5182A	MXG Vector Signal Generator	4/18/2018	Annual	4/18/2019	MY47420800
Amplifier Research	15S1G6	Amplifier	CBT	N/A	CBT	433971
Anritsu	MA2411B	Pulse Power Sensor	11/20/2018	Annual	11/20/2019	1027293
Anritsu	MA2411B	Pulse Power Sensor	10/30/2018	Annual	10/30/2019	1126066
Anritsu	ML2495A	Power Meter	10/21/2018	Annual	10/21/2019	941001
Control Company	4040	Therm./ Clock/ Humidity Monitor	10/9/2018	Biennial	10/9/2020	181647811
Control Company	4352	Ultra Long Stem Thermometer	5/2/2017	Biennial	5/2/2019	170330156
Keysight	772D	Dual Directional Coupler	CBT	N/A	CBT	MY52180215
Keysight Technologies	85033E	Standard Mechanical Calibration Kit (DC to 9GHz, 3.5mm)	6/4/2018	Annual	6/4/2019	MY53401181
MiniCircuits	VLF-6000+	Low Pass Filter	CBT	N/A	CBT	N/A
Mini-Circuits	BW-N20W5+	DC to 18 GHz Precision Fixed 20 dB Attenuator	CBT	N/A	CBT	N/A
Narda	4772-3	Attenuator (3dB)	CBT	N/A	CBT	9406
Pasternack	PE2209-10	Bidirectional Coupler	CBT	N/A	CBT	N/A
Seekonk	NC-100	Torque Wrench	7/11/2018	Annual	7/11/2019	N/A
SPEAG	EX3DV4	SAR Probe	6/25/2018	Annual	6/25/2019	7409
SPEAG	DAE4	Dasy Data Acquisition Electronics	6/18/2018	Annual	6/18/2019	1334
SPEAG	DAE4	Dasy Data Acquisition Electronics	2/13/2019	Annual	2/13/2020	665
SPEAG	EX3DV4	SAR Probe	2/19/2019	Annual	2/19/2020	7417
SPEAG	DAK-3.5	Dielectric Assessment Kit	9/11/2018	Annual	9/11/2019	1091

Measurement Uncertainty = $\pm 23\%$ (k=2)

	Name	Function	Signature
Calibrated By:	Brodie Halfoster	Test Engineer	<i>BRODIE HALFOSTER</i>
Approved By:	Kaitlin O'Keefe	Senior Technical Manager	<i>KOK</i>

DIPOLE CALIBRATION EXTENSION

Per KDB 865664 D01, calibration intervals of up to three years may be considered for reference dipoles when it is demonstrated that the SAR target, impedance and return loss of a dipole have remained stable according to the following requirements:

1. The measured SAR does not deviate more than 10% from the target on the calibration certificate.
2. The return-loss does not deviate more than 20% from the previous measurement and meets the required 20dB minimum return-loss requirement.
3. The measurement of real or imaginary parts of impedance does not deviate more than 5Ω from the previous measurement.

The following dipole was checked to pass the above 3 requirements to have 2-year calibration period from the calibration date:

Calibration Date	Extension Date	Certificate Electrical Delay (ns)	Certificate SAR Target Head (1g) W/kg @ 20.0 dBm	Measured Head SAR (1g) W/kg @ 20.0 dBm	Deviation 1g (%)	Certificate SAR Target Head (10g) W/kg @ 20.0 dBm	Measured Head SAR (10g) W/kg @ 20.0 dBm	Deviation 10g (%)	Certificate Impedance Head (Ohm) Real	Measured Impedance Head (Ohm) Real	Difference (Ohm) Real	Certificate Impedance Head (Ohm) Imaginary	Measured Impedance Head (Ohm) Imaginary	Difference (Ohm) Imaginary	Certificate Return Loss Head (dB)	Measured Return Loss Head (dB)	Deviation (%)	PASS/FAIL
4/11/2018	4/11/2019	1.140	5.59	5.51	-1.43%	2.51	2.47	-1.59%	47.7	48.5	0.8	-5.7	-5.1	0.6	-24.1	-25.6	-6.30%	PASS
Calibration Date	Extension Date	Certificate Electrical Delay (ns)	Certificate SAR Target Body (1g) W/kg @ 20.0 dBm	Measured Body SAR (1g) W/kg @ 20.0 dBm	Deviation 1g (%)	Certificate SAR Target Body (10g) W/kg @ 20.0 dBm	Measured Body SAR (10g) W/kg @ 20.0 dBm	Deviation 10g (%)	Certificate Impedance Body (Ohm) Real	Measured Impedance Body (Ohm) Real	Difference (Ohm) Real	Certificate Impedance Body (Ohm) Imaginary	Measured Impedance Body (Ohm) Imaginary	Difference (Ohm) Imaginary	Certificate Return Loss Body (dB)	Measured Return Loss Body (dB)	Deviation (%)	PASS/FAIL
4/11/2018	4/11/2019	1.140	5.48	5.65	3.10%	2.47	2.48	0.40%	46	46.6	0.6	-3.8	-4.7	0.9	-24.9	-24.5	1.80%	PASS

Impedance & Return-Loss Measurement Plot for Head TSL

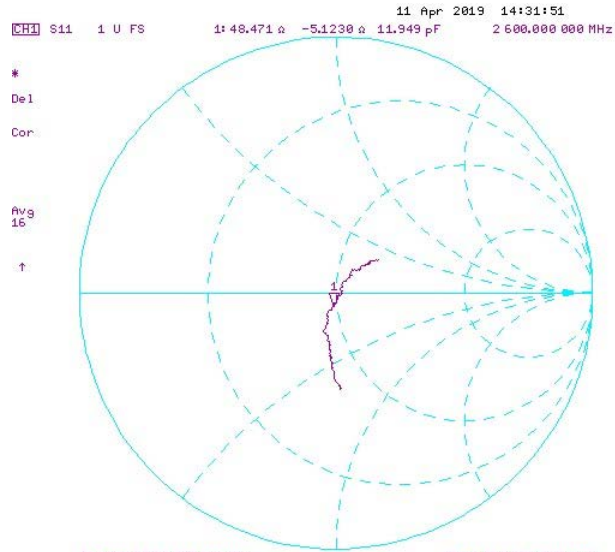

Impedance & Return-Loss Measurement Plot for Body TSL

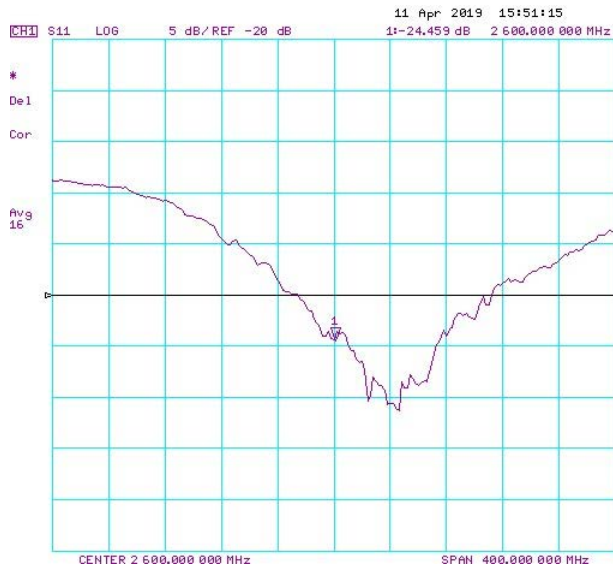
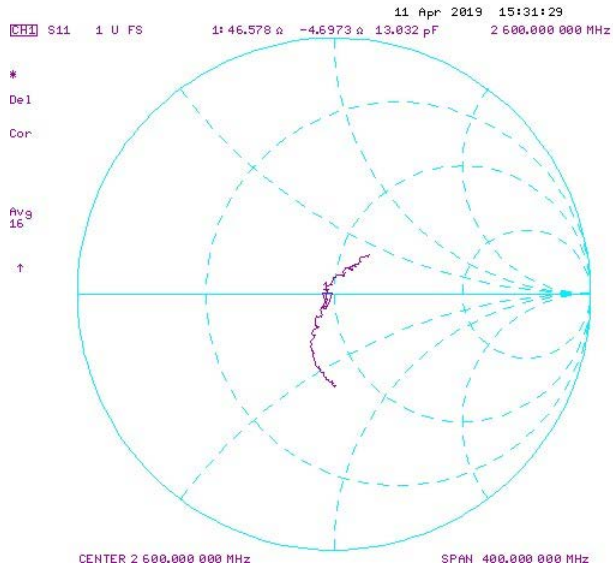



Accredited by the Swiss Accreditation Service (SAS)
The Swiss Accreditation Service is one of the signatories to the EA
Multilateral Agreement for the recognition of calibration certificates

Accreditation No.: **SCS 0108**

Client **PC Test**

Certificate No: **D3500V2-1059_Jan18**

CALIBRATION CERTIFICATE

Object **D3500V2 - SN:1059**

Calibration procedure(s) **QA CAL-22.v2
Calibration procedure for dipole validation kits between 3-6 GHz**

Calibration date: **January 11, 2018**

This calibration certificate documents the traceability to national standards, which realize the physical units of measurements (SI).
The measurements and the uncertainties with confidence probability are given on the following pages and are part of the certificate.

All calibrations have been conducted in the closed laboratory facility: environment temperature $(22 \pm 3)^\circ\text{C}$ and humidity $< 70\%$.

Calibration Equipment used (M&TE critical for calibration)

Primary Standards	ID #	Cal Date (Certificate No.)	Scheduled Calibration
Power meter NRP	SN: 104778	04-Apr-17 (No. 217-02521/02522)	Apr-18
Power sensor NRP-Z91	SN: 103244	04-Apr-17 (No. 217-02521)	Apr-18
Power sensor NRP-Z91	SN: 103245	04-Apr-17 (No. 217-02522)	Apr-18
Reference 20 dB Attenuator	SN: 5058 (20k)	07-Apr-17 (No. 217-02528)	Apr-18
Type-N mismatch combination	SN: 5047.2 / 06327	07-Apr-17 (No. 217-02529)	Apr-18
Reference Probe EX3DV4	SN: 3503	30-Dec-17 (No. EX3-3503_Dec17)	Dec-18
DAE4	SN: 601	26-Oct-17 (No. DAE4-601_Oct17)	Oct-18

Secondary Standards	ID #	Check Date (in house)	Scheduled Check
Power meter EPM-442A	SN: GB37480704	07-Oct-15 (in house check Oct-16)	In house check: Oct-18
Power sensor HP 8481A	SN: US37292783	07-Oct-15 (in house check Oct-16)	In house check: Oct-18
Power sensor HP 8481A	SN: MY41092317	07-Oct-15 (in house check Oct-16)	In house check: Oct-18
RF generator R&S SMT-06	SN: 100972	15-Jun-15 (in house check Oct-16)	In house check: Oct-18
Network Analyzer HP 8753E	SN: US37390585	18-Oct-01 (in house check Oct-17)	In house check: Oct-18

Calibrated by: **Michael Weber** Name: **Michael Weber** Function: **Laboratory Technician**

Approved by: **Katja Pokovic** Name: **Katja Pokovic** Technical Manager

Signature

Issued: January 16, 2018

This calibration certificate shall not be reproduced except in full without written approval of the laboratory.



Accredited by the Swiss Accreditation Service (SAS)

The Swiss Accreditation Service is one of the signatories to the EA
Multilateral Agreement for the recognition of calibration certificates

Accreditation No.: **SCS 0108**

Glossary:

TSL	tissue simulating liquid
ConvF	sensitivity in TSL / NORM x,y,z
N/A	not applicable or not measured

Calibration is Performed According to the Following Standards:

- IEEE Std 1528-2013, "IEEE Recommended Practice for Determining the Peak Spatial-Averaged Specific Absorption Rate (SAR) in the Human Head from Wireless Communications Devices: Measurement Techniques", June 2013
- IEC 62209-1, "Measurement procedure for the assessment of Specific Absorption Rate (SAR) from hand-held and body-mounted devices used next to the ear (frequency range of 300 MHz to 6 GHz)", July 2016
- IEC 62209-2, "Procedure to determine the Specific Absorption Rate (SAR) for wireless communication devices used in close proximity to the human body (frequency range of 30 MHz to 6 GHz)", March 2010
- KDB 865664, "SAR Measurement Requirements for 100 MHz to 6 GHz"

Additional Documentation:

- DASY4/5 System Handbook

Methods Applied and Interpretation of Parameters:

- Measurement Conditions:* Further details are available from the Validation Report at the end of the certificate. All figures stated in the certificate are valid at the frequency indicated.
- Antenna Parameters with TSL:* The dipole is mounted with the spacer to position its feed point exactly below the center marking of the flat phantom section, with the arms oriented parallel to the body axis.
- Feed Point Impedance and Return Loss:* These parameters are measured with the dipole positioned under the liquid filled phantom. The impedance stated is transformed from the measurement at the SMA connector to the feed point. The Return Loss ensures low reflected power. No uncertainty required.
- Electrical Delay:* One-way delay between the SMA connector and the antenna feed point. No uncertainty required.
- SAR measured:* SAR measured at the stated antenna input power.
- SAR normalized:* SAR as measured, normalized to an input power of 1 W at the antenna connector.
- SAR for nominal TSL parameters:* The measured TSL parameters are used to calculate the nominal SAR result.

The reported uncertainty of measurement is stated as the standard uncertainty of measurement multiplied by the coverage factor $k=2$, which for a normal distribution corresponds to a coverage probability of approximately 95%.

Measurement Conditions

DASY system configuration, as far as not given on page 1.

DASY Version	DASY5	V52.10.0
Extrapolation	Advanced Extrapolation	
Phantom	Modular Flat Phantom	
Distance Dipole Center - TSL	10 mm	with Spacer
Zoom Scan Resolution	dx, dy = 4 mm, dz = 1.4 mm	Graded Ratio = 1.4 (Z direction)
Frequency	3500 MHz ± 1 MHz	

Head TSL parameters

The following parameters and calculations were applied.

	Temperature	Permittivity	Conductivity
Nominal Head TSL parameters	22.0 °C	37.9	2.91 mho/m
Measured Head TSL parameters	(22.0 ± 0.2) °C	38.5 ± 6 %	2.91 mho/m ± 6 %
Head TSL temperature change during test	< 0.5 °C	----	----

SAR result with Head TSL

SAR averaged over 1 cm ³ (1 g) of Head TSL	Condition	
SAR measured	100 mW input power	6.44 W/kg
SAR for nominal Head TSL parameters	normalized to 1W	64.6 W/kg ± 19.9 % (k=2)

SAR averaged over 10 cm ³ (10 g) of Head TSL	condition	
SAR measured	100 mW input power	2.43 W/kg
SAR for nominal Head TSL parameters	normalized to 1W	24.4 W/kg ± 19.5 % (k=2)

Body TSL parameters

The following parameters and calculations were applied.

	Temperature	Permittivity	Conductivity
Nominal Body TSL parameters	22.0 °C	51.3	3.31 mho/m
Measured Body TSL parameters	(22.0 ± 0.2) °C	50.0 ± 6 %	3.32 mho/m ± 6 %
Body TSL temperature change during test	< 0.5 °C	----	----

SAR result with Body TSL

SAR averaged over 1 cm ³ (1 g) of Body TSL	Condition	
SAR measured	100 mW input power	6.55 W/kg
SAR for nominal Body TSL parameters	normalized to 1W	65.1 W/kg ± 19.9 % (k=2)

SAR averaged over 10 cm ³ (10 g) of Body TSL	condition	
SAR measured	100 mW input power	2.43 W/kg
SAR for nominal Body TSL parameters	normalized to 1W	24.2 W/kg ± 19.5 % (k=2)

Appendix (Additional assessments outside the scope of SCS 0108)

Antenna Parameters with Head TSL

Impedance, transformed to feed point	53.2 Ω - 7.1 j Ω
Return Loss	- 22.4 dB

Antenna Parameters with Body TSL

Impedance, transformed to feed point	53.4 Ω - 4.5 j Ω
Return Loss	- 25.3 dB

General Antenna Parameters and Design

Electrical Delay (one direction)	1.136 ns
----------------------------------	----------

After long term use with 100W radiated power, only a slight warming of the dipole near the feedpoint can be measured.

The dipole is made of standard semirigid coaxial cable. The center conductor of the feeding line is directly connected to the second arm of the dipole. The antenna is therefore short-circuited for DC-signals. On some of the dipoles, small end caps are added to the dipole arms in order to improve matching when loaded according to the position as explained in the "Measurement Conditions" paragraph. The SAR data are not affected by this change. The overall dipole length is still according to the Standard.

No excessive force must be applied to the dipole arms, because they might bend or the soldered connections near the feedpoint may be damaged.

Additional EUT Data

Manufactured by	SPEAG
Manufactured on	January 20, 2017

DASY5 Validation Report for Head TSL

Date: 11.01.2018

Test Laboratory: SPEAG, Zurich, Switzerland

DUT: Dipole 3500 MHz; Type: D3500V2; Serial: D3500V2 - SN:1059

Communication System: UID 0 - CW; Frequency: 3500 MHz

Medium parameters used: $f = 3500$ MHz; $\sigma = 2.91$ S/m; $\epsilon_r = 38.5$; $\rho = 1000$ kg/m³

Phantom section: Flat Section

Measurement Standard: DASY5 (IEEE/IEC/ANSI C63.19-2011)

DASY52 Configuration:

- Probe: EX3DV4 - SN3503; ConvF(7.8, 7.8, 7.8); Calibrated: 30.12.2017;
- Sensor-Surface: 1.4mm (Mechanical Surface Detection)
- Electronics: DAE4 Sn601; Calibrated: 26.10.2017
- Phantom: Flat Phantom 5.0 (front); Type: QD 000 P50 AA; Serial: 1001
- DASY52 52.10.0(1446); SEMCAD X 14.6.10(7417)

Dipole Calibration for Head Tissue/Pin=100 mW, d=10mm/Zoom Scan, dist=1.4mm

(8x8x8)/Cube 0: Measurement grid: dx=4mm, dy=4mm, dz=1.4mm

Reference Value = 69.59 V/m; Power Drift = -0.03 dB

Peak SAR (extrapolated) = 17.6 W/kg

SAR(1 g) = 6.44 W/kg; SAR(10 g) = 2.43 W/kg

Maximum value of SAR (measured) = 12.5 W/kg

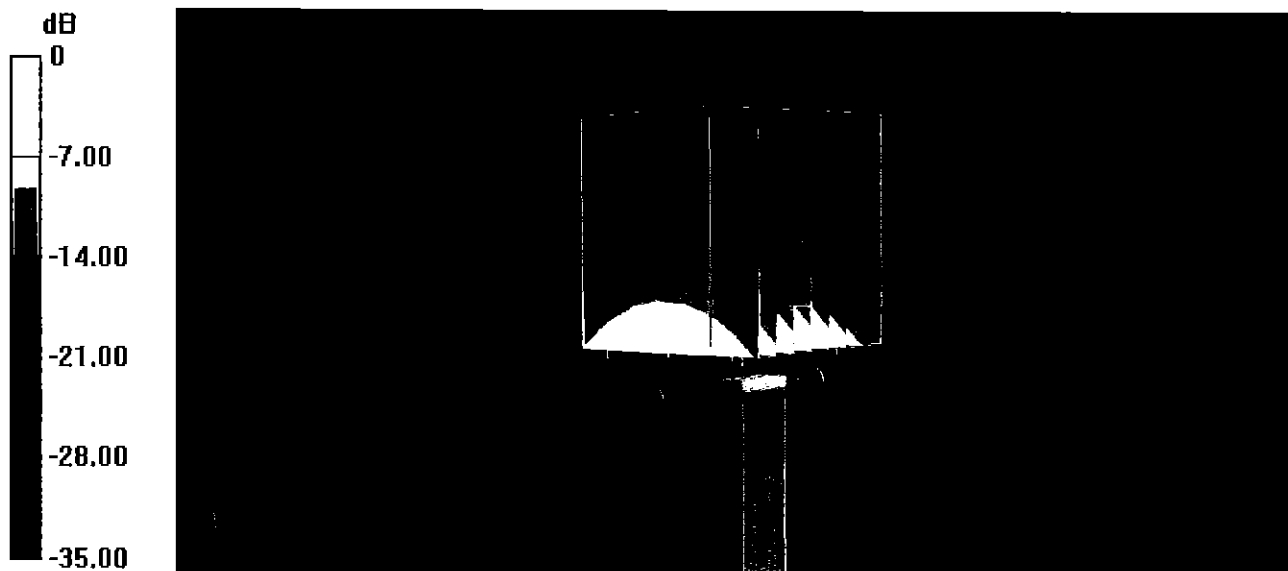

Impedance Measurement Plot for Head TSL

11 Jan 2018 16:35:59

CH1 S11 1 U FS 1: 53.178 Ω -7.1387 Ω 6.3699 pF 3 500.000 000 MHz

*
De l
CA

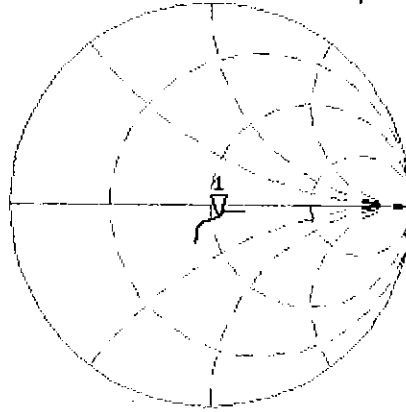

Avg
15

H1d

CH2 S11 LOG 5 dB/REF -20 dB 1: -22.432 dB 3 500.000 000 MHz

CA

Avg
15

H1d

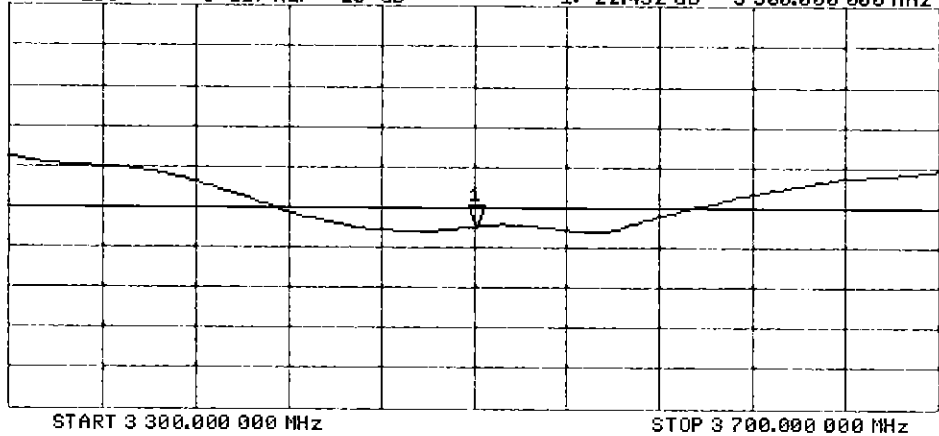

DASY5 Validation Report for Body TSL

Date: 10.01.2018

Test Laboratory: SPEAG, Zurich, Switzerland

DUT: Dipole 3500 MHz; Type: D3500V2; Serial: D3500V2 - SN:1059

Communication System: UID 0 - CW; Frequency: 3500 MHz

Medium parameters used: $f = 3500$ MHz; $\sigma = 3.32$ S/m; $\epsilon_r = 50$; $\rho = 1000$ kg/m³

Phantom section: Flat Section

Measurement Standard: DASY5 (IEEE/IEC/ANSI C63.19-2011)

DASY52 Configuration:

- Probe: EX3DV4 - SN3503; ConvF(7.43, 7.43, 7.43); Calibrated: 30.12.2017;
- Sensor-Surface: 1.4mm (Mechanical Surface Detection)
- Electronics: DAE4 Sn601; Calibrated: 26.10.2017
- Phantom: Flat Phantom 5.0 (back); Type: QD 000 P50 AA; Serial: 1002
- DASY52 52.10.0(1446); SEMCAD X 14.6.10(7417)

Dipole Calibration for Body Tissue/Pin=100 mW, d=10mm/Zoom Scan , dist=1.4mm

(8x8x8)/Cube 0: Measurement grid: dx=4mm, dy=4mm, dz=1.4mm

Reference Value = 66.18 V/m; Power Drift = -0.09 dB

Peak SAR (extrapolated) = 17.9 W/kg

SAR(1 g) = 6.55 W/kg; SAR(10 g) = 2.43 W/kg

Maximum value of SAR (measured) = 12.6 W/kg

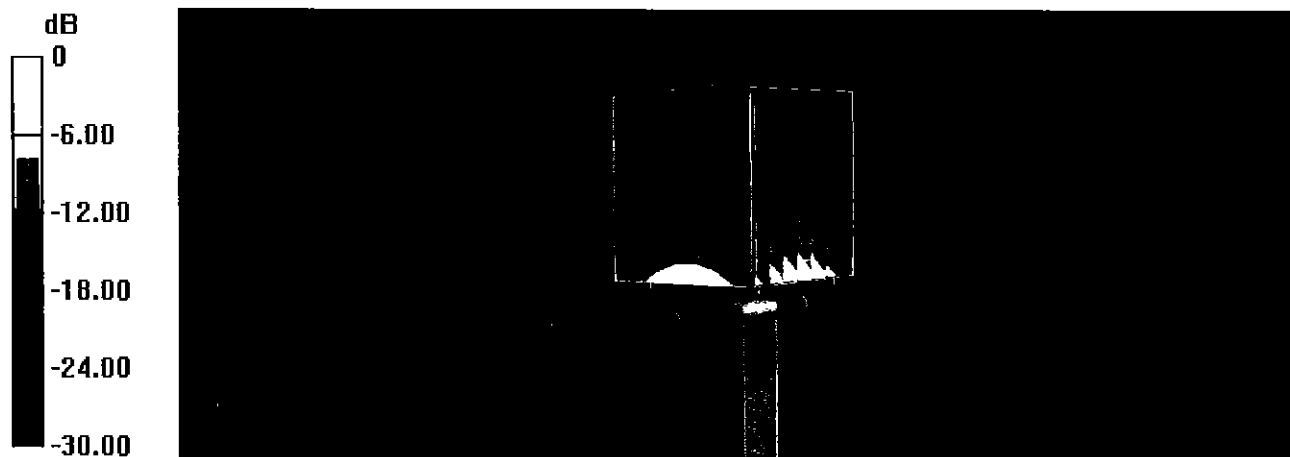

0 dB = 12.6 W/kg = 11.00 dBW/kg

Impedance Measurement Plot for Body TSL

10 Jan 2018 11:28:56

CH1 S11 1 U FS 1: 53.365 Ω -4.4648 Ω 10.185 pF 3 500.000 000 MHz

*
De1
CA

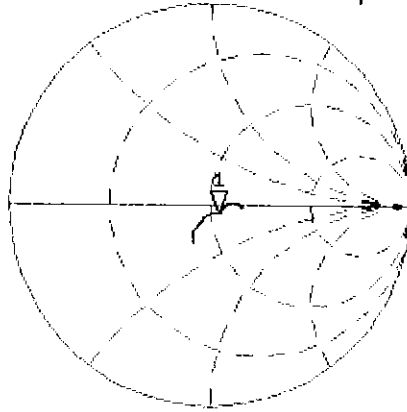

Avg
16

H1d

CH2 S11 LOG 5 dB/REF -20 dB 1: -25.338 dB 3 500.000 000 MHz

CA

Avg
16

H1d

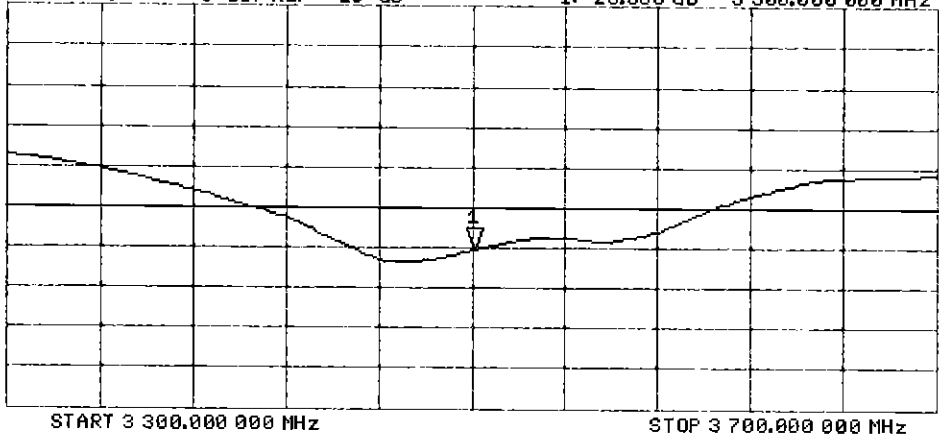

Certification of Calibration

Object: D3500V2 – SN: 1059

Calibration procedure(s): Procedure for Calibration Extension for SAR Dipoles.

Extension Calibration date: 1/11/2019

Description: SAR Validation Dipole at 3500 MHz.

Calibration Equipment used:

Manufacturer	Model	Description	Cal Date	Cal Interval	Cal Due	Serial Number
Agilent	8753ES	S-Parameter Network Analyzer	2/8/2018	Annual	2/8/2019	US39170122
Agilent	N5182A	MXG Vector Signal Generator	4/18/2018	Annual	4/18/2019	MY47420800
Amplifier Research	15S1G6	Amplifier	CBT	N/A	CBT	433971
Anritsu	MA2411B	Pulse Power Sensor	3/2/2018	Annual	3/2/2019	1207364
Anritsu	MA2411B	Pulse Power Sensor	3/2/2018	Annual	3/2/2019	1339018
Anritsu	ML2495A	Power Meter	10/21/2018	Annual	10/21/2019	941001
Control Company	4040	Therm./Clock/Humidity Monitor	3/31/2017	Biennial	3/31/2019	170232394
Control Company	4352	Ultra Long Stem Thermometer	5/2/2017	Biennial	5/2/2019	170330156
Keysight	772D	Dual Directional Coupler	CBT	N/A	CBT	MY52180215
Keysight Technologies	85033E	Standard Mechanical Calibration Kit (DC to 9GHz, 3.5mm)	6/4/2018	Annual	6/4/2019	MY53401181
MiniCircuits	VLF-6000+	Low Pass Filter	CBT	N/A	CBT	N/A
Mini-Circuits	BW-N20W5+	DC to 18 GHz Precision Fixed 20 dB Attenuator	CBT	N/A	CBT	N/A
Narda	4772-3	Attenuator (3dB)	CBT	N/A	CBT	9406
Pasternack	PE2209-10	Bidirectional Coupler	CBT	N/A	CBT	N/A
Seekonk	NC-100	Torque Wrench	7/11/2018	Annual	7/11/2019	N/A
SPEAG	DAE4	Dasy Data Acquisition Electronics	10/3/2018	Annual	10/3/2019	1558
SPEAG	DAE4	Dasy Data Acquisition Electronics	6/18/2018	Annual	6/18/2019	1334
SPEAG	DAK-3.5	Dielectric Assessment Kit	9/11/2018	Annual	9/11/2019	1091
SPEAG	EX3DV4	SAR Probe	2/14/2018	Annual	2/14/2019	3914
SPEAG	EX3DV4	SAR Probe	8/24/2018	Annual	8/24/2019	3949

Measurement Uncertainty = $\pm 23\%$ (k=2)

	Name	Function	Signature
Calibrated By:	Brodie Halfoster	Test Engineer	<i>BRODIE HALFOSTER</i>
Approved By:	Kaitlin O'Keefe	Senior Technical Manager	<i>KOK</i>

DIPOLE CALIBRATION EXTENSION

Per KDB 865664 D01, calibration intervals of up to three years may be considered for reference dipoles when it is demonstrated that the SAR target, impedance and return loss of a dipole have remained stable according to the following requirements:

1. The measured SAR does not deviate more than 10% from the target on the calibration certificate.
2. The return-loss does not deviate more than 20% from the previous measurement and meets the required 20dB minimum return-loss requirement.
3. The measurement of real or imaginary parts of impedance does not deviate more than 5Ω from the previous measurement.

The following dipole was checked to pass the above 3 requirements to have 2-year calibration period from the calibration date:

Calibration Date	Extension Date	Certificate Electrical Delay (ns)	Certificate SAR Target Head (1g) W/kg @ 20.0 dBm	Measured Head SAR (1g) W/kg @ 20.0 dBm	Deviation 1g (%)	Certificate SAR Target Head (10g) W/kg @ 20.0 dBm	Measured Head SAR (10g) W/kg @ 20.0 dBm	Deviation 10g (%)	Certificate Impedance Head (Ohm) Real	Measured Impedance Head (Ohm) Real	Difference (Ohm) Real	Certificate Impedance Head (Ohm) Imaginary	Measured Impedance Head (Ohm) Imaginary	Difference (Ohm) Imaginary	Certificate Return Loss Head (dB)	Measured Return Loss Head (dB)	Deviation (%)	PASS/FAIL
1/11/2018	1/16/2019	1.136	6.46	6.23	-3.56%	2.44	2.34	-4.10%	53.2	52.9	0.3	-7.1	-5.9	1.2	-22.4	-24	-7.20%	PASS
Calibration Date	Extension Date	Certificate Electrical Delay (ns)	Certificate SAR Target Body (1g) W/kg @ 20.0 dBm	Measured Body SAR (1g) W/kg @ 20.0 dBm	Deviation 1g (%)	Certificate SAR Target Body (10g) W/kg @ 20.0 dBm	Measured Body SAR (10g) W/kg @ 20.0 dBm	Deviation 10g (%)	Certificate Impedance Body (Ohm) Real	Measured Impedance Body (Ohm) Real	Difference (Ohm) Real	Certificate Impedance Body (Ohm) Imaginary	Measured Impedance Body (Ohm) Imaginary	Difference (Ohm) Imaginary	Certificate Return Loss Body (dB)	Measured Return Loss Body (dB)	Deviation (%)	PASS/FAIL
1/11/2018	1/16/2019	1.136	6.51	6	-7.83%	2.42	2.26	-6.61%	53.4	49.8	3.6	-4.5	-5	0.5	-25.3	-25.9	-2.40%	PASS

Impedance & Return-Loss Measurement Plot for Head TSL

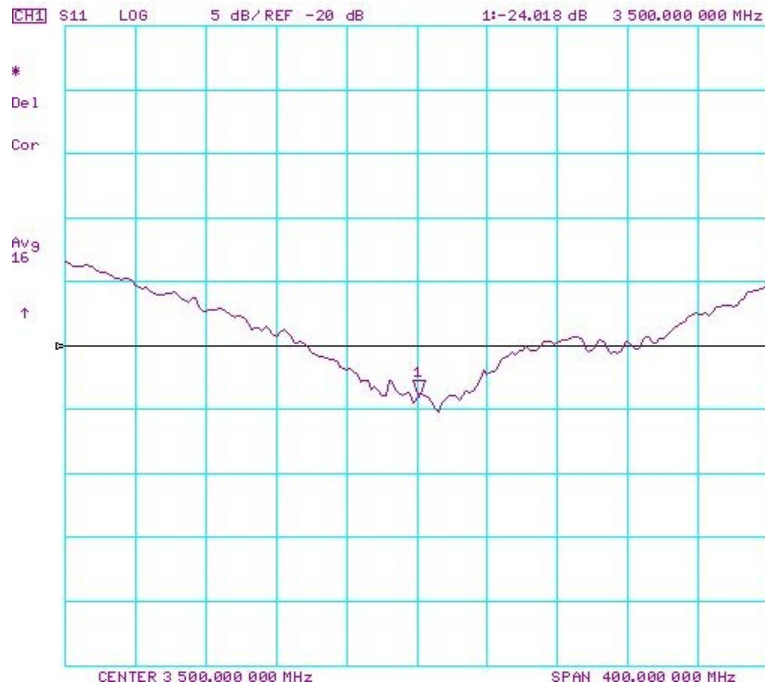
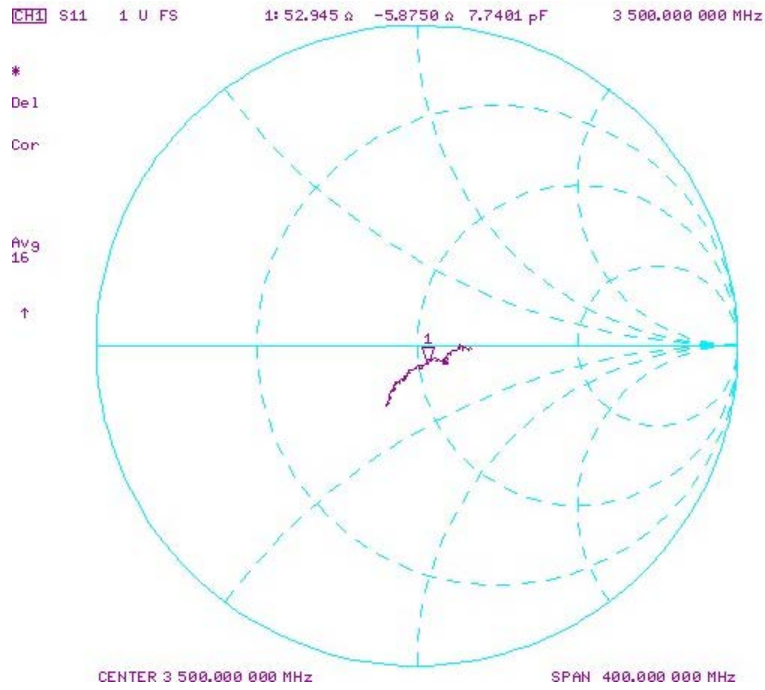

Impedance & Return-Loss Measurement Plot for Body TSL

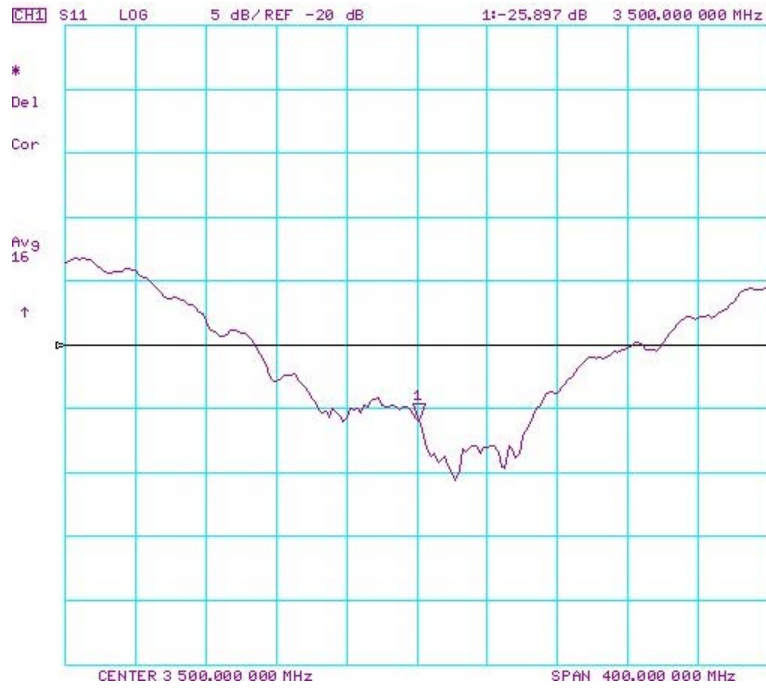
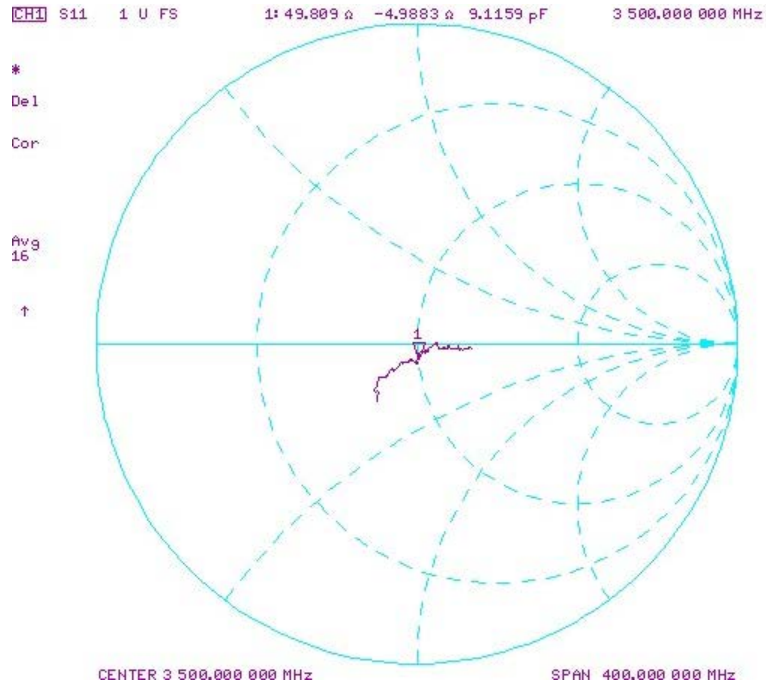



Accredited by the Swiss Accreditation Service (SAS)
The Swiss Accreditation Service is one of the signatories to the EA
Multilateral Agreement for the recognition of calibration certificates

Accreditation No.: **SCS 0108**

Client **PC Test**

Certificate No: **D3700V2-1018_Jan18**

CALIBRATION CERTIFICATE

Object **D3700V2 - SN:1018**

Calibration procedure(s) **QA CAL-22.v2
Calibration procedure for dipole validation kits between 3-6 GHz**

Calibration date: **January 11, 2018**

*BNV
01-26-2018*

This calibration certificate documents the traceability to national standards, which realize the physical units of measurements (SI).
The measurements and the uncertainties with confidence probability are given on the following pages and are part of the certificate.

*BNV
02/06/2019*

All calibrations have been conducted in the closed laboratory facility: environment temperature (22 ± 3)°C and humidity < 70%.

Calibration Equipment used (M&TE critical for calibration)

Primary Standards	ID #	Cal Date (Certificate No.)	Scheduled Calibration
Power meter NRP	SN: 104778	04-Apr-17 (No. 217-02521/02522)	Apr-18
Power sensor NRP-Z91	SN: 103244	04-Apr-17 (No. 217-02521)	Apr-18
Power sensor NRP-Z91	SN: 103245	04-Apr-17 (No. 217-02522)	Apr-18
Reference 20 dB Attenuator	SN: 5058 (20k)	07-Apr-17 (No. 217-02528)	Apr-18
Type-N mismatch combination	SN: 5047.2 / 06327	07-Apr-17 (No. 217-02529)	Apr-18
Reference Probe EX3DV4	SN: 3503	30-Dec-17 (No. EX3-3503_Dec17)	Dec-18
DAE4	SN: 601	26-Oct-17 (No. DAE4-601_Oct17)	Oct-18
Secondary Standards	ID #	Check Date (in house)	Scheduled Check
Power meter EPM-442A	SN: GB37480704	07-Oct-15 (in house check Oct-16)	In house check: Oct-18
Power sensor HP 8481A	SN: US37292783	07-Oct-15 (in house check Oct-16)	In house check: Oct-18
Power sensor HP 8481A	SN: MY41092317	07-Oct-15 (in house check Oct-16)	In house check: Oct-18
RF generator R&S SMT-06	SN: 100972	15-Jun-15 (in house check Oct-16)	In house check: Oct-18
Network Analyzer HP 8753E	SN: US37390585	18-Oct-01 (in house check Oct-17)	In house check: Oct-18

Calibrated by: **Michael Weber** Laboratory Technician
Approved by: **Katja Pokovic** Technical Manager

Signature
M. Weber
K. Pokovic

Issued: January 16, 2018

This calibration certificate shall not be reproduced except in full without written approval of the laboratory.



Accredited by the Swiss Accreditation Service (SAS)

The Swiss Accreditation Service is one of the signatories to the EA
Multilateral Agreement for the recognition of calibration certificates

Accreditation No.: **SCS 0108**

Glossary:

TSL	tissue simulating liquid
ConvF	sensitivity in TSL / NORM x,y,z
N/A	not applicable or not measured

Calibration is Performed According to the Following Standards:

- IEEE Std 1528-2013, "IEEE Recommended Practice for Determining the Peak Spatial-Averaged Specific Absorption Rate (SAR) in the Human Head from Wireless Communications Devices: Measurement Techniques", June 2013
- IEC 62209-1, "Measurement procedure for the assessment of Specific Absorption Rate (SAR) from hand-held and body-mounted devices used next to the ear (frequency range of 300 MHz to 6 GHz)", July 2016
- IEC 62209-2, "Procedure to determine the Specific Absorption Rate (SAR) for wireless communication devices used in close proximity to the human body (frequency range of 30 MHz to 6 GHz)", March 2010
- KDB 865664, "SAR Measurement Requirements for 100 MHz to 6 GHz"

Additional Documentation:

- DASY4/5 System Handbook

Methods Applied and Interpretation of Parameters:

- Measurement Conditions:** Further details are available from the Validation Report at the end of the certificate. All figures stated in the certificate are valid at the frequency indicated.
- Antenna Parameters with TSL:** The dipole is mounted with the spacer to position its feed point exactly below the center marking of the flat phantom section, with the arms oriented parallel to the body axis.
- Feed Point Impedance and Return Loss:** These parameters are measured with the dipole positioned under the liquid filled phantom. The impedance stated is transformed from the measurement at the SMA connector to the feed point. The Return Loss ensures low reflected power. No uncertainty required.
- Electrical Delay:** One-way delay between the SMA connector and the antenna feed point. No uncertainty required.
- SAR measured:** SAR measured at the stated antenna input power.
- SAR normalized:** SAR as measured, normalized to an input power of 1 W at the antenna connector.
- SAR for nominal TSL parameters:** The measured TSL parameters are used to calculate the nominal SAR result.

The reported uncertainty of measurement is stated as the standard uncertainty of measurement multiplied by the coverage factor $k=2$, which for a normal distribution corresponds to a coverage probability of approximately 95%.

Measurement Conditions

DASY system configuration, as far as not given on page 1.

DASY Version	DASY5	V52.10.0
Extrapolation	Advanced Extrapolation	
Phantom	Modular Flat Phantom	
Distance Dipole Center - TSL	10 mm	with Spacer
Zoom Scan Resolution	dx, dy = 4 mm, dz = 1.4 mm	Graded Ratio = 1.4 (Z direction)
Frequency	3700 MHz \pm 1 MHz	

Head TSL parameters

The following parameters and calculations were applied.

	Temperature	Permittivity	Conductivity
Nominal Head TSL parameters	22.0 °C	37.7	3.12 mho/m
Measured Head TSL parameters	(22.0 \pm 0.2) °C	38.3 \pm 6 %	3.07 mho/m \pm 6 %
Head TSL temperature change during test	< 0.5 °C	----	----

SAR result with Head TSL

SAR averaged over 1 cm³ (1 g) of Head TSL	Condition	
SAR measured	100 mW input power	6.54 W/kg
SAR for nominal Head TSL parameters	normalized to 1W	65.8 W/kg \pm 19.9 % (k=2)

SAR averaged over 10 cm³ (10 g) of Head TSL	condition	
SAR measured	100 mW input power	2.41 W/kg
SAR for nominal Head TSL parameters	normalized to 1W	24.2 W/kg \pm 19.5 % (k=2)

Body TSL parameters

The following parameters and calculations were applied.

	Temperature	Permittivity	Conductivity
Nominal Body TSL parameters	22.0 °C	51.0	3.55 mho/m
Measured Body TSL parameters	(22.0 \pm 0.2) °C	49.7 \pm 6 %	3.53 mho/m \pm 6 %
Body TSL temperature change during test	< 0.5 °C	----	----

SAR result with Body TSL

SAR averaged over 1 cm³ (1 g) of Body TSL	Condition	
SAR measured	100 mW input power	6.46 W/kg
SAR for nominal Body TSL parameters	normalized to 1W	64.3 W/kg \pm 19.9 % (k=2)

SAR averaged over 10 cm³ (10 g) of Body TSL	condition	
SAR measured	100 mW input power	2.32 W/kg
SAR for nominal Body TSL parameters	normalized to 1W	23.1 W/kg \pm 19.5 % (k=2)

Appendix (Additional assessments outside the scope of SCS 0108)

Antenna Parameters with Head TSL

Impedance, transformed to feed point	53.0 Ω - 8.3 j Ω
Return Loss	- 21.4 dB

Antenna Parameters with Body TSL

Impedance, transformed to feed point	51.5 Ω - 6.3 j Ω
Return Loss	- 23.9 dB

General Antenna Parameters and Design

Electrical Delay (one direction)	1.144 ns
----------------------------------	----------

After long term use with 100W radiated power, only a slight warming of the dipole near the feedpoint can be measured.

The dipole is made of standard semirigid coaxial cable. The center conductor of the feeding line is directly connected to the second arm of the dipole. The antenna is therefore short-circuited for DC-signals. On some of the dipoles, small end caps are added to the dipole arms in order to improve matching when loaded according to the position as explained in the "Measurement Conditions" paragraph. The SAR data are not affected by this change. The overall dipole length is still according to the Standard.

No excessive force must be applied to the dipole arms, because they might bend or the soldered connections near the feedpoint may be damaged.

Additional EUT Data

Manufactured by	SPEAG
Manufactured on	December 18, 2015

DASY5 Validation Report for Head TSL

Date: 11.01.2018

Test Laboratory: SPEAG, Zurich, Switzerland

DUT: Dipole 3700 MHz; Type: D3700V2; Serial: D3700V2 - SN:1018

Communication System: UID 0 - CW; Frequency: 3700 MHz

Medium parameters used: $f = 3700$ MHz; $\sigma = 3.07$ S/m; $\epsilon_r = 38.3$; $\rho = 1000$ kg/m³

Phantom section: Flat Section

Measurement Standard: DASY5 (IEEE/IEC/ANSI C63.19-2011)

DASY52 Configuration:

- Probe: EX3DV4 - SN3503; ConvF(7.5, 7.5, 7.5); Calibrated: 30.12.2017;
- Sensor-Surface: 1.4mm (Mechanical Surface Detection)
- Electronics: DAE4 Sn601; Calibrated: 26.10.2017
- Phantom: Flat Phantom 5.0 (front); Type: QD 000 P50 AA; Serial: 1001
- DASY52 52.10.0(1446); SEMCAD X 14.6.10(7417)

Dipole Calibration for Head Tissue/Pin=100 mW, d=10mm/Zoom Scan, dist=1.4mm

(8x8x8)/Cube 0: Measurement grid: dx=4mm, dy=4mm, dz=1.4mm

Reference Value = 69.40 V/m; Power Drift = -0.07 dB

Peak SAR (extrapolated) = 18.5 W/kg

SAR(1 g) = 6.54 W/kg; SAR(10 g) = 2.41 W/kg

Maximum value of SAR (measured) = 12.6 W/kg

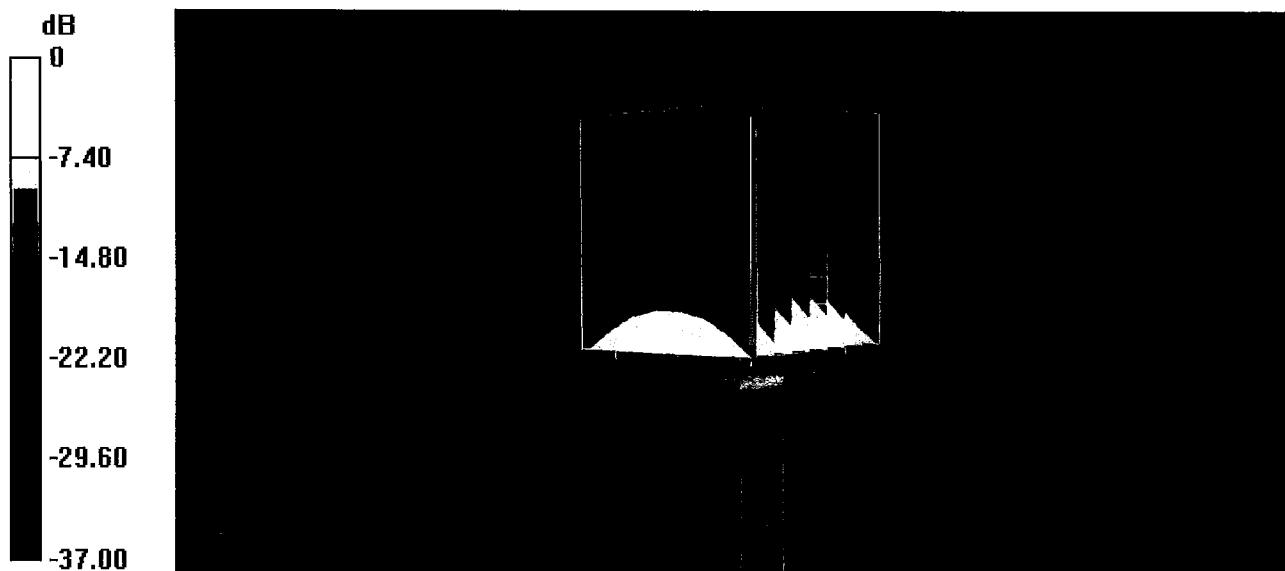

0 dB = 12.6 W/kg = 11.00 dBW/kg

Impedance Measurement Plot for Head TSL

11 Jan 2018 16:39:21

CH1 S11 1 U FS 1: 52.961 Ω -8.3184 Ω 5.1711 pF 3 700.000 000 MHz

*
De1
CA

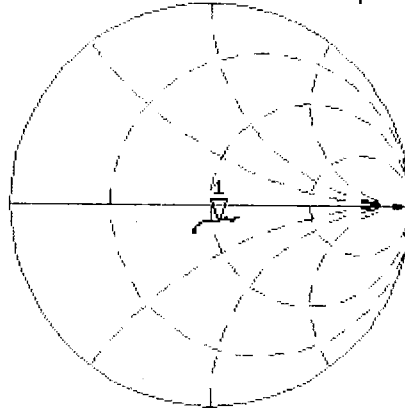

Avg
16

H1d

CH2 S11 LOG 5 dB/ REF -20 dB 1:-21.361 dB 3 700.000 000 MHz

CA

Avg
16

H1d

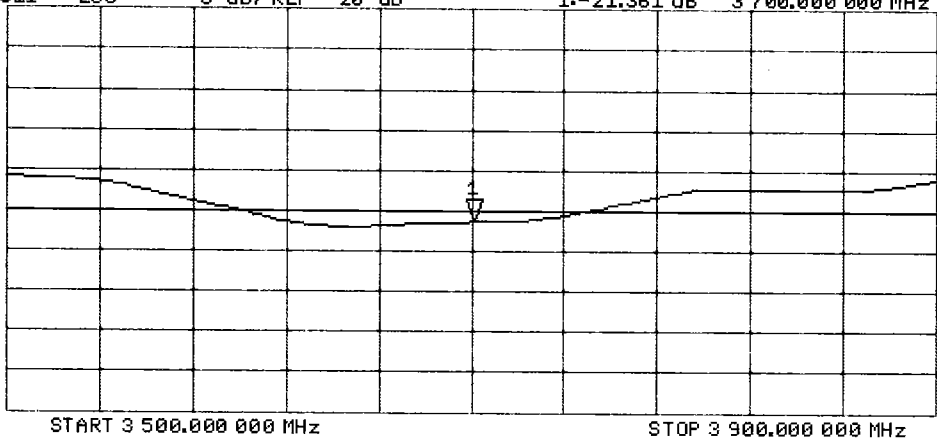

DASY5 Validation Report for Body TSL

Date: 10.01.2018

Test Laboratory: SPEAG, Zurich, Switzerland

DUT: Dipole 3700 MHz; Type: D3700V2; Serial: D3700V2 - SN:1018

Communication System: UID 0 - CW; Frequency: 3700 MHz

Medium parameters used: $f = 3700$ MHz; $\sigma = 3.53$ S/m; $\epsilon_r = 49.7$; $\rho = 1000$ kg/m³

Phantom section: Flat Section

Measurement Standard: DASY5 (IEEE/IEC/ANSI C63.19-2011)

DASY52 Configuration:

- Probe: EX3DV4 - SN3503; ConvF(7.28, 7.28, 7.28); Calibrated: 30.12.2017;
- Sensor-Surface: 1.4mm (Mechanical Surface Detection)
- Electronics: DAE4 Sn601; Calibrated: 26.10.2017
- Phantom: Flat Phantom 5.0 (back); Type: QD 000 P50 AA; Serial: 1002
- DASY52 52.10.0(1446); SEMCAD X 14.6.10(7417)

Dipole Calibration for Body Tissue/Pin=100 mW, d=10mm/Zoom Scan , dist=1.4mm

(8x8x8)/Cube 0: Measurement grid: dx=4mm, dy=4mm, dz=1.4mm

Reference Value = 64.16 V/m; Power Drift = -0.08 dB

Peak SAR (extrapolated) = 18.4 W/kg

SAR(1 g) = 6.46 W/kg; SAR(10 g) = 2.32 W/kg

Maximum value of SAR (measured) = 12.6 W/kg

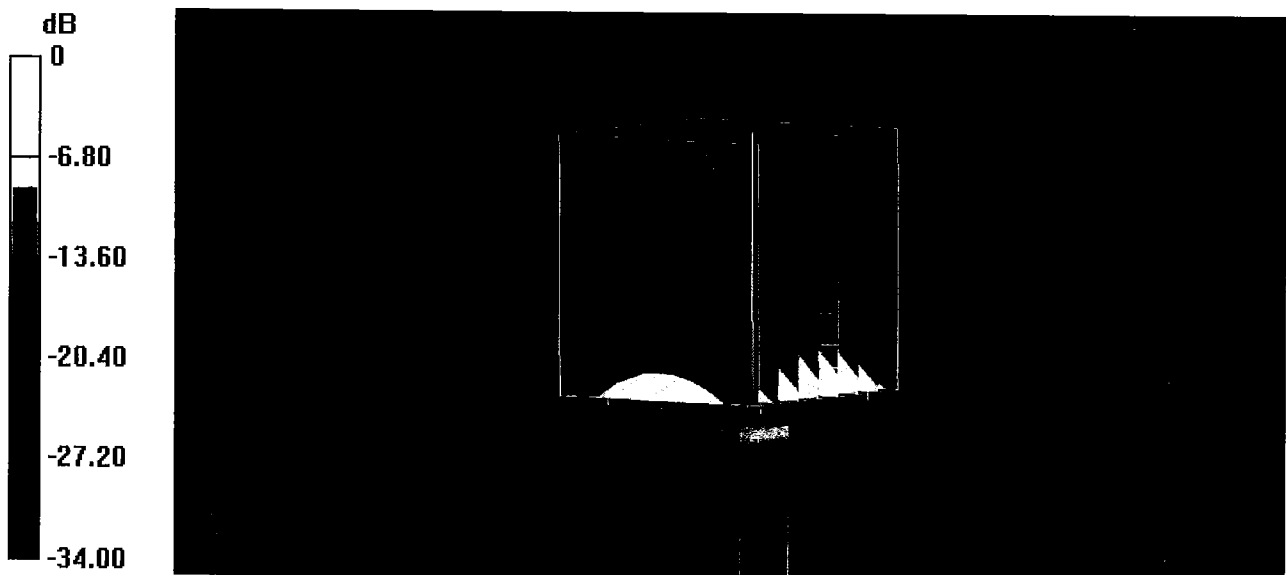

0 dB = 12.6 W/kg = 11.00 dBW/kg

Impedance Measurement Plot for Body TSL

10 Jan 2018 11:46:43

CH1 S11 1 U FS

1: 51.508 Ω -6.3027 Δ 6.8248 pF 3 700.000 000 MHz

*
De1
CA

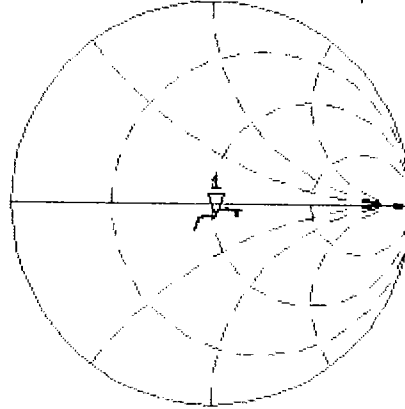

Avg
16

H1d

CH2 S11 LOG

5 dB/REF -20 dB

1:-23.913 dB 3 700.000 000 MHz

CA

Avg
16

H1d

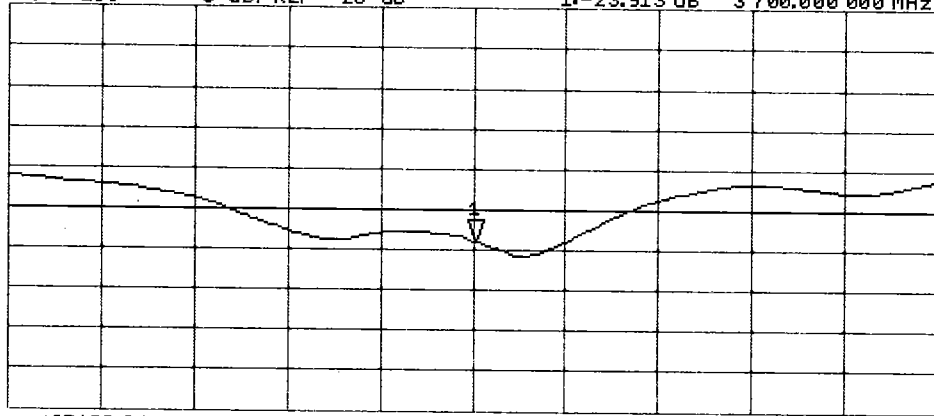

START 3 500.000 000 MHz

STOP 3 900.000 000 MHz

Certification of Calibration

Object: D3700V2 – SN: 1018

Calibration procedure(s): Procedure for Calibration Extension for SAR Dipoles.

Extension Calibration date: 1/11/2019

Description: SAR Validation Dipole at 3500 MHz.

Calibration Equipment used:

Manufacturer	Model	Description	Cal Date	Cal Interval	Cal Due	Serial Number
Agilent	8753ES	S-Parameter Network Analyzer	2/8/2018	Annual	2/8/2019	US39170122
Agilent	N5182A	MXG Vector Signal Generator	4/18/2018	Annual	4/18/2019	MY47420800
Amplifier Research	15S1G6	Amplifier	CBT	N/A	CBT	433971
Anritsu	MA2411B	Pulse Power Sensor	3/2/2018	Annual	3/2/2019	1207364
Anritsu	MA2411B	Pulse Power Sensor	3/2/2018	Annual	3/2/2019	1339018
Anritsu	ML2495A	Power Meter	10/21/2018	Annual	10/21/2019	941001
Control Company	4040	Therm./Clock/Humidity Monitor	3/31/2017	Biennial	3/31/2019	170232394
Control Company	4352	Ultra Long Stem Thermometer	5/2/2017	Biennial	5/2/2019	170330156
Keysight	772D	Dual Directional Coupler	CBT	N/A	CBT	MY52180215
Keysight Technologies	85033E	Standard Mechanical Calibration Kit (DC to 9GHz, 3.5mm)	6/4/2018	Annual	6/4/2019	MY53401181
MiniCircuits	VLF-6000+	Low Pass Filter	CBT	N/A	CBT	N/A
Mini-Circuits	BW-N20W5+	DC to 18 GHz Precision Fixed 20 dB Attenuator	CBT	N/A	CBT	N/A
Narda	4772-3	Attenuator (3dB)	CBT	N/A	CBT	9406
Pasternack	PE2209-10	Bidirectional Coupler	CBT	N/A	CBT	N/A
Seekonk	NC-100	Torque Wrench	7/11/2018	Annual	7/11/2019	N/A
SPEAG	DAE4	Dasy Data Acquisition Electronics	10/3/2018	Annual	10/3/2019	1558
SPEAG	DAE4	Dasy Data Acquisition Electronics	6/18/2018	Annual	6/18/2019	1334
SPEAG	DAK-3.5	Dielectric Assessment Kit	9/11/2018	Annual	9/11/2019	1091
SPEAG	EX3DV4	SAR Probe	2/14/2018	Annual	2/14/2019	3914
SPEAG	EX3DV4	SAR Probe	8/24/2018	Annual	8/24/2019	3949

Measurement Uncertainty = $\pm 23\%$ (k=2)

	Name	Function	Signature
Calibrated By:	Brodie Halfoster	Test Engineer	<i>BRODIE HALFOSTER</i>
Approved By:	Kaitlin O'Keefe	Senior Technical Manager	<i>KOK</i>

DIPOLE CALIBRATION EXTENSION

Per KDB 865664 D01, calibration intervals of up to three years may be considered for reference dipoles when it is demonstrated that the SAR target, impedance and return loss of a dipole have remained stable according to the following requirements:

1. The measured SAR does not deviate more than 10% from the target on the calibration certificate.
2. The return-loss does not deviate more than 20% from the previous measurement and meets the required 20dB minimum return-loss requirement.
3. The measurement of real or imaginary parts of impedance does not deviate more than 5Ω from the previous measurement.

The following dipole was checked to pass the above 3 requirements to have 2-year calibration period from the calibration date:

Calibration Date	Extension Date	Certificate Electrical Delay (ns)	Certificate SAR Target Head (1g) W/kg @ 20.0 dBm	Measured Head SAR (1g) W/kg @ 20.0 dBm	Deviation 1g (%)	Certificate SAR Target Head (10g) W/kg @ 20.0 dBm	Measured Head SAR (10g) W/kg @ 20.0 dBm	Deviation 10g (%)	Certificate Impedance Head (Ohm) Real	Measured Impedance Head (Ohm) Real	Difference (Ohm) Real	Certificate Impedance Head (Ohm) Imaginary	Measured Impedance Head (Ohm) Imaginary	Difference (Ohm) Imaginary	Certificate Return Loss Head (dB)	Measured Return Loss Head (dB)	Deviation (%)	PASS/FAIL
1/11/2018	1/11/2019	1.144	6.59	6.22	-5.47%	2.42	2.27	-8.20%	53	51.1	1.9	-8.3	-5.5	2.8	-21.4	-25.1	-17.20%	PASS
Calibration Date	Extension Date	Certificate Electrical Delay (ns)	Certificate SAR Target Body (1g) W/kg @ 20.0 dBm	Measured Body SAR (1g) W/kg @ 20.0 dBm	Deviation 1g (%)	Certificate SAR Target Body (10g) W/kg @ 20.0 dBm	Measured Body SAR (10g) W/kg @ 20.0 dBm	Deviation 10g (%)	Certificate Impedance Body (Ohm) Real	Measured Impedance Body (Ohm) Real	Difference (Ohm) Real	Certificate Impedance Body (Ohm) Imaginary	Measured Impedance Body (Ohm) Imaginary	Difference (Ohm) Imaginary	Certificate Return Loss Body (dB)	Measured Return Loss Body (dB)	Deviation (%)	PASS/FAIL
1/11/2018	1/11/2019	1.144	6.43	6.08	-5.44%	2.31	2.21	-4.33%	51.5	54.2	2.7	-6.3	-2.3	4	-23.9	-26.9	-12.40%	PASS

Impedance & Return-Loss Measurement Plot for Head TSL

