



CERTIFICATION TEST REPORT

Report Number. : 12563988-E4V2

Applicant : Samsung Electronics Co., Ltd.
129 Samsung-Ro, Yeongtong-Gu,
Suwon-Si, Gyeonggi-Do, 16677, Korea

Model : SM-G975N

FCC ID : A3LSMG975KOR

EUT Description : GSM/WCDMA/LTE phone with BT, DTS/UNII a/b/g/n/ac/11ax
HE20/40/80, ANT+ and NFC

Test Standard(s) : FCC 47 CFR PART 15 SUBPART C

Date Of Issue:
January 30, 2019

Prepared by:
UL Verification Services Inc.
47173 Benicia Street
Fremont, CA 94538 U.S.A.
TEL: (510) 771-1000
FAX: (510) 661-0888



REPORT REVISION HISTORY

Rev.	Issue Date	Revisions	Revised By
V1	1/29/2019	Initial Issue	
V2	1/30/2019	Updated Section 10.2	Steven Tran

TABLE OF CONTENTS

REPORT REVISION HISTORY	2
TABLE OF CONTENTS	3
1. ATTESTATION OF TEST RESULTS	5
2. INTRODUCTION OF TEST DATA REUSE.....	6
2.1. INTRODUCTION	6
2.2. DIFFERENCES	6
2.3. SPOT CHECK VERIFICATION RESULTS SUMMARY	6
2.3.1. SPOT CHECK DATA – SM-G975N (GLASS)	7
2.4. REFERENCE DETAIL	11
3. TEST METHODOLOGY	12
4. FACILITIES AND ACCREDITATION	12
5. CALIBRATION AND UNCERTAINTY	13
5.1. MEASURING INSTRUMENT CALIBRATION	13
5.2. SAMPLE CALCULATION	13
5.3. MEASUREMENT UNCERTAINTY.....	13
6. EQUIPMENT UNDER TEST	14
6.1. EUT DESCRIPTION	14
6.2. MAXIMUM OUTPUT POWER.....	14
6.3. DESCRIPTION OF AVAILABLE ANTENNAS	16
6.4. SOFTWARE AND FIRMWARE.....	16
6.5. WORST-CASE CONFIGURATION AND MODE.....	17
6.6. DESCRIPTION OF TEST SETUP.....	18
7. MEASUREMENT METHOD.....	21
8. TEST AND MEASUREMENT EQUIPMENT	22
9. ANTENNA PORT TEST RESULTS	23
9.1. ON TIME AND DUTY CYCLE.....	23
9.2. 99% BANDWIDTH.....	26
9.2.1. 802.11b MODE	27
9.2.2. 802.11g MODE	31
9.2.3. 802.11n HT20 MODE	34
9.2.4. 802.11ax HE20 MODE	37
9.3. 6 dB BANDWIDTH.....	40
9.3.1. 802.11b MODE	41

9.3.2.	802.11g MODE	45
9.3.3.	802.11n HT20 MODE	48
9.3.4.	802.11ax HE20 MODE	51
9.4.	OUTPUT POWER	54
9.4.1.	802.11b MODE	56
9.4.1.	802.11g MODE	58
9.4.2.	802.11n HT20 MODE	61
9.4.3.	802.11ax HE20 MODE	64
9.5.	POWER SPECTRAL DENSITY	94
9.5.1.	802.11b MODE	95
9.5.2.	802.11g MODE	99
9.5.3.	802.11n HT20 MODE	102
9.5.4.	802.11ax HE20 MODE	105
9.6.	CONDUCTED SPURIOUS EMISSIONS	132
9.6.1.	802.11b MODE	133
9.6.2.	802.11g MODE	137
9.6.3.	802.11n HT20 MODE	141
9.6.4.	802.11ax HE20 MODE	145
10.	RADIATED TEST RESULTS	156
10.1.	TRANSMITTER ABOVE 1 GHz	157
10.1.1.	TX ABOVE 1 GHz 802.11b MODE IN THE 2.4 GHz BAND	157
10.1.2.	TX ABOVE 1 GHz 802.11g MODE IN THE 2.4 GHz BAND	185
10.1.3.	TX ABOVE 1 GHz 802.11n HT20 MODE IN THE 2.4 GHz BAND.....	199
10.1.4.	TX ABOVE 1 GHz 802.11ax HE20 MODE IN THE 2.4 GHz BAND.....	213
10.1.5.	SPOT CHECK DATA – SM-G975F (CERAMIC)	257
10.1.1.	SPOT CHECK DATA – SM-G975N (CERAMIC).....	261
10.2.	SPURIOUS EMISSIONS FOR SIMULTANEOUS TRANSMISSION	265
10.2.1.	TEST CASE 1	266
10.2.2.	TEST CASE 2	268
10.2.3.	TEST CASE 3	270
10.2.4.	TEST CASE 4	272
10.2.5.	TEST CASE 5	274
10.3.	Worst Case Below 30 MHz	276
10.4.	Worst Case Below 1 GHz	278
10.5.	Worst Case 18-26 GHz	280
11.	AC POWER LINE CONDUCTED EMISSIONS	282
11.1.	AC Power Line Norm	283
12.	SETUP PHOTOS	285
12.1.	SM-G975F (Glass)	285
12.2.	SM-G975N (GLASS)	290
12.3.	SM-G975N (CERAMIC)	291

1. ATTESTATION OF TEST RESULTS

COMPANY NAME: Samsung Electronics Co., Ltd.
129 Samsung-Ro, Yeongtong-Gu,
Suwon-Si, Gyeonggi-Do, 16677, Korea

EUT DESCRIPTION: GSM/WCDMA/LTE phone with BT, DTS/UNII a/b/g/n/ac/11ax HE
20/40/80, ANT+ and NFC

MODEL: SM-G975N

SERIAL NUMBER: ORIGINAL: Conducted (Glass): R38KA093BOT, R38KA0L96BB
Radiated (Glass): R38KA0L97DV, R38KA0L971T
Radiated (Ceramic): R38KA092LGJ, R38KA0KV84N
SPOTCHECK: Radiated (Glass):R39KA0KPKH, R39KA0FDGAH,
R39KA0FDGTD
Radiated (Ceramic):R39KB0A1Z4, R39KB0A1YW,
R39KB0A1YV

DATE TESTED: November 2, 2018 – January 29, 2019 (Original)
December 14, 2018 – December 19, 2018 (Spotcheck)

APPLICABLE STANDARDS	
STANDARD	TEST RESULTS
CFR 47 Part 15 Subpart C	Complies

UL Verification Services Inc. tested the above equipment in accordance with the requirements set forth in the above standards. The test results show that the equipment tested is capable of demonstrating compliance with the requirements as documented in this report.

The results documented in this report apply only to the tested sample, under the conditions and modes of operation as described herein. It is the manufacturer's responsibility to assure that additional production units of this model are manufactured with identical electrical and mechanical components. All samples tested were in good operating condition throughout the entire test program. Measurement Uncertainties are published for informational purposes only and were not taken into account unless noted otherwise.

This document may not be altered or revised in any way unless done so by UL Verification Services Inc. and all revisions are duly noted in the revisions section. Any alteration of this document not carried out by UL Verification Services Inc. will constitute fraud and shall nullify the document. This report must not be used by the client to claim product certification, approval, or endorsement by NVLAP, NIST, any agency of the Federal Government, or any agency of the U.S. government.

Approved & Released For
UL Verification Services Inc. By:

Reviewed By:



Dan Corona
Operations Leader
Consumer Technology Division
UL Verification Services Inc.

Steven Tran
Project Engineer
Consumer Technology Division
UL Verification Services Inc.

2. INTRODUCTION OF TEST DATA REUSE

2.1. INTRODUCTION

According to the manufacturer, FCC ID: A3LSMG975F and FCC ID: A3LSMG975KOR non-licensed radios are electrically identical. The FCC ID: A3LSMG975F test data shall remain representative of FCC ID: A3LSMG975KOR.

The applicant takes full responsibility that the test data as referenced in this section represents compliance for this FCC ID.

2.2. DIFFERENCES

The FCC ID: A3LSMG975F, shares the same enclosure and circuit board as FCC ID: A3LSMG975KOR. The DTS WLAN antennas and surrounding circuitry and layout are identical between two models.

After confirming through preliminary radiated emissions that the performance of the FCC ID: A3LSMG975F remains representative of FCC ID: A3LSMG975KOR. The test data of FCC ID: A3LSMG975F being submitted for this application to cover DTS WLAN features.

2.3. SPOT CHECK VERIFICATION RESULTS SUMMARY

Spot check verification has been done on device A3LSMG975KOR(Glass and Ceramic) for radiated harmonic spurious and radiated band-edge. The data from the application has been verified through appropriate spot checks to demonstrate compliance for this device as shown in the summary below.

A3LSMG975KOR SPOT CHECK RESULTS										
Technology	Mode	Test Item	Channel	Measured Frequency	Original model		Spot check model		Delta (dB)	
					SM-G975F		SM-G975N		Peak Ave	
					A3LSMG975F		A3LSMG975KOR			
Peak	Ave	Peak	Ave	Peak	Ave					
DTS	11n HT20	RBE	1	2390MHz	67.13	51.89	66.14	46.16	-0.99	-5.73
	11g	RSE	1	11651MHz	49.41	39.25	49.88	39.32	0.47	0.07

Comparison of two models, upper deviation is within 3dB range and all tests are under FCC Technical Limits.

2.3.1. SPOT CHECK DATA – SM-G975N (GLASS)

BANDEDGE (LOW CHANNEL, CH 1)

HORIZONTAL RESULT

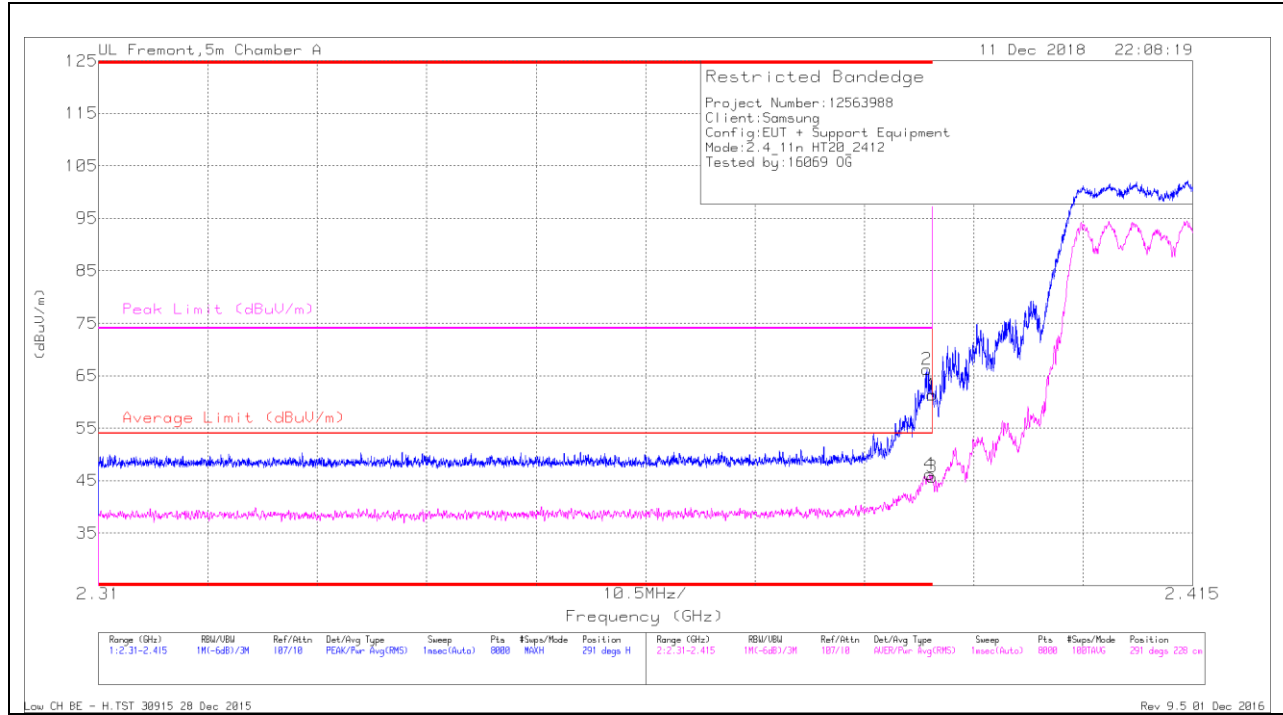

Trace Markers

Marker	Frequency (GHz)	Meter Reading (dBuV)	Det	AF T345 (dB/m)	Amp/Cb/Filtr/Pad (dB)	DC Corr (dB)	Corrected Reading (dBuV/m)	Average Limit (dBuV/m)	Margin (dB)	Peak Limit (dBuV/m)	PK Margin (dB)	Azimuth (Degs)	Height (cm)	Polarity
1	* 2.39	51.36	Pk	32	-22	0	61.36	-	-	74	-12.64	291	228	H
2	* 2.389	56.14	Pk	32	-22	0	66.14	-	-	74	-7.86	291	228	H
3	* 2.39	35.41	RMS	32	-22	.31	45.72	54	-8.28	-	-	291	228	H
4	* 2.39	35.85	RMS	32	-22	.31	46.16	54	-7.84	-	-	291	228	H

* - indicates frequency in CFR47 Pt 15 / IC RSS-Restricted Band

Pk - Peak detector

RMS - RMS detection

VERTICAL RESULT

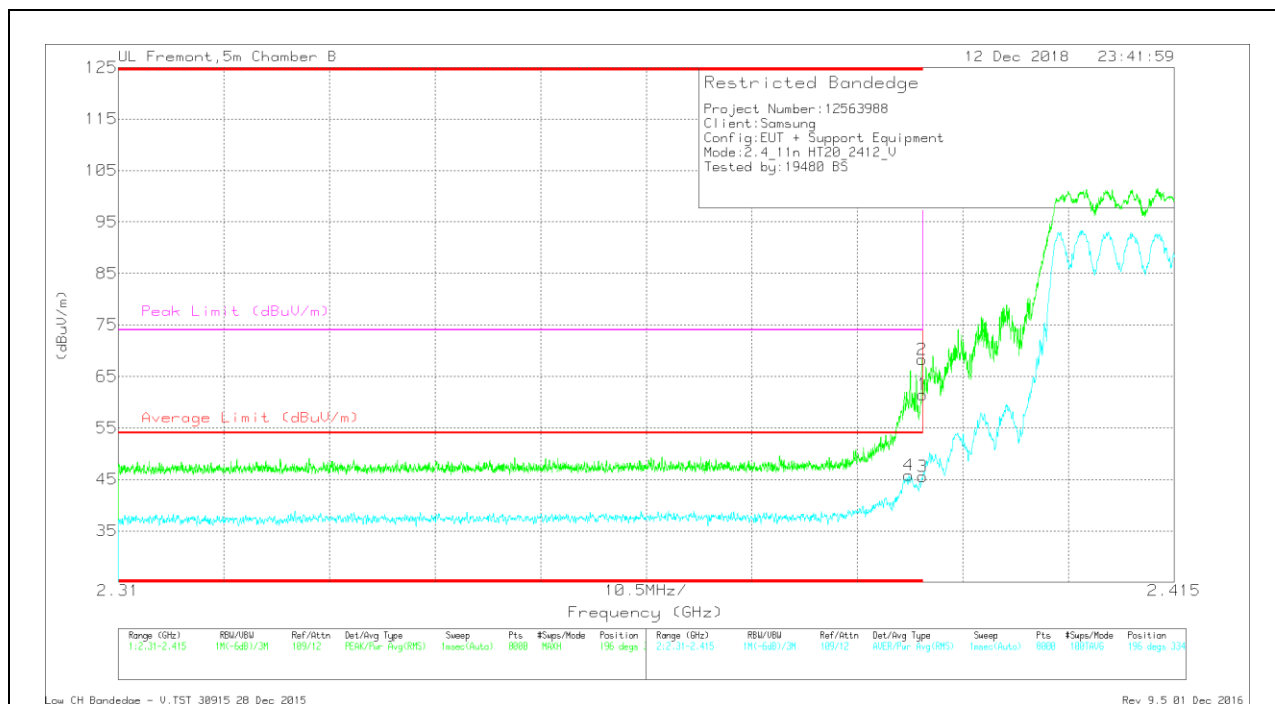

Trace Markers

Marker	Frequency (GHz)	Meter Reading (dBuV)	Det	AF T863 (dB/m)	Amp/Cb/Fltr/Pad (dB)	DC Corr (dB)	Corrected Reading (dBuV/m)	Average Limit (dBuV/m)	Margin (dB)	Peak Limit (dBuV/m)	PK Margin (dB)	Azimuth (Degs)	Height (cm)	Polarity
1	* 2.39	49.88	Pk	32.3	-20.7	0	61.48	-	-	74	-12.52	196	334	V
2	* 2.39	56.69	Pk	32.3	-20.7	0	68.29	-	-	74	-5.71	196	334	V
3	* 2.39	33.65	RMS	32.3	-20.7	.31	45.56	54	-8.44	-	-	196	334	V
4	* 2.389	33.9	RMS	32.3	-20.7	.31	45.81	54	-8.19	-	-	196	334	V

* - indicates frequency in CFR47 Pt 15 / IC RSS-Restricted Band

Pk - Peak detector

RMS - RMS detection

HARMONICS AND SPURIOUS EMISSIONS

LOW CHANNEL, CH 1 RESULTS

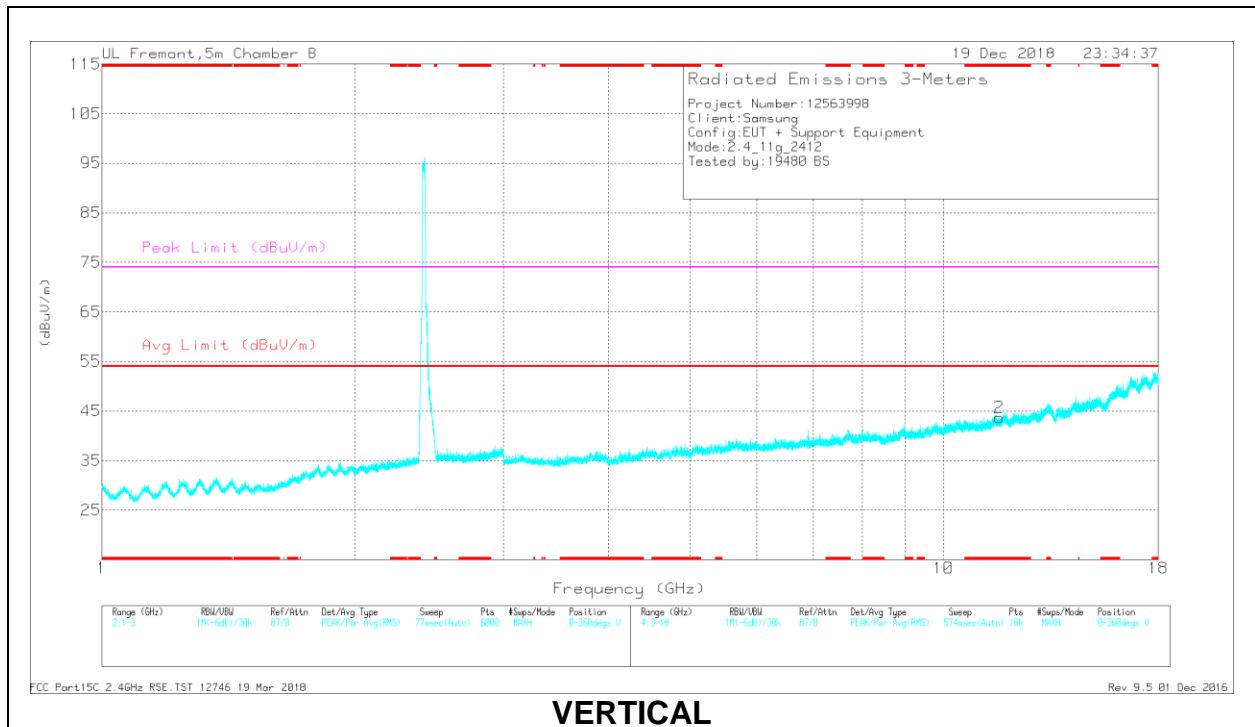
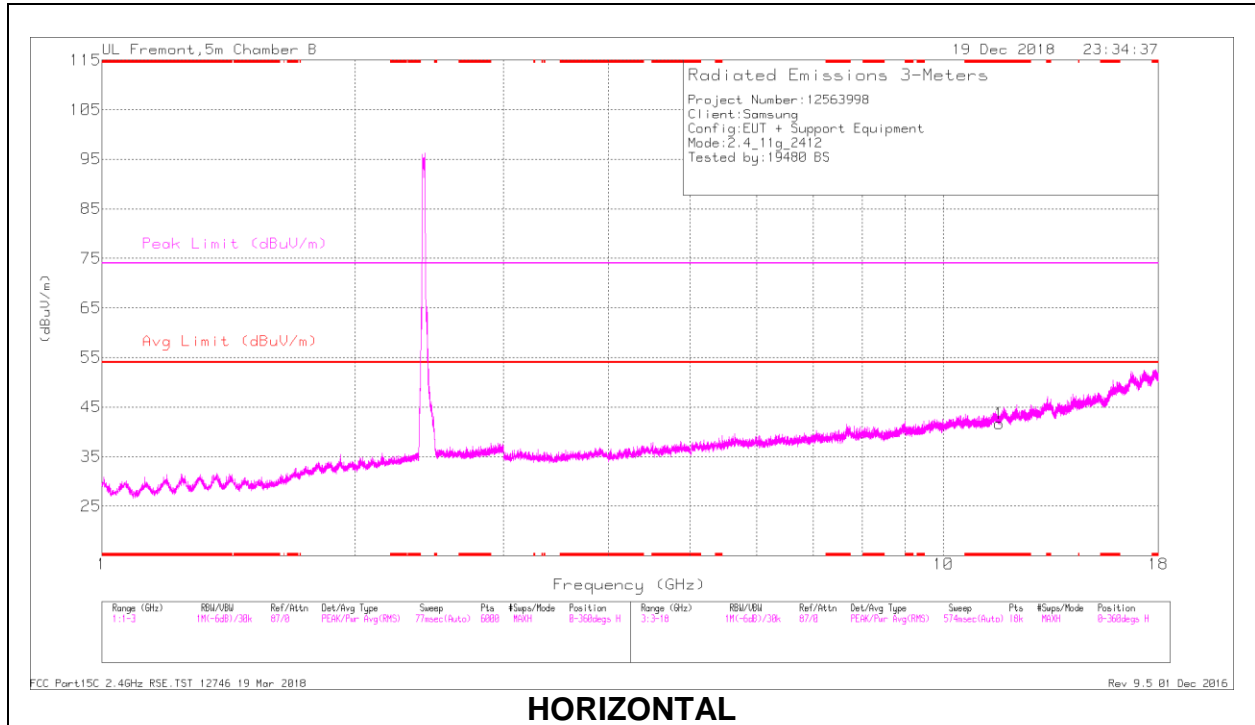

RADIATED EMISSIONS

Marker	Frequency (GHz)	Meter Reading (dBuV)	Det	AF T863 (dB/m)	Amp/Cbl/Filtr/Pad (dB)	DC Corr (dB)	Corrected Reading (dBuV/m)	Avg Limit (dBuV/m)	Margin (dB)	Peak Limit (dBuV/m)	PK Margin (dB)	Azimuth (Degs)	Height (cm)	Polarity
1	* 11.65	32.74	PK2	38.8	-22.1	0	49.44	-	-	74	-24.56	292	101	H
	* 11.653	21.4	MAv1	38.8	-22.2	1.21	39.21	54	-14.79	-	-	292	101	H
2	* 11.653	33.28	PK2	38.8	-22.2	0	49.88	-	-	74	-24.12	279	400	V
	* 11.652	21.51	MAv1	38.8	-22.2	1.21	39.32	54	-14.68	-	-	279	400	V

* - indicates frequency in CFR47 Pt 15 / IC RSS-Restricted Band

PK2 - KDB558074 Method: Maximum Peak

MAv1 - KDB558074 Option 1 Maximum RMS Average

2.4. REFERENCE DETAIL

Reference application that contains the reused reference data.

Equipment Class	Reference FCC ID	Type Grant/ Permissive Change	Reference Application	Folder Test/RF Exposure	Report Title/Section
PCE	A3LSMG975F	Grant	12563708-E1	Test	FCC Report WWAN / All sections except Appendix A
DSS	A3LSMG975F	Grant	12563708-E2	Test	FCC Report BT / All sections
DTS	A3LSMG975F	Grant	12563708-E3	Test	FCC Report BLE / All sections
	A3LSMG975F	Grant	12563708-E4	Test	FCC Report DTS WLAN / All sections
NII	A3LSMG975F	Grant	12563708-E5	Test	FCC Report UNII WLAN / All sections except DFS
DXX	A3LSMG975F	Grant	12563708-E7	Test	FCC Report NFC / All sections
			12563708-E8	Test	FCC Report ANT+ / All sections
DCD	A3LSMG975F	Grant	12563708-E9	Test	FCC Report Wireless Charging / All sections

3. TEST METHODOLOGY

The tests documented in this report were performed in accordance with FCC CFR 47 Part 2, FCC CFR 47 Part 15, ANSI C63.10-2013, and KDB 558074 D01 15.247 Meas Guidance v05.

4. FACILITIES AND ACCREDITATION

The test sites and measurement facilities used to collect data are located at 47173 and 47266 Benicia Street, and 47658 Kato Road, Fremont, California, USA. Line conducted emissions are measured only at the 47173 address. The following table identifies which facilities were utilized for radiated emission measurements documented in this report. Specific facilities are also identified in the test results sections.

47173 Benicia Street	47266 Benicia Street	47658 Kato Rd
<input checked="" type="checkbox"/> Chamber A (ISED:2324B-1)	<input type="checkbox"/> Chamber D (ISED:22541-1)	<input type="checkbox"/> Chamber I (ISED:2324A-5)
<input checked="" type="checkbox"/> Chamber B (ISED:2324B-2)	<input type="checkbox"/> Chamber E (ISED:22541-2)	<input type="checkbox"/> Chamber J (ISED:2324A-6)
<input type="checkbox"/> Chamber C (ISED:2324B-3)	<input type="checkbox"/> Chamber F (ISED:22541-3)	<input type="checkbox"/> Chamber K (ISED:2324A-1)
	<input type="checkbox"/> Chamber G (ISED:22541-4)	<input type="checkbox"/> Chamber L (ISED:2324A-3)
	<input type="checkbox"/> Chamber H (ISED:22541-5)	

The above test sites and facilities are covered under FCC Test Firm Registration # 208313. Chambers above are covered under Industry Canada company address and respective code

UL Verification Services Inc. is accredited by NVLAP, Laboratory Code 200065-0

5. CALIBRATION AND UNCERTAINTY

5.1. MEASURING INSTRUMENT CALIBRATION

The measuring equipment utilized to perform the tests documented in this report has been calibrated in accordance with the manufacturer's recommendations, and is traceable to recognized national standards.

5.2. SAMPLE CALCULATION

RADIATED EMISSIONS

Where relevant, the following sample calculation is provided:

Field Strength (dBuV/m) = Measured Voltage (dBuV) + Antenna Factor (dB/m) + Cable Loss (dB) – Preamp Gain (dB)

$$36.5 \text{ dBuV} + 18.7 \text{ dB/m} + 0.6 \text{ dB} - 26.9 \text{ dB} = 28.9 \text{ dBuV/m}$$

MAINS CONDUCTED EMISSIONS

Where relevant, the following sample calculation is provided:

Final Voltage (dBuV) = Measured Voltage (dBuV) + Cable Loss (dB) + Limiter Factor (dB) + LISN Insertion Loss.

$$36.5 \text{ dBuV} + 0 \text{ dB} + 10.1 \text{ dB} + 0 \text{ dB} = 46.6 \text{ dBuV}$$

5.3. MEASUREMENT UNCERTAINTY

Where relevant, the following measurement uncertainty levels have been estimated for tests performed on the apparatus:

PARAMETER	UNCERTAINTY
Worst Case Conducted Disturbance, 9KHz to 0.15 MHz	3.84 dB
Worst Case Conducted Disturbance, 0.15 to 30 MHz	3.65 dB
Worst Case Radiated Disturbance, 9KHz to 30 MHz	3.15 dB
Worst Case Radiated Disturbance, 30 to 1000 MHz	5.36 dB
Worst Case Radiated Disturbance, 1000 to 18000 MHz	4.32 dB
Worst Case Radiated Disturbance, 18000 to 26000 MHz	4.45 dB
Worst Case Radiated Disturbance, 26000 to 40000 MHz	5.24 dB

Uncertainty figures are valid to a confidence level of 95%.

6. EQUIPMENT UNDER TEST

6.1. EUT DESCRIPTION

The EUT is a GSM/WCDMA/LTE phone with BT, DTS/UNII a/b/g/n/ac/11ax HE 20/40/80, ANT+ and NFC. The test report addresses the DTS WLAN operational mode.

6.2. MAXIMUM OUTPUT POWER

The transmitter has a maximum conducted output power as follows:

2.4GHz BAND

Frequency Range (MHz)	Mode	Output Power (dBm)	Output Power (mW)
SISO			
2412 - 2472	802.11b (Chain 0)	18.92	77.98
2412 - 2472	802.11b (Chain 1)	18.96	78.70
2412 - 2472	802.11g (Chain 0)	16.47	44.36
2412 - 2472	802.11g (Chain 1)	16.73	47.10
2412 - 2472	802.11n HT20 (Chain 0)	16.11	40.83
2412 - 2472	802.11n HT20 (Chain 1)	16.47	44.36
2412 - 2472	802.11ax HE20 (Chain 0) SU	15.22	33.27
2412 - 2472	802.11ax HE20 (Chain 1) SU	15.47	35.24
2412 - 2472	802.11ax HE20 (Chain 0) RU size 242T	15.32	34.04
2412 - 2472	802.11ax HE20 (Chain 1) RU size 242T	15.77	37.76
2412 - 2472	802.11ax HE20 (Chain 0) RU size 106T	16.68	46.56
2412 - 2472	802.11ax HE20 (Chain 1) RU size 106T	16.82	48.08
2412 - 2472	802.11ax HE20 (Chain 0) RU size 52T	16.57	45.39
2412 - 2472	802.11ax HE20 (Chain 1) RU size 52T	16.66	46.34
2412 - 2472	802.11ax HE20 (Chain 0) RU size 26T	16.13	41.02
2412 - 2472	802.11ax HE20 (Chain 1) RU size 26T	16.52	44.87

Frequency Range (MHz)	Mode	Output Power (dBm)	Output Power (mW)
2TX			
2412 - 2472	802.11g CDD	19.72	93.76
2412 - 2472	802.11n HT20 CDD	19.57	90.57
2412 - 2472	802.11ax HE20 SU	18.51	70.96
2412 - 2472	802.11ax HE20 OFDMA, RU size 242T	18.81	76.03
2412 - 2472	802.11ax HE20 OFDMA, RU size 106T	19.85	96.61
2412 - 2472	802.11ax HE20 OFDMA, RU size 52T	19.83	96.16
2412 - 2472	802.11ax HE20 OFDMA, RU size 26T	19.54	89.95

Note: After investigated on the output power,

_The 11g SISO output power, chain 0 and chain 1, is lower or equal to 11g CDD. The 11g SISO is covered by the 11g CDD testing.

_The 11n HT20 SISO output power, chain 0 and chain 1, is lower or equal to 11n HT20 CDD. The 11n HT20 SISO is covered by the 11n HT20 CDD testing.

_The 11ax HE20 SISO output power, chain 0 and chain 1, is lower or equal to 11ax HE20 CDD. The 11ax HE20 SISO is covered by the to 11ax HE20 CDD testing.

In addition, the output power for 11ax SU Mode and 11ax Full Tones (242T) were investigated and the SU Mode is lower or equal to 11ax Full Tones (242T), therefore it will be covered by the 11ax Full Tones (242T) testing.

6.3. DESCRIPTION OF AVAILABLE ANTENNAS

The radio utilizes an FPCB antenna, with a maximum gain as below table:

Frequency Band (GHz)	Chain 0	Chain 1
	Antenna Gain (dBi)	Antenna Gain (dBi)
2412-2472	-0.40	-4.50

NOTE:

Antenna 1 = Chain 0

Antenna 2 = Chain 1

6.4. SOFTWARE AND FIRMWARE

The test utility software used during testing was G975N.001(SM-G975N).

6.5. WORST-CASE CONFIGURATION AND MODE

WORST-CASE CONFIGURATION AND MODE FOR FINAL TEST

This device may be formed with two different exterior materials: Glass and Ceramic. Glass model was set for full test and additional spot check verification was done with Ceramic model for radiated harmonic spurious and radiated band-edge as documented.

Radiated emissions below 1GHz, above 18GHz, and power line conducted emission were performed with the EUT set to transmit at the channel with highest output power as worst-case scenario.

Band edge and radiated emissions between 1GHz and 18GHz were performed with the EUT set to transmit at the highest power on low, middle and high channels.

For SISO (Antenna, Chain 0), the fundamental of the EUT was investigated in three orthogonal orientations X,Y,Z, it was determined that X orientation was worst-case orientation; therefore, all final radiated testing was performed with the EUT in X orientation.

For SISO (Antenna, Chain 1), the fundamental of the EUT was investigated in three orthogonal orientations X,Y,Z, it was determined that X orientation was worst-case orientation; therefore, all final radiated testing was performed with the EUT in X orientation.

For MIMO, the fundamental of the EUT was investigated in three orthogonal orientations X,Y,Z, it was determined that Y orientation was worst-case orientation; therefore, all final radiated testing was performed with the EUT in Y orientation.

Worst-case data rates as provided by the client were:

802.11b mode: 1 Mbps
802.11g mode: 6 Mbps
802.11n HT20mode: MCS0
802.11ax HE20mode: MCS0

All radios that can be transmitted simultaneously have been evaluated for radiated for all possible combinations of transmission and found to be in compliance.

6.6. DESCRIPTION OF TEST SETUP

SUPPORT EQUIPMENT

Support Equipment List				
Description	Manufacturer	Model	Serial Number	FCC ID
AC Adapter	Samsung	EP-TA300	R3KB5B01S1SE3	N/A
USB Data Cable	Samsung	N/A	N/A	N/A
Earphone	Samsung	N/A	N/A	N/A

I/O CABLES (CONDUCTED TEST)

I/O Cable List						
Cable No	Port	# of identical ports	Connector Type	Cable Type	Cable Length (m)	Remarks
1	Antenna	1	RF	Shielded	0.2	To spectrum Analyzer
2	USB	1	USB	Un-shielded	1	EUT to AC Mains

I/O CABLES (RADIATED AND CONDUCTED EMISSIONS)

I/O Cable List						
Cable No	Port	# of identical ports	Connector Type	Cable Type	Cable Length (m)	Remarks
1	USB	1	USB	Shielded	1	N/A
2	earphone	1	3.5mm	Un-shielded	1	N/A

TEST SETUP

The EUT is a stand alone. Test software exercised the radio card.

CONDUCTED TEST SETUP DIAGRAM

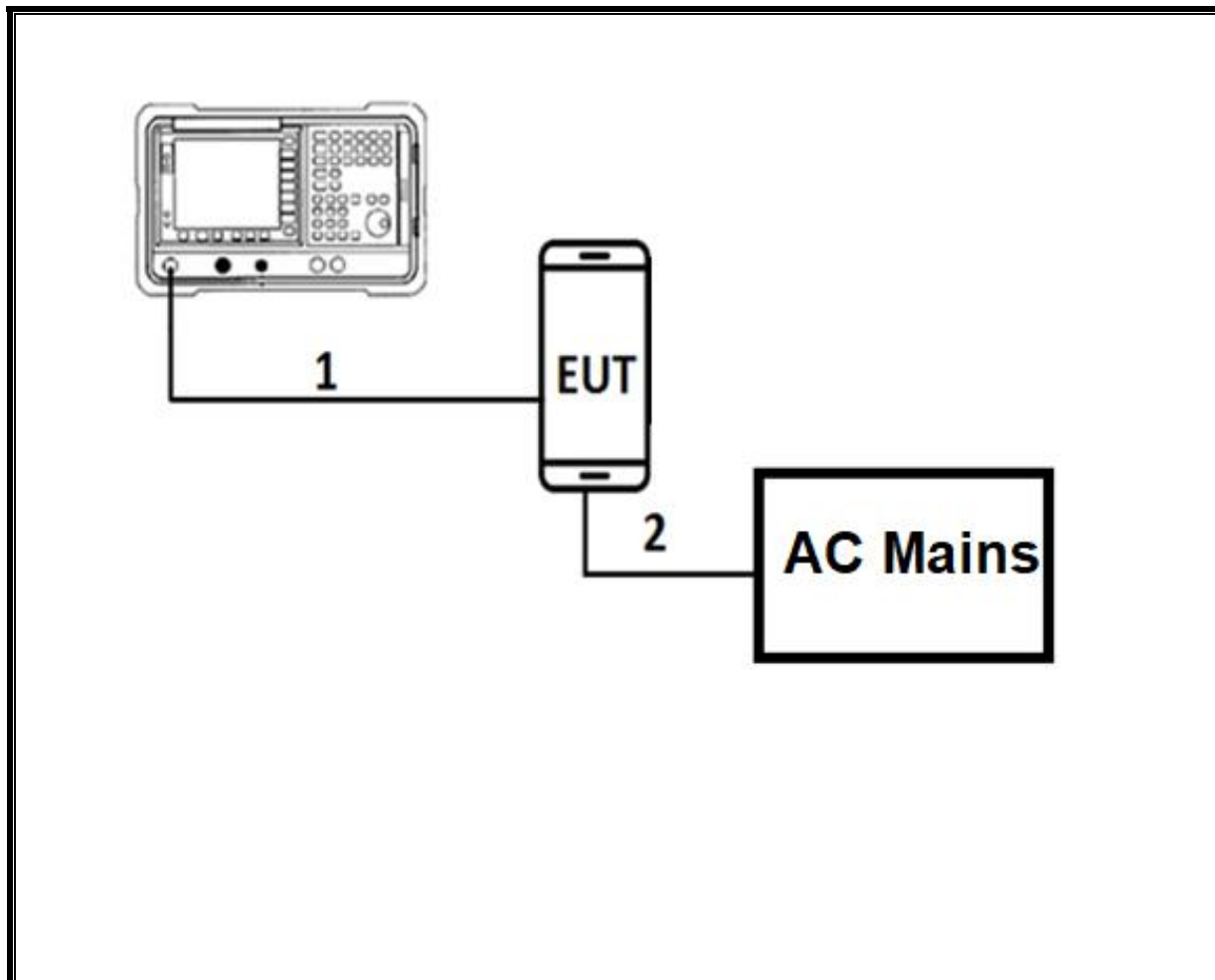

TEST SETUP

For conducted tests: the EUT was Stand alone. The test software exercises the radio.

RADIATED AND AC LINE CONDUCTED EMISSIONS SETUP DIAGRAM

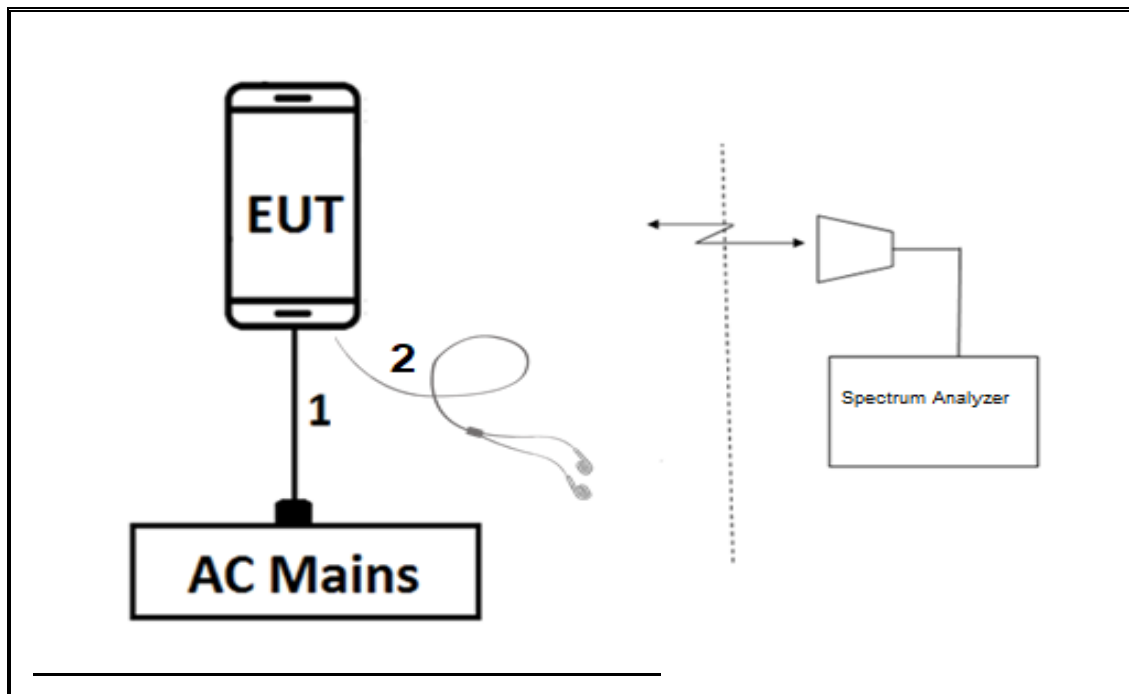

TEST SETUP

For radiated tests: EUT has support equipment (AC Adapter and Headset). The test software exercises the radio.

7. MEASUREMENT METHOD

On Time and Duty Cycle: KDB 558074 D01 v05, Section 6.

6 dB BW: ANSI C63.10 Subclause -11.8.1 RBW \geq DTS BW

99% BW: ANSI C63.10-2013, Section 6.9.3.

Output Power: ANSI C63.10 Subclause -11.9.2.3.2 Method AVGPM-G (Measurement using a gated RF average-reading power meter)

PSD: ANSI C63.10 Subclause -11.10.3 Method AVGPSD-1

Radiated emissions non-restricted frequency bands: ANSI C63.10 Subclause -11.11

Radiated emissions restricted frequency bands: ANSI C63.10 Subclause -11.12.1

Conducted emissions in restricted frequency bands: ANSI C63.10 Subclause -11.12.2

Band-edge: ANSI C63.10 Subclause -11.13.3.2 Integration method -Peak detection

Band-edge: ANSI C63.10 Subclause -11.13.3.4 Integration method -Trace averaging across ON and OFF times DC correction

AC Power Line Conducted Emissions: ANSI C63.10-2013, Section 6.2.

8. TEST AND MEASUREMENT EQUIPMENT

The following test and measurement equipment was utilized for the tests documented in this report:

TEST EQUIPMENT LIST					
Description	Manufacturer	Model	ID Num	Cal Due	Last Cal
Antenna, Broadband Hybrid, 30MHz to 2000MHz	Sunol Sciences Corp.	JB3	T407	05/10/2019	05/10/2018
Amplifier, 9kHz to 1GHz, 32dB	Sonoma Instrument	310	170649	11/01/2019	11/01/2018
Antenna, Horn 1-18GHz	ETS-Lindgren	3117	T345	04/25/2019	04/25/2018
Antenna, Horn 1-18GHz	ETS-Lindgren	3117	T863	06/21/2019	06/21/2018
Power Meter, P-series single channel	Agilent (Keysight) Technologies	N1911A	T1271	07/26/2019	07/26/2018
Power Sensor, P-series, 50MHz to 18GHz, Wideband	Agilent (Keysight) Technologies	N1921A	T1224	10/09/2019	10/09/2018
Directional Coupler	Mini-Circuits	ZUDC10-183+	T1136	06/18/2019	06/18/2018
EMI Receiver	Rohde & Schwarz	ESR	T1436	02/21/2019	02/21/2018
L.I.S.N.	FCC INC.	FCC LISN 50/250	T1310	06/15/2019	06/15/2018
L.I.S.N.	FCC INC.	FCC LISN 50/250	T24	03/06/2019	03/06/2018
Antenna, Active Loop 9kHz-30MHz	Com-Power Corp.	AL-130R	PRE0165308	12/13/2018	12/13/2017
18 - 26.5 GHz Horn Antenna	Seavey Division	MWH-1826/B	T89	01/18/2019	01/18/2018
Pre-Amp 1-26.5 GHz	Agilent	8449B	T404	03/09/2019	03/09/2018
RF Amplifier	MITEQ	AFS42-00101800-25-S-42	T493	10/13/2019	10/13/2018
RF Amplifier, 1-18GHz	MITEQ	AFS42-00101800-25-S-42	T1165	10/20/2019	10/20/2018
Spectrum Analyzer, PXA, 3Hz to 44GHz	Agilent (Keysight) Technologies	N9030A	T1113	12/21/2018	12/21/2017
Spectrum Analyzer	Agilent (Keysight) Technologies	E4446A	T146	08/13/2019	08/13/2018
Spectrum Analyzer, PXA, 3Hz to 44GHz	Agilent (Keysight) Technologies	N9030A	T1466	04/16/2019	04/16/2018
Spectrum Analyzer, PXA, 3Hz to 44GHz	Agilent (Keysight) Technologies	N9030A	T1454	01/08/2019	01/08/2018
Spectrum Analyzer, PXA, 3Hz to 44GHz	Agilent (Keysight) Technologies	N9030A	T908	05/08/2019	05/08/2018

Test Software List			
Description	Manufacturer	Model	Version
Radiated Software	UL	UL EMC	Ver 9.5, Dec 01, 2016
Antenna Port Software	UL	UL RF	Ver 9.1, Nov 15, 2018

9. ANTENNA PORT TEST RESULTS

9.1. ON TIME AND DUTY CYCLE

LIMITS

None; for reporting purposes only.

PROCEDURE

KDB 558074 D01 Zero-Span Spectrum Analyzer Method.

ON TIME AND DUTY CYCLE RESULTS

Mode	ON Time B (msec)	Period (msec)	Duty Cycle x (linear)	Duty Cycle (%)	Duty Cycle Correction Factor (dB)	1/B Minimum VBW (kHz)
2.4GHz Band						
802.11b 1TX MODE	1.000	1.000	1.000	100.00%	0.00	0.010
802.11g CDD MODE	1.425	1.885	0.756	75.60%	1.21	0.702
802.11n HT20 CDD MODE	1.335	1.435	0.930	93.03%	0.31	0.749
802.11ax HE20 OFDMA, RU size 242T	0.600	0.702	0.855	85.47%	0.68	1.667
802.11ax HE20 OFDMA, RU size 106T	1.280	1.385	0.924	92.42%	0.34	0.781
802.11ax HE20 OFDMA, RU size 52T	2.645	2.745	0.964	96.36%	0.16	0.378
802.11ax HE20 OFDMA, RU size 26T	5.210	5.340	0.976	97.57%	0.11	0.192

DUTY CYCLE PLOTS

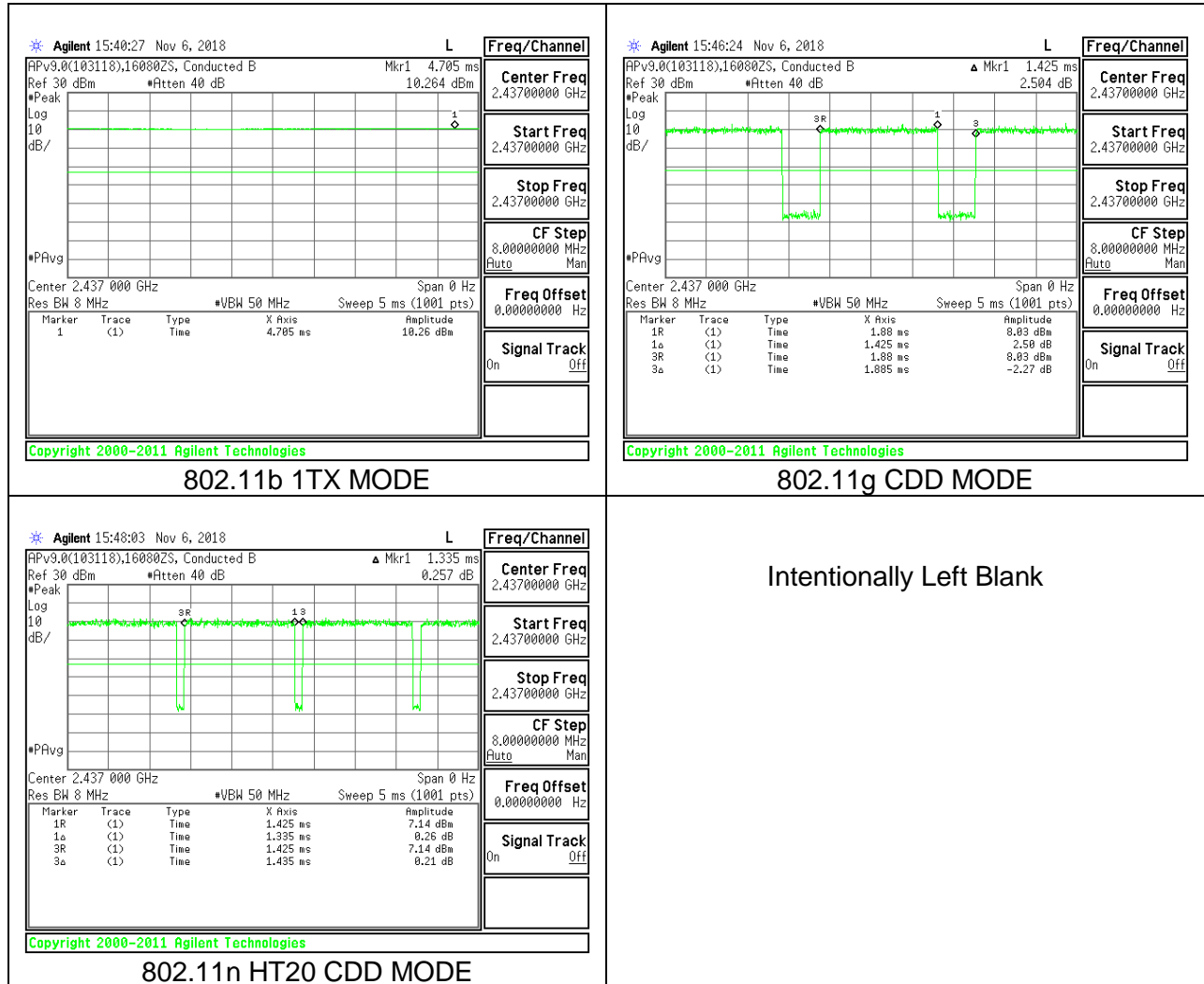

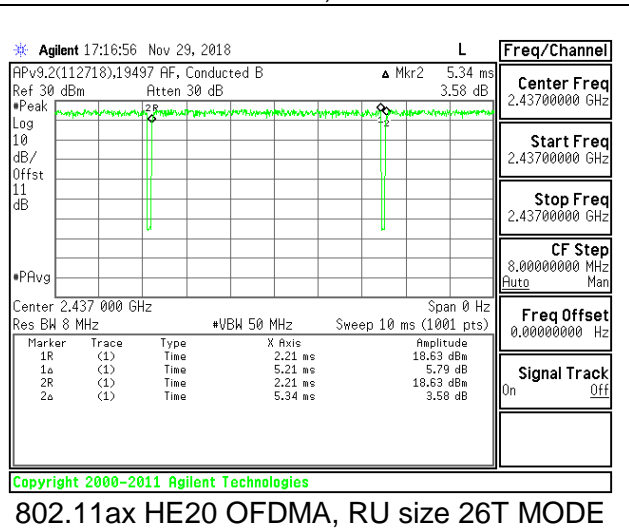
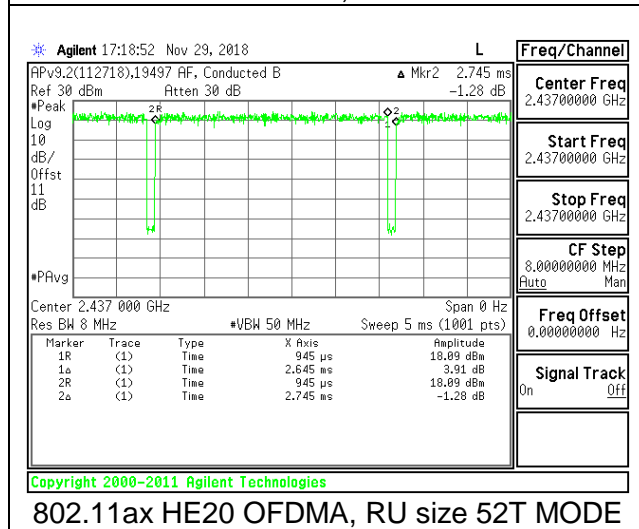
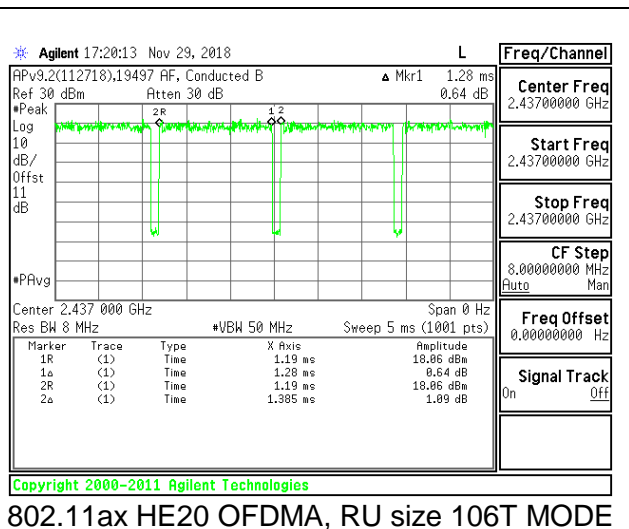
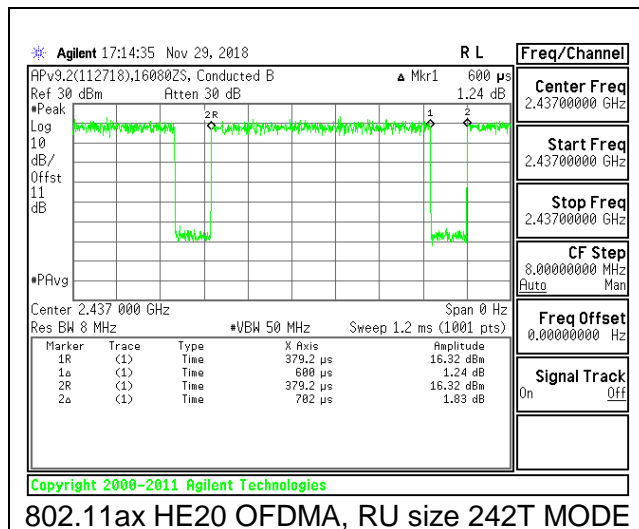

9.2. 99% BANDWIDTH

LIMITS

None; for reporting purposes only.

RESULTS

9.2.1. 802.11b MODE

1TX Antenna 1 MODE

Channel	Frequency (MHz)	99% Bandwidth (MHz)
Low 1	2412	12.0106
Mid 6	2437	12.0588
High 11	2462	12.0876
High 12	2467	12.1842
High 13	2472	12.1938

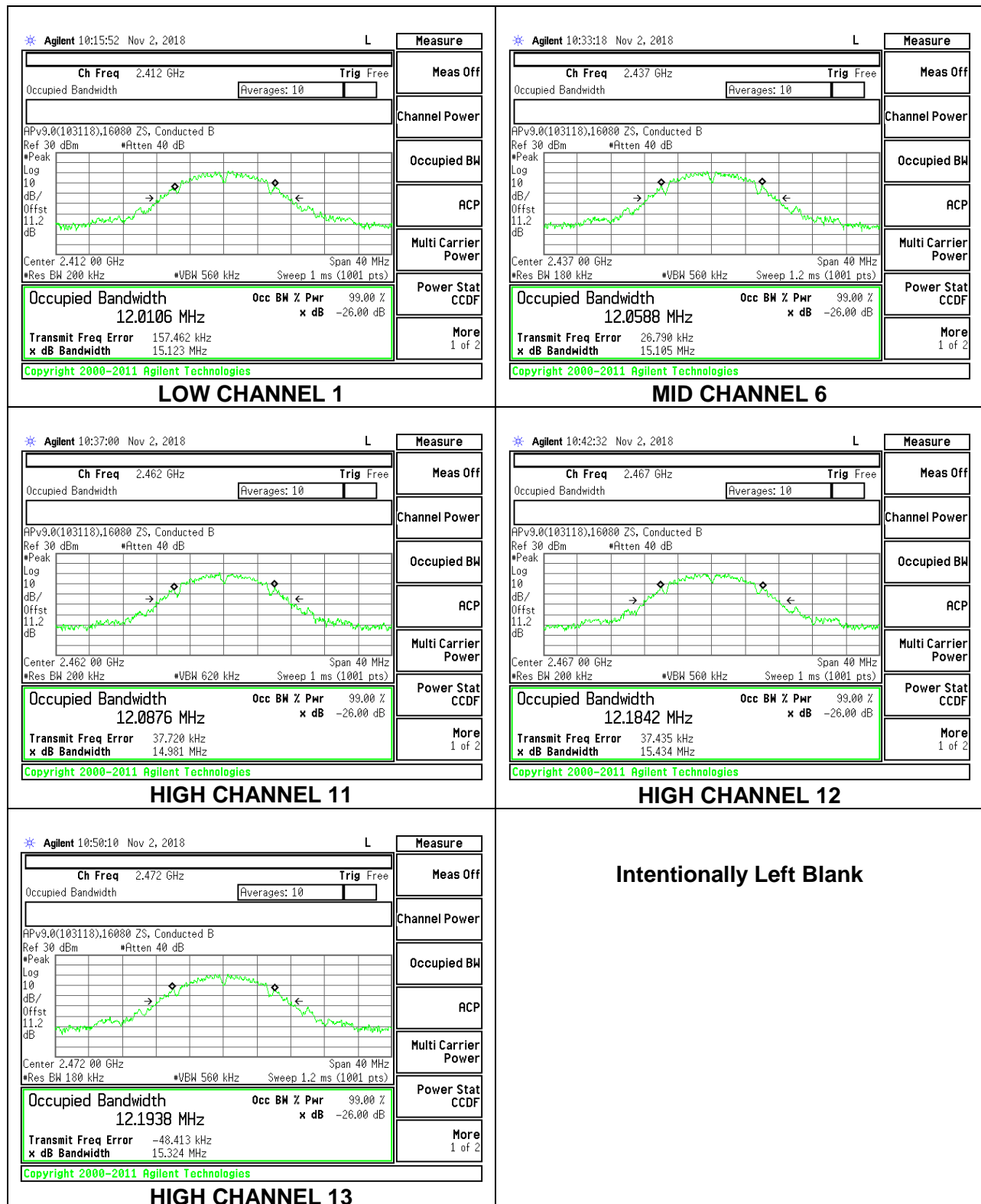

1TX Antenna 2 MODE

Channel	Frequency (MHz)	99% Bandwidth (MHz)
Low 1	2412	12.2404
Mid 6	2437	12.0682
High 11	2462	11.8527
High 12	2467	11.9700
High 13	2472	11.8817

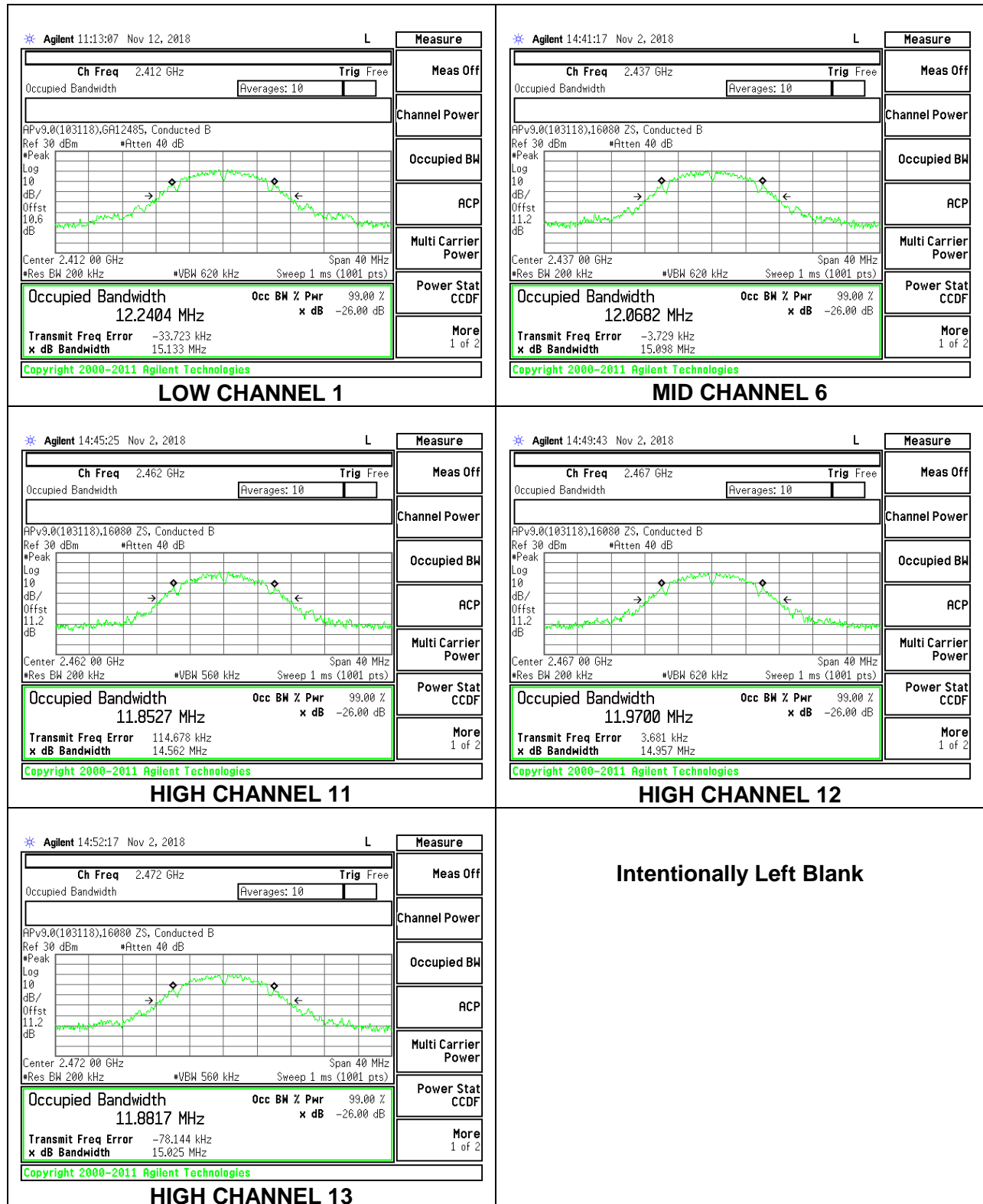

9.2.2. 802.11g MODE

2TX Antenna 1 + Antenna 2 CDD MODE

Channel	Frequency (MHz)	99% Bandwidth Chain 0 (MHz)	99% Bandwidth Chain 1 (MHz)
Low 1	2412	16.6626	16.7653
Mid 6	2437	16.6591	16.5683
High 11	2462	16.2636	16.5325
High 12	2467	16.5720	16.6322
High 13	2472	16.6475	16.5114

LOW CHANNEL 1

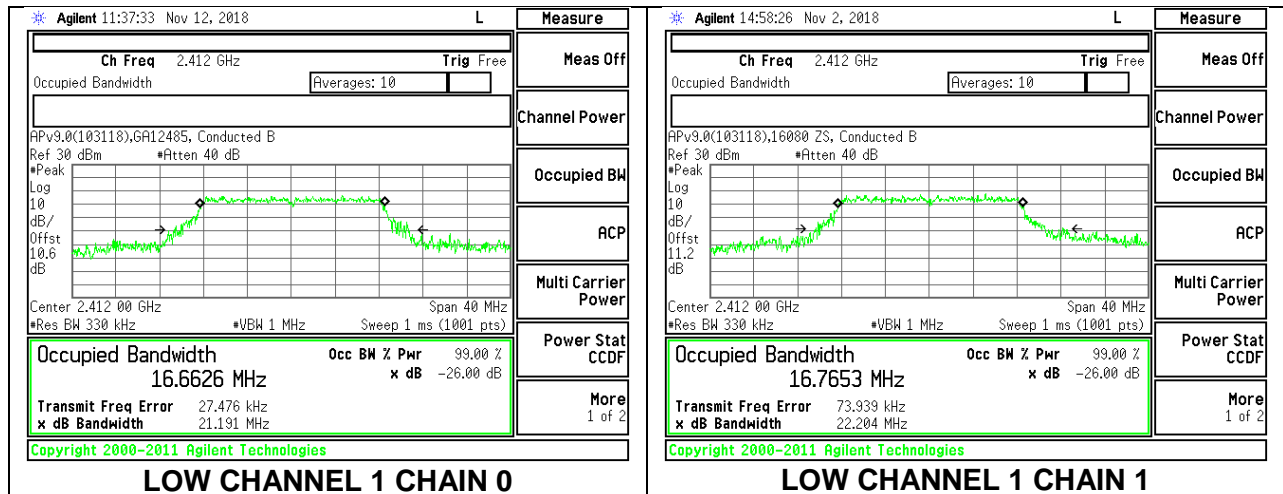

MID CHANNEL 6

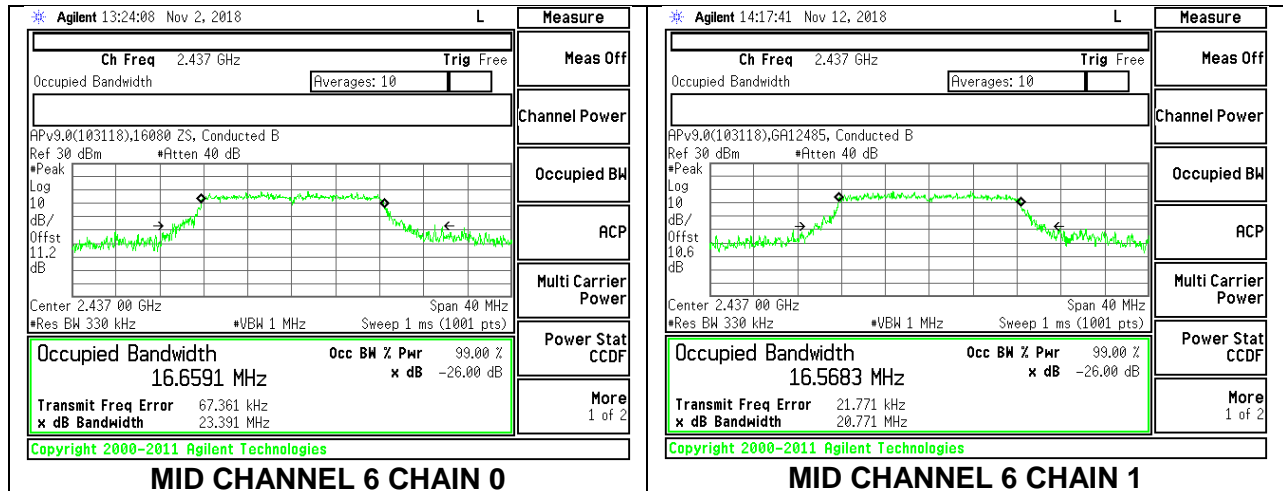

HIGH CHANNEL 11

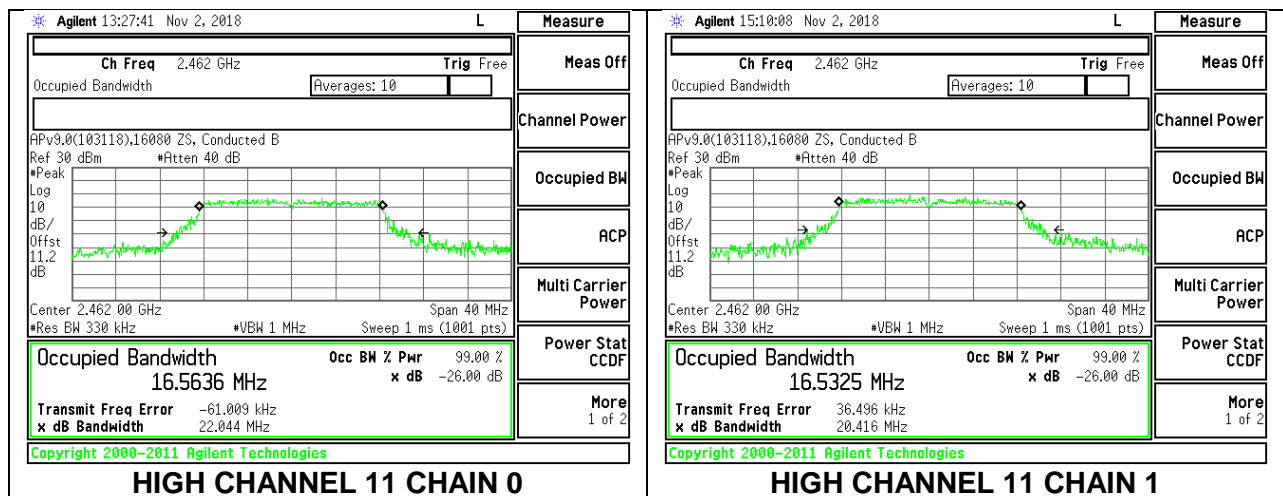

HIGH CHANNEL 12

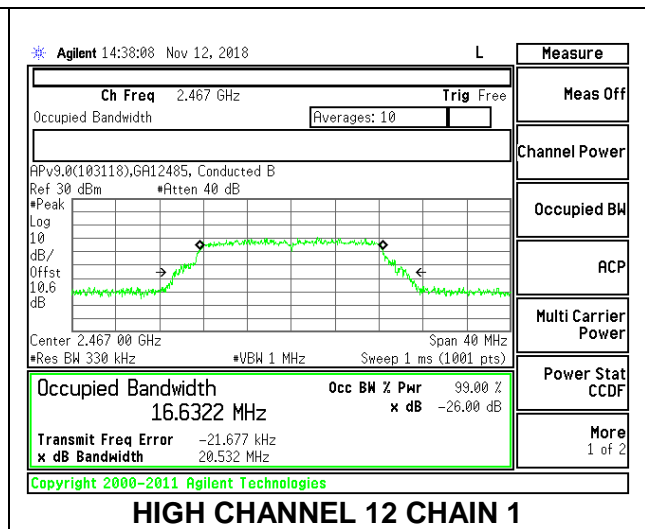
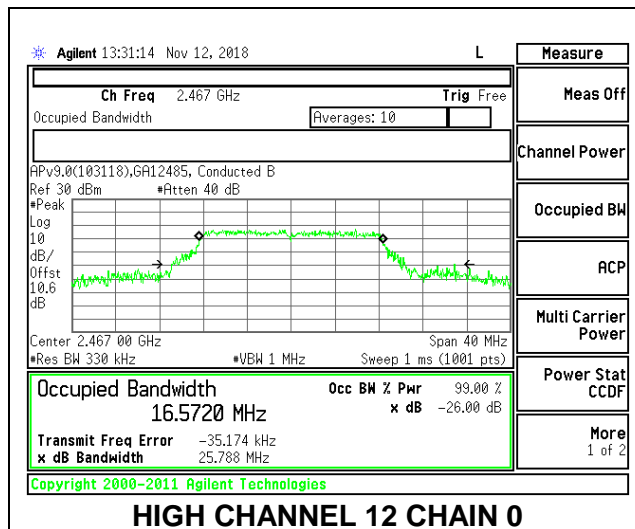

HIGH CHANNEL 13

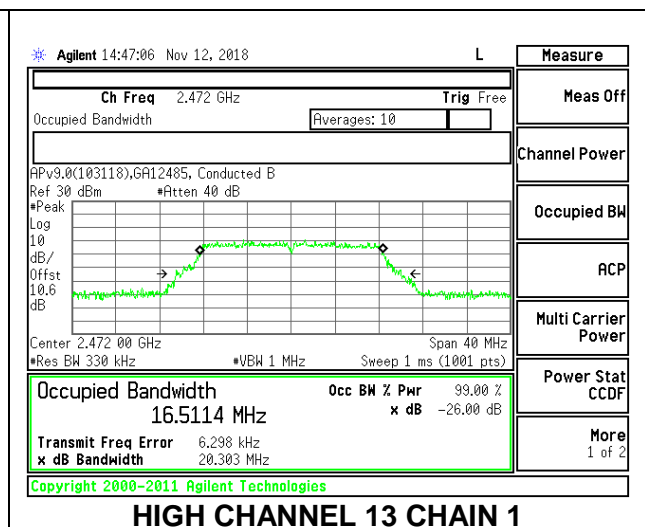
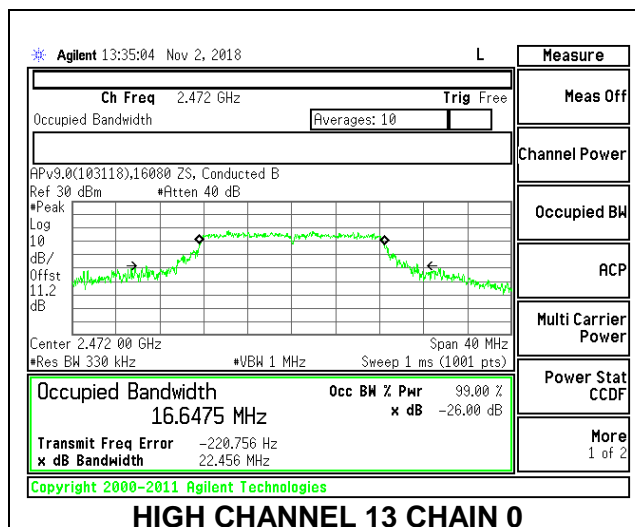

9.2.3. 802.11n HT20 MODE

2TX Antenna 1 + Antenna 2 CDD MODE

Channel	Frequency (MHz)	99% Bandwidth Chain 0 (MHz)	99% Bandwidth Chain 1 (MHz)
Low 1	2412	17.7800	17.8344
Mid 6	2437	17.6097	17.4380
High 11	2462	17.8121	17.7919
High 12	2467	17.8407	17.8324
High 13	2472	17.1859	17.9818

LOW CHANNEL 1

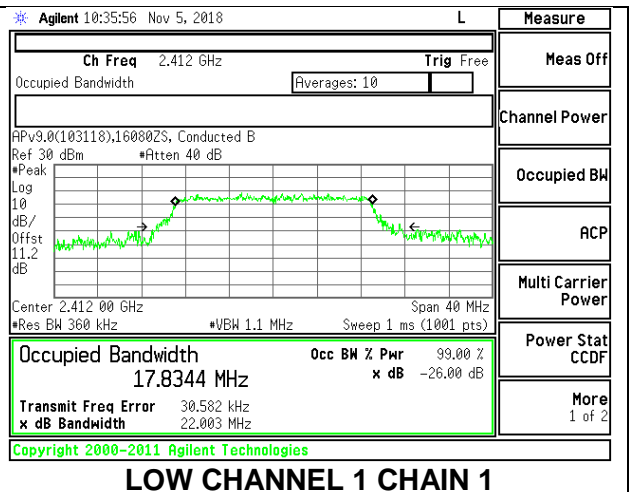
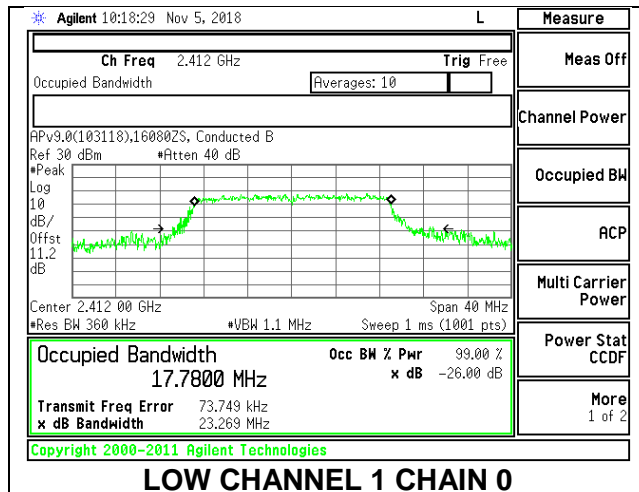

MID CHANNEL 6

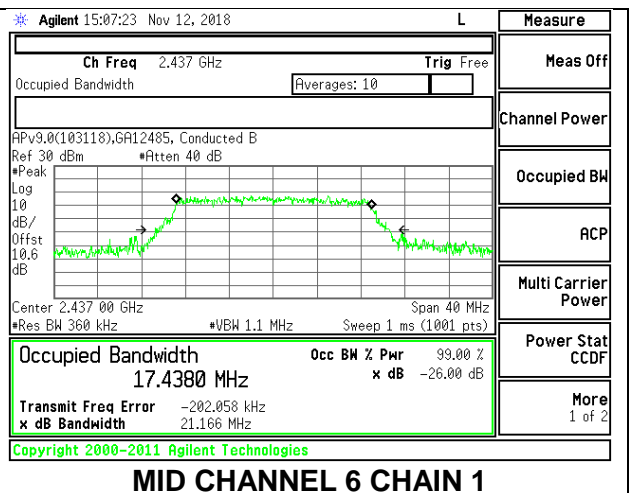
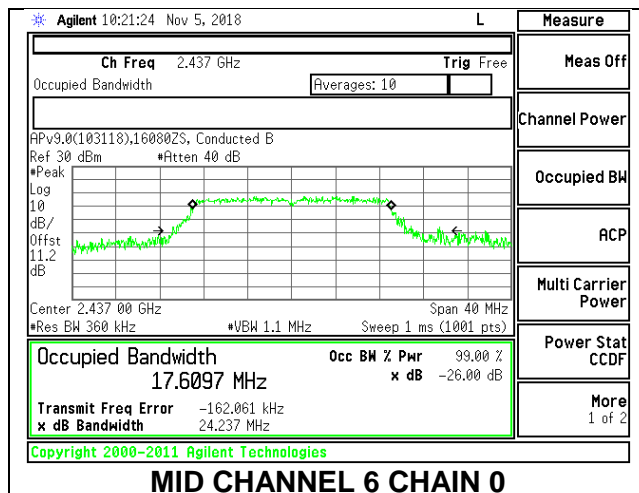

HIGH CHANNEL 11

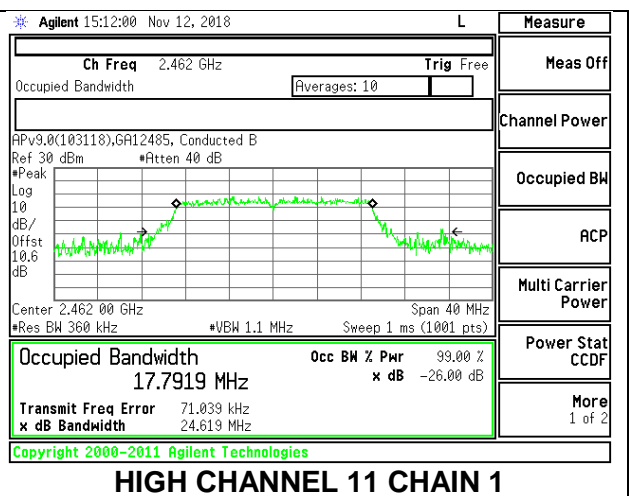
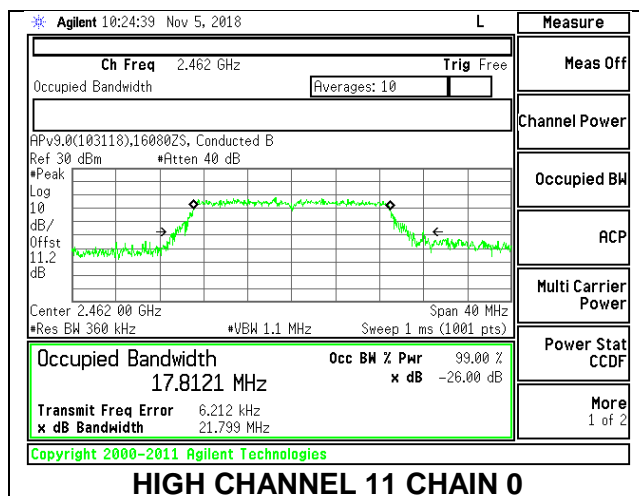

HIGH CHANNEL 12

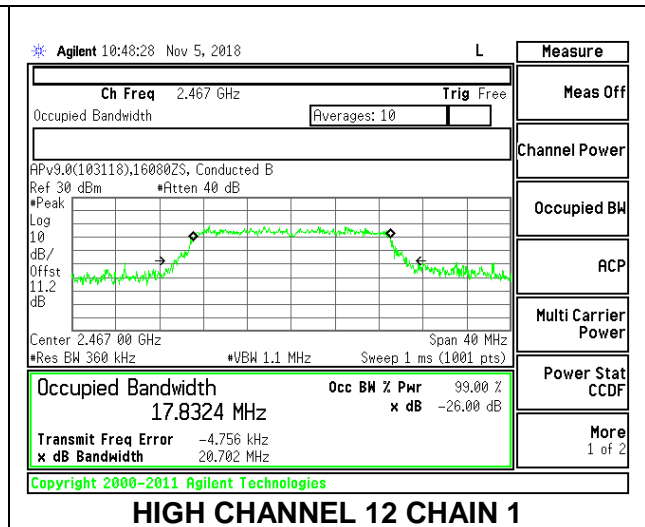
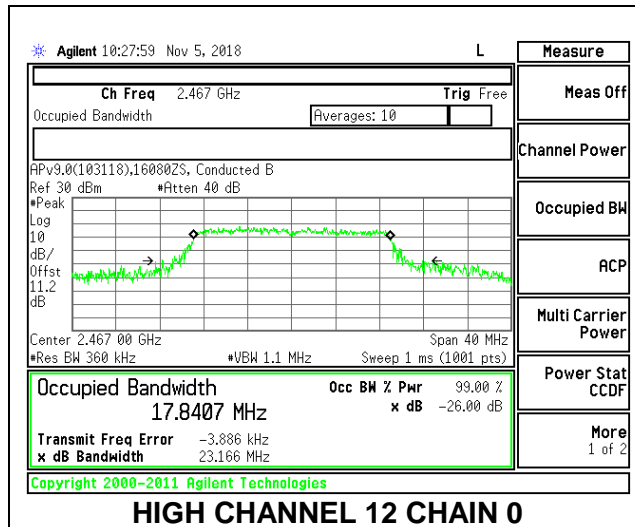

HIGH CHANNEL 13

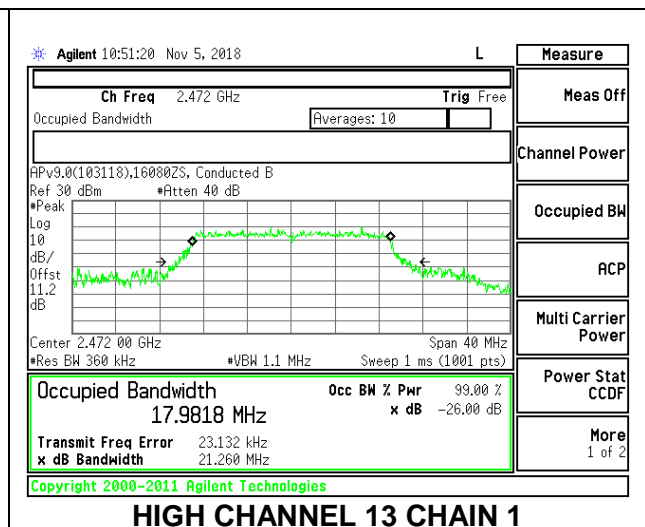
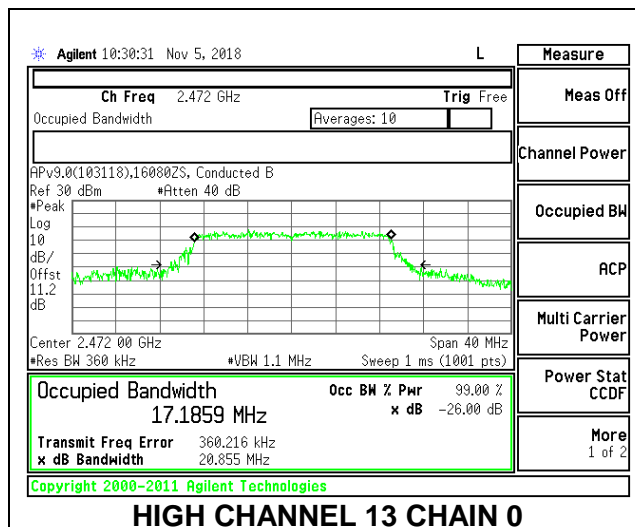

9.2.4. 802.11ax HE20 MODE

2TX Antenna 1 + Antenna 2 OFDMA MODE: 242-Tones, RU index 61

Channel	Frequency (MHz)	99% Bandwidth Chain 0 (MHz)	99% Bandwidth Chain 1 (MHz)
Low 1	2412	18.2231	18.1261
Mid 6	2437	18.9218	18.9901
High 11	2462	18.5641	18.9708
High 12	2467	18.9608	18.9416
High 13	2472	17.8143	17.3016

LOW CHANNEL 1

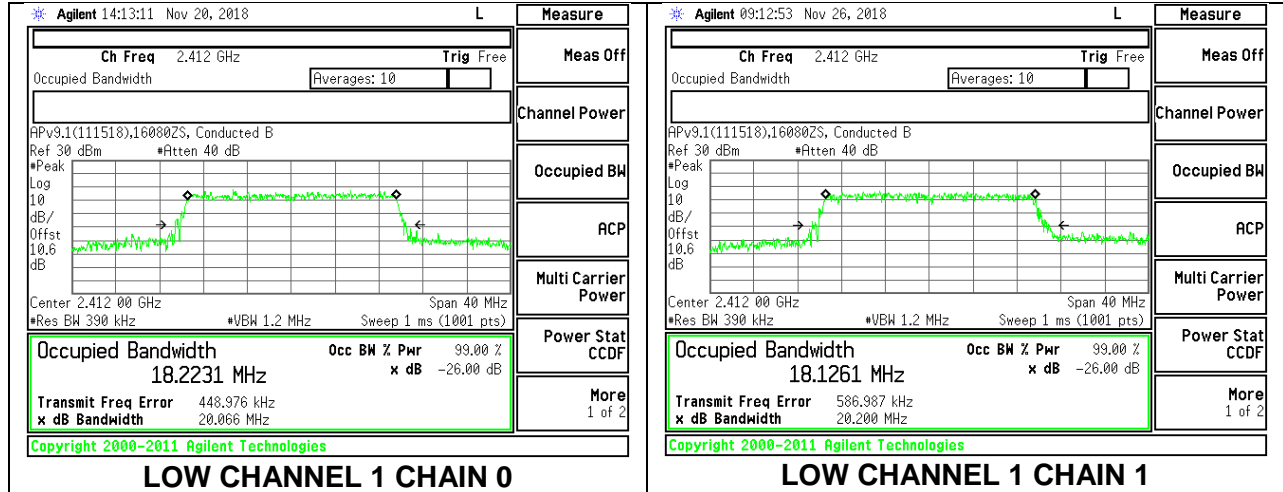

MID CHANNEL 6

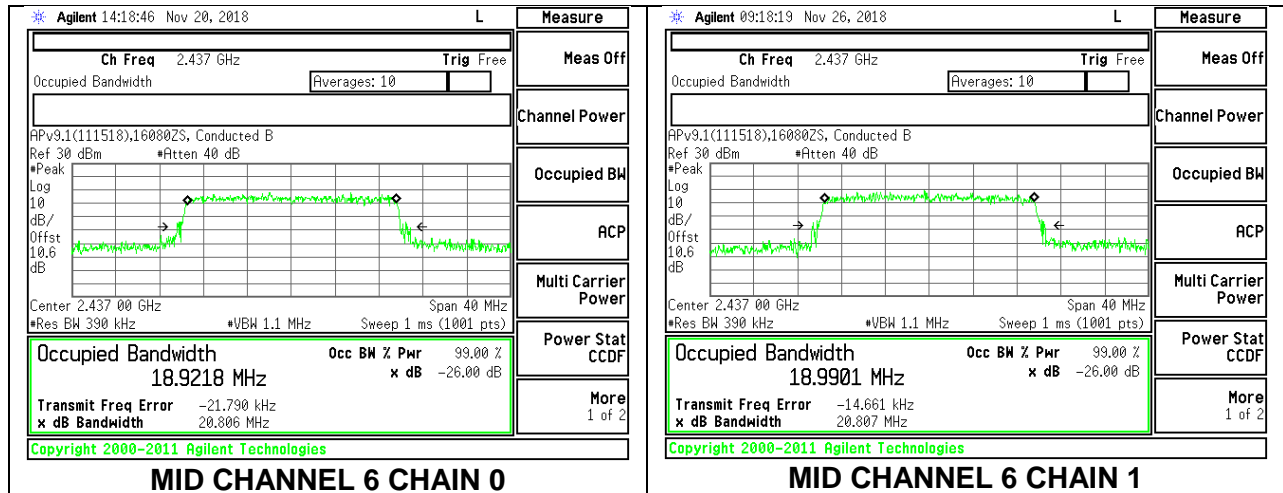

HIGH CHANNEL 11

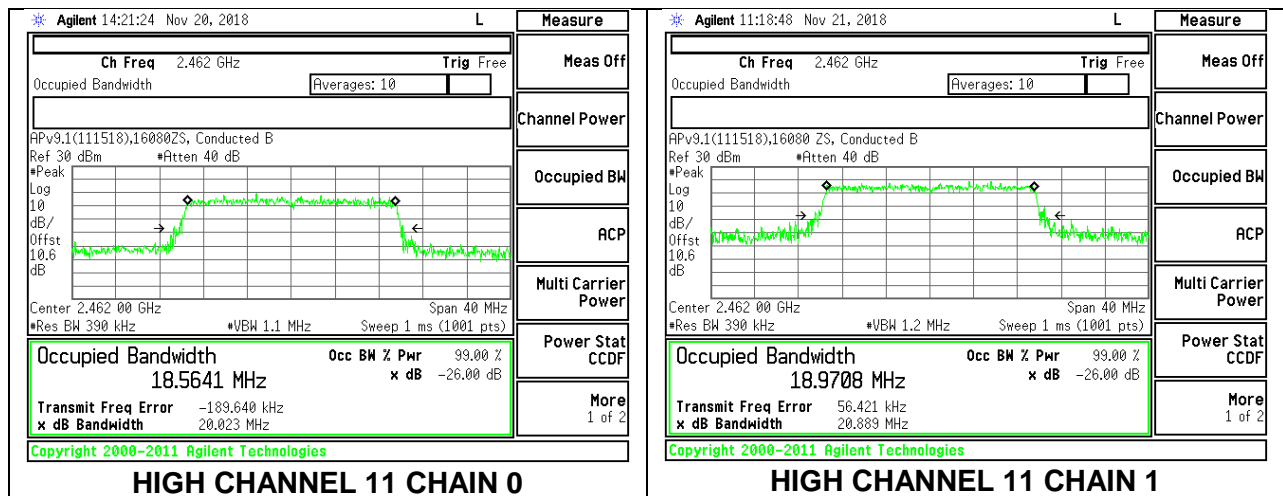

HIGH CHANNEL 12

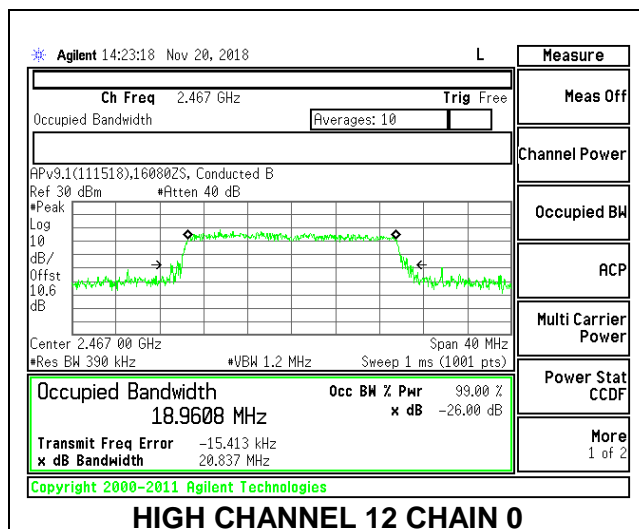

HIGH CHANNEL 12 CHAIN 0

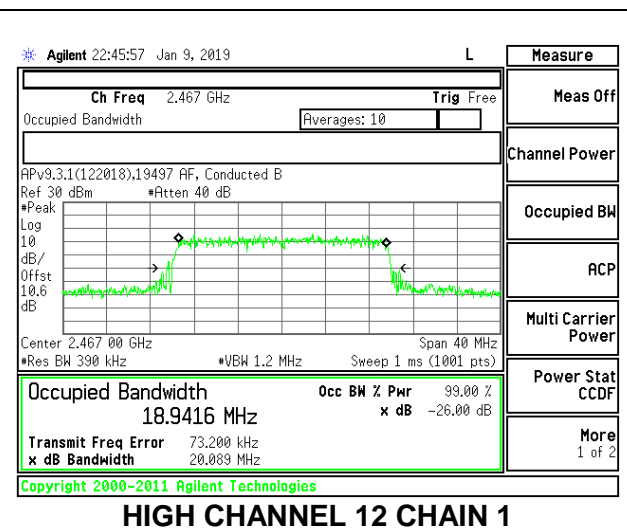

HIGH CHANNEL 12 CHAIN 1

HIGH CHANNEL 13

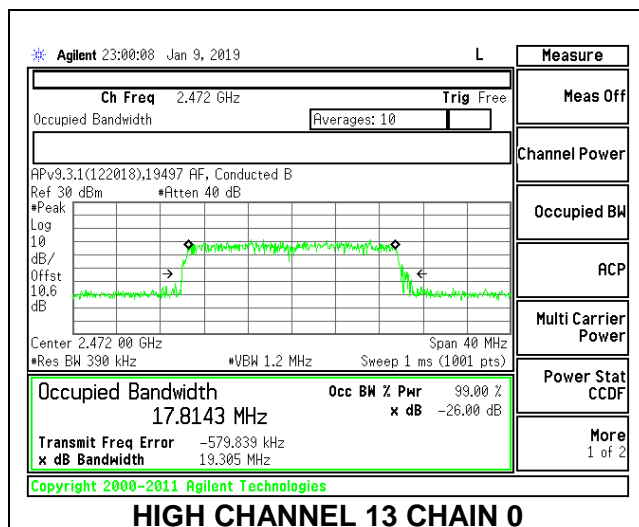

HIGH CHANNEL 13 CHAIN 0

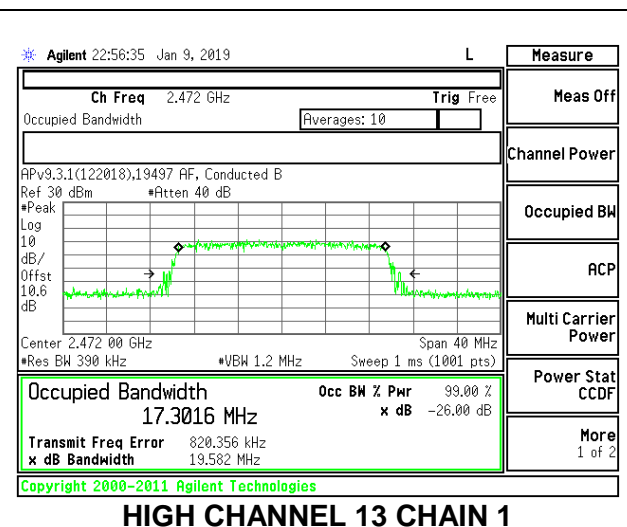

HIGH CHANNEL 13 CHAIN 1

9.3. 6 dB BANDWIDTH

LIMITS

FCC §15.247 (a) (2)

The minimum 6 dB bandwidth shall be at least 500 kHz.

RESULTS

9.3.1. 802.11b MODE

1TX Antenna 1 MODE

Channel	Frequency (MHz)	6 dB Bandwidth (MHz)	Minimum Limit (MHz)
Low 1	2412	7.60	0.5
Mid 6	2437	7.52	0.5
High 11	2462	6.64	0.5
High 12	2467	7.56	0.5
High 13	2472	7.12	0.5

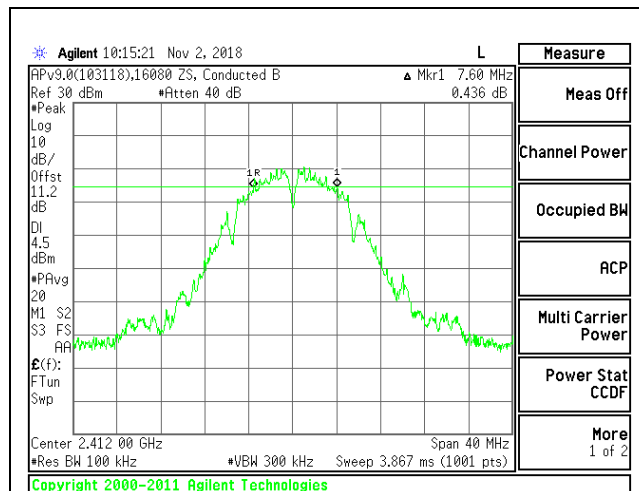

LOW CHANNEL 1

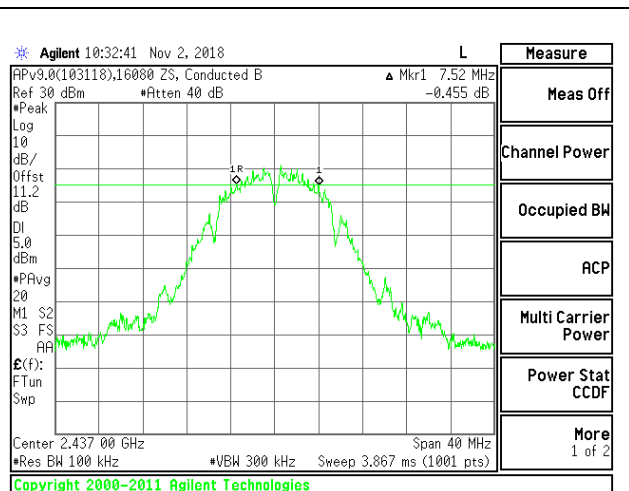

MID CHANNEL 6

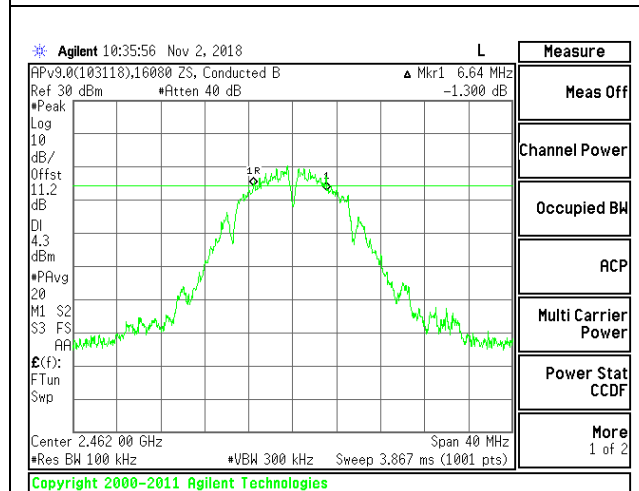

HIGH CHANNEL 11

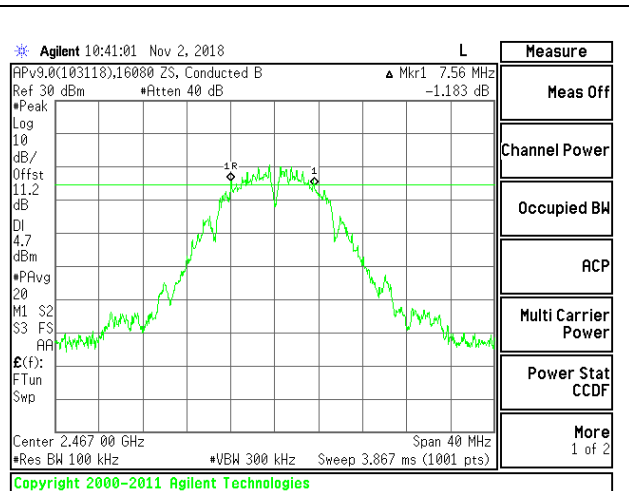

HIGH CHANNEL 12

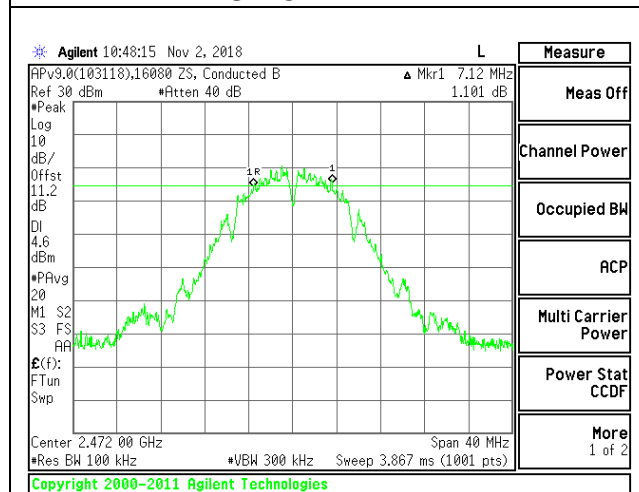

HIGH CHANNEL 13

Intentionally Left Blank

1TX Antenna 2 MODE

Channel	Frequency (MHz)	6 dB Bandwidth (MHz)	Minimum Limit (MHz)
Low 1	2412	7.60	0.5
Mid 6	2437	7.60	0.5
High 11	2462	7.04	0.5
High 12	2467	8.04	0.5
High 13	2472	8.52	0.5

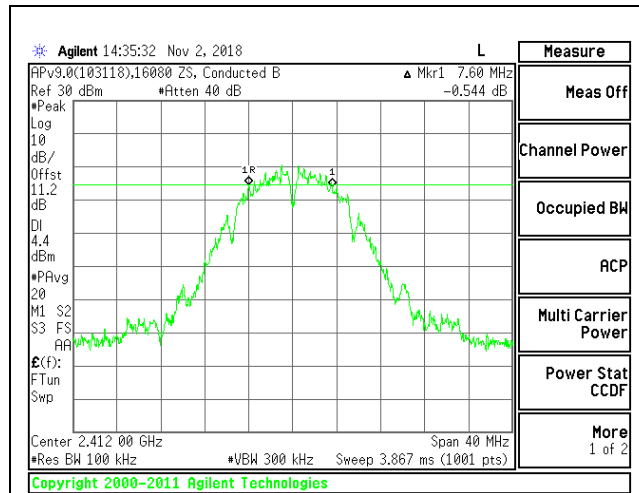

LOW CHANNEL 1

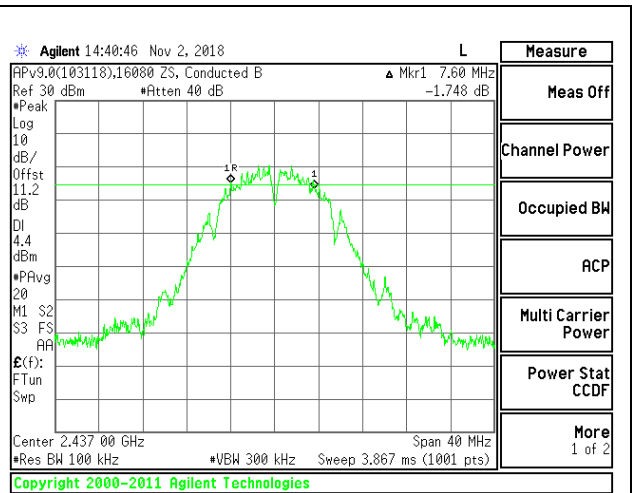

MID CHANNEL 6

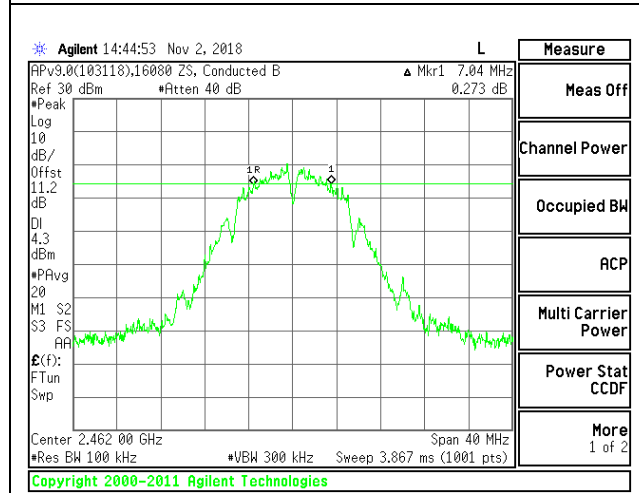

HIGH CHANNEL 11

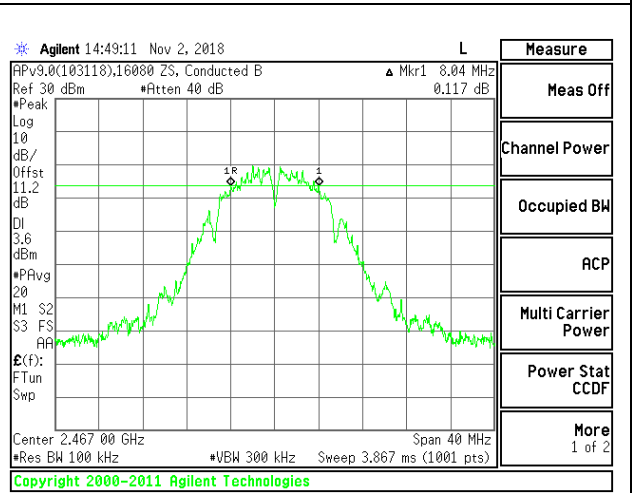

HIGH CHANNEL 12

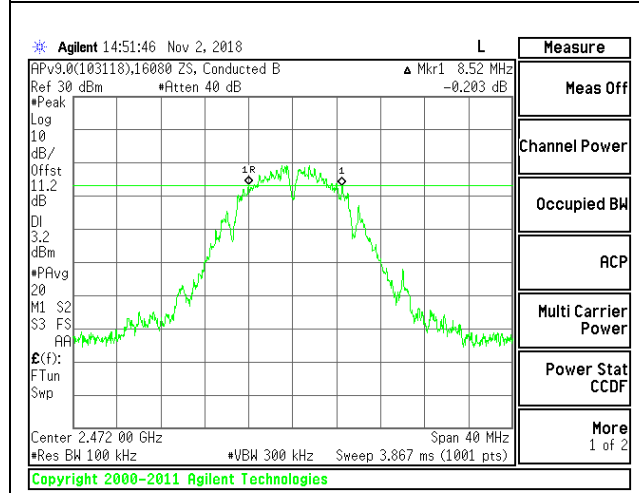

HIGH CHANNEL 13

Intentionally Left Blank

9.3.2. 802.11g MODE

2TX Antenna 1 + Antenna 2 CDD MODE

Channel	Frequency (MHz)	6 dB BW Chain 0 (MHz)	6 dB BW Chain 1 (MHz)	Minimum Limit (MHz)
Low 1	2412	16.40	16.36	0.5
Mid 6	2437	16.40	16.40	0.5
High 11	2462	16.32	16.40	0.5
High 12	2467	16.40	16.36	0.5
High 13	2472	16.36	16.36	0.5

LOW CHANNEL 1

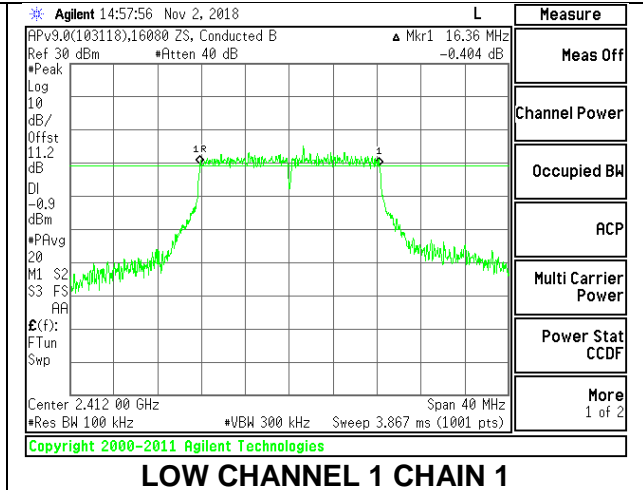
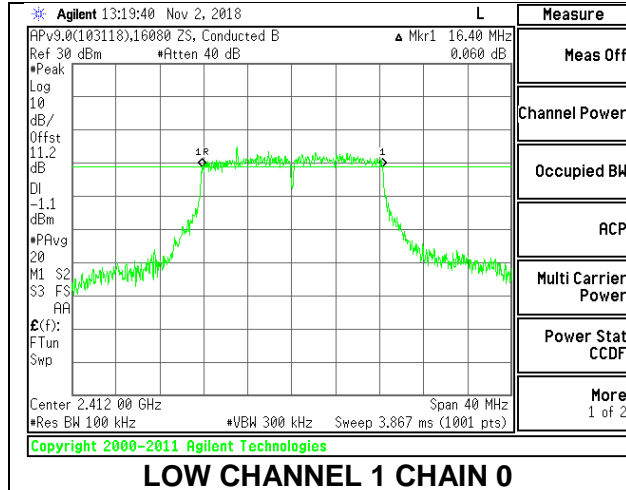

MID CHANNEL 6

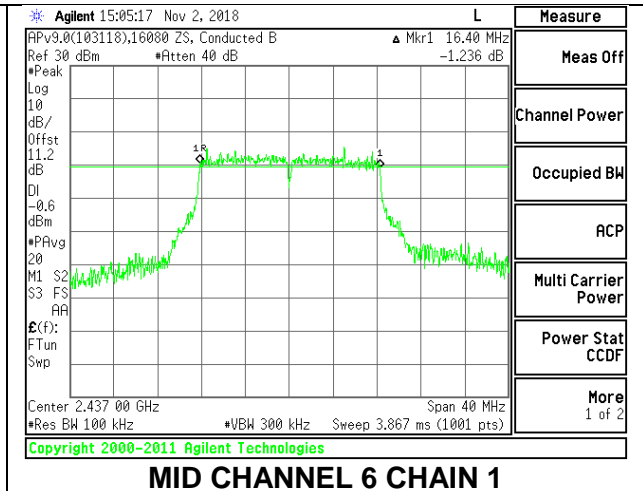
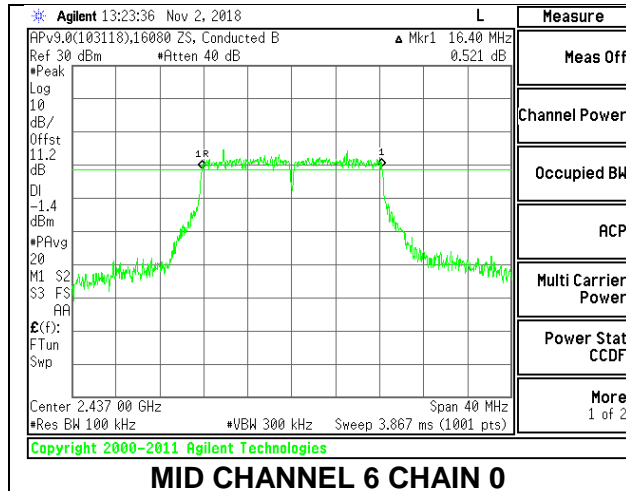

HIGH CHANNEL 11

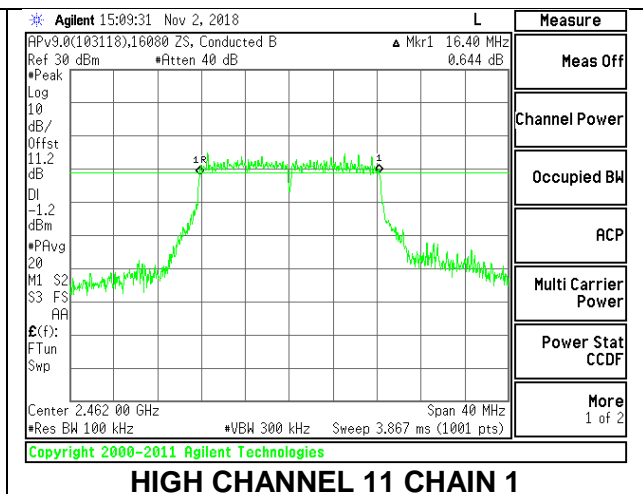
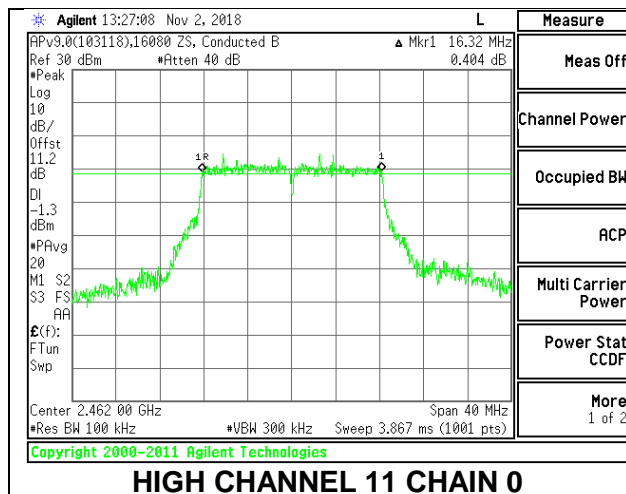

HIGH CHANNEL 12

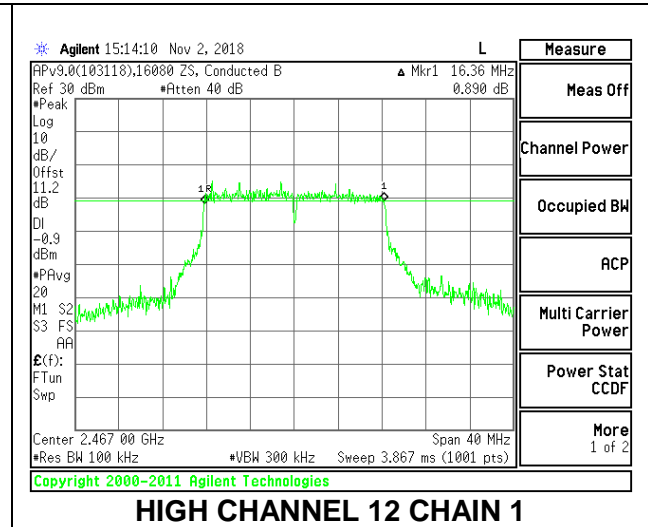
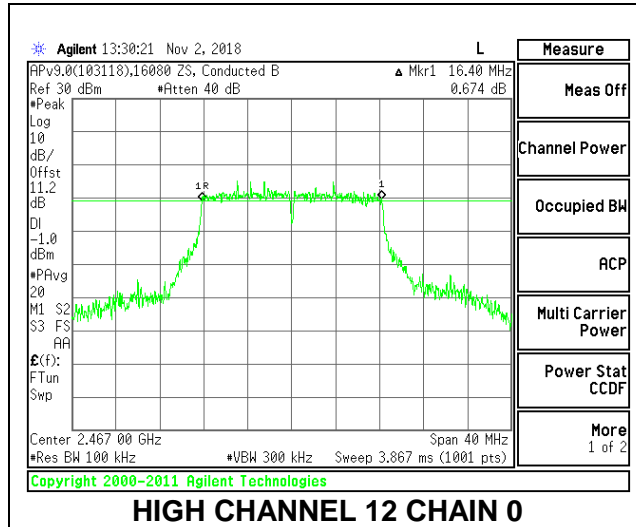

HIGH CHANNEL 13

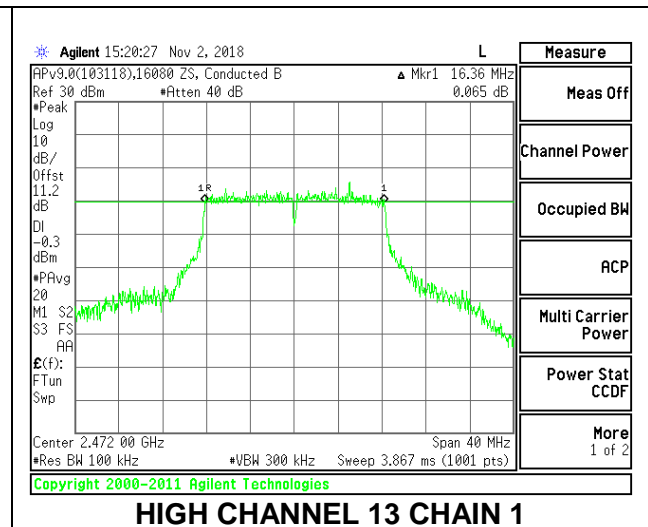
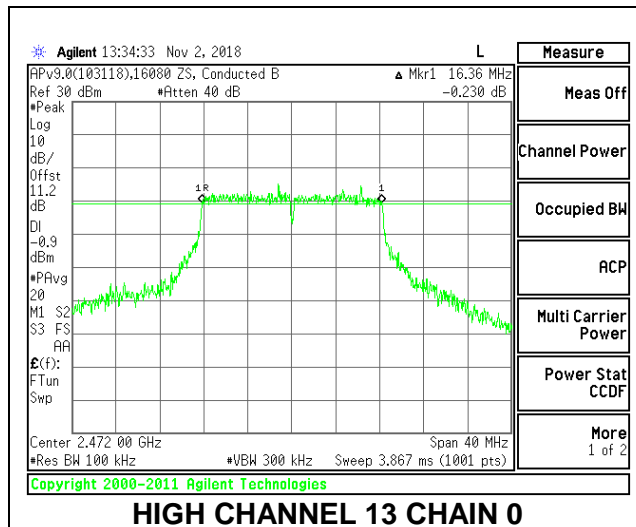

9.3.3. 802.11n HT20 MODE

2TX Antenna 1 + Antenna 2 CDD MODE

Channel	Frequency (MHz)	6 dB BW Chain 0 (MHz)	6 dB BW Chain 1 (MHz)	Minimum Limit (MHz)
Low 1	2412	17.60	17.64	0.5
Mid 6	2437	17.68	17.60	0.5
High 11	2462	17.60	17.60	0.5
High 12	2467	17.64	17.64	0.5
High 13	2472	17.60	17.64	0.5

LOW CHANNEL 1

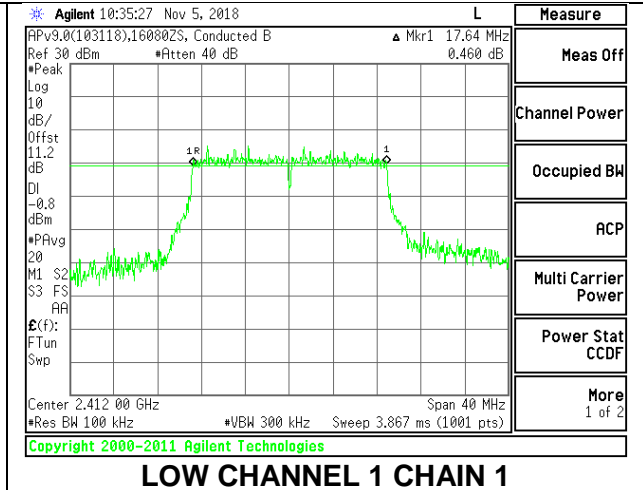
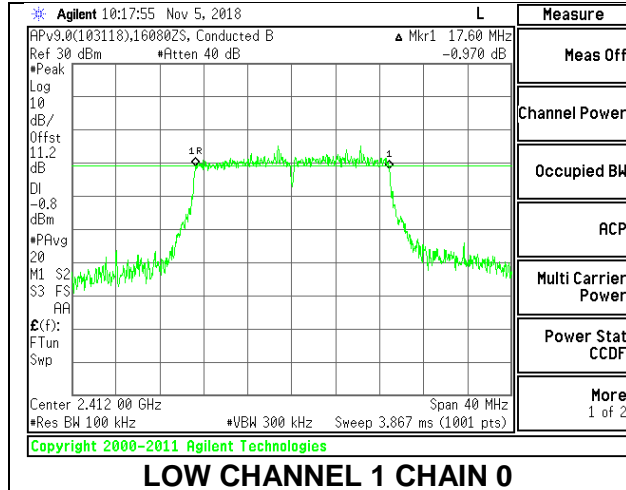

MID CHANNEL 6

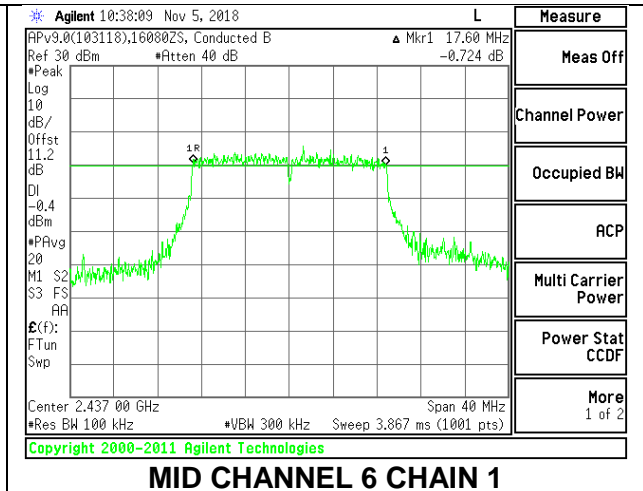
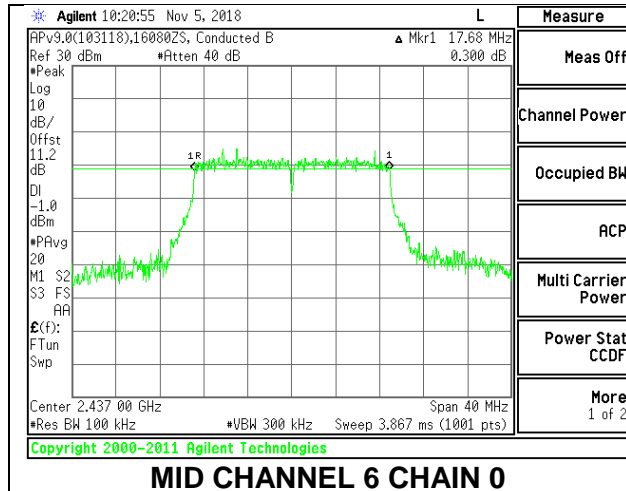

HIGH CHANNEL 11

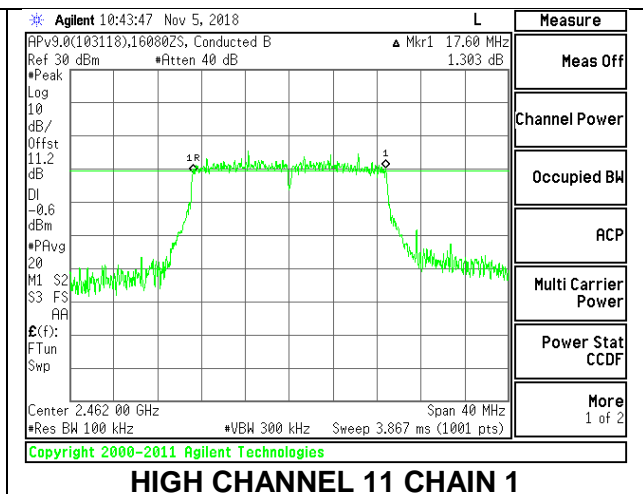
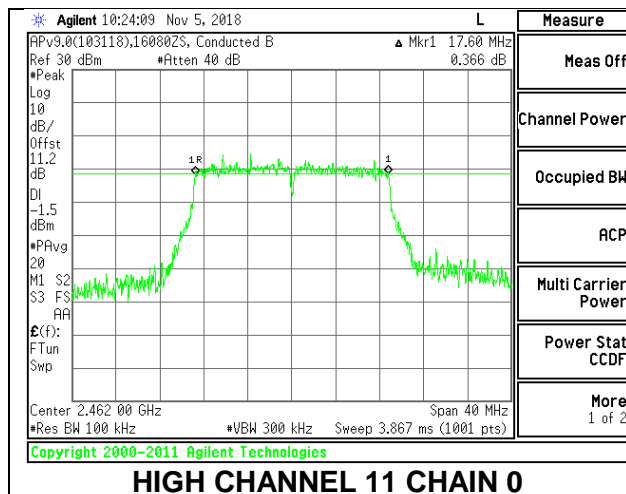

HIGH CHANNEL 12

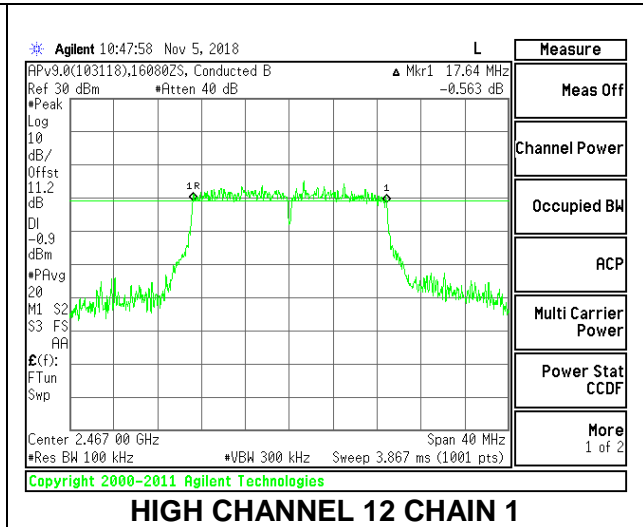
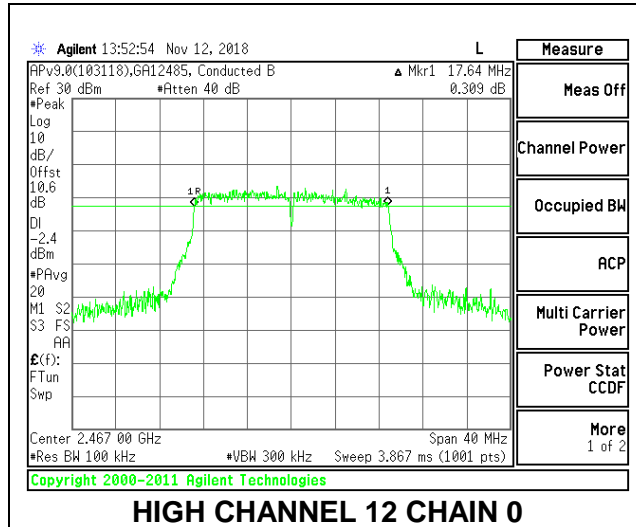

HIGH CHANNEL 13

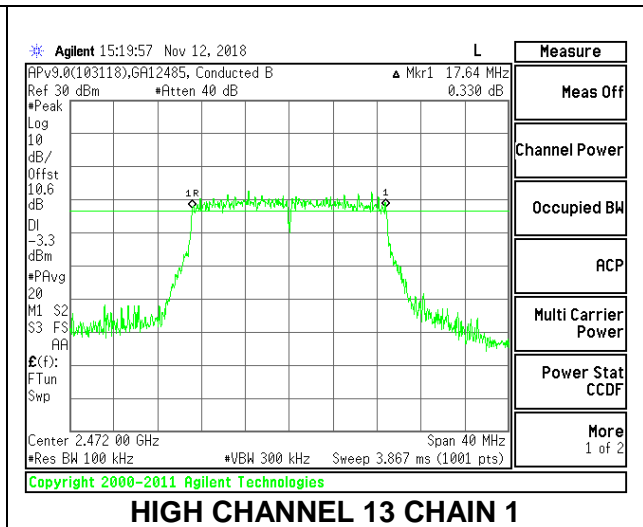
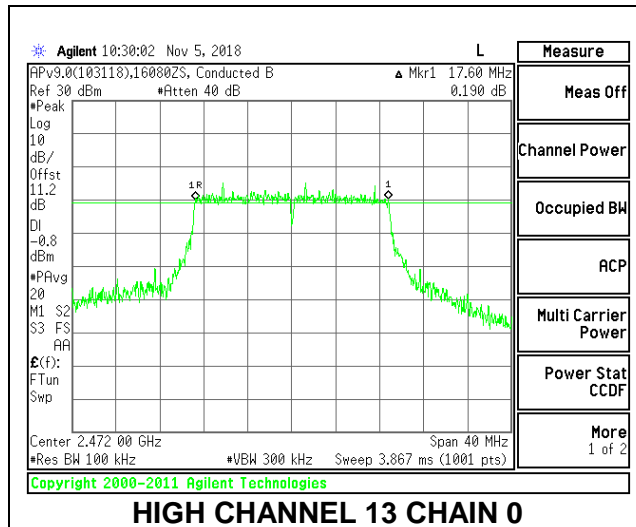

9.3.4. 802.11ax HE20 MODE

2TX Antenna 1 + Antenna 2 OFDMA MODE: 26-Tones, RU index 0

Channel	Frequency (MHz)	6 dB BW Chain 0 (MHz)	6 dB BW Chain 1 (MHz)	Minimum Limit (MHz)
Low 1	2412	2.12	2.04	0.5
Mid 6	2437	2.04	2.04	0.5
High 11	2462	2.04	2.08	0.5
High 12	2467	2.08	2.04	0.5
High 13	2472	2.04	2.04	0.5

LOW CHANNEL 1

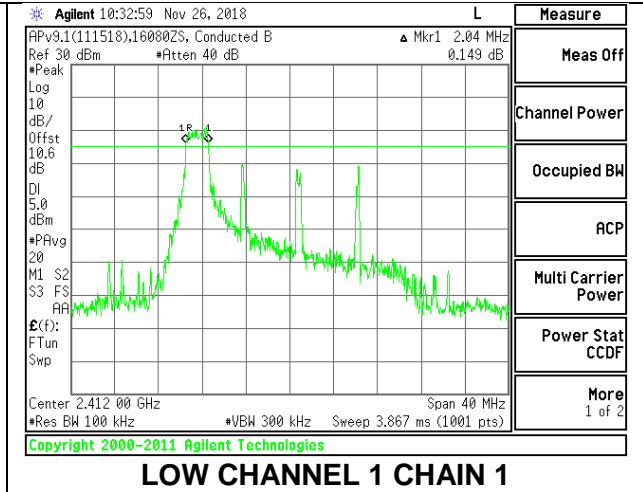
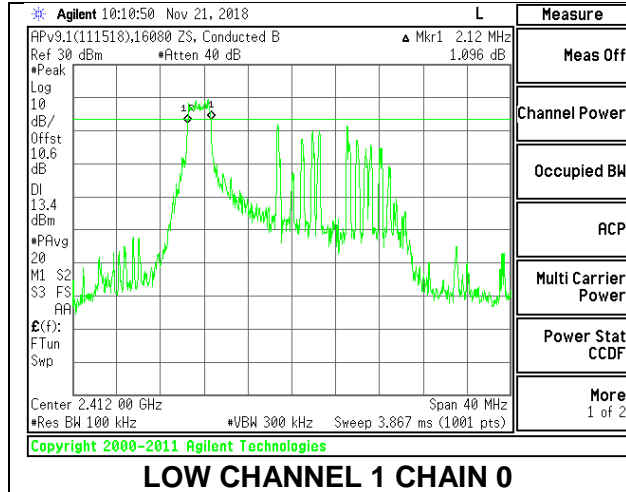

MID CHANNEL 6

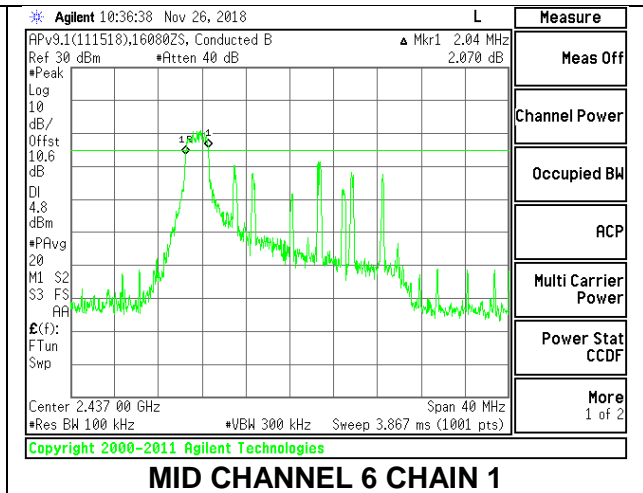
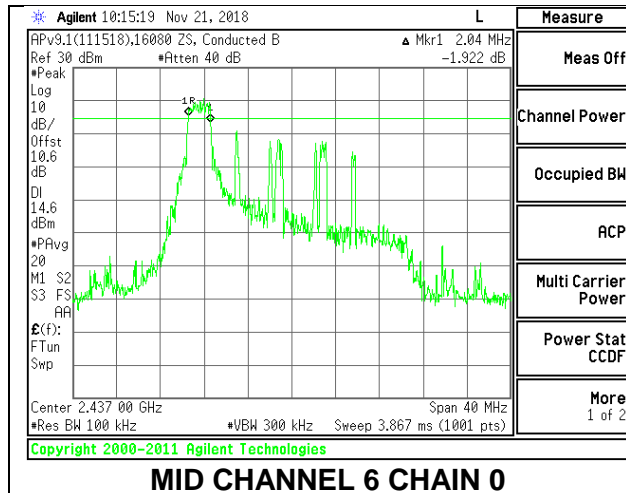

HIGH CHANNEL 11

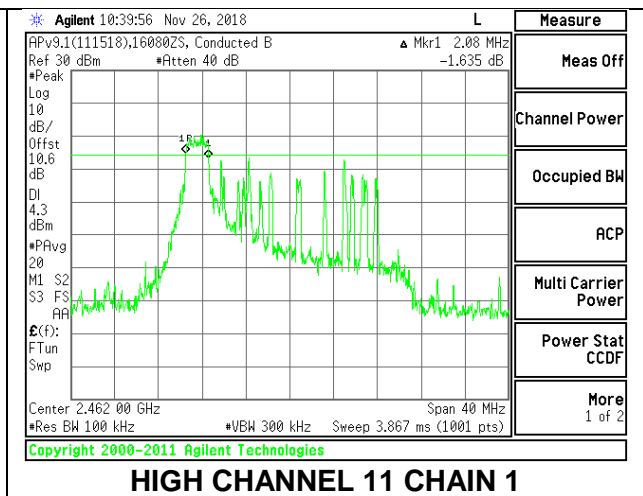
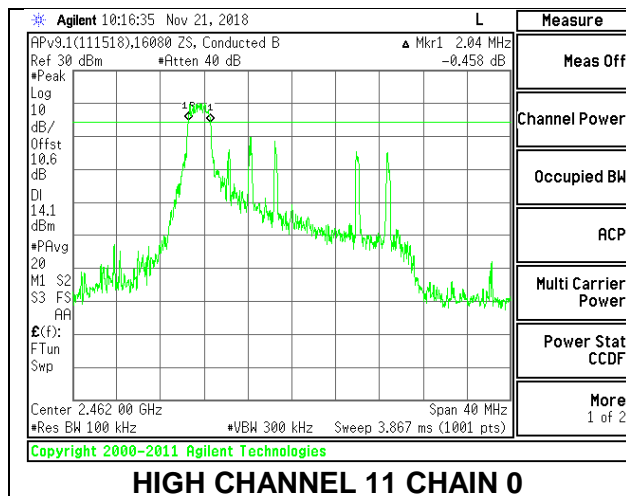

HIGH CHANNEL 12

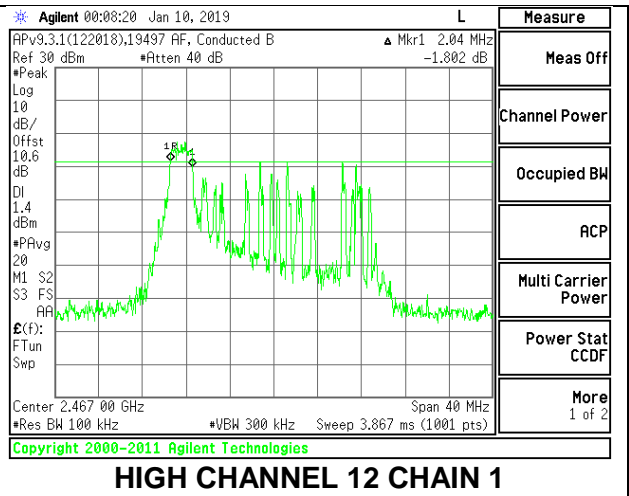
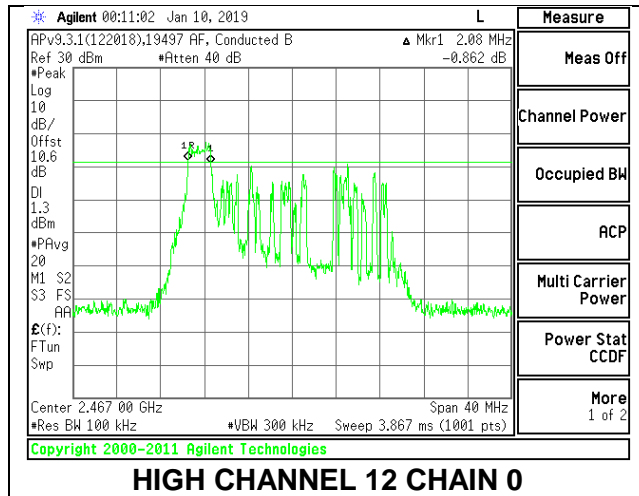

HIGH CHANNEL 13

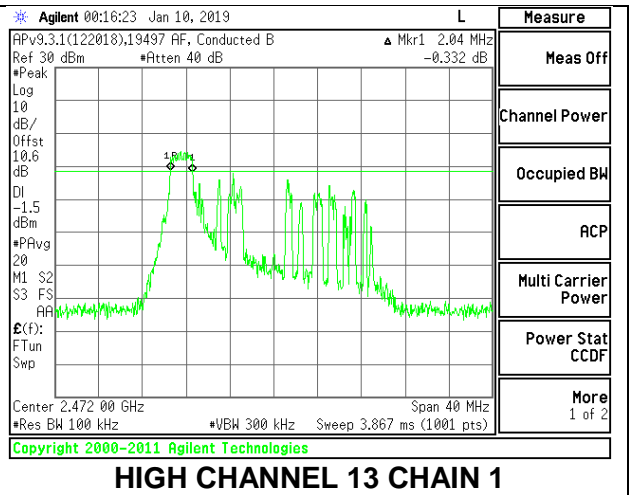
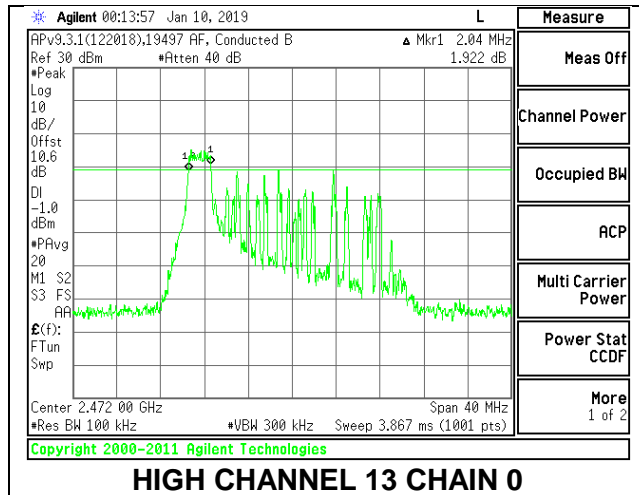

9.4. OUTPUT POWER

LIMITS

FCC §15.247 (b) (3)

For systems using digital modulation in the 902–928 MHz, 2400–2483.5 MHz, and 5725–5850 MHz bands: 1 Watt, based on the use of antennas with directional gains that do not exceed 6 dBi. If transmitting antennas of directional gain greater than 6 dBi are used, the conducted output power from the intentional radiator shall be reduced by the amount in dB that the directional gain of the antenna exceeds 6 dBi.

TEST PROCEDURE

The transmitter output is connected to a power meter. The cable assembly insertion loss was entered as an offset in the power meter to allow for a gated average reading of power.

DIRECTIONAL ANTENNA GAIN

For 2 TX:

Tx chains are uncorrelated for power and correlated for PSD due to the device supporting CDD in all MIMO modes. The directional gains are as follows:

Band (GHz)	Chain 0 Antenna Gain (dBi)	Chain 1 Antenna Gain (dBi)	Uncorrelated Chains Directional Gain (dBi)	Correlated Chains Directional Gain (dBi)
2.4	-0.40	-4.50	-1.98	0.80

RESULTS

9.4.1. 802.11b MODE

1TX Antenna 1 MODE

Limits

Channel	Frequency (MHz)	Directional Gain (dBi)	FCC Power Limit (dBm)	ISED Power Limit (dBm)	ISED EIRP Limit (dBm)	Max Power (dBm)
Low 1	2412	-0.40	30.00	30	36	30.00
Mid 6	2437	-0.40	30.00	30	36	30.00
High 11	2462	-0.40	30.00	30	36	30.00
High 12	2467	-0.40	30.00	30	36	30.00
High 13	2472	-0.40	30.00	30	36	30.00

Results

Channel	Frequency (MHz)	Meas Power (dBm)	Total Corr'd Power (dBm)	Power Limit (dBm)	Margin (dB)
Low 1	2412	18.72	18.72	30.00	-11.28
Mid 6	2437	18.92	18.92	30.00	-11.08
High 11	2462	18.22	18.22	30.00	-11.78
High 12	2467	12.39	12.39	30.00	-17.61
High 13	2472	6.20	6.20	30.00	-23.80

1TX Antenna 2 MODE

Limits

Channel	Frequency (MHz)	Directional Gain (dBi)	FCC Power Limit (dBm)	ISED Power Limit (dBm)	ISED EIRP Limit (dBm)	Max Power (dBm)
Low 1	2412	-4.50	30.00	30	36	30.00
Mid 6	2437	-4.50	30.00	30	36	30.00
High 11	2462	-4.50	30.00	30	36	30.00
High 12	2467	-4.50	30.00	30	36	30.00
High 13	2472	-4.50	30.00	30	36	30.00

Results

Channel	Frequency (MHz)	Meas Power (dBm)	Total Corr'd Power (dBm)	Power Limit (dBm)	Margin (dB)
Low 1	2412	18.96	18.96	30.00	-11.04
Mid 6	2437	18.31	18.31	30.00	-11.69
High 11	2462	18.40	18.40	30.00	-11.60
High 12	2467	12.67	12.67	30.00	-17.33
High 13	2472	6.26	6.26	30.00	-23.74

9.4.1. 802.11g MODE

1TX Antenna 1 MODE

Limits

Channel	Frequency (MHz)	Directional Gain (dBi)	FCC Power Limit (dBm)	ISED Power Limit (dBm)	ISED EIRP Limit (dBm)	Max Power (dBm)
Low 1	2412	-0.40	30.00	30	36	30.00
Mid 6	2437	-0.40	30.00	30	36	30.00
High 11	2462	-0.40	30.00	30	36	30.00
High 12	2467	-0.40	30.00	30	36	30.00
High 13	2472	-0.40	30.00	30	36	30.00

Results

Channel	Frequency (MHz)	Meas Power (dBm)	Total Corr'd Power (dBm)	Power Limit (dBm)	Margin (dB)
Low 1	2412	16.47	16.47	30.00	-13.53
Mid 6	2437	16.03	16.03	30.00	-13.97
High 11	2462	15.69	15.69	30.00	-14.31
High 12	2467	13.26	13.26	30.00	-16.74
High 13	2472	6.12	6.12	30.00	-23.88

1TX Antenna 2 MODE

Limits

Channel	Frequency (MHz)	Directional Gain (dBi)	FCC Power Limit (dBm)	ISED Power Limit (dBm)	ISED EIRP Limit (dBm)	Max Power (dBm)
Low 1	2412	-4.50	30.00	30	36	30.00
Mid 6	2437	-4.50	30.00	30	36	30.00
High 11	2462	-4.50	30.00	30	36	30.00
High 12	2467	-4.50	30.00	30	36	30.00
High 13	2472	-4.50	30.00	30	36	30.00

Results

Channel	Frequency (MHz)	Meas Power (dBm)	Total Corr'd Power (dBm)	Power Limit (dBm)	Margin (dB)
Low 1	2412	16.73	16.73	30.00	-13.27
Mid 6	2437	16.31	16.31	30.00	-13.69
High 11	2462	15.60	15.60	30.00	-14.40
High 12	2467	13.20	13.20	30.00	-16.80
High 13	2472	6.21	6.21	30.00	-23.79

2TX Antenna 1 + Antenna 2 CDD MODE

Limits

Channel	Frequency (MHz)	Directional Gain (dBi)	FCC/ISED Power Limit (dBm)	ISED EIRP Limit (dBm)	Max Power (dBm)
Low 1	2412	-1.98	30.00	36	30.00
Mid 6	2437	-1.98	30.00	36	30.00
High 11	2462	-1.98	30.00	36	30.00
High 12	2467	-1.98	30.00	36	30.00
High 13	2472	-1.98	30.00	36	30.00

Results

Channel	Frequency (MHz)	Chain 0 Meas Power (dBm)	Chain 1 Meas Power (dBm)	Total Corr'd Power (dBm)	Power Limit (dBm)	Margi (dB)
Low 1	2412	16.55	16.86	19.72	30.00	-10.28
Mid 6	2437	16.19	16.68	19.45	30.00	-10.55
High 11	2462	15.75	15.62	18.70	30.00	-11.30
High 12	2467	13.39	13.30	16.36	30.00	-13.64
High 13	2472	6.31	6.33	9.33	30.00	-20.67

9.4.2. 802.11n HT20 MODE

1TX Antenna 1 MODE

Limits

Channel	Frequency (MHz)	Directional Gain (dBi)	FCC Power Limit (dBm)	ISED Power Limit (dBm)	ISED EIRP Limit (dBm)	Max Power (dBm)
Low 1	2412	-0.40	30.00	30	36	30.00
Mid 6	2437	-0.40	30.00	30	36	30.00
High 11	2462	-0.40	30.00	30	36	30.00
High 12	2467	-0.40	30.00	30	36	30.00
High 13	2472	-0.40	30.00	30	36	30.00

Results

Channel	Frequency (MHz)	Meas Power (dBm)	Total Corr'd Power (dBm)	Power Limit (dBm)	Margin (dB)
Low 1	2412	14.32	14.32	30.00	-15.68
Mid 6	2437	16.11	16.11	30.00	-13.89
High 11	2462	14.47	14.47	30.00	-15.53
High 12	2467	12.30	12.30	30.00	-17.70
High 13	2472	6.15	6.15	30.00	-23.85

1TX Antenna 2 MODE

Limits

Channel	Frequency (MHz)	Directional Gain (dBi)	FCC Power Limit (dBm)	ISED Power Limit (dBm)	ISED EIRP Limit (dBm)	Max Power (dBm)
Low 1	2412	-4.50	30.00	30	36	30.00
Mid 6	2437	-4.50	30.00	30	36	30.00
High 11	2462	-4.50	30.00	30	36	30.00
High 12	2467	-4.50	30.00	30	36	30.00
High 13	2472	-4.50	30.00	30	36	30.00

Results

Channel	Frequency (MHz)	Meas Power (dBm)	Total Corr'd Power (dBm)	Power Limit (dBm)	Margin (dB)
Low 1	2412	14.92	14.92	30.00	-15.08
Mid 6	2437	16.47	16.47	30.00	-13.53
High 11	2462	14.22	14.22	30.00	-15.78
High 12	2467	12.55	12.55	30.00	-17.45
High 13	2472	6.29	6.29	30.00	-23.71

2TX Antenna 1 + Antenna 2 CDD MODE

Limits

Channel	Frequency (MHz)	Directional Gain (dBi)	FCC/ISED Power Limit (dBm)	ISED EIRP Limit (dBm)	Max Power (dBm)
Low 1	2412	-1.98	30.00	36	30.00
Mid 6	2437	-1.98	30.00	36	30.00
High 11	2462	-1.98	30.00	36	30.00
High 12	2467	-1.98	30.00	36	30.00
High 13	2472	-1.98	30.00	36	30.00

Results

Channel	Frequency (MHz)	Chain 0 Meas Power (dBm)	Chain 1 Meas Power (dBm)	Total Corr'd Power (dBm)	Power Limit (dBm)	Margi (dB)
Low 1	2412	14.70	15.28	18.01	30.00	-11.99
Mid 6	2437	16.26	16.84	19.57	30.00	-10.43
High 11	2462	14.55	14.34	17.46	30.00	-12.54
High 12	2467	12.46	12.67	15.58	30.00	-14.42
High 13	2472	6.23	6.31	9.28	30.00	-20.72

9.4.3. 802.11ax HE20 MODE

1TX Antenna 1 SU MODE

Limits

Channel	Frequency (MHz)	Directional Gain (dBi)	FCC Power Limit (dBm)	ISED Power Limit (dBm)	ISED EIRP Limit (dBm)	Max Power (dBm)
Low 1	2412	-0.40	30.00	30	36	30.00
Mid 6	2437	-0.40	30.00	30	36	30.00
High 11	2462	-0.40	30.00	30	36	30.00
High 12	2467	-0.40	30.00	30	36	30.00
High 13	2472	-0.40	30.00	30	36	30.00

Results

Channel	Frequency (MHz)	Meas Power (dBm)	Total Corr'd Power (dBm)	Power Limit (dBm)	Margin (dB)
Low 1	2412	13.66	13.66	30.00	-16.34
Mid 6	2437	15.22	15.22	30.00	-14.78
High 11	2462	13.55	13.55	30.00	-16.45
High 12	2467	12.15	12.15	30.00	-17.85
High 13	2472	6.25	6.25	30.00	-23.75

1TX Antenna 2 SU MODE

Limits

Channel	Frequency (MHz)	Directional Gain (dBi)	FCC Power Limit (dBm)	ISED Power Limit (dBm)	ISED EIRP Limit (dBm)	Max Power (dBm)
Low 1	2412	-4.50	30.00	30	36	30.00
Mid 6	2437	-4.50	30.00	30	36	30.00
High 11	2462	-4.50	30.00	30	36	30.00
High 12	2467	-4.50	30.00	30	36	30.00
High 13	2472	-4.50	30.00	30	36	30.00

Results

Channel	Frequency (MHz)	Meas Power (dBm)	Total Corr'd Power (dBm)	Power Limit (dBm)	Margin (dB)
Low 1	2412	13.79	13.79	30.00	-16.21
Mid 6	2437	15.47	15.47	30.00	-14.53
High 11	2462	13.67	13.67	30.00	-16.33
High 12	2467	12.20	12.20	30.00	-17.80
High 13	2472	6.31	6.31	30.00	-23.69

2TX Antenna 1 + Antenna 2 SU MODE

Limits

Channel	Frequency (MHz)	Directional Gain (dBi)	FCC/ISED Power Limit (dBm)	ISED EIRP Limit (dBm)	Max Power (dBm)
Low 1	2412	-1.98	30.00	36	30.00
Mid 6	2437	-1.98	30.00	36	30.00
High 11	2462	-1.98	30.00	36	30.00
High 12	2467	-1.98	30.00	36	30.00
High 13	2472	-1.98	30.00	36	30.00

Results

Channel	Frequency (MHz)	Chain 0 Meas Power (dBm)	Chain 1 Meas Power (dBm)	Total Corr'd Power (dBm)	Power Limit (dBm)	Margi (dB)
Low 1	2412	13.74	14.12	16.94	30.00	-13.06
Mid 6	2437	15.32	15.67	18.51	30.00	-11.49
High 11	2462	13.61	14.12	16.88	30.00	-13.12
High 12	2467	12.22	12.31	15.28	30.00	-14.72
High 13	2472	6.39	6.42	9.42	30.00	-20.58

1TX Antenna 1 OFDMA MODE: 242-Tones, RU index 61

Limits

Channel	Frequency (MHz)	Directional Gain (dBi)	FCC Power Limit (dBm)	ISED Power Limit (dBm)	ISED EIRP Limit (dBm)	Max Power (dBm)
Low 1	2412	-0.40	30.00	30	36	30.00
Mid 6	2437	-0.40	30.00	30	36	30.00
High 11	2462	-0.40	30.00	30	36	30.00
High 12	2467	-0.40	30.00	30	36	30.00
High 13	2472	-0.40	30.00	30	36	30.00

Results

Channel	Frequency (MHz)	Meas Power (dBm)	Total Corr'd Power (dBm)	Power Limit (dBm)	Margin (dB)
Low 1	2412	13.64	13.64	30.00	-16.36
Mid 6	2437	15.32	15.32	30.00	-14.68
High 11	2462	13.78	13.78	30.00	-16.22
High 12	2467	12.26	12.26	30.00	-17.74
High 13	2472	6.01	6.01	30.00	-23.99

1TX Antenna 2 OFDMA MODE: 242-Tones, RU index 61

Limits

Channel	Frequency (MHz)	Directional Gain (dBi)	FCC Power Limit (dBm)	ISED Power Limit (dBm)	ISED EIRP Limit (dBm)	Max Power (dBm)
Low 1	2412	-4.50	30.00	30	36	30.00
Mid 6	2437	-4.50	30.00	30	36	30.00
High 11	2462	-4.50	30.00	30	36	30.00
High 12	2467	-4.50	30.00	30	36	30.00
High 13	2472	-4.50	30.00	30	36	30.00

Results

Channel	Frequency (MHz)	Meas Power (dBm)	Total Corr'd Power (dBm)	Power Limit (dBm)	Margin (dB)
Low 1	2412	13.99	13.99	30.00	-16.01
Mid 6	2437	15.77	15.77	30.00	-14.23
High 11	2462	14.27	14.27	30.00	-15.73
High 12	2467	12.31	12.31	30.00	-17.69
High 13	2472	6.05	6.05	30.00	-23.95

2TX Antenna 1 + Antenna 2 OFDMA MODE: 242-Tones, RU index 61

Limits

Channel	Frequency (MHz)	Directional Gain (dBi)	FCC/ISED Power Limit (dBm)	ISED EIRP Limit (dBm)	Max Power (dBm)
Low 1	2412	-1.98	30.00	36	30.00
Mid 6	2437	-1.98	30.00	36	30.00
High 11	2462	-1.98	30.00	36	30.00
High 12	2467	-1.98	30.00	36	30.00
High 13	2472	-1.98	30.00	36	30.00

Results

Channel	Frequency (MHz)	Chain 0 Meas Power (dBm)	Chain 1 Meas Power (dBm)	Total Corr'd Power (dBm)	Power Limit (dBm)	Margi (dB)
Low 1	2412	13.80	14.64	17.25	30.00	-12.75
Mid 6	2437	15.44	16.13	18.81	30.00	-11.19
High 11	2462	13.85	14.60	17.25	30.00	-12.75
High 12	2467	12.32	12.47	15.41	30.00	-14.59
High 13	2472	6.04	6.09	9.08	30.00	-20.92

1TX Antenna 1 OFDMA MODE: 106-Tones, RU index 53

Limits

Channel	Frequency (MHz)	Directional Gain (dBi)	FCC Power Limit (dBm)	ISED Power Limit (dBm)	ISED EIRP Limit (dBm)	Max Power (dBm)
Low 1	2412	-0.40	30.00	30	36	30.00
Mid 6	2437	-0.40	30.00	30	36	30.00
High 11	2462	-0.40	30.00	30	36	30.00
High 12	2467	-0.40	30.00	30	36	30.00
High 13	2472	-0.40	30.00	30	36	30.00

Results

Channel	Frequency (MHz)	Meas Power (dBm)	Total Corr'd Power (dBm)	Power Limit (dBm)	Margin (dB)
Low 1	2412	16.15	16.15	30.00	-13.85
Mid 6	2437	16.68	16.68	30.00	-13.32
High 11	2462	16.31	16.31	30.00	-13.69
High 12	2467	12.88	12.88	30.00	-17.12
High 13	2472	6.10	6.10	30.00	-23.90

1TX Antenna 2 OFDMA MODE: 106-Tones, RU index 53

Limits

Channel	Frequency (MHz)	Directional Gain (dBi)	FCC Power Limit (dBm)	ISED Power Limit (dBm)	ISED EIRP Limit (dBm)	Max Power (dBm)
Low 1	2412	-4.50	30.00	30	36	30.00
Mid 6	2437	-4.50	30.00	30	36	30.00
High 11	2462	-4.50	30.00	30	36	30.00
High 12	2467	-4.50	30.00	30	36	30.00
High 13	2472	-4.50	30.00	30	36	30.00

Results

Channel	Frequency (MHz)	Meas Power (dBm)	Total Corr'd Power (dBm)	Power Limit (dBm)	Margin (dB)
Low 1	2412	16.40	16.40	30.00	-13.60
Mid 6	2437	16.82	16.82	30.00	-13.18
High 11	2462	16.20	16.20	30.00	-13.80
High 12	2467	13.06	13.06	30.00	-16.94
High 13	2472	6.17	6.17	30.00	-23.83

2TX Antenna 1 + Antenna 2 OFDMA MODE : 106-Tones, RU index 53

Limits

Channel	Frequency (MHz)	Directional Gain (dBi)	FCC/ISED Power Limit (dBm)	ISED EIRP Limit (dBm)	Max Power (dBm)
Low 1	2412	-1.98	30.00	36	30.00
Mid 6	2437	-1.98	30.00	36	30.00
High 11	2462	-1.98	30.00	36	30.00
High 12	2467	-1.98	30.00	36	30.00
High 13	2472	-1.98	30.00	36	30.00

Results

Channel	Frequency (MHz)	Chain 0 Meas Power (dBm)	Chain 1 Meas Power (dBm)	Total Corr'd Power (dBm)	Power Limit (dBm)	Margi (dB)
Low 1	2412	16.23	16.70	19.48	30.00	-10.52
Mid 6	2437	16.71	16.97	19.85	30.00	-10.15
High 11	2462	16.45	16.35	19.41	30.00	-10.59
High 12	2467	13.03	13.21	16.13	30.00	-13.87
High 13	2472	6.22	6.39	9.32	30.00	-20.68

1TX Antenna 1 OFDMA MODE: 106-Tones, RU index 54

Limits

Channel	Frequency (MHz)	Directional Gain (dBi)	FCC Power Limit (dBm)	ISED Power Limit (dBm)	ISED EIRP Limit (dBm)	Max Power (dBm)
Low 1	2412	-0.40	30.00	30	36	30.00
Mid 6	2437	-0.40	30.00	30	36	30.00
High 11	2462	-0.40	30.00	30	36	30.00
High 12	2467	-0.40	30.00	30	36	30.00
High 13	2472	-0.40	30.00	30	36	30.00

Results

Channel	Frequency (MHz)	Meas Power (dBm)	Total Corr'd Power (dBm)	Power Limit (dBm)	Margin (dB)
Low 1	2412	16.19	16.19	30.00	-13.81
Mid 6	2437	16.38	16.38	30.00	-13.62
High 11	2462	15.77	15.77	30.00	-14.23
High 12	2467	12.78	12.78	30.00	-17.22
High 13	2472	6.07	6.07	30.00	-23.93

1TX Antenna 2 OFDMA MODE: 106-Tones, RU index 54

Limits

Channel	Frequency (MHz)	Directional Gain (dBi)	FCC Power Limit (dBm)	ISED Power Limit (dBm)	ISED EIRP Limit (dBm)	Max Power (dBm)
Low 1	2412	-4.50	30.00	30	36	30.00
Mid 6	2437	-4.50	30.00	30	36	30.00
High 11	2462	-4.50	30.00	30	36	30.00
High 12	2467	-4.50	30.00	30	36	30.00
High 13	2472	-4.50	30.00	30	36	30.00

Results

Channel	Frequency (MHz)	Meas Power (dBm)	Total Corr'd Power (dBm)	Power Limit (dBm)	Margin (dB)
Low 1	2412	16.30	16.30	30.00	-13.70
Mid 6	2437	16.62	16.62	30.00	-13.38
High 11	2462	16.11	16.11	30.00	-13.89
High 12	2467	12.89	12.89	30.00	-17.11
High 13	2472	6.13	6.13	30.00	-23.87

2TX Antenna 1 + Antenna 2 OFDMA MODE: 106-Tones, RU index 54

Limits

Channel	Frequency (MHz)	Directional Gain (dBi)	FCC/ISED Power Limit (dBm)	ISED EIRP Limit (dBm)	Max Power (dBm)
Low 1	2412	-1.98	30.00	36	30.00
Mid 6	2437	-1.98	30.00	36	30.00
High 11	2462	-1.98	30.00	36	30.00
High 12	2467	-1.98	30.00	36	30.00
High 13	2472	-1.98	30.00	36	30.00

Results

Channel	Frequency (MHz)	Chain 0 Meas Power (dBm)	Chain 1 Meas Power (dBm)	Total Corr'd Power (dBm)	Power Limit (dBm)	Margi (dB)
Low 1	2412	16.31	16.42	19.38	30.00	-10.62
Mid 6	2437	16.65	16.80	19.74	30.00	-10.26
High 11	2462	15.92	16.50	19.23	30.00	-10.77
High 12	2467	12.93	13.17	16.06	30.00	-13.94
High 13	2472	6.14	6.28	9.22	30.00	-20.78

1TX Antenna 1 OFDMA MODE: 52-Tones, RU index 37

Limits

Channel	Frequency (MHz)	Directional Gain (dBi)	FCC Power Limit (dBm)	ISED Power Limit (dBm)	ISED EIRP Limit (dBm)	Max Power (dBm)
Low 1	2412	-0.40	30.00	30	36	30.00
Mid 6	2437	-0.40	30.00	30	36	30.00
High 11	2462	-0.40	30.00	30	36	30.00
High 12	2467	-0.40	30.00	30	36	30.00
High 13	2472	-0.40	30.00	30	36	30.00

Results

Channel	Frequency (MHz)	Meas Power (dBm)	Total Corr'd Power (dBm)	Power Limit (dBm)	Margin (dB)
Low 1	2412	16.55	16.55	30.00	-13.45
Mid 6	2437	16.57	16.57	30.00	-13.43
High 11	2462	15.77	15.77	30.00	-14.23
High 12	2467	12.84	12.84	30.00	-17.16
High 13	2472	6.06	6.06	30.00	-23.94

1TX Antenna 2 OFDMA MODE: 52-Tones, RU index 37

Limits

Channel	Frequency (MHz)	Directional Gain (dBi)	FCC Power Limit (dBm)	ISED Power Limit (dBm)	ISED EIRP Limit (dBm)	Max Power (dBm)
Low 1	2412	-4.50	30.00	30	36	30.00
Mid 6	2437	-4.50	30.00	30	36	30.00
High 11	2462	-4.50	30.00	30	36	30.00
High 12	2467	-4.50	30.00	30	36	30.00
High 13	2472	-4.50	30.00	30	36	30.00

Results

Channel	Frequency (MHz)	Meas Power (dBm)	Total Corr'd Power (dBm)	Power Limit (dBm)	Margin (dB)
Low 1	2412	16.60	16.60	30.00	-13.40
Mid 6	2437	16.66	16.66	30.00	-13.34
High 11	2462	15.80	15.80	30.00	-14.20
High 12	2467	12.95	12.95	30.00	-17.05
High 13	2472	6.15	6.15	30.00	-23.85

2TX Antenna 1 + Antenna 2 OFDMA MODE: 52-Tones, RU index 37

Limits

Channel	Frequency (MHz)	Directional Gain (dBi)	FCC/ISED Power Limit (dBm)	ISED EIRP Limit (dBm)	Max Power (dBm)
Low 1	2412	-1.98	30.00	36	30.00
Mid 6	2437	-1.98	30.00	36	30.00
High 11	2462	-1.98	30.00	36	30.00
High 12	2467	-1.98	30.00	36	30.00
High 13	2472	-1.98	30.00	36	30.00

Results

Channel	Frequency (MHz)	Chain 0 Meas Power (dBm)	Chain 1 Meas Power (dBm)	Total Corr'd Power (dBm)	Power Limit (dBm)	Margi (dB)
Low 1	2412	16.73	16.89	19.82	30.00	-10.18
Mid 6	2437	16.82	16.82	19.83	30.00	-10.17
High 11	2462	15.98	15.99	19.00	30.00	-11.00
High 12	2467	12.96	13.12	16.05	30.00	-13.95
High 13	2472	6.20	6.23	9.23	30.00	-20.77

1TX Antenna 1 OFDMA MODE: 52-Tones, RU index 38

Limits

Channel	Frequency (MHz)	Directional Gain (dBi)	FCC Power Limit (dBm)	ISED Power Limit (dBm)	ISED EIRP Limit (dBm)	Max Power (dBm)
Low 1	2412	-0.40	30.00	30	36	30.00
Mid 6	2437	-0.40	30.00	30	36	30.00
High 11	2462	-0.40	30.00	30	36	30.00
High 12	2467	-0.40	30.00	30	36	30.00
High 13	2472	-0.40	30.00	30	36	30.00

Results

Channel	Frequency (MHz)	Meas Power (dBm)	Total Corr'd Power (dBm)	Power Limit (dBm)	Margin (dB)
Low 1	2412	15.36	15.36	30.00	-14.64
Mid 6	2437	15.77	15.77	30.00	-14.23
High 11	2462	15.78	15.78	30.00	-14.22
High 12	2467	13.12	13.12	30.00	-16.88
High 13	2472	6.09	6.09	30.00	-23.91

1TX Antenna 2 OFDMA MODE: 52-Tones, RU index 38

Limits

Channel	Frequency (MHz)	Directional Gain (dBi)	FCC Power Limit (dBm)	ISED Power Limit (dBm)	ISED EIRP Limit (dBm)	Max Power (dBm)
Low 1	2412	-4.50	30.00	30	36	30.00
Mid 6	2437	-4.50	30.00	30	36	30.00
High 11	2462	-4.50	30.00	30	36	30.00
High 12	2467	-4.50	30.00	30	36	30.00
High 13	2472	-4.50	30.00	30	36	30.00

Results

Channel	Frequency (MHz)	Meas Power (dBm)	Total Corr'd Power (dBm)	Power Limit (dBm)	Margin (dB)
Low 1	2412	15.89	15.89	30.00	-14.11
Mid 6	2437	16.26	16.26	30.00	-13.74
High 11	2462	15.60	15.60	30.00	-14.40
High 12	2467	13.24	13.24	30.00	-16.76
High 13	2472	6.14	6.14	30.00	-23.86

2TX Antenna 1 + Antenna 2 OFDMA MODE : 52-Tones, RU index 38

Limits

Channel	Frequency (MHz)	Directional Gain (dBi)	FCC/ISED Power Limit (dBm)	ISED EIRP Limit (dBm)	Max Power (dBm)
Low 1	2412	-1.98	30.00	36	30.00
Mid 6	2437	-1.98	30.00	36	30.00
High 11	2462	-1.98	30.00	36	30.00
High 12	2467	-1.98	30.00	36	30.00
High 13	2472	-1.98	30.00	36	30.00

Results

Channel	Frequency (MHz)	Chain 0 Meas Power (dBm)	Chain 1 Meas Power (dBm)	Total Corr'd Power (dBm)	Power Limit (dBm)	Margi (dB)
Low 1	2412	15.45	16.23	18.87	30.00	-11.13
Mid 6	2437	16.09	16.72	19.43	30.00	-10.57
High 11	2462	15.93	15.72	18.84	30.00	-11.16
High 12	2467	13.24	13.31	16.29	30.00	-13.71
High 13	2472	6.12	6.23	9.19	30.00	-20.81

1TX Antenna 1 OFDMA MODE: 52-Tones, RU index 40

Limits

Channel	Frequency (MHz)	Directional Gain (dBi)	FCC Power Limit (dBm)	ISED Power Limit (dBm)	ISED EIRP Limit (dBm)	Max Power (dBm)
Low 1	2412	-0.40	30.00	30	36	30.00
Mid 6	2437	-0.40	30.00	30	36	30.00
High 11	2462	-0.40	30.00	30	36	30.00
High 12	2467	-0.40	30.00	30	36	30.00
High 13	2472	-0.40	30.00	30	36	30.00

Results

Channel	Frequency (MHz)	Meas Power (dBm)	Total Corr'd Power (dBm)	Power Limit (dBm)	Margin (dB)
Low 1	2412	15.97	15.97	30.00	-14.03
Mid 6	2437	16.18	16.18	30.00	-13.82
High 11	2462	15.34	15.34	30.00	-14.66
High 12	2467	12.84	12.84	30.00	-17.16
High 13	2472	6.21	6.21	30.00	-23.79

1TX Antenna 2 OFDMA MODE: 52-Tones, RU index 40

Limits

Channel	Frequency (MHz)	Directional Gain (dBi)	FCC Power Limit (dBm)	ISED Power Limit (dBm)	ISED EIRP Limit (dBm)	Max Power (dBm)
Low 1	2412	-4.50	30.00	30	36	30.00
Mid 6	2437	-4.50	30.00	30	36	30.00
High 11	2462	-4.50	30.00	30	36	30.00
High 12	2467	-4.50	30.00	30	36	30.00
High 13	2472	-4.50	30.00	30	36	30.00

Results

Channel	Frequency (MHz)	Meas Power (dBm)	Total Corr'd Power (dBm)	Power Limit (dBm)	Margin (dB)
Low 1	2412	16.01	16.01	30.00	-13.99
Mid 6	2437	16.61	16.61	30.00	-13.39
High 11	2462	15.66	15.66	30.00	-14.34
High 12	2467	12.92	12.92	30.00	-17.08
High 13	2472	6.35	6.35	30.00	-23.65

2TX Antenna 1 + Antenna 2 OFDMA MODE: 52-Tones, RU index 40

Limits

Channel	Frequency (MHz)	Directional Gain (dBi)	FCC/ISED Power Limit (dBm)	ISED EIRP Limit (dBm)	Max Power (dBm)
Low 1	2412	-1.98	30.00	36	30.00
Mid 6	2437	-1.98	30.00	36	30.00
High 11	2462	-1.98	30.00	36	30.00
High 12	2467	-1.98	30.00	36	30.00
High 13	2472	-1.98	30.00	36	30.00

Results

Channel	Frequency (MHz)	Chain 0 Meas Power (dBm)	Chain 1 Meas Power (dBm)	Total Corr'd Power (dBm)	Power Limit (dBm)	Margi (dB)
Low 1	2412	16.11	16.17	19.15	30.00	-10.85
Mid 6	2437	16.24	16.89	19.59	30.00	-10.41
High 11	2462	15.62	16.53	19.11	30.00	-10.89
High 12	2467	13.07	13.24	16.17	30.00	-13.83
High 13	2472	6.40	6.47	9.45	30.00	-20.55

1TX Antenna 1 OFDMA MODE: 26-Tones, RU index 0

Limits

Channel	Frequency (MHz)	Directional Gain (dBi)	FCC Power Limit (dBm)	ISED Power Limit (dBm)	ISED EIRP Limit (dBm)	Max Power (dBm)
Low 1	2412	-0.40	30.00	30	36	30.00
Mid 6	2437	-0.40	30.00	30	36	30.00
High 11	2462	-0.40	30.00	30	36	30.00
High 12	2467	-0.40	30.00	30	36	30.00
High 13	2472	-0.40	30.00	30	36	30.00

Results

Channel	Frequency (MHz)	Meas Power (dBm)	Total Corr'd Power (dBm)	Power Limit (dBm)	Margin (dB)
Low 1	2412	15.66	15.66	30.00	-14.34
Mid 6	2437	15.68	15.68	30.00	-14.32
High 11	2462	15.91	15.91	30.00	-14.09
High 12	2467	12.22	12.22	30.00	-17.78
High 13	2472	6.04	6.04	30.00	-23.96

1TX Antenna 2 OFDMA MODE: 26-Tones, RU index 0

Limits

Channel	Frequency (MHz)	Directional Gain (dBi)	FCC Power Limit (dBm)	ISED Power Limit (dBm)	ISED EIRP Limit (dBm)	Max Power (dBm)
Low 1	2412	-4.50	30.00	30	36	30.00
Mid 6	2437	-4.50	30.00	30	36	30.00
High 11	2462	-4.50	30.00	30	36	30.00
High 12	2467	-4.50	30.00	30	36	30.00
High 13	2472	-4.50	30.00	30	36	30.00

Results

Channel	Frequency (MHz)	Meas Power (dBm)	Total Corr'd Power (dBm)	Power Limit (dBm)	Margin (dB)
Low 1	2412	15.98	15.98	30.00	-14.02
Mid 6	2437	16.03	16.03	30.00	-13.97
High 11	2462	15.76	15.76	30.00	-14.24
High 12	2467	12.27	12.27	30.00	-17.73
High 13	2472	6.15	6.15	30.00	-23.85

2TX Antenna 1 + Antenna 2 OFDMA MODE: 26-Tones, RU index 0

Limits

Channel	Frequency (MHz)	Directional Gain (dBi)	FCC/ISED Power Limit (dBm)	ISED EIRP Limit (dBm)	Max Power (dBm)
Low 1	2412	-1.98	30.00	36	30.00
Mid 6	2437	-1.98	30.00	36	30.00
High 11	2462	-1.98	30.00	36	30.00
High 12	2467	-1.98	30.00	36	30.00
High 13	2472	-1.98	30.00	36	30.00

Results

Channel	Frequency (MHz)	Chain 0 Meas Power (dBm)	Chain 1 Meas Power (dBm)	Total Corr'd Power (dBm)	Power Limit (dBm)	Margi (dB)
Low 1	2412	15.71	16.21	18.98	30.00	-11.02
Mid 6	2437	15.87	16.27	19.08	30.00	-10.92
High 11	2462	16.09	15.84	18.98	30.00	-11.02
High 12	2467	12.35	12.49	15.43	30.00	-14.57
High 13	2472	6.22	6.34	9.29	30.00	-20.71

1TX Antenna 1 OFDMA MODE: 26-Tones, RU index 4

Limits

Channel	Frequency (MHz)	Directional Gain (dBi)	FCC Power Limit (dBm)	ISED Power Limit (dBm)	ISED EIRP Limit (dBm)	Max Power (dBm)
Low 1	2412	-0.40	30.00	30	36	30.00
Mid 6	2437	-0.40	30.00	30	36	30.00
High 11	2462	-0.40	30.00	30	36	30.00
High 12	2467	-0.40	30.00	30	36	30.00
High 13	2472	-0.40	30.00	30	36	30.00

Results

Channel	Frequency (MHz)	Meas Power (dBm)	Total Corr'd Power (dBm)	Power Limit (dBm)	Margin (dB)
Low 1	2412	15.37	15.37	30.00	-14.63
Mid 6	2437	15.99	15.99	30.00	-14.01
High 11	2462	15.34	15.34	30.00	-14.66
High 12	2467	12.21	12.21	30.00	-17.79
High 13	2472	6.02	6.02	30.00	-23.98

1TX Antenna 2 OFDMA MODE: 26-Tones, RU index 4

Limits

Channel	Frequency (MHz)	Directional Gain (dBi)	FCC Power Limit (dBm)	ISED Power Limit (dBm)	ISED EIRP Limit (dBm)	Max Power (dBm)
Low 1	2412	-4.50	30.00	30	36	30.00
Mid 6	2437	-4.50	30.00	30	36	30.00
High 11	2462	-4.50	30.00	30	36	30.00
High 12	2467	-4.50	30.00	30	36	30.00
High 13	2472	-4.50	30.00	30	36	30.00

Results

Channel	Frequency (MHz)	Meas Power (dBm)	Total Corr'd Power (dBm)	Power Limit (dBm)	Margin (dB)
Low 1	2412	15.61	15.61	30.00	-14.39
Mid 6	2437	16.40	16.40	30.00	-13.60
High 11	2462	15.79	15.79	30.00	-14.21
High 12	2467	12.37	12.37	30.00	-17.63
High 13	2472	6.12	6.12	30.00	-23.88

2TX Antenna 1 + Antenna 2 OFDMA MODE: 26-Tones, RU index 4

Limits

Channel	Frequency (MHz)	Directional Gain (dBi)	FCC/ISED Power Limit (dBm)	ISED EIRP Limit (dBm)	Max Power (dBm)
Low 1	2412	-1.98	30.00	36	30.00
Mid 6	2437	-1.98	30.00	36	30.00
High 11	2462	-1.98	30.00	36	30.00
High 12	2467	-1.98	30.00	36	30.00
High 13	2472	-1.98	30.00	36	30.00

Results

Channel	Frequency (MHz)	Chain 0 Meas Power (dBm)	Chain 1 Meas Power (dBm)	Total Corr'd Power (dBm)	Power Limit (dBm)	Margi (dB)
Low 1	2412	15.46	16.80	19.19	30.00	-10.81
Mid 6	2437	16.11	16.82	19.49	30.00	-10.51
High 11	2462	15.56	16.21	18.91	30.00	-11.09
High 12	2467	12.35	12.51	15.44	30.00	-14.56
High 13	2472	6.11	6.24	9.19	30.00	-20.81

1TX Antenna 1 OFDMA MODE: 26-Tones, RU index 8

Limits

Channel	Frequency (MHz)	Directional Gain (dBi)	FCC Power Limit (dBm)	ISED Power Limit (dBm)	ISED EIRP Limit (dBm)	Max Power (dBm)
Low 1	2412	-0.40	30.00	30	36	30.00
Mid 6	2437	-0.40	30.00	30	36	30.00
High 11	2462	-0.40	30.00	30	36	30.00
High 12	2467	-0.40	30.00	30	36	30.00
High 13	2472	-0.40	30.00	30	36	30.00

Results

Channel	Frequency (MHz)	Meas Power (dBm)	Total Corr'd Power (dBm)	Power Limit (dBm)	Margin (dB)
Low 1	2412	16.13	16.13	30.00	-13.87
Mid 6	2437	15.90	15.90	30.00	-14.10
High 11	2462	15.16	15.16	30.00	-14.84
High 12	2467	12.10	12.10	30.00	-17.90
High 13	2472	6.22	6.22	30.00	-23.78

1TX Antenna 2 OFDMA MODE: 26-Tones, RU index 8

Limits

Channel	Frequency (MHz)	Directional Gain (dBi)	FCC Power Limit (dBm)	ISED Power Limit (dBm)	ISED EIRP Limit (dBm)	Max Power (dBm)
Low 1	2412	-4.50	30.00	30	36	30.00
Mid 6	2437	-4.50	30.00	30	36	30.00
High 11	2462	-4.50	30.00	30	36	30.00
High 12	2467	-4.50	30.00	30	36	30.00
High 13	2472	-4.50	30.00	30	36	30.00

Results

Channel	Frequency (MHz)	Meas Power (dBm)	Total Corr'd Power (dBm)	Power Limit (dBm)	Margin (dB)
Low 1	2412	16.52	16.52	30.00	-13.48
Mid 6	2437	16.45	16.45	30.00	-13.55
High 11	2462	16.22	16.22	30.00	-13.78
High 12	2467	12.26	12.26	30.00	-17.74
High 13	2472	6.31	6.31	30.00	-23.69

2TX Antenna 1 + Antenna 2 OFDMA MODE: 26-Tones, RU index 8

Limits

Channel	Frequency (MHz)	Directional Gain (dBi)	FCC/ISED Power Limit (dBm)	ISED EIRP Limit (dBm)	Max Power (dBm)
Low 1	2412	-1.98	30.00	36	30.00
Mid 6	2437	-1.98	30.00	36	30.00
High 11	2462	-1.98	30.00	36	30.00
High 12	2467	-1.98	30.00	36	30.00
High 13	2472	-1.98	30.00	36	30.00

Results

Channel	Frequency (MHz)	Chain 0 Meas Power (dBm)	Chain 1 Meas Power (dBm)	Total Corr'd Power (dBm)	Power Limit (dBm)	Margi (dB)
Low 1	2412	16.27	16.78	19.54	30.00	-10.46
Mid 6	2437	16.02	16.99	19.54	30.00	-10.46
High 11	2462	15.24	16.90	19.16	30.00	-10.84
High 12	2467	12.24	12.46	15.36	30.00	-14.64
High 13	2472	6.37	6.55	9.47	30.00	-20.53

9.5. POWER SPECTRAL DENSITY

LIMITS

FCC §15.247 (e)

The power spectral density conducted from the transmitter to the antenna shall not be greater than 8 dBm in any 3 kHz band during any time interval of continuous transmission.

RESULTS

9.5.1. 802.11b MODE

1TX Antenna 1 MODE

Duty Cycle CF (dB)	0.00	Included in Calculations of Corr'd PSD
---------------------------	------	-----------------------------------------------

PSD Results

Channel	Frequency (MHz)	Chain 0 Meas (dBm)	Total Corr'd PSD (dBm)	Limit (dBm)	Margin (dB)
Low 1	2412	-2.984	-2.98	8.0	-11.0
Mid 6	2437	-2.837	-2.84	8.0	-10.8
High 11	2462	-3.088	-3.09	8.0	-11.1
High 12	2467	-9.849	-9.85	8.0	-17.8
High 13	2472	-14.117	-14.12	8.0	-22.1

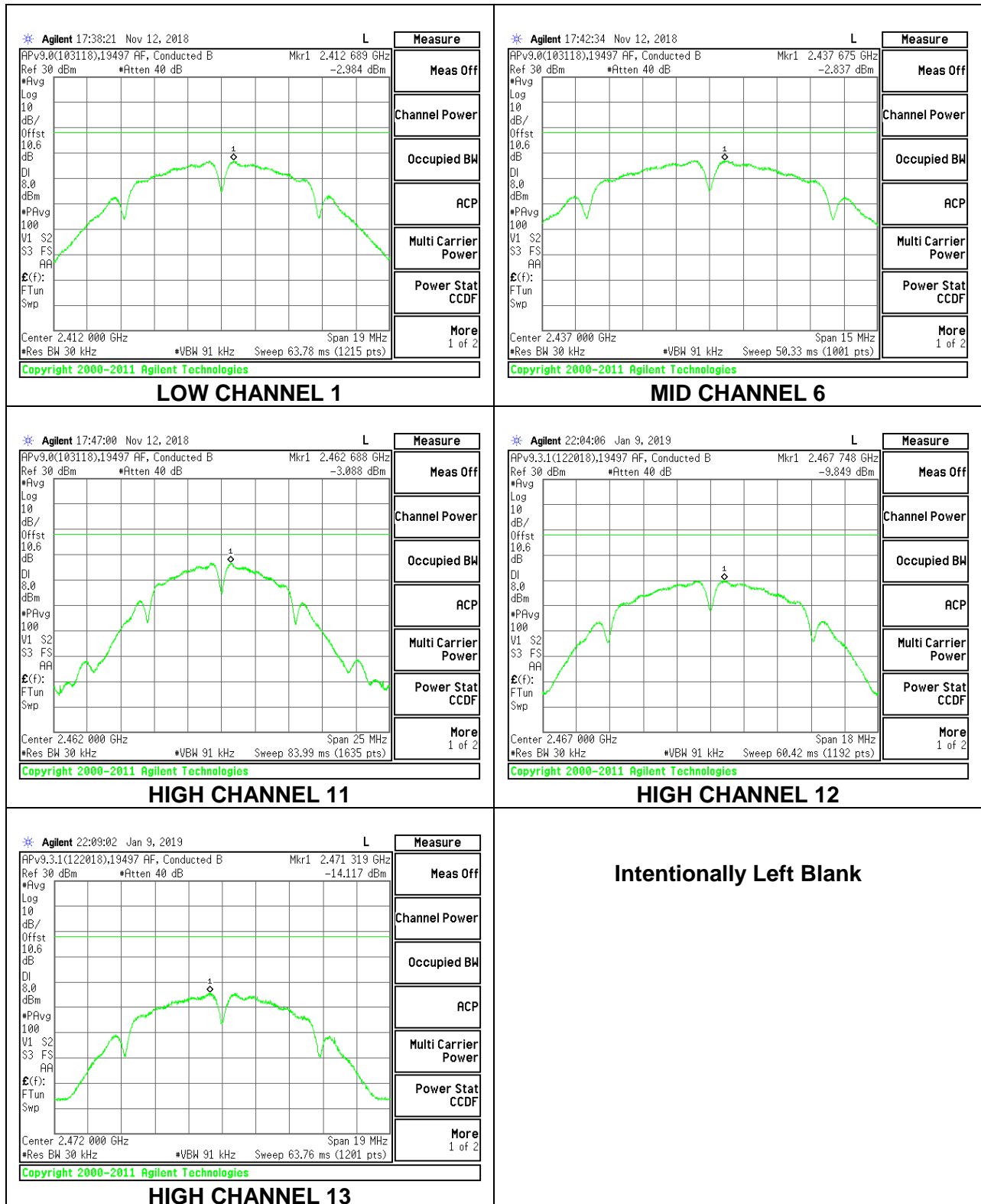

1TX Antenna 2 MODE

Duty Cycle CF (dB)	0.00	Included in Calculations of Corr'd PSD
---------------------------	------	-----------------------------------------------

PSD Results

Channel	Frequency (MHz)	Chain 0 Meas (dBm)	Total Corr'd PSD (dBm)	Limit (dBm)	Margin (dB)
Low 1	2412	-1.972	-1.97	8.0	-10.0
Mid 6	2437	-3.010	-3.01	8.0	-11.0
High 11	2462	-2.895	-2.90	8.0	-10.9
High 12	2467	-9.982	-9.98	8.0	-18.0
High 13	2472	-13.440	-13.44	8.0	-21.4

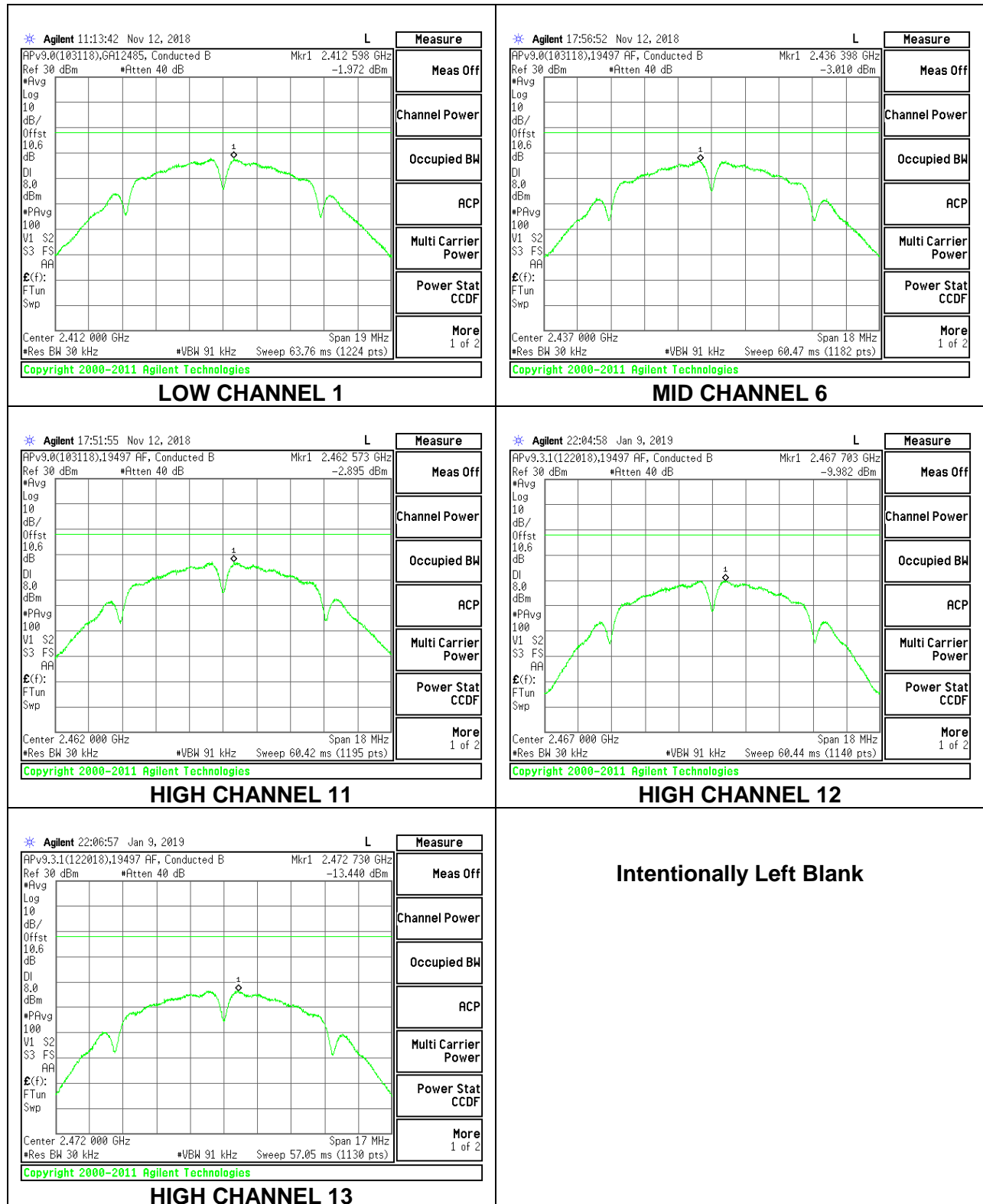

9.5.2. 802.11g MODE

2TX Antenna 1 + Antenna 2 CDD MODE

Duty Cycle CF (dB)	1.21	Included in Calculations of Corr'd PSD
---------------------------	------	-----------------------------------------------

PSD Results

Channel	Frequency (MHz)	Chain 0 Meas (dBm)	Chain 1 Meas (dBm)	Total Corr'd PSD (dBm)	Limit (dBm)	Margin (dB)
Low 1	2412	-8.603	-7.762	-3.94	8.0	-11.9
Mid 6	2437	-8.032	-6.939	-3.23	8.0	-11.2
High 11	2462	-8.108	-8.290	-3.98	8.0	-12.0
High 12	2467	-11.788	-11.744	-7.55	8.0	-15.5
High 13	2472	-15.758	-15.769	-11.54	8.0	-19.5

LOW CHANNEL 1

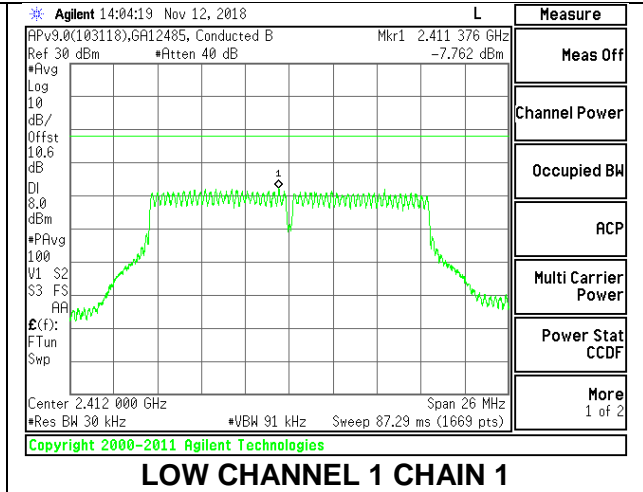
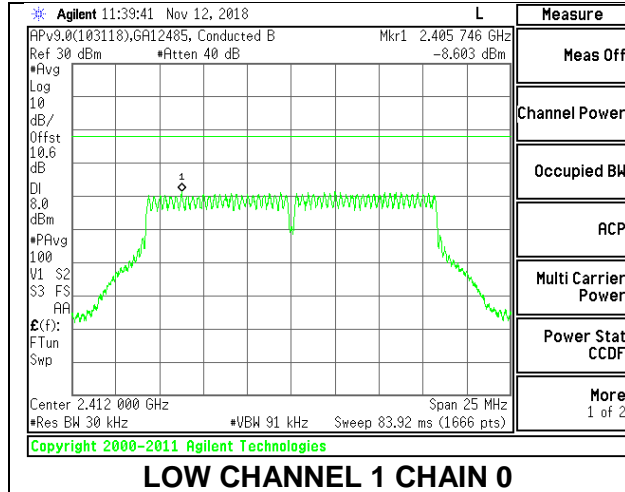

MID CHANNEL 6

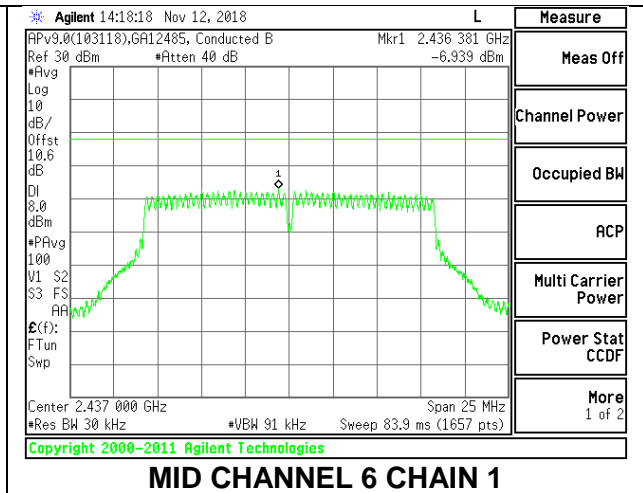
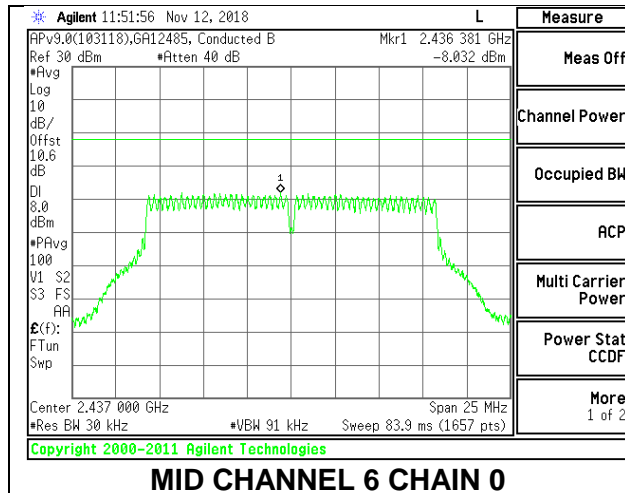

HIGH CHANNEL 11

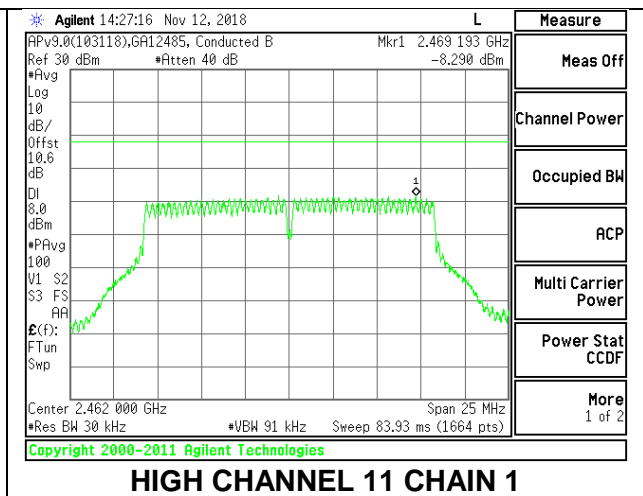
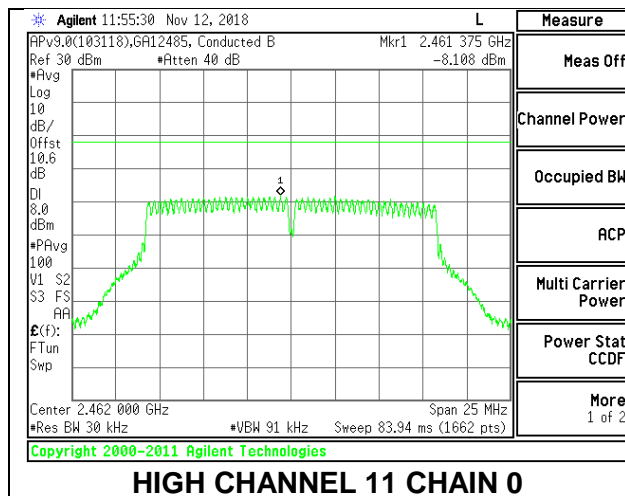

HIGH CHANNEL 12

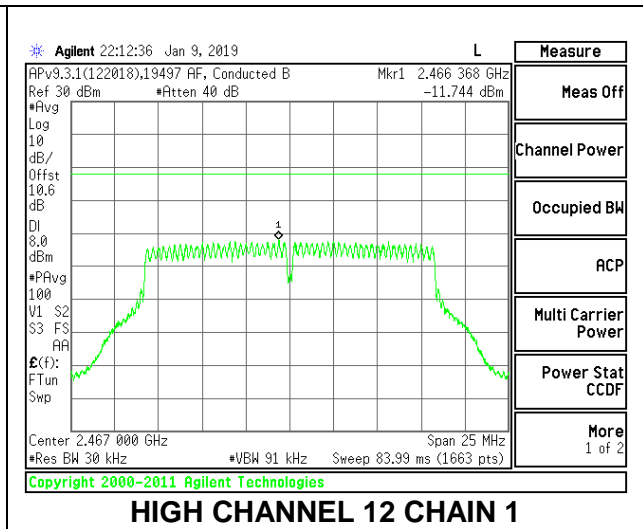
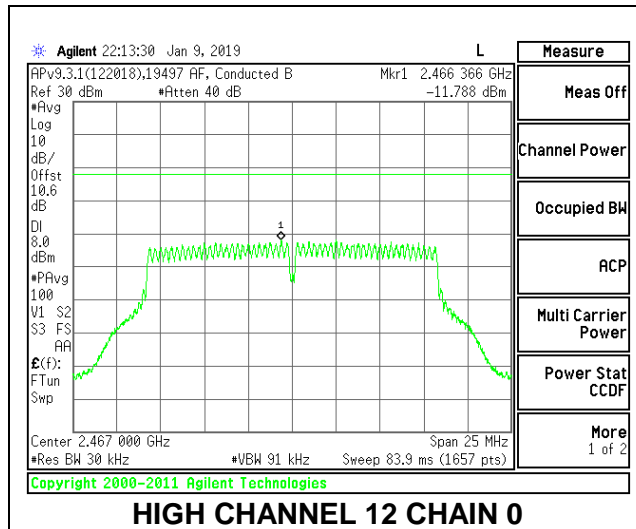

HIGH CHANNEL 13

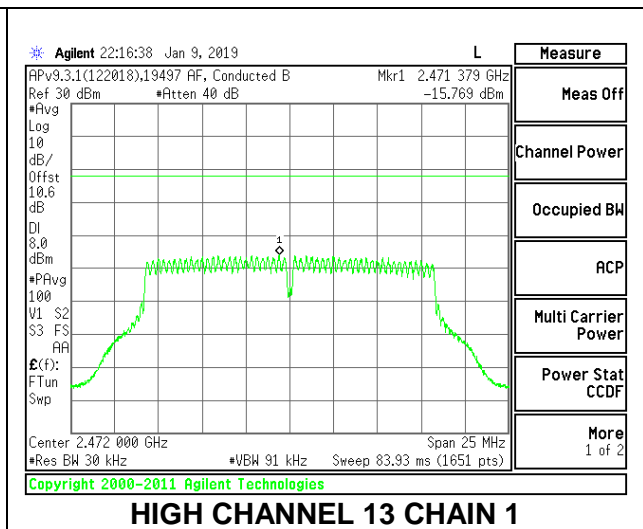
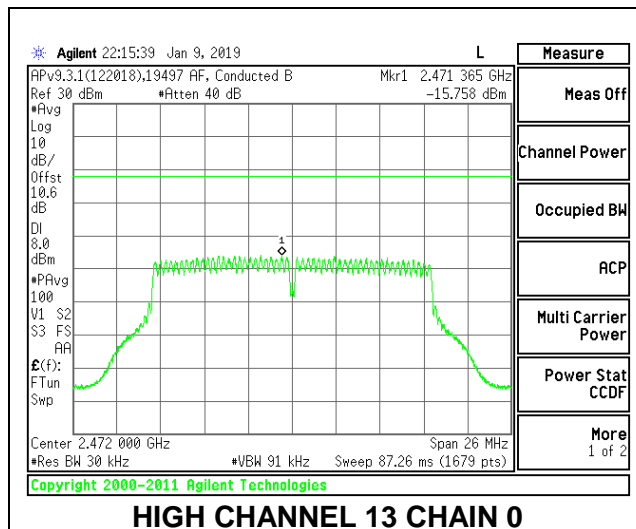

9.5.3. 802.11n HT20 MODE

2TX Antenna 1 + Antenna 2 CDD MODE

Duty Cycle CF (dB)	0.31	Included in Calculations of Corr'd PSD
---------------------------	------	-----------------------------------------------

PSD Results

Channel	Frequency (MHz)	Chain 0 Meas (dBm)	Chain 1 Meas (dBm)	Total Corr'd PSD (dBm)	Limit (dBm)	Margin (dB)
Low 1	2412	-9.099	-8.873	-5.66	8.0	-13.7
Mid 6	2437	-8.389	-7.993	-4.87	8.0	-12.9
High 11	2462	-8.349	-8.526	-5.12	8.0	-13.1
High 12	2467	-12.231	-12.309	-8.95	8.0	-16.9
High 13	2472	-15.814	-16.547	-12.84	8.0	-20.8

LOW CHANNEL 1

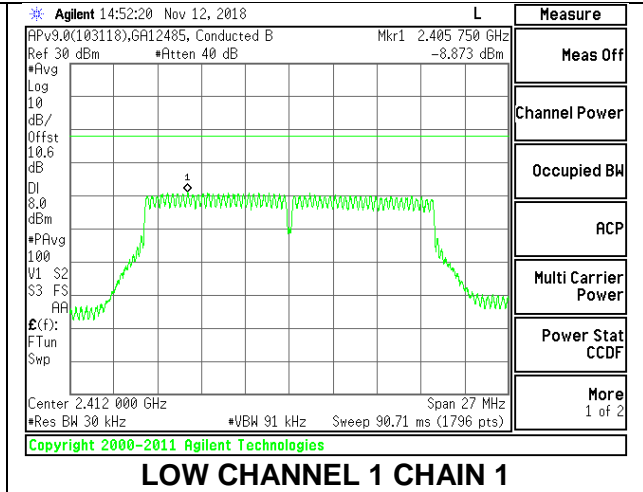
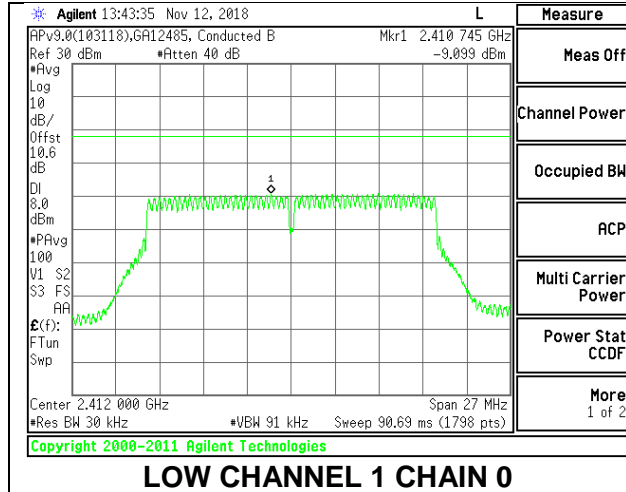

MID CHANNEL 6

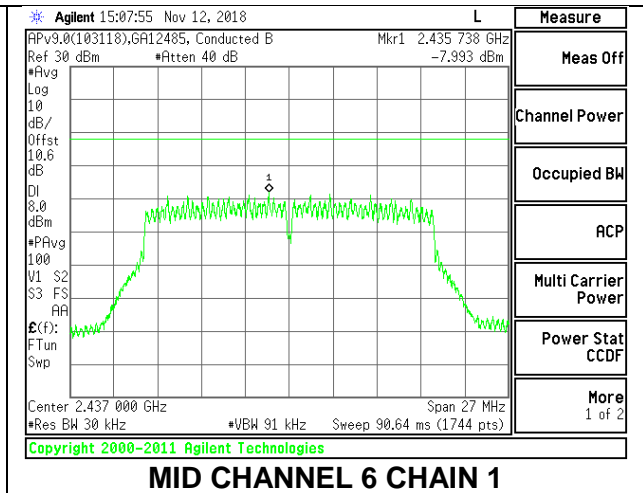
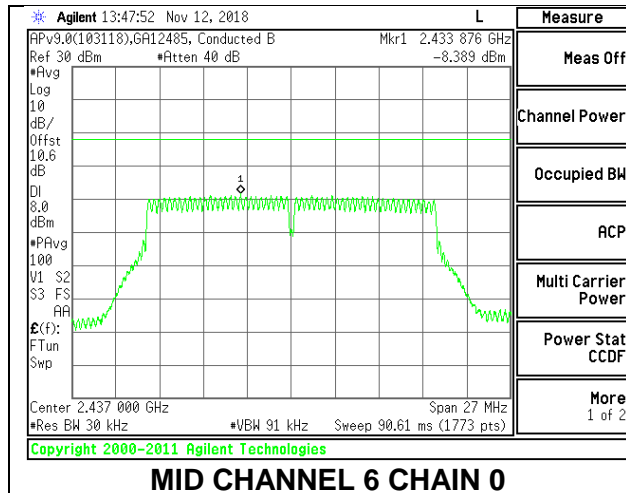

HIGH CHANNEL 11

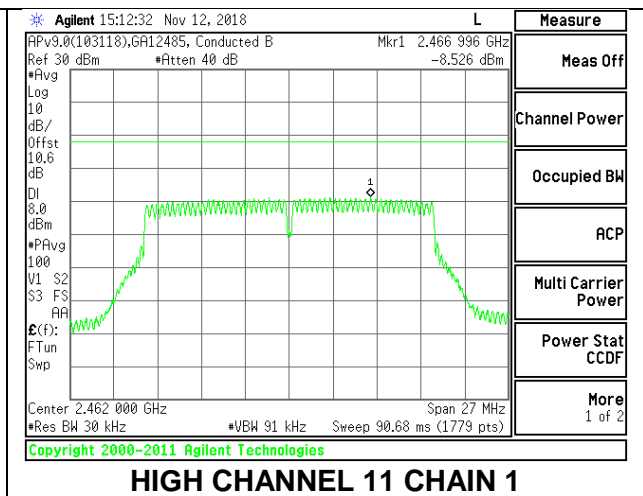
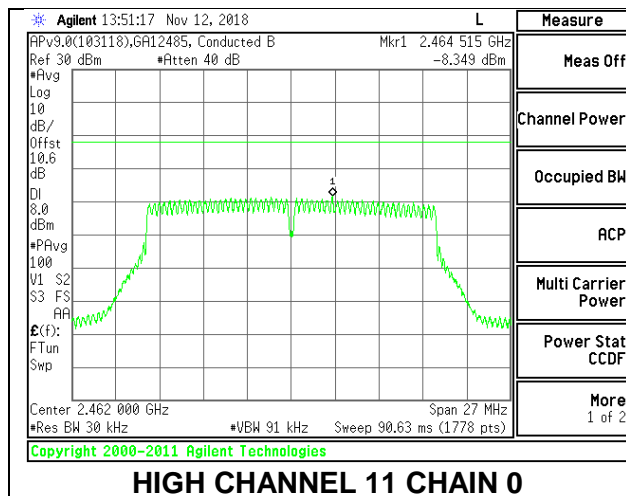

HIGH CHANNEL 12

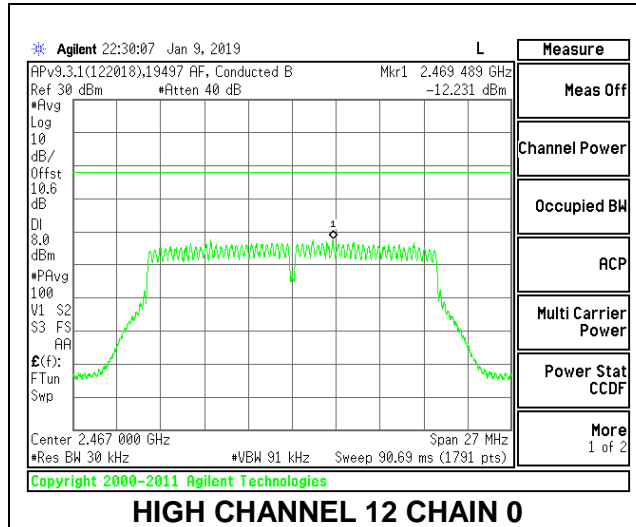

HIGH CHANNEL 12 CHAIN 0

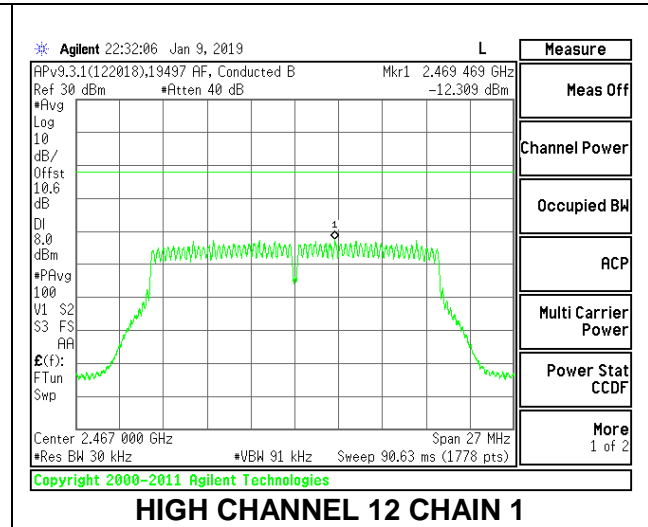

HIGH CHANNEL 12 CHAIN 1

HIGH CHANNEL 13

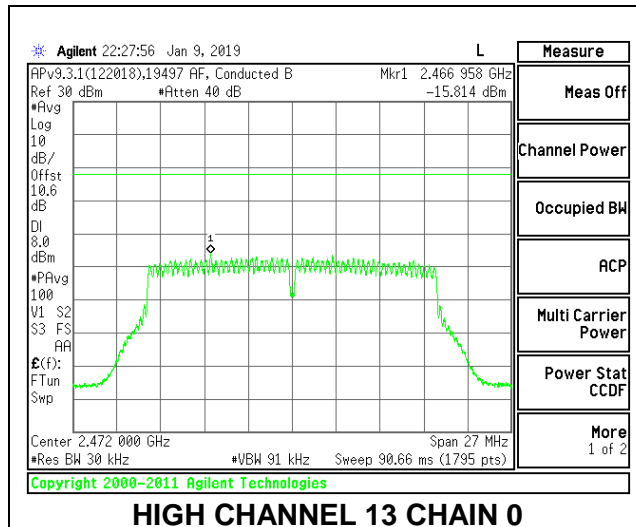

HIGH CHANNEL 13 CHAIN 0

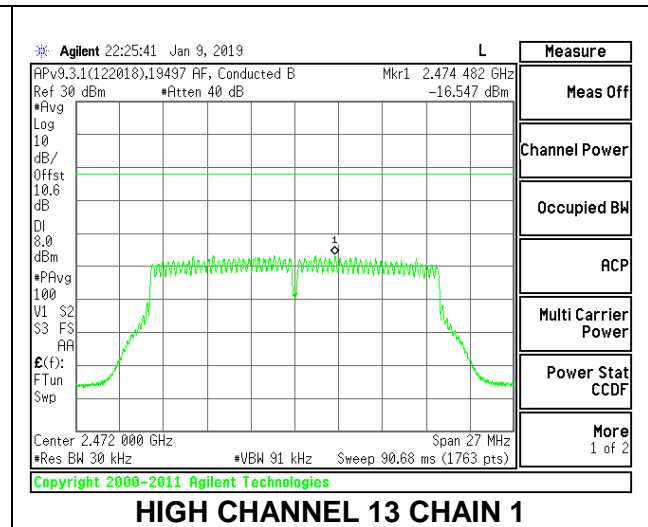

HIGH CHANNEL 13 CHAIN 1

9.5.4. 802.11ax HE20 MODE

2TX Antenna 1 + Antenna 2 OFDMA MODE: 242-Tones, RU Index 61

Duty Cycle CF (dB)	0.68	Included in Calculations of Corr'd PSD
---------------------------	------	-----------------------------------------------

PSD Results

Channel	Frequency (MHz)	Chain 0 Meas (dBm)	Chain 1 Meas (dBm)	Total Corr'd PSD (dBm)	Limit (dBm)	Margin (dB)
Low 1	2412	-12.819	-12.496	-8.96	8.0	-17.0
Mid 6	2437	-12.561	-12.075	-8.62	8.0	-16.6
High 11	2462	-12.619	-12.907	-9.07	8.0	-17.1
High 12	2467	-14.809	-14.459	-10.94	8.0	-18.9
High 13	2472	-17.960	-17.940	-14.26	8.0	-22.3

LOW CHANNEL 1

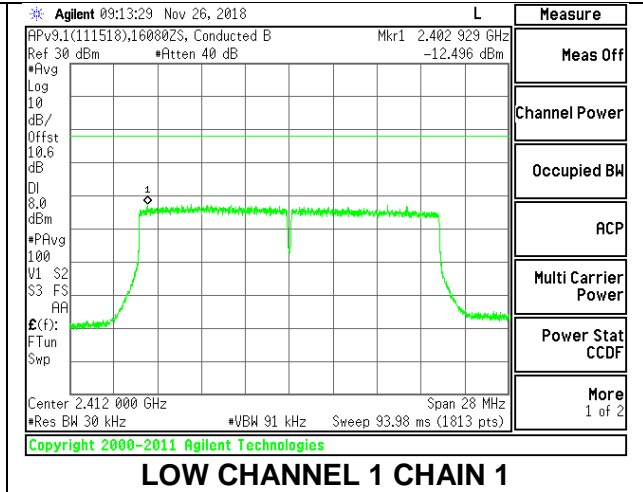
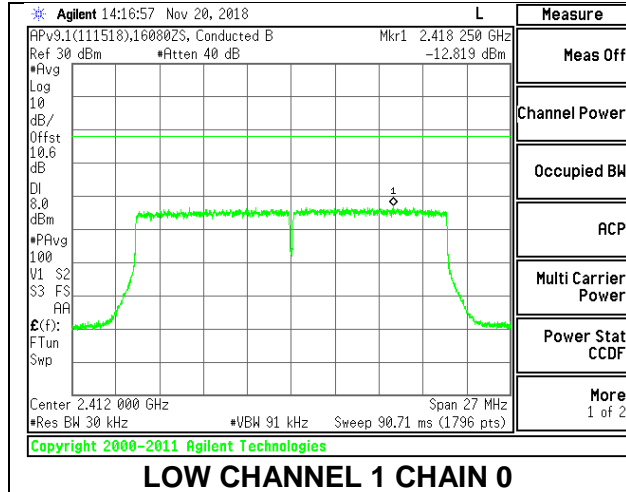

MID CHANNEL 6

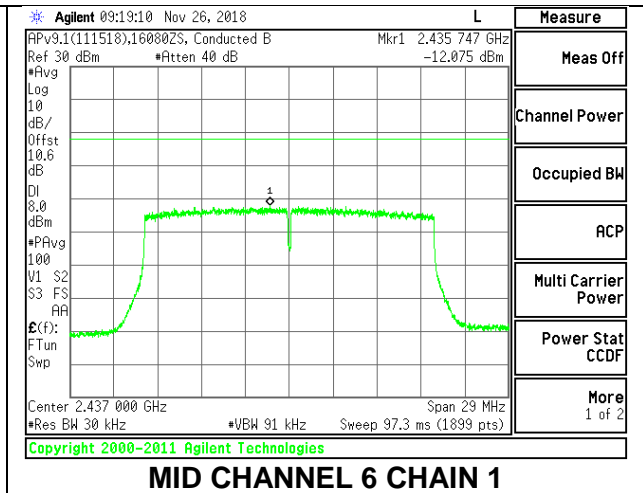
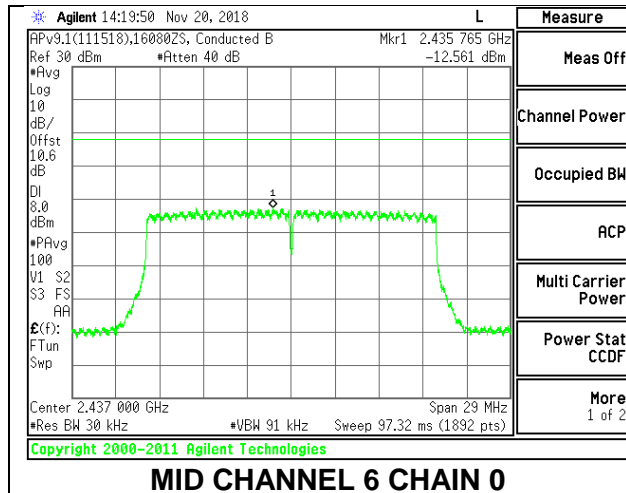

HIGH CHANNEL 11

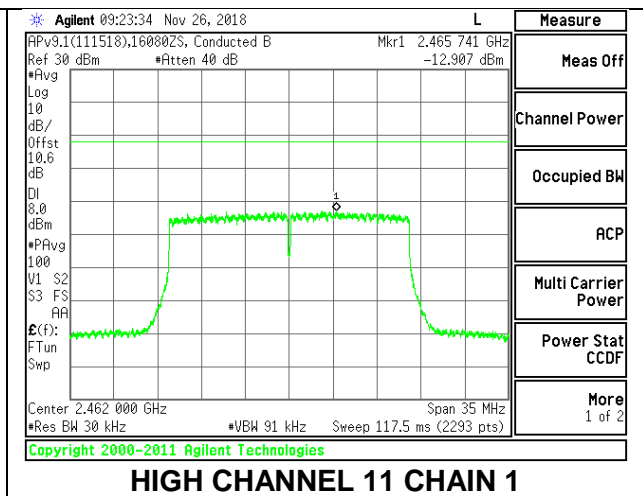
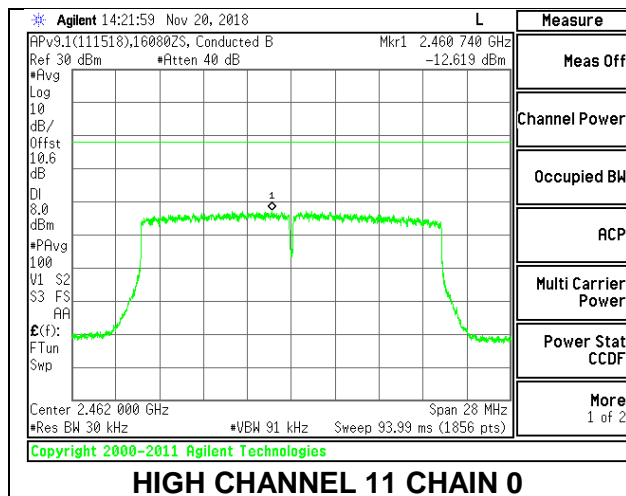

HIGH CHANNEL 12

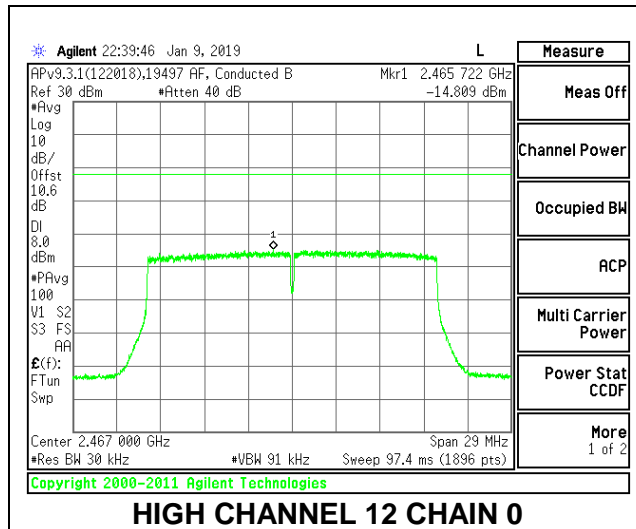

HIGH CHANNEL 12 CHAIN 0

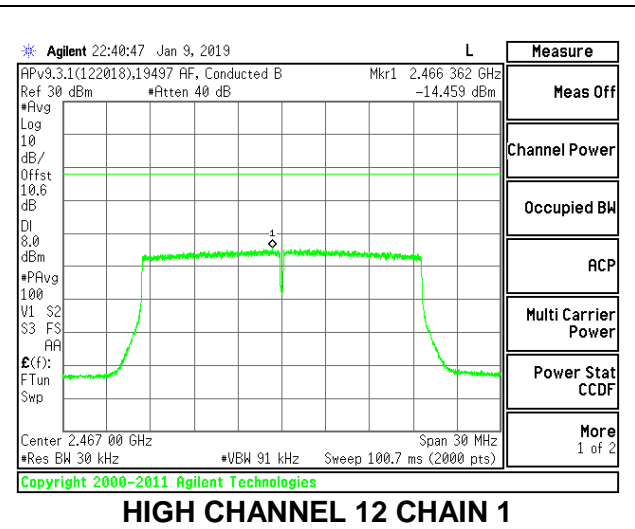

HIGH CHANNEL 12 CHAIN 1

HIGH CHANNEL 13

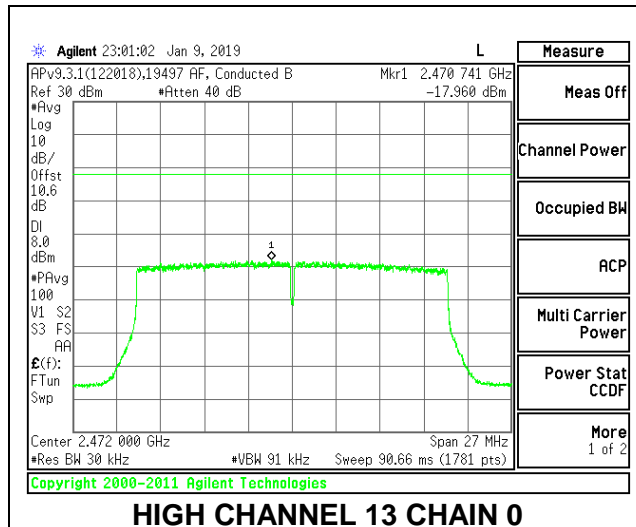

HIGH CHANNEL 13 CHAIN 0

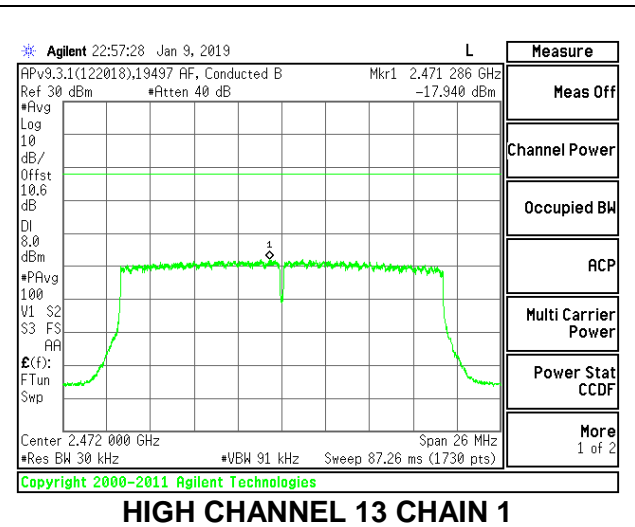

HIGH CHANNEL 13 CHAIN 1

2TX Antenna 1 + Antenna 2 OFDMA MODE: 106-Tones, RU Index 53

Duty Cycle CF (dB)	0.34	Included in Calculations of Corr'd PSD
---------------------------	------	-----------------------------------------------

PSD Results

Channel	Frequency (MHz)	Chain 0 Meas (dBm)	Chain 1 Meas (dBm)	Total Corr'd PSD (dBm)	Limit (dBm)	Margin (dB)
Low 1	2412	-8.921	-6.684	-4.31	8.0	-12.3
Mid 6	2437	-8.799	-7.252	-4.61	8.0	-12.6
High 11	2462	-8.666	-8.026	-4.98	8.0	-13.0
High 12	2467	-13.138	-13.370	-9.90	8.0	-17.9
High 13	2472	-16.376	-16.127	-12.90	8.0	-20.9

LOW CHANNEL 1

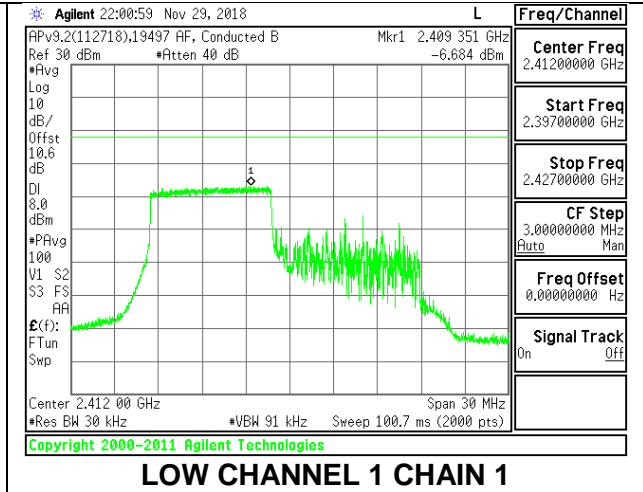
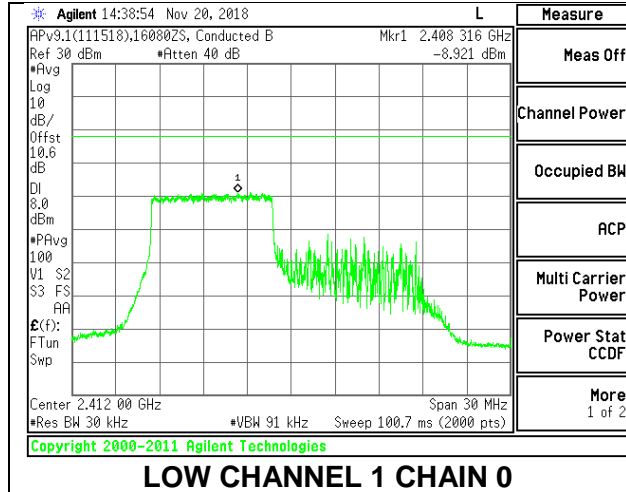

MID CHANNEL 6

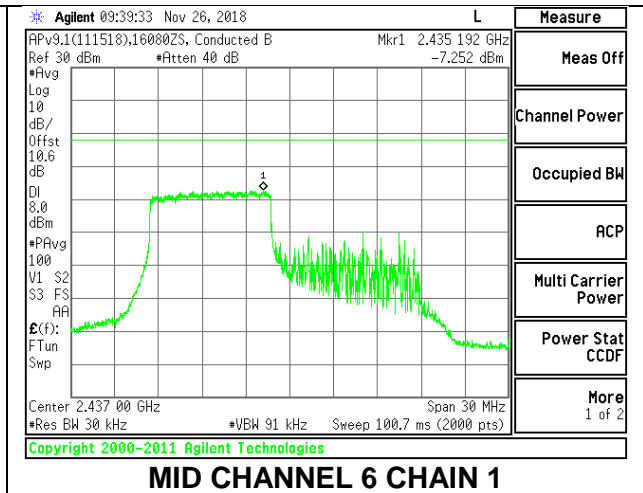
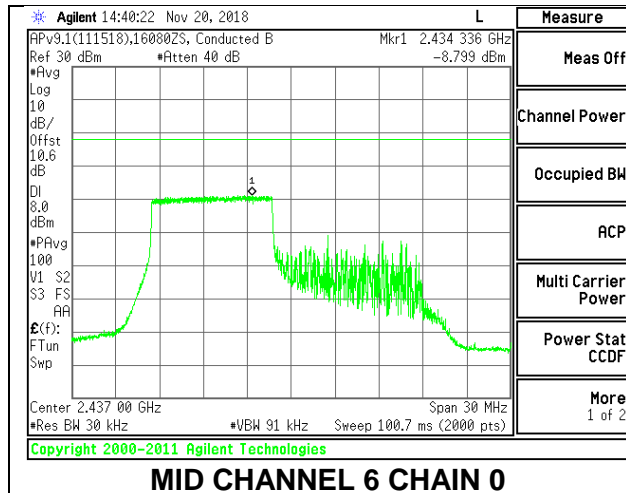

HIGH CHANNEL 11

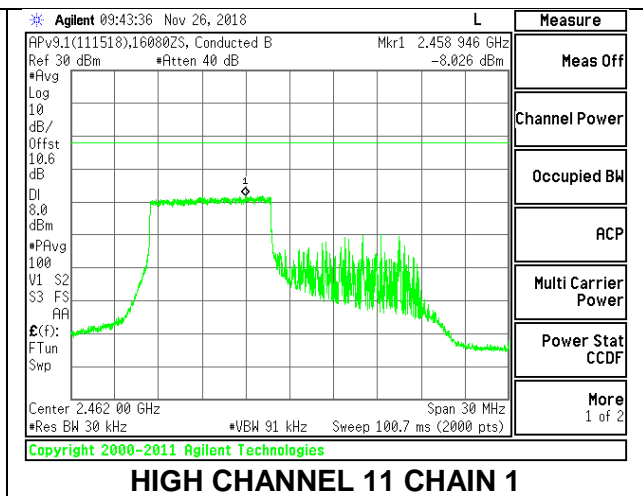
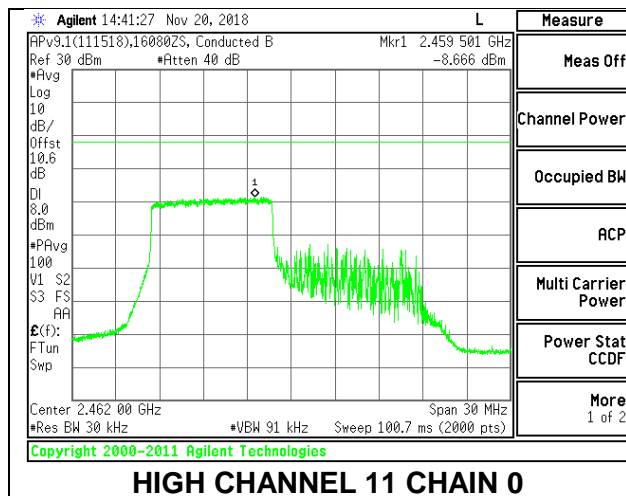

HIGH CHANNEL 12

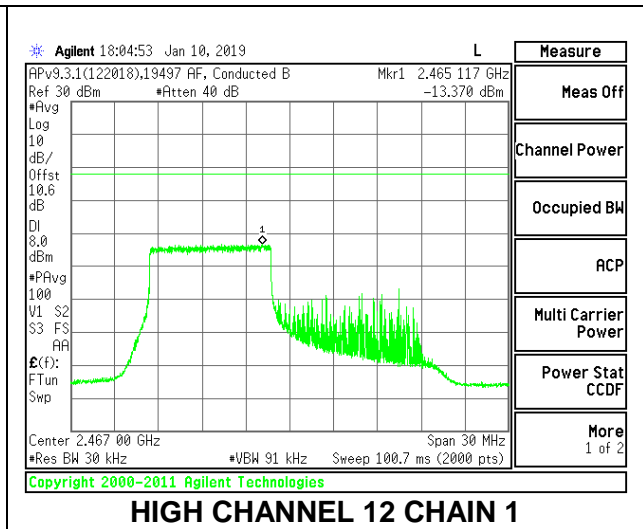
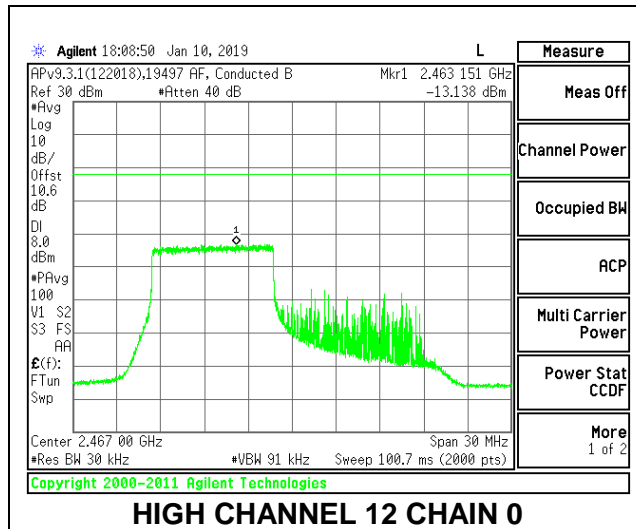

HIGH CHANNEL 13

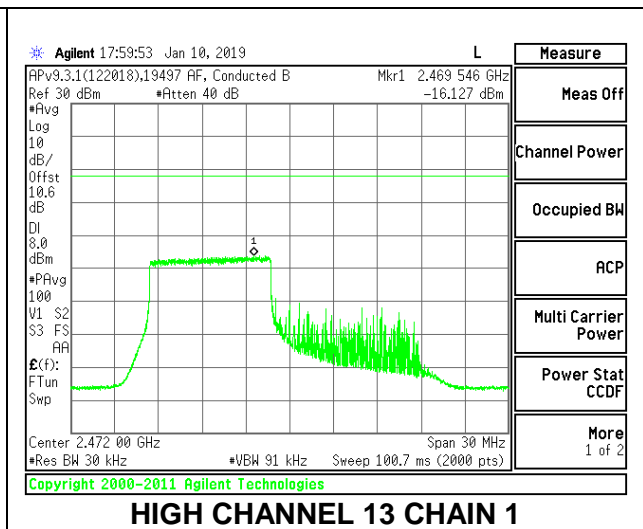
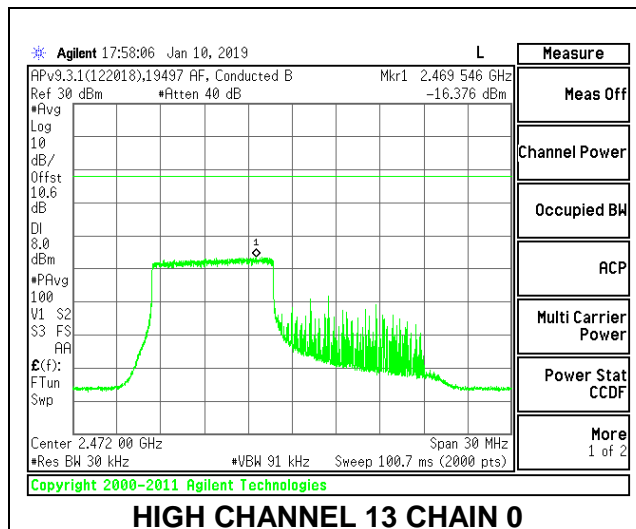

2TX Antenna 1 + Antenna 2 OFDMA MODE: 106-Tones, RU Index 54

Duty Cycle CF (dB)	0.34	Included in Calculations of Corr'd PSD
---------------------------	------	-----------------------------------------------

PSD Results

Channel	Frequency (MHz)	Chain 0 Meas (dBm)	Chain 1 Meas (dBm)	Total Corr'd PSD (dBm)	Limit (dBm)	Margin (dB)
Low 1	2412	-8.939	-7.887	-5.03	8.0	-13.0
Mid 6	2437	-8.572	-6.714	-4.19	8.0	-12.2
High 11	2462	-8.683	-7.719	-4.82	8.0	-12.8
High 12	2467	-11.714	-11.318	-8.16	8.0	-16.2
High 13	2472	-15.993	-16.142	-12.72	8.0	-20.7

LOW CHANNEL 1

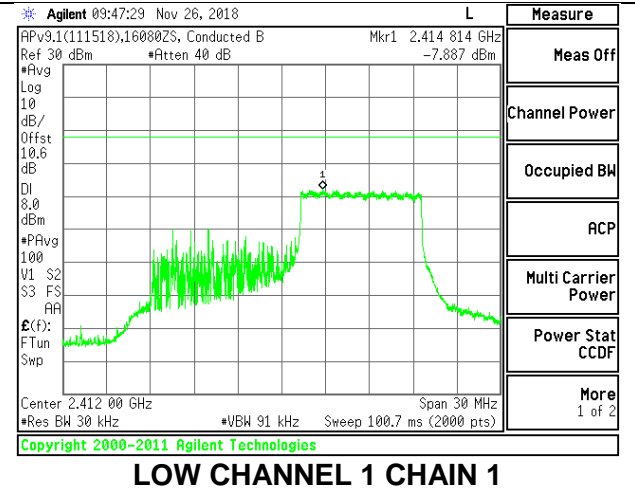
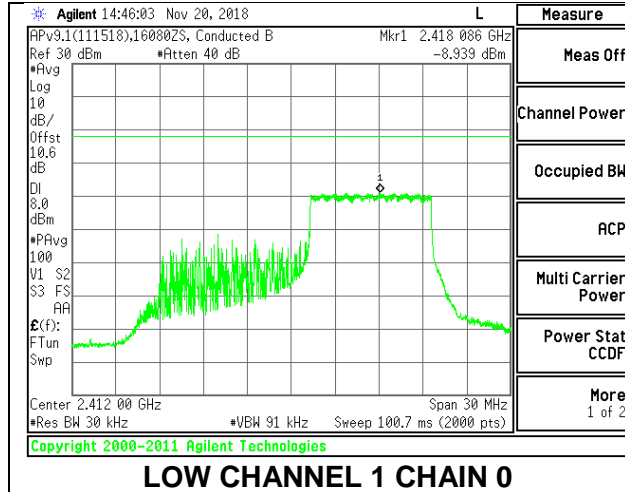

MID CHANNEL 6

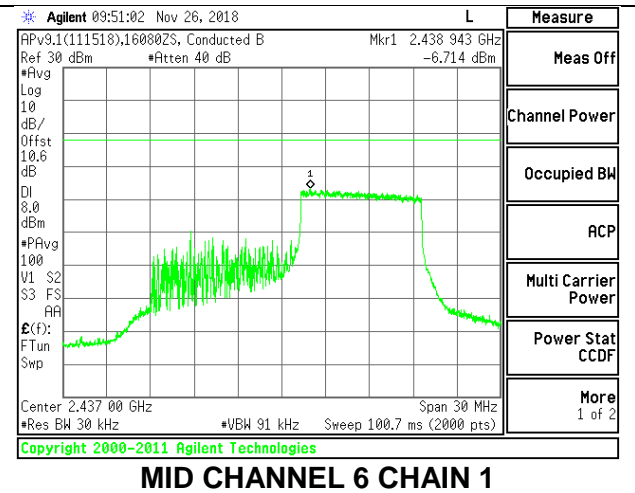
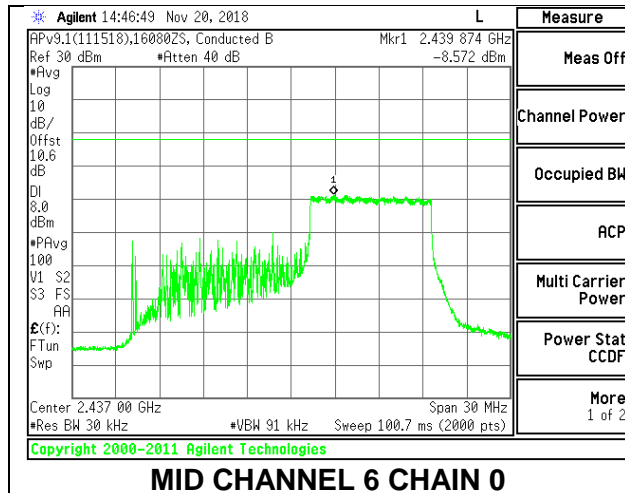

HIGH CHANNEL 11

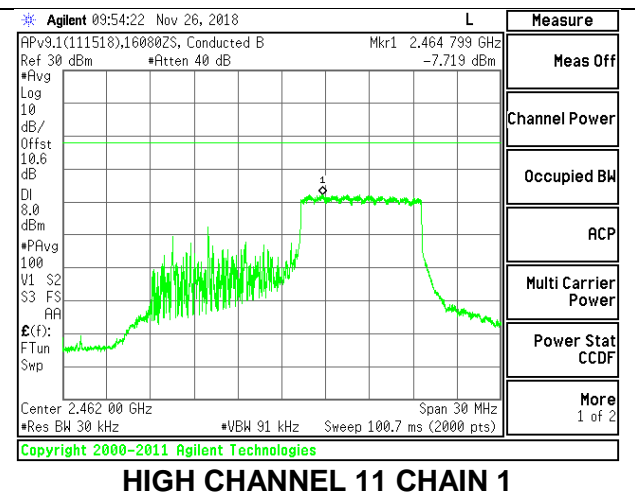
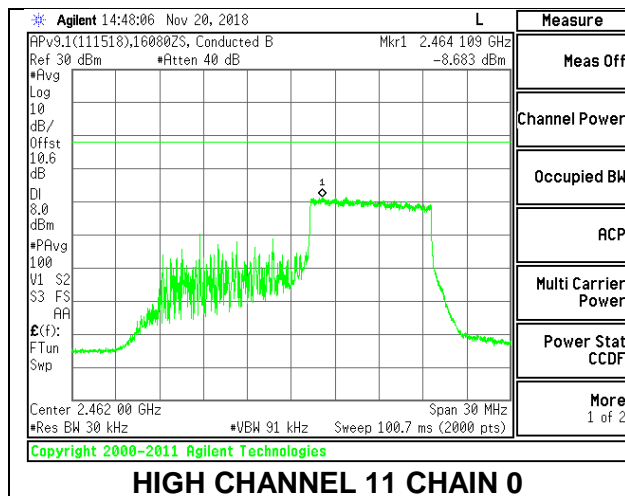

HIGH CHANNEL 12

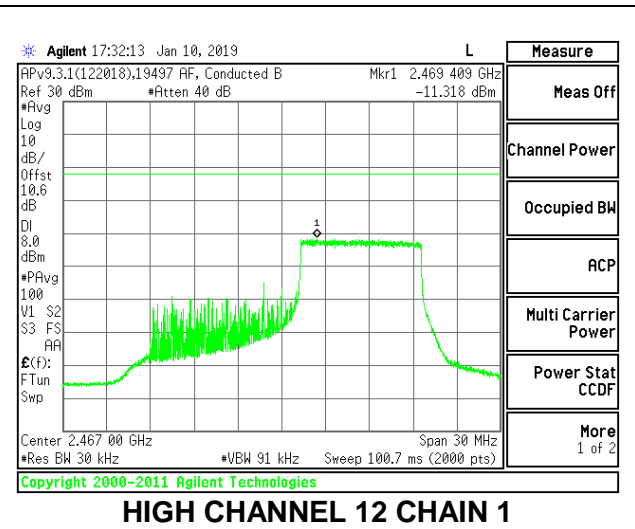
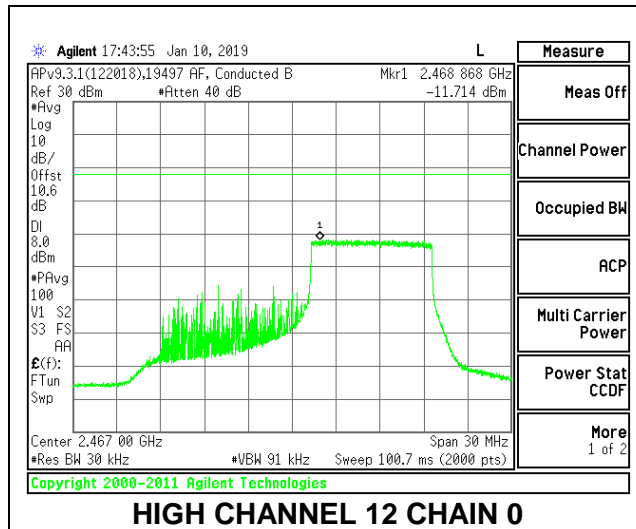

HIGH CHANNEL 13

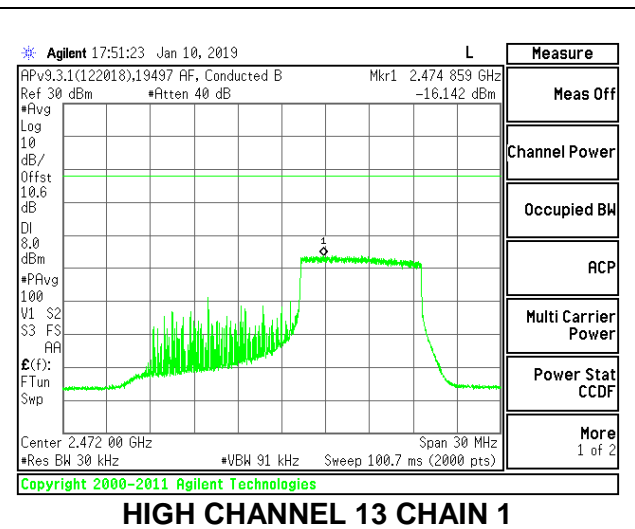
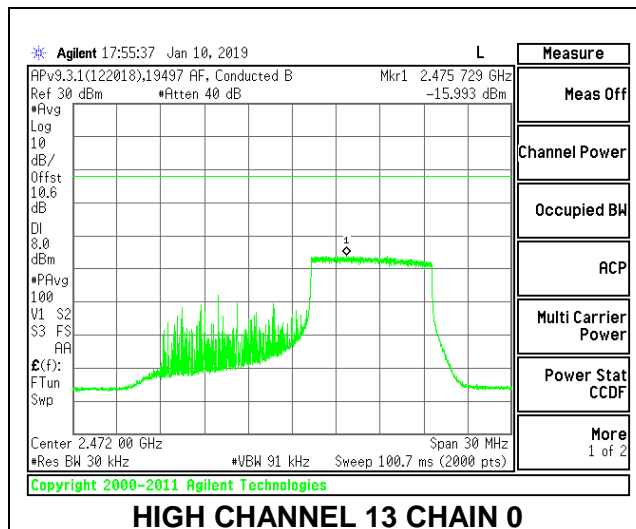

2TX Antenna 1 + Antenna 2 OFDMA MODE: 52-Tones, RU Index 37

Duty Cycle CF (dB)	0.16	Included in Calculations of Corr'd PSD
---------------------------	------	-----------------------------------------------

PSD Results

Channel	Frequency (MHz)	Chain 0 Meas (dBm)	Chain 1 Meas (dBm)	Total Corr'd PSD (dBm)	Limit (dBm)	Margin (dB)
Low 1	2412	-6.060	-5.183	-2.43	8.0	-10.4
Mid 6	2437	-5.337	-5.199	-2.10	8.0	-10.1
High 11	2462	-5.422	-5.674	-2.38	8.0	-10.4
High 12	2467	-8.692	-8.743	-5.55	8.0	-13.5
High 13	2472	-11.510	-11.894	-8.53	8.0	-16.5

LOW CHANNEL 1

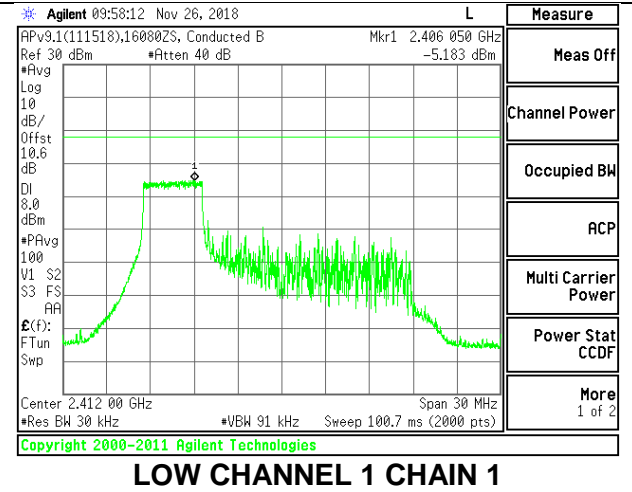
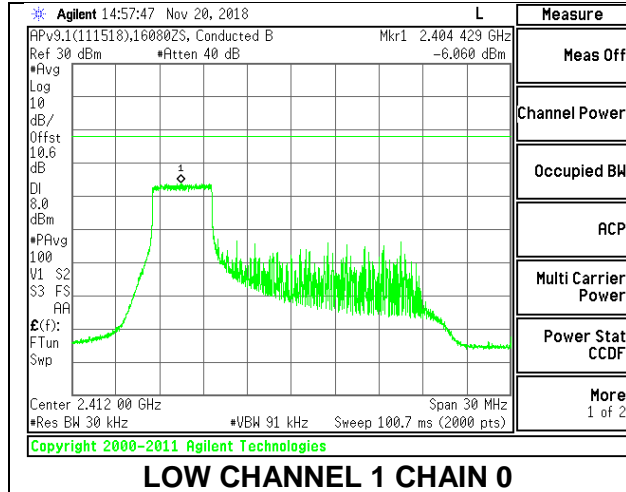

MID CHANNEL 6

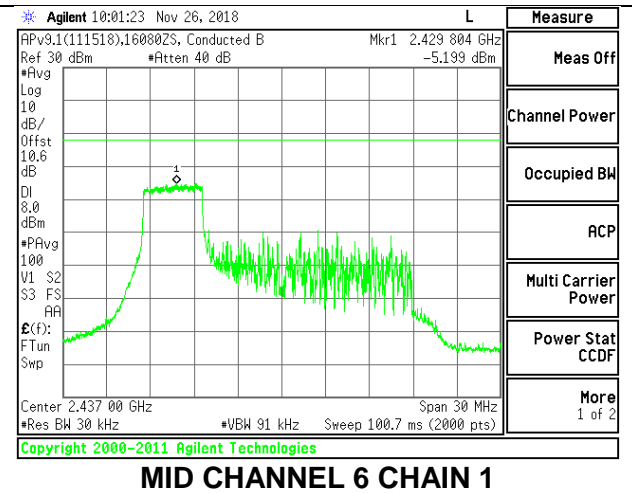
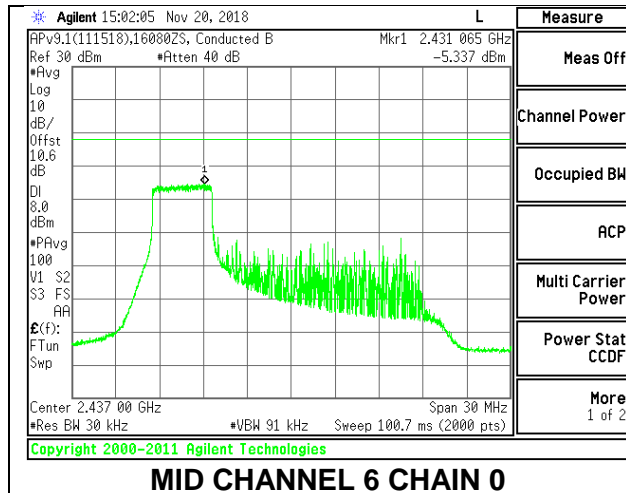

HIGH CHANNEL 11

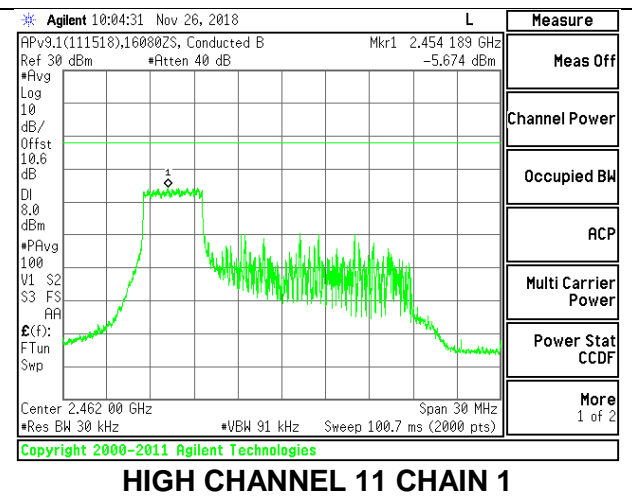
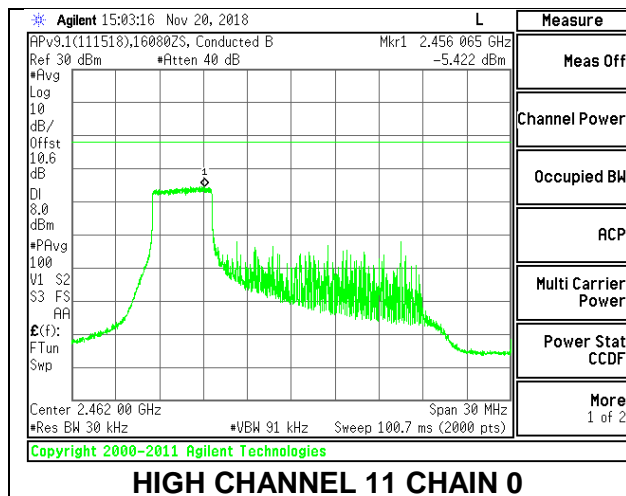

HIGH CHANNEL 12

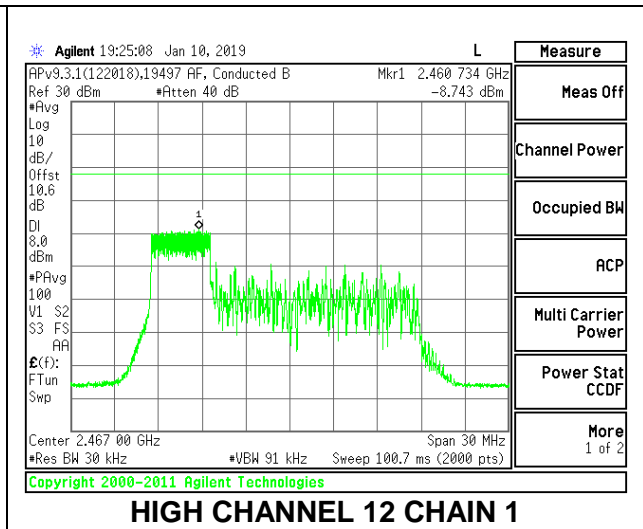
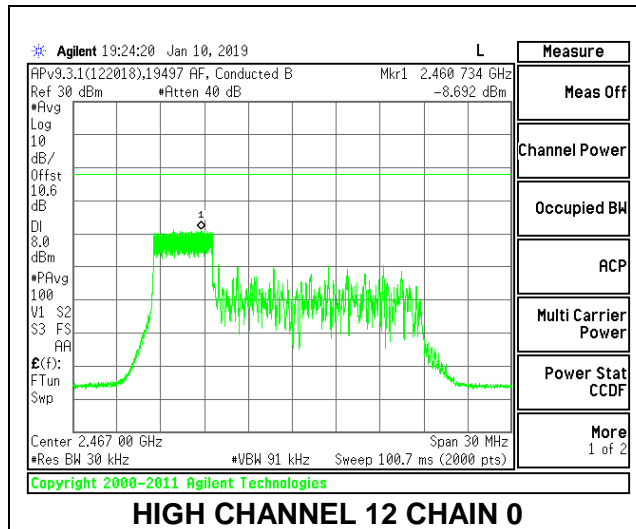

HIGH CHANNEL 13

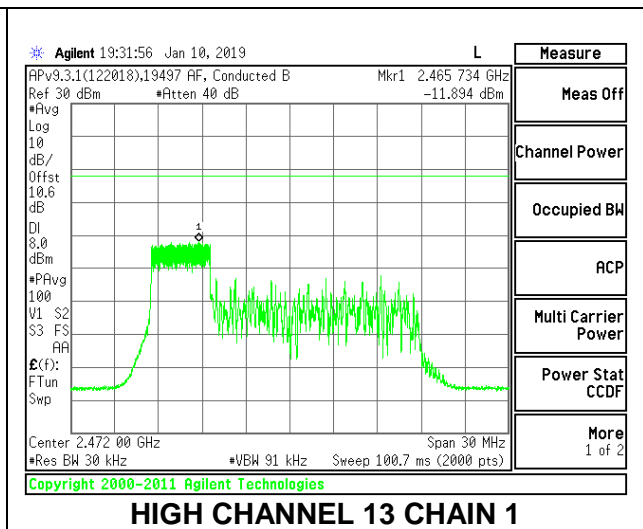
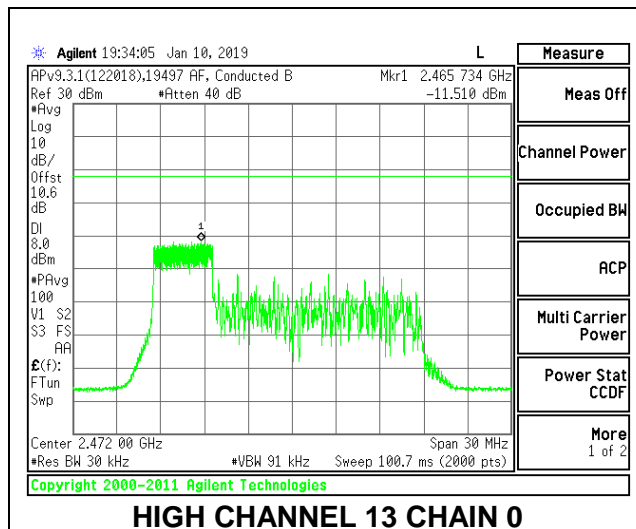

2TX Antenna 1 + Antenna 2 OFDMA MODE : 52-Tones, RU Index 38

Duty Cycle CF (dB)	0.16	Included in Calculations of Corr'd PSD
---------------------------	------	-----------------------------------------------

PSD Results

Channel	Frequency (MHz)	Chain 0 Meas (dBm)	Chain 1 Meas (dBm)	Total Corr'd PSD (dBm)	Limit (dBm)	Margin (dB)
Low 1	2412	-5.479	-5.821	-2.48	8.0	-10.5
Mid 6	2437	-4.936	-4.811	-1.70	8.0	-9.7
High 11	2462	-4.523	-6.297	-2.15	8.0	-10.1
High 12	2467	-8.386	-8.539	-5.29	8.0	-13.3
High 13	2472	-12.393	-12.309	-9.18	8.0	-17.2

LOW CHANNEL 1

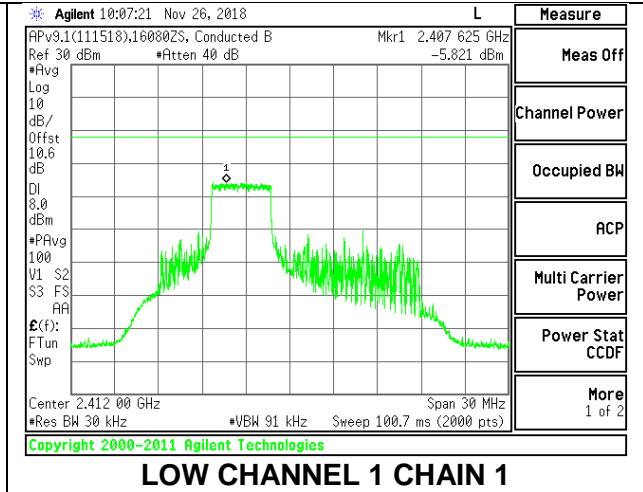
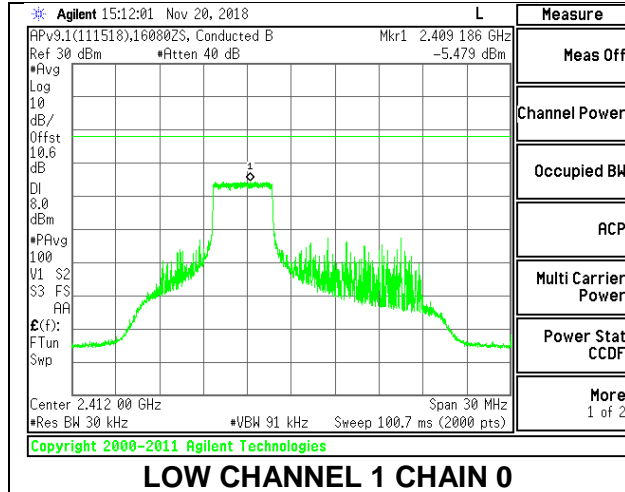

MID CHANNEL 6

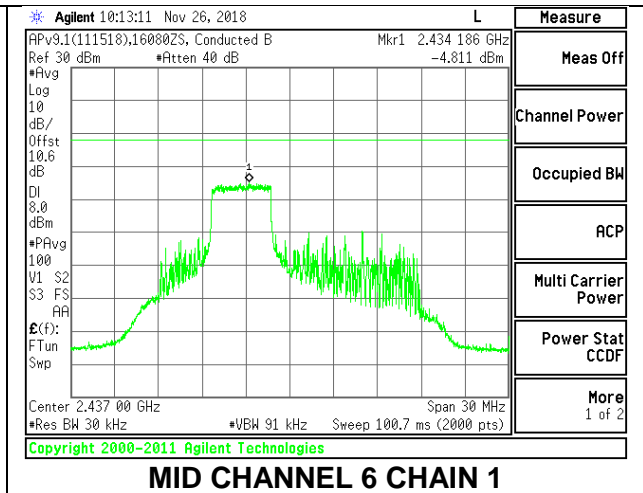
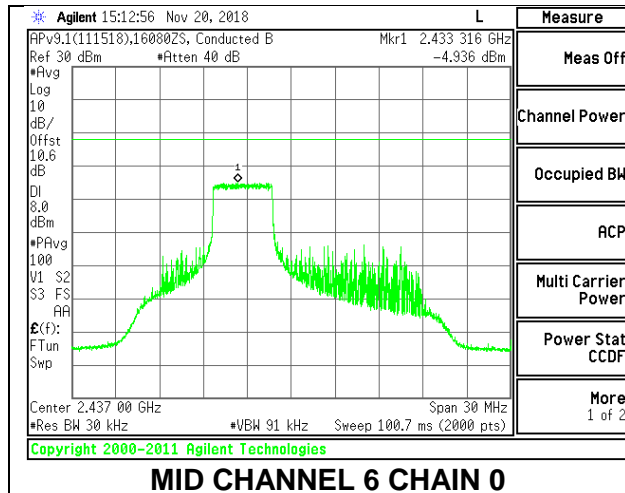

HIGH CHANNEL 11

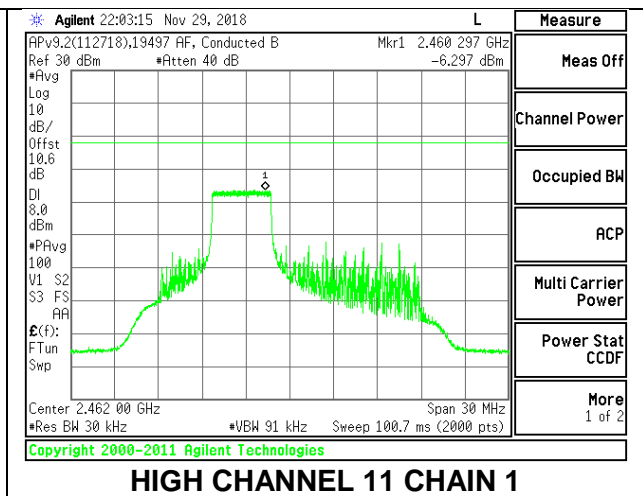
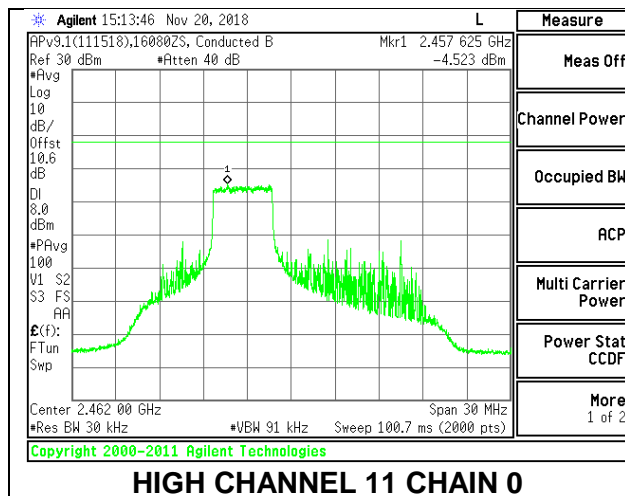

HIGH CHANNEL 12

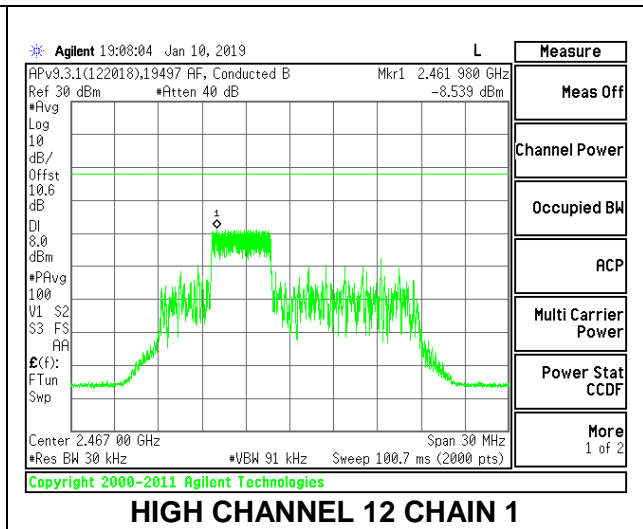
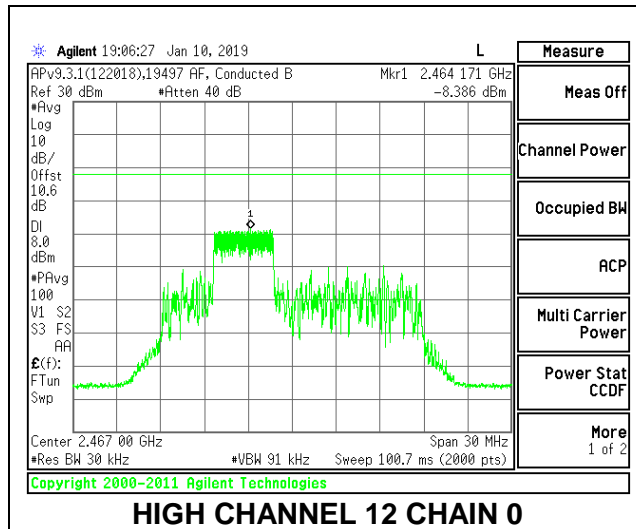

HIGH CHANNEL 13

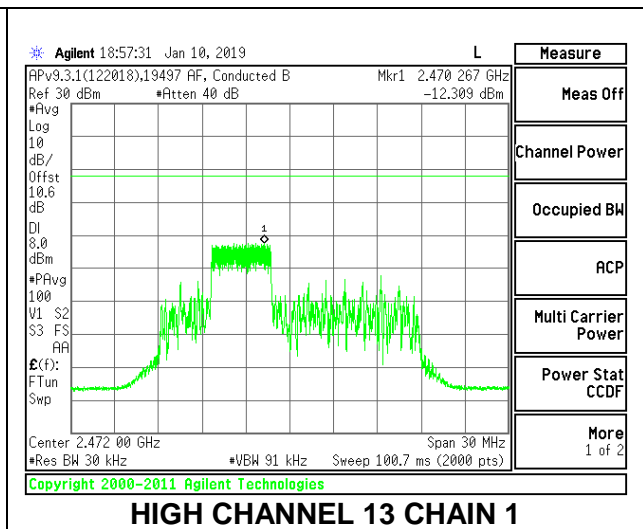
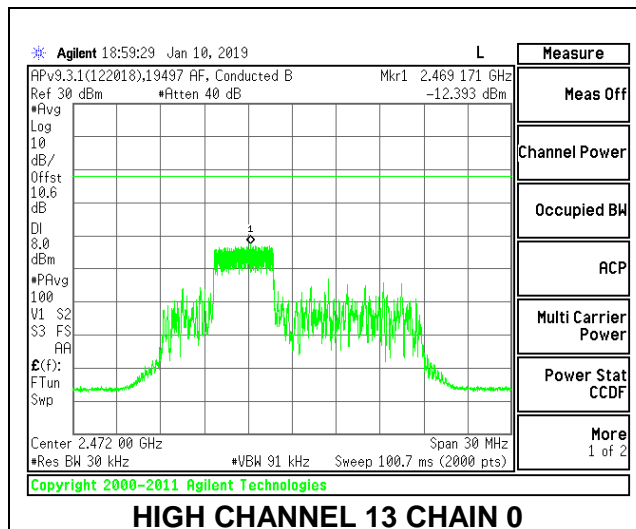

2TX Antenna 1 + Antenna 2 OFDMA MODE: 52-Tones, RU Index 40

Duty Cycle CF (dB)	0.16	Included in Calculations of Corr'd PSD
---------------------------	------	-----------------------------------------------

PSD Results

Channel	Frequency (MHz)	Chain 0 Meas (dBm)	Chain 1 Meas (dBm)	Total Corr'd PSD (dBm)	Limit (dBm)	Margin (dB)
Low 1	2412	-5.112	-5.954	-2.34	8.0	-10.3
Mid 6	2437	-5.913	-5.236	-2.39	8.0	-10.4
High 11	2462	-6.057	-5.334	-2.51	8.0	-10.5
High 12	2467	-9.057	-8.923	-5.82	8.0	-13.8
High 13	2472	-12.307	-11.642	-8.79	8.0	-16.8

LOW CHANNEL 1

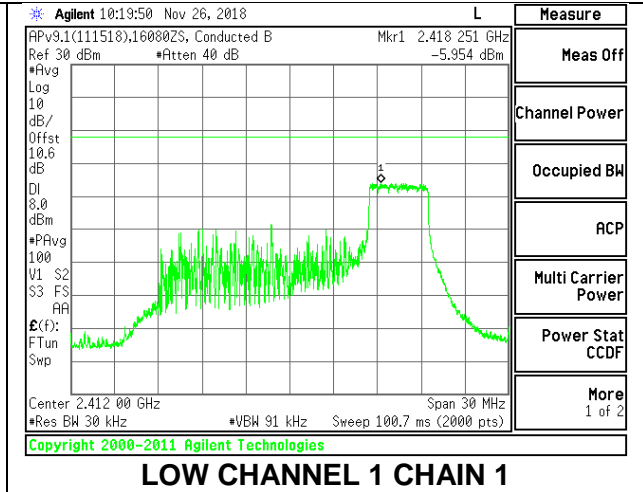
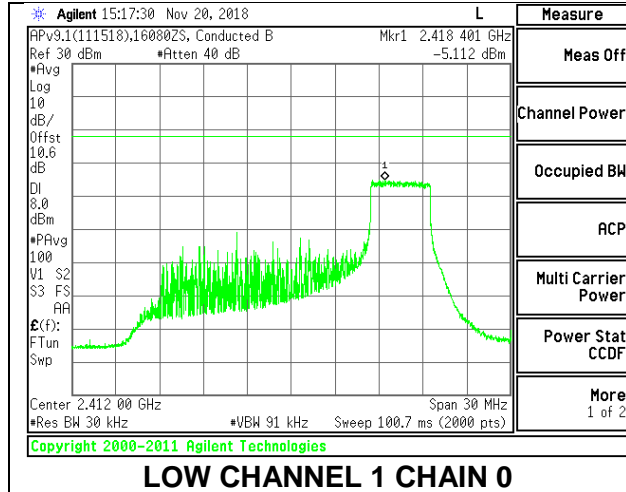

MID CHANNEL 6

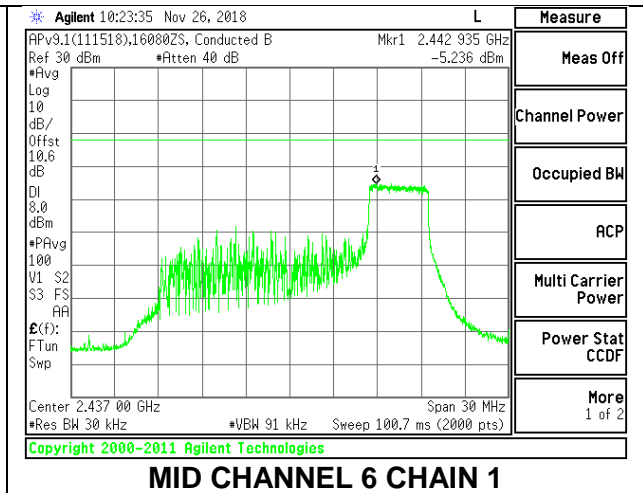
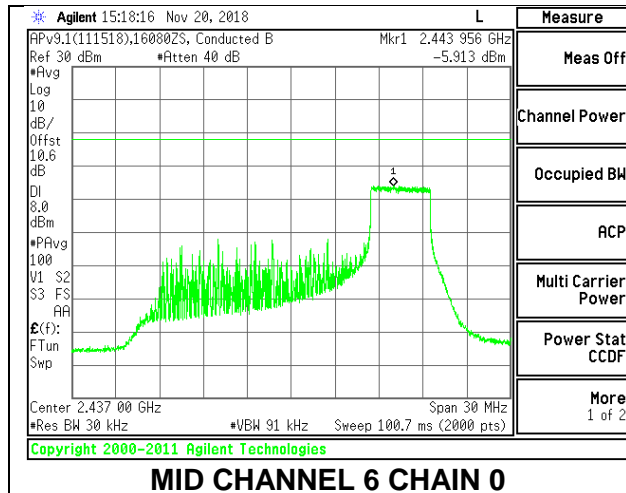

HIGH CHANNEL 11

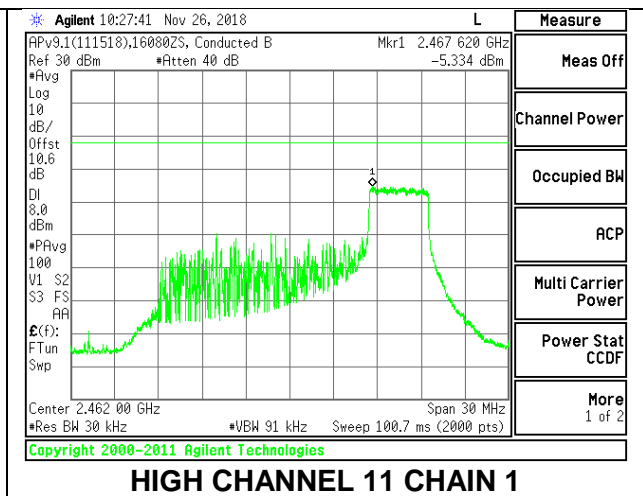
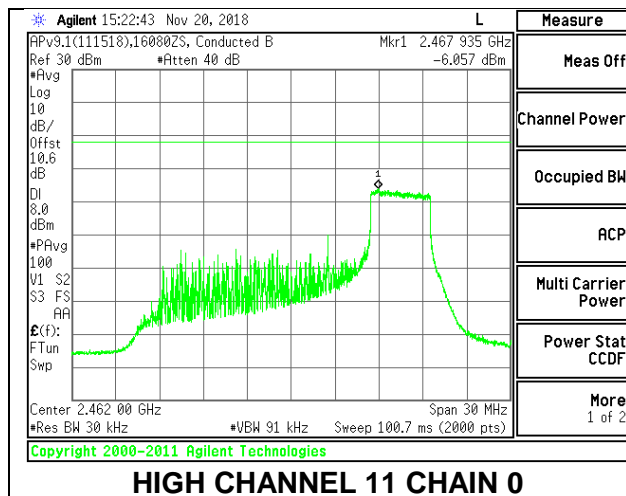

HIGH CHANNEL 12

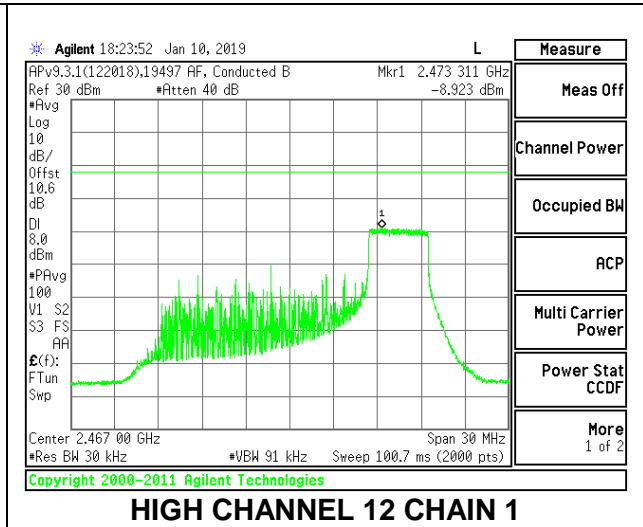
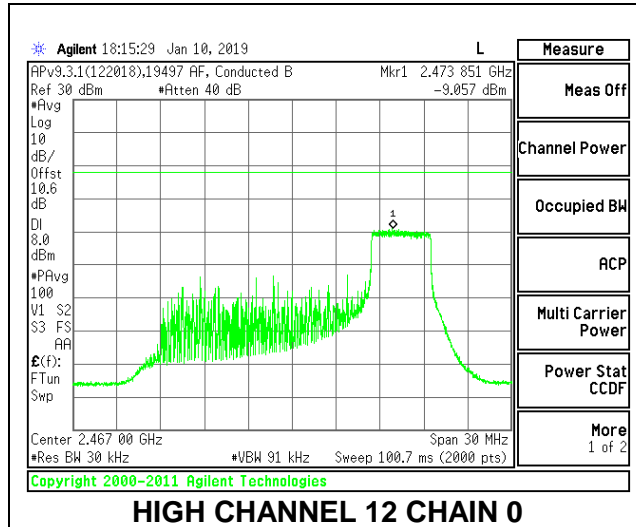

HIGH CHANNEL 13

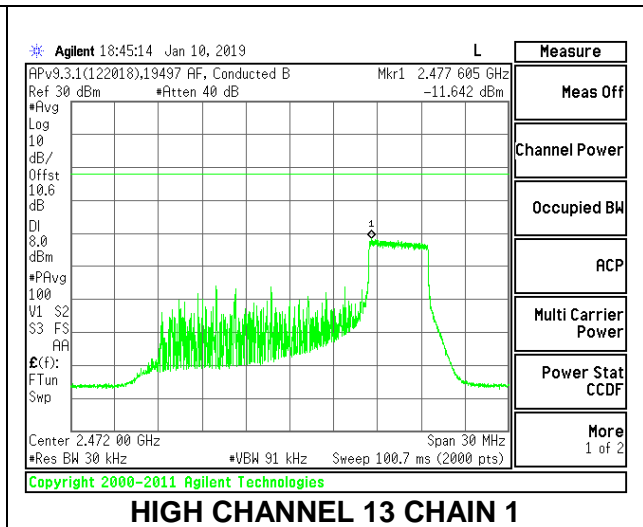
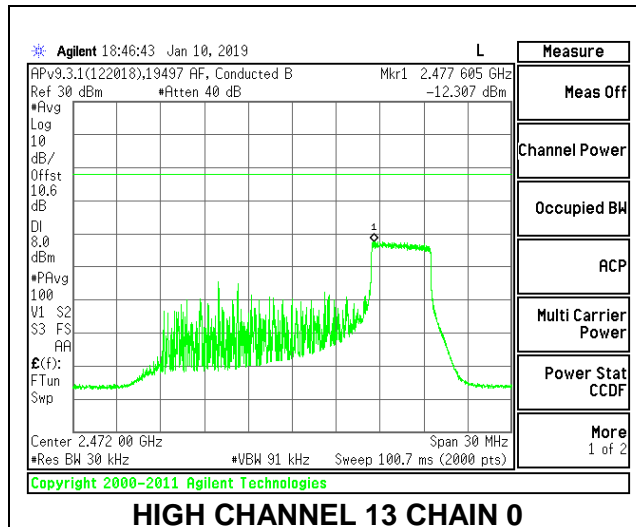

2TX Antenna 1 + Antenna 2 OFDMA MODE: 26-Tones, RU Index 0

Duty Cycle CF (dB)	0.11	Included in Calculations of Corr'd PSD
---------------------------	------	-----------------------------------------------

PSD Results

Channel	Frequency (MHz)	Chain 0 Meas (dBm)	Chain 1 Meas (dBm)	Total Corr'd PSD (dBm)	Limit (dBm)	Margin (dB)
Low 1	2412	-2.686	-1.775	0.91	8.0	-7.1
Mid 6	2437	-2.223	-2.144	0.94	8.0	-7.1
High 11	2462	-2.322	-2.915	0.51	8.0	-7.5
High 12	2467	-6.039	-6.380	-3.09	8.0	-11.1
High 13	2472	-8.417	-8.609	-5.39	8.0	-13.4

LOW CHANNEL 1

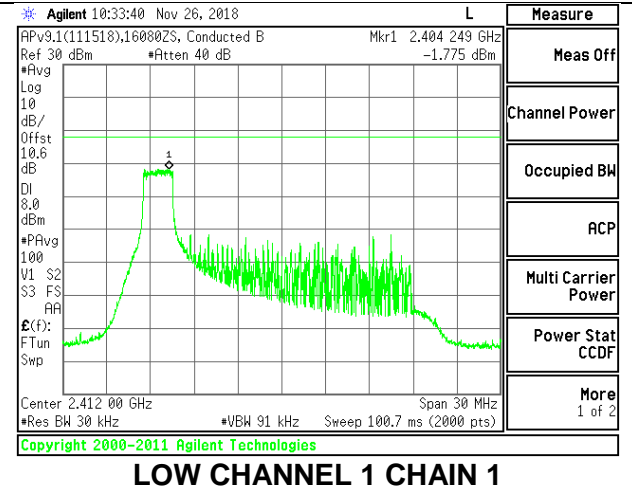
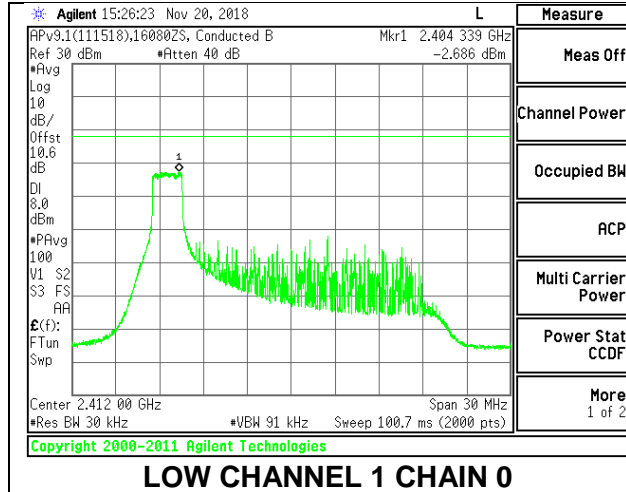

MID CHANNEL 6

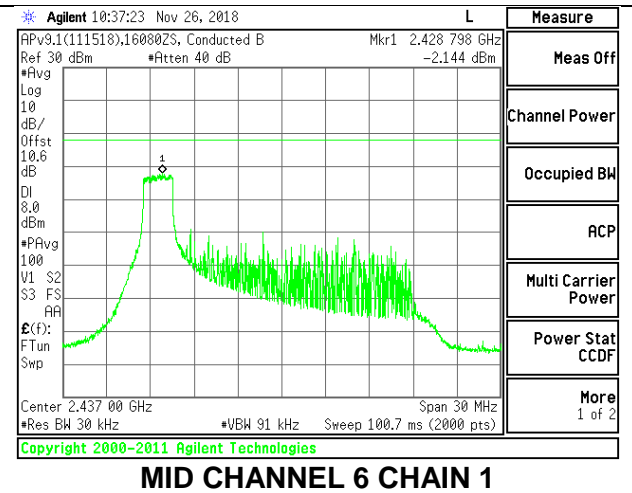
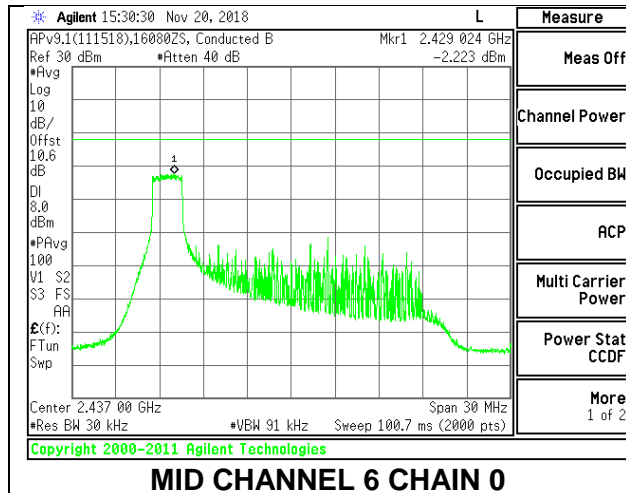

HIGH CHANNEL 11

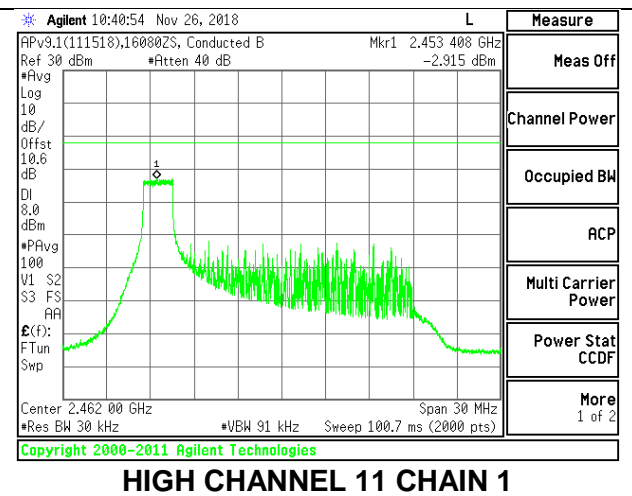
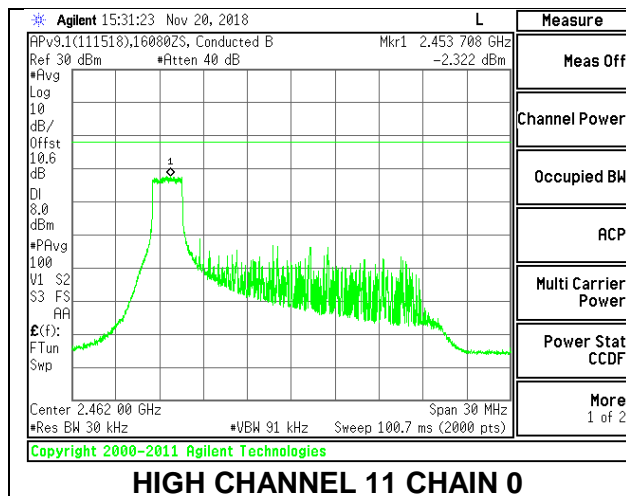

HIGH CHANNEL 12

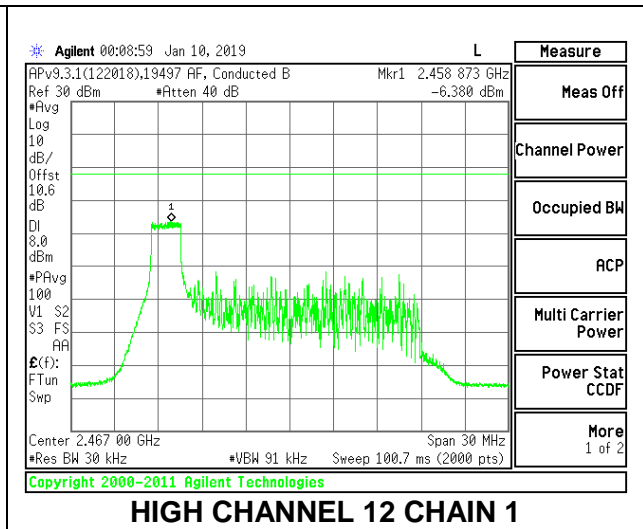
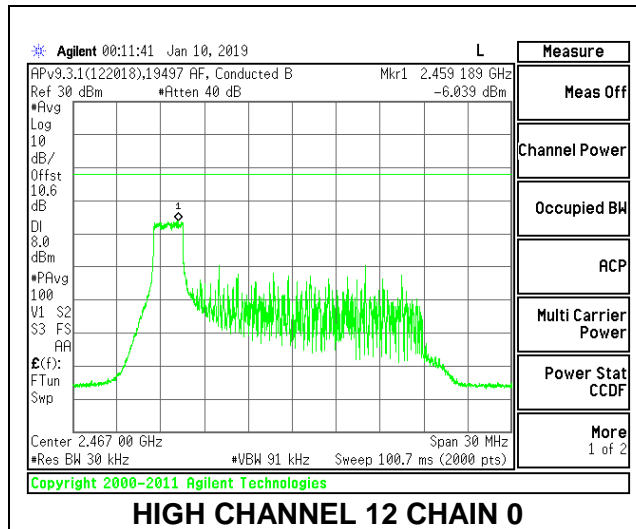

HIGH CHANNEL 13

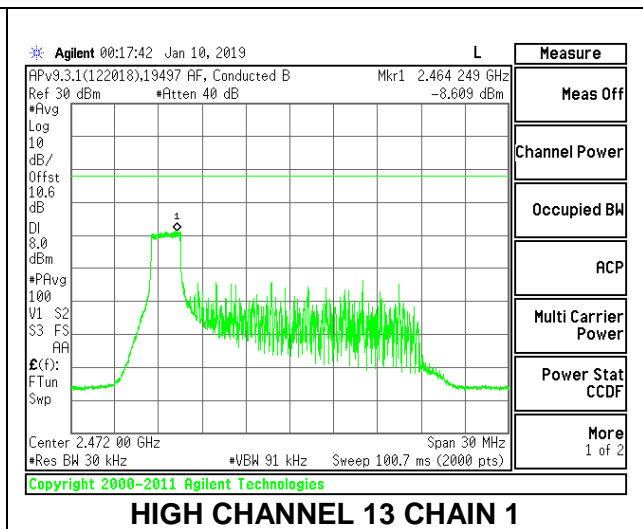
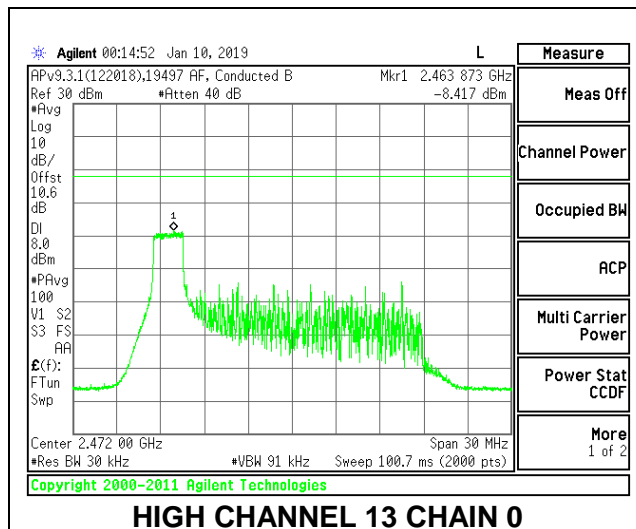

2TX Antenna 1 + Antenna 2 OFDMA MODE: 26-Tones, RU Index 4

Duty Cycle CF (dB)	0.11	Included in Calculations of Corr'd PSD
---------------------------	------	-----------------------------------------------

PSD Results

Channel	Frequency (MHz)	Chain 0 Meas (dBm)	Chain 1 Meas (dBm)	Total Corr'd (dBm)	Limit (dBm)	Margin (dB)
Low 1	2412	-2.730	-2.459	0.53	8.0	-7.5
Mid 6	2437	-2.264	-2.041	0.97	8.0	-7.0
High 11	2462	-2.107	-2.837	0.66	8.0	-7.3
High 12	2467	-5.495	-5.564	-2.41	8.0	-10.4
High 13	2472	-8.550	-8.496	-5.40	8.0	-13.4

LOW CHANNEL 1

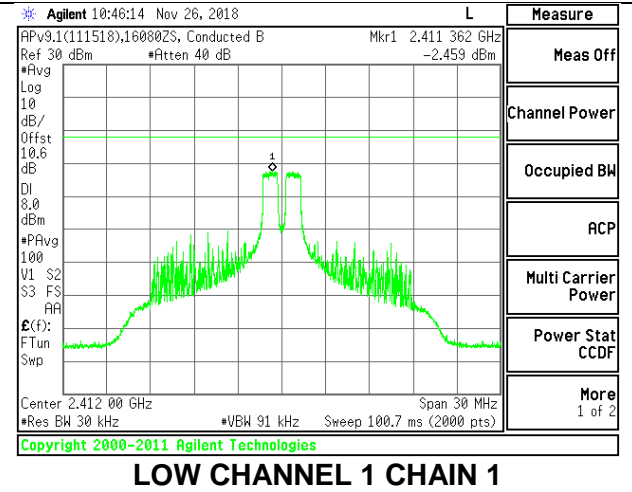
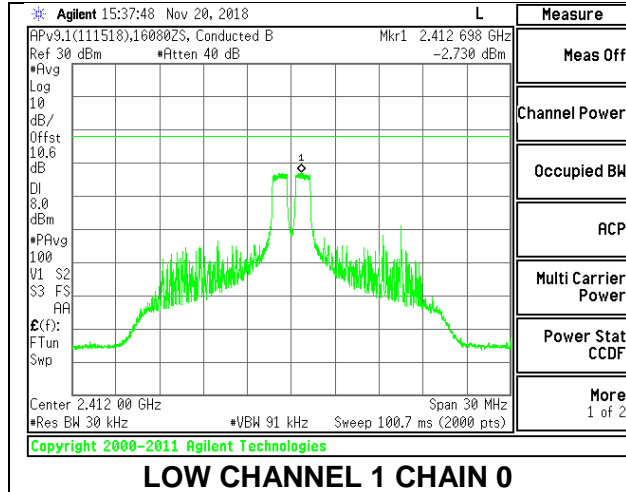

MID CHANNEL 6

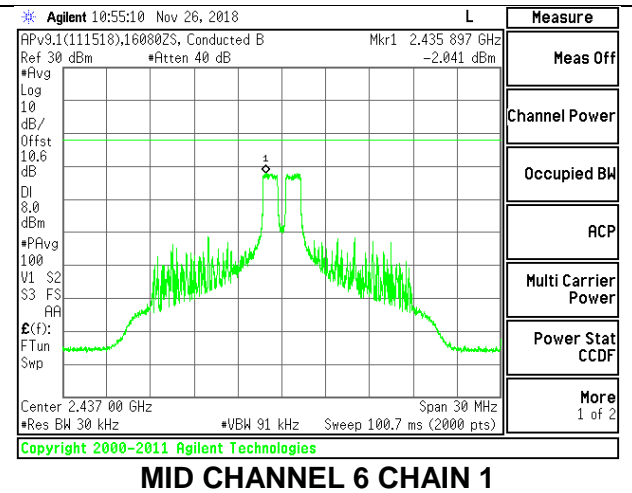
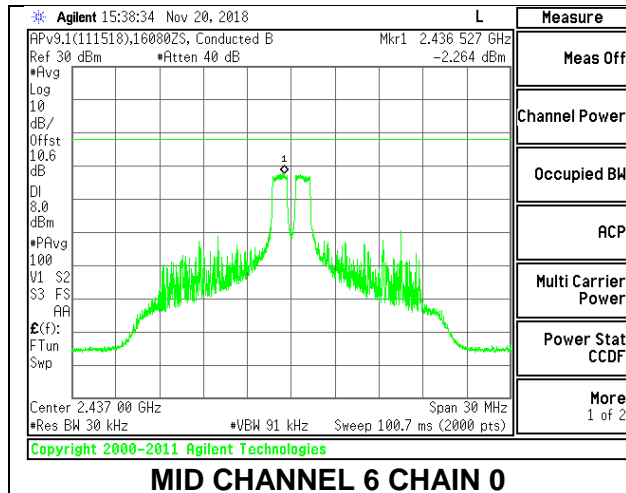

HIGH CHANNEL 11

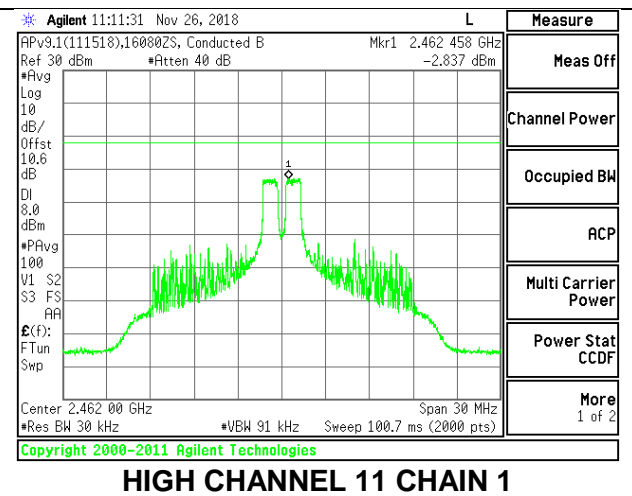
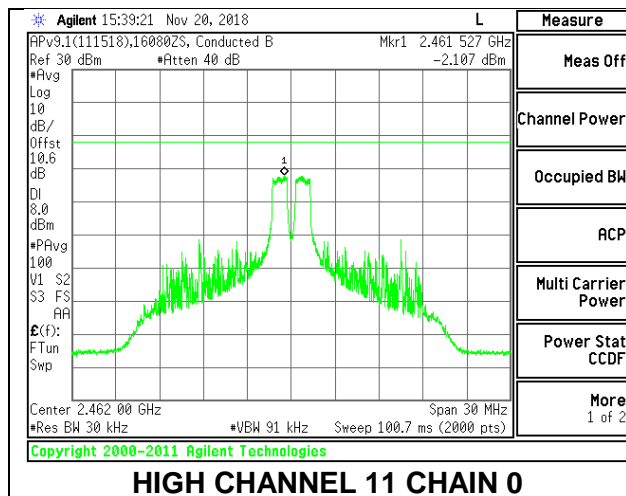

HIGH CHANNEL 12

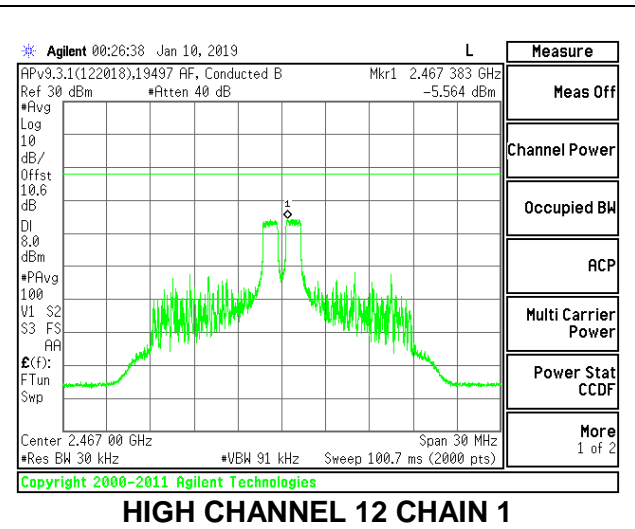
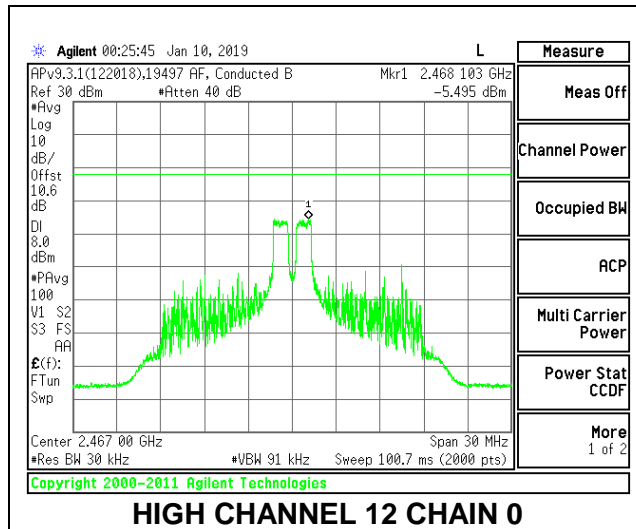

HIGH CHANNEL 13

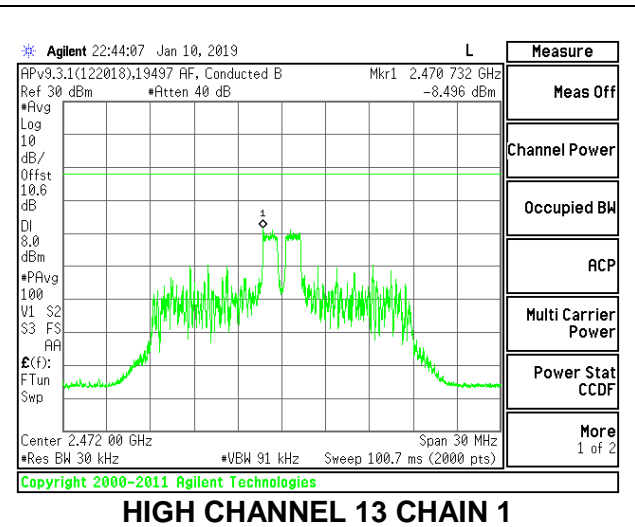
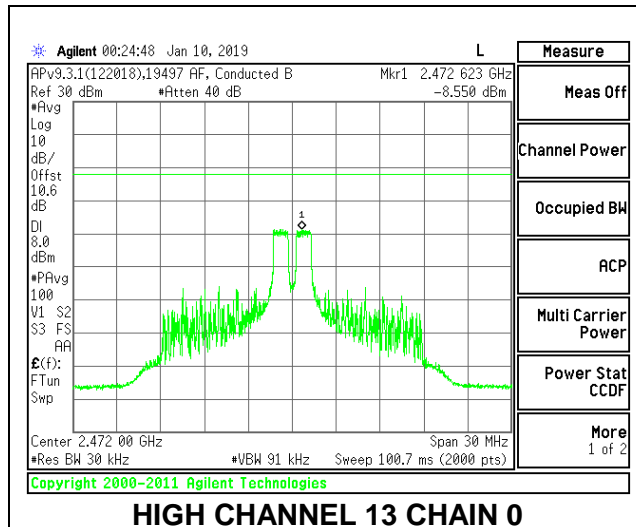

2TX Antenna 1 + Antenna 2 OFDMA MODE: 26-Tones, RU Index 8

Duty Cycle CF (dB)	0.11	Included in Calculations of Corr'd PSD
---------------------------	------	-----------------------------------------------

PSD Results

Channel	Frequency (MHz)	Chain 0 Meas (dBm)	Chain 1 Meas (dBm)	Total Corr'd (dBm)	Limit (dBm)	Margin (dB)
Low 1	2412	-2.635	-2.841	0.38	8.0	-7.6
Mid 6	2437	-2.793	-3.269	0.10	8.0	-7.9
High 11	2462	-3.064	-2.696	0.24	8.0	-7.8
High 12	2467	-5.382	-5.574	-2.36	8.0	-10.4
High 13	2472	-10.138	-9.712	-6.80	8.0	-14.8

LOW CHANNEL 1

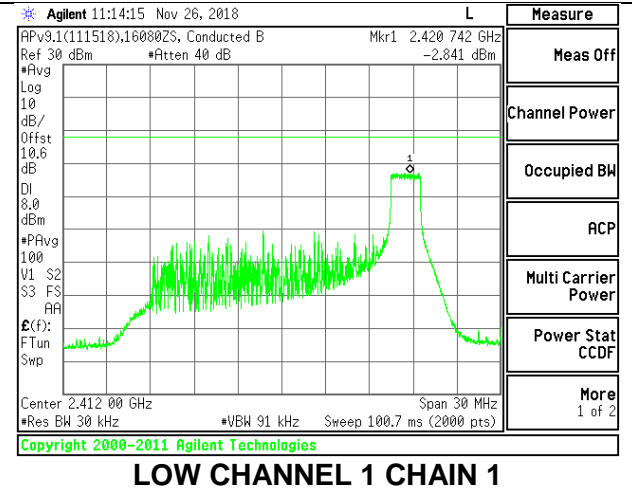
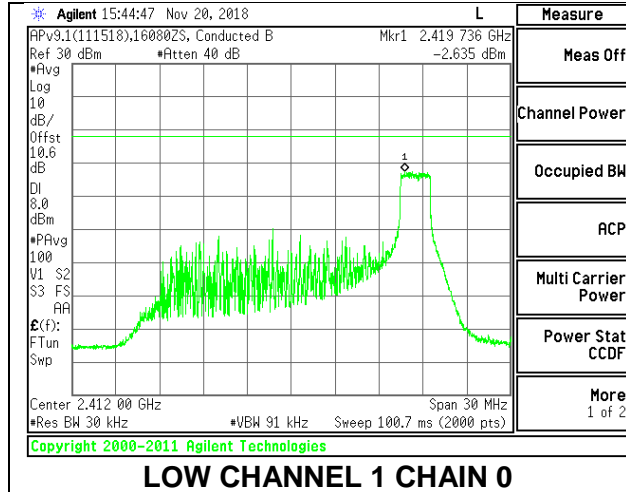

MID CHANNEL 6

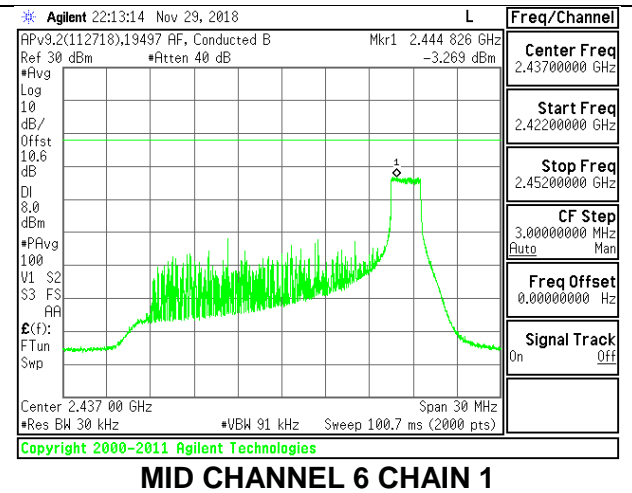
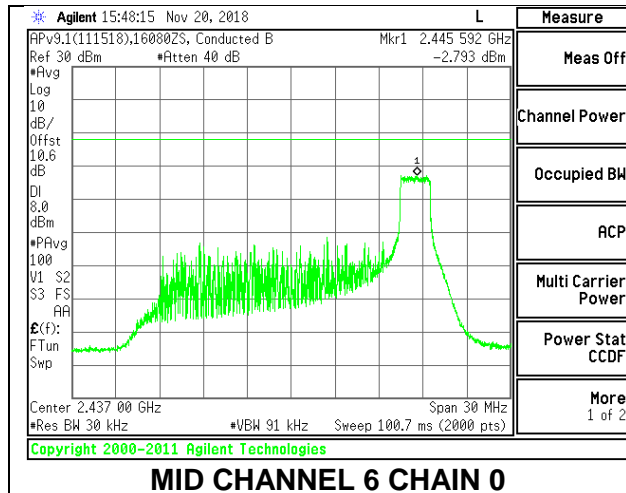

HIGH CHANNEL 11

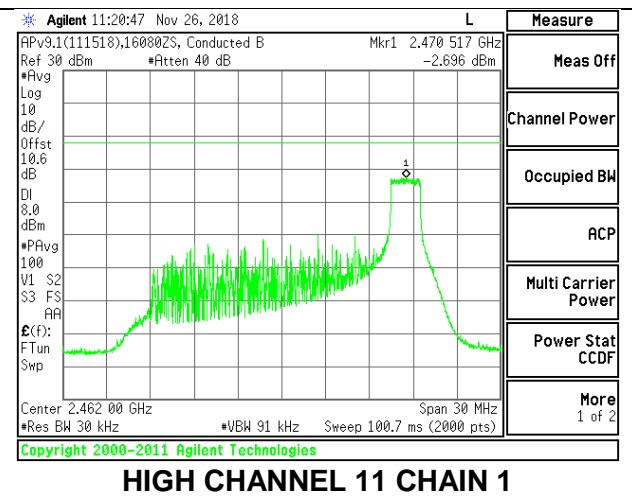
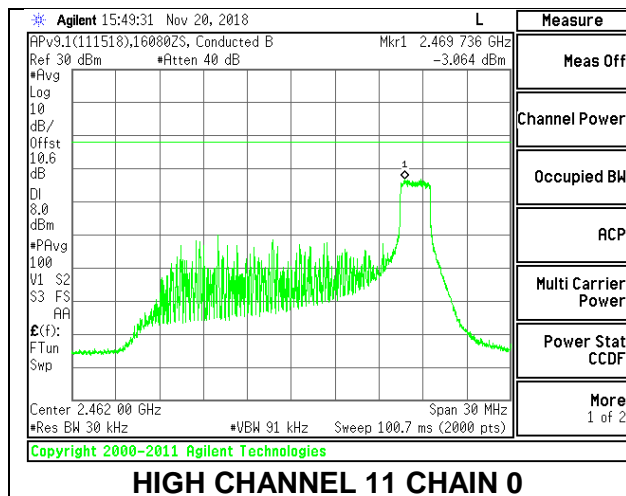

HIGH CHANNEL 12

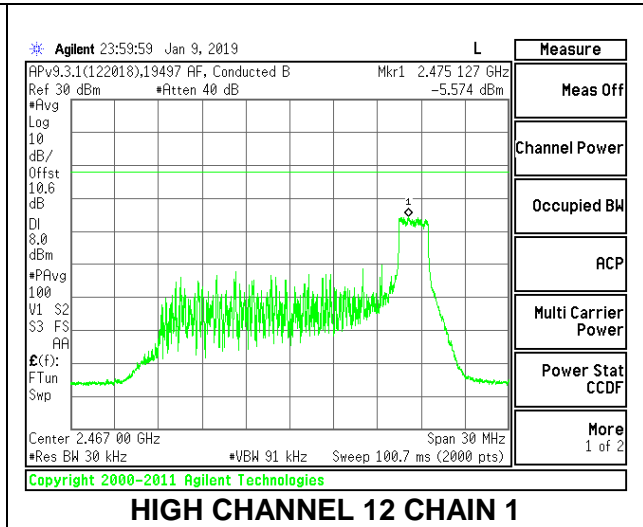
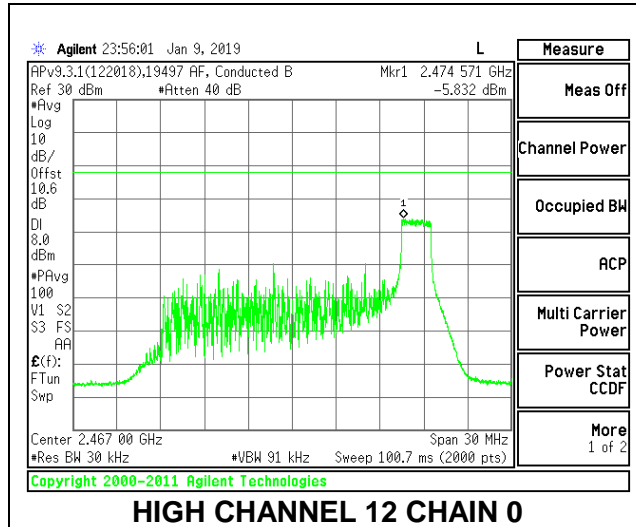

HIGH CHANNEL 13

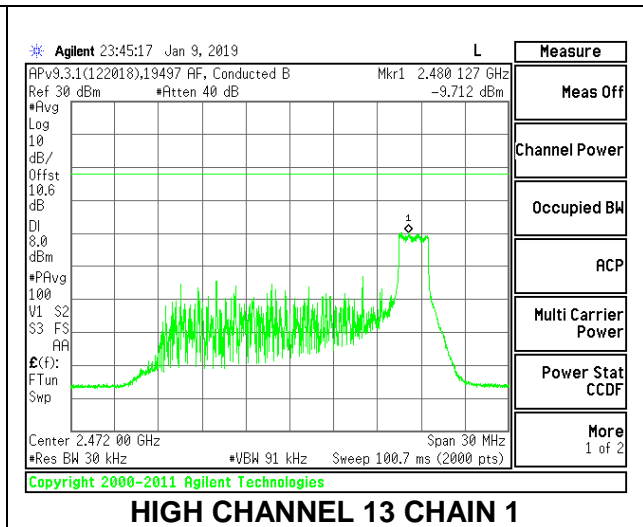
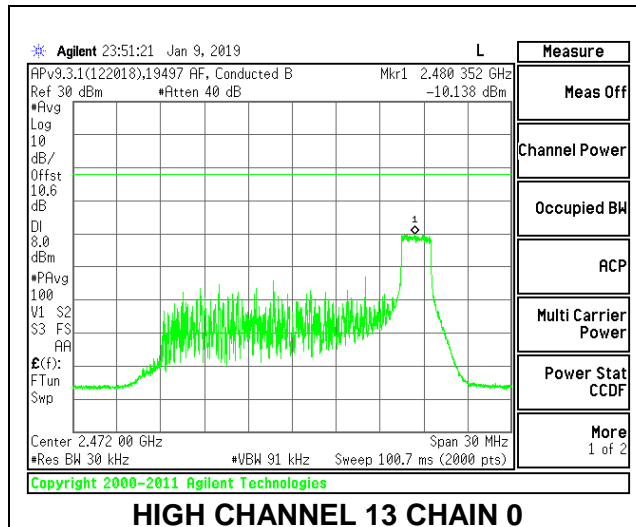

9.6. CONDUCTED SPURIOUS EMISSIONS

LIMITS

FCC §15.247 (d)

Output power was measured based on the use of peak measurement, therefore the required attenuation is 20 dB.

RESULTS

9.6.1. 802.11b MODE

1TX Antenna 1 MODE

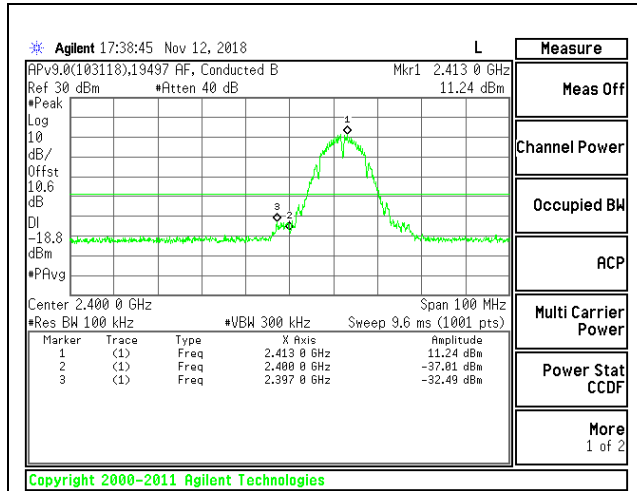

LOW CHANNEL 1 BANDEDGE

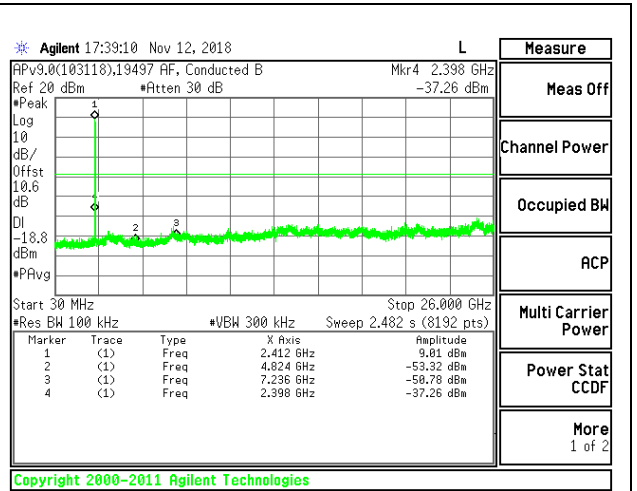

OUT-OF-BAND LOW CHANNEL 1

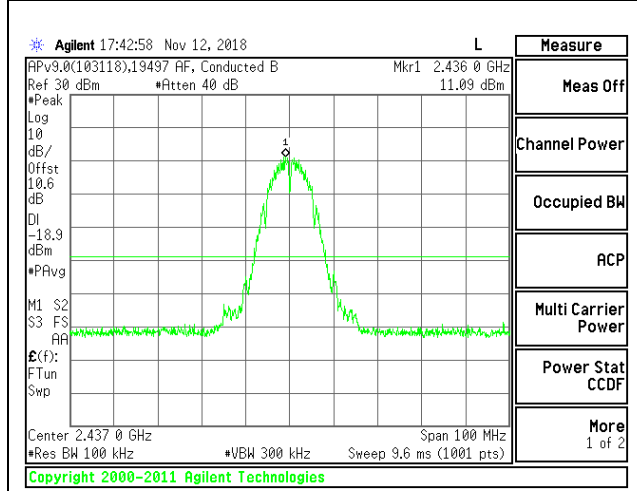

IN-BAND REFERENCE LEVEL

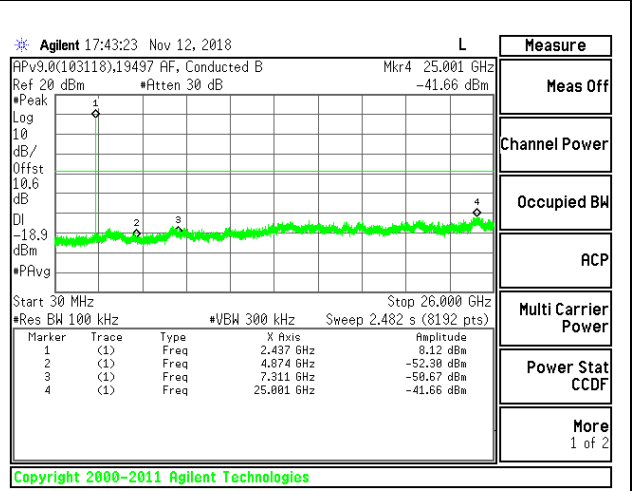

OUT-OF-BAND MID CHANNEL

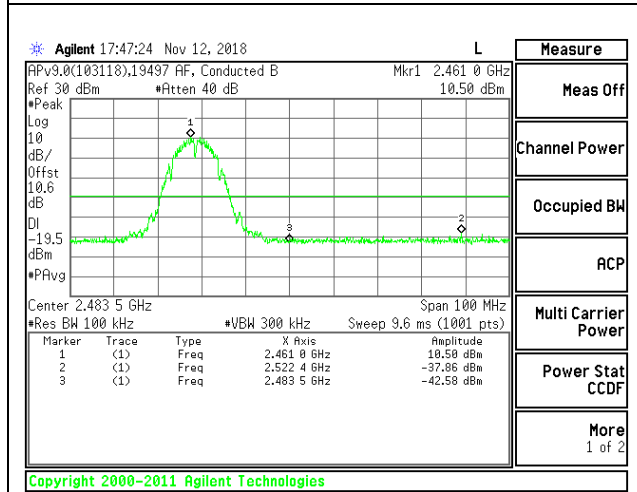

HIGH CHANNEL 11 BANDEDGE

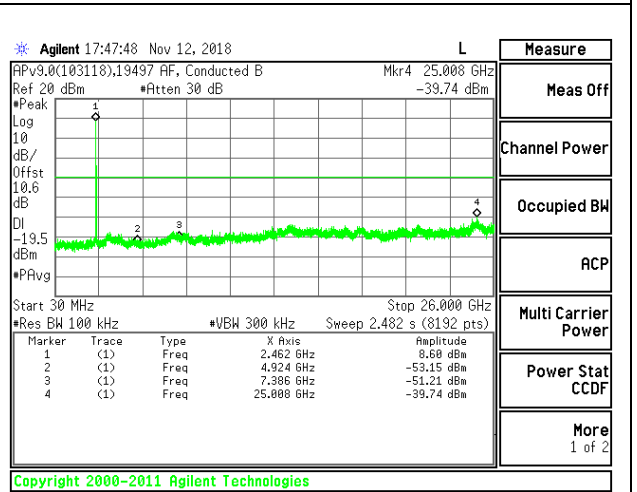

OUT-OF-BAND HIGH CHANNEL 11

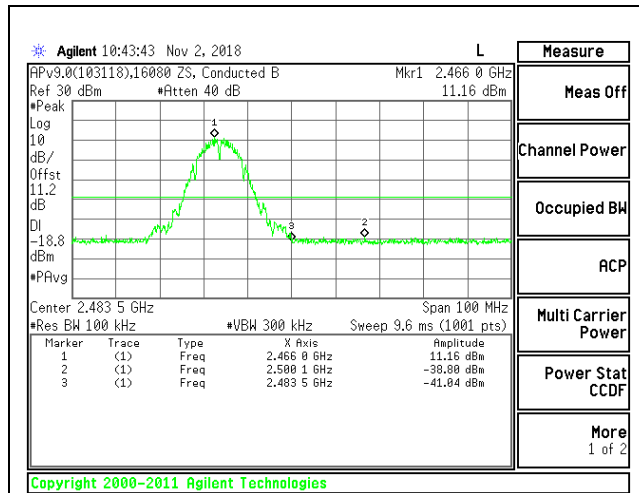

HIGH CHANNEL 12 BANDEDGE

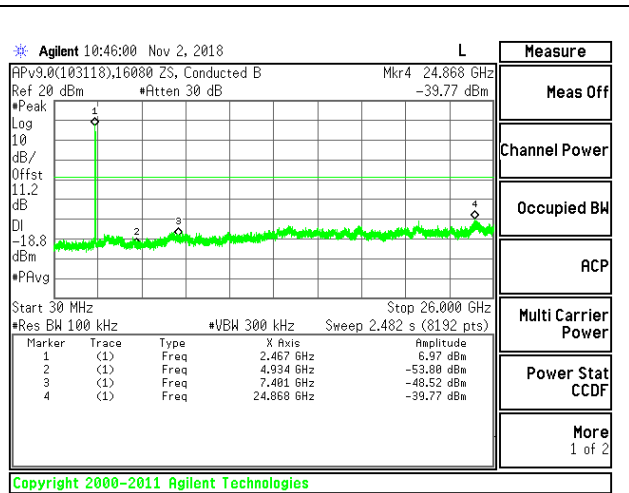

OUT-OF-BAND HIGH CHANNEL 12

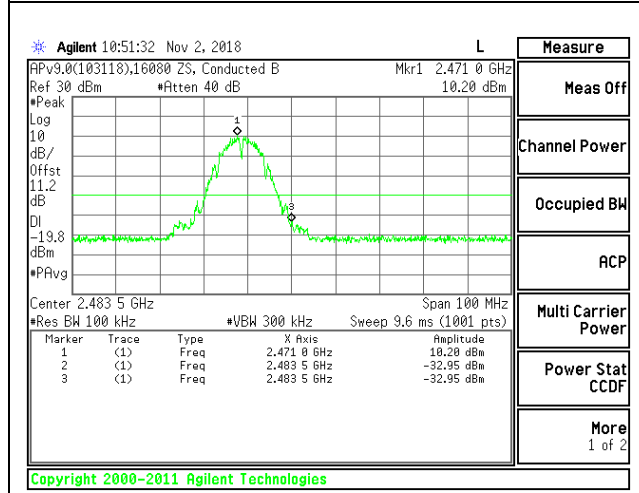

HIGH CHANNEL 13 BANDEDGE

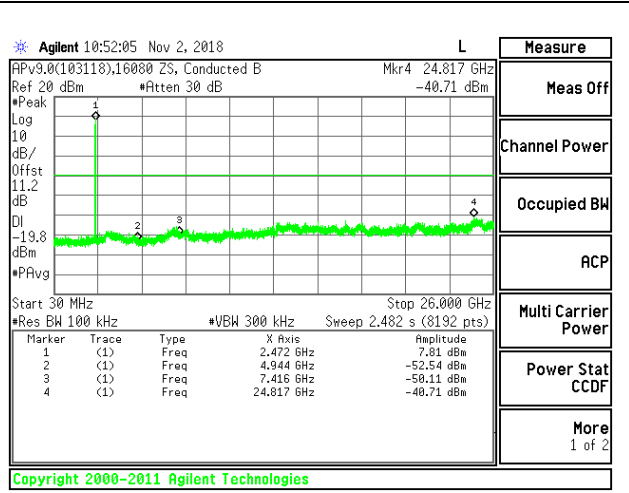

OUT-OF-BAND HIGH CHANNEL 13

1TX Antenna 2 MODE

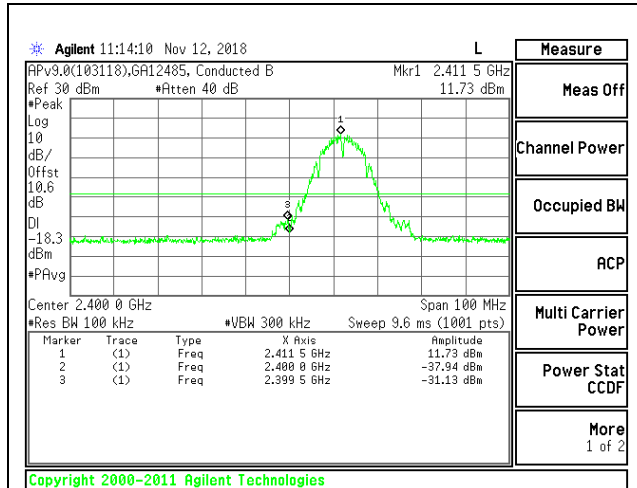

LOW CHANNEL 1 BANDEDGE

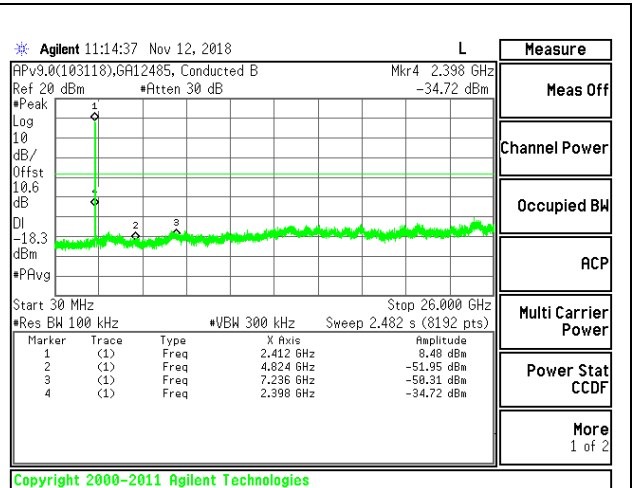

OUT-OF-BAND LOW CHANNEL 1

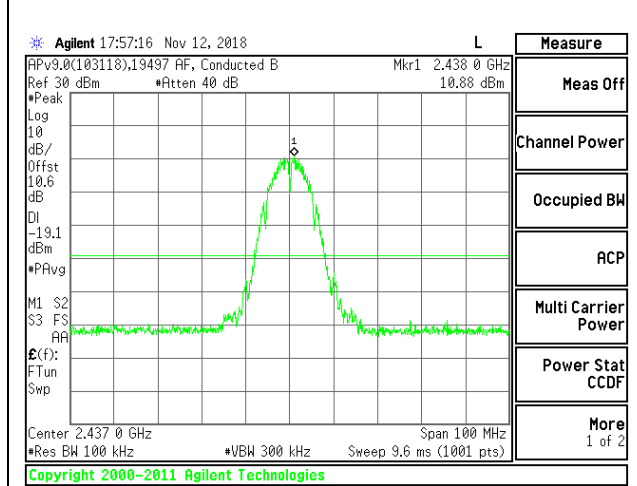

IN-BAND REFERENCE LEVEL

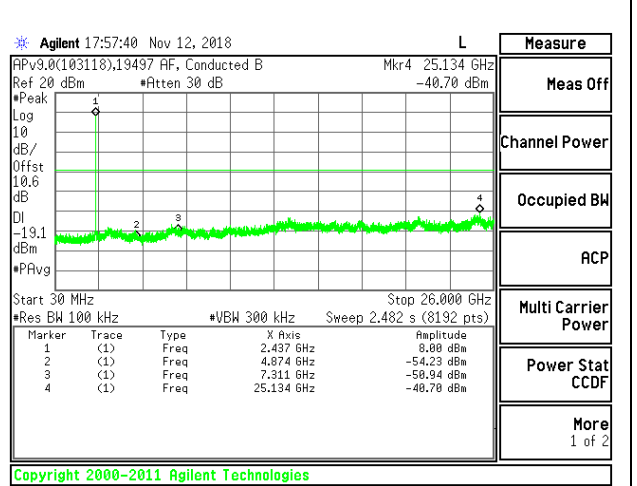

OUT-OF-BAND MID CHANNEL

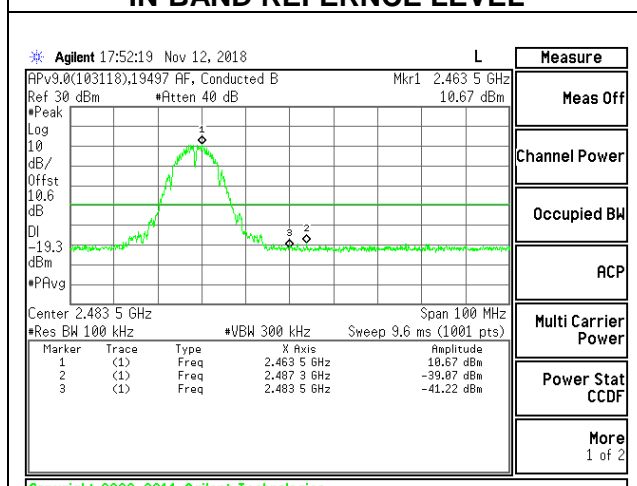

HIGH CHANNEL 11 BANDEDGE

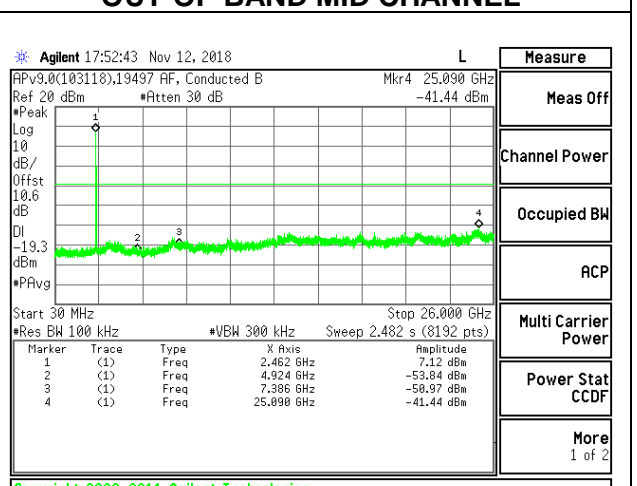

OUT-OF-BAND HIGH CHANNEL 11

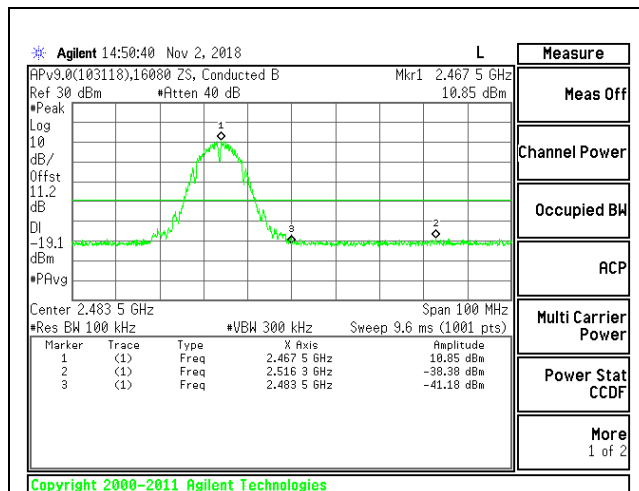

HIGH CHANNEL 12 BANDEDGE

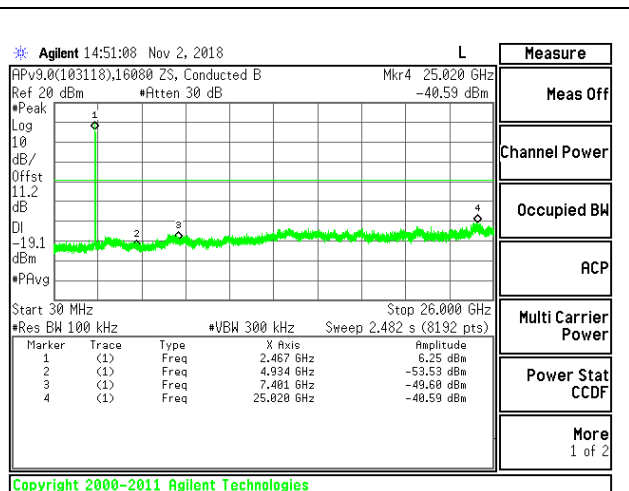

OUT-OF-BAND HIGH CHANNEL 12

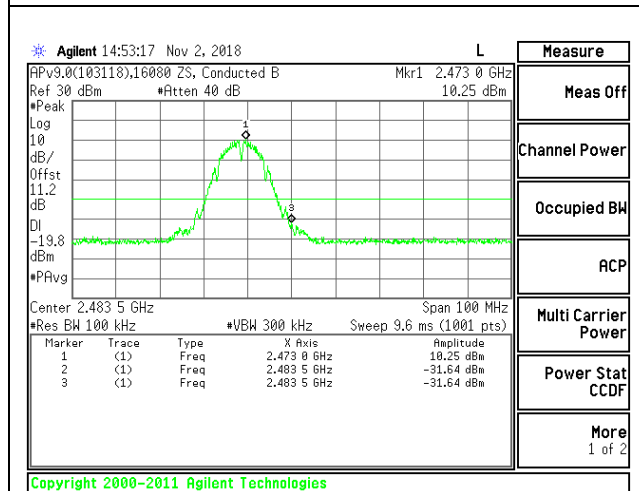

HIGH CHANNEL 13 BANDEDGE

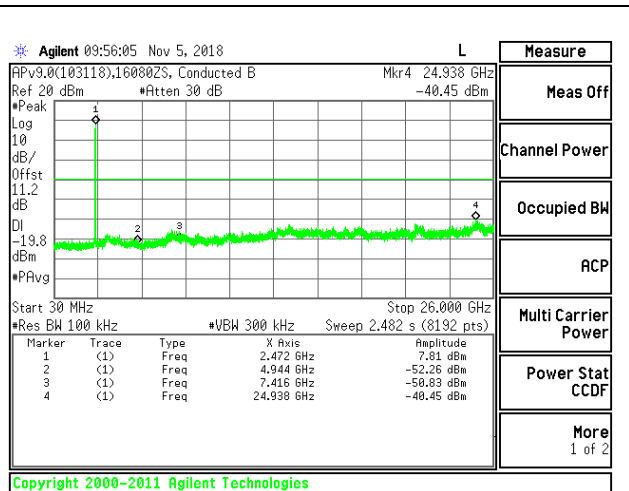

OUT-OF-BAND HIGH CHANNEL 13

9.6.2. 802.11g MODE

2TX Antenna 1 + Antenna 2 CDD MODE

