



CERTIFICATION TEST REPORT

Report Number. : 12563988-E2V1

Applicant : Samsung Electronics Co., Ltd.
129 Samsung-Ro, Yeongtong-Gu,
Suwon-Si, Gyeonggi-Do, 16677, Korea

Model : SM-G975N

FCC ID : A3LSMG975KOR

EUT Description : GSM/WCDMA/LTE phone with BT, DTS/UNII a/b/g/n/ac/11ax HE
20/40/80, ANT+ and NFC

Test Standard(s) : FCC 47 CFR PART 15 SUBPART C

Date Of Issue:

January 28, 2019

Prepared by:

UL Verification Services Inc.
47173 Benicia Street
Fremont, CA 94538 U.S.A.
TEL: (510) 771-1000
FAX: (510) 661-0888



NVLAP Lab code: 200065-0

REPORT REVISION HISTORY

Rev.	Issue Date	Revisions	Revised By
V1	1/28/2019	Initial Issue	

TABLE OF CONTENTS

REPORT REVISION HISTORY	2
TABLE OF CONTENTS	3
1. ATTESTATION OF TEST RESULTS	5
2. INTRODUCTION OF TEST DATA REUSE.....	6
2.1. INTRODUCTION	6
2.2. DEVICES DIFFERENCES.....	6
2.3. SPOT CHECK VERIFICATION RESULTS SUMMARY	6
2.3.1. SPOT CHECK DATA – SM-G975N (GLASS)	7
2.3.2. SPOT CHECK DATA – SM-G975N (CERAMIC)....	Error! Bookmark not defined.
3. TEST METHODOLOGY	12
4. FACILITIES AND ACCREDITATION	12
5. CALIBRATION AND UNCERTAINTY	13
5.1. MEASURING INSTRUMENT CALIBRATION	13
5.2. SAMPLE CALCULATION	13
5.3. MEASUREMENT UNCERTAINTY.....	13
6. EQUIPMENT UNDER TEST	14
6.1. EUT DESCRIPTION	14
6.2. MAXIMUM OUTPUT POWER.....	14
6.3. DESCRIPTION OF AVAILABLE ANTENNAS	14
6.4. SOFTWARE AND FIRMWARE.....	14
6.5. WORST-CASE CONFIGURATION AND MODE.....	15
6.6. DESCRIPTION OF TEST SETUP.....	16
7. TEST AND MEASUREMENT EQUIPMENT	19
8. MEASUREMENT METHODS	20
9. ANTENNA PORT TEST RESULTS	21
9.1. ON TIME AND DUTY CYCLE.....	21
9.2. 20 dB AND 99% BANDWIDTH	23
9.2.1. BLUETOOTH BASIC DATA RATE GFSK MODULATION	24
9.2.2. BLUETOOTH ENHANCED DATA RATE 8PSK MODULATION.....	25
9.3. HOPPING FREQUENCY SEPARATION	26
9.3.1. BLUETOOTH BASIC DATA RATE GFSK MODULATION	27
9.3.2. BLUETOOTH ENHANCED DATA RATE 8PSK MODULATION.....	28
9.4. NUMBER OF HOPPING CHANNELS.....	29
9.4.1. BLUETOOTH BASIC DATA RATE GFSK MODULATION	30

9.4.2.	BLUETOOTH ENHANCED DATA RATE 8PSK MODULATION.....	32
9.5.	AVERAGE TIME OF OCCUPANCY.....	34
9.5.1.	BLUETOOTH BASIC DATA RATE GFSK MODULATION	35
9.5.2.	BLUETOOTH ENHANCED DATA RATE 8PSK MODULATION.....	37
9.6.	OUTPUT POWER.....	39
9.6.1.	BLUETOOTH BASIC DATA RATE GFSK MODULATION	40
9.6.2.	BLUETOOTH ENHANCED DATA RATE 8PSK MODULATION.....	41
9.7.	AVERAGE POWER.....	42
9.7.1.	BLUETOOTH BASIC DATA RATE GFSK MODULATION	43
9.7.2.	BLUETOOTH ENHANCED DATA RATE 8PSK MODULATION.....	44
9.8.	CONDUCTED SPURIOUS EMISSIONS.....	45
9.8.1.	BLUETOOTH BASIC DATA RATE GFSK MODULATION	46
9.8.2.	BLUETOOTH ENHANCED DATA RATE 8PSK MODULATION.....	48
10.	RADIATED TEST RESULTS	50
10.1.	TRANSMITTER ABOVE 1 GHz.....	51
10.1.1.	BLUETOOTH BASIC DATA RATE GFSK MODULATION.....	51
10.1.2.	BLUETOOTH ENHANCED DATA RATE 8PSK MODULATION	61
10.1.3.	SPOT CHECK DATA (CERAMIC).....	71
10.2.	Worst Case Below 30 MHz.....	79
10.3.	Worst Case Below 1 GHz.....	81
10.4.	Worst Case 18-26 GHz	83
11.	AC POWER LINE CONDUCTED EMISSIONS	85
11.1.	AC Power Line Norm.....	86
12.	SETUP PHOTOS	88
12.1.	SM-G975F (Glass).....	88
12.2.	SETUP PHOTOS – SM-G975N (GLASS).....	91
12.3.	SETUP PHOTOS – SM-G975N (CERAMIC).....	92

1. ATTESTATION OF TEST RESULTS

COMPANY NAME: Samsung Electronics Co., Ltd.
129 Samsung-Ro, Yeongtong-Gu,
Suwon-Si, Gyeonggi-Do, 16677, Korea

EUT DESCRIPTION: GSM/WCDMA/LTE phone with BT, DTS/UNII a/b/g/n/ac/11ax HE
20/40/80, ANT+ and NFC

MODEL: SM-G975N

SERIAL NUMBER: ORIGINAL: Conducted (Glass): R38KA093BOT, R38KA0L96BB
Radiated (Glass): R38KA0L97DV, R38KA0L971T
Radiated (Ceramic): R38KA092LGJ, R38KA0KV84N
SPOTCHECK: Radiated (Glass):R39KA0KPKH, R39KA0FDGAH,
R39KA0FDGTD
Radiated (Ceramic):R39KB0A1Z4, R39KB0A1YW,
R39KB0A1YV

DATE TESTED: November 2, 2018 – December 19, 2018 (Original)
December 14, 2018 – December 19, 2018 (Spotcheck)

APPLICABLE STANDARDS	
STANDARD	TEST RESULTS
CFR 47 Part 15 Subpart C	Complies

UL Verification Services Inc. tested the above equipment in accordance with the requirements set forth in the above standards. The test results show that the equipment tested is capable of demonstrating compliance with the requirements as documented in this report.

The results documented in this report apply only to the tested sample, under the conditions and modes of operation as described herein. It is the manufacturer's responsibility to assure that additional production units of this model are manufactured with identical electrical and mechanical components. All samples tested were in good operating condition throughout the entire test program. Measurement Uncertainties are published for informational purposes only and were not taken into account unless noted otherwise.

This document may not be altered or revised in any way unless done so by UL Verification Services Inc. and all revisions are duly noted in the revisions section. Any alteration of this document not carried out by UL Verification Services Inc. will constitute fraud and shall nullify the document. This report must not be used by the client to claim product certification, approval, or endorsement by NVLAP, NIST, any agency of the Federal Government, or any agency of the U.S. government.

Approved & Released For
UL Verification Services Inc. By:



Dan Corona
Project Engineer/Operations Leader
Consumer Technology Division
UL Verification Services Inc.

Reviewed By:



Steven Tran
Project Engineer
Consumer Technology Division
UL Verification Services Inc.

2. INTRODUCTION OF TEST DATA REUSE

2.1. INTRODUCTION

According to the manufacturer, FCC ID: A3LSMG975F and FCC ID: A3LSMG975KOR non-licensed radios are electrically identical. The FCC ID: A3LSMG975F test data shall remain representative of FCC ID: A3LSMG975KOR.

The applicant takes full responsibility that the test data as referenced in this section represents compliance for this FCC ID.

2.2. DEVICES DIFFERENCES

The FCC ID: A3LSMG975F, shares the same enclosure and circuit board as FCC ID: A3LSMG975KOR. The BT antennas and surrounding circuitry and layout are identical between two models.

After confirming through preliminary radiated emissions that the performance of the FCC ID: A3LSMG975F remains representative of FCC ID: A3LSMG975KOR. The test data of FCC ID: A3LSMG975F being submitted for this application to cover BT features.

2.3. SPOT CHECK VERIFICATION RESULTS SUMMARY

Spot check verification has been done on device A3LSMG975KOR(Glass and Ceramic) for radiated harmonic spurious and radiated band-edge. The data from the application has been verified through appropriate spot checks to demonstrate compliance for this device as shown in the summary below.

A3LSMG975KOR SPOT CHECK RESULTS										
Technology	Mode	Test Item	Channel	Measured Frequency	Original Mode		Spotcheck Model		Delta (dB)	
					SM-G975F		SM-G975N			
					A3LSMG975F		A3LSMG975KOR			
					Peak	Ave	Peak	Ave	Peak	Ave
BT	GFSK	RBE	78	2484MHz	69.66	40.65	65.02	40.65	-4.64	-0.37
	8PSK	RSE	0	12261MHz	49.58	39.04	49.15	38.25	-0.43	-0.79

Comparison of two models, upper deviation is within 3dB range and all test are under FCC Technical Limits.

2.3.1. SPOT CHECK DATA – SM-G975N (GLASS)

BANDEDGE (HIGH CHANNEL)

HORIZONTAL RESULT

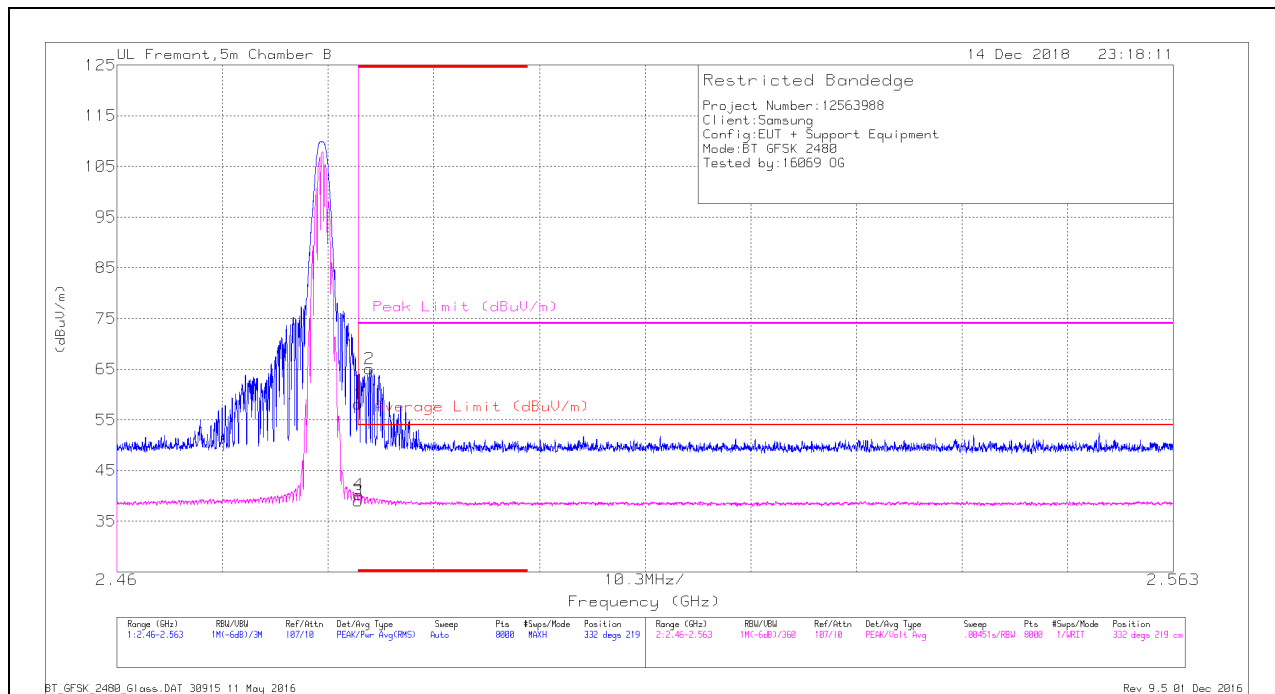

Trace Markers

Marker	Frequency (GHz)	Meter Reading (dBuV)	Det	AF T345 (dB/m)	Amp/Cb/Filtr/Pad (dB)	Corrected Reading (dBuV/m)	Average Limit (dBuV/m)	Margin (dB)	Peak Limit (dBuV/m)	PK Margin (dB)	Azimuth (Degs)	Height (cm)	Polarity
1	* 2.484	47.42	Pk	32.4	-21.7	58.12	-	-	74	-15.88	332	219	H
2	* 2.485	54.32	Pk	32.4	-21.7	65.02	-	-	74	-8.98	332	219	H
3	* 2.484	28.3	VA1T	32.4	-21.7	39	54	-15	-	-	332	219	H
4	* 2.484	29.58	VA1T	32.4	-21.7	40.28	54	-13.72	-	-	332	219	H

* - indicates frequency in CFR47 Pt 15 / IC RSS-Restricted Band

Pk - Peak detector

VA1T - FHSS: Linear Voltage Average VB=1/Ton where: Ton is transmit duration

VERTICAL RESULT

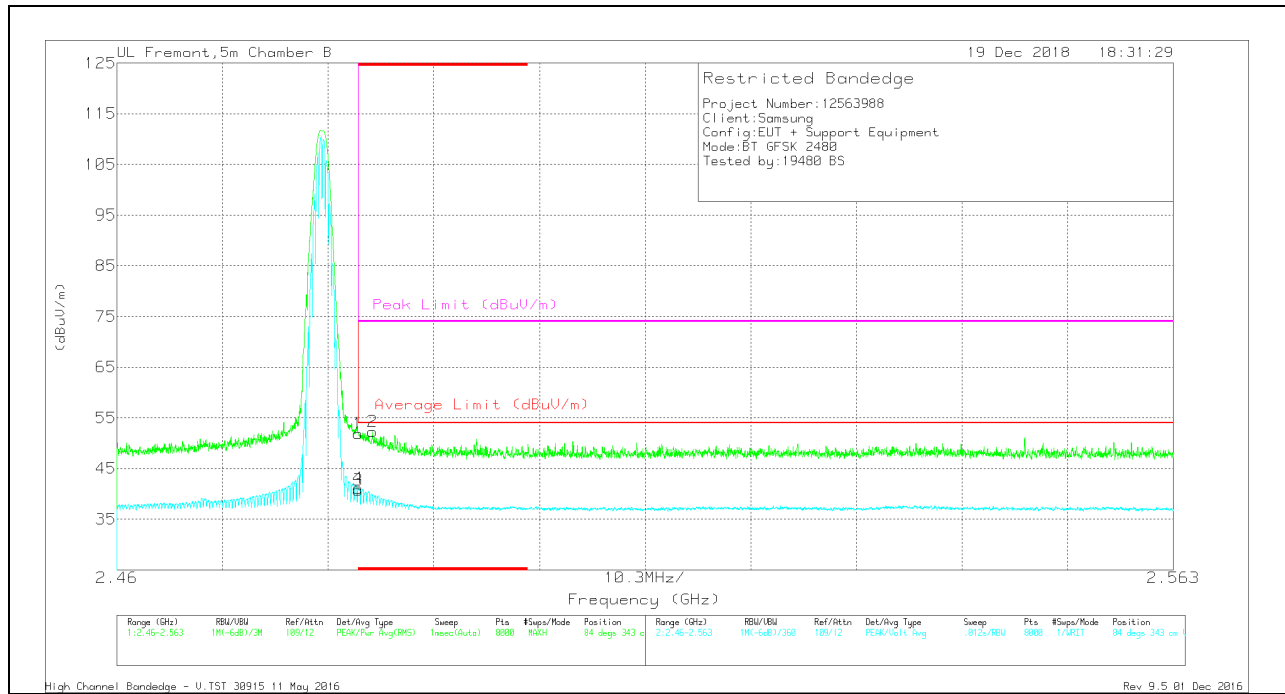

Trace Markers

Marker	Frequency (GHz)	Meter Reading (dBuV)	Det	AF T863 (dB/m)	Amp/Cb/Filtr/Pad (dB)	Corrected Reading (dBuV/m)	Average Limit (dBuV/m)	Margin (dB)	Peak Limit (dBuV/m)	PK Margin (dB)	Azimuth (Degs)	Height (cm)	Polarity
1	* 2.484	39.62	Pk	32.6	-20.3	51.92	-	-	74	-22.08	84	343	V
3	* 2.484	28.44	VA1T	32.6	-20.3	40.74	54	-13.26	-	-	84	343	V
4	* 2.484	28.78	VA1T	32.6	-20.3	41.08	54	-12.92	-	-	84	343	V
2	* 2.485	39.97	Pk	32.6	-20.3	52.27	-	-	74	-21.73	84	343	V

* - indicates frequency in CFR47 Pt 15 / IC RSS-Restricted Band

Pk - Peak detector

VA1T - FHSS: Linear Voltage Average $V_B=1/T_{on}$ where: T_{on} is transmit duration

HARMONICS AND SPURIOUS EMISSIONS

LOW CHANNEL RESULTS

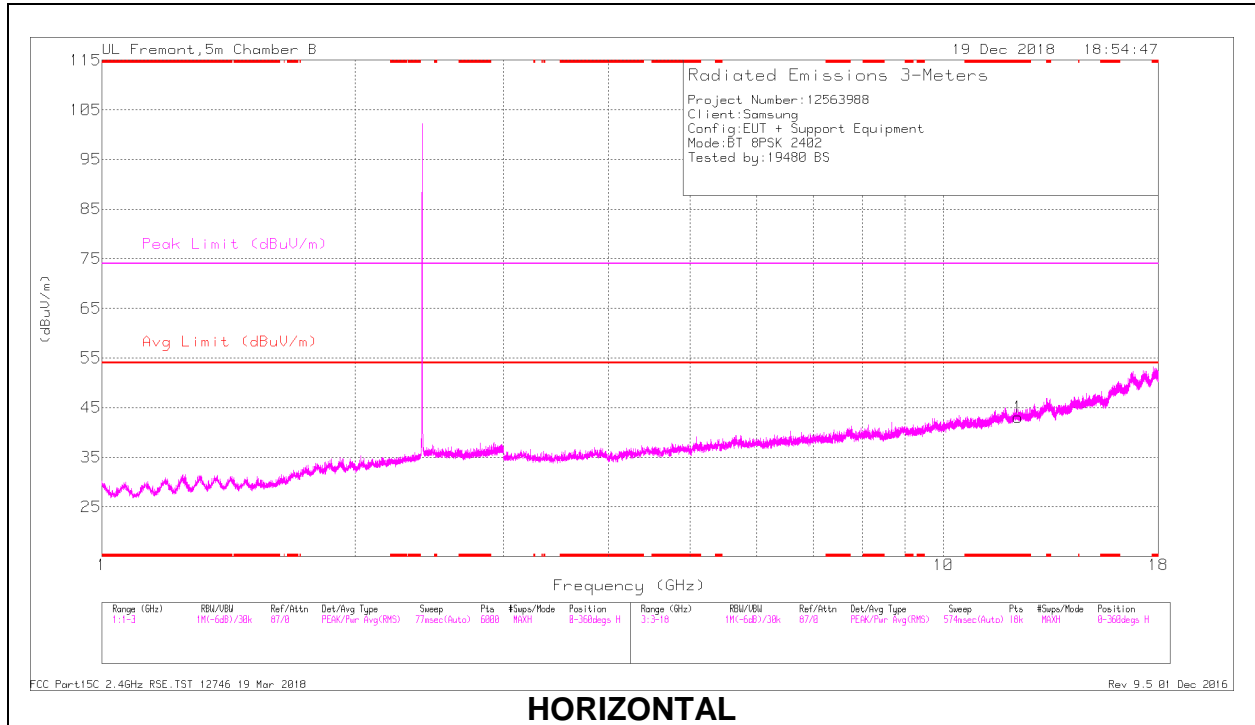

HORIZONTAL

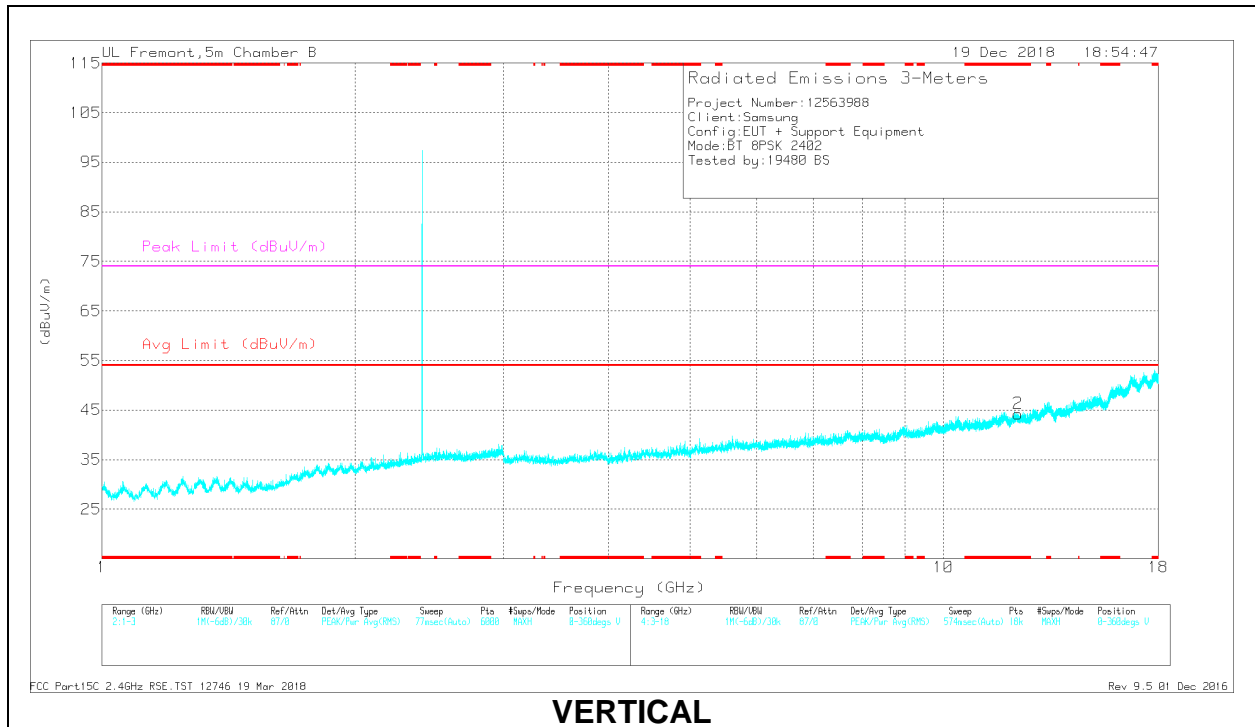

VERTICAL

RADIATED EMISSIONS

Marker	Frequency (GHz)	Meter Reading (dBuV)	Det	AF T863 (dB/m)	Amp/Cbl/Filtr/Pad (dB)	Corrected Reading (dBuV/m)	Avg Limit (dBuV/m)	Margin (dB)	Peak Limit (dBuV/m)	PK Margin (dB)	Azimuth (Degs)	Height (cm)	Polarity
1	* 12.259	32.82	PKFH	39.2	-21.9	50.12	-	-	74	-23.88	305	341	H
	* 12.261	20.79	VA1T	39.2	-21.9	38.09	54	-15.91	-	-	305	341	H
2	* 12.263	31.95	PKFH	39.1	-21.9	49.15	-	-	74	-24.85	360	400	V
	* 12.26	20.95	VA1T	39.2	-21.9	38.25	54	-15.75	-	-	360	400	V

* - indicates frequency in CFR47 Pt 15 Restricted Band

PKFH - FHSS: RB=100k/1MHz VB=3 x RB, Peak

VA1T - FHSS: Linear Voltage Average VB=1/Ton where: Ton is transmit duration

2.1. REFERENCE DETAIL

Reference application that contains the reused reference data.

Equipment Class	Reference FCC ID	Type Grant/ Permissive Change	Reference Application	Folder Test/RF Exposure	Report Title/Section
PCE	A3LSMG975F	Grant	12563708-E1	Test	FCC Report WWAN / All sections except Appendix A
DSS	A3LSMG975F	Grant	12563708-E2	Test	FCC Report BT / All sections
DTS	A3LSMG975F	Grant	12563708-E3	Test	FCC Report BLE / All sections
	A3LSMG975F	Grant	12563708-E4	Test	FCC Report DTS WLAN / All sections
NII	A3LSMG975F	Grant	12563708-E5	Test	FCC Report UNII WLAN / All sections except DFS
DXX	A3LSMG975F	Grant	12563708-E7	Test	FCC Report NFC / All sections
			12563708-E8	Test	FCC Report ANT+ / All sections
DCD	A3LSMG975F	Grant	12563708-E9	Test	FCC Report Wireless Charging / All sections

3. TEST METHODOLOGY

The tests documented in this report were performed in accordance with FCC CFR 47 Part 2, FCC CFR 47 Part 15, ANSI C63.10-2013, and KDB 558074 D01 15.247 Meas Guidance v05.

4. FACILITIES AND ACCREDITATION

The test sites and measurement facilities used to collect data are located at 47173 and 47266 Benicia Street, and 47658 Kato Road, Fremont, California, USA. Line conducted emissions are measured only at the 47173 address. The following table identifies which facilities were utilized for radiated emission measurements documented in this report. Specific facilities are also identified in the test results sections.

47173 Benicia Street	47266 Benicia Street	47658 Kato Rd
<input checked="" type="checkbox"/> Chamber A (ISED:2324B-1)	<input type="checkbox"/> Chamber D (ISED:22541-1)	<input type="checkbox"/> Chamber I (ISED:2324A-5)
<input checked="" type="checkbox"/> Chamber B (ISED:2324B-2)	<input type="checkbox"/> Chamber E (ISED:22541-2)	<input type="checkbox"/> Chamber J (ISED:2324A-6)
<input type="checkbox"/> Chamber C (ISED:2324B-3)	<input type="checkbox"/> Chamber F (ISED:22541-3)	<input type="checkbox"/> Chamber K (ISED:2324A-1)
	<input type="checkbox"/> Chamber G (ISED:22541-4)	<input type="checkbox"/> Chamber L (ISED:2324A-3)
	<input type="checkbox"/> Chamber H (ISED:22541-5)	

The above test sites and facilities are covered under FCC Test Firm Registration # 208313. Chambers above are covered under Industry Canada company address and respective code

UL Verification Services Inc. is accredited by NVLAP, Laboratory Code 200065-0

5. CALIBRATION AND UNCERTAINTY

5.1. MEASURING INSTRUMENT CALIBRATION

The measuring equipment utilized to perform the tests documented in this report has been calibrated in accordance with the manufacturer's recommendations, and is traceable to recognized national standards.

5.2. SAMPLE CALCULATION

RADIATED EMISSIONS

Where relevant, the following sample calculation is provided:

Field Strength (dBuV/m) = Measured Voltage (dBuV) + Antenna Factor (dB/m) + Cable Loss (dB) – Preamp Gain (dB)

$$36.5 \text{ dBuV} + 18.7 \text{ dB/m} + 0.6 \text{ dB} - 26.9 \text{ dB} = 28.9 \text{ dBuV/m}$$

MAINS CONDUCTED EMISSIONS

Where relevant, the following sample calculation is provided:

Final Voltage (dBuV) = Measured Voltage (dBuV) + Cable Loss (dB) + Limiter Factor (dB) + LISN Insertion Loss.

$$36.5 \text{ dBuV} + 0 \text{ dB} + 10.1 \text{ dB} + 0 \text{ dB} = 46.6 \text{ dBuV}$$

5.3. MEASUREMENT UNCERTAINTY

Where relevant, the following measurement uncertainty levels have been estimated for tests performed on the apparatus:

PARAMETER	UNCERTAINTY
Worst Case Conducted Disturbance, 9KHz to 0.15 MHz	3.84 dB
Worst Case Conducted Disturbance, 0.15 to 30 MHz	3.65 dB
Worst Case Radiated Disturbance, 9KHz to 30 MHz	3.15 dB
Worst Case Radiated Disturbance, 30 to 1000 MHz	5.36 dB
Worst Case Radiated Disturbance, 1000 to 18000 MHz	4.32 dB
Worst Case Radiated Disturbance, 18000 to 26000 MHz	4.45 dB
Worst Case Radiated Disturbance, 26000 to 40000 MHz	5.24 dB

Uncertainty figures are valid to a confidence level of 95%.

6. EQUIPMENT UNDER TEST

6.1. EUT DESCRIPTION

The EUT is a GSM/WCDMA/LTE phone with BT, DTS/UNII a/b/g/n/ac/11ax HE 20/40/80, ANT+ and NFC. The test report addresses the BT operational mode.

6.2. MAXIMUM OUTPUT POWER

The transmitter has a maximum peak conducted output power as follows:

Frequency Range (MHz)	Mode	Output Power (dBm)	Output Power (mW)
2402 - 2480	Basic GFSK	19.80	95.50
2402 - 2480	Enhanced 8PSK	16.50	44.67

Note: GFSK, DQPSK, 8PSK average Power are all investigated, The GFSK & 8PSK Power are the worst case. Testing is based on these modes to showing compliance. For average power data please refer to section 4.7.

6.3. DESCRIPTION OF AVAILABLE ANTENNAS

The radio utilizes an FPCB antenna, with a maximum gain of -0.4 dBi.

6.4. SOFTWARE AND FIRMWARE

The test utility software used during testing was G975N.001.

6.5. WORST-CASE CONFIGURATION AND MODE

WORST-CASE CONFIGURATION AND MODE FOR FINAL TEST

This device may be formed with two different exterior materials: Glass and Ceramic. Glass model was set for full test and additional spot check verification was done with Ceramic model for radiated harmonic spurious and radiated band-edge as documented.

Radiated emissions below 1GHz, above 18GHz, and power line conducted emission were performed with the EUT set to transmit at the channel with highest output power as worst-case scenario.

Band edge and radiated emissions between 1GHz and 18GHz were performed with the EUT set to transmit at the highest power on low, middle and high channels.

The fundamental of the EUT was investigated in three orthogonal orientations X,Y,Z, it was determined that X orientation was worst-case orientation; therefore, all final radiated testing was performed with the EUT in X orientation.

Worst-case data rates as provided by the client were:

GFSK mode: DH5
8PSK mode: 3-DH5

All radios that can be transmitted simultaneously have been evaluated for radiated for all possible combinations of transmission and found to be in compliance.

6.6. DESCRIPTION OF TEST SETUP

SUPPORT EQUIPMENT

Support Equipment List				
Description	Manufacturer	Model	Serial Number	FCC ID
AC Adapter	Samsung	EP-TA300	R3KB5B01S1SE3	N/A
USB Data Cable	Samsung	N/A	N/A	N/A
Earphone	Samsung	N/A	N/A	N/A

I/O CABLES (CONDUCTED TEST)

I/O Cable List						
Cable No	Port	# of identical ports	Connector Type	Cable Type	Cable Length (m)	Remarks
1	Antenna	1	RF	Shielded	0.2	To PSA and BT Tester
2	USB	1	USB	Un-shielded	1	EUT to AC Mains

I/O CABLES (RADIATED AND CONDUCTED EMISSIONS)

I/O Cable List						
Cable No	Port	# of identical ports	Connector Type	Cable Type	Cable Length (m)	Remarks
1	USB	1	USB	Shielded	1	N/A
2	earphone	1	3.5mm	Un-shielded	1	N/A

TEST SETUP

The EUT is a stand alone. Test software exercised the radio card.

CONDCUTED TEST SETUP DIAGRAM

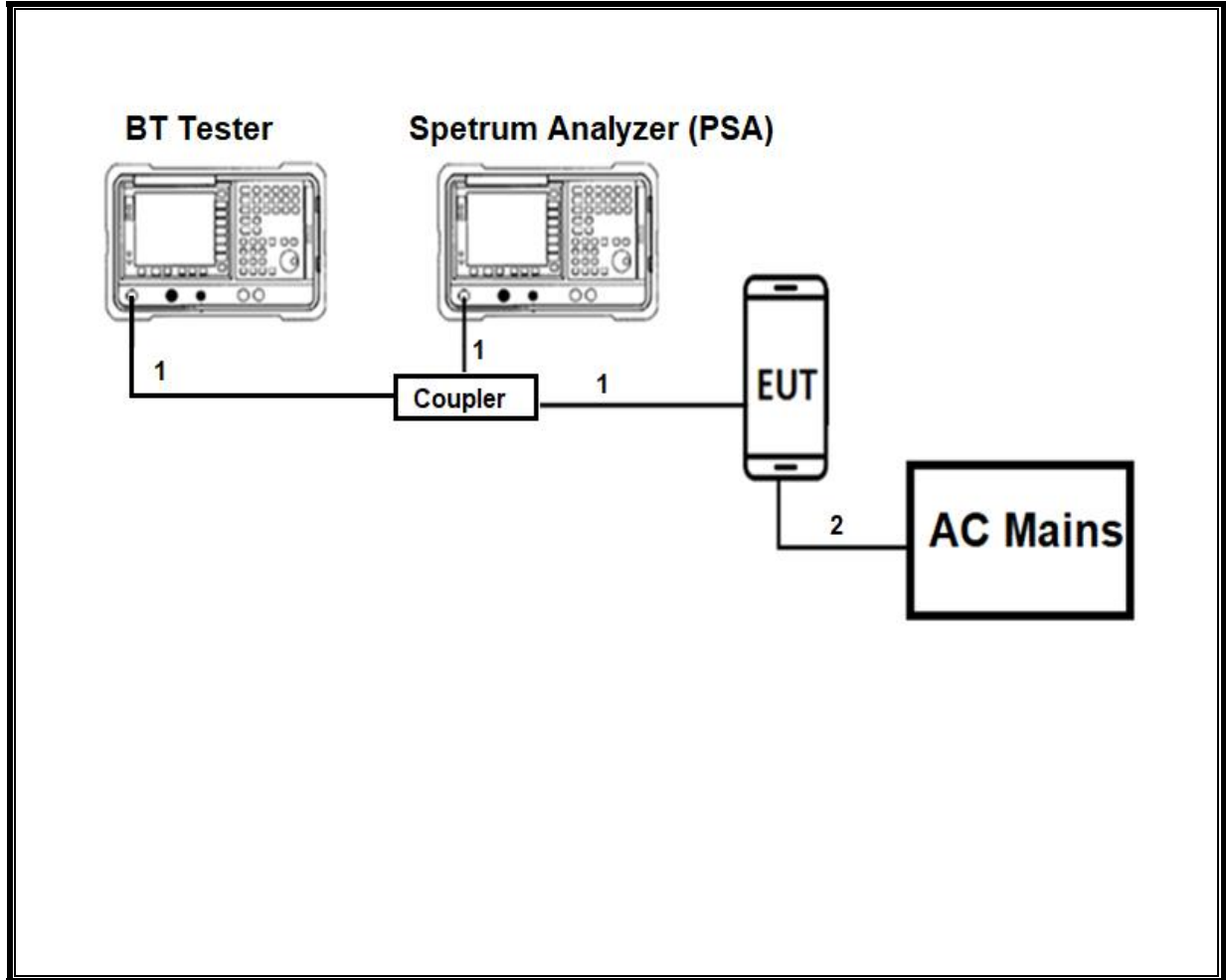

TEST SETUP

For conducted tests: the EUT was Stand alone. The test software exercises the radio.

RADIATED AND AC LINE CONDUCTED EMISSIONS SETUP DIAGRAM

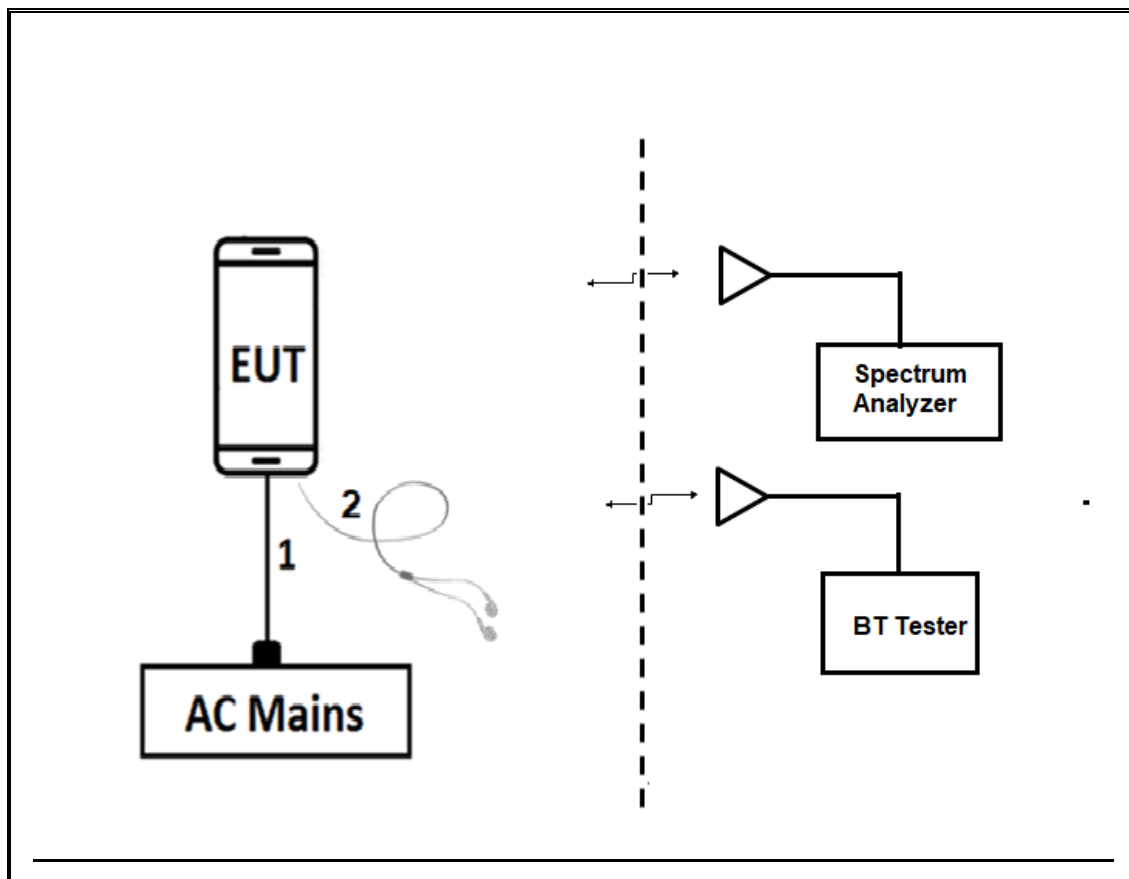

TEST SETUP

For radiated tests: EUT has support equipment (AC Adapter and Headset). The test software exercises the radio.

7. TEST AND MEASUREMENT EQUIPMENT

The following test and measurement equipment was utilized for the tests documented in this report:

TEST EQUIPMENT LIST					
Description	Manufacturer	Model	ID Num	Cal Due	Last Cal
Antenna, Broadband Hybrid, 30MHz to 2000MHz	Sunol Sciences Corp.	JB3	T407	05/10/2019	05/10/2018
Antenna, Horn 1-18GHz	ETS-Lindgren	3117	T345	04/25/2019	04/25/2018
Antenna, Horn 1-18GHz	ETS-Lindgren	3117	T863	06/21/2019	06/21/2018
Bluetooth Tester	Rohde & Schwarz (Koeln) GmbH & Co. KG	CBT	T258	02/23/2019	02/23/2018
Power Meter, P-series single channel	Agilent (Keysight) Technologies	N1911A	T1271	07/26/2019	07/26/2018
Power Sensor, P-series, 50MHz to 18GHz, Wideband	Agilent (Keysight) Technologies	N1921A	T1224	10/09/2019	10/09/2018
Directional Coupler	Mini-Circuits	ZUDC10-183+	T1136	06/18/2019	06/18/2018
EMI Receiver	Rohde & Schwarz	ESR	T1436	02/21/2019	02/21/2018
L.I.S.N.	FCC INC.	FCC LISN 50/250	T1310	06/15/2019	06/15/2018
L.I.S.N.	FCC INC.	FCC LISN 50/250	T24	03/06/2019	03/06/2018
Antenna, Active Loop 9kHz-30MHz	Com-Power Corp.	AL-130R	PRE0165308	12/13/2018	12/13/2017
18 - 26.5 GHz Horn Antenna	Seavey Division	MWH-1826/B	T89	01/18/2019	01/18/2018
Pre-Amp 1-26.5 GHz	Agilent	8449B	T404	03/09/2019	03/09/2018
RF Amplifier	MITEQ	AFS42-00101800-25-S-42	T493	10/13/2019	10/13/2018
RF Amplifier, 1-18GHz	MITEQ	AFS42-00101800-25-S-42	T1165	10/20/2019	10/20/2018
Spectrum Analyzer, PXA, 3Hz to 44GHz	Agilent (Keysight) Technologies	N9030A	T1113	12/21/2018	12/21/2017
Spectrum Analyzer	Agilent (Keysight) Technologies	E4446A	T146	08/13/2019	08/13/2018
Spectrum Analyzer, PXA, 3Hz to 44GHz	Agilent (Keysight) Technologies	N9030A	T1466	04/16/2019	04/16/2018
Spectrum Analyzer, PXA, 3Hz to 44GHz	Agilent (Keysight) Technologies	N9030A	T1454	01/08/2019	01/08/2018

Test Software List			
Description	Manufacturer	Model	Version
Radiated Software	UL	UL EMC	Ver 9.5, Dec 01, 2016
Antenna Port Software	UL	UL RF	Ver 9.0, Oct 31, 2018

8. MEASUREMENT METHODS

On Time and Duty Cycle: ANSI C63.10-2013 Section 11.6

Occupied BW (20dB): ANSI C63.10-2013 Section 6.9.2

Occupied BW (99%): ANSI C63.10-2013 Section 6.9.3

Carrier Frequency Separation: ANSI C63.10-2013 Section 7.8.2

Number of Hopping Frequencies: ANSI C63.10-2013 Section 7.8.3

Time of Occupancy (Dwell Time): ANSI C63.10-2013 Section 7.8.4

Peak Output Power: ANSI C63.10-2013 Section 7.8.5

Conducted Spurious Emissions: ANSI C63.10-2013 Section 7.8.8

Conducted Band-Edge: ANSI C63.10-2013 Section 6.10.4

Radiated Spurious Emissions 30-1000MHz: ANSI C63.10-2013 Section 6.3 and 6.5

Radiated Spurious Emissions above 1GHz: ANSI C63.10-2013 Section 6.3 and 6.6

Radiated Band-edge: ANSI C63.10-2013 Section 6.10.5

AC Power-line conducted emissions: ANSI C63.10-2013, Section 6.2.

9. ANTENNA PORT TEST RESULTS

9.1. ON TIME AND DUTY CYCLE

LIMITS

None; for reporting purposes only.

PROCEDURE

ANSI C63.10, Section 11.6 : Zero-Span Spectrum Analyzer Method.

ON TIME AND DUTY CYCLE RESULTS

Mode	ON Time B (msec)	Period (msec)	Duty Cycle x (linear)	Duty Cycle (%)	Duty Cycle Correction Factor (dB)	1/T Minimum VBW (kHz)
Bluetooth GFSK	2.883	3.759	0.767	76.7%	1.15	0.347
Bluetooth 8PSK	2.890	3.740	0.773	77.3%	1.12	0.346

DUTY CYCLE PLOTS

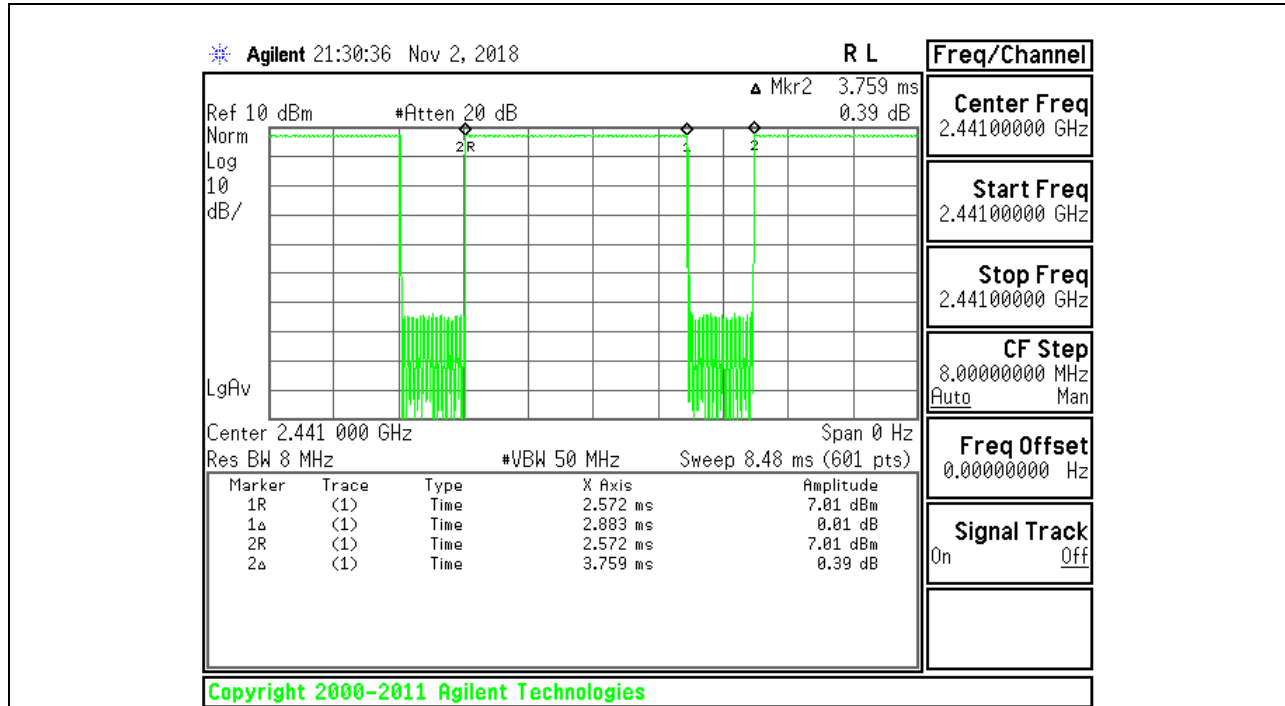

BLUETOOTH GFSK

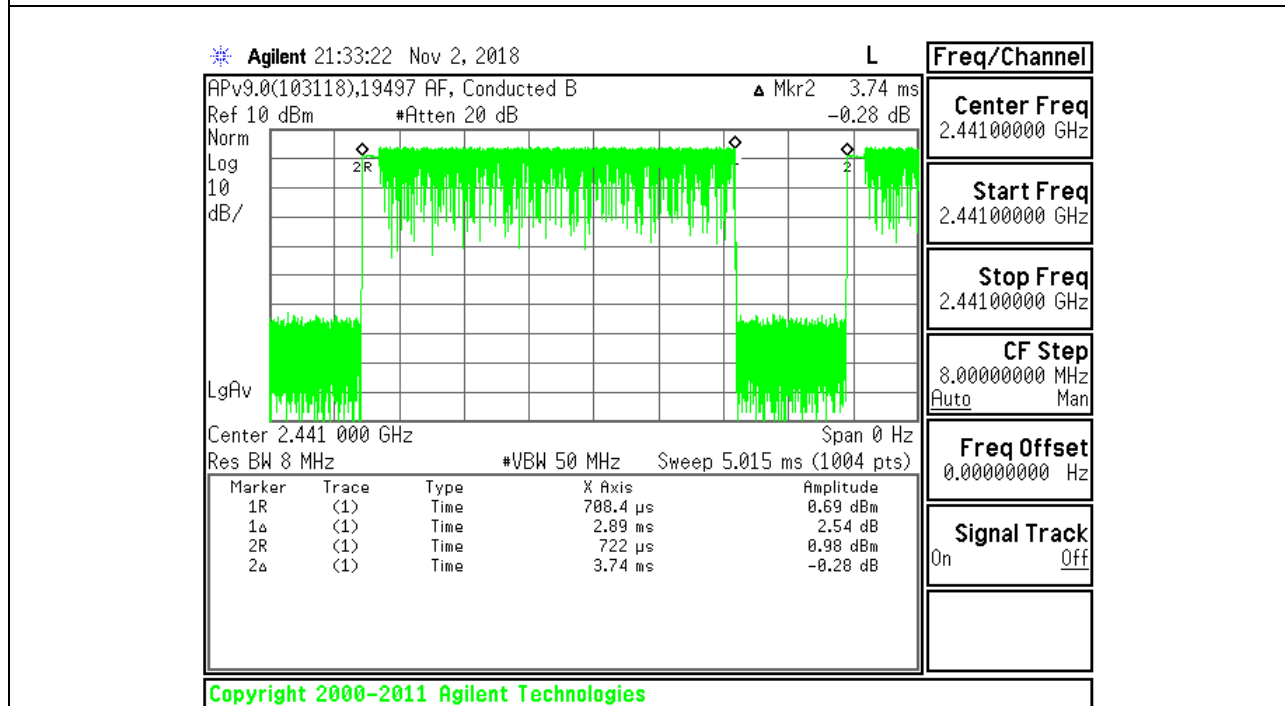

BLUETOOTH 8PSK

9.2. 20 dB AND 99% BANDWIDTH

LIMITS

None; for reporting purposes only.

TEST PROCEDURE

The transmitter output is connected to a spectrum analyzer. The RBW is set to $\geq 1\%$ of the 20 dB bandwidth. The VBW is set to \geq RBW. The sweep time is coupled.

RESULTS

9.2.1. BLUETOOTH BASIC DATA RATE GFSK MODULATION

Channel	Frequency (MHz)	20dB Bandwidth (MHz)	99% Bandwidth (MHz)
Low	2402	0.982	0.8902
Mid	2441	0.981	0.8906
High	2480	0.982	0.8877

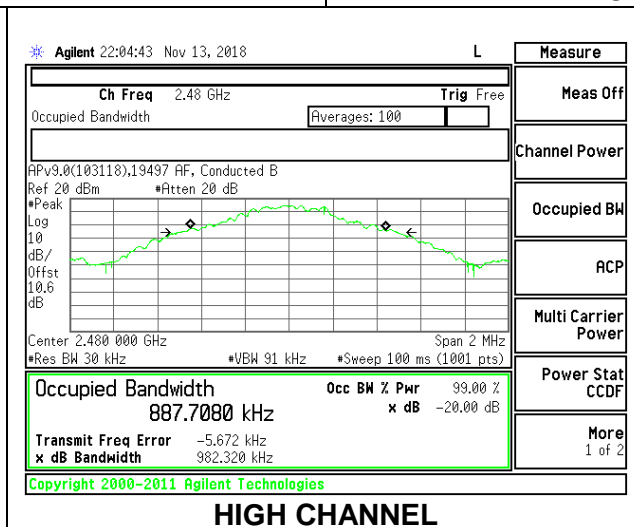
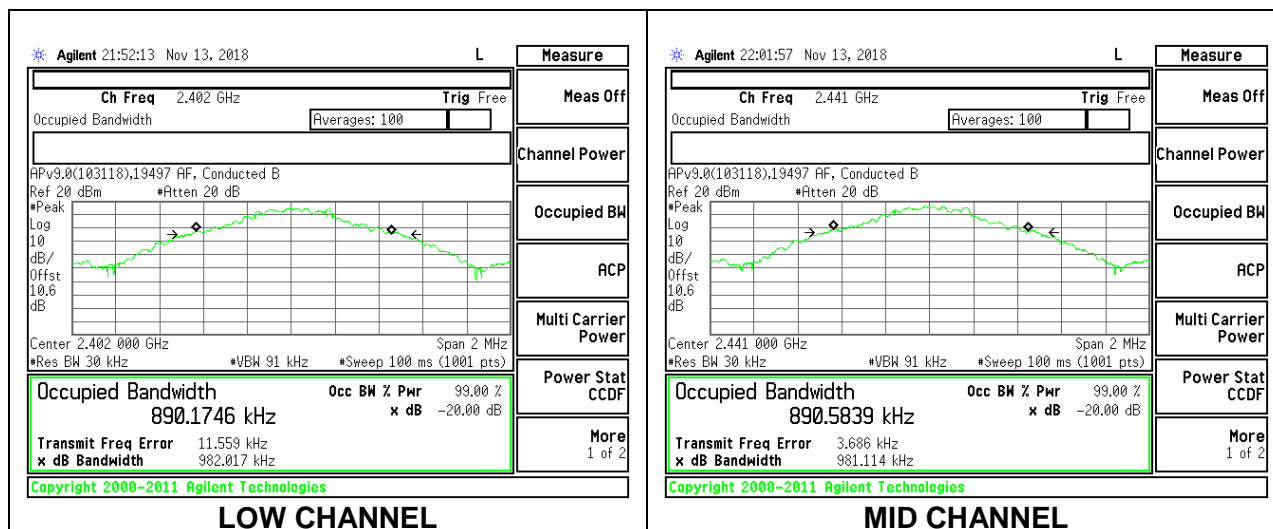

9.2.2. BLUETOOTH ENHANCED DATA RATE 8PSK MODULATION

Channel	Frequency (MHz)	20dB Bandwidth (MHz)	99% Bandwidth (MHz)
Low	2402	1.331	1.1972
Mid	2441	1.328	1.1964
High	2480	1.327	1.1957

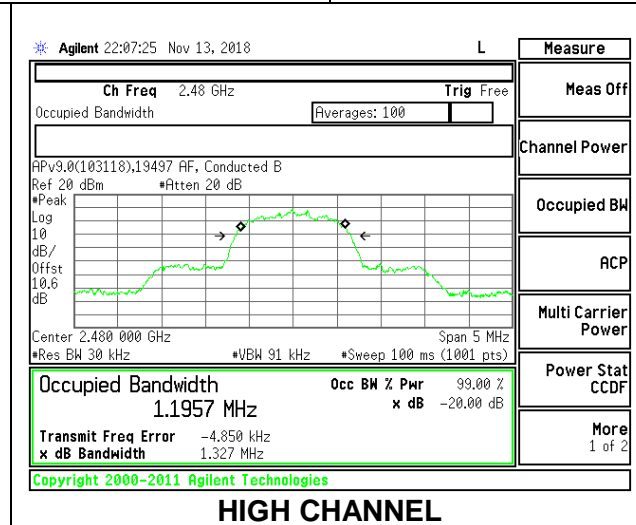
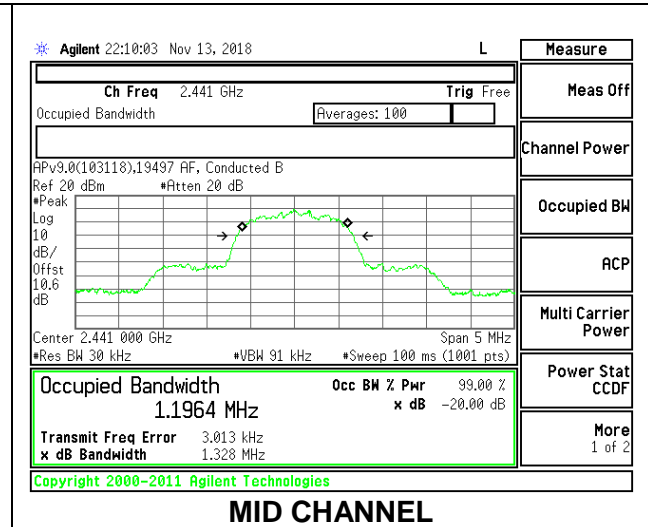
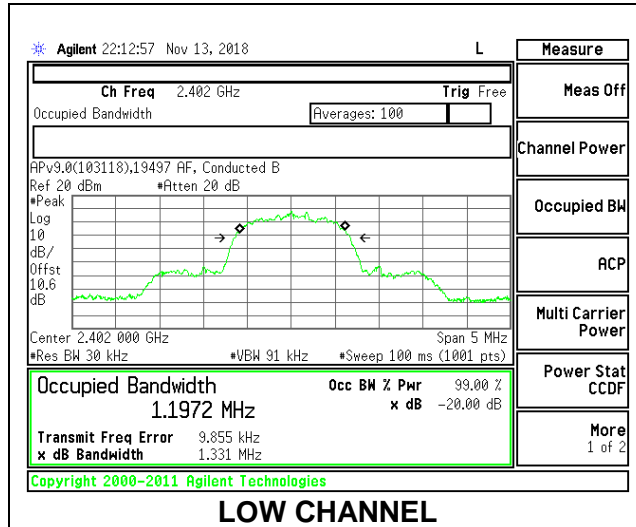

9.3. HOPPING FREQUENCY SEPARATION

LIMITS

FCC §15.247 (a) (1)

Frequency hopping systems shall have hopping channel carrier frequencies separated by a minimum of 25 kHz or the 20 dB bandwidth of the hopping channel, whichever is greater.

Alternatively, frequency hopping systems operating in the 2400-2483.5 MHz band may have hopping channel carrier frequencies that are separated by 25 kHz or two-thirds of the 20 dB bandwidth of the hopping channel, whichever is greater, provided the systems operate with an output power no greater than 125 mW.

TEST PROCEDURE

The transmitter output is connected to a spectrum analyzer. The RBW is set to 300 kHz and the VBW is set to 910 kHz. The sweep time is coupled.

RESULTS

9.3.1. BLUETOOTH BASIC DATA RATE GFSK MODULATION

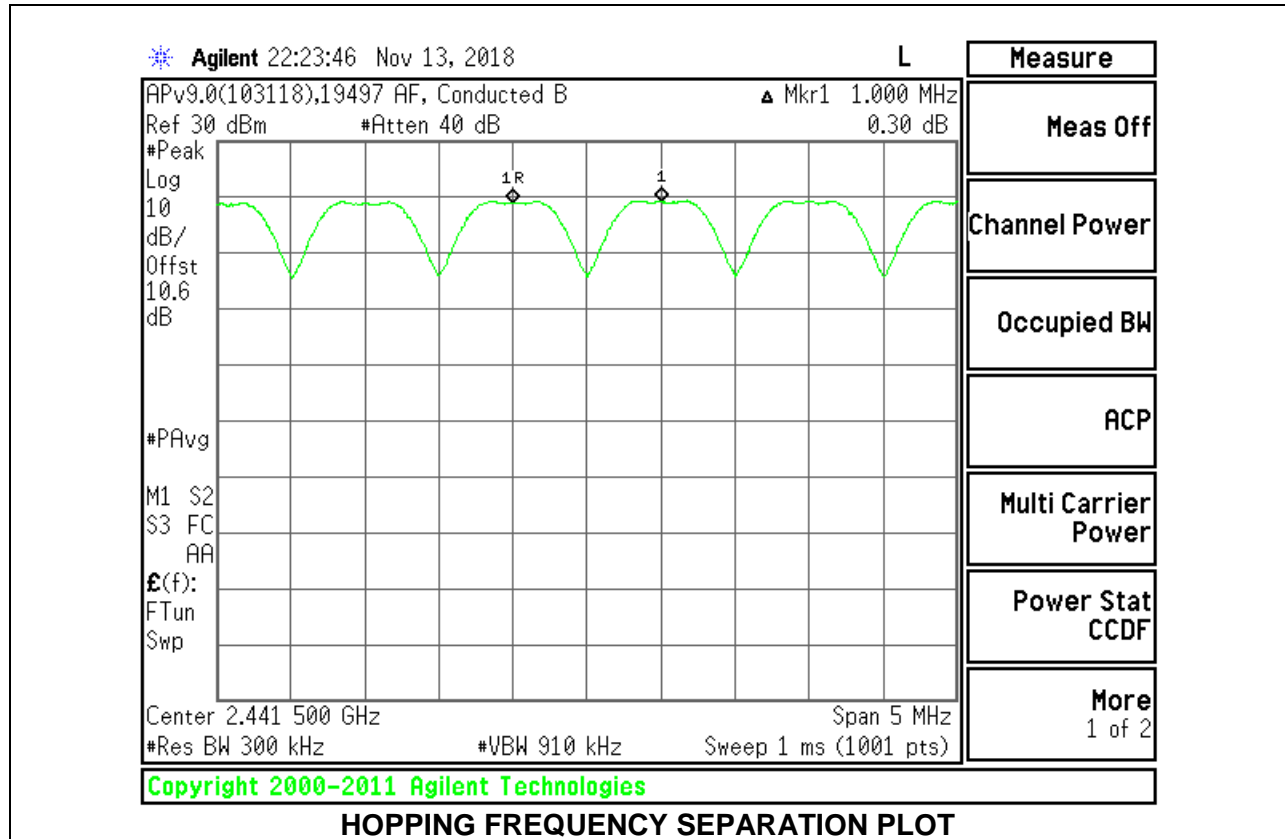

9.3.2. BLUETOOTH ENHANCED DATA RATE 8PSK MODULATION

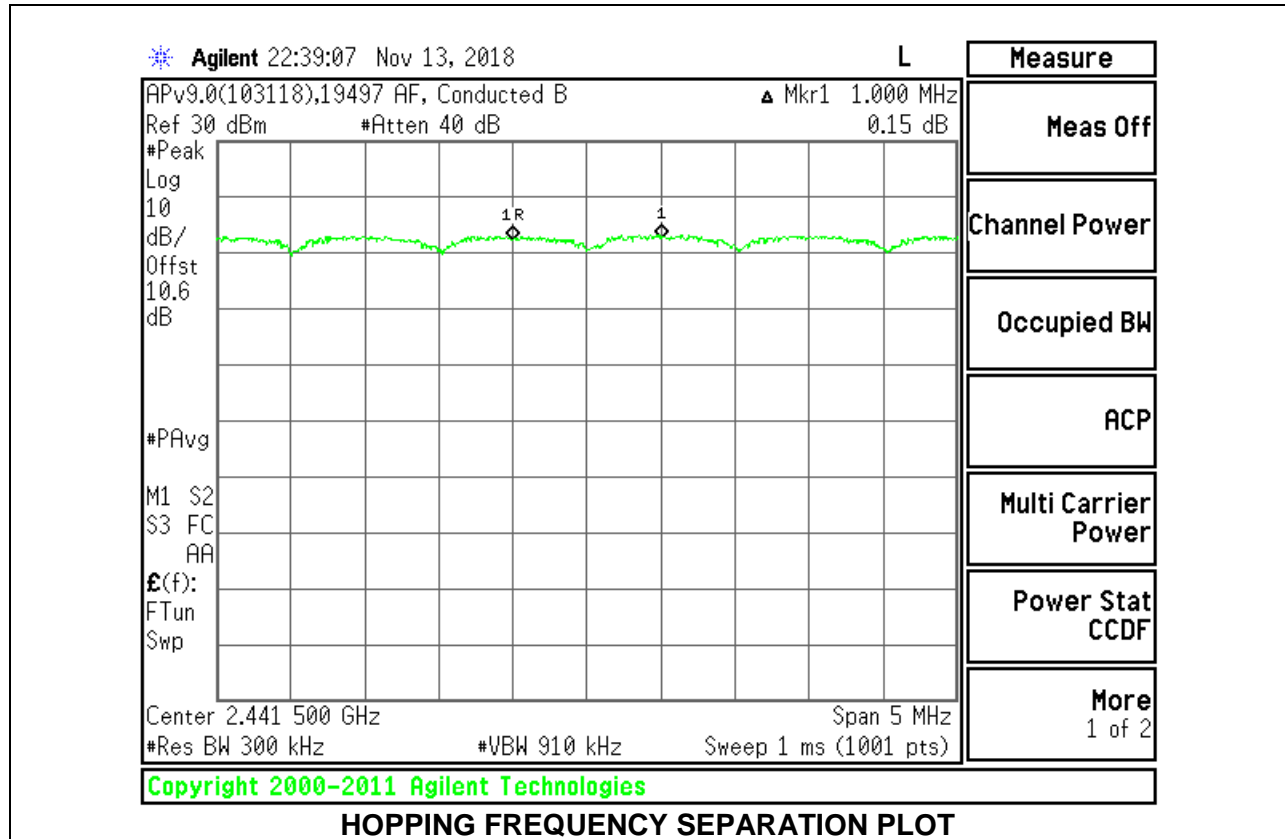

9.4. NUMBER OF HOPPING CHANNELS

LIMITS

FCC §15.247 (a) (1) (iii)

Frequency hopping systems in the 2400 – 2483.5 MHz band shall use at least 15 non-overlapping channels.

TEST PROCEDURE

The transmitter output is connected to a spectrum analyzer. The span is set to cover the entire authorized band, in either a single sweep or in multiple contiguous sweeps. The RBW is set to a maximum of 1 % of the span. The analyzer is set to Max Hold.

RESULTS

Normal Mode: 79 Channels Observed

9.4.1. BLUETOOTH BASIC DATA RATE GFSK MODULATION

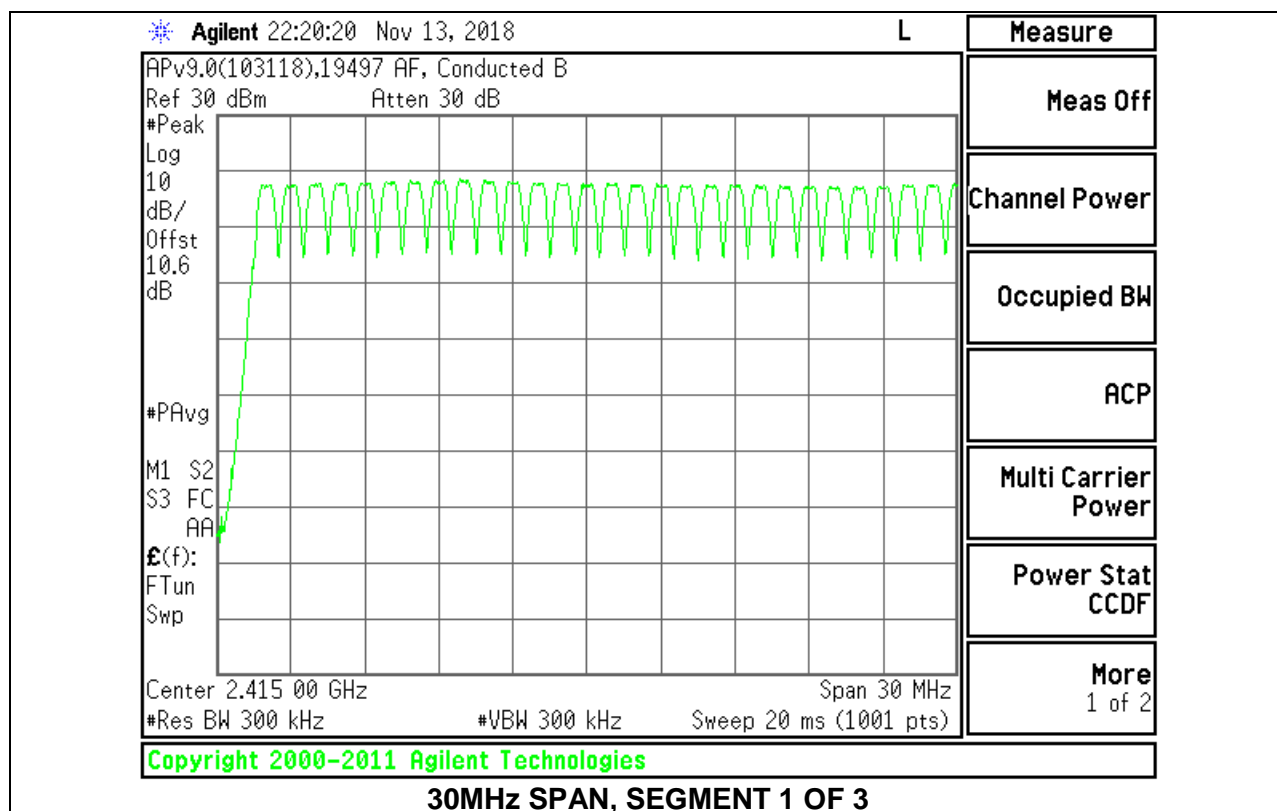
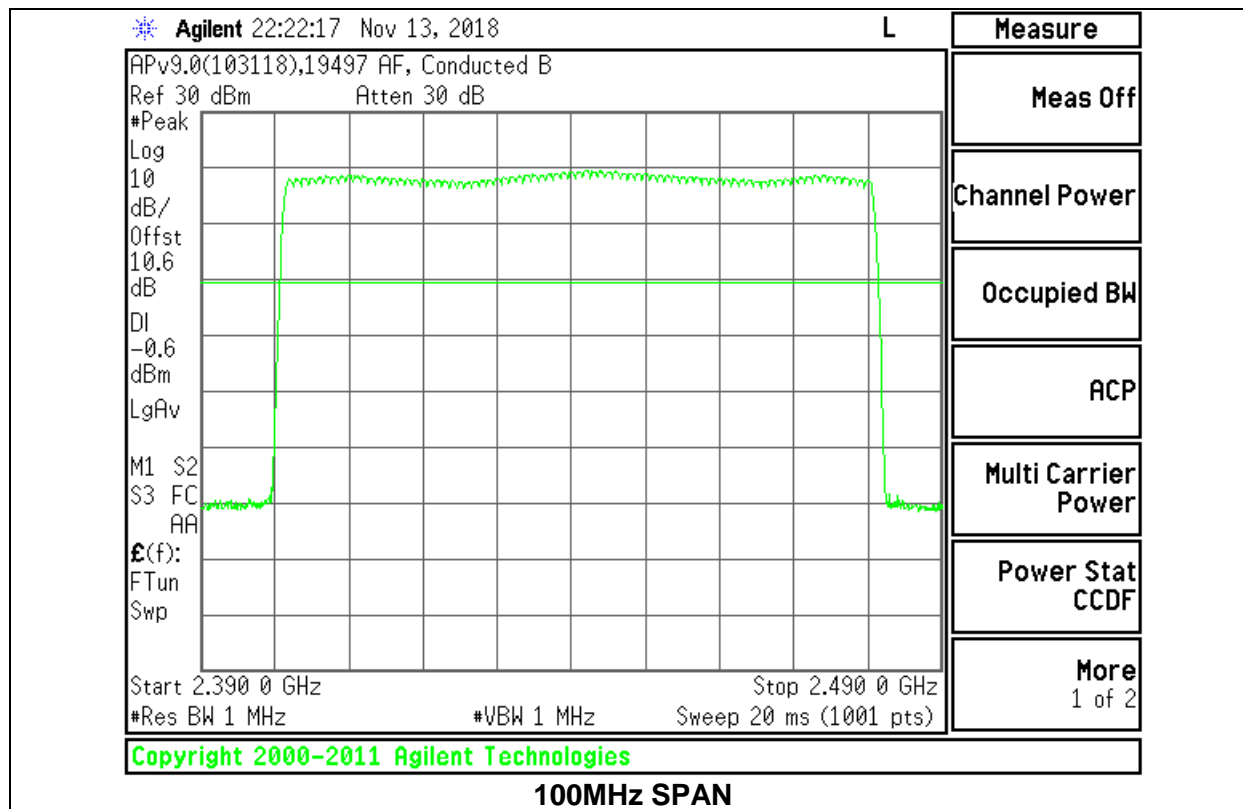

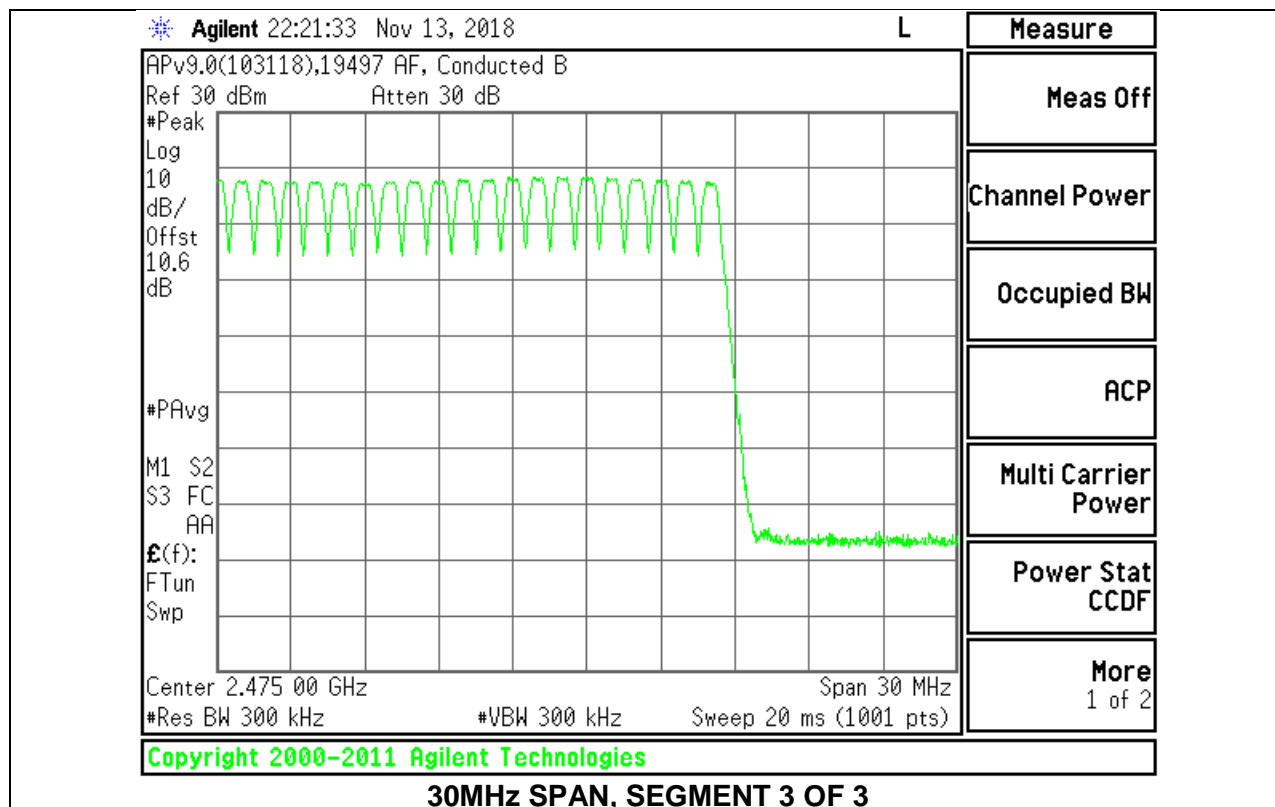
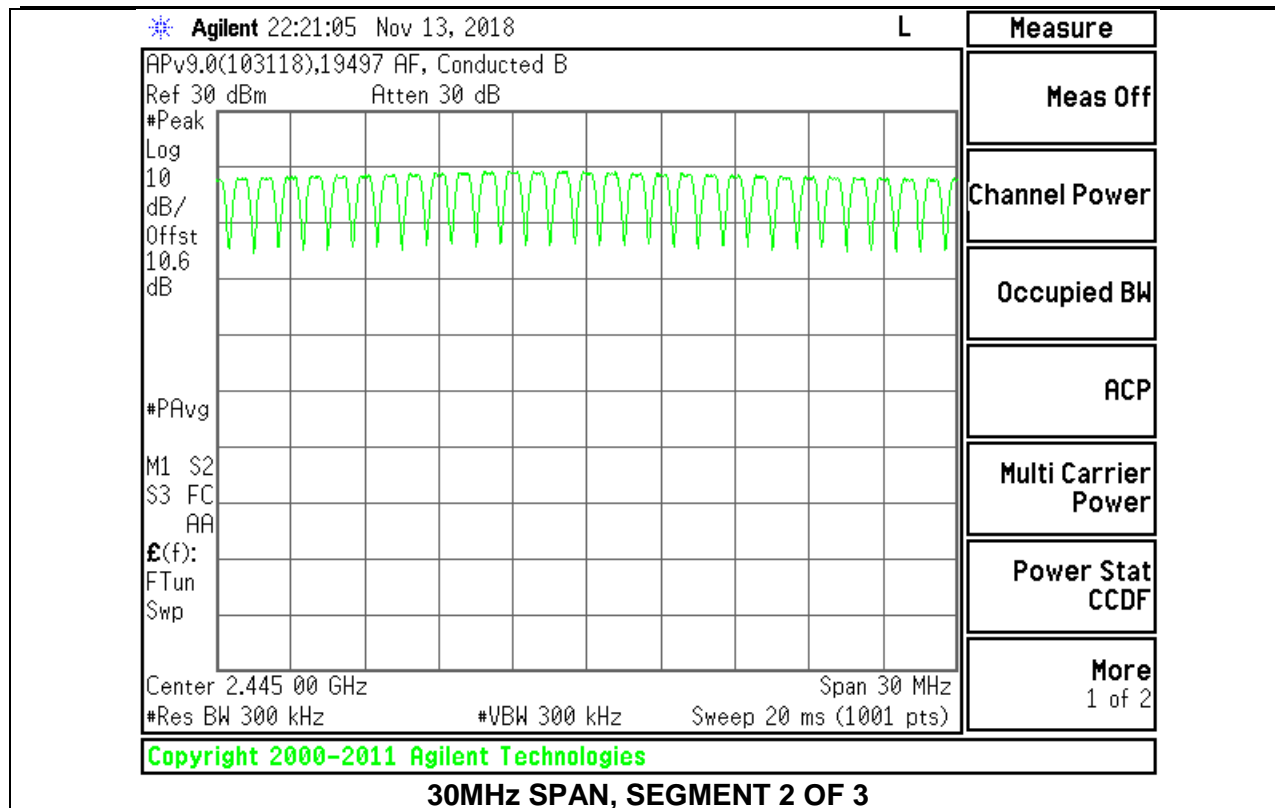

9.4.2. BLUETOOTH ENHANCED DATA RATE 8PSK MODULATION

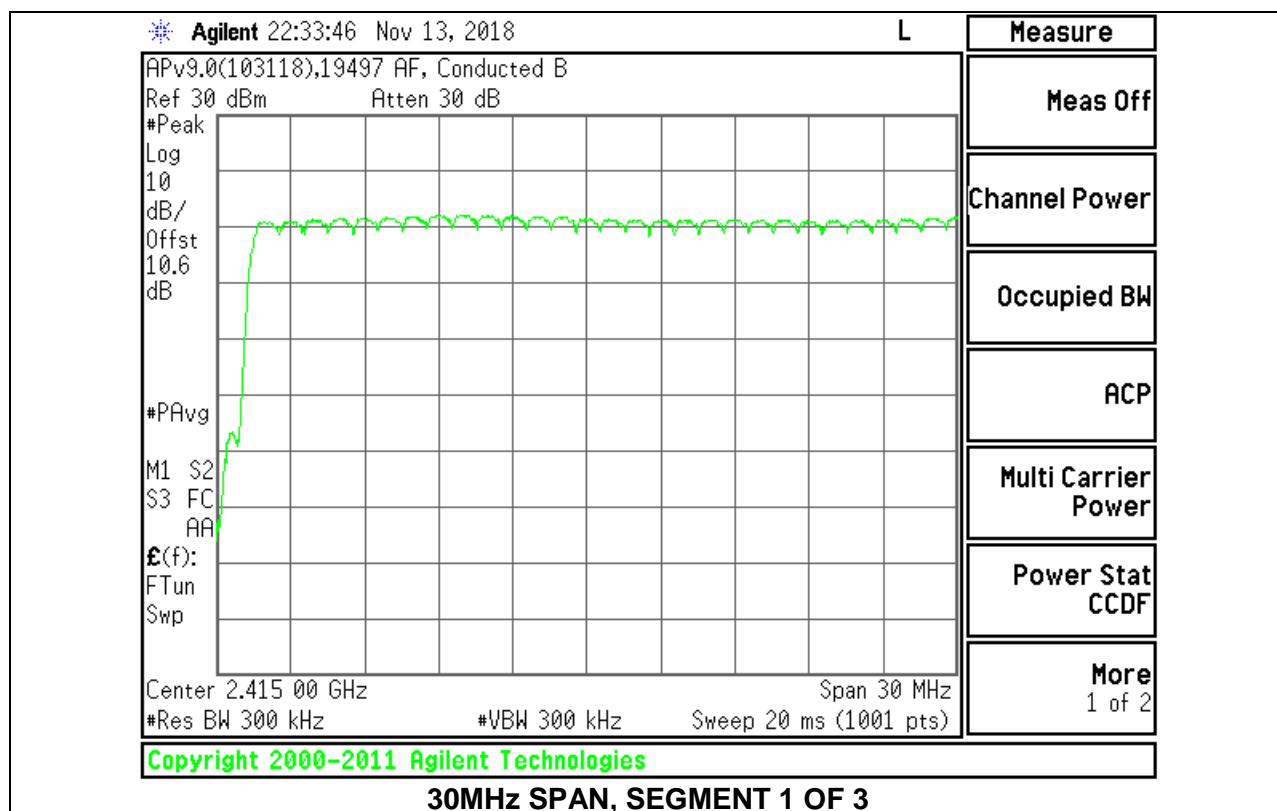
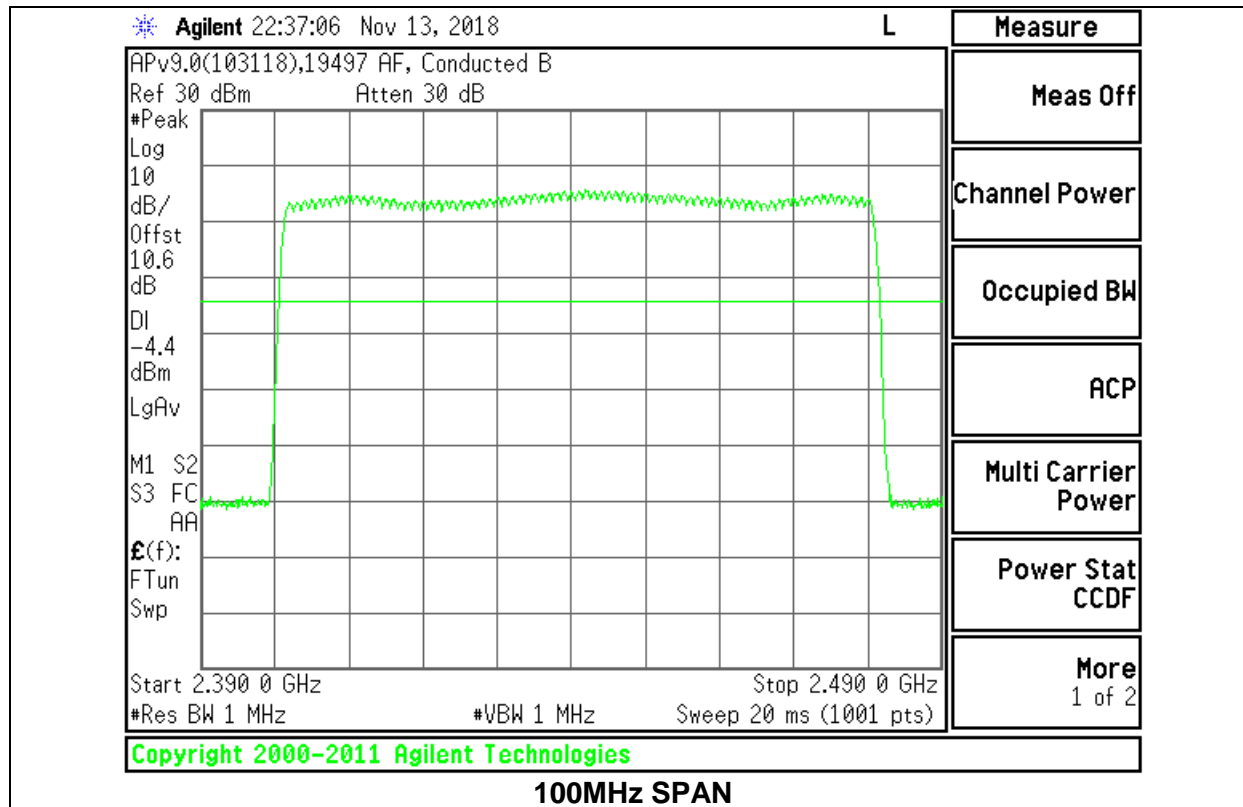

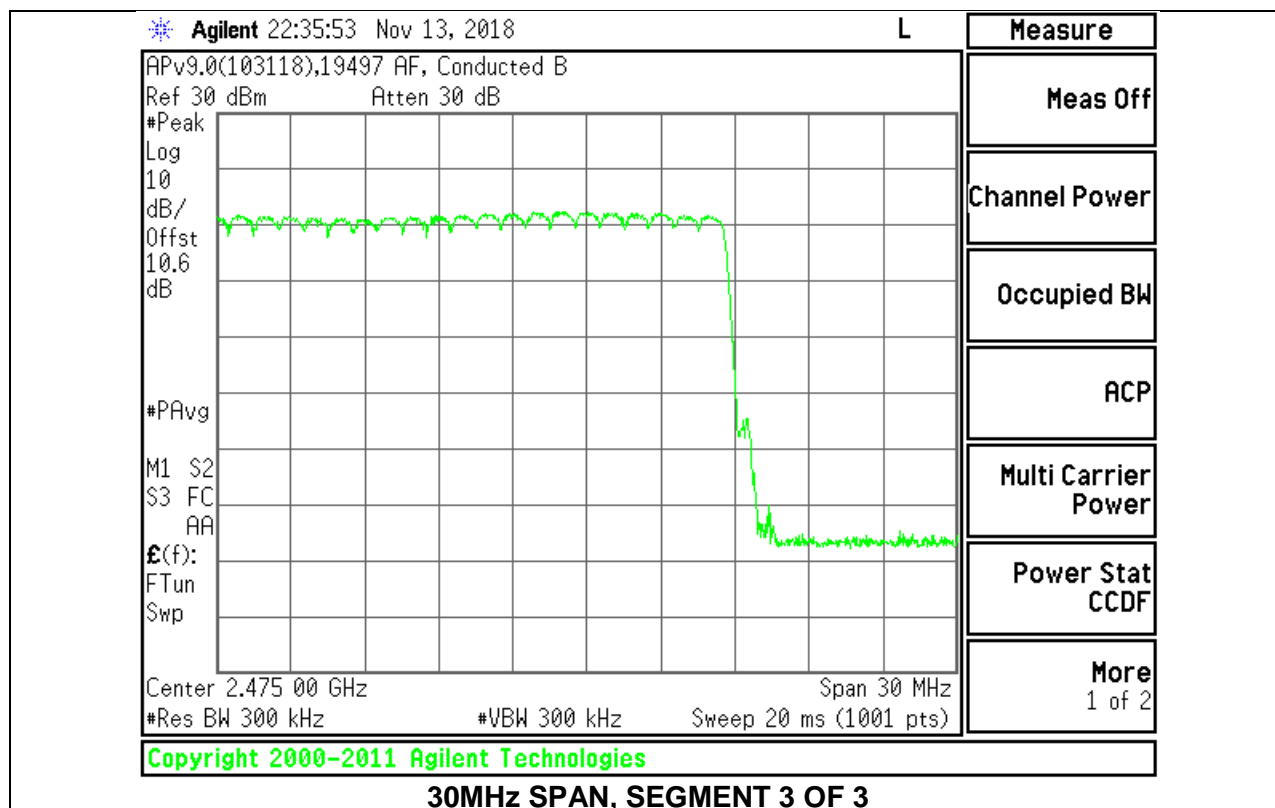
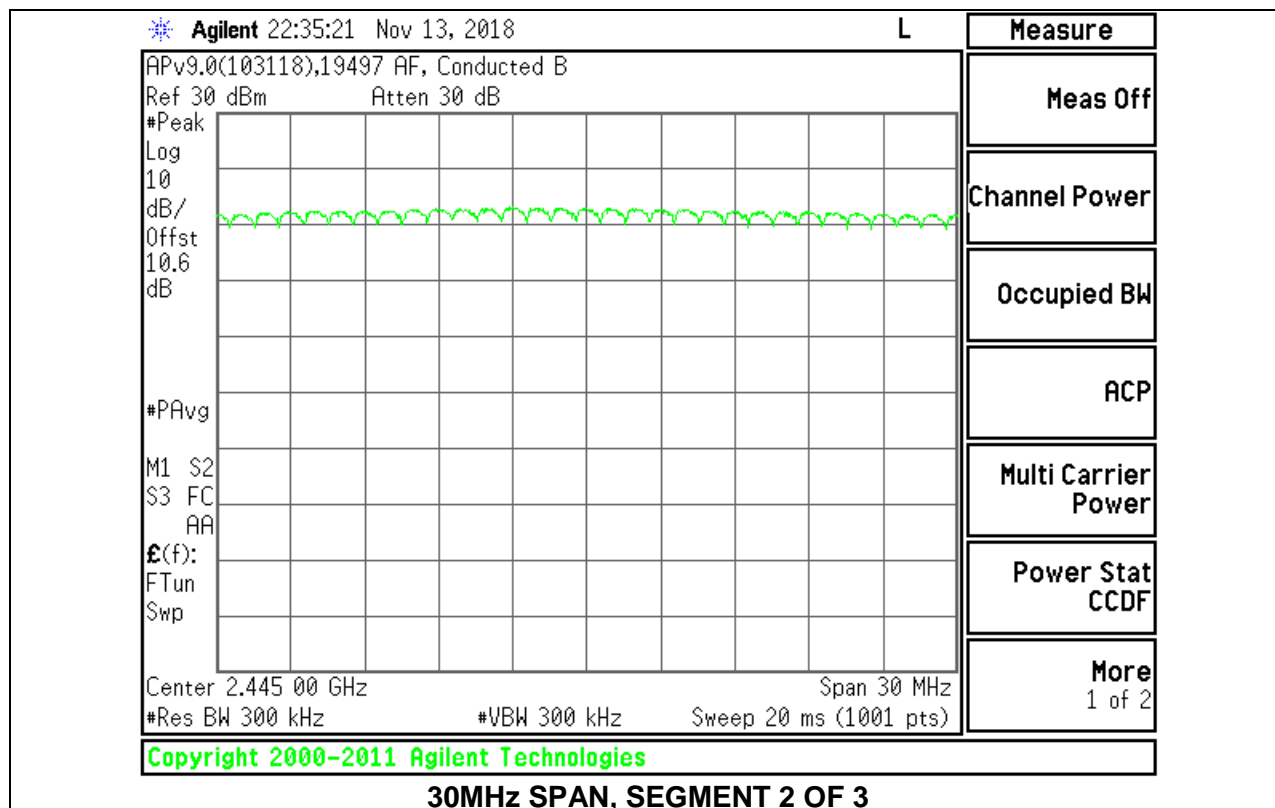

9.5. AVERAGE TIME OF OCCUPANCY

LIMITS

FCC §15.247 (a) (1) (iii)

The average time of occupancy on any channel shall not be greater than 0.4 seconds within a period of 0.4 seconds multiplied by the number of hopping channels employed.

TEST PROCEDURE

The transmitter output is connected to a spectrum analyzer. The span is set to 0 Hz, centered on a single, selected hopping channel. The width of a single pulse is measured in a fast scan. The number of pulses is measured in a 3.16 second scan, to enable resolution of each occurrence.

The average time of occupancy in the specified 3.16 second period (79 channels * 0.4 s) is equal to $10 * (\# \text{ of pulses in } 3.16 \text{ s}) * \text{ pulse width}$.

For AFH mode, the average time of occupancy in the specified 8 second period (20 channels * 0.4 seconds) is equal to $10 * (\# \text{ of pulses in } 0.8 \text{ s}) * \text{ pulse width}$.

RESULTS

9.5.1. BLUETOOTH BASIC DATA RATE GFSK MODULATION

DH Packet	Pulse Width (msec)	Number of Pulses in 3.16 seconds	Average Time of Occupancy (sec)	Limit (sec)	Margin (sec)
GFSK Normal Mode					
DH1	0.383	31	0.1187	0.4	-0.2813
DH3	1.639	16	0.2622	0.4	-0.1378
DH5	2.888	11	0.3177	0.4	-0.0823
GFSK AFH Mode					
DH Packet	Pulse Width (sec)	Number of Pulses in 0.8 seconds	Average Time of Occupancy (sec)	Limit (sec)	Margin (sec)
DH1	0.383	7.75	0.02968	0.4	-0.3703
DH3	1.639	4	0.06556	0.4	-0.3344
DH5	2.888	2.75	0.07942	0.4	-0.3206

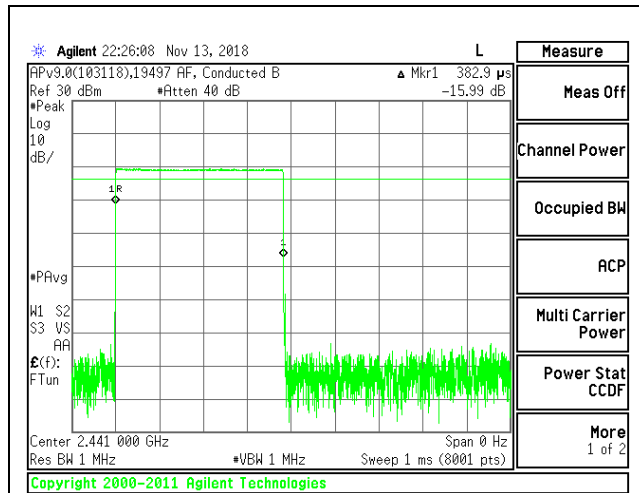

PULSE WIDTH - DH1

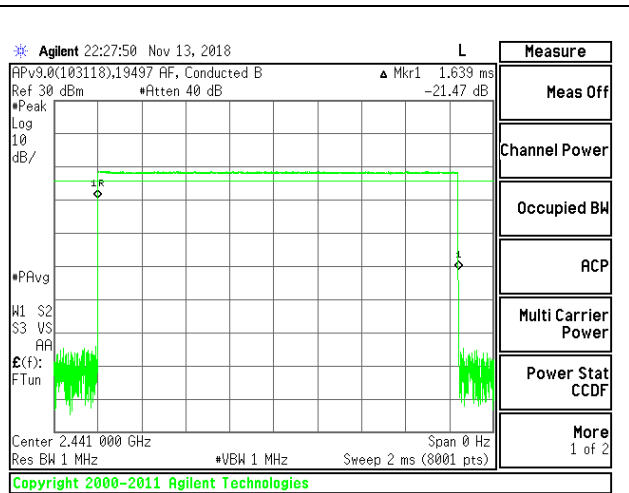

PULSE WIDTH - DH3

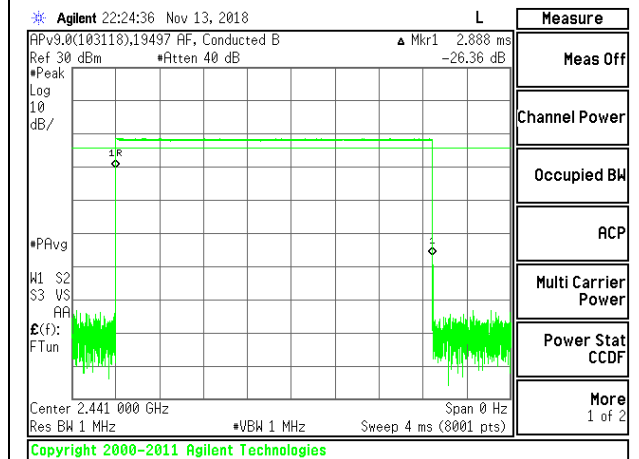

PULSE WIDTH - DH5

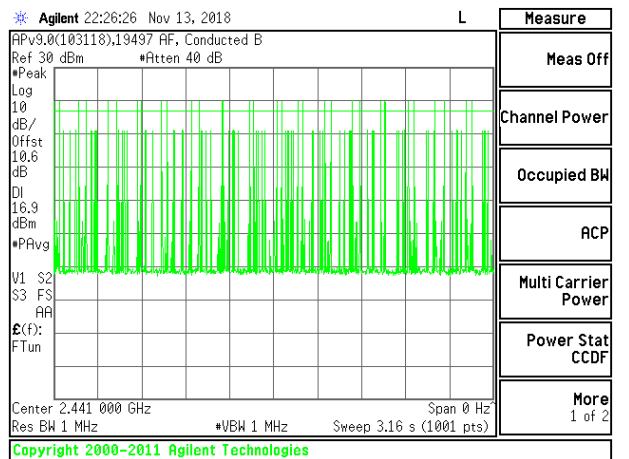

NUMBER OF PULSES IN 3.16 SECOND OBSERVATION PERIOD - DH1

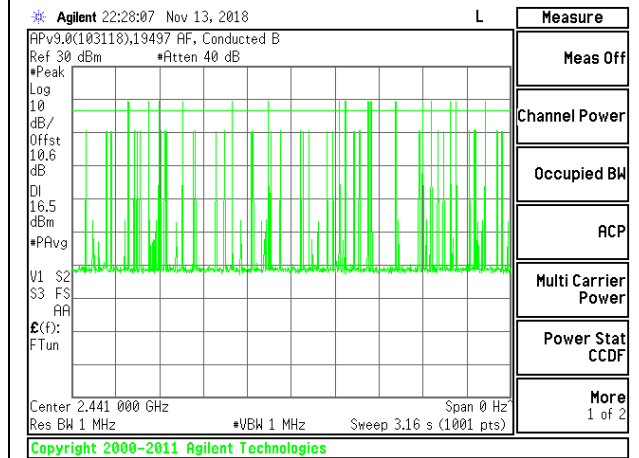

NUMBER OF PULSES IN 3.16 SECOND OBSERVATION PERIOD - DH3

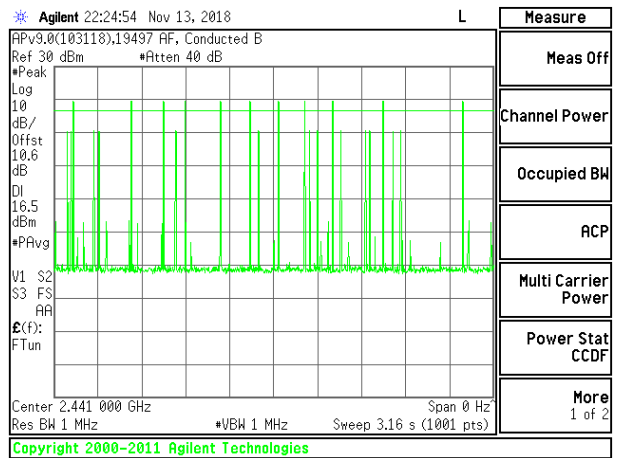

NUMBER OF PULSES IN 3.16 SECOND OBSERVATION PERIOD - DH5

9.5.2. BLUETOOTH ENHANCED DATA RATE 8PSK MODULATION

DH Packet	Pulse Width (msec)	Number of Pulses in 3.16 seconds	Average Time of Occupancy (sec)	Limit (sec)	Margin (sec)
8PSK Normal Mode					
3DH1	0.389	32	0.12448	0.4	-0.27552
3DH3	1.639	13	0.21307	0.4	-0.18693
3DH5	2.891	12	0.34692	0.4	-0.05308

Note: for AFH(8PSK) mode, please refer to the results of AFH(GFSK) mode; the channel selection and hopping rate are the same for both EDR and Basic Rate operation, data for Basic Rate demonstrates compliance with channel occupancy when AFH is employed.

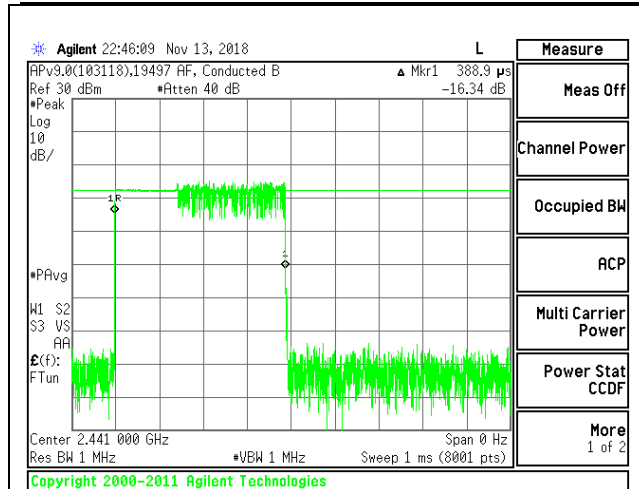

PULSE WIDTH - 3DH1

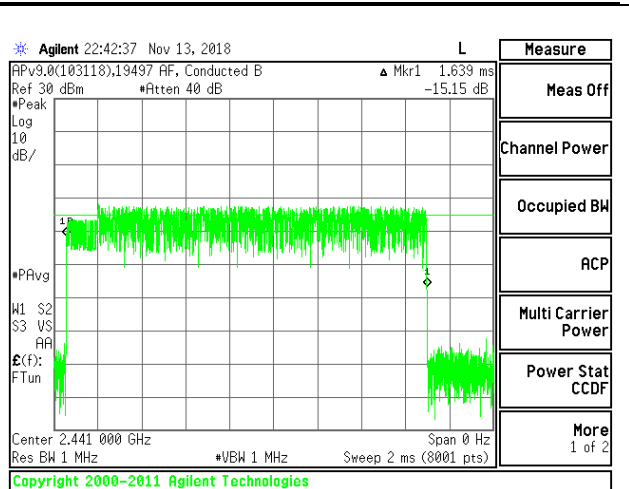

PULSE WIDTH - 3DH3

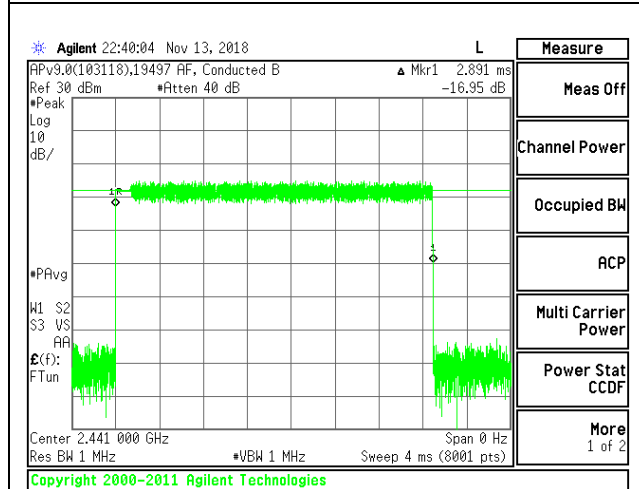

PULSE WIDTH - 3DH5

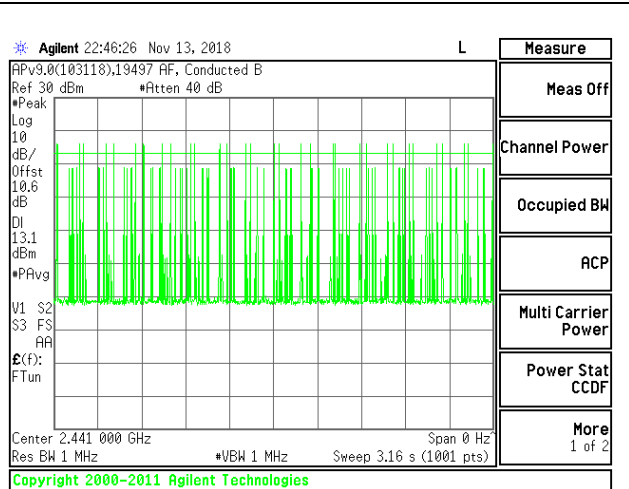

NUMBER OF PULSES IN 3.16 SECOND OBSERVATION PERIOD - 3DH1

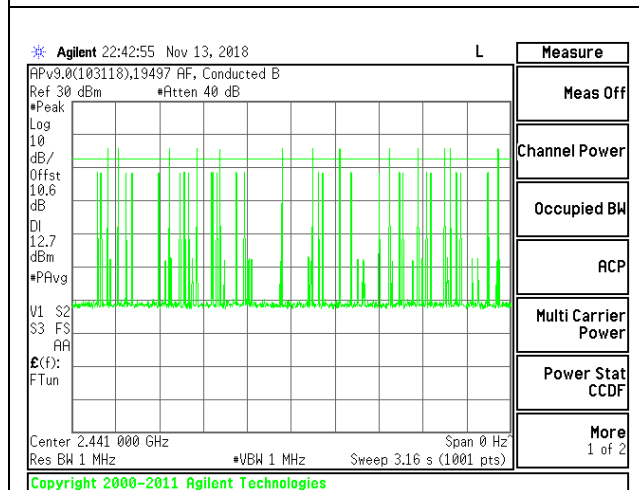

NUMBER OF PULSES IN 3.16 SECOND OBSERVATION PERIOD - 3DH3

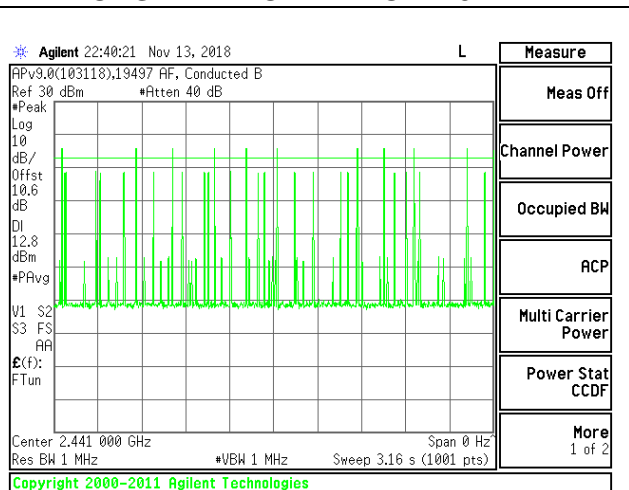

NUMBER OF PULSES IN 3.16 SECOND OBSERVATION PERIOD - 3DH5

9.6. OUTPUT POWER

LIMITS

§15.247 (b) (1)

The maximum antenna gain is less than 6 dBi, therefore the limit is 30 dBm. Alternatively, frequency hopping systems operating in the 2400-2483.5 MHz band may have hopping channel carrier frequencies that are separated by 25 kHz or two-thirds of the 20 dB bandwidth of the hopping channel, whichever is greater, provided the systems operate with an output power no greater than 125 mW.

TEST PROCEDURE

Measurements perform using a wideband gated RF power meter. The cable assembly insertion loss was entered as an offset in the power meter to allow for a gated peak reading of power.

RESULTS

9.6.1. BLUETOOTH BASIC DATA RATE GFSK MODULATION

Tested By:	19497AF
Date:	11/13/2018

Channel	Frequency (MHz)	Output Power (dBm)	Limit (dBm)	Margin (dB)
Low	2402	18.35	30	-11.65
Middle	2441	19.80	30	-10.2
High	2480	18.28	30	-11.72

9.6.2. BLUETOOTH ENHANCED DATA RATE 8PSK MODULATION

Tested By:	19497AF
Date:	11/13/2018

Channel	Frequency (MHz)	Output Power (dBm)	Limit (dBm)	Margin (dB)
Low	2402	14.67	21	-6.33
Middle	2441	16.50	21	-4.5
High	2480	15.13	21	-5.87

9.7. AVERAGE POWER

LIMITS

None; for reporting purposes only

TEST PROCEDURE

Measurements perform using a wideband gated RF power meter. The cable assembly insertion loss was entered as an offset in the power meter to allow for a gated average reading of power.

RESULTS

9.7.1. BLUETOOTH BASIC DATA RATE GFSK MODULATION

Tested By:	19497AF
Date	11/13/2018

Channel	Frequency (MHz)	Average Power (dBm)
Low	2402	17.87
Middle	2441	18.76
High	2480	17.90

9.7.2. BLUETOOTH ENHANCED DATA RATE 8PSK MODULATION

Tested By:	19497AF
Date	11/13/2018

Channel	Frequency (MHz)	Average Power (dBm)
Low	2402	11.12
Middle	2441	12.97
High	2480	11.65

9.8. CONDUCTED SPURIOUS EMISSIONS

LIMITS

FCC §15.247 (d)

Limit = -20 dBc

TEST PROCEDURE

The transmitter output is connected to a spectrum analyzer. The resolution bandwidth is set to 100 kHz. The video bandwidth is set to 300 kHz.

The spectrum from 30 MHz to 26 GHz is investigated with the transmitter set to the lowest, middle, and highest channels.

The bandedges at 2.4 and 2.4835 GHz are investigated with the transmitter set to the normal hopping mode.

RESULTS

9.8.1. BLUETOOTH BASIC DATA RATE GFSK MODULATION

Antenna 1 SPURIOUS EMISSIONS, NON-HOPPING

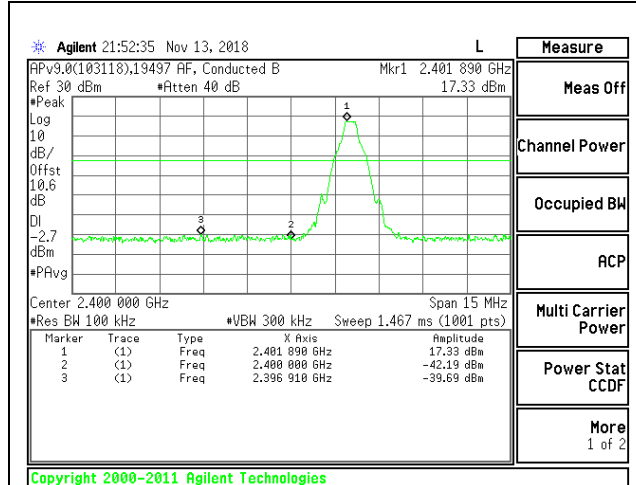

LOW CHANNEL BANDEGE

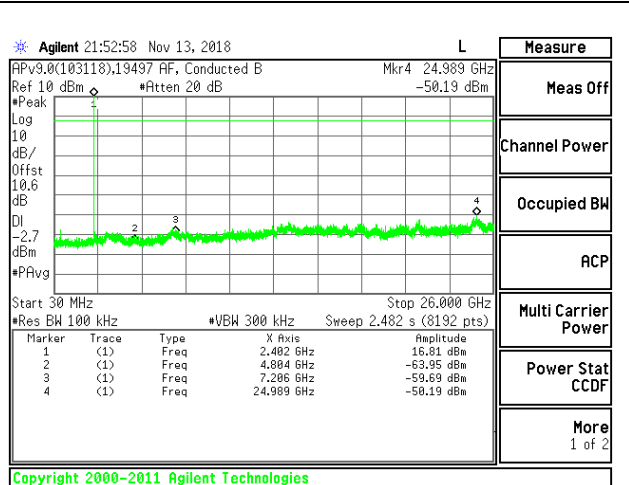

OUT-OF-BAND LOW CHANNEL

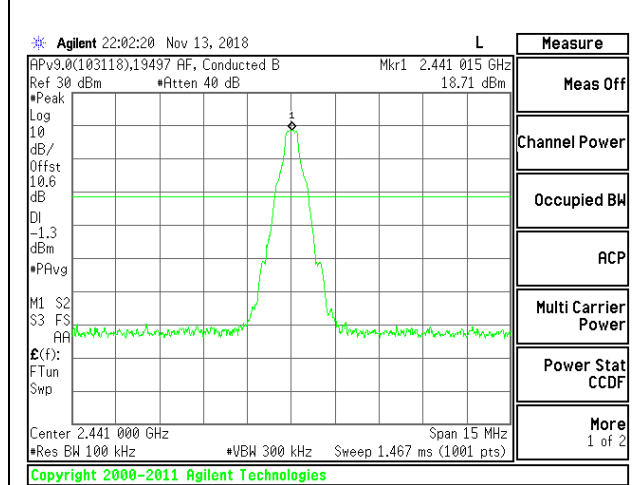

IN-BAND REFERENCE LEVEL

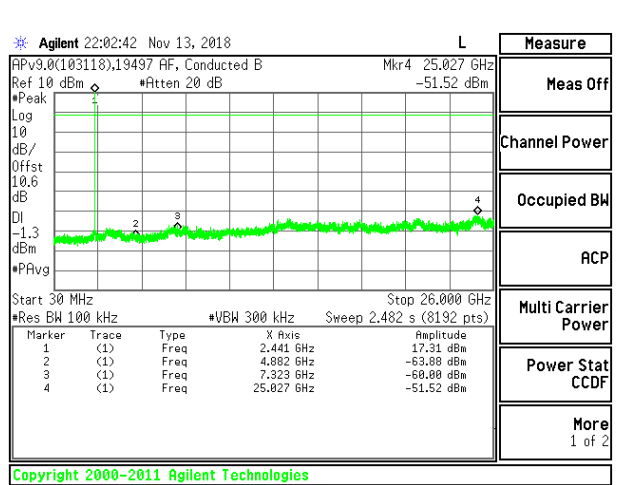

OUT-OF-BAND MID CHANNEL

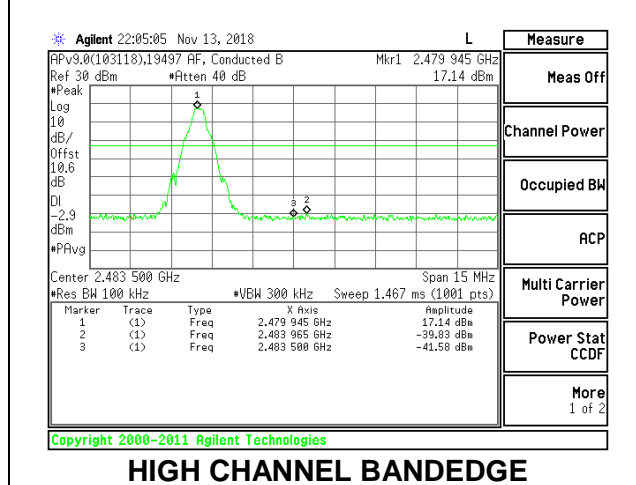

HIGH CHANNEL BANDEGE

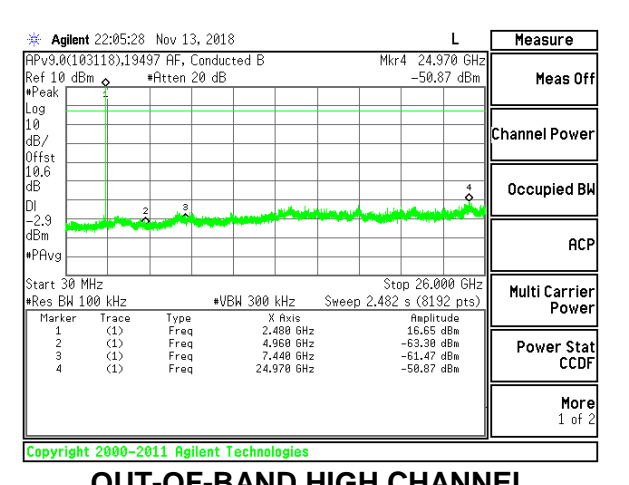

OUT-OF-BAND HIGH CHANNEL

Antenna 1 SPURIOUS BANDEDGE EMISSIONS WITH HOPPING ON

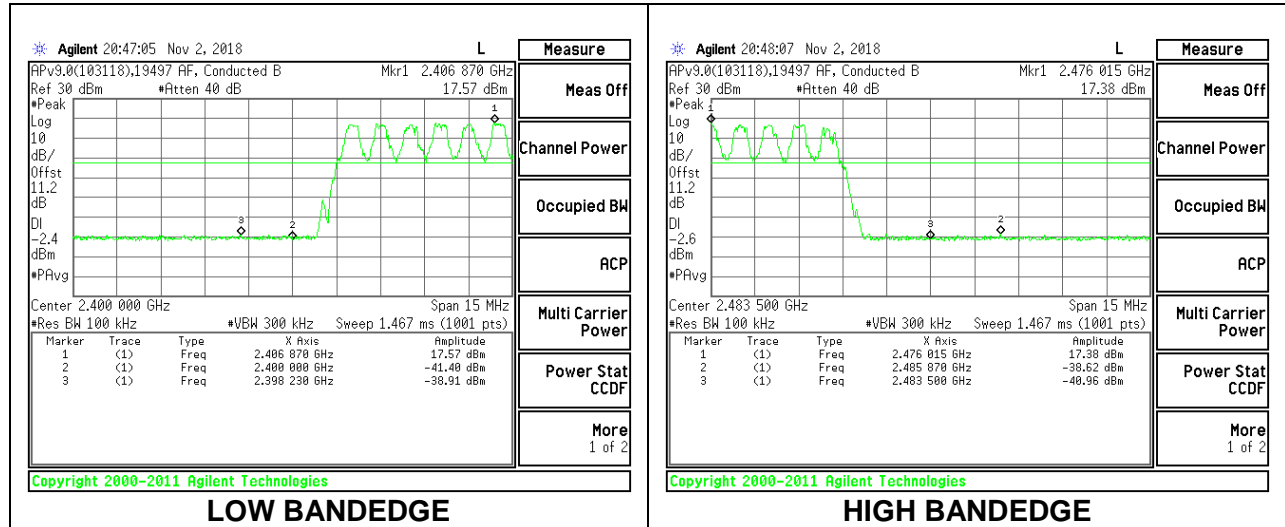

9.8.2. BLUETOOTH ENHANCED DATA RATE 8PSK MODULATION

Antenna 1 SPURIOUS EMISSIONS, NON-HOPPING

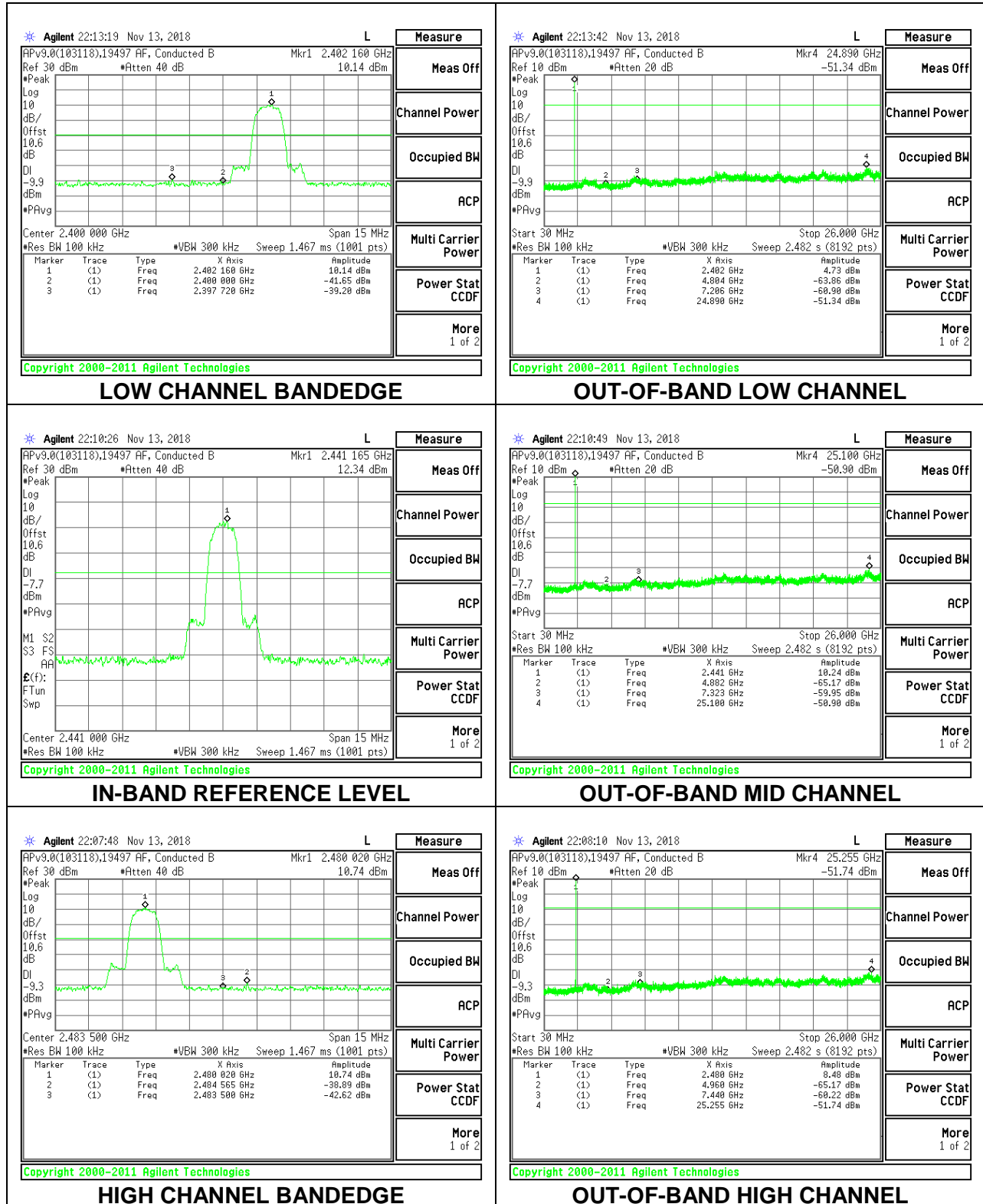

Antenna 1 SPURIOUS BANDEDGE EMISSIONS WITH HOPPING ON

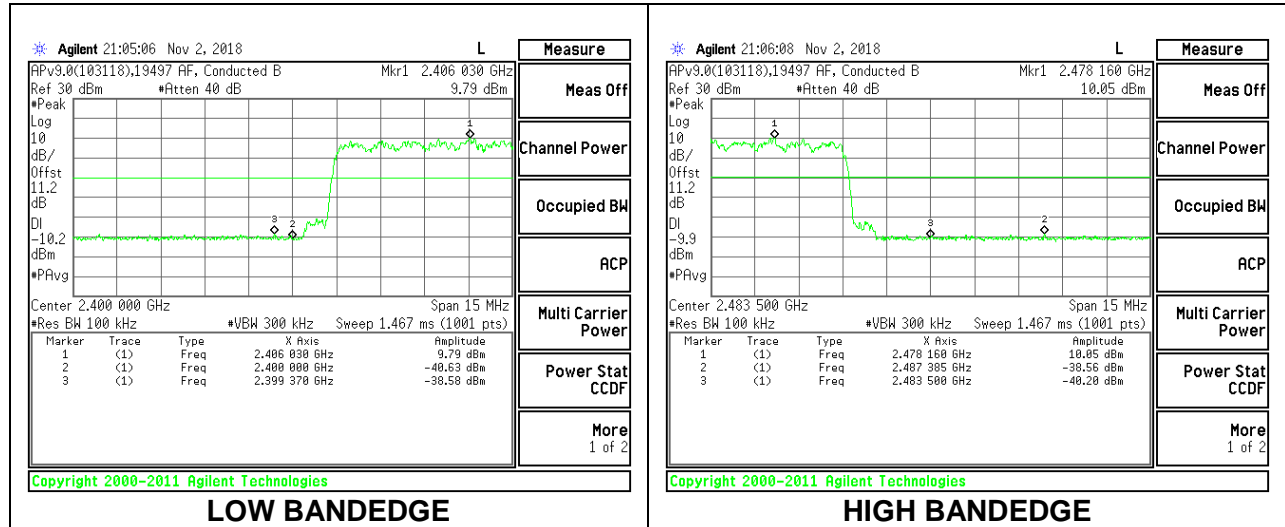

10. RADIATED TEST RESULTS

LIMITS

FCC §15.205 and §15.209

Frequency Range (MHz)	Field Strength Limit (uV/m) at 3 m	Field Strength Limit (dBuV/m) at 3 m
0.009-0.490	2400/F(kHz) @ 300 m	-
0.490-1.705	24000/F(kHz) @ 30 m	-
1.705 - 30	30 @ 30m	-
30 - 88	100	40
88 - 216	150	43.5
216 - 960	200	46
Above 960	500	54

TEST PROCEDURE

The EUT is placed on a non-conducting table 80 cm above the ground plane for measurement below 1GHz; 1.5 m above the ground plane for measurement above 1GHz. The antenna to EUT distance is 3 meters. The EUT is configured in accordance with ANSI C63.10. The EUT is set to transmit in a continuous mode.

For measurements below 1 GHz the resolution bandwidth is set to 100 kHz for peak detection measurements or 120 kHz for quasi-peak detection measurements. Peak detection is used unless otherwise noted as quasi-peak.

For pre-scans above 1 GHz the resolution bandwidth is set to 1 MHz; the video bandwidth is set to 30 KHz for peak measurements.

For measurements above 1 GHz the resolution bandwidth is set to 1 MHz, then the video bandwidth is set to 3 MHz for peak measurements and 1 MHz resolution bandwidth with 1/T (360Hz) video bandwidth with peak detector for average measurements.

The spectrum from 1 GHz to 18 GHz is investigated with the transmitter set to the lowest, middle, and highest channels in each applicable band. Below 1GHz and above 18GHz emissions, the channel with the highest output power was tested.

The frequency range of interest is monitored at a fixed antenna height and EUT azimuth. The EUT is rotated through 360 degrees to maximize emissions received. The antenna is scanned from 1 to 4 meters above the ground plane to further maximize the emission. Measurements are made with the antenna polarized in both the vertical and the horizontal positions.

10.1. TRANSMITTER ABOVE 1 GHz

10.1.1. BLUETOOTH BASIC DATA RATE GFSK MODULATION

BANDEDGE (LOW CHANNEL)

HORIZONTAL RESULT

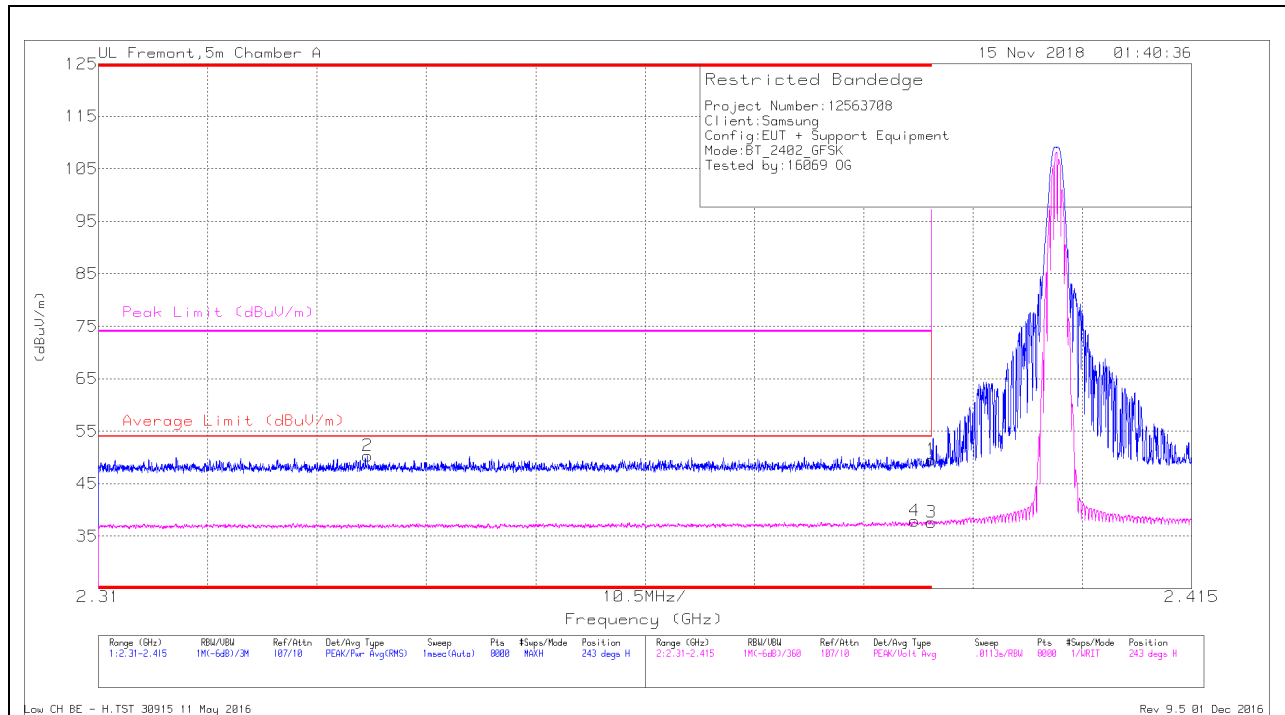

Trace Markers

Marker	Frequency (GHz)	Meter Reading (dBuV)	Det	AF T345 (dB/m)	Amp/Cbl/Filtr/Pad (dB)	Corrected Reading (dBuV/m)	Average Limit (dBuV/m)	Margin (dB)	Peak Limit (dBuV/m)	PK Margin (dB)	Azimuth (Degs)	Height (cm)	Polarity
2	* 2.336	40.89	Pk	31.6	-22.2	50.29	-	-	74	-23.71	243	227	H
4	* 2.388	28.14	VA1T	31.8	-22.1	37.84	54	-16.16	-	-	243	227	H
1	* 2.39	39.85	Pk	31.8	-22.1	49.55	-	-	74	-24.45	243	227	H
3	* 2.39	27.93	VA1T	31.8	-22.1	37.63	54	-16.37	-	-	243	227	H

* - indicates frequency in CFR47 Pt 15 / IC RSS-Restricted Band

Pk - Peak detector

VA1T - FHSS: Linear Voltage Average VB=1/Ton where: Ton is transmit duration

VERTICAL RESULT

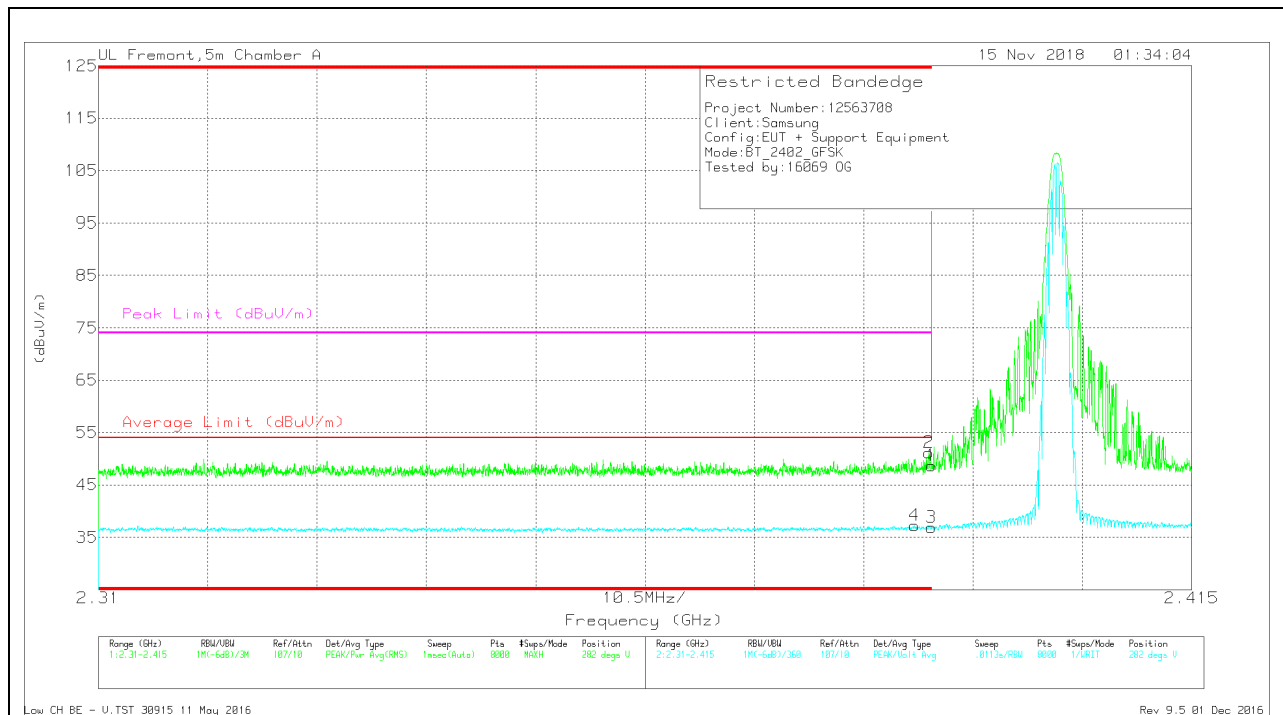

Trace Markers

Marker	Frequency (GHz)	Meter Reading (dBuV)	Det	AF T345 (dB/m)	Amp/Cbl/Filtr/Pad (dB)	Corrected Reading (dBuV/m)	Average Limit (dBuV/m)	Margin (dB)	Peak Limit (dBuV/m)	PK Margin (dB)	Azimuth (Degs)	Height (cm)	Polarity
4	* 2.388	27.5	VA1T	31.8	-22.1	37.2	54	-16.8	-	-	282	399	V
1	* 2.39	39	Pk	31.8	-22.1	48.7	-	-	74	-25.3	282	399	V
2	* 2.39	41.46	Pk	31.8	-22.1	51.16	-	-	74	-22.84	282	399	V
3	* 2.39	27.18	VA1T	31.8	-22.1	36.88	54	-17.12	-	-	282	399	V

* - indicates frequency in CFR47 Pt 15 / IC RSS-Restricted Band

Pk - Peak detector

VA1T - FHSS: Linear Voltage Average $V_B=1/T_{on}$ where: T_{on} is transmit duration

BANEDGE (HIGH CHANNEL)

HORIZONTAL RESULT

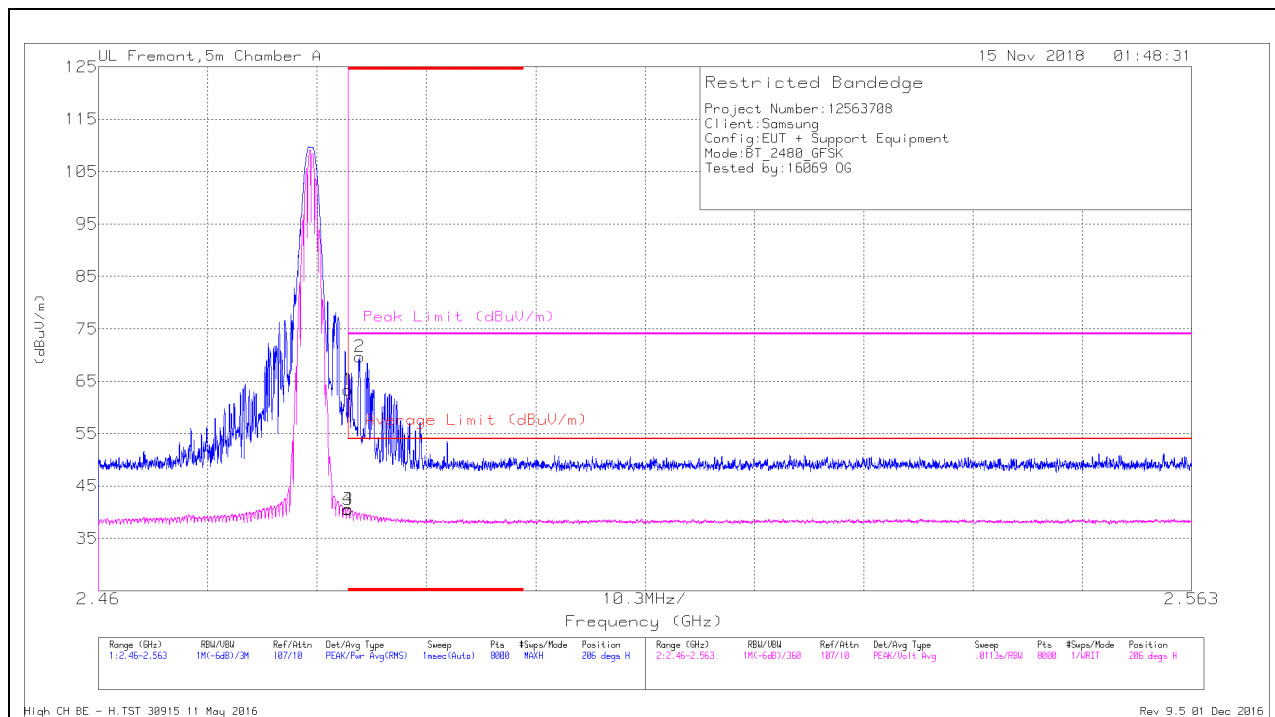

Trace Markers

Marker	Frequency (GHz)	Meter Reading (dBuV)	Det	AF T345 (dB/m)	Amp/Cbl/Filtr/Pad (dB)	Corrected Reading (dBuV/m)	Average Limit (dBuV/m)	Margin (dB)	Peak Limit (dBuV/m)	PK Margin (dB)	Azimuth (Degs)	Height (cm)	Polarity
1	* 2.484	52.87	Pk	32.3	-21.8	63.37	-	-	74	-10.63	206	160	H
3	* 2.484	30.01	VA1T	32.3	-21.8	40.51	54	-13.49	-	-	206	160	H
4	* 2.484	30.15	VA1T	32.3	-21.8	40.65	54	-13.35	-	-	206	160	H
2	* 2.485	59.16	Pk	32.3	-21.8	69.66	-	-	74	-4.34	206	160	H

* - indicates frequency in CFR47 Pt 15 / IC RSS-Restricted Band

Pk - Peak detector

VA1T - FHSS: Linear Voltage Average VB=1/Ton where: Ton is transmit duration

VERTICAL RESULT

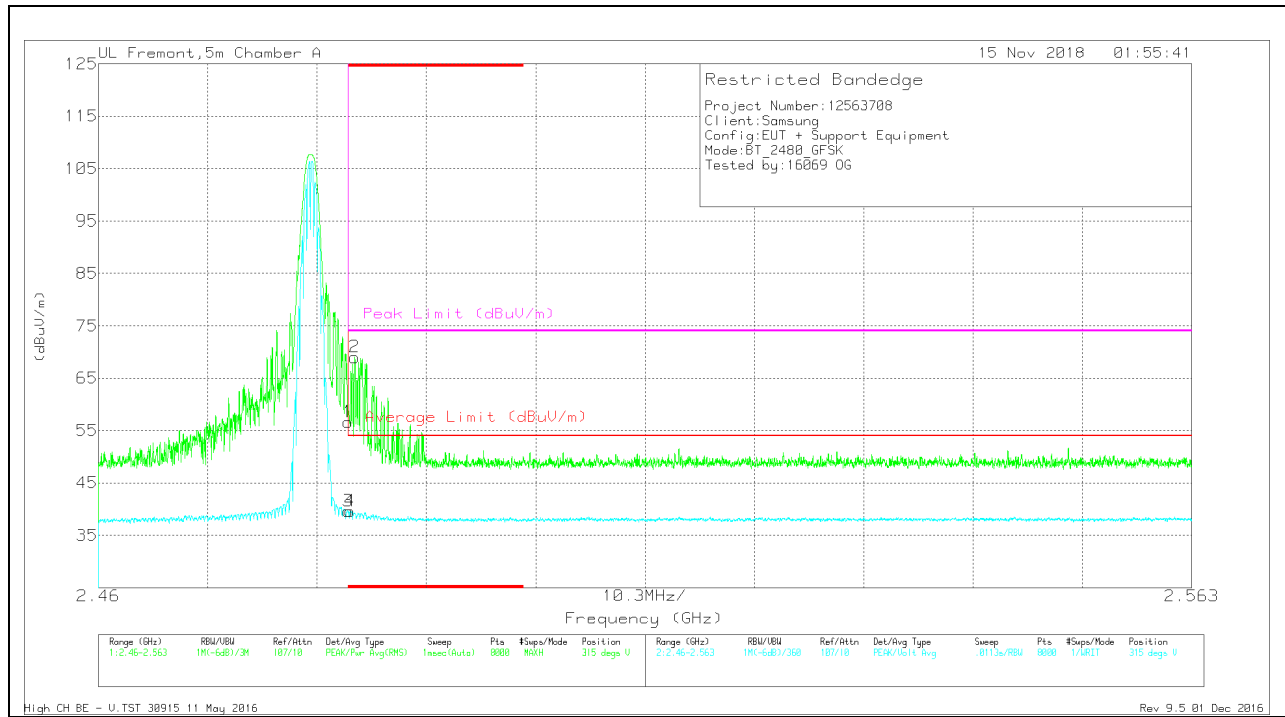

Trace Markers

Marker	Frequency (GHz)	Meter Reading (dBuV)	Det	AF T345 (dB/m)	Amp/Cbl/Filtr/Pad (dB)	Corrected Reading (dBuV/m)	Average Limit (dBuV/m)	Margin (dB)	Peak Limit (dBuV/m)	PK Margin (dB)	Azimuth (Degs)	Height (cm)	Polarity
1	* 2.484	46.13	Pk	32.3	-21.8	56.63	-	-	74	-17.37	315	330	V
2	* 2.484	58.48	Pk	32.3	-21.8	68.98	-	-	74	-5.02	315	330	V
3	* 2.484	29.06	VA1T	32.3	-21.8	39.56	54	-14.44	-	-	315	330	V
4	* 2.484	29.07	VA1T	32.3	-21.8	39.57	54	-14.43	-	-	315	330	V

* - indicates frequency in CFR47 Pt 15 / IC RSS-Restricted Band

Pk - Peak detector

VA1T - FHSS: Linear Voltage Average $V_B=1/T_{on}$ where: T_{on} is transmit duration

HARMONICS AND SPURIOUS EMISSIONS

LOW CHANNEL RESULTS

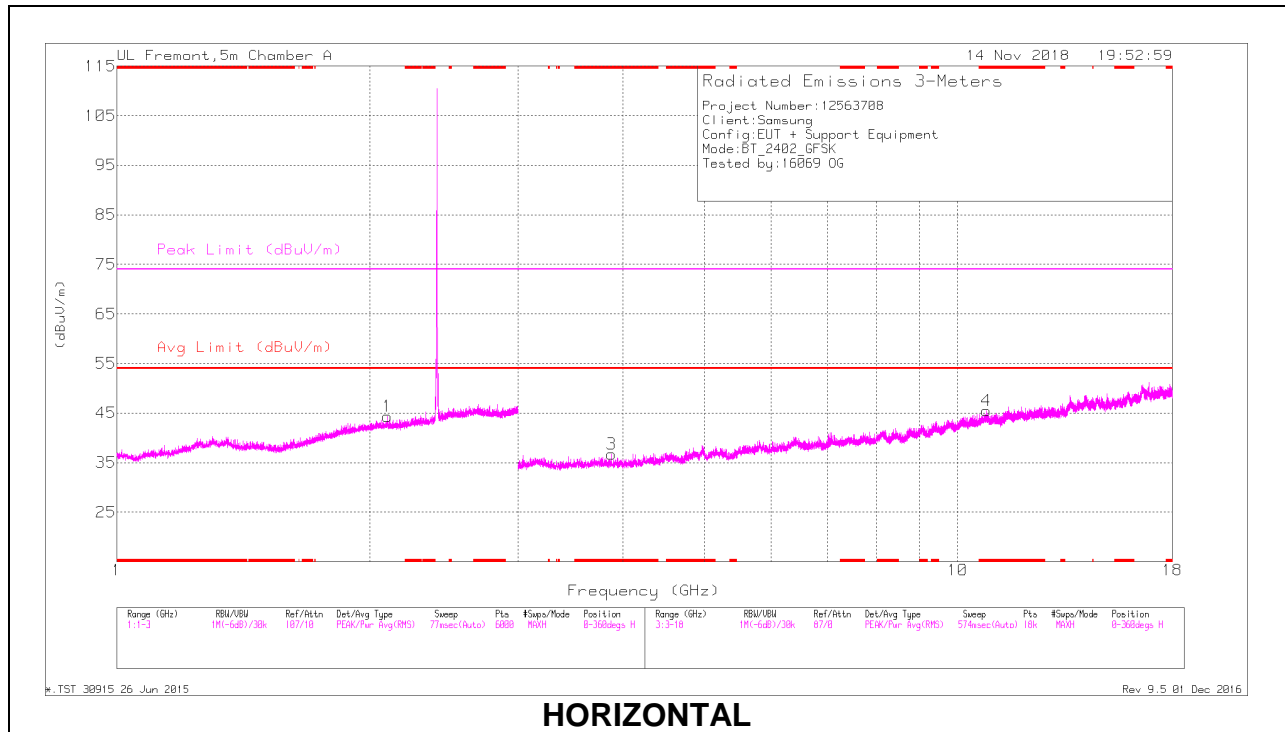

HORIZONTAL

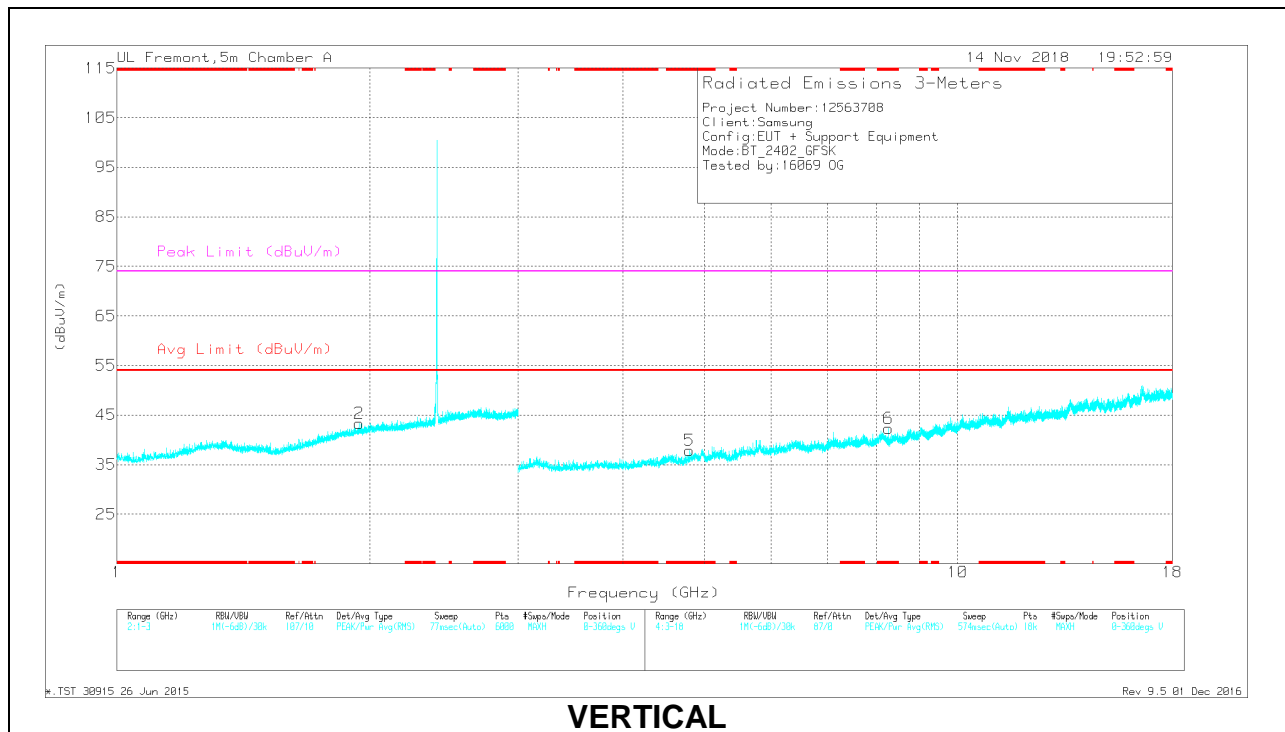

VERTICAL

RADIATED EMISSIONS

Marker	Frequency (GHz)	Meter Reading (dBuV)	Det	AF T345 (dB/m)	Amp/Cbl/Filtr/Pad (dB)	Corrected Reading (dBuV/m)	Avg Limit (dBuV/m)	Margin (dB)	Peak Limit (dBuV/m)	PK Margin (dB)	Azimuth (Degs)	Height (cm)	Polarity
3	* 3.877	36.2	PKFH	33	-28.2	41	-	-	74	-33	104	392	H
	* 3.876	24.32	VA1T	33	-28.2	29.12	54	-24.88	-	-	104	392	H
4	* 10.815	30.45	PKFH	37.8	-18.2	50.05	-	-	74	-23.95	0	156	H
	* 10.812	18.89	VA1T	37.8	-18.2	38.49	54	-15.51	-	-	0	156	H
5	* 4.799	33.94	PKFH	34.2	-26.3	41.84	-	-	74	-32.16	85	220	V
	* 4.801	22.92	VA1T	34.2	-26.3	30.82	54	-23.18	-	-	85	220	V
6	* 8.271	31.72	PKFH	35.9	-22.2	45.42	-	-	74	-28.58	285	235	V
	* 8.269	20.17	VA1T	35.9	-22.2	33.87	54	-20.13	-	-	285	235	V
2	1.942	38.12	PKFH	31.3	-23.1	46.32	-	-	-	-	360	100	V
	1.944	27.8	VA1T	31.3	-23.1	36	-	-	-	-	360	100	V
1	2.095	27.64	VA1T	31.2	-22.4	36.44	-	-	-	-	360	100	H
	2.099	39.34	PKFH	31.2	-22.4	48.14	-	-	-	-	360	100	H

* - indicates frequency in CFR47 Pt 15 / IC RSS-Restricted Band

PKFH - FHSS: RB=100k/1MHz VB=3 x RB, Peak

VA1T - FHSS: Linear Voltage Average VB=1/Ton where: Ton is transmit duration

MID CHANNEL RESULTS

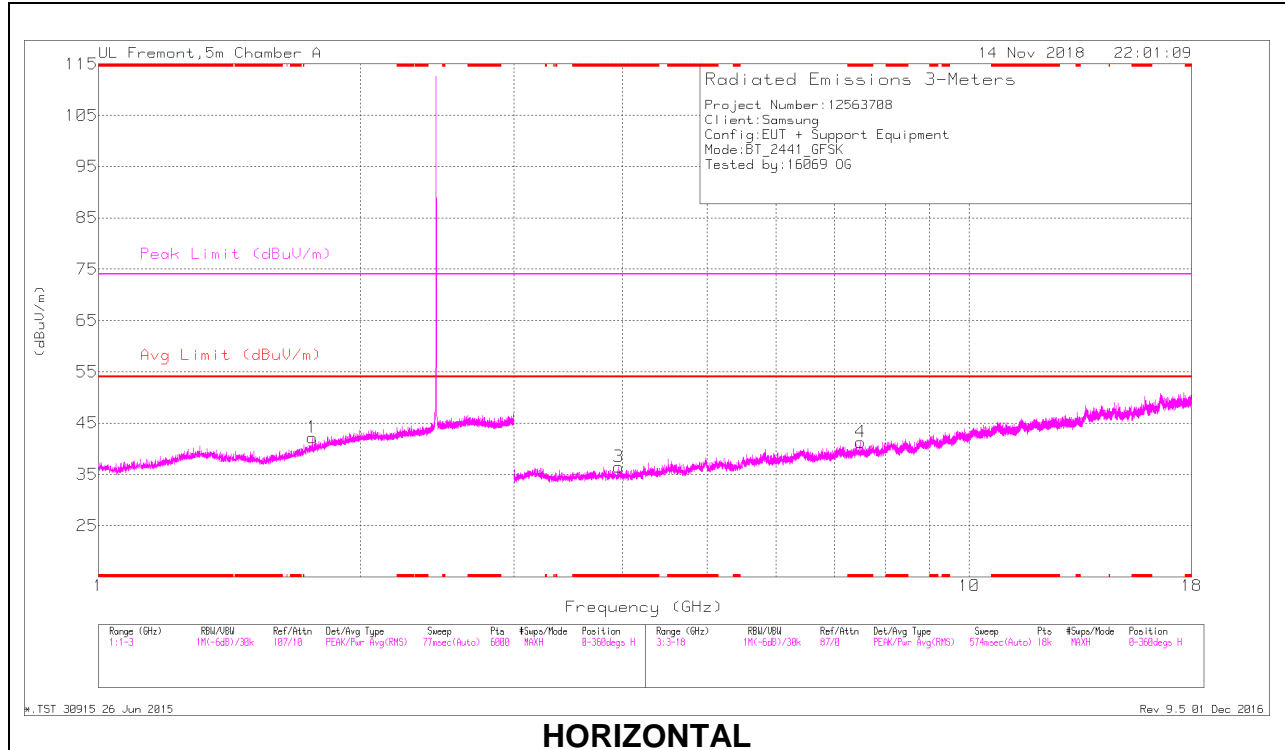

HORIZONTAL

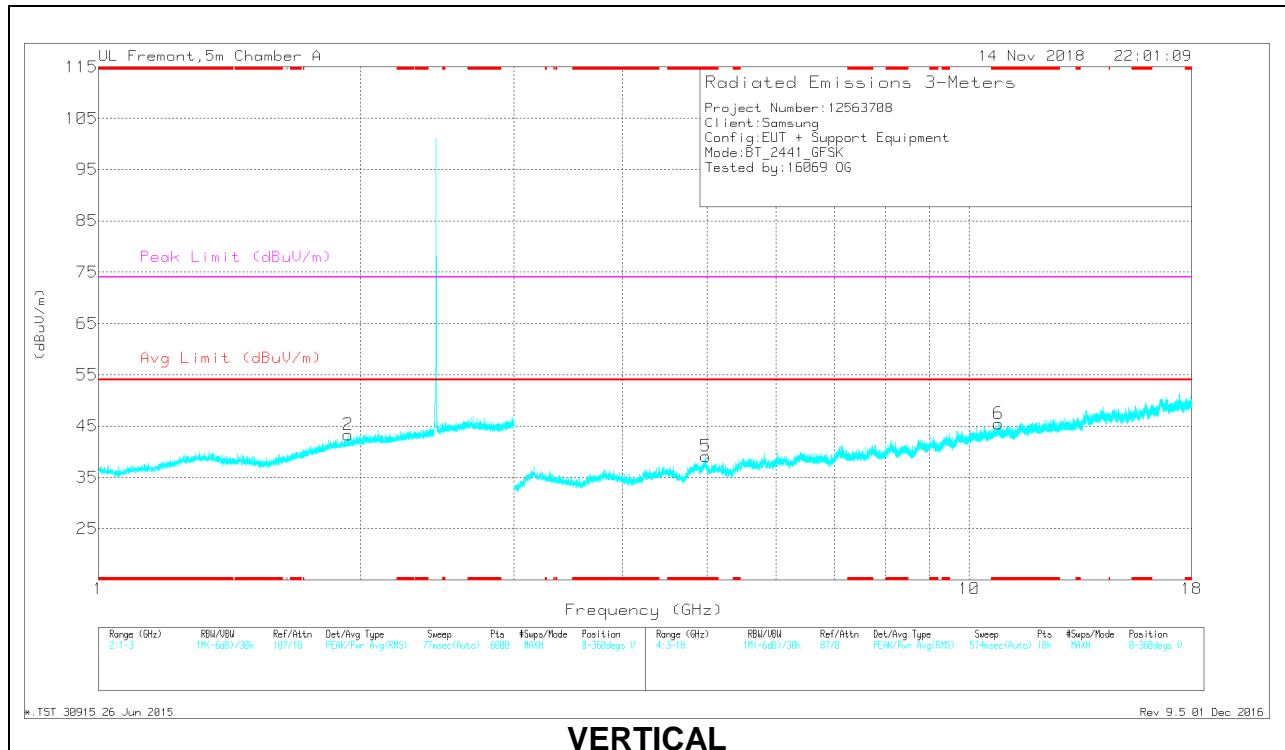

VERTICAL

RADIATED EMISSIONS

Marker	Frequency (GHz)	Meter Reading (dBuV)	Det	AF T345 (dB/m)	Amp/Cbl/Filtr/Pad (dB)	Corrected Reading (dBuV/m)	Avg Limit (dBuV/m)	Margin (dB)	Peak Limit (dBuV/m)	PK Margin (dB)	Azimuth (Degs)	Height (cm)	Polarity
3	* 3.954	34.76	PKFH	33.3	-27.9	40.16	-	-	74	-33.84	29	125	H
	* 3.954	23.97	VA1T	33.3	-27.9	29.37	54	-24.63	-	-	29	125	H
4	* 7.505	31.36	PKFH	35.7	-22.2	44.86	-	-	74	-29.14	316	203	H
	* 7.503	19.98	VA1T	35.7	-22.2	33.48	54	-20.52	-	-	316	203	H
5	* 4.98	35.73	PKFH	34.3	-27.1	42.93	-	-	74	-31.07	113	273	V
	* 4.977	24.58	VA1T	34.3	-27.1	31.78	54	-22.22	-	-	113	273	V
6	* 10.791	30.68	PKFH	37.8	-18.5	49.98	-	-	74	-24.02	73	149	V
	* 10.79	18.95	VA1T	37.8	-18.5	38.25	54	-15.75	-	-	73	149	V
1	1.76	39.28	PKFH	29.8	-23.2	45.88	-	-	-	-	360	101	H
	1.761	27.8	VA1T	29.9	-23.2	34.5	-	-	-	-	360	101	H
2	1.933	39.23	PKFH	31.3	-23.1	47.43	-	-	-	-	360	200	V
	1.935	27.73	VA1T	31.3	-23.1	35.93	-	-	-	-	360	200	V

* - indicates frequency in CFR47 Pt 15 / IC RSS-Restricted Band

PKFH - FHSS: RB=100k/1MHz VB=3 x RB, Peak

VA1T - FHSS: Linear Voltage Average VB=1/Ton where: Ton is transmit duration

HIGH CHANNEL RESULTS

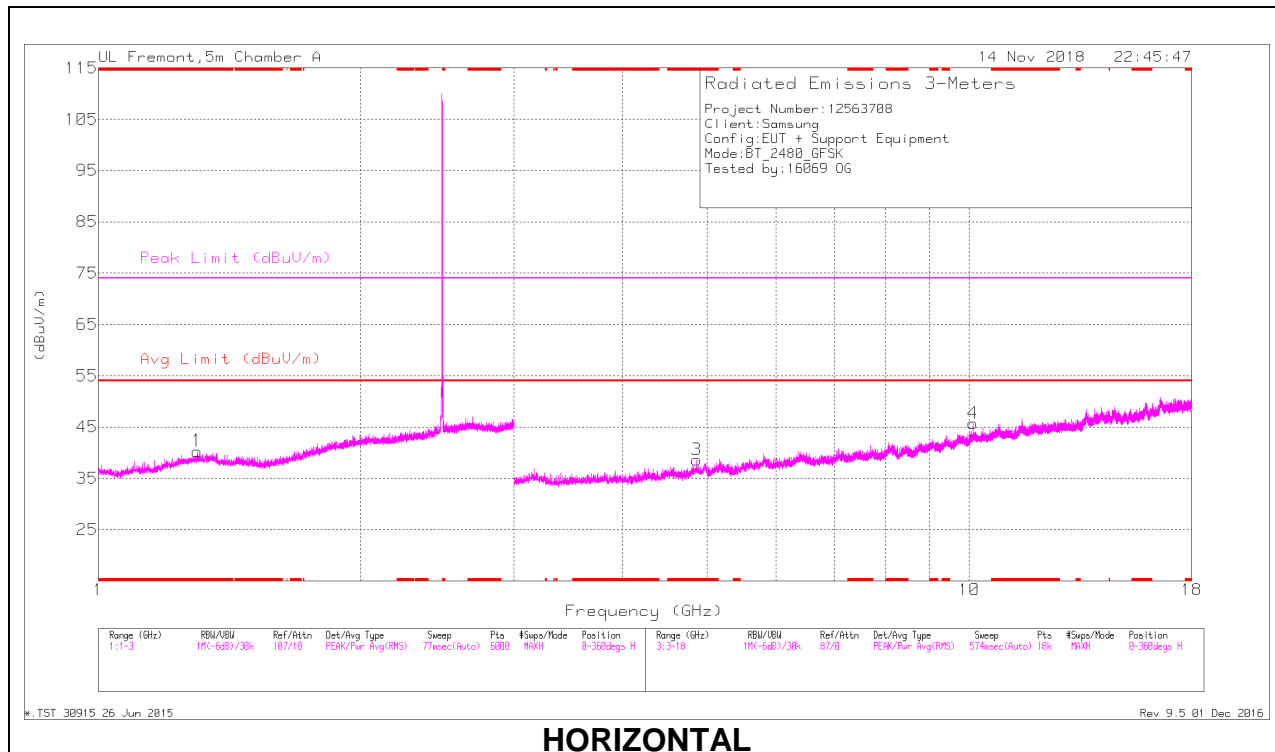

HORIZONTAL

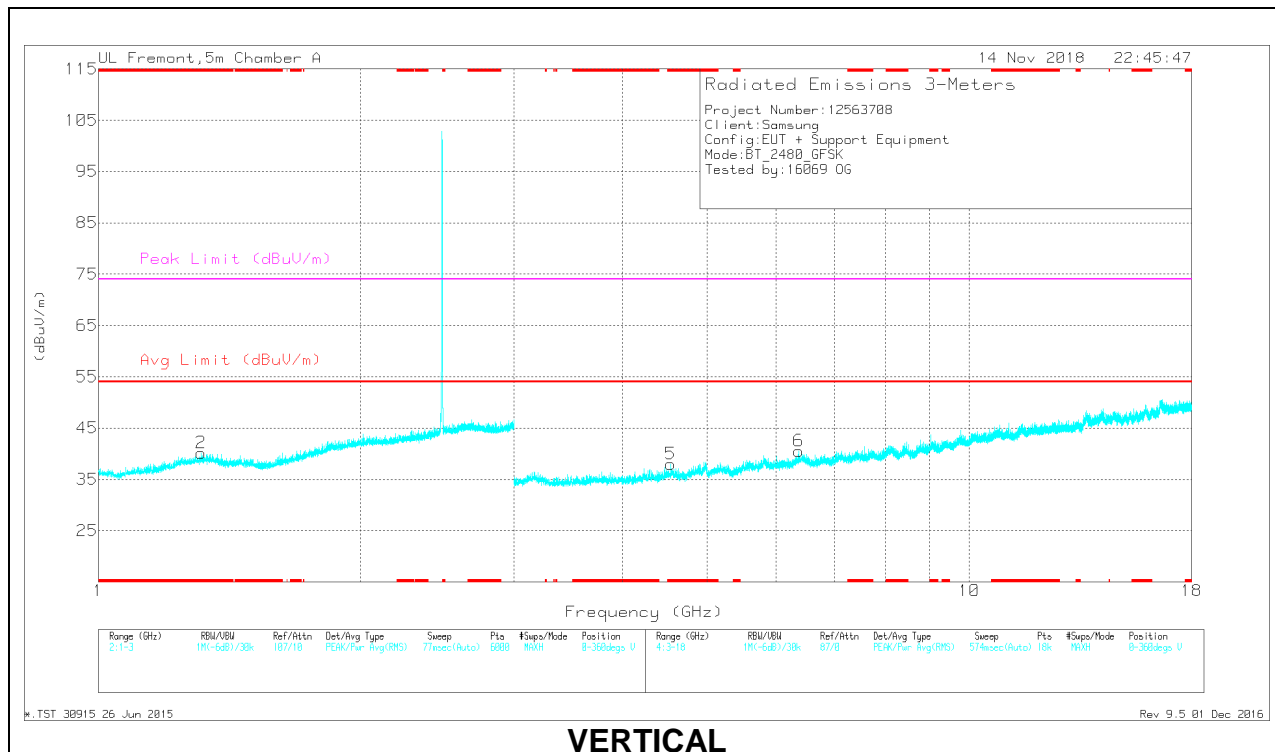

VERTICAL

RADIATED EMISSIONS

Marker	Frequency (GHz)	Meter Reading (dBuV)	Det	AF T345 (dB/m)	Amp/Cbl/Filtr/Pad (dB)	Corrected Reading (dBuV/m)	Avg Limit (dBuV/m)	Margin (dB)	Peak Limit (dBuV/m)	PK Margin (dB)	Azimuth (Degs)	Height (cm)	Polarity
1	* 1.297	39.06	PKFH	29.4	-24.3	44.16	-	-	74	-29.84	215	228	H
	* 1.299	27.93	VA1T	29.4	-24.3	33.03	54	-20.97	-	-	215	228	H
2	* 1.312	38.36	PKFH	29.5	-24.3	43.56	-	-	74	-30.44	66	142	V
	* 1.313	27.93	VA1T	29.5	-24.3	33.13	54	-20.87	-	-	66	142	V
3	* 4.858	33.66	PKFH	34.1	-26.1	41.66	-	-	74	-32.34	345	232	H
	* 4.862	22.97	VA1T	34.1	-26.1	30.97	54	-23.03	-	-	345	232	H
5	* 4.539	34.55	PKFH	34	-26.7	41.85	-	-	74	-32.15	281	172	V
	* 4.539	23.54	VA1T	34	-26.7	30.84	54	-23.16	-	-	281	172	V
6	6.367	32.67	PKFH	35.8	-24.3	44.17	-	-	-	-	281	200	V
	6.369	21.8	VA1T	35.8	-24.3	33.3	-	-	-	-	281	200	V
4	10.099	30.37	PKFH	37.5	-19.3	48.57	-	-	-	-	345	103	H
	10.1	19.29	VA1T	37.5	-19.3	37.49	-	-	-	-	345	103	H

* - indicates frequency in CFR47 Pt 15 / IC RSS-Restricted Band

PKFH - FHSS: RB=100k/1MHz VB=3 x RB, Peak

VA1T - FHSS: Linear Voltage Average VB=1/Ton where: Ton is transmit duration

10.1.2. BLUETOOTH ENHANCED DATA RATE 8PSK MODULATION

BANDEDGE (LOW CHANNEL)

HORIZONTAL RESULT

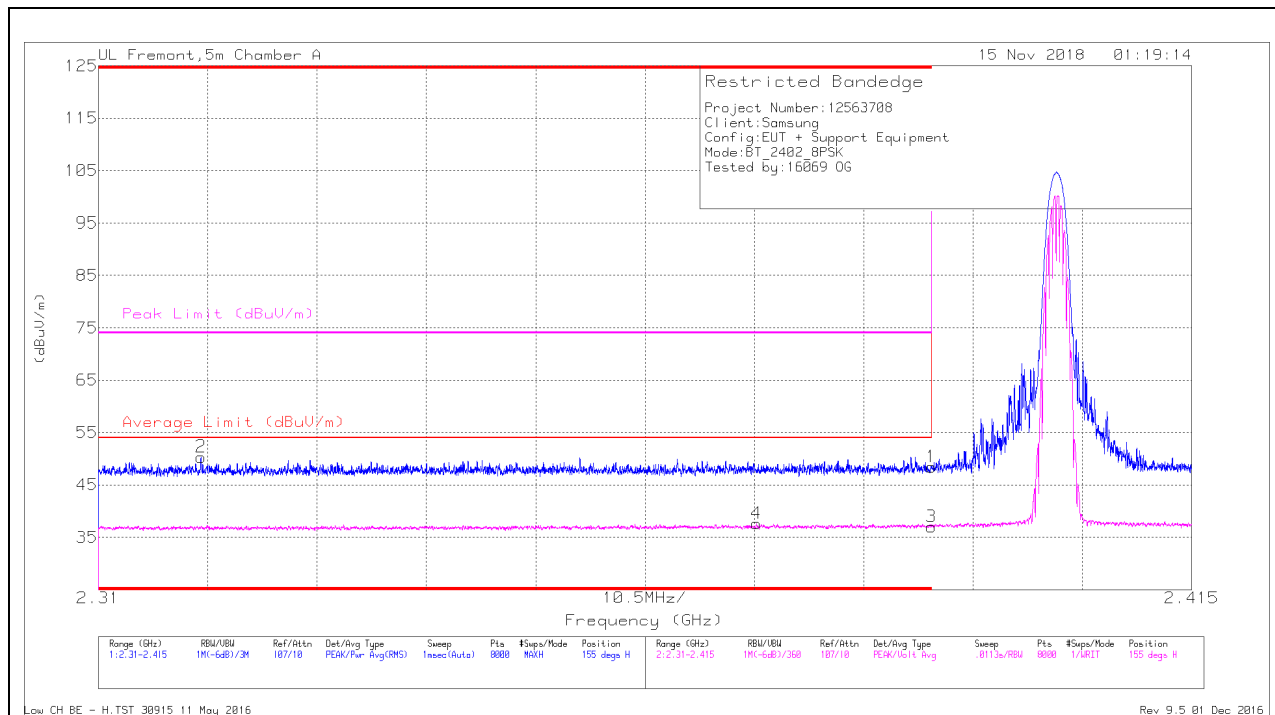

Trace Markers

Marker	Frequency (GHz)	Meter Reading (dBuV)	Det	AF T345 (dB/m)	Amp/Cb1/Filtr/Pad (dB)	Corrected Reading (dBuV/m)	Average Limit (dBuV/m)	Margin (dB)	Peak Limit (dBuV/m)	PK Margin (dB)	Azimuth (Degs)	Height (cm)	Polarity
2	* 2.32	40.95	Pk	31.5	-22.1	50.35	-	-	74	-23.65	155	216	H
4	* 2.373	27.99	VA1T	31.7	-22.1	37.59	54	-16.41	-	-	155	216	H
1	* 2.39	38.75	Pk	31.8	-22.1	48.45	-	-	74	-25.55	155	216	H
3	* 2.39	27.36	VA1T	31.8	-22.1	37.06	54	-16.94	-	-	155	216	H

* - indicates frequency in CFR47 Pt 15 / IC RSS-Restricted Band

Pk - Peak detector

VA1T - FHSS: Linear Voltage Average $V_B=1/T_{on}$ where: T_{on} is transmit duration

VERTICAL RESULT

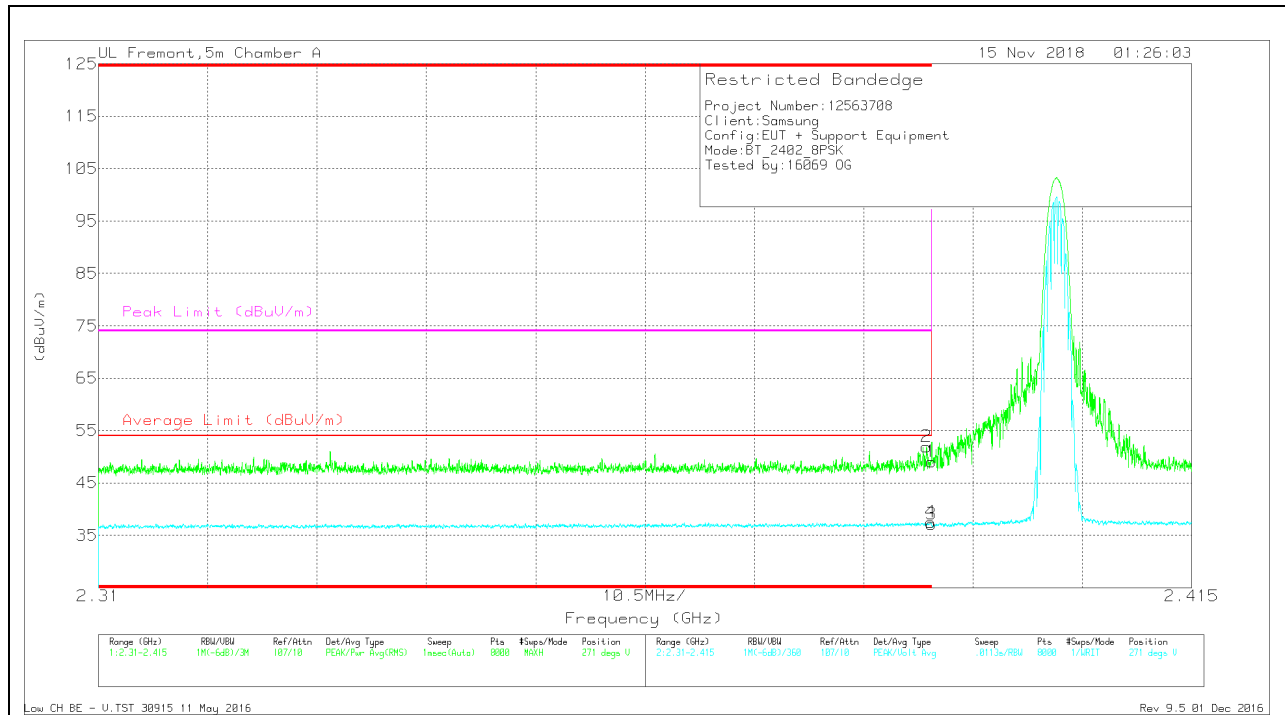

Trace Markers

Marker	Frequency (GHz)	Meter Reading (dBuV)	Det	AF T345 (dB/m)	Amp/Cbl/Filtr/Pad (dB)	Corrected Reading (dBuV/m)	Average Limit (dBuV/m)	Margin (dB)	Peak Limit (dBuV/m)	PK Margin (dB)	Azimuth (Degs)	Height (cm)	Polarity
1	* 2.39	39.33	Pk	31.8	-22.1	49.03	-	-	74	-24.97	271	398	V
2	* 2.39	42.26	Pk	31.8	-22.1	51.96	-	-	74	-22.04	271	398	V
3	* 2.39	27.39	VA1T	31.8	-22.1	37.09	54	-16.91	-	-	271	398	V
4	* 2.39	27.79	VA1T	31.8	-22.1	37.49	54	-16.51	-	-	271	398	V

* - indicates frequency in CFR47 Pt 15 / IC RSS-Restricted Band

Pk - Peak detector

VA1T - FHSS: Linear Voltage Average $V_B=1/T_{on}$ where: T_{on} is transmit duration

BANEDGE (HIGH CHANNEL)

HORIZONTAL RESULT

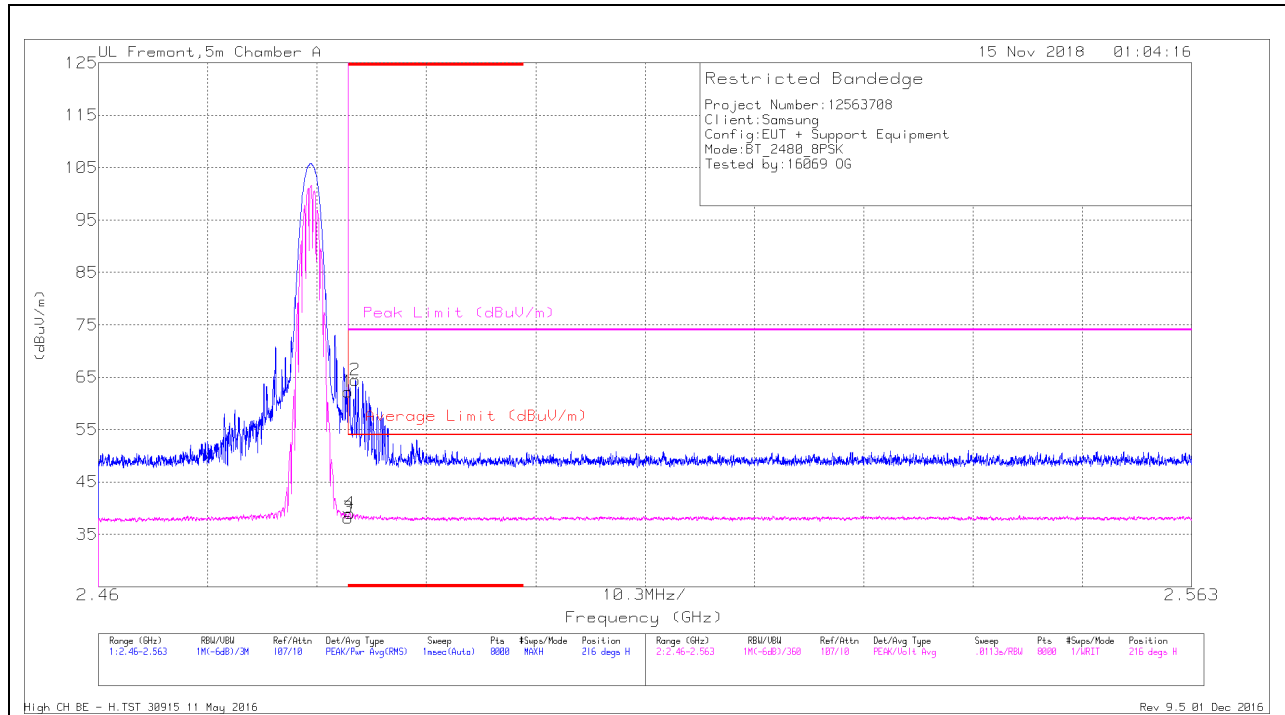

Trace Markers

Marker	Frequency (GHz)	Meter Reading (dBuV)	Det	AF T345 (dB/m)	Amp/Cbl/Filtr/Pad (dB)	Corrected Reading (dBuV/m)	Average Limit (dBuV/m)	Margin (dB)	Peak Limit (dBuV/m)	PK Margin (dB)	Azimuth (Degs)	Height (cm)	Polarity
1	* 2.484	51.73	Pk	32.3	-21.8	62.23	-	-	74	-11.77	216	207	H
2	* 2.484	53.94	Pk	32.3	-21.8	64.44	-	-	74	-9.56	216	207	H
3	* 2.484	27.61	VA1T	32.3	-21.8	38.11	54	-15.89	-	-	216	207	H
4	* 2.484	28.47	VA1T	32.3	-21.8	38.97	54	-15.03	-	-	216	207	H

* - indicates frequency in CFR47 Pt 15 / IC RSS-Restricted Band

Pk - Peak detector

VA1T - FHSS: Linear Voltage Average VB=1/Ton where: Ton is transmit duration

VERTICAL RESULT

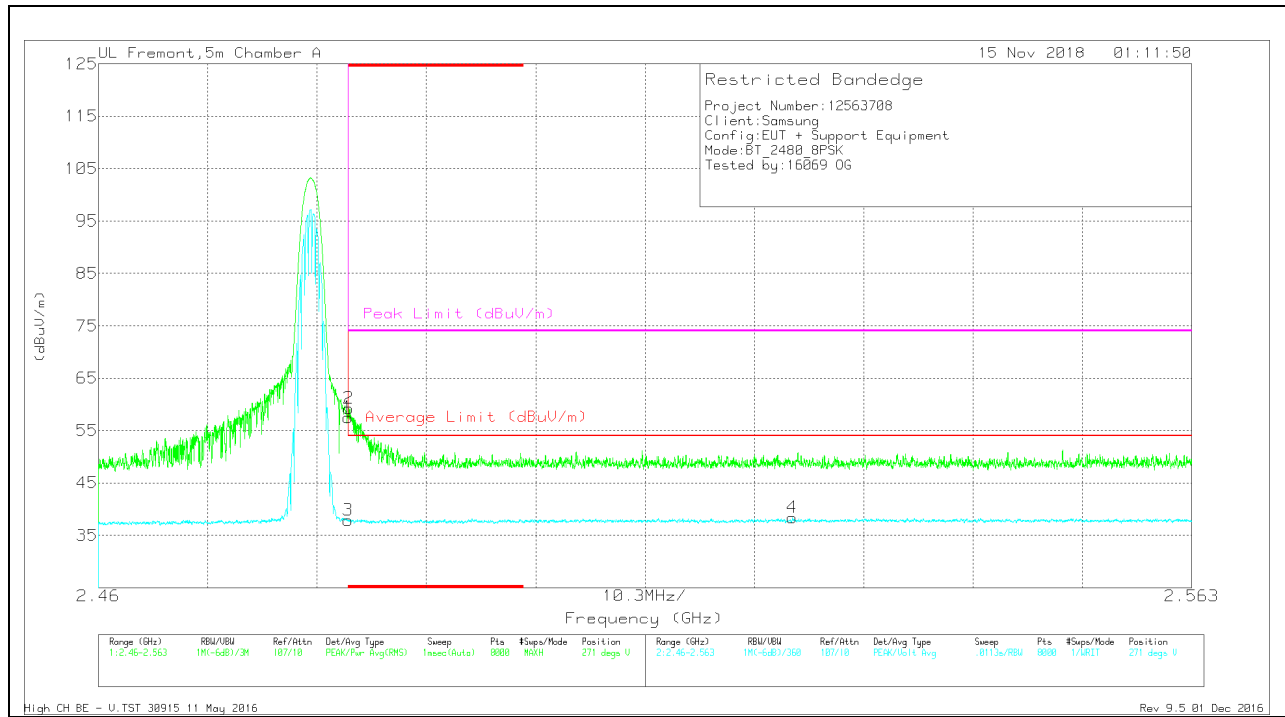

Trace Markers

Marker	Frequency (GHz)	Meter Reading (dBuV)	Det	AF T345 (dB/m)	Amp/Cbl/Filtr/Pad (dB)	Corrected Reading (dBuV/m)	Average Limit (dBuV/m)	Margin (dB)	Peak Limit (dBuV/m)	PK Margin (dB)	Azimuth (Degs)	Height (cm)	Polarity
1	* 2.484	46.94	Pk	32.3	-21.8	57.44	-	-	74	-16.56	271	330	V
2	* 2.484	48.75	Pk	32.3	-21.8	59.25	-	-	74	-14.75	271	330	V
3	* 2.484	27.32	VA1T	32.3	-21.8	37.82	54	-16.18	-	-	271	330	V
4	2.525	27.52	VA1T	32.4	-21.6	38.32	54	-15.68	-	-	271	330	V

* - indicates frequency in CFR47 Pt 15 / IC RSS-Restricted Band

Pk - Peak detector

VA1T - FHSS: Linear Voltage Average $V_B=1/T_{on}$ where: T_{on} is transmit duration

HARMONICS AND SPURIOUS EMISSIONS

LOW CHANNEL RESULTS

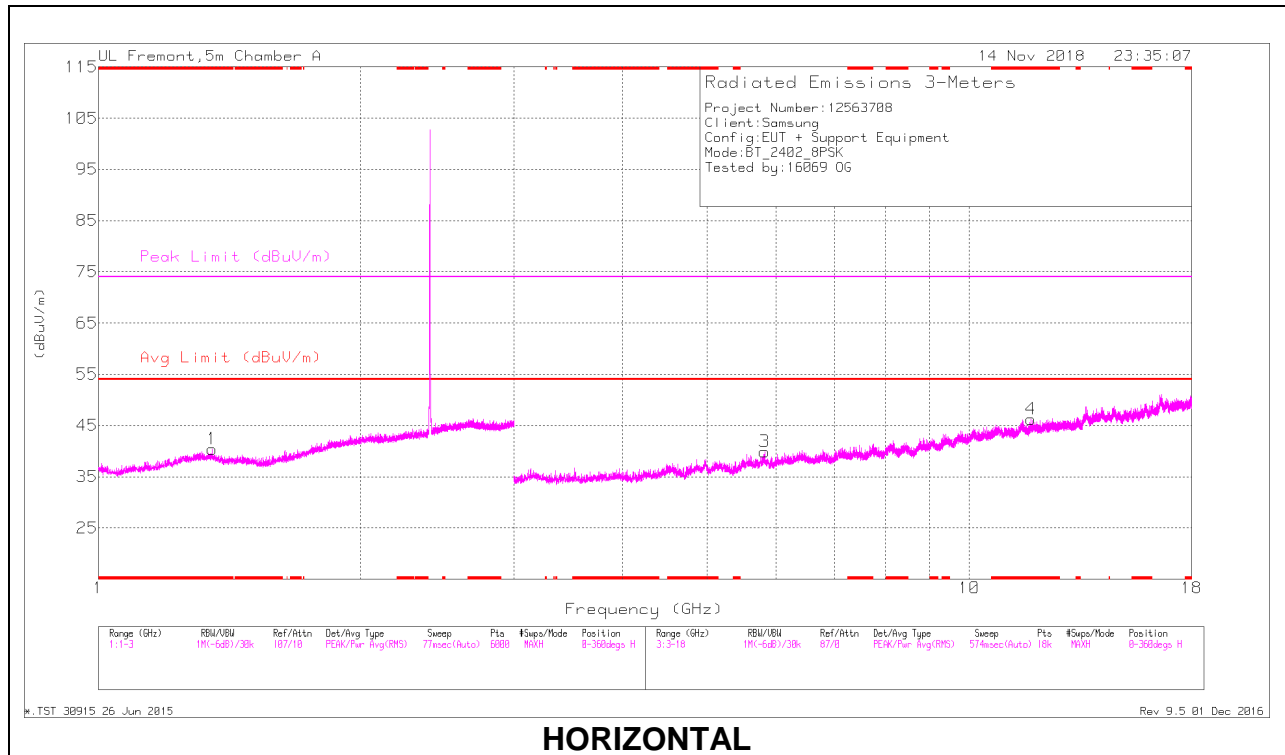

HORIZONTAL

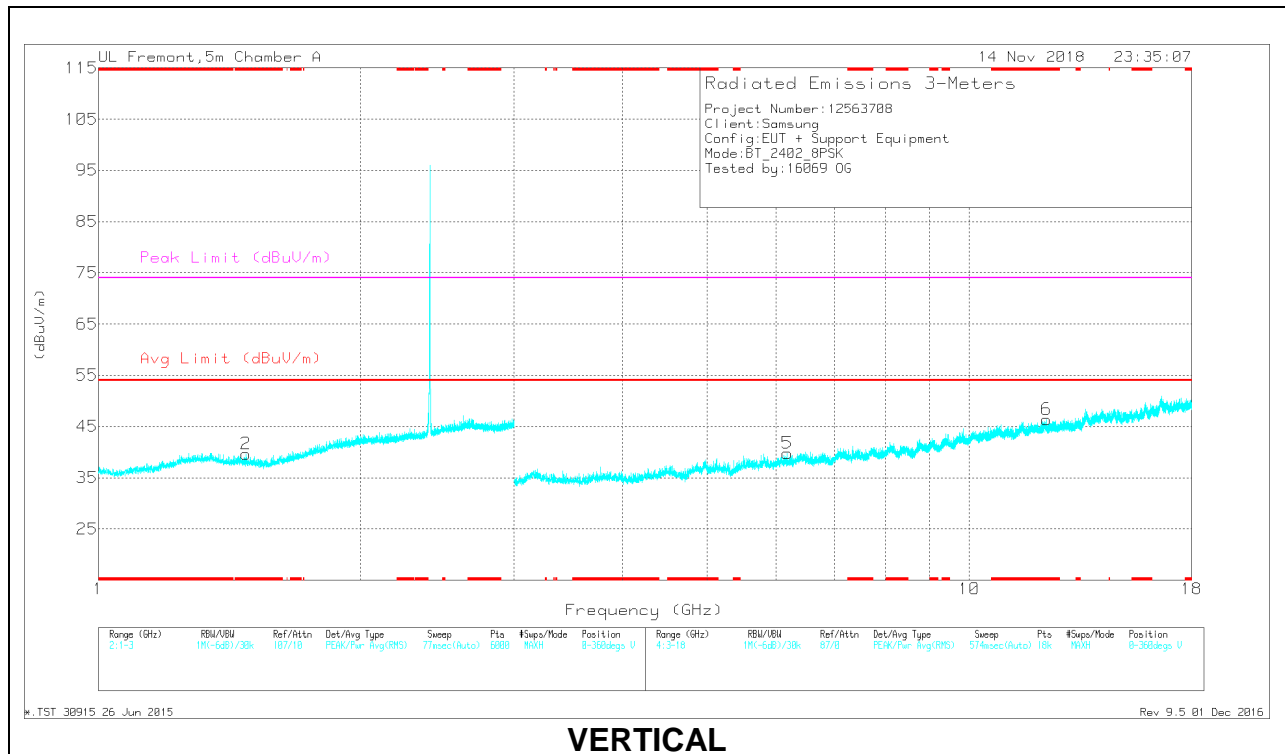

VERTICAL

RADIATED EMISSIONS

Marker	Frequency (GHz)	Meter Reading (dBuV)	Det	AF T345 (dB/m)	Amp/Cbl/Filtr/Pad (dB)	Corrected Reading (dBuV/m)	Avg Limit (dBuV/m)	Margin (dB)	Peak Limit (dBuV/m)	PK Margin (dB)	Azimuth (Degs)	Height (cm)	Polarity
1	* 1.351	38.68	PKFH	29.5	-24.3	43.88	-	-	74	-30.12	194	169	H
	* 1.351	27.85	VA1T	29.5	-24.3	33.05	54	-20.95	-	-	194	169	H
2	* 1.478	38.63	PKFH	28.6	-24.1	43.13	-	-	74	-30.87	355	157	V
	* 1.478	27.81	VA1T	28.6	-24.1	32.31	54	-21.69	-	-	355	157	V
4	* 11.768	29.96	PKFH	38.7	-18.4	50.26	-	-	74	-23.74	115	162	H
	* 11.769	18.62	VA1T	38.7	-18.5	38.82	54	-15.18	-	-	115	162	H
6	* 12.261	29.28	PKFH	39	-18.7	49.58	-	-	74	-24.42	323	177	V
	* 12.261	18.74	VA1T	39	-18.7	39.04	54	-14.96	-	-	323	177	V
3	5.819	22.02	VA1T	35.1	-24.6	32.52	-	-	-	-	355	102	H
	5.821	33.21	PKFH	35.1	-24.6	43.71	-	-	-	-	355	102	H
5	6.18	32.56	PKFH	35.6	-24.8	43.36	-	-	-	-	115	200	V
	6.182	21.6	VA1T	35.6	-24.7	32.5	-	-	-	-	115	200	V

* - indicates frequency in CFR47 Pt 15 / IC RSS-Restricted Band

PKFH - FHSS: RB=100k/1MHz VB=3 x RB, Peak

VA1T - FHSS: Linear Voltage Average VB=1/Ton where: Ton is transmit duration

MID CHANNEL RESULTS

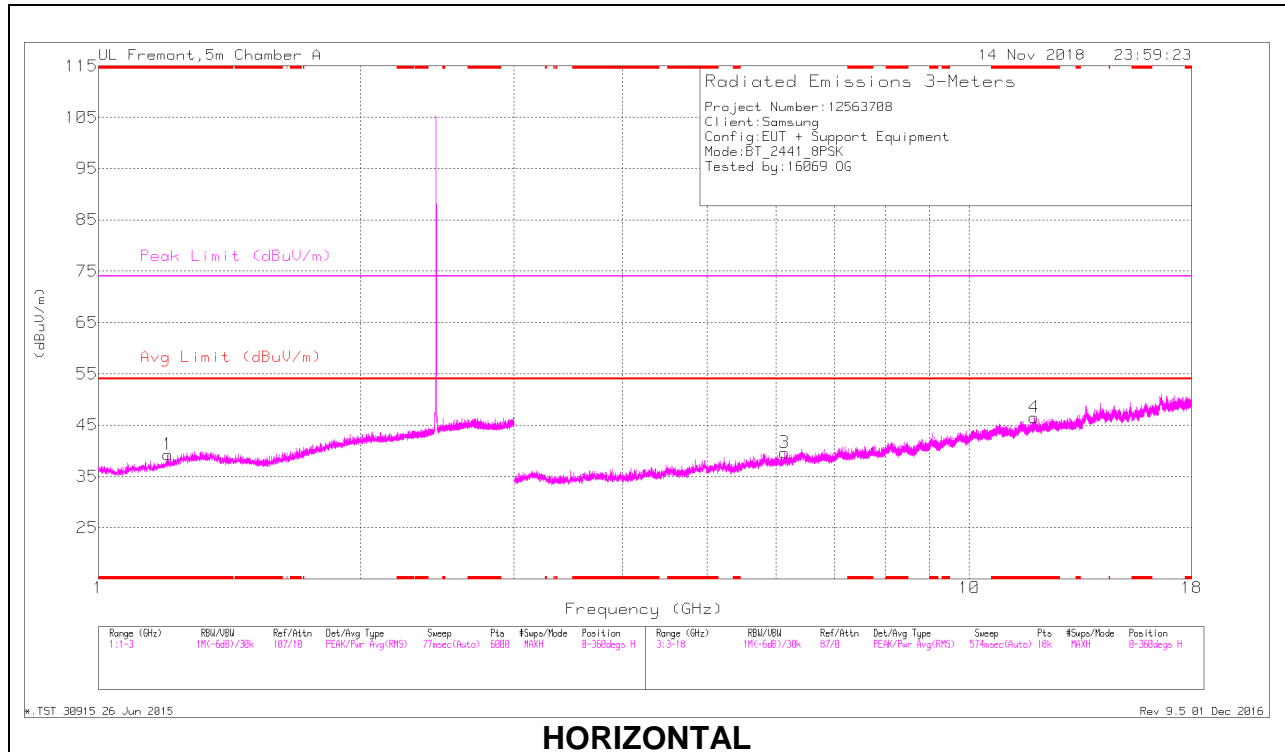

HORIZONTAL

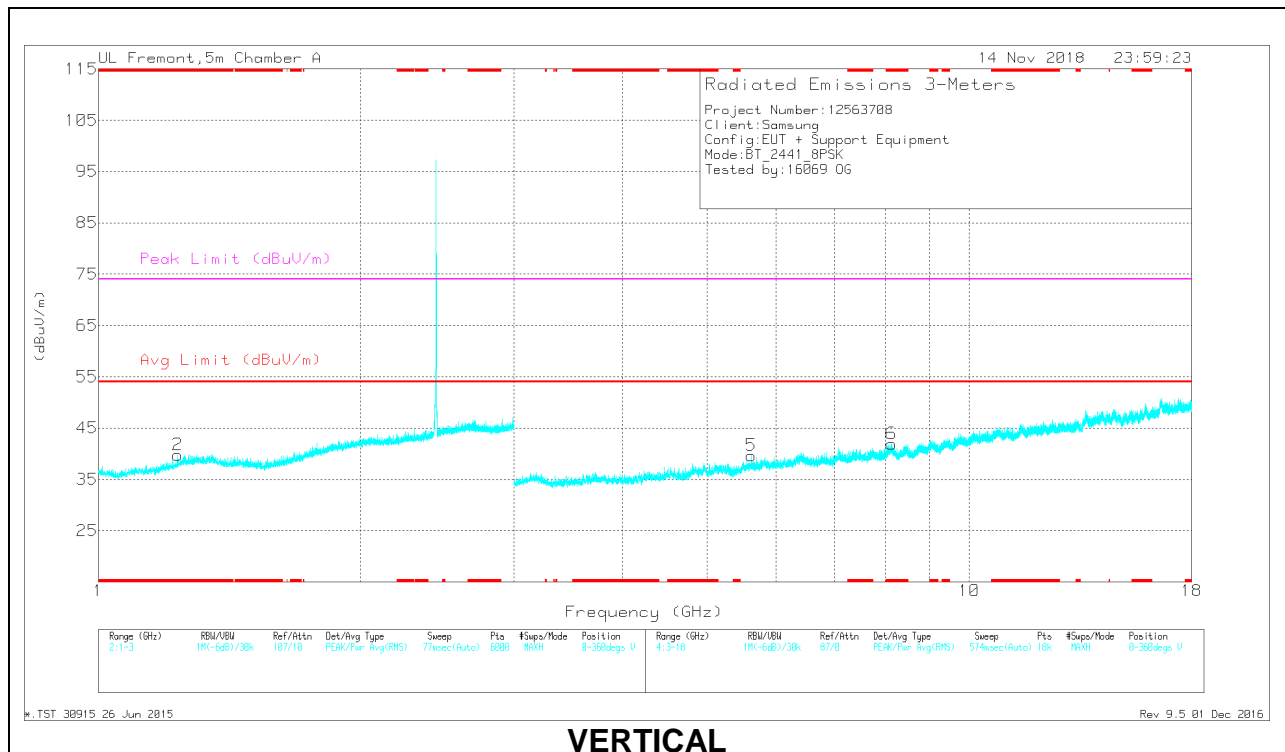

VERTICAL

RADIATED EMISSIONS

Marker	Frequency (GHz)	Meter Reading (dBuV)	Det	AF T345 (dB/m)	Amp/Cbl/Filtr/Pad (dB)	Corrected Reading (dBuV/m)	Avg Limit (dBuV/m)	Margin (dB)	Peak Limit (dBuV/m)	PK Margin (dB)	Azimuth (Degs)	Height (cm)	Polarity
1	* 1.201	38.71	PKFH	28.2	-24.4	42.51	-	-	74	-31.49	258	210	H
	* 1.2	28.06	VA1T	28.2	-24.4	31.86	54	-22.14	-	-	258	210	H
2	* 1.235	39.58	PKFH	28.8	-24.3	44.08	-	-	74	-29.92	308	235	V
	* 1.234	27.81	VA1T	28.8	-24.3	32.31	54	-21.69	-	-	308	235	V
4	* 11.878	29.58	PKFH	38.8	-18.4	49.98	-	-	74	-24.02	285	333	H
	* 11.879	18.49	VA1T	38.8	-18.4	38.89	54	-15.11	-	-	285	333	H
6	* 8.139	31.1	PKFH	35.8	-20.5	46.4	-	-	74	-27.6	100	374	V
	* 8.141	19.98	VA1T	35.8	-20.6	35.18	54	-18.82	-	-	100	374	V
5	5.614	23.33	VA1T	35.1	-26.2	32.23	-	-	-	-	285	201	V
	5.617	34.1	PKFH	35.1	-26.3	42.9	-	-	-	-	285	201	V
3	6.133	21.63	VA1T	35.5	-24.5	32.63	-	-	-	-	308	200	H
	6.135	33.32	PKFH	35.5	-24.5	44.32	-	-	-	-	308	200	H

* - indicates frequency in CFR47 Pt 15 / IC RSS-Restricted Band

PKFH - FHSS: RB=100k/1MHz VB=3 x RB, Peak

VA1T - FHSS: Linear Voltage Average VB=1/Ton where: Ton is transmit duration

HIGH CHANNEL RESULTS

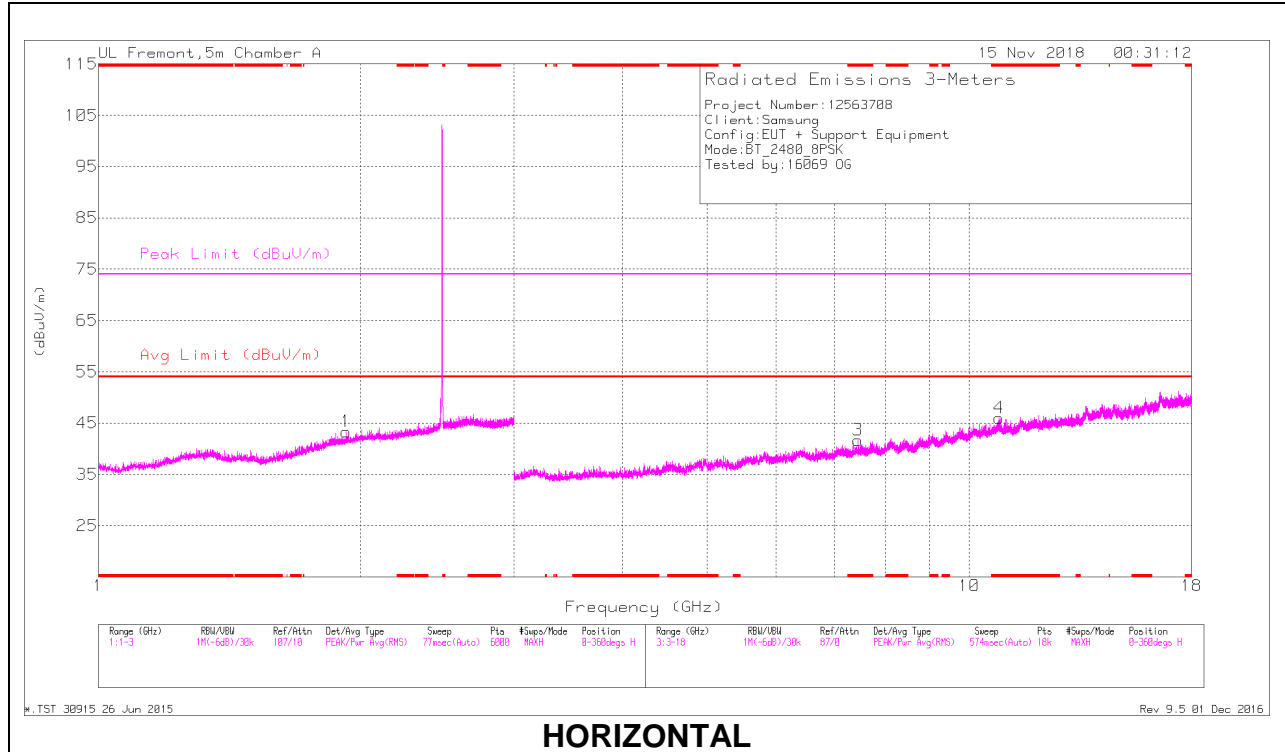

HORIZONTAL

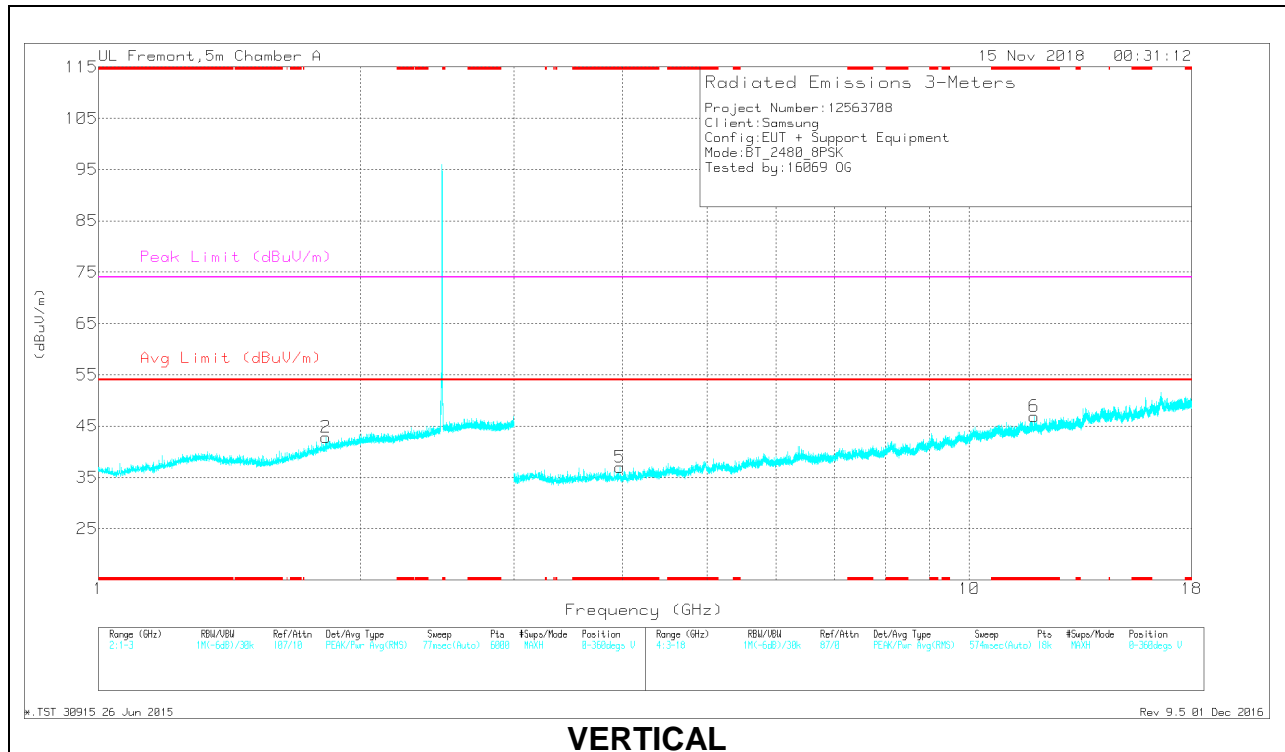

VERTICAL

RADIATED EMISSIONS

Marker	Frequency (GHz)	Meter Reading (dBuV)	Det	AF T345 (dB/m)	Amp/Cbl/Filtr/Pad (dB)	Corrected Reading (dBuV/m)	Avg Limit (dBuV/m)	Margin (dB)	Peak Limit (dBuV/m)	PK Margin (dB)	Azimuth (Degs)	Height (cm)	Polarity
3	* 7.454	31.67	PKFH	35.6	-21.9	45.37	-	-	74	-28.63	267	181	H
	* 7.454	20	VA1T	35.6	-21.9	33.7	54	-20.3	-	-	267	181	H
4	* 10.826	29.94	PKFH	37.8	-18.3	49.44	-	-	74	-24.56	27	156	H
	* 10.826	18.73	VA1T	37.8	-18.3	38.23	54	-15.77	-	-	27	156	H
5	* 3.974	36.26	PKFH	33.3	-27.8	41.76	-	-	74	-32.24	167	378	V
	* 3.972	24.15	VA1T	33.3	-27.7	29.75	54	-24.25	-	-	167	378	V
6	* 11.868	29.22	PKFH	38.8	-18.5	49.52	-	-	74	-24.48	104	193	V
	* 11.868	18.73	VA1T	38.8	-18.5	39.03	54	-14.97	-	-	104	193	V
2	1.824	38.73	PKFH	30.5	-23.2	46.03	-	-	-	-	0	200	V
	1.827	27.77	VA1T	30.6	-23.2	35.17	-	-	-	-	0	200	V
1	1.924	39.06	PKFH	31.2	-23	47.26	-	-	-	-	0	100	H
	1.927	27.84	VA1T	31.2	-23.1	35.94	-	-	-	-	0	100	H

* - indicates frequency in CFR47 Pt 15 / IC RSS-Restricted Band

PKFH - FHSS: RB=100k/1MHz VB=3 x RB, Peak

VA1T - FHSS: Linear Voltage Average VB=1/Ton where: Ton is transmit duration

10.1.3. SPOT CHECK DATA – SM-G975F (CERAMIC)

BANDEDGE (HIGH CHANNEL)

HORIZONTAL RESULT

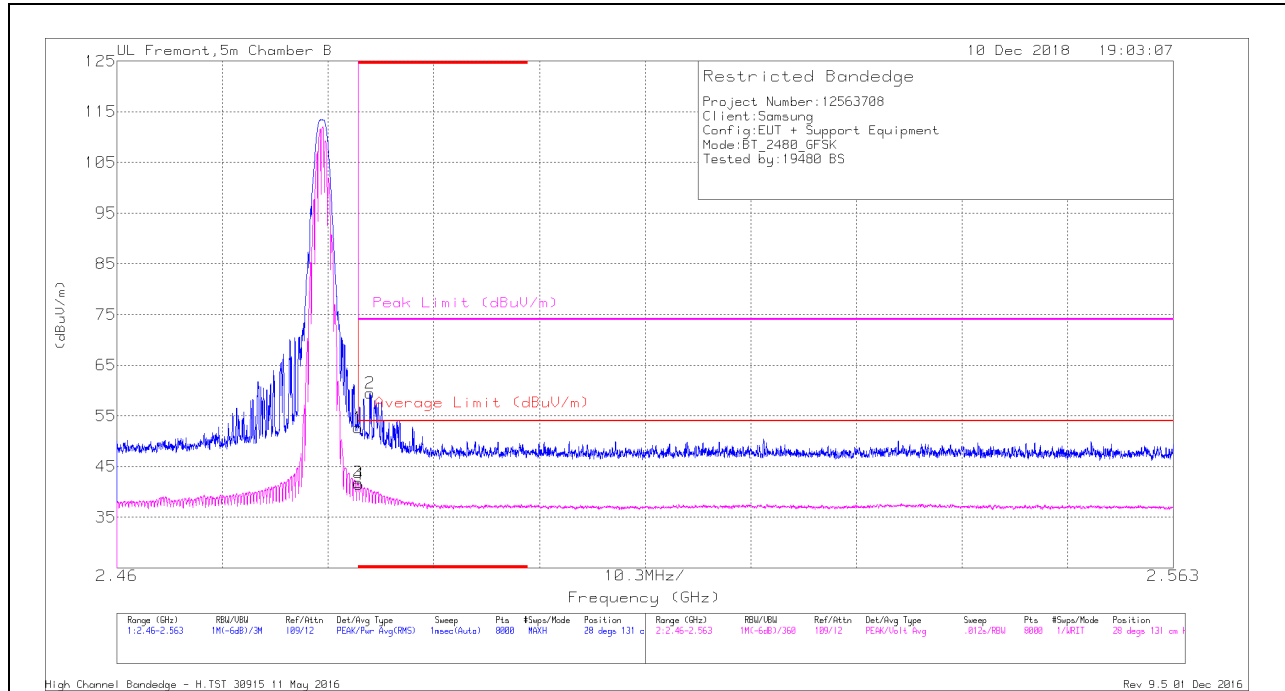

Trace Markers

Marker	Frequency (GHz)	Meter Reading (dBuV)	Det	AF T863 (dB/m)	Amp/Cb/Filt/Pad (dB)	Corrected Reading (dBuV/m)	Average Limit (dBuV/m)	Margin (dB)	Peak Limit (dBuV/m)	PK Margin (dB)	Azimuth (Degs)	Height (cm)	Polarity
1	* 2.484	40.35	Pk	32.6	-20.3	52.65	-	-	74	-21.35	28	131	H
2	* 2.485	47.32	Pk	32.6	-20.4	59.52	-	-	74	-14.48	28	131	H
3	* 2.484	29.54	VA1T	32.6	-20.3	41.84	54	-12.16	-	-	28	131	H
4	* 2.484	29.13	VA1T	32.6	-20.3	41.43	54	-12.57	-	-	28	131	H

* - indicates frequency in CFR47 Pt 15 / IC RSS-Restricted Band

Pk - Peak detector

VA1T - FHSS: Linear Voltage Average VB=1/Ton where: Ton is transmit duration

VERTICAL RESULT

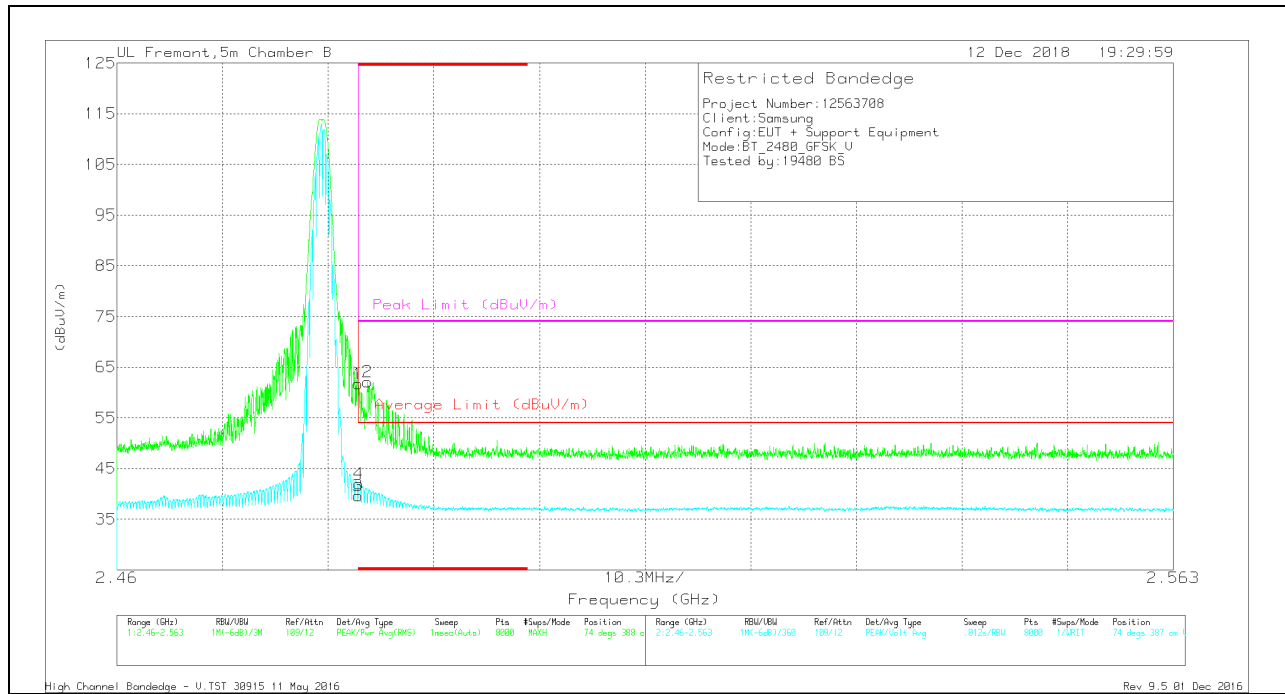

Trace Markers

Marker	Frequency (GHz)	Meter Reading (dBuV)	Det	AF T863 (dB/m)	Amp/Cb/Fltr/Pad (dB)	Corrected Reading (dBuV/m)	Average Limit (dBuV/m)	Margin (dB)	Peak Limit (dBuV/m)	PK Margin (dB)	Azimuth (Degs)	Height (cm)	Polarity
1	* 2.484	49.38	Pk	32.6	-20.3	61.68	-	-	74	-12.32	74	388	V
2	* 2.484	49.89	Pk	32.6	-20.4	62.09	-	-	74	-11.91	74	388	V
3	* 2.484	27.32	VA1T	32.6	-20.3	39.62	54	-14.38	-	-	74	387	V
4	* 2.484	29.69	VA1T	32.6	-20.3	41.99	54	-12.01	-	-	74	387	V

* - indicates frequency in CFR47 Pt 15 / IC RSS-Restricted Band

Pk - Peak detector

VA1T - FHSS: Linear Voltage Average $V_B=1/T_{on}$ where: T_{on} is transmit duration

HARMONICS AND SPURIOUS EMISSIONS

LOW CHANNEL RESULTS

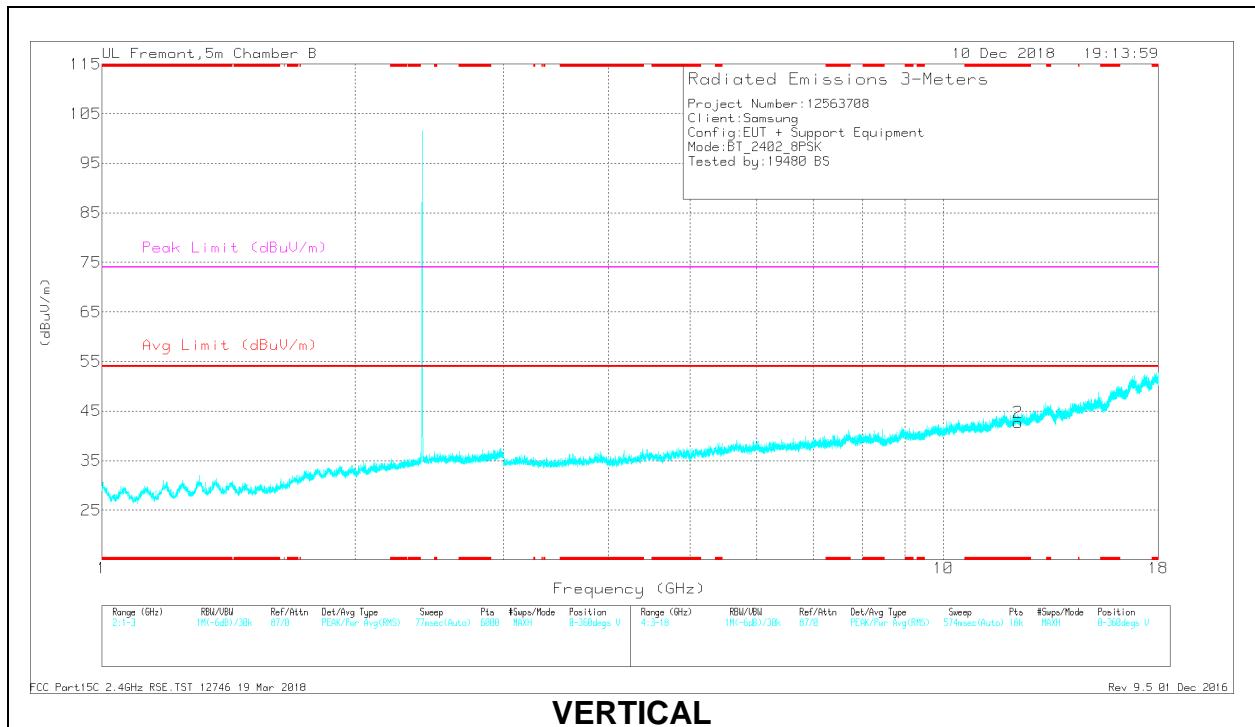
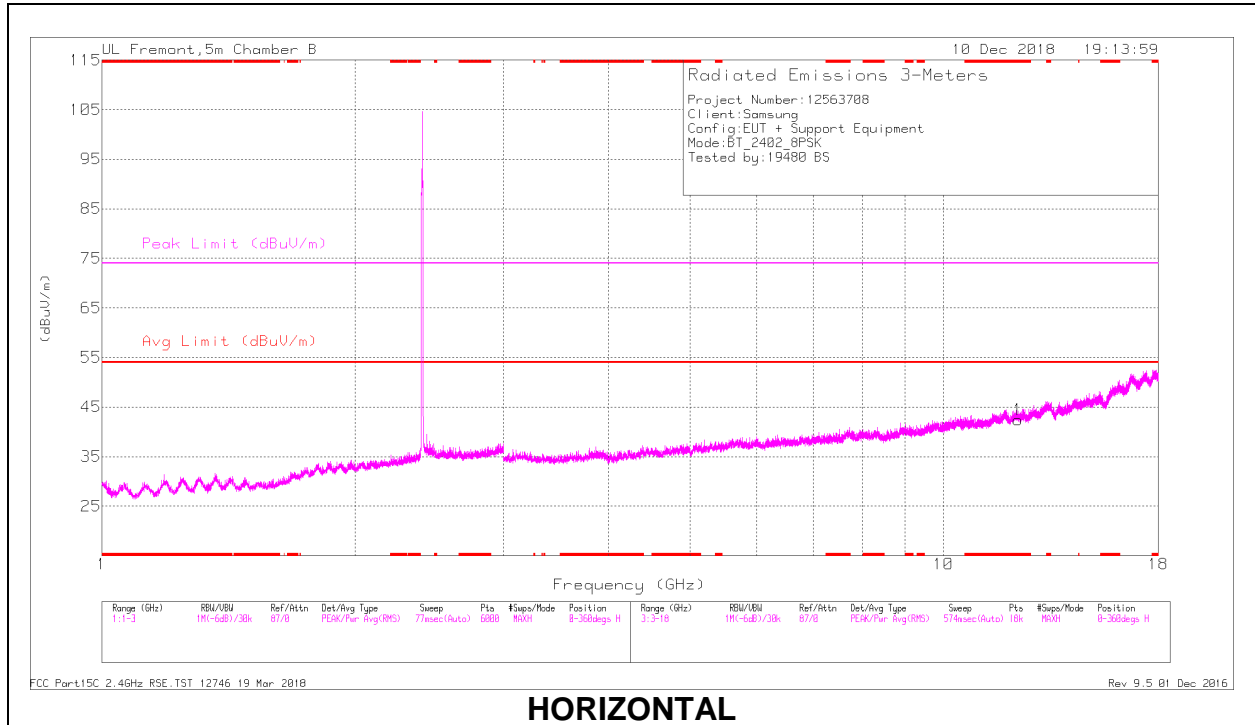

RADIATED EMISSIONS

Marker	Frequency (GHz)	Meter Reading (dBuV)	Det	AF T863 (dB/m)	Amp/Cbl/Filtr/Pad (dB)	Corrected Reading (dBuV/m)	Avg Limit (dBuV/m)	Margin (dB)	Peak Limit (dBuV/m)	PK Margin (dB)	Azimuth (Degs)	Height (cm)	Polarity
1	* 12.259	31.43	PKFH	39.2	-21.9	48.73	-	-	74	-25.27	78	113	H
	* 12.259	20.38	VA1T	39.2	-21.9	37.68	54	-16.32	-	-	78	113	H
2	* 12.263	31.88	PKFH	39.1	-21.9	49.08	-	-	74	-24.92	11	353	V
	* 12.263	20.6	VA1T	39.1	-21.9	37.8	54	-16.2	-	-	11	353	V

* - indicates frequency in CFR47 Pt 15 Restricted Band

PKFH - FHSS: RB=100k/1MHz VB=3 x RB, Peak

VA1T - FHSS: Linear Voltage Average VB=1/Ton where: Ton is transmit duration

10.1.4. SPOT CHECK DATA – SM-G975N (CERAMIC)

BANDEDGE (HIGH CHANNEL)

HORIZONTAL RESULT

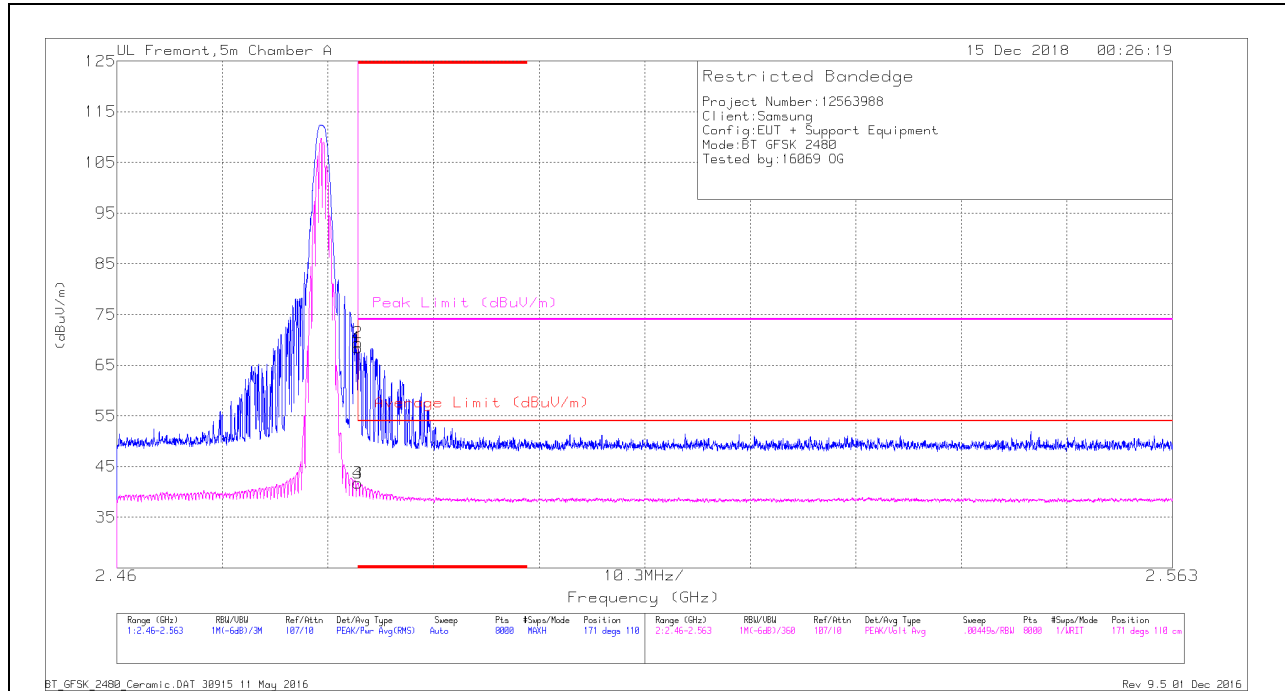

Trace Markers

Marker	Frequency (GHz)	Meter Reading (dBuV)	Det	AF T345 (dB/m)	Amp/Cb/Fltr/Pad (dB)	Corrected Reading (dBuV/m)	Average Limit (dBuV/m)	Margin (dB)	Peak Limit (dBuV/m)	PK Margin (dB)	Azimuth (Degs)	Height (cm)	Polarity
1	* 2.484	57.71	Pk	32.4	-21.7	68.41	-	-	74	-5.59	171	110	H
2	* 2.484	58.73	Pk	32.4	-21.7	69.43	-	-	74	-4.57	171	110	H
3	* 2.484	31.04	VA1T	32.4	-21.7	41.74	54	-12.26	-	-	171	110	H
4	* 2.484	30.99	VA1T	32.4	-21.7	41.69	54	-12.31	-	-	171	110	H

* - indicates frequency in CFR47 Pt 15 / IC RSS-Restricted Band

Pk - Peak detector

VA1T - FHSS: Linear Voltage Average VB=1/Ton where: Ton is transmit duration

VERTICAL RESULT

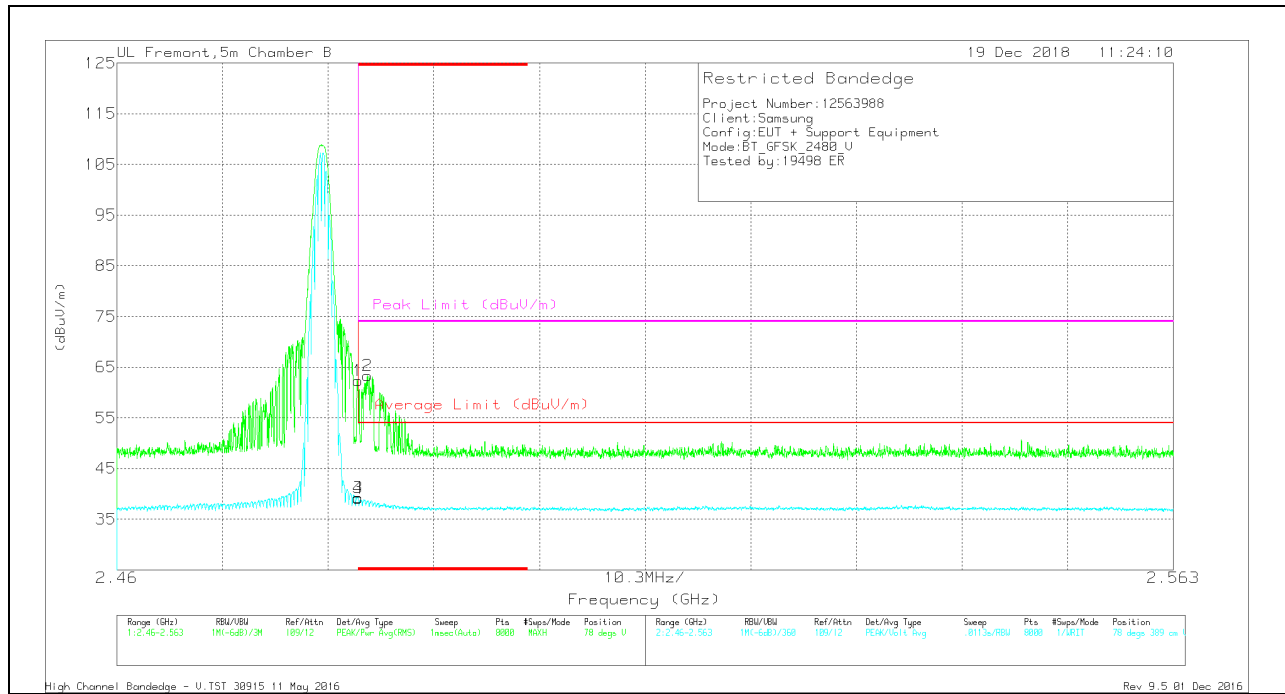

Trace Markers

Marker	Frequency (GHz)	Meter Reading (dBuV)	Det	AF T863 (dB/m)	Amp/Cb/Ftr/Pad (dB)	Corrected Reading (dBuV/m)	Average Limit (dBuV/m)	Margin (dB)	Peak Limit (dBuV/m)	PK Margin (dB)	Azimuth (Degs)	Height (cm)	Polarity
1	* 2.484	50.08	Pk	32.6	-20.3	62.38	-	-	74	-11.62	78	390	V
2	* 2.484	51.1	Pk	32.6	-20.4	63.3	-	-	74	-10.7	78	390	V
3	* 2.484	26.98	VA1T	32.6	-20.3	39.28	54	-14.72	-	-	78	389	V
4	* 2.484	26.84	VA1T	32.6	-20.3	39.14	54	-14.86	-	-	78	389	V

* - indicates frequency in CFR47 Pt 15 / IC RSS-Restricted Band

Pk - Peak detector

VA1T - FHSS: Linear Voltage Average $V_B=1/T_{on}$ where: T_{on} is transmit duration

HARMONICS AND SPURIOUS EMISSIONS

LOW CHANNEL RESULTS

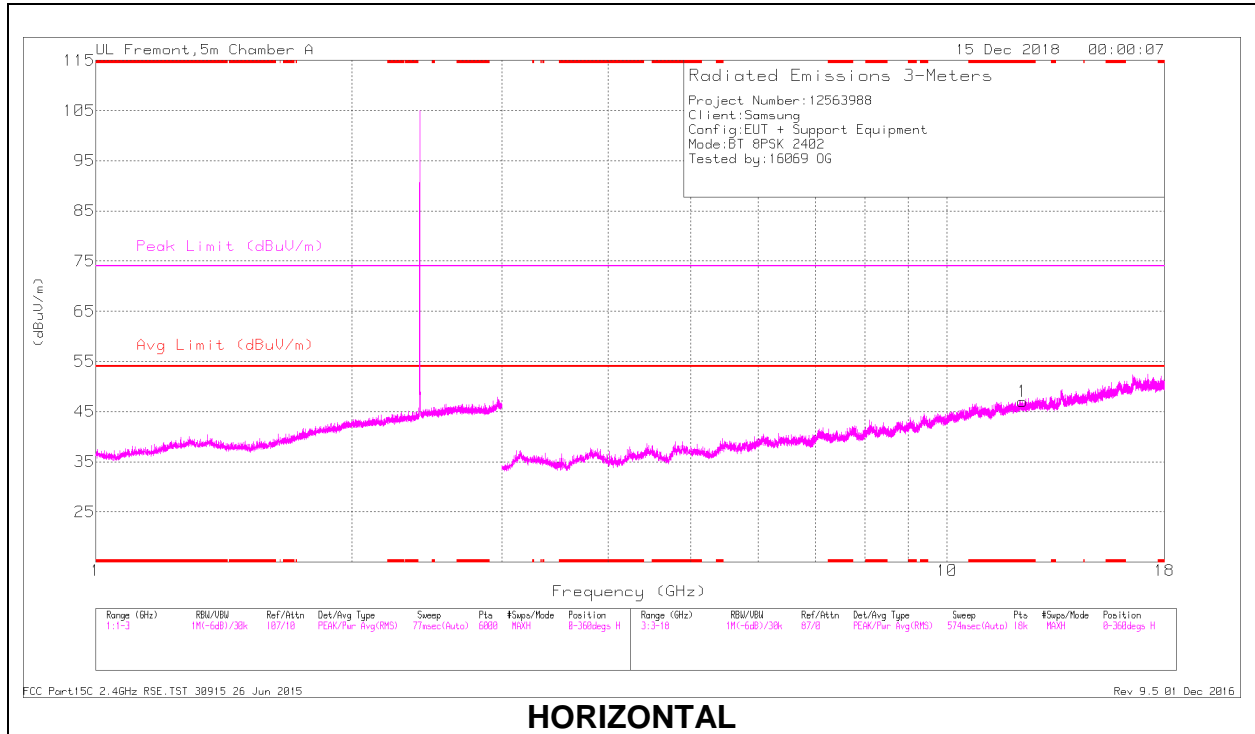

HORIZONTAL

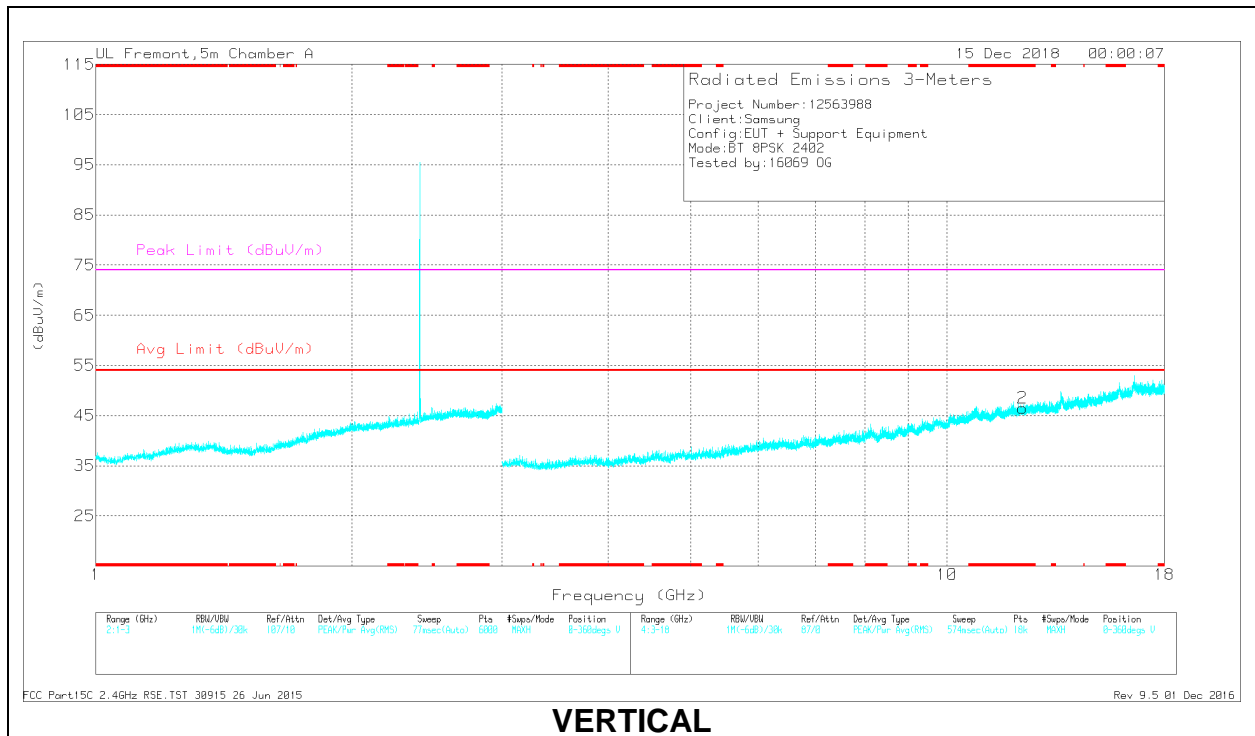

VERTICAL

RADIATED EMISSIONS

Marker	Frequency (GHz)	Meter Reading (dBuV)	Det	AF T863 (dB/m)	Amp/Cbl/Filtr/Pad (dB)	Corrected Reading (dBuV/m)	Avg Limit (dBuV/m)	Margin (dB)	Peak Limit (dBuV/m)	PK Margin (dB)	Azimuth (Degs)	Height (cm)	Polarity
1	* 12.662	32.02	PKFH	39.2	-21.9	49.32	-	-	74	-24.68	81	178	H
	* 12.66	20.26	VA1T	39.2	-21.9	37.56	54	-16.44	-	-	81	178	H
2	* 12.662	31.79	PKFH	39.2	-21.9	49.09	-	-	74	-24.91	125	190	V
	* 12.661	20.43	VA1T	39.2	-21.9	37.73	54	-16.27	-	-	125	190	V

* - indicates frequency in CFR47 Pt 15 Restricted Band

PKFH - FHSS: RB=100k/1MHz VB=3 x RB, Peak

VA1T - FHSS: Linear Voltage Average VB=1/Ton where: Ton is transmit duration

10.2. Worst Case Below 30 MHz

SPURIOUS EMISSIONS 9 kHz TO 30 MHz (WORST-CASE CONFIGURATION)

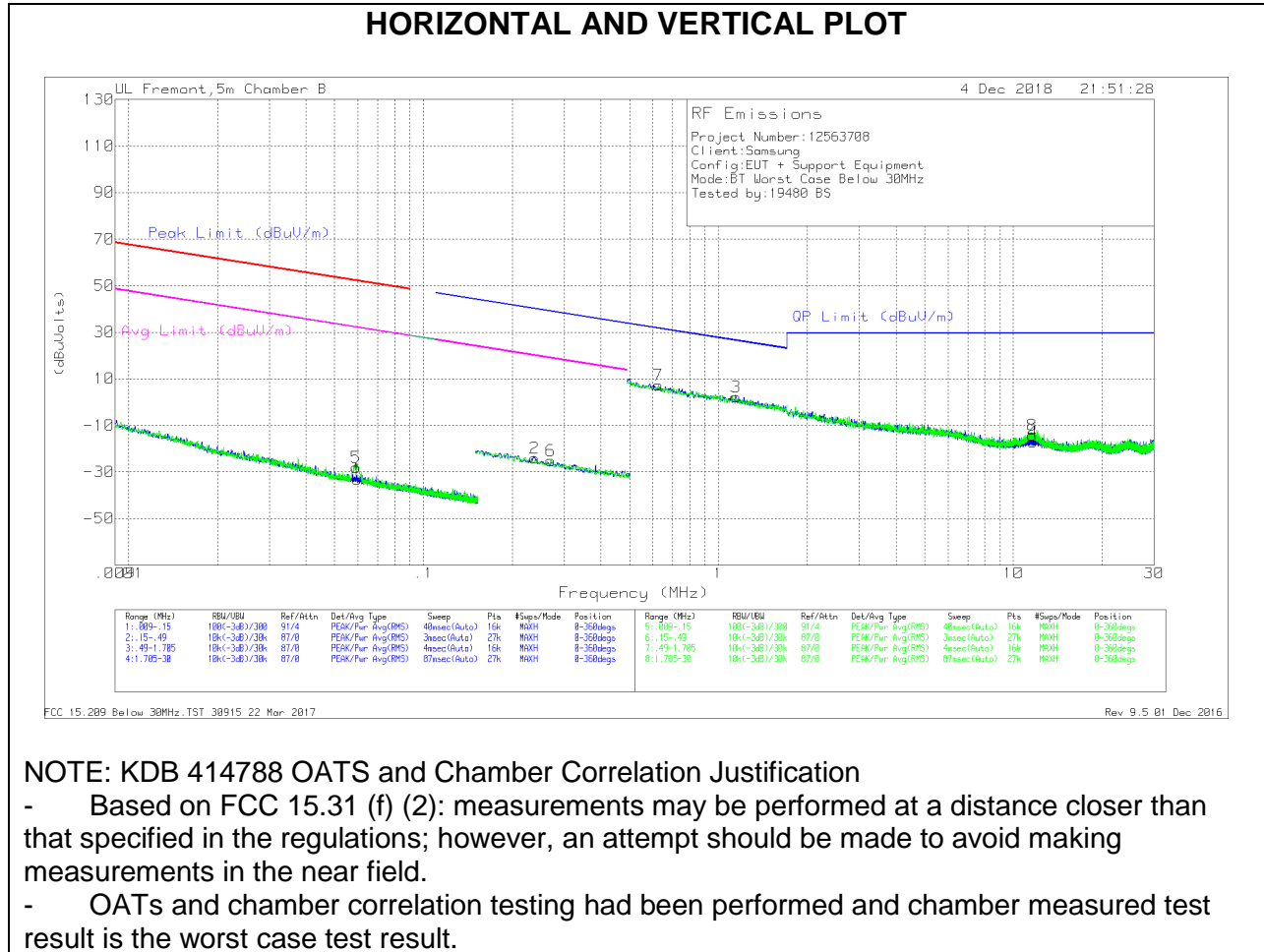

Below 30 MHz Data

Trace Markers

Marker	Frequency (MHz)	Meter Reading (dBuV)	Det	Loop Antenna (dB/m)	Cables (dB)	Dist Corr 300m	Corrected Reading (dBuVolts)	Peak Limit (dBuV/m)	Margin (dB)	Avg Limit (dBuV/m)	Margin (dB)	Peak Limit (dBuV/m)	Margin (dB)	Avg Limit (dBuV/m)	Margin (dB)	Azimuth (Degs)
5	.05911	40.06	Pk	11.8	0	-80	-28.14	52.15	-80.29	32.15	-60.29	-	-	-	-	0-360
1	.05968	35.09	Pk	11.8	0	-80	-33.11	52.07	-85.18	32.07	-65.18	-	-	-	-	0-360
2	.23825	44.95	Pk	11	.1	-80	-23.95	-	-	-	-	40.07	-64.02	20.07	-44.02	0-360
6	.27013	43.96	Pk	10.9	.1	-80	-25.04	-	-	-	-	38.98	-64.02	18.98	-44.02	0-360

Pk - Peak detector

Marker	Frequency (MHz)	Meter Reading (dBuV)	Det	Loop Antenna (dB/m)	Cables (dB)	Dist Corr (dB) 40Log	Corrected Reading (dBuVolts)	QP Limit (dBuV/m)	Margin (dB)	Peak Limit (dBuV/m)	Margin (dB)	Avg Limit (dBuV/m)	Margin (dB)	Azimuth (Degs)
7	.62574	35.97	Pk	11.1	.1	-40	7.17	31.68	-24.51	-	-	-	-	0-360
3	1.1458	30.9	Pk	11.3	.1	-40	2.3	26.44	-24.14	-	-	-	-	0-360
8	11.59183	14.29	Pk	11	.4	-40	-14.31	29.5	-43.81	-	-	-	-	0-360
4	11.64056	11.49	Pk	11	.4	-40	-17.11	29.5	-46.61	-	-	-	-	0-360

Pk - Peak detector

10.3. Worst Case Below 1 GHz

SPURIOUS EMISSIONS 30 TO 1000 MHz (WORST-CASE CONFIGURATION)

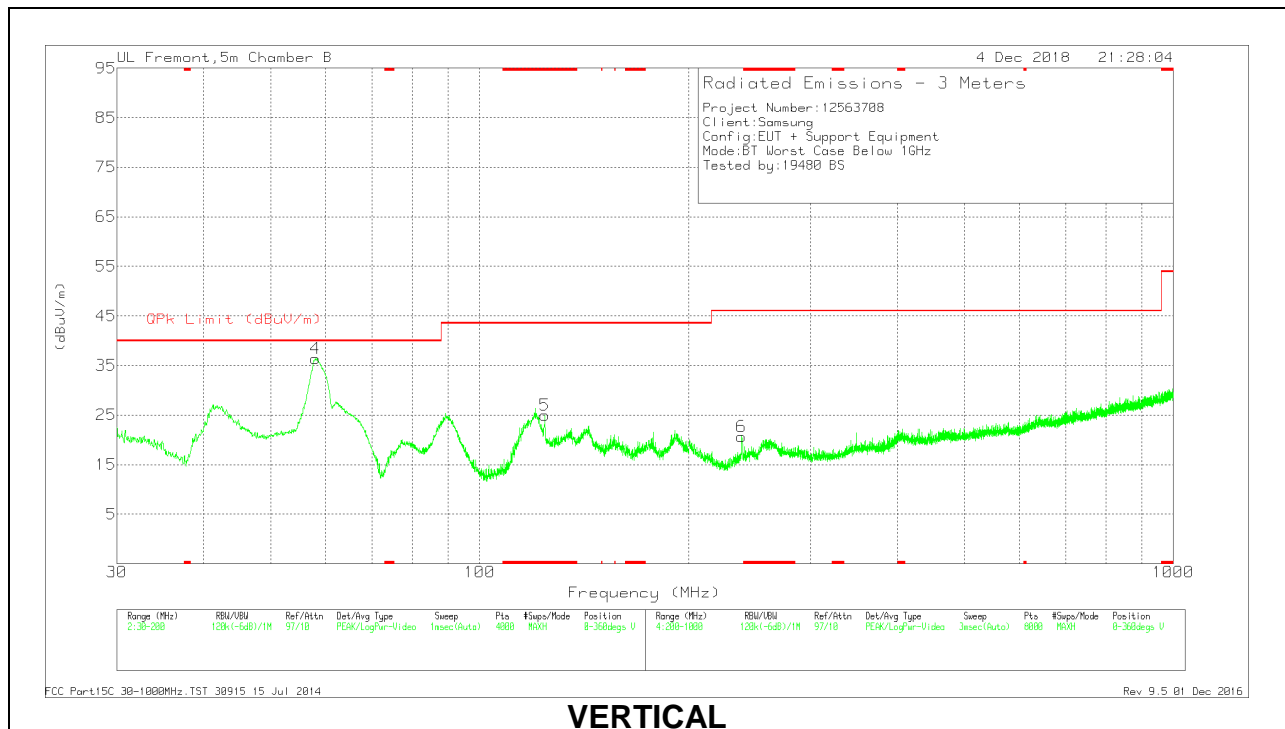
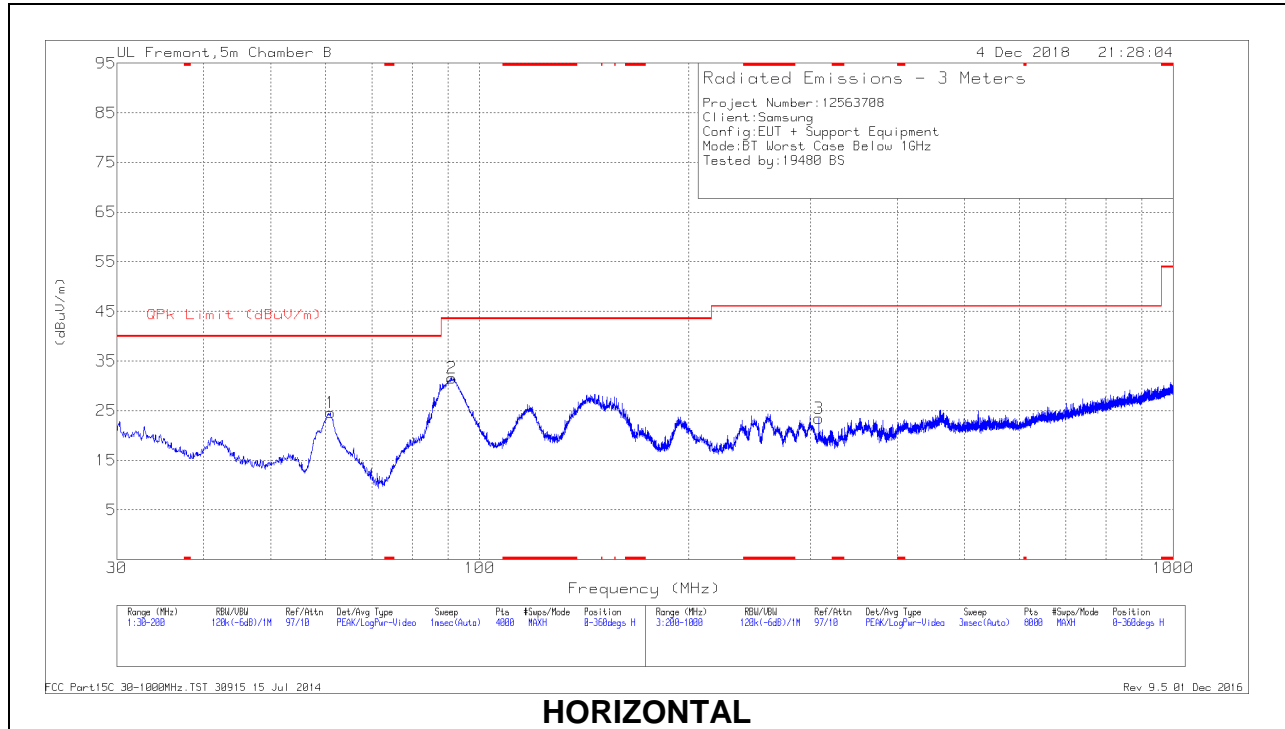

Below 1GHz Data

Marker	Frequency (MHz)	Meter Reading (dBuV)	Det	AF T407 (dB/m)	Amp/Cbl (dB)	Corrected Reading (dBuV/m)	QPk Limit (dBuV/m)	Margin (dB)	Azimuth (Degs)	Height (cm)	Polarity
5	* 124.1406	37.61	Pk	17.9	-30.5	25.01	43.52	-18.51	0-360	100	V
4	57.9722	56.06	Pk	11.4	-31.1	36.36	40	-3.64	0-360	100	V
	58.0055	47.69	Qp	11.4	-31.1	27.99	40	-12.01	0	100	V
1	60.9055	43.95	Pk	11.7	-31.1	24.55	40	-15.45	0-360	100	H
2	91.1733	50.42	Pk	11.9	-30.7	31.62	43.52	-11.9	0-360	200	H
6	238.505	35	Pk	15.5	-29.9	20.6	46.02	-25.42	0-360	200	V
3	308.3141	35.39	Pk	17.6	-29.6	23.39	46.02	-22.63	0-360	100	H

* - indicates frequency in CFR47 Pt 15 / IC RSS-Restricted Band

Pk - Peak detector

Qp - Quasi-Peak detector

10.4. Worst Case 18-26 GHz

SPURIOUS EMISSIONS 18-26 GHz (WORST-CASE CONFIGURATION)

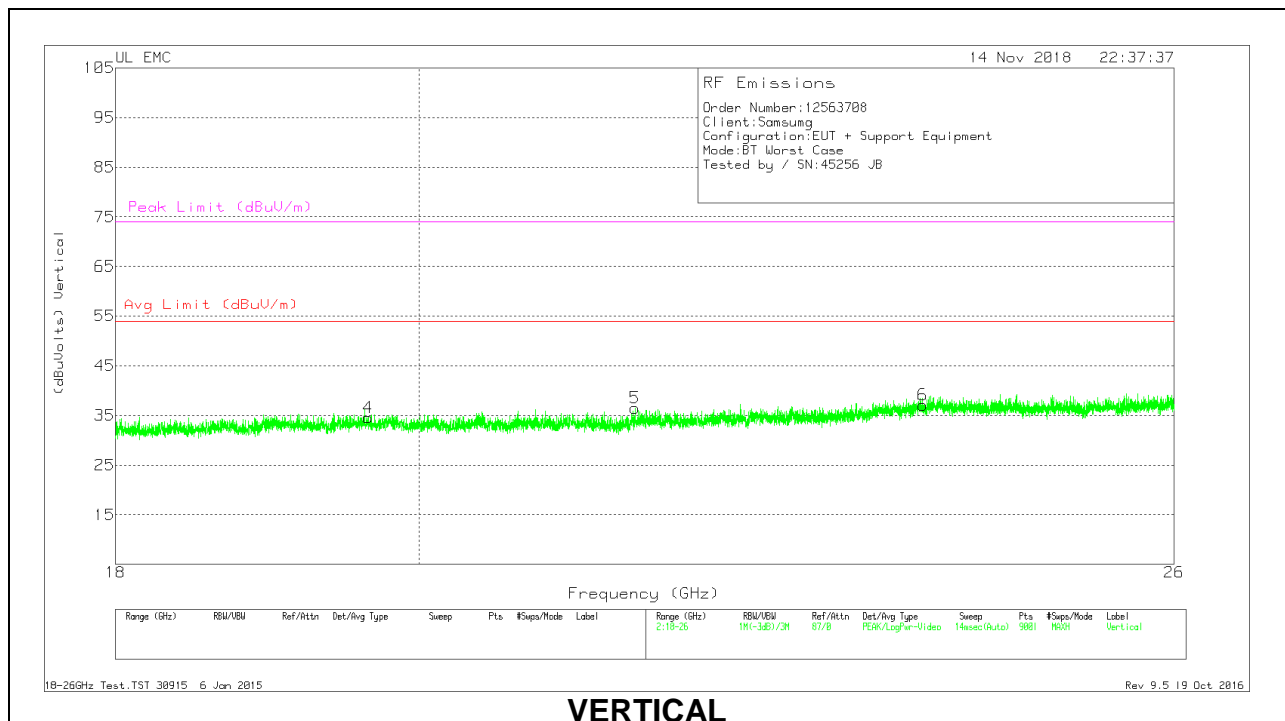
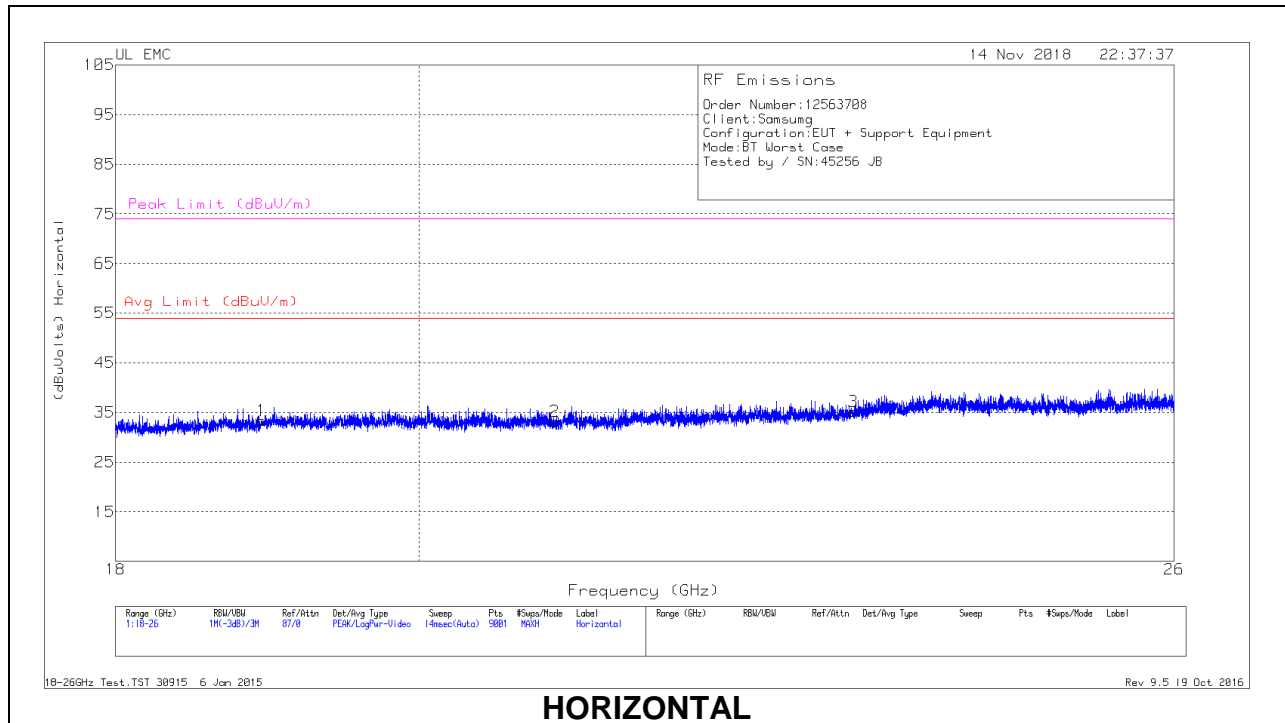

18 – 26GHz DATA

Marker	Frequency (GHz)	Meter Reading (dBuV)	Det	T89 AF (dB/m)	Amp/Cbl (dB)	Dist Corr (dB)	Corrected Reading (dBuVolts)	Avg Limit (dBuV/m)	Margin (dB)	Peak Limit (dBuV/m)	PK Margin (dB)
1	18.935	35.54	Pk	32.5	-25.2	-9.5	33.34	54	-20.66	74	-40.66
2	20.967	35.19	Pk	33.1	-25.6	-9.5	33.19	54	-20.81	74	-40.81
3	23.257	35.84	Pk	33.7	-24.9	-9.5	35.14	54	-18.86	74	-38.86
4	19.65	36.23	Pk	32.8	-25	-9.5	34.53	54	-19.47	74	-39.47
5	21.558	38.18	Pk	33.1	-25.3	-9.5	36.48	54	-17.52	74	-37.52
6	23.826	36.59	Pk	34.2	-24.2	-9.5	37.09	54	-16.91	74	-36.91

Pk - Peak detector

11. AC POWER LINE CONDUCTED EMISSIONS

LIMITS

FCC §15.207 (a)

Frequency of Emission (MHz)	Conducted Limit (dBuV)	
	Quasi-peak	Average
0.15-0.5	66 to 56*	56 to 46*
0.5-5	56	46
5-30	60	50

*Decreases with the logarithm of the frequency.

TEST PROCEDURE

The EUT is placed on a non-conducting table 40 cm from the vertical ground plane and 80 cm above the horizontal ground plane. The EUT is configured in accordance with ANSI C63.10.

The receiver is set to a resolution bandwidth of 9 kHz. Peak detection is used unless otherwise noted as quasi-peak or average.

Line conducted data is recorded for both NEUTRAL and HOT lines.

RESULTS

11.1. AC Power Line Norm

LINE 1 RESULTS

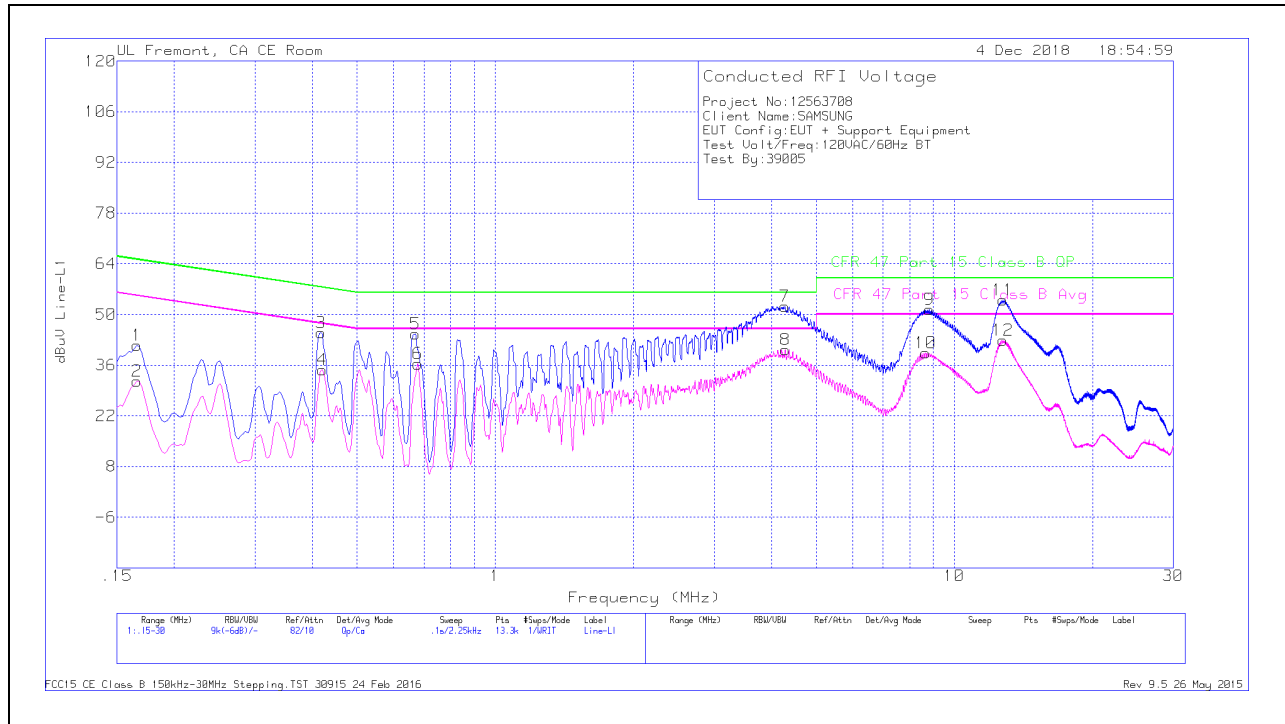

Trace Markers

Range 1: Line-L1 .15 - 30MHz											
Marker	Frequency (MHz)	Meter Reading (dBuV)	Det	LISN L1	LC Cables C1&C3	Limiter (dB)	Corrected Reading dBuV	CFR 47 Part 15 Class B QP	QP Margin (dB)	CFR 47 Part 15 Class B Avg	Av(CISPR) Margin (dB)
1	.16575	31.28	Qp	.1	0	10.1	41.48	65.17	-23.69	-	-
2	.16575	21.39	Ca	.1	0	10.1	31.59	-	-	55.17	-23.58
3	.41775	34.8	Qp	0	0	10.1	44.9	57.49	-12.59	-	-
4	.42	24.63	Ca	0	0	10.1	34.73	-	-	47.45	-12.72
5	.66975	34.51	Qp	0	0	10.1	44.61	56	-11.39	-	-
6	.67875	26.26	Ca	0	0	10.1	36.36	-	-	46	-9.64
7	4.27875	42.01	Qp	0	.1	10.1	52.21	56	-3.79	-	-
8	4.28663	30.12	Ca	0	.1	10.1	40.32	-	-	46	-5.68
9	8.81475	40.91	Qp	0	.2	10.2	51.31	60	-8.69	-	-
10	8.673	28.95	Ca	0	.2	10.2	39.35	-	-	50	-10.65
11	12.75675	43.5	Qp	.1	.2	10.2	54	60	-6	-	-
12	12.7635	32.4	Ca	.1	.2	10.2	42.9	-	-	50	-7.1

Qp - Quasi-Peak detector
 Ca - CISPR average detection

LINE 2 RESULTS

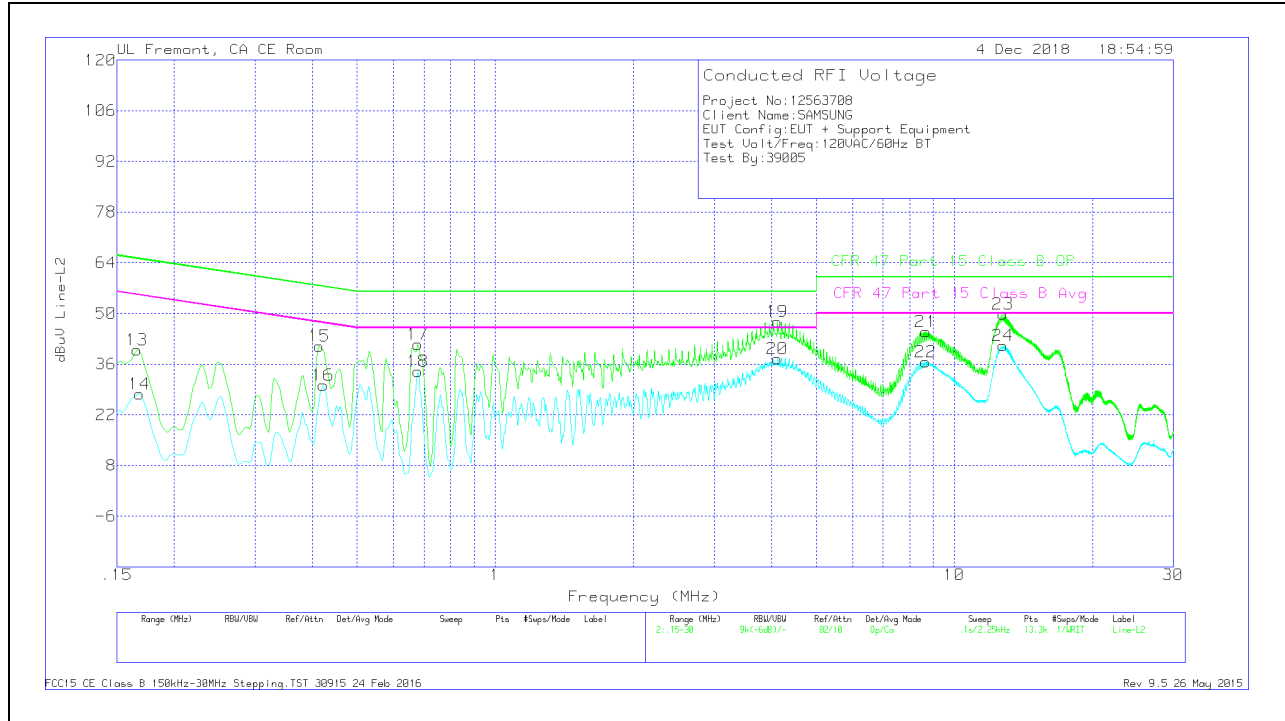

Trace Markers

Range 2: Line-L2 .15 - 30MHz											
Marker	Frequency (MHz)	Meter Reading (dBuV)	Det	LISN L2	LC Cables C2&C3	Limiter (dB)	Corrected Reading dBuV	CFR 47 Part 15 Class B QP	QP Margin (dB)	CFR 47 Part 15 Class B Avg	Av(CISPR) Margin (dB)
13	.16575	29.73	Qp	.1	0	10.1	39.93	65.17	-25.24	-	-
14	.168	17.53	Ca	.1	0	10.1	27.73	-	-	55.06	-27.33
15	.41325	30.93	Qp	0	0	10.1	41.03	57.58	-16.55	-	-
16	.42225	20.02	Ca	0	0	10.1	30.12	-	-	47.4	-17.28
17	.67875	31.44	Qp	0	0	10.1	41.54	56	-14.46	-	-
18	.67875	23.88	Ca	0	0	10.1	33.98	-	-	46	-12.02
19	4.119	37.59	Qp	0	.1	10.1	47.79	56	-8.21	-	-
20	4.12125	27.3	Ca	0	.1	10.1	37.5	-	-	46	-8.5
21	8.67525	34.5	Qp	0	.2	10.2	44.9	60	-15.1	-	-
22	8.6505	26.27	Ca	0	.2	10.2	36.67	-	-	50	-13.33
23	12.77475	39.39	Qp	.1	.2	10.2	49.89	60	-10.11	-	-
24	12.7725	30.68	Ca	.1	.2	10.2	41.18	-	-	50	-8.82

Qp - Quasi-Peak detector
 Ca - CISPR average detection