



CERTIFICATION TEST REPORT

Report Number. : 12563988-E7V1

Applicant : Samsung Electronics Co., Ltd.
129 Samsung-Ro, Yeongtong-Gu,
Suwon-Si, Gyeonggi-Do, 16677, Korea

Model : SM-G975N

FCC ID : A3LSMG975KOR

EUT Description : GSM/WCDMA/LTE phone with BT, DTS/UNII a/b/g/n/ac/11ax HE
20/40/80, ANT+ and NFC

Test Standard(s) : FCC 47 CFR PART 15 SUBPART C

Date Of Issue:

January 29, 2019

Prepared by:

UL Verification Services Inc.
47173 Benicia Street
Fremont, CA 94538 U.S.A.
TEL: (510) 771-1000
FAX: (510) 661-0888



NVLAP Lab code: 200065-0

Report Revision History

Rev.	Issue Date	Revisions	Revised By
V1	1/29/2019	Initial Issue	

TABLE OF CONTENTS

Report Revision History	2
TABLE OF CONTENTS	3
1. ATTESTATION OF TEST RESULTS	5
2. INTRODUCTION OF TEST DATA REUSE.....	6
2.1. INTRODUCTION	6
2.2. DEVICES DIFFERENCES.....	6
2.3. SPOT CHECK VERIFICATION RESULTS SUMMARY	7
2.3.1. SPOT CHECK DATA – SM-G975N (GLASS)	8
2.4. REFERENCE DETAIL	11
3. TEST METHODOLOGY	12
4. FACILITIES AND ACCREDITATION	12
5. CALIBRATION AND UNCERTAINTY	13
5.1. MEASURING INSTRUMENT CALIBRATION	13
5.2. SAMPLE CALCULATION	13
5.3. MEASUREMENT UNCERTAINTY.....	13
6. EQUIPMENT UNDER TEST	14
6.1. DESCRIPTION OF EUT	14
6.2. MAXIMUM OUTPUT POWER.....	14
6.3. SOFTWARE AND FIRMWARE.....	14
6.4. WORST-CASE CONFIGURATION AND MODE.....	15
6.5. DESCRIPTION OF TEST SETUP.....	16
7. TEST AND MEASUREMENT EQUIPMENT	18
8. OCCUPIED BANDWIDTH	19
8.1. TYPE A.....	20
8.2. TYPE B.....	22
8.3. TYPE F.....	24
9. RADIATED EMISSION TEST RESULTS.....	25
9.1. LIMITS AND PROCEDURE.....	25
9.2. FUNDAMENTAL AND SPURIOUS EMISSIONS (0.15 - 1000 MHz),	27
9.3. SPOT CHECK DATA - SM-G975F (CERAMIC)	32
9.4. SPOT CHECK DATA – SM-G975N (CERAMIC).....	36

10. FREQUENCY STABILITY.....	39
11. AC MAINS LINE CONDUCTED EMISSIONS	40
11.1. EUT with ANTENNA.....	41
11.2. EUT with ANTENNA TERMINATED.....	43
12. SETUP PHOTOS	45
12.1. SM-G975F (Glass).....	45
12.2. SETUP PHOTOS – SM-G975N (GLASS).....	47
12.3. SETUP PHOTOS – SM-G975N (CERAMIC).....	48

1. ATTESTATION OF TEST RESULTS

COMPANY NAME: Samsung Electronics Co., Ltd.
129 Samsung-Ro, Yeongtong-Gu,
Suwon-Si, Gyeonggi-Do, 16677, Korea

EUT DESCRIPTION: GSM/WCDMA/LTE phone with BT, DTS/UNII a/b/g/n/ac/11ax HE
20/40/80, ANT+ and NFC

MODEL: SM-G975N

SERIAL NUMBER: Radiated:R38KA0L97DV, R38KA0L971T (Glass)
Radiated:R38KA092LGJ, R38KA0KV84N (Ceramic) - (ORIGINAL)
Radiated:R39KA0KPKH, R39KA0FDGAH, R39KA0FDGTD (Glass)
Radiated:R39KB0A1Z4, R39KB0A1YW, R39KB0A1YV (Ceramic) -
(SPOTCHECK)

DATE TESTED: November 27, 2018 – January 22, 2019 (ORIGINAL)
December 11, 2018 – December 28, 2019 (SPOTCHECK)

APPLICABLE STANDARDS	
STANDARD	TEST RESULTS
FCC PART 15 SUBPART C	Complies

UL Verification Services Inc. tested the above equipment in accordance with the requirements set forth in the above standards. The test results show that the equipment tested is capable of demonstrating compliance with the requirements as documented in this report.

The results documented in this report apply only to the tested sample, under the conditions and modes of operation as described herein. It is the manufacturer's responsibility to assure that additional production units of this model are manufactured with identical electrical and mechanical components. All samples tested were in good operating condition throughout the entire test program. Measurement Uncertainties are published for informational purposes only and were not taken into account unless noted otherwise.

This document may not be altered or revised in any way unless done so by UL Verification Services Inc. and all revisions are duly noted in the revisions section. Any alteration of this document not carried out by UL Verification Services Inc. will constitute fraud and shall nullify the document. This report must not be used by the client to claim product certification, approval, or endorsement by NVLAP, NIST, any agency of the Federal Government, or any agency of the U.S. government.

Approved & Released For
UL Verification Services Inc. By:

Reviewed By:



Dan Corona
Operations Leader
Consumer Technology Division
UL Verification Services Inc.

Steven Tran
Project Engineer
Consumer Technology Division
UL Verification Services Inc.

2. INTRODUCTION OF TEST DATA REUSE

2.1. INTRODUCTION

According to the manufacturer, FCC ID: A3LSMG975F and FCC ID: A3LSMG975KOR non-licensed radios are electrically identical. The FCC ID: A3LSMG975F test data shall remain representative of FCC ID: A3LSMG975KOR.

The applicant takes full responsibility that the test data as referenced in this section represents compliance for this FCC ID.

2.2. DEVICES DIFFERENCES

The FCC ID: A3LSMG975F, shares the same enclosure and circuit board as FCC ID: A3LSMG975KOR. The NFC antennas and surrounding circuitry and layout are identical between two models.

After confirming through preliminary radiated emissions that the performance of the FCC ID: A3LSMG975F remains representative of FCC ID: A3LSMG975KOR. The test data of FCC ID: A3LSMG975F being submitted for this application to cover NFC features.

2.3. SPOT CHECK VERIFICATION RESULTS SUMMARY

Spot check verification has been done on device A3LSMG975KOR (Glass and Ceramic) for radiated harmonic spurious and radiated fundamental. The data from the application has been verified through appropriate spot checks to demonstrate compliance for this device as shown in the summary below.

A3LSMG975KOR SPOT CHECK RESULTS					
Technology	Test Item	Measured Frequency	Original model	Spot check model	Delta (dB)
			SM-G975F	SM-G975N	
			A3LSMG975F	A3LSMG975KOR	Peak/Quasi-Peak (dBµV)
NFC	Fundamental	13.56MHz	14.57 Pk	15.09 Pk	0.52
	Spurious Emissions	54.66MHz	33.43 QP	14.23 QP	-19.2

Comparison of the models, upper deviation is within 3dB range and all test are under FCC Technical Limits.

2.3.1. SPOT CHECK DATA – SM-G975N (GLASS)

FUNDAMENTAL EMISSION MASK – TYPE A, 106Kbps (11.56 – 15.56 MHz)

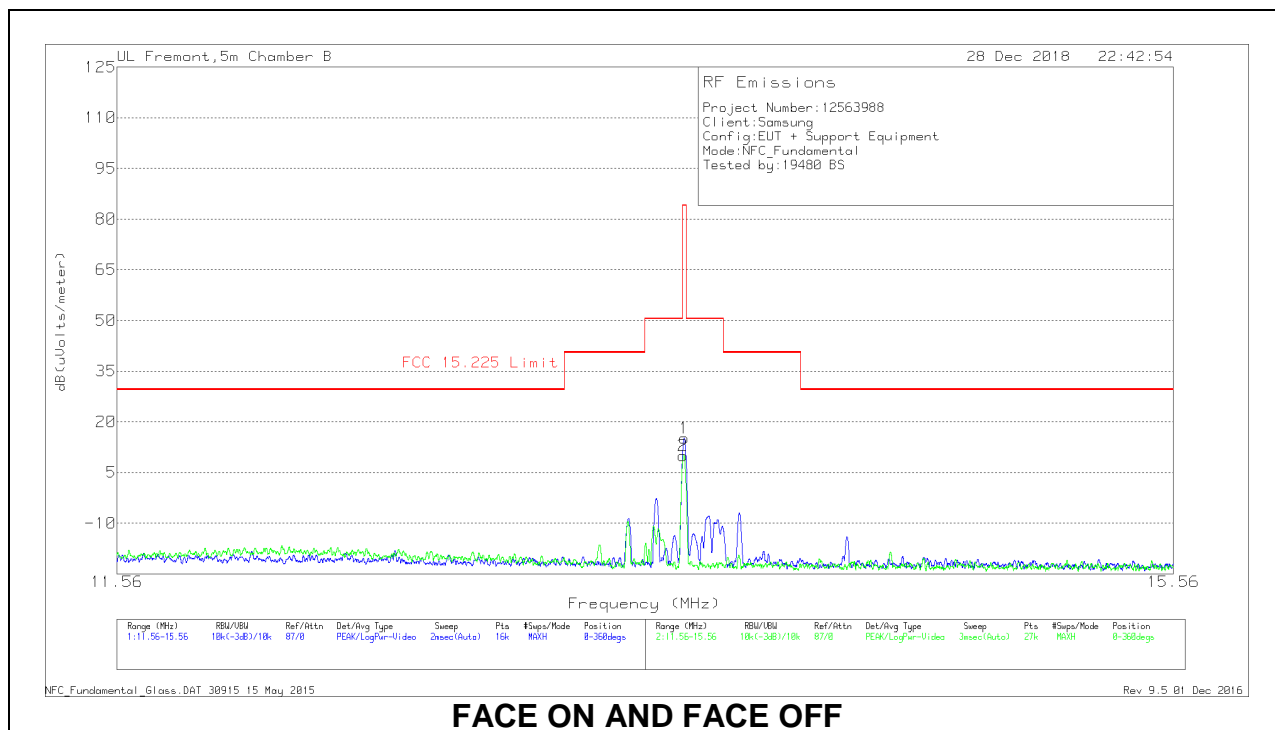

NOTE: All data rate Field Strength was investigated and Type A, 106k found to have the highest Field Strength results and represents as the worst case data rate.

DATA

Marker	Frequency (MHz)	Meter Reading (dBuV)	Det	Loop Antenna (dB/m)	Cables (dB)	Dist Corr (dB) 40Log	Corrected Reading dB(uVolts/meter)	FCC 15.225 Limit	PK Margin (dB)	Azimuth (Degs)
2	13.55637	38.83	Pk	10.6	.5	-40	9.93	84	-74.07	0-360
1	13.55975	43.99	Pk	10.6	.5	-40	15.09	84	-68.91	0-360

* - Indicates fundamental frequency
 Pk - Peak detector

SPURIOUS EMISSIONS - TYPE A, 106kbps (30 – 1000MHz)

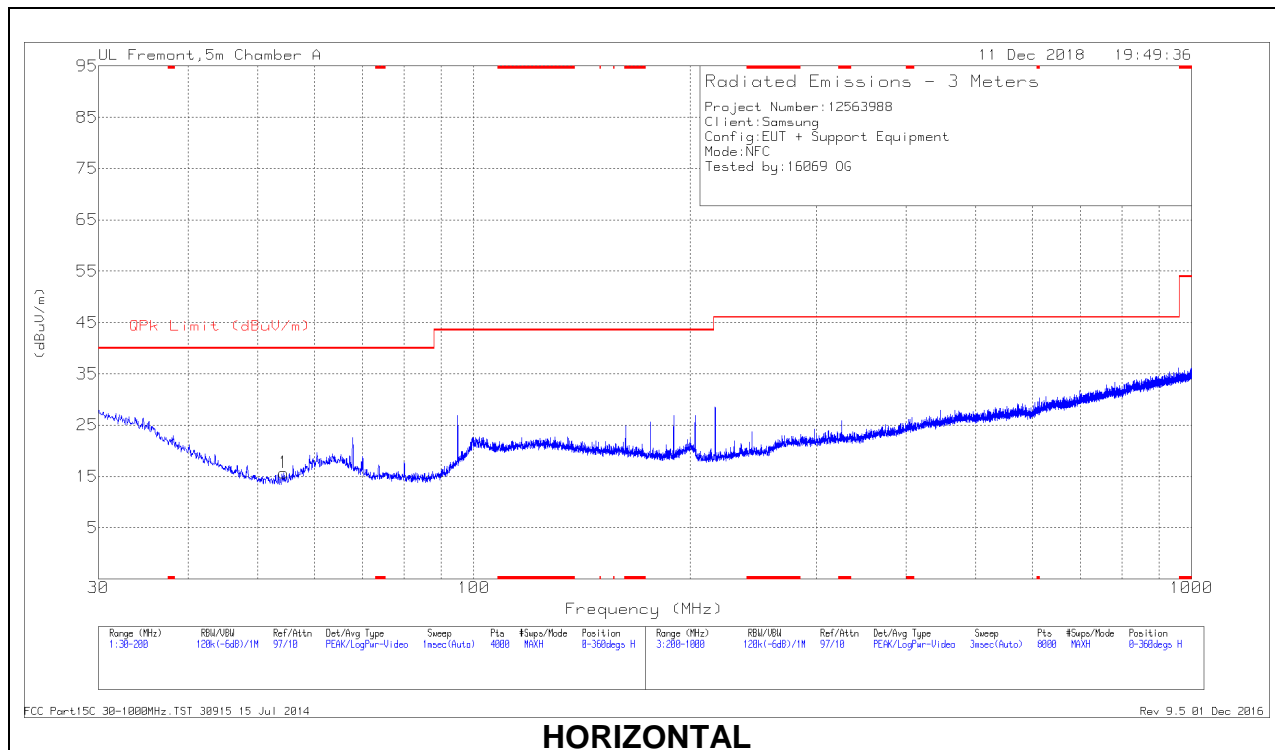

HORIZONTAL

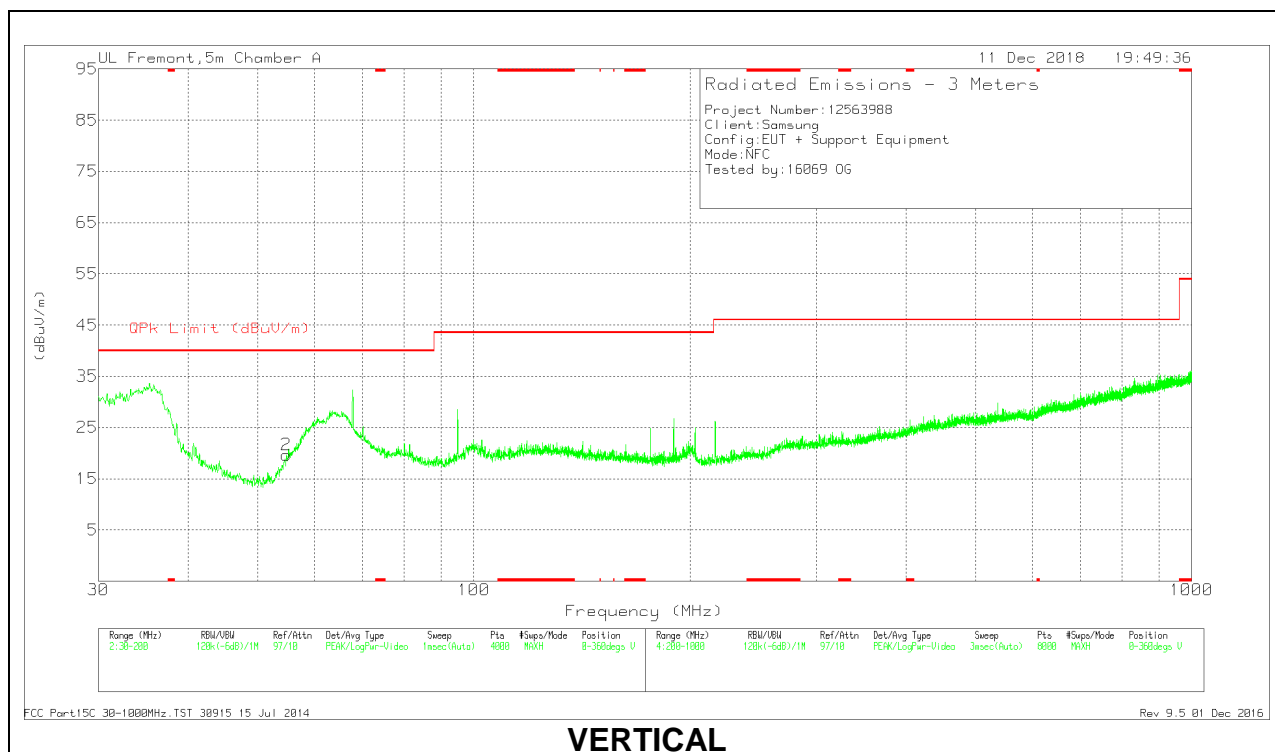

VERTICAL

DATA

Marker	Frequency (MHz)	Meter Reading (dBuV)	Det	AF PRE0181574 (dB/m)	Amp/Cbl (dB/m)	Corrected Reading (dBuV/m)	QPk Limit (dBuV/m)	Margin (dB)	Azimuth (Degs)	Height (cm)	Polarity
1	54.4013	29.44	Pk	13.2	-26.9	15.74	40	-24.26	0-360	400	H
2	54.9037	33.16	Pk	13.1	-26.9	19.36	40	-20.64	277	102	V
	54.9814	28.03	Qp	13.1	-26.9	14.23	40	-25.77	277	102	V

* - indicates frequency in CFR47 Pt 15 / IC RSS-Restricted Band

Pk - Peak detector

Qp - Quasi-Peak detector

2.4. REFERENCE DETAIL

Reference application that contains the reused reference data.

Equipment Class	Reference FCC ID	Type Grant/ Permissive Change	Reference Application	Folder Test/RF Exposure	Report Title/Section
PCE	A3LSMG975F	Grant	12563708-E1	Test	FCC Report WWAN / All sections except Appendix A
DSS	A3LSMG975F	Grant	12563708-E2	Test	FCC Report BT / All sections
DTS	A3LSMG975F	Grant	12563708-E3	Test	FCC Report BLE / All sections
	A3LSMG975F	Grant	12563708-E4	Test	FCC Report DTS WLAN / All sections
NII	A3LSMG975F	Grant	12563708-E5	Test	FCC Report UNII WLAN / All sections except DFS
DXX	A3LSMG975F	Grant	12563708-E7	Test	FCC Report NFC / All sections
			12563708-E8	Test	FCC Report ANT+ / All sections
DCD	A3LSMG975F	Grant	12563708-E9	Test	FCC Report Wireless Charging / All sections

3. TEST METHODOLOGY

The tests documented in this report were performed in accordance with ANSI C63.10-2013, FCC CFR 47 Part 2, and FCC CFR 47 Part 15.

4. FACILITIES AND ACCREDITATION

The test sites and measurement facilities used to collect data are located at 47173 and 47266 Benicia Street, and 47658 Kato Road, Fremont, California, USA. Line conducted emissions are measured only at the 47173 address. The following table identifies which facilities were utilized for radiated emission measurements documented in this report. Specific facilities are also identified in the test results sections.

47173 Benicia Street	47266 Benicia Street	47658 Kato Rd
<input type="checkbox"/> Chamber A (ISED:2324B-1)	<input type="checkbox"/> Chamber D (ISED:22541-1)	<input type="checkbox"/> Chamber I (ISED:2324A-5)
<input checked="" type="checkbox"/> Chamber B (ISED:2324B-2)	<input type="checkbox"/> Chamber E (ISED:22541-2)	<input type="checkbox"/> Chamber J (ISED:2324A-6)
<input type="checkbox"/> Chamber C (ISED:2324B-3)	<input type="checkbox"/> Chamber F (ISED:22541-3)	<input type="checkbox"/> Chamber K (ISED:2324A-1)
	<input type="checkbox"/> Chamber G (ISED:22541-4)	<input type="checkbox"/> Chamber L (ISED:2324A-3)
	<input type="checkbox"/> Chamber H (ISED:22541-5)	

The above test sites and facilities are covered under FCC Test Firm Registration # 208313. Chambers above are covered under Industry Canada company address and respective code

UL Verification Services Inc. is accredited by NVLAP, Laboratory Code 200065-0

5. CALIBRATION AND UNCERTAINTY

5.1. MEASURING INSTRUMENT CALIBRATION

The measuring equipment utilized to perform the tests documented in this report has been calibrated in accordance with the manufacturer's recommendations, and is traceable to recognized national standards.

5.2. SAMPLE CALCULATION

RADIATED EMISSIONS

Where relevant, the following sample calculation is provided:

Field Strength (dBuV/m) = Measured Voltage (dBuV) + Antenna Factor (dB/m) + Cable Loss (dB) – Preamp Gain (dB)

36.5 dBuV + 18.7 dB/m + 0.6 dB – 26.9 dB = 28.9 dBuV/m

MAINS CONDUCTED EMISSIONS

Where relevant, the following sample calculation is provided:

Final Voltage (dBuV) = Measured Voltage (dBuV) + Cable Loss (dB) + Limiter Factor (dB) + LISN Insertion Loss.

36.5 dBuV + 0 dB + 10.1 dB + 0 dB = 46.6 dBuV

5.3. MEASUREMENT UNCERTAINTY

Where relevant, the following measurement uncertainty levels have been estimated for tests performed on the apparatus:

PARAMETER	UNCERTAINTY
Worst Case Conducted Disturbance, 9KHz to 0.15 MHz	3.84 dB
Worst Case Conducted Disturbance, 0.15 to 30 MHz	3.65 dB
Worst Case Radiated Disturbance, 9KHz to 30 MHz	3.15 dB
Worst Case Radiated Disturbance, 30 to 1000 MHz	5.36 dB
Worst Case Radiated Disturbance, 1000 to 18000 MHz	4.32 dB
Worst Case Radiated Disturbance, 18000 to 26000 MHz	4.45 dB
Worst Case Radiated Disturbance, 26000 to 40000 MHz	5.24 dB

Uncertainty figures are valid to a confidence level of 95%.

6. EQUIPMENT UNDER TEST

6.1. DESCRIPTION OF EUT

The EUT is a GSM/WCDMA/LTE phone with BT, DTS/UNII a/b/g/n/ac/11ax HE 20/40/80, ANT+ and NFC. The model SM-G975F was used for final testing and is representative of the test results in this report.

6.2. MAXIMUM OUTPUT POWER

The testing was performed at 3 meters. The transmitter maximum E-field at 30 meter distance was 14.57 dBuV/m, which was converted from the 3 meter data.

6.3. SOFTWARE AND FIRMWARE

The test utility software used during testing was G975F.001 (SM-G975F) and G975N.001 (SM-G975N).

6.4. WORST-CASE CONFIGURATION AND MODE

WORST-CASE CONFIGURATION AND MODE FOR FINAL TEST

This device may be formed with two different exterior materials: Glass and Ceramic. Glass model was set for full test and additional spot check verification was done with Ceramic model for radiated fundamental and radiated harmonic spurious as documented.

The fundamental of the EUT was investigated under three orthogonal orientations X (Flatbed), Y (Landscape), and Z (Portrait). The Z orientation with AC/DC adapter and headphone was determined to be the worst-case orientation; therefore, all final radiated testing was performed with the EUT in Z orientation with AC/DC adapter and headphone.

In addition, Type A, B and F were investigated to determine the worst case based on the highest power and spurious emissions. Type A, and data rate of 106kbps was determined to be the worst case and therefore Type A was selected for all final tests.

Although these tests were performed other than open area test site, adequate comparison measurements were confirmed against 30 m open are test site. Therefore sufficient tests were made to demonstrate that the alternative site produces results that correlate with the ones of tests made in an open field based on KDB 414788

6.5. DESCRIPTION OF TEST SETUP

SUPPORT EQUIPMENT

Support Equipment List				
Description	Manufacturer	Model	Serial Number	FCC ID
AC Adapter	Samsung	EP-TA300	R3KB5B01S1SE3	N/A
USB Data Cable	Samsung	N/A	N/A	N/A
Earphone	Samsung	N/A	N/A	N/A

I/O CABLES (CONDUCTED TEST)

I/O Cable List						
Cable No	Port	# of identical ports	Connector Type	Cable Type	Cable Length (m)	Remarks
1	Antenna	1	RF	Shielded	0.2	To spectrum Analyzer
2	USB	1	USB	Un-shielded	1	EUT to AC Mains

TEST SETUP

The EUT is a stand alone. Test software exercised the radio card.

SETUP DIAGRAM

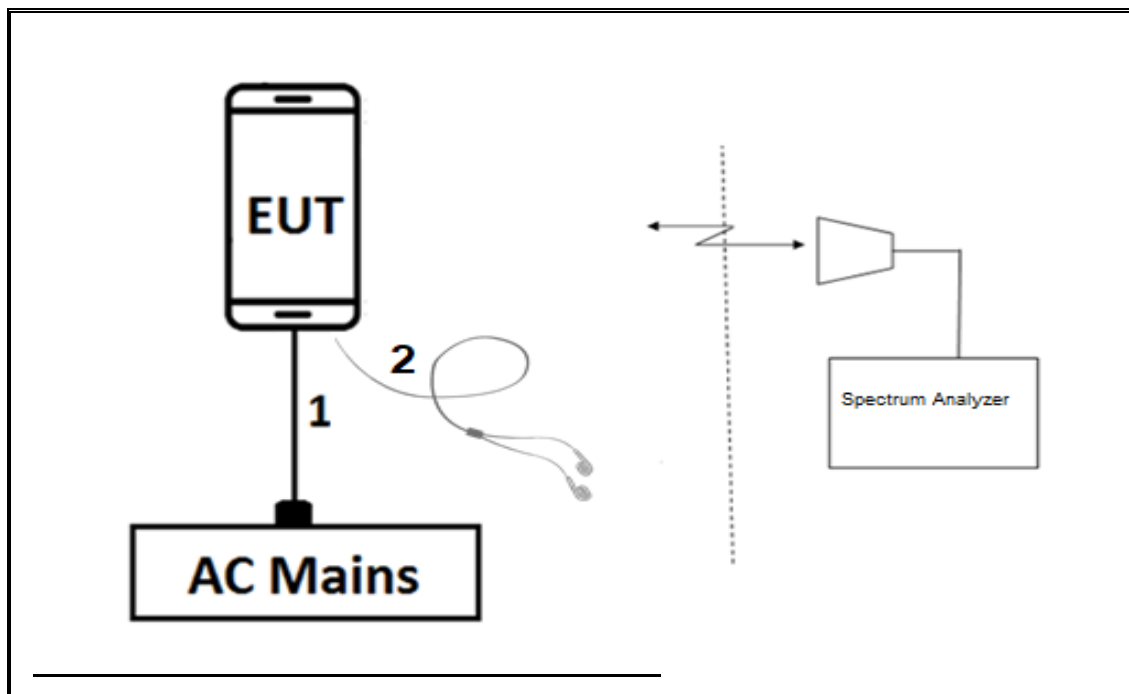

TEST SETUP

For radiated tests: EUT is Stand alone. The test software exercises the radio.

7. TEST AND MEASUREMENT EQUIPMENT

The following test and measurement equipment was utilized for the tests documented in this report:

TEST EQUIPMENT LIST					
Description	Manufacturer	Model	ID Num	Cal Due	Last Cal
Antenna, Broadband Hybrid, 30MHz to 2000MHz	Sunol Sciences Corp.	JB3	T407	05/10/2019	05/10/2018
Amplifier, 9kHz to 1GHz, 32dB	Sonoma Instrument	310	170649	11/01/2019	11/01/2018
EMI Reciever	Rohde & Schwarz	ESR	T1436	02/21/2019	02/21/2018
L.I.S.N.	FCC INC.	FCC LISN 50/250	T1310	06/15/2019	06/15/2018
L.I.S.N.	FCC INC.	FCC LISN 50/250	T24	03/06/2019	03/06/2018
Antenna, Active Loop 9kHz-30MHz	Com-Power Corp.	AL-130R	PRE0165308	01/08/2020	01/08/2019
Temp Chamber	Thermotron Industries	SE-600-10-10	T80	05/01/2019	11/01/2018
Spectrum Analyzer, PXA, 3Hz to 44GHz	Agilent (Keysight) Technologies	N9030A	T339	09/11/2019	09/11/2018
Spectrum Analyzer, PXA, 3Hz to 44GHz	Agilent (Keysight) Technologies	N9030A	1466	04/16/2019	04/16/2018
Spectrum Analyzer, PXA, 3Hz to 44GHz	Agilent (Keysight) Technologies	N9030A	T1454	01/08/2019	01/08/2018

Test Software List			
Description	Manufacturer	Model	Version
Radiated Software	UL	UL EMC	Ver 9.5, Dec 01, 2016
Antenna Port Software	UL	UL RF	Ver 9.0, Oct 31, 2018

8. OCCUPIED BANDWIDTH

LIMITS

None; for reporting purposes only.

TEST PROCEDURE

The transmitter output is connected to the spectrum analyzer. The RBW is set to 10kHz. The VBW is set to 3 times the RBW. The sweep time is coupled. The spectrum analyzer internal 99% bandwidth function is utilized.

Note: Because the measured signal is CW or CW-like adjusting the RBW per C63.10 would not be practical since measured bandwidth will always follow the RBW and the result will be approximately twice the RBW

RESULTS

99% and 20dB BW

Type A

Mode Kbps	Frequency (MHz)	99% Bandwidth (KHz)	20dB Bandwidth (KHz)
424	13.56	21.142	24.94
212	13.56	21.149	24.95
106	13.56	21.149	24.96

Type B

Mode Kbps	Frequency (MHz)	99% Bandwidth (KHz)	20dB Bandwidth (KHz)
424	13.56	21.143	24.94
212	13.56	21.132	24.92
106	13.56	21.149	24.93

Type F

Mode Kbps	Frequency (MHz)	99% Bandwidth (KHz)	20dB Bandwidth (KHz)
424	13.56	21.144	24.95
212	13.56	21.134	24.93

8.1. TYPE A

424Kbps

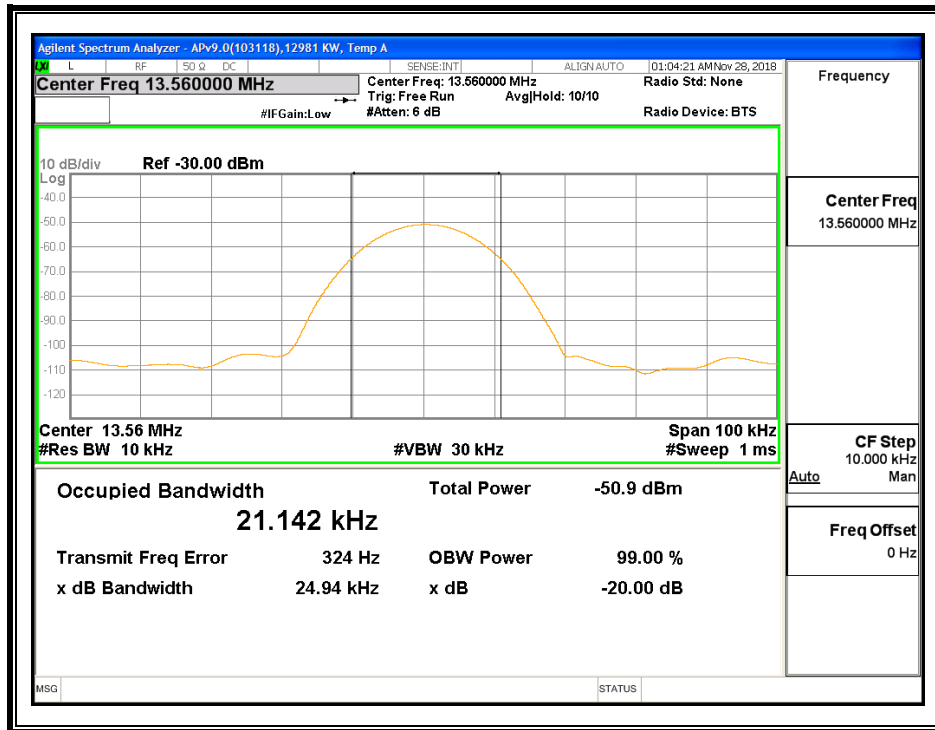

212Kbps

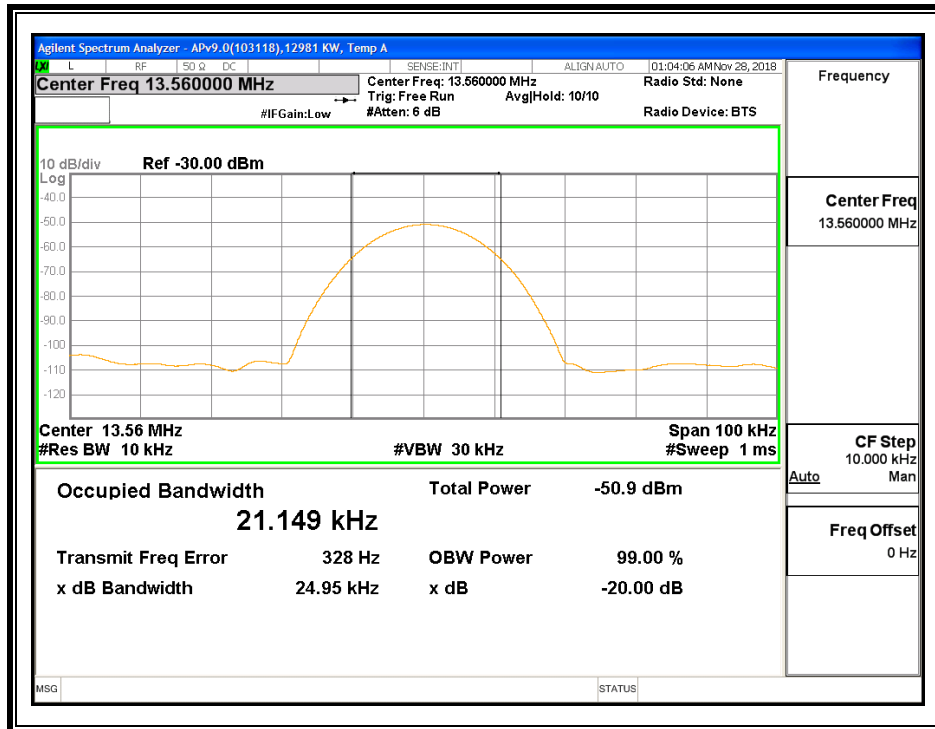

106Kbps



8.2. TYPE B

424Kbps

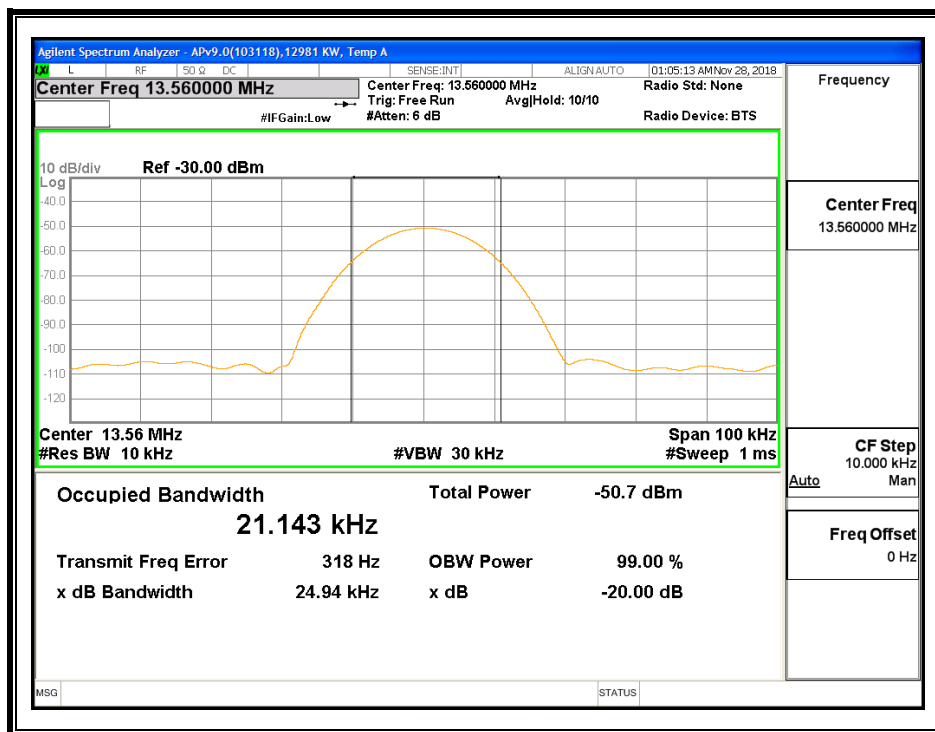

212Kbps

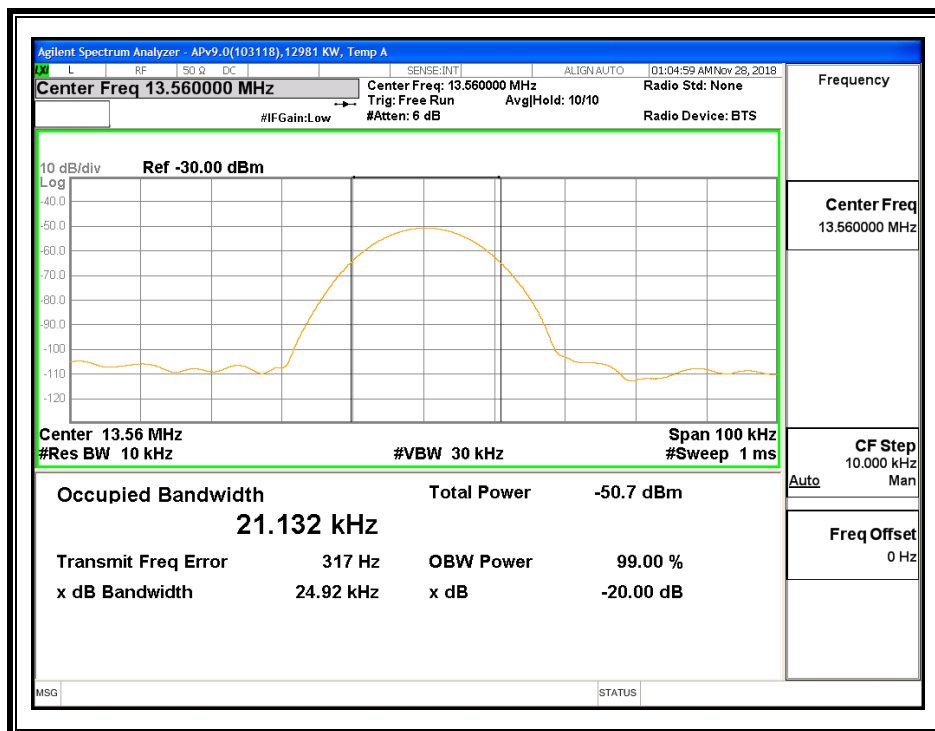

106Kbps

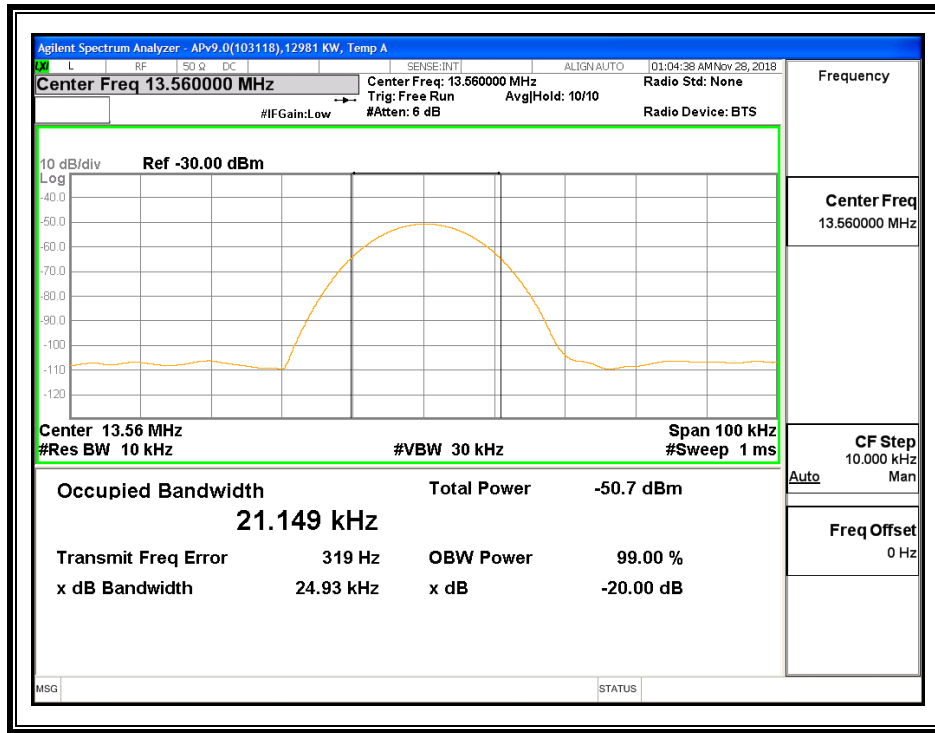

8.3. TYPE F

424Kbps

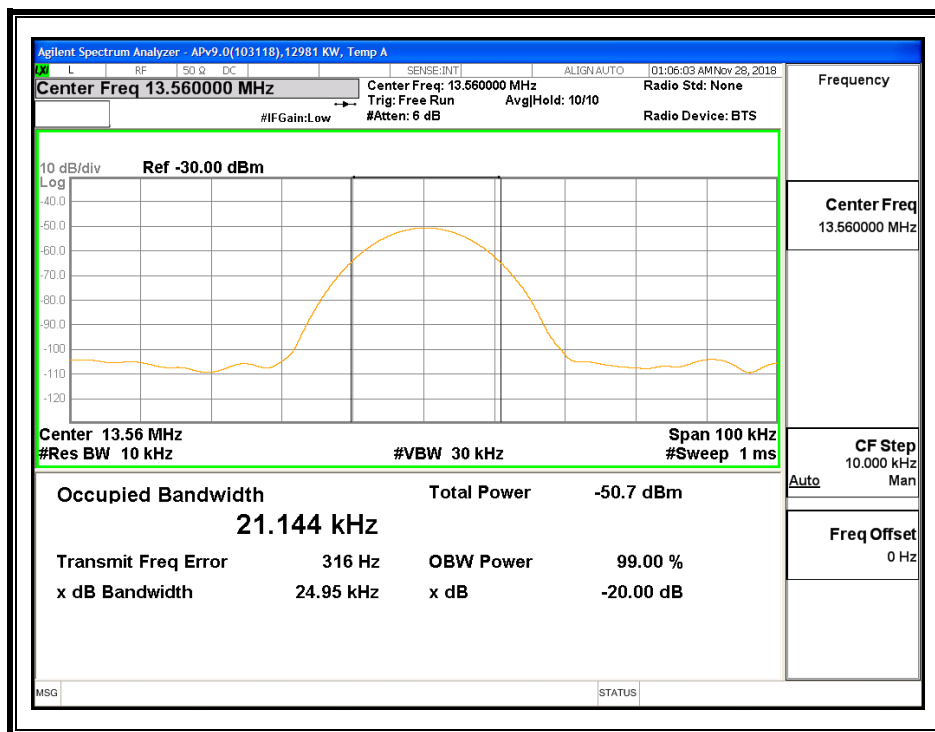

212Kbps

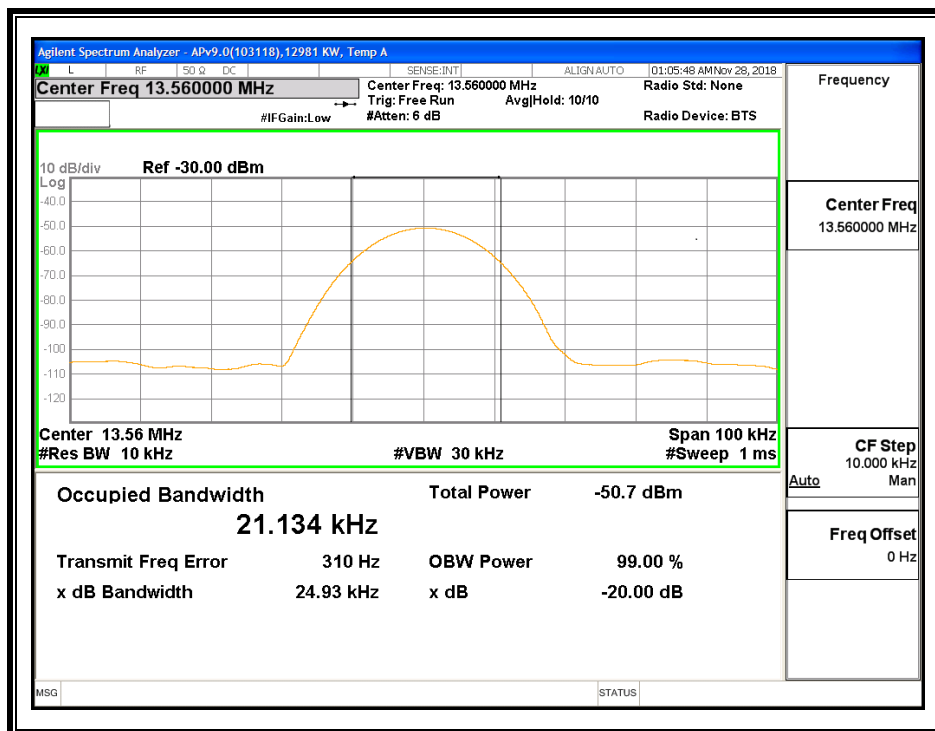

9. RADIATED EMISSION TEST RESULTS

9.1. LIMITS AND PROCEDURE

LIMIT

§15.225

(a) The field strength of any emissions within the band 13.553–13.567 MHz shall not exceed 15,848 microvolts/ meter at 30 meters.

(b) Within the bands 13.410–13.553 MHz and 13.567–13.710 MHz, the field strength of any emissions shall not exceed 334 microvolts/meter at 30 meters.

(c) Within the bands 13.110–13.410 MHz and 13.710–14.010 MHz the field strength of any emissions shall not exceed 106 microvolts/meter at 30 meters.

(d) The field strength of any emissions appearing outside of the 13.110– 14.010 MHz and shall not exceed the general radiated emission limits in § 15.209 as follows:

§15.209 (a) Except as provided elsewhere in this subpart, the emissions from an intentional radiator shall not exceed the field strength levels specified in the following table:

Limits for radiated disturbance of an intentional radiator		
Frequency range (MHz)	Limits (µV/m)	Measurement Distance (m)
0.009 – 0.490	2400 / F (kHz)	300
0.490 – 1.705	24000 / F (kHz)	30
1.705 – 30.0	30	30
30 – 88	100**	3
88 - 216	150**	3
216 – 960	200**	3
Above 960	500	3

** Except as provided in paragraph (g), fundamental emissions from intentional radiators operating under this section shall not be located in the frequency bands 54-72 MHz, 76-88 MHz, 174-216 MHz or 470-806 MHz. However, operation within these frequency bands is permitted under other sections of this part, e.g. §§ 15.231 and 15.241.

§15.209 (b) In the emission table above, the tighter limit applies at the band edges.

Formula for converting the filed strength from uV/m to dBuV/m is:

Limit (dBuV/m) = 20 log limit (uV/m)

In addition:

§15.209 (d) The emission limits shown the above table are based on measurements employing a CISPR quasi-peak detector except for the frequency bands 9-90 kHz, 110-490 kHz and above 1000 MHz. Radiated emissions limits in these three bands are based on measurements employing an average detector.

§15.209 (d) The provisions in §§ 15.225, measuring emissions at distances other than the distances specified in the above table, determining the frequency range over which radiated emissions are to be measured, and limiting peak emissions apply to all devices operated under this part.

TEST PROCEDURE

ANSI C63.10, 2013

The EUT is an intentional radiator that incorporates a digital device, the highest fundamental frequency generated or used in the device is 13.56 MHz; therefore, the frequency range was investigated from 0.15 MHz to the 10th harmonic of the highest fundamental frequency, or 1000 MHz, whichever is greater.

RESULTS

9.2. FUNDAMENTAL AND SPURIOUS EMISSIONS (0.15 - 1000 MHz),

FUNDAMENTAL EMISSION MASK – TYPE A, 106Kbps (11.56 – 15.56 MHz)

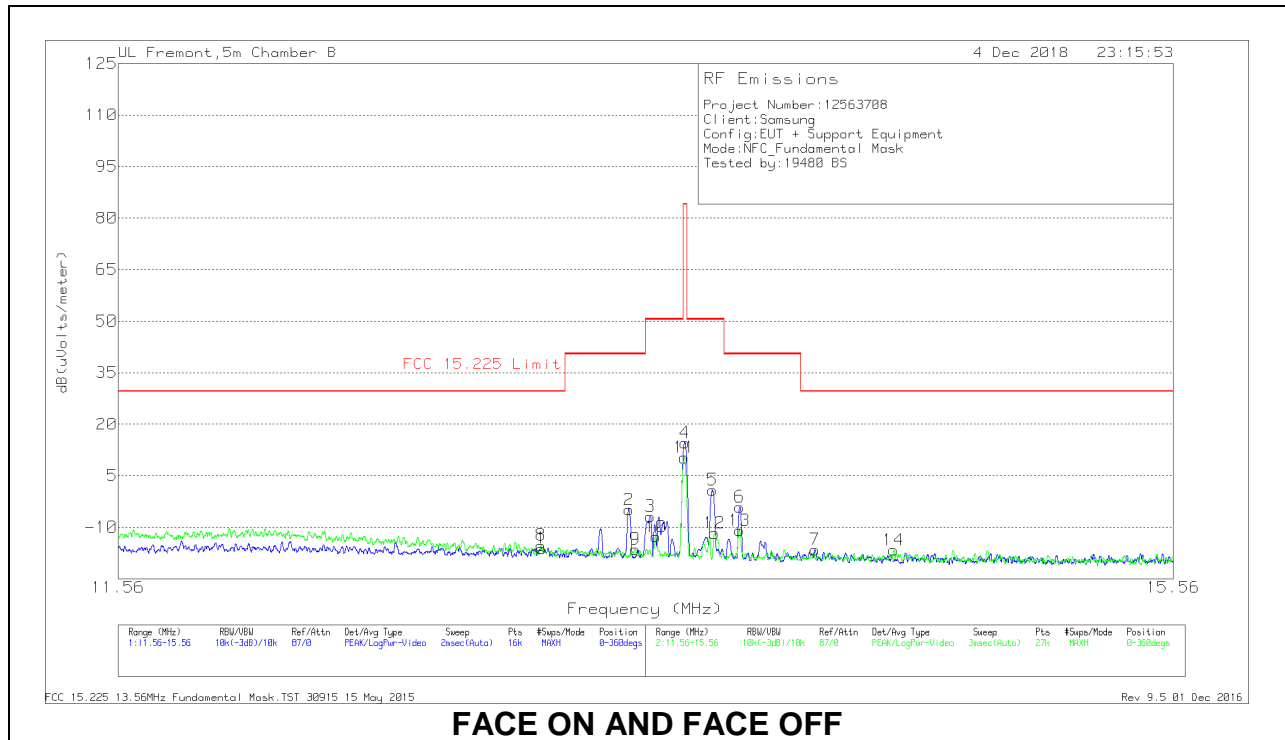

FACE ON AND FACE OFF

NOTE: All data rate Field Strength was investigated and Type A, 106k found to have the highest Field Strength results and represents as the worst case data rate.

DATA

Marker	Frequency (MHz)	Meter Reading (dBuV)	Det	Loop Antenna (dB/m)	Cables (dB)	Dist Corr (dB) 40Log	Corrected Reading dB(uVolts/meter)	FCC 15.225 Limit	PK Margin (dB)	Azimuth (Degs)	Polarity
8	13.02246	13.53	Pk	10.7	.5	-40	-15.27	29.54	-44.81	0-360	Face-Off
1	13.02438	12.63	Pk	10.7	.5	-40	-16.17	29.54	-45.71	0-360	Face-On
2	13.3495	23.86	Pk	10.7	.5	-40	-4.94	40.51	-45.45	0-360	Face-On
9	13.37219	12.4	Pk	10.7	.5	-40	-16.4	40.51	-56.91	0-360	Face-Off
3	13.42888	21.94	Pk	10.7	.5	-40	-6.86	50.5	-57.36	0-360	Face-On
10	13.45114	15.98	Pk	10.7	.5	-40	-12.82	50.5	-63.32	0-360	Face-Off
11	*13.55807	39.17	Pk	10.6	.5	-40	10.27	84	-73.73	0-360	Face-Off
4	*13.56175	43.47	Pk	10.6	.5	-40	14.57	84	-69.43	0-360	Face-On
5	13.66613	29.75	Pk	10.6	.5	-40	.85	50.5	-49.65	0-360	Face-On
12	13.6747	17.15	Pk	10.6	.5	-40	-11.75	50.5	-62.25	0-360	Face-Off
13	13.77112	17.96	Pk	10.6	.5	-40	-10.94	40.51	-51.45	0-360	Face-Off
6	13.77175	24.82	Pk	10.6	.5	-40	-4.08	40.51	-44.59	0-360	Face-On
7	14.0675	12.36	Pk	10.6	.5	-40	-16.54	29.54	-46.08	0-360	Face-On
14	14.38184	12.23	Pk	10.6	.5	-40	-16.67	29.54	-46.21	0-360	Face-Off

* - Indicates fundamental frequency
 Pk - Peak detector

SPURIOUS EMISSIONS - TYPE A, 106kbps (0.09 – 30MHz)

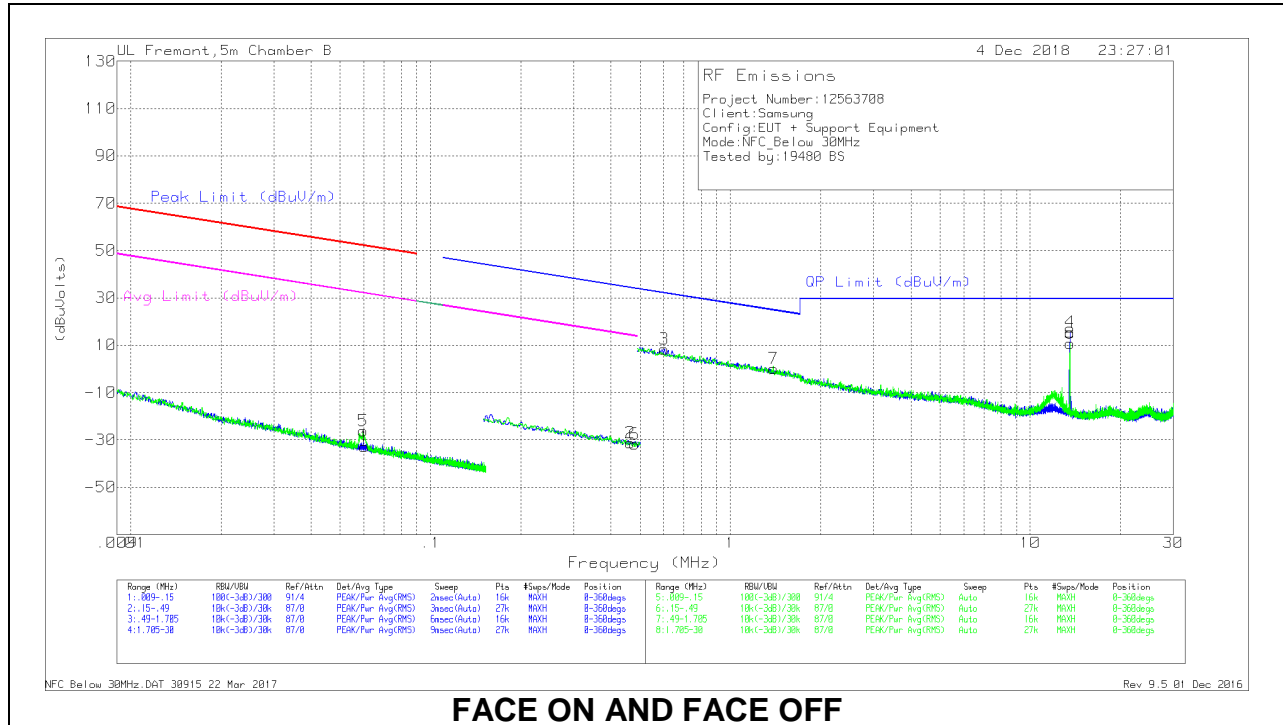

DATA

Marker	Frequency (MHz)	Meter Reading (dBuV)	Det	Loop Antenna (dB/m)	Cables (dB)	Dist Corr 300m	Corrected Reading (dBuVolts)	Peak Limit (dBuV/m)	Margin (dB)	Avg Limit (dBuV/m)	Margin (dB)	Peak Limit (dBuV/m)	Margin (dB)	Avg Limit (dBuV/m)	Margin (dB)	Azimuth (Degs)	Polarity
5	.05957	42.04	Pk	11.8	0	-80	-26.16	52.08	-78.24	32.08	-58.24	-	-	-	-	0-360	Face-Off
1	.06017	35.44	Pk	11.8	0	-80	-32.76	52	-84.76	32	-64.76	-	-	-	-	0-360	Face-On
2	.46359	37.71	Pk	11.1	.1	-80	-31.19	-	-	-	-	34.28	-65.47	14.28	-45.47	0-360	Face-On
6	.48036	36.92	Pk	11.1	.1	-80	-31.88	-	-	-	-	33.97	-65.85	13.97	-45.85	0-360	Face-Off

Pk - Peak detector

Marker	Frequency (MHz)	Meter Reading (dBuV)	Det	Loop Antenna (dB/m)	Cables (dB)	Dist Corr (dB) 40Log	Corrected Reading (dBuVolts)	QP Limit (dBuV/m)	Margin (dB)	Azimuth (Degs)	Polarity
3	.60297	37.1	Pk	11.1	.1	-40	8.3	32	-23.7	0-360	Face-On
7	1.39372	28.52	Pk	11.3	.2	-40	.02	24.75	-24.73	0-360	Face-Off

Pk - Peak detector

Note: marker 4 and 8 are the fundamental signal

SPURIOUS EMISSIONS - TYPE A, 106kbps (30 – 1000MHz)

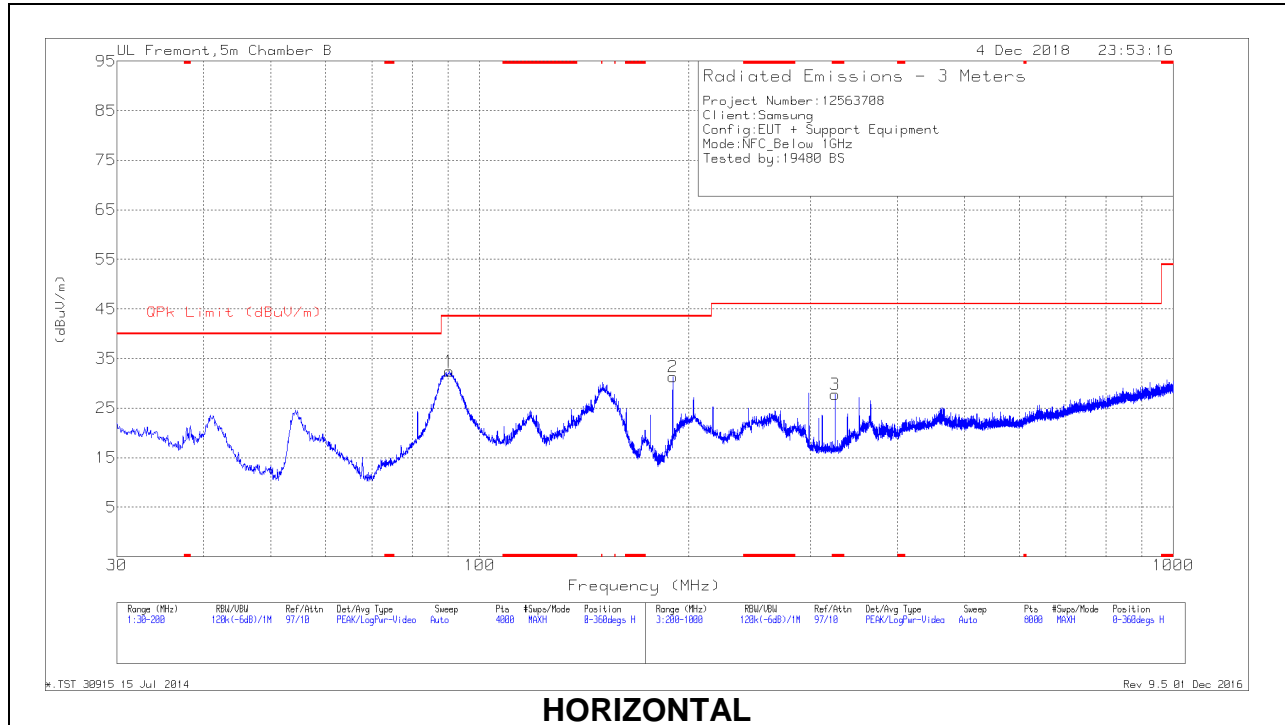

HORIZONTAL

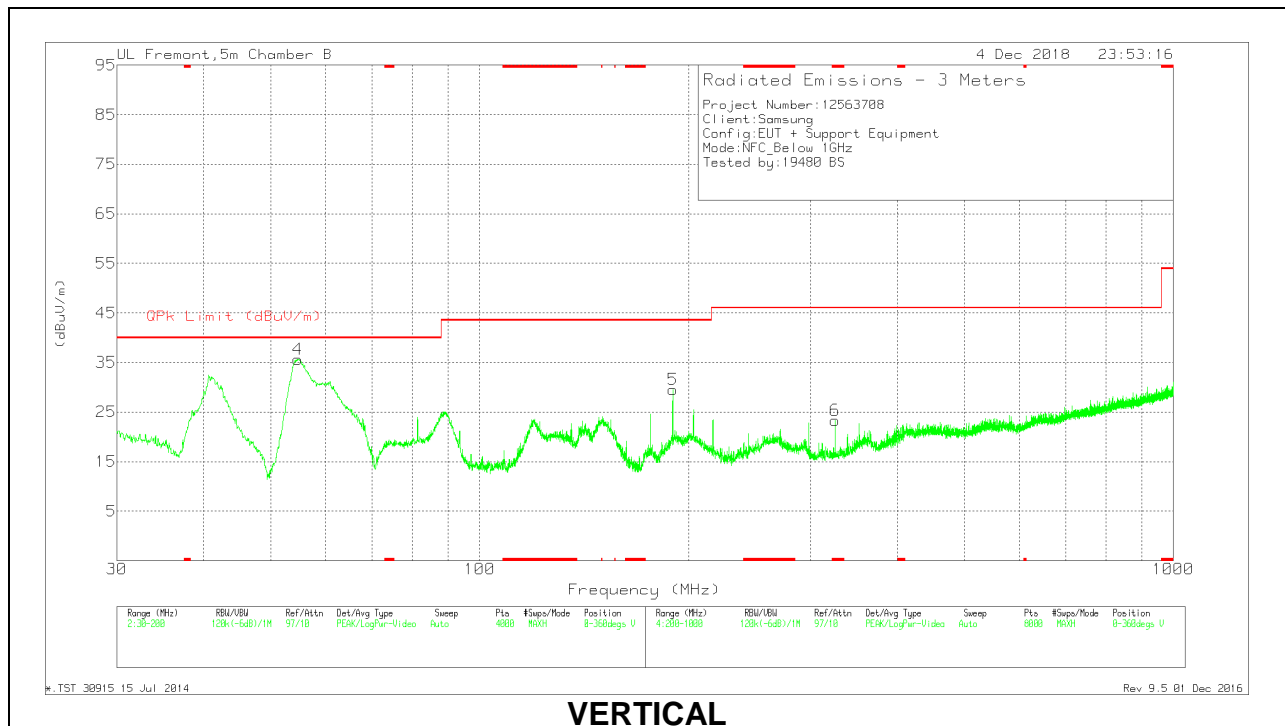

VERTICAL

DATA

Marker	Frequency (MHz)	Meter Reading (dBUV)	Det	AF T407 (dB/m)	Amp/Cbl (dB)	Corrected Reading (dBUV/m)	QPk Limit (dBUV/m)	Margin (dB)	Azimuth (Degs)	Height (cm)	Polarity
3	* 325.4163	39.27	Pk	18	-29.5	27.77	46.02	-18.25	0-360	100	H
6	* 325.4163	34.82	Pk	18	-29.5	23.32	46.02	-22.7	0-360	100	V
4	54.6564	55.58	Pk	11.2	-31.1	35.68	40	-4.32	0-360	100	V
	54.6745	53.33	Qp	11.2	-31.1	33.43	40	-6.57	0	100	V
1	90.4506	51.41	Pk	11.8	-30.8	32.41	43.52	-11.11	0-360	200	H
2	189.8414	46.26	Pk	15.3	-30.2	31.36	43.52	-12.16	0-360	200	H
5	189.8414	44.4	Pk	15.3	-30.2	29.5	43.52	-14.02	0-360	100	V

* - indicates frequency in CFR47 Pt 15 / IC RSS-Restricted Band

Pk - Peak detector

Qp - Quasi-Peak detector

9.3. SPOT CHECK DATA - SM-G975F (CERAMIC)

FUNDAMENTAL EMISSION MASK – TYPE A, 106Kbps (11.56 – 15.56 MHz)

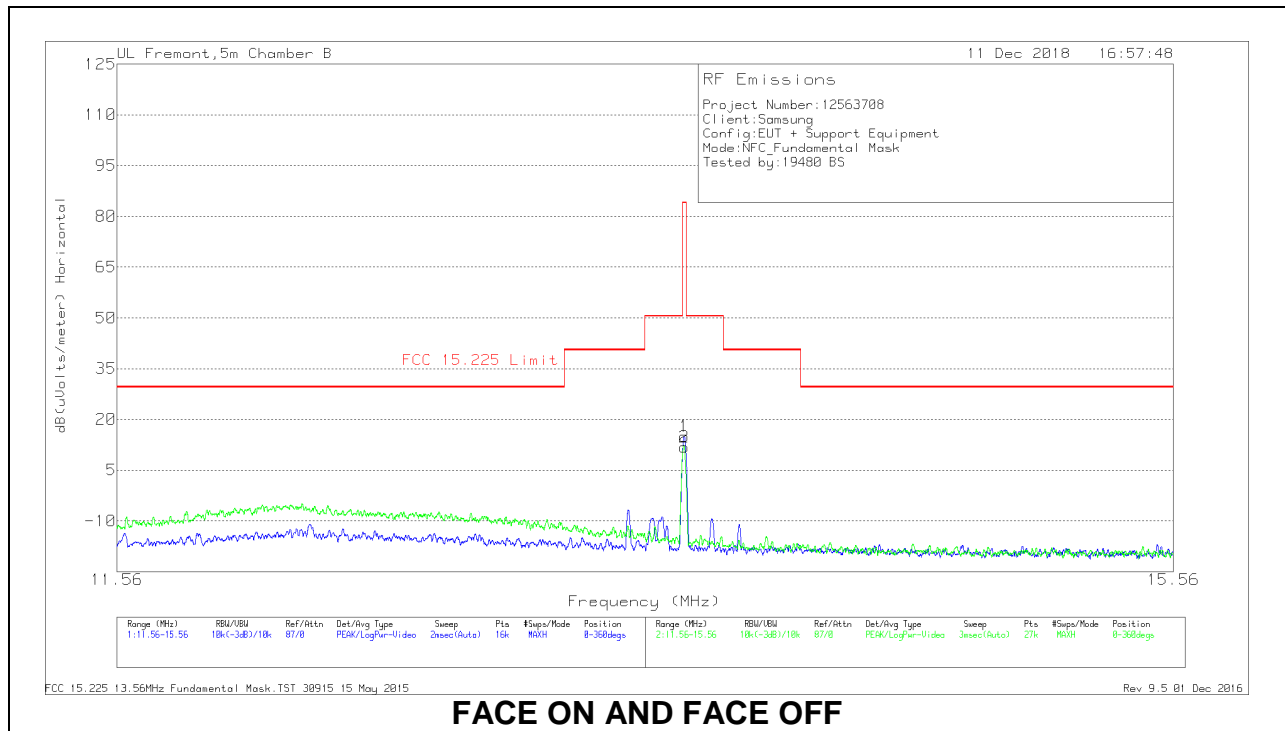

NOTE: All data rate Field Strength was investigated and Type A, 106k found to have the highest Field Strength results and represents as the worst case data rate.

DATA

Marker	Frequency (MHz)	Meter Reading (dBuV)	Det	Loop Antenna (dB/m)	Cables (dB)	Dist Corr (dB) 40Log	Corrected Reading dB(uVolts/meter)	FCC 15.225 Limit	PK Margin (dB)	Azimuth (Degs)
1	13.56	43.91	Pk	10.6	.5	-40	15.01	84	-68.99	0-360
2	13.56007	40.75	Pk	10.6	.5	-40	11.85	84	-72.15	0-360

* - Indicates fundamental frequency
 Pk - Peak detector

SPURIOUS EMISSIONS - TYPE A, 106kbps (0.09 – 30MHz)

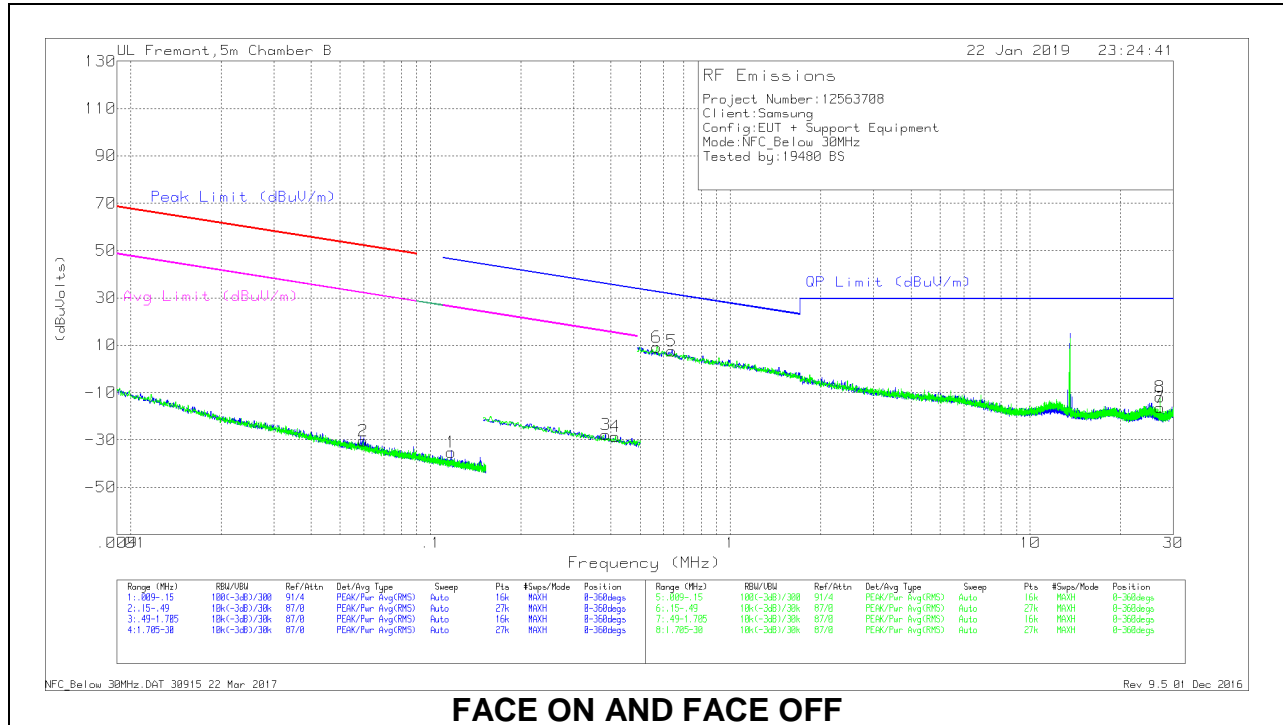

FACE ON AND FACE OFF

DATA

Marker	Frequency (MHz)	Meter Reading (dBuV)	Det	Loop Antenna (dB/m)	Cables (dB)	Dist Corr 300m	Corrected Reading (dBuVolts)	Peak Limit (dBuV/m)	Margin (dB)	Avg Limit (dBuV/m)	Margin (dB)	Peak Limit (dBuV/m)	Margin (dB)	Avg Limit (dBuV/m)	Margin (dB)	Azimuth (Degs)
2	.05952	37.69	Pk	11.8	0	-80	-30.51	52.09	-82.6	32.09	-62.6	-	-	-	-	0-360
1	.11726	33.59	Pk	11.1	0	-80	-35.31	-	-	-	-	46.24	-81.55	26.24	-61.55	0-360
3	.38321	41.09	Pk	10.9	.1	-80	-27.91	-	-	-	-	35.94	-63.85	15.94	-43.85	0-360
4	.41385	40.51	Pk	10.9	.1	-80	-28.49	-	-	-	-	35.27	-63.76	15.27	-43.76	0-360

Pk - Peak detector

Marker	Frequency (MHz)	Meter Reading (dBuV)	Det	Loop Antenna (dB/m)	Cables (dB)	Dist Corr (dB) 40Log	Corrected Reading (dBuVolts)	QP Limit (dBuV/m)	Margin (dB)	Azimuth (Degs)
6	.56881	37.96	Pk	11.1	.1	-40	9.16	32.51	-23.35	0-360
5	.63676	36.3	Pk	11.1	.1	-40	7.5	31.53	-24.03	0-360
7	27.12005	12.79	Pk	10.1	.7	-40	-16.41	29.5	-45.91	0-360
8	27.12005	17.28	Pk	10.1	.7	-40	-11.92	29.5	-41.42	0-360

Pk - Peak detector

SPURIOUS EMISSIONS - TYPE A, 106kbps (30 – 1000MHz)

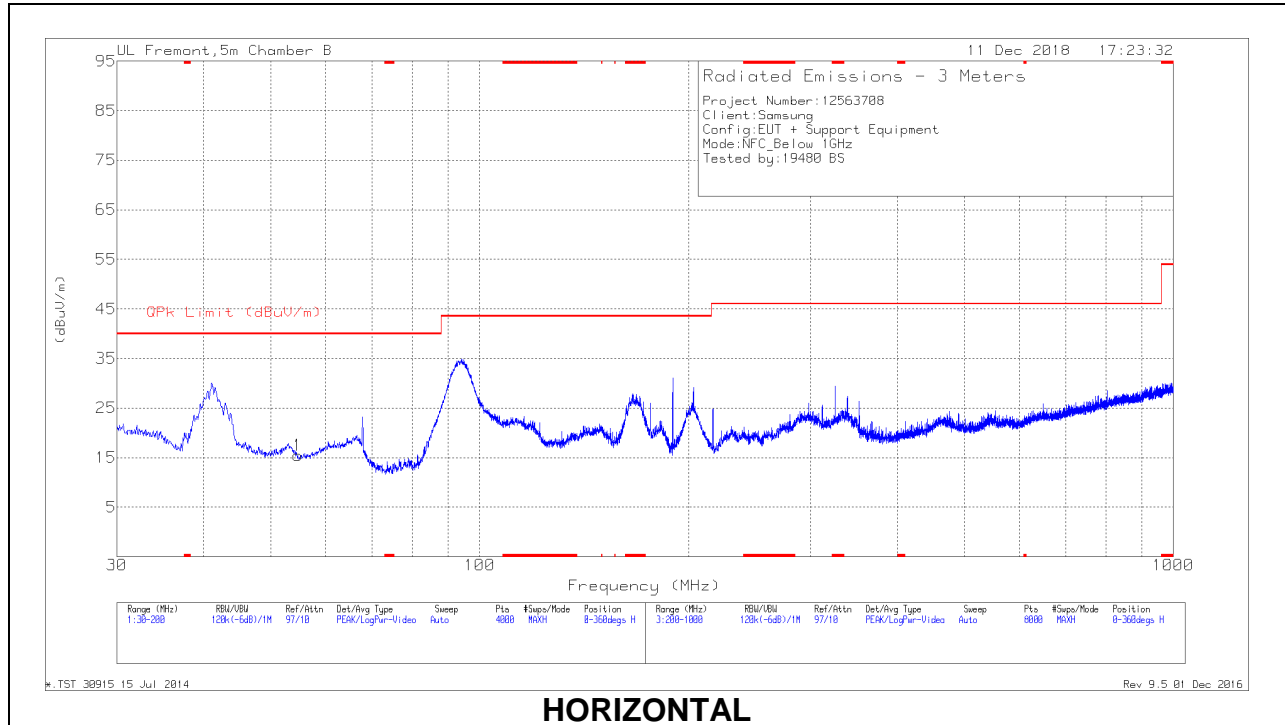

HORIZONTAL

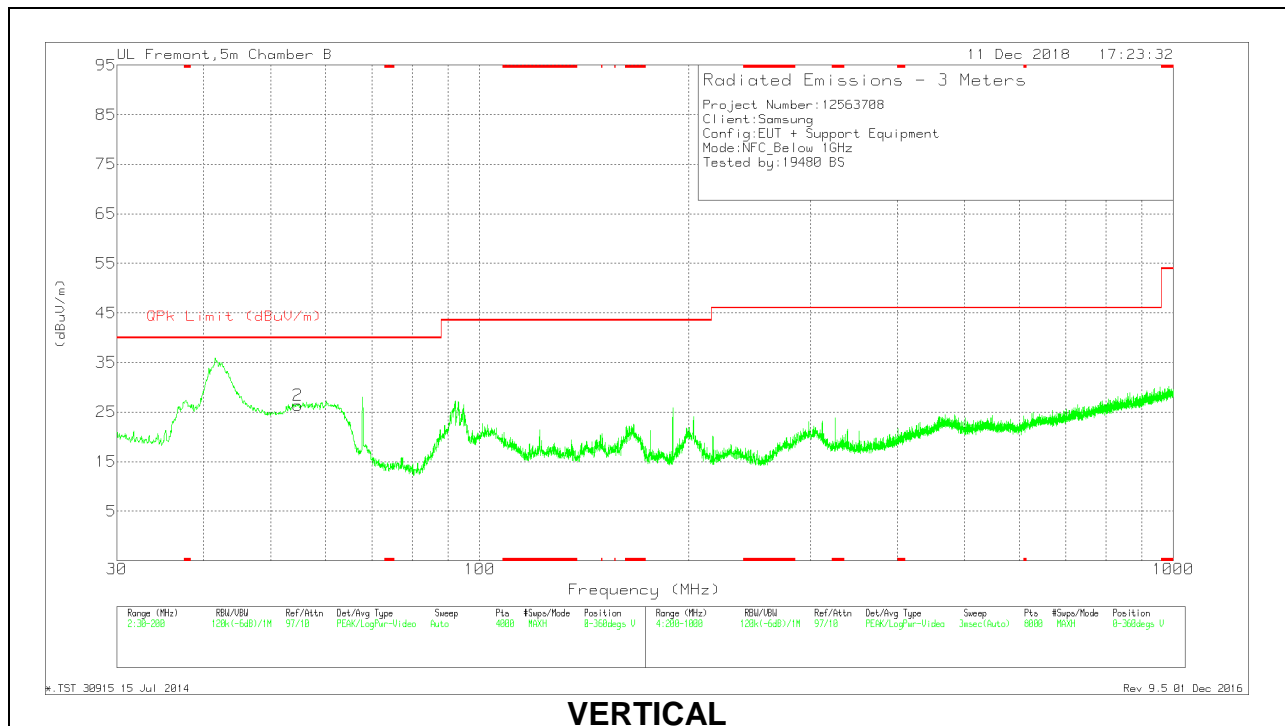

VERTICAL

DATA

Marker	Frequency (MHz)	Meter Reading (dBuV)	Det	AF T407 (dB/m)	Amp/Cbl (dB)	Corrected Reading (dBuV/m)	QPk Limit (dBuV/m)	Margin (dB)	Azimuth (Degs)	Height (cm)	Polarity
1	54.6564	35.33	Pk	11.2	-31.1	15.43	40	-24.57	0-360	300	H
2	54.6989	46.29	Pk	11.2	-31.1	26.39	40	-13.61	0-360	100	V
	54.7227	40.09	Qp	11.2	-31.1	20.19	40	-19.81	360	100	V

* - indicates frequency in CFR47 Pt 15 / IC RSS-Restricted Band

Pk - Peak detector

Qp - Quasi-Peak detector

9.4. SPOT CHECK DATA – SM-G975N (CERAMIC)

FUNDAMENTAL EMISSION MASK – TYPE A, 106Kbps (11.56 – 15.56 MHz)

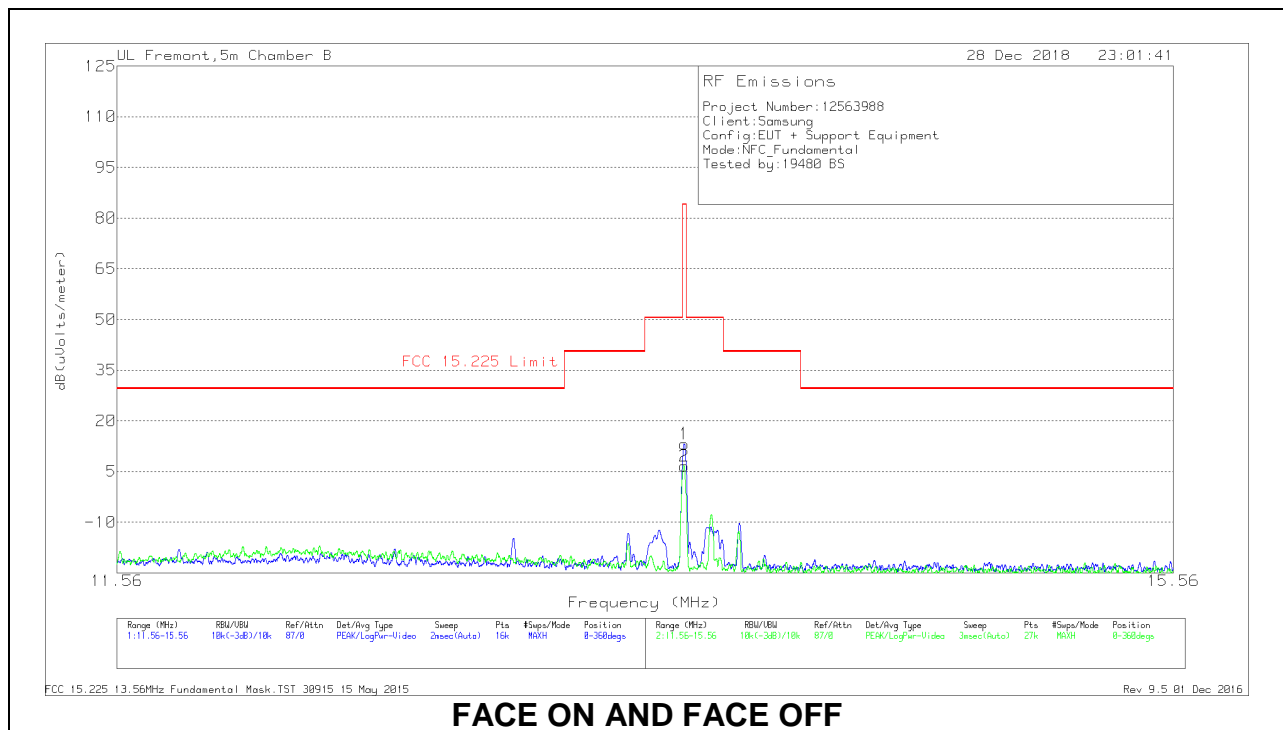

NOTE: All data rate Field Strength was investigated and Type A, 106k found to have the highest Field Strength results and represents as the worst case data rate.

DATA

Marker	Frequency (MHz)	Meter Reading (dBuV)	Det	Loop Antenna (dB/m)	Cables (dB)	Dist Corr (dB) 40Log	Corrected Reading dB(uVolts/meter)	FCC 15.225 Limit	PK Margin (dB)	Azimuth (Degs)
2	13.55933	35.44	Pk	10.6	.5	-40	6.54	84	-77.46	0-360
1	13.56	42.11	Pk	10.6	.5	-40	13.21	84	-70.79	0-360

* - Indicates fundamental frequency
 Pk - Peak detector

SPURIOUS EMISSIONS - TYPE A, 106kbps (30 – 1000MHz)

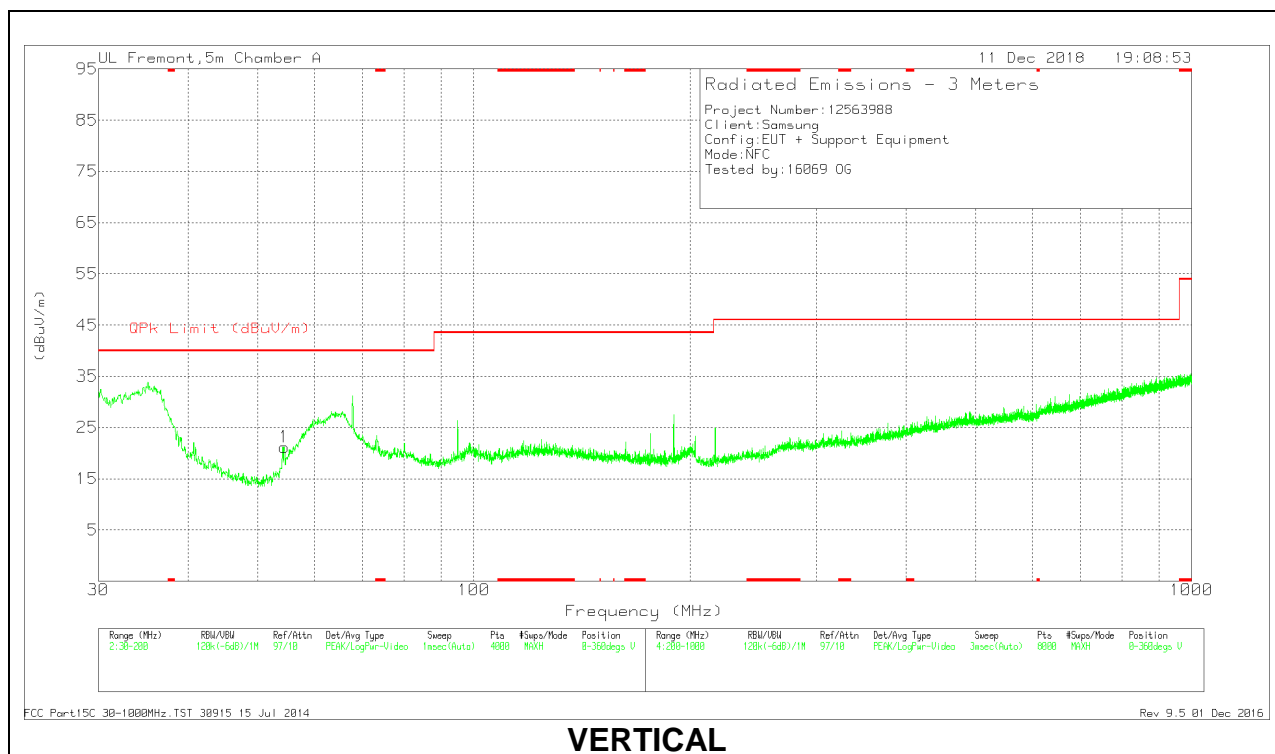
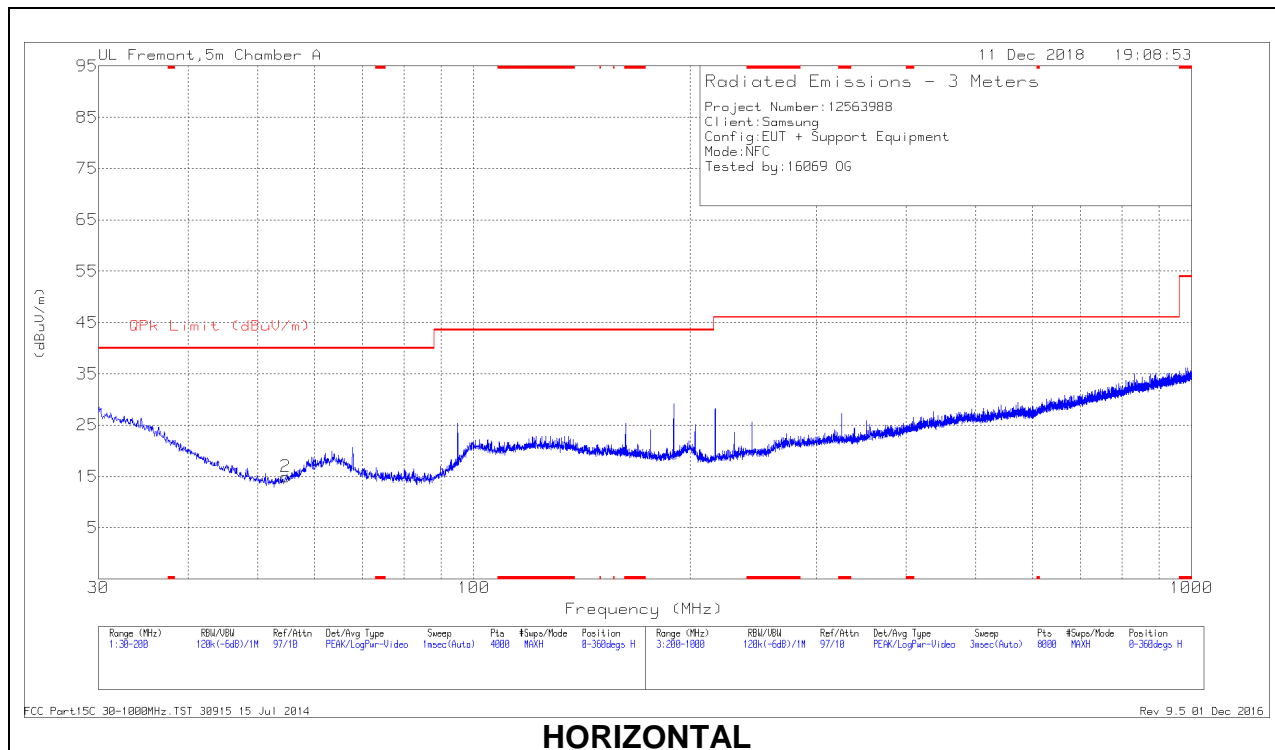

DATA

Marker	Frequency (MHz)	Meter Reading (dBuV)	Det	AF PRE0181574 (dB/m)	Amp/Cbl (dB/m)	Corrected Reading (dBuV/m)	QPk Limit (dBuV/m)	Margin (dB)	Azimuth (Degs)	Height (cm)	Polarity
1	54.3161	26.68	Qp	13.2	-26.9	12.98	40	-27.02	243	115	V
	54.4659	32.59	Pk	13.2	-26.9	18.89	40	-21.11	243	115	V
2	54.6564	28.77	Pk	13.1	-26.9	14.97	40	-25.03	0-360	400	H

* - indicates frequency in CFR47 Pt 15 / IC RSS-Restricted Band

Pk - Peak detector

Qp - Quasi-Peak detector

10. FREQUENCY STABILITY

LIMIT

§15.225 (e) The frequency tolerance of the carrier signal shall be maintained within $\pm 0.01\%$ of the operating frequency, over a temperature variation of -20 degrees to +50 degrees C at normal supply voltage, and for a variation in the primary supply voltage from 85% to 115% of the rated supply voltage at a temperature of 20 degrees C. For battery operated equipment, the equipment tests shall be performed using a new battery.

TEST PROCEDURE

ANSI C63.10-2013 Clause 6.8

RESULTS

ID:	12981 KW	Date:	11/27/18
------------	----------	--------------	----------

No non-compliance noted.

Reference Frequency: EUT Channel 13.56 MHz @ 20°C Limit: ± 100 ppm = 1.356 kHz										
Power Supply	Envir. Temp	Frequency Deviation Measured with Time Elapse								
(Vdc)	(°C)	Startup (MHz)	Delta (ppm)	@ 2 mins (MHz)	Delta (ppm)	@ 5 mins (MHz)	Delta (ppm)	@ 10 mins (MHz)	Delta (ppm)	Limit (ppm)
3.80	50	13.5599979	-0.070	13.5599980	-0.076	13.5599982	-0.090	13.5599984	-0.106	± 100
3.80	40	13.5599976	-0.046	13.5599977	-0.052	13.5599978	-0.057	13.5599978	-0.061	± 100
3.80	30	13.5599973	-0.023	13.5599974	-0.027	13.5599974	-0.032	13.5599975	-0.040	± 100
3.80	20	13.5599970	0.000	13.5599970	0.000	13.5599970	0.000	13.5599970	-0.001	± 100
3.80	10	13.5599969	0.004	13.5599969	0.004	13.5599969	0.005	13.5599969	0.006	± 100
3.80	0	13.5599973	-0.021	13.5599973	-0.026	13.5599974	-0.029	13.5599974	-0.032	± 100
3.80	-10	13.5599975	-0.038	13.5599977	-0.054	13.5599979	-0.064	13.5599980	-0.072	± 100
3.23	20	13.5599973	-0.021	13.5599972	-0.017	13.5599972	-0.013	13.5599971	-0.011	± 100
4.37	20	13.5599976	-0.045	13.5599976	-0.042	13.5599976	-0.042	13.5599976	-0.043	± 100

11. AC MAINS LINE CONDUCTED EMISSIONS

LIMITS

§15.207

(a) Except as shown in paragraphs (b) and (c) of this section, for an intentional radiator that is designed to be connected to the public utility (AC) power line, the radio frequency voltage that is conducted back onto the AC power line on any frequency or frequencies, within the band 150 kHz to 30 MHz, shall not exceed the limits in the following table, as measured using a 50μH/50 ohms line impedance stabilization network (LISN). Compliance with the provisions of this paragraph shall be based on the measurement of the radio frequency voltage between each power line and ground at the power terminal. The lower limit applies at the band edges.

Frequency range (MHz)	Limits (dBμV)	
	Quasi-peak	Average
0.15 to 0.50	66 to 56	56 to 46
0.50 to 5	56	46
5 to 30	60	50

Notes:
 1. The lower limit shall apply at the transition frequencies
 2. The limit decreases linearly with the logarithm of the frequency in the range 0.15 MHz to 0.50 MHz.

TEST PROCEDURE

ANSI C63.10:2013

RESULTS

No non-compliance noted:

11.1. EUT with ANTENNA

LINE 1 RESULTS

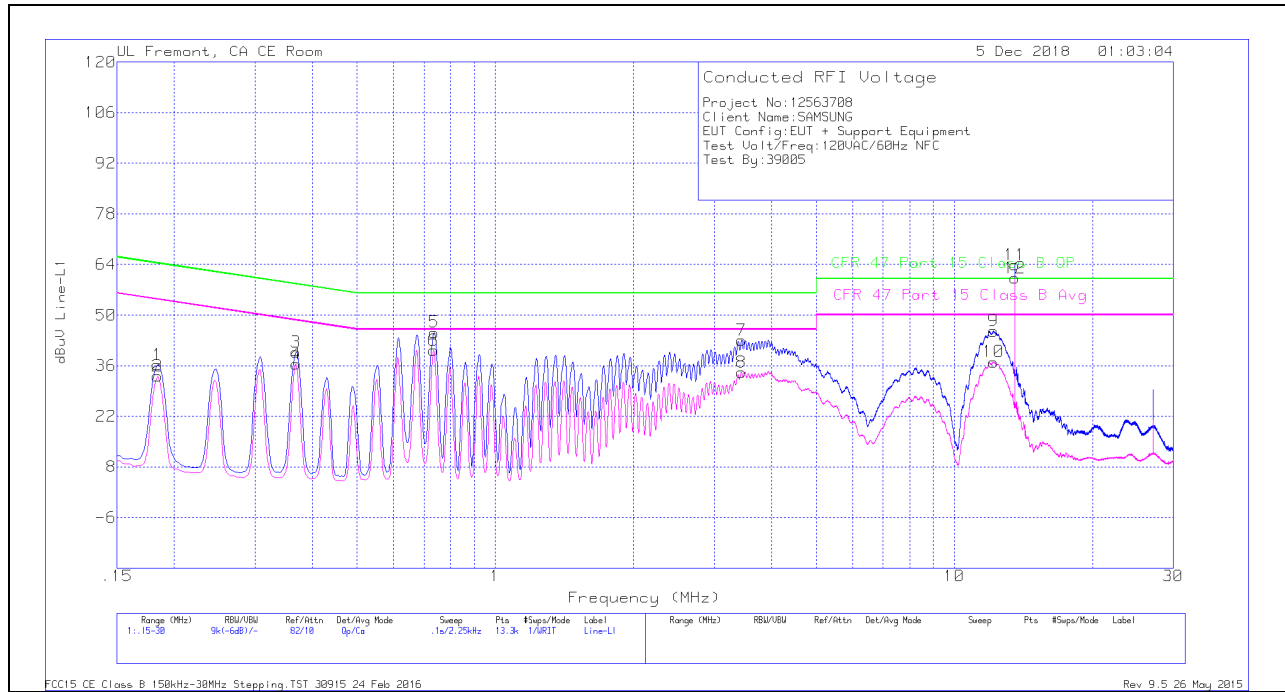

WORST EMISSIONS

Range 1: Line-L1 .15 - 30MHz											
Marker	Frequency (MHz)	Meter Reading (dBuV)	Det	LISN L1	LC Cables C1&C3	Limiter (dB)	Corrected Reading dBuV	CFR 47 Part 15 Class B QP	QP Margin (dB)	CFR 47 Part 15 Class B Avg	Av(CISPR) Margin (dB)
1	.18375	26.23	Qp	0	0	10.1	36.33	64.31	-27.98	-	-
2	.18375	22.96	Ca	0	0	10.1	33.06	-	-	54.31	-21.25
3	.36825	29.69	Qp	0	0	10.1	39.79	58.54	-18.75	-	-
4	.36825	26.27	Ca	0	0	10.1	36.37	-	-	48.54	-12.17
5	.73725	35.12	Qp	0	0	10.1	45.22	56	-10.78	-	-
6	.735	30.16	Ca	0	0	10.1	40.26	-	-	46	-5.74
7	3.444	32.92	Qp	0	.1	10.1	43.12	56	-12.88	-	-
8	3.4395	23.99	Ca	0	.1	10.1	34.19	-	-	46	-11.81
9	12.16725	35.07	Qp	.1	.2	10.2	45.57	60	-14.43	-	-
10	12.1695	26.55	Ca	.1	.2	10.2	37.05	-	-	50	-12.95
11	13.56	53.43	Qp	.1	.2	10.2	63.93	60	3.93	-	-
12	13.56	49.73	Ca	.1	.2	10.2	60.23	-	-	50	10.23

Qp - Quasi-Peak detector

Ca - CISPR average detection

Note: Markers 11 and 12 are the 13.56MHz NFC Fundamental

LINE 2 RESULTS

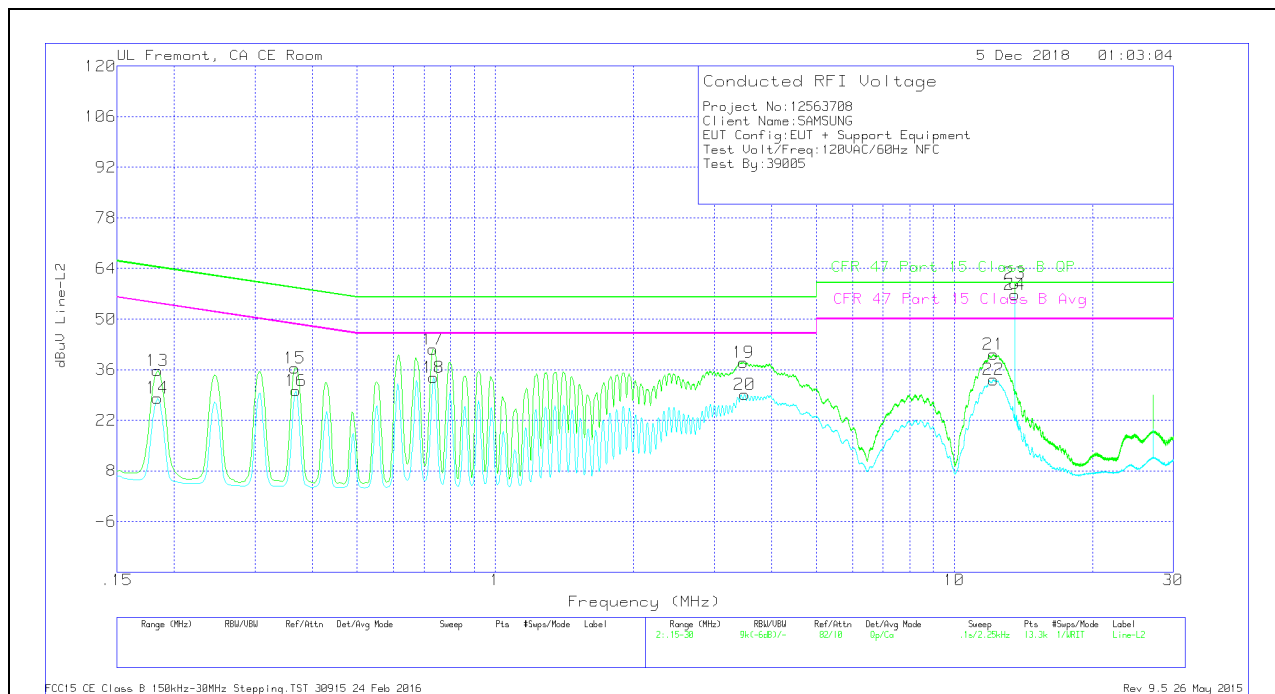

WORST EMISSIONS

Range 2: Line-L2 .15 - 30MHz											
Marker	Frequency (MHz)	Meter Reading (dBuV)	Det	LISN L2	LC Cables C2&C3	Limiter (dB)	Corrected Reading dBuV	CFR 47 Part 15 Class B QP	QP Margin (dB)	CFR 47 Part 15 Class B Avg	Av(CISPR) Margin (dB)
13	.18375	25.72	Qp	0	0	10.1	35.82	64.31	-28.49	-	-
14	.18375	18.08	Ca	0	0	10.1	28.18	-	-	54.31	-26.13
15	.366	26.41	Qp	0	0	10.1	36.51	58.59	-22.08	-	-
16	.36825	20.05	Ca	0	0	10.1	30.15	-	-	48.54	-18.39
17	.73275	31.49	Qp	0	0	10.1	41.59	56	-14.41	-	-
18	.735	23.75	Ca	0	0	10.1	33.85	-	-	46	-12.15
19	3.47325	27.86	Qp	0	.1	10.1	38.06	56	-17.94	-	-
20	3.49013	18.88	Ca	0	.1	10.1	29.08	-	-	46	-16.92
21	12.15825	29.69	Qp	.1	.2	10.2	40.19	60	-19.81	-	-
22	12.18075	22.73	Ca	.1	.2	10.2	33.23	-	-	50	-16.77
23	13.56	49.46	Qp	.1	.2	10.2	59.96	60	-.04	-	-
24	13.56	46.24	Ca	.1	.2	10.2	56.74	-	-	50	6.74

Qp - Quasi-Peak detector

Ca - CISPR average detection

Note: Markers 23 and 24 are the 13.56MHz NFC Fundamental

11.2. EUT with ANTENNA TERMINATED

LINE 1 RESULTS

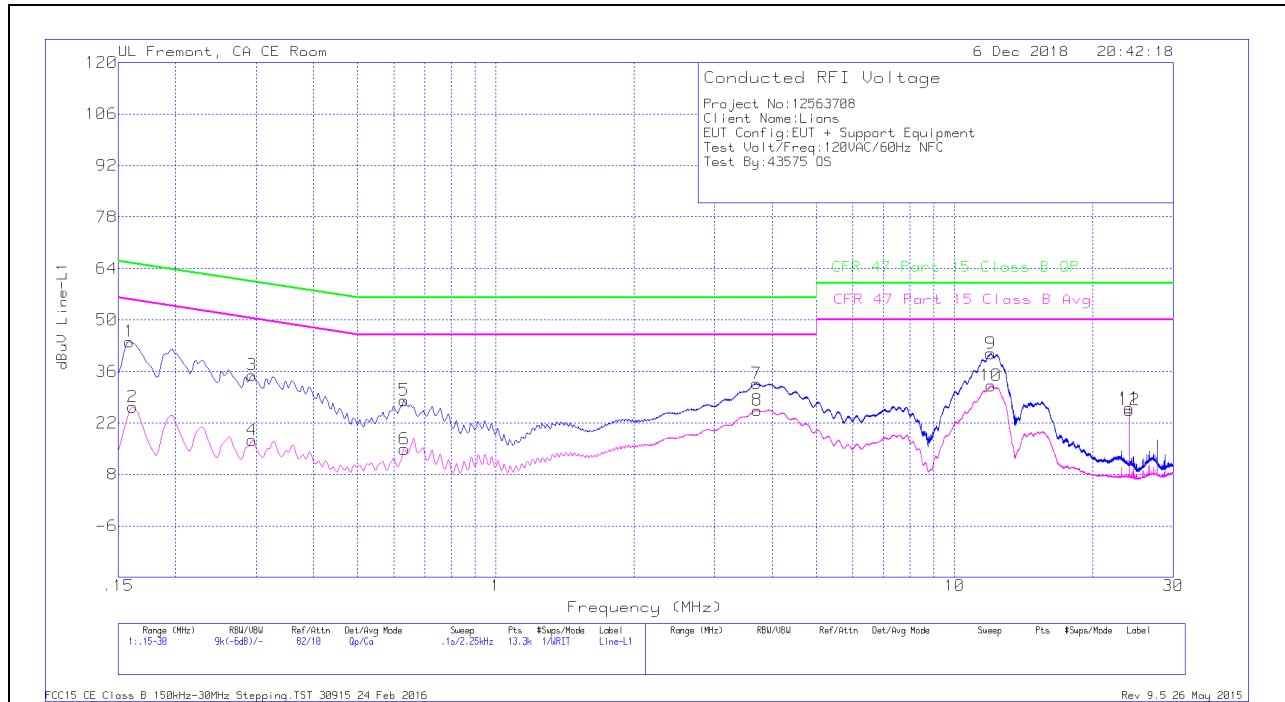

WORST EMISSIONS

Range 1: Line-L1 .15 - 30MHz											
Marker	Frequency (MHz)	Meter Reading (dBuV)	Det	LISN L1	LC Cables C1&C3	Limiter (dB)	Corrected Reading dBuV	CFR 47 Part 15 Class B QP	QP Margin (dB)	CFR 47 Part 15 Class B Avg	Av(CISPR) Margin (dB)
1	.159	33.9	Qp	.1	0	10.1	44.1	65.52	-21.42	-	-
2	.16125	16.15	Ca	.1	0	10.1	26.35	-	-	55.4	-29.05
3	.294	24.94	Qp	0	0	10.1	35.04	60.41	-25.37	-	-
4	.294	7.16	Ca	0	0	10.1	17.26	-	-	50.41	-33.15
5	.63037	18.07	Qp	0	0	10.1	28.17	56	-27.83	-	-
6	.6315	4.78	Ca	0	0	10.1	14.88	-	-	46	-31.12
7	3.70275	22.53	Qp	0	.1	10.1	32.73	56	-23.27	-	-
8	3.714	15.23	Ca	0	.1	10.1	25.43	-	-	46	-20.57
9	11.99625	30.37	Qp	.1	.2	10.2	40.87	60	-19.13	-	-
10	12.01313	21.64	Ca	.1	.2	10.2	32.14	-	-	50	-17.86
11	24.054	15.15	Qp	.1	.3	10.5	26.05	60	-33.95	-	-
12	24.054	14.56	Ca	.1	.3	10.5	25.46	-	-	50	-24.54

Qp - Quasi-Peak detector

Ca - CISPR average detection

Note: Markers 11 and 12 are the 13.56MHz NFC Fundamental

LINE 2 RESULTS

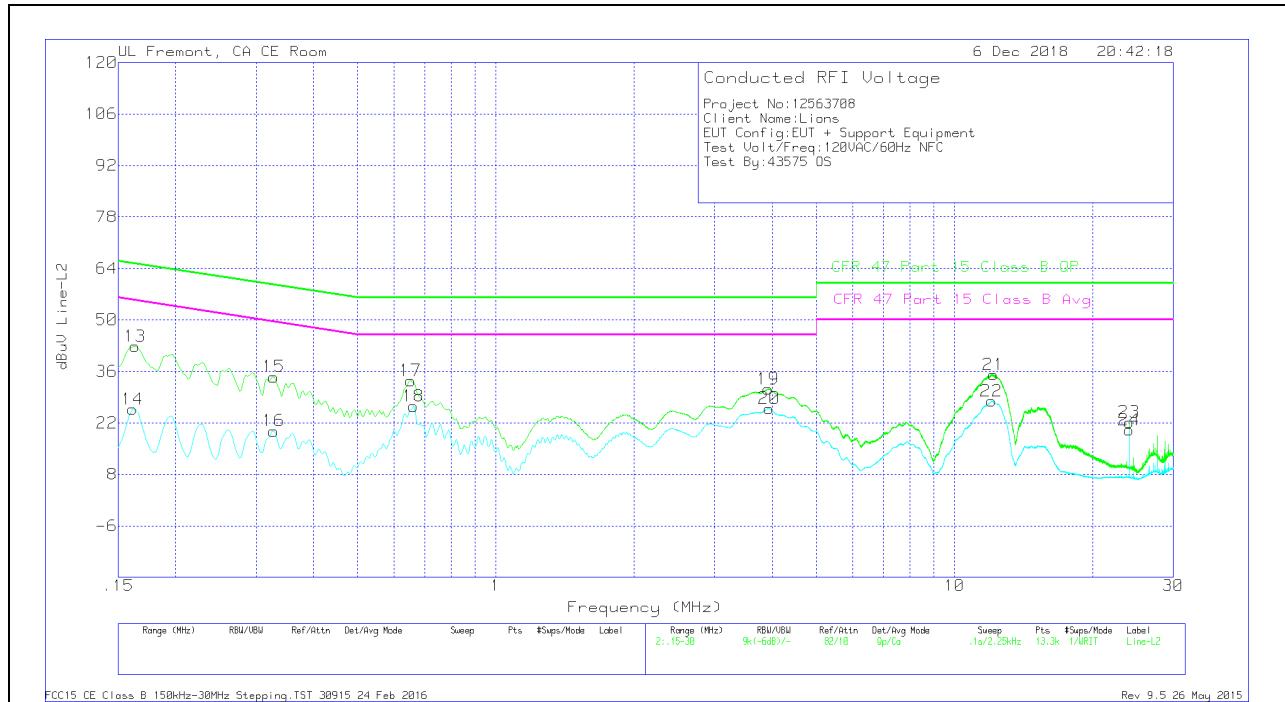

WORST EMISSIONS

Trace Markers

Range 2: Line-L2 .15 - 30MHz											
Marker	Frequency (MHz)	Meter Reading (dBuV)	Det	LISN L2	LC Cables C2&C3	Limiter (dB)	Corrected Reading dBuV	CFR 47 Part 15 Class B QP	QP Margin (dB)	CFR 47 Part 15 Class B Avg	Av(CISPR) Margin (dB)
13	.1635	32.62	Qp	.1	0	10.1	42.82	65.28	-22.46	-	-
14	.16125	15.49	Ca	.1	0	10.1	25.69	-	-	55.4	-29.71
15	.32775	24.43	Qp	0	0	10.1	34.53	59.51	-24.98	-	-
16	.32775	9.71	Ca	0	0	10.1	19.81	-	-	49.51	-29.7
17	.65175	23.38	Qp	0	0	10.1	33.48	56	-22.52	-	-
18	.66075	16.42	Ca	0	0	10.1	26.52	-	-	46	-19.48
19	3.9255	21.02	Qp	0	.1	10.1	31.22	56	-24.78	-	-
20	3.94575	15.72	Ca	0	.1	10.1	25.92	-	-	46	-20.08
21	12.1605	24.62	Qp	.1	.2	10.2	35.12	60	-24.88	-	-
22	12.03675	17.4	Ca	.1	.2	10.2	27.9	-	-	50	-22.1
23	24.054	11.28	Qp	.1	.3	10.5	22.18	60	-37.82	-	-
24	24.054	9.15	Ca	.1	.3	10.5	20.05	-	-	50	-29.95

Qp - Quasi-Peak detector
 Ca - CISPR average detection