

Impedance Measurement Plot for Body TSL

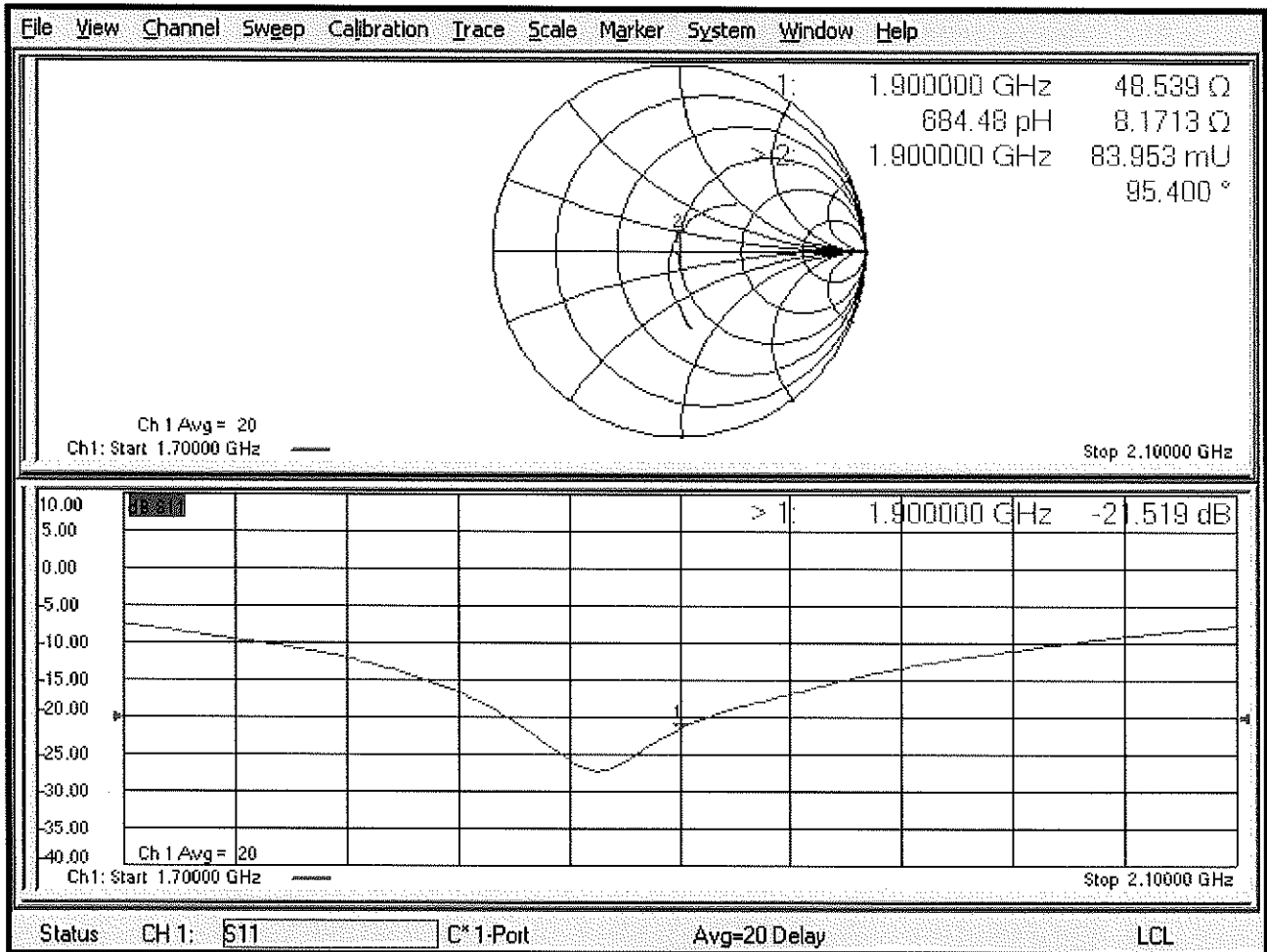

**Calibration Laboratory of
Schmid & Partner
Engineering AG**
Zeughausstrasse 43, 8004 Zurich, Switzerland



S Schweizerischer Kalibrierdienst
C Service suisse d'étalonnage
S Servizio svizzero di taratura
S Swiss Calibration Service

Accredited by the Swiss Accreditation Service (SAS)
The Swiss Accreditation Service is one of the signatories to the EA
Multilateral Agreement for the recognition of calibration certificates

Accreditation No.: **SCS 0108**

Client **PC Test**

Certificate No: **D2450V2-719_Aug17**

CALIBRATION CERTIFICATE

Object **D2450V2 - SN:719**

Calibration procedure(s) **QA CAL-05.v9
Calibration procedure for dipole validation kits above 700 MHz**

Calibration date: **August 17, 2017**

PNV
8/27/17
Extended
BN
7/19/2018

This calibration certificate documents the traceability to national standards, which realize the physical units of measurements (SI).
The measurements and the uncertainties with confidence probability are given on the following pages and are part of the certificate.

All calibrations have been conducted in the closed laboratory facility: environment temperature (22 ± 3)°C and humidity < 70%.

Calibration Equipment used (M&TE critical for calibration)

Primary Standards	ID #	Cal Date (Certificate No.)	Scheduled Calibration
Power meter NRP	SN: 104778	04-Apr-17 (No. 217-02521/02522)	Apr-18
Power sensor NRP-Z91	SN: 103244	04-Apr-17 (No. 217-02521)	Apr-18
Power sensor NRP-Z91	SN: 103245	04-Apr-17 (No. 217-02522)	Apr-18
Reference 20 dB Attenuator	SN: 5058 (20K)	07-Apr-17 (No. 217-02528)	Apr-18
Type-N mismatch combination	SN: 5047.2 / 06327	07-Apr-17 (No. 217-02529)	Apr-18
Reference Probe EX3DV4	SN: 7349	31-May-17 (No. EX3-7349_May17)	May-18
DAE4	SN: 601	28-Mar-17 (No. DAE4-601_Mar17)	Mar-18

Secondary Standards	ID #	Check Date (in house)	Scheduled Check
Power meter EPM-442A	SN: GB37480704	07-Oct-15 (in house check Oct-16)	In house check: Oct-18
Power sensor HP 8481A	SN: US37292783	07-Oct-15 (in house check Oct-16)	In house check: Oct-18
Power sensor HP 8481A	SN: MY41092317	07-Oct-15 (in house check Oct-16)	In house check: Oct-18
RF generator R&S SMT-06	SN: 100972	15-Jun-15 (in house check Oct-16)	In house check: Oct-18
Network Analyzer HP 8753E	SN: US37390585	18-Oct-01 (in house check Oct-16)	In house check: Oct-17

Calibrated by: **Michael Weber** Name: Michael Weber Function: Laboratory Technician

Approved by: **Katja Pokovic** Name: Katja Pokovic Function: Technical Manager

Signature
M. Weber
K. Pokovic

Issued: August 17, 2017

This calibration certificate shall not be reproduced except in full without written approval of the laboratory.



Accredited by the Swiss Accreditation Service (SAS)
The Swiss Accreditation Service is one of the signatories to the EA
Multilateral Agreement for the recognition of calibration certificates

Accreditation No.: **SCS 0108**

Glossary:

TSL	tissue simulating liquid
ConvF	sensitivity in TSL / NORM x,y,z
N/A	not applicable or not measured

Calibration is Performed According to the Following Standards:

- IEEE Std 1528-2013, "IEEE Recommended Practice for Determining the Peak Spatial-Averaged Specific Absorption Rate (SAR) in the Human Head from Wireless Communications Devices: Measurement Techniques", June 2013
- IEC 62209-1, "Measurement procedure for the assessment of Specific Absorption Rate (SAR) from hand-held and body-mounted devices used next to the ear (frequency range of 300 MHz to 6 GHz)", July 2016
- IEC 62209-2, "Procedure to determine the Specific Absorption Rate (SAR) for wireless communication devices used in close proximity to the human body (frequency range of 30 MHz to 6 GHz)", March 2010
- KDB 865664, "SAR Measurement Requirements for 100 MHz to 6 GHz"

Additional Documentation:

- DASY4/5 System Handbook

Methods Applied and Interpretation of Parameters:

- Measurement Conditions:** Further details are available from the Validation Report at the end of the certificate. All figures stated in the certificate are valid at the frequency indicated.
- Antenna Parameters with TSL:** The dipole is mounted with the spacer to position its feed point exactly below the center marking of the flat phantom section, with the arms oriented parallel to the body axis.
- Feed Point Impedance and Return Loss:** These parameters are measured with the dipole positioned under the liquid filled phantom. The impedance stated is transformed from the measurement at the SMA connector to the feed point. The Return Loss ensures low reflected power. No uncertainty required.
- Electrical Delay:** One-way delay between the SMA connector and the antenna feed point. No uncertainty required.
- SAR measured:** SAR measured at the stated antenna input power.
- SAR normalized:** SAR as measured, normalized to an input power of 1 W at the antenna connector.
- SAR for nominal TSL parameters:** The measured TSL parameters are used to calculate the nominal SAR result.

The reported uncertainty of measurement is stated as the standard uncertainty of measurement multiplied by the coverage factor $k=2$, which for a normal distribution corresponds to a coverage probability of approximately 95%.

Measurement Conditions

DASY system configuration, as far as not given on page 1.

DASY Version	DASY5	V52.10.0
Extrapolation	Advanced Extrapolation	
Phantom	Modular Flat Phantom	
Distance Dipole Center - TSL	10 mm	with Spacer
Zoom Scan Resolution	dx, dy, dz = 5 mm	
Frequency	2450 MHz \pm 1 MHz	

Head TSL parameters

The following parameters and calculations were applied.

	Temperature	Permittivity	Conductivity
Nominal Head TSL parameters	22.0 °C	39.2	1.80 mho/m
Measured Head TSL parameters	(22.0 \pm 0.2) °C	37.8 \pm 6 %	1.86 mho/m \pm 6 %
Head TSL temperature change during test	< 0.5 °C	----	----

SAR result with Head TSL

SAR averaged over 1 cm³ (1 g) of Head TSL	Condition	
SAR measured	250 mW input power	13.3 W/kg
SAR for nominal Head TSL parameters	normalized to 1W	51.9 W/kg \pm 17.0 % (k=2)

SAR averaged over 10 cm³ (10 g) of Head TSL	condition	
SAR measured	250 mW input power	6.15 W/kg
SAR for nominal Head TSL parameters	normalized to 1W	24.3 W/kg \pm 16.5 % (k=2)

Body TSL parameters

The following parameters and calculations were applied.

	Temperature	Permittivity	Conductivity
Nominal Body TSL parameters	22.0 °C	52.7	1.95 mho/m
Measured Body TSL parameters	(22.0 \pm 0.2) °C	51.9 \pm 6 %	2.03 mho/m \pm 6 %
Body TSL temperature change during test	< 0.5 °C	----	----

SAR result with Body TSL

SAR averaged over 1 cm³ (1 g) of Body TSL	Condition	
SAR measured	250 mW input power	12.8 W/kg
SAR for nominal Body TSL parameters	normalized to 1W	50.1 W/kg \pm 17.0 % (k=2)

SAR averaged over 10 cm³ (10 g) of Body TSL	condition	
SAR measured	250 mW input power	6.00 W/kg
SAR for nominal Body TSL parameters	normalized to 1W	23.7 W/kg \pm 16.5 % (k=2)

Appendix (Additional assessments outside the scope of SCS 0108)

Antenna Parameters with Head TSL

Impedance, transformed to feed point	55.7 Ω + 7.0 j Ω
Return Loss	- 21.4 dB

Antenna Parameters with Body TSL

Impedance, transformed to feed point	51.4 Ω + 8.1 j Ω
Return Loss	- 21.8 dB

General Antenna Parameters and Design

Electrical Delay (one direction)	1.150 ns
----------------------------------	----------

After long term use with 100W radiated power, only a slight warming of the dipole near the feedpoint can be measured.

The dipole is made of standard semirigid coaxial cable. The center conductor of the feeding line is directly connected to the second arm of the dipole. The antenna is therefore short-circuited for DC-signals. On some of the dipoles, small end caps are added to the dipole arms in order to improve matching when loaded according to the position as explained in the "Measurement Conditions" paragraph. The SAR data are not affected by this change. The overall dipole length is still according to the Standard.

No excessive force must be applied to the dipole arms, because they might bend or the soldered connections near the feedpoint may be damaged.

Additional EUT Data

Manufactured by	SPEAG
Manufactured on	September 10, 2002

DASY5 Validation Report for Head TSL

Date: 17.08.2017

Test Laboratory: SPEAG, Zurich, Switzerland

DUT: Dipole 2450 MHz; Type: D2450V2; Serial: D2450V2 - SN: 719

Communication System: UID 0 - CW; Frequency: 2450 MHz

Medium parameters used: $f = 2450$ MHz; $\sigma = 1.86$ S/m; $\epsilon_r = 37.8$; $\rho = 1000$ kg/m³

Phantom section: Flat Section

Measurement Standard: DASY5 (IEEE/IEC/ANSI C63.19-2011)

DASY52 Configuration:

- Probe: EX3DV4 - SN7349; ConvF(8.12, 8.12, 8.12); Calibrated: 31.05.2017;
- Sensor-Surface: 1.4mm (Mechanical Surface Detection)
- Electronics: DAE4 Sn601; Calibrated: 28.03.2017
- Phantom: Flat Phantom 5.0 (front); Type: QD 000 P50 AA; Serial: 1001
- DASY52 52.10.0(1446); SEMCAD X 14.6.10(7417)

Dipole Calibration for Head Tissue/Pin=250 mW, d=10mm/Zoom Scan (7x7x7)/Cube 0:

Measurement grid: dx=5mm, dy=5mm, dz=5mm

Reference Value = 112.8 V/m; Power Drift = -0.01 dB

Peak SAR (extrapolated) = 26.9 W/kg

SAR(1 g) = 13.3 W/kg; SAR(10 g) = 6.15 W/kg

Maximum value of SAR (measured) = 21.6 W/kg

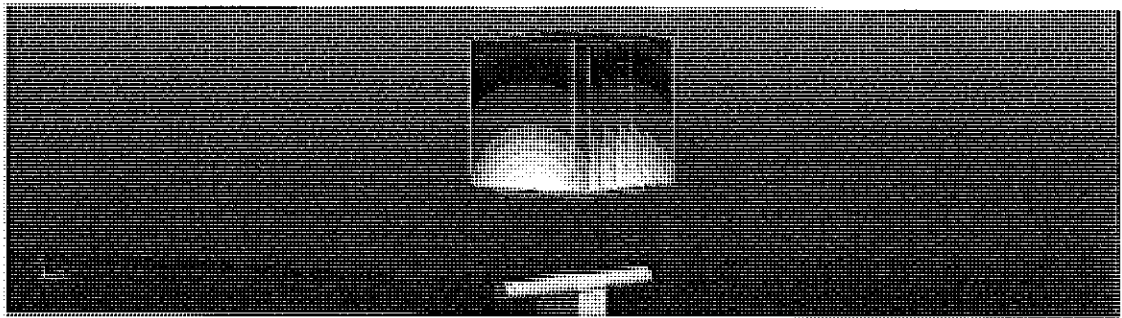
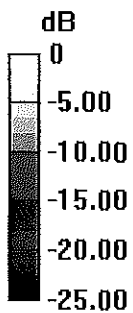

0 dB = 21.6 W/kg = 13.34 dBW/kg

Impedance Measurement Plot for Head TSL

17 Aug 2017 12:38:03
 CH1 S11 1 U FS 1: 55.682 Ω 6.9766 Ω 453.21 μH 2 450.000 000 MHz

*
 De1
 CA

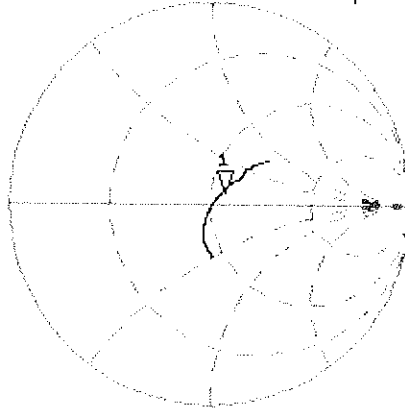

Avg
 16

H1d

CH2 S11 LOG 5 dB/REF -20 dB 1: -21.413 dB 2 450.000 000 MHz

CA

Avg
 16

H1d

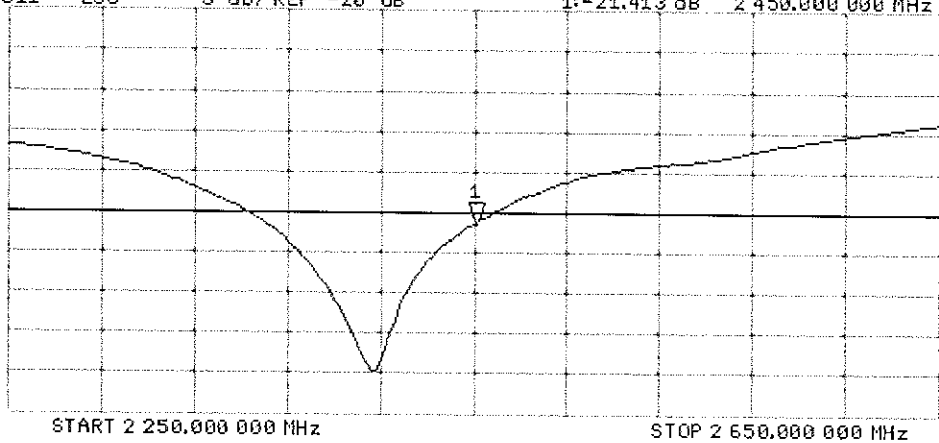

DASY5 Validation Report for Body TSL

Date: 17.08.2017

Test Laboratory: SPEAG, Zurich, Switzerland

DUT: Dipole 2450 MHz; Type: D2450V2; Serial: D2450V2 - SN: 719

Communication System: UID 0 - CW; Frequency: 2450 MHz

Medium parameters used: $f = 2450$ MHz; $\sigma = 2.03$ S/m; $\epsilon_r = 51.9$; $\rho = 1000$ kg/m³

Phantom section: Flat Section

Measurement Standard: DASY5 (IEEE/IEC/ANSI C63.19-2011)

DASY52 Configuration:

- Probe: EX3DV4 - SN7349; ConvF(8.1, 8.1, 8.1); Calibrated: 31.05.2017;
- Sensor-Surface: 1.4mm (Mechanical Surface Detection)
- Electronics: DAE4 Sn601; Calibrated: 28.03.2017
- Phantom: Flat Phantom 5.0 (back); Type: QD 000 P50 AA; Serial: 1002
- DASY52 52.10.0(1446); SEMCAD X 14.6.10(7417)

Dipole Calibration for Body Tissue/Pin=250 mW, d=10mm/Zoom Scan (7x7x7)/Cube 0:

Measurement grid: dx=5mm, dy=5mm, dz=5mm

Reference Value = 103.0 V/m; Power Drift = -0.07 dB

Peak SAR (extrapolated) = 25.2 W/kg

SAR(1 g) = 12.8 W/kg; SAR(10 g) = 6 W/kg

Maximum value of SAR (measured) = 19.8 W/kg

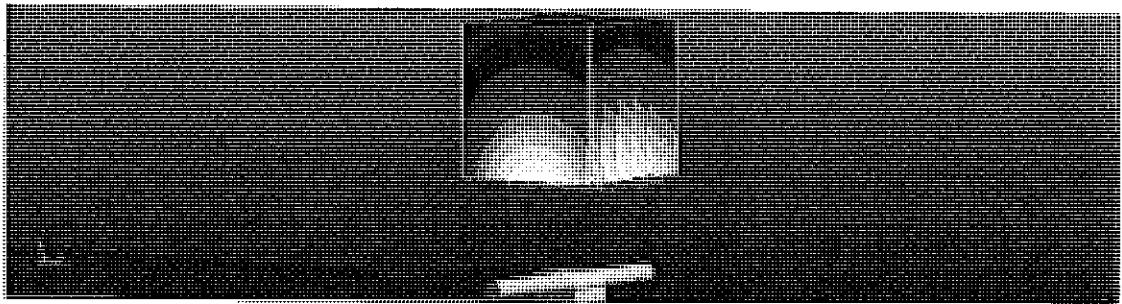
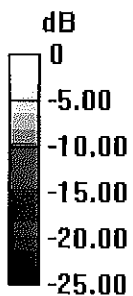

0 dB = 19.8 W/kg = 12.97 dBW/kg

Impedance Measurement Plot for Body TSL

17 Aug 2017 12:37:27
[CH1] S11 1 U FS 1: 51.379 Ω 8.1367 Ω 528.57 pF 2 450.000 000 MHz

*
De1
C4

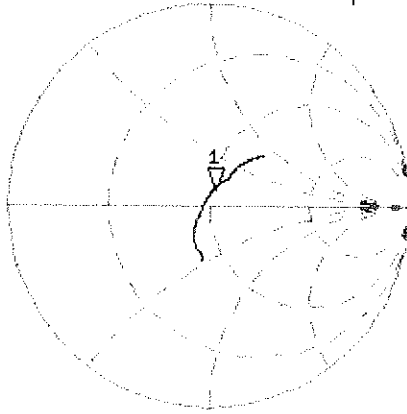

Avg
16

H1d

CH2 S11 LOG 5 dB/REF -20 dB 1: -21.809 dB 2 450.000 000 MHz

C4

Avg
16

H1d

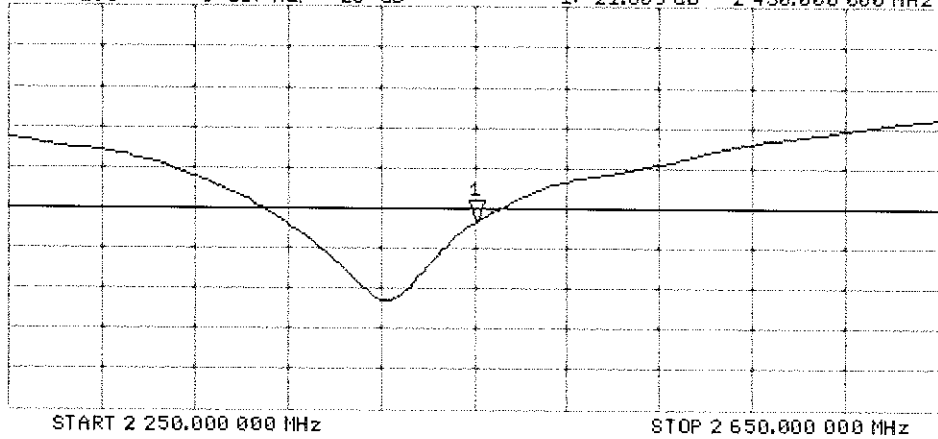

Certification of Calibration

Object: D2450V2 – SN: 719

Calibration procedure(s): Procedure for Calibration Extension for SAR Dipoles.

Extended Calibration date: 07/18/2018

Description: SAR Validation Dipole at 2450 MHz.

Calibration Equipment used:

Manufacturer	Model	Description	Cal Date	Cal Interval	Cal Due	Serial Number
Agilent	E4438C	ESG Vector Signal Generator	3/24/2017	Biennial	3/24/2019	MY42082385
Agilent	8753ES	S-Parameter Network Analyzer	9/14/2017	Annual	9/14/2018	US39170118
Amplifier Research	15S1G6	Amplifier	CBT	N/A	CBT	433971
Anritsu	ML2495A	Power Meter	11/28/2017	Annual	11/28/2018	1039008
Anritsu	MA2411B	Pulse Power Sensor	3/2/2018	Annual	3/2/2019	1207364
Anritsu	MA2411B	Pulse Power Sensor	11/15/2017	Annual	11/15/2018	1339007
Control Company	4040	Therm./Clock/Humidity Monitor	3/31/2017	Biennial	3/31/2019	170232394
Control Company	4352	Ultra Long Stem Thermometer	5/2/2017	Biennial	5/2/2019	170330156
Keysight	772D	Dual Directional Coupler	CBT	N/A	CBT	MY52180215
Keysight Technologies	85033E	Standard Mechanical Calibration Kit (DC to 9GHz, 3.5mm)	6/4/2018	Annual	6/4/2019	MY53401181
Mini-Circuits	BW-N20W5+	DC to 18 GHz Precision Fixed 20 dB Attenuator	CBT	N/A	CBT	N/A
Mini-Circuits	NLP-2950+	Low Pass Filter DC to 2700 MHz	CBT	N/A	CBT	N/A
Narda	4772-3	Attenuator (3dB)	CBT	N/A	CBT	9406
Pasternack	PE2209-10	Bidirectional Coupler	CBT	N/A	CBT	N/A
Pasternack	PE5011-1	Torque Wrench	7/19/2017	Biennial	7/19/2019	N/A
SPEAG	DAE4	Dasy Data Acquisition Electronics	3/7/2018	Annual	3/7/2019	1368
SPEAG	DAE4	Dasy Data Acquisition Electronics	8/9/2017	Annual	8/9/2018	1323
SPEAG	DAK-3.5	Dielectric Assessment Kit	9/12/2017	Annual	9/12/2018	1091
SPEAG	ES3DV3	SAR Probe	3/13/2018	Annual	3/13/2019	3319
SPEAG	ES3DV3	SAR Probe	8/14/2017	Annual	8/14/2018	3332

Measurement Uncertainty = $\pm 23\%$ (k=2)

	Name	Function	Signature
Calibrated By:	Brodie Halfoster	Test Engineer	<i>BRODIE HALFOSTER</i>
Approved By:	Kaitlin O'Keefe	Senior Technical Manager	<i>KOK</i>

DIPOLE CALIBRATION EXTENSION

Per KDB 865664 D01, calibration intervals of up to three years may be considered for reference dipoles when it is demonstrated that the SAR target, impedance and return loss of a dipole have remained stable according to the following requirements:

1. The measured SAR does not deviate more than 10% from the target on the calibration certificate.
2. The return-loss does not deviate more than 20% from the previous measurement and meets the required 20dB minimum return-loss requirement.
3. The measurement of real or imaginary parts of impedance does not deviate more than 5Ω from the previous measurement.

The following dipole was checked to pass the above 3 requirements to have 2-year calibration period from the calibration date:

Calibration Date	Extension Date	Certificate Electrical Delay (ns)	Certificate SAR Target Head (1g) W/kg @ 20.0 dBm	Measured Head SAR (1g) W/kg @ 20.0 dBm	Deviation 1g (%)	Certificate SAR Target Head (10g) W/kg @ 20.0 dBm	Measured Head SAR (10g) W/kg @ 20.0 dBm	Deviation 10g (%)	Certificate Impedance Head (Ohm) Real	Measured Impedance Head (Ohm) Real	Difference (Ohm) Real	Certificate Impedance Head (Ohm) Imaginary	Measured Impedance Head (Ohm) Imaginary	Difference (Ohm) Imaginary	Certificate Return Loss Head (dB)	Measured Return Loss Head (dB)	Deviation (%)	PASS/FAIL
8/17/2017	7/18/2018	1.150	5.19	5.46	5.20%	2.43	2.51	3.29%	55.7	53.9	1.8	7.0	2.9	4.1	-21.4	-25.4	-18.70%	PASS
Calibration Date	Extension Date	Certificate Electrical Delay (ns)	Certificate SAR Target Body (1g) W/kg @ 20.0 dBm	Measured Body SAR (1g) W/kg @ 20.0 dBm	Deviation 1g (%)	Certificate SAR Target Body (10g) W/kg @ 20.0 dBm	Measured Body SAR (10g) W/kg @ 20.0 dBm	Deviation 10g (%)	Certificate Impedance Body (Ohm) Real	Measured Impedance Body (Ohm) Real	Difference (Ohm) Real	Certificate Impedance Body (Ohm) Imaginary	Measured Impedance Body (Ohm) Imaginary	Difference (Ohm) Imaginary	Certificate Return Loss Body (dB)	Measured Return Loss Body (dB)	Deviation (%)	PASS/FAIL
8/17/2017	7/18/2018	1.150	5.01	5.19	3.59%	2.37	2.38	0.42%	51.4	50.2	1.2	8.1	5.9	2.2	-21.8	-24.6	-12.80%	PASS

Impedance & Return-Loss Measurement Plot for Head TSL

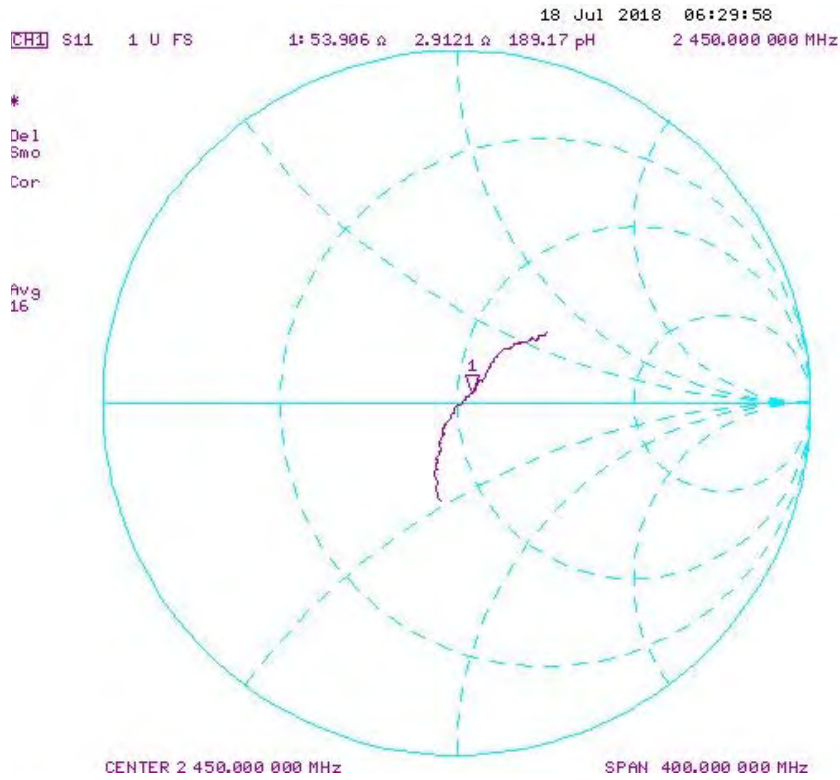

Impedance & Return-Loss Measurement Plot for Body TSL

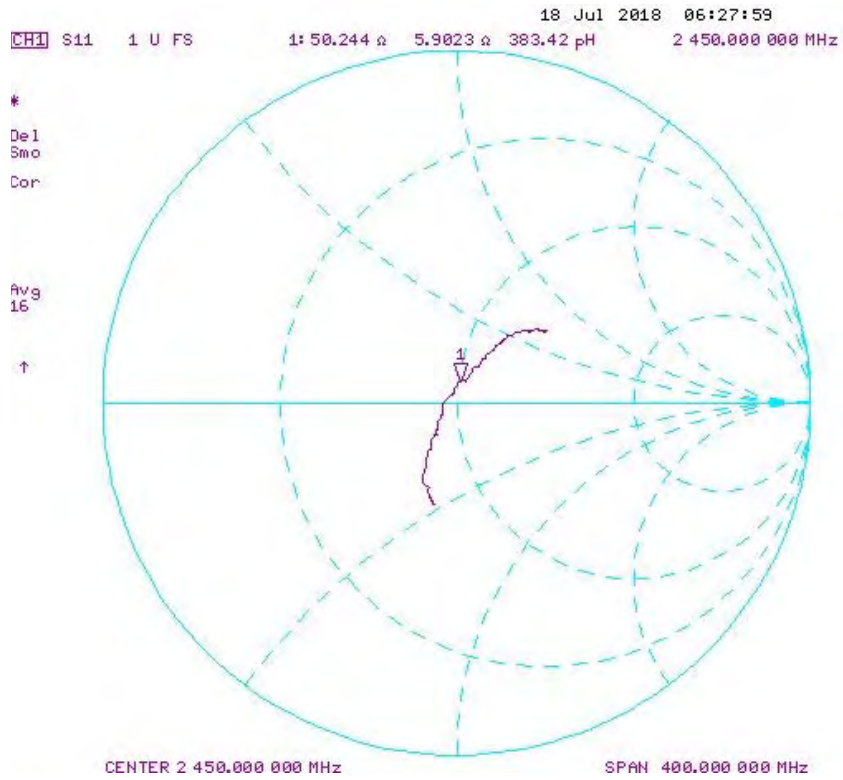

DIPOLE CALIBRATION EXTENSION

Per KDB 865664 D01, calibration intervals of up to three years may be considered for reference dipoles when it is demonstrated that the SAR target, impedance and return loss of a dipole have remained stable according to the following requirements:

1. The measured SAR does not deviate more than 10% from the target on the calibration certificate.
2. The return-loss does not deviate more than 20% from the previous measurement and meets the required 20dB minimum return-loss requirement.
3. The measurement of real or imaginary parts of impedance does not deviate more than 5Ω from the previous measurement.

The following dipole was checked to pass the above 3 requirements to have 2-year calibration period from the calibration date:

Calibration Date	Extension Date	Certificate Electrical Delay (ns)	Certificate SAR Target Head (1g) W/kg @ 20.0 dBm	Measured Head SAR (1g) W/kg @ 20.0 dBm	Deviation (g) (%)	Certificate SAR Target Head (10g) W/kg @ 20.0 dBm	Measured Head SAR (10g) W/kg @ 20.0 dBm	Deviation (g) (%)	Certificate Impedance Head (Ohm) Real	Measured Impedance Head (Ohm) Real	Difference (Ohm) Real	Certificate Impedance Head (Ohm) Imaginary	Measured Impedance Head (Ohm) Imaginary	Difference (Ohm) Imaginary	Certificate Return Loss Head (dB)	Measured Return Loss Head (dB)	Deviation (dB) (%)	FACTOR/AC
8/17/2017	7/18/2018	1.150	5.19	5.48	5.20%	2.43	2.51	3.29%	55.7	53.0	2.8		3.8	4.1	-21.4	-20.4	-18.70%	PASS
Calibration Date	Extension Date	Certificate Electrical Delay (ns)	Certificate SAR Target Body (1g) W/kg @ 20.0 dBm	Measured Body SAR (1g) W/kg @ 20.0 dBm	Deviation (g) (%)	Certificate SAR Target Body (10g) W/kg @ 20.0 dBm	Measured Body SAR (10g) W/kg @ 20.0 dBm	Deviation (g) (%)	Certificate Impedance Body (Ohm) Real	Measured Impedance Body (Ohm) Real	Difference (Ohm) Real	Certificate Impedance Body (Ohm) Imaginary	Measured Impedance Body (Ohm) Imaginary	Difference (Ohm) Imaginary	Certificate Return Loss Body (dB)	Measured Return Loss Body (dB)	Deviation (dB) (%)	FACTOR/AC
8/17/2017	7/18/2018	1.150	8.01	8.18	3.59%	2.37	2.38	0.42%	51.4	50.2	1.2		5.8	2.2	-21.8	-24.8	-12.80%	PASS



Accredited by the Swiss Accreditation Service (SAS)
The Swiss Accreditation Service is one of the signatories to the EA
Multilateral Agreement for the recognition of calibration certificates

Accreditation No.: **SCS 0108**

Client **PC Test**

Certificate No: **D2450V2-797_Sep17**

CALIBRATION CERTIFICATE

Object **D2450V2 - SN:797**

Calibration procedure(s) **QA CAL-05.v9**
Calibration procedure for dipole validation kits above 700 MHz

Calibration date: **September 11, 2017**

SCV
10/03/2017
Extended PMV
9/20/2018

This calibration certificate documents the traceability to national standards, which realize the physical units of measurements (SI).
The measurements and the uncertainties with confidence probability are given on the following pages and are part of the certificate.

All calibrations have been conducted in the closed laboratory facility: environment temperature (22 ± 3)°C and humidity < 70%.

Calibration Equipment used (M&TE critical for calibration)

Primary Standards	ID #	Cal Date (Certificate No.)	Scheduled Calibration
Power meter NRP	SN: 104778	04-Apr-17 (No. 217-02521/02522)	Apr-18
Power sensor NRP-Z91	SN: 103244	04-Apr-17 (No. 217-02521)	Apr-18
Power sensor NRP-Z91	SN: 103245	04-Apr-17 (No. 217-02522)	Apr-18
Reference 20 dB Attenuator	SN: 5058 (20k)	07-Apr-17 (No. 217-02528)	Apr-18
Type-N mismatch combination	SN: 5047.2 / 08327	07-Apr-17 (No. 217-02529)	Apr-18
Reference Probe EX3DV4	SN: 7349	31-May-17 (No. EX3-7349_May17)	May-18
DAE4	SN: 601	28-Mar-17 (No. DAE4-601_Mar17)	Mar-18
Secondary Standards	ID #	Check Date (in house)	Scheduled Check
Power meter EPM-442A	SN: GB37480704	07-Oct-15 (in house check Oct-16)	In house check: Oct-18
Power sensor HP 8481A	SN: US37292783	07-Oct-15 (in house check Oct-16)	In house check: Oct-18
Power sensor HP 8481A	SN: MY41092317	07-Oct-15 (in house check Oct-16)	In house check: Oct-18
RF generator R&S SMT-08	SN: 100972	15-Jun-15 (in house check Oct-16)	In house check: Oct-18
Network Analyzer HP 8753E	SN: US37390585	18-Oct-01 (in house check Oct-16)	In house check: Oct-17

Calibrated by: **Michael Weber** Name: Michael Weber Function: Laboratory Technician

Approved by: **Katja Pokovic** Name: Katja Pokovic Function: Technical Manager

Signature
M. Weber
K. Pokovic

Issued: September 11, 2017

This calibration certificate shall not be reproduced except in full without written approval of the laboratory.

**Calibration Laboratory of
Schmid & Partner
Engineering AG**
Zeughausstrasse 43, 8004 Zurich, Switzerland



S Schweizerischer Kalibrierdienst
C Service suisse d'étalonnage
S Servizio svizzero di taratura
S Swiss Calibration Service

Accredited by the Swiss Accreditation Service (SAS)
The Swiss Accreditation Service is one of the signatories to the EA
Multilateral Agreement for the recognition of calibration certificates

Accreditation No.: **SCS 0108**

Glossary:

TSL tissue simulating liquid
ConvF sensitivity in TSL / NORM x,y,z
N/A not applicable or not measured

Calibration is Performed According to the Following Standards:

- a) IEEE Std 1528-2013, "IEEE Recommended Practice for Determining the Peak Spatial-Averaged Specific Absorption Rate (SAR) in the Human Head from Wireless Communications Devices: Measurement Techniques", June 2013
- b) IEC 62209-1, "Measurement procedure for the assessment of Specific Absorption Rate (SAR) from hand-held and body-mounted devices used next to the ear (frequency range of 300 MHz to 6 GHz)", July 2016
- c) IEC 62209-2, "Procedure to determine the Specific Absorption Rate (SAR) for wireless communication devices used in close proximity to the human body (frequency range of 30 MHz to 6 GHz)", March 2010
- d) KDB 865664, "SAR Measurement Requirements for 100 MHz to 6 GHz"

Additional Documentation:

- e) DASY4/5 System Handbook

Methods Applied and Interpretation of Parameters:

- *Measurement Conditions:* Further details are available from the Validation Report at the end of the certificate. All figures stated in the certificate are valid at the frequency indicated.
- *Antenna Parameters with TSL:* The dipole is mounted with the spacer to position its feed point exactly below the center marking of the flat phantom section, with the arms oriented parallel to the body axis.
- *Feed Point Impedance and Return Loss:* These parameters are measured with the dipole positioned under the liquid filled phantom. The impedance stated is transformed from the measurement at the SMA connector to the feed point. The Return Loss ensures low reflected power. No uncertainty required.
- *Electrical Delay:* One-way delay between the SMA connector and the antenna feed point. No uncertainty required.
- *SAR measured:* SAR measured at the stated antenna input power.
- *SAR normalized:* SAR as measured, normalized to an input power of 1 W at the antenna connector.
- *SAR for nominal TSL parameters:* The measured TSL parameters are used to calculate the nominal SAR result.

The reported uncertainty of measurement is stated as the standard uncertainty of measurement multiplied by the coverage factor $k=2$, which for a normal distribution corresponds to a coverage probability of approximately 95%.

Measurement Conditions

DASY system configuration, as far as not given on page 1.

DASY Version	DASY5	V52.10.0
Extrapolation	Advanced Extrapolation	
Phantom	Modular Flat Phantom	
Distance Dipole Center - TSL	10 mm	with Spacer
Zoom Scan Resolution	dx, dy, dz = 5 mm	
Frequency	2450 MHz \pm 1 MHz	

Head TSL parameters

The following parameters and calculations were applied.

	Temperature	Permittivity	Conductivity
Nominal Head TSL parameters	22.0 °C	39.2	1.80 mho/m
Measured Head TSL parameters	(22.0 \pm 0.2) °C	37.8 \pm 6 %	1.86 mho/m \pm 6 %
Head TSL temperature change during test	< 0.5 °C	----	----

SAR result with Head TSL

SAR averaged over 1 cm ³ (1 g) of Head TSL	Condition	
SAR measured	250 mW input power	13.5 W/kg
SAR for nominal Head TSL parameters	normalized to 1W	52.7 W/kg \pm 17.0 % (k=2)

SAR averaged over 10 cm ³ (10 g) of Head TSL	condition	
SAR measured	250 mW input power	6.28 W/kg
SAR for nominal Head TSL parameters	normalized to 1W	24.8 W/kg \pm 16.5 % (k=2)

Body TSL parameters

The following parameters and calculations were applied.

	Temperature	Permittivity	Conductivity
Nominal Body TSL parameters	22.0 °C	52.7	1.95 mho/m
Measured Body TSL parameters	(22.0 \pm 0.2) °C	51.9 \pm 6 %	2.04 mho/m \pm 6 %
Body TSL temperature change during test	< 0.5 °C	----	----

SAR result with Body TSL

SAR averaged over 1 cm ³ (1 g) of Body TSL	Condition	
SAR measured	250 mW input power	13.1 W/kg
SAR for nominal Body TSL parameters	normalized to 1W	51.1 W/kg \pm 17.0 % (k=2)

SAR averaged over 10 cm ³ (10 g) of Body TSL	condition	
SAR measured	250 mW input power	6.14 W/kg
SAR for nominal Body TSL parameters	normalized to 1W	24.2 W/kg \pm 16.5 % (k=2)

Appendix (Additional assessments outside the scope of SCS 0108)

Antenna Parameters with Head TSL

Impedance, transformed to feed point	53.8 Ω + 7.4 j Ω
Return Loss	- 21.9 dB

Antenna Parameters with Body TSL

Impedance, transformed to feed point	49.7 Ω + 9.1 j Ω
Return Loss	- 20.9 dB

General Antenna Parameters and Design

Electrical Delay (one direction)	1.152 ns
----------------------------------	----------

After long term use with 100W radiated power, only a slight warming of the dipole near the feedpoint can be measured.

The dipole is made of standard semirigid coaxial cable. The center conductor of the feeding line is directly connected to the second arm of the dipole. The antenna is therefore short-circuited for DC-signals. On some of the dipoles, small end caps are added to the dipole arms in order to improve matching when loaded according to the position as explained in the "Measurement Conditions" paragraph. The SAR data are not affected by this change. The overall dipole length is still according to the Standard.

No excessive force must be applied to the dipole arms, because they might bend or the soldered connections near the feedpoint may be damaged.

Additional EUT Data

Manufactured by	SPEAG
Manufactured on	January 24, 2006

DASY5 Validation Report for Head TSL

Date: 11.09.2017

Test Laboratory: SPEAG, Zurich, Switzerland

DUT: Dipole 2450 MHz; Type: D2450V2; Serial: D2450V2 - SN: 797

Communication System: UID 0 - CW; Frequency: 2450 MHz

Medium parameters used: $f = 2450$ MHz; $\sigma = 1.86$ S/m; $\epsilon_r = 37.8$; $\rho = 1000$ kg/m³

Phantom section: Flat Section

Measurement Standard: DASY5 (IEEE/IEC/ANSI C63.19-2011)

DASY52 Configuration:

- Probe: EX3DV4 - SN7349; ConvF(8.12, 8.12, 8.12); Calibrated: 31.05.2017;
- Sensor-Surface: 1.4mm (Mechanical Surface Detection)
- Electronics: DAE4 Sn601; Calibrated: 28.03.2017
- Phantom: Flat Phantom 5.0 (front); Type: QD 000 P50 AA; Serial: 1001
- DASY52 52.10.0(1446); SEMCAD X 14.6.10(7417)

Dipole Calibration for Head Tissue/ $P_{in}=250$ mW, $d=10$ mm/Zoom Scan (7x7x7)/Cube 0:

Measurement grid: $dx=5$ mm, $dy=5$ mm, $dz=5$ mm

Reference Value = 113.5 V/m; Power Drift = -0.08 dB

Peak SAR (extrapolated) = 26.9 W/kg

SAR(1 g) = 13.5 W/kg; SAR(10 g) = 6.28 W/kg

Maximum value of SAR (measured) = 21.6 W/kg

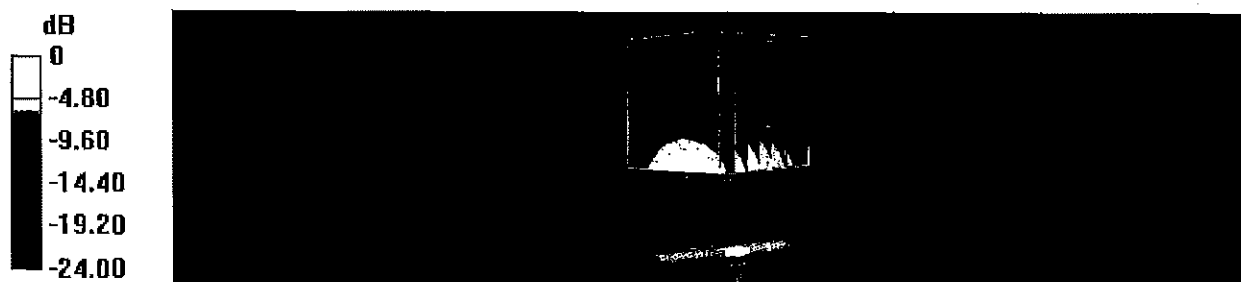

0 dB = 21.6 W/kg = 13.34 dBW/kg

Impedance Measurement Plot for Head TSL

11 Sep 2017 11:52:57

CH1 S11 1 U FS 1: 53.777 Ω 7.4395 Ω 483.28 μ H 2 450.000 000 MHz

*
DeI
CA

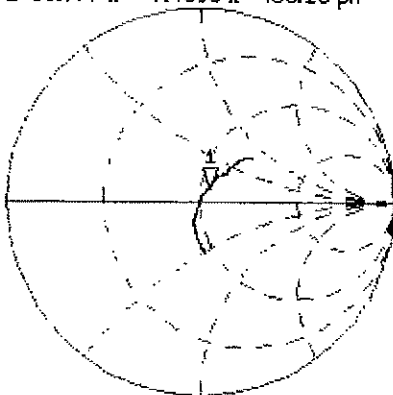

Avg
16

H1d

CH2 S11 LOG 5 dB/REF -20 dB 1: -21.911 dB 2 450.000 000 MHz

CA
Avg
16
H1d

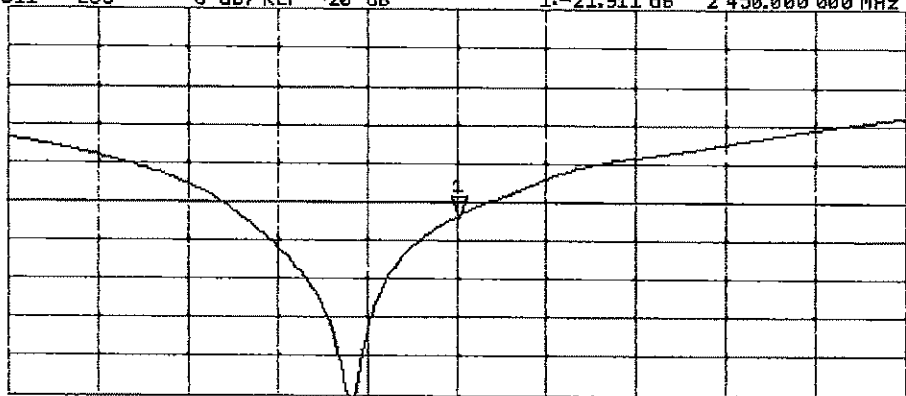

START 2 250.000 000 MHz

STOP 2 650.000 000 MHz

DASY5 Validation Report for Body TSL

Date: 11.09.2017

Test Laboratory: SPEAG, Zurich, Switzerland

DUT: Dipole 2450 MHz; Type: D2450V2; Serial: D2450V2 - SN: 797

Communication System: UID 0 - CW; Frequency: 2450 MHz

Medium parameters used: $f = 2450$ MHz; $\sigma = 2.04$ S/m; $\epsilon_r = 51.9$; $\rho = 1000$ kg/m³

Phantom section: Flat Section

Measurement Standard: DASY5 (IEEE/IEC/ANSI C63.19-2011)

DASY52 Configuration:

- Probe: EX3DV4 - SN7349; ConvF(8.1, 8.1, 8.1); Calibrated: 31.05.2017;
- Sensor-Surface: 1.4mm (Mechanical Surface Detection)
- Electronics: DAB4 Sn601; Calibrated: 28.03.2017
- Phantom: Flat Phantom 5.0 (back); Type: QD 000 P50 AA; Serial: 1002
- DASY52 52.10.0(1446); SEMCAD X 14.6.10(7417)

Dipole Calibration for Body Tissue/Pin=250 mW, d=10mm/Zoom Scan (7x7x7)/Cube 0:

Measurement grid: dx=5mm, dy=5mm, dz=5mm

Reference Value = 105.4 V/m; Power Drift = -0.08 dB

Peak SAR (extrapolated) = 25.6 W/kg

SAR(1 g) = 13.1 W/kg; SAR(10 g) = 6.14 W/kg

Maximum value of SAR (measured) = 20.3 W/kg

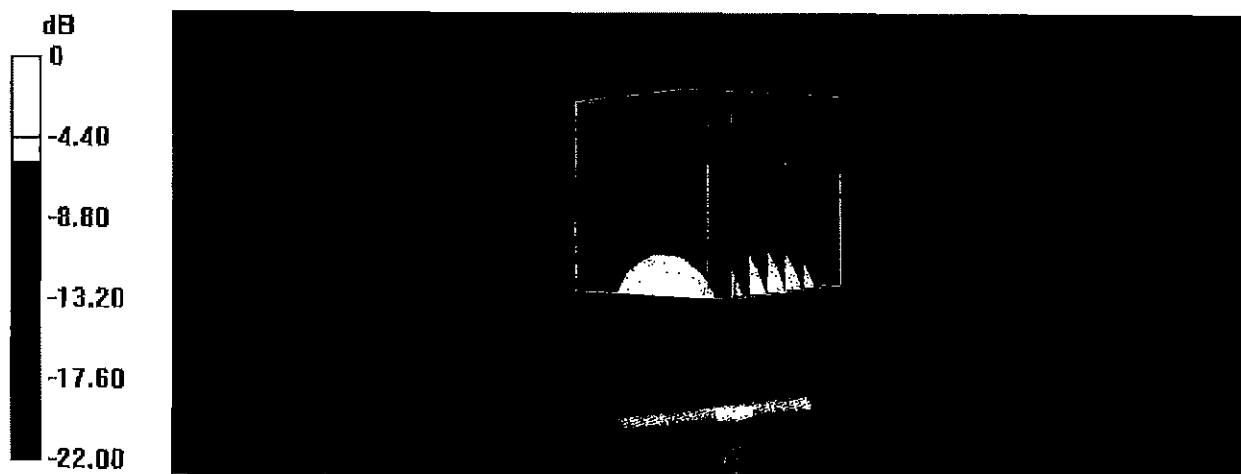

0 dB = 20.3 W/kg = 13.07 dBW/kg

Impedance Measurement Plot for Body TSL

11 Sep 2017 11:52:10

CH1 S11 1 U FS 1: 49.725 Ω 9.0703 Ω 589.22 pF 2 450.000 000 MHz

De1
CA

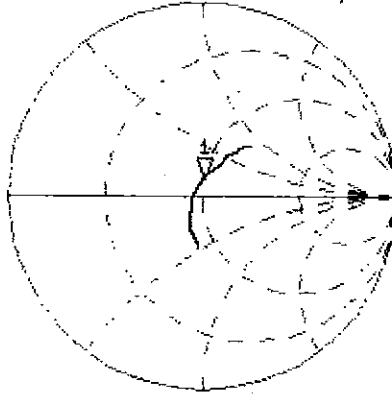

Avg
16

H1d

CH2 S11 LOG 5 dB/REF -20 dB 1: -20.854 dB 2 450.000 000 MHz

CA

Avg
16

H1d

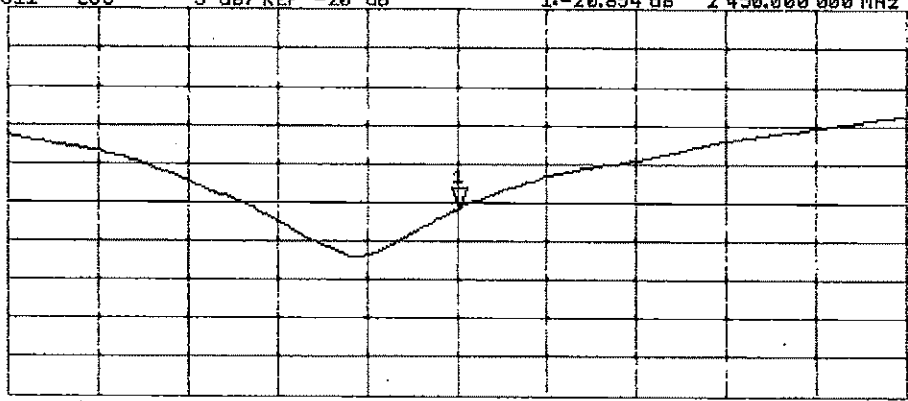

START 2 250.000 000 MHz

STOP 2 650.000 000 MHz

Certification of Calibration

Object: D2450V2 – SN: 797

Calibration procedure(s): Procedure for Calibration Extension for SAR Dipoles.

Extended Calibration date: September 11, 2018

Description: SAR Validation Dipole at 2450 MHz.

Calibration Equipment used:

Manufacturer	Model	Description	Cal Date	Cal Interval	Cal Due	Serial Number
Control Company	4040	Therm./Clock/Humidity Monitor	3/31/2017	Biennial	3/31/2019	170232394
Control Company	4352	Ultra Long Stem Thermometer	5/2/2017	Biennial	5/2/2019	170330156
Amplifier Research	1551G6	Amplifier	CBT	N/A	CBT	433971
Narda	4772-3	Attenuator {3dB}	CBT	N/A	CBT	9406
Keysight	772D	Dual Directional Coupler	CBT	N/A	CBT	MY52180215
Keysight Technologies	85033E	Standard Mechanical Calibration Kit (DC to 9GHz, 3.5mm)	6/4/2018	Annual	6/4/2019	MY53401181
Agilent	8753ES	S-Parameter Vector Network Analyzer	8/30/2018	Annual	8/30/2019	MY40003841
Mini-Circuits	BW-N20W5+	DC to 18 GHz Precision Fixed 20 dB Attenuator	CBT	N/A	CBT	N/A
SPEAG	DAK-3.5	Dielectric Assessment Kit	5/15/2018	Annual	5/15/2019	1070
SPEAG	EX3DV4	SAR Probe	7/20/2018	Annual	7/20/2019	7410
SPEAG	DAE4	Dasy Data Acquisition Electronics	7/11/2018	Annual	7/11/2019	1322
SPEAG	ES3DV3	SAR Probe	3/13/2018	Annual	3/13/2019	3319
SPEAG	DAE4	Dasy Data Acquisition Electronics	3/7/2018	Annual	3/7/2019	1368
Anritsu	MA2411B	Pulse Power Sensor	3/2/2018	Annual	3/2/2019	1207364
Anritsu	MA2411B	Pulse Power Sensor	3/2/2018	Annual	3/2/2019	1339018
Anritsu	ML2495A	Power Meter	10/22/2017	Annual	10/22/2018	1328004
Agilent	NS182A	MXG Vector Signal Generator	4/18/2018	Annual	4/18/2019	MY47420800
Seekonk	NC-100	Torque Wrench	7/11/2018	Annual	7/11/2019	N/A
MiniCircuits	VLF-6000+	Low Pass Filter	CBT	N/A	CBT	N/A
Narda	4014C-6	4 - 8 GHz SMA 6 dB Directional Coupler	CBT	N/A	CBT	N/A

Note: CBT (Calibrated Before Testing). Prior to testing, the measurement paths containing a cable, amplifier, attenuator, coupler or filter were connected to a calibrated source (i.e. a signal generator) to determine the losses of the measurement path.

Measurement Uncertainty = $\pm 23\%$ (k=2)

	Name	Function	Signature
Calibrated By:	Brodie Halfoster	Team Lead Engineer	<i>BRODIE HALFOSTER</i>
Approved By:	Kaitlin O'Keefe	Senior Technical Manager	<i>KOK</i>

DIPOLE CALIBRATION EXTENSION

Per KDB 865664 D01, calibration intervals of up to three years may be considered for reference dipoles when it is demonstrated that the SAR target, impedance and return loss of a dipole have remained stable according to the following requirements:

1. The measured SAR does not deviate more than 10% from the target on the calibration certificate.
2. The return-loss does not deviate more than 20% from the previous measurement and meets the required 20dB minimum return-loss requirement.
3. The measurement of real or imaginary parts of impedance does not deviate more than 5Ω from the previous measurement.

The following dipole was checked to pass the above 3 requirements to have 2-year calibration period from the calibration date:

Calibrator Date	Extension Date	Certificate Electrical Delay (ns)	Certificate SAR Target Head (1g) W/kg @ 20.0 dBm	Measured Head SAR (1g) W/kg @ 20.0 dBm	Deviation 1g (%)	Certificate SAR Target Head (10g) W/kg @ 20.0 dBm	Measured Head SAR (10g) W/kg @ 20.0 dBm	Deviation 10g (%)	Certificate Impedance Head (Ohm) Real	Measured Impedance Head (Ohm) Real	Difference (Ohm) Real	Certificate Impedance Head (Ohm) Imaginary	Measured Impedance Head (Ohm) Imaginary	Difference (Ohm) Imaginary	Certificate Return Loss Head (dB)	Measured Return Loss Head (dB)	Deviation (%)	PASS/FAIL
9/11/2017	9/11/2018	1.152	5.27	5.52	4.74%	2.48	2.54	2.42%	53.8	49.8	4	7.4	7.1	0.3	-21.9	-23	-4.80%	PASS

Calibrator Date	Extension Date	Certificate Electrical Delay (ns)	Certificate SAR Target Body (1g) W/kg @ 20.0 dBm	Measured Body SAR (1g) W/kg @ 20.0 dBm	Deviation 1g (%)	Certificate SAR Target Body (10g) W/kg @ 20.0 dBm	Measured Body SAR (10g) W/kg @ 20.0 dBm	Deviation 10g (%)	Certificate Impedance Body (Ohm) Real	Measured Impedance Body (Ohm) Real	Difference (Ohm) Real	Certificate Impedance Body (Ohm) Imaginary	Measured Impedance Body (Ohm) Imaginary	Difference (Ohm) Imaginary	Certificate Return Loss Body (dB)	Measured Return Loss Body (dB)	Deviation (%)	PASS/FAIL
9/11/2017	9/11/2018	1.152	5.11	5.17	1.17%	2.42	2.37	-2.07%	49.7	49.6	0.1	8.1	7.2	1.9	-20.9	-22.6	-8.20%	PASS

Impedance & Return-Loss Measurement Plot for Head TSL

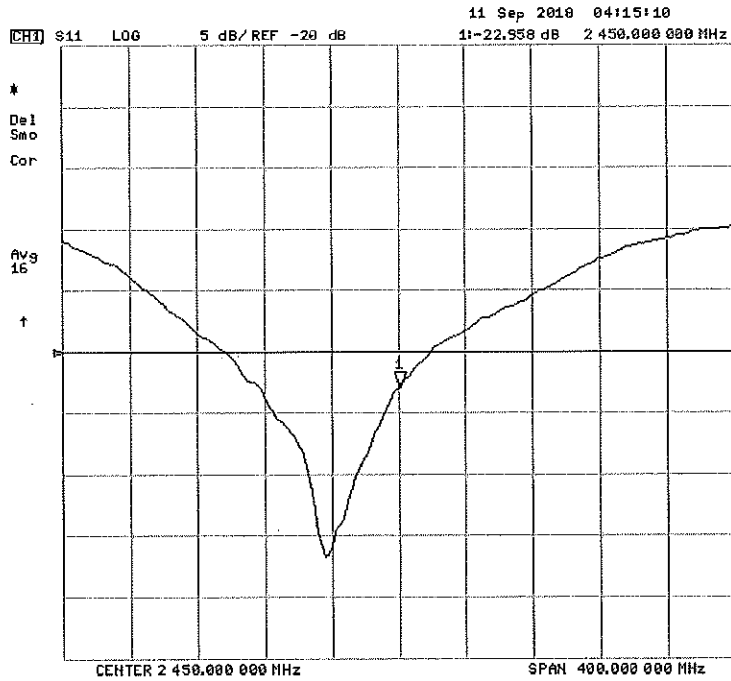
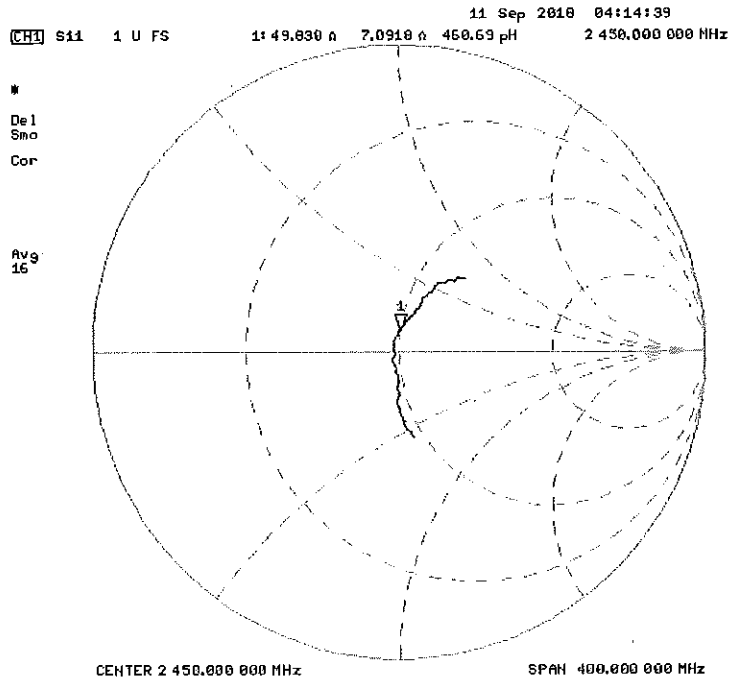

Object:

D2450V2 -- SN: 797

Date Issued:

09/11/2018

Page 3 of 4

Impedance & Return-Loss Measurement Plot for Body TSL

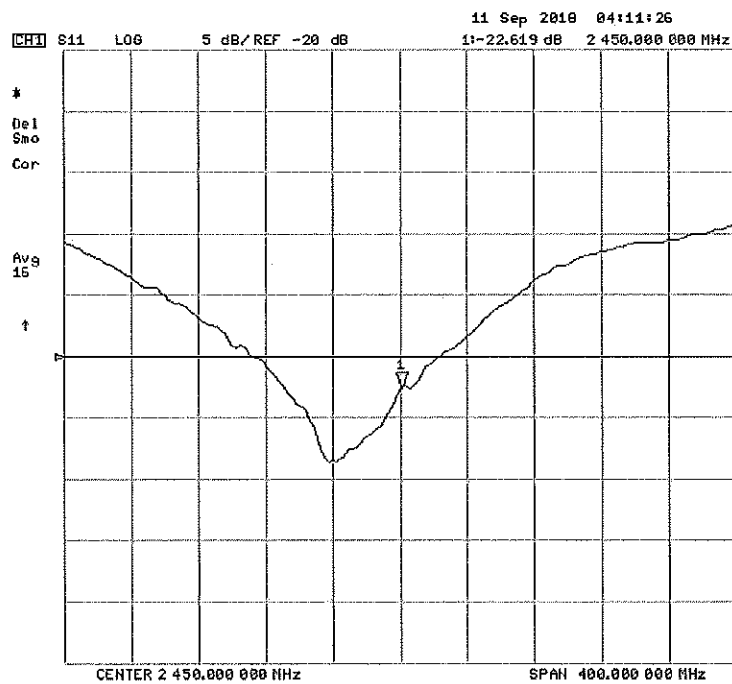
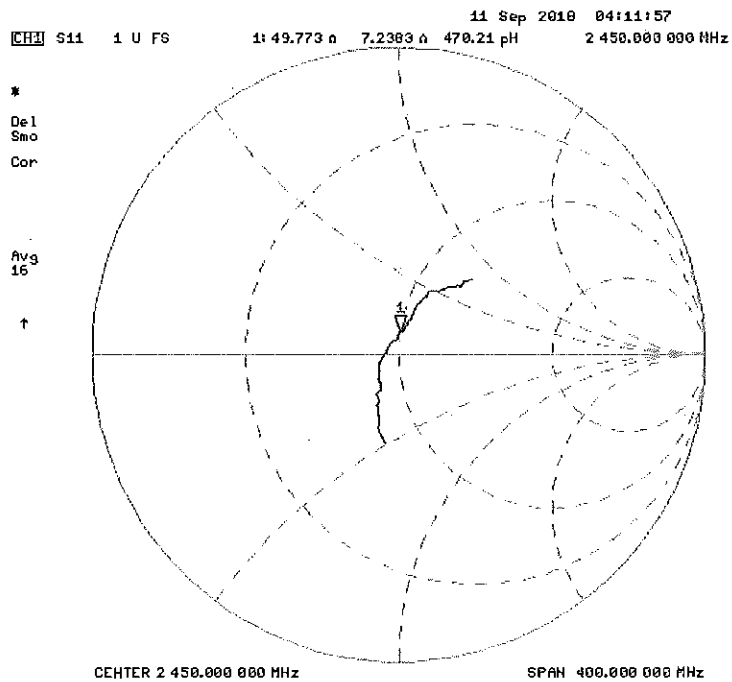

DIPOLE CALIBRATION EXTENSION

Per KDB 865664 D01, calibration intervals of up to three years may be considered for reference dipoles when it is demonstrated that the SAR target, impedance and return loss of a dipole have remained stable according to the following requirements:

1. The measured SAR does not deviate more than 10% from the target on the calibration certificate.
2. The return-loss does not deviate more than 20% from the previous measurement and meets the required 20dB minimum return-loss requirement.
3. The measurement of real or imaginary parts of impedance does not deviate more than 5Ω from the previous measurement.

The following dipole was checked to pass the above 3 requirements to have 2-year calibration period from the calibration date:

Calibration Date	Extension Date	Certificate Electrical Delay (ns)	Certificate SAR Target Head (1g) W/kg @ 20.0 dBm	Measured Head SAR (1g) W/kg @ 20.0 dBm	Deviation 1g (%)	Certificate SAR Target Head (10g) W/kg @ 20.0 dBm	Measured Head SAR (10g) W/kg @ 20.0 dBm	Deviation 10g (%)	Certificate Impedance Head (Ohm) Real	Measured Impedance Head (Ohm) Real	Difference (Ohm) Real	Certificate Impedance Head (Ohm) Imaginary	Measured Impedance Head (Ohm) Imaginary	Difference (Ohm) Imaginary	Certificate Return Loss Head (dB)	Measured Return Loss Head (dB)	Deviation (%)	PASS/FAIL
9/11/2017	9/11/2018	1.152	5.27	5.52	4.74%	2.48	2.54	2.42%	53.8	49.8	4	7.4	7.1	0.3	-21.9	-23	-4.80%	PASS

Calibration Date	Extension Date	Certificate Electrical Delay (ns)	Certificate SAR Target Body (1g) W/kg @ 20.0 dBm	Measured Body SAR (1g) W/kg @ 20.0 dBm	Deviation 1g (%)	Certificate SAR Target Body (10g) W/kg @ 20.0 dBm	Measured Body SAR (10g) W/kg @ 20.0 dBm	Deviation 10g (%)	Certificate Impedance Body (Ohm) Real	Measured Impedance Body (Ohm) Real	Difference (Ohm) Real	Certificate Impedance Body (Ohm) Imaginary	Measured Impedance Body (Ohm) Imaginary	Difference (Ohm) Imaginary	Certificate Return Loss Body (dB)	Measured Return Loss Body (dB)	Deviation (%)	PASS/FAIL
9/11/2017	9/11/2018	1.152	5.11	5.17	1.17%	2.42	2.37	-2.07%	49.7	49.8	0.1	9.1	7.2	1.9	-20.9	-22.6	-8.20%	PASS



Accredited by the Swiss Accreditation Service (SAS)
The Swiss Accreditation Service is one of the signatories to the EA
Multilateral Agreement for the recognition of calibration certificates

Accreditation No.: **SCS 0108**

Client **PC Test**

Certificate No: **D2600V2-1071_Sep16**

CALIBRATION CERTIFICATE

Object : D2600V2 - SN:1071

Calibration procedure(s) : QA CAL-05.v9
Calibration procedure for dipole validation kits above 700 MHz.

BNV
09-28-2016

Calibration date: : September 13, 2016

Extended PM ✓
9/20/2018

This calibration certificate documents the traceability to national standards, which realize the physical units of measurements (SI).
The measurements and the uncertainties with confidence probability are given on the following pages and are part of the certificate.

All calibrations have been conducted in the closed laboratory facility: environment temperature (22 ± 3)°C and humidity < 70%.

Calibration Equipment used (M&TE critical for calibration)

Primary Standards	ID #	Cal Date (Certificate No.)	Scheduled Calibration
Power meter NRP	SN: 104778	06-Apr-16 (No. 217-02288/02289)	Apr-17
Power sensor NRP-Z91	SN: 103244	06-Apr-16 (No. 217-02288)	Apr-17
Power sensor NRP-Z91	SN: 103245	06-Apr-16 (No. 217-02289)	Apr-17
Reference 20 dB Attenuator	SN: 5058 (20k)	05-Apr-16 (No. 217-02292)	Apr-17
Type-N mismatch combination	SN: 5047.2 / 06327	05-Apr-16 (No. 217-02295)	Apr-17
Reference Probe EX3DV4	SN: 7349	15-Jun-16 (No. EX3-7349_Jun16)	Jun-17
DAE4	SN: 601	30-Dec-15 (No. DAE4-601_Dec15)	Dec-16

Secondary Standards	ID #	Check Date (in house)	Scheduled Check
Power meter EPM-442A	SN: GB37480704	07-Oct-15 (No. 217-02222)	In house check: Oct-16
Power sensor HP 8481A	SN: US97292783	07-Oct-15 (No. 217-02222)	In house check: Oct-16
Power sensor HP 8481A	SN: MY41092317	07-Oct-15 (No. 217-02223)	In house check: Oct-16
RF generator R&S SMT-06	SN: 100972	15-Jun-15 (in house check Jun-15)	In house check: Oct-16
Network Analyzer HP 8753E	SN: US97390585	18-Oct-01 (in house check Oct-15)	In house check: Oct-16

Calibrated by: **Jeton Kastalt** Name: **Jeton Kastalt** Function: **Laboratory Technician**

Approved by: **Katja Pokovic** Name: **Katja Pokovic** Function: **Technical Manager**

Signature: *[Handwritten Signature]*

Issued: September 13, 2016

This calibration certificate shall not be reproduced except in full without written approval of the laboratory.

**Calibration Laboratory of
Schmid & Partner
Engineering AG**
Zeughausstrasse 43, 8004 Zurich, Switzerland



S Schweizerischer Kalibrierdienst
C Service suisse d'étalonnage
S Servizio svizzero di taratura
S Swiss Calibration Service

Accredited by the Swiss Accreditation Service (SAS)
The Swiss Accreditation Service is one of the signatories to the EA
Multilateral Agreement for the recognition of calibration certificates

Accreditation No.: **SCS 0108**

Glossary:

TSL tissue simulating liquid
ConvF sensitivity in TSL / NORM x,y,z
N/A not applicable or not measured

Calibration is Performed According to the Following Standards:

- a) IEEE Std 1528-2013, "IEEE Recommended Practice for Determining the Peak Spatial-Averaged Specific Absorption Rate (SAR) in the Human Head from Wireless Communications Devices: Measurement Techniques", June 2013
- b) IEC 62209-1, "Procedure to measure the Specific Absorption Rate (SAR) for hand-held devices used in close proximity to the ear (frequency range of 300 MHz to 3 GHz)", February 2005
- c) IEC 62209-2, "Procedure to determine the Specific Absorption Rate (SAR) for wireless communication devices used in close proximity to the human body (frequency range of 30 MHz to 6 GHz)", March 2010
- d) KDB 865664, "SAR Measurement Requirements for 100 MHz to 6 GHz"

Additional Documentation:

- e) DASY4/5 System Handbook

Methods Applied and Interpretation of Parameters:

- *Measurement Conditions:* Further details are available from the Validation Report at the end of the certificate. All figures stated in the certificate are valid at the frequency indicated.
- *Antenna Parameters with TSL:* The dipole is mounted with the spacer to position its feed point exactly below the center marking of the flat phantom section, with the arms oriented parallel to the body axis.
- *Feed Point Impedance and Return Loss:* These parameters are measured with the dipole positioned under the liquid filled phantom. The impedance stated is transformed from the measurement at the SMA connector to the feed point. The Return Loss ensures low reflected power. No uncertainty required.
- *Electrical Delay:* One-way delay between the SMA connector and the antenna feed point. No uncertainty required.
- *SAR measured:* SAR measured at the stated antenna input power.
- *SAR normalized:* SAR as measured, normalized to an input power of 1 W at the antenna connector.
- *SAR for nominal TSL parameters:* The measured TSL parameters are used to calculate the nominal SAR result.

The reported uncertainty of measurement is stated as the standard uncertainty of measurement multiplied by the coverage factor $k=2$, which for a normal distribution corresponds to a coverage probability of approximately 95%.

Measurement Conditions

DASY system configuration, as far as not given on page 1.

DASY Version	DASY5	V52.8.8
Extrapolation	Advanced Extrapolation	
Phantom	Modular Flat Phantom	
Distance Dipole Center - TSL	10 mm	with Spacer
Zoom Scan Resolution	dx, dy, dz = 5 mm	
Frequency	2600 MHz ± 1 MHz	

Head TSL parameters

The following parameters and calculations were applied.

	Temperature	Permittivity	Conductivity
Nominal Head TSL parameters	22.0 °C	39.0	1.96 mho/m
Measured Head TSL parameters	(22.0 ± 0.2) °C	37.3 ± 6 %	2.05 mho/m ± 6 %
Head TSL temperature change during test	< 0.5 °C	----	----

SAR result with Head TSL

SAR averaged over 1 cm ³ (1 g) of Head TSL	Condition	
SAR measured	250 mW input power	14.5 W/kg
SAR for nominal Head TSL parameters	normalized to 1W	56.3 W/kg ± 17.0 % (k=2)

SAR averaged over 10 cm ³ (10 g) of Head TSL	condition	
SAR measured	250 mW input power	6.45 W/kg
SAR for nominal Head TSL parameters	normalized to 1W	25.3 W/kg ± 16.5 % (k=2)

Body TSL parameters

The following parameters and calculations were applied.

	Temperature	Permittivity	Conductivity
Nominal Body TSL parameters	22.0 °C	52.5	2.16 mho/m
Measured Body TSL parameters	(22.0 ± 0.2) °C	51.1 ± 6 %	2.22 mho/m ± 6 %
Body TSL temperature change during test	< 0.5 °C	----	----

SAR result with Body TSL

SAR averaged over 1 cm ³ (1 g) of Body TSL	Condition	
SAR measured	250 mW input power	13.8 W/kg
SAR for nominal Body TSL parameters	normalized to 1W	54.2 W/kg ± 17.0 % (k=2)

SAR averaged over 10 cm ³ (10 g) of Body TSL	condition	
SAR measured	250 mW input power	6.20 W/kg
SAR for nominal Body TSL parameters	normalized to 1W	24.5 W/kg ± 16.5 % (k=2)

Appendix (Additional assessments outside the scope of SCS 0108)

Antenna Parameters with Head TSL

Impedance, transformed to feed point	49.9 Ω - 6.7 j Ω
Return Loss	-23.5 dB

Antenna Parameters with Body TSL

Impedance, transformed to feed point	46.1 Ω - 2.1 j Ω
Return Loss	-26.7 dB

General Antenna Parameters and Design

Electrical Delay (one direction)	1.153 ns
----------------------------------	----------

After long term use with 100W radiated power, only a slight warming of the dipole near the feedpoint can be measured.

The dipole is made of standard semirigid coaxial cable. The center conductor of the feeding line is directly connected to the second arm of the dipole. The antenna is therefore short-circuited for DC-signals. On some of the dipoles, small end caps are added to the dipole arms in order to improve matching when loaded according to the position as explained in the "Measurement Conditions" paragraph. The SAR data are not affected by this change. The overall dipole length is still according to the Standard.

No excessive force must be applied to the dipole arms, because they might bend or the soldered connections near the feedpoint may be damaged.

Additional EUT Data

Manufactured by	SPEAG
Manufactured on	July 17, 2013

DASY5 Validation Report for Head TSL

Date: 13.09.2016

Test Laboratory: SPEAG, Zurich, Switzerland

DUT: Dipole 2600 MHz; Type: D2600V2; Serial: D2600V2 - SN:1071

Communication System: UID 0 - CW; Frequency: 2600 MHz

Medium parameters used: $f = 2600$ MHz; $\sigma = 2.05$ S/m; $\epsilon_r = 37.3$; $\rho = 1000$ kg/m³

Phantom section: Flat Section

Measurement Standard: DASY5 (IEBE/IEC/ANSI C63.19-2011)

DASY52 Configuration:

- Probe: EX3DV4 - SN7349; ConvF(7.56, 7.56, 7.56); Calibrated: 15.06.2016;
- Sensor-Surface: 1.4mm (Mechanical Surface Detection)
- Electronics: DAB4 Sn601; Calibrated: 30.12.2015
- Phantom: Flat Phantom 5.0 (front); Type: QD000P50AA; Serial: 1001
- DASY52 52.8.8(1258); SEMCAD X 14.6.10(7372)

Dipole Calibration for Head Tissue/Pin=250 mW, d=10mm/Zoom Scan (7x7x7)/Cube 0:

Measurement grid: dx=5mm, dy=5mm, dz=5mm

Reference Value = 115.1 V/m; Power Drift = -0.02 dB

Peak SAR (extrapolated) = 30.4 W/kg

SAR(1 g) = 14.5 W/kg; SAR(10 g) = 6.45 W/kg

Maximum value of SAR (measured) = 24.6 W/kg



0 dB = 24.6 W/kg = 13.91 dBW/kg

Impedance Measurement Plot for Head TSL

CH1 S11 1 U F8 12 Sep 2016 13:13:44
 4: 49.902 Ω -6.6523 Ω 9.2010 pF 2 600.000 000 MHz

*
 De l
 CA
 Avg
 16
 H1 d

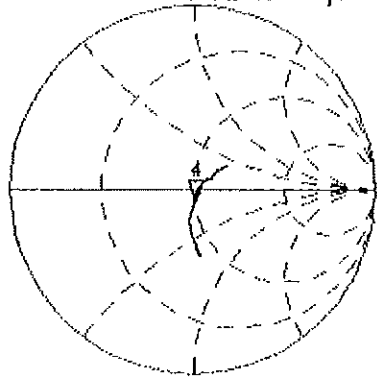

CH2 S11 LOG 5 dB/REF -20 dB 4:-23.548 dB 2 600.000 000 MHz

CA
 Avg
 16
 H1 d

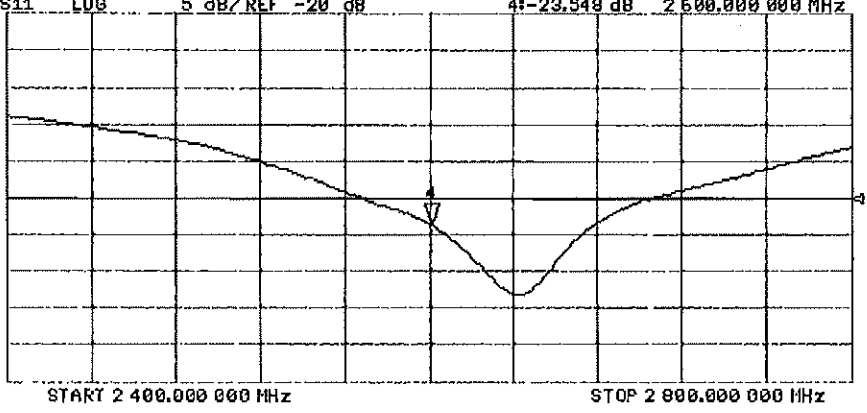

DASY5 Validation Report for Body TSL

Date: 13.09.2016

Test Laboratory: SPEAG, Zurich, Switzerland

DUT: Dipole 2600 MHz; Type: D2600V2; Serial: D2600V2 - SN:1071

Communication System: UID 0 - CW; Frequency: 2600 MHz

Medium parameters used: $f = 2600$ MHz; $\sigma = 2.22$ S/m; $\epsilon_r = 51.1$; $\rho = 1000$ kg/m³

Phantom section: Flat Section

Measurement Standard: DASY5 (IEEE/IEC/ANSI C63.19-2011)

DASY52 Configuration:

- Probe: EX3DV4 - SN7349; ConvF(7.48, 7.48, 7.48); Calibrated: 15.06.2016;
- Sensor-Surface: 1.4mm (Mechanical Surface Detection)
- Electronics: DAE4 Sn601; Calibrated: 30.12.2015
- Phantom: Flat Phantom 5.0 (back); Type: QD000P50AA; Serial: 1002
- DASY52 52.8.8(1258); SEMCAD X 14.6.10(7372)

Dipole Calibration for Body Tissue/Pin=250 mW, d=10mm/Zoom Scan (7x7x7)/Cube 0:

Measurement grid: dx=5mm, dy=5mm, dz=5mm

Reference Value = 107.7 V/m; Power Drift = -0.03 dB

Peak SAR (extrapolated) = 28.3 W/kg

SAR(1 g) = 13.8 W/kg; SAR(10 g) = 6.2 W/kg

Maximum value of SAR (measured) = 23.3 W/kg

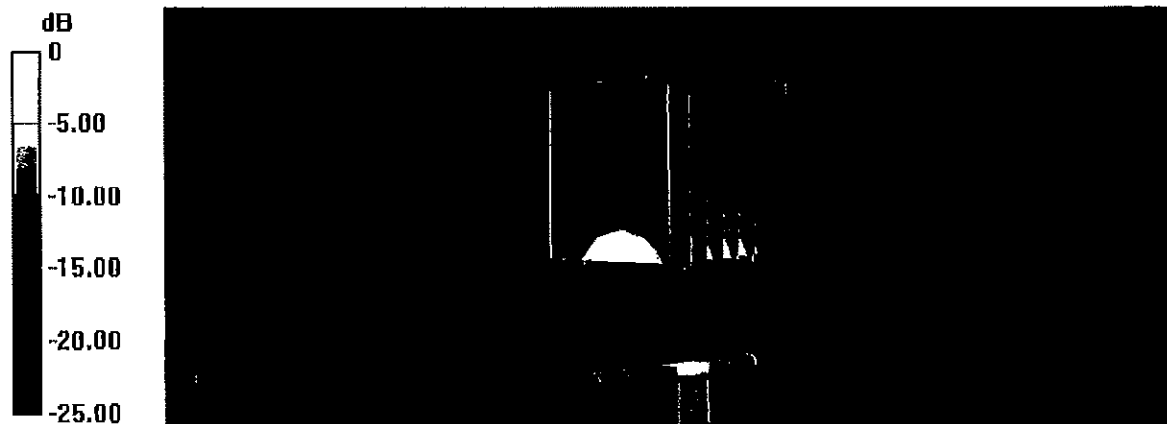

0 dB = 23.3 W/kg = 13.67 dBW/kg

Impedance Measurement Plot for Body TSL

CH1 S11 1 U FS 41 46.078 Ω -2.0762 Ω 29.404 pF 12 Sep 2016 13:13:09 2 600.000 000 MHz

*
 De l
 CA

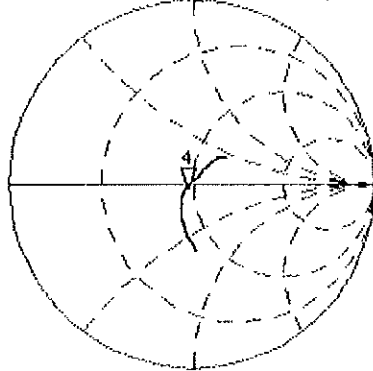

Avg
 16

H1d

CH2 S11 LOG 5 dB/REF -20 dB 41-26.721 dB 2 600.000 000 MHz

CA

Avg
 16

H1d

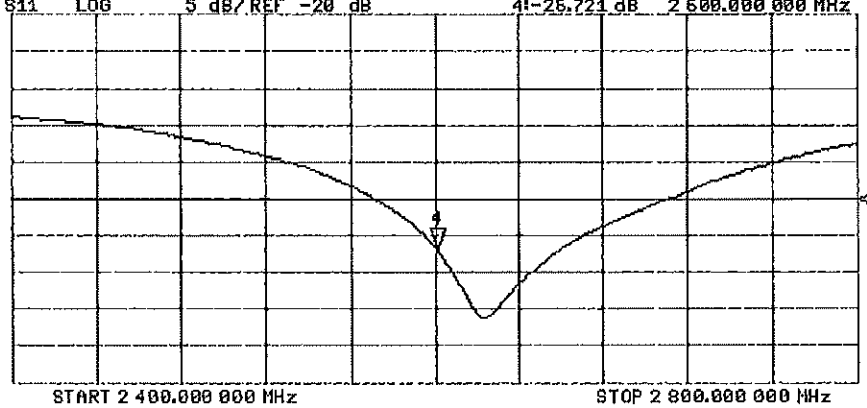

Certification of Calibration

Object: D2600V2 – SN: 1071

Calibration procedure(s): Procedure for Calibration Extension for SAR Dipoles.

Calibration date: 09/07/2017

Description: SAR Validation Dipole at 2600 MHz.

Calibration Equipment used:

Manufacturer	Model	Description	Cal Date	Cal Interval	Cal Due	Serial Number
Control Company	4040	Therm./Clock/Humidity Monitor	3/31/2017	Biennial	3/31/2019	170232394
Control Company	4352	Ultra Long Stem Thermometer	5/2/2017	Biennial	5/2/2019	170330156
Amplifier Research	15S1G6	Amplifier	CBT	N/A	CBT	433971
Narda	4772-3	Attenuator (3dB)	CBT	N/A	CBT	9406
Keysight	772D	Dual Directional Coupler	CBT	N/A	CBT	MY52180215
Keysight Technologies	85033E	Standard Mechanical Calibration Kit (DC to 9GHz, 3.5mm)	6/1/2017	Annual	6/1/2018	MY53401181
Agilent	8759ES	S-Parameter Network Analyzer	10/26/2016	Annual	10/26/2017	US39170118
Mini-Circuits	BW-N20W5+	DC to 18 GHz Precision Fixed 20 dB Attenuator	CBT	N/A	CBT	N/A
SPEAG	DAE4	Dasy Data Acquisition Electronics	7/13/2017	Annual	7/13/2018	1322
SPEAG	DAK-3.5	Dielectric Assessment Kit	5/10/2017	Annual	5/10/2018	1070
SPEAG	EX3DV4	SAR Probe	7/17/2017	Annual	7/17/2018	7410
Anritsu	MA2411B	Pulse Power Sensor	2/10/2017	Annual	2/10/2018	1207364
Anritsu	MA2411B	Pulse Power Sensor	2/10/2017	Annual	2/10/2018	1339018
Anritsu	ML2495A	Power Meter	10/16/2015	Biennial	10/16/2017	941001
Agilent	N5182A	MXG Vector Signal Generator	2/28/2017	Annual	2/28/2018	MY47420800
Seekonk	NC-100	Torque Wrench	11/6/2015	Biennial	11/6/2017	N/A
Mini-Circuits	NLP-2950+	Low Pass Filter DC to 2700 MHz	CBT	N/A	CBT	N/A

Note: CBT (Calibrated Before Testing). Prior to testing, the measurement paths containing a cable, amplifier, attenuator, coupler or filter were connected to a calibrated source (i.e. a signal generator) to determine the losses of the measurement path.

Measurement Uncertainty = $\pm 23\%$ (k=2)

	Name	Function	Signature
Calibrated By:	Brodie Halfoster	Test Engineer	<i>BRODIE HALFOSTER</i>
Approved By:	Kaitlin O'Keefe	Senior Technical Manager	<i>KOK</i>

DIPOLE CALIBRATION EXTENSION

Per KDB 865664 D01, calibration intervals of up to three years may be considered for reference dipoles when it is demonstrated that the SAR target, impedance and return loss of a dipole have remained stable according to the following requirements:

1. The measured SAR does not deviate more than 10% from the target on the calibration certificate.
2. The return-loss does not deviate more than 20% from the previous measurement and meets the required 20dB minimum return-loss requirement.
3. The measurement of real or imaginary parts of impedance does not deviate more than 5Ω from the previous measurement.

The following dipole was checked to pass the above 3 requirements to have 2-year calibration period from the calibration date:

Calibration Date	Extension Date	Certificate Electrical Delay (ns)	Certificate SAR Target Head (1g) W/kg @ 20.0 dBm	Measured Head SAR (1g) W/kg @ 20.0 dBm	Deviation 1g (%)	Certificate SAR Target Head (10g) W/kg @ 20.0 dBm	Measured Head SAR (10g) W/kg @ 20.0 dBm	Deviation 10g (%)	Certificate Impedance Head (Ohm) Real	Measured Impedance Head (Ohm) Real	Difference (Ohm) Real	Certificate Impedance Head (Ohm) Imaginary	Measured Impedance Head (Ohm) Imaginary	Difference (Ohm) Imaginary	Certificate Return Loss Head (dB)	Measured Return Loss Head (dB)	Deviation (%)	PASS/FAIL
9/13/2016	9/7/2017	1.153	5.63	5.73	1.78%	2.53	2.52	-0.40%	49.9	50.3	0.4	-6.7	-5.7	1.0	-23.5	-24.0	-2.10%	PASS
Calibration Date	Extension Date	Certificate Electrical Delay (ns)	Certificate SAR Target Body (1g) W/kg @ 20.0 dBm	Measured Body SAR (1g) W/kg @ 20.0 dBm	Deviation 1g (%)	Certificate SAR Target Body (10g) W/kg @ 20.0 dBm	Measured Body SAR (10g) W/kg @ 20.0 dBm	Deviation 10g (%)	Certificate Impedance Body (Ohm) Real	Measured Impedance Body (Ohm) Real	Difference (Ohm) Real	Certificate Impedance Body (Ohm) Imaginary	Measured Impedance Body (Ohm) Imaginary	Difference (Ohm) Imaginary	Certificate Return Loss Body (dB)	Measured Return Loss Body (dB)	Deviation (%)	PASS/FAIL
9/13/2016	9/7/2017	1.153	5.42	5.34	-1.48%	2.45	2.33	-4.90%	46.1	47.9	1.8	-2.1	-5.3	3.2	-26.7	-25.0	6.40%	PASS

Impedance & Return-Loss Measurement Plot for Head TSL

7 Sep 2017 06:46:37
 [CH1] S11 1 U FS 1: 50.281 Ω -5.7227 Ω 10.595 pF 2 500.000 000 MHz

 De1
 Smo
 Cor

Avg
 15

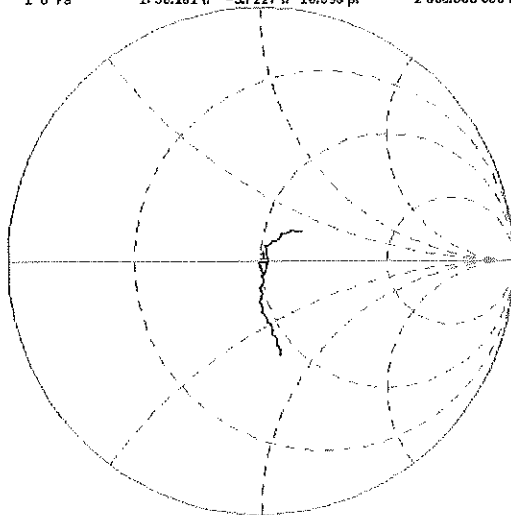

7 Sep 2017 06:47:02
 [CH1] S11 L00 5 dB/REF -20 dB 1:-24.018 dB 2 500.000 000 MHz

 De1
 Smo
 Cor

Avg
 15

†

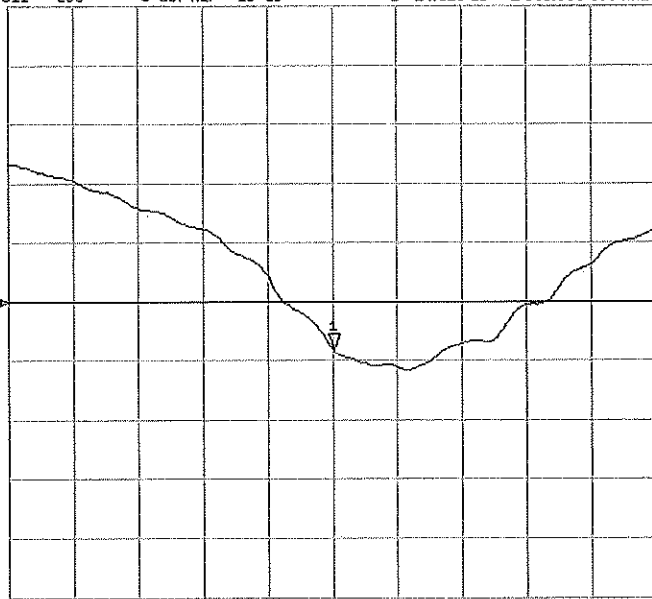

Impedance & Return-Loss Measurement Plot for Body TSL

7 Sep 2017 07:30:38
 [CH1] S11 1 U FS 1: 47.926 Ω -5.3252 Ω 11.493 pF 2 600.000 000 MHz

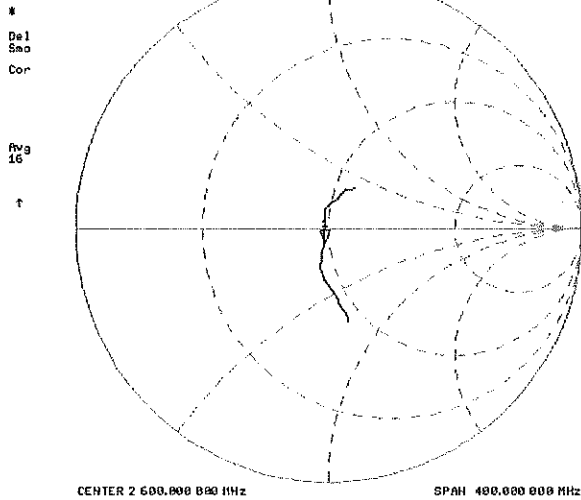

7 Sep 2017 07:31:13
 [CH1] S11 LOG 5 dB/REF -20 dB 1:-24.991 dB 2 600.000 000 MHz

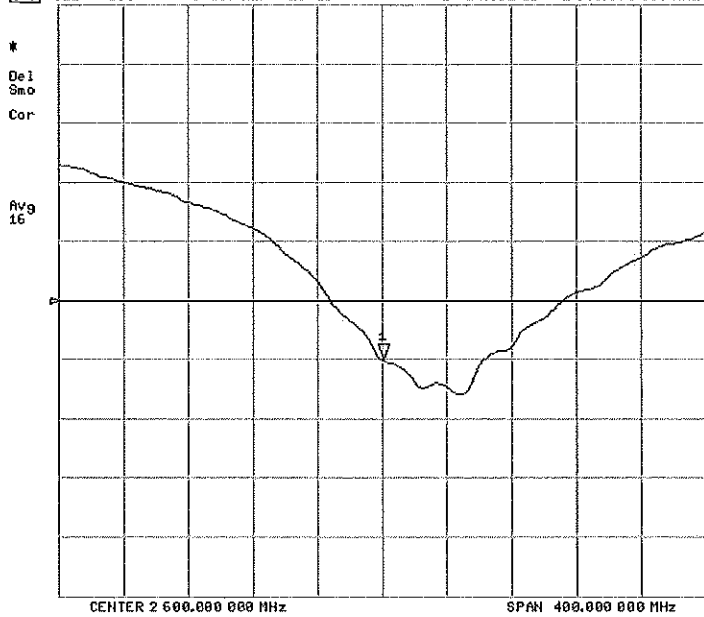

Certification of Calibration

Object: D2600V2 – SN: 1071

Calibration procedure(s): Procedure for Calibration Extension for SAR Dipoles.

Calibration date: 09/11/2018

Description: SAR Validation Dipole at 2600 MHz.

Calibration Equipment used:

Manufacturer	Model	Description	Cal Date	Cal Interval	Cal Due	Serial Number
Control Company	4040	Therm./Clock/Humidity Monitor	3/31/2017	Biennial	3/31/2019	170232394
Control Company	4352	Ultra Long Stem Thermometer	5/2/2017	Biennial	5/2/2019	170330156
Amplifier Research	15S1G6	Amplifier	CBT	N/A	CBT	433971
Narda	4772-3	Attenuator (3dB)	CBT	N/A	CBT	9406
Keysight	772D	Dual Directional Coupler	CBT	N/A	CBT	MY52180215
Keysight Technologies	B5033E	Standard Mechanical Calibration Kit (DC to 9GHz, 3.5mm)	6/4/2018	Annual	6/4/2019	MY53401181
Agilent	8753ES	S-Parameter Vector Network Analyzer	8/30/2018	Annual	8/30/2019	MY40003841
Mini-Circuits	8W-N20W5+	DC to 18 GHz Precision Fixed 20 dB Attenuator	CBT	N/A	CBT	N/A
SPEAG	DAK-3.5	Dielectric Assessment Kit	5/15/2018	Annual	5/15/2019	1070
SPEAG	EX3DV4	SAR Probe	7/20/2018	Annual	7/20/2019	7410
SPEAG	DAE4	Dasy Data Acquisition Electronics	7/11/2018	Annual	7/11/2019	1322
SPEAG	ES3DV3	SAR Probe	3/13/2018	Annual	3/13/2019	3319
SPEAG	DAE4	Dasy Data Acquisition Electronics	3/7/2018	Annual	3/7/2019	1368
Anritsu	MA2411B	Pulse Power Sensor	3/2/2018	Annual	3/2/2019	1207364
Anritsu	MA2411B	Pulse Power Sensor	3/2/2018	Annual	3/2/2019	1339018
Anritsu	ML2495A	Power Meter	10/22/2017	Annual	10/22/2018	1328004
Agilent	NS182A	MXG Vector Signal Generator	4/18/2018	Annual	4/18/2019	MY47420800
Seekonk	NC-100	Torque Wrench	7/11/2018	Annual	7/11/2019	N/A
MiniCircuits	VLF-6000+	Low Pass Filter	CBT	N/A	CBT	N/A
Narda	4014C-6	4 - 8 GHz SMA 6 dB Directional Coupler	CBT	N/A	CBT	N/A

Note: CBT (Calibrated Before Testing). Prior to testing, the measurement paths containing a cable, amplifier, attenuator, coupler or filter were connected to a calibrated source (i.e. a signal generator) to determine the losses of the measurement path.

Measurement Uncertainty = $\pm 23\%$ (k=2)

	Name	Function	Signature
Calibrated By:	Brodie Halfoster	Test Engineer	<i>BRODIE HALFOSTER</i>
Approved By:	Kaitlin O'Keefe	Senior Technical Manager	<i>KOK</i>

DIPOLE CALIBRATION EXTENSION

Per KDB 865664 D01, calibration intervals of up to three years may be considered for reference dipoles when it is demonstrated that the SAR target, impedance and return loss of a dipole have remained stable according to the following requirements:

1. The measured SAR does not deviate more than 10% from the target on the calibration certificate.
2. The return-loss does not deviate more than 20% from the previous measurement and meets the required 20dB minimum return-loss requirement.
3. The measurement of real or imaginary parts of impedance does not deviate more than 5Ω from the previous measurement.

The following dipole was checked to pass the above 3 requirements to have 3-year calibration period from the calibration date:

Calibration Date	Extension Date	Certificate Electrical Delay (ns)	Certificate SAR Target Head (1g) W/kg @ 20.0 dBm	Measured Head SAR (1g) W/kg @ 20.0 dBm	Deviation 1g (%)	Certificate SAR Target Head (10g) W/kg @ 20.0 dBm	Measured Head SAR (10g) W/kg @ 20.0 dBm	Deviation 10g (%)	Certificate Impedance Head (Ohm) Real	Measured Impedance Head (Ohm) Real	Difference (Ohm) Real	Certificate Impedance Head (Ohm) Imaginary	Measured Impedance Head (Ohm) Imaginary	Difference (Ohm) Imaginary	Certificate Return Loss Head (dB)	Measured Return Loss Head (dB)	Deviation (%)	PASS/FAIL
9/13/2016	9/11/2018	1.153	5.63	5.52	-1.95%	2.53	2.47	-2.37%	49.9	49	0.9	-6.7	-5.4	1.3	-23.5	-25.2	-7.40%	PASS
Calibration Date	Extension Date	Certificate Electrical Delay (ns)	Certificate SAR Target Body (1g) W/kg @ 20.0 dBm	Measured Body SAR (1g) W/kg @ 20.0 dBm	Deviation 1g (%)	Certificate SAR Target Body (10g) W/kg @ 20.0 dBm	Measured Body SAR (10g) W/kg @ 20.0 dBm	Deviation 10g (%)	Certificate Impedance Body (Ohm) Real	Measured Impedance Body (Ohm) Real	Difference (Ohm) Real	Certificate Impedance Body (Ohm) Imaginary	Measured Impedance Body (Ohm) Imaginary	Difference (Ohm) Imaginary	Certificate Return Loss Body (dB)	Measured Return Loss Body (dB)	Deviation (%)	PASS/FAIL
9/13/2016	9/11/2018	1.153	5.42	5.57	2.77%	2.45	2.46	0.41%	46.1	47.7	1.6	-2.1	-4.6	2.5	-26.7	-25.6	4.30%	PASS

Impedance & Return-Loss Measurement Plot for Head TSL

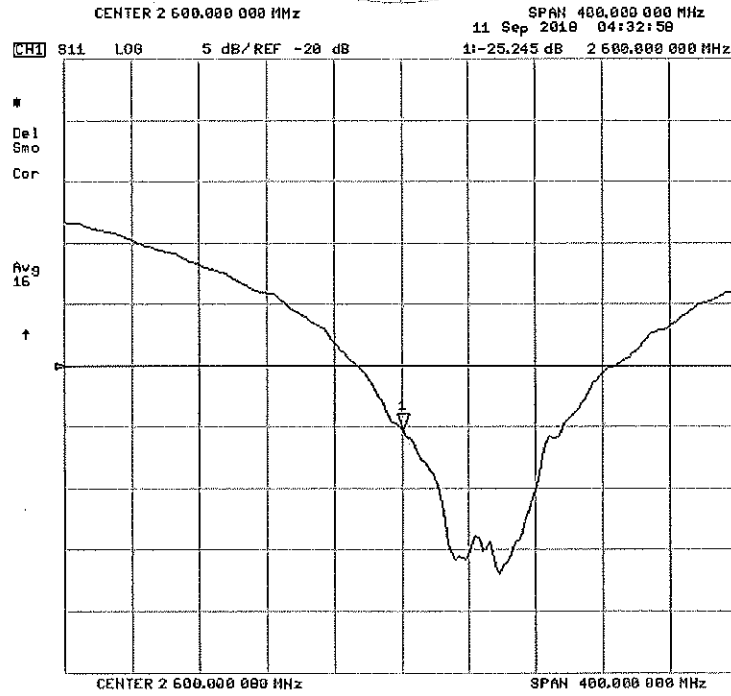
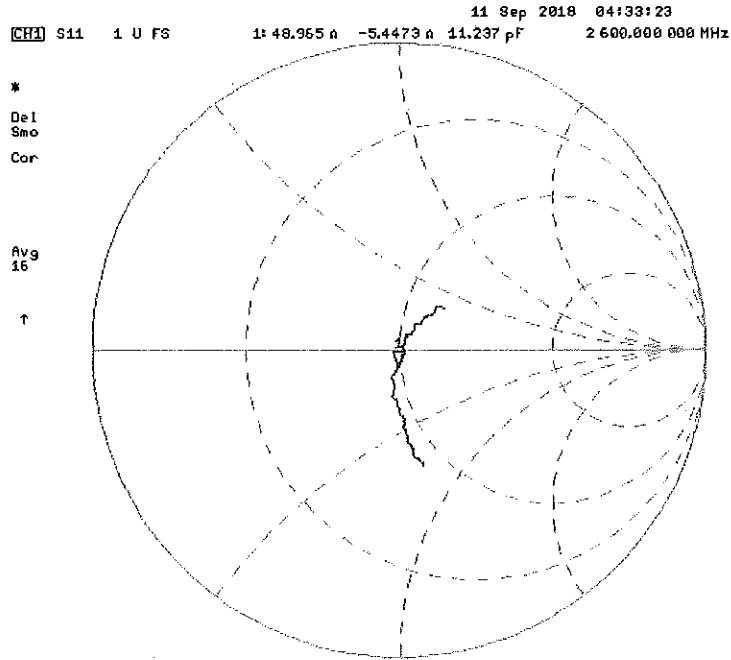

Impedance & Return-Loss Measurement Plot for Body TSL

11 Sep 2018 04:34:32
[CH1] S11 1 U FS 1:47.696 Ω -4.5665 Ω 13.422 pF 2 600.000 000 MHz

*
 Del
 Smo
 Cor

Avg
 16

↑

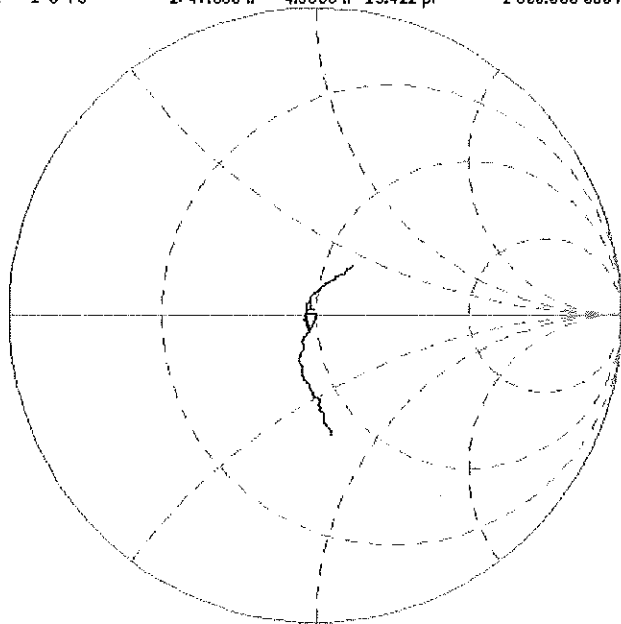

CENTER 2 600.000 000 MHz SPAN 400.000 000 MHz

11 Sep 2018 04:34:52
[CH1] S11 LOG 5 dB/REF -20 dB 1:-25.552 dB 2 600.000 000 MHz

*
 Del
 Smo
 Cor

Avg
 16

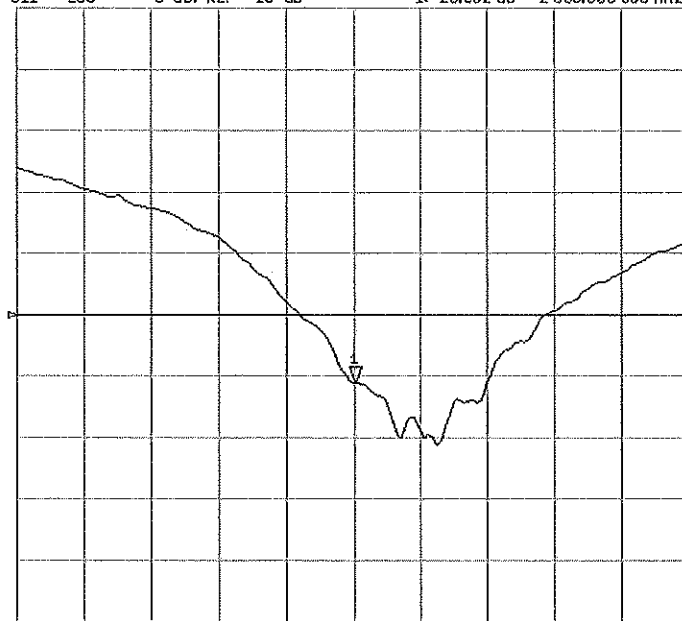

CENTER 2 600.000 000 MHz SPAN 400.000 000 MHz



Accredited by the Swiss Accreditation Service (SAS)
The Swiss Accreditation Service is one of the signatories to the EA
Multilateral Agreement for the recognition of calibration certificates

Accreditation No.: **SCS 0108**

Client **PC Test**

Certificate No: **ES3-3287_Oct18**

CALIBRATION CERTIFICATE

Object **ES3DV3 - SN:3287**

Calibration procedure(s) **QA CAL-01.v9, QA CAL-23.v5, QA CAL-25.v6
Calibration procedure for dosimetric E-field probes**

Calibration date: **October 22, 2018**

*BNW
10-30-2018*

This calibration certificate documents the traceability to national standards, which realize the physical units of measurements (SI).
The measurements and the uncertainties with confidence probability are given on the following pages and are part of the certificate.

All calibrations have been conducted in the closed laboratory facility: environment temperature (22 ± 3)°C and humidity < 70%.

Calibration Equipment used (M&TE critical for calibration)

Primary Standards	ID	Cal Date (Certificate No.)	Scheduled Calibration
Power meter NRP	SN: 104778	04-Apr-18 (No. 217-02672/02673)	Apr-19
Power sensor NRP-Z91	SN: 103244	04-Apr-18 (No. 217-02672)	Apr-19
Power sensor NRP-Z91	SN: 103245	04-Apr-18 (No. 217-02673)	Apr-19
Reference 20 dB Attenuator	SN: S5277 (20x)	04-Apr-18 (No. 217-02682)	Apr-19
Reference Probe ES3DV2	SN: 3013	30-Dec-17 (No. ES3-3013_Dec17)	Dec-18
DAE4	SN: 660	21-Dec-17 (No. DAE4-660_Dec17)	Dec-18
Secondary Standards	ID	Check Date (in house)	Scheduled Check
Power meter E4419B	SN: GB41293874	06-Apr-16 (in house check Jun-18)	In house check: Jun-20
Power sensor E4412A	SN: MY41498087	06-Apr-16 (in house check Jun-18)	In house check: Jun-20
Power sensor E4412A	SN: 000110210	06-Apr-16 (in house check Jun-18)	In house check: Jun-20
RF generator HP 8648C	SN: US3642U01700	04-Aug-99 (in house check Jun-18)	In house check: Jun-20
Network Analyzer E8358A	SN: US41080477	31-Mar-14 (in house check Oct-18)	In house check: Oct-19

Calibrated by: **Name: Claudio Leubler, Function: Laboratory Technician, Signature: [Signature]**

Approved by: **Name: Katja Pokovic, Function: Technical Manager, Signature: [Signature]**

Issued: October 23, 2018

This calibration certificate shall not be reproduced except in full without written approval of the laboratory.



Accredited by the Swiss Accreditation Service (SAS)

Accreditation No.: **SCS 0108**

The Swiss Accreditation Service is one of the signatories to the EA
Multilateral Agreement for the recognition of calibration certificates

Glossary:

TSL	tissue simulating liquid
NORM _{x,y,z}	sensitivity in free space
ConvF	sensitivity in TSL / NORM _{x,y,z}
DCP	diode compression point
CF	crest factor (1/duty_cycle) of the RF signal
A, B, C, D	modulation dependent linearization parameters
Polarization φ	φ rotation around probe axis
Polarization ϑ	ϑ rotation around an axis that is in the plane normal to probe axis (at measurement center), i.e., $\vartheta = 0$ is normal to probe axis
Connector Angle	information used in DASY system to align probe sensor X to the robot coordinate system

Calibration is Performed According to the Following Standards:

- IEEE Std 1528-2013, "IEEE Recommended Practice for Determining the Peak Spatial-Averaged Specific Absorption Rate (SAR) in the Human Head from Wireless Communications Devices: Measurement Techniques", June 2013
- IEC 62209-1, "Measurement procedure for the assessment of Specific Absorption Rate (SAR) from hand-held and body-mounted devices used next to the ear (frequency range of 300 MHz to 6 GHz)", July 2016
- IEC 62209-2, "Procedure to determine the Specific Absorption Rate (SAR) for wireless communication devices used in close proximity to the human body (frequency range of 30 MHz to 6 GHz)", March 2010
- KDB 865664, "SAR Measurement Requirements for 100 MHz to 6 GHz"

Methods Applied and Interpretation of Parameters:

- NORM_{x,y,z}**: Assessed for E-field polarization $\vartheta = 0$ ($f \leq 900$ MHz in TEM-cell; $f > 1800$ MHz: R22 waveguide). NORM_{x,y,z} are only intermediate values, i.e., the uncertainties of NORM_{x,y,z} does not affect the E^2 -field uncertainty inside TSL (see below *ConvF*).
- NORM(f)_{x,y,z}** = NORM_{x,y,z} * *frequency_response* (see Frequency Response Chart). This linearization is implemented in DASY4 software versions later than 4.2. The uncertainty of the frequency response is included in the stated uncertainty of *ConvF*.
- DCP_{x,y,z}**: DCP are numerical linearization parameters assessed based on the data of power sweep with CW signal (no uncertainty required). DCP does not depend on frequency nor media.
- PAR**: PAR is the Peak to Average Ratio that is not calibrated but determined based on the signal characteristics
- A_{x,y,z}; B_{x,y,z}; C_{x,y,z}; D_{x,y,z}; VR_{x,y,z}**: A, B, C, D are numerical linearization parameters assessed based on the data of power sweep for specific modulation signal. The parameters do not depend on frequency nor media. VR is the maximum calibration range expressed in RMS voltage across the diode.
- ConvF and Boundary Effect Parameters**: Assessed in flat phantom using E-field (or Temperature Transfer Standard for $f \leq 800$ MHz) and inside waveguide using analytical field distributions based on power measurements for $f > 800$ MHz. The same setups are used for assessment of the parameters applied for boundary compensation (alpha, depth) of which typical uncertainty values are given. These parameters are used in DASY4 software to improve probe accuracy close to the boundary. The sensitivity in TSL corresponds to NORM_{x,y,z} * ConvF whereby the uncertainty corresponds to that given for ConvF. A frequency dependent ConvF is used in DASY version 4.4 and higher which allows extending the validity from ± 50 MHz to ± 100 MHz.
- Spherical isotropy (3D deviation from isotropy)**: in a field of low gradients realized using a flat phantom exposed by a patch antenna.
- Sensor Offset**: The sensor offset corresponds to the offset of virtual measurement center from the probe tip (on probe axis). No tolerance required.
- Connector Angle**: The angle is assessed using the information gained by determining the NORM_x (no uncertainty required).

Probe ES3DV3

SN:3287

Manufactured: June 7, 2010
Calibrated: October 22, 2018

Calibrated for DASY/EASY Systems
(Note: non-compatible with DASY2 system!)

DASY/EASY - Parameters of Probe: ES3DV3 - SN:3287

Basic Calibration Parameters

	Sensor X	Sensor Y	Sensor Z	Unc (k=2)
Norm ($\mu\text{V}/(\text{V}/\text{m})^2$) ^A	0.88	0.99	1.01	$\pm 10.1\%$
DCP (mV) ^B	106.5	104.5	106.2	

Modulation Calibration Parameters

UID	Communication System Name		A dB	B dB $\sqrt{\mu\text{V}}$	C	D dB	VR mV	Unc ^E (k=2)
0	CW	X	0.0	0.0	1.0	0.00	170.5	$\pm 3.3\%$
		Y	0.0	0.0	1.0		183.9	
		Z	0.0	0.0	1.0		185.7	

Note: For details on UID parameters see Appendix.

Sensor Model Parameters

	C1 fF	C2 fF	α V ⁻¹	T1 ms.V ⁻²	T2 ms.V ⁻¹	T3 ms	T4 V ⁻²	T5 V ⁻¹	T6
X	63.21	438.0	33.52	29.02	2.824	5.044	1.538	0.382	1.009
Y	66.95	483.3	35.70	29.79	3.474	5.100	0.294	0.696	1.011
Z	55.14	387.3	34.16	28.13	2.433	5.100	1.594	0.322	1.010

The reported uncertainty of measurement is stated as the standard uncertainty of measurement multiplied by the coverage factor k=2, which for a normal distribution corresponds to a coverage probability of approximately 95%.

^A The uncertainties of Norm X,Y,Z do not affect the E²-field uncertainty inside TSL (see Pages 5 and 6).

^B Numerical linearization parameter: uncertainty not required.

^E Uncertainty is determined using the max. deviation from linear response applying rectangular distribution and is expressed for the square of the field value.

DASY/EASY - Parameters of Probe: ES3DV3 - SN:3287

Calibration Parameter Determined in Head Tissue Simulating Media

f (MHz) ^C	Relative Permittivity ^F	Conductivity (S/m) ^F	ConvF X	ConvF Y	ConvF Z	Alpha ^G	Depth ^G (mm)	Unc (k=2)
750	41.9	0.89	6.76	6.76	6.76	0.28	1.78	± 12.0 %
835	41.5	0.90	6.61	6.61	6.61	0.60	1.20	± 12.0 %
1750	40.1	1.37	5.48	5.48	5.48	0.53	1.28	± 12.0 %
1900	40.0	1.40	5.24	5.24	5.24	0.41	1.52	± 12.0 %
2300	39.5	1.67	4.82	4.82	4.82	0.42	1.57	± 12.0 %
2450	39.2	1.80	4.63	4.63	4.63	0.55	1.39	± 12.0 %
2600	39.0	1.96	4.38	4.38	4.38	0.58	1.43	± 12.0 %

^C Frequency validity above 300 MHz of ± 100 MHz only applies for DASY v4.4 and higher (see Page 2), else it is restricted to ± 50 MHz. The uncertainty is the RSS of the ConvF uncertainty at calibration frequency and the uncertainty for the indicated frequency band. Frequency validity below 300 MHz is ± 10, 25, 40, 50 and 70 MHz for ConvF assessments at 30, 64, 128, 150 and 220 MHz respectively. Above 5 GHz frequency validity can be extended to ± 110 MHz.

^F At frequencies below 3 GHz, the validity of tissue parameters (ϵ and σ) can be relaxed to ± 10% if liquid compensation formula is applied to measured SAR values. At frequencies above 3 GHz, the validity of tissue parameters (ϵ and σ) is restricted to ± 5%. The uncertainty is the RSS of the ConvF uncertainty for indicated target tissue parameters.

^G Alpha/Depth are determined during calibration. SPEAG warrants that the remaining deviation due to the boundary effect after compensation is always less than ± 1% for frequencies below 3 GHz and below ± 2% for frequencies between 3-6 GHz at any distance larger than half the probe tip diameter from the boundary.

DASY/EASY - Parameters of Probe: ES3DV3 - SN:3287

Calibration Parameter Determined in Body Tissue Simulating Media

f (MHz) ^C	Relative Permittivity ^F	Conductivity (S/m) ^F	ConvF X	ConvF Y	ConvF Z	Alpha ^G	Depth ^G (mm)	Unc (k=2)
750	55.5	0.96	6.43	6.43	6.43	0.72	1.15	± 12.0 %
835	55.2	0.97	6.34	6.34	6.34	0.52	1.32	± 12.0 %
1750	53.4	1.49	4.98	4.98	4.98	0.28	2.12	± 12.0 %
1900	53.3	1.52	4.83	4.83	4.83	0.43	1.57	± 12.0 %
2300	52.9	1.81	4.55	4.55	4.55	0.62	1.36	± 12.0 %
2450	52.7	1.95	4.29	4.29	4.29	0.72	1.17	± 12.0 %
2600	52.5	2.16	4.19	4.19	4.19	0.50	1.20	± 12.0 %

^C Frequency validity above 300 MHz of ± 100 MHz only applies for DASY v4.4 and higher (see Page 2), else it is restricted to ± 50 MHz. The uncertainty is the RSS of the ConvF uncertainty at calibration frequency and the uncertainty for the indicated frequency band. Frequency validity below 300 MHz is ± 10, 25, 40, 50 and 70 MHz for ConvF assessments at 30, 64, 128, 150 and 220 MHz respectively. Above 5 GHz frequency validity can be extended to ± 110 MHz.

^F At frequencies below 3 GHz, the validity of tissue parameters (ϵ and σ) can be relaxed to ± 10% if liquid compensation formula is applied to measured SAR values. At frequencies above 3 GHz, the validity of tissue parameters (ϵ and σ) is restricted to ± 5%. The uncertainty is the RSS of the ConvF uncertainty for indicated target tissue parameters.

^G Alpha/Depth are determined during calibration. SPEAG warrants that the remaining deviation due to the boundary effect after compensation is always less than ± 1% for frequencies below 3 GHz and below ± 2% for frequencies between 3-6 GHz at any distance larger than half the probe tip diameter from the boundary.

Frequency Response of E-Field (TEM-Cell:ifi110 EXX, Waveguide: R22)

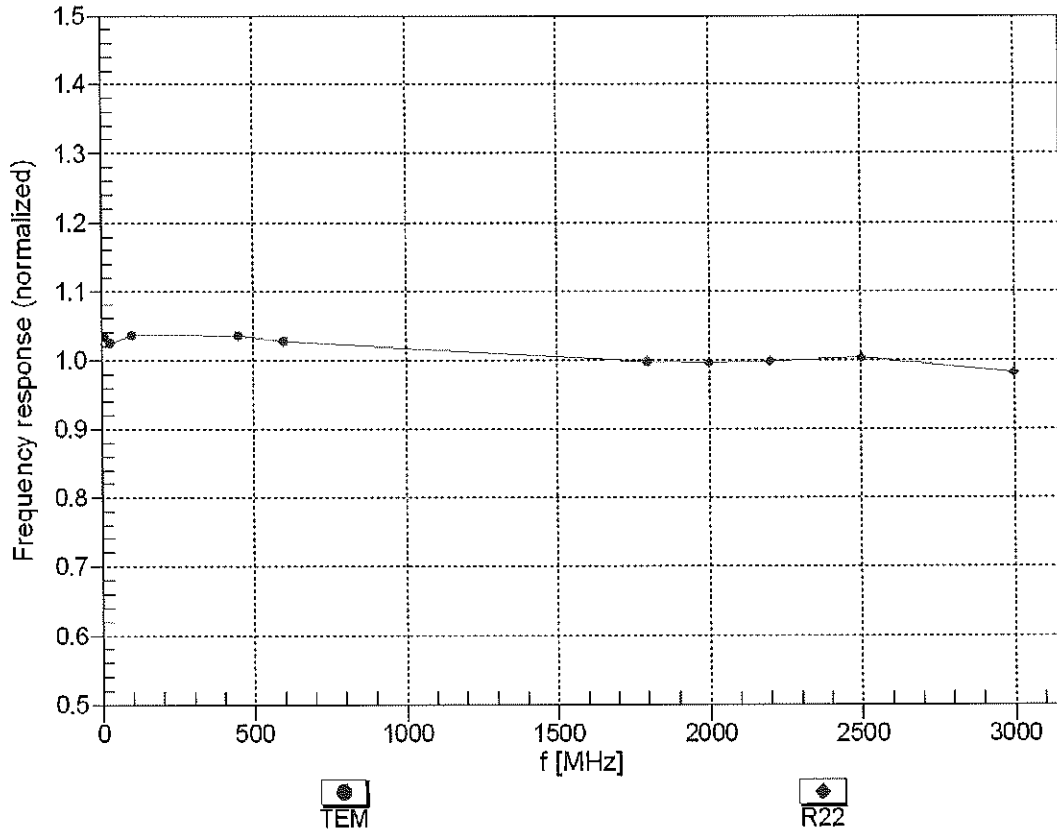

Uncertainty of Frequency Response of E-field: $\pm 6.3\%$ (k=2)

Receiving Pattern (ϕ), $\vartheta = 0^\circ$

f=600 MHz, TEM

f=1800 MHz, R22

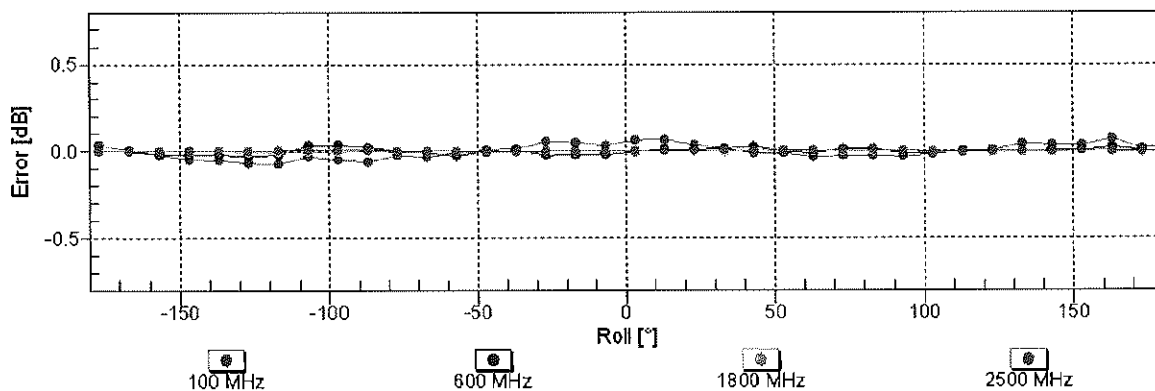
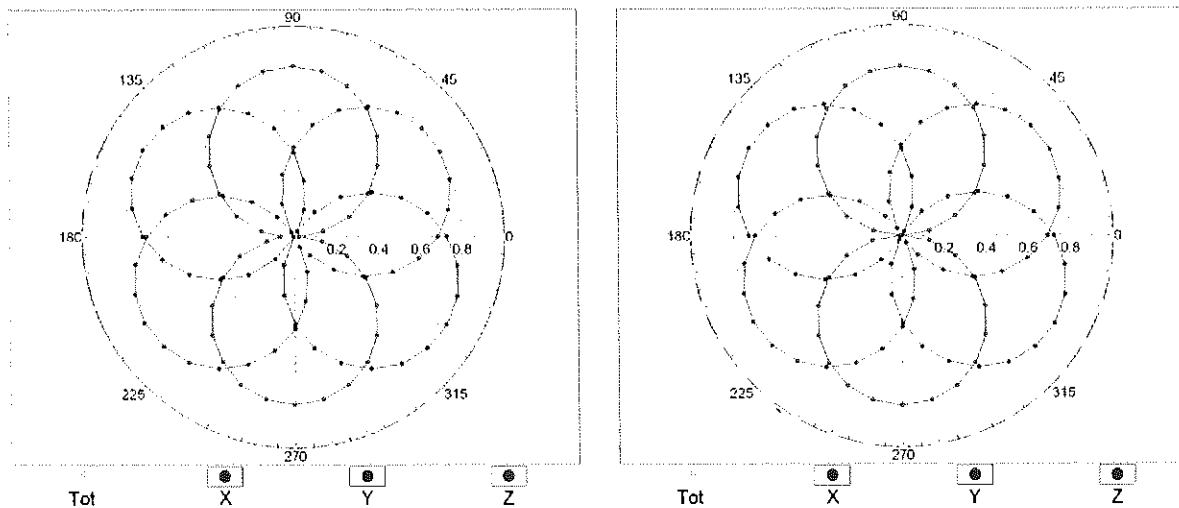

Uncertainty of Axial Isotropy Assessment: $\pm 0.5\%$ (k=2)

Dynamic Range $f(\text{SAR}_{\text{head}})$ (TEM cell, $f_{\text{eval}} = 1900 \text{ MHz}$)

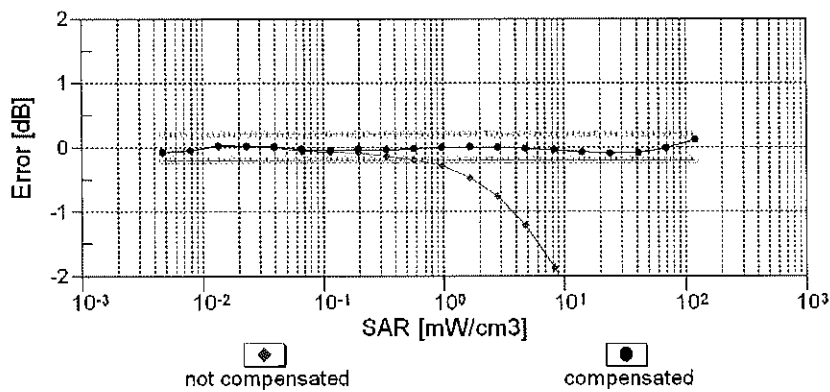
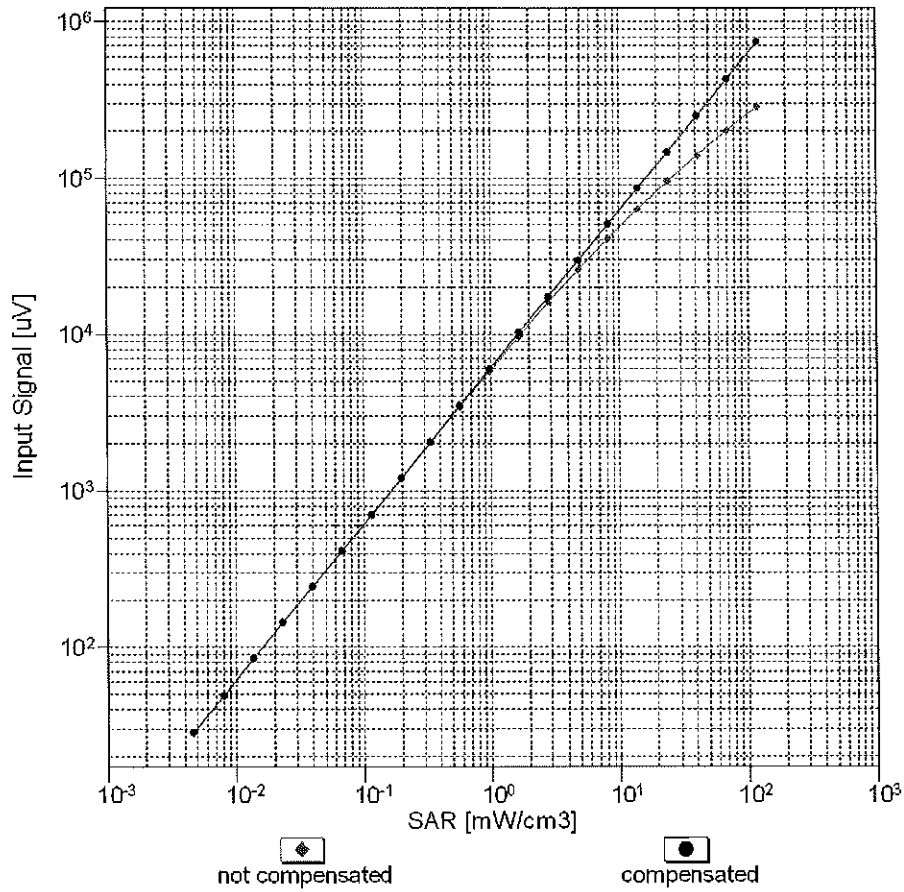

Uncertainty of Linearity Assessment: $\pm 0.6\%$ ($k=2$)

Conversion Factor Assessment

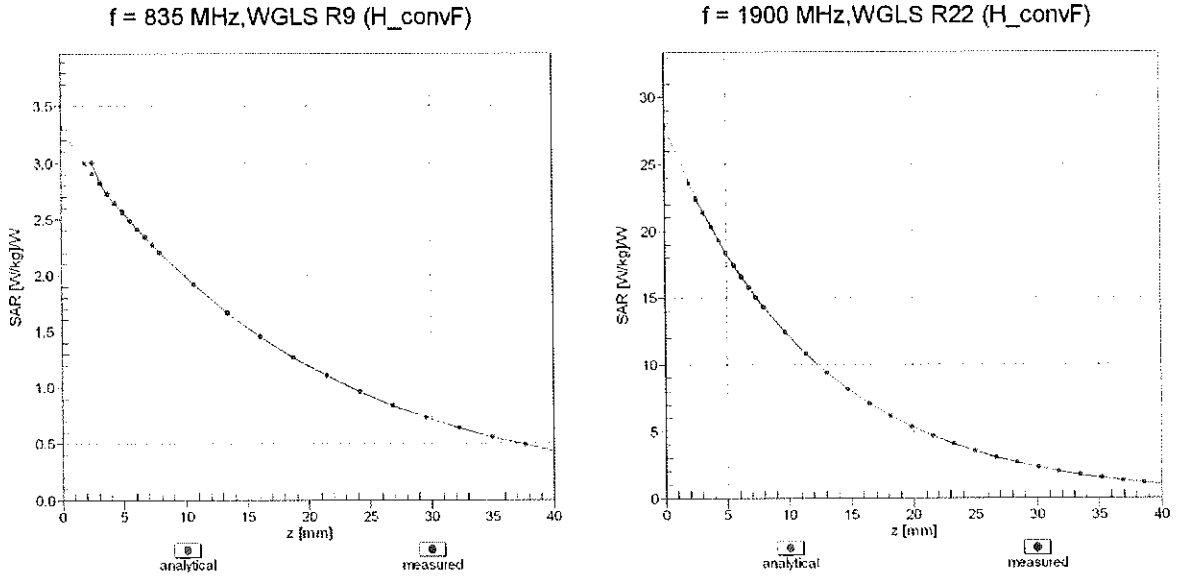

Deviation from Isotropy in Liquid Error (ϕ, θ), f = 900 MHz

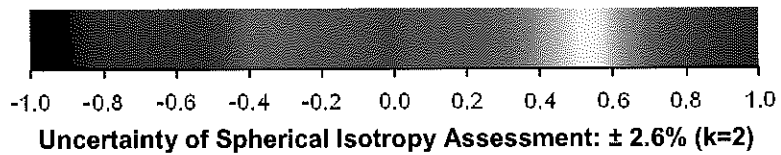
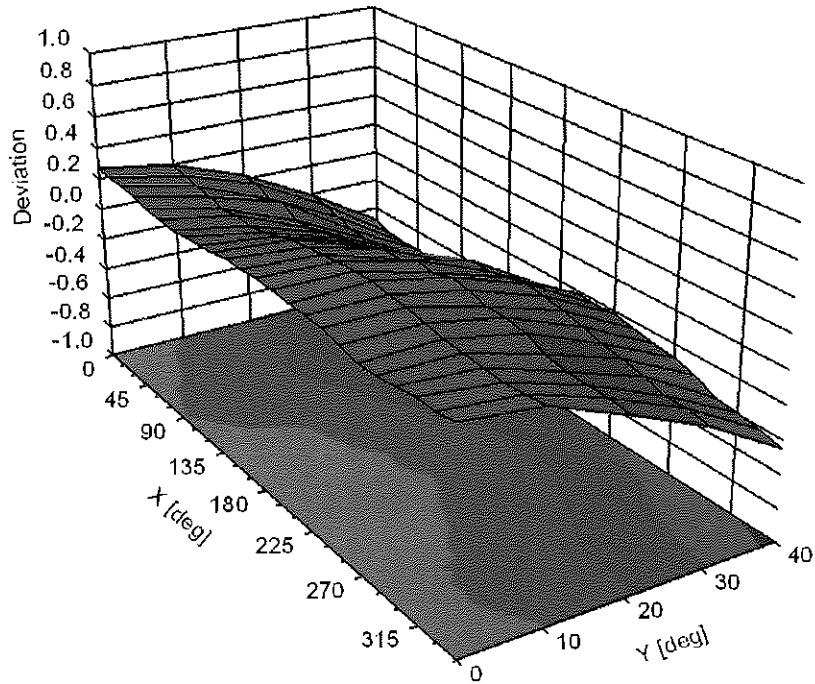

DASY/EASY - Parameters of Probe: ES3DV3 - SN:3287

Other Probe Parameters

Sensor Arrangement	Triangular
Connector Angle (°)	93.1
Mechanical Surface Detection Mode	enabled
Optical Surface Detection Mode	disabled
Probe Overall Length	337 mm
Probe Body Diameter	10 mm
Tip Length	10 mm
Tip Diameter	4 mm
Probe Tip to Sensor X Calibration Point	2 mm
Probe Tip to Sensor Y Calibration Point	2 mm
Probe Tip to Sensor Z Calibration Point	2 mm
Recommended Measurement Distance from Surface	3 mm

Appendix: Modulation Calibration Parameters

UID	Communication System Name		A dB	B dB μ V	C	D dB	VR mV	Max Unc ^E (k=2)
0	CW	X	0.00	0.00	1.00	0.00	170.5	$\pm 3.3\%$
		Y	0.00	0.00	1.00		183.9	
		Z	0.00	0.00	1.00		185.7	
10010- CAA	SAR Validation (Square, 100ms, 10ms)	X	7.53	77.06	17.83	10.00	25.0	$\pm 9.6\%$
		Y	8.14	78.38	19.04		25.0	
		Z	9.25	80.89	19.28		25.0	
10011- CAB	UMTS-FDD (WCDMA)	X	1.43	73.85	18.87	0.00	150.0	$\pm 9.6\%$
		Y	0.97	66.02	14.16		150.0	
		Z	1.09	68.86	15.96		150.0	
10012- CAB	IEEE 802.11b WiFi 2.4 GHz (DSSS, 1 Mbps)	X	1.37	66.92	17.13	0.41	150.0	$\pm 9.6\%$
		Y	1.26	64.41	15.18		150.0	
		Z	1.30	65.60	16.10		150.0	
10013- CAB	IEEE 802.11g WiFi 2.4 GHz (DSSS-OFDM, 6 Mbps)	X	5.15	67.38	17.44	1.46	150.0	$\pm 9.6\%$
		Y	5.18	67.06	17.28		150.0	
		Z	5.09	67.36	17.42		150.0	
10021- DAC	GSM-FDD (TDMA, GMSK)	X	14.53	88.52	23.56	9.39	50.0	$\pm 9.6\%$
		Y	14.96	89.86	24.90		50.0	
		Z	31.90	102.69	28.16		50.0	
10023- DAC	GPRS-FDD (TDMA, GMSK, TN 0)	X	13.53	87.25	23.18	9.57	50.0	$\pm 9.6\%$
		Y	14.02	88.59	24.52		50.0	
		Z	26.42	99.51	27.28		50.0	
10024- DAC	GPRS-FDD (TDMA, GMSK, TN 0-1)	X	52.08	107.25	27.36	6.56	60.0	$\pm 9.6\%$
		Y	41.48	106.06	28.00		60.0	
		Z	100.00	118.06	30.27		60.0	
10025- DAC	EDGE-FDD (TDMA, 8PSK, TN 0)	X	16.26	99.58	37.07	12.57	50.0	$\pm 9.6\%$
		Y	13.58	93.24	34.70		50.0	
		Z	21.87	110.76	41.97		50.0	
10026- DAC	EDGE-FDD (TDMA, 8PSK, TN 0-1)	X	18.41	99.97	33.81	9.56	60.0	$\pm 9.6\%$
		Y	15.35	95.05	32.27		60.0	
		Z	21.72	105.96	36.44		60.0	
10027- DAC	GPRS-FDD (TDMA, GMSK, TN 0-1-2)	X	100.00	115.09	28.07	4.80	80.0	$\pm 9.6\%$
		Y	100.00	117.60	29.52		80.0	
		Z	100.00	116.87	28.79		80.0	
10028- DAC	GPRS-FDD (TDMA, GMSK, TN 0-1-2-3)	X	100.00	115.09	27.27	3.55	100.0	$\pm 9.6\%$
		Y	100.00	116.90	28.32		100.0	
		Z	100.00	116.94	28.01		100.0	
10029- DAC	EDGE-FDD (TDMA, 8PSK, TN 0-1-2)	X	13.44	93.53	30.58	7.80	80.0	$\pm 9.6\%$
		Y	11.59	89.61	29.29		80.0	
		Z	14.19	96.32	32.08		80.0	
10030- CAA	IEEE 802.15.1 Bluetooth (GFSK, DH1)	X	100.00	114.89	28.31	5.30	70.0	$\pm 9.6\%$
		Y	92.82	116.56	29.65		70.0	
		Z	100.00	116.45	28.94		70.0	
10031- CAA	IEEE 802.15.1 Bluetooth (GFSK, DH3)	X	100.00	116.79	26.49	1.88	100.0	$\pm 9.6\%$
		Y	100.00	115.79	26.19		100.0	
		Z	100.00	117.41	26.65		100.0	

10032-CAA	IEEE 802.15.1 Bluetooth (GFSK, DH5)	X	100.00	123.13	28.06	1.17	100.0	± 9.6 %
		Y	100.00	116.53	25.36		100.0	
		Z	100.00	121.10	27.07		100.0	
10033-CAA	IEEE 802.15.1 Bluetooth (PI/4-DQPSK, DH1)	X	15.49	93.49	25.39	5.30	70.0	± 9.6 %
		Y	12.09	89.66	24.64		70.0	
		Z	22.85	100.72	27.71		70.0	
10034-CAA	IEEE 802.15.1 Bluetooth (PI/4-DQPSK, DH3)	X	11.69	94.03	24.43	1.88	100.0	± 9.6 %
		Y	5.21	81.43	20.33		100.0	
		Z	10.45	92.04	23.50		100.0	
10035-CAA	IEEE 802.15.1 Bluetooth (PI/4-DQPSK, DH5)	X	7.19	89.07	22.83	1.17	100.0	± 9.6 %
		Y	3.19	76.15	18.09		100.0	
		Z	5.32	84.13	20.72		100.0	
10036-CAA	IEEE 802.15.1 Bluetooth (8-DPSK, DH1)	X	18.47	96.50	26.38	5.30	70.0	± 9.6 %
		Y	13.77	92.00	25.46		70.0	
		Z	29.42	105.03	29.00		70.0	
10037-CAA	IEEE 802.15.1 Bluetooth (8-DPSK, DH3)	X	11.12	93.30	24.16	1.88	100.0	± 9.6 %
		Y	5.06	81.04	20.15		100.0	
		Z	9.78	91.13	23.19		100.0	
10038-CAA	IEEE 802.15.1 Bluetooth (8-DPSK, DH5)	X	7.70	90.38	23.33	1.17	100.0	± 9.6 %
		Y	3.27	76.73	18.38		100.0	
		Z	5.57	85.06	21.13		100.0	
10039-CAB	CDMA2000 (1xRTT, RC1)	X	3.68	82.65	21.02	0.00	150.0	± 9.6 %
		Y	1.70	69.59	15.11		150.0	
		Z	2.11	74.03	16.84		150.0	
10042-CAB	IS-54 / IS-136 FDD (TDMA/FDM, PI/4-DQPSK, Halfrate)	X	23.70	95.06	24.07	7.78	50.0	± 9.6 %
		Y	21.98	95.27	24.98		50.0	
		Z	100.00	116.88	29.97		50.0	
10044-CAA	IS-91/EIA/TIA-553 FDD (FDMA, FM)	X	0.00	115.10	1.28	0.00	150.0	± 9.6 %
		Y	0.01	122.01	1.58		150.0	
		Z	0.00	110.42	5.98		150.0	
10048-CAA	DECT (TDD, TDMA/FDM, GFSK, Full Slot, 24)	X	9.90	79.84	22.32	13.80	25.0	± 9.6 %
		Y	10.52	80.91	23.58		25.0	
		Z	12.94	86.06	24.76		25.0	
10049-CAA	DECT (TDD, TDMA/FDM, GFSK, Double Slot, 12)	X	11.07	83.29	22.21	10.79	40.0	± 9.6 %
		Y	11.66	84.62	23.55		40.0	
		Z	15.99	90.77	24.97		40.0	
10056-CAA	UMTS-TDD (TD-SCDMA, 1.28 Mcps)	X	11.47	84.45	23.20	9.03	50.0	± 9.6 %
		Y	11.19	84.08	23.66		50.0	
		Z	14.67	89.92	25.31		50.0	
10058-DAC	EDGE-FDD (TDMA, 8PSK, TN 0-1-2-3)	X	10.29	88.76	28.24	6.55	100.0	± 9.6 %
		Y	9.12	85.50	27.09		100.0	
		Z	10.20	89.78	29.04		100.0	
10059-CAB	IEEE 802.11b WiFi 2.4 GHz (DSSS, 2 Mbps)	X	1.61	69.65	18.33	0.61	110.0	± 9.6 %
		Y	1.43	66.43	16.16		110.0	
		Z	1.49	68.00	17.26		110.0	
10060-CAB	IEEE 802.11b WiFi 2.4 GHz (DSSS, 5.5 Mbps)	X	100.00	131.01	33.54	1.30	110.0	± 9.6 %
		Y	22.84	107.12	27.36		110.0	
		Z	100.00	130.89	33.42		110.0	

10061-CAB	IEEE 802.11b WiFi 2.4 GHz (DSSS, 11 Mbps)	X	18.52	105.45	29.38	2.04	110.0	± 9.6 %
		Y	6.96	88.43	24.11		110.0	
		Z	15.38	103.23	28.94		110.0	
10062-CAC	IEEE 802.11a/h WiFi 5 GHz (OFDM, 6 Mbps)	X	4.90	67.27	16.85	0.49	100.0	± 9.6 %
		Y	4.89	66.79	16.55		100.0	
		Z	4.81	67.12	16.71		100.0	
10063-CAC	IEEE 802.11a/h WiFi 5 GHz (OFDM, 9 Mbps)	X	4.93	67.42	16.97	0.72	100.0	± 9.6 %
		Y	4.94	66.96	16.70		100.0	
		Z	4.85	67.28	16.85		100.0	
10064-CAC	IEEE 802.11a/h WiFi 5 GHz (OFDM, 12 Mbps)	X	5.27	67.73	17.21	0.86	100.0	± 9.6 %
		Y	5.30	67.34	16.98		100.0	
		Z	5.17	67.59	17.11		100.0	
10065-CAC	IEEE 802.11a/h WiFi 5 GHz (OFDM, 18 Mbps)	X	5.17	67.74	17.34	1.21	100.0	± 9.6 %
		Y	5.20	67.39	17.15		100.0	
		Z	5.08	67.64	17.28		100.0	
10066-CAC	IEEE 802.11a/h WiFi 5 GHz (OFDM, 24 Mbps)	X	5.22	67.85	17.55	1.46	100.0	± 9.6 %
		Y	5.26	67.54	17.39		100.0	
		Z	5.14	67.77	17.52		100.0	
10067-CAC	IEEE 802.11a/h WiFi 5 GHz (OFDM, 36 Mbps)	X	5.52	67.92	17.94	2.04	100.0	± 9.6 %
		Y	5.59	67.70	17.86		100.0	
		Z	5.46	67.96	17.98		100.0	
10068-CAC	IEEE 802.11a/h WiFi 5 GHz (OFDM, 48 Mbps)	X	5.67	68.31	18.30	2.55	100.0	± 9.6 %
		Y	5.76	68.13	18.25		100.0	
		Z	5.59	68.29	18.34		100.0	
10069-CAC	IEEE 802.11a/h WiFi 5 GHz (OFDM, 54 Mbps)	X	5.74	68.18	18.44	2.67	100.0	± 9.6 %
		Y	5.83	68.02	18.41		100.0	
		Z	5.67	68.25	18.53		100.0	
10071-CAB	IEEE 802.11g WiFi 2.4 GHz (DSSS/OFDM, 9 Mbps)	X	5.29	67.59	17.79	1.99	100.0	± 9.6 %
		Y	5.34	67.32	17.67		100.0	
		Z	5.24	67.60	17.81		100.0	
10072-CAB	IEEE 802.11g WiFi 2.4 GHz (DSSS/OFDM, 12 Mbps)	X	5.36	68.17	18.10	2.30	100.0	± 9.6 %
		Y	5.42	67.91	18.00		100.0	
		Z	5.30	68.17	18.14		100.0	
10073-CAB	IEEE 802.11g WiFi 2.4 GHz (DSSS/OFDM, 18 Mbps)	X	5.49	68.49	18.48	2.83	100.0	± 9.6 %
		Y	5.57	68.29	18.43		100.0	
		Z	5.44	68.53	18.57		100.0	
10074-CAB	IEEE 802.11g WiFi 2.4 GHz (DSSS/OFDM, 24 Mbps)	X	5.52	68.57	18.73	3.30	100.0	± 9.6 %
		Y	5.62	68.40	18.71		100.0	
		Z	5.48	68.62	18.83		100.0	
10075-CAB	IEEE 802.11g WiFi 2.4 GHz (DSSS/OFDM, 36 Mbps)	X	5.69	69.08	19.21	3.82	90.0	± 9.6 %
		Y	5.81	68.98	19.24		90.0	
		Z	5.63	69.10	19.33		90.0	
10076-CAB	IEEE 802.11g WiFi 2.4 GHz (DSSS/OFDM, 48 Mbps)	X	5.69	68.85	19.30	4.15	90.0	± 9.6 %
		Y	5.82	68.76	19.35		90.0	
		Z	5.65	68.92	19.46		90.0	
10077-CAB	IEEE 802.11g WiFi 2.4 GHz (DSSS/OFDM, 54 Mbps)	X	5.73	68.94	19.41	4.30	90.0	± 9.6 %
		Y	5.86	68.86	19.45		90.0	
		Z	5.70	69.02	19.57		90.0	

10081-CAB	CDMA2000 (1xRTT, RC3)	X	1.50	74.73	17.78	0.00	150.0	± 9.6 %
		Y	0.85	64.97	12.38		150.0	
		Z	0.93	67.53	13.57		150.0	
10082-CAB	IS-54 / IS-136 FDD (TDMA/FDM, PI/4-DQPSK, Fullrate)	X	2.13	63.53	8.53	4.77	80.0	± 9.6 %
		Y	2.34	64.23	9.30		80.0	
		Z	2.05	63.65	8.54		80.0	
10090-DAC	GPRS-FDD (TDMA, GMSK, TN 0-4)	X	49.50	106.58	27.22	6.56	60.0	± 9.6 %
		Y	40.33	105.69	27.94		60.0	
		Z	100.00	118.15	30.33		60.0	
10097-CAB	UMTS-FDD (HSDPA)	X	2.07	70.20	17.39	0.00	150.0	± 9.6 %
		Y	1.76	66.51	15.04		150.0	
		Z	1.86	68.23	16.00		150.0	
10098-CAB	UMTS-FDD (HSUPA, Subtest 2)	X	2.03	70.21	17.38	0.00	150.0	± 9.6 %
		Y	1.72	66.45	14.99		150.0	
		Z	1.83	68.21	15.97		150.0	
10099-DAC	EDGE-FDD (TDMA, 8PSK, TN 0-4)	X	18.31	99.80	33.74	9.56	60.0	± 9.6 %
		Y	15.30	94.94	32.23		60.0	
		Z	21.61	105.78	36.38		60.0	
10100-CAE	LTE-FDD (SC-FDMA, 100% RB, 20 MHz, QPSK)	X	3.71	73.39	18.12	0.00	150.0	± 9.6 %
		Y	3.14	69.82	16.14		150.0	
		Z	3.27	71.18	16.96		150.0	
10101-CAE	LTE-FDD (SC-FDMA, 100% RB, 20 MHz, 16-QAM)	X	3.51	69.02	16.73	0.00	150.0	± 9.6 %
		Y	3.32	67.43	15.69		150.0	
		Z	3.32	68.05	16.10		150.0	
10102-CAE	LTE-FDD (SC-FDMA, 100% RB, 20 MHz, 64-QAM)	X	3.59	68.86	16.77	0.00	150.0	± 9.6 %
		Y	3.42	67.38	15.79		150.0	
		Z	3.42	67.96	16.18		150.0	
10103-CAG	LTE-TDD (SC-FDMA, 100% RB, 20 MHz, QPSK)	X	8.68	77.91	20.86	3.98	65.0	± 9.6 %
		Y	8.39	76.97	20.64		65.0	
		Z	8.88	79.01	21.52		65.0	
10104-CAG	LTE-TDD (SC-FDMA, 100% RB, 20 MHz, 16-QAM)	X	8.68	76.81	21.30	3.98	65.0	± 9.6 %
		Y	8.50	76.03	21.10		65.0	
		Z	8.59	77.26	21.68		65.0	
10105-CAG	LTE-TDD (SC-FDMA, 100% RB, 20 MHz, 64-QAM)	X	8.09	75.44	21.00	3.98	65.0	± 9.6 %
		Y	7.65	73.94	20.48		65.0	
		Z	7.67	75.03	21.01		65.0	
10108-CAG	LTE-FDD (SC-FDMA, 100% RB, 10 MHz, QPSK)	X	3.25	72.47	17.95	0.00	150.0	± 9.6 %
		Y	2.79	69.04	15.96		150.0	
		Z	2.87	70.38	16.80		150.0	
10109-CAG	LTE-FDD (SC-FDMA, 100% RB, 10 MHz, 16-QAM)	X	3.18	68.93	16.75	0.00	150.0	± 9.6 %
		Y	2.99	67.17	15.59		150.0	
		Z	2.98	67.88	16.03		150.0	
10110-CAG	LTE-FDD (SC-FDMA, 100% RB, 5 MHz, QPSK)	X	2.67	71.57	17.72	0.00	150.0	± 9.6 %
		Y	2.28	68.03	15.59		150.0	
		Z	2.34	69.49	16.47		150.0	
10111-CAG	LTE-FDD (SC-FDMA, 100% RB, 5 MHz, 16-QAM)	X	2.93	69.90	17.29	0.00	150.0	± 9.6 %
		Y	2.67	67.50	15.78		150.0	
		Z	2.69	68.60	16.34		150.0	

10112-CAG	LTE-FDD (SC-FDMA, 100% RB, 10 MHz, 64-QAM)	X	3.29	68.76	16.73	0.00	150.0	± 9.6 %
		Y	3.11	67.13	15.65		150.0	
		Z	3.10	67.82	16.07		150.0	
10113-CAG	LTE-FDD (SC-FDMA, 100% RB, 5 MHz, 64-QAM)	X	3.07	69.85	17.32	0.00	150.0	± 9.6 %
		Y	2.83	67.62	15.92		150.0	
		Z	2.84	68.68	16.45		150.0	
10114-CAC	IEEE 802.11n (HT Greenfield, 13.5 Mbps, BPSK)	X	5.26	67.69	16.67	0.00	150.0	± 9.6 %
		Y	5.23	67.13	16.29		150.0	
		Z	5.17	67.44	16.47		150.0	
10115-CAC	IEEE 802.11n (HT Greenfield, 81 Mbps, 16-QAM)	X	5.63	67.96	16.80	0.00	150.0	± 9.6 %
		Y	5.62	67.49	16.48		150.0	
		Z	5.52	67.74	16.63		150.0	
10116-CAC	IEEE 802.11n (HT Greenfield, 135 Mbps, 64-QAM)	X	5.39	67.95	16.72	0.00	150.0	± 9.6 %
		Y	5.36	67.40	16.35		150.0	
		Z	5.29	67.69	16.52		150.0	
10117-CAC	IEEE 802.11n (HT Mixed, 13.5 Mbps, BPSK)	X	5.27	67.71	16.70	0.00	150.0	± 9.6 %
		Y	5.24	67.16	16.33		150.0	
		Z	5.16	67.39	16.47		150.0	
10118-CAC	IEEE 802.11n (HT Mixed, 81 Mbps, 16-QAM)	X	5.69	68.10	16.87	0.00	150.0	± 9.6 %
		Y	5.66	67.55	16.52		150.0	
		Z	5.60	67.91	16.73		150.0	
10119-CAC	IEEE 802.11n (HT Mixed, 135 Mbps, 64-QAM)	X	5.36	67.90	16.71	0.00	150.0	± 9.6 %
		Y	5.33	67.36	16.35		150.0	
		Z	5.26	67.63	16.50		150.0	
10140-CAE	LTE-FDD (SC-FDMA, 100% RB, 15 MHz, 16-QAM)	X	3.65	68.85	16.68	0.00	150.0	± 9.6 %
		Y	3.47	67.39	15.72		150.0	
		Z	3.46	67.97	16.10		150.0	
10141-CAE	LTE-FDD (SC-FDMA, 100% RB, 15 MHz, 64-QAM)	X	3.76	68.83	16.80	0.00	150.0	± 9.6 %
		Y	3.60	67.45	15.88		150.0	
		Z	3.58	68.02	16.25		150.0	
10142-CAE	LTE-FDD (SC-FDMA, 100% RB, 3 MHz, QPSK)	X	2.48	71.91	17.76	0.00	150.0	± 9.6 %
		Y	2.05	67.79	15.33		150.0	
		Z	2.12	69.52	16.24		150.0	
10143-CAE	LTE-FDD (SC-FDMA, 100% RB, 3 MHz, 16-QAM)	X	2.90	71.18	17.49	0.00	150.0	± 9.6 %
		Y	2.52	67.93	15.59		150.0	
		Z	2.57	69.41	16.20		150.0	
10144-CAE	LTE-FDD (SC-FDMA, 100% RB, 3 MHz, 64-QAM)	X	2.62	68.68	15.85	0.00	150.0	± 9.6 %
		Y	2.38	66.30	14.35		150.0	
		Z	2.36	67.27	14.69		150.0	
10145-CAF	LTE-FDD (SC-FDMA, 100% RB, 1.4 MHz, QPSK)	X	2.00	71.99	16.45	0.00	150.0	± 9.6 %
		Y	1.42	65.89	13.07		150.0	
		Z	1.41	66.95	13.17		150.0	
10146-CAF	LTE-FDD (SC-FDMA, 100% RB, 1.4 MHz, 16-QAM)	X	5.79	80.59	18.98	0.00	150.0	± 9.6 %
		Y	3.05	71.20	15.41		150.0	
		Z	3.43	73.13	15.30		150.0	
10147-CAF	LTE-FDD (SC-FDMA, 100% RB, 1.4 MHz, 64-QAM)	X	9.98	88.43	21.82	0.00	150.0	± 9.6 %
		Y	3.72	74.13	16.84		150.0	
		Z	4.87	77.77	17.26		150.0	

10149-CAE	LTE-FDD (SC-FDMA, 50% RB, 20 MHz, 16-QAM)	X	3.19	69.00	16.80	0.00	150.0	± 9.6 %
		Y	3.00	67.22	15.63		150.0	
		Z	2.99	67.94	16.08		150.0	
10150-CAE	LTE-FDD (SC-FDMA, 50% RB, 20 MHz, 64-QAM)	X	3.30	68.82	16.78	0.00	150.0	± 9.6 %
		Y	3.12	67.17	15.69		150.0	
		Z	3.11	67.87	16.11		150.0	
10151-CAG	LTE-TDD (SC-FDMA, 50% RB, 20 MHz, QPSK)	X	9.20	80.06	21.79	3.98	65.0	± 9.6 %
		Y	8.68	78.68	21.42		65.0	
		Z	9.50	81.45	22.55		65.0	
10152-CAG	LTE-TDD (SC-FDMA, 50% RB, 20 MHz, 16-QAM)	X	8.32	76.99	21.17	3.98	65.0	± 9.6 %
		Y	8.10	76.11	20.95		65.0	
		Z	8.24	77.53	21.54		65.0	
10153-CAG	LTE-TDD (SC-FDMA, 50% RB, 20 MHz, 64-QAM)	X	8.68	77.73	21.81	3.98	65.0	± 9.6 %
		Y	8.45	76.81	21.57		65.0	
		Z	8.63	78.31	22.20		65.0	
10154-CAG	LTE-FDD (SC-FDMA, 50% RB, 10 MHz, QPSK)	X	2.76	72.22	18.09	0.00	150.0	± 9.6 %
		Y	2.34	68.47	15.87		150.0	
		Z	2.39	69.94	16.75		150.0	
10155-CAG	LTE-FDD (SC-FDMA, 50% RB, 10 MHz, 16-QAM)	X	2.93	69.90	17.30	0.00	150.0	± 9.6 %
		Y	2.67	67.50	15.78		150.0	
		Z	2.69	68.61	16.35		150.0	
10156-CAG	LTE-FDD (SC-FDMA, 50% RB, 5 MHz, QPSK)	X	2.40	72.73	18.02	0.00	150.0	± 9.6 %
		Y	1.91	67.88	15.23		150.0	
		Z	1.98	69.77	16.17		150.0	
10157-CAG	LTE-FDD (SC-FDMA, 50% RB, 5 MHz, 16-QAM)	X	2.54	69.89	16.32	0.00	150.0	± 9.6 %
		Y	2.20	66.71	14.41		150.0	
		Z	2.21	67.97	14.84		150.0	
10158-CAG	LTE-FDD (SC-FDMA, 50% RB, 10 MHz, 64-QAM)	X	3.08	69.91	17.37	0.00	150.0	± 9.6 %
		Y	2.83	67.66	15.96		150.0	
		Z	2.85	68.73	16.49		150.0	
10159-CAG	LTE-FDD (SC-FDMA, 50% RB, 5 MHz, 64-QAM)	X	2.68	70.46	16.65	0.00	150.0	± 9.6 %
		Y	2.30	67.13	14.70		150.0	
		Z	2.33	68.43	15.13		150.0	
10160-CAE	LTE-FDD (SC-FDMA, 50% RB, 15 MHz, QPSK)	X	3.08	70.59	17.38	0.00	150.0	± 9.6 %
		Y	2.80	68.13	15.84		150.0	
		Z	2.83	69.23	16.52		150.0	
10161-CAE	LTE-FDD (SC-FDMA, 50% RB, 15 MHz, 16-QAM)	X	3.19	68.74	16.75	0.00	150.0	± 9.6 %
		Y	3.01	67.04	15.62		150.0	
		Z	3.00	67.79	16.05		150.0	
10162-CAE	LTE-FDD (SC-FDMA, 50% RB, 15 MHz, 64-QAM)	X	3.29	68.74	16.78	0.00	150.0	± 9.6 %
		Y	3.12	67.09	15.70		150.0	
		Z	3.11	67.88	16.13		150.0	
10166-CAF	LTE-FDD (SC-FDMA, 50% RB, 1.4 MHz, QPSK)	X	4.20	71.91	20.30	3.01	150.0	± 9.6 %
		Y	3.97	69.88	19.20		150.0	
		Z	4.01	71.48	20.04		150.0	
10167-CAF	LTE-FDD (SC-FDMA, 50% RB, 1.4 MHz, 16-QAM)	X	5.82	76.43	21.33	3.01	150.0	± 9.6 %
		Y	5.06	72.83	19.70		150.0	
		Z	5.46	75.92	21.03		150.0	

10168-CAF	LTE-FDD (SC-FDMA, 50% RB, 1.4 MHz, 64-QAM)	X	6.57	79.03	22.72	3.01	150.0	± 9.6 %
		Y	5.52	74.71	20.84		150.0	
		Z	6.17	78.53	22.43		150.0	
10169-CAE	LTE-FDD (SC-FDMA, 1 RB, 20 MHz, QPSK)	X	4.18	75.15	21.66	3.01	150.0	± 9.6 %
		Y	3.68	71.43	19.79		150.0	
		Z	3.71	73.29	20.84		150.0	
10170-CAE	LTE-FDD (SC-FDMA, 1 RB, 20 MHz, 16-QAM)	X	8.28	87.06	25.72	3.01	150.0	± 9.6 %
		Y	5.41	77.71	22.06		150.0	
		Z	6.71	83.81	24.55		150.0	
10171-AAE	LTE-FDD (SC-FDMA, 1 RB, 20 MHz, 64-QAM)	X	5.78	79.38	21.89	3.01	150.0	± 9.6 %
		Y	4.38	73.23	19.30		150.0	
		Z	4.93	77.24	21.04		150.0	
10172-CAG	LTE-TDD (SC-FDMA, 1 RB, 20 MHz, QPSK)	X	34.48	110.68	33.22	6.02	65.0	± 9.6 %
		Y	19.27	99.23	30.20		65.0	
		Z	64.25	125.69	37.96		65.0	
10173-CAG	LTE-TDD (SC-FDMA, 1 RB, 20 MHz, 16-QAM)	X	43.93	109.49	31.07	6.02	65.0	± 9.6 %
		Y	20.84	96.83	28.02		65.0	
		Z	100.00	126.58	36.03		65.0	
10174-CAG	LTE-TDD (SC-FDMA, 1 RB, 20 MHz, 64-QAM)	X	30.93	102.12	28.52	6.02	65.0	± 9.6 %
		Y	17.32	92.53	26.25		65.0	
		Z	61.98	116.33	32.90		65.0	
10175-CAG	LTE-FDD (SC-FDMA, 1 RB, 10 MHz, QPSK)	X	4.10	74.63	21.33	3.01	150.0	± 9.6 %
		Y	3.62	71.04	19.52		150.0	
		Z	3.65	72.87	20.55		150.0	
10176-CAG	LTE-FDD (SC-FDMA, 1 RB, 10 MHz, 16-QAM)	X	8.30	87.09	25.74	3.01	150.0	± 9.6 %
		Y	5.42	77.74	22.07		150.0	
		Z	6.72	83.85	24.57		150.0	
10177-CAI	LTE-FDD (SC-FDMA, 1 RB, 5 MHz, QPSK)	X	4.15	74.88	21.47	3.01	150.0	± 9.6 %
		Y	3.66	71.24	19.64		150.0	
		Z	3.69	73.07	20.66		150.0	
10178-CAG	LTE-FDD (SC-FDMA, 1 RB, 5 MHz, 16-QAM)	X	8.06	86.52	25.50	3.01	150.0	± 9.6 %
		Y	5.33	77.40	21.91		150.0	
		Z	6.59	83.44	24.39		150.0	
10179-CAG	LTE-FDD (SC-FDMA, 1 RB, 10 MHz, 64-QAM)	X	6.83	82.82	23.58	3.01	150.0	± 9.6 %
		Y	4.83	75.24	20.50		150.0	
		Z	5.71	80.26	22.61		150.0	
10180-CAG	LTE-FDD (SC-FDMA, 1 RB, 5 MHz, 64-QAM)	X	5.73	79.20	21.80	3.01	150.0	± 9.6 %
		Y	4.36	73.12	19.23		150.0	
		Z	4.90	77.11	20.97		150.0	
10181-CAE	LTE-FDD (SC-FDMA, 1 RB, 15 MHz, QPSK)	X	4.14	74.86	21.46	3.01	150.0	± 9.6 %
		Y	3.65	71.22	19.63		150.0	
		Z	3.68	73.05	20.65		150.0	
10182-CAE	LTE-FDD (SC-FDMA, 1 RB, 15 MHz, 16-QAM)	X	8.05	86.48	25.49	3.01	150.0	± 9.6 %
		Y	5.32	77.37	21.89		150.0	
		Z	6.57	83.40	24.38		150.0	
10183-AAD	LTE-FDD (SC-FDMA, 1 RB, 15 MHz, 64-QAM)	X	5.72	79.16	21.78	3.01	150.0	± 9.6 %
		Y	4.35	73.09	19.22		150.0	
		Z	4.89	77.08	20.96		150.0	

10184-CAE	LTE-FDD (SC-FDMA, 1 RB, 3 MHz, QPSK)	X	4.16	74.92	21.48	3.01	150.0	± 9.6 %
		Y	3.67	71.26	19.65		150.0	
		Z	3.70	73.10	20.68		150.0	
10185-CAE	LTE-FDD (SC-FDMA, 1 RB, 3 MHz, 16-QAM)	X	8.10	86.60	25.54	3.01	150.0	± 9.6 %
		Y	5.35	77.45	21.93		150.0	
		Z	6.62	83.51	24.42		150.0	
10186-AAE	LTE-FDD (SC-FDMA, 1 RB, 3 MHz, 64-QAM)	X	5.76	79.27	21.83	3.01	150.0	± 9.6 %
		Y	4.38	73.16	19.26		150.0	
		Z	4.92	77.18	21.00		150.0	
10187-CAF	LTE-FDD (SC-FDMA, 1 RB, 1.4 MHz, QPSK)	X	4.17	74.96	21.54	3.01	150.0	± 9.6 %
		Y	3.67	71.29	19.69		150.0	
		Z	3.71	73.16	20.74		150.0	
10188-CAF	LTE-FDD (SC-FDMA, 1 RB, 1.4 MHz, 16-QAM)	X	8.67	87.99	26.14	3.01	150.0	± 9.6 %
		Y	5.56	78.25	22.35		150.0	
		Z	6.98	84.62	24.93		150.0	
10189-AAF	LTE-FDD (SC-FDMA, 1 RB, 1.4 MHz, 64-QAM)	X	5.99	80.05	22.22	3.01	150.0	± 9.6 %
		Y	4.49	73.64	19.55		150.0	
		Z	5.09	77.84	21.35		150.0	
10193-CAC	IEEE 802.11n (HT Greenfield, 6.5 Mbps, BPSK)	X	4.70	67.14	16.49	0.00	150.0	± 9.6 %
		Y	4.65	66.50	16.06		150.0	
		Z	4.58	66.86	16.22		150.0	
10194-CAC	IEEE 802.11n (HT Greenfield, 39 Mbps, 16-QAM)	X	4.90	67.52	16.60	0.00	150.0	± 9.6 %
		Y	4.86	66.88	16.17		150.0	
		Z	4.77	67.20	16.34		150.0	
10195-CAC	IEEE 802.11n (HT Greenfield, 65 Mbps, 64-QAM)	X	4.94	67.52	16.60	0.00	150.0	± 9.6 %
		Y	4.90	66.89	16.18		150.0	
		Z	4.81	67.23	16.35		150.0	
10196-CAC	IEEE 802.11n (HT Mixed, 6.5 Mbps, BPSK)	X	4.72	67.25	16.53	0.00	150.0	± 9.6 %
		Y	4.68	66.61	16.10		150.0	
		Z	4.60	66.94	16.25		150.0	
10197-CAC	IEEE 802.11n (HT Mixed, 39 Mbps, 16-QAM)	X	4.91	67.54	16.61	0.00	150.0	± 9.6 %
		Y	4.87	66.90	16.18		150.0	
		Z	4.78	67.23	16.35		150.0	
10198-CAC	IEEE 802.11n (HT Mixed, 65 Mbps, 64-QAM)	X	4.94	67.54	16.61	0.00	150.0	± 9.6 %
		Y	4.90	66.90	16.19		150.0	
		Z	4.81	67.24	16.37		150.0	
10219-CAC	IEEE 802.11n (HT Mixed, 7.2 Mbps, BPSK)	X	4.67	67.27	16.50	0.00	150.0	± 9.6 %
		Y	4.63	66.62	16.06		150.0	
		Z	4.54	66.96	16.22		150.0	
10220-CAC	IEEE 802.11n (HT Mixed, 43.3 Mbps, 16-QAM)	X	4.91	67.53	16.61	0.00	150.0	± 9.6 %
		Y	4.87	66.90	16.18		150.0	
		Z	4.78	67.21	16.35		150.0	
10221-CAC	IEEE 802.11n (HT Mixed, 72.2 Mbps, 64-QAM)	X	4.95	67.46	16.60	0.00	150.0	± 9.6 %
		Y	4.91	66.85	16.18		150.0	
		Z	4.82	67.17	16.35		150.0	
10222-CAC	IEEE 802.11n (HT Mixed, 15 Mbps, BPSK)	X	5.25	67.74	16.71	0.00	150.0	± 9.6 %
		Y	5.22	67.19	16.33		150.0	
		Z	5.14	67.40	16.47		150.0	

10223-CAC	IEEE 802.11n (HT Mixed, 90 Mbps, 16-QAM)	X	5.62	68.04	16.87	0.00	150.0	± 9.6 %
		Y	5.61	67.57	16.55		150.0	
		Z	5.46	67.62	16.59		150.0	
10224-CAC	IEEE 802.11n (HT Mixed, 150 Mbps, 64-QAM)	X	5.30	67.86	16.69	0.00	150.0	± 9.6 %
		Y	5.27	67.29	16.31		150.0	
		Z	5.18	67.50	16.44		150.0	
10225-CAB	UMTS-FDD (HSPA+)	X	3.00	67.11	16.18	0.00	150.0	± 9.6 %
		Y	2.89	65.79	15.26		150.0	
		Z	2.86	66.46	15.54		150.0	
10226-CAA	LTE-TDD (SC-FDMA, 1 RB, 1.4 MHz, 16-QAM)	X	47.57	111.04	31.57	6.02	65.0	± 9.6 %
		Y	21.77	97.71	28.37		65.0	
		Z	100.00	126.78	36.17		65.0	
10227-CAA	LTE-TDD (SC-FDMA, 1 RB, 1.4 MHz, 64-QAM)	X	33.21	103.47	29.00	6.02	65.0	± 9.6 %
		Y	18.61	93.88	26.76		65.0	
		Z	72.01	119.09	33.69		65.0	
10228-CAA	LTE-TDD (SC-FDMA, 1 RB, 1.4 MHz, QPSK)	X	43.41	115.45	34.63	6.02	65.0	± 9.6 %
		Y	21.18	101.54	31.02		65.0	
		Z	73.36	128.78	38.85		65.0	
10229-CAC	LTE-TDD (SC-FDMA, 1 RB, 3 MHz, 16-QAM)	X	43.98	109.51	31.08	6.02	65.0	± 9.6 %
		Y	20.89	96.85	28.04		65.0	
		Z	100.00	126.58	36.04		65.0	
10230-CAC	LTE-TDD (SC-FDMA, 1 RB, 3 MHz, 64-QAM)	X	31.28	102.35	28.60	6.02	65.0	± 9.6 %
		Y	17.95	93.18	26.47		65.0	
		Z	65.65	117.34	33.17		65.0	
10231-CAC	LTE-TDD (SC-FDMA, 1 RB, 3 MHz, QPSK)	X	40.51	113.99	34.16	6.02	65.0	± 9.6 %
		Y	20.32	100.64	30.68		65.0	
		Z	66.72	126.73	38.25		65.0	
10232-CAF	LTE-TDD (SC-FDMA, 1 RB, 5 MHz, 16-QAM)	X	43.98	109.51	31.08	6.02	65.0	± 9.6 %
		Y	20.87	96.85	28.04		65.0	
		Z	100.00	126.58	36.04		65.0	
10233-CAF	LTE-TDD (SC-FDMA, 1 RB, 5 MHz, 64-QAM)	X	31.31	102.37	28.61	6.02	65.0	± 9.6 %
		Y	17.95	93.19	26.47		65.0	
		Z	65.78	117.38	33.18		65.0	
10234-CAF	LTE-TDD (SC-FDMA, 1 RB, 5 MHz, QPSK)	X	37.61	112.37	33.61	6.02	65.0	± 9.6 %
		Y	19.46	99.66	30.29		65.0	
		Z	60.59	124.57	37.59		65.0	
10235-CAF	LTE-TDD (SC-FDMA, 1 RB, 10 MHz, 16-QAM)	X	44.16	109.59	31.10	6.02	65.0	± 9.6 %
		Y	20.90	96.88	28.05		65.0	
		Z	100.00	126.59	36.05		65.0	
10236-CAF	LTE-TDD (SC-FDMA, 1 RB, 10 MHz, 64-QAM)	X	31.57	102.49	28.64	6.02	65.0	± 9.6 %
		Y	18.06	93.27	26.50		65.0	
		Z	66.68	117.58	33.22		65.0	
10237-CAF	LTE-TDD (SC-FDMA, 1 RB, 10 MHz, QPSK)	X	40.98	114.23	34.22	6.02	65.0	± 9.6 %
		Y	20.43	100.76	30.72		65.0	
		Z	67.89	127.10	38.35		65.0	
10238-CAF	LTE-TDD (SC-FDMA, 1 RB, 15 MHz, 16-QAM)	X	44.02	109.54	31.08	6.02	65.0	± 9.6 %
		Y	20.87	96.85	28.04		65.0	
		Z	100.00	126.59	36.04		65.0	

10239-CAF	LTE-TDD (SC-FDMA, 1 RB, 15 MHz, 64-QAM)	X	31.34	102.40	28.62	6.02	65.0	± 9.6 %
		Y	17.95	93.19	26.48		65.0	
		Z	65.90	117.43	33.19		65.0	
10240-CAF	LTE-TDD (SC-FDMA, 1 RB, 15 MHz, QPSK)	X	40.84	114.17	34.21	6.02	65.0	± 9.6 %
		Y	20.37	100.72	30.70		65.0	
		Z	67.60	127.02	38.33		65.0	
10241-CAA	LTE-TDD (SC-FDMA, 50% RB, 1.4 MHz, 16-QAM)	X	13.50	87.98	27.59	6.98	65.0	± 9.6 %
		Y	11.90	84.56	26.53		65.0	
		Z	14.12	90.28	28.72		65.0	
10242-CAA	LTE-TDD (SC-FDMA, 50% RB, 1.4 MHz, 64-QAM)	X	13.27	87.58	27.38	6.98	65.0	± 9.6 %
		Y	11.12	83.03	25.85		65.0	
		Z	12.87	88.25	27.90		65.0	
10243-CAA	LTE-TDD (SC-FDMA, 50% RB, 1.4 MHz, QPSK)	X	9.24	81.69	25.97	6.98	65.0	± 9.6 %
		Y	9.29	80.98	25.85		65.0	
		Z	9.97	84.60	27.47		65.0	
10244-CAC	LTE-TDD (SC-FDMA, 50% RB, 3 MHz, 16-QAM)	X	10.07	81.06	21.15	3.98	65.0	± 9.6 %
		Y	9.37	79.84	21.15		65.0	
		Z	10.40	82.17	21.43		65.0	
10245-CAC	LTE-TDD (SC-FDMA, 50% RB, 3 MHz, 64-QAM)	X	9.92	80.58	20.93	3.98	65.0	± 9.6 %
		Y	9.29	79.47	20.97		65.0	
		Z	10.13	81.50	21.13		65.0	
10246-CAC	LTE-TDD (SC-FDMA, 50% RB, 3 MHz, QPSK)	X	9.36	82.64	21.70	3.98	65.0	± 9.6 %
		Y	8.42	80.73	21.28		65.0	
		Z	9.87	84.16	22.17		65.0	
10247-CAF	LTE-TDD (SC-FDMA, 50% RB, 5 MHz, 16-QAM)	X	7.85	77.75	20.44	3.98	65.0	± 9.6 %
		Y	7.56	76.79	20.29		65.0	
		Z	7.78	78.21	20.53		65.0	
10248-CAF	LTE-TDD (SC-FDMA, 50% RB, 5 MHz, 64-QAM)	X	7.84	77.28	20.24	3.98	65.0	± 9.6 %
		Y	7.59	76.41	20.13		65.0	
		Z	7.72	77.63	20.29		65.0	
10249-CAF	LTE-TDD (SC-FDMA, 50% RB, 5 MHz, QPSK)	X	10.16	84.10	22.78	3.98	65.0	± 9.6 %
		Y	9.02	81.83	22.19		65.0	
		Z	11.03	86.34	23.62		65.0	
10250-CAF	LTE-TDD (SC-FDMA, 50% RB, 10 MHz, 16-QAM)	X	8.66	79.41	22.21	3.98	65.0	± 9.6 %
		Y	8.28	78.20	21.90		65.0	
		Z	8.69	80.22	22.63		65.0	
10251-CAF	LTE-TDD (SC-FDMA, 50% RB, 10 MHz, 64-QAM)	X	8.19	77.31	21.11	3.98	65.0	± 9.6 %
		Y	7.93	76.33	20.88		65.0	
		Z	8.16	77.97	21.45		65.0	
10252-CAF	LTE-TDD (SC-FDMA, 50% RB, 10 MHz, QPSK)	X	9.91	83.04	22.96	3.98	65.0	± 9.6 %
		Y	9.02	81.03	22.39		65.0	
		Z	10.55	85.09	23.89		65.0	
10253-CAF	LTE-TDD (SC-FDMA, 50% RB, 15 MHz, 16-QAM)	X	8.10	76.42	20.99	3.98	65.0	± 9.6 %
		Y	7.91	75.57	20.78		65.0	
		Z	8.03	76.94	21.33		65.0	
10254-CAF	LTE-TDD (SC-FDMA, 50% RB, 15 MHz, 64-QAM)	X	8.47	77.16	21.59	3.98	65.0	± 9.6 %
		Y	8.27	76.28	21.37		65.0	
		Z	8.42	77.71	21.94		65.0	

10255-CAF	LTE-TDD (SC-FDMA, 50% RB, 15 MHz, QPSK)	X	8.92	79.74	21.91	3.98	65.0	± 9.6 %
		Y	8.44	78.38	21.54		65.0	
		Z	9.16	81.05	22.63		65.0	
10256-CAA	LTE-TDD (SC-FDMA, 100% RB, 1.4 MHz, 16-QAM)	X	8.96	78.82	19.56	3.98	65.0	± 9.6 %
		Y	8.66	78.38	19.92		65.0	
		Z	8.87	79.14	19.45		65.0	
10257-CAA	LTE-TDD (SC-FDMA, 100% RB, 1.4 MHz, 64-QAM)	X	8.76	78.15	19.23	3.98	65.0	± 9.6 %
		Y	8.57	77.86	19.65		65.0	
		Z	8.54	78.21	19.01		65.0	
10258-CAA	LTE-TDD (SC-FDMA, 100% RB, 1.4 MHz, QPSK)	X	8.23	80.27	20.30	3.98	65.0	± 9.6 %
		Y	7.69	79.06	20.18		65.0	
		Z	8.13	80.56	20.22		65.0	
10259-CAC	LTE-TDD (SC-FDMA, 100% RB, 3 MHz, 16-QAM)	X	8.16	78.29	21.04	3.98	65.0	± 9.6 %
		Y	7.83	77.23	20.83		65.0	
		Z	8.14	78.91	21.27		65.0	
10260-CAC	LTE-TDD (SC-FDMA, 100% RB, 3 MHz, 64-QAM)	X	8.18	78.05	20.97	3.98	65.0	± 9.6 %
		Y	7.89	77.07	20.79		65.0	
		Z	8.12	78.59	21.15		65.0	
10261-CAC	LTE-TDD (SC-FDMA, 100% RB, 3 MHz, QPSK)	X	9.70	83.10	22.69	3.98	65.0	± 9.6 %
		Y	8.75	81.03	22.13		65.0	
		Z	10.33	85.06	23.50		65.0	
10262-CAF	LTE-TDD (SC-FDMA, 100% RB, 5 MHz, 16-QAM)	X	8.65	79.37	22.18	3.98	65.0	± 9.6 %
		Y	8.27	78.16	21.87		65.0	
		Z	8.68	80.17	22.59		65.0	
10263-CAF	LTE-TDD (SC-FDMA, 100% RB, 5 MHz, 64-QAM)	X	8.18	77.31	21.11	3.98	65.0	± 9.6 %
		Y	7.93	76.34	20.88		65.0	
		Z	8.15	77.96	21.45		65.0	
10264-CAF	LTE-TDD (SC-FDMA, 100% RB, 5 MHz, QPSK)	X	9.85	82.90	22.89	3.98	65.0	± 9.6 %
		Y	8.97	80.91	22.33		65.0	
		Z	10.47	84.92	23.82		65.0	
10265-CAF	LTE-TDD (SC-FDMA, 100% RB, 10 MHz, 16-QAM)	X	8.32	77.00	21.17	3.98	65.0	± 9.6 %
		Y	8.10	76.11	20.95		65.0	
		Z	8.24	77.53	21.55		65.0	
10266-CAF	LTE-TDD (SC-FDMA, 100% RB, 10 MHz, 64-QAM)	X	8.68	77.72	21.80	3.98	65.0	± 9.6 %
		Y	8.45	76.80	21.57		65.0	
		Z	8.63	78.31	22.20		65.0	
10267-CAF	LTE-TDD (SC-FDMA, 100% RB, 10 MHz, QPSK)	X	9.19	80.02	21.78	3.98	65.0	± 9.6 %
		Y	8.67	78.65	21.41		65.0	
		Z	9.48	81.42	22.54		65.0	
10268-CAF	LTE-TDD (SC-FDMA, 100% RB, 15 MHz, 16-QAM)	X	8.76	76.52	21.32	3.98	65.0	± 9.6 %
		Y	8.60	75.79	21.15		65.0	
		Z	8.66	76.94	21.68		65.0	
10269-CAF	LTE-TDD (SC-FDMA, 100% RB, 15 MHz, 64-QAM)	X	8.68	76.12	21.24	3.98	65.0	± 9.6 %
		Y	8.54	75.43	21.08		65.0	
		Z	8.58	76.51	21.57		65.0	
10270-CAF	LTE-TDD (SC-FDMA, 100% RB, 15 MHz, QPSK)	X	8.76	77.59	20.98	3.98	65.0	± 9.6 %
		Y	8.48	76.66	20.76		65.0	
		Z	8.82	78.43	21.53		65.0	

10274-CAB	UMTS-FDD (HSUPA, Subtest 5, 3GPP Rel8.10)	X	2.75	67.54	16.13	0.00	150.0	± 9.6 %
		Y	2.59	65.84	14.97		150.0	
		Z	2.62	66.79	15.44		150.0	
10275-CAB	UMTS-FDD (HSUPA, Subtest 5, 3GPP Rel8.4)	X	1.98	71.72	17.77	0.00	150.0	± 9.6 %
		Y	1.57	66.85	14.80		150.0	
		Z	1.68	68.85	15.99		150.0	
10277-CAA	PHS (QPSK)	X	5.52	68.98	13.68	9.03	50.0	± 9.6 %
		Y	6.18	70.61	15.13		50.0	
		Z	5.33	69.04	13.51		50.0	
10278-CAA	PHS (QPSK, BW 884MHz, Rolloff 0.5)	X	8.68	78.27	19.91	9.03	50.0	± 9.6 %
		Y	9.24	79.43	21.04		50.0	
		Z	9.06	79.61	20.36		50.0	
10279-CAA	PHS (QPSK, BW 884MHz, Rolloff 0.38)	X	8.84	78.47	20.00	9.03	50.0	± 9.6 %
		Y	9.40	79.62	21.12		50.0	
		Z	9.21	79.79	20.45		50.0	
10290-AAB	CDMA2000, RC1, SO55, Full Rate	X	2.53	76.75	18.53	0.00	150.0	± 9.6 %
		Y	1.47	67.51	13.90		150.0	
		Z	1.65	70.41	15.02		150.0	
10291-AAB	CDMA2000, RC3, SO55, Full Rate	X	1.44	74.15	17.52	0.00	150.0	± 9.6 %
		Y	0.84	64.78	12.27		150.0	
		Z	0.91	67.24	13.41		150.0	
10292-AAB	CDMA2000, RC3, SO32, Full Rate	X	2.94	86.43	22.66	0.00	150.0	± 9.6 %
		Y	0.94	67.21	13.88		150.0	
		Z	1.25	72.55	16.26		150.0	
10293-AAB	CDMA2000, RC3, SO3, Full Rate	X	8.52	104.26	28.75	0.00	150.0	± 9.6 %
		Y	1.19	70.50	15.89		150.0	
		Z	2.08	80.22	19.81		150.0	
10295-AAB	CDMA2000, RC1, SO3, 1/8th Rate 25 fr.	X	9.77	81.63	23.08	9.03	50.0	± 9.6 %
		Y	9.82	81.44	23.46		50.0	
		Z	11.19	84.96	24.41		50.0	
10297-AAD	LTE-FDD (SC-FDMA, 50% RB, 20 MHz, QPSK)	X	3.27	72.60	18.02	0.00	150.0	± 9.6 %
		Y	2.80	69.13	16.02		150.0	
		Z	2.88	70.48	16.86		150.0	
10298-AAD	LTE-FDD (SC-FDMA, 50% RB, 3 MHz, QPSK)	X	2.28	73.12	17.57	0.00	150.0	± 9.6 %
		Y	1.68	67.21	14.31		150.0	
		Z	1.73	69.06	15.02		150.0	
10299-AAD	LTE-FDD (SC-FDMA, 50% RB, 3 MHz, 16-QAM)	X	5.83	80.69	19.80	0.00	150.0	± 9.6 %
		Y	3.42	72.22	16.49		150.0	
		Z	4.30	76.07	17.39		150.0	
10300-AAD	LTE-FDD (SC-FDMA, 50% RB, 3 MHz, 64-QAM)	X	3.42	71.78	15.52	0.00	150.0	± 9.6 %
		Y	2.69	67.85	13.82		150.0	
		Z	2.73	68.87	13.61		150.0	
10301-AAA	IEEE 802.16e WIMAX (29:18, 5ms, 10MHz, QPSK, PUSC)	X	5.57	67.67	18.57	4.17	80.0	± 9.6 %
		Y	5.78	67.86	18.57		80.0	
		Z	5.72	68.56	18.87		80.0	
10302-AAA	IEEE 802.16e WIMAX (29:18, 5ms, 10MHz, QPSK, PUSC, 3 CTRL symbols)	X	6.16	68.78	19.58	4.96	80.0	± 9.6 %
		Y	6.30	68.51	19.30		80.0	
		Z	6.18	69.12	19.60		80.0	

10303-AAA	IEEE 802.16e WiMAX (31:15, 5ms, 10MHz, 64QAM, PUSC)	X	6.02	68.90	19.67	4.96	80.0	± 9.6 %
		Y	6.17	68.65	19.39		80.0	
		Z	6.04	69.21	19.66		80.0	
10304-AAA	IEEE 802.16e WiMAX (29:18, 5ms, 10MHz, 64QAM, PUSC)	X	5.66	68.19	18.86	4.17	80.0	± 9.6 %
		Y	5.77	67.85	18.54		80.0	
		Z	5.66	68.44	18.81		80.0	
10305-AAA	IEEE 802.16e WiMAX (31:15, 10ms, 10MHz, 64QAM, PUSC, 15 symbols)	X	7.03	75.37	23.25	6.02	50.0	± 9.6 %
		Y	9.48	82.40	26.40		50.0	
		Z	9.45	83.47	26.75		50.0	
10306-AAA	IEEE 802.16e WiMAX (29:18, 10ms, 10MHz, 64QAM, PUSC, 18 symbols)	X	6.41	71.60	21.68	6.02	50.0	± 9.6 %
		Y	6.61	71.33	21.32		50.0	
		Z	6.53	72.26	21.74		50.0	
10307-AAA	IEEE 802.16e WiMAX (29:18, 10ms, 10MHz, QPSK, PUSC, 18 symbols)	X	6.53	72.42	21.88	6.02	50.0	± 9.6 %
		Y	6.71	72.00	21.44		50.0	
		Z	6.64	73.01	21.90		50.0	
10308-AAA	IEEE 802.16e WiMAX (29:18, 10ms, 10MHz, 16QAM, PUSC)	X	6.58	72.85	22.10	6.02	50.0	± 9.6 %
		Y	7.88	77.20	24.23		50.0	
		Z	6.72	73.52	22.14		50.0	
10309-AAA	IEEE 802.16e WiMAX (29:18, 10ms, 10MHz, 16QAM, AMC 2x3, 18 symbols)	X	6.53	71.94	21.86	6.02	50.0	± 9.6 %
		Y	6.73	71.62	21.48		50.0	
		Z	6.64	72.61	21.93		50.0	
10310-AAA	IEEE 802.16e WiMAX (29:18, 10ms, 10MHz, QPSK, AMC 2x3, 18 symbols)	X	6.43	71.87	21.71	6.02	50.0	± 9.6 %
		Y	6.62	71.53	21.32		50.0	
		Z	6.55	72.54	21.77		50.0	
10311-AAD	LTE-FDD (SC-FDMA, 100% RB, 15 MHz, QPSK)	X	3.66	71.76	17.57	0.00	150.0	± 9.6 %
		Y	3.14	68.49	15.73		150.0	
		Z	3.24	69.73	16.49		150.0	
10313-AAA	iDEN 1:3	X	6.89	76.52	17.70	6.99	70.0	± 9.6 %
		Y	6.61	75.87	17.81		70.0	
		Z	7.80	79.06	18.82		70.0	
10314-AAA	iDEN 1:6	X	8.95	82.07	22.06	10.00	30.0	± 9.6 %
		Y	7.91	79.82	21.63		30.0	
		Z	10.67	86.11	23.72		30.0	
10315-AAB	IEEE 802.11b WiFi 2.4 GHz (DSSS, 1 Mbps, 96pc duty cycle)	X	1.22	66.52	17.02	0.17	150.0	± 9.6 %
		Y	1.11	63.83	14.85		150.0	
		Z	1.15	65.06	15.82		150.0	
10316-AAB	IEEE 802.11g WiFi 2.4 GHz (ERP-OFDM, 6 Mbps, 96pc duty cycle)	X	4.79	67.26	16.63	0.17	150.0	± 9.6 %
		Y	4.77	66.71	16.27		150.0	
		Z	4.69	67.06	16.44		150.0	
10317-AAC	IEEE 802.11a WiFi 5 GHz (OFDM, 6 Mbps, 96pc duty cycle)	X	4.79	67.26	16.63	0.17	150.0	± 9.6 %
		Y	4.77	66.71	16.27		150.0	
		Z	4.69	67.06	16.44		150.0	
10400-AAD	IEEE 802.11ac WiFi (20MHz, 64-QAM, 99pc duty cycle)	X	4.91	67.58	16.59	0.00	150.0	± 9.6 %
		Y	4.87	66.94	16.16		150.0	
		Z	4.77	67.27	16.35		150.0	
10401-AAD	IEEE 802.11ac WiFi (40MHz, 64-QAM, 99pc duty cycle)	X	5.51	67.53	16.59	0.00	150.0	± 9.6 %
		Y	5.48	67.02	16.26		150.0	
		Z	5.43	67.39	16.46		150.0	

10402-AAD	IEEE 802.11ac WiFi (80MHz, 64-QAM, 99pc duty cycle)	X	5.82	68.12	16.73	0.00	150.0	± 9.6 %
		Y	5.79	67.61	16.40		150.0	
		Z	5.71	67.82	16.52		150.0	
10403-AAB	CDMA2000 (1xEV-DO, Rev. 0)	X	2.53	76.75	18.53	0.00	115.0	± 9.6 %
		Y	1.47	67.51	13.90		115.0	
		Z	1.65	70.41	15.02		115.0	
10404-AAB	CDMA2000 (1xEV-DO, Rev. A)	X	2.53	76.75	18.53	0.00	115.0	± 9.6 %
		Y	1.47	67.51	13.90		115.0	
		Z	1.65	70.41	15.02		115.0	
10406-AAB	CDMA2000, RC3, SO32, SCH0, Full Rate	X	100.00	121.33	30.70	0.00	100.0	± 9.6 %
		Y	17.68	98.28	25.62		100.0	
		Z	100.00	119.36	29.52		100.0	
10410-AAF	LTE-TDD (SC-FDMA, 1 RB, 10 MHz, QPSK, UL Subframe=2,3,4,7,8,9, Subframe Conf=4)	X	100.00	117.12	29.14	3.23	80.0	± 9.6 %
		Y	100.00	119.43	30.56		80.0	
		Z	100.00	119.33	29.99		80.0	
10415-AAA	IEEE 802.11b WiFi 2.4 GHz (DSSS, 1 Mbps, 99pc duty cycle)	X	1.05	64.70	16.09	0.00	150.0	± 9.6 %
		Y	0.96	62.34	13.96		150.0	
		Z	1.00	63.43	14.88		150.0	
10416-AAA	IEEE 802.11g WiFi 2.4 GHz (ERP-OFDM, 6 Mbps, 99pc duty cycle)	X	4.70	67.17	16.53	0.00	150.0	± 9.6 %
		Y	4.65	66.53	16.09		150.0	
		Z	4.59	66.90	16.28		150.0	
10417-AAB	IEEE 802.11a/h WiFi 5 GHz (OFDM, 6 Mbps, 99pc duty cycle)	X	4.70	67.17	16.53	0.00	150.0	± 9.6 %
		Y	4.65	66.53	16.09		150.0	
		Z	4.59	66.90	16.28		150.0	
10418-AAA	IEEE 802.11g WiFi 2.4 GHz (DSSS-OFDM, 6 Mbps, 99pc duty cycle, Long preamble)	X	4.69	67.33	16.54	0.00	150.0	± 9.6 %
		Y	4.64	66.65	16.08		150.0	
		Z	4.57	67.05	16.29		150.0	
10419-AAA	IEEE 802.11g WiFi 2.4 GHz (DSSS-OFDM, 6 Mbps, 99pc duty cycle, Short preamble)	X	4.71	67.28	16.55	0.00	150.0	± 9.6 %
		Y	4.66	66.62	16.10		150.0	
		Z	4.60	67.00	16.30		150.0	
10422-AAB	IEEE 802.11n (HT Greenfield, 7.2 Mbps, BPSK)	X	4.83	67.27	16.55	0.00	150.0	± 9.6 %
		Y	4.79	66.64	16.13		150.0	
		Z	4.72	67.01	16.31		150.0	
10423-AAB	IEEE 802.11n (HT Greenfield, 43.3 Mbps, 16-QAM)	X	5.04	67.66	16.69	0.00	150.0	± 9.6 %
		Y	5.01	67.04	16.28		150.0	
		Z	4.90	67.36	16.44		150.0	
10424-AAB	IEEE 802.11n (HT Greenfield, 72.2 Mbps, 64-QAM)	X	4.95	67.60	16.66	0.00	150.0	± 9.6 %
		Y	4.91	66.97	16.23		150.0	
		Z	4.82	67.30	16.41		150.0	
10425-AAB	IEEE 802.11n (HT Greenfield, 15 Mbps, BPSK)	X	5.50	67.84	16.74	0.00	150.0	± 9.6 %
		Y	5.49	67.38	16.43		150.0	
		Z	5.41	67.63	16.57		150.0	
10426-AAB	IEEE 802.11n (HT Greenfield, 90 Mbps, 16-QAM)	X	5.52	67.88	16.76	0.00	150.0	± 9.6 %
		Y	5.51	67.41	16.44		150.0	
		Z	5.41	67.63	16.57		150.0	

10427-AAB	IEEE 802.11n (HT Greenfield, 150 Mbps, 64-QAM)	X	5.54	67.91	16.77	0.00	150.0	± 9.6 %
		Y	5.52	67.43	16.44		150.0	
		Z	5.42	67.62	16.56		150.0	
10430-AAD	LTE-FDD (OFDMA, 5 MHz, E-TM 3.1)	X	4.52	71.31	18.76	0.00	150.0	± 9.6 %
		Y	4.32	69.77	17.85		150.0	
		Z	4.28	70.66	18.14		150.0	
10431-AAD	LTE-FDD (OFDMA, 10 MHz, E-TM 3.1)	X	4.46	67.83	16.68	0.00	150.0	± 9.6 %
		Y	4.39	67.02	16.13		150.0	
		Z	4.30	67.47	16.32		150.0	
10432-AAC	LTE-FDD (OFDMA, 15 MHz, E-TM 3.1)	X	4.74	67.68	16.66	0.00	150.0	± 9.6 %
		Y	4.69	66.98	16.18		150.0	
		Z	4.59	67.35	16.37		150.0	
10433-AAC	LTE-FDD (OFDMA, 20 MHz, E-TM 3.1)	X	4.97	67.65	16.69	0.00	150.0	± 9.6 %
		Y	4.93	67.02	16.26		150.0	
		Z	4.83	67.34	16.43		150.0	
10434-AAA	W-CDMA (BS Test Model 1, 64 DPCH)	X	4.66	72.23	18.86	0.00	150.0	± 9.6 %
		Y	4.38	70.37	17.81		150.0	
		Z	4.38	71.47	18.13		150.0	
10435-AAF	LTE-TDD (SC-FDMA, 1 RB, 20 MHz, QPSK, UL Subframe=2,3,4,7,8,9)	X	100.00	116.95	29.06	3.23	80.0	± 9.6 %
		Y	100.00	119.28	30.50		80.0	
		Z	100.00	119.16	29.91		80.0	
10447-AAD	LTE-FDD (OFDMA, 5 MHz, E-TM 3.1, Clipping 44%)	X	3.81	68.11	16.36	0.00	150.0	± 9.6 %
		Y	3.69	66.93	15.60		150.0	
		Z	3.61	67.54	15.77		150.0	
10448-AAD	LTE-FDD (OFDMA, 10 MHz, E-TM 3.1, Clipping 44%)	X	4.28	67.62	16.54	0.00	150.0	± 9.6 %
		Y	4.20	66.78	15.97		150.0	
		Z	4.13	67.25	16.18		150.0	
10449-AAC	LTE-FDD (OFDMA, 15 MHz, E-TM 3.1, Clipping 44%)	X	4.52	67.52	16.57	0.00	150.0	± 9.6 %
		Y	4.46	66.78	16.07		150.0	
		Z	4.39	67.18	16.27		150.0	
10450-AAC	LTE-FDD (OFDMA, 20 MHz, E-TM 3.1, Clipping 44%)	X	4.69	67.43	16.56	0.00	150.0	± 9.6 %
		Y	4.64	66.74	16.10		150.0	
		Z	4.58	67.10	16.28		150.0	
10451-AAA	W-CDMA (BS Test Model 1, 64 DPCH, Clipping 44%)	X	3.77	68.52	16.20	0.00	150.0	± 9.6 %
		Y	3.62	67.16	15.35		150.0	
		Z	3.52	67.79	15.46		150.0	
10456-AAB	IEEE 802.11ac WiFi (160MHz, 64-QAM, 99pc duty cycle)	X	6.36	68.45	16.90	0.00	150.0	± 9.6 %
		Y	6.35	68.04	16.63		150.0	
		Z	6.26	68.19	16.72		150.0	
10457-AAA	UMTS-FDD (DC-HSDPA)	X	3.87	65.81	16.29	0.00	150.0	± 9.6 %
		Y	3.82	65.17	15.81		150.0	
		Z	3.80	65.53	16.00		150.0	
10458-AAA	CDMA2000 (1xEV-DO, Rev. B, 2 carriers)	X	4.22	71.17	18.26	0.00	150.0	± 9.6 %
		Y	3.94	69.22	17.15		150.0	
		Z	4.01	70.71	17.59		150.0	
10459-AAA	CDMA2000 (1xEV-DO, Rev. B, 3 carriers)	X	5.26	68.17	18.33	0.00	150.0	± 9.6 %
		Y	5.16	67.29	17.83		150.0	
		Z	5.10	68.13	18.06		150.0	

10460-AAA	UMTS-FDD (WCDMA, AMR)	X	1.33	76.50	20.68	0.00	150.0	± 9.6 %
		Y	0.81	66.18	14.61		150.0	
		Z	0.95	69.86	16.92		150.0	
10461-AAA	LTE-TDD (SC-FDMA, 1 RB, 1.4 MHz, QPSK, UL Subframe=2,3,4,7,8,9)	X	100.00	120.53	30.78	3.29	80.0	± 9.6 %
		Y	100.00	120.99	31.37		80.0	
		Z	100.00	124.03	32.20		80.0	
10462-AAA	LTE-TDD (SC-FDMA, 1 RB, 1.4 MHz, 16-QAM, UL Subframe=2,3,4,7,8,9)	X	100.00	105.89	23.78	3.23	80.0	± 9.6 %
		Y	68.65	104.80	24.72		80.0	
		Z	100.00	107.80	24.46		80.0	
10463-AAA	LTE-TDD (SC-FDMA, 1 RB, 1.4 MHz, 64-QAM, UL Subframe=2,3,4,7,8,9)	X	34.22	92.48	19.99	3.23	80.0	± 9.6 %
		Y	20.78	89.39	20.30		80.0	
		Z	100.00	104.65	22.95		80.0	
10464-AAB	LTE-TDD (SC-FDMA, 1 RB, 3 MHz, QPSK, UL Subframe=2,3,4,7,8,9)	X	100.00	118.59	29.74	3.23	80.0	± 9.6 %
		Y	100.00	119.30	30.44		80.0	
		Z	100.00	122.02	31.12		80.0	
10465-AAB	LTE-TDD (SC-FDMA, 1 RB, 3 MHz, 16-QAM, UL Subframe=2,3,4,7,8,9)	X	100.00	105.43	23.55	3.23	80.0	± 9.6 %
		Y	36.42	97.15	22.76		80.0	
		Z	100.00	107.28	24.20		80.0	
10466-AAB	LTE-TDD (SC-FDMA, 1 RB, 3 MHz, 64-QAM, UL Subframe=2,3,4,7,8,9)	X	17.89	85.74	18.15	3.23	80.0	± 9.6 %
		Y	13.99	84.78	18.93		80.0	
		Z	100.00	104.18	22.73		80.0	
10467-AAE	LTE-TDD (SC-FDMA, 1 RB, 5 MHz, QPSK, UL Subframe=2,3,4,7,8,9)	X	100.00	118.79	29.83	3.23	80.0	± 9.6 %
		Y	100.00	119.47	30.52		80.0	
		Z	100.00	122.25	31.22		80.0	
10468-AAE	LTE-TDD (SC-FDMA, 1 RB, 5 MHz, 16-QAM, UL Subframe=2,3,4,7,8,9)	X	100.00	105.55	23.61	3.23	80.0	± 9.6 %
		Y	42.04	98.90	23.22		80.0	
		Z	100.00	107.44	24.27		80.0	
10469-AAE	LTE-TDD (SC-FDMA, 1 RB, 5 MHz, 64-QAM, UL Subframe=2,3,4,7,8,9)	X	18.42	86.04	18.22	3.23	80.0	± 9.6 %
		Y	14.20	84.95	18.97		80.0	
		Z	100.00	104.18	22.73		80.0	
10470-AAE	LTE-TDD (SC-FDMA, 1 RB, 10 MHz, QPSK, UL Subframe=2,3,4,7,8,9)	X	100.00	118.81	29.83	3.23	80.0	± 9.6 %
		Y	100.00	119.49	30.52		80.0	
		Z	100.00	122.27	31.22		80.0	
10471-AAE	LTE-TDD (SC-FDMA, 1 RB, 10 MHz, 16-QAM, UL Subframe=2,3,4,7,8,9)	X	100.00	105.50	23.58	3.23	80.0	± 9.6 %
		Y	42.06	98.87	23.20		80.0	
		Z	100.00	107.39	24.25		80.0	
10472-AAE	LTE-TDD (SC-FDMA, 1 RB, 10 MHz, 64-QAM, UL Subframe=2,3,4,7,8,9)	X	18.24	85.92	18.18	3.23	80.0	± 9.6 %
		Y	14.18	84.92	18.95		80.0	
		Z	100.00	104.13	22.70		80.0	
10473-AAE	LTE-TDD (SC-FDMA, 1 RB, 15 MHz, QPSK, UL Subframe=2,3,4,7,8,9)	X	100.00	118.78	29.81	3.23	80.0	± 9.6 %
		Y	100.00	119.47	30.51		80.0	
		Z	100.00	122.24	31.21		80.0	
10474-AAE	LTE-TDD (SC-FDMA, 1 RB, 15 MHz, 16-QAM, UL Subframe=2,3,4,7,8,9)	X	100.00	105.51	23.58	3.23	80.0	± 9.6 %
		Y	41.44	98.71	23.16		80.0	
		Z	100.00	107.39	24.25		80.0	
10475-AAE	LTE-TDD (SC-FDMA, 1 RB, 15 MHz, 64-QAM, UL Subframe=2,3,4,7,8,9)	X	18.00	85.79	18.14	3.23	80.0	± 9.6 %
		Y	14.03	84.82	18.92		80.0	
		Z	100.00	104.14	22.70		80.0	

10477-AAF	LTE-TDD (SC-FDMA, 1 RB, 20 MHz, 16-QAM, UL Subframe=2,3,4,7,8,9)	X	100.00	105.36	23.51	3.23	80.0	± 9.6 %
		Y	37.47	97.45	22.82		80.0	
		Z	100.00	107.23	24.17		80.0	
10478-AAF	LTE-TDD (SC-FDMA, 1 RB, 20 MHz, 64-QAM, UL Subframe=2,3,4,7,8,9)	X	17.45	85.46	18.04	3.23	80.0	± 9.6 %
		Y	13.87	84.66	18.87		80.0	
		Z	100.00	104.09	22.68		80.0	
10479-AAA	LTE-TDD (SC-FDMA, 50% RB, 1.4 MHz, QPSK, UL Subframe=2,3,4,7,8,9)	X	19.39	97.98	26.98	3.23	80.0	± 9.6 %
		Y	9.97	87.11	23.93		80.0	
		Z	31.86	106.57	29.32		80.0	
10480-AAA	LTE-TDD (SC-FDMA, 50% RB, 1.4 MHz, 16-QAM, UL Subframe=2,3,4,7,8,9)	X	21.21	93.58	24.05	3.23	80.0	± 9.6 %
		Y	10.89	84.18	21.64		80.0	
		Z	36.29	101.38	25.98		80.0	
10481-AAA	LTE-TDD (SC-FDMA, 50% RB, 1.4 MHz, 64-QAM, UL Subframe=2,3,4,7,8,9)	X	17.21	89.86	22.63	3.23	80.0	± 9.6 %
		Y	9.94	82.29	20.73		80.0	
		Z	25.83	95.66	24.06		80.0	
10482-AAB	LTE-TDD (SC-FDMA, 50% RB, 3 MHz, QPSK, UL Subframe=2,3,4,7,8,9)	X	7.29	82.03	20.94	2.23	80.0	± 9.6 %
		Y	4.92	75.71	18.70		80.0	
		Z	6.76	81.31	20.47		80.0	
10483-AAB	LTE-TDD (SC-FDMA, 50% RB, 3 MHz, 16-QAM, UL Subframe=2,3,4,7,8,9)	X	10.85	84.57	21.63	2.23	80.0	± 9.6 %
		Y	7.87	79.68	20.28		80.0	
		Z	11.75	85.89	21.77		80.0	
10484-AAB	LTE-TDD (SC-FDMA, 50% RB, 3 MHz, 64-QAM, UL Subframe=2,3,4,7,8,9)	X	9.90	83.05	21.15	2.23	80.0	± 9.6 %
		Y	7.49	78.74	19.95		80.0	
		Z	10.27	83.81	21.11		80.0	
10485-AAE	LTE-TDD (SC-FDMA, 50% RB, 5 MHz, QPSK, UL Subframe=2,3,4,7,8,9)	X	7.24	82.21	21.64	2.23	80.0	± 9.6 %
		Y	5.20	76.44	19.53		80.0	
		Z	6.79	81.80	21.44		80.0	
10486-AAE	LTE-TDD (SC-FDMA, 50% RB, 5 MHz, 16-QAM, UL Subframe=2,3,4,7,8,9)	X	5.34	74.77	18.72	2.23	80.0	± 9.6 %
		Y	4.58	71.87	17.58		80.0	
		Z	5.06	74.40	18.37		80.0	
10487-AAE	LTE-TDD (SC-FDMA, 50% RB, 5 MHz, 64-QAM, UL Subframe=2,3,4,7,8,9)	X	5.26	74.21	18.50	2.23	80.0	± 9.6 %
		Y	4.59	71.54	17.46		80.0	
		Z	4.97	73.79	18.13		80.0	
10488-AAE	LTE-TDD (SC-FDMA, 50% RB, 10 MHz, QPSK, UL Subframe=2,3,4,7,8,9)	X	6.65	79.53	21.12	2.23	80.0	± 9.6 %
		Y	5.36	75.42	19.52		80.0	
		Z	6.19	79.05	21.03		80.0	
10489-AAE	LTE-TDD (SC-FDMA, 50% RB, 10 MHz, 16-QAM, UL Subframe=2,3,4,7,8,9)	X	5.18	73.29	18.99	2.23	80.0	± 9.6 %
		Y	4.74	71.24	18.12		80.0	
		Z	4.94	73.02	18.87		80.0	
10490-AAE	LTE-TDD (SC-FDMA, 50% RB, 10 MHz, 64-QAM, UL Subframe=2,3,4,7,8,9)	X	5.20	72.84	18.84	2.23	80.0	± 9.6 %
		Y	4.81	70.96	18.04		80.0	
		Z	4.98	72.63	18.73		80.0	
10491-AAE	LTE-TDD (SC-FDMA, 50% RB, 15 MHz, QPSK, UL Subframe=2,3,4,7,8,9)	X	6.09	76.27	20.02	2.23	80.0	± 9.6 %
		Y	5.32	73.47	18.88		80.0	
		Z	5.74	75.88	19.98		80.0	
10492-AAE	LTE-TDD (SC-FDMA, 50% RB, 15 MHz, 16-QAM, UL Subframe=2,3,4,7,8,9)	X	5.29	71.86	18.63	2.23	80.0	± 9.6 %
		Y	5.01	70.36	17.98		80.0	
		Z	5.08	71.61	18.56		80.0	

10493-AAE	LTE-TDD (SC-FDMA, 50% RB, 15 MHz, 64-QAM, UL Subframe=2,3,4,7,8,9)	X	5.33	71.59	18.55	2.23	80.0	± 9.6 %
		Y	5.07	70.18	17.93		80.0	
		Z	5.12	71.37	18.48		80.0	
10494-AAF	LTE-TDD (SC-FDMA, 50% RB, 20 MHz, QPSK, UL Subframe=2,3,4,7,8,9)	X	7.00	78.56	20.67	2.23	80.0	± 9.6 %
		Y	5.85	75.11	19.32		80.0	
		Z	6.51	77.97	20.58		80.0	
10495-AAF	LTE-TDD (SC-FDMA, 50% RB, 20 MHz, 16-QAM, UL Subframe=2,3,4,7,8,9)	X	5.43	72.52	18.88	2.23	80.0	± 9.6 %
		Y	5.10	70.90	18.18		80.0	
		Z	5.18	72.18	18.80		80.0	
10496-AAF	LTE-TDD (SC-FDMA, 50% RB, 20 MHz, 64-QAM, UL Subframe=2,3,4,7,8,9)	X	5.43	71.99	18.72	2.23	80.0	± 9.6 %
		Y	5.15	70.54	18.08		80.0	
		Z	5.20	71.70	18.65		80.0	
10497-AAA	LTE-TDD (SC-FDMA, 100% RB, 1.4 MHz, QPSK, UL Subframe=2,3,4,7,8,9)	X	5.92	78.88	19.20	2.23	80.0	± 9.6 %
		Y	4.08	73.19	17.18		80.0	
		Z	5.11	76.97	18.12		80.0	
10498-AAA	LTE-TDD (SC-FDMA, 100% RB, 1.4 MHz, 16-QAM, UL Subframe=2,3,4,7,8,9)	X	4.00	70.80	15.33	2.23	80.0	± 9.6 %
		Y	3.45	68.39	14.47		80.0	
		Z	3.24	68.34	13.80		80.0	
10499-AAA	LTE-TDD (SC-FDMA, 100% RB, 1.4 MHz, 64-QAM, UL Subframe=2,3,4,7,8,9)	X	3.89	70.09	14.92	2.23	80.0	± 9.6 %
		Y	3.42	67.98	14.18		80.0	
		Z	3.10	67.51	13.31		80.0	
10500-AAB	LTE-TDD (SC-FDMA, 100% RB, 3 MHz, QPSK, UL Subframe=2,3,4,7,8,9)	X	6.64	80.28	21.17	2.23	80.0	± 9.6 %
		Y	5.11	75.52	19.37		80.0	
		Z	6.26	79.98	21.06		80.0	
10501-AAB	LTE-TDD (SC-FDMA, 100% RB, 3 MHz, 16-QAM, UL Subframe=2,3,4,7,8,9)	X	5.23	73.99	18.74	2.23	80.0	± 9.6 %
		Y	4.64	71.50	17.74		80.0	
		Z	4.99	73.73	18.51		80.0	
10502-AAB	LTE-TDD (SC-FDMA, 100% RB, 3 MHz, 64-QAM, UL Subframe=2,3,4,7,8,9)	X	5.24	73.65	18.58	2.23	80.0	± 9.6 %
		Y	4.68	71.29	17.63		80.0	
		Z	5.01	73.41	18.34		80.0	
10503-AAE	LTE-TDD (SC-FDMA, 100% RB, 5 MHz, QPSK, UL Subframe=2,3,4,7,8,9)	X	6.55	79.28	21.02	2.23	80.0	± 9.6 %
		Y	5.29	75.23	19.44		80.0	
		Z	6.10	78.82	20.93		80.0	
10504-AAE	LTE-TDD (SC-FDMA, 100% RB, 5 MHz, 16-QAM, UL Subframe=2,3,4,7,8,9)	X	5.15	73.20	18.93	2.23	80.0	± 9.6 %
		Y	4.72	71.16	18.07		80.0	
		Z	4.91	72.93	18.81		80.0	
10505-AAE	LTE-TDD (SC-FDMA, 100% RB, 5 MHz, 64-QAM, UL Subframe=2,3,4,7,8,9)	X	5.17	72.74	18.78	2.23	80.0	± 9.6 %
		Y	4.79	70.88	17.99		80.0	
		Z	4.95	72.53	18.68		80.0	
10506-AAE	LTE-TDD (SC-FDMA, 100% RB, 10 MHz, QPSK, UL Subframe=2,3,4,7,8,9)	X	6.92	78.38	20.59	2.23	80.0	± 9.6 %
		Y	5.80	74.97	19.25		80.0	
		Z	6.45	77.80	20.51		80.0	
10507-AAE	LTE-TDD (SC-FDMA, 100% RB, 10 MHz, 16-QAM, UL Subframe=2,3,4,7,8,9)	X	5.40	72.45	18.84	2.23	80.0	± 9.6 %
		Y	5.08	70.84	18.14		80.0	
		Z	5.16	72.12	18.76		80.0	

10508-AAE	LTE-TDD (SC-FDMA, 100% RB, 10 MHz, 64-QAM, UL Subframe=2,3,4,7,8,9)	X	5.41	71.92	18.67	2.23	80.0	± 9.6 %
		Y	5.13	70.47	18.04		80.0	
		Z	5.18	71.63	18.60		80.0	
10509-AAE	LTE-TDD (SC-FDMA, 100% RB, 15 MHz, QPSK, UL Subframe=2,3,4,7,8,9)	X	6.58	75.63	19.59	2.23	80.0	± 9.6 %
		Y	5.87	73.25	18.62		80.0	
		Z	6.22	75.16	19.53		80.0	
10510-AAE	LTE-TDD (SC-FDMA, 100% RB, 15 MHz, 16-QAM, UL Subframe=2,3,4,7,8,9)	X	5.77	71.69	18.60	2.23	80.0	± 9.6 %
		Y	5.53	70.43	18.05		80.0	
		Z	5.54	71.36	18.54		80.0	
10511-AAE	LTE-TDD (SC-FDMA, 100% RB, 15 MHz, 64-QAM, UL Subframe=2,3,4,7,8,9)	X	5.76	71.27	18.48	2.23	80.0	± 9.6 %
		Y	5.55	70.11	17.98		80.0	
		Z	5.55	70.97	18.43		80.0	
10512-AAF	LTE-TDD (SC-FDMA, 100% RB, 20 MHz, QPSK, UL Subframe=2,3,4,7,8,9)	X	7.41	78.14	20.36	2.23	80.0	± 9.6 %
		Y	6.29	75.00	19.14		80.0	
		Z	6.91	77.49	20.25		80.0	
10513-AAF	LTE-TDD (SC-FDMA, 100% RB, 20 MHz, 16-QAM, UL Subframe=2,3,4,7,8,9)	X	5.76	72.30	18.82	2.23	80.0	± 9.6 %
		Y	5.46	70.89	18.20		80.0	
		Z	5.50	71.88	18.73		80.0	
10514-AAF	LTE-TDD (SC-FDMA, 100% RB, 20 MHz, 64-QAM, UL Subframe=2,3,4,7,8,9)	X	5.67	71.64	18.62	2.23	80.0	± 9.6 %
		Y	5.42	70.37	18.07		80.0	
		Z	5.44	71.27	18.55		80.0	
10515-AAA	IEEE 802.11b WiFi 2.4 GHz (DSSS, 2 Mbps, 99pc duty cycle)	X	1.02	65.05	16.27	0.00	150.0	± 9.6 %
		Y	0.92	62.47	13.97		150.0	
		Z	0.96	63.65	14.96		150.0	
10516-AAA	IEEE 802.11b WiFi 2.4 GHz (DSSS, 5.5 Mbps, 99pc duty cycle)	X	2.27	97.97	29.12	0.00	150.0	± 9.6 %
		Y	0.48	66.91	14.54		150.0	
		Z	0.71	74.58	19.09		150.0	
10517-AAA	IEEE 802.11b WiFi 2.4 GHz (DSSS, 11 Mbps, 99pc duty cycle)	X	0.95	69.11	18.10	0.00	150.0	± 9.6 %
		Y	0.76	63.96	14.22		150.0	
		Z	0.83	66.01	15.81		150.0	
10518-AAB	IEEE 802.11a/h WiFi 5 GHz (OFDM, 9 Mbps, 99pc duty cycle)	X	4.70	67.26	16.52	0.00	150.0	± 9.6 %
		Y	4.65	66.61	16.07		150.0	
		Z	4.58	66.98	16.26		150.0	
10519-AAB	IEEE 802.11a/h WiFi 5 GHz (OFDM, 12 Mbps, 99pc duty cycle)	X	4.92	67.55	16.65	0.00	150.0	± 9.6 %
		Y	4.88	66.92	16.23		150.0	
		Z	4.78	67.24	16.39		150.0	
10520-AAB	IEEE 802.11a/h WiFi 5 GHz (OFDM, 18 Mbps, 99pc duty cycle)	X	4.77	67.56	16.60	0.00	150.0	± 9.6 %
		Y	4.73	66.89	16.14		150.0	
		Z	4.63	67.21	16.32		150.0	
10521-AAB	IEEE 802.11a/h WiFi 5 GHz (OFDM, 24 Mbps, 99pc duty cycle)	X	4.71	67.58	16.60	0.00	150.0	± 9.6 %
		Y	4.66	66.89	16.12		150.0	
		Z	4.57	67.22	16.30		150.0	
10522-AAB	IEEE 802.11a/h WiFi 5 GHz (OFDM, 36 Mbps, 99pc duty cycle)	X	4.75	67.52	16.61	0.00	150.0	± 9.6 %
		Y	4.70	66.83	16.14		150.0	
		Z	4.62	67.26	16.37		150.0	

10523-AAB	IEEE 802.11a/h WiFi 5 GHz (OFDM, 48 Mbps, 99pc duty cycle)	X	4.62	67.46	16.49	0.00	150.0	± 9.6 %
		Y	4.57	66.74	16.00		150.0	
		Z	4.50	67.13	16.21		150.0	
10524-AAB	IEEE 802.11a/h WiFi 5 GHz (OFDM, 54 Mbps, 99pc duty cycle)	X	4.70	67.49	16.61	0.00	150.0	± 9.6 %
		Y	4.65	66.81	16.14		150.0	
		Z	4.57	67.19	16.34		150.0	
10525-AAB	IEEE 802.11ac WiFi (20MHz, MCS0, 99pc duty cycle)	X	4.66	66.53	16.20	0.00	150.0	± 9.6 %
		Y	4.60	65.83	15.72		150.0	
		Z	4.54	66.22	15.93		150.0	
10526-AAB	IEEE 802.11ac WiFi (20MHz, MCS1, 99pc duty cycle)	X	4.87	66.95	16.34	0.00	150.0	± 9.6 %
		Y	4.81	66.24	15.87		150.0	
		Z	4.73	66.61	16.08		150.0	
10527-AAB	IEEE 802.11ac WiFi (20MHz, MCS2, 99pc duty cycle)	X	4.78	66.94	16.31	0.00	150.0	± 9.6 %
		Y	4.72	66.21	15.82		150.0	
		Z	4.64	66.58	16.02		150.0	
10528-AAB	IEEE 802.11ac WiFi (20MHz, MCS3, 99pc duty cycle)	X	4.80	66.96	16.34	0.00	150.0	± 9.6 %
		Y	4.74	66.23	15.85		150.0	
		Z	4.66	66.60	16.06		150.0	
10529-AAB	IEEE 802.11ac WiFi (20MHz, MCS4, 99pc duty cycle)	X	4.80	66.96	16.34	0.00	150.0	± 9.6 %
		Y	4.74	66.23	15.85		150.0	
		Z	4.66	66.60	16.06		150.0	
10531-AAB	IEEE 802.11ac WiFi (20MHz, MCS6, 99pc duty cycle)	X	4.82	67.12	16.37	0.00	150.0	± 9.6 %
		Y	4.76	66.38	15.88		150.0	
		Z	4.66	66.73	16.08		150.0	
10532-AAB	IEEE 802.11ac WiFi (20MHz, MCS7, 99pc duty cycle)	X	4.67	67.01	16.33	0.00	150.0	± 9.6 %
		Y	4.60	66.25	15.82		150.0	
		Z	4.52	66.59	16.02		150.0	
10533-AAB	IEEE 802.11ac WiFi (20MHz, MCS8, 99pc duty cycle)	X	4.82	66.98	16.32	0.00	150.0	± 9.6 %
		Y	4.75	66.24	15.83		150.0	
		Z	4.67	66.63	16.04		150.0	
10534-AAB	IEEE 802.11ac WiFi (40MHz, MCS0, 99pc duty cycle)	X	5.30	67.05	16.34	0.00	150.0	± 9.6 %
		Y	5.26	66.45	15.95		150.0	
		Z	5.18	66.72	16.10		150.0	
10535-AAB	IEEE 802.11ac WiFi (40MHz, MCS1, 99pc duty cycle)	X	5.37	67.19	16.39	0.00	150.0	± 9.6 %
		Y	5.33	66.59	16.00		150.0	
		Z	5.25	66.87	16.17		150.0	
10536-AAB	IEEE 802.11ac WiFi (40MHz, MCS2, 99pc duty cycle)	X	5.25	67.20	16.39	0.00	150.0	± 9.6 %
		Y	5.19	66.57	15.97		150.0	
		Z	5.12	66.85	16.14		150.0	
10537-AAB	IEEE 802.11ac WiFi (40MHz, MCS3, 99pc duty cycle)	X	5.31	67.16	16.37	0.00	150.0	± 9.6 %
		Y	5.26	66.55	15.97		150.0	
		Z	5.18	66.81	16.12		150.0	
10538-AAB	IEEE 802.11ac WiFi (40MHz, MCS4, 99pc duty cycle)	X	5.42	67.22	16.43	0.00	150.0	± 9.6 %
		Y	5.38	66.65	16.06		150.0	
		Z	5.28	66.86	16.19		150.0	
10540-AAB	IEEE 802.11ac WiFi (40MHz, MCS6, 99pc duty cycle)	X	5.32	67.17	16.43	0.00	150.0	± 9.6 %
		Y	5.28	66.57	16.03		150.0	
		Z	5.20	66.84	16.19		150.0	

10541-AAB	IEEE 802.11ac WiFi (40MHz, MCS7, 99pc duty cycle)	X	5.31	67.10	16.39	0.00	150.0	± 9.6 %
		Y	5.26	66.51	16.00		150.0	
		Z	5.17	66.72	16.13		150.0	
10542-AAB	IEEE 802.11ac WiFi (40MHz, MCS8, 99pc duty cycle)	X	5.45	67.10	16.40	0.00	150.0	± 9.6 %
		Y	5.41	66.53	16.03		150.0	
		Z	5.33	66.78	16.17		150.0	
10543-AAB	IEEE 802.11ac WiFi (40MHz, MCS9, 99pc duty cycle)	X	5.54	67.11	16.42	0.00	150.0	± 9.6 %
		Y	5.50	66.55	16.05		150.0	
		Z	5.41	66.81	16.20		150.0	
10544-AAB	IEEE 802.11ac WiFi (80MHz, MCS0, 99pc duty cycle)	X	5.58	67.14	16.31	0.00	150.0	± 9.6 %
		Y	5.53	66.57	15.94		150.0	
		Z	5.48	66.82	16.09		150.0	
10545-AAB	IEEE 802.11ac WiFi (80MHz, MCS1, 99pc duty cycle)	X	5.78	67.52	16.44	0.00	150.0	± 9.6 %
		Y	5.75	66.98	16.08		150.0	
		Z	5.68	67.24	16.24		150.0	
10546-AAB	IEEE 802.11ac WiFi (80MHz, MCS2, 99pc duty cycle)	X	5.68	67.44	16.42	0.00	150.0	± 9.6 %
		Y	5.63	66.87	16.05		150.0	
		Z	5.56	67.08	16.18		150.0	
10547-AAB	IEEE 802.11ac WiFi (80MHz, MCS3, 99pc duty cycle)	X	5.77	67.50	16.44	0.00	150.0	± 9.6 %
		Y	5.72	66.94	16.07		150.0	
		Z	5.64	67.14	16.20		150.0	
10548-AAB	IEEE 802.11ac WiFi (80MHz, MCS4, 99pc duty cycle)	X	6.03	68.45	16.88	0.00	150.0	± 9.6 %
		Y	6.07	68.12	16.63		150.0	
		Z	5.92	68.14	16.67		150.0	
10550-AAB	IEEE 802.11ac WiFi (80MHz, MCS6, 99pc duty cycle)	X	5.70	67.38	16.39	0.00	150.0	± 9.6 %
		Y	5.65	66.81	16.02		150.0	
		Z	5.58	67.05	16.17		150.0	
10551-AAB	IEEE 802.11ac WiFi (80MHz, MCS7, 99pc duty cycle)	X	5.71	67.48	16.40	0.00	150.0	± 9.6 %
		Y	5.68	66.94	16.05		150.0	
		Z	5.59	67.11	16.16		150.0	
10552-AAB	IEEE 802.11ac WiFi (80MHz, MCS8, 99pc duty cycle)	X	5.61	67.24	16.31	0.00	150.0	± 9.6 %
		Y	5.57	66.68	15.94		150.0	
		Z	5.50	66.90	16.07		150.0	
10553-AAB	IEEE 802.11ac WiFi (80MHz, MCS9, 99pc duty cycle)	X	5.71	67.29	16.35	0.00	150.0	± 9.6 %
		Y	5.66	66.72	15.98		150.0	
		Z	5.59	66.95	16.12		150.0	
10554-AAC	IEEE 802.11ac WiFi (160MHz, MCS0, 99pc duty cycle)	X	5.97	67.50	16.39	0.00	150.0	± 9.6 %
		Y	5.93	66.97	16.05		150.0	
		Z	5.88	67.19	16.18		150.0	
10555-AAC	IEEE 802.11ac WiFi (160MHz, MCS1, 99pc duty cycle)	X	6.13	67.85	16.53	0.00	150.0	± 9.6 %
		Y	6.09	67.34	16.20		150.0	
		Z	6.02	67.50	16.31		150.0	
10556-AAC	IEEE 802.11ac WiFi (160MHz, MCS2, 99pc duty cycle)	X	6.13	67.85	16.53	0.00	150.0	± 9.6 %
		Y	6.09	67.32	16.19		150.0	
		Z	6.04	67.54	16.32		150.0	
10557-AAC	IEEE 802.11ac WiFi (160MHz, MCS3, 99pc duty cycle)	X	6.12	67.82	16.54	0.00	150.0	± 9.6 %
		Y	6.09	67.31	16.21		150.0	
		Z	6.01	67.47	16.31		150.0	

10558-AAC	IEEE 802.11ac WiFi (160MHz, MCS4, 99pc duty cycle)	X	6.18	68.01	16.64	0.00	150.0	± 9.6 %
		Y	6.16	67.51	16.32		150.0	
		Z	6.06	67.65	16.41		150.0	
10560-AAC	IEEE 802.11ac WiFi (160MHz, MCS6, 99pc duty cycle)	X	6.18	67.85	16.60	0.00	150.0	± 9.6 %
		Y	6.14	67.33	16.27		150.0	
		Z	6.06	67.49	16.37		150.0	
10561-AAC	IEEE 802.11ac WiFi (160MHz, MCS7, 99pc duty cycle)	X	6.09	67.79	16.61	0.00	150.0	± 9.6 %
		Y	6.05	67.28	16.28		150.0	
		Z	5.98	67.45	16.39		150.0	
10562-AAC	IEEE 802.11ac WiFi (160MHz, MCS8, 99pc duty cycle)	X	6.24	68.26	16.85	0.00	150.0	± 9.6 %
		Y	6.23	67.81	16.55		150.0	
		Z	6.12	67.89	16.61		150.0	
10563-AAC	IEEE 802.11ac WiFi (160MHz, MCS9, 99pc duty cycle)	X	6.53	68.65	16.98	0.00	150.0	± 9.6 %
		Y	6.51	68.18	16.68		150.0	
		Z	6.46	68.48	16.85		150.0	
10564-AAA	IEEE 802.11g WiFi 2.4 GHz (DSSS-OFDM, 9 Mbps, 99pc duty cycle)	X	5.03	67.33	16.65	0.46	150.0	± 9.6 %
		Y	5.00	66.77	16.28		150.0	
		Z	4.92	67.10	16.44		150.0	
10565-AAA	IEEE 802.11g WiFi 2.4 GHz (DSSS-OFDM, 12 Mbps, 99pc duty cycle)	X	5.29	67.82	16.98	0.46	150.0	± 9.6 %
		Y	5.27	67.28	16.62		150.0	
		Z	5.16	67.55	16.76		150.0	
10566-AAA	IEEE 802.11g WiFi 2.4 GHz (DSSS-OFDM, 18 Mbps, 99pc duty cycle)	X	5.13	67.71	16.82	0.46	150.0	± 9.6 %
		Y	5.10	67.14	16.44		150.0	
		Z	5.00	67.42	16.59		150.0	
10567-AAA	IEEE 802.11g WiFi 2.4 GHz (DSSS-OFDM, 24 Mbps, 99pc duty cycle)	X	5.16	68.12	17.17	0.46	150.0	± 9.6 %
		Y	5.12	67.51	16.77		150.0	
		Z	5.02	67.79	16.92		150.0	
10568-AAA	IEEE 802.11g WiFi 2.4 GHz (DSSS-OFDM, 36 Mbps, 99pc duty cycle)	X	5.03	67.41	16.55	0.46	150.0	± 9.6 %
		Y	5.01	66.85	16.18		150.0	
		Z	4.92	67.21	16.38		150.0	
10569-AAA	IEEE 802.11g WiFi 2.4 GHz (DSSS-OFDM, 48 Mbps, 99pc duty cycle)	X	5.10	68.15	17.20	0.46	150.0	± 9.6 %
		Y	5.06	67.52	16.78		150.0	
		Z	4.97	67.85	16.96		150.0	
10570-AAA	IEEE 802.11g WiFi 2.4 GHz (DSSS-OFDM, 54 Mbps, 99pc duty cycle)	X	5.14	67.95	17.12	0.46	150.0	± 9.6 %
		Y	5.10	67.36	16.72		150.0	
		Z	5.01	67.70	16.91		150.0	
10571-AAA	IEEE 802.11b WiFi 2.4 GHz (DSSS, 1 Mbps, 90pc duty cycle)	X	1.44	68.10	17.64	0.46	130.0	± 9.6 %
		Y	1.29	65.22	15.55		130.0	
		Z	1.34	66.59	16.56		130.0	
10572-AAA	IEEE 802.11b WiFi 2.4 GHz (DSSS, 2 Mbps, 90pc duty cycle)	X	1.48	69.02	18.14	0.46	130.0	± 9.6 %
		Y	1.31	65.80	15.88		130.0	
		Z	1.37	67.32	16.97		130.0	
10573-AAA	IEEE 802.11b WiFi 2.4 GHz (DSSS, 5.5 Mbps, 90pc duty cycle)	X	100.00	147.85	39.47	0.46	130.0	± 9.6 %
		Y	2.24	82.28	20.72		130.0	
		Z	17.41	116.36	31.42		130.0	
10574-AAA	IEEE 802.11b WiFi 2.4 GHz (DSSS, 11 Mbps, 90pc duty cycle)	X	2.28	80.74	23.27	0.46	130.0	± 9.6 %
		Y	1.50	71.42	18.45		130.0	
		Z	1.74	75.30	20.61		130.0	

10575-AAA	IEEE 802.11g WiFi 2.4 GHz (DSSS-OFDM, 6 Mbps, 90pc duty cycle)	X	4.83	67.17	16.72	0.46	130.0	± 9.6 %
		Y	4.82	66.65	16.39		130.0	
		Z	4.74	66.99	16.56		130.0	
10576-AAA	IEEE 802.11g WiFi 2.4 GHz (DSSS-OFDM, 9 Mbps, 90pc duty cycle)	X	4.86	67.33	16.79	0.46	130.0	± 9.6 %
		Y	4.85	66.81	16.45		130.0	
		Z	4.77	67.14	16.61		130.0	
10577-AAA	IEEE 802.11g WiFi 2.4 GHz (DSSS-OFDM, 12 Mbps, 90pc duty cycle)	X	5.10	67.66	16.96	0.46	130.0	± 9.6 %
		Y	5.09	67.16	16.64		130.0	
		Z	4.98	67.44	16.78		130.0	
10578-AAA	IEEE 802.11g WiFi 2.4 GHz (DSSS-OFDM, 18 Mbps, 90pc duty cycle)	X	5.00	67.86	17.08	0.46	130.0	± 9.6 %
		Y	4.98	67.32	16.73		130.0	
		Z	4.88	67.61	16.88		130.0	
10579-AAA	IEEE 802.11g WiFi 2.4 GHz (DSSS-OFDM, 24 Mbps, 90pc duty cycle)	X	4.77	67.23	16.44	0.46	130.0	± 9.6 %
		Y	4.76	66.70	16.10		130.0	
		Z	4.66	66.98	16.25		130.0	
10580-AAA	IEEE 802.11g WiFi 2.4 GHz (DSSS-OFDM, 36 Mbps, 90pc duty cycle)	X	4.81	67.17	16.42	0.46	130.0	± 9.6 %
		Y	4.81	66.65	16.08		130.0	
		Z	4.70	66.98	16.26		130.0	
10581-AAA	IEEE 802.11g WiFi 2.4 GHz (DSSS-OFDM, 48 Mbps, 90pc duty cycle)	X	4.91	67.97	17.05	0.46	130.0	± 9.6 %
		Y	4.89	67.40	16.68		130.0	
		Z	4.78	67.68	16.84		130.0	
10582-AAA	IEEE 802.11g WiFi 2.4 GHz (DSSS-OFDM, 54 Mbps, 90pc duty cycle)	X	4.72	66.95	16.22	0.46	130.0	± 9.6 %
		Y	4.72	66.45	15.89		130.0	
		Z	4.61	66.75	16.05		130.0	
10583-AAB	IEEE 802.11a/h WiFi 5 GHz (OFDM, 6 Mbps, 90pc duty cycle)	X	4.83	67.17	16.72	0.46	130.0	± 9.6 %
		Y	4.82	66.65	16.39		130.0	
		Z	4.74	66.99	16.56		130.0	
10584-AAB	IEEE 802.11a/h WiFi 5 GHz (OFDM, 9 Mbps, 90pc duty cycle)	X	4.86	67.33	16.79	0.46	130.0	± 9.6 %
		Y	4.85	66.81	16.45		130.0	
		Z	4.77	67.14	16.61		130.0	
10585-AAB	IEEE 802.11a/h WiFi 5 GHz (OFDM, 12 Mbps, 90pc duty cycle)	X	5.10	67.66	16.96	0.46	130.0	± 9.6 %
		Y	5.09	67.16	16.64		130.0	
		Z	4.98	67.44	16.78		130.0	
10586-AAB	IEEE 802.11a/h WiFi 5 GHz (OFDM, 18 Mbps, 90pc duty cycle)	X	5.00	67.86	17.08	0.46	130.0	± 9.6 %
		Y	4.98	67.32	16.73		130.0	
		Z	4.88	67.61	16.88		130.0	
10587-AAB	IEEE 802.11a/h WiFi 5 GHz (OFDM, 24 Mbps, 90pc duty cycle)	X	4.77	67.23	16.44	0.46	130.0	± 9.6 %
		Y	4.76	66.70	16.10		130.0	
		Z	4.66	66.98	16.25		130.0	
10588-AAB	IEEE 802.11a/h WiFi 5 GHz (OFDM, 36 Mbps, 90pc duty cycle)	X	4.81	67.17	16.42	0.46	130.0	± 9.6 %
		Y	4.81	66.65	16.08		130.0	
		Z	4.70	66.98	16.26		130.0	
10589-AAB	IEEE 802.11a/h WiFi 5 GHz (OFDM, 48 Mbps, 90pc duty cycle)	X	4.91	67.97	17.05	0.46	130.0	± 9.6 %
		Y	4.89	67.40	16.68		130.0	
		Z	4.78	67.68	16.84		130.0	
10590-AAB	IEEE 802.11a/h WiFi 5 GHz (OFDM, 54 Mbps, 90pc duty cycle)	X	4.72	66.95	16.22	0.46	130.0	± 9.6 %
		Y	4.72	66.45	15.89		130.0	
		Z	4.61	66.75	16.05		130.0	

10591-AAB	IEEE 802.11n (HT Mixed, 20MHz, MCS0, 90pc duty cycle)	X	4.98	67.21	16.80	0.46	130.0	± 9.6 %
		Y	4.97	66.72	16.49		130.0	
		Z	4.89	67.03	16.64		130.0	
10592-AAB	IEEE 802.11n (HT Mixed, 20MHz, MCS1, 90pc duty cycle)	X	5.16	67.56	16.92	0.46	130.0	± 9.6 %
		Y	5.15	67.07	16.61		130.0	
		Z	5.05	67.37	16.77		130.0	
10593-AAB	IEEE 802.11n (HT Mixed, 20MHz, MCS2, 90pc duty cycle)	X	5.09	67.52	16.84	0.46	130.0	± 9.6 %
		Y	5.09	67.03	16.52		130.0	
		Z	4.98	67.31	16.67		130.0	
10594-AAB	IEEE 802.11n (HT Mixed, 20MHz, MCS3, 90pc duty cycle)	X	5.14	67.66	16.97	0.46	130.0	± 9.6 %
		Y	5.13	67.17	16.66		130.0	
		Z	5.03	67.46	16.81		130.0	
10595-AAB	IEEE 802.11n (HT Mixed, 20MHz, MCS4, 90pc duty cycle)	X	5.12	67.64	16.89	0.46	130.0	± 9.6 %
		Y	5.12	67.15	16.57		130.0	
		Z	5.00	67.42	16.71		130.0	
10596-AAB	IEEE 802.11n (HT Mixed, 20MHz, MCS5, 90pc duty cycle)	X	5.06	67.64	16.89	0.46	130.0	± 9.6 %
		Y	5.05	67.13	16.56		130.0	
		Z	4.94	67.43	16.72		130.0	
10597-AAB	IEEE 802.11n (HT Mixed, 20MHz, MCS6, 90pc duty cycle)	X	5.01	67.59	16.80	0.46	130.0	± 9.6 %
		Y	5.00	67.08	16.47		130.0	
		Z	4.89	67.36	16.62		130.0	
10598-AAB	IEEE 802.11n (HT Mixed, 20MHz, MCS7, 90pc duty cycle)	X	5.00	67.87	17.08	0.46	130.0	± 9.6 %
		Y	4.98	67.33	16.73		130.0	
		Z	4.87	67.59	16.87		130.0	
10599-AAB	IEEE 802.11n (HT Mixed, 40MHz, MCS0, 90pc duty cycle)	X	5.63	67.75	16.95	0.46	130.0	± 9.6 %
		Y	5.64	67.37	16.71		130.0	
		Z	5.54	67.56	16.82		130.0	
10600-AAB	IEEE 802.11n (HT Mixed, 40MHz, MCS1, 90pc duty cycle)	X	5.83	68.33	17.20	0.46	130.0	± 9.6 %
		Y	5.90	68.12	17.06		130.0	
		Z	5.71	68.07	17.05		130.0	
10601-AAB	IEEE 802.11n (HT Mixed, 40MHz, MCS2, 90pc duty cycle)	X	5.69	67.99	17.05	0.46	130.0	± 9.6 %
		Y	5.72	67.66	16.84		130.0	
		Z	5.58	67.77	16.91		130.0	
10602-AAB	IEEE 802.11n (HT Mixed, 40MHz, MCS3, 90pc duty cycle)	X	5.78	67.98	16.97	0.46	130.0	± 9.6 %
		Y	5.82	67.70	16.78		130.0	
		Z	5.67	67.76	16.83		130.0	
10603-AAB	IEEE 802.11n (HT Mixed, 40MHz, MCS4, 90pc duty cycle)	X	5.89	68.37	17.29	0.46	130.0	± 9.6 %
		Y	5.93	68.09	17.10		130.0	
		Z	5.76	68.08	17.11		130.0	
10604-AAB	IEEE 802.11n (HT Mixed, 40MHz, MCS5, 90pc duty cycle)	X	5.64	67.73	16.96	0.46	130.0	± 9.6 %
		Y	5.66	67.36	16.73		130.0	
		Z	5.55	67.52	16.82		130.0	
10605-AAB	IEEE 802.11n (HT Mixed, 40MHz, MCS6, 90pc duty cycle)	X	5.74	67.99	17.09	0.46	130.0	± 9.6 %
		Y	5.77	67.65	16.87		130.0	
		Z	5.66	67.85	16.99		130.0	
10606-AAB	IEEE 802.11n (HT Mixed, 40MHz, MCS7, 90pc duty cycle)	X	5.53	67.51	16.73	0.46	130.0	± 9.6 %
		Y	5.54	67.14	16.49		130.0	
		Z	5.44	67.32	16.59		130.0	

10607-AAB	IEEE 802.11ac WiFi (20MHz, MCS0, 90pc duty cycle)	X	4.82	66.53	16.43	0.46	130.0	± 9.6 %
		Y	4.79	65.97	16.07		130.0	
		Z	4.72	66.33	16.26		130.0	
10608-AAB	IEEE 802.11ac WiFi (20MHz, MCS1, 90pc duty cycle)	X	5.04	66.97	16.59	0.46	130.0	± 9.6 %
		Y	5.01	66.40	16.23		130.0	
		Z	4.92	66.75	16.42		130.0	
10609-AAB	IEEE 802.11ac WiFi (20MHz, MCS2, 90pc duty cycle)	X	4.93	66.86	16.46	0.46	130.0	± 9.6 %
		Y	4.90	66.28	16.10		130.0	
		Z	4.81	66.62	16.28		130.0	
10610-AAB	IEEE 802.11ac WiFi (20MHz, MCS3, 90pc duty cycle)	X	4.98	67.02	16.62	0.46	130.0	± 9.6 %
		Y	4.96	66.44	16.25		130.0	
		Z	4.86	66.77	16.43		130.0	
10611-AAB	IEEE 802.11ac WiFi (20MHz, MCS4, 90pc duty cycle)	X	4.90	66.85	16.48	0.46	130.0	± 9.6 %
		Y	4.88	66.29	16.12		130.0	
		Z	4.78	66.60	16.29		130.0	
10612-AAB	IEEE 802.11ac WiFi (20MHz, MCS5, 90pc duty cycle)	X	4.92	67.00	16.52	0.46	130.0	± 9.6 %
		Y	4.90	66.42	16.15		130.0	
		Z	4.80	66.76	16.34		130.0	
10613-AAB	IEEE 802.11ac WiFi (20MHz, MCS6, 90pc duty cycle)	X	4.94	66.93	16.43	0.46	130.0	± 9.6 %
		Y	4.91	66.35	16.06		130.0	
		Z	4.81	66.67	16.24		130.0	
10614-AAB	IEEE 802.11ac WiFi (20MHz, MCS7, 90pc duty cycle)	X	4.87	67.14	16.68	0.46	130.0	± 9.6 %
		Y	4.84	66.54	16.29		130.0	
		Z	4.74	66.84	16.45		130.0	
10615-AAB	IEEE 802.11ac WiFi (20MHz, MCS8, 90pc duty cycle)	X	4.90	66.65	16.25	0.46	130.0	± 9.6 %
		Y	4.88	66.09	15.90		130.0	
		Z	4.79	66.44	16.08		130.0	
10616-AAB	IEEE 802.11ac WiFi (40MHz, MCS0, 90pc duty cycle)	X	5.46	67.05	16.59	0.46	130.0	± 9.6 %
		Y	5.45	66.60	16.30		130.0	
		Z	5.36	66.82	16.44		130.0	
10617-AAB	IEEE 802.11ac WiFi (40MHz, MCS1, 90pc duty cycle)	X	5.52	67.16	16.60	0.46	130.0	± 9.6 %
		Y	5.52	66.71	16.32		130.0	
		Z	5.42	66.95	16.47		130.0	
10618-AAB	IEEE 802.11ac WiFi (40MHz, MCS2, 90pc duty cycle)	X	5.42	67.26	16.68	0.46	130.0	± 9.6 %
		Y	5.41	66.77	16.37		130.0	
		Z	5.32	67.01	16.51		130.0	
10619-AAB	IEEE 802.11ac WiFi (40MHz, MCS3, 90pc duty cycle)	X	5.44	67.06	16.51	0.46	130.0	± 9.6 %
		Y	5.43	66.58	16.21		130.0	
		Z	5.34	66.85	16.37		130.0	
10620-AAB	IEEE 802.11ac WiFi (40MHz, MCS4, 90pc duty cycle)	X	5.56	67.16	16.61	0.46	130.0	± 9.6 %
		Y	5.56	66.73	16.34		130.0	
		Z	5.44	66.90	16.45		130.0	
10621-AAB	IEEE 802.11ac WiFi (40MHz, MCS5, 90pc duty cycle)	X	5.53	67.24	16.76	0.46	130.0	± 9.6 %
		Y	5.52	66.78	16.47		130.0	
		Z	5.42	66.97	16.59		130.0	
10622-AAB	IEEE 802.11ac WiFi (40MHz, MCS6, 90pc duty cycle)	X	5.53	67.34	16.81	0.46	130.0	± 9.6 %
		Y	5.52	66.87	16.51		130.0	
		Z	5.43	67.11	16.66		130.0	

10623-AAB	IEEE 802.11ac WiFi (40MHz, MCS7, 90pc duty cycle)	X	5.42	66.95	16.50	0.46	130.0	± 9.6 %
		Y	5.42	66.51	16.22		130.0	
		Z	5.31	66.68	16.33		130.0	
10624-AAB	IEEE 802.11ac WiFi (40MHz, MCS8, 90pc duty cycle)	X	5.60	67.07	16.62	0.46	130.0	± 9.6 %
		Y	5.60	66.64	16.35		130.0	
		Z	5.51	66.87	16.48		130.0	
10625-AAB	IEEE 802.11ac WiFi (40MHz, MCS9, 90pc duty cycle)	X	5.97	68.00	17.12	0.46	130.0	± 9.6 %
		Y	6.00	67.65	16.90		130.0	
		Z	5.91	67.94	17.06		130.0	
10626-AAB	IEEE 802.11ac WiFi (80MHz, MCS0, 90pc duty cycle)	X	5.71	67.08	16.51	0.46	130.0	± 9.6 %
		Y	5.70	66.63	16.24		130.0	
		Z	5.64	66.86	16.37		130.0	
10627-AAB	IEEE 802.11ac WiFi (80MHz, MCS1, 90pc duty cycle)	X	5.96	67.58	16.71	0.46	130.0	± 9.6 %
		Y	5.96	67.18	16.47		130.0	
		Z	5.89	67.42	16.61		130.0	
10628-AAB	IEEE 802.11ac WiFi (80MHz, MCS2, 90pc duty cycle)	X	5.78	67.26	16.49	0.46	130.0	± 9.6 %
		Y	5.78	66.83	16.23		130.0	
		Z	5.69	67.01	16.35		130.0	
10629-AAB	IEEE 802.11ac WiFi (80MHz, MCS3, 90pc duty cycle)	X	5.87	67.32	16.51	0.46	130.0	± 9.6 %
		Y	5.88	66.93	16.27		130.0	
		Z	5.78	67.09	16.38		130.0	
10630-AAB	IEEE 802.11ac WiFi (80MHz, MCS4, 90pc duty cycle)	X	6.37	68.98	17.34	0.46	130.0	± 9.6 %
		Y	6.50	68.90	17.25		130.0	
		Z	6.28	68.77	17.22		130.0	
10631-AAB	IEEE 802.11ac WiFi (80MHz, MCS5, 90pc duty cycle)	X	6.28	68.81	17.44	0.46	130.0	± 9.6 %
		Y	6.32	68.50	17.24		130.0	
		Z	6.15	68.46	17.24		130.0	
10632-AAB	IEEE 802.11ac WiFi (80MHz, MCS6, 90pc duty cycle)	X	5.95	67.71	16.91	0.46	130.0	± 9.6 %
		Y	5.94	67.27	16.65		130.0	
		Z	5.85	67.45	16.76		130.0	
10633-AAB	IEEE 802.11ac WiFi (80MHz, MCS7, 90pc duty cycle)	X	5.89	67.53	16.65	0.46	130.0	± 9.6 %
		Y	5.90	67.16	16.42		130.0	
		Z	5.76	67.17	16.45		130.0	
10634-AAB	IEEE 802.11ac WiFi (80MHz, MCS8, 90pc duty cycle)	X	5.86	67.52	16.71	0.46	130.0	± 9.6 %
		Y	5.87	67.11	16.46		130.0	
		Z	5.74	67.18	16.52		130.0	
10635-AAB	IEEE 802.11ac WiFi (80MHz, MCS9, 90pc duty cycle)	X	5.74	66.83	16.11	0.46	130.0	± 9.6 %
		Y	5.74	66.43	15.86		130.0	
		Z	5.63	66.58	15.96		130.0	
10636-AAC	IEEE 802.11ac WiFi (160MHz, MCS0, 90pc duty cycle)	X	6.11	67.45	16.59	0.46	130.0	± 9.6 %
		Y	6.11	67.04	16.35		130.0	
		Z	6.05	67.24	16.46		130.0	
10637-AAC	IEEE 802.11ac WiFi (160MHz, MCS1, 90pc duty cycle)	X	6.29	67.85	16.76	0.46	130.0	± 9.6 %
		Y	6.30	67.47	16.54		130.0	
		Z	6.21	67.62	16.63		130.0	
10638-AAC	IEEE 802.11ac WiFi (160MHz, MCS2, 90pc duty cycle)	X	6.28	67.80	16.72	0.46	130.0	± 9.6 %
		Y	6.28	67.40	16.49		130.0	
		Z	6.21	67.59	16.60		130.0	

10639-AAC	IEEE 802.11ac WiFi (160MHz, MCS3, 90pc duty cycle)	X	6.29	67.84	16.79	0.46	130.0	± 9.6 %
		Y	6.29	67.45	16.56		130.0	
		Z	6.20	67.57	16.63		130.0	
10640-AAC	IEEE 802.11ac WiFi (160MHz, MCS4, 90pc duty cycle)	X	6.31	67.90	16.76	0.46	130.0	± 9.6 %
		Y	6.33	67.56	16.55		130.0	
		Z	6.21	67.63	16.61		130.0	
10641-AAC	IEEE 802.11ac WiFi (160MHz, MCS5, 90pc duty cycle)	X	6.30	67.63	16.64	0.46	130.0	± 9.6 %
		Y	6.31	67.25	16.42		130.0	
		Z	6.23	67.43	16.53		130.0	
10642-AAC	IEEE 802.11ac WiFi (160MHz, MCS6, 90pc duty cycle)	X	6.38	68.00	16.99	0.46	130.0	± 9.6 %
		Y	6.38	67.59	16.75		130.0	
		Z	6.28	67.72	16.83		130.0	
10643-AAC	IEEE 802.11ac WiFi (160MHz, MCS7, 90pc duty cycle)	X	6.20	67.66	16.73	0.46	130.0	± 9.6 %
		Y	6.21	67.28	16.50		130.0	
		Z	6.12	67.42	16.59		130.0	
10644-AAC	IEEE 802.11ac WiFi (160MHz, MCS8, 90pc duty cycle)	X	6.43	68.34	17.09	0.46	130.0	± 9.6 %
		Y	6.47	68.05	16.91		130.0	
		Z	6.32	68.03	16.92		130.0	
10645-AAC	IEEE 802.11ac WiFi (160MHz, MCS9, 90pc duty cycle)	X	6.73	68.76	17.24	0.46	130.0	± 9.6 %
		Y	6.75	68.40	17.03		130.0	
		Z	6.77	68.92	17.31		130.0	
10646-AAF	LTE-TDD (SC-FDMA, 1 RB, 5 MHz, QPSK, UL Subframe=2,7)	X	30.32	110.51	35.84	9.30	60.0	± 9.6 %
		Y	21.24	102.23	33.62		60.0	
		Z	57.15	128.16	41.75		60.0	
10647-AAF	LTE-TDD (SC-FDMA, 1 RB, 20 MHz, QPSK, UL Subframe=2,7)	X	31.53	112.13	36.44	9.30	60.0	± 9.6 %
		Y	21.67	103.39	34.10		60.0	
		Z	60.26	130.33	42.49		60.0	
10648-AAA	CDMA2000 (1x Advanced)	X	1.02	68.95	14.63	0.00	150.0	± 9.6 %
		Y	0.73	63.24	10.94		150.0	
		Z	0.74	64.50	11.46		150.0	
10652-AAD	LTE-TDD (OFDMA, 5 MHz, E-TM 3.1, Clipping 44%)	X	4.61	69.49	17.77	2.23	80.0	± 9.6 %
		Y	4.42	68.17	17.13		80.0	
		Z	4.44	69.19	17.56		80.0	
10653-AAD	LTE-TDD (OFDMA, 10 MHz, E-TM 3.1, Clipping 44%)	X	5.02	68.51	17.69	2.23	80.0	± 9.6 %
		Y	4.91	67.60	17.24		80.0	
		Z	4.88	68.24	17.54		80.0	
10654-AAD	LTE-TDD (OFDMA, 15 MHz, E-TM 3.1, Clipping 44%)	X	4.94	68.17	17.67	2.23	80.0	± 9.6 %
		Y	4.84	67.30	17.24		80.0	
		Z	4.81	67.88	17.53		80.0	
10655-AAE	LTE-TDD (OFDMA, 20 MHz, E-TM 3.1, Clipping 44%)	X	4.99	68.20	17.71	2.23	80.0	± 9.6 %
		Y	4.89	67.36	17.28		80.0	
		Z	4.87	67.89	17.57		80.0	
10658-AAA	Pulse Waveform (200Hz, 10%)	X	10.67	82.28	21.32	10.00	50.0	± 9.6 %
		Y	11.44	83.93	22.76		50.0	
		Z	15.38	89.40	23.97		50.0	
10659-AAA	Pulse Waveform (200Hz, 20%)	X	21.33	93.47	23.49	6.99	60.0	± 9.6 %
		Y	21.39	94.92	24.80		60.0	
		Z	100.00	116.73	29.85		60.0	

10660-AAA	Pulse Waveform (200Hz, 40%)	X	100.00	113.01	26.63	3.98	80.0	± 9.6 %
		Y	100.00	115.25	27.91		80.0	
		Z	100.00	114.49	27.21		80.0	
10661-AAA	Pulse Waveform (200Hz, 60%)	X	100.00	114.40	25.85	2.22	100.0	± 9.6 %
		Y	100.00	114.52	26.06		100.0	
		Z	100.00	115.33	26.15		100.0	
10662-AAA	Pulse Waveform (200Hz, 80%)	X	100.00	122.98	27.56	0.97	120.0	± 9.6 %
		Y	100.00	113.64	23.74		120.0	
		Z	100.00	119.02	25.78		120.0	
10670-AAA	Bluetooth Low Energy	X	100.00	114.95	26.37	2.19	100.0	± 9.6 %
		Y	100.00	115.10	26.57		100.0	
		Z	100.00	115.80	26.64		100.0	

^E Uncertainty is determined using the max. deviation from linear response applying rectangular distribution and is expressed for the square of the field value.



Accredited by the Swiss Accreditation Service (SAS)
The Swiss Accreditation Service is one of the signatories to the EA
Multilateral Agreement for the recognition of calibration certificates

Accreditation No.: **SCS 0108**

Client **PC Test**

Certificate No: **EX3-7410_Jul18**

CALIBRATION CERTIFICATE

Object: **EX3DV4 - SN:7410**

Calibration procedure(s): **QA CAL-01.v9, QA CAL-23.v5, QA CAL-25.v6
Calibration procedure for dosimetric E-field probes** BN ✓
07/26/2018

Calibration date: **July 20, 2018**

This calibration certificate documents the traceability to national standards, which realize the physical units of measurements (SI).
The measurements and the uncertainties with confidence probability are given on the following pages and are part of the certificate.

All calibrations have been conducted in the closed laboratory facility: environment temperature (22 ± 3)°C and humidity < 70%.

Calibration Equipment used (M&TE critical for calibration)

Primary Standards	ID	Cal Date (Certificate No.)	Scheduled Calibration
Power meter NRP	SN: 104778	04-Apr-18 (No. 217-02672/02673)	Apr-19
Power sensor NRP-Z91	SN: 103244	04-Apr-18 (No. 217-02672)	Apr-19
Power sensor NRP-Z91	SN: 103245	04-Apr-18 (No. 217-02673)	Apr-19
Reference 20 dB Attenuator	SN: S5277 (20x)	04-Apr-18 (No. 217-02682)	Apr-19
Reference Probe ES3DV2	SN: 3013	30-Dec-17 (No. ES3-3013_Dec17)	Dec-18
DAE4	SN: 660	21-Dec-17 (No. DAE4-660_Dec17)	Dec-18
Secondary Standards	ID	Check Date (in house)	Scheduled Check
Power meter E4419B	SN: GB41293874	06-Apr-16 (in house check Jun-18)	In house check: Jun-20
Power sensor E4412A	SN: MY41498087	06-Apr-16 (in house check Jun-18)	In house check: Jun-20
Power sensor E4412A	SN: 000110210	06-Apr-16 (in house check Jun-18)	In house check: Jun-20
RF generator HP 8648C	SN: US3642U01700	04-Aug-99 (in house check Jun-18)	In house check: Jun-20
Network Analyzer E8358A	SN: US41080477	31-Mar-14 (in house check Oct-17)	In house check: Oct-18

Calibrated by: **Michael Weber** (Name) / **Laboratory Technician** (Function) / *[Signature]* (Signature)

Approved by: **Katja Pokovic** (Name) / **Technical Manager** (Function) / *[Signature]* (Signature)

Issued: July 21, 2018

This calibration certificate shall not be reproduced except in full without written approval of the laboratory.



Accredited by the Swiss Accreditation Service (SAS)

Accreditation No.: **SCS 0108**

The Swiss Accreditation Service is one of the signatories to the EA
 Multilateral Agreement for the recognition of calibration certificates

Glossary:

TSL	tissue simulating liquid
NORM _{x,y,z}	sensitivity in free space
ConvF	sensitivity in TSL / NORM _{x,y,z}
DCP	diode compression point
CF	crest factor (1/duty_cycle) of the RF signal
A, B, C, D	modulation dependent linearization parameters
Polarization φ	φ rotation around probe axis
Polarization ϑ	ϑ rotation around an axis that is in the plane normal to probe axis (at measurement center), i.e., $\vartheta = 0$ is normal to probe axis
Connector Angle	information used in DASY system to align probe sensor X to the robot coordinate system

Calibration is Performed According to the Following Standards:

- a) IEEE Std 1528-2013, "IEEE Recommended Practice for Determining the Peak Spatial-Averaged Specific Absorption Rate (SAR) in the Human Head from Wireless Communications Devices: Measurement Techniques", June 2013
- b) IEC 62209-1, "Measurement procedure for the assessment of Specific Absorption Rate (SAR) from hand-held and body-mounted devices used next to the ear (frequency range of 300 MHz to 6 GHz)", July 2016
- c) IEC 62209-2, "Procedure to determine the Specific Absorption Rate (SAR) for wireless communication devices used in close proximity to the human body (frequency range of 30 MHz to 6 GHz)", March 2010
- d) KDB 865664, "SAR Measurement Requirements for 100 MHz to 6 GHz"

Methods Applied and Interpretation of Parameters:

- *NORM_{x,y,z}*: Assessed for E-field polarization $\vartheta = 0$ ($f \leq 900$ MHz in TEM-cell; $f > 1800$ MHz: R22 waveguide). *NORM_{x,y,z}* are only intermediate values, i.e., the uncertainties of *NORM_{x,y,z}* does not affect the E^2 -field uncertainty inside TSL (see below *ConvF*).
- *NORM(f)_{x,y,z}* = *NORM_{x,y,z}* * *frequency_response* (see Frequency Response Chart). This linearization is implemented in DASY4 software versions later than 4.2. The uncertainty of the frequency response is included in the stated uncertainty of *ConvF*.
- *DCP_{x,y,z}*: DCP are numerical linearization parameters assessed based on the data of power sweep with CW signal (no uncertainty required). DCP does not depend on frequency nor media.
- *PAR*: PAR is the Peak to Average Ratio that is not calibrated but determined based on the signal characteristics
- *A_{x,y,z}*; *B_{x,y,z}*; *C_{x,y,z}*; *D_{x,y,z}*; *VR_{x,y,z}*: *A, B, C, D* are numerical linearization parameters assessed based on the data of power sweep for specific modulation signal. The parameters do not depend on frequency nor media. *VR* is the maximum calibration range expressed in RMS voltage across the diode.
- *ConvF and Boundary Effect Parameters*: Assessed in flat phantom using E-field (or Temperature Transfer Standard for $f \leq 800$ MHz) and inside waveguide using analytical field distributions based on power measurements for $f > 800$ MHz. The same setups are used for assessment of the parameters applied for boundary compensation (alpha, depth) of which typical uncertainty values are given. These parameters are used in DASY4 software to improve probe accuracy close to the boundary. The sensitivity in TSL corresponds to *NORM_{x,y,z}* * *ConvF* whereby the uncertainty corresponds to that given for *ConvF*. A frequency dependent *ConvF* is used in DASY version 4.4 and higher which allows extending the validity from ± 50 MHz to ± 100 MHz.
- *Spherical isotropy (3D deviation from isotropy)*: in a field of low gradients realized using a flat phantom exposed by a patch antenna.
- *Sensor Offset*: The sensor offset corresponds to the offset of virtual measurement center from the probe tip (on probe axis). No tolerance required.
- *Connector Angle*: The angle is assessed using the information gained by determining the *NORM_x* (no uncertainty required).

Probe EX3DV4

SN:7410

Manufactured: November 24, 2015
Calibrated: July 20, 2018

Calibrated for DASY/EASY Systems
(Note: non-compatible with DASY2 system!)

DASY/EASY - Parameters of Probe: EX3DV4 - SN:7410

Basic Calibration Parameters

	Sensor X	Sensor Y	Sensor Z	Unc (k=2)
Norm ($\mu\text{V}/(\text{V}/\text{m})^2$) ^A	0.41	0.47	0.43	$\pm 10.1 \%$
DCP (mV) ^B	93.6	99.2	96.3	

Modulation Calibration Parameters

UID	Communication System Name		A dB	B dB $\sqrt{\mu\text{V}}$	C	D dB	VR mV	Unc ^E (k=2)
0	CW	X	0.0	0.0	1.0	0.00	142.1	$\pm 2.5 \%$
		Y	0.0	0.0	1.0		157.1	
		Z	0.0	0.0	1.0		143.0	

Note: For details on UID parameters see Appendix.

Sensor Model Parameters

	C1 fF	C2 fF	α V^{-1}	T1 $\text{ms}\cdot\text{V}^{-2}$	T2 $\text{ms}\cdot\text{V}^{-1}$	T3 ms	T4 V^{-2}	T5 V^{-1}	T6
X	32.22	246.3	37.01	4.015	0.380	5.018	0.000	0.327	1.006
Y	34.20	252.5	34.94	7.011	0.000	5.034	0.846	0.193	1.003
Z	38.58	298.4	37.77	5.097	0.373	5.059	0.000	0.338	1.011

The reported uncertainty of measurement is stated as the standard uncertainty of measurement multiplied by the coverage factor $k=2$, which for a normal distribution corresponds to a coverage probability of approximately 95%.

^A The uncertainties of Norm X,Y,Z do not affect the E^2 -field uncertainty inside TSL (see Pages 5 and 6).

^B Numerical linearization parameter: uncertainty not required.

^E Uncertainty is determined using the max. deviation from linear response applying rectangular distribution and is expressed for the square of the field value.

DASY/EASY - Parameters of Probe: EX3DV4 - SN:7410

Calibration Parameter Determined in Head Tissue Simulating Media

f (MHz) ^C	Relative Permittivity ^F	Conductivity (S/m) ^F	ConvF X	ConvF Y	ConvF Z	Alpha ^G	Depth (mm) ^G	Unc (k=2)
750	41.9	0.89	10.13	10.13	10.13	0.37	0.98	± 12.0 %
835	41.5	0.90	9.81	9.81	9.81	0.47	0.80	± 12.0 %
1750	40.1	1.37	8.40	8.40	8.40	0.60	0.80	± 12.0 %
1900	40.0	1.40	8.16	8.16	8.16	0.56	0.80	± 12.0 %
2300	39.5	1.67	7.78	7.78	7.78	0.32	0.85	± 12.0 %
2450	39.2	1.80	7.50	7.50	7.50	0.34	0.84	± 12.0 %
2600	39.0	1.96	7.24	7.24	7.24	0.32	0.89	± 12.0 %

^C Frequency validity above 300 MHz of ± 100 MHz only applies for DASY v4.4 and higher (see Page 2), else it is restricted to ± 50 MHz. The uncertainty is the RSS of the ConvF uncertainty at calibration frequency and the uncertainty for the indicated frequency band. Frequency validity below 300 MHz is ± 10, 25, 40, 50 and 70 MHz for ConvF assessments at 30, 64, 128, 150 and 220 MHz respectively. Above 5 GHz frequency validity can be extended to ± 110 MHz.

^F At frequencies below 3 GHz, the validity of tissue parameters (ϵ and σ) can be relaxed to ± 10% if liquid compensation formula is applied to measured SAR values. At frequencies above 3 GHz, the validity of tissue parameters (ϵ and σ) is restricted to ± 5%. The uncertainty is the RSS of the ConvF uncertainty for indicated target tissue parameters.

^G Alpha/Depth are determined during calibration. SPEAG warrants that the remaining deviation due to the boundary effect after compensation is always less than ± 1% for frequencies below 3 GHz and below ± 2% for frequencies between 3-6 GHz at any distance larger than half the probe tip diameter from the boundary.

DASY/EASY - Parameters of Probe: EX3DV4 - SN:7410

Calibration Parameter Determined in Body Tissue Simulating Media

f (MHz) ^C	Relative Permittivity ^F	Conductivity (S/m) ^F	ConvF X	ConvF Y	ConvF Z	Alpha ^G	Depth (mm) ^G	Unc (k=2)
750	55.5	0.96	9.87	9.87	9.87	0.33	1.02	± 12.0 %
835	55.2	0.97	9.63	9.63	9.63	0.42	0.86	± 12.0 %
1750	53.4	1.49	8.06	8.06	8.06	0.35	0.85	± 12.0 %
1900	53.3	1.52	7.78	7.78	7.78	0.39	0.80	± 12.0 %
2300	52.9	1.81	7.64	7.64	7.64	0.35	0.85	± 12.0 %
2450	52.7	1.95	7.45	7.45	7.45	0.32	0.86	± 12.0 %
2600	52.5	2.16	7.34	7.34	7.34	0.31	0.94	± 12.0 %

^C Frequency validity above 300 MHz of ± 100 MHz only applies for DASY v4.4 and higher (see Page 2), else it is restricted to ± 50 MHz. The uncertainty is the RSS of the ConvF uncertainty at calibration frequency and the uncertainty for the indicated frequency band. Frequency validity below 300 MHz is ± 10, 25, 40, 50 and 70 MHz for ConvF assessments at 30, 64, 128, 150 and 220 MHz respectively. Above 5 GHz frequency validity can be extended to ± 110 MHz.

^F At frequencies below 3 GHz, the validity of tissue parameters (ϵ and σ) can be relaxed to ± 10% if liquid compensation formula is applied to measured SAR values. At frequencies above 3 GHz, the validity of tissue parameters (ϵ and σ) is restricted to ± 5%. The uncertainty is the RSS of the ConvF uncertainty for indicated target tissue parameters.

^G Alpha/Depth are determined during calibration. SPEAG warrants that the remaining deviation due to the boundary effect after compensation is always less than ± 1% for frequencies below 3 GHz and below ± 2% for frequencies between 3-6 GHz at any distance larger than half the probe tip diameter from the boundary.

Frequency Response of E-Field (TEM-Cell:ifi110 EXX, Waveguide: R22)

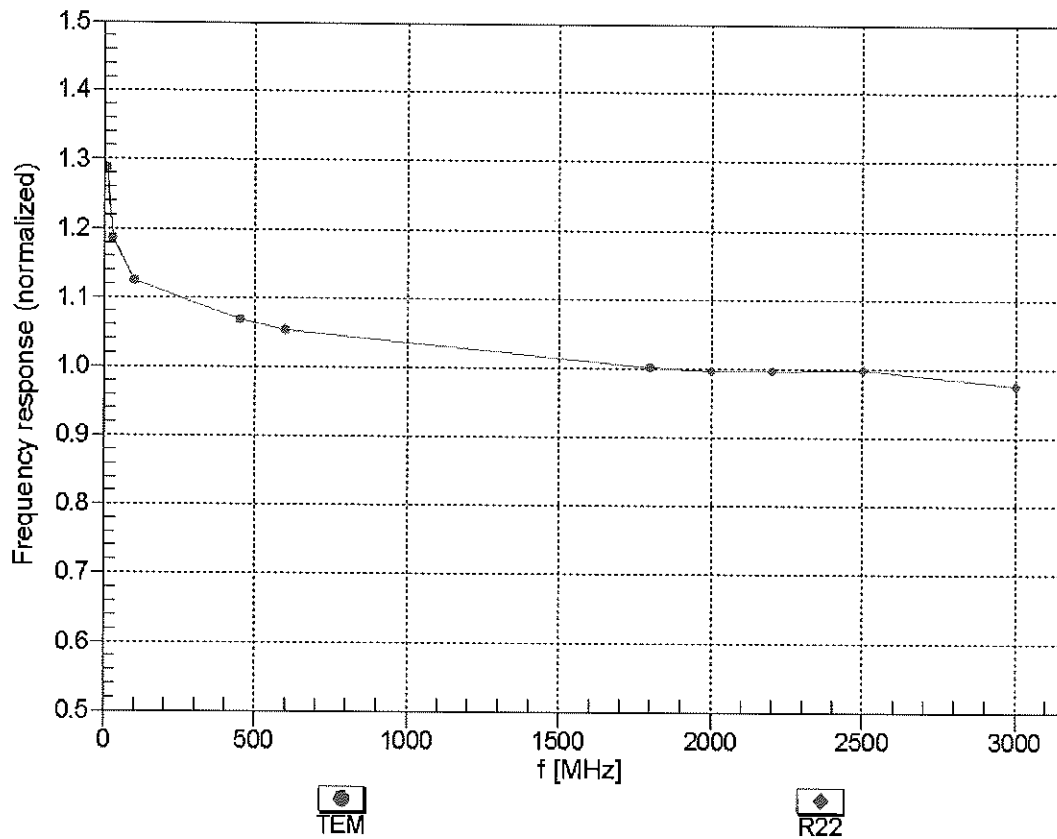

Uncertainty of Frequency Response of E-field: $\pm 6.3\%$ (k=2)

Receiving Pattern (ϕ), $\theta = 0^\circ$

f=600 MHz, TEM

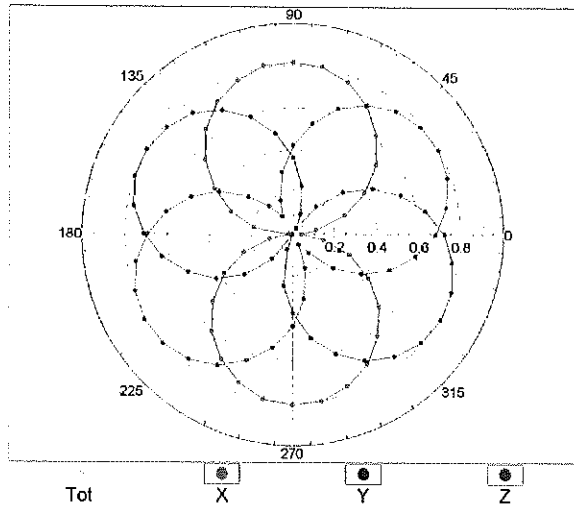

f=1800 MHz, R22

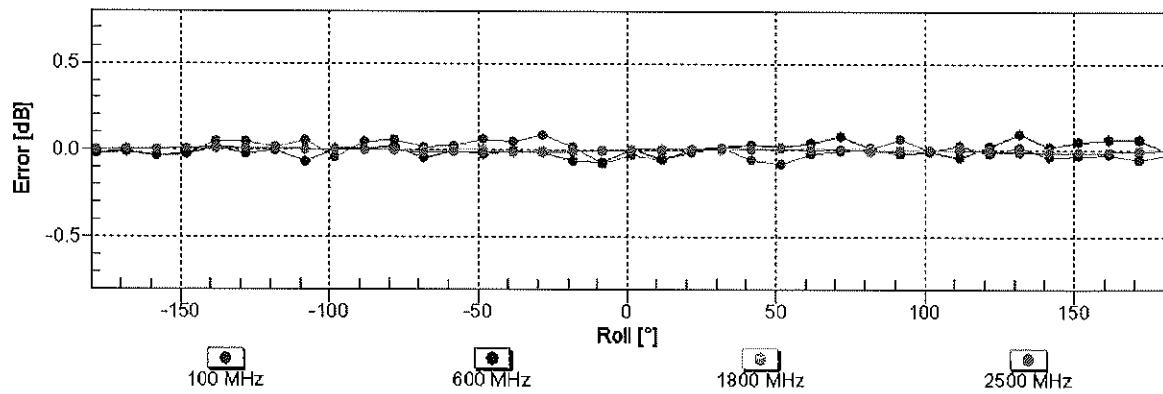
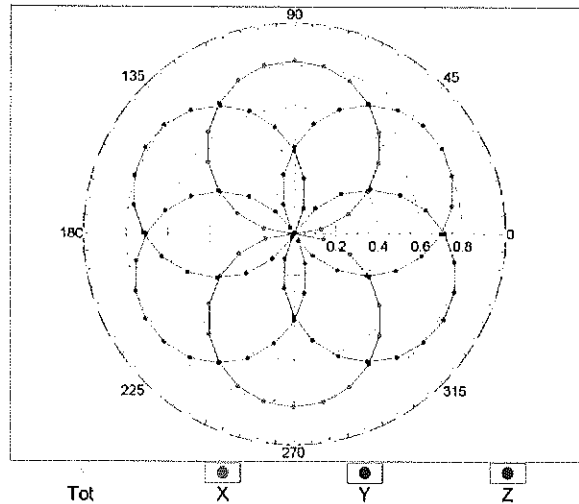

Uncertainty of Axial Isotropy Assessment: $\pm 0.5\%$ (k=2)

Dynamic Range $f(\text{SAR}_{\text{head}})$ (TEM cell , $f_{\text{eval}} = 1900 \text{ MHz}$)

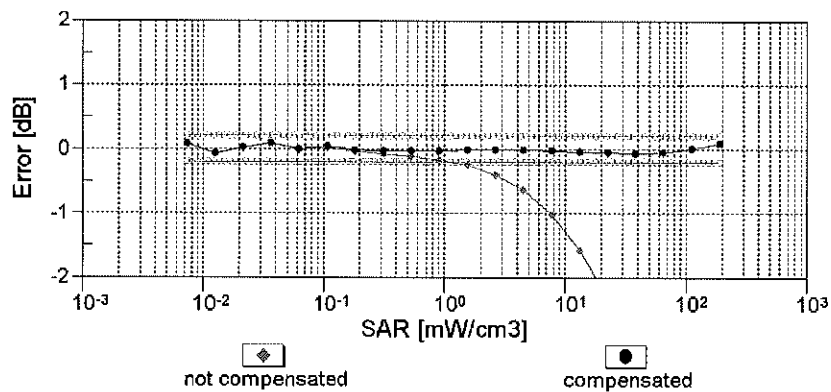
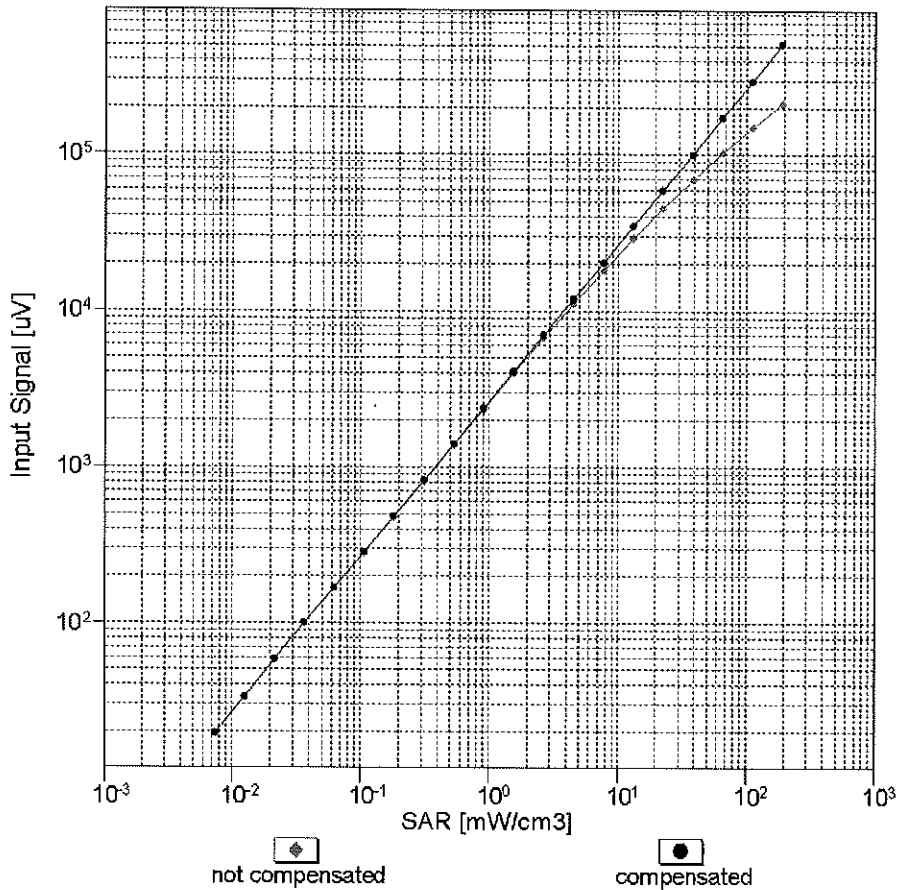

Uncertainty of Linearity Assessment: $\pm 0.6\%$ ($k=2$)

Conversion Factor Assessment

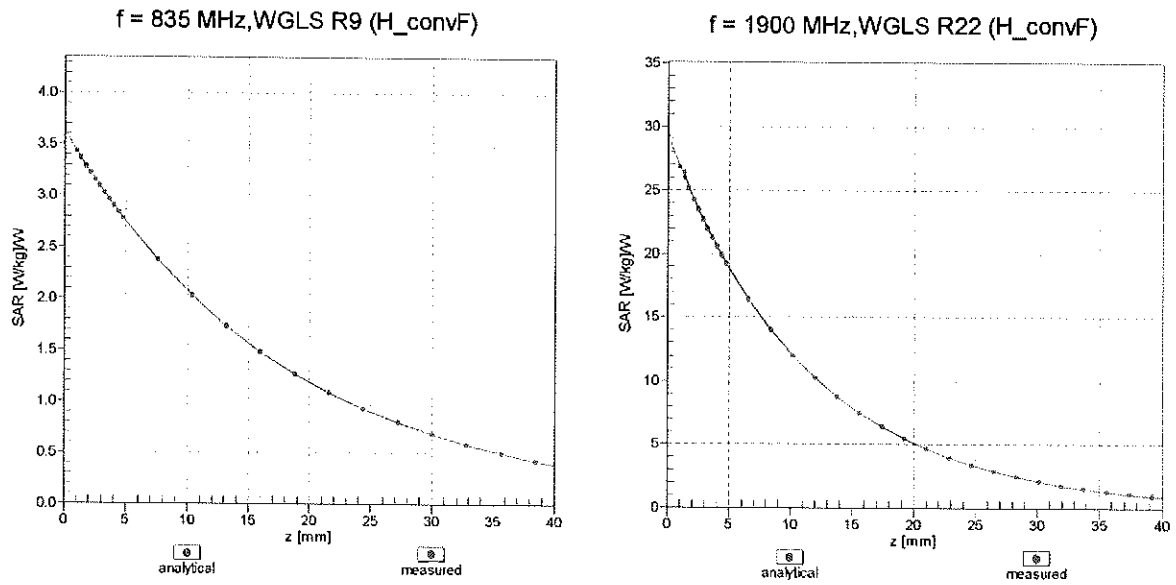

Deviation from Isotropy in Liquid

Error (ϕ, θ), f = 900 MHz

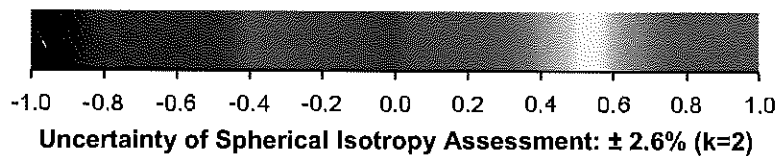
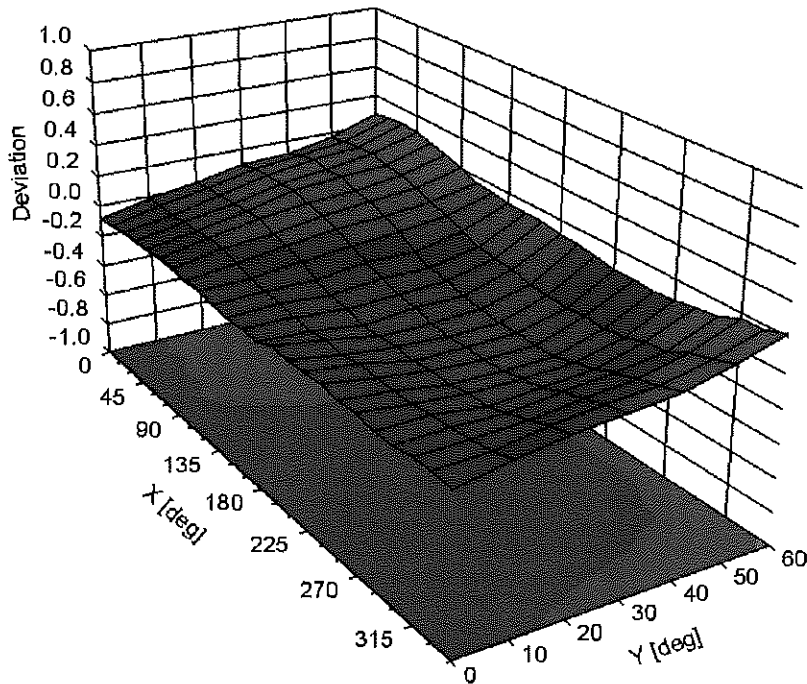

DASY/EASY - Parameters of Probe: EX3DV4 - SN:7410

Other Probe Parameters

Sensor Arrangement	Triangular
Connector Angle (°)	1.8
Mechanical Surface Detection Mode	enabled
Optical Surface Detection Mode	disabled
Probe Overall Length	337 mm
Probe Body Diameter	10 mm
Tip Length	9 mm
Tip Diameter	2.5 mm
Probe Tip to Sensor X Calibration Point	1 mm
Probe Tip to Sensor Y Calibration Point	1 mm
Probe Tip to Sensor Z Calibration Point	1 mm
Recommended Measurement Distance from Surface	1.4 mm

Appendix: Modulation Calibration Parameters

UID	Communication System Name		A dB	B dB μ V	C	D dB	VR mV	Max Unc ^E (k=2)
0	CW	X	0.00	0.00	1.00	0.00	142.1	$\pm 2.5\%$
		Y	0.00	0.00	1.00		157.1	
		Z	0.00	0.00	1.00		143.0	
10010- CAA	SAR Validation (Square, 100ms, 10ms)	X	1.62	62.34	7.74	10.00	20.0	$\pm 9.6\%$
		Y	1.47	62.51	7.58		20.0	
		Z	1.74	63.23	8.42		20.0	
10011- CAB	UMTS-FDD (WCDMA)	X	0.82	65.36	13.43	0.00	150.0	$\pm 9.6\%$
		Y	1.01	68.19	15.53		150.0	
		Z	0.83	64.89	13.22		150.0	
10012- CAB	IEEE 802.11b WiFi 2.4 GHz (DSSS, 1 Mbps)	X	1.03	62.67	14.19	0.41	150.0	$\pm 9.6\%$
		Y	1.12	63.85	15.21		150.0	
		Z	1.03	62.50	14.16		150.0	
10013- CAB	IEEE 802.11g WiFi 2.4 GHz (DSSS-OFDM, 6 Mbps)	X	4.54	66.46	16.76	1.46	150.0	$\pm 9.6\%$
		Y	4.63	66.78	17.00		150.0	
		Z	4.66	66.40	16.88		150.0	
10021- DAC	GSM-FDD (TDMA, GMSK)	X	13.15	84.51	17.52	9.39	50.0	$\pm 9.6\%$
		Y	100.00	105.54	22.55		50.0	
		Z	100.00	109.08	24.59		50.0	
10023- DAC	GPRS-FDD (TDMA, GMSK, TN 0)	X	7.05	77.63	15.35	9.57	50.0	$\pm 9.6\%$
		Y	100.00	104.89	22.31		50.0	
		Z	100.00	108.55	24.42		50.0	
10024- DAC	GPRS-FDD (TDMA, GMSK, TN 0-1)	X	100.00	103.12	20.53	6.56	60.0	$\pm 9.6\%$
		Y	100.00	106.39	21.86		60.0	
		Z	100.00	108.56	23.07		60.0	
10025- DAC	EDGE-FDD (TDMA, 8PSK, TN 0)	X	3.34	64.62	22.65	12.57	50.0	$\pm 9.6\%$
		Y	5.12	80.55	32.48		50.0	
		Z	3.40	65.03	23.22		50.0	
10026- DAC	EDGE-FDD (TDMA, 8PSK, TN 0-1)	X	5.08	79.74	27.91	9.56	60.0	$\pm 9.6\%$
		Y	6.12	86.23	31.42		60.0	
		Z	5.62	82.16	29.24		60.0	
10027- DAC	GPRS-FDD (TDMA, GMSK, TN 0-1-2)	X	100.00	101.64	19.06	4.80	80.0	$\pm 9.6\%$
		Y	100.00	109.60	22.50		80.0	
		Z	100.00	108.56	22.18		80.0	
10028- DAC	GPRS-FDD (TDMA, GMSK, TN 0-1-2-3)	X	100.00	99.62	17.55	3.55	100.0	$\pm 9.6\%$
		Y	100.00	115.32	24.21		100.0	
		Z	100.00	107.61	21.03		100.0	
10029- DAC	EDGE-FDD (TDMA, 8PSK, TN 0-1-2)	X	3.55	72.28	23.51	7.80	80.0	$\pm 9.6\%$
		Y	3.97	75.71	25.59		80.0	
		Z	3.84	73.87	24.49		80.0	
10030- CAA	IEEE 802.15.1 Bluetooth (GFSK, DH1)	X	2.93	72.58	11.67	5.30	70.0	$\pm 9.6\%$
		Y	100.00	104.73	20.69		70.0	
		Z	100.00	105.98	21.40		70.0	
10031- CAA	IEEE 802.15.1 Bluetooth (GFSK, DH3)	X	0.19	60.00	3.86	1.88	100.0	$\pm 9.6\%$
		Y	100.00	108.46	20.17		100.0	
		Z	0.20	60.00	4.39		100.0	

10032-CAA	IEEE 802.15.1 Bluetooth (GFSK, DH5)	X	8.28	60.36	1.45	1.17	100.0	± 9.6 %
		Y	100.00	125.60	25.79		100.0	
		Z	9.15	64.10	3.12		100.0	
10033-CAA	IEEE 802.15.1 Bluetooth (PI/4-DQPSK, DH1)	X	3.18	74.95	16.76	5.30	70.0	± 9.6 %
		Y	16.17	99.83	25.75		70.0	
		Z	6.70	87.29	22.45		70.0	
10034-CAA	IEEE 802.15.1 Bluetooth (PI/4-DQPSK, DH3)	X	1.10	65.34	10.90	1.88	100.0	± 9.6 %
		Y	2.67	76.50	16.58		100.0	
		Z	1.54	69.44	13.90		100.0	
10035-CAA	IEEE 802.15.1 Bluetooth (PI/4-DQPSK, DH5)	X	0.87	63.89	9.87	1.17	100.0	± 9.6 %
		Y	1.73	72.02	14.58		100.0	
		Z	1.13	66.49	12.17		100.0	
10036-CAA	IEEE 802.15.1 Bluetooth (8-DPSK, DH1)	X	3.74	77.33	17.73	5.30	70.0	± 9.6 %
		Y	34.06	110.90	28.74		70.0	
		Z	9.80	93.25	24.40		70.0	
10037-CAA	IEEE 802.15.1 Bluetooth (8-DPSK, DH3)	X	1.04	64.82	10.64	1.88	100.0	± 9.6 %
		Y	2.27	74.65	15.89		100.0	
		Z	1.43	68.68	13.56		100.0	
10038-CAA	IEEE 802.15.1 Bluetooth (8-DPSK, DH5)	X	0.88	64.05	10.08	1.17	100.0	± 9.6 %
		Y	1.75	72.43	14.90		100.0	
		Z	1.13	66.71	12.40		100.0	
10039-CAB	CDMA2000 (1xRTT, RC1)	X	0.74	62.99	8.94	0.00	150.0	± 9.6 %
		Y	1.38	69.75	13.20		150.0	
		Z	0.98	64.89	10.73		150.0	
10042-CAB	IS-54 / IS-136 FDD (TDMA/FDM, PI/4-DQPSK, Halfrate)	X	2.54	68.84	11.04	7.78	50.0	± 9.6 %
		Y	100.00	102.42	20.46		50.0	
		Z	100.00	104.71	21.76		50.0	
10044-CAA	IS-91/EIA/TIA-553 FDD (FDMA, FM)	X	0.06	120.88	5.44	0.00	150.0	± 9.6 %
		Y	0.00	104.37	4.38		150.0	
		Z	0.08	121.43	6.73		150.0	
10048-CAA	DECT (TDD, TDMA/FDM, GFSK, Full Slot, 24)	X	4.91	69.00	13.47	13.80	25.0	± 9.6 %
		Y	7.93	75.14	15.14		25.0	
		Z	10.77	79.26	17.66		25.0	
10049-CAA	DECT (TDD, TDMA/FDM, GFSK, Double Slot, 12)	X	4.71	71.69	13.37	10.79	40.0	± 9.6 %
		Y	12.12	82.16	16.51		40.0	
		Z	15.08	85.95	18.75		40.0	
10056-CAA	UMTS-TDD (TD-SCDMA, 1.28 Mcps)	X	9.20	83.60	20.05	9.03	50.0	± 9.6 %
		Y	100.00	119.47	30.42		50.0	
		Z	26.92	101.32	26.50		50.0	
10058-DAC	EDGE-FDD (TDMA, 8PSK, TN 0-1-2-3)	X	2.97	69.27	21.35	6.55	100.0	± 9.6 %
		Y	3.27	71.77	22.91		100.0	
		Z	3.17	70.45	22.11		100.0	
10059-CAB	IEEE 802.11b WiFi 2.4 GHz (DSSS, 2 Mbps)	X	1.02	63.20	14.50	0.61	110.0	± 9.6 %
		Y	1.12	64.64	15.70		110.0	
		Z	1.03	63.16	14.59		110.0	
10060-CAB	IEEE 802.11b WiFi 2.4 GHz (DSSS, 5.5 Mbps)	X	1.55	78.45	19.20	1.30	110.0	± 9.6 %
		Y	11.63	111.29	30.45		110.0	
		Z	2.11	82.91	21.03		110.0	

10061-CAB	IEEE 802.11b WiFi 2.4 GHz (DSSS, 11 Mbps)	X	1.39	70.50	17.86	2.04	110.0	± 9.6 %
		Y	1.94	76.74	21.24		110.0	
		Z	1.58	72.59	19.16		110.0	
10062-CAC	IEEE 802.11a/h WiFi 5 GHz (OFDM, 6 Mbps)	X	4.34	66.44	16.20	0.49	100.0	± 9.6 %
		Y	4.45	66.80	16.45		100.0	
		Z	4.46	66.35	16.27		100.0	
10063-CAC	IEEE 802.11a/h WiFi 5 GHz (OFDM, 9 Mbps)	X	4.35	66.52	16.28	0.72	100.0	± 9.6 %
		Y	4.46	66.88	16.54		100.0	
		Z	4.47	66.44	16.36		100.0	
10064-CAC	IEEE 802.11a/h WiFi 5 GHz (OFDM, 12 Mbps)	X	4.58	66.71	16.48	0.86	100.0	± 9.6 %
		Y	4.69	67.07	16.73		100.0	
		Z	4.73	66.68	16.59		100.0	
10065-CAC	IEEE 802.11a/h WiFi 5 GHz (OFDM, 18 Mbps)	X	4.45	66.52	16.53	1.21	100.0	± 9.6 %
		Y	4.56	66.89	16.79		100.0	
		Z	4.60	66.53	16.67		100.0	
10066-CAC	IEEE 802.11a/h WiFi 5 GHz (OFDM, 24 Mbps)	X	4.45	66.48	16.65	1.46	100.0	± 9.6 %
		Y	4.56	66.86	16.93		100.0	
		Z	4.61	66.54	16.84		100.0	
10067-CAC	IEEE 802.11a/h WiFi 5 GHz (OFDM, 36 Mbps)	X	4.73	66.77	17.13	2.04	100.0	± 9.6 %
		Y	4.84	67.12	17.40		100.0	
		Z	4.90	66.81	17.33		100.0	
10068-CAC	IEEE 802.11a/h WiFi 5 GHz (OFDM, 48 Mbps)	X	4.76	66.66	17.29	2.55	100.0	± 9.6 %
		Y	4.86	67.00	17.55		100.0	
		Z	4.92	66.73	17.50		100.0	
10069-CAC	IEEE 802.11a/h WiFi 5 GHz (OFDM, 54 Mbps)	X	4.81	66.68	17.46	2.67	100.0	± 9.6 %
		Y	4.92	67.01	17.74		100.0	
		Z	5.00	66.78	17.71		100.0	
10071-CAB	IEEE 802.11g WiFi 2.4 GHz (DSSS/OFDM, 9 Mbps)	X	4.62	66.50	17.03	1.99	100.0	± 9.6 %
		Y	4.72	66.82	17.28		100.0	
		Z	4.75	66.47	17.18		100.0	
10072-CAB	IEEE 802.11g WiFi 2.4 GHz (DSSS/OFDM, 12 Mbps)	X	4.56	66.67	17.18	2.30	100.0	± 9.6 %
		Y	4.66	67.03	17.45		100.0	
		Z	4.70	66.70	17.36		100.0	
10073-CAB	IEEE 802.11g WiFi 2.4 GHz (DSSS/OFDM, 18 Mbps)	X	4.61	66.83	17.49	2.83	100.0	± 9.6 %
		Y	4.71	67.17	17.77		100.0	
		Z	4.75	66.85	17.68		100.0	
10074-CAB	IEEE 802.11g WiFi 2.4 GHz (DSSS/OFDM, 24 Mbps)	X	4.62	66.77	17.64	3.30	100.0	± 9.6 %
		Y	4.70	67.09	17.92		100.0	
		Z	4.74	66.75	17.83		100.0	
10075-CAB	IEEE 802.11g WiFi 2.4 GHz (DSSS/OFDM, 36 Mbps)	X	4.63	66.75	17.86	3.82	90.0	± 9.6 %
		Y	4.71	67.06	18.15		90.0	
		Z	4.76	66.76	18.09		90.0	
10076-CAB	IEEE 802.11g WiFi 2.4 GHz (DSSS/OFDM, 48 Mbps)	X	4.68	66.63	18.04	4.15	90.0	± 9.6 %
		Y	4.74	66.91	18.31		90.0	
		Z	4.79	66.61	18.24		90.0	
10077-CAB	IEEE 802.11g WiFi 2.4 GHz (DSSS/OFDM, 54 Mbps)	X	4.71	66.72	18.15	4.30	90.0	± 9.6 %
		Y	4.77	66.99	18.42		90.0	
		Z	4.82	66.69	18.35		90.0	

10081-CAB	CDMA2000 (1xRTT, RC3)	X	0.41	60.41	6.86	0.00	150.0	± 9.6 %
		Y	0.64	64.39	10.26		150.0	
		Z	0.51	61.51	8.28		150.0	
10082-CAB	IS-54 / IS-136 FDD (TDMA/FDM, PI/4-DQPSK, Fullrate)	X	6.37	60.67	1.90	4.77	80.0	± 9.6 %
		Y	0.58	60.00	3.05		80.0	
		Z	0.60	60.00	3.10		80.0	
10090-DAC	GPRS-FDD (TDMA, GMSK, TN 0-4)	X	100.00	103.19	20.57	6.56	60.0	± 9.6 %
		Y	100.00	106.40	21.88		60.0	
		Z	100.00	108.67	23.14		60.0	
10097-CAB	UMTS-FDD (HSDPA)	X	1.61	66.98	14.45	0.00	150.0	± 9.6 %
		Y	1.83	68.94	15.87		150.0	
		Z	1.61	66.33	14.36		150.0	
10098-CAB	UMTS-FDD (HSUPA, Subtest 2)	X	1.57	66.91	14.41	0.00	150.0	± 9.6 %
		Y	1.80	68.88	15.85		150.0	
		Z	1.57	66.26	14.32		150.0	
10099-DAC	EDGE-FDD (TDMA, 8PSK, TN 0-4)	X	5.11	79.85	27.95	9.56	60.0	± 9.6 %
		Y	6.18	86.42	31.49		60.0	
		Z	5.66	82.29	29.29		60.0	
10100-CAE	LTE-FDD (SC-FDMA, 100% RB, 20 MHz, QPSK)	X	2.72	68.86	15.96	0.00	150.0	± 9.6 %
		Y	2.98	70.42	16.85		150.0	
		Z	2.77	68.66	15.78		150.0	
10101-CAE	LTE-FDD (SC-FDMA, 100% RB, 20 MHz, 16-QAM)	X	2.94	66.71	15.42	0.00	150.0	± 9.6 %
		Y	3.09	67.54	15.94		150.0	
		Z	3.00	66.60	15.35		150.0	
10102-CAE	LTE-FDD (SC-FDMA, 100% RB, 20 MHz, 64-QAM)	X	3.05	66.78	15.55	0.00	150.0	± 9.6 %
		Y	3.19	67.54	16.04		150.0	
		Z	3.11	66.65	15.49		150.0	
10103-CAF	LTE-TDD (SC-FDMA, 100% RB, 20 MHz, QPSK)	X	4.63	72.33	19.10	3.98	65.0	± 9.6 %
		Y	5.31	74.95	20.40		65.0	
		Z	5.01	73.33	19.72		65.0	
10104-CAF	LTE-TDD (SC-FDMA, 100% RB, 20 MHz, 16-QAM)	X	4.71	70.15	18.78	3.98	65.0	± 9.6 %
		Y	5.12	71.87	19.74		65.0	
		Z	4.99	70.84	19.32		65.0	
10105-CAF	LTE-TDD (SC-FDMA, 100% RB, 20 MHz, 64-QAM)	X	4.62	69.52	18.79	3.98	65.0	± 9.6 %
		Y	4.98	71.08	19.67		65.0	
		Z	4.89	70.18	19.31		65.0	
10108-CAF	LTE-FDD (SC-FDMA, 100% RB, 10 MHz, QPSK)	X	2.32	68.23	15.74	0.00	150.0	± 9.6 %
		Y	2.56	69.77	16.68		150.0	
		Z	2.39	67.99	15.57		150.0	
10109-CAF	LTE-FDD (SC-FDMA, 100% RB, 10 MHz, 16-QAM)	X	2.57	66.62	15.17	0.00	150.0	± 9.6 %
		Y	2.73	67.56	15.82		150.0	
		Z	2.64	66.42	15.13		150.0	
10110-CAF	LTE-FDD (SC-FDMA, 100% RB, 5 MHz, QPSK)	X	1.82	67.31	15.00	0.00	150.0	± 9.6 %
		Y	2.06	69.08	16.19		150.0	
		Z	1.89	67.03	14.94		150.0	
10111-CAF	LTE-FDD (SC-FDMA, 100% RB, 5 MHz, 16-QAM)	X	2.27	67.56	15.11	0.00	150.0	± 9.6 %
		Y	2.50	68.95	16.11		150.0	
		Z	2.32	67.14	15.12		150.0	

10112-CAF	LTE-FDD (SC-FDMA, 100% RB, 10 MHz, 64-QAM)	X	2.70	66.75	15.29	0.00	150.0	± 9.6 %
		Y	2.86	67.62	15.89		150.0	
		Z	2.77	66.52	15.24		150.0	
10113-CAF	LTE-FDD (SC-FDMA, 100% RB, 5 MHz, 64-QAM)	X	2.41	67.80	15.29	0.00	150.0	± 9.6 %
		Y	2.64	69.12	16.24		150.0	
		Z	2.47	67.38	15.32		150.0	
10114-CAC	IEEE 802.11n (HT Greenfield, 13.5 Mbps, BPSK)	X	4.85	66.91	16.28	0.00	150.0	± 9.6 %
		Y	4.92	67.20	16.42		150.0	
		Z	4.93	66.80	16.23		150.0	
10115-CAC	IEEE 802.11n (HT Greenfield, 81 Mbps, 16-QAM)	X	5.08	66.97	16.31	0.00	150.0	± 9.6 %
		Y	5.16	67.24	16.44		150.0	
		Z	5.19	66.91	16.30		150.0	
10116-CAC	IEEE 802.11n (HT Greenfield, 135 Mbps, 64-QAM)	X	4.91	67.06	16.28	0.00	150.0	± 9.6 %
		Y	5.00	67.37	16.44		150.0	
		Z	5.02	67.01	16.26		150.0	
10117-CAC	IEEE 802.11n (HT Mixed, 13.5 Mbps, BPSK)	X	4.82	66.80	16.24	0.00	150.0	± 9.6 %
		Y	4.91	67.14	16.41		150.0	
		Z	4.92	66.75	16.22		150.0	
10118-CAC	IEEE 802.11n (HT Mixed, 81 Mbps, 16-QAM)	X	5.15	67.18	16.42	0.00	150.0	± 9.6 %
		Y	5.23	67.42	16.54		150.0	
		Z	5.28	67.15	16.43		150.0	
10119-CAC	IEEE 802.11n (HT Mixed, 135 Mbps, 64-QAM)	X	4.92	67.09	16.30	0.00	150.0	± 9.6 %
		Y	5.00	67.37	16.45		150.0	
		Z	5.02	67.00	16.27		150.0	
10140-CAE	LTE-FDD (SC-FDMA, 100% RB, 15 MHz, 16-QAM)	X	3.06	66.79	15.45	0.00	150.0	± 9.6 %
		Y	3.21	67.57	15.95		150.0	
		Z	3.13	66.66	15.40		150.0	
10141-CAE	LTE-FDD (SC-FDMA, 100% RB, 15 MHz, 64-QAM)	X	3.19	67.01	15.68	0.00	150.0	± 9.6 %
		Y	3.34	67.73	16.14		150.0	
		Z	3.26	66.83	15.61		150.0	
10142-CAE	LTE-FDD (SC-FDMA, 100% RB, 3 MHz, QPSK)	X	1.53	66.71	13.85	0.00	150.0	± 9.6 %
		Y	1.82	69.13	15.54		150.0	
		Z	1.62	66.60	14.09		150.0	
10143-CAE	LTE-FDD (SC-FDMA, 100% RB, 3 MHz, 16-QAM)	X	1.93	66.97	13.55	0.00	150.0	± 9.6 %
		Y	2.31	69.49	15.29		150.0	
		Z	2.06	67.05	14.07		150.0	
10144-CAE	LTE-FDD (SC-FDMA, 100% RB, 3 MHz, 64-QAM)	X	1.68	64.38	11.67	0.00	150.0	± 9.6 %
		Y	1.94	66.13	13.09		150.0	
		Z	1.85	64.82	12.42		150.0	
10145-CAF	LTE-FDD (SC-FDMA, 100% RB, 1.4 MHz, QPSK)	X	0.61	60.00	6.25	0.00	150.0	± 9.6 %
		Y	0.75	61.41	7.98		150.0	
		Z	0.75	60.75	7.63		150.0	
10146-CAF	LTE-FDD (SC-FDMA, 100% RB, 1.4 MHz, 16-QAM)	X	0.82	60.00	5.83	0.00	150.0	± 9.6 %
		Y	0.92	60.25	6.35		150.0	
		Z	1.12	61.59	7.98		150.0	
10147-CAF	LTE-FDD (SC-FDMA, 100% RB, 1.4 MHz, 64-QAM)	X	0.84	60.00	5.89	0.00	150.0	± 9.6 %
		Y	0.96	60.55	6.61		150.0	
		Z	1.20	62.21	8.43		150.0	

10149-CAE	LTE-FDD (SC-FDMA, 50% RB, 20 MHz, 16-QAM)	X	2.58	66.69	15.22	0.00	150.0	± 9.6 %
		Y	2.74	67.63	15.87		150.0	
		Z	2.65	66.49	15.18		150.0	
10150-CAE	LTE-FDD (SC-FDMA, 50% RB, 20 MHz, 64-QAM)	X	2.71	66.82	15.33	0.00	150.0	± 9.6 %
		Y	2.87	67.69	15.94		150.0	
		Z	2.78	66.58	15.28		150.0	
10151-CAF	LTE-TDD (SC-FDMA, 50% RB, 20 MHz, QPSK)	X	4.58	74.10	19.83	3.98	65.0	± 9.6 %
		Y	5.45	77.40	21.46		65.0	
		Z	5.00	75.19	20.56		65.0	
10152-CAF	LTE-TDD (SC-FDMA, 50% RB, 20 MHz, 16-QAM)	X	4.21	69.89	18.16	3.98	65.0	± 9.6 %
		Y	4.65	71.84	19.30		65.0	
		Z	4.51	70.68	18.85		65.0	
10153-CAF	LTE-TDD (SC-FDMA, 50% RB, 20 MHz, 64-QAM)	X	4.55	71.06	19.09	3.98	65.0	± 9.6 %
		Y	5.01	72.96	20.18		65.0	
		Z	4.85	71.76	19.74		65.0	
10154-CAF	LTE-FDD (SC-FDMA, 50% RB, 10 MHz, QPSK)	X	1.85	67.65	15.22	0.00	150.0	± 9.6 %
		Y	2.10	69.48	16.44		150.0	
		Z	1.92	67.37	15.16		150.0	
10155-CAF	LTE-FDD (SC-FDMA, 50% RB, 10 MHz, 16-QAM)	X	2.27	67.61	15.14	0.00	150.0	± 9.6 %
		Y	2.50	69.00	16.15		150.0	
		Z	2.33	67.17	15.15		150.0	
10156-CAF	LTE-FDD (SC-FDMA, 50% RB, 5 MHz, QPSK)	X	1.31	65.90	12.85	0.00	150.0	± 9.6 %
		Y	1.64	68.88	14.94		150.0	
		Z	1.43	66.11	13.38		150.0	
10157-CAF	LTE-FDD (SC-FDMA, 50% RB, 5 MHz, 16-QAM)	X	1.43	63.96	10.91	0.00	150.0	± 9.6 %
		Y	1.74	66.31	12.74		150.0	
		Z	1.63	64.73	11.94		150.0	
10158-CAF	LTE-FDD (SC-FDMA, 50% RB, 10 MHz, 64-QAM)	X	2.42	67.89	15.35	0.00	150.0	± 9.6 %
		Y	2.65	69.22	16.31		150.0	
		Z	2.48	67.46	15.37		150.0	
10159-CAF	LTE-FDD (SC-FDMA, 50% RB, 5 MHz, 64-QAM)	X	1.49	64.13	11.04	0.00	150.0	± 9.6 %
		Y	1.82	66.66	12.95		150.0	
		Z	1.70	65.00	12.13		150.0	
10160-CAE	LTE-FDD (SC-FDMA, 50% RB, 15 MHz, QPSK)	X	2.41	67.89	15.65	0.00	150.0	± 9.6 %
		Y	2.60	69.05	16.44		150.0	
		Z	2.48	67.64	15.56		150.0	
10161-CAE	LTE-FDD (SC-FDMA, 50% RB, 15 MHz, 16-QAM)	X	2.59	66.74	15.14	0.00	150.0	± 9.6 %
		Y	2.76	67.68	15.82		150.0	
		Z	2.66	66.50	15.14		150.0	
10162-CAE	LTE-FDD (SC-FDMA, 50% RB, 15 MHz, 64-QAM)	X	2.70	67.00	15.31	0.00	150.0	± 9.6 %
		Y	2.87	67.91	15.97		150.0	
		Z	2.77	66.73	15.29		150.0	
10166-CAF	LTE-FDD (SC-FDMA, 50% RB, 1.4 MHz, QPSK)	X	2.91	67.87	18.41	3.01	150.0	± 9.6 %
		Y	3.09	68.81	18.75		150.0	
		Z	3.17	68.75	19.02		150.0	
10167-CAF	LTE-FDD (SC-FDMA, 50% RB, 1.4 MHz, 16-QAM)	X	3.24	69.92	18.52	3.01	150.0	± 9.6 %
		Y	3.65	71.74	19.22		150.0	
		Z	3.63	71.08	19.26		150.0	

10168-CAF	LTE-FDD (SC-FDMA, 50% RB, 1.4 MHz, 64-QAM)	X	3.66	72.66	20.22	3.01	150.0	± 9.6 %
		Y	4.14	74.51	20.83		150.0	
		Z	4.11	73.91	20.95		150.0	
10169-CAE	LTE-FDD (SC-FDMA, 1 RB, 20 MHz, QPSK)	X	2.32	65.83	17.44	3.01	150.0	± 9.6 %
		Y	2.49	67.28	18.07		150.0	
		Z	2.46	66.70	18.14		150.0	
10170-CAE	LTE-FDD (SC-FDMA, 1 RB, 20 MHz, 16-QAM)	X	2.74	70.01	19.35	3.01	150.0	± 9.6 %
		Y	3.21	72.95	20.48		150.0	
		Z	3.00	71.51	20.32		150.0	
10171-AAE	LTE-FDD (SC-FDMA, 1 RB, 20 MHz, 64-QAM)	X	2.31	66.53	16.58	3.01	150.0	± 9.6 %
		Y	2.63	68.93	17.60		150.0	
		Z	2.50	67.67	17.42		150.0	
10172-CAF	LTE-TDD (SC-FDMA, 1 RB, 20 MHz, QPSK)	X	2.90	74.23	22.35	6.02	65.0	± 9.6 %
		Y	3.68	79.90	24.98		65.0	
		Z	3.91	80.19	25.56		65.0	
10173-CAF	LTE-TDD (SC-FDMA, 1 RB, 20 MHz, 16-QAM)	X	3.92	78.79	22.40	6.02	65.0	± 9.6 %
		Y	6.85	89.50	26.38		65.0	
		Z	6.70	89.11	27.06		65.0	
10174-CAF	LTE-TDD (SC-FDMA, 1 RB, 20 MHz, 64-QAM)	X	2.90	73.28	19.67	6.02	65.0	± 9.6 %
		Y	5.51	84.77	24.11		65.0	
		Z	4.93	82.66	24.17		65.0	
10175-CAF	LTE-FDD (SC-FDMA, 1 RB, 10 MHz, QPSK)	X	2.30	65.58	17.20	3.01	150.0	± 9.6 %
		Y	2.47	67.02	17.83		150.0	
		Z	2.44	66.43	17.89		150.0	
10176-CAF	LTE-FDD (SC-FDMA, 1 RB, 10 MHz, 16-QAM)	X	2.74	70.03	19.36	3.01	150.0	± 9.6 %
		Y	3.21	72.97	20.49		150.0	
		Z	3.00	71.53	20.33		150.0	
10177-CAH	LTE-FDD (SC-FDMA, 1 RB, 5 MHz, QPSK)	X	2.31	65.68	17.27	3.01	150.0	± 9.6 %
		Y	2.48	67.13	17.91		150.0	
		Z	2.45	66.56	17.98		150.0	
10178-CAF	LTE-FDD (SC-FDMA, 1 RB, 5 MHz, 16-QAM)	X	2.73	69.91	19.28	3.01	150.0	± 9.6 %
		Y	3.19	72.83	20.41		150.0	
		Z	2.98	71.36	20.23		150.0	
10179-CAF	LTE-FDD (SC-FDMA, 1 RB, 10 MHz, 64-QAM)	X	2.50	68.14	17.82	3.01	150.0	± 9.6 %
		Y	2.89	70.84	18.91		150.0	
		Z	2.72	69.48	18.74		150.0	
10180-CAF	LTE-FDD (SC-FDMA, 1 RB, 5 MHz, 64-QAM)	X	2.31	66.50	16.56	3.01	150.0	± 9.6 %
		Y	2.63	68.90	17.57		150.0	
		Z	2.50	67.63	17.39		150.0	
10181-CAE	LTE-FDD (SC-FDMA, 1 RB, 15 MHz, QPSK)	X	2.31	65.67	17.27	3.01	150.0	± 9.6 %
		Y	2.48	67.11	17.90		150.0	
		Z	2.45	66.54	17.97		150.0	
10182-CAE	LTE-FDD (SC-FDMA, 1 RB, 15 MHz, 16-QAM)	X	2.73	69.88	19.27	3.01	150.0	± 9.6 %
		Y	3.19	72.81	20.40		150.0	
		Z	2.98	71.34	20.21		150.0	
10183-AAD	LTE-FDD (SC-FDMA, 1 RB, 15 MHz, 64-QAM)	X	2.31	66.48	16.55	3.01	150.0	± 9.6 %
		Y	2.63	68.87	17.56		150.0	
		Z	2.49	67.61	17.37		150.0	

10184-CAE	LTE-FDD (SC-FDMA, 1 RB, 3 MHz, QPSK)	X	2.32	65.70	17.29	3.01	150.0	± 9.6 %
		Y	2.49	67.15	17.92		150.0	
		Z	2.46	66.58	17.99		150.0	
10185-CAE	LTE-FDD (SC-FDMA, 1 RB, 3 MHz, 16-QAM)	X	2.74	69.95	19.31	3.01	150.0	± 9.6 %
		Y	3.20	72.88	20.43		150.0	
		Z	2.99	71.41	20.26		150.0	
10186-AAE	LTE-FDD (SC-FDMA, 1 RB, 3 MHz, 64-QAM)	X	2.32	66.53	16.58	3.01	150.0	± 9.6 %
		Y	2.64	68.94	17.60		150.0	
		Z	2.51	67.67	17.41		150.0	
10187-CAF	LTE-FDD (SC-FDMA, 1 RB, 1.4 MHz, QPSK)	X	2.33	65.78	17.37	3.01	150.0	± 9.6 %
		Y	2.50	67.22	18.00		150.0	
		Z	2.47	66.64	18.07		150.0	
10188-CAF	LTE-FDD (SC-FDMA, 1 RB, 1.4 MHz, 16-QAM)	X	2.80	70.47	19.65	3.01	150.0	± 9.6 %
		Y	3.29	73.46	20.79		150.0	
		Z	3.07	72.01	20.64		150.0	
10189-AAF	LTE-FDD (SC-FDMA, 1 RB, 1.4 MHz, 64-QAM)	X	2.35	66.85	16.82	3.01	150.0	± 9.6 %
		Y	2.69	69.31	17.86		150.0	
		Z	2.55	68.03	17.68		150.0	
10193-CAC	IEEE 802.11n (HT Greenfield, 6.5 Mbps, BPSK)	X	4.23	66.54	15.90	0.00	150.0	± 9.6 %
		Y	4.33	66.90	16.14		150.0	
		Z	4.32	66.32	15.87		150.0	
10194-CAC	IEEE 802.11n (HT Greenfield, 39 Mbps, 16-QAM)	X	4.36	66.75	16.04	0.00	150.0	± 9.6 %
		Y	4.47	67.12	16.27		150.0	
		Z	4.47	66.58	16.01		150.0	
10195-CAC	IEEE 802.11n (HT Greenfield, 65 Mbps, 64-QAM)	X	4.39	66.76	16.05	0.00	150.0	± 9.6 %
		Y	4.50	67.13	16.28		150.0	
		Z	4.50	66.61	16.03		150.0	
10196-CAC	IEEE 802.11n (HT Mixed, 6.5 Mbps, BPSK)	X	4.21	66.52	15.87	0.00	150.0	± 9.6 %
		Y	4.32	66.89	16.12		150.0	
		Z	4.31	66.33	15.87		150.0	
10197-CAC	IEEE 802.11n (HT Mixed, 39 Mbps, 16-QAM)	X	4.37	66.75	16.04	0.00	150.0	± 9.6 %
		Y	4.48	67.12	16.28		150.0	
		Z	4.48	66.59	16.02		150.0	
10198-CAC	IEEE 802.11n (HT Mixed, 65 Mbps, 64-QAM)	X	4.38	66.75	16.05	0.00	150.0	± 9.6 %
		Y	4.50	67.13	16.28		150.0	
		Z	4.50	66.62	16.04		150.0	
10219-CAC	IEEE 802.11n (HT Mixed, 7.2 Mbps, BPSK)	X	4.16	66.56	15.85	0.00	150.0	± 9.6 %
		Y	4.27	66.93	16.10		150.0	
		Z	4.26	66.35	15.83		150.0	
10220-CAC	IEEE 802.11n (HT Mixed, 43.3 Mbps, 16-QAM)	X	4.36	66.72	16.03	0.00	150.0	± 9.6 %
		Y	4.47	67.08	16.26		150.0	
		Z	4.47	66.56	16.01		150.0	
10221-CAC	IEEE 802.11n (HT Mixed, 72.2 Mbps, 64-QAM)	X	4.40	66.71	16.04	0.00	150.0	± 9.6 %
		Y	4.51	67.07	16.27		150.0	
		Z	4.51	66.56	16.03		150.0	
10222-CAC	IEEE 802.11n (HT Mixed, 15 Mbps, BPSK)	X	4.80	66.80	16.23	0.00	150.0	± 9.6 %
		Y	4.88	67.12	16.39		150.0	
		Z	4.89	66.72	16.20		150.0	

10223-CAC	IEEE 802.11n (HT Mixed, 90 Mbps, 16-QAM)	X	5.04	66.95	16.32	0.00	150.0	± 9.6 %
		Y	5.14	67.29	16.49		150.0	
		Z	5.18	66.99	16.36		150.0	
10224-CAC	IEEE 802.11n (HT Mixed, 150 Mbps, 64-QAM)	X	4.84	66.92	16.22	0.00	150.0	± 9.6 %
		Y	4.92	67.24	16.38		150.0	
		Z	4.93	66.82	16.18		150.0	
10225-CAB	UMTS-FDD (HSPA+)	X	2.46	65.56	14.20	0.00	150.0	± 9.6 %
		Y	2.62	66.44	14.96		150.0	
		Z	2.55	65.41	14.45		150.0	
10226-CAA	LTE-TDD (SC-FDMA, 1 RB, 1.4 MHz, 16-QAM)	X	4.12	79.74	22.87	6.02	65.0	± 9.6 %
		Y	7.38	90.96	26.97		65.0	
		Z	7.19	90.56	27.66		65.0	
10227-CAA	LTE-TDD (SC-FDMA, 1 RB, 1.4 MHz, 64-QAM)	X	4.10	78.95	21.90	6.02	65.0	± 9.6 %
		Y	7.43	89.71	25.78		65.0	
		Z	7.75	90.70	26.99		65.0	
10228-CAA	LTE-TDD (SC-FDMA, 1 RB, 1.4 MHz, QPSK)	X	3.12	75.94	23.15	6.02	65.0	± 9.6 %
		Y	4.06	82.01	25.85		65.0	
		Z	4.25	82.24	26.47		65.0	
10229-CAC	LTE-TDD (SC-FDMA, 1 RB, 3 MHz, 16-QAM)	X	3.94	78.88	22.44	6.02	65.0	± 9.6 %
		Y	6.91	89.62	26.42		65.0	
		Z	6.76	89.24	27.11		65.0	
10230-CAC	LTE-TDD (SC-FDMA, 1 RB, 3 MHz, 64-QAM)	X	3.89	78.03	21.47	6.02	65.0	± 9.6 %
		Y	6.86	88.27	25.23		65.0	
		Z	7.16	89.19	26.40		65.0	
10231-CAC	LTE-TDD (SC-FDMA, 1 RB, 3 MHz, QPSK)	X	3.03	75.32	22.81	6.02	65.0	± 9.6 %
		Y	3.92	81.25	25.48		65.0	
		Z	4.10	81.44	26.07		65.0	
10232-CAE	LTE-TDD (SC-FDMA, 1 RB, 5 MHz, 16-QAM)	X	3.94	78.86	22.44	6.02	65.0	± 9.6 %
		Y	6.89	89.60	26.42		65.0	
		Z	6.74	89.21	27.10		65.0	
10233-CAE	LTE-TDD (SC-FDMA, 1 RB, 5 MHz, 64-QAM)	X	3.88	77.99	21.46	6.02	65.0	± 9.6 %
		Y	6.83	88.22	25.21		65.0	
		Z	7.13	89.13	26.38		65.0	
10234-CAE	LTE-TDD (SC-FDMA, 1 RB, 5 MHz, QPSK)	X	2.96	74.84	22.48	6.02	65.0	± 9.6 %
		Y	3.82	80.66	25.12		65.0	
		Z	4.00	80.82	25.70		65.0	
10235-CAE	LTE-TDD (SC-FDMA, 1 RB, 10 MHz, 16-QAM)	X	3.94	78.87	22.44	6.02	65.0	± 9.6 %
		Y	6.90	89.63	26.43		65.0	
		Z	6.75	89.23	27.11		65.0	
10236-CAE	LTE-TDD (SC-FDMA, 1 RB, 10 MHz, 64-QAM)	X	3.92	78.11	21.50	6.02	65.0	± 9.6 %
		Y	6.93	88.43	25.27		65.0	
		Z	7.23	89.34	26.44		65.0	
10237-CAE	LTE-TDD (SC-FDMA, 1 RB, 10 MHz, QPSK)	X	3.03	75.32	22.81	6.02	65.0	± 9.6 %
		Y	3.92	81.27	25.49		65.0	
		Z	4.10	81.45	26.08		65.0	
10238-CAE	LTE-TDD (SC-FDMA, 1 RB, 15 MHz, 16-QAM)	X	3.93	78.83	22.43	6.02	65.0	± 9.6 %
		Y	6.87	89.57	26.41		65.0	
		Z	6.72	89.17	27.08		65.0	

10239-CAE	LTE-TDD (SC-FDMA, 1 RB, 15 MHz, 64-QAM)	X	3.87	77.95	21.45	6.02	65.0	± 9.6 %
		Y	6.80	88.17	25.20		65.0	
		Z	7.10	89.08	26.37		65.0	
10240-CAE	LTE-TDD (SC-FDMA, 1 RB, 15 MHz, QPSK)	X	3.02	75.30	22.81	6.02	65.0	± 9.6 %
		Y	3.91	81.25	25.48		65.0	
		Z	4.09	81.42	26.07		65.0	
10241-CAA	LTE-TDD (SC-FDMA, 50% RB, 1.4 MHz, 16-QAM)	X	5.47	76.60	23.52	6.98	65.0	± 9.6 %
		Y	6.28	79.70	24.95		65.0	
		Z	6.08	77.98	24.56		65.0	
10242-CAA	LTE-TDD (SC-FDMA, 50% RB, 1.4 MHz, 64-QAM)	X	5.17	75.55	22.99	6.98	65.0	± 9.6 %
		Y	5.96	78.71	24.47		65.0	
		Z	5.82	77.10	24.09		65.0	
10243-CAA	LTE-TDD (SC-FDMA, 50% RB, 1.4 MHz, QPSK)	X	4.47	72.66	22.57	6.98	65.0	± 9.6 %
		Y	4.85	74.66	23.64		65.0	
		Z	4.89	73.70	23.43		65.0	
10244-CAC	LTE-TDD (SC-FDMA, 50% RB, 3 MHz, 16-QAM)	X	2.59	65.60	11.95	3.98	65.0	± 9.6 %
		Y	3.16	68.30	13.59		65.0	
		Z	3.94	71.58	16.14		65.0	
10245-CAC	LTE-TDD (SC-FDMA, 50% RB, 3 MHz, 64-QAM)	X	2.56	65.23	11.69	3.98	65.0	± 9.6 %
		Y	3.08	67.71	13.25		65.0	
		Z	3.80	70.75	15.70		65.0	
10246-CAC	LTE-TDD (SC-FDMA, 50% RB, 3 MHz, QPSK)	X	2.30	67.33	13.29	3.98	65.0	± 9.6 %
		Y	3.40	73.14	16.55		65.0	
		Z	3.20	71.92	16.41		65.0	
10247-CAE	LTE-TDD (SC-FDMA, 50% RB, 5 MHz, 16-QAM)	X	2.93	67.28	14.07	3.98	65.0	± 9.6 %
		Y	3.57	70.51	16.14		65.0	
		Z	3.50	69.72	16.15		65.0	
10248-CAE	LTE-TDD (SC-FDMA, 50% RB, 5 MHz, 64-QAM)	X	2.93	66.83	13.84	3.98	65.0	± 9.6 %
		Y	3.51	69.74	15.76		65.0	
		Z	3.49	69.17	15.87		65.0	
10249-CAE	LTE-TDD (SC-FDMA, 50% RB, 5 MHz, QPSK)	X	3.40	72.89	17.31	3.98	65.0	± 9.6 %
		Y	5.05	79.62	20.60		65.0	
		Z	4.35	76.73	19.72		65.0	
10250-CAE	LTE-TDD (SC-FDMA, 50% RB, 10 MHz, 16-QAM)	X	4.07	71.77	18.68	3.98	65.0	± 9.6 %
		Y	4.65	74.35	20.17		65.0	
		Z	4.43	72.91	19.73		65.0	
10251-CAE	LTE-TDD (SC-FDMA, 50% RB, 10 MHz, 64-QAM)	X	3.86	69.66	17.25	3.98	65.0	± 9.6 %
		Y	4.37	71.98	18.68		65.0	
		Z	4.24	70.85	18.35		65.0	
10252-CAE	LTE-TDD (SC-FDMA, 50% RB, 10 MHz, QPSK)	X	4.28	75.56	20.13	3.98	65.0	± 9.6 %
		Y	5.50	80.28	22.41		65.0	
		Z	4.84	77.34	21.32		65.0	
10253-CAE	LTE-TDD (SC-FDMA, 50% RB, 15 MHz, 16-QAM)	X	4.17	69.62	17.88	3.98	65.0	± 9.6 %
		Y	4.59	71.50	19.03		65.0	
		Z	4.46	70.34	18.61		65.0	
10254-CAE	LTE-TDD (SC-FDMA, 50% RB, 15 MHz, 64-QAM)	X	4.46	70.60	18.66	3.98	65.0	± 9.6 %
		Y	4.90	72.45	19.77		65.0	
		Z	4.75	71.28	19.37		65.0	

10255-CAE	LTE-TDD (SC-FDMA, 50% RB, 15 MHz, QPSK)	X	4.40	73.51	19.69	3.98	65.0	± 9.6 %
		Y	5.16	76.59	21.27		65.0	
		Z	4.77	74.49	20.43		65.0	
10256-CAA	LTE-TDD (SC-FDMA, 100% RB, 1.4 MHz, 16-QAM)	X	1.88	62.21	8.80	3.98	65.0	± 9.6 %
		Y	2.16	63.72	9.95		65.0	
		Z	2.68	66.18	12.27		65.0	
10257-CAA	LTE-TDD (SC-FDMA, 100% RB, 1.4 MHz, 64-QAM)	X	1.87	61.92	8.53	3.98	65.0	± 9.6 %
		Y	2.13	63.28	9.61		65.0	
		Z	2.60	65.47	11.78		65.0	
10258-CAA	LTE-TDD (SC-FDMA, 100% RB, 1.4 MHz, QPSK)	X	1.63	62.98	9.76	3.98	65.0	± 9.6 %
		Y	2.11	66.24	12.11		65.0	
		Z	2.20	66.42	12.68		65.0	
10259-CAC	LTE-TDD (SC-FDMA, 100% RB, 3 MHz, 16-QAM)	X	3.37	69.09	15.81	3.98	65.0	± 9.6 %
		Y	4.03	72.21	17.73		65.0	
		Z	3.88	71.08	17.53		65.0	
10260-CAC	LTE-TDD (SC-FDMA, 100% RB, 3 MHz, 64-QAM)	X	3.41	68.89	15.70	3.98	65.0	± 9.6 %
		Y	4.05	71.86	17.55		65.0	
		Z	3.92	70.83	17.40		65.0	
10261-CAC	LTE-TDD (SC-FDMA, 100% RB, 3 MHz, QPSK)	X	3.65	73.54	18.24	3.98	65.0	± 9.6 %
		Y	4.99	79.08	21.01		65.0	
		Z	4.36	76.25	20.08		65.0	
10262-CAE	LTE-TDD (SC-FDMA, 100% RB, 5 MHz, 16-QAM)	X	4.05	71.68	18.62	3.98	65.0	± 9.6 %
		Y	4.63	74.27	20.11		65.0	
		Z	4.42	72.84	19.67		65.0	
10263-CAE	LTE-TDD (SC-FDMA, 100% RB, 5 MHz, 64-QAM)	X	3.85	69.65	17.25	3.98	65.0	± 9.6 %
		Y	4.36	71.96	18.67		65.0	
		Z	4.23	70.83	18.35		65.0	
10264-CAE	LTE-TDD (SC-FDMA, 100% RB, 5 MHz, QPSK)	X	4.23	75.35	20.01	3.98	65.0	± 9.6 %
		Y	5.43	80.04	22.29		65.0	
		Z	4.79	77.13	21.21		65.0	
10265-CAE	LTE-TDD (SC-FDMA, 100% RB, 10 MHz, 16-QAM)	X	4.21	69.90	18.16	3.98	65.0	± 9.6 %
		Y	4.65	71.84	19.30		65.0	
		Z	4.51	70.68	18.86		65.0	
10266-CAE	LTE-TDD (SC-FDMA, 100% RB, 10 MHz, 64-QAM)	X	4.55	71.05	19.08	3.98	65.0	± 9.6 %
		Y	5.00	72.95	20.16		65.0	
		Z	4.85	71.75	19.72		65.0	
10267-CAE	LTE-TDD (SC-FDMA, 100% RB, 10 MHz, QPSK)	X	4.57	74.06	19.81	3.98	65.0	± 9.6 %
		Y	5.43	77.35	21.43		65.0	
		Z	4.99	75.14	20.54		65.0	
10268-CAE	LTE-TDD (SC-FDMA, 100% RB, 15 MHz, 16-QAM)	X	4.89	70.28	18.92	3.98	65.0	± 9.6 %
		Y	5.29	71.90	19.82		65.0	
		Z	5.16	70.86	19.41		65.0	
10269-CAE	LTE-TDD (SC-FDMA, 100% RB, 15 MHz, 64-QAM)	X	4.93	70.03	18.82	3.98	65.0	± 9.6 %
		Y	5.31	71.54	19.69		65.0	
		Z	5.18	70.53	19.29		65.0	
10270-CAE	LTE-TDD (SC-FDMA, 100% RB, 15 MHz, QPSK)	X	4.82	72.26	19.25	3.98	65.0	± 9.6 %
		Y	5.40	74.50	20.39		65.0	
		Z	5.12	72.93	19.74		65.0	

10274-CAB	UMTS-FDD (HSUPA, Subtest 5, 3GPP Rel8.10)	X	2.30	66.08	14.21	0.00	150.0	± 9.6 %
		Y	2.48	67.13	15.07		150.0	
		Z	2.37	65.78	14.35		150.0	
10275-CAB	UMTS-FDD (HSUPA, Subtest 5, 3GPP Rel8.4)	X	1.33	66.42	14.09	0.00	150.0	± 9.6 %
		Y	1.55	68.66	15.67		150.0	
		Z	1.35	65.99	13.99		150.0	
10277-CAA	PHS (QPSK)	X	1.44	58.96	4.35	9.03	50.0	± 9.6 %
		Y	1.29	58.94	4.16		50.0	
		Z	1.60	59.77	5.29		50.0	
10278-CAA	PHS (QPSK, BW 884MHz, Rolloff 0.5)	X	2.42	63.55	9.32	9.03	50.0	± 9.6 %
		Y	2.50	65.00	10.23		50.0	
		Z	3.00	66.61	11.73		50.0	
10279-CAA	PHS (QPSK, BW 884MHz, Rolloff 0.38)	X	2.47	63.72	9.48	9.03	50.0	± 9.6 %
		Y	2.58	65.28	10.45		50.0	
		Z	3.09	66.89	11.94		50.0	
10290-AAB	CDMA2000, RC1, SO55, Full Rate	X	0.64	61.56	7.87	0.00	150.0	± 9.6 %
		Y	0.98	65.79	11.09		150.0	
		Z	0.84	63.19	9.57		150.0	
10291-AAB	CDMA2000, RC3, SO55, Full Rate	X	0.41	60.33	6.79	0.00	150.0	± 9.6 %
		Y	0.62	64.18	10.12		150.0	
		Z	0.50	61.40	8.20		150.0	
10292-AAB	CDMA2000, RC3, SO32, Full Rate	X	0.46	61.89	7.99	0.00	150.0	± 9.6 %
		Y	1.01	70.37	13.40		150.0	
		Z	0.57	63.19	9.51		150.0	
10293-AAB	CDMA2000, RC3, SO3, Full Rate	X	0.64	65.03	10.07	0.00	150.0	± 9.6 %
		Y	4.97	89.66	20.54		150.0	
		Z	0.76	66.38	11.57		150.0	
10295-AAB	CDMA2000, RC1, SO3, 1/8th Rate 25 fr.	X	14.73	88.54	22.30	9.03	50.0	± 9.6 %
		Y	21.95	97.75	26.07		50.0	
		Z	14.97	91.80	24.79		50.0	
10297-AAD	LTE-FDD (SC-FDMA, 50% RB, 20 MHz, QPSK)	X	2.34	68.34	15.82	0.00	150.0	± 9.6 %
		Y	2.58	69.89	16.76		150.0	
		Z	2.40	68.08	15.64		150.0	
10298-AAD	LTE-FDD (SC-FDMA, 50% RB, 3 MHz, QPSK)	X	0.86	62.29	9.16	0.00	150.0	± 9.6 %
		Y	1.16	65.45	11.69		150.0	
		Z	1.05	63.56	10.60		150.0	
10299-AAD	LTE-FDD (SC-FDMA, 50% RB, 3 MHz, 16-QAM)	X	1.14	61.76	8.21	0.00	150.0	± 9.6 %
		Y	1.41	63.51	9.50		150.0	
		Z	1.73	65.72	11.49		150.0	
10300-AAD	LTE-FDD (SC-FDMA, 50% RB, 3 MHz, 64-QAM)	X	0.97	60.07	6.55	0.00	150.0	± 9.6 %
		Y	1.14	61.11	7.49		150.0	
		Z	1.33	62.21	8.89		150.0	
10301-AAA	IEEE 802.16e WiMAX (29:18, 5ms, 10MHz, QPSK, PUSC)	X	4.13	64.55	16.56	4.17	50.0	± 9.6 %
		Y	4.26	65.00	16.97		50.0	
		Z	4.39	64.86	16.90		50.0	
10302-AAA	IEEE 802.16e WiMAX (29:18, 5ms, 10MHz, QPSK, PUSC, 3 CTRL symbols)	X	4.66	65.38	17.39	4.96	50.0	± 9.6 %
		Y	4.76	65.70	17.72		50.0	
		Z	4.88	65.46	17.59		50.0	

10303-AAA	IEEE 802.16e WiMAX (31:15, 5ms, 10MHz, 64QAM, PUSC)	X	4.45	65.36	17.40	4.96	50.0	± 9.6 %
		Y	4.51	65.30	17.48		50.0	
		Z	4.62	65.06	17.37		50.0	
10304-AAA	IEEE 802.16e WiMAX (29:18, 5ms, 10MHz, 64QAM, PUSC)	X	4.25	64.98	16.73	4.17	50.0	± 9.6 %
		Y	4.36	65.33	17.07		50.0	
		Z	4.45	64.98	16.90		50.0	
10305-AAA	IEEE 802.16e WiMAX (31:15, 10ms, 10MHz, 64QAM, PUSC, 15 symbols)	X	3.81	66.28	17.81	6.02	35.0	± 9.6 %
		Y	3.76	65.91	18.03		35.0	
		Z	4.04	66.66	18.48		35.0	
10306-AAA	IEEE 802.16e WiMAX (29:18, 10ms, 10MHz, 64QAM, PUSC, 18 symbols)	X	4.18	65.73	17.92	6.02	35.0	± 9.6 %
		Y	4.17	65.55	18.11		35.0	
		Z	4.39	65.94	18.38		35.0	
10307-AAA	IEEE 802.16e WiMAX (29:18, 10ms, 10MHz, QPSK, PUSC, 18 symbols)	X	4.05	65.69	17.78	6.02	35.0	± 9.6 %
		Y	4.04	65.48	17.96		35.0	
		Z	4.27	65.96	18.27		35.0	
10308-AAA	IEEE 802.16e WiMAX (29:18, 10ms, 10MHz, 16QAM, PUSC)	X	4.03	65.87	17.91	6.02	35.0	± 9.6 %
		Y	4.01	65.64	18.09		35.0	
		Z	4.25	66.15	18.40		35.0	
10309-AAA	IEEE 802.16e WiMAX (29:18, 10ms, 10MHz, 16QAM, AMC 2x3, 18 symbols)	X	4.18	65.77	18.00	6.02	35.0	± 9.6 %
		Y	4.19	65.61	18.20		35.0	
		Z	4.42	66.06	18.49		35.0	
10310-AAA	IEEE 802.16e WiMAX (29:18, 10ms, 10MHz, QPSK, AMC 2x3, 18 symbols)	X	4.13	65.78	17.90	6.02	35.0	± 9.6 %
		Y	4.12	65.57	18.08		35.0	
		Z	4.34	65.98	18.35		35.0	
10311-AAD	LTE-FDD (SC-FDMA, 100% RB, 15 MHz, QPSK)	X	2.69	67.62	15.56	0.00	150.0	± 9.6 %
		Y	2.94	69.08	16.39		150.0	
		Z	2.75	67.40	15.38		150.0	
10313-AAA	IDEN 1:3	X	1.80	67.21	13.40	6.99	70.0	± 9.6 %
		Y	2.78	73.35	16.36		70.0	
		Z	2.09	69.09	14.51		70.0	
10314-AAA	IDEN 1:6	X	3.26	75.39	19.57	10.00	30.0	± 9.6 %
		Y	5.56	85.97	24.05		30.0	
		Z	4.04	79.23	21.39		30.0	
10315-AAB	IEEE 802.11b WiFi 2.4 GHz (DSSS, 1 Mbps, 96pc duty cycle)	X	0.96	62.72	14.16	0.17	150.0	± 9.6 %
		Y	1.05	63.94	15.22		150.0	
		Z	0.96	62.45	14.04		150.0	
10316-AAB	IEEE 802.11g WiFi 2.4 GHz (ERP-OFDM, 6 Mbps, 96pc duty cycle)	X	4.24	66.42	15.96	0.17	150.0	± 9.6 %
		Y	4.35	66.80	16.22		150.0	
		Z	4.36	66.32	16.01		150.0	
10317-AAC	IEEE 802.11a WiFi 5 GHz (OFDM, 6 Mbps, 96pc duty cycle)	X	4.24	66.42	15.96	0.17	150.0	± 9.6 %
		Y	4.35	66.80	16.22		150.0	
		Z	4.36	66.32	16.01		150.0	
10400-AAD	IEEE 802.11ac WiFi (20MHz, 64-QAM, 99pc duty cycle)	X	4.31	66.71	15.99	0.00	150.0	± 9.6 %
		Y	4.43	67.11	16.24		150.0	
		Z	4.43	66.60	15.99		150.0	
10401-AAD	IEEE 802.11ac WiFi (40MHz, 64-QAM, 99pc duty cycle)	X	4.98	66.52	16.05	0.00	150.0	± 9.6 %
		Y	5.08	66.87	16.24		150.0	
		Z	5.16	66.70	16.18		150.0	

10402-AAD	IEEE 802.11ac WiFi (80MHz, 64-QAM, 99pc duty cycle)	X	5.36	67.14	16.28	0.00	150.0	± 9.6 %
		Y	5.44	67.45	16.42		150.0	
		Z	5.45	67.07	16.25		150.0	
10403-AAB	CDMA2000 (1xEV-DO, Rev. 0)	X	0.64	61.56	7.87	0.00	115.0	± 9.6 %
		Y	0.98	65.79	11.09		115.0	
		Z	0.84	63.19	9.57		115.0	
10404-AAB	CDMA2000 (1xEV-DO, Rev. A)	X	0.64	61.56	7.87	0.00	115.0	± 9.6 %
		Y	0.98	65.79	11.09		115.0	
		Z	0.84	63.19	9.57		115.0	
10406-AAB	CDMA2000, RC3, SO32, SCH0, Full Rate	X	100.00	119.53	28.08	0.00	100.0	± 9.6 %
		Y	100.00	115.68	26.57		100.0	
		Z	100.00	126.19	31.47		100.0	
10410-AAE	LTE-TDD (SC-FDMA, 1 RB, 10 MHz, QPSK, UL Subframe=2,3,4,7,8,9, Subframe Conf=4)	X	2.86	79.80	18.70	3.23	80.0	± 9.6 %
		Y	25.09	107.33	26.44		80.0	
		Z	100.00	133.23	34.42		80.0	
10415-AAA	IEEE 802.11b WiFi 2.4 GHz (DSSS, 1 Mbps, 99pc duty cycle)	X	0.92	62.32	13.80	0.00	150.0	± 9.6 %
		Y	1.00	63.42	14.80		150.0	
		Z	0.91	61.96	13.60		150.0	
10416-AAA	IEEE 802.11g WiFi 2.4 GHz (ERP-OFDM, 6 Mbps, 99pc duty cycle)	X	4.22	66.50	15.96	0.00	150.0	± 9.6 %
		Y	4.32	66.87	16.21		150.0	
		Z	4.32	66.33	15.95		150.0	
10417-AAB	IEEE 802.11a/h WiFi 5 GHz (OFDM, 6 Mbps, 99pc duty cycle)	X	4.22	66.50	15.96	0.00	150.0	± 9.6 %
		Y	4.32	66.87	16.21		150.0	
		Z	4.32	66.33	15.95		150.0	
10418-AAA	IEEE 802.11g WiFi 2.4 GHz (DSSS-OFDM, 6 Mbps, 99pc duty cycle, Long preamble)	X	4.21	66.71	16.02	0.00	150.0	± 9.6 %
		Y	4.32	67.09	16.27		150.0	
		Z	4.31	66.51	15.99		150.0	
10419-AAA	IEEE 802.11g WiFi 2.4 GHz (DSSS-OFDM, 6 Mbps, 99pc duty cycle, Short preamble)	X	4.23	66.64	16.01	0.00	150.0	± 9.6 %
		Y	4.34	67.01	16.25		150.0	
		Z	4.33	66.45	15.98		150.0	
10422-AAB	IEEE 802.11n (HT Greenfield, 7.2 Mbps, BPSK)	X	4.33	66.62	16.03	0.00	150.0	± 9.6 %
		Y	4.44	66.98	16.26		150.0	
		Z	4.44	66.45	16.00		150.0	
10423-AAB	IEEE 802.11n (HT Greenfield, 43.3 Mbps, 16-QAM)	X	4.45	66.86	16.11	0.00	150.0	± 9.6 %
		Y	4.56	67.23	16.34		150.0	
		Z	4.57	66.72	16.10		150.0	
10424-AAB	IEEE 802.11n (HT Greenfield, 72.2 Mbps, 64-QAM)	X	4.38	66.81	16.08	0.00	150.0	± 9.6 %
		Y	4.50	67.18	16.32		150.0	
		Z	4.50	66.66	16.07		150.0	
10425-AAB	IEEE 802.11n (HT Greenfield, 15 Mbps, BPSK)	X	5.03	67.03	16.34	0.00	150.0	± 9.6 %
		Y	5.11	67.32	16.49		150.0	
		Z	5.14	66.98	16.33		150.0	
10426-AAB	IEEE 802.11n (HT Greenfield, 90 Mbps, 16-QAM)	X	5.06	67.16	16.40	0.00	150.0	± 9.6 %
		Y	5.13	67.40	16.52		150.0	
		Z	5.17	67.10	16.39		150.0	

10427-AAB	IEEE 802.11n (HT Greenfield, 150 Mbps, 64-QAM)	X	5.01	66.91	16.27	0.00	150.0	± 9.6 %
		Y	5.09	67.19	16.41		150.0	
		Z	5.13	66.90	16.28		150.0	
10430-AAC	LTE-FDD (OFDMA, 5 MHz, E-TM 3.1)	X	4.07	72.07	17.91	0.00	150.0	± 9.6 %
		Y	4.24	72.56	18.40		150.0	
		Z	4.04	71.02	17.78		150.0	
10431-AAC	LTE-FDD (OFDMA, 10 MHz, E-TM 3.1)	X	3.79	66.99	15.69	0.00	150.0	± 9.6 %
		Y	3.94	67.49	16.09		150.0	
		Z	3.92	66.79	15.76		150.0	
10432-AAC	LTE-FDD (OFDMA, 15 MHz, E-TM 3.1)	X	4.13	66.89	15.96	0.00	150.0	± 9.6 %
		Y	4.26	67.30	16.25		150.0	
		Z	4.25	66.71	15.96		150.0	
10433-AAC	LTE-FDD (OFDMA, 20 MHz, E-TM 3.1)	X	4.40	66.85	16.11	0.00	150.0	± 9.6 %
		Y	4.51	67.22	16.34		150.0	
		Z	4.51	66.70	16.09		150.0	
10434-AAA	W-CDMA (BS Test Model 1, 64 DPCH)	X	4.05	72.38	17.35	0.00	150.0	± 9.6 %
		Y	4.37	73.48	18.19		150.0	
		Z	4.07	71.60	17.46		150.0	
10435-AAE	LTE-TDD (SC-FDMA, 1 RB, 20 MHz, QPSK, UL Subframe=2,3,4,7,8,9)	X	2.72	79.05	18.38	3.23	80.0	± 9.6 %
		Y	21.44	105.07	25.81		80.0	
		Z	100.00	132.91	34.27		80.0	
10447-AAC	LTE-FDD (OFDMA, 5 MHz, E-TM 3.1, Clipping 44%)	X	2.96	66.34	14.12	0.00	150.0	± 9.6 %
		Y	3.18	67.31	14.92		150.0	
		Z	3.13	66.39	14.53		150.0	
10448-AAC	LTE-FDD (OFDMA, 10 MHz, E-TM 3.1, Clipping 44%)	X	3.67	66.79	15.57	0.00	150.0	± 9.6 %
		Y	3.81	67.30	15.97		150.0	
		Z	3.78	66.58	15.62		150.0	
10449-AAC	LTE-FDD (OFDMA, 15 MHz, E-TM 3.1, Clipping 44%)	X	3.98	66.71	15.86	0.00	150.0	± 9.6 %
		Y	4.10	67.14	16.16		150.0	
		Z	4.09	66.52	15.85		150.0	
10450-AAC	LTE-FDD (OFDMA, 20 MHz, E-TM 3.1, Clipping 44%)	X	4.21	66.62	15.96	0.00	150.0	± 9.6 %
		Y	4.32	67.01	16.21		150.0	
		Z	4.30	66.46	15.93		150.0	
10451-AAA	W-CDMA (BS Test Model 1, 64 DPCH, Clipping 44%)	X	2.70	65.75	13.11	0.00	150.0	± 9.6 %
		Y	2.96	67.00	14.12		150.0	
		Z	2.94	66.14	13.79		150.0	
10456-AAB	IEEE 802.11ac WiFi (160MHz, 64-QAM, 99pc duty cycle)	X	5.99	67.61	16.55	0.00	150.0	± 9.6 %
		Y	6.02	67.80	16.61		150.0	
		Z	6.11	67.72	16.61		150.0	
10457-AAA	UMTS-FDD (DC-HSDPA)	X	3.61	65.32	15.70	0.00	150.0	± 9.6 %
		Y	3.69	65.64	15.94		150.0	
		Z	3.65	65.04	15.66		150.0	
10458-AAA	CDMA2000 (1xEV-DO, Rev. B, 2 carriers)	X	3.19	69.07	15.08	0.00	150.0	± 9.6 %
		Y	3.69	71.30	16.62		150.0	
		Z	3.53	69.92	16.16		150.0	
10459-AAA	CDMA2000 (1xEV-DO, Rev. B, 3 carriers)	X	4.69	69.03	17.48	0.00	150.0	± 9.6 %
		Y	4.79	69.11	17.75		150.0	
		Z	4.84	68.73	17.83		150.0	

10460-AAA	UMTS-FDD (WCDMA, AMR)	X	0.72	66.02	14.12	0.00	150.0	± 9.6 %
		Y	0.91	69.57	16.66		150.0	
		Z	0.71	65.26	13.72		150.0	
10461-AAA	LTE-TDD (SC-FDMA, 1 RB, 1.4 MHz, QPSK, UL Subframe=2,3,4,7,8,9)	X	1.93	75.92	18.31	3.29	80.0	± 9.6 %
		Y	6.83	93.43	24.06		80.0	
		Z	100.00	137.66	36.58		80.0	
10462-AAA	LTE-TDD (SC-FDMA, 1 RB, 1.4 MHz, 16-QAM, UL Subframe=2,3,4,7,8,9)	X	0.63	60.00	7.27	3.23	80.0	± 9.6 %
		Y	0.63	60.00	7.19		80.0	
		Z	1.15	65.31	10.99		80.0	
10463-AAA	LTE-TDD (SC-FDMA, 1 RB, 1.4 MHz, 64-QAM, UL Subframe=2,3,4,7,8,9)	X	0.65	60.00	6.55	3.23	80.0	± 9.6 %
		Y	0.66	60.00	6.45		80.0	
		Z	0.67	60.00	7.76		80.0	
10464-AAB	LTE-TDD (SC-FDMA, 1 RB, 3 MHz, QPSK, UL Subframe=2,3,4,7,8,9)	X	1.38	71.32	15.83	3.23	80.0	± 9.6 %
		Y	4.54	86.66	21.20		80.0	
		Z	100.00	134.26	34.80		80.0	
10465-AAB	LTE-TDD (SC-FDMA, 1 RB, 3 MHz, 16-QAM, UL Subframe=2,3,4,7,8,9)	X	0.63	60.00	7.20	3.23	80.0	± 9.6 %
		Y	0.63	60.00	7.11		80.0	
		Z	0.94	63.37	10.05		80.0	
10466-AAB	LTE-TDD (SC-FDMA, 1 RB, 3 MHz, 64-QAM, UL Subframe=2,3,4,7,8,9)	X	0.65	60.00	6.50	3.23	80.0	± 9.6 %
		Y	0.66	60.00	6.41		80.0	
		Z	0.68	60.00	7.70		80.0	
10467-AAD	LTE-TDD (SC-FDMA, 1 RB, 5 MHz, QPSK, UL Subframe=2,3,4,7,8,9)	X	1.47	72.19	16.22	3.23	80.0	± 9.6 %
		Y	5.30	88.83	21.91		80.0	
		Z	100.00	134.76	35.02		80.0	
10468-AAD	LTE-TDD (SC-FDMA, 1 RB, 5 MHz, 16-QAM, UL Subframe=2,3,4,7,8,9)	X	0.63	60.00	7.22	3.23	80.0	± 9.6 %
		Y	0.63	60.00	7.14		80.0	
		Z	0.99	63.90	10.32		80.0	
10469-AAD	LTE-TDD (SC-FDMA, 1 RB, 5 MHz, 64-QAM, UL Subframe=2,3,4,7,8,9)	X	0.65	60.00	6.51	3.23	80.0	± 9.6 %
		Y	0.66	60.00	6.41		80.0	
		Z	0.68	60.00	7.70		80.0	
10470-AAD	LTE-TDD (SC-FDMA, 1 RB, 10 MHz, QPSK, UL Subframe=2,3,4,7,8,9)	X	1.46	72.21	16.22	3.23	80.0	± 9.6 %
		Y	5.35	88.98	21.94		80.0	
		Z	100.00	134.82	35.03		80.0	
10471-AAD	LTE-TDD (SC-FDMA, 1 RB, 10 MHz, 16-QAM, UL Subframe=2,3,4,7,8,9)	X	0.63	60.00	7.21	3.23	80.0	± 9.6 %
		Y	0.63	60.00	7.12		80.0	
		Z	0.98	63.79	10.26		80.0	
10472-AAD	LTE-TDD (SC-FDMA, 1 RB, 10 MHz, 64-QAM, UL Subframe=2,3,4,7,8,9)	X	0.65	60.00	6.49	3.23	80.0	± 9.6 %
		Y	0.66	60.00	6.39		80.0	
		Z	0.67	60.00	7.68		80.0	
10473-AAD	LTE-TDD (SC-FDMA, 1 RB, 15 MHz, QPSK, UL Subframe=2,3,4,7,8,9)	X	1.46	72.15	16.20	3.23	80.0	± 9.6 %
		Y	5.31	88.87	21.90		80.0	
		Z	100.00	134.77	35.01		80.0	
10474-AAD	LTE-TDD (SC-FDMA, 1 RB, 15 MHz, 16-QAM, UL Subframe=2,3,4,7,8,9)	X	0.63	60.00	7.20	3.23	80.0	± 9.6 %
		Y	0.63	60.00	7.12		80.0	
		Z	0.97	63.74	10.23		80.0	
10475-AAD	LTE-TDD (SC-FDMA, 1 RB, 15 MHz, 64-QAM, UL Subframe=2,3,4,7,8,9)	X	0.65	60.00	6.49	3.23	80.0	± 9.6 %
		Y	0.66	60.00	6.39		80.0	
		Z	0.67	60.00	7.69		80.0	

10477-AAE	LTE-TDD (SC-FDMA, 1 RB, 20 MHz, 16-QAM, UL Subframe=2,3,4,7,8,9)	X	0.63	60.00	7.17	3.23	80.0	± 9.6 %
		Y	0.63	60.00	7.08		80.0	
		Z	0.93	63.31	10.01		80.0	
10478-AAE	LTE-TDD (SC-FDMA, 1 RB, 20 MHz, 64-QAM, UL Subframe=2,3,4,7,8,9)	X	0.65	60.00	6.47	3.23	80.0	± 9.6 %
		Y	0.66	60.00	6.37		80.0	
		Z	0.67	60.00	7.67		80.0	
10479-AAA	LTE-TDD (SC-FDMA, 50% RB, 1.4 MHz, QPSK, UL Subframe=2,3,4,7,8,9)	X	4.26	80.69	20.19	3.23	80.0	± 9.6 %
		Y	7.01	87.70	22.71		80.0	
		Z	21.27	105.57	28.88		80.0	
10480-AAA	LTE-TDD (SC-FDMA, 50% RB, 1.4 MHz, 16-QAM, UL Subframe=2,3,4,7,8,9)	X	1.88	66.39	12.32	3.23	80.0	± 9.6 %
		Y	3.13	71.95	14.74		80.0	
		Z	13.52	90.52	21.87		80.0	
10481-AAA	LTE-TDD (SC-FDMA, 50% RB, 1.4 MHz, 64-QAM, UL Subframe=2,3,4,7,8,9)	X	1.43	63.16	10.40	3.23	80.0	± 9.6 %
		Y	2.06	66.80	12.23		80.0	
		Z	6.11	79.62	18.02		80.0	
10482-AAB	LTE-TDD (SC-FDMA, 50% RB, 3 MHz, QPSK, UL Subframe=2,3,4,7,8,9)	X	1.06	61.11	9.78	2.23	80.0	± 9.6 %
		Y	1.73	66.89	13.39		80.0	
		Z	1.53	64.78	12.61		80.0	
10483-AAB	LTE-TDD (SC-FDMA, 50% RB, 3 MHz, 16-QAM, UL Subframe=2,3,4,7,8,9)	X	1.23	60.00	8.50	2.23	80.0	± 9.6 %
		Y	1.57	62.45	10.22		80.0	
		Z	2.78	68.98	14.19		80.0	
10484-AAB	LTE-TDD (SC-FDMA, 50% RB, 3 MHz, 64-QAM, UL Subframe=2,3,4,7,8,9)	X	1.26	60.00	8.49	2.23	80.0	± 9.6 %
		Y	1.54	61.98	9.97		80.0	
		Z	2.53	67.57	13.58		80.0	
10485-AAD	LTE-TDD (SC-FDMA, 50% RB, 5 MHz, QPSK, UL Subframe=2,3,4,7,8,9)	X	1.66	65.74	13.74	2.23	80.0	± 9.6 %
		Y	2.52	71.78	17.06		80.0	
		Z	2.10	68.47	15.70		80.0	
10486-AAD	LTE-TDD (SC-FDMA, 50% RB, 5 MHz, 16-QAM, UL Subframe=2,3,4,7,8,9)	X	1.66	62.56	11.27	2.23	80.0	± 9.6 %
		Y	2.26	66.58	13.85		80.0	
		Z	2.12	65.12	13.38		80.0	
10487-AAD	LTE-TDD (SC-FDMA, 50% RB, 5 MHz, 64-QAM, UL Subframe=2,3,4,7,8,9)	X	1.67	62.33	11.12	2.23	80.0	± 9.6 %
		Y	2.24	66.10	13.59		80.0	
		Z	2.14	64.83	13.21		80.0	
10488-AAD	LTE-TDD (SC-FDMA, 50% RB, 10 MHz, QPSK, UL Subframe=2,3,4,7,8,9)	X	2.26	67.65	16.13	2.23	80.0	± 9.6 %
		Y	2.82	71.24	18.12		80.0	
		Z	2.57	69.00	17.08		80.0	
10489-AAD	LTE-TDD (SC-FDMA, 50% RB, 10 MHz, 16-QAM, UL Subframe=2,3,4,7,8,9)	X	2.49	65.85	15.07	2.23	80.0	± 9.6 %
		Y	2.90	68.21	16.54		80.0	
		Z	2.74	66.70	15.91		80.0	
10490-AAD	LTE-TDD (SC-FDMA, 50% RB, 10 MHz, 64-QAM, UL Subframe=2,3,4,7,8,9)	X	2.57	65.79	15.03	2.23	80.0	± 9.6 %
		Y	2.97	68.04	16.46		80.0	
		Z	2.83	66.63	15.88		80.0	
10491-AAD	LTE-TDD (SC-FDMA, 50% RB, 15 MHz, QPSK, UL Subframe=2,3,4,7,8,9)	X	2.64	67.24	16.30	2.23	80.0	± 9.6 %
		Y	3.09	69.79	17.74		80.0	
		Z	2.92	68.21	16.96		80.0	
10492-AAD	LTE-TDD (SC-FDMA, 50% RB, 15 MHz, 16-QAM, UL Subframe=2,3,4,7,8,9)	X	2.93	65.80	15.66	2.23	80.0	± 9.6 %
		Y	3.24	67.45	16.69		80.0	
		Z	3.14	66.35	16.22		80.0	

10493-AAD	LTE-TDD (SC-FDMA, 50% RB, 15 MHz, 64-QAM, UL Subframe=2,3,4,7,8,9)	X	2.99	65.74	15.62	2.23	80.0	± 9.6 %
		Y	3.29	67.32	16.63		80.0	
		Z	3.21	66.28	16.18		80.0	
10494-AAE	LTE-TDD (SC-FDMA, 50% RB, 20 MHz, QPSK, UL Subframe=2,3,4,7,8,9)	X	2.77	68.16	16.65	2.23	80.0	± 9.6 %
		Y	3.31	71.10	18.21		80.0	
		Z	3.09	69.31	17.33		80.0	
10495-AAE	LTE-TDD (SC-FDMA, 50% RB, 20 MHz, 16-QAM, UL Subframe=2,3,4,7,8,9)	X	2.95	66.01	15.89	2.23	80.0	± 9.6 %
		Y	3.25	67.67	16.91		80.0	
		Z	3.16	66.59	16.41		80.0	
10496-AAE	LTE-TDD (SC-FDMA, 50% RB, 20 MHz, 64-QAM, UL Subframe=2,3,4,7,8,9)	X	3.04	65.92	15.89	2.23	80.0	± 9.6 %
		Y	3.34	67.48	16.84		80.0	
		Z	3.25	66.45	16.38		80.0	
10497-AAA	LTE-TDD (SC-FDMA, 100% RB, 1.4 MHz, QPSK, UL Subframe=2,3,4,7,8,9)	X	0.90	60.00	7.56	2.23	80.0	± 9.6 %
		Y	0.94	60.22	8.59		80.0	
		Z	0.98	60.00	8.77		80.0	
10498-AAA	LTE-TDD (SC-FDMA, 100% RB, 1.4 MHz, 16-QAM, UL Subframe=2,3,4,7,8,9)	X	1.09	60.00	6.33	2.23	80.0	± 9.6 %
		Y	1.09	60.00	7.12		80.0	
		Z	1.16	60.00	7.58		80.0	
10499-AAA	LTE-TDD (SC-FDMA, 100% RB, 1.4 MHz, 64-QAM, UL Subframe=2,3,4,7,8,9)	X	1.11	60.00	6.17	2.23	80.0	± 9.6 %
		Y	1.11	60.00	6.94		80.0	
		Z	1.17	60.00	7.42		80.0	
10500-AAB	LTE-TDD (SC-FDMA, 100% RB, 3 MHz, QPSK, UL Subframe=2,3,4,7,8,9)	X	1.91	66.68	14.78	2.23	80.0	± 9.6 %
		Y	2.64	71.54	17.49		80.0	
		Z	2.29	68.68	16.26		80.0	
10501-AAB	LTE-TDD (SC-FDMA, 100% RB, 3 MHz, 16-QAM, UL Subframe=2,3,4,7,8,9)	X	2.02	64.23	12.91	2.23	80.0	± 9.6 %
		Y	2.60	67.75	15.11		80.0	
		Z	2.42	66.09	14.51		80.0	
10502-AAB	LTE-TDD (SC-FDMA, 100% RB, 3 MHz, 64-QAM, UL Subframe=2,3,4,7,8,9)	X	2.05	64.07	12.75	2.23	80.0	± 9.6 %
		Y	2.63	67.51	14.92		80.0	
		Z	2.46	65.95	14.37		80.0	
10503-AAD	LTE-TDD (SC-FDMA, 100% RB, 5 MHz, QPSK, UL Subframe=2,3,4,7,8,9)	X	2.23	67.47	16.03	2.23	80.0	± 9.6 %
		Y	2.79	71.03	18.01		80.0	
		Z	2.54	68.82	16.98		80.0	
10504-AAD	LTE-TDD (SC-FDMA, 100% RB, 5 MHz, 16-QAM, UL Subframe=2,3,4,7,8,9)	X	2.48	65.75	15.00	2.23	80.0	± 9.6 %
		Y	2.88	68.10	16.48		80.0	
		Z	2.73	66.60	15.85		80.0	
10505-AAD	LTE-TDD (SC-FDMA, 100% RB, 5 MHz, 64-QAM, UL Subframe=2,3,4,7,8,9)	X	2.55	65.70	14.97	2.23	80.0	± 9.6 %
		Y	2.95	67.94	16.40		80.0	
		Z	2.81	66.54	15.82		80.0	
10506-AAD	LTE-TDD (SC-FDMA, 100% RB, 10 MHz, QPSK, UL Subframe=2,3,4,7,8,9)	X	2.76	68.04	16.58	2.23	80.0	± 9.6 %
		Y	3.29	70.96	18.14		80.0	
		Z	3.07	69.18	17.26		80.0	
10507-AAD	LTE-TDD (SC-FDMA, 100% RB, 10 MHz, 16-QAM, UL Subframe=2,3,4,7,8,9)	X	2.93	65.95	15.85	2.23	80.0	± 9.6 %
		Y	3.24	67.61	16.87		80.0	
		Z	3.14	66.53	16.37		80.0	

10508-AAD	LTE-TDD (SC-FDMA, 100% RB, 10 MHz, 64-QAM, UL Subframe=2,3,4,7,8,9)	X	3.03	65.86	15.84	2.23	80.0	± 9.6 %
		Y	3.33	67.40	16.79		80.0	
		Z	3.24	66.38	16.33		80.0	
10509-AAD	LTE-TDD (SC-FDMA, 100% RB, 15 MHz, QPSK, UL Subframe=2,3,4,7,8,9)	X	3.24	67.72	16.53	2.23	80.0	± 9.6 %
		Y	3.69	69.96	17.72		80.0	
		Z	3.51	68.56	17.03		80.0	
10510-AAD	LTE-TDD (SC-FDMA, 100% RB, 15 MHz, 16-QAM, UL Subframe=2,3,4,7,8,9)	X	3.43	65.97	16.12	2.23	80.0	± 9.6 %
		Y	3.71	67.32	16.91		80.0	
		Z	3.64	66.47	16.52		80.0	
10511-AAD	LTE-TDD (SC-FDMA, 100% RB, 15 MHz, 64-QAM, UL Subframe=2,3,4,7,8,9)	X	3.52	65.89	16.12	2.23	80.0	± 9.6 %
		Y	3.78	67.15	16.86		80.0	
		Z	3.71	66.32	16.49		80.0	
10512-AAE	LTE-TDD (SC-FDMA, 100% RB, 20 MHz, QPSK, UL Subframe=2,3,4,7,8,9)	X	3.22	68.47	16.72	2.23	80.0	± 9.6 %
		Y	3.79	71.22	18.12		80.0	
		Z	3.54	69.57	17.32		80.0	
10513-AAE	LTE-TDD (SC-FDMA, 100% RB, 20 MHz, 16-QAM, UL Subframe=2,3,4,7,8,9)	X	3.32	66.00	16.15	2.23	80.0	± 9.6 %
		Y	3.60	67.43	16.98		80.0	
		Z	3.52	66.56	16.56		80.0	
10514-AAE	LTE-TDD (SC-FDMA, 100% RB, 20 MHz, 64-QAM, UL Subframe=2,3,4,7,8,9)	X	3.39	65.79	16.10	2.23	80.0	± 9.6 %
		Y	3.64	67.11	16.88		80.0	
		Z	3.57	66.28	16.49		80.0	
10515-AAA	IEEE 802.11b WiFi 2.4 GHz (DSSS, 2 Mbps, 99pc duty cycle)	X	0.88	62.44	13.81	0.00	150.0	± 9.6 %
		Y	0.96	63.62	14.88		150.0	
		Z	0.87	62.07	13.59		150.0	
10516-AAA	IEEE 802.11b WiFi 2.4 GHz (DSSS, 5.5 Mbps, 99pc duty cycle)	X	0.45	66.98	14.48	0.00	150.0	± 9.6 %
		Y	0.65	72.72	18.47		150.0	
		Z	0.42	65.95	13.66		150.0	
10517-AAA	IEEE 802.11b WiFi 2.4 GHz (DSSS, 11 Mbps, 99pc duty cycle)	X	0.70	63.68	13.97	0.00	150.0	± 9.6 %
		Y	0.81	65.65	15.62		150.0	
		Z	0.69	63.23	13.65		150.0	
10518-AAB	IEEE 802.11a/h WiFi 5 GHz (OFDM, 9 Mbps, 99pc duty cycle)	X	4.21	66.61	15.96	0.00	150.0	± 9.6 %
		Y	4.32	66.98	16.20		150.0	
		Z	4.31	66.42	15.93		150.0	
10519-AAB	IEEE 802.11a/h WiFi 5 GHz (OFDM, 12 Mbps, 99pc duty cycle)	X	4.34	66.77	16.04	0.00	150.0	± 9.6 %
		Y	4.46	67.14	16.28		150.0	
		Z	4.46	66.61	16.03		150.0	
10520-AAB	IEEE 802.11a/h WiFi 5 GHz (OFDM, 18 Mbps, 99pc duty cycle)	X	4.20	66.68	15.95	0.00	150.0	± 9.6 %
		Y	4.32	67.07	16.20		150.0	
		Z	4.31	66.53	15.94		150.0	
10521-AAB	IEEE 802.11a/h WiFi 5 GHz (OFDM, 24 Mbps, 99pc duty cycle)	X	4.13	66.63	15.92	0.00	150.0	± 9.6 %
		Y	4.25	67.04	16.18		150.0	
		Z	4.24	66.49	15.91		150.0	
10522-AAB	IEEE 802.11a/h WiFi 5 GHz (OFDM, 36 Mbps, 99pc duty cycle)	X	4.17	66.72	15.99	0.00	150.0	± 9.6 %
		Y	4.29	67.14	16.26		150.0	
		Z	4.30	66.63	16.02		150.0	

10523-AAB	IEEE 802.11a/h WiFi 5 GHz (OFDM, 48 Mbps, 99pc duty cycle)	X	4.12	66.80	15.96	0.00	150.0	± 9.6 %
		Y	4.24	67.19	16.22		150.0	
		Z	4.21	66.57	15.90		150.0	
10524-AAB	IEEE 802.11a/h WiFi 5 GHz (OFDM, 54 Mbps, 99pc duty cycle)	X	4.13	66.73	16.01	0.00	150.0	± 9.6 %
		Y	4.25	67.13	16.27		150.0	
		Z	4.25	66.57	15.99		150.0	
10525-AAB	IEEE 802.11ac WiFi (20MHz, MCS0, 99pc duty cycle)	X	4.18	65.86	15.65	0.00	150.0	± 9.6 %
		Y	4.29	66.26	15.91		150.0	
		Z	4.27	65.65	15.61		150.0	
10526-AAB	IEEE 802.11ac WiFi (20MHz, MCS1, 99pc duty cycle)	X	4.28	66.10	15.76	0.00	150.0	± 9.6 %
		Y	4.41	66.52	16.01		150.0	
		Z	4.40	65.94	15.73		150.0	
10527-AAB	IEEE 802.11ac WiFi (20MHz, MCS2, 99pc duty cycle)	X	4.22	66.07	15.69	0.00	150.0	± 9.6 %
		Y	4.34	66.49	15.96		150.0	
		Z	4.33	65.90	15.66		150.0	
10528-AAB	IEEE 802.11ac WiFi (20MHz, MCS3, 99pc duty cycle)	X	4.23	66.08	15.73	0.00	150.0	± 9.6 %
		Y	4.36	66.51	15.99		150.0	
		Z	4.34	65.91	15.70		150.0	
10529-AAB	IEEE 802.11ac WiFi (20MHz, MCS4, 99pc duty cycle)	X	4.23	66.08	15.73	0.00	150.0	± 9.6 %
		Y	4.36	66.51	15.99		150.0	
		Z	4.34	65.91	15.70		150.0	
10531-AAB	IEEE 802.11ac WiFi (20MHz, MCS6, 99pc duty cycle)	X	4.19	66.07	15.68	0.00	150.0	± 9.6 %
		Y	4.32	66.52	15.96		150.0	
		Z	4.31	65.94	15.68		150.0	
10532-AAB	IEEE 802.11ac WiFi (20MHz, MCS7, 99pc duty cycle)	X	4.08	65.93	15.61	0.00	150.0	± 9.6 %
		Y	4.20	66.39	15.90		150.0	
		Z	4.19	65.79	15.60		150.0	
10533-AAB	IEEE 802.11ac WiFi (20MHz, MCS8, 99pc duty cycle)	X	4.23	66.16	15.73	0.00	150.0	± 9.6 %
		Y	4.36	66.60	16.00		150.0	
		Z	4.35	65.98	15.69		150.0	
10534-AAB	IEEE 802.11ac WiFi (40MHz, MCS0, 99pc duty cycle)	X	4.82	66.10	15.85	0.00	150.0	± 9.6 %
		Y	4.91	66.46	16.04		150.0	
		Z	4.91	66.02	15.83		150.0	
10535-AAB	IEEE 802.11ac WiFi (40MHz, MCS1, 99pc duty cycle)	X	4.85	66.20	15.91	0.00	150.0	± 9.6 %
		Y	4.94	66.56	16.09		150.0	
		Z	4.97	66.17	15.90		150.0	
10536-AAB	IEEE 802.11ac WiFi (40MHz, MCS2, 99pc duty cycle)	X	4.74	66.19	15.87	0.00	150.0	± 9.6 %
		Y	4.84	66.58	16.08		150.0	
		Z	4.85	66.14	15.86		150.0	
10537-AAB	IEEE 802.11ac WiFi (40MHz, MCS3, 99pc duty cycle)	X	4.82	66.26	15.91	0.00	150.0	± 9.6 %
		Y	4.91	66.59	16.08		150.0	
		Z	4.91	66.13	15.86		150.0	
10538-AAB	IEEE 802.11ac WiFi (40MHz, MCS4, 99pc duty cycle)	X	4.87	66.17	15.91	0.00	150.0	± 9.6 %
		Y	4.97	66.52	16.09		150.0	
		Z	4.98	66.12	15.90		150.0	
10540-AAB	IEEE 802.11ac WiFi (40MHz, MCS6, 99pc duty cycle)	X	4.80	66.12	15.90	0.00	150.0	± 9.6 %
		Y	4.90	66.49	16.09		150.0	
		Z	4.91	66.07	15.89		150.0	

10541-AAB	IEEE 802.11ac WiFi (40MHz, MCS7, 99pc duty cycle)	X	4.79	66.06	15.85	0.00	150.0	± 9.6 %
		Y	4.89	66.43	16.04		150.0	
		Z	4.89	65.96	15.82		150.0	
10542-AAB	IEEE 802.11ac WiFi (40MHz, MCS8, 99pc duty cycle)	X	4.94	66.17	15.92	0.00	150.0	± 9.6 %
		Y	5.04	66.51	16.10		150.0	
		Z	5.05	66.09	15.90		150.0	
10543-AAB	IEEE 802.11ac WiFi (40MHz, MCS9, 99pc duty cycle)	X	5.03	66.31	16.03	0.00	150.0	± 9.6 %
		Y	5.11	66.60	16.17		150.0	
		Z	5.12	66.17	15.97		150.0	
10544-AAB	IEEE 802.11ac WiFi (80MHz, MCS0, 99pc duty cycle)	X	5.18	66.16	15.86	0.00	150.0	± 9.6 %
		Y	5.26	66.52	16.02		150.0	
		Z	5.26	66.12	15.84		150.0	
10545-AAB	IEEE 802.11ac WiFi (80MHz, MCS1, 99pc duty cycle)	X	5.36	66.65	16.06	0.00	150.0	± 9.6 %
		Y	5.42	66.93	16.19		150.0	
		Z	5.45	66.61	16.04		150.0	
10546-AAB	IEEE 802.11ac WiFi (80MHz, MCS2, 99pc duty cycle)	X	5.20	66.27	15.88	0.00	150.0	± 9.6 %
		Y	5.29	66.63	16.05		150.0	
		Z	5.29	66.25	15.87		150.0	
10547-AAB	IEEE 802.11ac WiFi (80MHz, MCS3, 99pc duty cycle)	X	5.31	66.50	15.99	0.00	150.0	± 9.6 %
		Y	5.37	66.75	16.11		150.0	
		Z	5.38	66.37	15.93		150.0	
10548-AAB	IEEE 802.11ac WiFi (80MHz, MCS4, 99pc duty cycle)	X	5.41	66.98	16.21	0.00	150.0	± 9.6 %
		Y	5.49	67.30	16.36		150.0	
		Z	5.57	67.13	16.28		150.0	
10550-AAB	IEEE 802.11ac WiFi (80MHz, MCS6, 99pc duty cycle)	X	5.30	66.60	16.06	0.00	150.0	± 9.6 %
		Y	5.35	66.83	16.16		150.0	
		Z	5.37	66.46	15.99		150.0	
10551-AAB	IEEE 802.11ac WiFi (80MHz, MCS7, 99pc duty cycle)	X	5.19	66.21	15.83	0.00	150.0	± 9.6 %
		Y	5.28	66.60	16.01		150.0	
		Z	5.30	66.24	15.84		150.0	
10552-AAB	IEEE 802.11ac WiFi (80MHz, MCS8, 99pc duty cycle)	X	5.18	66.29	15.86	0.00	150.0	± 9.6 %
		Y	5.27	66.65	16.04		150.0	
		Z	5.26	66.20	15.82		150.0	
10553-AAB	IEEE 802.11ac WiFi (80MHz, MCS9, 99pc duty cycle)	X	5.23	66.22	15.86	0.00	150.0	± 9.6 %
		Y	5.32	66.58	16.03		150.0	
		Z	5.32	66.18	15.85		150.0	
10554-AAC	IEEE 802.11ac WiFi (160MHz, MCS0, 99pc duty cycle)	X	5.62	66.51	15.95	0.00	150.0	± 9.6 %
		Y	5.68	66.84	16.09		150.0	
		Z	5.69	66.48	15.94		150.0	
10555-AAC	IEEE 802.11ac WiFi (160MHz, MCS1, 99pc duty cycle)	X	5.69	66.71	16.04	0.00	150.0	± 9.6 %
		Y	5.76	67.04	16.18		150.0	
		Z	5.79	66.75	16.05		150.0	
10556-AAC	IEEE 802.11ac WiFi (160MHz, MCS2, 99pc duty cycle)	X	5.75	66.88	16.11	0.00	150.0	± 9.6 %
		Y	5.80	67.16	16.23		150.0	
		Z	5.83	66.85	16.10		150.0	
10557-AAC	IEEE 802.11ac WiFi (160MHz, MCS3, 99pc duty cycle)	X	5.69	66.70	16.04	0.00	150.0	± 9.6 %
		Y	5.76	67.04	16.19		150.0	
		Z	5.77	66.69	16.03		150.0	

10558-AAC	IEEE 802.11ac WiFi (160MHz, MCS4, 99pc duty cycle)	X	5.67	66.68	16.05	0.00	150.0	± 9.6 %
		Y	5.76	67.07	16.22		150.0	
		Z	5.80	66.79	16.10		150.0	
10560-AAC	IEEE 802.11ac WiFi (160MHz, MCS6, 99pc duty cycle)	X	5.71	66.66	16.07	0.00	150.0	± 9.6 %
		Y	5.79	67.02	16.23		150.0	
		Z	5.81	66.69	16.09		150.0	
10561-AAC	IEEE 802.11ac WiFi (160MHz, MCS7, 99pc duty cycle)	X	5.65	66.65	16.10	0.00	150.0	± 9.6 %
		Y	5.72	67.00	16.25		150.0	
		Z	5.75	66.69	16.12		150.0	
10562-AAC	IEEE 802.11ac WiFi (160MHz, MCS8, 99pc duty cycle)	X	5.68	66.77	16.16	0.00	150.0	± 9.6 %
		Y	5.77	67.15	16.33		150.0	
		Z	5.80	66.87	16.21		150.0	
10563-AAC	IEEE 802.11ac WiFi (160MHz, MCS9, 99pc duty cycle)	X	5.80	66.82	16.15	0.00	150.0	± 9.6 %
		Y	5.88	67.15	16.29		150.0	
		Z	5.91	66.85	16.17		150.0	
10564-AAA	IEEE 802.11g WiFi 2.4 GHz (DSSS-OFDM, 9 Mbps, 99pc duty cycle)	X	4.52	66.62	16.09	0.46	150.0	± 9.6 %
		Y	4.63	66.97	16.32		150.0	
		Z	4.63	66.48	16.09		150.0	
10565-AAA	IEEE 802.11g WiFi 2.4 GHz (DSSS-OFDM, 12 Mbps, 99pc duty cycle)	X	4.71	67.05	16.42	0.46	150.0	± 9.6 %
		Y	4.82	67.38	16.63		150.0	
		Z	4.83	66.91	16.42		150.0	
10566-AAA	IEEE 802.11g WiFi 2.4 GHz (DSSS-OFDM, 18 Mbps, 99pc duty cycle)	X	4.54	66.82	16.20	0.46	150.0	± 9.6 %
		Y	4.65	67.19	16.43		150.0	
		Z	4.66	66.71	16.22		150.0	
10567-AAA	IEEE 802.11g WiFi 2.4 GHz (DSSS-OFDM, 24 Mbps, 99pc duty cycle)	X	4.58	67.25	16.61	0.46	150.0	± 9.6 %
		Y	4.69	67.60	16.82		150.0	
		Z	4.69	67.12	16.60		150.0	
10568-AAA	IEEE 802.11g WiFi 2.4 GHz (DSSS-OFDM, 36 Mbps, 99pc duty cycle)	X	4.42	66.46	15.88	0.46	150.0	± 9.6 %
		Y	4.54	66.88	16.15		150.0	
		Z	4.56	66.45	15.95		150.0	
10569-AAA	IEEE 802.11g WiFi 2.4 GHz (DSSS-OFDM, 48 Mbps, 99pc duty cycle)	X	4.58	67.53	16.78	0.46	150.0	± 9.6 %
		Y	4.68	67.86	16.97		150.0	
		Z	4.68	67.31	16.72		150.0	
10570-AAA	IEEE 802.11g WiFi 2.4 GHz (DSSS-OFDM, 54 Mbps, 99pc duty cycle)	X	4.57	67.27	16.64	0.46	150.0	± 9.6 %
		Y	4.68	67.61	16.85		150.0	
		Z	4.69	67.12	16.62		150.0	
10571-AAA	IEEE 802.11b WiFi 2.4 GHz (DSSS, 1 Mbps, 90pc duty cycle)	X	0.99	62.81	14.23	0.46	130.0	± 9.6 %
		Y	1.09	64.12	15.35		130.0	
		Z	1.00	62.69	14.25		130.0	
10572-AAA	IEEE 802.11b WiFi 2.4 GHz (DSSS, 2 Mbps, 90pc duty cycle)	X	1.00	63.25	14.53	0.46	130.0	± 9.6 %
		Y	1.10	64.66	15.71		130.0	
		Z	1.00	63.12	14.54		130.0	
10573-AAA	IEEE 802.11b WiFi 2.4 GHz (DSSS, 5.5 Mbps, 90pc duty cycle)	X	0.77	71.94	17.18	0.46	130.0	± 9.6 %
		Y	1.53	83.79	23.08		130.0	
		Z	0.78	71.84	17.05		130.0	
10574-AAA	IEEE 802.11b WiFi 2.4 GHz (DSSS, 11 Mbps, 90pc duty cycle)	X	0.97	67.27	16.73	0.46	130.0	± 9.6 %
		Y	1.16	70.12	18.67		130.0	
		Z	0.98	67.08	16.66		130.0	

10575-AAA	IEEE 802.11g WiFi 2.4 GHz (DSSS-OFDM, 6 Mbps, 90pc duty cycle)	X	4.29	66.33	16.06	0.46	130.0	± 9.6 %
		Y	4.40	66.70	16.31		130.0	
		Z	4.41	66.24	16.12		130.0	
10576-AAA	IEEE 802.11g WiFi 2.4 GHz (DSSS-OFDM, 9 Mbps, 90pc duty cycle)	X	4.32	66.56	16.16	0.46	130.0	± 9.6 %
		Y	4.43	66.92	16.41		130.0	
		Z	4.43	66.43	16.20		130.0	
10577-AAA	IEEE 802.11g WiFi 2.4 GHz (DSSS-OFDM, 12 Mbps, 90pc duty cycle)	X	4.47	66.78	16.31	0.46	130.0	± 9.6 %
		Y	4.58	67.14	16.55		130.0	
		Z	4.60	66.69	16.36		130.0	
10578-AAA	IEEE 802.11g WiFi 2.4 GHz (DSSS-OFDM, 18 Mbps, 90pc duty cycle)	X	4.38	66.93	16.42	0.46	130.0	± 9.6 %
		Y	4.49	67.29	16.66		130.0	
		Z	4.50	66.83	16.46		130.0	
10579-AAA	IEEE 802.11g WiFi 2.4 GHz (DSSS-OFDM, 24 Mbps, 90pc duty cycle)	X	4.12	66.01	15.59	0.46	130.0	± 9.6 %
		Y	4.24	66.44	15.89		130.0	
		Z	4.26	65.99	15.69		130.0	
10580-AAA	IEEE 802.11g WiFi 2.4 GHz (DSSS-OFDM, 36 Mbps, 90pc duty cycle)	X	4.14	66.03	15.59	0.46	130.0	± 9.6 %
		Y	4.27	66.48	15.90		130.0	
		Z	4.30	66.06	15.72		130.0	
10581-AAA	IEEE 802.11g WiFi 2.4 GHz (DSSS-OFDM, 48 Mbps, 90pc duty cycle)	X	4.29	67.01	16.39	0.46	130.0	± 9.6 %
		Y	4.41	67.39	16.65		130.0	
		Z	4.41	66.87	16.41		130.0	
10582-AAA	IEEE 802.11g WiFi 2.4 GHz (DSSS-OFDM, 54 Mbps, 90pc duty cycle)	X	4.04	65.76	15.35	0.46	130.0	± 9.6 %
		Y	4.17	66.20	15.67		130.0	
		Z	4.19	65.76	15.46		130.0	
10583-AAB	IEEE 802.11a/h WiFi 5 GHz (OFDM, 6 Mbps, 90pc duty cycle)	X	4.29	66.33	16.06	0.46	130.0	± 9.6 %
		Y	4.40	66.70	16.31		130.0	
		Z	4.41	66.24	16.12		130.0	
10584-AAB	IEEE 802.11a/h WiFi 5 GHz (OFDM, 9 Mbps, 90pc duty cycle)	X	4.32	66.56	16.16	0.46	130.0	± 9.6 %
		Y	4.43	66.92	16.41		130.0	
		Z	4.43	66.43	16.20		130.0	
10585-AAB	IEEE 802.11a/h WiFi 5 GHz (OFDM, 12 Mbps, 90pc duty cycle)	X	4.47	66.78	16.31	0.46	130.0	± 9.6 %
		Y	4.58	67.14	16.55		130.0	
		Z	4.60	66.69	16.36		130.0	
10586-AAB	IEEE 802.11a/h WiFi 5 GHz (OFDM, 18 Mbps, 90pc duty cycle)	X	4.38	66.93	16.42	0.46	130.0	± 9.6 %
		Y	4.49	67.29	16.66		130.0	
		Z	4.50	66.83	16.46		130.0	
10587-AAB	IEEE 802.11a/h WiFi 5 GHz (OFDM, 24 Mbps, 90pc duty cycle)	X	4.12	66.01	15.59	0.46	130.0	± 9.6 %
		Y	4.24	66.44	15.89		130.0	
		Z	4.26	65.99	15.69		130.0	
10588-AAB	IEEE 802.11a/h WiFi 5 GHz (OFDM, 36 Mbps, 90pc duty cycle)	X	4.14	66.03	15.59	0.46	130.0	± 9.6 %
		Y	4.27	66.48	15.90		130.0	
		Z	4.30	66.06	15.72		130.0	
10589-AAB	IEEE 802.11a/h WiFi 5 GHz (OFDM, 48 Mbps, 90pc duty cycle)	X	4.29	67.01	16.39	0.46	130.0	± 9.6 %
		Y	4.41	67.39	16.65		130.0	
		Z	4.41	66.87	16.41		130.0	
10590-AAB	IEEE 802.11a/h WiFi 5 GHz (OFDM, 54 Mbps, 90pc duty cycle)	X	4.04	65.76	15.35	0.46	130.0	± 9.6 %
		Y	4.17	66.20	15.67		130.0	
		Z	4.19	65.76	15.46		130.0	

10591-AAB	IEEE 802.11n (HT Mixed, 20MHz, MCS0, 90pc duty cycle)	X	4.45	66.46	16.22	0.46	130.0	± 9.6 %
		Y	4.56	66.80	16.44		130.0	
		Z	4.57	66.34	16.25		130.0	
10592-AAB	IEEE 802.11n (HT Mixed, 20MHz, MCS1, 90pc duty cycle)	X	4.56	66.73	16.33	0.46	130.0	± 9.6 %
		Y	4.67	67.08	16.56		130.0	
		Z	4.69	66.64	16.38		130.0	
10593-AAB	IEEE 802.11n (HT Mixed, 20MHz, MCS2, 90pc duty cycle)	X	4.47	66.59	16.17	0.46	130.0	± 9.6 %
		Y	4.59	66.95	16.42		130.0	
		Z	4.60	66.51	16.23		130.0	
10594-AAB	IEEE 802.11n (HT Mixed, 20MHz, MCS3, 90pc duty cycle)	X	4.53	66.78	16.36	0.46	130.0	± 9.6 %
		Y	4.64	67.13	16.59		130.0	
		Z	4.66	66.69	16.40		130.0	
10595-AAB	IEEE 802.11n (HT Mixed, 20MHz, MCS4, 90pc duty cycle)	X	4.49	66.75	16.26	0.46	130.0	± 9.6 %
		Y	4.61	67.12	16.50		130.0	
		Z	4.62	66.66	16.30		130.0	
10596-AAB	IEEE 802.11n (HT Mixed, 20MHz, MCS5, 90pc duty cycle)	X	4.42	66.68	16.23	0.46	130.0	± 9.6 %
		Y	4.53	67.07	16.49		130.0	
		Z	4.55	66.62	16.29		130.0	
10597-AAB	IEEE 802.11n (HT Mixed, 20MHz, MCS6, 90pc duty cycle)	X	4.37	66.54	16.07	0.46	130.0	± 9.6 %
		Y	4.49	66.93	16.34		130.0	
		Z	4.51	66.49	16.14		130.0	
10598-AAB	IEEE 802.11n (HT Mixed, 20MHz, MCS7, 90pc duty cycle)	X	4.38	66.81	16.37	0.46	130.0	± 9.6 %
		Y	4.49	67.18	16.61		130.0	
		Z	4.50	66.72	16.41		130.0	
10599-AAB	IEEE 802.11n (HT Mixed, 40MHz, MCS0, 90pc duty cycle)	X	5.17	67.00	16.56	0.46	130.0	± 9.6 %
		Y	5.23	67.23	16.68		130.0	
		Z	5.27	66.93	16.57		130.0	
10600-AAB	IEEE 802.11n (HT Mixed, 40MHz, MCS1, 90pc duty cycle)	X	5.26	67.35	16.71	0.46	130.0	± 9.6 %
		Y	5.31	67.52	16.80		130.0	
		Z	5.40	67.37	16.76		130.0	
10601-AAB	IEEE 802.11n (HT Mixed, 40MHz, MCS2, 90pc duty cycle)	X	5.19	67.20	16.65	0.46	130.0	± 9.6 %
		Y	5.24	67.37	16.74		130.0	
		Z	5.28	67.08	16.63		130.0	
10602-AAB	IEEE 802.11n (HT Mixed, 40MHz, MCS3, 90pc duty cycle)	X	5.24	67.11	16.52	0.46	130.0	± 9.6 %
		Y	5.31	67.34	16.64		130.0	
		Z	5.41	67.24	16.63		130.0	
10603-AAB	IEEE 802.11n (HT Mixed, 40MHz, MCS4, 90pc duty cycle)	X	5.29	67.35	16.79	0.46	130.0	± 9.6 %
		Y	5.38	67.63	16.93		130.0	
		Z	5.49	67.59	16.94		130.0	
10604-AAB	IEEE 802.11n (HT Mixed, 40MHz, MCS5, 90pc duty cycle)	X	5.15	66.85	16.51	0.46	130.0	± 9.6 %
		Y	5.25	67.21	16.70		130.0	
		Z	5.37	67.21	16.74		130.0	
10605-AAB	IEEE 802.11n (HT Mixed, 40MHz, MCS6, 90pc duty cycle)	X	5.23	67.14	16.65	0.46	130.0	± 9.6 %
		Y	5.30	67.39	16.79		130.0	
		Z	5.38	67.23	16.74		130.0	
10606-AAB	IEEE 802.11n (HT Mixed, 40MHz, MCS7, 90pc duty cycle)	X	5.05	66.67	16.26	0.46	130.0	± 9.6 %
		Y	5.11	66.89	16.39		130.0	
		Z	5.14	66.57	16.26		130.0	

10607-AAB	IEEE 802.11ac WiFi (20MHz, MCS0, 90pc duty cycle)	X	4.30	65.79	15.85	0.46	130.0	± 9.6 %
		Y	4.41	66.18	16.11		130.0	
		Z	4.41	65.65	15.87		130.0	
10608-AAB	IEEE 802.11ac WiFi (20MHz, MCS1, 90pc duty cycle)	X	4.42	66.08	15.98	0.46	130.0	± 9.6 %
		Y	4.54	66.48	16.24		130.0	
		Z	4.55	65.99	16.03		130.0	
10609-AAB	IEEE 802.11ac WiFi (20MHz, MCS2, 90pc duty cycle)	X	4.32	65.89	15.79	0.46	130.0	± 9.6 %
		Y	4.44	66.32	16.07		130.0	
		Z	4.44	65.81	15.84		130.0	
10610-AAB	IEEE 802.11ac WiFi (20MHz, MCS3, 90pc duty cycle)	X	4.37	66.08	15.98	0.46	130.0	± 9.6 %
		Y	4.49	66.49	16.24		130.0	
		Z	4.49	65.99	16.01		130.0	
10611-AAB	IEEE 802.11ac WiFi (20MHz, MCS4, 90pc duty cycle)	X	4.28	65.85	15.80	0.46	130.0	± 9.6 %
		Y	4.40	66.28	16.08		130.0	
		Z	4.41	65.78	15.85		130.0	
10612-AAB	IEEE 802.11ac WiFi (20MHz, MCS5, 90pc duty cycle)	X	4.26	65.94	15.82	0.46	130.0	± 9.6 %
		Y	4.39	66.39	16.11		130.0	
		Z	4.40	65.90	15.88		130.0	
10613-AAB	IEEE 802.11ac WiFi (20MHz, MCS6, 90pc duty cycle)	X	4.25	65.75	15.65	0.46	130.0	± 9.6 %
		Y	4.38	66.20	15.95		130.0	
		Z	4.40	65.73	15.73		130.0	
10614-AAB	IEEE 802.11ac WiFi (20MHz, MCS7, 90pc duty cycle)	X	4.24	66.02	15.94	0.46	130.0	± 9.6 %
		Y	4.36	66.46	16.22		130.0	
		Z	4.36	65.95	15.99		130.0	
10615-AAB	IEEE 802.11ac WiFi (20MHz, MCS8, 90pc duty cycle)	X	4.26	65.66	15.54	0.46	130.0	± 9.6 %
		Y	4.39	66.11	15.84		130.0	
		Z	4.40	65.60	15.61		130.0	
10616-AAB	IEEE 802.11ac WiFi (40MHz, MCS0, 90pc duty cycle)	X	4.95	66.09	16.09	0.46	130.0	± 9.6 %
		Y	5.04	66.42	16.27		130.0	
		Z	5.06	66.06	16.12		130.0	
10617-AAB	IEEE 802.11ac WiFi (40MHz, MCS1, 90pc duty cycle)	X	4.98	66.18	16.11	0.46	130.0	± 9.6 %
		Y	5.07	66.52	16.29		130.0	
		Z	5.13	66.25	16.19		130.0	
10618-AAB	IEEE 802.11ac WiFi (40MHz, MCS2, 90pc duty cycle)	X	4.89	66.22	16.14	0.46	130.0	± 9.6 %
		Y	4.99	66.61	16.35		130.0	
		Z	5.02	66.28	16.21		130.0	
10619-AAB	IEEE 802.11ac WiFi (40MHz, MCS3, 90pc duty cycle)	X	4.94	66.16	16.04	0.46	130.0	± 9.6 %
		Y	5.01	66.45	16.21		130.0	
		Z	5.04	66.09	16.05		130.0	
10620-AAB	IEEE 802.11ac WiFi (40MHz, MCS4, 90pc duty cycle)	X	4.98	66.07	16.05	0.46	130.0	± 9.6 %
		Y	5.08	66.42	16.24		130.0	
		Z	5.12	66.10	16.11		130.0	
10621-AAB	IEEE 802.11ac WiFi (40MHz, MCS5, 90pc duty cycle)	X	5.00	66.21	16.25	0.46	130.0	± 9.6 %
		Y	5.09	66.55	16.43		130.0	
		Z	5.12	66.22	16.29		130.0	
10622-AAB	IEEE 802.11ac WiFi (40MHz, MCS6, 90pc duty cycle)	X	4.98	66.29	16.29	0.46	130.0	± 9.6 %
		Y	5.08	66.63	16.46		130.0	
		Z	5.11	66.32	16.34		130.0	

10623-AAB	IEEE 802.11ac WiFi (40MHz, MCS7, 90pc duty cycle)	X	4.88	65.86	15.92	0.46	130.0	± 9.6 %
		Y	4.97	66.20	16.11		130.0	
		Z	4.99	65.82	15.95		130.0	
10624-AAB	IEEE 802.11ac WiFi (40MHz, MCS8, 90pc duty cycle)	X	5.07	66.13	16.12	0.46	130.0	± 9.6 %
		Y	5.16	66.45	16.30		130.0	
		Z	5.20	66.12	16.17		130.0	
10625-AAB	IEEE 802.11ac WiFi (40MHz, MCS9, 90pc duty cycle)	X	5.18	66.36	16.31	0.46	130.0	± 9.6 %
		Y	5.24	66.57	16.42		130.0	
		Z	5.32	66.38	16.36		130.0	
10626-AAB	IEEE 802.11ac WiFi (80MHz, MCS0, 90pc duty cycle)	X	5.30	66.10	16.05	0.46	130.0	± 9.6 %
		Y	5.38	66.44	16.22		130.0	
		Z	5.40	66.12	16.09		130.0	
10627-AAB	IEEE 802.11ac WiFi (80MHz, MCS1, 90pc duty cycle)	X	5.53	66.77	16.36	0.46	130.0	± 9.6 %
		Y	5.59	67.01	16.48		130.0	
		Z	5.65	66.81	16.41		130.0	
10628-AAB	IEEE 802.11ac WiFi (80MHz, MCS2, 90pc duty cycle)	X	5.29	66.06	15.93	0.46	130.0	± 9.6 %
		Y	5.37	66.41	16.10		130.0	
		Z	5.40	66.11	15.98		130.0	
10629-AAB	IEEE 802.11ac WiFi (80MHz, MCS3, 90pc duty cycle)	X	5.43	66.42	16.11	0.46	130.0	± 9.6 %
		Y	5.47	66.61	16.20		130.0	
		Z	5.50	66.31	16.08		130.0	
10630-AAB	IEEE 802.11ac WiFi (80MHz, MCS4, 90pc duty cycle)	X	5.59	67.09	16.45	0.46	130.0	± 9.6 %
		Y	5.66	67.38	16.59		130.0	
		Z	5.82	67.46	16.66		130.0	
10631-AAB	IEEE 802.11ac WiFi (80MHz, MCS5, 90pc duty cycle)	X	5.58	67.18	16.70	0.46	130.0	± 9.6 %
		Y	5.66	67.50	16.84		130.0	
		Z	5.74	67.33	16.79		130.0	
10632-AAB	IEEE 802.11ac WiFi (80MHz, MCS6, 90pc duty cycle)	X	5.57	67.09	16.67	0.46	130.0	± 9.6 %
		Y	5.60	67.22	16.72		130.0	
		Z	5.64	66.96	16.63		130.0	
10633-AAB	IEEE 802.11ac WiFi (80MHz, MCS7, 90pc duty cycle)	X	5.30	66.12	16.00	0.46	130.0	± 9.6 %
		Y	5.39	66.49	16.18		130.0	
		Z	5.45	66.28	16.11		130.0	
10634-AAB	IEEE 802.11ac WiFi (80MHz, MCS8, 90pc duty cycle)	X	5.34	66.35	16.17	0.46	130.0	± 9.6 %
		Y	5.43	66.70	16.34		130.0	
		Z	5.44	66.35	16.20		130.0	
10635-AAB	IEEE 802.11ac WiFi (80MHz, MCS9, 90pc duty cycle)	X	5.19	65.54	15.47	0.46	130.0	± 9.6 %
		Y	5.28	65.93	15.68		130.0	
		Z	5.31	65.62	15.55		130.0	
10636-AAC	IEEE 802.11ac WiFi (160MHz, MCS0, 90pc duty cycle)	X	5.75	66.48	16.16	0.46	130.0	± 9.6 %
		Y	5.81	66.78	16.30		130.0	
		Z	5.84	66.50	16.20		130.0	
10637-AAC	IEEE 802.11ac WiFi (160MHz, MCS1, 90pc duty cycle)	X	5.86	66.76	16.29	0.46	130.0	± 9.6 %
		Y	5.91	67.05	16.42		130.0	
		Z	5.98	66.87	16.37		130.0	
10638-AAC	IEEE 802.11ac WiFi (160MHz, MCS2, 90pc duty cycle)	X	5.90	66.89	16.33	0.46	130.0	± 9.6 %
		Y	5.95	67.16	16.45		130.0	
		Z	5.98	66.88	16.35		130.0	

10639-AAC	IEEE 802.11ac WiFi (160MHz, MCS3, 90pc duty cycle)	X	5.83	66.70	16.28	0.46	130.0	± 9.6 %
		Y	5.90	67.02	16.42		130.0	
		Z	5.94	66.76	16.33		130.0	
10640-AAC	IEEE 802.11ac WiFi (160MHz, MCS4, 90pc duty cycle)	X	5.77	66.49	16.12	0.46	130.0	± 9.6 %
		Y	5.85	66.88	16.30		130.0	
		Z	5.92	66.69	16.24		130.0	
10641-AAC	IEEE 802.11ac WiFi (160MHz, MCS5, 90pc duty cycle)	X	5.90	66.70	16.24	0.46	130.0	± 9.6 %
		Y	5.96	66.97	16.37		130.0	
		Z	6.02	66.77	16.30		130.0	
10642-AAC	IEEE 802.11ac WiFi (160MHz, MCS6, 90pc duty cycle)	X	5.91	66.85	16.49	0.46	130.0	± 9.6 %
		Y	5.98	67.18	16.64		130.0	
		Z	6.03	66.94	16.56		130.0	
10643-AAC	IEEE 802.11ac WiFi (160MHz, MCS7, 90pc duty cycle)	X	5.75	66.52	16.20	0.46	130.0	± 9.6 %
		Y	5.83	66.86	16.37		130.0	
		Z	5.88	66.65	16.30		130.0	
10644-AAC	IEEE 802.11ac WiFi (160MHz, MCS8, 90pc duty cycle)	X	5.80	66.66	16.30	0.46	130.0	± 9.6 %
		Y	5.88	67.03	16.47		130.0	
		Z	5.94	66.85	16.42		130.0	
10645-AAC	IEEE 802.11ac WiFi (160MHz, MCS9, 90pc duty cycle)	X	5.94	66.78	16.33	0.46	130.0	± 9.6 %
		Y	6.00	67.06	16.46		130.0	
		Z	6.15	67.15	16.54		130.0	
10646-AAE	LTE-TDD (SC-FDMA, 1 RB, 5 MHz, QPSK, UL Subframe=2,7)	X	5.05	83.78	28.65	9.30	60.0	± 9.6 %
		Y	6.98	93.27	32.89		60.0	
		Z	7.15	91.85	32.42		60.0	
10647-AAE	LTE-TDD (SC-FDMA, 1 RB, 20 MHz, QPSK, UL Subframe=2,7)	X	4.54	81.82	27.99	9.30	60.0	± 9.6 %
		Y	5.99	90.07	31.84		60.0	
		Z	6.33	89.46	31.67		60.0	
10648-AAA	CDMA2000 (1x Advanced)	X	0.37	60.00	6.05	0.00	150.0	± 9.6 %
		Y	0.48	61.63	8.16		150.0	
		Z	0.43	60.11	6.90		150.0	
10652-AAC	LTE-TDD (OFDMA, 5 MHz, E-TM 3.1, Clipping 44%)	X	2.93	65.21	15.11	2.23	80.0	± 9.6 %
		Y	3.20	66.58	16.05		80.0	
		Z	3.10	65.44	15.57		80.0	
10653-AAC	LTE-TDD (OFDMA, 10 MHz, E-TM 3.1, Clipping 44%)	X	3.55	64.93	15.73	2.23	80.0	± 9.6 %
		Y	3.74	65.80	16.31		80.0	
		Z	3.68	65.02	15.99		80.0	
10654-AAC	LTE-TDD (OFDMA, 15 MHz, E-TM 3.1, Clipping 44%)	X	3.60	64.60	15.83	2.23	80.0	± 9.6 %
		Y	3.76	65.39	16.34		80.0	
		Z	3.70	64.69	16.04		80.0	
10655-AAD	LTE-TDD (OFDMA, 20 MHz, E-TM 3.1, Clipping 44%)	X	3.69	64.52	15.89	2.23	80.0	± 9.6 %
		Y	3.83	65.30	16.38		80.0	
		Z	3.78	64.64	16.09		80.0	
10658-AAA	Pulse Waveform (200Hz, 10%)	X	3.48	68.63	11.85	10.00	50.0	± 9.6 %
		Y	5.65	74.45	13.80		50.0	
		Z	7.21	77.53	15.77		50.0	
10659-AAA	Pulse Waveform (200Hz, 20%)	X	2.03	66.95	10.03	6.99	60.0	± 9.6 %
		Y	100.00	101.12	19.79		60.0	
		Z	100.00	104.10	21.38		60.0	

10660-AAA	Pulse Waveform (200Hz, 40%)	X	0.68	62.61	6.79	3.98	80.0	± 9.6 %
		Y	100.00	101.16	18.64		80.0	
		Z	100.00	99.78	18.10		80.0	
10661-AAA	Pulse Waveform (200Hz, 60%)	X	0.25	60.00	4.25	2.22	100.0	± 9.6 %
		Y	100.00	102.31	18.13		100.0	
		Z	0.28	60.39	4.93		100.0	
10662-AAA	Pulse Waveform (200Hz, 80%)	X	6.06	60.21	1.38	0.97	120.0	± 9.6 %
		Y	100.00	96.37	14.68		120.0	
		Z	9.95	60.38	1.42		120.0	

^E Uncertainty is determined using the max. deviation from linear response applying rectangular distribution and is expressed for the square of the field value.



Accredited by the Swiss Accreditation Service (SAS)
The Swiss Accreditation Service is one of the signatories to the EA
Multilateral Agreement for the recognition of calibration certificates

Accreditation No.: **SCS 0108**

Client **PC Test**

Certificate No: **EX3-7409_Jun18**

CALIBRATION CERTIFICATE

Object: **EX3DV4 - SN:7409**

Calibration procedure(s): **QA CAL-01.v9, QA CAL-14.v4, QA CAL-23.v5, QA CAL-25.v6
Calibration procedure for dosimetric E-field probes**

Calibration date: **June 25, 2018**

This calibration certificate documents the traceability to national standards, which realize the physical units of measurements (SI).
The measurements and the uncertainties with confidence probability are given on the following pages and are part of the certificate.

All calibrations have been conducted in the closed laboratory facility: environment temperature (22 ± 3)°C and humidity < 70%.

Calibration Equipment used (M&TE critical for calibration)

*BN ✓
07/16/2018*

Primary Standards	ID	Cal Date (Certificate No.)	Scheduled Calibration
Power meter NRP	SN: 104778	04-Apr-18 (No. 217-02672/02673)	Apr-19
Power sensor NRP-Z91	SN: 103244	04-Apr-18 (No. 217-02672)	Apr-19
Power sensor NRP-Z91	SN: 103245	04-Apr-18 (No. 217-02673)	Apr-19
Reference 20 dB Attenuator	SN: S5277 (20x)	04-Apr-18 (No. 217-02682)	Apr-19
Reference Probe ES3DV2	SN: 3013	30-Dec-17 (No. ES3-3013_Dec17)	Dec-18
DAE4	SN: 660	21-Dec-17 (No. DAE4-660_Dec17)	Dec-18
Secondary Standards	ID	Check Date (in house)	Scheduled Check
Power meter E4419B	SN: GB41293874	06-Apr-16 (in house check Jun-18)	In house check: Jun-20
Power sensor E4412A	SN: MY41498087	06-Apr-16 (in house check Jun-18)	In house check: Jun-20
Power sensor E4412A	SN: 000110210	06-Apr-16 (in house check Jun-18)	In house check: Jun-20
RF generator HP 8648C	SN: US3642U01700	04-Aug-99 (in house check Jun-18)	In house check: Jun-20
Network Analyzer HP 8753E	SN: US37390585	18-Oct-01 (in house check Oct-17)	In house check: Oct-18

Calibrated by: **Claudio Leubler** (Name), **Laboratory Technician** (Function), *[Signature]* (Signature)

Approved by: **Katja Pokovic** (Name), **Technical Manager** (Function), *[Signature]* (Signature)

Issued: June 26, 2018

This calibration certificate shall not be reproduced except in full without written approval of the laboratory.



Accredited by the Swiss Accreditation Service (SAS)

Accreditation No.: **SCS 0108**

The Swiss Accreditation Service is one of the signatories to the EA
Multilateral Agreement for the recognition of calibration certificates

Glossary:

TSL	tissue simulating liquid
NORM _{x,y,z}	sensitivity in free space
ConvF	sensitivity in TSL / NORM _{x,y,z}
DCP	diode compression point
CF	crest factor (1/duty_cycle) of the RF signal
A, B, C, D	modulation dependent linearization parameters
Polarization φ	φ rotation around probe axis
Polarization ϑ	ϑ rotation around an axis that is in the plane normal to probe axis (at measurement center), i.e., $\vartheta = 0$ is normal to probe axis
Connector Angle	information used in DASY system to align probe sensor X to the robot coordinate system

Calibration is Performed According to the Following Standards:

- IEEE Std 1528-2013, "IEEE Recommended Practice for Determining the Peak Spatial-Averaged Specific Absorption Rate (SAR) in the Human Head from Wireless Communications Devices: Measurement Techniques", June 2013
- IEC 62209-1, "Measurement procedure for the assessment of Specific Absorption Rate (SAR) from hand-held and body-mounted devices used next to the ear (frequency range of 300 MHz to 6 GHz)", July 2016
- IEC 62209-2, "Procedure to determine the Specific Absorption Rate (SAR) for wireless communication devices used in close proximity to the human body (frequency range of 30 MHz to 6 GHz)", March 2010
- KDB 865664, "SAR Measurement Requirements for 100 MHz to 6 GHz"

Methods Applied and Interpretation of Parameters:

- NORM_{x,y,z}**: Assessed for E-field polarization $\vartheta = 0$ ($f \leq 900$ MHz in TEM-cell; $f > 1800$ MHz: R22 waveguide). NORM_{x,y,z} are only intermediate values, i.e., the uncertainties of NORM_{x,y,z} does not affect the E²-field uncertainty inside TSL (see below *ConvF*).
- NORM(f)_{x,y,z}** = NORM_{x,y,z} * frequency_response (see Frequency Response Chart). This linearization is implemented in DASY4 software versions later than 4.2. The uncertainty of the frequency response is included in the stated uncertainty of *ConvF*.
- DCP_{x,y,z}**: DCP are numerical linearization parameters assessed based on the data of power sweep with CW signal (no uncertainty required). DCP does not depend on frequency nor media.
- PAR**: PAR is the Peak to Average Ratio that is not calibrated but determined based on the signal characteristics
- A_{x,y,z}; B_{x,y,z}; C_{x,y,z}; D_{x,y,z}; VR_{x,y,z}**: A, B, C, D are numerical linearization parameters assessed based on the data of power sweep for specific modulation signal. The parameters do not depend on frequency nor media. VR is the maximum calibration range expressed in RMS voltage across the diode.
- ConvF and Boundary Effect Parameters**: Assessed in flat phantom using E-field (or Temperature Transfer Standard for $f \leq 800$ MHz) and inside waveguide using analytical field distributions based on power measurements for $f > 800$ MHz. The same setups are used for assessment of the parameters applied for boundary compensation (alpha, depth) of which typical uncertainty values are given. These parameters are used in DASY4 software to improve probe accuracy close to the boundary. The sensitivity in TSL corresponds to NORM_{x,y,z} * ConvF whereby the uncertainty corresponds to that given for ConvF. A frequency dependent ConvF is used in DASY version 4.4 and higher which allows extending the validity from ± 50 MHz to ± 100 MHz.
- Spherical isotropy (3D deviation from isotropy)**: in a field of low gradients realized using a flat phantom exposed by a patch antenna.
- Sensor Offset**: The sensor offset corresponds to the offset of virtual measurement center from the probe tip (on probe axis). No tolerance required.
- Connector Angle**: The angle is assessed using the information gained by determining the NORM_x (no uncertainty required).

Probe EX3DV4

SN:7409

Manufactured: November 24, 2015
Calibrated: June 25, 2018

Calibrated for DASY/EASY Systems
(Note: non-compatible with DASY2 system!)

DASY/EASY - Parameters of Probe: EX3DV4 - SN:7409

Basic Calibration Parameters

	Sensor X	Sensor Y	Sensor Z	Unc (k=2)
Norm ($\mu\text{V}/(\text{V}/\text{m})^2$) ^A	0.38	0.33	0.38	$\pm 10.1 \%$
DCP (mV) ^B	100.8	102.3	97.7	

Modulation Calibration Parameters

UID	Communication System Name		A dB	B dB $\sqrt{\mu\text{V}}$	C	D dB	VR mV	Unc ^E (k=2)
0	CW	X	0.0	0.0	1.0	0.00	157.1	$\pm 2.2 \%$
		Y	0.0	0.0	1.0		172.6	
		Z	0.0	0.0	1.0		175.7	

Note: For details on UID parameters see Appendix.

Sensor Model Parameters

	C1 fF	C2 fF	α V^{-1}	T1 $\text{ms}\cdot\text{V}^{-2}$	T2 $\text{ms}\cdot\text{V}^{-1}$	T3 ms	T4 V^{-2}	T5 V^{-1}	T6
X	15.40	116.5	36.38	2.655	0.140	4.978	0.000	0.017	1.008
Y	27.94	206.6	35.20	4.338	0.095	4.989	1.642	0.000	1.004
Z	31.47	244.0	37.99	3.819	0.313	5.030	0.103	0.363	1.006

The reported uncertainty of measurement is stated as the standard uncertainty of measurement multiplied by the coverage factor $k=2$, which for a normal distribution corresponds to a coverage probability of approximately 95%.

^A The uncertainties of Norm X,Y,Z do not affect the E^2 -field uncertainty inside TSL (see Pages 5 and 6).

^B Numerical linearization parameter: uncertainty not required.

^E Uncertainty is determined using the max. deviation from linear response applying rectangular distribution and is expressed for the square of the field value.

DASY/EASY - Parameters of Probe: EX3DV4 - SN:7409

Calibration Parameter Determined in Head Tissue Simulating Media

f (MHz) ^C	Relative Permittivity ^F	Conductivity (S/m) ^F	ConvF X	ConvF Y	ConvF Z	Alpha ^G	Depth ^G (mm)	Unc (k=2)
750	41.9	0.89	9.91	9.91	9.91	0.44	0.90	± 12.0 %
835	41.5	0.90	9.67	9.67	9.67	0.46	0.85	± 12.0 %
1750	40.1	1.37	8.43	8.43	8.43	0.38	0.80	± 12.0 %
1900	40.0	1.40	8.05	8.05	8.05	0.38	0.84	± 12.0 %
2300	39.5	1.67	7.57	7.57	7.57	0.32	0.80	± 12.0 %
2450	39.2	1.80	7.23	7.23	7.23	0.34	0.86	± 12.0 %
2600	39.0	1.96	6.98	6.98	6.98	0.39	0.86	± 12.0 %
5250	35.9	4.71	5.20	5.20	5.20	0.40	1.80	± 13.1 %
5600	35.5	5.07	4.77	4.77	4.77	0.40	1.80	± 13.1 %
5750	35.4	5.22	4.82	4.82	4.82	0.40	1.80	± 13.1 %

^C Frequency validity above 300 MHz of ± 100 MHz only applies for DASY v4.4 and higher (see Page 2), else it is restricted to ± 50 MHz. The uncertainty is the RSS of the ConvF uncertainty at calibration frequency and the uncertainty for the indicated frequency band. Frequency validity below 300 MHz is ± 10, 25, 40, 50 and 70 MHz for ConvF assessments at 30, 64, 128, 150 and 220 MHz respectively. Above 5 GHz frequency validity can be extended to ± 110 MHz.

^F At frequencies below 3 GHz, the validity of tissue parameters (ϵ and σ) can be relaxed to ± 10% if liquid compensation formula is applied to measured SAR values. At frequencies above 3 GHz, the validity of tissue parameters (ϵ and σ) is restricted to ± 5%. The uncertainty is the RSS of the ConvF uncertainty for indicated target tissue parameters.

^G Alpha/Depth are determined during calibration. SPEAG warrants that the remaining deviation due to the boundary effect after compensation is always less than ± 1% for frequencies below 3 GHz and below ± 2% for frequencies between 3-6 GHz at any distance larger than half the probe tip diameter from the boundary.

DASY/EASY - Parameters of Probe: EX3DV4 - SN:7409

Calibration Parameter Determined in Body Tissue Simulating Media

f (MHz) ^C	Relative Permittivity ^F	Conductivity (S/m) ^F	ConvF X	ConvF Y	ConvF Z	Alpha ^G	Depth ^G (mm)	Unc (k=2)
750	55.5	0.96	9.82	9.82	9.82	0.52	0.84	± 12.0 %
835	55.2	0.97	9.63	9.63	9.63	0.48	0.80	± 12.0 %
1750	53.4	1.49	7.91	7.91	7.91	0.36	0.93	± 12.0 %
1900	53.3	1.52	7.60	7.60	7.60	0.44	0.80	± 12.0 %
2300	52.9	1.81	7.36	7.36	7.36	0.38	0.88	± 12.0 %
2450	52.7	1.95	7.24	7.24	7.24	0.33	0.89	± 12.0 %
2600	52.5	2.16	7.07	7.07	7.07	0.32	0.96	± 12.0 %
5250	48.9	5.36	4.67	4.67	4.67	0.50	1.90	± 13.1 %
5600	48.5	5.77	4.25	4.25	4.25	0.50	1.90	± 13.1 %
5750	48.3	5.94	4.32	4.32	4.32	0.50	1.90	± 13.1 %

^C Frequency validity above 300 MHz of ± 100 MHz only applies for DASY v4.4 and higher (see Page 2), else it is restricted to ± 50 MHz. The uncertainty is the RSS of the ConvF uncertainty at calibration frequency and the uncertainty for the indicated frequency band. Frequency validity below 300 MHz is ± 10, 25, 40, 50 and 70 MHz for ConvF assessments at 30, 64, 128, 150 and 220 MHz respectively. Above 5 GHz frequency validity can be extended to ± 110 MHz.

^F At frequencies below 3 GHz, the validity of tissue parameters (ϵ and σ) can be relaxed to ± 10% if liquid compensation formula is applied to measured SAR values. At frequencies above 3 GHz, the validity of tissue parameters (ϵ and σ) is restricted to ± 5%. The uncertainty is the RSS of the ConvF uncertainty for indicated target tissue parameters.

^G Alpha/Depth are determined during calibration. SPEAG warrants that the remaining deviation due to the boundary effect after compensation is always less than ± 1% for frequencies below 3 GHz and below ± 2% for frequencies between 3-6 GHz at any distance larger than half the probe tip diameter from the boundary.

Frequency Response of E-Field (TEM-Cell:ifi110 EXX, Waveguide: R22)

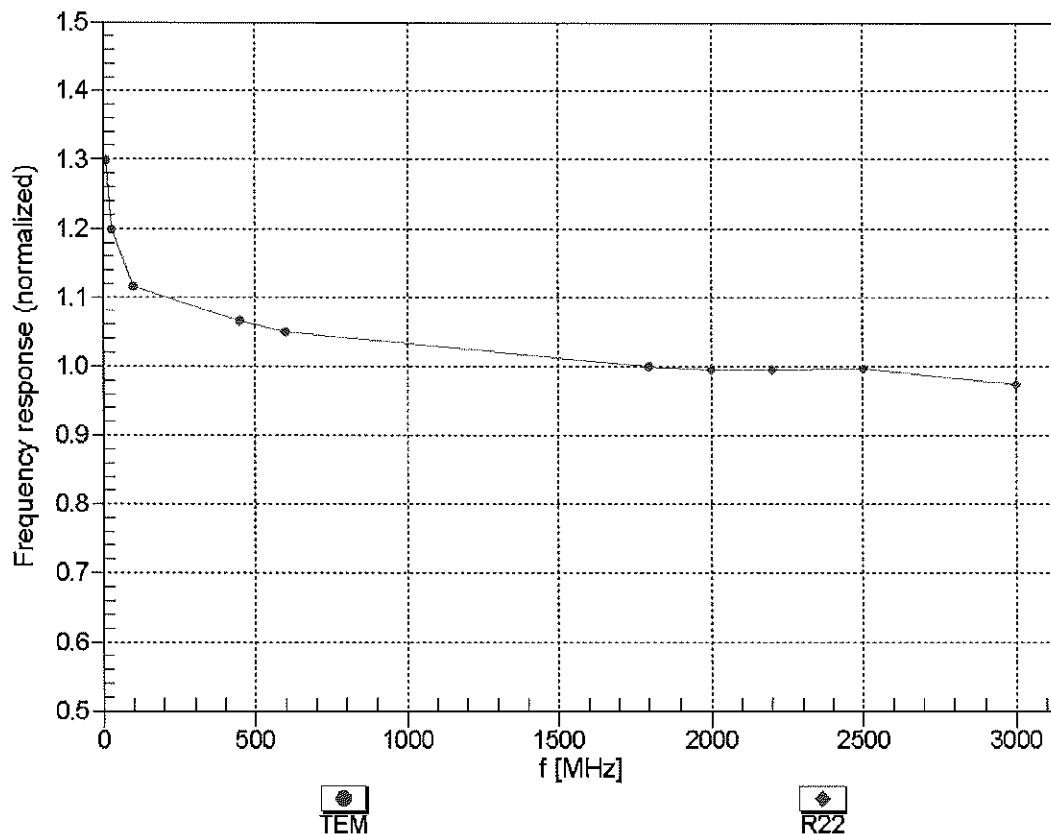

Uncertainty of Frequency Response of E-field: $\pm 6.3\%$ (k=2)

Receiving Pattern (ϕ), $\theta = 0^\circ$

f=600 MHz,TEM

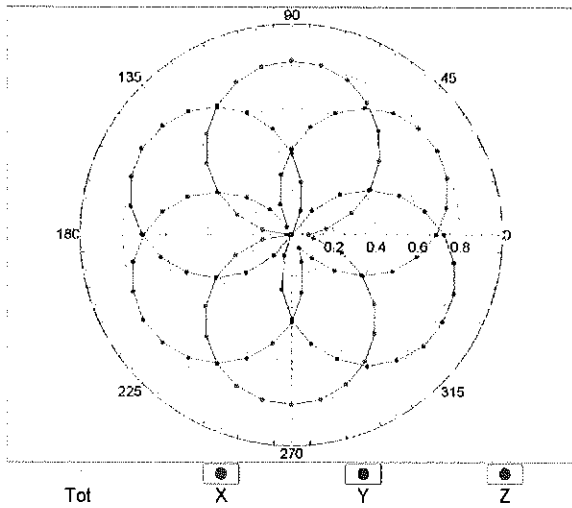

f=1800 MHz,R22

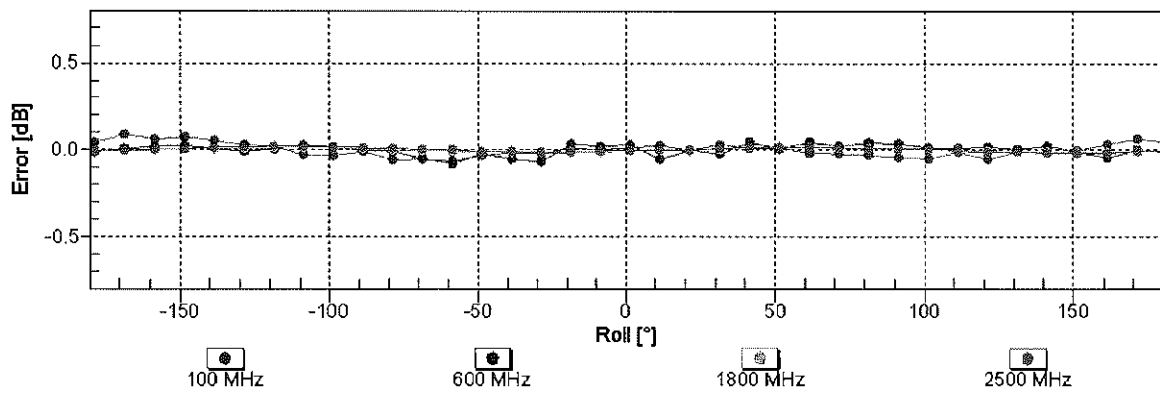
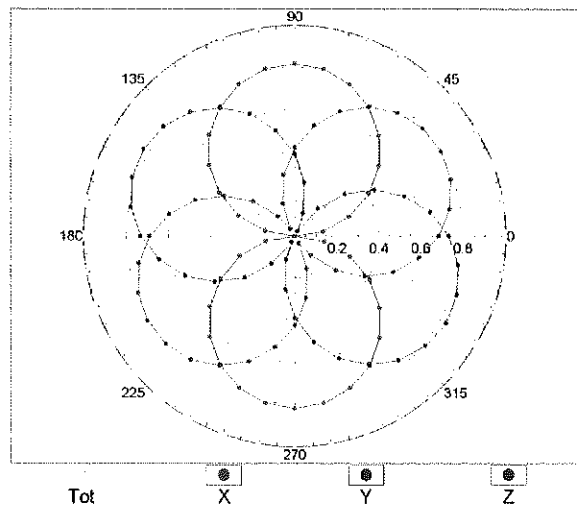

Uncertainty of Axial Isotropy Assessment: $\pm 0.5\%$ ($k=2$)

Dynamic Range $f(SAR_{head})$ (TEM cell, $f_{eval} = 1900$ MHz)

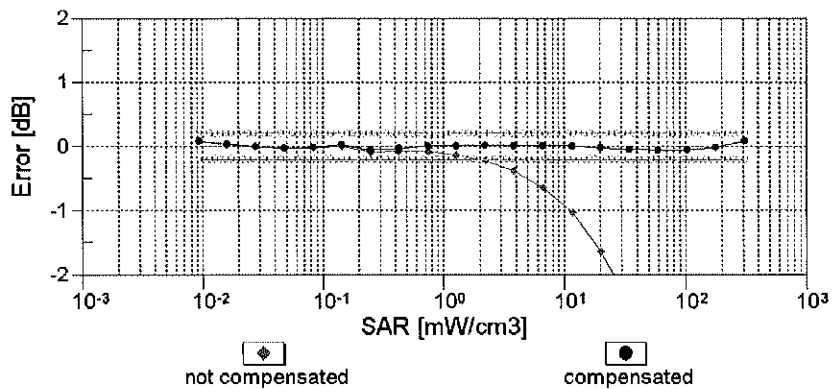
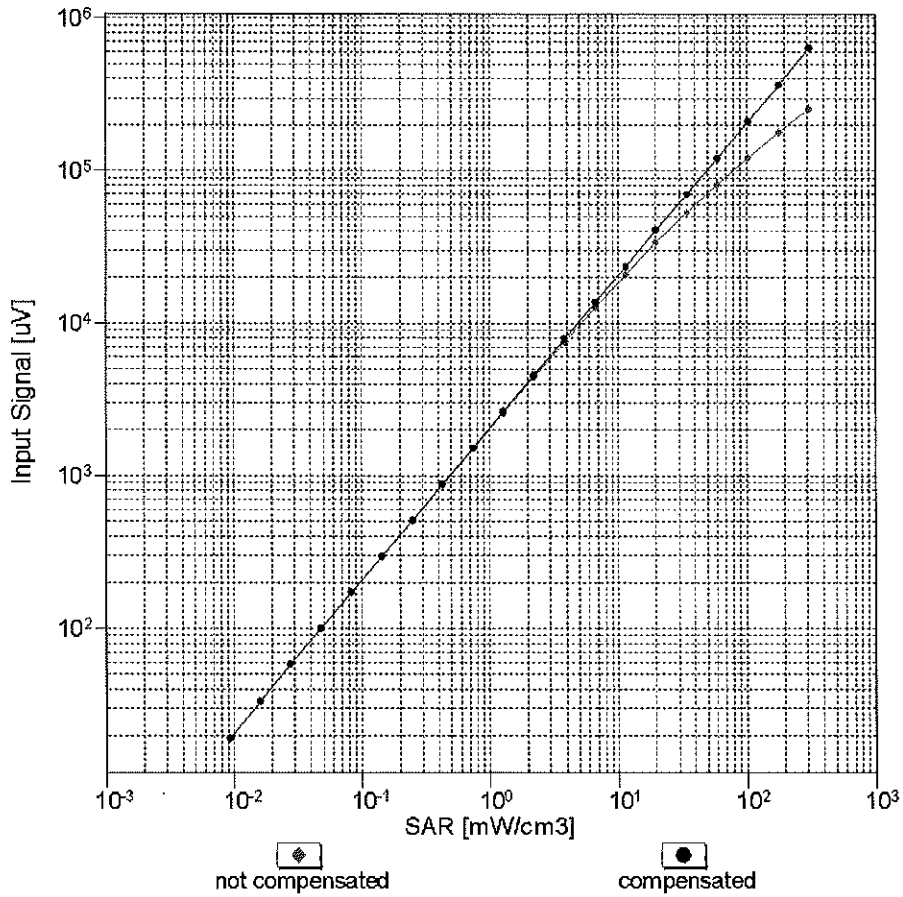

Uncertainty of Linearity Assessment: $\pm 0.6\%$ ($k=2$)

Conversion Factor Assessment

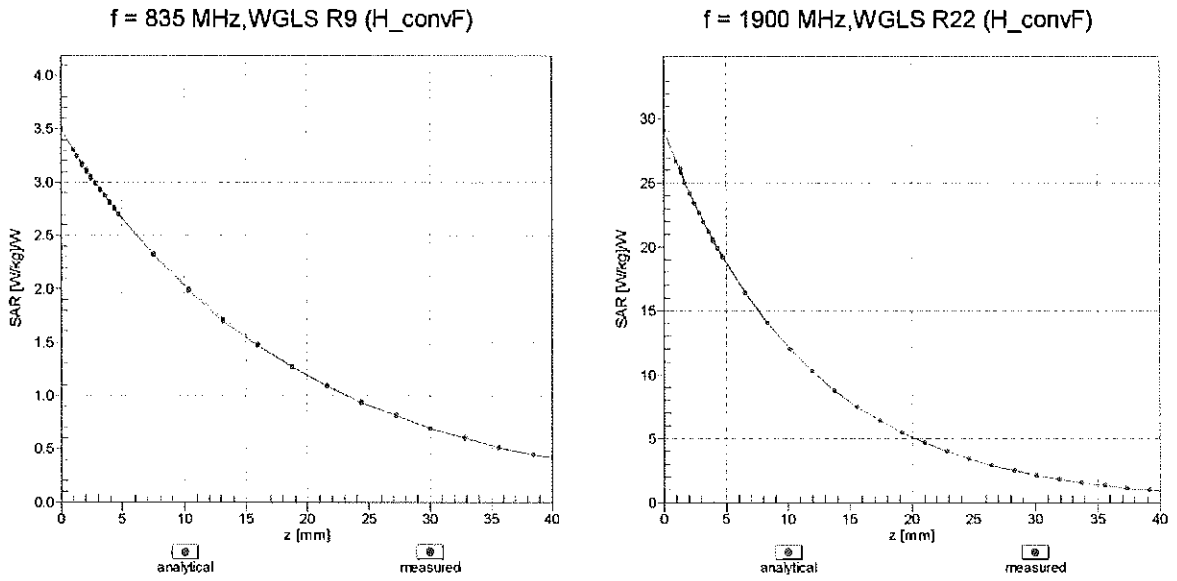

Deviation from Isotropy in Liquid Error (ϕ, θ), f = 900 MHz

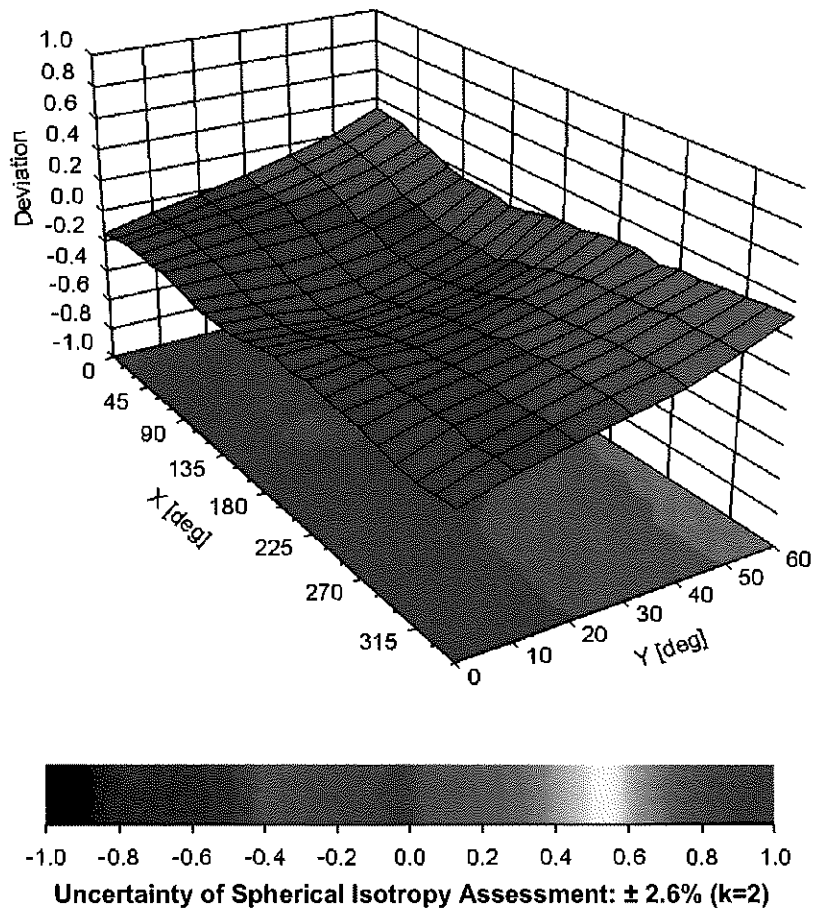

DASY/EASY - Parameters of Probe: EX3DV4 - SN:7409

Other Probe Parameters

Sensor Arrangement	Triangular
Connector Angle (°)	41.5
Mechanical Surface Detection Mode	enabled
Optical Surface Detection Mode	disabled
Probe Overall Length	337 mm
Probe Body Diameter	10 mm
Tip Length	9 mm
Tip Diameter	2.5 mm
Probe Tip to Sensor X Calibration Point	1 mm
Probe Tip to Sensor Y Calibration Point	1 mm
Probe Tip to Sensor Z Calibration Point	1 mm
Recommended Measurement Distance from Surface	1.4 mm

Appendix: Modulation Calibration Parameters

UID	Communication System Name		A dB	B dB $\sqrt{\mu}$ V	C	D dB	VR mV	Max Unc ^E (k=2)
0	CW	X	0.00	0.00	1.00	0.00	157.1	$\pm 2.2\%$
		Y	0.00	0.00	1.00		172.6	
		Z	0.00	0.00	1.00		175.7	
10010- CAA	SAR Validation (Square, 100ms, 10ms)	X	1.25	60.42	5.97	10.00	20.0	$\pm 9.6\%$
		Y	1.37	61.35	6.72		20.0	
		Z	1.46	61.54	7.06		20.0	
10011- CAB	UMTS-FDD (WCDMA)	X	0.71	66.47	12.38	0.00	150.0	$\pm 9.6\%$
		Y	1.49	76.31	19.52		150.0	
		Z	0.80	65.38	13.27		150.0	
10012- CAB	IEEE 802.11b WiFi 2.4 GHz (DSSS, 1 Mbps)	X	0.97	63.61	14.22	0.41	150.0	$\pm 9.6\%$
		Y	1.14	65.32	16.39		150.0	
		Z	1.01	62.66	14.20		150.0	
10013- CAB	IEEE 802.11g WiFi 2.4 GHz (DSSS-OFDM, 6 Mbps)	X	3.98	66.92	16.39	1.46	150.0	$\pm 9.6\%$
		Y	4.51	67.09	17.14		150.0	
		Z	4.51	66.48	16.81		150.0	
10021- DAC	GSM-FDD (TDMA, GMSK)	X	2.93	68.02	10.47	9.39	50.0	$\pm 9.6\%$
		Y	5.30	74.12	13.20		50.0	
		Z	8.30	79.26	15.55		50.0	
10023- DAC	GPRS-FDD (TDMA, GMSK, TN 0)	X	2.04	64.26	8.75	9.57	50.0	$\pm 9.6\%$
		Y	3.75	70.52	11.87		50.0	
		Z	5.18	74.16	13.81		50.0	
10024- DAC	GPRS-FDD (TDMA, GMSK, TN 0-1)	X	0.77	60.84	5.97	6.56	60.0	$\pm 9.6\%$
		Y	100.00	98.81	18.33		60.0	
		Z	7.39	79.44	14.17		60.0	
10025- DAC	EDGE-FDD (TDMA, 8PSK, TN 0)	X	2.92	62.32	21.25	12.57	50.0	$\pm 9.6\%$
		Y	3.79	70.21	26.28		50.0	
		Z	3.08	62.64	21.59		50.0	
10026- DAC	EDGE-FDD (TDMA, 8PSK, TN 0-1)	X	4.19	76.79	26.73	9.56	60.0	$\pm 9.6\%$
		Y	5.08	81.51	29.10		60.0	
		Z	4.89	79.35	27.91		60.0	
10027- DAC	GPRS-FDD (TDMA, GMSK, TN 0-1-2)	X	0.43	60.00	4.84	4.80	80.0	$\pm 9.6\%$
		Y	100.00	98.82	17.61		80.0	
		Z	99.96	97.90	17.31		80.0	
10028- DAC	GPRS-FDD (TDMA, GMSK, TN 0-1-2-3)	X	0.29	60.00	4.20	3.55	100.0	$\pm 9.6\%$
		Y	100.00	100.72	17.79		100.0	
		Z	0.57	63.31	6.83		100.0	
10029- DAC	EDGE-FDD (TDMA, 8PSK, TN 0-1-2)	X	3.08	70.55	22.84	7.80	80.0	$\pm 9.6\%$
		Y	3.50	73.17	24.28		80.0	
		Z	3.45	72.07	23.57		80.0	
10030- CAA	IEEE 802.15.1 Bluetooth (GFSK, DH1)	X	0.52	60.00	4.79	5.30	70.0	$\pm 9.6\%$
		Y	1.54	67.33	9.06		70.0	
		Z	1.17	65.26	8.49		70.0	
10031- CAA	IEEE 802.15.1 Bluetooth (GFSK, DH3)	X	0.04	196.26	30.81	1.88	100.0	$\pm 9.6\%$
		Y	0.17	60.00	4.10		100.0	
		Z	15.90	60.96	1.69		100.0	

10032-CAA	IEEE 802.15.1 Bluetooth (GFSK, DH5)	X	0.00	86.08	35.43	1.17	100.0	± 9.6 %
		Y	99.99	344.89	100.44		100.0	
		Z	1.14	132.41	13.71		100.0	
10033-CAA	IEEE 802.15.1 Bluetooth (PI/4-DQPSK, DH1)	X	0.95	60.75	6.54	5.30	70.0	± 9.6 %
		Y	4.98	80.79	18.23		70.0	
		Z	3.25	75.39	16.74		70.0	
10034-CAA	IEEE 802.15.1 Bluetooth (PI/4-DQPSK, DH3)	X	3.04	65.72	5.34	1.88	100.0	± 9.6 %
		Y	1.68	70.56	12.82		100.0	
		Z	0.99	64.34	10.07		100.0	
10035-CAA	IEEE 802.15.1 Bluetooth (PI/4-DQPSK, DH5)	X	24.75	218.80	26.78	1.17	100.0	± 9.6 %
		Y	1.37	69.43	12.15		100.0	
		Z	0.77	62.85	8.95		100.0	
10036-CAA	IEEE 802.15.1 Bluetooth (8-DPSK, DH1)	X	0.94	60.83	6.63	5.30	70.0	± 9.6 %
		Y	7.23	85.73	19.90		70.0	
		Z	3.94	78.17	17.83		70.0	
10037-CAA	IEEE 802.15.1 Bluetooth (8-DPSK, DH3)	X	1.41	63.61	4.82	1.88	100.0	± 9.6 %
		Y	1.40	68.85	12.14		100.0	
		Z	0.93	63.88	9.84		100.0	
10038-CAA	IEEE 802.15.1 Bluetooth (8-DPSK, DH5)	X	26.17	217.46	26.16	1.17	100.0	± 9.6 %
		Y	1.45	70.29	12.67		100.0	
		Z	0.78	63.02	9.17		100.0	
10039-CAB	CDMA2000 (1xRTT, RC1)	X	21.96	306.20	30.49	0.00	150.0	± 9.6 %
		Y	1.63	72.13	12.95		150.0	
		Z	0.63	61.62	7.75		150.0	
10042-CAB	IS-54 / IS-136 FDD (TDMA/FDM, PI/4-DQPSK, Halfrate)	X	1.01	60.95	6.26	7.78	50.0	± 9.6 %
		Y	1.74	65.58	9.03		50.0	
		Z	1.77	65.58	9.34		50.0	
10044-CAA	IS-91/EIA/TIA-553 FDD (FDMA, FM)	X	0.10	124.30	3.45	0.00	150.0	± 9.6 %
		Y	0.01	119.74	2.99		150.0	
		Z	0.14	123.41	9.03		150.0	
10048-CAA	DECT (TDD, TDMA/FDM, GFSK, Full Slot, 24)	X	2.82	62.25	9.34	13.80	25.0	± 9.6 %
		Y	3.46	64.98	10.90		25.0	
		Z	4.35	67.54	12.61		25.0	
10049-CAA	DECT (TDD, TDMA/FDM, GFSK, Double Slot, 12)	X	2.47	64.28	8.96	10.79	40.0	± 9.6 %
		Y	3.27	67.55	10.82		40.0	
		Z	4.02	69.88	12.36		40.0	
10056-CAA	UMTS-TDD (TD-SCDMA, 1.28 Mcps)	X	2.81	66.64	10.78	9.03	50.0	± 9.6 %
		Y	11.82	86.24	20.09		50.0	
		Z	9.59	84.12	20.02		50.0	
10058-DAC	EDGE-FDD (TDMA, 8PSK, TN 0-1-2-3)	X	2.65	68.11	20.96	6.55	100.0	± 9.6 %
		Y	2.94	70.05	22.07		100.0	
		Z	2.91	69.15	21.44		100.0	
10059-CAB	IEEE 802.11b WiFi 2.4 GHz (DSSS, 2 Mbps)	X	0.95	64.02	14.39	0.61	110.0	± 9.6 %
		Y	1.14	66.10	16.82		110.0	
		Z	1.00	63.23	14.55		110.0	
10060-CAB	IEEE 802.11b WiFi 2.4 GHz (DSSS, 5.5 Mbps)	X	1.76	81.26	19.48	1.30	110.0	± 9.6 %
		Y	100.00	150.16	40.00		110.0	
		Z	1.90	81.85	20.27		110.0	

10061-CAB	IEEE 802.11b WiFi 2.4 GHz (DSSS, 11 Mbps)	X	1.18	69.71	16.58	2.04	110.0	± 9.6 %
		Y	1.94	78.32	21.99		110.0	
		Z	1.40	71.35	18.33		110.0	
10062-CAC	IEEE 802.11a/h WiFi 5 GHz (OFDM, 6 Mbps)	X	3.80	66.99	15.87	0.49	100.0	± 9.6 %
		Y	4.35	67.21	16.69		100.0	
		Z	4.31	66.43	16.23		100.0	
10063-CAC	IEEE 802.11a/h WiFi 5 GHz (OFDM, 9 Mbps)	X	3.81	67.06	15.96	0.72	100.0	± 9.6 %
		Y	4.36	67.29	16.77		100.0	
		Z	4.32	66.52	16.32		100.0	
10064-CAC	IEEE 802.11a/h WiFi 5 GHz (OFDM, 12 Mbps)	X	3.97	67.23	16.12	0.86	100.0	± 9.6 %
		Y	4.56	67.40	16.91		100.0	
		Z	4.55	66.72	16.52		100.0	
10065-CAC	IEEE 802.11a/h WiFi 5 GHz (OFDM, 18 Mbps)	X	3.85	66.82	16.06	1.21	100.0	± 9.6 %
		Y	4.42	67.15	16.92		100.0	
		Z	4.42	66.52	16.58		100.0	
10066-CAC	IEEE 802.11a/h WiFi 5 GHz (OFDM, 24 Mbps)	X	3.83	66.65	16.06	1.46	100.0	± 9.6 %
		Y	4.41	67.05	17.01		100.0	
		Z	4.42	66.49	16.71		100.0	
10067-CAC	IEEE 802.11a/h WiFi 5 GHz (OFDM, 36 Mbps)	X	4.01	66.66	16.35	2.04	100.0	± 9.6 %
		Y	4.65	67.23	17.40		100.0	
		Z	4.70	66.78	17.19		100.0	
10068-CAC	IEEE 802.11a/h WiFi 5 GHz (OFDM, 48 Mbps)	X	4.12	66.97	16.78	2.55	100.0	± 9.6 %
		Y	4.69	67.14	17.56		100.0	
		Z	4.73	66.69	17.36		100.0	
10069-CAC	IEEE 802.11a/h WiFi 5 GHz (OFDM, 54 Mbps)	X	4.11	66.73	16.77	2.67	100.0	± 9.6 %
		Y	4.72	67.08	17.69		100.0	
		Z	4.78	66.70	17.53		100.0	
10071-CAB	IEEE 802.11g WiFi 2.4 GHz (DSSS/OFDM, 9 Mbps)	X	4.07	66.96	16.68	1.99	100.0	± 9.6 %
		Y	4.59	67.07	17.37		100.0	
		Z	4.60	66.53	17.10		100.0	
10072-CAB	IEEE 802.11g WiFi 2.4 GHz (DSSS/OFDM, 12 Mbps)	X	3.98	66.89	16.71	2.30	100.0	± 9.6 %
		Y	4.51	67.19	17.50		100.0	
		Z	4.54	66.70	17.26		100.0	
10073-CAB	IEEE 802.11g WiFi 2.4 GHz (DSSS/OFDM, 18 Mbps)	X	4.03	67.09	17.06	2.83	100.0	± 9.6 %
		Y	4.56	67.35	17.81		100.0	
		Z	4.59	66.87	17.58		100.0	
10074-CAB	IEEE 802.11g WiFi 2.4 GHz (DSSS/OFDM, 24 Mbps)	X	4.11	67.36	17.40	3.30	100.0	± 9.6 %
		Y	4.57	67.31	17.95		100.0	
		Z	4.60	66.82	17.73		100.0	
10075-CAB	IEEE 802.11g WiFi 2.4 GHz (DSSS/OFDM, 36 Mbps)	X	4.18	67.58	17.73	3.82	90.0	± 9.6 %
		Y	4.58	67.25	18.15		90.0	
		Z	4.61	66.79	17.96		90.0	
10076-CAB	IEEE 802.11g WiFi 2.4 GHz (DSSS/OFDM, 48 Mbps)	X	4.24	67.48	17.91	4.15	90.0	± 9.6 %
		Y	4.61	67.08	18.28		90.0	
		Z	4.65	66.67	18.13		90.0	
10077-CAB	IEEE 802.11g WiFi 2.4 GHz (DSSS/OFDM, 54 Mbps)	X	4.28	67.60	18.06	4.30	90.0	± 9.6 %
		Y	4.64	67.18	18.41		90.0	
		Z	4.68	66.76	18.25		90.0	

10081-CAB	CDMA2000 (1xRTT, RC3)	X	7.85	258.95	40.09	0.00	150.0	± 9.6 %
		Y	0.57	64.50	9.19		150.0	
		Z	0.37	60.00	6.09		150.0	
10082-CAB	IS-54 / IS-136 FDD (TDMA/FDM, PI/4-DQPSK, Fullrate)	X	72.13	59.07	0.77	4.77	80.0	± 9.6 %
		Y	7.02	60.09	1.53		80.0	
		Z	7.63	60.12	1.53		80.0	
10090-DAC	GPRS-FDD (TDMA, GMSK, TN 0-4)	X	0.78	60.88	6.00	6.56	60.0	± 9.6 %
		Y	100.00	98.83	18.35		60.0	
		Z	8.66	80.77	14.58		60.0	
10097-CAB	UMTS-FDD (HSDPA)	X	1.12	65.69	11.46	0.00	150.0	± 9.6 %
		Y	2.39	74.48	18.29		150.0	
		Z	1.58	66.95	14.31		150.0	
10098-CAB	UMTS-FDD (HSUPA, Subtest 2)	X	1.11	65.81	11.55	0.00	150.0	± 9.6 %
		Y	2.34	74.47	18.31		150.0	
		Z	1.54	66.88	14.28		150.0	
10099-DAC	EDGE-FDD (TDMA, 8PSK, TN 0-4)	X	4.22	76.90	26.77	9.56	60.0	± 9.6 %
		Y	5.12	81.66	29.15		60.0	
		Z	4.92	79.46	27.95		60.0	
10100-CAD	LTE-FDD (SC-FDMA, 100% RB, 20 MHz, QPSK)	X	2.39	69.31	16.37	0.00	150.0	± 9.6 %
		Y	3.20	72.58	18.18		150.0	
		Z	2.69	68.81	15.94		150.0	
10101-CAD	LTE-FDD (SC-FDMA, 100% RB, 20 MHz, 16-QAM)	X	2.61	67.07	15.44	0.00	150.0	± 9.6 %
		Y	3.12	68.53	16.66		150.0	
		Z	2.91	66.65	15.40		150.0	
10102-CAD	LTE-FDD (SC-FDMA, 100% RB, 20 MHz, 64-QAM)	X	2.71	67.23	15.58	0.00	150.0	± 9.6 %
		Y	3.22	68.53	16.74		150.0	
		Z	3.02	66.72	15.54		150.0	
10103-CAD	LTE-TDD (SC-FDMA, 100% RB, 20 MHz, QPSK)	X	3.72	71.26	18.49	3.98	65.0	± 9.6 %
		Y	4.70	73.63	19.84		65.0	
		Z	4.41	71.81	18.98		65.0	
10104-CAD	LTE-TDD (SC-FDMA, 100% RB, 20 MHz, 16-QAM)	X	3.95	69.27	17.90	3.98	65.0	± 9.6 %
		Y	4.71	71.04	19.29		65.0	
		Z	4.63	70.10	18.86		65.0	
10105-CAD	LTE-TDD (SC-FDMA, 100% RB, 20 MHz, 64-QAM)	X	3.78	68.25	17.72	3.98	65.0	± 9.6 %
		Y	4.47	69.73	18.97		65.0	
		Z	4.37	68.68	18.48		65.0	
10108-CAE	LTE-FDD (SC-FDMA, 100% RB, 10 MHz, QPSK)	X	1.98	69.15	15.95	0.00	150.0	± 9.6 %
		Y	2.77	72.39	18.20		150.0	
		Z	2.29	68.22	15.72		150.0	
10109-CAE	LTE-FDD (SC-FDMA, 100% RB, 10 MHz, 16-QAM)	X	2.19	67.24	14.70	0.00	150.0	± 9.6 %
		Y	2.80	69.06	16.71		150.0	
		Z	2.54	66.58	15.14		150.0	
10110-CAE	LTE-FDD (SC-FDMA, 100% RB, 5 MHz, QPSK)	X	1.35	66.94	13.41	0.00	150.0	± 9.6 %
		Y	2.32	72.63	18.00		150.0	
		Z	1.78	67.28	14.92		150.0	
10111-CAE	LTE-FDD (SC-FDMA, 100% RB, 5 MHz, 16-QAM)	X	1.58	65.90	12.12	0.00	150.0	± 9.6 %
		Y	2.81	72.30	17.60		150.0	
		Z	2.22	67.49	14.99		150.0	

10112-CAE	LTE-FDD (SC-FDMA, 100% RB, 10 MHz, 64-QAM)	X	2.30	67.45	14.81	0.00	150.0	± 9.6 %
		Y	2.93	69.12	16.76		150.0	
		Z	2.66	66.72	15.26		150.0	
10113-CAE	LTE-FDD (SC-FDMA, 100% RB, 5 MHz, 64-QAM)	X	1.64	65.77	12.05	0.00	150.0	± 9.6 %
		Y	2.95	72.32	17.65		150.0	
		Z	2.37	67.73	15.17		150.0	
10114-CAC	IEEE 802.11n (HT Greenfield, 13.5 Mbps, BPSK)	X	4.34	66.99	16.28	0.00	150.0	± 9.6 %
		Y	4.86	67.57	16.78		150.0	
		Z	4.82	66.90	16.32		150.0	
10115-CAC	IEEE 802.11n (HT Greenfield, 81 Mbps, 16-QAM)	X	4.58	67.29	16.33	0.00	150.0	± 9.6 %
		Y	5.08	67.61	16.77		150.0	
		Z	5.06	66.98	16.35		150.0	
10116-CAC	IEEE 802.11n (HT Greenfield, 135 Mbps, 64-QAM)	X	4.40	67.26	16.31	0.00	150.0	± 9.6 %
		Y	4.93	67.75	16.79		150.0	
		Z	4.89	67.04	16.31		150.0	
10117-CAC	IEEE 802.11n (HT Mixed, 13.5 Mbps, BPSK)	X	4.33	66.90	16.26	0.00	150.0	± 9.6 %
		Y	4.84	67.46	16.74		150.0	
		Z	4.79	66.75	16.26		150.0	
10118-CAC	IEEE 802.11n (HT Mixed, 81 Mbps, 16-QAM)	X	4.58	67.24	16.31	0.00	150.0	± 9.6 %
		Y	5.15	67.78	16.86		150.0	
		Z	5.14	67.21	16.48		150.0	
10119-CAC	IEEE 802.11n (HT Mixed, 135 Mbps, 64-QAM)	X	4.39	67.16	16.27	0.00	150.0	± 9.6 %
		Y	4.94	67.78	16.81		150.0	
		Z	4.90	67.08	16.34		150.0	
10140-CAD	LTE-FDD (SC-FDMA, 100% RB, 15 MHz, 16-QAM)	X	2.65	67.18	15.35	0.00	150.0	± 9.6 %
		Y	3.23	68.57	16.65		150.0	
		Z	3.03	66.74	15.44		150.0	
10141-CAD	LTE-FDD (SC-FDMA, 100% RB, 15 MHz, 64-QAM)	X	2.80	67.68	15.68	0.00	150.0	± 9.6 %
		Y	3.37	68.79	16.86		150.0	
		Z	3.16	66.97	15.67		150.0	
10142-CAD	LTE-FDD (SC-FDMA, 100% RB, 3 MHz, QPSK)	X	0.71	61.44	8.06	0.00	150.0	± 9.6 %
		Y	2.27	74.06	17.56		150.0	
		Z	1.48	66.51	13.59		150.0	
10143-CAD	LTE-FDD (SC-FDMA, 100% RB, 3 MHz, 16-QAM)	X	0.73	60.00	6.15	0.00	150.0	± 9.6 %
		Y	2.80	73.44	16.54		150.0	
		Z	1.85	66.55	13.15		150.0	
10144-CAD	LTE-FDD (SC-FDMA, 100% RB, 3 MHz, 64-QAM)	X	0.73	60.00	5.65	0.00	150.0	± 9.6 %
		Y	1.85	66.75	12.85		150.0	
		Z	1.61	64.01	11.28		150.0	
10145-CAE	LTE-FDD (SC-FDMA, 100% RB, 1.4 MHz, QPSK)	X	5.16	385.51	36.59	0.00	150.0	± 9.6 %
		Y	0.54	60.00	5.91		150.0	
		Z	0.58	60.00	5.88		150.0	
10146-CAE	LTE-FDD (SC-FDMA, 100% RB, 1.4 MHz, 16-QAM)	X	0.00	60.00	0.00	0.00	150.0	± 9.6 %
		Y	0.74	60.00	4.95		150.0	
		Z	0.80	60.00	5.53		150.0	
10147-CAE	LTE-FDD (SC-FDMA, 100% RB, 1.4 MHz, 64-QAM)	X	0.00	60.00	0.00	0.00	150.0	± 9.6 %
		Y	0.60	58.26	3.86		150.0	
		Z	0.82	60.00	5.58		150.0	

10149-CAD	LTE-FDD (SC-FDMA, 50% RB, 20 MHz, 16-QAM)	X	2.21	67.36	14.78	0.00	150.0	± 9.6 %
		Y	2.81	69.16	16.77		150.0	
		Z	2.55	66.65	15.19		150.0	
10150-CAD	LTE-FDD (SC-FDMA, 50% RB, 20 MHz, 64-QAM)	X	2.32	67.56	14.88	0.00	150.0	± 9.6 %
		Y	2.94	69.22	16.82		150.0	
		Z	2.67	66.78	15.30		150.0	
10151-CAD	LTE-TDD (SC-FDMA, 50% RB, 20 MHz, QPSK)	X	3.66	73.29	18.78	3.98	65.0	± 9.6 %
		Y	4.98	76.80	21.12		65.0	
		Z	4.55	74.40	20.06		65.0	
10152-CAD	LTE-TDD (SC-FDMA, 50% RB, 20 MHz, 16-QAM)	X	3.31	68.29	16.15	3.98	65.0	± 9.6 %
		Y	4.23	70.96	18.67		65.0	
		Z	4.14	69.89	18.22		65.0	
10153-CAD	LTE-TDD (SC-FDMA, 50% RB, 20 MHz, 64-QAM)	X	3.64	69.78	17.29	3.98	65.0	± 9.6 %
		Y	4.61	72.30	19.68		65.0	
		Z	4.49	71.11	19.19		65.0	
10154-CAE	LTE-FDD (SC-FDMA, 50% RB, 10 MHz, QPSK)	X	1.38	67.29	13.63	0.00	150.0	± 9.6 %
		Y	2.40	73.30	18.35		150.0	
		Z	1.82	67.63	15.14		150.0	
10155-CAE	LTE-FDD (SC-FDMA, 50% RB, 10 MHz, 16-QAM)	X	1.60	66.02	12.20	0.00	150.0	± 9.6 %
		Y	2.83	72.40	17.66		150.0	
		Z	2.23	67.54	15.03		150.0	
10156-CAE	LTE-FDD (SC-FDMA, 50% RB, 5 MHz, QPSK)	X	0.51	60.00	5.91	0.00	150.0	± 9.6 %
		Y	2.15	74.23	16.90		150.0	
		Z	1.25	65.50	12.43		150.0	
10157-CAE	LTE-FDD (SC-FDMA, 50% RB, 5 MHz, 16-QAM)	X	0.57	60.00	4.69	0.00	150.0	± 9.6 %
		Y	1.61	66.51	12.13		150.0	
		Z	1.35	63.41	10.38		150.0	
10158-CAE	LTE-FDD (SC-FDMA, 50% RB, 10 MHz, 64-QAM)	X	1.65	65.90	12.13	0.00	150.0	± 9.6 %
		Y	2.98	72.51	17.74		150.0	
		Z	2.38	67.83	15.24		150.0	
10159-CAE	LTE-FDD (SC-FDMA, 50% RB, 5 MHz, 64-QAM)	X	0.59	60.00	4.69	0.00	150.0	± 9.6 %
		Y	1.68	66.77	12.27		150.0	
		Z	1.39	63.54	10.48		150.0	
10160-CAD	LTE-FDD (SC-FDMA, 50% RB, 15 MHz, QPSK)	X	1.93	68.16	15.00	0.00	150.0	± 9.6 %
		Y	2.76	71.39	17.74		150.0	
		Z	2.38	67.93	15.64		150.0	
10161-CAD	LTE-FDD (SC-FDMA, 50% RB, 15 MHz, 16-QAM)	X	2.12	67.05	14.02	0.00	150.0	± 9.6 %
		Y	2.84	69.35	16.71		150.0	
		Z	2.55	66.69	15.09		150.0	
10162-CAD	LTE-FDD (SC-FDMA, 50% RB, 15 MHz, 64-QAM)	X	2.21	67.37	14.17	0.00	150.0	± 9.6 %
		Y	2.96	69.65	16.87		150.0	
		Z	2.66	66.96	15.26		150.0	
10166-CAE	LTE-FDD (SC-FDMA, 50% RB, 1.4 MHz, QPSK)	X	2.13	65.17	17.70	3.01	150.0	± 9.6 %
		Y	3.00	69.75	19.60		150.0	
		Z	2.90	67.96	18.43		150.0	
10167-CAE	LTE-FDD (SC-FDMA, 50% RB, 1.4 MHz, 16-QAM)	X	1.98	65.92	17.43	3.01	150.0	± 9.6 %
		Y	3.74	74.17	20.63		150.0	
		Z	3.28	70.17	18.57		150.0	

10168-CAE	LTE-FDD (SC-FDMA, 50% RB, 1.4 MHz, 64-QAM)	X	2.18	68.43	19.32	3.01	150.0	± 9.6 %
		Y	4.55	78.58	22.96		150.0	
		Z	3.73	73.08	20.34		150.0	
10169-CAD	LTE-FDD (SC-FDMA, 1 RB, 20 MHz, QPSK)	X	1.87	64.00	17.04	3.01	150.0	± 9.6 %
		Y	2.53	68.75	19.16		150.0	
		Z	2.36	66.10	17.52		150.0	
10170-CAD	LTE-FDD (SC-FDMA, 1 RB, 20 MHz, 16-QAM)	X	1.85	66.74	18.73	3.01	150.0	± 9.6 %
		Y	3.84	78.32	23.19		150.0	
		Z	2.87	70.66	19.54		150.0	
10171-AAD	LTE-FDD (SC-FDMA, 1 RB, 20 MHz, 64-QAM)	X	1.59	63.66	15.82	3.01	150.0	± 9.6 %
		Y	2.83	71.75	19.17		150.0	
		Z	2.39	66.90	16.66		150.0	
10172-CAD	LTE-TDD (SC-FDMA, 1 RB, 20 MHz, QPSK)	X	1.63	66.94	19.47	6.02	65.0	± 9.6 %
		Y	2.64	75.18	23.09		65.0	
		Z	2.68	72.94	21.86		65.0	
10173-CAD	LTE-TDD (SC-FDMA, 1 RB, 20 MHz, 16-QAM)	X	1.75	70.70	19.61	6.02	65.0	± 9.6 %
		Y	6.55	90.87	26.66		65.0	
		Z	4.15	79.90	22.82		65.0	
10174-CAD	LTE-TDD (SC-FDMA, 1 RB, 20 MHz, 64-QAM)	X	1.33	66.12	16.85	6.02	65.0	± 9.6 %
		Y	3.87	81.08	22.62		65.0	
		Z	2.77	72.65	19.43		65.0	
10175-CAE	LTE-FDD (SC-FDMA, 1 RB, 10 MHz, QPSK)	X	1.85	63.78	16.81	3.01	150.0	± 9.6 %
		Y	2.49	68.40	18.88		150.0	
		Z	2.33	65.83	17.28		150.0	
10176-CAE	LTE-FDD (SC-FDMA, 1 RB, 10 MHz, 16-QAM)	X	1.86	66.75	18.74	3.01	150.0	± 9.6 %
		Y	3.85	78.36	23.20		150.0	
		Z	2.87	70.68	19.55		150.0	
10177-CAG	LTE-FDD (SC-FDMA, 1 RB, 5 MHz, QPSK)	X	1.86	63.82	16.84	3.01	150.0	± 9.6 %
		Y	2.51	68.53	18.95		150.0	
		Z	2.34	65.93	17.35		150.0	
10178-CAE	LTE-FDD (SC-FDMA, 1 RB, 5 MHz, 16-QAM)	X	1.85	66.70	18.70	3.01	150.0	± 9.6 %
		Y	3.81	78.15	23.10		150.0	
		Z	2.85	70.55	19.47		150.0	
10179-CAE	LTE-FDD (SC-FDMA, 1 RB, 10 MHz, 64-QAM)	X	1.70	65.12	17.16	3.01	150.0	± 9.6 %
		Y	3.27	74.82	21.01		150.0	
		Z	2.59	68.61	17.93		150.0	
10180-CAE	LTE-FDD (SC-FDMA, 1 RB, 5 MHz, 64-QAM)	X	1.59	63.66	15.82	3.01	150.0	± 9.6 %
		Y	2.82	71.71	19.14		150.0	
		Z	2.39	66.88	16.63		150.0	
10181-CAD	LTE-FDD (SC-FDMA, 1 RB, 15 MHz, QPSK)	X	1.86	63.82	16.84	3.01	150.0	± 9.6 %
		Y	2.50	68.51	18.95		150.0	
		Z	2.34	65.92	17.34		150.0	
10182-CAD	LTE-FDD (SC-FDMA, 1 RB, 15 MHz, 16-QAM)	X	1.85	66.68	18.69	3.01	150.0	± 9.6 %
		Y	3.80	78.11	23.08		150.0	
		Z	2.85	70.52	19.45		150.0	
10183-AAC	LTE-FDD (SC-FDMA, 1 RB, 15 MHz, 64-QAM)	X	1.59	63.65	15.80	3.01	150.0	± 9.6 %
		Y	2.82	71.68	19.12		150.0	
		Z	2.38	66.86	16.62		150.0	

10184-CAD	LTE-FDD (SC-FDMA, 1 RB, 3 MHz, QPSK)	X	1.86	63.84	16.85	3.01	150.0	± 9.6 %
		Y	2.51	68.55	18.97		150.0	
		Z	2.35	65.96	17.36		150.0	
10185-CAD	LTE-FDD (SC-FDMA, 1 RB, 3 MHz, 16-QAM)	X	1.86	66.74	18.73	3.01	150.0	± 9.6 %
		Y	3.83	78.22	23.13		150.0	
		Z	2.86	70.59	19.49		150.0	
10186-AAD	LTE-FDD (SC-FDMA, 1 RB, 3 MHz, 64-QAM)	X	1.59	63.69	15.83	3.01	150.0	± 9.6 %
		Y	2.83	71.76	19.16		150.0	
		Z	2.39	66.91	16.65		150.0	
10187-CAE	LTE-FDD (SC-FDMA, 1 RB, 1.4 MHz, QPSK)	X	1.87	63.97	16.99	3.01	150.0	± 9.6 %
		Y	2.53	68.67	19.08		150.0	
		Z	2.36	66.04	17.45		150.0	
10188-CAE	LTE-FDD (SC-FDMA, 1 RB, 1.4 MHz, 16-QAM)	X	1.89	67.14	19.05	3.01	150.0	± 9.6 %
		Y	4.00	79.20	23.64		150.0	
		Z	2.94	71.15	19.86		150.0	
10189-AAE	LTE-FDD (SC-FDMA, 1 RB, 1.4 MHz, 64-QAM)	X	1.61	63.93	16.07	3.01	150.0	± 9.6 %
		Y	2.91	72.32	19.52		150.0	
		Z	2.43	67.24	16.90		150.0	
10193-CAC	IEEE 802.11n (HT Greenfield, 6.5 Mbps, BPSK)	X	3.74	67.40	15.79	0.00	150.0	± 9.6 %
		Y	4.29	67.57	16.55		150.0	
		Z	4.20	66.51	15.90		150.0	
10194-CAC	IEEE 802.11n (HT Greenfield, 39 Mbps, 16-QAM)	X	3.82	67.41	15.90	0.00	150.0	± 9.6 %
		Y	4.40	67.71	16.67		150.0	
		Z	4.32	66.72	16.05		150.0	
10195-CAC	IEEE 802.11n (HT Greenfield, 65 Mbps, 64-QAM)	X	3.83	67.37	15.89	0.00	150.0	± 9.6 %
		Y	4.42	67.68	16.66		150.0	
		Z	4.35	66.72	16.06		150.0	
10196-CAC	IEEE 802.11n (HT Mixed, 6.5 Mbps, BPSK)	X	3.72	67.37	15.75	0.00	150.0	± 9.6 %
		Y	4.26	67.52	16.51		150.0	
		Z	4.17	66.48	15.88		150.0	
10197-CAC	IEEE 802.11n (HT Mixed, 39 Mbps, 16-QAM)	X	3.82	67.41	15.91	0.00	150.0	± 9.6 %
		Y	4.41	67.70	16.67		150.0	
		Z	4.33	66.72	16.05		150.0	
10198-CAC	IEEE 802.11n (HT Mixed, 65 Mbps, 64-QAM)	X	3.82	67.36	15.88	0.00	150.0	± 9.6 %
		Y	4.41	67.66	16.65		150.0	
		Z	4.34	66.71	16.05		150.0	
10219-CAC	IEEE 802.11n (HT Mixed, 7.2 Mbps, BPSK)	X	3.68	67.48	15.78	0.00	150.0	± 9.6 %
		Y	4.22	67.61	16.52		150.0	
		Z	4.13	66.53	15.85		150.0	
10220-CAC	IEEE 802.11n (HT Mixed, 43.3 Mbps, 16-QAM)	X	3.82	67.41	15.91	0.00	150.0	± 9.6 %
		Y	4.40	67.66	16.65		150.0	
		Z	4.32	66.68	16.04		150.0	
10221-CAC	IEEE 802.11n (HT Mixed, 72.2 Mbps, 64-QAM)	X	3.85	67.40	15.91	0.00	150.0	± 9.6 %
		Y	4.43	67.62	16.64		150.0	
		Z	4.36	66.67	16.05		150.0	
10222-CAC	IEEE 802.11n (HT Mixed, 15 Mbps, BPSK)	X	4.34	66.97	16.27	0.00	150.0	± 9.6 %
		Y	4.82	67.47	16.73		150.0	
		Z	4.77	66.77	16.26		150.0	

10223-CAC	IEEE 802.11n (HT Mixed, 90 Mbps, 16-QAM)	X	4.49	67.10	16.25	0.00	150.0	± 9.6 %
		Y	5.02	67.50	16.74		150.0	
		Z	5.01	66.90	16.33		150.0	
10224-CAC	IEEE 802.11n (HT Mixed, 150 Mbps, 64-QAM)	X	4.35	67.14	16.26	0.00	150.0	± 9.6 %
		Y	4.86	67.63	16.73		150.0	
		Z	4.81	66.90	16.25		150.0	
10225-CAB	UMTS-FDD (HSPA+)	X	1.60	62.87	10.00	0.00	150.0	± 9.6 %
		Y	2.64	67.73	15.37		150.0	
		Z	2.42	65.46	14.06		150.0	
10226-CAA	LTE-TDD (SC-FDMA, 1 RB, 1.4 MHz, 16-QAM)	X	1.83	71.58	20.13	6.02	65.0	± 9.6 %
		Y	7.36	93.10	27.50		65.0	
		Z	4.39	80.98	23.33		65.0	
10227-CAA	LTE-TDD (SC-FDMA, 1 RB, 1.4 MHz, 64-QAM)	X	1.73	70.59	18.93	6.02	65.0	± 9.6 %
		Y	7.00	90.72	25.86		65.0	
		Z	4.34	79.99	22.28		65.0	
10228-CAA	LTE-TDD (SC-FDMA, 1 RB, 1.4 MHz, QPSK)	X	1.83	69.36	20.71	6.02	65.0	± 9.6 %
		Y	3.28	79.62	24.97		65.0	
		Z	3.15	76.53	23.48		65.0	
10229-CAB	LTE-TDD (SC-FDMA, 1 RB, 3 MHz, 16-QAM)	X	1.76	70.79	19.64	6.02	65.0	± 9.6 %
		Y	6.63	91.03	26.72		65.0	
		Z	4.18	80.00	22.86		65.0	
10230-CAB	LTE-TDD (SC-FDMA, 1 RB, 3 MHz, 64-QAM)	X	1.65	69.73	18.45	6.02	65.0	± 9.6 %
		Y	6.22	88.63	25.09		65.0	
		Z	4.10	78.96	21.82		65.0	
10231-CAB	LTE-TDD (SC-FDMA, 1 RB, 3 MHz, QPSK)	X	1.79	68.81	20.33	6.02	65.0	± 9.6 %
		Y	3.15	78.74	24.52		65.0	
		Z	3.06	75.85	23.10		65.0	
10232-CAD	LTE-TDD (SC-FDMA, 1 RB, 5 MHz, 16-QAM)	X	1.76	70.77	19.64	6.02	65.0	± 9.6 %
		Y	6.61	91.00	26.71		65.0	
		Z	4.18	79.98	22.86		65.0	
10233-CAD	LTE-TDD (SC-FDMA, 1 RB, 5 MHz, 64-QAM)	X	1.65	69.70	18.44	6.02	65.0	± 9.6 %
		Y	6.19	88.57	25.08		65.0	
		Z	4.09	78.93	21.81		65.0	
10234-CAD	LTE-TDD (SC-FDMA, 1 RB, 5 MHz, QPSK)	X	1.76	68.43	20.02	6.02	65.0	± 9.6 %
		Y	3.07	78.12	24.14		65.0	
		Z	2.98	75.33	22.76		65.0	
10235-CAD	LTE-TDD (SC-FDMA, 1 RB, 10 MHz, 16-QAM)	X	1.76	70.76	19.64	6.02	65.0	± 9.6 %
		Y	6.61	91.04	26.73		65.0	
		Z	4.18	80.00	22.87		65.0	
10236-CAD	LTE-TDD (SC-FDMA, 1 RB, 10 MHz, 64-QAM)	X	1.66	69.79	18.48	6.02	65.0	± 9.6 %
		Y	6.30	88.80	25.14		65.0	
		Z	4.13	79.05	21.85		65.0	
10237-CAD	LTE-TDD (SC-FDMA, 1 RB, 10 MHz, QPSK)	X	1.78	68.76	20.32	6.02	65.0	± 9.6 %
		Y	3.15	78.74	24.53		65.0	
		Z	3.05	75.85	23.11		65.0	
10238-CAD	LTE-TDD (SC-FDMA, 1 RB, 15 MHz, 16-QAM)	X	1.76	70.75	19.64	6.02	65.0	± 9.6 %
		Y	6.59	90.97	26.70		65.0	
		Z	4.17	79.95	22.85		65.0	

10239-CAD	LTE-TDD (SC-FDMA, 1 RB, 15 MHz, 64-QAM)	X	1.65	69.67	18.43	6.02	65.0	± 9.6 %
		Y	6.16	88.50	25.06		65.0	
		Z	4.07	78.89	21.79		65.0	
10240-CAD	LTE-TDD (SC-FDMA, 1 RB, 15 MHz, QPSK)	X	1.78	68.77	20.32	6.02	65.0	± 9.6 %
		Y	3.14	78.73	24.52		65.0	
		Z	3.05	75.83	23.10		65.0	
10241-CAA	LTE-TDD (SC-FDMA, 50% RB, 1.4 MHz, 16-QAM)	X	3.09	71.04	21.81	6.98	65.0	± 9.6 %
		Y	5.84	80.29	25.20		65.0	
		Z	5.54	77.13	23.79		65.0	
10242-CAA	LTE-TDD (SC-FDMA, 50% RB, 1.4 MHz, 64-QAM)	X	2.70	68.41	20.47	6.98	65.0	± 9.6 %
		Y	4.94	76.94	23.76		65.0	
		Z	4.89	74.64	22.64		65.0	
10243-CAA	LTE-TDD (SC-FDMA, 50% RB, 1.4 MHz, QPSK)	X	2.78	67.24	20.54	6.98	65.0	± 9.6 %
		Y	4.14	72.94	22.88		65.0	
		Z	4.22	71.72	22.18		65.0	
10244-CAB	LTE-TDD (SC-FDMA, 50% RB, 3 MHz, 16-QAM)	X	0.80	57.73	3.36	3.98	65.0	± 9.6 %
		Y	2.15	64.01	10.18		65.0	
		Z	2.44	64.99	11.42		65.0	
10245-CAB	LTE-TDD (SC-FDMA, 50% RB, 3 MHz, 64-QAM)	X	0.82	57.61	3.20	3.98	65.0	± 9.6 %
		Y	2.13	63.69	9.96		65.0	
		Z	2.42	64.65	11.19		65.0	
10246-CAB	LTE-TDD (SC-FDMA, 50% RB, 3 MHz, QPSK)	X	0.87	60.00	5.50	3.98	65.0	± 9.6 %
		Y	2.12	67.09	12.65		65.0	
		Z	2.17	66.84	12.89		65.0	
10247-CAD	LTE-TDD (SC-FDMA, 50% RB, 5 MHz, 16-QAM)	X	1.26	60.00	6.38	3.98	65.0	± 9.6 %
		Y	2.78	67.32	13.60		65.0	
		Z	2.82	66.99	13.82		65.0	
10248-CAD	LTE-TDD (SC-FDMA, 50% RB, 5 MHz, 64-QAM)	X	1.30	60.00	6.40	3.98	65.0	± 9.6 %
		Y	2.73	66.64	13.26		65.0	
		Z	2.81	66.52	13.58		65.0	
10249-CAD	LTE-TDD (SC-FDMA, 50% RB, 5 MHz, QPSK)	X	1.24	61.72	8.36	3.98	65.0	± 9.6 %
		Y	3.85	75.74	18.20		65.0	
		Z	3.35	73.06	17.32		65.0	
10250-CAD	LTE-TDD (SC-FDMA, 50% RB, 10 MHz, 16-QAM)	X	2.74	67.58	14.25	3.98	65.0	± 9.6 %
		Y	4.25	73.58	19.37		65.0	
		Z	4.02	71.93	18.78		65.0	
10251-CAD	LTE-TDD (SC-FDMA, 50% RB, 10 MHz, 64-QAM)	X	2.46	65.14	12.48	3.98	65.0	± 9.6 %
		Y	3.86	70.68	17.56		65.0	
		Z	3.78	69.64	17.25		65.0	
10252-CAD	LTE-TDD (SC-FDMA, 50% RB, 10 MHz, QPSK)	X	2.82	71.28	16.40	3.98	65.0	± 9.6 %
		Y	4.98	79.52	21.77		65.0	
		Z	4.29	76.11	20.42		65.0	
10253-CAD	LTE-TDD (SC-FDMA, 50% RB, 15 MHz, 16-QAM)	X	3.12	67.32	15.07	3.98	65.0	± 9.6 %
		Y	4.18	70.66	18.33		65.0	
		Z	4.10	69.61	17.93		65.0	
10254-CAD	LTE-TDD (SC-FDMA, 50% RB, 15 MHz, 64-QAM)	X	3.39	68.52	15.96	3.98	65.0	± 9.6 %
		Y	4.50	71.75	19.15		65.0	
		Z	4.39	70.63	18.74		65.0	

10255-CAD	LTE-TDD (SC-FDMA, 50% RB, 15 MHz, QPSK)	X	3.40	72.07	17.90	3.98	65.0	± 9.6 %
		Y	4.72	76.03	20.86		65.0	
		Z	4.36	73.79	19.90		65.0	
10256-CAA	LTE-TDD (SC-FDMA, 100% RB, 1.4 MHz, 16-QAM)	X	0.74	56.57	1.48	3.98	65.0	± 9.6 %
		Y	1.50	60.83	7.03		65.0	
		Z	1.77	61.73	8.31		65.0	
10257-CAA	LTE-TDD (SC-FDMA, 100% RB, 1.4 MHz, 64-QAM)	X	0.63	56.72	1.58	3.98	65.0	± 9.6 %
		Y	1.50	60.62	6.80		65.0	
		Z	1.77	61.47	8.06		65.0	
10258-CAA	LTE-TDD (SC-FDMA, 100% RB, 1.4 MHz, QPSK)	X	0.75	60.00	4.13	3.98	65.0	± 9.6 %
		Y	1.38	61.96	8.52		65.0	
		Z	1.52	62.42	9.24		65.0	
10259-CAB	LTE-TDD (SC-FDMA, 100% RB, 3 MHz, 16-QAM)	X	1.62	61.68	8.48	3.98	65.0	± 9.6 %
		Y	3.35	69.89	15.82		65.0	
		Z	3.28	68.97	15.69		65.0	
10260-CAB	LTE-TDD (SC-FDMA, 100% RB, 3 MHz, 64-QAM)	X	1.65	61.61	8.42	3.98	65.0	± 9.6 %
		Y	3.36	69.55	15.64		65.0	
		Z	3.31	68.75	15.57		65.0	
10261-CAB	LTE-TDD (SC-FDMA, 100% RB, 3 MHz, QPSK)	X	1.63	64.06	10.69	3.98	65.0	± 9.6 %
		Y	4.19	76.83	19.42		65.0	
		Z	3.63	73.87	18.36		65.0	
10262-CAD	LTE-TDD (SC-FDMA, 100% RB, 5 MHz, 16-QAM)	X	2.73	67.47	14.17	3.98	65.0	± 9.6 %
		Y	4.22	73.47	19.30		65.0	
		Z	4.00	71.83	18.72		65.0	
10263-CAD	LTE-TDD (SC-FDMA, 100% RB, 5 MHz, 64-QAM)	X	2.46	65.13	12.47	3.98	65.0	± 9.6 %
		Y	3.85	70.66	17.56		65.0	
		Z	3.77	69.62	17.25		65.0	
10264-CAD	LTE-TDD (SC-FDMA, 100% RB, 5 MHz, QPSK)	X	2.78	71.03	16.25	3.98	65.0	± 9.6 %
		Y	4.91	79.23	21.63		65.0	
		Z	4.25	75.88	20.29		65.0	
10265-CAD	LTE-TDD (SC-FDMA, 100% RB, 10 MHz, 16-QAM)	X	3.31	68.31	16.16	3.98	65.0	± 9.6 %
		Y	4.23	70.96	18.67		65.0	
		Z	4.14	69.89	18.23		65.0	
10266-CAD	LTE-TDD (SC-FDMA, 100% RB, 10 MHz, 64-QAM)	X	3.64	69.75	17.27	3.98	65.0	± 9.6 %
		Y	4.61	72.28	19.66		65.0	
		Z	4.48	71.09	19.18		65.0	
10267-CAD	LTE-TDD (SC-FDMA, 100% RB, 10 MHz, QPSK)	X	3.65	73.23	18.74	3.98	65.0	± 9.6 %
		Y	4.96	76.74	21.09		65.0	
		Z	4.55	74.35	20.04		65.0	
10268-CAD	LTE-TDD (SC-FDMA, 100% RB, 15 MHz, 16-QAM)	X	4.08	69.60	17.97	3.98	65.0	± 9.6 %
		Y	4.89	71.20	19.41		65.0	
		Z	4.81	70.25	18.99		65.0	
10269-CAD	LTE-TDD (SC-FDMA, 100% RB, 15 MHz, 64-QAM)	X	4.15	69.51	17.90	3.98	65.0	± 9.6 %
		Y	4.93	70.92	19.29		65.0	
		Z	4.85	69.98	18.89		65.0	
10270-CAD	LTE-TDD (SC-FDMA, 100% RB, 15 MHz, QPSK)	X	4.11	72.44	19.03	3.98	65.0	± 9.6 %
		Y	5.01	74.05	20.18		65.0	
		Z	4.76	72.38	19.41		65.0	

10274-CAB	UMTS-FDD (HSUPA, Subtest 5, 3GPP Rel8.10)	X	1.45	63.39	10.22	0.00	150.0	± 9.6 %
		Y	2.58	68.99	15.79		150.0	
		Z	2.26	65.99	14.08		150.0	
10275-CAB	UMTS-FDD (HSUPA, Subtest 5, 3GPP Rel8.4)	X	1.00	66.09	12.05	0.00	150.0	± 9.6 %
		Y	1.98	74.04	18.23		150.0	
		Z	1.30	66.38	13.95		150.0	
10277-CAA	PHS (QPSK)	X	4.43	65.00	5.66	9.03	50.0	± 9.6 %
		Y	1.25	57.54	2.57		50.0	
		Z	1.34	58.35	3.69		50.0	
10278-CAA	PHS (QPSK, BW 884MHz, Rolloff 0.5)	X	1.39	58.79	4.19	9.03	50.0	± 9.6 %
		Y	2.00	62.01	7.70		50.0	
		Z	2.27	62.99	8.81		50.0	
10279-CAA	PHS (QPSK, BW 884MHz, Rolloff 0.38)	X	1.42	58.87	4.28	9.03	50.0	± 9.6 %
		Y	2.04	62.14	7.84		50.0	
		Z	2.32	63.16	8.96		50.0	
10290-AAB	CDMA2000, RC1, SO55, Full Rate	X	24.89	264.54	21.43	0.00	150.0	± 9.6 %
		Y	0.75	64.32	9.28		150.0	
		Z	0.55	60.53	6.84		150.0	
10291-AAB	CDMA2000, RC3, SO55, Full Rate	X	8.17	257.05	37.61	0.00	150.0	± 9.6 %
		Y	0.54	64.12	8.98		150.0	
		Z	0.37	60.00	6.07		150.0	
10292-AAB	CDMA2000, RC3, SO32, Full Rate	X	2.31	326.58	8.83	0.00	150.0	± 9.6 %
		Y	100.00	114.29	23.68		150.0	
		Z	0.37	60.29	6.50		150.0	
10293-AAB	CDMA2000, RC3, SO3, Full Rate	X	2.41	304.08	37.98	0.00	150.0	± 9.6 %
		Y	100.00	121.87	26.96		150.0	
		Z	0.47	62.33	8.10		150.0	
10295-AAB	CDMA2000, RC1, SO3, 1/8th Rate 25 fr.	X	11.16	76.14	13.68	9.03	50.0	± 9.6 %
		Y	24.30	94.04	23.00		50.0	
		Z	21.29	93.19	23.41		50.0	
10297-AAC	LTE-FDD (SC-FDMA, 50% RB, 20 MHz, QPSK)	X	2.00	69.33	16.06	0.00	150.0	± 9.6 %
		Y	2.80	72.57	18.31		150.0	
		Z	2.31	68.33	15.80		150.0	
10298-AAC	LTE-FDD (SC-FDMA, 50% RB, 3 MHz, QPSK)	X	8.49	243.95	30.00	0.00	150.0	± 9.6 %
		Y	0.98	64.80	10.42		150.0	
		Z	0.78	61.52	8.38		150.0	
10299-AAC	LTE-FDD (SC-FDMA, 50% RB, 3 MHz, 16-QAM)	X	12.17	331.10	45.12	0.00	150.0	± 9.6 %
		Y	0.99	61.11	7.01		150.0	
		Z	1.06	61.03	7.46		150.0	
10300-AAC	LTE-FDD (SC-FDMA, 50% RB, 3 MHz, 64-QAM)	X	10.15	348.38	28.30	0.00	150.0	± 9.6 %
		Y	0.82	59.43	5.36		150.0	
		Z	0.95	60.00	6.23		150.0	
10301-AAA	IEEE 802.16e WIMAX (29:18, 5ms, 10MHz, QPSK, PUSC)	X	3.30	64.31	15.03	4.17	50.0	± 9.6 %
		Y	4.07	65.29	17.00		50.0	
		Z	4.16	64.88	16.72		50.0	
10302-AAA	IEEE 802.16e WIMAX (29:18, 5ms, 10MHz, QPSK, PUSC, 3 CTRL symbols)	X	3.81	65.12	15.99	4.96	50.0	± 9.6 %
		Y	4.52	65.76	17.66		50.0	
		Z	4.66	65.71	17.60		50.0	

10303-AAA	IEEE 802.16e WiMAX (31:15, 5ms, 10MHz, 64QAM, PUSC)	X	3.64	65.07	15.71	4.96	50.0	± 9.6 %
		Y	4.29	65.44	17.44		50.0	
		Z	4.42	65.39	17.39		50.0	
10304-AAA	IEEE 802.16e WiMAX (29:18, 5ms, 10MHz, 64QAM, PUSC)	X	3.46	64.98	15.29	4.17	50.0	± 9.6 %
		Y	4.15	65.58	17.11		50.0	
		Z	4.21	64.95	16.68		50.0	
10305-AAA	IEEE 802.16e WiMAX (31:15, 10ms, 10MHz, 64QAM, PUSC, 15 symbols)	X	2.52	62.00	12.12	6.02	35.0	± 9.6 %
		Y	3.52	65.78	17.45		35.0	
		Z	3.76	66.23	17.67		35.0	
10306-AAA	IEEE 802.16e WiMAX (29:18, 10ms, 10MHz, 64QAM, PUSC, 18 symbols)	X	3.12	63.64	14.29	6.02	35.0	± 9.6 %
		Y	3.94	65.53	17.75		35.0	
		Z	4.14	65.73	17.85		35.0	
10307-AAA	IEEE 802.16e WiMAX (29:18, 10ms, 10MHz, QPSK, PUSC, 18 symbols)	X	3.01	63.42	14.02	6.02	35.0	± 9.6 %
		Y	3.81	65.44	17.59		35.0	
		Z	4.01	65.68	17.70		35.0	
10308-AAA	IEEE 802.16e WiMAX (29:18, 10ms, 10MHz, 16QAM, PUSC)	X	3.02	63.75	14.28	6.02	35.0	± 9.6 %
		Y	3.78	65.60	17.74		35.0	
		Z	3.98	65.86	17.83		35.0	
10309-AAA	IEEE 802.16e WiMAX (29:18, 10ms, 10MHz, 16QAM, AMC 2x3, 18 symbols)	X	3.17	63.94	14.58	6.02	35.0	± 9.6 %
		Y	3.94	65.55	17.83		35.0	
		Z	4.14	65.77	17.93		35.0	
10310-AAA	IEEE 802.16e WiMAX (29:18, 10ms, 10MHz, QPSK, AMC 2x3, 18 symbols)	X	3.11	63.82	14.42	6.02	35.0	± 9.6 %
		Y	3.89	65.58	17.76		35.0	
		Z	4.09	65.78	17.84		35.0	
10311-AAC	LTE-FDD (SC-FDMA, 100% RB, 15 MHz, QPSK)	X	2.31	68.15	15.92	0.00	150.0	± 9.6 %
		Y	3.15	71.23	17.71		150.0	
		Z	2.66	67.57	15.55		150.0	
10313-AAA	iDEN 1:3	X	1.67	67.67	13.40	6.99	70.0	± 9.6 %
		Y	2.25	71.10	15.22		70.0	
		Z	1.73	67.06	13.24		70.0	
10314-AAA	iDEN 1:6	X	6.12	86.17	23.14	10.00	30.0	± 9.6 %
		Y	7.14	89.19	24.60		30.0	
		Z	3.49	76.84	20.05		30.0	
10315-AAB	IEEE 802.11b WiFi 2.4 GHz (DSSS, 1 Mbps, 96pc duty cycle)	X	0.91	63.92	14.34	0.17	150.0	± 9.6 %
		Y	1.09	65.84	16.70		150.0	
		Z	0.93	62.70	14.16		150.0	
10316-AAB	IEEE 802.11g WiFi 2.4 GHz (ERP-OFDM, 6 Mbps, 96pc duty cycle)	X	3.71	66.95	15.64	0.17	150.0	± 9.6 %
		Y	4.26	67.26	16.51		150.0	
		Z	4.21	66.40	15.98		150.0	
10317-AAC	IEEE 802.11a WiFi 5 GHz (OFDM, 6 Mbps, 96pc duty cycle)	X	3.71	66.95	15.64	0.17	150.0	± 9.6 %
		Y	4.26	67.26	16.51		150.0	
		Z	4.21	66.40	15.98		150.0	
10400-AAD	IEEE 802.11ac WiFi (20MHz, 64-QAM, 99pc duty cycle)	X	3.67	66.95	15.61	0.00	150.0	± 9.6 %
		Y	4.32	67.59	16.58		150.0	
		Z	4.27	66.67	15.99		150.0	
10401-AAD	IEEE 802.11ac WiFi (40MHz, 64-QAM, 99pc duty cycle)	X	4.49	66.84	16.09	0.00	150.0	± 9.6 %
		Y	5.01	67.23	16.55		150.0	
		Z	4.95	66.47	16.07		150.0	

10402-AAD	IEEE 802.11ac WiFi (80MHz, 64-QAM, 99pc duty cycle)	X	4.90	67.23	16.33	0.00	150.0	± 9.6 %
		Y	5.37	67.75	16.72		150.0	
		Z	5.33	67.10	16.30		150.0	
10403-AAB	CDMA2000 (1xEV-DO, Rev. 0)	X	24.89	264.54	21.43	0.00	115.0	± 9.6 %
		Y	0.75	64.32	9.28		115.0	
		Z	0.55	60.53	6.84		115.0	
10404-AAB	CDMA2000 (1xEV-DO, Rev. A)	X	24.89	264.54	21.43	0.00	115.0	± 9.6 %
		Y	0.75	64.32	9.28		115.0	
		Z	0.55	60.53	6.84		115.0	
10406-AAB	CDMA2000, RC3, SO32, SCH0, Full Rate	X	0.25	60.00	3.04	0.00	100.0	± 9.6 %
		Y	100.00	107.14	22.27		100.0	
		Z	35.03	104.04	23.84		100.0	
10410-AAD	LTE-TDD (SC-FDMA, 1 RB, 10 MHz, QPSK, UL Subframe=2,3,4,7,8,9, Subframe Conf=4)	X	1.11	74.02	16.29	3.23	80.0	± 9.6 %
		Y	100.00	123.32	29.06		80.0	
		Z	3.02	80.23	18.57		80.0	
10415-AAA	IEEE 802.11b WiFi 2.4 GHz (DSSS, 1 Mbps, 99pc duty cycle)	X	0.88	63.60	14.08	0.00	150.0	± 9.6 %
		Y	1.05	65.44	16.40		150.0	
		Z	0.90	62.27	13.77		150.0	
10416-AAA	IEEE 802.11g WiFi 2.4 GHz (ERP-OFDM, 6 Mbps, 99pc duty cycle)	X	3.72	67.22	15.78	0.00	150.0	± 9.6 %
		Y	4.26	67.46	16.59		150.0	
		Z	4.18	66.47	15.97		150.0	
10417-AAB	IEEE 802.11a/h WiFi 5 GHz (OFDM, 6 Mbps, 99pc duty cycle)	X	3.72	67.22	15.78	0.00	150.0	± 9.6 %
		Y	4.26	67.46	16.59		150.0	
		Z	4.18	66.47	15.97		150.0	
10418-AAA	IEEE 802.11g WiFi 2.4 GHz (DSSS-OFDM, 6 Mbps, 99pc duty cycle, Long preamble)	X	3.67	67.37	15.86	0.00	150.0	± 9.6 %
		Y	4.26	67.73	16.69		150.0	
		Z	4.18	66.68	16.03		150.0	
10419-AAA	IEEE 802.11g WiFi 2.4 GHz (DSSS-OFDM, 6 Mbps, 99pc duty cycle, Short preamble)	X	3.70	67.32	15.83	0.00	150.0	± 9.6 %
		Y	4.28	67.63	16.66		150.0	
		Z	4.19	66.61	16.02		150.0	
10422-AAB	IEEE 802.11n (HT Greenfield, 7.2 Mbps, BPSK)	X	3.79	67.23	15.85	0.00	150.0	± 9.6 %
		Y	4.37	67.55	16.64		150.0	
		Z	4.30	66.59	16.04		150.0	
10423-AAB	IEEE 802.11n (HT Greenfield, 43.3 Mbps, 16-QAM)	X	3.85	67.43	15.91	0.00	150.0	± 9.6 %
		Y	4.48	67.79	16.72		150.0	
		Z	4.41	66.83	16.12		150.0	
10424-AAB	IEEE 802.11n (HT Greenfield, 72.2 Mbps, 64-QAM)	X	3.80	67.32	15.87	0.00	150.0	± 9.6 %
		Y	4.41	67.73	16.70		150.0	
		Z	4.34	66.77	16.09		150.0	
10425-AAB	IEEE 802.11n (HT Greenfield, 15 Mbps, BPSK)	X	4.52	67.29	16.36	0.00	150.0	± 9.6 %
		Y	5.01	67.60	16.77		150.0	
		Z	5.00	66.98	16.36		150.0	
10426-AAB	IEEE 802.11n (HT Greenfield, 90 Mbps, 16-QAM)	X	4.54	67.39	16.40	0.00	150.0	± 9.6 %
		Y	5.06	67.79	16.86		150.0	
		Z	5.04	67.17	16.45		150.0	

10427-AAB	IEEE 802.11n (HT Greenfield, 150 Mbps, 64-QAM)	X	4.54	67.34	16.38	0.00	150.0	± 9.6 %
		Y	5.02	67.56	16.74		150.0	
		Z	4.99	66.89	16.30		150.0	
10430-AAB	LTE-FDD (OFDMA, 5 MHz, E-TM 3.1)	X	2.54	67.86	12.99	0.00	150.0	± 9.6 %
		Y	5.20	77.46	20.26		150.0	
		Z	4.04	72.15	17.87		150.0	
10431-AAB	LTE-FDD (OFDMA, 10 MHz, E-TM 3.1)	X	3.04	66.93	14.37	0.00	150.0	± 9.6 %
		Y	3.88	68.36	16.49		150.0	
		Z	3.75	66.95	15.66		150.0	
10432-AAB	LTE-FDD (OFDMA, 15 MHz, E-TM 3.1)	X	3.52	67.40	15.50	0.00	150.0	± 9.6 %
		Y	4.19	67.98	16.66		150.0	
		Z	4.09	66.85	15.96		150.0	
10433-AAB	LTE-FDD (OFDMA, 20 MHz, E-TM 3.1)	X	3.82	67.39	15.92	0.00	150.0	± 9.6 %
		Y	4.43	67.78	16.72		150.0	
		Z	4.36	66.81	16.12		150.0	
10434-AAA	W-CDMA (BS Test Model 1, 64 DPCH)	X	1.61	62.74	9.15	0.00	150.0	± 9.6 %
		Y	5.68	78.98	20.05		150.0	
		Z	3.98	72.24	17.17		150.0	
10435-AAC	LTE-TDD (SC-FDMA, 1 RB, 20 MHz, QPSK, UL Subframe=2,3,4,7,8,9)	X	1.04	73.03	15.81	3.23	80.0	± 9.6 %
		Y	100.00	122.83	28.83		80.0	
		Z	2.85	79.40	18.23		80.0	
10447-AAB	LTE-FDD (OFDMA, 5 MHz, E-TM 3.1, Clipping 44%)	X	1.63	62.08	8.98	0.00	150.0	± 9.6 %
		Y	3.10	68.15	14.99		150.0	
		Z	2.89	66.18	13.94		150.0	
10448-AAB	LTE-FDD (OFDMA, 10 MHz, E-TM 3.1, Clipping 44%)	X	2.97	66.84	14.33	0.00	150.0	± 9.6 %
		Y	3.76	68.19	16.40		150.0	
		Z	3.63	66.75	15.54		150.0	
10449-AAB	LTE-FDD (OFDMA, 15 MHz, E-TM 3.1, Clipping 44%)	X	3.43	67.31	15.47	0.00	150.0	± 9.6 %
		Y	4.05	67.84	16.58		150.0	
		Z	3.95	66.68	15.86		150.0	
10450-AAB	LTE-FDD (OFDMA, 20 MHz, E-TM 3.1, Clipping 44%)	X	3.70	67.17	15.79	0.00	150.0	± 9.6 %
		Y	4.26	67.58	16.60		150.0	
		Z	4.17	66.58	15.96		150.0	
10451-AAA	W-CDMA (BS Test Model 1, 64 DPCH, Clipping 44%)	X	1.22	60.20	6.79	0.00	150.0	± 9.6 %
		Y	2.78	67.25	13.76		150.0	
		Z	2.61	65.48	12.83		150.0	
10456-AAB	IEEE 802.11ac WiFi (160MHz, 64-QAM, 99pc duty cycle)	X	5.60	67.64	16.61	0.00	150.0	± 9.6 %
		Y	6.26	68.94	17.34		150.0	
		Z	6.00	67.69	16.64		150.0	
10457-AAA	UMTS-FDD (DC-HSDPA)	X	3.27	66.46	15.58	0.00	150.0	± 9.6 %
		Y	3.68	66.34	16.37		150.0	
		Z	3.59	65.30	15.71		150.0	
10458-AAA	CDMA2000 (1xEV-DO, Rev. B, 2 carriers)	X	1.12	60.00	5.83	0.00	150.0	± 9.6 %
		Y	3.56	71.73	16.05		150.0	
		Z	3.03	68.42	14.58		150.0	
10459-AAA	CDMA2000 (1xEV-DO, Rev. B, 3 carriers)	X	2.37	61.19	9.10	0.00	150.0	± 9.6 %
		Y	4.86	70.51	17.92		150.0	
		Z	4.63	68.94	17.35		150.0	

10460-AAA	UMTS-FDD (WCDMA, AMR)	X	0.77	69.97	14.37	0.00	150.0	± 9.6 %
		Y	1.81	83.33	22.94		150.0	
		Z	0.70	66.15	13.99		150.0	
10461-AAA	LTE-TDD (SC-FDMA, 1 RB, 1.4 MHz, QPSK, UL Subframe=2,3,4,7,8,9)	X	1.10	74.88	17.91	3.29	80.0	± 9.6 %
		Y	100.00	130.63	32.41		80.0	
		Z	2.28	78.08	18.84		80.0	
10462-AAA	LTE-TDD (SC-FDMA, 1 RB, 1.4 MHz, 16-QAM, UL Subframe=2,3,4,7,8,9)	X	5.93	230.19	29.26	3.23	80.0	± 9.6 %
		Y	0.59	60.00	5.55		80.0	
		Z	0.64	60.00	7.06		80.0	
10463-AAA	LTE-TDD (SC-FDMA, 1 RB, 1.4 MHz, 64-QAM, UL Subframe=2,3,4,7,8,9)	X	3.96	233.23	22.29	3.23	80.0	± 9.6 %
		Y	23.26	230.85	21.52		80.0	
		Z	0.66	60.00	6.36		80.0	
10464-AAA	LTE-TDD (SC-FDMA, 1 RB, 3 MHz, QPSK, UL Subframe=2,3,4,7,8,9)	X	0.60	67.04	13.62	3.23	80.0	± 9.6 %
		Y	100.00	124.51	29.50		80.0	
		Z	1.46	72.00	15.83		80.0	
10465-AAA	LTE-TDD (SC-FDMA, 1 RB, 3 MHz, 16-QAM, UL Subframe=2,3,4,7,8,9)	X	6.88	228.32	21.10	3.23	80.0	± 9.6 %
		Y	0.24	55.14	2.95		80.0	
		Z	0.64	60.00	7.00		80.0	
10466-AAA	LTE-TDD (SC-FDMA, 1 RB, 3 MHz, 64-QAM, UL Subframe=2,3,4,7,8,9)	X	4.90	230.59	11.80	3.23	80.0	± 9.6 %
		Y	24.92	227.37	29.84		80.0	
		Z	0.66	60.00	6.32		80.0	
10467-AAC	LTE-TDD (SC-FDMA, 1 RB, 5 MHz, QPSK, UL Subframe=2,3,4,7,8,9)	X	0.65	68.17	14.23	3.23	80.0	± 9.6 %
		Y	100.00	125.25	29.82		80.0	
		Z	1.58	73.06	16.29		80.0	
10468-AAC	LTE-TDD (SC-FDMA, 1 RB, 5 MHz, 16-QAM, UL Subframe=2,3,4,7,8,9)	X	6.75	228.62	22.92	3.23	80.0	± 9.6 %
		Y	0.24	55.19	3.02		80.0	
		Z	0.64	60.00	7.02		80.0	
10469-AAC	LTE-TDD (SC-FDMA, 1 RB, 5 MHz, 64-QAM, UL Subframe=2,3,4,7,8,9)	X	4.89	230.67	12.36	3.23	80.0	± 9.6 %
		Y	24.62	227.52	30.16		80.0	
		Z	0.66	60.00	6.32		80.0	
10470-AAC	LTE-TDD (SC-FDMA, 1 RB, 10 MHz, QPSK, UL Subframe=2,3,4,7,8,9)	X	0.65	68.21	14.25	3.23	80.0	± 9.6 %
		Y	100.00	125.26	29.81		80.0	
		Z	1.58	73.08	16.29		80.0	
10471-AAC	LTE-TDD (SC-FDMA, 1 RB, 10 MHz, 16-QAM, UL Subframe=2,3,4,7,8,9)	X	6.71	228.68	22.79	3.23	80.0	± 9.6 %
		Y	0.24	55.16	2.98		80.0	
		Z	0.64	60.00	7.01		80.0	
10472-AAC	LTE-TDD (SC-FDMA, 1 RB, 10 MHz, 64-QAM, UL Subframe=2,3,4,7,8,9)	X	4.83	230.72	12.16	3.23	80.0	± 9.6 %
		Y	24.39	227.78	30.29		80.0	
		Z	0.66	60.00	6.30		80.0	
10473-AAC	LTE-TDD (SC-FDMA, 1 RB, 15 MHz, QPSK, UL Subframe=2,3,4,7,8,9)	X	0.65	68.12	14.21	3.23	80.0	± 9.6 %
		Y	100.00	125.20	29.78		80.0	
		Z	1.57	73.01	16.25		80.0	
10474-AAC	LTE-TDD (SC-FDMA, 1 RB, 15 MHz, 16-QAM, UL Subframe=2,3,4,7,8,9)	X	6.67	228.73	22.56	3.23	80.0	± 9.6 %
		Y	0.59	60.00	5.48		80.0	
		Z	0.64	60.00	7.01		80.0	
10475-AAC	LTE-TDD (SC-FDMA, 1 RB, 15 MHz, 64-QAM, UL Subframe=2,3,4,7,8,9)	X	4.82	230.67	11.80	3.23	80.0	± 9.6 %
		Y	24.34	227.67	30.21		80.0	
		Z	0.66	60.00	6.30		80.0	

10477-AAC	LTE-TDD (SC-FDMA, 1 RB, 20 MHz, 16-QAM, UL Subframe=2,3,4,7,8,9)	X	6.74	228.54	21.21	3.23	80.0	± 9.6 %
		Y	0.23	55.08	2.89		80.0	
		Z	0.64	60.00	6.98		80.0	
10478-AAC	LTE-TDD (SC-FDMA, 1 RB, 20 MHz, 64-QAM, UL Subframe=2,3,4,7,8,9)	X	4.84	230.57	11.22	3.23	80.0	± 9.6 %
		Y	24.37	227.68	30.04		80.0	
		Z	0.66	60.00	6.29		80.0	
10479-AAA	LTE-TDD (SC-FDMA, 50% RB, 1.4 MHz, QPSK, UL Subframe=2,3,4,7,8,9)	X	3.02	84.98	21.47	3.23	80.0	± 9.6 %
		Y	100.00	125.48	31.72		80.0	
		Z	5.02	83.00	20.76		80.0	
10480-AAA	LTE-TDD (SC-FDMA, 50% RB, 1.4 MHz, 16-QAM, UL Subframe=2,3,4,7,8,9)	X	0.47	60.00	6.63	3.23	80.0	± 9.6 %
		Y	1.92	67.54	11.86		80.0	
		Z	1.73	65.44	11.67		80.0	
10481-AAA	LTE-TDD (SC-FDMA, 50% RB, 1.4 MHz, 64-QAM, UL Subframe=2,3,4,7,8,9)	X	0.22	55.04	3.12	3.23	80.0	± 9.6 %
		Y	1.09	61.90	8.89		80.0	
		Z	1.31	62.31	9.77		80.0	
10482-AAA	LTE-TDD (SC-FDMA, 50% RB, 3 MHz, QPSK, UL Subframe=2,3,4,7,8,9)	X	53.67	208.87	10.65	2.23	80.0	± 9.6 %
		Y	1.05	62.14	9.95		80.0	
		Z	0.98	60.56	9.26		80.0	
10483-AAA	LTE-TDD (SC-FDMA, 50% RB, 3 MHz, 16-QAM, UL Subframe=2,3,4,7,8,9)	X	64.01	327.64	15.81	2.23	80.0	± 9.6 %
		Y	1.10	60.00	7.60		80.0	
		Z	1.21	60.00	8.23		80.0	
10484-AAA	LTE-TDD (SC-FDMA, 50% RB, 3 MHz, 64-QAM, UL Subframe=2,3,4,7,8,9)	X	72.15	316.72	7.23	2.23	80.0	± 9.6 %
		Y	1.13	60.00	7.59		80.0	
		Z	1.24	60.00	8.22		80.0	
10485-AAC	LTE-TDD (SC-FDMA, 50% RB, 5 MHz, QPSK, UL Subframe=2,3,4,7,8,9)	X	0.75	60.00	6.88	2.23	80.0	± 9.6 %
		Y	2.48	72.41	16.54		80.0	
		Z	1.64	65.93	13.71		80.0	
10486-AAC	LTE-TDD (SC-FDMA, 50% RB, 5 MHz, 16-QAM, UL Subframe=2,3,4,7,8,9)	X	1.01	60.00	5.53	2.23	80.0	± 9.6 %
		Y	1.68	63.79	11.57		80.0	
		Z	1.58	62.22	10.94		80.0	
10487-AAC	LTE-TDD (SC-FDMA, 50% RB, 5 MHz, 64-QAM, UL Subframe=2,3,4,7,8,9)	X	1.04	60.00	5.50	2.23	80.0	± 9.6 %
		Y	1.66	63.28	11.27		80.0	
		Z	1.59	61.98	10.79		80.0	
10488-AAC	LTE-TDD (SC-FDMA, 50% RB, 10 MHz, QPSK, UL Subframe=2,3,4,7,8,9)	X	1.44	64.72	13.06	2.23	80.0	± 9.6 %
		Y	2.82	72.60	18.56		80.0	
		Z	2.27	68.12	16.38		80.0	
10489-AAC	LTE-TDD (SC-FDMA, 50% RB, 10 MHz, 16-QAM, UL Subframe=2,3,4,7,8,9)	X	1.47	61.87	10.73	2.23	80.0	± 9.6 %
		Y	2.82	68.91	16.54		80.0	
		Z	2.48	66.05	15.16		80.0	
10490-AAC	LTE-TDD (SC-FDMA, 50% RB, 10 MHz, 64-QAM, UL Subframe=2,3,4,7,8,9)	X	1.47	61.55	10.50	2.23	80.0	± 9.6 %
		Y	2.86	68.61	16.37		80.0	
		Z	2.55	65.97	15.11		80.0	
10491-AAC	LTE-TDD (SC-FDMA, 50% RB, 15 MHz, QPSK, UL Subframe=2,3,4,7,8,9)	X	1.98	66.25	14.91	2.23	80.0	± 9.6 %
		Y	2.98	70.44	18.02		80.0	
		Z	2.64	67.54	16.51		80.0	
10492-AAC	LTE-TDD (SC-FDMA, 50% RB, 15 MHz, 16-QAM, UL Subframe=2,3,4,7,8,9)	X	2.19	64.63	13.64	2.23	80.0	± 9.6 %
		Y	3.11	67.88	16.76		80.0	
		Z	2.90	65.95	15.77		80.0	

10493-AAC	LTE-TDD (SC-FDMA, 50% RB, 15 MHz, 64-QAM, UL Subframe=2,3,4,7,8,9)	X	2.21	64.43	13.47	2.23	80.0	± 9.6 %
		Y	3.16	67.71	16.66		80.0	
		Z	2.96	65.87	15.72		80.0	
10494-AAC	LTE-TDD (SC-FDMA, 50% RB, 20 MHz, QPSK, UL Subframe=2,3,4,7,8,9)	X	2.11	67.23	15.74	2.23	80.0	± 9.6 %
		Y	3.21	71.79	18.57		80.0	
		Z	2.78	68.52	16.88		80.0	
10495-AAC	LTE-TDD (SC-FDMA, 50% RB, 20 MHz, 16-QAM, UL Subframe=2,3,4,7,8,9)	X	2.35	65.50	14.66	2.23	80.0	± 9.6 %
		Y	3.14	68.07	17.04		80.0	
		Z	2.93	66.16	16.02		80.0	
10496-AAC	LTE-TDD (SC-FDMA, 50% RB, 20 MHz, 64-QAM, UL Subframe=2,3,4,7,8,9)	X	2.42	65.39	14.61	2.23	80.0	± 9.6 %
		Y	3.21	67.85	16.95		80.0	
		Z	3.02	66.06	16.01		80.0	
10497-AAA	LTE-TDD (SC-FDMA, 100% RB, 1.4 MHz, QPSK, UL Subframe=2,3,4,7,8,9)	X	4.50	220.48	26.76	2.23	80.0	± 9.6 %
		Y	0.82	60.00	6.90		80.0	
		Z	0.88	60.00	7.23		80.0	
10498-AAA	LTE-TDD (SC-FDMA, 100% RB, 1.4 MHz, 16-QAM, UL Subframe=2,3,4,7,8,9)	X	0.00	60.00	0.00	2.23	80.0	± 9.6 %
		Y	1.06	60.00	5.49		80.0	
		Z	1.08	60.00	6.01		80.0	
10499-AAA	LTE-TDD (SC-FDMA, 100% RB, 1.4 MHz, 64-QAM, UL Subframe=2,3,4,7,8,9)	X	0.00	60.00	0.00	2.23	80.0	± 9.6 %
		Y	1.10	60.00	5.30		80.0	
		Z	1.11	60.00	5.84		80.0	
10500-AAA	LTE-TDD (SC-FDMA, 100% RB, 3 MHz, QPSK, UL Subframe=2,3,4,7,8,9)	X	0.83	60.00	8.23	2.23	80.0	± 9.6 %
		Y	2.68	72.91	17.52		80.0	
		Z	1.91	67.05	14.90		80.0	
10501-AAA	LTE-TDD (SC-FDMA, 100% RB, 3 MHz, 16-QAM, UL Subframe=2,3,4,7,8,9)	X	1.03	60.00	6.96	2.23	80.0	± 9.6 %
		Y	2.26	66.74	13.90		80.0	
		Z	1.97	64.14	12.76		80.0	
10502-AAA	LTE-TDD (SC-FDMA, 100% RB, 3 MHz, 64-QAM, UL Subframe=2,3,4,7,8,9)	X	1.05	60.00	6.86	2.23	80.0	± 9.6 %
		Y	2.24	66.31	13.60		80.0	
		Z	1.99	63.95	12.58		80.0	
10503-AAC	LTE-TDD (SC-FDMA, 100% RB, 5 MHz, QPSK, UL Subframe=2,3,4,7,8,9)	X	1.42	64.51	12.94	2.23	80.0	± 9.6 %
		Y	2.78	72.32	18.42		80.0	
		Z	2.24	67.93	16.27		80.0	
10504-AAC	LTE-TDD (SC-FDMA, 100% RB, 5 MHz, 16-QAM, UL Subframe=2,3,4,7,8,9)	X	1.45	61.75	10.65	2.23	80.0	± 9.6 %
		Y	2.79	68.76	16.45		80.0	
		Z	2.46	65.95	15.09		80.0	
10505-AAC	LTE-TDD (SC-FDMA, 100% RB, 5 MHz, 64-QAM, UL Subframe=2,3,4,7,8,9)	X	1.46	61.45	10.42	2.23	80.0	± 9.6 %
		Y	2.84	68.47	16.29		80.0	
		Z	2.53	65.87	15.05		80.0	
10506-AAC	LTE-TDD (SC-FDMA, 100% RB, 10 MHz, QPSK, UL Subframe=2,3,4,7,8,9)	X	2.09	67.08	15.65	2.23	80.0	± 9.6 %
		Y	3.18	71.61	18.48		80.0	
		Z	2.76	68.39	16.81		80.0	
10507-AAC	LTE-TDD (SC-FDMA, 100% RB, 10 MHz, 16-QAM, UL Subframe=2,3,4,7,8,9)	X	2.34	65.41	14.60	2.23	80.0	± 9.6 %
		Y	3.12	67.99	16.99		80.0	
		Z	2.92	66.10	15.98		80.0	

10508-AAC	LTE-TDD (SC-FDMA, 100% RB, 10 MHz, 64-QAM, UL Subframe=2,3,4,7,8,9)	X	2.40	65.29	14.54	2.23	80.0	± 9.6 %
		Y	3.20	67.76	16.90		80.0	
		Z	3.01	65.99	15.96		80.0	
10509-AAC	LTE-TDD (SC-FDMA, 100% RB, 15 MHz, QPSK, UL Subframe=2,3,4,7,8,9)	X	2.58	67.03	16.09	2.23	80.0	± 9.6 %
		Y	3.55	70.28	17.97		80.0	
		Z	3.24	67.94	16.71		80.0	
10510-AAC	LTE-TDD (SC-FDMA, 100% RB, 15 MHz, 16-QAM, UL Subframe=2,3,4,7,8,9)	X	2.84	65.59	15.48	2.23	80.0	± 9.6 %
		Y	3.55	67.42	17.00		80.0	
		Z	3.41	66.05	16.23		80.0	
10511-AAC	LTE-TDD (SC-FDMA, 100% RB, 15 MHz, 64-QAM, UL Subframe=2,3,4,7,8,9)	X	2.92	65.56	15.46	2.23	80.0	± 9.6 %
		Y	3.62	67.28	16.95		80.0	
		Z	3.49	65.96	16.22		80.0	
10512-AAC	LTE-TDD (SC-FDMA, 100% RB, 20 MHz, QPSK, UL Subframe=2,3,4,7,8,9)	X	2.57	67.43	16.22	2.23	80.0	± 9.6 %
		Y	3.65	71.51	18.37		80.0	
		Z	3.23	68.73	16.92		80.0	
10513-AAC	LTE-TDD (SC-FDMA, 100% RB, 20 MHz, 16-QAM, UL Subframe=2,3,4,7,8,9)	X	2.79	65.51	15.59	2.23	80.0	± 9.6 %
		Y	3.45	67.50	17.07		80.0	
		Z	3.30	66.08	16.26		80.0	
10514-AAC	LTE-TDD (SC-FDMA, 100% RB, 20 MHz, 64-QAM, UL Subframe=2,3,4,7,8,9)	X	2.87	65.41	15.56	2.23	80.0	± 9.6 %
		Y	3.50	67.18	16.96		80.0	
		Z	3.36	65.86	16.21		80.0	
10515-AAA	IEEE 802.11b WiFi 2.4 GHz (DSSS, 2 Mbps, 99pc duty cycle)	X	0.84	63.77	14.11	0.00	150.0	± 9.6 %
		Y	1.02	65.86	16.61		150.0	
		Z	0.85	62.40	13.77		150.0	
10516-AAA	IEEE 802.11b WiFi 2.4 GHz (DSSS, 5.5 Mbps, 99pc duty cycle)	X	0.62	73.89	17.55	0.00	150.0	± 9.6 %
		Y	4.44	111.45	33.24		150.0	
		Z	0.45	67.70	14.48		150.0	
10517-AAA	IEEE 802.11b WiFi 2.4 GHz (DSSS, 11 Mbps, 99pc duty cycle)	X	0.68	65.50	14.61	0.00	150.0	± 9.6 %
		Y	0.96	70.28	18.66		150.0	
		Z	0.68	63.72	13.93		150.0	
10518-AAB	IEEE 802.11a/h WiFi 5 GHz (OFDM, 9 Mbps, 99pc duty cycle)	X	3.70	67.39	15.82	0.00	150.0	± 9.6 %
		Y	4.26	67.62	16.61		150.0	
		Z	4.17	66.58	15.96		150.0	
10519-AAB	IEEE 802.11a/h WiFi 5 GHz (OFDM, 12 Mbps, 99pc duty cycle)	X	3.79	67.51	15.88	0.00	150.0	± 9.6 %
		Y	4.38	67.73	16.67		150.0	
		Z	4.31	66.74	16.05		150.0	
10520-AAB	IEEE 802.11a/h WiFi 5 GHz (OFDM, 18 Mbps, 99pc duty cycle)	X	3.65	67.31	15.75	0.00	150.0	± 9.6 %
		Y	4.25	67.68	16.61		150.0	
		Z	4.16	66.65	15.95		150.0	
10521-AAB	IEEE 802.11a/h WiFi 5 GHz (OFDM, 24 Mbps, 99pc duty cycle)	X	3.59	67.16	15.66	0.00	150.0	± 9.6 %
		Y	4.18	67.62	16.58		150.0	
		Z	4.10	66.58	15.92		150.0	
10522-AAB	IEEE 802.11a/h WiFi 5 GHz (OFDM, 36 Mbps, 99pc duty cycle)	X	3.61	67.21	15.68	0.00	150.0	± 9.6 %
		Y	4.20	67.65	16.61		150.0	
		Z	4.13	66.67	15.99		150.0	

10523-AAB	IEEE 802.11a/h WiFi 5 GHz (OFDM, 48 Mbps, 99pc duty cycle)	X	3.58	67.41	15.78	0.00	150.0	± 9.6 %
		Y	4.19	67.90	16.68		150.0	
		Z	4.09	66.77	15.97		150.0	
10524-AAB	IEEE 802.11a/h WiFi 5 GHz (OFDM, 54 Mbps, 99pc duty cycle)	X	3.55	67.17	15.73	0.00	150.0	± 9.6 %
		Y	4.18	67.74	16.69		150.0	
		Z	4.09	66.69	16.02		150.0	
10525-AAB	IEEE 802.11ac WiFi (20MHz, MCS0, 99pc duty cycle)	X	3.68	66.62	15.57	0.00	150.0	± 9.6 %
		Y	4.25	66.93	16.35		150.0	
		Z	4.15	65.82	15.66		150.0	
10526-AAB	IEEE 802.11ac WiFi (20MHz, MCS1, 99pc duty cycle)	X	3.72	66.70	15.62	0.00	150.0	± 9.6 %
		Y	4.34	67.14	16.44		150.0	
		Z	4.25	66.06	15.76		150.0	
10527-AAB	IEEE 802.11ac WiFi (20MHz, MCS2, 99pc duty cycle)	X	3.68	66.74	15.58	0.00	150.0	± 9.6 %
		Y	4.29	67.16	16.40		150.0	
		Z	4.18	66.03	15.70		150.0	
10528-AAB	IEEE 802.11ac WiFi (20MHz, MCS3, 99pc duty cycle)	X	3.67	66.65	15.55	0.00	150.0	± 9.6 %
		Y	4.30	67.15	16.42		150.0	
		Z	4.20	66.04	15.73		150.0	
10529-AAB	IEEE 802.11ac WiFi (20MHz, MCS4, 99pc duty cycle)	X	3.67	66.65	15.55	0.00	150.0	± 9.6 %
		Y	4.30	67.15	16.42		150.0	
		Z	4.20	66.04	15.73		150.0	
10531-AAB	IEEE 802.11ac WiFi (20MHz, MCS6, 99pc duty cycle)	X	3.64	66.66	15.53	0.00	150.0	± 9.6 %
		Y	4.25	67.14	16.38		150.0	
		Z	4.15	66.02	15.69		150.0	
10532-AAB	IEEE 802.11ac WiFi (20MHz, MCS7, 99pc duty cycle)	X	3.57	66.55	15.48	0.00	150.0	± 9.6 %
		Y	4.15	67.03	16.34		150.0	
		Z	4.04	65.89	15.62		150.0	
10533-AAB	IEEE 802.11ac WiFi (20MHz, MCS8, 99pc duty cycle)	X	3.68	66.88	15.62	0.00	150.0	± 9.6 %
		Y	4.30	67.28	16.44		150.0	
		Z	4.20	66.13	15.73		150.0	
10534-AAB	IEEE 802.11ac WiFi (40MHz, MCS0, 99pc duty cycle)	X	4.34	66.44	15.93	0.00	150.0	± 9.6 %
		Y	4.85	66.86	16.39		150.0	
		Z	4.79	66.06	15.87		150.0	
10535-AAB	IEEE 802.11ac WiFi (40MHz, MCS1, 99pc duty cycle)	X	4.34	66.46	15.95	0.00	150.0	± 9.6 %
		Y	4.87	66.95	16.44		150.0	
		Z	4.82	66.17	15.93		150.0	
10536-AAB	IEEE 802.11ac WiFi (40MHz, MCS2, 99pc duty cycle)	X	4.25	66.45	15.91	0.00	150.0	± 9.6 %
		Y	4.78	66.98	16.43		150.0	
		Z	4.71	66.14	15.89		150.0	
10537-AAB	IEEE 802.11ac WiFi (40MHz, MCS3, 99pc duty cycle)	X	4.35	66.61	16.01	0.00	150.0	± 9.6 %
		Y	4.86	67.05	16.47		150.0	
		Z	4.80	66.24	15.94		150.0	
10538-AAB	IEEE 802.11ac WiFi (40MHz, MCS4, 99pc duty cycle)	X	4.37	66.44	15.94	0.00	150.0	± 9.6 %
		Y	4.89	66.89	16.42		150.0	
		Z	4.84	66.13	15.93		150.0	
10540-AAB	IEEE 802.11ac WiFi (40MHz, MCS6, 99pc duty cycle)	X	4.31	66.35	15.93	0.00	150.0	± 9.6 %
		Y	4.83	66.86	16.43		150.0	
		Z	4.77	66.08	15.92		150.0	

10541-AAB	IEEE 802.11ac WiFi (40MHz, MCS7, 99pc duty cycle)	X	4.33	66.41	15.92	0.00	150.0	± 9.6 %
		Y	4.83	66.83	16.39		150.0	
		Z	4.77	66.02	15.87		150.0	
10542-AAB	IEEE 802.11ac WiFi (40MHz, MCS8, 99pc duty cycle)	X	4.45	66.54	16.01	0.00	150.0	± 9.6 %
		Y	4.97	66.88	16.43		150.0	
		Z	4.91	66.12	15.94		150.0	
10543-AAB	IEEE 802.11ac WiFi (40MHz, MCS9, 99pc duty cycle)	X	4.48	66.49	16.02	0.00	150.0	± 9.6 %
		Y	5.04	66.97	16.50		150.0	
		Z	5.01	66.28	16.06		150.0	
10544-AAB	IEEE 802.11ac WiFi (80MHz, MCS0, 99pc duty cycle)	X	4.77	66.20	15.88	0.00	150.0	± 9.6 %
		Y	5.21	66.81	16.32		150.0	
		Z	5.15	66.11	15.87		150.0	
10545-AAB	IEEE 802.11ac WiFi (80MHz, MCS1, 99pc duty cycle)	X	4.82	66.41	15.96	0.00	150.0	± 9.6 %
		Y	5.37	67.24	16.50		150.0	
		Z	5.34	66.63	16.10		150.0	
10546-AAB	IEEE 802.11ac WiFi (80MHz, MCS2, 99pc duty cycle)	X	4.77	66.27	15.89	0.00	150.0	± 9.6 %
		Y	5.24	66.91	16.35		150.0	
		Z	5.18	66.22	15.90		150.0	
10547-AAB	IEEE 802.11ac WiFi (80MHz, MCS3, 99pc duty cycle)	X	4.83	66.38	15.95	0.00	150.0	± 9.6 %
		Y	5.36	67.18	16.48		150.0	
		Z	5.31	66.51	16.04		150.0	
10548-AAB	IEEE 802.11ac WiFi (80MHz, MCS4, 99pc duty cycle)	X	4.82	66.54	16.01	0.00	150.0	± 9.6 %
		Y	5.39	67.48	16.61		150.0	
		Z	5.39	66.96	16.24		150.0	
10550-AAB	IEEE 802.11ac WiFi (80MHz, MCS6, 99pc duty cycle)	X	4.79	66.46	16.00	0.00	150.0	± 9.6 %
		Y	5.34	67.29	16.55		150.0	
		Z	5.30	66.62	16.12		150.0	
10551-AAB	IEEE 802.11ac WiFi (80MHz, MCS7, 99pc duty cycle)	X	4.75	66.25	15.87	0.00	150.0	± 9.6 %
		Y	5.21	66.84	16.29		150.0	
		Z	5.16	66.14	15.84		150.0	
10552-AAB	IEEE 802.11ac WiFi (80MHz, MCS8, 99pc duty cycle)	X	4.78	66.50	15.97	0.00	150.0	± 9.6 %
		Y	5.22	66.98	16.36		150.0	
		Z	5.16	66.23	15.88		150.0	
10553-AAB	IEEE 802.11ac WiFi (80MHz, MCS9, 99pc duty cycle)	X	4.79	66.33	15.90	0.00	150.0	± 9.6 %
		Y	5.26	66.86	16.32		150.0	
		Z	5.20	66.16	15.87		150.0	
10554-AAC	IEEE 802.11ac WiFi (160MHz, MCS0, 99pc duty cycle)	X	5.25	66.42	15.95	0.00	150.0	± 9.6 %
		Y	5.65	67.07	16.36		150.0	
		Z	5.60	66.46	15.97		150.0	
10555-AAC	IEEE 802.11ac WiFi (160MHz, MCS1, 99pc duty cycle)	X	5.31	66.63	16.05	0.00	150.0	± 9.6 %
		Y	5.71	67.24	16.43		150.0	
		Z	5.68	66.67	16.06		150.0	
10556-AAC	IEEE 802.11ac WiFi (160MHz, MCS2, 99pc duty cycle)	X	5.32	66.65	16.05	0.00	150.0	± 9.6 %
		Y	5.77	67.42	16.51		150.0	
		Z	5.74	66.86	16.15		150.0	
10557-AAC	IEEE 802.11ac WiFi (160MHz, MCS3, 99pc duty cycle)	X	5.28	66.55	16.01	0.00	150.0	± 9.6 %
		Y	5.72	67.25	16.45		150.0	
		Z	5.67	66.64	16.06		150.0	

10558-AAC	IEEE 802.11ac WiFi (160MHz, MCS4, 99pc duty cycle)	X	5.24	66.46	15.98	0.00	150.0	± 9.6 %
		Y	5.69	67.20	16.44		150.0	
		Z	5.65	66.61	16.06		150.0	
10560-AAC	IEEE 802.11ac WiFi (160MHz, MCS6, 99pc duty cycle)	X	5.28	66.44	16.00	0.00	150.0	± 9.6 %
		Y	5.72	67.18	16.47		150.0	
		Z	5.68	66.60	16.09		150.0	
10561-AAC	IEEE 802.11ac WiFi (160MHz, MCS7, 99pc duty cycle)	X	5.21	66.38	15.99	0.00	150.0	± 9.6 %
		Y	5.66	67.17	16.49		150.0	
		Z	5.63	66.59	16.12		150.0	
10562-AAC	IEEE 802.11ac WiFi (160MHz, MCS8, 99pc duty cycle)	X	5.30	66.67	16.13	0.00	150.0	± 9.6 %
		Y	5.70	67.29	16.55		150.0	
		Z	5.66	66.70	16.17		150.0	
10563-AAC	IEEE 802.11ac WiFi (160MHz, MCS9, 99pc duty cycle)	X	5.57	67.31	16.43	0.00	150.0	± 9.6 %
		Y	5.83	67.40	16.57		150.0	
		Z	5.78	66.77	16.18		150.0	
10564-AAA	IEEE 802.11g WiFi 2.4 GHz (DSSS-OFDM, 9 Mbps, 99pc duty cycle)	X	3.98	67.19	15.91	0.46	150.0	± 9.6 %
		Y	4.54	67.45	16.63		150.0	
		Z	4.49	66.59	16.10		150.0	
10565-AAA	IEEE 802.11g WiFi 2.4 GHz (DSSS-OFDM, 12 Mbps, 99pc duty cycle)	X	4.14	67.73	16.32	0.46	150.0	± 9.6 %
		Y	4.73	67.88	16.97		150.0	
		Z	4.67	67.02	16.44		150.0	
10566-AAA	IEEE 802.11g WiFi 2.4 GHz (DSSS-OFDM, 18 Mbps, 99pc duty cycle)	X	3.97	67.32	16.02	0.46	150.0	± 9.6 %
		Y	4.56	67.66	16.76		150.0	
		Z	4.51	66.79	16.21		150.0	
10567-AAA	IEEE 802.11g WiFi 2.4 GHz (DSSS-OFDM, 24 Mbps, 99pc duty cycle)	X	4.06	67.96	16.56	0.46	150.0	± 9.6 %
		Y	4.62	68.16	17.21		150.0	
		Z	4.55	67.23	16.63		150.0	
10568-AAA	IEEE 802.11g WiFi 2.4 GHz (DSSS-OFDM, 36 Mbps, 99pc duty cycle)	X	3.80	66.64	15.45	0.46	150.0	± 9.6 %
		Y	4.41	67.18	16.36		150.0	
		Z	4.38	66.42	15.88		150.0	
10569-AAA	IEEE 802.11g WiFi 2.4 GHz (DSSS-OFDM, 48 Mbps, 99pc duty cycle)	X	4.07	68.35	16.82	0.46	150.0	± 9.6 %
		Y	4.63	68.53	17.43		150.0	
		Z	4.55	67.52	16.81		150.0	
10570-AAA	IEEE 802.11g WiFi 2.4 GHz (DSSS-OFDM, 54 Mbps, 99pc duty cycle)	X	3.99	67.81	16.52	0.46	150.0	± 9.6 %
		Y	4.60	68.17	17.24		150.0	
		Z	4.53	67.25	16.66		150.0	
10571-AAA	IEEE 802.11b WiFi 2.4 GHz (DSSS, 1 Mbps, 90pc duty cycle)	X	0.93	63.68	14.15	0.46	130.0	± 9.6 %
		Y	1.11	65.62	16.53		130.0	
		Z	0.97	62.81	14.25		130.0	
10572-AAA	IEEE 802.11b WiFi 2.4 GHz (DSSS, 2 Mbps, 90pc duty cycle)	X	0.94	64.27	14.56	0.46	130.0	± 9.6 %
		Y	1.13	66.40	17.03		130.0	
		Z	0.97	63.27	14.57		130.0	
10573-AAA	IEEE 802.11b WiFi 2.4 GHz (DSSS, 5.5 Mbps, 90pc duty cycle)	X	1.10	79.41	19.97	0.46	130.0	± 9.6 %
		Y	29.09	140.84	40.18		130.0	
		Z	0.81	73.52	17.65		130.0	
10574-AAA	IEEE 802.11b WiFi 2.4 GHz (DSSS, 11 Mbps, 90pc duty cycle)	X	1.00	70.10	17.80	0.46	130.0	± 9.6 %
		Y	1.40	75.63	21.83		130.0	
		Z	0.96	67.63	16.92		130.0	

10575-AAA	IEEE 802.11g WiFi 2.4 GHz (DSSS-OFDM, 6 Mbps, 90pc duty cycle)	X	3.74	66.83	15.70	0.46	130.0	± 9.6 %
		Y	4.30	67.12	16.57		130.0	
		Z	4.26	66.31	16.08		130.0	
10576-AAA	IEEE 802.11g WiFi 2.4 GHz (DSSS-OFDM, 9 Mbps, 90pc duty cycle)	X	3.78	67.20	15.91	0.46	130.0	± 9.6 %
		Y	4.34	67.41	16.71		130.0	
		Z	4.29	66.55	16.18		130.0	
10577-AAA	IEEE 802.11g WiFi 2.4 GHz (DSSS-OFDM, 12 Mbps, 90pc duty cycle)	X	3.89	67.42	16.06	0.46	130.0	± 9.6 %
		Y	4.48	67.61	16.83		130.0	
		Z	4.44	66.77	16.33		130.0	
10578-AAA	IEEE 802.11g WiFi 2.4 GHz (DSSS-OFDM, 18 Mbps, 90pc duty cycle)	X	3.83	67.60	16.23	0.46	130.0	± 9.6 %
		Y	4.40	67.82	17.00		130.0	
		Z	4.35	66.92	16.45		130.0	
10579-AAA	IEEE 802.11g WiFi 2.4 GHz (DSSS-OFDM, 24 Mbps, 90pc duty cycle)	X	3.51	66.09	15.01	0.46	130.0	± 9.6 %
		Y	4.12	66.74	16.08		130.0	
		Z	4.09	65.97	15.60		130.0	
10580-AAA	IEEE 802.11g WiFi 2.4 GHz (DSSS-OFDM, 36 Mbps, 90pc duty cycle)	X	3.49	65.97	14.89	0.46	130.0	± 9.6 %
		Y	4.12	66.69	16.03		130.0	
		Z	4.11	65.99	15.59		130.0	
10581-AAA	IEEE 802.11g WiFi 2.4 GHz (DSSS-OFDM, 48 Mbps, 90pc duty cycle)	X	3.74	67.63	16.20	0.46	130.0	± 9.6 %
		Y	4.33	67.99	17.02		130.0	
		Z	4.26	67.01	16.43		130.0	
10582-AAA	IEEE 802.11g WiFi 2.4 GHz (DSSS-OFDM, 54 Mbps, 90pc duty cycle)	X	3.37	65.61	14.64	0.46	130.0	± 9.6 %
		Y	4.03	66.45	15.82		130.0	
		Z	4.01	65.72	15.36		130.0	
10583-AAB	IEEE 802.11a/h WiFi 5 GHz (OFDM, 6 Mbps, 90pc duty cycle)	X	3.74	66.83	15.70	0.46	130.0	± 9.6 %
		Y	4.30	67.12	16.57		130.0	
		Z	4.26	66.31	16.08		130.0	
10584-AAB	IEEE 802.11a/h WiFi 5 GHz (OFDM, 9 Mbps, 90pc duty cycle)	X	3.78	67.20	15.91	0.46	130.0	± 9.6 %
		Y	4.34	67.41	16.71		130.0	
		Z	4.29	66.55	16.18		130.0	
10585-AAB	IEEE 802.11a/h WiFi 5 GHz (OFDM, 12 Mbps, 90pc duty cycle)	X	3.89	67.42	16.06	0.46	130.0	± 9.6 %
		Y	4.48	67.61	16.83		130.0	
		Z	4.44	66.77	16.33		130.0	
10586-AAB	IEEE 802.11a/h WiFi 5 GHz (OFDM, 18 Mbps, 90pc duty cycle)	X	3.83	67.60	16.23	0.46	130.0	± 9.6 %
		Y	4.40	67.82	17.00		130.0	
		Z	4.35	66.92	16.45		130.0	
10587-AAB	IEEE 802.11a/h WiFi 5 GHz (OFDM, 24 Mbps, 90pc duty cycle)	X	3.51	66.09	15.01	0.46	130.0	± 9.6 %
		Y	4.12	66.74	16.08		130.0	
		Z	4.09	65.97	15.60		130.0	
10588-AAB	IEEE 802.11a/h WiFi 5 GHz (OFDM, 36 Mbps, 90pc duty cycle)	X	3.49	65.97	14.89	0.46	130.0	± 9.6 %
		Y	4.12	66.69	16.03		130.0	
		Z	4.11	65.99	15.59		130.0	
10589-AAB	IEEE 802.11a/h WiFi 5 GHz (OFDM, 48 Mbps, 90pc duty cycle)	X	3.74	67.63	16.20	0.46	130.0	± 9.6 %
		Y	4.33	67.99	17.02		130.0	
		Z	4.26	67.01	16.43		130.0	
10590-AAB	IEEE 802.11a/h WiFi 5 GHz (OFDM, 54 Mbps, 90pc duty cycle)	X	3.37	65.61	14.64	0.46	130.0	± 9.6 %
		Y	4.03	66.45	15.82		130.0	
		Z	4.01	65.72	15.36		130.0	

10591-AAB	IEEE 802.11n (HT Mixed, 20MHz, MCS0, 90pc duty cycle)	X	3.91	67.05	15.98	0.46	130.0	± 9.6 %
		Y	4.46	67.24	16.72		130.0	
		Z	4.42	66.45	16.24		130.0	
10592-AAB	IEEE 802.11n (HT Mixed, 20MHz, MCS1, 90pc duty cycle)	X	3.96	67.20	16.07	0.46	130.0	± 9.6 %
		Y	4.56	67.49	16.83		130.0	
		Z	4.52	66.71	16.36		130.0	
10593-AAB	IEEE 802.11n (HT Mixed, 20MHz, MCS2, 90pc duty cycle)	X	3.89	67.09	15.91	0.46	130.0	± 9.6 %
		Y	4.48	67.36	16.68		130.0	
		Z	4.44	66.57	16.20		130.0	
10594-AAB	IEEE 802.11n (HT Mixed, 20MHz, MCS3, 90pc duty cycle)	X	3.93	67.20	16.06	0.46	130.0	± 9.6 %
		Y	4.53	67.56	16.87		130.0	
		Z	4.50	66.76	16.38		130.0	
10595-AAB	IEEE 802.11n (HT Mixed, 20MHz, MCS4, 90pc duty cycle)	X	3.88	67.15	15.95	0.46	130.0	± 9.6 %
		Y	4.50	67.54	16.78		130.0	
		Z	4.46	66.73	16.29		130.0	
10596-AAB	IEEE 802.11n (HT Mixed, 20MHz, MCS5, 90pc duty cycle)	X	3.78	66.88	15.82	0.46	130.0	± 9.6 %
		Y	4.41	67.44	16.74		130.0	
		Z	4.38	66.66	16.26		130.0	
10597-AAB	IEEE 802.11n (HT Mixed, 20MHz, MCS6, 90pc duty cycle)	X	3.79	66.92	15.72	0.46	130.0	± 9.6 %
		Y	4.37	67.31	16.57		130.0	
		Z	4.34	66.51	16.09		130.0	
10598-AAB	IEEE 802.11n (HT Mixed, 20MHz, MCS7, 90pc duty cycle)	X	3.85	67.45	16.19	0.46	130.0	± 9.6 %
		Y	4.40	67.66	16.93		130.0	
		Z	4.34	66.79	16.40		130.0	
10599-AAB	IEEE 802.11n (HT Mixed, 40MHz, MCS0, 90pc duty cycle)	X	4.79	67.73	16.77	0.46	130.0	± 9.6 %
		Y	5.21	67.73	17.04		130.0	
		Z	5.16	67.02	16.62		130.0	
10600-AAB	IEEE 802.11n (HT Mixed, 40MHz, MCS1, 90pc duty cycle)	X	4.68	67.39	16.57	0.46	130.0	± 9.6 %
		Y	5.21	67.78	17.04		130.0	
		Z	5.26	67.42	16.79		130.0	
10601-AAB	IEEE 802.11n (HT Mixed, 40MHz, MCS2, 90pc duty cycle)	X	4.64	67.32	16.56	0.46	130.0	± 9.6 %
		Y	5.18	67.81	17.08		130.0	
		Z	5.18	67.25	16.73		130.0	
10602-AAB	IEEE 802.11n (HT Mixed, 40MHz, MCS3, 90pc duty cycle)	X	4.63	67.06	16.35	0.46	130.0	± 9.6 %
		Y	5.19	67.55	16.86		130.0	
		Z	5.23	67.15	16.59		130.0	
10603-AAB	IEEE 802.11n (HT Mixed, 40MHz, MCS4, 90pc duty cycle)	X	4.68	67.32	16.65	0.46	130.0	± 9.6 %
		Y	5.23	67.74	17.10		130.0	
		Z	5.27	67.35	16.84		130.0	
10604-AAB	IEEE 802.11n (HT Mixed, 40MHz, MCS5, 90pc duty cycle)	X	4.64	67.04	16.46	0.46	130.0	± 9.6 %
		Y	5.12	67.34	16.87		130.0	
		Z	5.13	66.84	16.55		130.0	
10605-AAB	IEEE 802.11n (HT Mixed, 40MHz, MCS6, 90pc duty cycle)	X	4.61	67.01	16.45	0.46	130.0	± 9.6 %
		Y	5.17	67.54	16.97		130.0	
		Z	5.21	67.15	16.70		130.0	
10606-AAB	IEEE 802.11n (HT Mixed, 40MHz, MCS7, 90pc duty cycle)	X	4.52	66.73	16.13	0.46	130.0	± 9.6 %
		Y	5.04	67.22	16.65		130.0	
		Z	5.04	66.71	16.33		130.0	

10607-AAB	IEEE 802.11ac WiFi (20MHz, MCS0, 90pc duty cycle)	X	3.77	66.40	15.66	0.46	130.0	± 9.6 %
		Y	4.33	66.69	16.43		130.0	
		Z	4.27	65.78	15.88		130.0	
10608-AAB	IEEE 802.11ac WiFi (20MHz, MCS1, 90pc duty cycle)	X	3.82	66.54	15.73	0.46	130.0	± 9.6 %
		Y	4.44	66.96	16.55		130.0	
		Z	4.38	66.06	16.01		130.0	
10609-AAB	IEEE 802.11ac WiFi (20MHz, MCS2, 90pc duty cycle)	X	3.73	66.35	15.52	0.46	130.0	± 9.6 %
		Y	4.34	66.78	16.36		130.0	
		Z	4.28	65.87	15.81		130.0	
10610-AAB	IEEE 802.11ac WiFi (20MHz, MCS3, 90pc duty cycle)	X	3.78	66.52	15.70	0.46	130.0	± 9.6 %
		Y	4.40	66.99	16.56		130.0	
		Z	4.34	66.07	16.00		130.0	
10611-AAB	IEEE 802.11ac WiFi (20MHz, MCS4, 90pc duty cycle)	X	3.70	66.30	15.52	0.46	130.0	± 9.6 %
		Y	4.30	66.73	16.37		130.0	
		Z	4.25	65.83	15.82		130.0	
10612-AAB	IEEE 802.11ac WiFi (20MHz, MCS5, 90pc duty cycle)	X	3.61	66.09	15.37	0.46	130.0	± 9.6 %
		Y	4.27	66.79	16.38		130.0	
		Z	4.22	65.92	15.84		130.0	
10613-AAB	IEEE 802.11ac WiFi (20MHz, MCS6, 90pc duty cycle)	X	3.64	66.03	15.27	0.46	130.0	± 9.6 %
		Y	4.27	66.59	16.20		130.0	
		Z	4.22	65.72	15.67		130.0	
10614-AAB	IEEE 802.11ac WiFi (20MHz, MCS7, 90pc duty cycle)	X	3.70	66.56	15.73	0.46	130.0	± 9.6 %
		Y	4.27	66.95	16.54		130.0	
		Z	4.20	66.00	15.96		130.0	
10615-AAB	IEEE 802.11ac WiFi (20MHz, MCS8, 90pc duty cycle)	X	3.64	65.99	15.16	0.46	130.0	± 9.6 %
		Y	4.28	66.52	16.09		130.0	
		Z	4.23	65.64	15.56		130.0	
10616-AAB	IEEE 802.11ac WiFi (40MHz, MCS0, 90pc duty cycle)	X	4.45	66.34	16.08	0.46	130.0	± 9.6 %
		Y	4.95	66.71	16.53		130.0	
		Z	4.93	66.07	16.13		130.0	
10617-AAB	IEEE 802.11ac WiFi (40MHz, MCS1, 90pc duty cycle)	X	4.43	66.27	16.03	0.46	130.0	± 9.6 %
		Y	4.97	66.78	16.54		130.0	
		Z	4.96	66.18	16.16		130.0	
10618-AAB	IEEE 802.11ac WiFi (40MHz, MCS2, 90pc duty cycle)	X	4.37	66.39	16.11	0.46	130.0	± 9.6 %
		Y	4.90	66.88	16.61		130.0	
		Z	4.86	66.19	16.18		130.0	
10619-AAB	IEEE 802.11ac WiFi (40MHz, MCS3, 90pc duty cycle)	X	4.42	66.32	16.00	0.46	130.0	± 9.6 %
		Y	4.94	66.79	16.49		130.0	
		Z	4.93	66.18	16.10		130.0	
10620-AAB	IEEE 802.11ac WiFi (40MHz, MCS4, 90pc duty cycle)	X	4.43	66.13	15.93	0.46	130.0	± 9.6 %
		Y	4.96	66.62	16.45		130.0	
		Z	4.96	66.05	16.09		130.0	
10621-AAB	IEEE 802.11ac WiFi (40MHz, MCS5, 90pc duty cycle)	X	4.50	66.48	16.27	0.46	130.0	± 9.6 %
		Y	5.00	66.84	16.69		130.0	
		Z	4.97	66.18	16.29		130.0	
10622-AAB	IEEE 802.11ac WiFi (40MHz, MCS6, 90pc duty cycle)	X	4.46	66.43	16.25	0.46	130.0	± 9.6 %
		Y	4.98	66.91	16.73		130.0	
		Z	4.96	66.27	16.33		130.0	

10623-AAB	IEEE 802.11ac WiFi (40MHz, MCS7, 90pc duty cycle)	X	4.39	66.10	15.89	0.46	130.0	± 9.6 %
		Y	4.89	66.49	16.36		130.0	
		Z	4.86	65.84	15.96		130.0	
10624-AAB	IEEE 802.11ac WiFi (40MHz, MCS8, 90pc duty cycle)	X	4.54	66.35	16.10	0.46	130.0	± 9.6 %
		Y	5.06	66.70	16.53		130.0	
		Z	5.05	66.11	16.17		130.0	
10625-AAB	IEEE 802.11ac WiFi (40MHz, MCS9, 90pc duty cycle)	X	4.65	66.63	16.32	0.46	130.0	± 9.6 %
		Y	5.15	66.88	16.69		130.0	
		Z	5.16	66.34	16.36		130.0	
10626-AAB	IEEE 802.11ac WiFi (80MHz, MCS0, 90pc duty cycle)	X	4.87	66.09	16.03	0.46	130.0	± 9.6 %
		Y	5.31	66.64	16.44		130.0	
		Z	5.28	66.07	16.09		130.0	
10627-AAB	IEEE 802.11ac WiFi (80MHz, MCS1, 90pc duty cycle)	X	4.96	66.39	16.17	0.46	130.0	± 9.6 %
		Y	5.52	67.25	16.73		130.0	
		Z	5.53	66.80	16.43		130.0	
10628-AAB	IEEE 802.11ac WiFi (80MHz, MCS2, 90pc duty cycle)	X	4.83	65.96	15.85	0.46	130.0	± 9.6 %
		Y	5.28	66.56	16.30		130.0	
		Z	5.27	66.03	15.96		130.0	
10629-AAB	IEEE 802.11ac WiFi (80MHz, MCS3, 90pc duty cycle)	X	4.89	66.11	15.93	0.46	130.0	± 9.6 %
		Y	5.45	66.99	16.52		130.0	
		Z	5.45	66.49	16.20		130.0	
10630-AAB	IEEE 802.11ac WiFi (80MHz, MCS4, 90pc duty cycle)	X	4.94	66.47	16.13	0.46	130.0	± 9.6 %
		Y	5.52	67.40	16.73		130.0	
		Z	5.58	67.09	16.50		130.0	
10631-AAB	IEEE 802.11ac WiFi (80MHz, MCS5, 90pc duty cycle)	X	5.04	67.01	16.63	0.46	130.0	± 9.6 %
		Y	5.56	67.66	17.07		130.0	
		Z	5.56	67.16	16.74		130.0	
10632-AAB	IEEE 802.11ac WiFi (80MHz, MCS6, 90pc duty cycle)	X	5.02	66.85	16.55	0.46	130.0	± 9.6 %
		Y	5.59	67.70	17.10		130.0	
		Z	5.59	67.18	16.77		130.0	
10633-AAB	IEEE 802.11ac WiFi (80MHz, MCS7, 90pc duty cycle)	X	4.86	66.17	16.01	0.46	130.0	± 9.6 %
		Y	5.30	66.64	16.39		130.0	
		Z	5.27	66.07	16.03		130.0	
10634-AAB	IEEE 802.11ac WiFi (80MHz, MCS8, 90pc duty cycle)	X	4.95	66.64	16.30	0.46	130.0	± 9.6 %
		Y	5.35	66.92	16.58		130.0	
		Z	5.32	66.32	16.21		130.0	
10635-AAB	IEEE 802.11ac WiFi (80MHz, MCS9, 90pc duty cycle)	X	4.70	65.44	15.34	0.46	130.0	± 9.6 %
		Y	5.17	66.01	15.82		130.0	
		Z	5.16	65.50	15.50		130.0	
10636-AAC	IEEE 802.11ac WiFi (160MHz, MCS0, 90pc duty cycle)	X	5.37	66.35	16.11	0.46	130.0	± 9.6 %
		Y	5.75	66.94	16.50		130.0	
		Z	5.74	66.45	16.20		130.0	
10637-AAC	IEEE 802.11ac WiFi (160MHz, MCS1, 90pc duty cycle)	X	5.47	66.68	16.28	0.46	130.0	± 9.6 %
		Y	5.84	67.17	16.61		130.0	
		Z	5.85	66.75	16.34		130.0	
10638-AAC	IEEE 802.11ac WiFi (160MHz, MCS2, 90pc duty cycle)	X	5.45	66.60	16.21	0.46	130.0	± 9.6 %
		Y	5.91	67.37	16.68		130.0	
		Z	5.90	66.89	16.39		130.0	

10639-AAC	IEEE 802.11ac WiFi (160MHz, MCS3, 90pc duty cycle)	X	5.40	66.48	16.20	0.46	130.0	± 9.6 %
		Y	5.83	67.15	16.61		130.0	
		Z	5.82	66.67	16.32		130.0	
10640-AAC	IEEE 802.11ac WiFi (160MHz, MCS4, 90pc duty cycle)	X	5.32	66.22	15.99	0.46	130.0	± 9.6 %
		Y	5.75	66.89	16.42		130.0	
		Z	5.75	66.45	16.15		130.0	
10641-AAC	IEEE 802.11ac WiFi (160MHz, MCS5, 90pc duty cycle)	X	5.45	66.45	16.13	0.46	130.0	± 9.6 %
		Y	5.88	67.07	16.54		130.0	
		Z	5.90	66.70	16.30		130.0	
10642-AAC	IEEE 802.11ac WiFi (160MHz, MCS6, 90pc duty cycle)	X	5.46	66.60	16.39	0.46	130.0	± 9.6 %
		Y	5.90	67.28	16.81		130.0	
		Z	5.89	66.80	16.53		130.0	
10643-AAC	IEEE 802.11ac WiFi (160MHz, MCS7, 90pc duty cycle)	X	5.28	66.13	16.00	0.46	130.0	± 9.6 %
		Y	5.73	66.91	16.51		130.0	
		Z	5.74	66.48	16.24		130.0	
10644-AAC	IEEE 802.11ac WiFi (160MHz, MCS8, 90pc duty cycle)	X	5.42	66.58	16.26	0.46	130.0	± 9.6 %
		Y	5.78	67.08	16.62		130.0	
		Z	5.78	66.62	16.33		130.0	
10645-AAC	IEEE 802.11ac WiFi (160MHz, MCS9, 90pc duty cycle)	X	5.81	67.58	16.73	0.46	130.0	± 9.6 %
		Y	5.91	67.16	16.62		130.0	
		Z	5.93	66.77	16.38		130.0	
10646-AAD	LTE-TDD (SC-FDMA, 1 RB, 5 MHz, QPSK, UL Subframe=2,7)	X	2.64	72.38	24.11	9.30	60.0	± 9.6 %
		Y	4.60	84.41	29.31		60.0	
		Z	4.84	83.41	28.63		60.0	
10647-AAC	LTE-TDD (SC-FDMA, 1 RB, 20 MHz, QPSK, UL Subframe=2,7)	X	2.46	71.01	23.55	9.30	60.0	± 9.6 %
		Y	4.04	81.81	28.38		60.0	
		Z	4.35	81.42	27.96		60.0	
10648-AAA	CDMA2000 (1x Advanced)	X	2.44	155.88	0.83	0.00	150.0	± 9.6 %
		Y	0.35	60.28	6.28		150.0	
		Z	0.35	60.00	5.54		150.0	
10652-AAB	LTE-TDD (OFDMA, 5 MHz, E-TM 3.1, Clipping 44%)	X	2.08	63.49	12.30	2.23	80.0	± 9.6 %
		Y	3.15	67.39	16.19		80.0	
		Z	2.91	65.29	15.14		80.0	
10653-AAB	LTE-TDD (OFDMA, 10 MHz, E-TM 3.1, Clipping 44%)	X	3.02	65.17	14.89	2.23	80.0	± 9.6 %
		Y	3.64	66.22	16.46		80.0	
		Z	3.52	64.96	15.78		80.0	
10654-AAB	LTE-TDD (OFDMA, 15 MHz, E-TM 3.1, Clipping 44%)	X	3.20	64.95	15.39	2.23	80.0	± 9.6 %
		Y	3.67	65.70	16.49		80.0	
		Z	3.57	64.61	15.88		80.0	
10655-AAB	LTE-TDD (OFDMA, 20 MHz, E-TM 3.1, Clipping 44%)	X	3.35	64.77	15.59	2.23	80.0	± 9.6 %
		Y	3.76	65.50	16.51		80.0	
		Z	3.66	64.52	15.94		80.0	
10658-AAA	Pulse Waveform (200Hz, 10%)	X	2.01	62.76	7.94	10.00	50.0	± 9.6 %
		Y	2.58	65.57	9.73		50.0	
		Z	3.05	67.26	11.01		50.0	
10659-AAA	Pulse Waveform (200Hz, 20%)	X	0.84	60.00	5.36	6.99	60.0	± 9.6 %
		Y	1.33	63.54	7.82		60.0	
		Z	1.53	64.53	8.66		60.0	

10660-AAA	Pulse Waveform (200Hz, 40%)	X	0.39	60.00	3.98	3.98	80.0	± 9.6 %
		Y	0.54	61.57	5.88		80.0	
		Z	0.45	60.00	5.04		80.0	
10661-AAA	Pulse Waveform (200Hz, 60%)	X	17.64	60.43	1.44	2.22	100.0	± 9.6 %
		Y	0.23	60.00	4.28		100.0	
		Z	0.25	60.00	3.48		100.0	
10662-AAA	Pulse Waveform (200Hz, 80%)	X	0.00	84.91	40.93	0.97	120.0	± 9.6 %
		Y	49.30	1078.61	357.44		120.0	
		Z	0.03	139.18	4.12		120.0	

^E Uncertainty is determined using the max. deviation from linear response applying rectangular distribution and is expressed for the square of the field value.



Accredited by the Swiss Accreditation Service (SAS)
The Swiss Accreditation Service is one of the signatories to the EA
Multilateral Agreement for the recognition of calibration certificates

Accreditation No.: **SCS 0108**

Client **PC Test**

Certificate No: **EX3-7406_May18**

CALIBRATION CERTIFICATE

Object: **EX3DV4 - SN:7406**

Calibration procedure(s): **QA CAL-01.v9, QA CAL-12.v9, QA CAL-23.v5, QA CAL-25.v6
Calibration procedure for dosimetric E-field probes**

Calibration date: **May 22, 2018**

*BNV
06-25-2018*

This calibration certificate documents the traceability to national standards, which realize the physical units of measurements (SI).
The measurements and the uncertainties with confidence probability are given on the following pages and are part of the certificate.

All calibrations have been conducted in the closed laboratory facility: environment temperature (22 ± 3)°C and humidity < 70%.

Calibration Equipment used (M&TE critical for calibration)

Primary Standards	ID	Cal Date (Certificate No.)	Scheduled Calibration
Power meter NRP	SN: 104778	04-Apr-18 (No. 217-02672/02673)	Apr-19
Power sensor NRP-Z91	SN: 103244	04-Apr-18 (No. 217-02672)	Apr-19
Power sensor NRP-Z91	SN: 103245	04-Apr-18 (No. 217-02673)	Apr-19
Reference 20 dB Attenuator	SN: S5277 (20x)	04-Apr-18 (No. 217-02682)	Apr-19
Reference Probe ES3DV2	SN: 3013	30-Dec-17 (No. ES3-3013_Dec17)	Dec-18
DAE4	SN: 660	21-Dec-17 (No. DAE4-660_Dec17)	Dec-18
Secondary Standards	ID	Check Date (in house)	Scheduled Check
Power meter E4419B	SN: GB41293874	06-Apr-16 (in house check Jun-16)	In house check: Jun-18
Power sensor E4412A	SN: MY41498087	06-Apr-16 (in house check Jun-16)	In house check: Jun-18
Power sensor E4412A	SN: 000110210	06-Apr-16 (in house check Jun-16)	In house check: Jun-18
RF generator HP 8648C	SN: US3642U01700	04-Aug-99 (in house check Jun-16)	In house check: Jun-18
Network Analyzer HP 8753E	SN: US37390585	18-Oct-01 (in house check Oct-17)	In house check: Oct-18

	Name	Function	Signature
Calibrated by:	Jeton Kastrati	Laboratory Technician	
Approved by:	Katja Pokovic	Technical Manager	

Issued: May 22, 2018

This calibration certificate shall not be reproduced except in full without written approval of the laboratory.



Accredited by the Swiss Accreditation Service (SAS)

Accreditation No.: **SCS 0108**

The Swiss Accreditation Service is one of the signatories to the EA
Multilateral Agreement for the recognition of calibration certificates

Glossary:

TSL	tissue simulating liquid
NORM _{x,y,z}	sensitivity in free space
ConvF	sensitivity in TSL / NORM _{x,y,z}
DCP	diode compression point
CF	crest factor (1/duty_cycle) of the RF signal
A, B, C, D	modulation dependent linearization parameters
Polarization φ	φ rotation around probe axis
Polarization ϑ	ϑ rotation around an axis that is in the plane normal to probe axis (at measurement center), i.e., $\vartheta = 0$ is normal to probe axis
Connector Angle	information used in DASY system to align probe sensor X to the robot coordinate system

Calibration is Performed According to the Following Standards:

- IEEE Std 1528-2013, "IEEE Recommended Practice for Determining the Peak Spatial-Averaged Specific Absorption Rate (SAR) in the Human Head from Wireless Communications Devices: Measurement Techniques", June 2013
- IEC 62209-1, "Measurement procedure for the assessment of Specific Absorption Rate (SAR) from hand-held and body-mounted devices used next to the ear (frequency range of 300 MHz to 6 GHz)", July 2016
- IEC 62209-2, "Procedure to determine the Specific Absorption Rate (SAR) for wireless communication devices used in close proximity to the human body (frequency range of 30 MHz to 6 GHz)", March 2010
- KDB 865664, "SAR Measurement Requirements for 100 MHz to 6 GHz"

Methods Applied and Interpretation of Parameters:

- NORM_{x,y,z}**: Assessed for E-field polarization $\vartheta = 0$ ($f \leq 900$ MHz in TEM-cell; $f > 1800$ MHz: R22 waveguide). NORM_{x,y,z} are only intermediate values, i.e., the uncertainties of NORM_{x,y,z} does not affect the E²-field uncertainty inside TSL (see below ConvF).
- NORM(f)_{x,y,z}** = NORM_{x,y,z} * frequency_response (see Frequency Response Chart). This linearization is implemented in DASY4 software versions later than 4.2. The uncertainty of the frequency response is included in the stated uncertainty of ConvF.
- DCP_{x,y,z}**: DCP are numerical linearization parameters assessed based on the data of power sweep with CW signal (no uncertainty required). DCP does not depend on frequency nor media.
- PAR**: PAR is the Peak to Average Ratio that is not calibrated but determined based on the signal characteristics
- A_{x,y,z}; B_{x,y,z}; C_{x,y,z}; D_{x,y,z}; VR_{x,y,z}**: A, B, C, D are numerical linearization parameters assessed based on the data of power sweep for specific modulation signal. The parameters do not depend on frequency nor media. VR is the maximum calibration range expressed in RMS voltage across the diode.
- ConvF and Boundary Effect Parameters**: Assessed in flat phantom using E-field (or Temperature Transfer Standard for $f \leq 800$ MHz) and inside waveguide using analytical field distributions based on power measurements for $f > 800$ MHz. The same setups are used for assessment of the parameters applied for boundary compensation (alpha, depth) of which typical uncertainty values are given. These parameters are used in DASY4 software to improve probe accuracy close to the boundary. The sensitivity in TSL corresponds to NORM_{x,y,z} * ConvF whereby the uncertainty corresponds to that given for ConvF. A frequency dependent ConvF is used in DASY version 4.4 and higher which allows extending the validity from ± 50 MHz to ± 100 MHz.
- Spherical isotropy (3D deviation from isotropy)**: in a field of low gradients realized using a flat phantom exposed by a patch antenna.
- Sensor Offset**: The sensor offset corresponds to the offset of virtual measurement center from the probe tip (on probe axis). No tolerance required.
- Connector Angle**: The angle is assessed using the information gained by determining the NORM_x (no uncertainty required).

Probe EX3DV4

SN:7406

Manufactured: November 24, 2015
Calibrated: May 22, 2018

Calibrated for DASY/EASY Systems
(Note: non-compatible with DASY2 system!)

DASY/EASY - Parameters of Probe: EX3DV4 - SN:7406

Basic Calibration Parameters

	Sensor X	Sensor Y	Sensor Z	Unc (k=2)
Norm ($\mu\text{V}/(\text{V}/\text{m})^2$) ^A	0.47	0.43	0.46	$\pm 10.1 \%$
DCP (mV) ^B	98.8	100.2	97.1	

Modulation Calibration Parameters

UID	Communication System Name		A dB	B dB $\sqrt{\mu\text{V}}$	C	D dB	VR mV	Unc ^E (k=2)
0	CW	X	0.0	0.0	1.0	0.00	159.0	$\pm 3.3 \%$
		Y	0.0	0.0	1.0		176.8	
		Z	0.0	0.0	1.0		172.1	

Note: For details on UID parameters see Appendix.

Sensor Model Parameters

	C1 fF	C2 fF	α V ⁻¹	T1 ms.V ⁻²	T2 ms.V ⁻¹	T3 ms	T4 V ⁻²	T5 V ⁻¹	T6
X	40.51	308.1	36.65	8.462	0.498	5.057	0.000	0.453	1.008
Y	20.79	155.9	36.07	8.177	0.281	5.026	0.312	0.202	1.000
Z	39.96	308.6	37.72	7.122	0.556	5.056	0.094	0.485	1.007

The reported uncertainty of measurement is stated as the standard uncertainty of measurement multiplied by the coverage factor k=2, which for a normal distribution corresponds to a coverage probability of approximately 95%.

^A The uncertainties of Norm X,Y,Z do not affect the E²-field uncertainty inside TSL (see Pages 5 and 6).

^B Numerical linearization parameter: uncertainty not required.

^E Uncertainty is determined using the max. deviation from linear response applying rectangular distribution and is expressed for the square of the field value.

DASY/EASY - Parameters of Probe: EX3DV4 - SN:7406

Calibration Parameter Determined in Head Tissue Simulating Media

f (MHz) ^C	Relative Permittivity ^F	Conductivity (S/m) ^F	ConvF X	ConvF Y	ConvF Z	Alpha ^G	Depth ^G (mm)	Unc (k=2)
30	55.0	0.75	16.52	16.52	16.52	0.00	1.00	± 13.3 %
750	41.9	0.89	10.09	10.09	10.09	0.48	0.90	± 12.0 %
835	41.5	0.90	9.70	9.70	9.70	0.43	0.91	± 12.0 %
1750	40.1	1.37	8.58	8.58	8.58	0.35	0.80	± 12.0 %
1900	40.0	1.40	8.22	8.22	8.22	0.39	0.84	± 12.0 %
2300	39.5	1.67	7.95	7.95	7.95	0.30	0.84	± 12.0 %
2450	39.2	1.80	7.54	7.54	7.54	0.31	0.87	± 12.0 %
2600	39.0	1.96	7.40	7.40	7.40	0.25	0.95	± 12.0 %

^C Frequency validity above 300 MHz of ± 100 MHz only applies for DASY v4.4 and higher (see Page 2), else it is restricted to ± 50 MHz. The uncertainty is the RSS of the ConvF uncertainty at calibration frequency and the uncertainty for the indicated frequency band. Frequency validity below 300 MHz is ± 10, 25, 40, 50 and 70 MHz for ConvF assessments at 30, 64, 128, 150 and 220 MHz respectively. Above 5 GHz frequency validity can be extended to ± 110 MHz.

^F At frequencies below 3 GHz, the validity of tissue parameters (ϵ and σ) can be relaxed to ± 10% if liquid compensation formula is applied to measured SAR values. At frequencies above 3 GHz, the validity of tissue parameters (ϵ and σ) is restricted to ± 5%. The uncertainty is the RSS of the ConvF uncertainty for indicated target tissue parameters.

^G Alpha/Depth are determined during calibration. SPEAG warrants that the remaining deviation due to the boundary effect after compensation is always less than ± 1% for frequencies below 3 GHz and below ± 2% for frequencies between 3-6 GHz at any distance larger than half the probe tip diameter from the boundary.

DASY/EASY - Parameters of Probe: EX3DV4 - SN:7406

Calibration Parameter Determined in Body Tissue Simulating Media

f (MHz) ^C	Relative Permittivity ^F	Conductivity (S/m) ^F	ConvF X	ConvF Y	ConvF Z	Alpha ^G	Depth ^G (mm)	Unc (k=2)
750	55.5	0.96	9.91	9.91	9.91	0.52	0.80	± 12.0 %
835	55.2	0.97	9.61	9.61	9.61	0.52	0.80	± 12.0 %
1750	53.4	1.49	8.04	8.04	8.04	0.43	0.84	± 12.0 %
1900	53.3	1.52	7.74	7.74	7.74	0.39	0.84	± 12.0 %
2300	52.9	1.81	7.46	7.46	7.46	0.41	0.86	± 12.0 %
2450	52.7	1.95	7.30	7.30	7.30	0.43	0.88	± 12.0 %
2600	52.5	2.16	7.27	7.27	7.27	0.33	0.98	± 12.0 %

^C Frequency validity above 300 MHz of ± 100 MHz only applies for DASY v4.4 and higher (see Page 2), else it is restricted to ± 50 MHz. The uncertainty is the RSS of the ConvF uncertainty at calibration frequency and the uncertainty for the indicated frequency band. Frequency validity below 300 MHz is ± 10, 25, 40, 50 and 70 MHz for ConvF assessments at 30, 64, 128, 150 and 220 MHz respectively. Above 5 GHz frequency validity can be extended to ± 110 MHz.

^F At frequencies below 3 GHz, the validity of tissue parameters (ϵ and σ) can be relaxed to ± 10% if liquid compensation formula is applied to measured SAR values. At frequencies above 3 GHz, the validity of tissue parameters (ϵ and σ) is restricted to ± 5%. The uncertainty is the RSS of the ConvF uncertainty for indicated target tissue parameters.

^G Alpha/Depth are determined during calibration. SPEAG warrants that the remaining deviation due to the boundary effect after compensation is always less than ± 1% for frequencies below 3 GHz and below ± 2% for frequencies between 3-6 GHz at any distance larger than half the probe tip diameter from the boundary.

Frequency Response of E-Field (TEM-Cell:ifi110 EXX, Waveguide: R22)

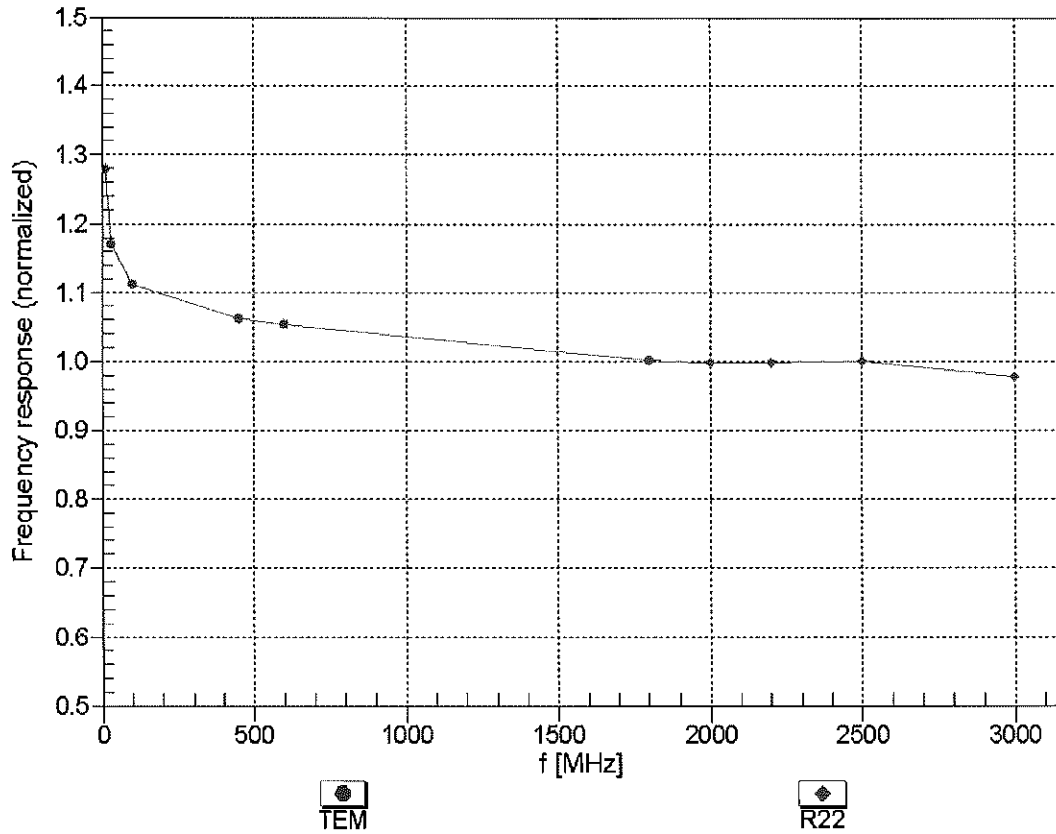

Uncertainty of Frequency Response of E-field: $\pm 6.3\%$ (k=2)

Receiving Pattern (ϕ), $\theta = 0^\circ$

f=600 MHz, TEM

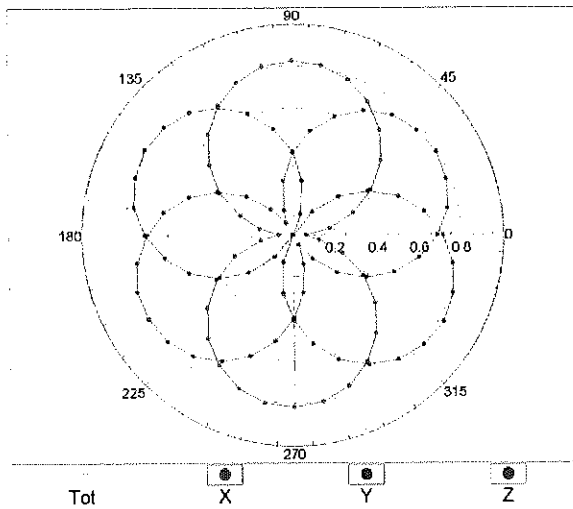

f=1800 MHz, R22

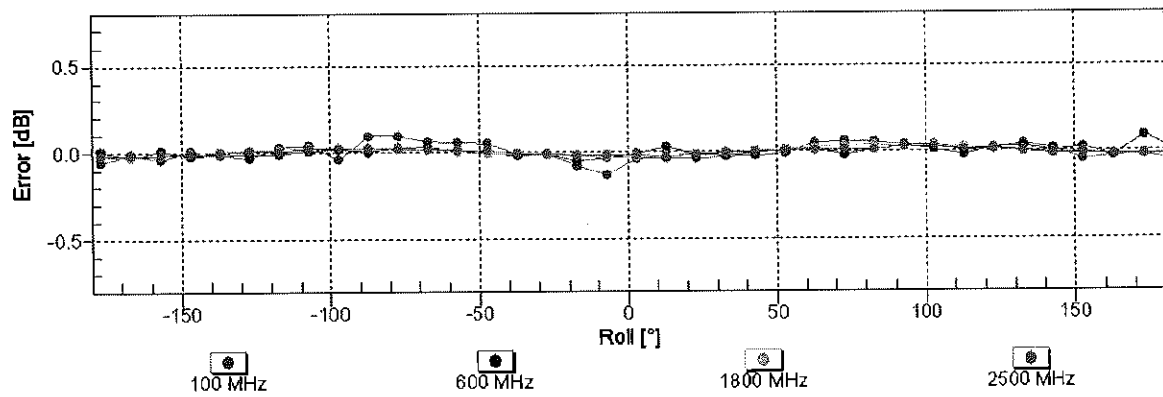
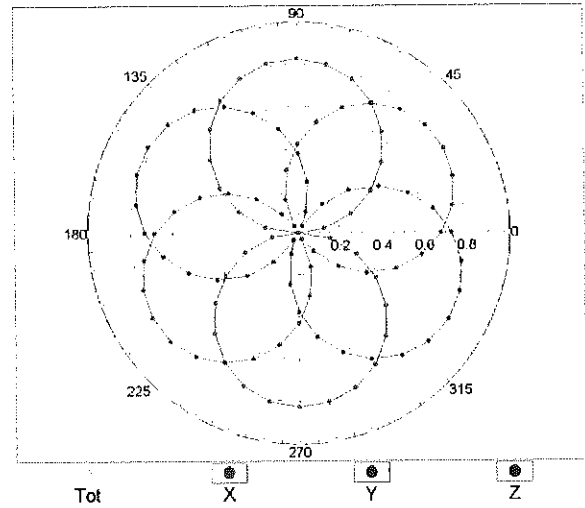

Uncertainty of Axial Isotropy Assessment: $\pm 0.5\%$ ($k=2$)

Dynamic Range $f(SAR_{head})$ (TEM cell , $f_{eval} = 1900$ MHz)

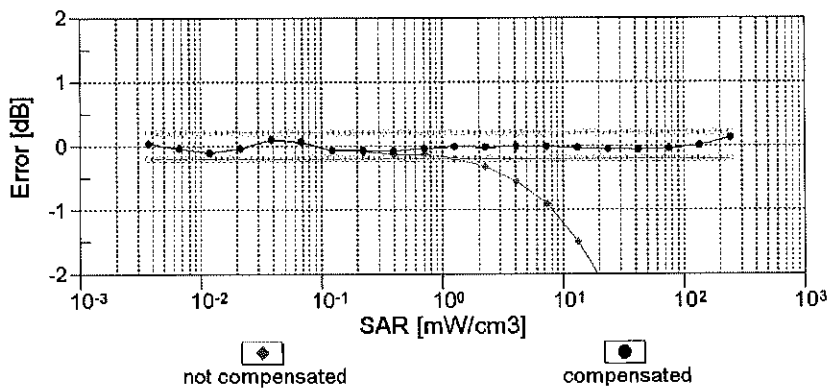
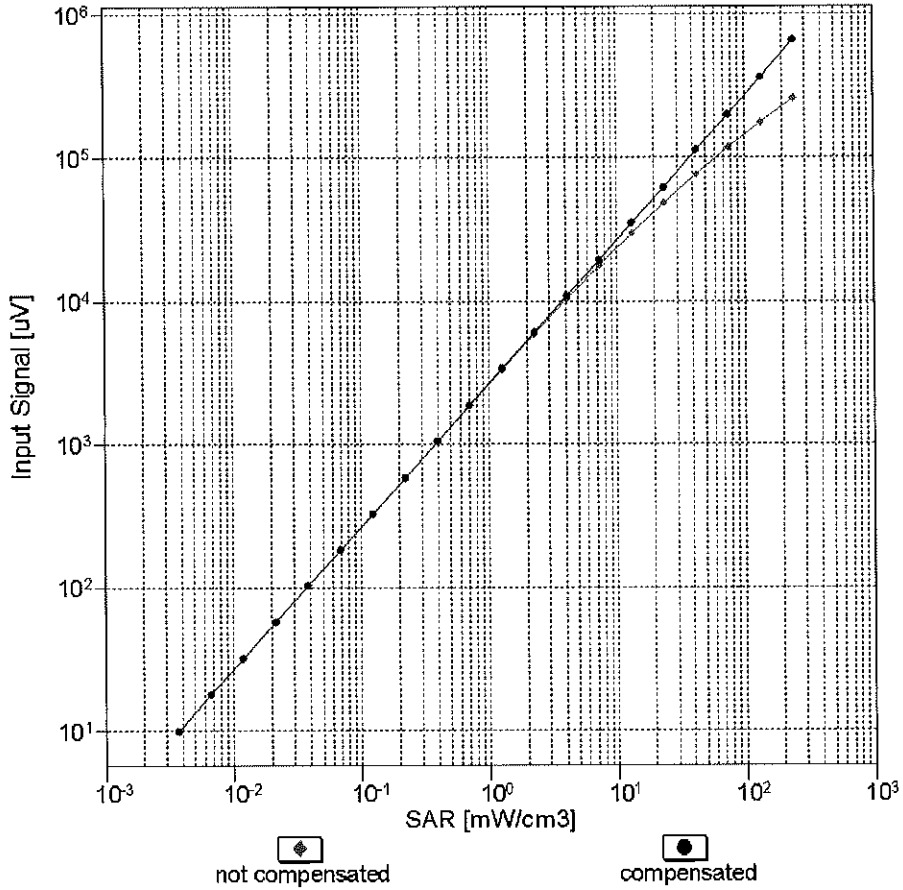

Uncertainty of Linearity Assessment: ± 0.6% (k=2)

Conversion Factor Assessment

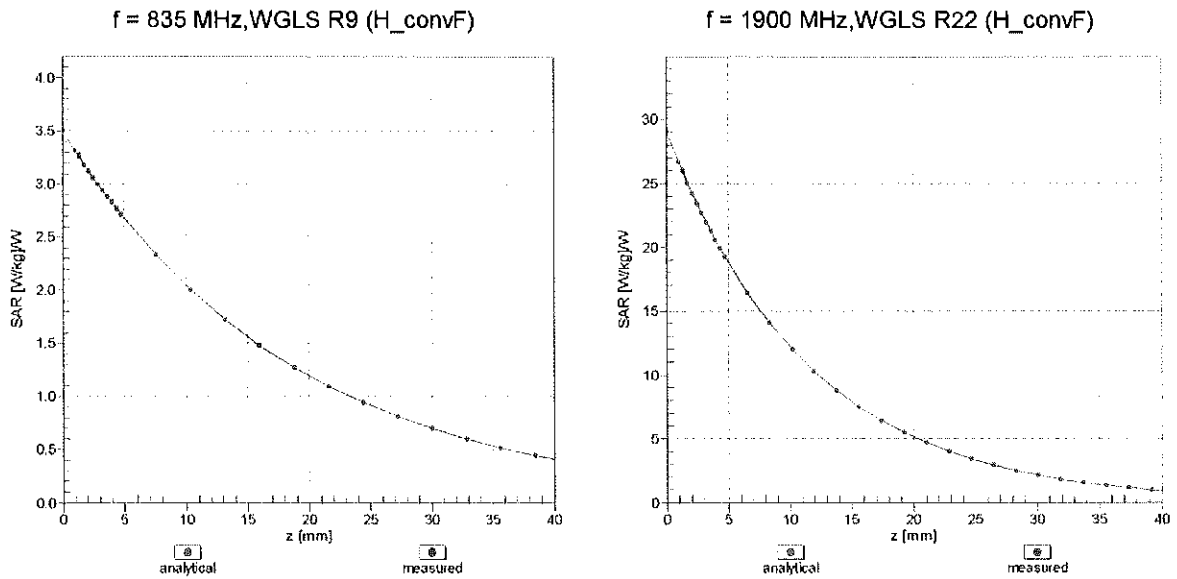

Deviation from Isotropy in Liquid Error (ϕ, θ), f = 900 MHz

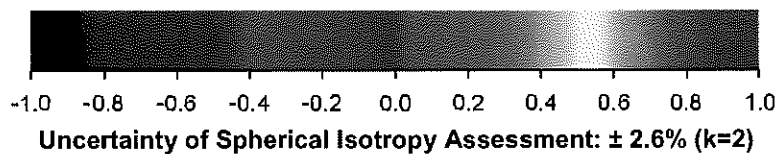
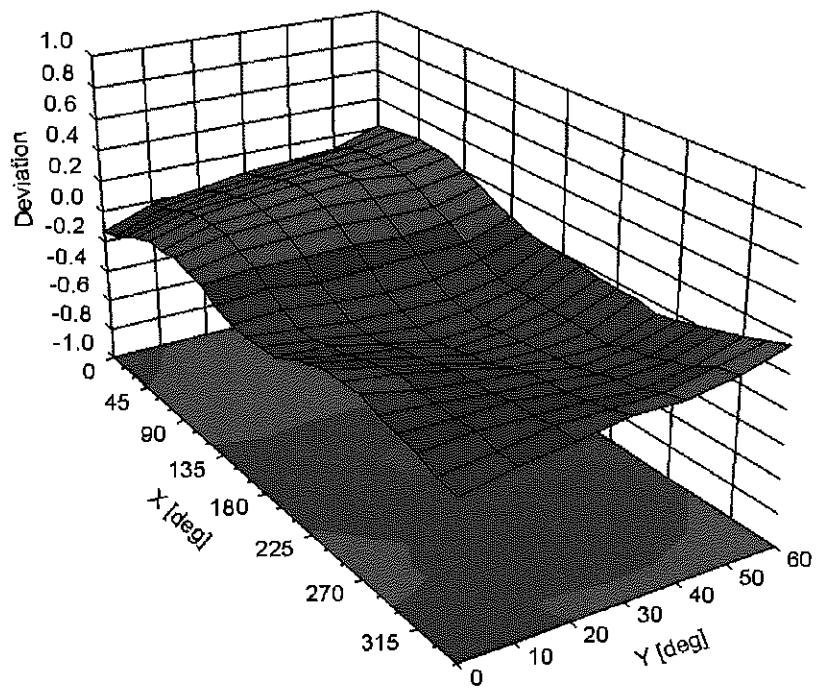

DASY/EASY - Parameters of Probe: EX3DV4 - SN:7406

Other Probe Parameters

Sensor Arrangement	Triangular
Connector Angle (°)	2.9
Mechanical Surface Detection Mode	enabled
Optical Surface Detection Mode	disabled
Probe Overall Length	337 mm
Probe Body Diameter	10 mm
Tip Length	9 mm
Tip Diameter	2.5 mm
Probe Tip to Sensor X Calibration Point	1 mm
Probe Tip to Sensor Y Calibration Point	1 mm
Probe Tip to Sensor Z Calibration Point	1 mm
Recommended Measurement Distance from Surface	1.4 mm

Appendix: Modulation Calibration Parameters

UID	Communication System Name		A dB	B dB $\sqrt{\mu V}$	C	D dB	VR mV	Max Unc ^E (k=2)
0	CW	X	0.00	0.00	1.00	0.00	159.0	$\pm 3.3\%$
		Y	0.00	0.00	1.00		176.8	
		Z	0.00	0.00	1.00		172.1	
10010- CAA	SAR Validation (Square, 100ms, 10ms)	X	2.08	64.96	9.67	10.00	20.0	$\pm 9.6\%$
		Y	1.53	62.37	7.61		20.0	
		Z	1.91	63.93	9.02		20.0	
10011- CAB	UMTS-FDD (WCDMA)	X	0.84	64.72	13.20	0.00	150.0	$\pm 9.6\%$
		Y	2.29	84.03	21.49		150.0	
		Z	0.87	65.77	13.83		150.0	
10012- CAB	IEEE 802.11b WiFi 2.4 GHz (DSSS, 1 Mbps)	X	1.07	62.64	14.17	0.41	150.0	$\pm 9.6\%$
		Y	1.16	66.58	16.90		150.0	
		Z	1.05	62.95	14.54		150.0	
10013- CAB	IEEE 802.11g WiFi 2.4 GHz (DSSS-OFDM, 6 Mbps)	X	4.71	66.44	16.84	1.46	150.0	$\pm 9.6\%$
		Y	4.37	67.68	17.36		150.0	
		Z	4.70	66.50	16.96		150.0	
10021- DAC	GSM-FDD (TDMA, GMSK)	X	100.00	111.67	26.02	9.39	50.0	$\pm 9.6\%$
		Y	100.00	105.88	22.91		50.0	
		Z	100.00	110.56	25.48		50.0	
10023- DAC	GPRS-FDD (TDMA, GMSK, TN 0)	X	100.00	111.18	25.86	9.57	50.0	$\pm 9.6\%$
		Y	100.00	104.93	22.52		50.0	
		Z	100.00	110.10	25.33		50.0	
10024- DAC	GPRS-FDD (TDMA, GMSK, TN 0-1)	X	100.00	110.92	24.51	6.56	60.0	$\pm 9.6\%$
		Y	100.00	104.17	21.07		60.0	
		Z	100.00	109.40	23.71		60.0	
10025- DAC	EDGE-FDD (TDMA, 8PSK, TN 0)	X	3.97	69.08	25.47	12.57	50.0	$\pm 9.6\%$
		Y	6.34	86.82	35.22		50.0	
		Z	3.66	66.66	24.05		50.0	
10026- DAC	EDGE-FDD (TDMA, 8PSK, TN 0-1)	X	6.82	85.96	30.56	9.56	60.0	$\pm 9.6\%$
		Y	6.90	89.59	32.84		60.0	
		Z	6.52	85.14	30.29		60.0	
10027- DAC	GPRS-FDD (TDMA, GMSK, TN 0-1-2)	X	100.00	111.11	23.76	4.80	80.0	$\pm 9.6\%$
		Y	100.00	105.05	20.71		80.0	
		Z	100.00	108.99	22.68		80.0	
10028- DAC	GPRS-FDD (TDMA, GMSK, TN 0-1-2-3)	X	100.00	111.34	23.14	3.55	100.0	$\pm 9.6\%$
		Y	100.00	107.81	21.20		100.0	
		Z	100.00	108.15	21.58		100.0	
10029- DAC	EDGE-FDD (TDMA, 8PSK, TN 0-1-2)	X	4.51	76.74	25.54	7.80	80.0	$\pm 9.6\%$
		Y	4.44	78.91	27.21		80.0	
		Z	4.34	76.19	25.41		80.0	
10030- CAA	IEEE 802.15.1 Bluetooth (GFSK, DH1)	X	100.00	108.75	23.04	5.30	70.0	$\pm 9.6\%$
		Y	100.00	100.28	18.89		70.0	
		Z	100.00	106.90	22.09		70.0	
10031- CAA	IEEE 802.15.1 Bluetooth (GFSK, DH3)	X	100.00	99.67	17.08	1.88	100.0	$\pm 9.6\%$
		Y	50.08	84.31	11.26		100.0	
		Z	0.35	62.17	5.86		100.0	

10032-CAA	IEEE 802.15.1 Bluetooth (GFSK, DH5)	X	28.56	85.45	12.04	1.17	100.0	± 9.6 %
		Y	0.15	60.00	3.24		100.0	
		Z	0.16	60.00	3.46		100.0	
10033-CAA	IEEE 802.15.1 Bluetooth (PI/4-DQPSK, DH1)	X	8.12	89.17	23.19	5.30	70.0	± 9.6 %
		Y	5.53	78.60	16.12		70.0	
		Z	8.77	90.41	23.45		70.0	
10034-CAA	IEEE 802.15.1 Bluetooth (PI/4-DQPSK, DH3)	X	1.89	71.18	14.91	1.88	100.0	± 9.6 %
		Y	0.70	61.17	6.54		100.0	
		Z	1.94	71.91	15.07		100.0	
10035-CAA	IEEE 802.15.1 Bluetooth (PI/4-DQPSK, DH5)	X	1.33	67.78	13.07	1.17	100.0	± 9.6 %
		Y	0.50	60.00	5.45		100.0	
		Z	1.34	68.27	13.15		100.0	
10036-CAA	IEEE 802.15.1 Bluetooth (8-DPSK, DH1)	X	11.58	94.76	24.99	5.30	70.0	± 9.6 %
		Y	7.92	82.80	17.55		70.0	
		Z	13.45	97.05	25.53		70.0	
10037-CAA	IEEE 802.15.1 Bluetooth (8-DPSK, DH3)	X	1.76	70.41	14.56	1.88	100.0	± 9.6 %
		Y	0.67	60.87	6.38		100.0	
		Z	1.78	71.00	14.68		100.0	
10038-CAA	IEEE 802.15.1 Bluetooth (8-DPSK, DH5)	X	1.33	68.01	13.29	1.17	100.0	± 9.6 %
		Y	0.50	60.00	5.57		100.0	
		Z	1.35	68.60	13.42		100.0	
10039-CAB	CDMA2000 (1xRTT, RC1)	X	1.09	65.82	11.60	0.00	150.0	± 9.6 %
		Y	0.33	60.00	4.54		150.0	
		Z	1.10	66.30	11.64		150.0	
10042-CAB	IS-54 / IS-136 FDD (TDMA/FDM, PI/4-DQPSK, Halfrate)	X	100.00	107.41	23.26	7.78	50.0	± 9.6 %
		Y	57.23	96.27	18.96		50.0	
		Z	100.00	105.97	22.54		50.0	
10044-CAA	IS-91/EIA/TIA-553 FDD (FDMA, FM)	X	0.03	118.97	9.94	0.00	150.0	± 9.6 %
		Y	0.05	129.23	11.15		150.0	
		Z	0.09	122.00	10.41		150.0	
10048-CAA	DECT (TDD, TDMA/FDM, GFSK, Full Slot, 24)	X	21.95	89.61	21.44	13.80	25.0	± 9.6 %
		Y	5.10	70.47	13.72		25.0	
		Z	12.15	81.59	18.87		25.0	
10049-CAA	DECT (TDD, TDMA/FDM, GFSK, Double Slot, 12)	X	43.64	100.12	23.34	10.79	40.0	± 9.6 %
		Y	5.90	74.58	14.22		40.0	
		Z	17.31	88.39	19.94		40.0	
10056-CAA	UMTS-TDD (TD-SCDMA, 1.28 Mcps)	X	25.07	100.73	26.75	9.03	50.0	± 9.6 %
		Y	12.75	86.31	19.79		50.0	
		Z	22.08	98.32	25.86		50.0	
10058-DAC	EDGE-FDD (TDMA, 8PSK, TN 0-1-2-3)	X	3.64	72.69	22.94	6.55	100.0	± 9.6 %
		Y	3.58	74.51	24.46		100.0	
		Z	3.51	72.30	22.90		100.0	
10059-CAB	IEEE 802.11b WiFi 2.4 GHz (DSSS, 2 Mbps)	X	1.08	63.42	14.64	0.61	110.0	± 9.6 %
		Y	1.21	68.14	17.70		110.0	
		Z	1.06	63.79	15.05		110.0	
10060-CAB	IEEE 802.11b WiFi 2.4 GHz (DSSS, 5.5 Mbps)	X	2.61	84.17	21.25	1.30	110.0	± 9.6 %
		Y	100.00	147.02	38.69		110.0	
		Z	5.12	95.07	24.77		110.0	

10061-CAB	IEEE 802.11b WiFi 2.4 GHz (DSSS, 11 Mbps)	X	1.89	74.28	19.62	2.04	110.0	± 9.6 %
		Y	6.72	99.45	28.86		110.0	
		Z	1.98	76.00	20.54		110.0	
10062-CAC	IEEE 802.11a/h WiFi 5 GHz (OFDM, 6 Mbps)	X	4.50	66.38	16.23	0.49	100.0	± 9.6 %
		Y	4.17	67.64	16.77		100.0	
		Z	4.49	66.45	16.37		100.0	
10063-CAC	IEEE 802.11a/h WiFi 5 GHz (OFDM, 9 Mbps)	X	4.52	66.46	16.33	0.72	100.0	± 9.6 %
		Y	4.19	67.78	16.90		100.0	
		Z	4.51	66.54	16.46		100.0	
10064-CAC	IEEE 802.11a/h WiFi 5 GHz (OFDM, 12 Mbps)	X	4.78	66.72	16.56	0.86	100.0	± 9.6 %
		Y	4.37	67.91	17.05		100.0	
		Z	4.77	66.78	16.69		100.0	
10065-CAC	IEEE 802.11a/h WiFi 5 GHz (OFDM, 18 Mbps)	X	4.65	66.59	16.65	1.21	100.0	± 9.6 %
		Y	4.25	67.66	17.08		100.0	
		Z	4.64	66.65	16.78		100.0	
10066-CAC	IEEE 802.11a/h WiFi 5 GHz (OFDM, 24 Mbps)	X	4.67	66.60	16.82	1.46	100.0	± 9.6 %
		Y	4.25	67.56	17.16		100.0	
		Z	4.65	66.66	16.94		100.0	
10067-CAC	IEEE 802.11a/h WiFi 5 GHz (OFDM, 36 Mbps)	X	4.96	66.87	17.31	2.04	100.0	± 9.6 %
		Y	4.45	67.61	17.49		100.0	
		Z	4.95	66.92	17.43		100.0	
10068-CAC	IEEE 802.11a/h WiFi 5 GHz (OFDM, 48 Mbps)	X	5.00	66.83	17.50	2.55	100.0	± 9.6 %
		Y	4.58	67.92	17.91		100.0	
		Z	4.98	66.87	17.60		100.0	
10069-CAC	IEEE 802.11a/h WiFi 5 GHz (OFDM, 54 Mbps)	X	5.07	66.86	17.70	2.67	100.0	± 9.6 %
		Y	4.58	67.73	17.95		100.0	
		Z	5.05	66.90	17.80		100.0	
10071-CAB	IEEE 802.11g WiFi 2.4 GHz (DSSS/OFDM, 9 Mbps)	X	4.80	66.52	17.15	1.99	100.0	± 9.6 %
		Y	4.47	67.76	17.67		100.0	
		Z	4.79	66.57	17.27		100.0	
10072-CAB	IEEE 802.11g WiFi 2.4 GHz (DSSS/OFDM, 12 Mbps)	X	4.77	66.78	17.34	2.30	100.0	± 9.6 %
		Y	4.40	67.85	17.80		100.0	
		Z	4.75	66.83	17.46		100.0	
10073-CAB	IEEE 802.11g WiFi 2.4 GHz (DSSS/OFDM, 18 Mbps)	X	4.82	66.94	17.68	2.83	100.0	± 9.6 %
		Y	4.48	68.17	18.22		100.0	
		Z	4.81	66.99	17.79		100.0	
10074-CAB	IEEE 802.11g WiFi 2.4 GHz (DSSS/OFDM, 24 Mbps)	X	4.82	66.85	17.82	3.30	100.0	± 9.6 %
		Y	4.56	68.39	18.51		100.0	
		Z	4.80	66.90	17.93		100.0	
10075-CAB	IEEE 802.11g WiFi 2.4 GHz (DSSS/OFDM, 36 Mbps)	X	4.84	66.90	18.10	3.82	90.0	± 9.6 %
		Y	4.62	68.53	18.81		90.0	
		Z	4.82	66.93	18.20		90.0	
10076-CAB	IEEE 802.11g WiFi 2.4 GHz (DSSS/OFDM, 48 Mbps)	X	4.87	66.75	18.26	4.15	90.0	± 9.6 %
		Y	4.66	68.36	18.96		90.0	
		Z	4.85	66.78	18.35		90.0	
10077-CAB	IEEE 802.11g WiFi 2.4 GHz (DSSS/OFDM, 54 Mbps)	X	4.90	66.83	18.36	4.30	90.0	± 9.6 %
		Y	4.70	68.52	19.13		90.0	
		Z	4.88	66.86	18.46		90.0	

10081-CAB	CDMA2000 (1xRTT, RC3)	X	0.57	62.19	9.13	0.00	150.0	± 9.6 %
		Y	27.42	131.24	12.30		150.0	
		Z	0.55	62.22	8.90		150.0	
10082-CAB	IS-54 / IS-136 FDD (TDMA/FDM, PI/4-DQPSK, Fullrate)	X	5.02	67.53	6.38	4.77	80.0	± 9.6 %
		Y	1.48	62.15	3.83		80.0	
		Z	0.60	60.00	3.69		80.0	
10090-DAC	GPRS-FDD (TDMA, GMSK, TN 0-4)	X	100.00	110.99	24.56	6.56	60.0	± 9.6 %
		Y	100.00	104.24	21.12		60.0	
		Z	100.00	109.50	23.78		60.0	
10097-CAB	UMTS-FDD (HSDPA)	X	1.62	66.19	14.37	0.00	150.0	± 9.6 %
		Y	2.77	77.65	18.43		150.0	
		Z	1.66	66.92	14.80		150.0	
10098-CAB	UMTS-FDD (HSUPA, Subtest 2)	X	1.59	66.12	14.32	0.00	150.0	± 9.6 %
		Y	2.75	77.82	18.53		150.0	
		Z	1.63	66.85	14.76		150.0	
10099-DAC	EDGE-FDD (TDMA, 8PSK, TN 0-4)	X	6.86	86.10	30.61	9.56	60.0	± 9.6 %
		Y	6.96	89.80	32.91		60.0	
		Z	6.57	85.27	30.34		60.0	
10100-CAD	LTE-FDD (SC-FDMA, 100% RB, 20 MHz, QPSK)	X	2.79	68.67	15.73	0.00	150.0	± 9.6 %
		Y	3.01	72.73	18.31		150.0	
		Z	2.85	69.21	16.10		150.0	
10101-CAD	LTE-FDD (SC-FDMA, 100% RB, 20 MHz, 16-QAM)	X	3.03	66.63	15.32	0.00	150.0	± 9.6 %
		Y	2.95	68.63	16.67		150.0	
		Z	3.05	66.87	15.55		150.0	
10102-CAD	LTE-FDD (SC-FDMA, 100% RB, 20 MHz, 64-QAM)	X	3.14	66.68	15.45	0.00	150.0	± 9.6 %
		Y	3.05	68.65	16.75		150.0	
		Z	3.16	66.90	15.67		150.0	
10103-CAD	LTE-TDD (SC-FDMA, 100% RB, 20 MHz, QPSK)	X	5.48	74.24	19.94	3.98	65.0	± 9.6 %
		Y	5.83	78.05	21.80		65.0	
		Z	5.16	73.46	19.72		65.0	
10104-CAD	LTE-TDD (SC-FDMA, 100% RB, 20 MHz, 16-QAM)	X	5.43	71.87	19.65	3.98	65.0	± 9.6 %
		Y	5.15	73.23	20.29		65.0	
		Z	5.30	71.66	19.65		65.0	
10105-CAD	LTE-TDD (SC-FDMA, 100% RB, 20 MHz, 64-QAM)	X	5.28	71.13	19.61	3.98	65.0	± 9.6 %
		Y	5.09	72.76	20.36		65.0	
		Z	5.27	71.32	19.81		65.0	
10108-CAE	LTE-FDD (SC-FDMA, 100% RB, 10 MHz, QPSK)	X	2.42	67.95	15.52	0.00	150.0	± 9.6 %
		Y	2.65	73.21	18.48		150.0	
		Z	2.47	68.55	15.91		150.0	
10109-CAE	LTE-FDD (SC-FDMA, 100% RB, 10 MHz, 16-QAM)	X	2.67	66.43	15.11	0.00	150.0	± 9.6 %
		Y	2.65	69.54	16.65		150.0	
		Z	2.69	66.74	15.37		150.0	
10110-CAE	LTE-FDD (SC-FDMA, 100% RB, 5 MHz, QPSK)	X	1.92	66.97	14.92	0.00	150.0	± 9.6 %
		Y	2.27	74.05	18.03		150.0	
		Z	1.96	67.64	15.34		150.0	
10111-CAE	LTE-FDD (SC-FDMA, 100% RB, 5 MHz, 16-QAM)	X	2.36	67.07	15.14	0.00	150.0	± 9.6 %
		Y	2.72	73.04	17.01		150.0	
		Z	2.39	67.59	15.47		150.0	

10112-CAE	LTE-FDD (SC-FDMA, 100% RB, 10 MHz, 64-QAM)	X	2.80	66.52	15.22	0.00	150.0	± 9.6 %
		Y	2.78	69.65	16.71		150.0	
		Z	2.82	66.81	15.47		150.0	
10113-CAE	LTE-FDD (SC-FDMA, 100% RB, 5 MHz, 64-QAM)	X	2.51	67.31	15.33	0.00	150.0	± 9.6 %
		Y	2.80	72.79	16.92		150.0	
		Z	2.54	67.82	15.65		150.0	
10114-CAC	IEEE 802.11n (HT Greenfield, 13.5 Mbps, BPSK)	X	4.96	66.85	16.19	0.00	150.0	± 9.6 %
		Y	4.63	67.53	16.79		150.0	
		Z	4.96	66.92	16.33		150.0	
10115-CAC	IEEE 802.11n (HT Greenfield, 81 Mbps, 16-QAM)	X	5.22	66.93	16.24	0.00	150.0	± 9.6 %
		Y	4.88	67.74	16.83		150.0	
		Z	5.22	67.01	16.38		150.0	
10116-CAC	IEEE 802.11n (HT Greenfield, 135 Mbps, 64-QAM)	X	5.05	67.03	16.21	0.00	150.0	± 9.6 %
		Y	4.70	67.78	16.83		150.0	
		Z	5.05	67.12	16.36		150.0	
10117-CAC	IEEE 802.11n (HT Mixed, 13.5 Mbps, BPSK)	X	4.94	66.75	16.16	0.00	150.0	± 9.6 %
		Y	4.61	67.43	16.76		150.0	
		Z	4.95	66.84	16.31		150.0	
10118-CAC	IEEE 802.11n (HT Mixed, 81 Mbps, 16-QAM)	X	5.30	67.13	16.35	0.00	150.0	± 9.6 %
		Y	4.86	67.63	16.79		150.0	
		Z	5.31	67.24	16.51		150.0	
10119-CAC	IEEE 802.11n (HT Mixed, 135 Mbps, 64-QAM)	X	5.04	67.00	16.20	0.00	150.0	± 9.6 %
		Y	4.69	67.70	16.79		150.0	
		Z	5.05	67.10	16.36		150.0	
10140-CAD	LTE-FDD (SC-FDMA, 100% RB, 15 MHz, 16-QAM)	X	3.17	66.68	15.36	0.00	150.0	± 9.6 %
		Y	3.04	68.72	16.64		150.0	
		Z	3.18	66.91	15.58		150.0	
10141-CAD	LTE-FDD (SC-FDMA, 100% RB, 15 MHz, 64-QAM)	X	3.30	66.85	15.57	0.00	150.0	± 9.6 %
		Y	3.18	69.04	16.88		150.0	
		Z	3.31	67.07	15.79		150.0	
10142-CAD	LTE-FDD (SC-FDMA, 100% RB, 3 MHz, QPSK)	X	1.67	66.60	14.19	0.00	150.0	± 9.6 %
		Y	1.87	72.33	15.40		150.0	
		Z	1.70	67.34	14.60		150.0	
10143-CAD	LTE-FDD (SC-FDMA, 100% RB, 3 MHz, 16-QAM)	X	2.12	67.16	14.28	0.00	150.0	± 9.6 %
		Y	1.56	66.54	11.72		150.0	
		Z	2.16	67.74	14.58		150.0	
10144-CAD	LTE-FDD (SC-FDMA, 100% RB, 3 MHz, 64-QAM)	X	1.92	65.03	12.70	0.00	150.0	± 9.6 %
		Y	1.13	62.33	8.88		150.0	
		Z	1.92	65.29	12.82		150.0	
10145-CAE	LTE-FDD (SC-FDMA, 100% RB, 1.4 MHz, QPSK)	X	0.84	61.53	8.53	0.00	150.0	± 9.6 %
		Y	0.42	60.00	3.23		150.0	
		Z	0.80	61.27	8.17		150.0	
10146-CAE	LTE-FDD (SC-FDMA, 100% RB, 1.4 MHz, 16-QAM)	X	1.25	62.09	8.49	0.00	150.0	± 9.6 %
		Y	15.63	136.67	2.52		150.0	
		Z	1.18	61.53	7.92		150.0	
10147-CAE	LTE-FDD (SC-FDMA, 100% RB, 1.4 MHz, 64-QAM)	X	1.33	62.76	8.97	0.00	150.0	± 9.6 %
		Y	175.53	59.57	0.91		150.0	
		Z	1.25	62.05	8.31		150.0	

10149-CAD	LTE-FDD (SC-FDMA, 50% RB, 20 MHz, 16-QAM)	X	2.68	66.49	15.16	0.00	150.0	± 9.6 %
		Y	2.67	69.66	16.73		150.0	
		Z	2.70	66.80	15.42		150.0	
10150-CAD	LTE-FDD (SC-FDMA, 50% RB, 20 MHz, 64-QAM)	X	2.81	66.57	15.26	0.00	150.0	± 9.6 %
		Y	2.79	69.76	16.78		150.0	
		Z	2.82	66.87	15.51		150.0	
10151-CAD	LTE-TDD (SC-FDMA, 50% RB, 20 MHz, QPSK)	X	5.57	76.26	20.83	3.98	65.0	± 9.6 %
		Y	6.54	82.28	23.19		65.0	
		Z	5.47	76.32	20.97		65.0	
10152-CAD	LTE-TDD (SC-FDMA, 50% RB, 20 MHz, 16-QAM)	X	4.95	71.73	19.22	3.98	65.0	± 9.6 %
		Y	4.69	73.27	19.41		65.0	
		Z	4.83	71.56	19.23		65.0	
10153-CAD	LTE-TDD (SC-FDMA, 50% RB, 20 MHz, 64-QAM)	X	5.31	72.79	20.07	3.98	65.0	± 9.6 %
		Y	5.16	74.91	20.53		65.0	
		Z	5.19	72.65	20.11		65.0	
10154-CAE	LTE-FDD (SC-FDMA, 50% RB, 10 MHz, QPSK)	X	1.96	67.30	15.14	0.00	150.0	± 9.6 %
		Y	2.37	74.79	18.39		150.0	
		Z	2.00	68.02	15.59		150.0	
10155-CAE	LTE-FDD (SC-FDMA, 50% RB, 10 MHz, 16-QAM)	X	2.36	67.10	15.16	0.00	150.0	± 9.6 %
		Y	2.75	73.23	17.11		150.0	
		Z	2.39	67.62	15.50		150.0	
10156-CAE	LTE-FDD (SC-FDMA, 50% RB, 5 MHz, QPSK)	X	1.48	66.22	13.61	0.00	150.0	± 9.6 %
		Y	1.17	67.13	11.92		150.0	
		Z	1.51	66.95	13.98		150.0	
10157-CAE	LTE-FDD (SC-FDMA, 50% RB, 5 MHz, 16-QAM)	X	1.71	65.06	12.34	0.00	150.0	± 9.6 %
		Y	0.82	60.69	7.08		150.0	
		Z	1.71	65.33	12.43		150.0	
10158-CAE	LTE-FDD (SC-FDMA, 50% RB, 10 MHz, 64-QAM)	X	2.51	67.38	15.38	0.00	150.0	± 9.6 %
		Y	2.84	73.04	17.05		150.0	
		Z	2.55	67.90	15.71		150.0	
10159-CAE	LTE-FDD (SC-FDMA, 50% RB, 5 MHz, 64-QAM)	X	1.79	65.38	12.55	0.00	150.0	± 9.6 %
		Y	0.84	60.64	7.05		150.0	
		Z	1.79	65.65	12.65		150.0	
10160-CAD	LTE-FDD (SC-FDMA, 50% RB, 15 MHz, QPSK)	X	2.49	67.50	15.47	0.00	150.0	± 9.6 %
		Y	2.56	71.83	17.66		150.0	
		Z	2.54	68.10	15.86		150.0	
10161-CAD	LTE-FDD (SC-FDMA, 50% RB, 15 MHz, 16-QAM)	X	2.70	66.49	15.13	0.00	150.0	± 9.6 %
		Y	2.68	69.90	16.49		150.0	
		Z	2.71	66.81	15.39		150.0	
10162-CAD	LTE-FDD (SC-FDMA, 50% RB, 15 MHz, 64-QAM)	X	2.81	66.70	15.28	0.00	150.0	± 9.6 %
		Y	2.80	70.26	16.67		150.0	
		Z	2.82	67.03	15.53		150.0	
10166-CAE	LTE-FDD (SC-FDMA, 50% RB, 1.4 MHz, QPSK)	X	3.24	68.52	18.59	3.01	150.0	± 9.6 %
		Y	2.46	67.16	18.36		150.0	
		Z	3.27	68.87	18.81		150.0	
10167-CAE	LTE-FDD (SC-FDMA, 50% RB, 1.4 MHz, 16-QAM)	X	3.78	70.80	18.80	3.01	150.0	± 9.6 %
		Y	2.65	69.44	18.59		150.0	
		Z	3.87	71.35	19.05		150.0	

10168-CAE	LTE-FDD (SC-FDMA, 50% RB, 1.4 MHz, 64-QAM)	X	4.22	73.24	20.28	3.01	150.0	± 9.6 %
		Y	2.98	72.19	20.36		150.0	
		Z	4.38	74.05	20.65		150.0	
10169-CAD	LTE-FDD (SC-FDMA, 1 RB, 20 MHz, QPSK)	X	2.60	66.96	17.88	3.01	150.0	± 9.6 %
		Y	2.17	66.08	17.74		150.0	
		Z	2.64	67.39	18.13		150.0	
10170-CAD	LTE-FDD (SC-FDMA, 1 RB, 20 MHz, 16-QAM)	X	3.25	71.58	19.84	3.01	150.0	± 9.6 %
		Y	2.55	70.69	19.84		150.0	
		Z	3.42	72.54	20.26		150.0	
10171-AAD	LTE-FDD (SC-FDMA, 1 RB, 20 MHz, 64-QAM)	X	2.73	68.00	17.17	3.01	150.0	± 9.6 %
		Y	2.14	67.11	17.01		150.0	
		Z	2.83	68.55	17.41		150.0	
10172-CAD	LTE-TDD (SC-FDMA, 1 RB, 20 MHz, QPSK)	X	4.83	82.25	25.65	6.02	65.0	± 9.6 %
		Y	3.25	78.99	24.66		65.0	
		Z	4.17	79.62	24.62		65.0	
10173-CAD	LTE-TDD (SC-FDMA, 1 RB, 20 MHz, 16-QAM)	X	7.80	88.67	26.11	6.02	65.0	± 9.6 %
		Y	4.97	85.33	24.86		65.0	
		Z	8.07	89.25	26.21		65.0	
10174-CAD	LTE-TDD (SC-FDMA, 1 RB, 20 MHz, 64-QAM)	X	6.67	84.99	24.27	6.02	65.0	± 9.6 %
		Y	3.85	80.27	22.34		65.0	
		Z	5.89	82.90	23.46		65.0	
10175-CAE	LTE-FDD (SC-FDMA, 1 RB, 10 MHz, QPSK)	X	2.57	66.69	17.64	3.01	150.0	± 9.6 %
		Y	2.15	65.85	17.52		150.0	
		Z	2.61	67.10	17.88		150.0	
10176-CAE	LTE-FDD (SC-FDMA, 1 RB, 10 MHz, 16-QAM)	X	3.26	71.60	19.85	3.01	150.0	± 9.6 %
		Y	2.56	70.71	19.85		150.0	
		Z	3.43	72.56	20.27		150.0	
10177-CAG	LTE-FDD (SC-FDMA, 1 RB, 5 MHz, QPSK)	X	2.59	66.81	17.73	3.01	150.0	± 9.6 %
		Y	2.16	65.91	17.56		150.0	
		Z	2.63	67.23	17.97		150.0	
10178-CAE	LTE-FDD (SC-FDMA, 1 RB, 5 MHz, 16-QAM)	X	3.23	71.44	19.75	3.01	150.0	± 9.6 %
		Y	2.55	70.64	19.81		150.0	
		Z	3.40	72.38	20.17		150.0	
10179-CAE	LTE-FDD (SC-FDMA, 1 RB, 10 MHz, 64-QAM)	X	2.96	69.67	18.37	3.01	150.0	± 9.6 %
		Y	2.32	68.83	18.31		150.0	
		Z	3.09	70.38	18.68		150.0	
10180-CAE	LTE-FDD (SC-FDMA, 1 RB, 5 MHz, 64-QAM)	X	2.73	67.95	17.14	3.01	150.0	± 9.6 %
		Y	2.14	67.11	17.00		150.0	
		Z	2.82	68.50	17.37		150.0	
10181-CAD	LTE-FDD (SC-FDMA, 1 RB, 15 MHz, QPSK)	X	2.59	66.80	17.72	3.01	150.0	± 9.6 %
		Y	2.15	65.90	17.56		150.0	
		Z	2.63	67.21	17.96		150.0	
10182-CAD	LTE-FDD (SC-FDMA, 1 RB, 15 MHz, 16-QAM)	X	3.23	71.42	19.74	3.01	150.0	± 9.6 %
		Y	2.55	70.62	19.79		150.0	
		Z	3.40	72.36	20.16		150.0	
10183-AAC	LTE-FDD (SC-FDMA, 1 RB, 15 MHz, 64-QAM)	X	2.73	67.93	17.12	3.01	150.0	± 9.6 %
		Y	2.14	67.09	16.99		150.0	
		Z	2.82	68.48	17.36		150.0	

10184-CAD	LTE-FDD (SC-FDMA, 1 RB, 3 MHz, QPSK)	X	2.60	66.84	17.74	3.01	150.0	± 9.6 %
		Y	2.16	65.93	17.57		150.0	
		Z	2.64	67.25	17.98		150.0	
10185-CAD	LTE-FDD (SC-FDMA, 1 RB, 3 MHz, 16-QAM)	X	3.24	71.49	19.78	3.01	150.0	± 9.6 %
		Y	2.56	70.68	19.83		150.0	
		Z	3.41	72.43	20.20		150.0	
10186-AAD	LTE-FDD (SC-FDMA, 1 RB, 3 MHz, 64-QAM)	X	2.74	67.99	17.16	3.01	150.0	± 9.6 %
		Y	2.14	67.14	17.02		150.0	
		Z	2.83	68.54	17.39		150.0	
10187-CAE	LTE-FDD (SC-FDMA, 1 RB, 1.4 MHz, QPSK)	X	2.60	66.90	17.81	3.01	150.0	± 9.6 %
		Y	2.17	66.04	17.68		150.0	
		Z	2.65	67.32	18.06		150.0	
10188-CAE	LTE-FDD (SC-FDMA, 1 RB, 1.4 MHz, 16-QAM)	X	3.33	72.04	20.13	3.01	150.0	± 9.6 %
		Y	2.61	71.14	20.14		150.0	
		Z	3.51	73.05	20.58		150.0	
10189-AAE	LTE-FDD (SC-FDMA, 1 RB, 1.4 MHz, 64-QAM)	X	2.79	68.33	17.41	3.01	150.0	± 9.6 %
		Y	2.18	67.45	17.26		150.0	
		Z	2.89	68.91	17.66		150.0	
10193-CAC	IEEE 802.11n (HT Greenfield, 6.5 Mbps, BPSK)	X	4.35	66.32	15.83	0.00	150.0	± 9.6 %
		Y	4.08	67.94	16.57		150.0	
		Z	4.35	66.41	15.97		150.0	
10194-CAC	IEEE 802.11n (HT Greenfield, 39 Mbps, 16-QAM)	X	4.50	66.59	15.97	0.00	150.0	± 9.6 %
		Y	4.17	67.97	16.67		150.0	
		Z	4.50	66.68	16.11		150.0	
10195-CAC	IEEE 802.11n (HT Greenfield, 65 Mbps, 64-QAM)	X	4.54	66.63	15.99	0.00	150.0	± 9.6 %
		Y	4.18	67.89	16.64		150.0	
		Z	4.54	66.71	16.13		150.0	
10196-CAC	IEEE 802.11n (HT Mixed, 6.5 Mbps, BPSK)	X	4.34	66.34	15.84	0.00	150.0	± 9.6 %
		Y	4.05	67.87	16.52		150.0	
		Z	4.34	66.43	15.98		150.0	
10197-CAC	IEEE 802.11n (HT Mixed, 39 Mbps, 16-QAM)	X	4.52	66.61	15.98	0.00	150.0	± 9.6 %
		Y	4.17	67.97	16.68		150.0	
		Z	4.51	66.70	16.12		150.0	
10198-CAC	IEEE 802.11n (HT Mixed, 65 Mbps, 64-QAM)	X	4.54	66.63	16.00	0.00	150.0	± 9.6 %
		Y	4.17	67.88	16.63		150.0	
		Z	4.53	66.72	16.14		150.0	
10219-CAC	IEEE 802.11n (HT Mixed, 7.2 Mbps, BPSK)	X	4.29	66.36	15.79	0.00	150.0	± 9.6 %
		Y	4.02	68.01	16.56		150.0	
		Z	4.29	66.45	15.94		150.0	
10220-CAC	IEEE 802.11n (HT Mixed, 43.3 Mbps, 16-QAM)	X	4.51	66.57	15.97	0.00	150.0	± 9.6 %
		Y	4.17	67.92	16.66		150.0	
		Z	4.50	66.66	16.11		150.0	
10221-CAC	IEEE 802.11n (HT Mixed, 72.2 Mbps, 64-QAM)	X	4.55	66.57	15.99	0.00	150.0	± 9.6 %
		Y	4.19	67.87	16.64		150.0	
		Z	4.55	66.66	16.13		150.0	
10222-CAC	IEEE 802.11n (HT Mixed, 15 Mbps, BPSK)	X	4.91	66.74	16.14	0.00	150.0	± 9.6 %
		Y	4.61	67.46	16.76		150.0	
		Z	4.92	66.81	16.28		150.0	

10223-CAC	IEEE 802.11n (HT Mixed, 90 Mbps, 16-QAM)	X	5.20	66.98	16.29	0.00	150.0	± 9.6 %
		Y	4.78	67.52	16.75		150.0	
		Z	5.21	67.07	16.44		150.0	
10224-CAC	IEEE 802.11n (HT Mixed, 150 Mbps, 64-QAM)	X	4.95	66.84	16.12	0.00	150.0	± 9.6 %
		Y	4.64	67.65	16.77		150.0	
		Z	4.95	66.92	16.26		150.0	
10225-CAB	UMTS-FDD (HSPA+)	X	2.60	65.43	14.52	0.00	150.0	± 9.6 %
		Y	2.31	67.01	13.92		150.0	
		Z	2.60	65.66	14.70		150.0	
10226-CAA	LTE-TDD (SC-FDMA, 1 RB, 1.4 MHz, 16-QAM)	X	8.30	89.91	26.63	6.02	65.0	± 9.6 %
		Y	5.39	86.92	25.51		65.0	
		Z	8.64	90.59	26.77		65.0	
10227-CAA	LTE-TDD (SC-FDMA, 1 RB, 1.4 MHz, 64-QAM)	X	8.42	88.94	25.65	6.02	65.0	± 9.6 %
		Y	4.82	84.03	23.72		65.0	
		Z	8.66	89.39	25.69		65.0	
10228-CAA	LTE-TDD (SC-FDMA, 1 RB, 1.4 MHz, QPSK)	X	5.33	84.56	26.61	6.02	65.0	± 9.6 %
		Y	3.51	80.74	25.42		65.0	
		Z	5.37	85.04	26.79		65.0	
10229-CAB	LTE-TDD (SC-FDMA, 1 RB, 3 MHz, 16-QAM)	X	7.86	88.78	26.15	6.02	65.0	± 9.6 %
		Y	5.00	85.42	24.89		65.0	
		Z	8.13	89.36	26.26		65.0	
10230-CAB	LTE-TDD (SC-FDMA, 1 RB, 3 MHz, 64-QAM)	X	7.90	87.76	25.18	6.02	65.0	± 9.6 %
		Y	4.45	82.60	23.15		65.0	
		Z	8.08	88.11	25.19		65.0	
10231-CAB	LTE-TDD (SC-FDMA, 1 RB, 3 MHz, QPSK)	X	5.13	83.76	26.22	6.02	65.0	± 9.6 %
		Y	3.36	79.77	24.94		65.0	
		Z	5.16	84.16	26.37		65.0	
10232-CAD	LTE-TDD (SC-FDMA, 1 RB, 5 MHz, 16-QAM)	X	7.85	88.76	26.15	6.02	65.0	± 9.6 %
		Y	4.99	85.41	24.89		65.0	
		Z	8.11	89.34	26.25		65.0	
10233-CAD	LTE-TDD (SC-FDMA, 1 RB, 5 MHz, 64-QAM)	X	7.87	87.73	25.17	6.02	65.0	± 9.6 %
		Y	4.44	82.56	23.14		65.0	
		Z	8.06	88.08	25.18		65.0	
10234-CAD	LTE-TDD (SC-FDMA, 1 RB, 5 MHz, QPSK)	X	4.98	83.08	25.85	6.02	65.0	± 9.6 %
		Y	3.27	79.15	24.57		65.0	
		Z	5.00	83.43	25.98		65.0	
10235-CAD	LTE-TDD (SC-FDMA, 1 RB, 10 MHz, 16-QAM)	X	7.85	88.79	26.16	6.02	65.0	± 9.6 %
		Y	5.00	85.44	24.91		65.0	
		Z	8.12	89.37	26.27		65.0	
10236-CAD	LTE-TDD (SC-FDMA, 1 RB, 10 MHz, 64-QAM)	X	7.96	87.89	25.21	6.02	65.0	± 9.6 %
		Y	4.49	82.70	23.18		65.0	
		Z	8.15	88.24	25.23		65.0	
10237-CAD	LTE-TDD (SC-FDMA, 1 RB, 10 MHz, QPSK)	X	5.13	83.78	26.24	6.02	65.0	± 9.6 %
		Y	3.35	79.76	24.95		65.0	
		Z	5.16	84.20	26.39		65.0	
10238-CAD	LTE-TDD (SC-FDMA, 1 RB, 15 MHz, 16-QAM)	X	7.83	88.73	26.14	6.02	65.0	± 9.6 %
		Y	4.99	85.40	24.89		65.0	
		Z	8.09	89.31	26.24		65.0	

10239-CAD	LTE-TDD (SC-FDMA, 1 RB, 15 MHz, 64-QAM)	X	7.84	87.68	25.15	6.02	65.0	± 9.6 %
		Y	4.43	82.52	23.13		65.0	
		Z	8.03	88.04	25.17		65.0	
10240-CAD	LTE-TDD (SC-FDMA, 1 RB, 15 MHz, QPSK)	X	5.12	83.75	26.22	6.02	65.0	± 9.6 %
		Y	3.35	79.78	24.95		65.0	
		Z	5.14	84.16	26.38		65.0	
10241-CAA	LTE-TDD (SC-FDMA, 50% RB, 1.4 MHz, 16-QAM)	X	6.74	78.78	24.52	6.98	65.0	± 9.6 %
		Y	5.69	81.27	25.87		65.0	
		Z	6.76	79.00	24.59		65.0	
10242-CAA	LTE-TDD (SC-FDMA, 50% RB, 1.4 MHz, 64-QAM)	X	6.37	77.64	23.95	6.98	65.0	± 9.6 %
		Y	5.22	79.69	25.18		65.0	
		Z	6.58	78.48	24.29		65.0	
10243-CAA	LTE-TDD (SC-FDMA, 50% RB, 1.4 MHz, QPSK)	X	5.29	74.44	23.43	6.98	65.0	± 9.6 %
		Y	4.45	76.12	24.64		65.0	
		Z	4.96	73.24	22.88		65.0	
10244-CAB	LTE-TDD (SC-FDMA, 50% RB, 3 MHz, 16-QAM)	X	4.30	71.80	16.21	3.98	65.0	± 9.6 %
		Y	1.55	60.92	7.03		65.0	
		Z	4.03	70.91	15.66		65.0	
10245-CAB	LTE-TDD (SC-FDMA, 50% RB, 3 MHz, 64-QAM)	X	4.18	71.11	15.84	3.98	65.0	± 9.6 %
		Y	1.55	60.79	6.91		65.0	
		Z	3.92	70.24	15.30		65.0	
10246-CAB	LTE-TDD (SC-FDMA, 50% RB, 3 MHz, QPSK)	X	3.86	73.77	17.33	3.98	65.0	± 9.6 %
		Y	1.55	63.11	9.15		65.0	
		Z	3.72	73.55	17.17		65.0	
10247-CAD	LTE-TDD (SC-FDMA, 50% RB, 5 MHz, 16-QAM)	X	3.97	70.99	16.82	3.98	65.0	± 9.6 %
		Y	2.28	64.64	10.82		65.0	
		Z	3.84	70.75	16.69		65.0	
10248-CAD	LTE-TDD (SC-FDMA, 50% RB, 5 MHz, 64-QAM)	X	3.96	70.43	16.55	3.98	65.0	± 9.6 %
		Y	2.25	64.13	10.55		65.0	
		Z	3.83	70.16	16.40		65.0	
10249-CAD	LTE-TDD (SC-FDMA, 50% RB, 5 MHz, QPSK)	X	5.06	78.16	20.28	3.98	65.0	± 9.6 %
		Y	3.58	73.72	16.05		65.0	
		Z	5.04	78.50	20.42		65.0	
10250-CAD	LTE-TDD (SC-FDMA, 50% RB, 10 MHz, 16-QAM)	X	4.92	73.99	20.11	3.98	65.0	± 9.6 %
		Y	4.91	76.06	19.61		65.0	
		Z	4.82	73.98	20.18		65.0	
10251-CAD	LTE-TDD (SC-FDMA, 50% RB, 10 MHz, 64-QAM)	X	4.70	71.93	18.79	3.98	65.0	± 9.6 %
		Y	4.06	71.69	17.17		65.0	
		Z	4.58	71.78	18.78		65.0	
10252-CAD	LTE-TDD (SC-FDMA, 50% RB, 10 MHz, QPSK)	X	5.51	78.57	21.66	3.98	65.0	± 9.6 %
		Y	7.63	86.68	23.81		65.0	
		Z	5.47	78.89	21.88		65.0	
10253-CAD	LTE-TDD (SC-FDMA, 50% RB, 15 MHz, 16-QAM)	X	4.88	71.33	18.98	3.98	65.0	± 9.6 %
		Y	4.55	72.63	18.75		65.0	
		Z	4.76	71.16	18.98		65.0	
10254-CAD	LTE-TDD (SC-FDMA, 50% RB, 15 MHz, 64-QAM)	X	5.20	72.27	19.72	3.98	65.0	± 9.6 %
		Y	4.94	73.95	19.64		65.0	
		Z	5.08	72.13	19.74		65.0	

10255-CAD	LTE-TDD (SC-FDMA, 50% RB, 15 MHz, QPSK)	X	5.31	75.57	20.73	3.98	65.0	± 9.6 %
		Y	6.09	81.09	22.63		65.0	
		Z	5.22	75.61	20.85		65.0	
10256-CAA	LTE-TDD (SC-FDMA, 100% RB, 1.4 MHz, 16-QAM)	X	3.08	67.09	12.82	3.98	65.0	± 9.6 %
		Y	1.10	59.01	4.61		65.0	
		Z	2.85	66.14	12.16		65.0	
10257-CAA	LTE-TDD (SC-FDMA, 100% RB, 1.4 MHz, 64-QAM)	X	3.00	66.43	12.39	3.98	65.0	± 9.6 %
		Y	1.10	58.89	4.44		65.0	
		Z	2.79	65.56	11.75		65.0	
10258-CAA	LTE-TDD (SC-FDMA, 100% RB, 1.4 MHz, QPSK)	X	2.70	68.34	13.85	3.98	65.0	± 9.6 %
		Y	1.08	60.00	5.96		65.0	
		Z	2.52	67.66	13.41		65.0	
10259-CAB	LTE-TDD (SC-FDMA, 100% RB, 3 MHz, 16-QAM)	X	4.36	72.23	18.07	3.98	65.0	± 9.6 %
		Y	3.05	68.29	13.76		65.0	
		Z	4.25	72.11	18.03		65.0	
10260-CAB	LTE-TDD (SC-FDMA, 100% RB, 3 MHz, 64-QAM)	X	4.39	71.97	17.95	3.98	65.0	± 9.6 %
		Y	3.03	67.89	13.54		65.0	
		Z	4.27	71.82	17.89		65.0	
10261-CAB	LTE-TDD (SC-FDMA, 100% RB, 3 MHz, QPSK)	X	5.00	77.54	20.53	3.98	65.0	± 9.6 %
		Y	4.86	78.27	18.84		65.0	
		Z	4.96	77.83	20.69		65.0	
10262-CAD	LTE-TDD (SC-FDMA, 100% RB, 5 MHz, 16-QAM)	X	4.91	73.93	20.06	3.98	65.0	± 9.6 %
		Y	4.87	75.90	19.51		65.0	
		Z	4.80	73.90	20.13		65.0	
10263-CAD	LTE-TDD (SC-FDMA, 100% RB, 5 MHz, 64-QAM)	X	4.69	71.90	18.78	3.98	65.0	± 9.6 %
		Y	4.05	71.68	17.17		65.0	
		Z	4.57	71.76	18.77		65.0	
10264-CAD	LTE-TDD (SC-FDMA, 100% RB, 5 MHz, QPSK)	X	5.45	78.36	21.55	3.98	65.0	± 9.6 %
		Y	7.43	86.19	23.60		65.0	
		Z	5.41	78.66	21.76		65.0	
10265-CAD	LTE-TDD (SC-FDMA, 100% RB, 10 MHz, 16-QAM)	X	4.95	71.73	19.22	3.98	65.0	± 9.6 %
		Y	4.69	73.28	19.42		65.0	
		Z	4.83	71.56	19.24		65.0	
10266-CAD	LTE-TDD (SC-FDMA, 100% RB, 10 MHz, 64-QAM)	X	5.30	72.77	20.06	3.98	65.0	± 9.6 %
		Y	5.16	74.89	20.52		65.0	
		Z	5.18	72.63	20.09		65.0	
10267-CAD	LTE-TDD (SC-FDMA, 100% RB, 10 MHz, QPSK)	X	5.56	76.21	20.81	3.98	65.0	± 9.6 %
		Y	6.50	82.16	23.14		65.0	
		Z	5.46	76.27	20.95		65.0	
10268-CAD	LTE-TDD (SC-FDMA, 100% RB, 15 MHz, 16-QAM)	X	5.60	71.84	19.73	3.98	65.0	± 9.6 %
		Y	5.34	73.47	20.38		65.0	
		Z	5.47	71.64	19.74		65.0	
10269-CAD	LTE-TDD (SC-FDMA, 100% RB, 15 MHz, 64-QAM)	X	5.61	71.49	19.61	3.98	65.0	± 9.6 %
		Y	5.38	73.21	20.25		65.0	
		Z	5.48	71.28	19.61		65.0	
10270-CAD	LTE-TDD (SC-FDMA, 100% RB, 15 MHz, QPSK)	X	5.61	73.88	19.99	3.98	65.0	± 9.6 %
		Y	5.96	77.92	21.88		65.0	
		Z	5.49	73.78	20.05		65.0	

10274-CAB	UMTS-FDD (HSUPA, Subtest 5, 3GPP Rel8.10)	X	2.40	65.75	14.40	0.00	150.0	± 9.6 %
		Y	2.28	68.52	14.52		150.0	
		Z	2.41	66.07	14.63		150.0	
10275-CAB	UMTS-FDD (HSUPA, Subtest 5, 3GPP Rel8.4)	X	1.37	65.89	14.00	0.00	150.0	± 9.6 %
		Y	2.24	77.18	18.60		150.0	
		Z	1.41	66.69	14.48		150.0	
10277-CAA	PHS (QPSK)	X	1.83	60.56	6.14	9.03	50.0	± 9.6 %
		Y	1.18	58.25	3.31		50.0	
		Z	1.78	60.31	5.89		50.0	
10278-CAA	PHS (QPSK, BW 884MHz, Rolloff 0.5)	X	3.52	68.49	13.06	9.03	50.0	± 9.6 %
		Y	1.90	61.19	6.81		50.0	
		Z	3.28	67.42	12.39		50.0	
10279-CAA	PHS (QPSK, BW 884MHz, Rolloff 0.38)	X	3.63	68.79	13.26	9.03	50.0	± 9.6 %
		Y	1.93	61.26	6.89		50.0	
		Z	3.38	67.71	12.59		50.0	
10290-AAB	CDMA2000, RC1, SO55, Full Rate	X	0.93	64.00	10.40	0.00	150.0	± 9.6 %
		Y	0.33	60.00	4.23		150.0	
		Z	0.92	64.13	10.27		150.0	
10291-AAB	CDMA2000, RC3, SO55, Full Rate	X	0.56	62.08	9.05	0.00	150.0	± 9.6 %
		Y	0.25	60.00	3.73		150.0	
		Z	0.54	62.09	8.81		150.0	
10292-AAB	CDMA2000, RC3, SO32, Full Rate	X	0.64	64.04	10.45	0.00	150.0	± 9.6 %
		Y	0.23	60.00	3.99		150.0	
		Z	0.63	64.48	10.42		150.0	
10293-AAB	CDMA2000, RC3, SO3, Full Rate	X	0.84	67.30	12.52	0.00	150.0	± 9.6 %
		Y	0.24	60.00	4.44		150.0	
		Z	0.95	69.16	13.11		150.0	
10295-AAB	CDMA2000, RC1, SO3, 1/8th Rate 25 fr.	X	11.34	87.79	23.91	9.03	50.0	± 9.6 %
		Y	100.00	106.64	24.70		50.0	
		Z	13.04	89.56	24.26		50.0	
10297-AAC	LTE-FDD (SC-FDMA, 50% RB, 20 MHz, QPSK)	X	2.43	68.04	15.58	0.00	150.0	± 9.6 %
		Y	2.68	73.41	18.60		150.0	
		Z	2.48	68.65	15.99		150.0	
10298-AAC	LTE-FDD (SC-FDMA, 50% RB, 3 MHz, QPSK)	X	1.13	64.13	11.23	0.00	150.0	± 9.6 %
		Y	0.47	60.00	5.40		150.0	
		Z	1.12	64.36	11.24		150.0	
10299-AAC	LTE-FDD (SC-FDMA, 50% RB, 3 MHz, 16-QAM)	X	1.79	65.44	11.45	0.00	150.0	± 9.6 %
		Y	0.62	60.00	4.41		150.0	
		Z	1.72	64.98	11.00		150.0	
10300-AAC	LTE-FDD (SC-FDMA, 50% RB, 3 MHz, 64-QAM)	X	1.44	62.46	9.17	0.00	150.0	± 9.6 %
		Y	0.61	60.00	3.80		150.0	
		Z	1.39	62.14	8.79		150.0	
10301-AAA	IEEE 802.16e WIMAX (29:18, 5ms, 10MHz, QPSK, PUSC)	X	4.49	65.00	16.96	4.17	50.0	± 9.6 %
		Y	4.09	66.69	17.12		50.0	
		Z	4.52	65.33	17.21		50.0	
10302-AAA	IEEE 802.16e WIMAX (29:18, 5ms, 10MHz, QPSK, PUSC, 3 CTRL symbols)	X	4.99	65.68	17.71	4.96	50.0	± 9.6 %
		Y	4.49	66.84	17.65		50.0	
		Z	4.97	65.74	17.79		50.0	

10303-AAA	IEEE 802.16e WiMAX (31:15, 5ms, 10MHz, 64QAM, PUSC)	X	4.74	65.30	17.51	4.96	50.0	± 9.6 %
		Y	4.42	67.46	17.88		50.0	
		Z	4.72	65.36	17.59		50.0	
10304-AAA	IEEE 802.16e WiMAX (29:18, 5ms, 10MHz, 64QAM, PUSC)	X	4.55	65.18	17.01	4.17	50.0	± 9.6 %
		Y	4.17	66.84	17.11		50.0	
		Z	4.53	65.26	17.11		50.0	
10305-AAA	IEEE 802.16e WiMAX (31:15, 10ms, 10MHz, 64QAM, PUSC, 15 symbols)	X	4.22	67.24	18.89	6.02	35.0	± 9.6 %
		Y	3.80	67.97	17.01		35.0	
		Z	4.24	67.52	19.03		35.0	
10306-AAA	IEEE 802.16e WiMAX (29:18, 10ms, 10MHz, 64QAM, PUSC, 18 symbols)	X	4.53	66.32	18.64	6.02	35.0	± 9.6 %
		Y	4.12	67.69	17.81		35.0	
		Z	4.53	66.50	18.76		35.0	
10307-AAA	IEEE 802.16e WiMAX (29:18, 10ms, 10MHz, QPSK, PUSC, 18 symbols)	X	4.42	66.39	18.56	6.02	35.0	± 9.6 %
		Y	4.01	67.62	17.64		35.0	
		Z	4.42	66.59	18.68		35.0	
10308-AAA	IEEE 802.16e WiMAX (29:18, 10ms, 10MHz, 16QAM, PUSC)	X	4.40	66.60	18.70	6.02	35.0	± 9.6 %
		Y	4.05	68.08	17.93		35.0	
		Z	4.40	66.81	18.83		35.0	
10309-AAA	IEEE 802.16e WiMAX (29:18, 10ms, 10MHz, 16QAM, AMC 2x3, 18 symbols)	X	4.57	66.46	18.76	6.02	35.0	± 9.6 %
		Y	4.15	67.86	18.00		35.0	
		Z	4.57	66.64	18.88		35.0	
10310-AAA	IEEE 802.16e WiMAX (29:18, 10ms, 10MHz, QPSK, AMC 2x3, 18 symbols)	X	4.48	66.38	18.62	6.02	35.0	± 9.6 %
		Y	4.11	67.92	17.93		35.0	
		Z	4.48	66.57	18.74		35.0	
10311-AAC	LTE-FDD (SC-FDMA, 100% RB, 15 MHz, QPSK)	X	2.77	67.40	15.33	0.00	150.0	± 9.6 %
		Y	2.94	71.44	17.85		150.0	
		Z	2.83	67.92	15.69		150.0	
10313-AAA	iDEN 1:3	X	2.63	70.72	15.17	6.99	70.0	± 9.6 %
		Y	4.78	79.70	18.53		70.0	
		Z	2.45	70.15	14.87		70.0	
10314-AAA	iDEN 1:6	X	4.23	78.95	21.28	10.00	30.0	± 9.6 %
		Y	21.13	105.84	29.54		30.0	
		Z	4.50	79.98	21.54		30.0	
10315-AAB	IEEE 802.11b WiFi 2.4 GHz (DSSS, 1 Mbps, 96pc duty cycle)	X	0.98	62.52	14.02	0.17	150.0	± 9.6 %
		Y	1.09	67.04	17.16		150.0	
		Z	0.97	62.89	14.44		150.0	
10316-AAB	IEEE 802.11g WiFi 2.4 GHz (ERP-OFDM, 6 Mbps, 96pc duty cycle)	X	4.40	66.34	15.98	0.17	150.0	± 9.6 %
		Y	4.07	67.64	16.55		150.0	
		Z	4.39	66.42	16.11		150.0	
10317-AAC	IEEE 802.11a WiFi 5 GHz (OFDM, 6 Mbps, 96pc duty cycle)	X	4.40	66.34	15.98	0.17	150.0	± 9.6 %
		Y	4.07	67.64	16.55		150.0	
		Z	4.39	66.42	16.11		150.0	
10400-AAD	IEEE 802.11ac WiFi (20MHz, 64-QAM, 99pc duty cycle)	X	4.48	66.62	15.95	0.00	150.0	± 9.6 %
		Y	4.04	67.65	16.49		150.0	
		Z	4.47	66.71	16.10		150.0	
10401-AAD	IEEE 802.11ac WiFi (40MHz, 64-QAM, 99pc duty cycle)	X	5.21	66.82	16.17	0.00	150.0	± 9.6 %
		Y	4.85	67.54	16.72		150.0	
		Z	5.22	66.92	16.32		150.0	

10402-AAD	IEEE 802.11ac WiFi (80MHz, 64-QAM, 99pc duty cycle)	X	5.47	67.11	16.20	0.00	150.0	± 9.6 %
		Y	5.17	67.73	16.77		150.0	
		Z	5.47	67.15	16.32		150.0	
10403-AAB	CDMA2000 (1xEV-DO, Rev. 0)	X	0.93	64.00	10.40	0.00	115.0	± 9.6 %
		Y	0.33	60.00	4.23		115.0	
		Z	0.92	64.13	10.27		115.0	
10404-AAB	CDMA2000 (1xEV-DO, Rev. A)	X	0.93	64.00	10.40	0.00	115.0	± 9.6 %
		Y	0.33	60.00	4.23		115.0	
		Z	0.92	64.13	10.27		115.0	
10406-AAB	CDMA2000, RC3, SO32, SCH0, Full Rate	X	16.67	98.68	24.47	0.00	100.0	± 9.6 %
		Y	7.21	81.11	14.31		100.0	
		Z	37.53	107.95	26.47		100.0	
10410-AAD	LTE-TDD (SC-FDMA, 1 RB, 10 MHz, QPSK, UL Subframe=2,3,4,7,8,9, Subframe Conf=4)	X	24.48	107.00	27.24	3.23	80.0	± 9.6 %
		Y	15.52	100.17	23.54		80.0	
		Z	35.49	111.31	27.96		80.0	
10415-AAA	IEEE 802.11b WiFi 2.4 GHz (DSSS, 1 Mbps, 99pc duty cycle)	X	0.93	61.94	13.54	0.00	150.0	± 9.6 %
		Y	1.01	66.17	16.61		150.0	
		Z	0.92	62.29	13.95		150.0	
10416-AAA	IEEE 802.11g WiFi 2.4 GHz (ERP-OFDM, 6 Mbps, 99pc duty cycle)	X	4.35	66.34	15.91	0.00	150.0	± 9.6 %
		Y	4.05	67.74	16.57		150.0	
		Z	4.35	66.43	16.05		150.0	
10417-AAB	IEEE 802.11a/h WiFi 5 GHz (OFDM, 6 Mbps, 99pc duty cycle)	X	4.35	66.34	15.91	0.00	150.0	± 9.6 %
		Y	4.05	67.74	16.57		150.0	
		Z	4.35	66.43	16.05		150.0	
10418-AAA	IEEE 802.11g WiFi 2.4 GHz (DSSS-OFDM, 6 Mbps, 99pc duty cycle, Long preamble)	X	4.34	66.51	15.94	0.00	150.0	± 9.6 %
		Y	4.03	68.00	16.69		150.0	
		Z	4.34	66.61	16.09		150.0	
10419-AAA	IEEE 802.11g WiFi 2.4 GHz (DSSS-OFDM, 6 Mbps, 99pc duty cycle, Short preamble)	X	4.36	66.46	15.94	0.00	150.0	± 9.6 %
		Y	4.05	67.90	16.64		150.0	
		Z	4.36	66.55	16.08		150.0	
10422-AAB	IEEE 802.11n (HT Greenfield, 7.2 Mbps, BPSK)	X	4.47	66.46	15.96	0.00	150.0	± 9.6 %
		Y	4.14	67.79	16.63		150.0	
		Z	4.47	66.54	16.10		150.0	
10423-AAB	IEEE 802.11n (HT Greenfield, 43.3 Mbps, 16-QAM)	X	4.61	66.73	16.06	0.00	150.0	± 9.6 %
		Y	4.22	68.01	16.69		150.0	
		Z	4.61	66.82	16.20		150.0	
10424-AAB	IEEE 802.11n (HT Greenfield, 72.2 Mbps, 64-QAM)	X	4.54	66.68	16.03	0.00	150.0	± 9.6 %
		Y	4.16	67.92	16.66		150.0	
		Z	4.53	66.77	16.18		150.0	
10425-AAB	IEEE 802.11n (HT Greenfield, 15 Mbps, BPSK)	X	5.17	66.99	16.27	0.00	150.0	± 9.6 %
		Y	4.80	67.69	16.83		150.0	
		Z	5.17	67.08	16.41		150.0	
10426-AAB	IEEE 802.11n (HT Greenfield, 90 Mbps, 16-QAM)	X	5.19	67.07	16.30	0.00	150.0	± 9.6 %
		Y	4.84	67.85	16.90		150.0	
		Z	5.20	67.19	16.47		150.0	

10427-AAB	IEEE 802.11n (HT Greenfield, 150 Mbps, 64-QAM)	X	5.17	66.95	16.24	0.00	150.0	± 9.6 %
		Y	4.81	67.67	16.81		150.0	
		Z	5.17	67.02	16.38		150.0	
10430-AAB	LTE-FDD (OFDMA, 5 MHz, E-TM 3.1)	X	4.04	70.70	17.69	0.00	150.0	± 9.6 %
		Y	5.18	78.06	19.24		150.0	
		Z	4.12	71.34	18.06		150.0	
10431-AAB	LTE-FDD (OFDMA, 10 MHz, E-TM 3.1)	X	3.97	66.79	15.75	0.00	150.0	± 9.6 %
		Y	3.59	68.58	16.14		150.0	
		Z	3.97	66.94	15.91		150.0	
10432-AAB	LTE-FDD (OFDMA, 15 MHz, E-TM 3.1)	X	4.30	66.71	15.93	0.00	150.0	± 9.6 %
		Y	3.93	68.25	16.56		150.0	
		Z	4.29	66.83	16.08		150.0	
10433-AAB	LTE-FDD (OFDMA, 20 MHz, E-TM 3.1)	X	4.56	66.71	16.05	0.00	150.0	± 9.6 %
		Y	4.18	67.98	16.70		150.0	
		Z	4.55	66.80	16.19		150.0	
10434-AAA	W-CDMA (BS Test Model 1, 64 DPCH)	X	4.08	71.35	17.45	0.00	150.0	± 9.6 %
		Y	4.19	74.65	16.76		150.0	
		Z	4.19	72.07	17.82		150.0	
10435-AAC	LTE-TDD (SC-FDMA, 1 RB, 20 MHz, QPSK, UL Subframe=2,3,4,7,8,9)	X	22.01	105.36	26.76	3.23	80.0	± 9.6 %
		Y	12.26	97.11	22.67		80.0	
		Z	30.46	109.05	27.35		80.0	
10447-AAB	LTE-FDD (OFDMA, 5 MHz, E-TM 3.1, Clipping 44%)	X	3.20	66.45	14.65	0.00	150.0	± 9.6 %
		Y	2.49	66.31	12.90		150.0	
		Z	3.20	66.65	14.79		150.0	
10448-AAB	LTE-FDD (OFDMA, 10 MHz, E-TM 3.1, Clipping 44%)	X	3.83	66.57	15.61	0.00	150.0	± 9.6 %
		Y	3.50	68.44	16.07		150.0	
		Z	3.83	66.72	15.77		150.0	
10449-AAB	LTE-FDD (OFDMA, 15 MHz, E-TM 3.1, Clipping 44%)	X	4.13	66.53	15.82	0.00	150.0	± 9.6 %
		Y	3.82	68.12	16.50		150.0	
		Z	4.12	66.65	15.98		150.0	
10450-AAB	LTE-FDD (OFDMA, 20 MHz, E-TM 3.1, Clipping 44%)	X	4.34	66.47	15.89	0.00	150.0	± 9.6 %
		Y	4.03	67.78	16.58		150.0	
		Z	4.33	66.57	16.04		150.0	
10451-AAA	W-CDMA (BS Test Model 1, 64 DPCH, Clipping 44%)	X	3.02	66.30	14.00	0.00	150.0	± 9.6 %
		Y	1.96	63.95	10.66		150.0	
		Z	3.02	66.48	14.10		150.0	
10456-AAB	IEEE 802.11ac WiFi (160MHz, 64-QAM, 99pc duty cycle)	X	6.11	67.70	16.53	0.00	150.0	± 9.6 %
		Y	6.19	69.21	17.55		150.0	
		Z	6.14	67.81	16.68		150.0	
10457-AAA	UMTS-FDD (DC-HSDPA)	X	3.68	65.04	15.61	0.00	150.0	± 9.6 %
		Y	3.54	66.84	16.42		150.0	
		Z	3.67	65.12	15.76		150.0	
10458-AAA	CDMA2000 (1xEV-DO, Rev. B, 2 carriers)	X	3.62	70.05	16.39	0.00	150.0	± 9.6 %
		Y	1.73	62.72	9.51		150.0	
		Z	3.68	70.56	16.64		150.0	
10459-AAA	CDMA2000 (1xEV-DO, Rev. B, 3 carriers)	X	4.87	68.53	17.80	0.00	150.0	± 9.6 %
		Y	3.66	66.63	14.39		150.0	
		Z	4.93	68.95	18.05		150.0	

10460-AAA	UMTS-FDD (WCDMA, AMR)	X	0.72	64.98	13.65	0.00	150.0	± 9.6 %
		Y	8.89	109.57	29.93		150.0	
		Z	0.75	66.41	14.51		150.0	
10461-AAA	LTE-TDD (SC-FDMA, 1 RB, 1.4 MHz, QPSK, UL Subframe=2,3,4,7,8,9)	X	13.94	101.67	26.79	3.29	80.0	± 9.6 %
		Y	100.00	127.12	30.86		80.0	
		Z	40.31	115.94	29.98		80.0	
10462-AAA	LTE-TDD (SC-FDMA, 1 RB, 1.4 MHz, 16-QAM, UL Subframe=2,3,4,7,8,9)	X	1.11	63.17	10.06	3.23	80.0	± 9.6 %
		Y	0.26	55.58	3.51		80.0	
		Z	0.94	61.56	9.02		80.0	
10463-AAA	LTE-TDD (SC-FDMA, 1 RB, 1.4 MHz, 64-QAM, UL Subframe=2,3,4,7,8,9)	X	0.81	60.00	7.90	3.23	80.0	± 9.6 %
		Y	1.89	63.59	6.01		80.0	
		Z	0.81	60.00	7.64		80.0	
10464-AAA	LTE-TDD (SC-FDMA, 1 RB, 3 MHz, QPSK, UL Subframe=2,3,4,7,8,9)	X	10.27	95.95	24.48	3.23	80.0	± 9.6 %
		Y	10.37	95.51	22.29		80.0	
		Z	21.85	105.27	26.52		80.0	
10465-AAA	LTE-TDD (SC-FDMA, 1 RB, 3 MHz, 16-QAM, UL Subframe=2,3,4,7,8,9)	X	1.01	62.26	9.56	3.23	80.0	± 9.6 %
		Y	0.26	55.51	3.41		80.0	
		Z	0.88	60.92	8.64		80.0	
10466-AAA	LTE-TDD (SC-FDMA, 1 RB, 3 MHz, 64-QAM, UL Subframe=2,3,4,7,8,9)	X	0.81	60.00	7.85	3.23	80.0	± 9.6 %
		Y	2.94	64.67	6.15		80.0	
		Z	0.81	60.00	7.59		80.0	
10467-AAC	LTE-TDD (SC-FDMA, 1 RB, 5 MHz, QPSK, UL Subframe=2,3,4,7,8,9)	X	12.26	98.51	25.22	3.23	80.0	± 9.6 %
		Y	17.71	102.01	24.01		80.0	
		Z	30.02	109.65	27.64		80.0	
10468-AAC	LTE-TDD (SC-FDMA, 1 RB, 5 MHz, 16-QAM, UL Subframe=2,3,4,7,8,9)	X	1.04	62.52	9.70	3.23	80.0	± 9.6 %
		Y	0.26	55.56	3.48		80.0	
		Z	0.90	61.11	8.75		80.0	
10469-AAC	LTE-TDD (SC-FDMA, 1 RB, 5 MHz, 64-QAM, UL Subframe=2,3,4,7,8,9)	X	0.81	60.00	7.85	3.23	80.0	± 9.6 %
		Y	0.90	60.91	5.15		80.0	
		Z	0.81	60.00	7.59		80.0	
10470-AAC	LTE-TDD (SC-FDMA, 1 RB, 10 MHz, QPSK, UL Subframe=2,3,4,7,8,9)	X	12.39	98.68	25.27	3.23	80.0	± 9.6 %
		Y	18.66	102.62	24.14		80.0	
		Z	30.74	109.98	27.71		80.0	
10471-AAC	LTE-TDD (SC-FDMA, 1 RB, 10 MHz, 16-QAM, UL Subframe=2,3,4,7,8,9)	X	1.03	62.46	9.66	3.23	80.0	± 9.6 %
		Y	0.26	55.54	3.46		80.0	
		Z	0.89	61.06	8.72		80.0	
10472-AAC	LTE-TDD (SC-FDMA, 1 RB, 10 MHz, 64-QAM, UL Subframe=2,3,4,7,8,9)	X	0.81	60.00	7.83	3.23	80.0	± 9.6 %
		Y	1.83	63.55	6.01		80.0	
		Z	0.81	60.00	7.57		80.0	
10473-AAC	LTE-TDD (SC-FDMA, 1 RB, 15 MHz, QPSK, UL Subframe=2,3,4,7,8,9)	X	12.30	98.56	25.23	3.23	80.0	± 9.6 %
		Y	17.97	102.17	24.03		80.0	
		Z	30.28	109.75	27.65		80.0	
10474-AAC	LTE-TDD (SC-FDMA, 1 RB, 15 MHz, 16-QAM, UL Subframe=2,3,4,7,8,9)	X	1.02	62.43	9.65	3.23	80.0	± 9.6 %
		Y	0.26	55.54	3.45		80.0	
		Z	0.89	61.04	8.70		80.0	
10475-AAC	LTE-TDD (SC-FDMA, 1 RB, 15 MHz, 64-QAM, UL Subframe=2,3,4,7,8,9)	X	0.81	60.00	7.83	3.23	80.0	± 9.6 %
		Y	3.14	65.15	6.35		80.0	
		Z	0.81	60.00	7.57		80.0	

10477-AAC	LTE-TDD (SC-FDMA, 1 RB, 20 MHz, 16-QAM, UL Subframe=2,3,4,7,8,9)	X	1.00	62.22	9.52	3.23	80.0	± 9.6 %
		Y	0.26	55.50	3.40		80.0	
		Z	0.88	60.88	8.60		80.0	
10478-AAC	LTE-TDD (SC-FDMA, 1 RB, 20 MHz, 64-QAM, UL Subframe=2,3,4,7,8,9)	X	0.81	60.00	7.82	3.23	80.0	± 9.6 %
		Y	3.81	65.69	6.44		80.0	
		Z	0.81	60.00	7.56		80.0	
10479-AAA	LTE-TDD (SC-FDMA, 50% RB, 1.4 MHz, QPSK, UL Subframe=2,3,4,7,8,9)	X	6.59	85.50	22.56	3.23	80.0	± 9.6 %
		Y	100.00	124.45	30.64		80.0	
		Z	8.59	89.42	23.62		80.0	
10480-AAA	LTE-TDD (SC-FDMA, 50% RB, 1.4 MHz, 16-QAM, UL Subframe=2,3,4,7,8,9)	X	4.79	76.18	17.27	3.23	80.0	± 9.6 %
		Y	0.79	60.53	7.96		80.0	
		Z	4.72	75.80	16.90		80.0	
10481-AAA	LTE-TDD (SC-FDMA, 50% RB, 1.4 MHz, 64-QAM, UL Subframe=2,3,4,7,8,9)	X	3.50	71.72	15.20	3.23	80.0	± 9.6 %
		Y	0.75	60.00	7.10		80.0	
		Z	3.26	70.74	14.59		80.0	
10482-AAA	LTE-TDD (SC-FDMA, 50% RB, 3 MHz, QPSK, UL Subframe=2,3,4,7,8,9)	X	1.78	66.01	13.40	2.23	80.0	± 9.6 %
		Y	0.80	60.00	6.87		80.0	
		Z	1.80	66.49	13.54		80.0	
10483-AAA	LTE-TDD (SC-FDMA, 50% RB, 3 MHz, 16-QAM, UL Subframe=2,3,4,7,8,9)	X	2.59	67.30	13.51	2.23	80.0	± 9.6 %
		Y	1.09	60.00	5.52		80.0	
		Z	2.37	66.27	12.85		80.0	
10484-AAA	LTE-TDD (SC-FDMA, 50% RB, 3 MHz, 64-QAM, UL Subframe=2,3,4,7,8,9)	X	2.46	66.44	13.12	2.23	80.0	± 9.6 %
		Y	1.12	60.00	5.52		80.0	
		Z	2.26	65.46	12.48		80.0	
10485-AAC	LTE-TDD (SC-FDMA, 50% RB, 5 MHz, QPSK, UL Subframe=2,3,4,7,8,9)	X	2.31	69.06	16.01	2.23	80.0	± 9.6 %
		Y	2.52	71.75	14.63		80.0	
		Z	2.43	70.26	16.55		80.0	
10486-AAC	LTE-TDD (SC-FDMA, 50% RB, 5 MHz, 16-QAM, UL Subframe=2,3,4,7,8,9)	X	2.35	65.93	13.92	2.23	80.0	± 9.6 %
		Y	1.10	60.00	7.99		80.0	
		Z	2.35	66.25	14.03		80.0	
10487-AAC	LTE-TDD (SC-FDMA, 50% RB, 5 MHz, 64-QAM, UL Subframe=2,3,4,7,8,9)	X	2.36	65.64	13.75	2.23	80.0	± 9.6 %
		Y	1.13	60.00	7.94		80.0	
		Z	2.36	65.89	13.84		80.0	
10488-AAC	LTE-TDD (SC-FDMA, 50% RB, 10 MHz, QPSK, UL Subframe=2,3,4,7,8,9)	X	2.76	69.44	17.18	2.23	80.0	± 9.6 %
		Y	4.34	80.02	20.91		80.0	
		Z	2.84	70.33	17.68		80.0	
10489-AAC	LTE-TDD (SC-FDMA, 50% RB, 10 MHz, 16-QAM, UL Subframe=2,3,4,7,8,9)	X	2.91	67.08	16.06	2.23	80.0	± 9.6 %
		Y	3.28	71.79	16.98		80.0	
		Z	2.93	67.51	16.34		80.0	
10490-AAC	LTE-TDD (SC-FDMA, 50% RB, 10 MHz, 64-QAM, UL Subframe=2,3,4,7,8,9)	X	3.00	67.01	16.04	2.23	80.0	± 9.6 %
		Y	3.19	70.91	16.56		80.0	
		Z	3.01	67.40	16.29		80.0	
10491-AAC	LTE-TDD (SC-FDMA, 50% RB, 15 MHz, QPSK, UL Subframe=2,3,4,7,8,9)	X	3.11	68.64	17.05	2.23	80.0	± 9.6 %
		Y	3.62	74.69	19.64		80.0	
		Z	3.15	69.19	17.41		80.0	
10492-AAC	LTE-TDD (SC-FDMA, 50% RB, 15 MHz, 16-QAM, UL Subframe=2,3,4,7,8,9)	X	3.31	66.73	16.33	2.23	80.0	± 9.6 %
		Y	3.42	70.36	17.49		80.0	
		Z	3.30	66.98	16.55		80.0	

10493-AAC	LTE-TDD (SC-FDMA, 50% RB, 15 MHz, 64-QAM, UL Subframe=2,3,4,7,8,9)	X	3.37	66.65	16.30	2.23	80.0	± 9.6 %
		Y	3.42	69.99	17.28		80.0	
		Z	3.37	66.89	16.51		80.0	
10494-AAC	LTE-TDD (SC-FDMA, 50% RB, 20 MHz, QPSK, UL Subframe=2,3,4,7,8,9)	X	3.29	69.76	17.41	2.23	80.0	± 9.6 %
		Y	3.96	76.26	20.40		80.0	
		Z	3.36	70.43	17.82		80.0	
10495-AAC	LTE-TDD (SC-FDMA, 50% RB, 20 MHz, 16-QAM, UL Subframe=2,3,4,7,8,9)	X	3.32	66.99	16.51	2.23	80.0	± 9.6 %
		Y	3.45	70.58	17.96		80.0	
		Z	3.32	67.26	16.75		80.0	
10496-AAC	LTE-TDD (SC-FDMA, 50% RB, 20 MHz, 64-QAM, UL Subframe=2,3,4,7,8,9)	X	3.41	66.83	16.48	2.23	80.0	± 9.6 %
		Y	3.49	70.20	17.79		80.0	
		Z	3.41	67.07	16.70		80.0	
10497-AAA	LTE-TDD (SC-FDMA, 100% RB, 1.4 MHz, QPSK, UL Subframe=2,3,4,7,8,9)	X	1.18	61.39	9.87	2.23	80.0	± 9.6 %
		Y	0.42	53.98	1.19		80.0	
		Z	1.11	61.01	9.51		80.0	
10498-AAA	LTE-TDD (SC-FDMA, 100% RB, 1.4 MHz, 16-QAM, UL Subframe=2,3,4,7,8,9)	X	1.22	60.00	7.98	2.23	80.0	± 9.6 %
		Y	99.99	258.49	1.69		80.0	
		Z	1.20	60.00	7.80		80.0	
10499-AAA	LTE-TDD (SC-FDMA, 100% RB, 1.4 MHz, 64-QAM, UL Subframe=2,3,4,7,8,9)	X	1.24	60.00	7.83	2.23	80.0	± 9.6 %
		Y	99.95	273.67	5.17		80.0	
		Z	1.21	60.00	7.64		80.0	
10500-AAA	LTE-TDD (SC-FDMA, 100% RB, 3 MHz, QPSK, UL Subframe=2,3,4,7,8,9)	X	2.48	69.15	16.47	2.23	80.0	± 9.6 %
		Y	4.15	78.35	18.23		80.0	
		Z	2.59	70.22	16.99		80.0	
10501-AAA	LTE-TDD (SC-FDMA, 100% RB, 3 MHz, 16-QAM, UL Subframe=2,3,4,7,8,9)	X	2.62	66.65	14.86	2.23	80.0	± 9.6 %
		Y	1.65	63.40	10.90		80.0	
		Z	2.64	67.08	15.07		80.0	
10502-AAA	LTE-TDD (SC-FDMA, 100% RB, 3 MHz, 64-QAM, UL Subframe=2,3,4,7,8,9)	X	2.66	66.53	14.74	2.23	80.0	± 9.6 %
		Y	1.59	62.74	10.46		80.0	
		Z	2.68	66.92	14.92		80.0	
10503-AAC	LTE-TDD (SC-FDMA, 100% RB, 5 MHz, QPSK, UL Subframe=2,3,4,7,8,9)	X	2.73	69.26	17.09	2.23	80.0	± 9.6 %
		Y	4.21	79.52	20.70		80.0	
		Z	2.81	70.13	17.57		80.0	
10504-AAC	LTE-TDD (SC-FDMA, 100% RB, 5 MHz, 16-QAM, UL Subframe=2,3,4,7,8,9)	X	2.89	66.99	16.00	2.23	80.0	± 9.6 %
		Y	3.22	71.53	16.84		80.0	
		Z	2.91	67.41	16.27		80.0	
10505-AAC	LTE-TDD (SC-FDMA, 100% RB, 5 MHz, 64-QAM, UL Subframe=2,3,4,7,8,9)	X	2.98	66.92	15.98	2.23	80.0	± 9.6 %
		Y	3.15	70.69	16.45		80.0	
		Z	3.00	67.30	16.23		80.0	
10506-AAC	LTE-TDD (SC-FDMA, 100% RB, 10 MHz, QPSK, UL Subframe=2,3,4,7,8,9)	X	3.27	69.63	17.34	2.23	80.0	± 9.6 %
		Y	3.91	76.02	20.28		80.0	
		Z	3.33	70.28	17.74		80.0	
10507-AAC	LTE-TDD (SC-FDMA, 100% RB, 10 MHz, 16-QAM, UL Subframe=2,3,4,7,8,9)	X	3.31	66.93	16.47	2.23	80.0	± 9.6 %
		Y	3.43	70.48	17.90		80.0	
		Z	3.31	67.19	16.70		80.0	

10508-AAC	LTE-TDD (SC-FDMA, 100% RB, 10 MHz, 64-QAM, UL Subframe=2,3,4,7,8,9)	X	3.40	66.77	16.43	2.23	80.0	± 9.6 %
		Y	3.47	70.07	17.72		80.0	
		Z	3.40	67.00	16.65		80.0	
10509-AAC	LTE-TDD (SC-FDMA, 100% RB, 15 MHz, QPSK, UL Subframe=2,3,4,7,8,9)	X	3.71	68.99	17.10	2.23	80.0	± 9.6 %
		Y	3.93	72.91	19.23		80.0	
		Z	3.74	69.39	17.40		80.0	
10510-AAC	LTE-TDD (SC-FDMA, 100% RB, 15 MHz, 16-QAM, UL Subframe=2,3,4,7,8,9)	X	3.81	66.87	16.61	2.23	80.0	± 9.6 %
		Y	3.70	69.03	17.73		80.0	
		Z	3.80	67.02	16.79		80.0	
10511-AAC	LTE-TDD (SC-FDMA, 100% RB, 15 MHz, 64-QAM, UL Subframe=2,3,4,7,8,9)	X	3.88	66.72	16.58	2.23	80.0	± 9.6 %
		Y	3.77	68.83	17.64		80.0	
		Z	3.87	66.85	16.75		80.0	
10512-AAC	LTE-TDD (SC-FDMA, 100% RB, 20 MHz, QPSK, UL Subframe=2,3,4,7,8,9)	X	3.76	70.05	17.41	2.23	80.0	± 9.6 %
		Y	4.13	74.35	19.72		80.0	
		Z	3.82	70.57	17.75		80.0	
10513-AAC	LTE-TDD (SC-FDMA, 100% RB, 20 MHz, 16-QAM, UL Subframe=2,3,4,7,8,9)	X	3.69	66.99	16.66	2.23	80.0	± 9.6 %
		Y	3.62	69.07	17.83		80.0	
		Z	3.68	67.16	16.86		80.0	
10514-AAC	LTE-TDD (SC-FDMA, 100% RB, 20 MHz, 64-QAM, UL Subframe=2,3,4,7,8,9)	X	3.74	66.70	16.58	2.23	80.0	± 9.6 %
		Y	3.66	68.68	17.67		80.0	
		Z	3.72	66.84	16.77		80.0	
10515-AAA	IEEE 802.11b WiFi 2.4 GHz (DSSS, 2 Mbps, 99pc duty cycle)	X	0.89	62.04	13.53	0.00	150.0	± 9.6 %
		Y	0.99	66.72	16.88		150.0	
		Z	0.88	62.43	13.97		150.0	
10516-AAA	IEEE 802.11b WiFi 2.4 GHz (DSSS, 5.5 Mbps, 99pc duty cycle)	X	0.42	65.22	13.44	0.00	150.0	± 9.6 %
		Y	100.00	170.44	46.50		150.0	
		Z	0.47	67.93	14.90		150.0	
10517-AAA	IEEE 802.11b WiFi 2.4 GHz (DSSS, 11 Mbps, 99pc duty cycle)	X	0.71	63.10	13.56	0.00	150.0	± 9.6 %
		Y	0.99	72.70	19.61		150.0	
		Z	0.71	63.90	14.21		150.0	
10518-AAB	IEEE 802.11a/h WiFi 5 GHz (OFDM, 9 Mbps, 99pc duty cycle)	X	4.34	66.42	15.89	0.00	150.0	± 9.6 %
		Y	4.04	67.95	16.62		150.0	
		Z	4.34	66.52	16.03		150.0	
10519-AAB	IEEE 802.11a/h WiFi 5 GHz (OFDM, 12 Mbps, 99pc duty cycle)	X	4.50	66.62	16.00	0.00	150.0	± 9.6 %
		Y	4.14	68.05	16.67		150.0	
		Z	4.49	66.71	16.14		150.0	
10520-AAB	IEEE 802.11a/h WiFi 5 GHz (OFDM, 18 Mbps, 99pc duty cycle)	X	4.35	66.54	15.90	0.00	150.0	± 9.6 %
		Y	4.01	67.95	16.60		150.0	
		Z	4.35	66.64	16.05		150.0	
10521-AAB	IEEE 802.11a/h WiFi 5 GHz (OFDM, 24 Mbps, 99pc duty cycle)	X	4.29	66.51	15.88	0.00	150.0	± 9.6 %
		Y	3.94	67.81	16.52		150.0	
		Z	4.28	66.61	16.02		150.0	
10522-AAB	IEEE 802.11a/h WiFi 5 GHz (OFDM, 36 Mbps, 99pc duty cycle)	X	4.34	66.65	15.98	0.00	150.0	± 9.6 %
		Y	3.95	67.80	16.52		150.0	
		Z	4.34	66.75	16.13		150.0	

10523-AAB	IEEE 802.11a/h WiFi 5 GHz (OFDM, 48 Mbps, 99pc duty cycle)	X	4.25	66.56	15.85	0.00	150.0	± 9.6 %
		Y	3.96	68.17	16.68		150.0	
		Z	4.25	66.67	16.01		150.0	
10524-AAB	IEEE 802.11a/h WiFi 5 GHz (OFDM, 54 Mbps, 99pc duty cycle)	X	4.29	66.57	15.95	0.00	150.0	± 9.6 %
		Y	3.92	67.94	16.65		150.0	
		Z	4.28	66.68	16.11		150.0	
10525-AAB	IEEE 802.11ac WiFi (20MHz, MCS0, 99pc duty cycle)	X	4.30	65.65	15.56	0.00	150.0	± 9.6 %
		Y	4.04	67.23	16.37		150.0	
		Z	4.30	65.76	15.72		150.0	
10526-AAB	IEEE 802.11ac WiFi (20MHz, MCS1, 99pc duty cycle)	X	4.44	65.96	15.69	0.00	150.0	± 9.6 %
		Y	4.10	67.36	16.43		150.0	
		Z	4.44	66.06	15.84		150.0	
10527-AAB	IEEE 802.11ac WiFi (20MHz, MCS2, 99pc duty cycle)	X	4.36	65.91	15.62	0.00	150.0	± 9.6 %
		Y	4.06	67.43	16.42		150.0	
		Z	4.36	66.02	15.78		150.0	
10528-AAB	IEEE 802.11ac WiFi (20MHz, MCS3, 99pc duty cycle)	X	4.38	65.93	15.65	0.00	150.0	± 9.6 %
		Y	4.05	67.35	16.40		150.0	
		Z	4.38	66.04	15.81		150.0	
10529-AAB	IEEE 802.11ac WiFi (20MHz, MCS4, 99pc duty cycle)	X	4.38	65.93	15.65	0.00	150.0	± 9.6 %
		Y	4.05	67.35	16.40		150.0	
		Z	4.38	66.04	15.81		150.0	
10531-AAB	IEEE 802.11ac WiFi (20MHz, MCS6, 99pc duty cycle)	X	4.35	65.97	15.64	0.00	150.0	± 9.6 %
		Y	4.01	67.35	16.37		150.0	
		Z	4.35	66.08	15.79		150.0	
10532-AAB	IEEE 802.11ac WiFi (20MHz, MCS7, 99pc duty cycle)	X	4.23	65.82	15.56	0.00	150.0	± 9.6 %
		Y	3.93	67.27	16.33		150.0	
		Z	4.23	65.93	15.72		150.0	
10533-AAB	IEEE 802.11ac WiFi (20MHz, MCS8, 99pc duty cycle)	X	4.39	65.99	15.65	0.00	150.0	± 9.6 %
		Y	4.07	67.57	16.46		150.0	
		Z	4.39	66.11	15.81		150.0	
10534-AAB	IEEE 802.11ac WiFi (40MHz, MCS0, 99pc duty cycle)	X	4.94	66.05	15.78	0.00	150.0	± 9.6 %
		Y	4.64	66.91	16.43		150.0	
		Z	4.95	66.13	15.92		150.0	
10535-AAB	IEEE 802.11ac WiFi (40MHz, MCS1, 99pc duty cycle)	X	5.00	66.21	15.85	0.00	150.0	± 9.6 %
		Y	4.65	66.98	16.47		150.0	
		Z	5.00	66.29	16.00		150.0	
10536-AAB	IEEE 802.11ac WiFi (40MHz, MCS2, 99pc duty cycle)	X	4.88	66.17	15.81	0.00	150.0	± 9.6 %
		Y	4.56	66.99	16.45		150.0	
		Z	4.88	66.26	15.96		150.0	
10537-AAB	IEEE 802.11ac WiFi (40MHz, MCS3, 99pc duty cycle)	X	4.93	66.14	15.80	0.00	150.0	± 9.6 %
		Y	4.65	67.13	16.53		150.0	
		Z	4.94	66.23	15.95		150.0	
10538-AAB	IEEE 802.11ac WiFi (40MHz, MCS4, 99pc duty cycle)	X	5.01	66.14	15.84	0.00	150.0	± 9.6 %
		Y	4.66	66.91	16.44		150.0	
		Z	5.02	66.22	15.99		150.0	
10540-AAB	IEEE 802.11ac WiFi (40MHz, MCS6, 99pc duty cycle)	X	4.94	66.12	15.84	0.00	150.0	± 9.6 %
		Y	4.60	66.83	16.43		150.0	
		Z	4.95	66.20	15.99		150.0	

10541-AAB	IEEE 802.11ac WiFi (40MHz, MCS7, 99pc duty cycle)	X	4.92	66.01	15.78	0.00	150.0	± 9.6 %
		Y	4.61	66.86	16.41		150.0	
		Z	4.92	66.07	15.91		150.0	
10542-AAB	IEEE 802.11ac WiFi (40MHz, MCS8, 99pc duty cycle)	X	5.08	66.12	15.85	0.00	150.0	± 9.6 %
		Y	4.74	66.92	16.46		150.0	
		Z	5.08	66.19	15.99		150.0	
10543-AAB	IEEE 802.11ac WiFi (40MHz, MCS9, 99pc duty cycle)	X	5.14	66.15	15.90	0.00	150.0	± 9.6 %
		Y	4.79	66.97	16.52		150.0	
		Z	5.15	66.24	16.04		150.0	
10544-AAB	IEEE 802.11ac WiFi (80MHz, MCS0, 99pc duty cycle)	X	5.28	66.17	15.79	0.00	150.0	± 9.6 %
		Y	5.02	66.72	16.34		150.0	
		Z	5.29	66.22	15.92		150.0	
10545-AAB	IEEE 802.11ac WiFi (80MHz, MCS1, 99pc duty cycle)	X	5.46	66.60	15.97	0.00	150.0	± 9.6 %
		Y	5.15	67.11	16.50		150.0	
		Z	5.48	66.70	16.12		150.0	
10546-AAB	IEEE 802.11ac WiFi (80MHz, MCS2, 99pc duty cycle)	X	5.32	66.30	15.83	0.00	150.0	± 9.6 %
		Y	5.04	66.80	16.35		150.0	
		Z	5.32	66.36	15.96		150.0	
10547-AAB	IEEE 802.11ac WiFi (80MHz, MCS3, 99pc duty cycle)	X	5.39	66.39	15.87	0.00	150.0	± 9.6 %
		Y	5.17	67.18	16.54		150.0	
		Z	5.41	66.46	16.01		150.0	
10548-AAB	IEEE 802.11ac WiFi (80MHz, MCS4, 99pc duty cycle)	X	5.58	67.13	16.21	0.00	150.0	± 9.6 %
		Y	5.08	67.06	16.46		150.0	
		Z	5.61	67.28	16.39		150.0	
10550-AAB	IEEE 802.11ac WiFi (80MHz, MCS6, 99pc duty cycle)	X	5.37	66.44	15.91	0.00	150.0	± 9.6 %
		Y	5.20	67.46	16.69		150.0	
		Z	5.39	66.55	16.06		150.0	
10551-AAB	IEEE 802.11ac WiFi (80MHz, MCS7, 99pc duty cycle)	X	5.33	66.33	15.82	0.00	150.0	± 9.6 %
		Y	5.00	66.73	16.30		150.0	
		Z	5.34	66.38	15.94		150.0	
10552-AAB	IEEE 802.11ac WiFi (80MHz, MCS8, 99pc duty cycle)	X	5.29	66.25	15.78	0.00	150.0	± 9.6 %
		Y	5.03	66.95	16.40		150.0	
		Z	5.29	66.30	15.90		150.0	
10553-AAB	IEEE 802.11ac WiFi (80MHz, MCS9, 99pc duty cycle)	X	5.35	66.24	15.81	0.00	150.0	± 9.6 %
		Y	5.04	66.77	16.32		150.0	
		Z	5.35	66.28	15.93		150.0	
10554-AAC	IEEE 802.11ac WiFi (160MHz, MCS0, 99pc duty cycle)	X	5.70	66.53	15.89	0.00	150.0	± 9.6 %
		Y	5.48	66.93	16.36		150.0	
		Z	5.71	66.58	16.01		150.0	
10555-AAC	IEEE 802.11ac WiFi (160MHz, MCS1, 99pc duty cycle)	X	5.81	66.79	16.00	0.00	150.0	± 9.6 %
		Y	5.55	67.14	16.45		150.0	
		Z	5.82	66.86	16.13		150.0	
10556-AAC	IEEE 802.11ac WiFi (160MHz, MCS2, 99pc duty cycle)	X	5.84	66.87	16.04	0.00	150.0	± 9.6 %
		Y	5.59	67.27	16.51		150.0	
		Z	5.85	66.94	16.17		150.0	
10557-AAC	IEEE 802.11ac WiFi (160MHz, MCS3, 99pc duty cycle)	X	5.79	66.74	15.99	0.00	150.0	± 9.6 %
		Y	5.53	67.10	16.44		150.0	
		Z	5.80	66.79	16.11		150.0	

10558-AAC	IEEE 802.11ac WiFi (160MHz, MCS4, 99pc duty cycle)	X	5.83	66.87	16.07	0.00	150.0	± 9.6 %
		Y	5.48	66.99	16.40		150.0	
		Z	5.83	66.91	16.19		150.0	
10560-AAC	IEEE 802.11ac WiFi (160MHz, MCS6, 99pc duty cycle)	X	5.83	66.75	16.05	0.00	150.0	± 9.6 %
		Y	5.52	66.99	16.43		150.0	
		Z	5.84	66.79	16.17		150.0	
10561-AAC	IEEE 802.11ac WiFi (160MHz, MCS7, 99pc duty cycle)	X	5.76	66.74	16.07	0.00	150.0	± 9.6 %
		Y	5.46	66.95	16.44		150.0	
		Z	5.77	66.80	16.20		150.0	
10562-AAC	IEEE 802.11ac WiFi (160MHz, MCS8, 99pc duty cycle)	X	5.83	66.96	16.19	0.00	150.0	± 9.6 %
		Y	5.52	67.16	16.55		150.0	
		Z	5.84	67.00	16.31		150.0	
10563-AAC	IEEE 802.11ac WiFi (160MHz, MCS9, 99pc duty cycle)	X	5.92	66.88	16.11	0.00	150.0	± 9.6 %
		Y	5.81	67.79	16.83		150.0	
		Z	5.94	66.97	16.26		150.0	
10564-AAA	IEEE 802.11g WiFi 2.4 GHz (DSSS-OFDM, 9 Mbps, 99pc duty cycle)	X	4.67	66.49	16.06	0.46	150.0	± 9.6 %
		Y	4.32	67.73	16.66		150.0	
		Z	4.66	66.56	16.18		150.0	
10565-AAA	IEEE 802.11g WiFi 2.4 GHz (DSSS-OFDM, 12 Mbps, 99pc duty cycle)	X	4.87	66.92	16.38	0.46	150.0	± 9.6 %
		Y	4.49	68.17	17.00		150.0	
		Z	4.86	67.00	16.52		150.0	
10566-AAA	IEEE 802.11g WiFi 2.4 GHz (DSSS-OFDM, 18 Mbps, 99pc duty cycle)	X	4.71	66.74	16.18	0.46	150.0	± 9.6 %
		Y	4.33	67.89	16.77		150.0	
		Z	4.70	66.81	16.31		150.0	
10567-AAA	IEEE 802.11g WiFi 2.4 GHz (DSSS-OFDM, 24 Mbps, 99pc duty cycle)	X	4.74	67.14	16.55	0.46	150.0	± 9.6 %
		Y	4.39	68.40	17.22		150.0	
		Z	4.73	67.23	16.70		150.0	
10568-AAA	IEEE 802.11g WiFi 2.4 GHz (DSSS-OFDM, 36 Mbps, 99pc duty cycle)	X	4.61	66.49	15.93	0.46	150.0	± 9.6 %
		Y	4.16	67.29	16.29		150.0	
		Z	4.60	66.56	16.05		150.0	
10569-AAA	IEEE 802.11g WiFi 2.4 GHz (DSSS-OFDM, 48 Mbps, 99pc duty cycle)	X	4.71	67.30	16.65	0.46	150.0	± 9.6 %
		Y	4.41	68.83	17.49		150.0	
		Z	4.71	67.41	16.81		150.0	
10570-AAA	IEEE 802.11g WiFi 2.4 GHz (DSSS-OFDM, 54 Mbps, 99pc duty cycle)	X	4.73	67.11	16.56	0.46	150.0	± 9.6 %
		Y	4.35	68.37	17.24		150.0	
		Z	4.72	67.21	16.71		150.0	
10571-AAA	IEEE 802.11b WiFi 2.4 GHz (DSSS, 1 Mbps, 90pc duty cycle)	X	1.04	62.89	14.28	0.46	130.0	± 9.6 %
		Y	1.15	67.27	17.22		130.0	
		Z	1.02	63.22	14.67		130.0	
10572-AAA	IEEE 802.11b WiFi 2.4 GHz (DSSS, 2 Mbps, 90pc duty cycle)	X	1.04	63.32	14.57	0.46	130.0	± 9.6 %
		Y	1.18	68.30	17.83		130.0	
		Z	1.03	63.72	15.00		130.0	
10573-AAA	IEEE 802.11b WiFi 2.4 GHz (DSSS, 5.5 Mbps, 90pc duty cycle)	X	0.83	71.63	16.92	0.46	130.0	± 9.6 %
		Y	100.00	162.55	44.35		130.0	
		Z	1.07	76.86	19.24		130.0	
10574-AAA	IEEE 802.11b WiFi 2.4 GHz (DSSS, 11 Mbps, 90pc duty cycle)	X	1.02	67.14	16.57	0.46	130.0	± 9.6 %
		Y	1.91	82.76	24.56		130.0	
		Z	1.05	68.53	17.52		130.0	

10575-AAA	IEEE 802.11g WiFi 2.4 GHz (DSSS-OFDM, 6 Mbps, 90pc duty cycle)	X	4.45	66.27	16.09	0.46	130.0	± 9.6 %
		Y	4.10	67.49	16.61		130.0	
		Z	4.44	66.34	16.22		130.0	
10576-AAA	IEEE 802.11g WiFi 2.4 GHz (DSSS-OFDM, 9 Mbps, 90pc duty cycle)	X	4.47	66.45	16.16	0.46	130.0	± 9.6 %
		Y	4.15	67.84	16.79		130.0	
		Z	4.47	66.53	16.30		130.0	
10577-AAA	IEEE 802.11g WiFi 2.4 GHz (DSSS-OFDM, 12 Mbps, 90pc duty cycle)	X	4.65	66.71	16.33	0.46	130.0	± 9.6 %
		Y	4.27	68.02	16.91		130.0	
		Z	4.64	66.79	16.46		130.0	
10578-AAA	IEEE 802.11g WiFi 2.4 GHz (DSSS-OFDM, 18 Mbps, 90pc duty cycle)	X	4.55	66.84	16.42	0.46	130.0	± 9.6 %
		Y	4.20	68.23	17.08		130.0	
		Z	4.54	66.94	16.56		130.0	
10579-AAA	IEEE 802.11g WiFi 2.4 GHz (DSSS-OFDM, 24 Mbps, 90pc duty cycle)	X	4.31	66.05	15.67	0.46	130.0	± 9.6 %
		Y	3.90	66.98	16.06		130.0	
		Z	4.30	66.11	15.79		130.0	
10580-AAA	IEEE 802.11g WiFi 2.4 GHz (DSSS-OFDM, 36 Mbps, 90pc duty cycle)	X	4.35	66.12	15.70	0.46	130.0	± 9.6 %
		Y	3.88	66.84	15.95		130.0	
		Z	4.34	66.18	15.83		130.0	
10581-AAA	IEEE 802.11g WiFi 2.4 GHz (DSSS-OFDM, 48 Mbps, 90pc duty cycle)	X	4.45	66.88	16.36	0.46	130.0	± 9.6 %
		Y	4.14	68.42	17.13		130.0	
		Z	4.44	66.99	16.52		130.0	
10582-AAA	IEEE 802.11g WiFi 2.4 GHz (DSSS-OFDM, 54 Mbps, 90pc duty cycle)	X	4.24	65.81	15.45	0.46	130.0	± 9.6 %
		Y	3.79	66.65	15.78		130.0	
		Z	4.23	65.87	15.57		130.0	
10583-AAB	IEEE 802.11a/h WiFi 5 GHz (OFDM, 6 Mbps, 90pc duty cycle)	X	4.45	66.27	16.09	0.46	130.0	± 9.6 %
		Y	4.10	67.49	16.61		130.0	
		Z	4.44	66.34	16.22		130.0	
10584-AAB	IEEE 802.11a/h WiFi 5 GHz (OFDM, 9 Mbps, 90pc duty cycle)	X	4.47	66.45	16.16	0.46	130.0	± 9.6 %
		Y	4.15	67.84	16.79		130.0	
		Z	4.47	66.53	16.30		130.0	
10585-AAB	IEEE 802.11a/h WiFi 5 GHz (OFDM, 12 Mbps, 90pc duty cycle)	X	4.65	66.71	16.33	0.46	130.0	± 9.6 %
		Y	4.27	68.02	16.91		130.0	
		Z	4.64	66.79	16.46		130.0	
10586-AAB	IEEE 802.11a/h WiFi 5 GHz (OFDM, 18 Mbps, 90pc duty cycle)	X	4.55	66.84	16.42	0.46	130.0	± 9.6 %
		Y	4.20	68.23	17.08		130.0	
		Z	4.54	66.94	16.56		130.0	
10587-AAB	IEEE 802.11a/h WiFi 5 GHz (OFDM, 24 Mbps, 90pc duty cycle)	X	4.31	66.05	15.67	0.46	130.0	± 9.6 %
		Y	3.90	66.98	16.06		130.0	
		Z	4.30	66.11	15.79		130.0	
10588-AAB	IEEE 802.11a/h WiFi 5 GHz (OFDM, 36 Mbps, 90pc duty cycle)	X	4.35	66.12	15.70	0.46	130.0	± 9.6 %
		Y	3.88	66.84	15.95		130.0	
		Z	4.34	66.18	15.83		130.0	
10589-AAB	IEEE 802.11a/h WiFi 5 GHz (OFDM, 48 Mbps, 90pc duty cycle)	X	4.45	66.88	16.36	0.46	130.0	± 9.6 %
		Y	4.14	68.42	17.13		130.0	
		Z	4.44	66.99	16.52		130.0	
10590-AAB	IEEE 802.11a/h WiFi 5 GHz (OFDM, 54 Mbps, 90pc duty cycle)	X	4.24	65.81	15.45	0.46	130.0	± 9.6 %
		Y	3.79	66.65	15.78		130.0	
		Z	4.23	65.87	15.57		130.0	

10591-AAB	IEEE 802.11n (HT Mixed, 20MHz, MCS0, 90pc duty cycle)	X	4.61	66.36	16.22	0.46	130.0	± 9.6 %
		Y	4.27	67.61	16.79		130.0	
		Z	4.60	66.43	16.35		130.0	
10592-AAB	IEEE 802.11n (HT Mixed, 20MHz, MCS1, 90pc duty cycle)	X	4.73	66.67	16.34	0.46	130.0	± 9.6 %
		Y	4.33	67.81	16.89		130.0	
		Z	4.72	66.74	16.48		130.0	
10593-AAB	IEEE 802.11n (HT Mixed, 20MHz, MCS2, 90pc duty cycle)	X	4.65	66.54	16.20	0.46	130.0	± 9.6 %
		Y	4.27	67.73	16.75		130.0	
		Z	4.64	66.61	16.33		130.0	
10594-AAB	IEEE 802.11n (HT Mixed, 20MHz, MCS3, 90pc duty cycle)	X	4.71	66.72	16.37	0.46	130.0	± 9.6 %
		Y	4.31	67.86	16.91		130.0	
		Z	4.70	66.80	16.50		130.0	
10595-AAB	IEEE 802.11n (HT Mixed, 20MHz, MCS4, 90pc duty cycle)	X	4.67	66.68	16.26	0.46	130.0	± 9.6 %
		Y	4.27	67.85	16.83		130.0	
		Z	4.66	66.76	16.40		130.0	
10596-AAB	IEEE 802.11n (HT Mixed, 20MHz, MCS5, 90pc duty cycle)	X	4.60	66.65	16.25	0.46	130.0	± 9.6 %
		Y	4.18	67.67	16.75		130.0	
		Z	4.59	66.73	16.39		130.0	
10597-AAB	IEEE 802.11n (HT Mixed, 20MHz, MCS6, 90pc duty cycle)	X	4.55	66.52	16.11	0.46	130.0	± 9.6 %
		Y	4.16	67.60	16.61		130.0	
		Z	4.54	66.60	16.24		130.0	
10598-AAB	IEEE 802.11n (HT Mixed, 20MHz, MCS7, 90pc duty cycle)	X	4.54	66.75	16.38	0.46	130.0	± 9.6 %
		Y	4.21	68.06	17.02		130.0	
		Z	4.53	66.84	16.52		130.0	
10599-AAB	IEEE 802.11n (HT Mixed, 40MHz, MCS0, 90pc duty cycle)	X	5.29	66.89	16.48	0.46	130.0	± 9.6 %
		Y	5.11	68.25	17.34		130.0	
		Z	5.30	66.99	16.63		130.0	
10600-AAB	IEEE 802.11n (HT Mixed, 40MHz, MCS1, 90pc duty cycle)	X	5.40	67.29	16.65	0.46	130.0	± 9.6 %
		Y	5.01	67.95	17.16		130.0	
		Z	5.43	67.45	16.83		130.0	
10601-AAB	IEEE 802.11n (HT Mixed, 40MHz, MCS2, 90pc duty cycle)	X	5.30	67.04	16.55	0.46	130.0	± 9.6 %
		Y	4.95	67.81	17.11		130.0	
		Z	5.31	67.16	16.70		130.0	
10602-AAB	IEEE 802.11n (HT Mixed, 40MHz, MCS3, 90pc duty cycle)	X	5.43	67.22	16.56	0.46	130.0	± 9.6 %
		Y	4.98	67.69	16.96		130.0	
		Z	5.44	67.31	16.70		130.0	
10603-AAB	IEEE 802.11n (HT Mixed, 40MHz, MCS4, 90pc duty cycle)	X	5.50	67.52	16.84	0.46	130.0	± 9.6 %
		Y	5.00	67.82	17.18		130.0	
		Z	5.52	67.67	17.02		130.0	
10604-AAB	IEEE 802.11n (HT Mixed, 40MHz, MCS5, 90pc duty cycle)	X	5.38	67.17	16.65	0.46	130.0	± 9.6 %
		Y	4.97	67.66	17.06		130.0	
		Z	5.40	67.31	16.82		130.0	
10605-AAB	IEEE 802.11n (HT Mixed, 40MHz, MCS6, 90pc duty cycle)	X	5.40	67.20	16.66	0.46	130.0	± 9.6 %
		Y	4.93	67.56	17.02		130.0	
		Z	5.42	67.33	16.82		130.0	
10606-AAB	IEEE 802.11n (HT Mixed, 40MHz, MCS7, 90pc duty cycle)	X	5.15	66.52	16.17	0.46	130.0	± 9.6 %
		Y	4.95	67.77	16.96		130.0	
		Z	5.16	66.62	16.32		130.0	

10607-AAB	IEEE 802.11ac WiFi (20MHz, MCS0, 90pc duty cycle)	X	4.44	65.66	15.83	0.46	130.0	± 9.6 %
		Y	4.14	67.09	16.52		130.0	
		Z	4.44	65.75	15.97		130.0	
10608-AAB	IEEE 802.11ac WiFi (20MHz, MCS1, 90pc duty cycle)	X	4.60	66.02	15.98	0.46	130.0	± 9.6 %
		Y	4.22	67.28	16.62		130.0	
		Z	4.59	66.11	16.13		130.0	
10609-AAB	IEEE 802.11ac WiFi (20MHz, MCS2, 90pc duty cycle)	X	4.49	65.84	15.80	0.46	130.0	± 9.6 %
		Y	4.13	67.14	16.44		130.0	
		Z	4.48	65.93	15.94		130.0	
10610-AAB	IEEE 802.11ac WiFi (20MHz, MCS3, 90pc duty cycle)	X	4.54	66.01	15.97	0.46	130.0	± 9.6 %
		Y	4.18	67.30	16.61		130.0	
		Z	4.53	66.10	16.12		130.0	
10611-AAB	IEEE 802.11ac WiFi (20MHz, MCS4, 90pc duty cycle)	X	4.45	65.81	15.81	0.46	130.0	± 9.6 %
		Y	4.09	67.07	16.44		130.0	
		Z	4.45	65.90	15.96		130.0	
10612-AAB	IEEE 802.11ac WiFi (20MHz, MCS5, 90pc duty cycle)	X	4.45	65.93	15.85	0.46	130.0	± 9.6 %
		Y	4.03	67.00	16.38		130.0	
		Z	4.44	66.03	15.99		130.0	
10613-AAB	IEEE 802.11ac WiFi (20MHz, MCS6, 90pc duty cycle)	X	4.44	65.77	15.70	0.46	130.0	± 9.6 %
		Y	4.05	66.88	16.24		130.0	
		Z	4.44	65.85	15.84		130.0	
10614-AAB	IEEE 802.11ac WiFi (20MHz, MCS7, 90pc duty cycle)	X	4.41	65.98	15.95	0.46	130.0	± 9.6 %
		Y	4.08	67.31	16.62		130.0	
		Z	4.40	66.08	16.10		130.0	
10615-AAB	IEEE 802.11ac WiFi (20MHz, MCS8, 90pc duty cycle)	X	4.45	65.64	15.58	0.46	130.0	± 9.6 %
		Y	4.06	66.87	16.16		130.0	
		Z	4.44	65.72	15.71		130.0	
10616-AAB	IEEE 802.11ac WiFi (40MHz, MCS0, 90pc duty cycle)	X	5.09	66.09	16.06	0.46	130.0	± 9.6 %
		Y	4.76	66.84	16.63		130.0	
		Z	5.10	66.16	16.20		130.0	
10617-AAB	IEEE 802.11ac WiFi (40MHz, MCS1, 90pc duty cycle)	X	5.16	66.28	16.13	0.46	130.0	± 9.6 %
		Y	4.76	66.87	16.63		130.0	
		Z	5.16	66.37	16.28		130.0	
10618-AAB	IEEE 802.11ac WiFi (40MHz, MCS2, 90pc duty cycle)	X	5.05	66.30	16.16	0.46	130.0	± 9.6 %
		Y	4.69	66.97	16.69		130.0	
		Z	5.06	66.39	16.30		130.0	
10619-AAB	IEEE 802.11ac WiFi (40MHz, MCS3, 90pc duty cycle)	X	5.06	66.08	15.98	0.46	130.0	± 9.6 %
		Y	4.75	66.94	16.61		130.0	
		Z	5.07	66.17	16.13		130.0	
10620-AAB	IEEE 802.11ac WiFi (40MHz, MCS4, 90pc duty cycle)	X	5.14	66.12	16.05	0.46	130.0	± 9.6 %
		Y	4.76	66.75	16.54		130.0	
		Z	5.15	66.20	16.19		130.0	
10621-AAB	IEEE 802.11ac WiFi (40MHz, MCS5, 90pc duty cycle)	X	5.15	66.26	16.24	0.46	130.0	± 9.6 %
		Y	4.80	66.94	16.78		130.0	
		Z	5.16	66.33	16.38		130.0	
10622-AAB	IEEE 802.11ac WiFi (40MHz, MCS6, 90pc duty cycle)	X	5.15	66.36	16.29	0.46	130.0	± 9.6 %
		Y	4.77	66.96	16.79		130.0	
		Z	5.15	66.43	16.42		130.0	

10623-AAB	IEEE 802.11ac WiFi (40MHz, MCS7, 90pc duty cycle)	X	5.03	65.89	15.92	0.46	130.0	± 9.6 %
		Y	4.69	66.61	16.45		130.0	
		Z	5.03	65.94	16.04		130.0	
10624-AAB	IEEE 802.11ac WiFi (40MHz, MCS8, 90pc duty cycle)	X	5.23	66.15	16.11	0.46	130.0	± 9.6 %
		Y	4.85	66.81	16.62		130.0	
		Z	5.23	66.22	16.25		130.0	
10625-AAB	IEEE 802.11ac WiFi (40MHz, MCS9, 90pc duty cycle)	X	5.41	66.58	16.39	0.46	130.0	± 9.6 %
		Y	4.98	67.17	16.88		130.0	
		Z	5.39	66.59	16.50		130.0	
10626-AAB	IEEE 802.11ac WiFi (80MHz, MCS0, 90pc duty cycle)	X	5.42	66.17	16.04	0.46	130.0	± 9.6 %
		Y	5.14	66.64	16.52		130.0	
		Z	5.42	66.21	16.16		130.0	
10627-AAB	IEEE 802.11ac WiFi (80MHz, MCS1, 90pc duty cycle)	X	5.65	66.77	16.32	0.46	130.0	± 9.6 %
		Y	5.31	67.18	16.77		130.0	
		Z	5.68	66.90	16.48		130.0	
10628-AAB	IEEE 802.11ac WiFi (80MHz, MCS2, 90pc duty cycle)	X	5.42	66.16	15.94	0.46	130.0	± 9.6 %
		Y	5.11	66.54	16.37		130.0	
		Z	5.42	66.21	16.06		130.0	
10629-AAB	IEEE 802.11ac WiFi (80MHz, MCS3, 90pc duty cycle)	X	5.51	66.29	16.00	0.46	130.0	± 9.6 %
		Y	5.29	67.09	16.65		130.0	
		Z	5.53	66.38	16.14		130.0	
10630-AAB	IEEE 802.11ac WiFi (80MHz, MCS4, 90pc duty cycle)	X	5.82	67.43	16.57	0.46	130.0	± 9.6 %
		Y	5.21	66.99	16.61		130.0	
		Z	5.87	67.63	16.77		130.0	
10631-AAB	IEEE 802.11ac WiFi (80MHz, MCS5, 90pc duty cycle)	X	5.76	67.37	16.74	0.46	130.0	± 9.6 %
		Y	5.33	67.57	17.10		130.0	
		Z	5.78	67.47	16.89		130.0	
10632-AAB	IEEE 802.11ac WiFi (80MHz, MCS6, 90pc duty cycle)	X	5.64	66.89	16.52	0.46	130.0	± 9.6 %
		Y	5.50	68.05	17.35		130.0	
		Z	5.67	67.03	16.69		130.0	
10633-AAB	IEEE 802.11ac WiFi (80MHz, MCS7, 90pc duty cycle)	X	5.49	66.38	16.08	0.46	130.0	± 9.6 %
		Y	5.12	66.68	16.49		130.0	
		Z	5.49	66.42	16.20		130.0	
10634-AAB	IEEE 802.11ac WiFi (80MHz, MCS8, 90pc duty cycle)	X	5.47	66.40	16.15	0.46	130.0	± 9.6 %
		Y	5.20	67.06	16.73		130.0	
		Z	5.47	66.45	16.27		130.0	
10635-AAB	IEEE 802.11ac WiFi (80MHz, MCS9, 90pc duty cycle)	X	5.34	65.69	15.52	0.46	130.0	± 9.6 %
		Y	4.98	66.00	15.88		130.0	
		Z	5.34	65.71	15.62		130.0	
10636-AAC	IEEE 802.11ac WiFi (160MHz, MCS0, 90pc duty cycle)	X	5.85	66.55	16.15	0.46	130.0	± 9.6 %
		Y	5.60	66.87	16.55		130.0	
		Z	5.86	66.59	16.27		130.0	
10637-AAC	IEEE 802.11ac WiFi (160MHz, MCS1, 90pc duty cycle)	X	5.99	66.90	16.31	0.46	130.0	± 9.6 %
		Y	5.71	67.22	16.72		130.0	
		Z	6.00	66.97	16.44		130.0	
10638-AAC	IEEE 802.11ac WiFi (160MHz, MCS2, 90pc duty cycle)	X	5.99	66.89	16.28	0.46	130.0	± 9.6 %
		Y	5.74	67.30	16.74		130.0	
		Z	6.01	66.96	16.42		130.0	

10639-AAC	IEEE 802.11ac WiFi (160MHz, MCS3, 90pc duty cycle)	X	5.96	66.80	16.28	0.46	130.0	± 9.6 %
		Y	5.67	67.08	16.67		130.0	
		Z	5.97	66.85	16.40		130.0	
10640-AAC	IEEE 802.11ac WiFi (160MHz, MCS4, 90pc duty cycle)	X	5.95	66.77	16.21	0.46	130.0	± 9.6 %
		Y	5.56	66.76	16.45		130.0	
		Z	5.95	66.81	16.32		130.0	
10641-AAC	IEEE 802.11ac WiFi (160MHz, MCS5, 90pc duty cycle)	X	6.02	66.79	16.24	0.46	130.0	± 9.6 %
		Y	5.69	66.96	16.57		130.0	
		Z	6.04	66.86	16.37		130.0	
10642-AAC	IEEE 802.11ac WiFi (160MHz, MCS6, 90pc duty cycle)	X	6.05	66.99	16.51	0.46	130.0	± 9.6 %
		Y	5.71	67.14	16.83		130.0	
		Z	6.06	67.04	16.63		130.0	
10643-AAC	IEEE 802.11ac WiFi (160MHz, MCS7, 90pc duty cycle)	X	5.89	66.69	16.25	0.46	130.0	± 9.6 %
		Y	5.55	66.75	16.51		130.0	
		Z	5.91	66.75	16.38		130.0	
10644-AAC	IEEE 802.11ac WiFi (160MHz, MCS8, 90pc duty cycle)	X	5.98	66.95	16.40	0.46	130.0	± 9.6 %
		Y	5.64	67.07	16.70		130.0	
		Z	5.98	66.98	16.51		130.0	
10645-AAC	IEEE 802.11ac WiFi (160MHz, MCS9, 90pc duty cycle)	X	6.12	67.04	16.41	0.46	130.0	± 9.6 %
		Y	6.04	68.05	17.16		130.0	
		Z	6.18	67.23	16.60		130.0	
10646-AAD	LTE-TDD (SC-FDMA, 1 RB, 5 MHz, QPSK, UL Subframe=2,7)	X	9.30	96.04	33.28	9.30	60.0	± 9.6 %
		Y	4.72	85.46	29.98		60.0	
		Z	9.03	95.55	33.06		60.0	
10647-AAC	LTE-TDD (SC-FDMA, 1 RB, 20 MHz, QPSK, UL Subframe=2,7)	X	8.21	93.71	32.60	9.30	60.0	± 9.6 %
		Y	4.16	82.96	29.11		60.0	
		Z	7.96	93.24	32.39		60.0	
10648-AAA	CDMA2000 (1x Advanced)	X	0.48	60.73	7.74	0.00	150.0	± 9.6 %
		Y	0.28	60.00	2.97		150.0	
		Z	0.45	60.55	7.36		150.0	
10652-AAB	LTE-TDD (OFDMA, 5 MHz, E-TM 3.1, Clipping 44%)	X	3.22	65.68	15.68	2.23	80.0	± 9.6 %
		Y	3.30	69.14	16.34		80.0	
		Z	3.22	65.91	15.87		80.0	
10653-AAB	LTE-TDD (OFDMA, 10 MHz, E-TM 3.1, Clipping 44%)	X	3.80	65.29	16.06	2.23	80.0	± 9.6 %
		Y	3.72	67.55	16.85		80.0	
		Z	3.78	65.38	16.21		80.0	
10654-AAB	LTE-TDD (OFDMA, 15 MHz, E-TM 3.1, Clipping 44%)	X	3.81	64.97	16.11	2.23	80.0	± 9.6 %
		Y	3.74	66.80	16.91		80.0	
		Z	3.80	65.03	16.25		80.0	
10655-AAB	LTE-TDD (OFDMA, 20 MHz, E-TM 3.1, Clipping 44%)	X	3.89	64.93	16.16	2.23	80.0	± 9.6 %
		Y	3.83	66.43	16.92		80.0	
		Z	3.87	64.98	16.29		80.0	
10658-AAA	Pulse Waveform (200Hz, 10%)	X	14.05	86.04	19.08	10.00	50.0	± 9.6 %
		Y	3.58	69.28	11.90		50.0	
		Z	8.33	79.49	16.82		50.0	
10659-AAA	Pulse Waveform (200Hz, 20%)	X	100.00	106.74	22.89	6.99	60.0	± 9.6 %
		Y	3.69	71.79	11.78		60.0	
		Z	100.00	105.40	22.19		60.0	

10660-AAA	Pulse Waveform (200Hz, 40%)	X	100.00	104.23	20.43	3.98	80.0	± 9.6 %
		Y	100.00	95.42	16.30		80.0	
		Z	100.00	101.41	19.06		80.0	
10661-AAA	Pulse Waveform (200Hz, 60%)	X	100.00	99.34	17.30	2.22	100.0	± 9.6 %
		Y	100.00	88.65	12.65		100.0	
		Z	15.45	82.53	12.34		100.0	
10662-AAA	Pulse Waveform (200Hz, 80%)	X	0.16	60.00	3.79	0.97	120.0	± 9.6 %
		Y	0.01	60.00	22597.33		120.0	
		Z	27.38	213.45	12.35		120.0	

^E Uncertainty is determined using the max. deviation from linear response applying rectangular distribution and is expressed for the square of the field value.



Accredited by the Swiss Accreditation Service (SAS)
The Swiss Accreditation Service is one of the signatories to the EA
Multilateral Agreement for the recognition of calibration certificates

Accreditation No.: **SCS 0108**

Client **PC Test**

Certificate No: **ES3-3347_Mar18**

CALIBRATION CERTIFICATE

Object **ES3DV3 - SN:3347**

Calibration procedure(s) **QA CAL-01.v9, QA CAL-23.v5, QA CAL-25.v6
Calibration procedure for dosimetric E-field probes**

*BMW
04-05-2018*

Calibration date: **March 27, 2018**

This calibration certificate documents the traceability to national standards, which realize the physical units of measurements (SI).
The measurements and the uncertainties with confidence probability are given on the following pages and are part of the certificate.

All calibrations have been conducted in the closed laboratory facility: environment temperature (22 ± 3)°C and humidity < 70%.

Calibration Equipment used (M&TE critical for calibration)

Primary Standards	ID	Cal Date (Certificate No.)	Scheduled Calibration
Power meter NRP	SN: 104778	04-Apr-17 (No. 217-02521/02522)	Apr-18
Power sensor NRP-Z91	SN: 103244	04-Apr-17 (No. 217-02521)	Apr-18
Power sensor NRP-Z91	SN: 103245	04-Apr-17 (No. 217-02525)	Apr-18
Reference 20 dB Attenuator	SN: S5277 (20x)	07-Apr-17 (No. 217-02528)	Apr-18
Reference Probe ES3DV2	SN: 3013	30-Dec-17 (No. ES3-3013_Dec17)	Dec-18
DAE4	SN: 660	21-Dec-17 (No. DAE4-660_Dec17)	Dec-18
Secondary Standards	ID	Check Date (in house)	Scheduled Check
Power meter E4419B	SN: GB41293874	06-Apr-16 (in house check Jun-16)	In house check: Jun-18
Power sensor E4412A	SN: MY41498087	06-Apr-16 (in house check Jun-16)	In house check: Jun-18
Power sensor E4412A	SN: 000110210	06-Apr-16 (in house check Jun-16)	In house check: Jun-18
RF generator HP 8648C	SN: US3642U01700	04-Aug-99 (in house check Jun-16)	In house check: Jun-18
Network Analyzer HP 8753E	SN: US37390585	18-Oct-01 (in house check Oct-17)	In house check: Oct-18

Calibrated by:	Name Michael Weber	Function Laboratory Technician	Signature <i>M. Weber</i>
Approved by:	Katja Pokovic	Technical Manager	<i>K. Pokovic</i>
			Issued: March 27, 2018
This calibration certificate shall not be reproduced except in full without written approval of the laboratory.			



Accredited by the Swiss Accreditation Service (SAS)

Accreditation No.: **SCS 0108**

The Swiss Accreditation Service is one of the signatories to the EA Multilateral Agreement for the recognition of calibration certificates

Glossary:

TSL	tissue simulating liquid
NORM _{x,y,z}	sensitivity in free space
ConvF	sensitivity in TSL / NORM _{x,y,z}
DCP	diode compression point
CF	crest factor (1/duty_cycle) of the RF signal
A, B, C, D	modulation dependent linearization parameters
Polarization φ	φ rotation around probe axis
Polarization ϑ	ϑ rotation around an axis that is in the plane normal to probe axis (at measurement center), i.e., $\vartheta = 0$ is normal to probe axis
Connector Angle	information used in DASY system to align probe sensor X to the robot coordinate system

Calibration is Performed According to the Following Standards:

- a) IEEE Std 1528-2013, "IEEE Recommended Practice for Determining the Peak Spatial-Averaged Specific Absorption Rate (SAR) in the Human Head from Wireless Communications Devices: Measurement Techniques", June 2013
- b) IEC 62209-1, "Measurement procedure for the assessment of Specific Absorption Rate (SAR) from hand-held and body-mounted devices used next to the ear (frequency range of 300 MHz to 6 GHz)", July 2016
- c) IEC 62209-2, "Procedure to determine the Specific Absorption Rate (SAR) for wireless communication devices used in close proximity to the human body (frequency range of 30 MHz to 6 GHz)", March 2010
- d) KDB 865664, "SAR Measurement Requirements for 100 MHz to 6 GHz"

Methods Applied and Interpretation of Parameters:

- *NORM_{x,y,z}*: Assessed for E-field polarization $\vartheta = 0$ ($f \leq 900$ MHz in TEM-cell; $f > 1800$ MHz: R22 waveguide). *NORM_{x,y,z}* are only intermediate values, i.e., the uncertainties of *NORM_{x,y,z}* does not affect the E^2 -field uncertainty inside TSL (see below *ConvF*).
- *NORM(f)_{x,y,z}* = *NORM_{x,y,z}* * *frequency_response* (see Frequency Response Chart). This linearization is implemented in DASY4 software versions later than 4.2. The uncertainty of the frequency response is included in the stated uncertainty of *ConvF*.
- *DCP_{x,y,z}*: DCP are numerical linearization parameters assessed based on the data of power sweep with CW signal (no uncertainty required). DCP does not depend on frequency nor media.
- *PAR*: PAR is the Peak to Average Ratio that is not calibrated but determined based on the signal characteristics
- *A_{x,y,z}*; *B_{x,y,z}*; *C_{x,y,z}*; *D_{x,y,z}*; *VR_{x,y,z}*; *A, B, C, D* are numerical linearization parameters assessed based on the data of power sweep for specific modulation signal. The parameters do not depend on frequency nor media. *VR* is the maximum calibration range expressed in RMS voltage across the diode.
- *ConvF and Boundary Effect Parameters*: Assessed in flat phantom using E-field (or Temperature Transfer Standard for $f \leq 800$ MHz) and inside waveguide using analytical field distributions based on power measurements for $f > 800$ MHz. The same setups are used for assessment of the parameters applied for boundary compensation (alpha, depth) of which typical uncertainty values are given. These parameters are used in DASY4 software to improve probe accuracy close to the boundary. The sensitivity in TSL corresponds to *NORM_{x,y,z}* * *ConvF* whereby the uncertainty corresponds to that given for *ConvF*. A frequency dependent *ConvF* is used in DASY version 4.4 and higher which allows extending the validity from ± 50 MHz to ± 100 MHz.
- *Spherical isotropy (3D deviation from isotropy)*: in a field of low gradients realized using a flat phantom exposed by a patch antenna.
- *Sensor Offset*: The sensor offset corresponds to the offset of virtual measurement center from the probe tip (on probe axis). No tolerance required.
- *Connector Angle*: The angle is assessed using the information gained by determining the *NORM_x* (no uncertainty required).

Probe ES3DV3

SN:3347

Manufactured:	March 15, 2012
Repaired:	March 15, 2018
Calibrated:	March 27, 2018

Calibrated for DASY/EASY Systems
(Note: non-compatible with DASY2 system!)

DASY/EASY - Parameters of Probe: ES3DV3 - SN:3347

Basic Calibration Parameters

	Sensor X	Sensor Y	Sensor Z	Unc (k=2)
Norm ($\mu\text{V}/(\text{V}/\text{m})^2$) ^A	1.15	1.18	1.21	± 10.1 %
DCP (mV) ^B	101.9	105.1	102.9	

Modulation Calibration Parameters

UID	Communication System Name		A dB	B dB/ μV	C	D dB	VR mV	Unc ^E (k=2)
0	CW	X	0.0	0.0	1.0	0.00	201.8	±3.3 %
		Y	0.0	0.0	1.0		203.9	
		Z	0.0	0.0	1.0		204.8	

Note: For details on UID parameters see Appendix.

Sensor Model Parameters

	C1 fF	C2 fF	α V^{-1}	T1 $\text{ms}\cdot\text{V}^{-2}$	T2 $\text{ms}\cdot\text{V}^{-1}$	T3 ms	T4 V^{-2}	T5 V^{-1}	T6
X	52.41	376.6	35.43	28.01	1.852	5.10	0.578	0.488	1.008
Y	42.65	300.9	34.31	25.12	1.310	5.10	1.279	0.204	1.011
Z	48.12	344.8	35.26	27.10	1.587	5.10	0.868	0.385	1.009

The reported uncertainty of measurement is stated as the standard uncertainty of measurement multiplied by the coverage factor $k=2$, which for a normal distribution corresponds to a coverage probability of approximately 95%.

^A The uncertainties of Norm X,Y,Z do not affect the E^2 -field uncertainty inside TSL (see Pages 5 and 6).

^B Numerical linearization parameter: uncertainty not required.

^E Uncertainty is determined using the max. deviation from linear response applying rectangular distribution and is expressed for the square of the field value.

DASY/EASY - Parameters of Probe: ES3DV3 - SN:3347

Calibration Parameter Determined in Head Tissue Simulating Media

f (MHz) ^C	Relative Permittivity ^F	Conductivity (S/m) ^F	ConvF X	ConvF Y	ConvF Z	Alpha ^G	Depth ^G (mm)	Unc (k=2)
750	41.9	0.89	6.77	6.77	6.77	0.65	1.32	± 12.0 %
835	41.5	0.90	6.41	6.41	6.41	0.40	1.64	± 12.0 %
1750	40.1	1.37	5.58	5.58	5.58	0.54	1.42	± 12.0 %
1900	40.0	1.40	5.36	5.36	5.36	0.80	1.16	± 12.0 %
2300	39.5	1.67	5.11	5.11	5.11	0.74	1.29	± 12.0 %
2450	39.2	1.80	4.81	4.81	4.81	0.80	1.24	± 12.0 %
2600	39.0	1.96	4.66	4.66	4.66	0.75	1.25	± 12.0 %

^C Frequency validity above 300 MHz of ± 100 MHz only applies for DASY v4.4 and higher (see Page 2), else it is restricted to ± 50 MHz. The uncertainty is the RSS of the ConvF uncertainty at calibration frequency and the uncertainty for the indicated frequency band. Frequency validity below 300 MHz is ± 10, 25, 40, 50 and 70 MHz for ConvF assessments at 30, 64, 128, 150 and 220 MHz respectively. Above 5 GHz frequency validity can be extended to ± 110 MHz.

^F At frequencies below 3 GHz, the validity of tissue parameters (ϵ and σ) can be relaxed to ± 10% if liquid compensation formula is applied to measured SAR values. At frequencies above 3 GHz, the validity of tissue parameters (ϵ and σ) is restricted to ± 5%. The uncertainty is the RSS of the ConvF uncertainty for indicated target tissue parameters.

^G Alpha/Depth are determined during calibration. SPEAG warrants that the remaining deviation due to the boundary effect after compensation is always less than ± 1% for frequencies below 3 GHz and below ± 2% for frequencies between 3-6 GHz at any distance larger than half the probe tip diameter from the boundary.

DASY/EASY - Parameters of Probe: ES3DV3 - SN:3347

Calibration Parameter Determined in Body Tissue Simulating Media

f (MHz) ^C	Relative Permittivity ^F	Conductivity (S/m) ^F	ConvF X	ConvF Y	ConvF Z	Alpha ^G	Depth ^G (mm)	Unc (k=2)
750	55.5	0.96	6.59	6.59	6.59	0.77	1.22	± 12.0 %
835	55.2	0.97	6.37	6.37	6.37	0.80	1.17	± 12.0 %
1750	53.4	1.49	5.17	5.17	5.17	0.49	1.59	± 12.0 %
1900	53.3	1.52	4.94	4.94	4.94	0.52	1.49	± 12.0 %
2300	52.9	1.81	4.74	4.74	4.74	0.80	1.25	± 12.0 %
2450	52.7	1.95	4.64	4.64	4.64	0.75	1.20	± 12.0 %
2600	52.5	2.16	4.49	4.49	4.49	0.80	1.20	± 12.0 %

^C Frequency validity above 300 MHz of ± 100 MHz only applies for DASY v4.4 and higher (see Page 2), else it is restricted to ± 50 MHz. The uncertainty is the RSS of the ConvF uncertainty at calibration frequency and the uncertainty for the indicated frequency band. Frequency validity below 300 MHz is ± 10, 25, 40, 50 and 70 MHz for ConvF assessments at 30, 64, 128, 150 and 220 MHz respectively. Above 5 GHz frequency validity can be extended to ± 110 MHz.

^F At frequencies below 3 GHz, the validity of tissue parameters (ϵ and σ) can be relaxed to ± 10% if liquid compensation formula is applied to measured SAR values. At frequencies above 3 GHz, the validity of tissue parameters (ϵ and σ) is restricted to ± 5%. The uncertainty is the RSS of the ConvF uncertainty for indicated target tissue parameters.

^G Alpha/Depth are determined during calibration. SPEAG warrants that the remaining deviation due to the boundary effect after compensation is always less than ± 1% for frequencies below 3 GHz and below ± 2% for frequencies between 3-6 GHz at any distance larger than half the probe tip diameter from the boundary.

Frequency Response of E-Field (TEM-Cell:ifi110 EXX, Waveguide: R22)

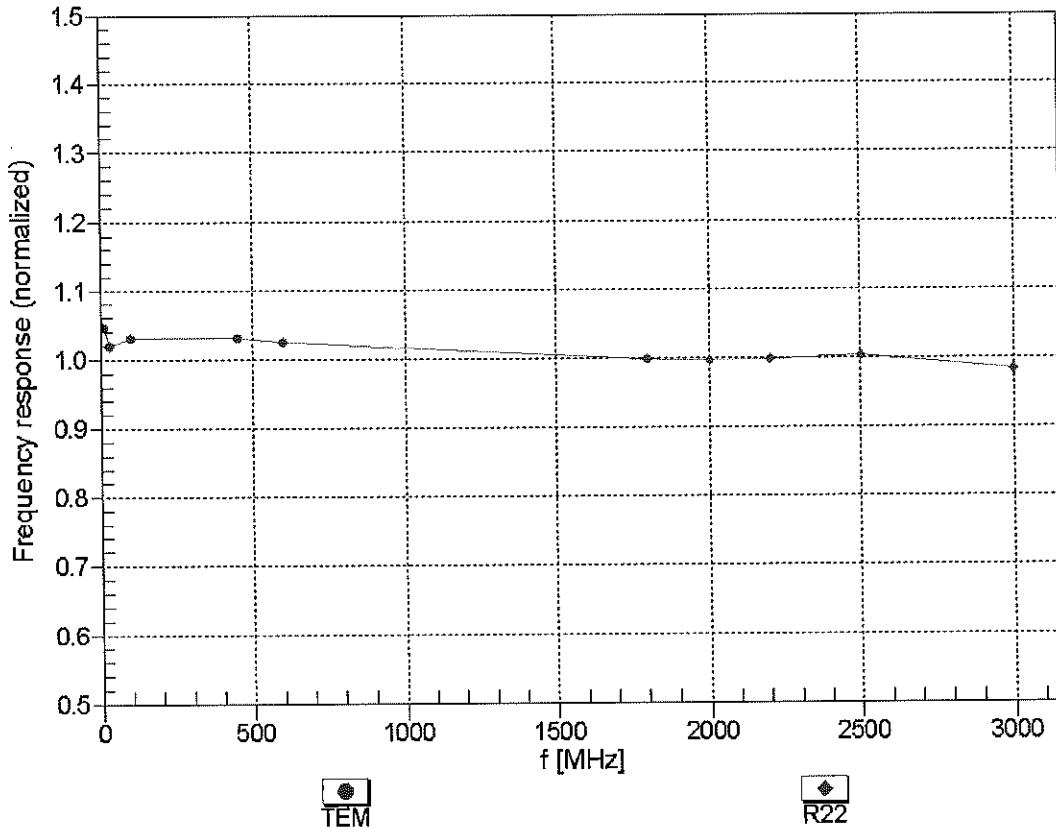

Uncertainty of Frequency Response of E-field: $\pm 6.3\%$ (k=2)

Receiving Pattern (ϕ), $\theta = 0^\circ$

f=600 MHz, TEM

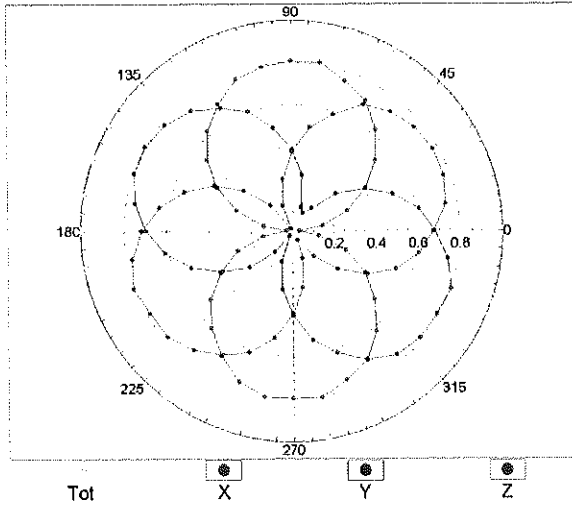

f=1800 MHz, R22

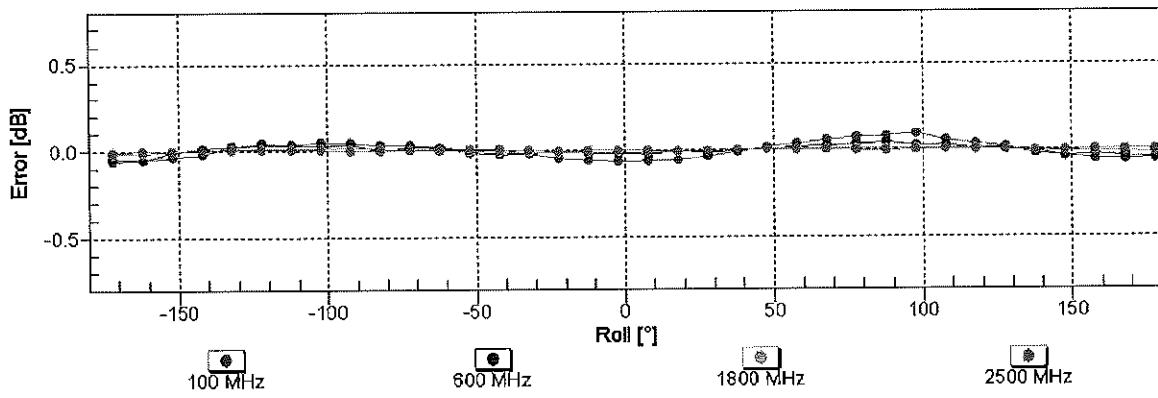
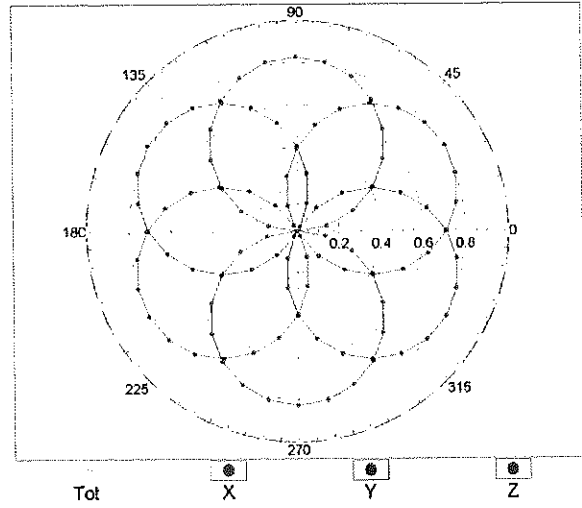

Uncertainty of Axial Isotropy Assessment: $\pm 0.5\%$ (k=2)

Dynamic Range f(SAR_{head}) (TEM cell , f_{eval}= 1900 MHz)

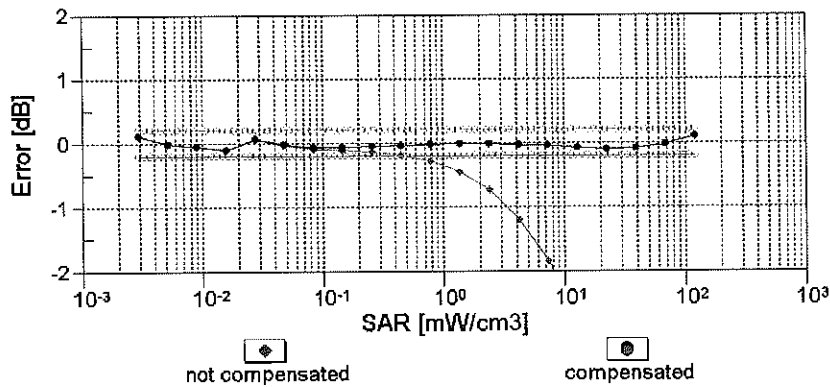
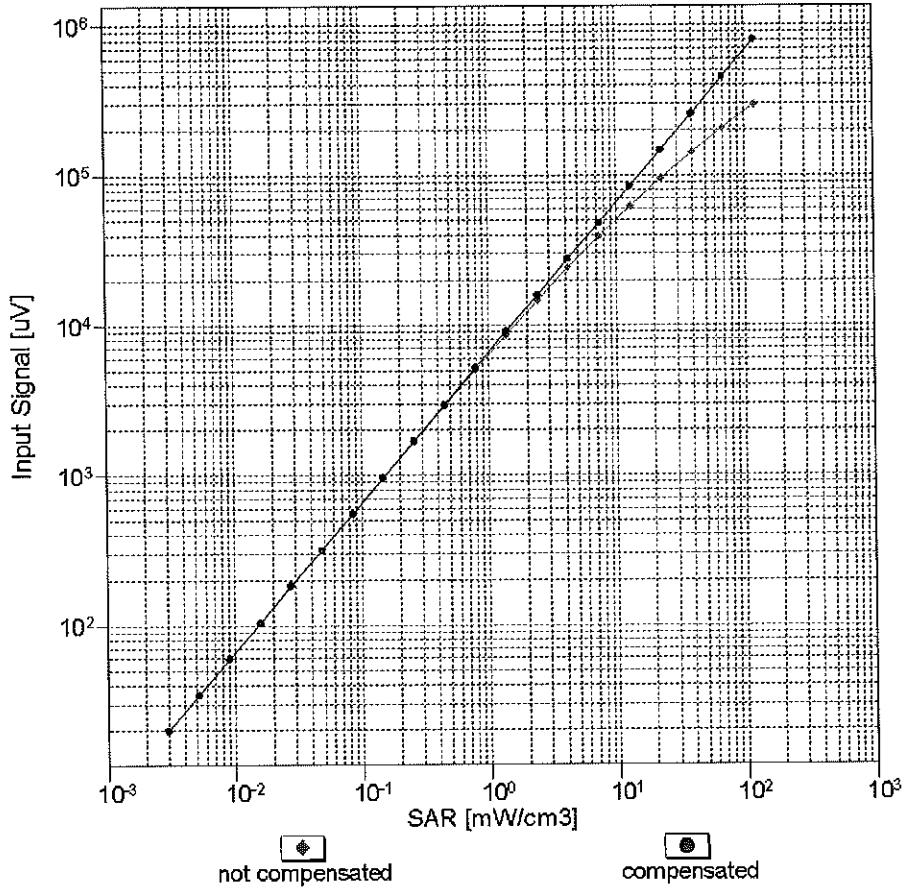

Uncertainty of Linearity Assessment: ± 0.6% (k=2)

Conversion Factor Assessment

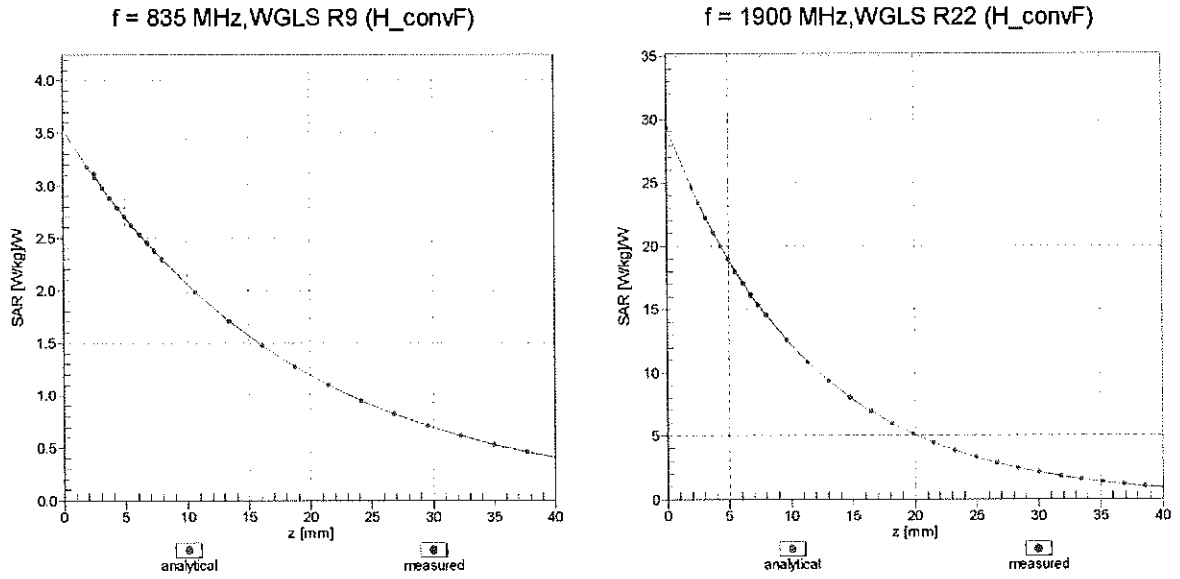

Deviation from Isotropy in Liquid Error (ϕ, θ), f = 900 MHz

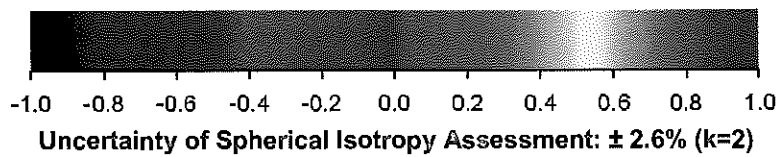
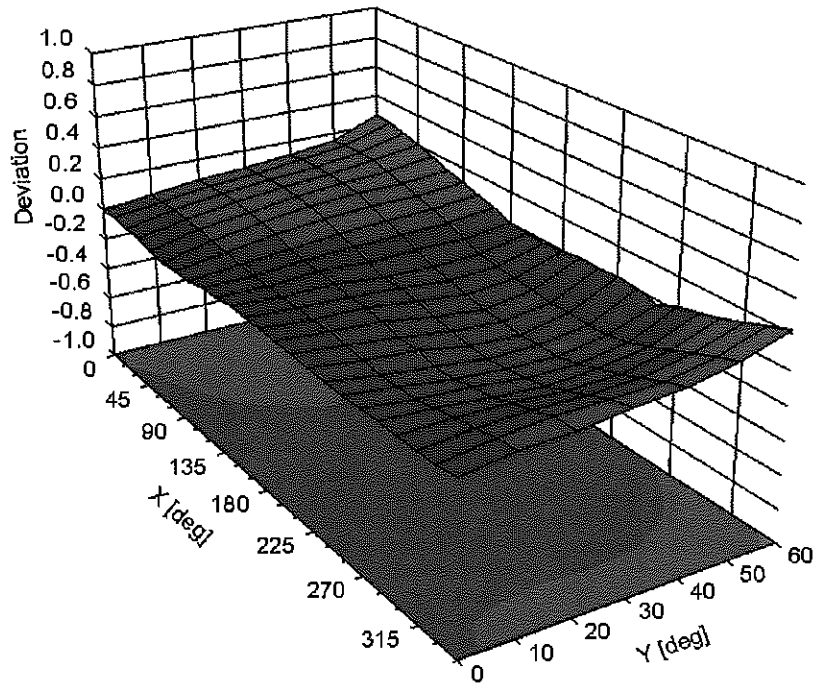

DASY/EASY - Parameters of Probe: ES3DV3 - SN:3347**Other Probe Parameters**

Sensor Arrangement	Triangular
Connector Angle (°)	-16.5
Mechanical Surface Detection Mode	enabled
Optical Surface Detection Mode	disabled
Probe Overall Length	337 mm
Probe Body Diameter	10 mm
Tip Length	10 mm
Tip Diameter	4 mm
Probe Tip to Sensor X Calibration Point	2 mm
Probe Tip to Sensor Y Calibration Point	2 mm
Probe Tip to Sensor Z Calibration Point	2 mm
Recommended Measurement Distance from Surface	3 mm

Appendix: Modulation Calibration Parameters

UID	Communication System Name		A dB	B dB $\sqrt{\mu V}$	C	D dB	VR mV	Max Unc ^E (k=2)
0	CW	X	0.00	0.00	1.00	0.00	201.8	± 3.3 %
		Y	0.00	0.00	1.00		203.9	
		Z	0.00	0.00	1.00		204.8	
10010- CAA	SAR Validation (Square, 100ms, 10ms)	X	7.57	78.06	17.49	10.00	25.0	± 9.6 %
		Y	9.85	82.39	18.69		25.0	
		Z	7.35	77.81	17.08		25.0	
10011- CAB	UMTS-FDD (WCDMA)	X	0.93	66.02	14.08	0.00	150.0	± 9.6 %
		Y	0.97	66.67	14.52		150.0	
		Z	0.93	66.21	14.17		150.0	
10012- CAB	IEEE 802.11b WiFi 2.4 GHz (DSSS, 1 Mbps)	X	1.22	64.40	15.16	0.41	150.0	± 9.6 %
		Y	1.24	64.68	15.35		150.0	
		Z	1.21	64.49	15.23		150.0	
10013- CAB	IEEE 802.11g WiFi 2.4 GHz (DSSS-OFDM, 6 Mbps)	X	5.02	67.09	17.26	1.46	150.0	± 9.6 %
		Y	4.93	67.32	17.31		150.0	
		Z	4.97	67.16	17.27		150.0	
10021- DAC	GSM-FDD (TDMA, GMSK)	X	91.36	118.07	31.34	9.39	50.0	± 9.6 %
		Y	100.00	119.30	31.14		50.0	
		Z	100.00	118.75	31.10		50.0	
10023- DAC	GPRS-FDD (TDMA, GMSK, TN 0)	X	58.54	111.16	29.65	9.57	50.0	± 9.6 %
		Y	100.00	119.20	31.14		50.0	
		Z	100.00	118.71	31.13		50.0	
10024- DAC	GPRS-FDD (TDMA, GMSK, TN 0-1)	X	100.00	115.85	28.82	6.56	60.0	± 9.6 %
		Y	100.00	116.32	28.70		60.0	
		Z	100.00	115.26	28.36		60.0	
10025- DAC	EDGE-FDD (TDMA, 8PSK, TN 0)	X	19.84	109.66	41.73	12.57	50.0	± 9.6 %
		Y	49.03	143.08	53.86		50.0	
		Z	21.37	113.26	43.24		50.0	
10026- DAC	EDGE-FDD (TDMA, 8PSK, TN 0-1)	X	21.22	106.46	36.65	9.56	60.0	± 9.6 %
		Y	31.58	119.85	41.69		60.0	
		Z	22.56	108.96	37.62		60.0	
10027- DAC	GPRS-FDD (TDMA, GMSK, TN 0-1-2)	X	100.00	114.36	27.28	4.80	80.0	± 9.6 %
		Y	100.00	115.58	27.56		80.0	
		Z	100.00	113.91	26.92		80.0	
10028- DAC	GPRS-FDD (TDMA, GMSK, TN 0-1-2-3)	X	100.00	113.86	26.30	3.55	100.0	± 9.6 %
		Y	100.00	115.98	27.02		100.0	
		Z	100.00	113.53	26.01		100.0	
10029- DAC	EDGE-FDD (TDMA, 8PSK, TN 0-1-2)	X	12.94	95.02	31.64	7.80	80.0	± 9.6 %
		Y	14.07	99.40	33.81		80.0	
		Z	12.89	95.72	32.02		80.0	
10030- CAA	IEEE 802.15.1 Bluetooth (GFSK, DH1)	X	100.00	113.99	27.43	5.30	70.0	± 9.6 %
		Y	100.00	114.60	27.41		70.0	
		Z	100.00	113.38	26.98		70.0	
10031- CAA	IEEE 802.15.1 Bluetooth (GFSK, DH3)	X	100.00	111.77	23.93	1.88	100.0	± 9.6 %
		Y	100.00	115.39	25.33		100.0	
		Z	100.00	111.26	23.59		100.0	

10032-CAA	IEEE 802.15.1 Bluetooth (GFSK, DH5)	X	100.00	111.85	22.94	1.17	100.0	± 9.6 %
		Y	100.00	118.40	25.59		100.0	
		Z	100.00	111.34	22.62		100.0	
10033-CAA	IEEE 802.15.1 Bluetooth (PI/4-DQPSK, DH1)	X	23.91	101.19	27.41	5.30	70.0	± 9.6 %
		Y	36.18	107.81	28.88		70.0	
		Z	30.63	104.89	28.18		70.0	
10034-CAA	IEEE 802.15.1 Bluetooth (PI/4-DQPSK, DH3)	X	6.24	84.08	20.44	1.88	100.0	± 9.6 %
		Y	7.24	85.92	20.55		100.0	
		Z	6.85	85.19	20.50		100.0	
10035-CAA	IEEE 802.15.1 Bluetooth (PI/4-DQPSK, DH5)	X	3.29	76.95	17.63	1.17	100.0	± 9.6 %
		Y	3.58	78.09	17.57		100.0	
		Z	3.42	77.43	17.51		100.0	
10036-CAA	IEEE 802.15.1 Bluetooth (8-DPSK, DH1)	X	32.79	106.39	28.91	5.30	70.0	± 9.6 %
		Y	55.24	114.58	30.68		70.0	
		Z	45.73	111.34	29.95		70.0	
10037-CAA	IEEE 802.15.1 Bluetooth (8-DPSK, DH3)	X	5.86	83.28	20.13	1.88	100.0	± 9.6 %
		Y	6.54	84.66	20.12		100.0	
		Z	6.31	84.13	20.12		100.0	
10038-CAA	IEEE 802.15.1 Bluetooth (8-DPSK, DH5)	X	3.39	77.59	17.96	1.17	100.0	± 9.6 %
		Y	3.66	78.64	17.87		100.0	
		Z	3.53	78.11	17.85		100.0	
10039-CAB	CDMA2000 (1xRTT, RC1)	X	1.52	69.16	14.18	0.00	150.0	± 9.6 %
		Y	1.40	68.90	13.55		150.0	
		Z	1.46	69.03	13.83		150.0	
10042-CAB	IS-54 / IS-136 FDD (TDMA/FDM, PI/4-DQPSK, Halfrate)	X	100.00	114.62	28.47	7.78	50.0	± 9.6 %
		Y	100.00	114.70	28.14		50.0	
		Z	100.00	113.88	27.92		50.0	
10044-CAA	IS-91/EIA/TIA-553 FDD (FDMA, FM)	X	0.01	121.88	0.68	0.00	150.0	± 9.6 %
		Y	0.00	97.83	1.91		150.0	
		Z	0.01	122.55	0.35		150.0	
10048-CAA	DECT (TDD, TDMA/FDM, GFSK, Full Slot, 24)	X	17.94	92.17	26.06	13.80	25.0	± 9.6 %
		Y	42.19	107.21	29.95		25.0	
		Z	24.74	97.63	27.36		25.0	
10049-CAA	DECT (TDD, TDMA/FDM, GFSK, Double Slot, 12)	X	22.69	96.29	25.94	10.79	40.0	± 9.6 %
		Y	68.20	113.74	30.23		40.0	
		Z	32.65	101.85	27.19		40.0	
10056-CAA	UMTS-TDD (TD-SCDMA, 1.28 Mcps)	X	16.99	92.79	25.84	9.03	50.0	± 9.6 %
		Y	27.63	101.84	28.34		50.0	
		Z	20.13	95.81	26.57		50.0	
10058-DAC	EDGE-FDD (TDMA, 8PSK, TN 0-1-2-3)	X	9.12	87.95	28.36	6.55	100.0	± 9.6 %
		Y	8.98	89.45	29.43		100.0	
		Z	8.90	88.06	28.51		100.0	
10059-CAB	IEEE 802.11b WiFi 2.4 GHz (DSSS, 2 Mbps)	X	1.37	66.39	16.16	0.61	110.0	± 9.6 %
		Y	1.38	66.59	16.33		110.0	
		Z	1.36	66.49	16.23		110.0	
10060-CAB	IEEE 802.11b WiFi 2.4 GHz (DSSS, 5.5 Mbps)	X	100.00	128.08	31.98	1.30	110.0	± 9.6 %
		Y	100.00	131.22	33.31		110.0	
		Z	100.00	128.65	32.15		110.0	

10061-CAB	IEEE 802.11b WiFi 2.4 GHz (DSSS, 11 Mbps)	X	9.25	94.71	26.12	2.04	110.0	± 9.6 %
		Y	9.59	96.73	27.06		110.0	
		Z	10.28	96.95	26.85		110.0	
10062-CAC	IEEE 802.11a/h WiFi 5 GHz (OFDM, 6 Mbps)	X	4.74	66.85	16.53	0.49	100.0	± 9.6 %
		Y	4.66	67.04	16.57		100.0	
		Z	4.70	66.90	16.54		100.0	
10063-CAC	IEEE 802.11a/h WiFi 5 GHz (OFDM, 9 Mbps)	X	4.78	67.00	16.67	0.72	100.0	± 9.6 %
		Y	4.69	67.19	16.70		100.0	
		Z	4.73	67.05	16.68		100.0	
10064-CAC	IEEE 802.11a/h WiFi 5 GHz (OFDM, 12 Mbps)	X	5.09	67.32	16.93	0.86	100.0	± 9.6 %
		Y	4.97	67.46	16.94		100.0	
		Z	5.03	67.35	16.93		100.0	
10065-CAC	IEEE 802.11a/h WiFi 5 GHz (OFDM, 18 Mbps)	X	4.99	67.34	17.10	1.21	100.0	± 9.6 %
		Y	4.88	67.46	17.11		100.0	
		Z	4.93	67.36	17.10		100.0	
10066-CAC	IEEE 802.11a/h WiFi 5 GHz (OFDM, 24 Mbps)	X	5.05	67.46	17.33	1.46	100.0	± 9.6 %
		Y	4.92	67.57	17.33		100.0	
		Z	4.98	67.48	17.32		100.0	
10067-CAC	IEEE 802.11a/h WiFi 5 GHz (OFDM, 36 Mbps)	X	5.36	67.67	17.81	2.04	100.0	± 9.6 %
		Y	5.25	67.92	17.88		100.0	
		Z	5.30	67.73	17.82		100.0	
10068-CAC	IEEE 802.11a/h WiFi 5 GHz (OFDM, 48 Mbps)	X	5.48	67.95	18.15	2.55	100.0	± 9.6 %
		Y	5.33	68.04	18.16		100.0	
		Z	5.40	67.94	18.13		100.0	
10069-CAC	IEEE 802.11a/h WiFi 5 GHz (OFDM, 54 Mbps)	X	5.56	67.94	18.35	2.67	100.0	± 9.6 %
		Y	5.42	68.11	18.40		100.0	
		Z	5.49	67.96	18.34		100.0	
10071-CAB	IEEE 802.11g WiFi 2.4 GHz (DSSS/OFDM, 9 Mbps)	X	5.16	67.32	17.64	1.99	100.0	± 9.6 %
		Y	5.07	67.53	17.70		100.0	
		Z	5.11	67.37	17.65		100.0	
10072-CAB	IEEE 802.11g WiFi 2.4 GHz (DSSS/OFDM, 12 Mbps)	X	5.20	67.83	17.95	2.30	100.0	± 9.6 %
		Y	5.09	67.99	18.00		100.0	
		Z	5.14	67.86	17.96		100.0	
10073-CAB	IEEE 802.11g WiFi 2.4 GHz (DSSS/OFDM, 18 Mbps)	X	5.32	68.17	18.37	2.83	100.0	± 9.6 %
		Y	5.22	68.36	18.44		100.0	
		Z	5.26	68.20	18.38		100.0	
10074-CAB	IEEE 802.11g WiFi 2.4 GHz (DSSS/OFDM, 24 Mbps)	X	5.35	68.22	18.60	3.30	100.0	± 9.6 %
		Y	5.26	68.43	18.68		100.0	
		Z	5.29	68.25	18.61		100.0	
10075-CAB	IEEE 802.11g WiFi 2.4 GHz (DSSS/OFDM, 36 Mbps)	X	5.48	68.62	19.07	3.82	90.0	± 9.6 %
		Y	5.35	68.73	19.11		90.0	
		Z	5.40	68.60	19.05		90.0	
10076-CAB	IEEE 802.11g WiFi 2.4 GHz (DSSS/OFDM, 48 Mbps)	X	5.50	68.45	19.21	4.15	90.0	± 9.6 %
		Y	5.40	68.64	19.31		90.0	
		Z	5.44	68.46	19.21		90.0	
10077-CAB	IEEE 802.11g WiFi 2.4 GHz (DSSS/OFDM, 54 Mbps)	X	5.54	68.54	19.31	4.30	90.0	± 9.6 %
		Y	5.44	68.76	19.43		90.0	
		Z	5.48	68.56	19.32		90.0	

10081-CAB	CDMA2000 (1xRTT, RC3)	X	0.74	64.32	11.31	0.00	150.0	± 9.6 %
		Y	0.70	64.20	10.81		150.0	
		Z	0.71	64.15	10.92		150.0	
10082-CAB	IS-54 / IS-136 FDD (TDMA/FDM, PI/4-DQPSK, Fullrate)	X	1.69	62.26	7.32	4.77	80.0	± 9.6 %
		Y	1.49	62.02	6.99		80.0	
		Z	1.55	61.83	6.90		80.0	
10090-DAC	GPRS-FDD (TDMA, GMSK, TN 0-4)	X	100.00	115.94	28.89	6.56	60.0	± 9.6 %
		Y	100.00	116.39	28.75		60.0	
		Z	100.00	115.35	28.42		60.0	
10097-CAB	UMTS-FDD (HSDPA)	X	1.73	66.76	14.97	0.00	150.0	± 9.6 %
		Y	1.76	67.41	15.16		150.0	
		Z	1.72	67.00	15.02		150.0	
10098-CAB	UMTS-FDD (HSUPA, Subtest 2)	X	1.69	66.71	14.93	0.00	150.0	± 9.6 %
		Y	1.72	67.36	15.13		150.0	
		Z	1.69	66.94	14.98		150.0	
10099-DAC	EDGE-FDD (TDMA, 8PSK, TN 0-4)	X	21.17	106.37	36.62	9.56	60.0	± 9.6 %
		Y	31.53	119.75	41.66		60.0	
		Z	22.53	108.88	37.59		60.0	
10100-CAD	LTE-FDD (SC-FDMA, 100% RB, 20 MHz, QPSK)	X	3.02	69.66	16.13	0.00	150.0	± 9.6 %
		Y	2.98	69.86	16.33		150.0	
		Z	2.99	69.71	16.19		150.0	
10101-CAD	LTE-FDD (SC-FDMA, 100% RB, 20 MHz, 16-QAM)	X	3.20	67.30	15.63	0.00	150.0	± 9.6 %
		Y	3.15	67.42	15.72		150.0	
		Z	3.17	67.31	15.65		150.0	
10102-CAD	LTE-FDD (SC-FDMA, 100% RB, 20 MHz, 64-QAM)	X	3.31	67.28	15.74	0.00	150.0	± 9.6 %
		Y	3.26	67.39	15.81		150.0	
		Z	3.27	67.30	15.76		150.0	
10103-CAD	LTE-TDD (SC-FDMA, 100% RB, 20 MHz, QPSK)	X	8.39	78.42	21.27	3.98	65.0	± 9.6 %
		Y	8.55	79.75	21.92		65.0	
		Z	8.43	78.92	21.50		65.0	
10104-CAD	LTE-TDD (SC-FDMA, 100% RB, 20 MHz, 16-QAM)	X	8.28	76.92	21.52	3.98	65.0	± 9.6 %
		Y	8.11	77.48	21.85		65.0	
		Z	8.18	77.09	21.61		65.0	
10105-CAD	LTE-TDD (SC-FDMA, 100% RB, 20 MHz, 64-QAM)	X	7.63	75.31	21.13	3.98	65.0	± 9.6 %
		Y	7.72	76.48	21.73		65.0	
		Z	7.57	75.55	21.26		65.0	
10108-CAE	LTE-FDD (SC-FDMA, 100% RB, 10 MHz, QPSK)	X	2.65	68.92	15.95	0.00	150.0	± 9.6 %
		Y	2.59	69.14	16.15		150.0	
		Z	2.61	68.99	16.01		150.0	
10109-CAE	LTE-FDD (SC-FDMA, 100% RB, 10 MHz, 16-QAM)	X	2.86	67.08	15.50	0.00	150.0	± 9.6 %
		Y	2.80	67.24	15.55		150.0	
		Z	2.82	67.11	15.51		150.0	
10110-CAE	LTE-FDD (SC-FDMA, 100% RB, 5 MHz, QPSK)	X	2.15	67.97	15.52	0.00	150.0	± 9.6 %
		Y	2.09	68.27	15.68		150.0	
		Z	2.11	68.06	15.56		150.0	
10111-CAE	LTE-FDD (SC-FDMA, 100% RB, 5 MHz, 16-QAM)	X	2.54	67.60	15.65	0.00	150.0	± 9.6 %
		Y	2.49	67.90	15.64		150.0	
		Z	2.51	67.74	15.66		150.0	

10112-CAE	LTE-FDD (SC-FDMA, 100% RB, 10 MHz, 64-QAM)	X	2.98	67.08	15.57	0.00	150.0	± 9.6 %
		Y	2.92	67.27	15.62		150.0	
		Z	2.94	67.13	15.58		150.0	
10113-CAE	LTE-FDD (SC-FDMA, 100% RB, 5 MHz, 64-QAM)	X	2.70	67.76	15.81	0.00	150.0	± 9.6 %
		Y	2.63	68.07	15.78		150.0	
		Z	2.66	67.92	15.82		150.0	
10114-CAC	IEEE 802.11n (HT Greenfield, 13.5 Mbps, BPSK)	X	5.13	67.22	16.34	0.00	150.0	± 9.6 %
		Y	5.06	67.35	16.39		150.0	
		Z	5.10	67.28	16.37		150.0	
10115-CAC	IEEE 802.11n (HT Greenfield, 81 Mbps, 16-QAM)	X	5.46	67.47	16.48	0.00	150.0	± 9.6 %
		Y	5.32	67.42	16.43		150.0	
		Z	5.39	67.43	16.46		150.0	
10116-CAC	IEEE 802.11n (HT Greenfield, 135 Mbps, 64-QAM)	X	5.25	67.46	16.39	0.00	150.0	± 9.6 %
		Y	5.15	67.53	16.41		150.0	
		Z	5.20	67.47	16.40		150.0	
10117-CAC	IEEE 802.11n (HT Mixed, 13.5 Mbps, BPSK)	X	5.10	67.11	16.30	0.00	150.0	± 9.6 %
		Y	5.03	67.22	16.34		150.0	
		Z	5.06	67.11	16.31		150.0	
10118-CAC	IEEE 802.11n (HT Mixed, 81 Mbps, 16-QAM)	X	5.56	67.71	16.61	0.00	150.0	± 9.6 %
		Y	5.40	67.63	16.55		150.0	
		Z	5.48	67.67	16.59		150.0	
10119-CAC	IEEE 802.11n (HT Mixed, 135 Mbps, 64-QAM)	X	5.22	67.39	16.37	0.00	150.0	± 9.6 %
		Y	5.13	67.49	16.40		150.0	
		Z	5.18	67.42	16.38		150.0	
10140-CAD	LTE-FDD (SC-FDMA, 100% RB, 15 MHz, 16-QAM)	X	3.35	67.28	15.66	0.00	150.0	± 9.6 %
		Y	3.29	67.41	15.73		150.0	
		Z	3.31	67.30	15.68		150.0	
10141-CAD	LTE-FDD (SC-FDMA, 100% RB, 15 MHz, 64-QAM)	X	3.47	67.38	15.84	0.00	150.0	± 9.6 %
		Y	3.41	67.52	15.90		150.0	
		Z	3.43	67.42	15.86		150.0	
10142-CAD	LTE-FDD (SC-FDMA, 100% RB, 3 MHz, QPSK)	X	1.91	67.75	15.10	0.00	150.0	± 9.6 %
		Y	1.84	68.07	15.11		150.0	
		Z	1.87	67.86	15.08		150.0	
10143-CAD	LTE-FDD (SC-FDMA, 100% RB, 3 MHz, 16-QAM)	X	2.37	68.04	15.25	0.00	150.0	± 9.6 %
		Y	2.29	68.28	15.02		150.0	
		Z	2.33	68.17	15.16		150.0	
10144-CAD	LTE-FDD (SC-FDMA, 100% RB, 3 MHz, 64-QAM)	X	2.20	66.14	13.84	0.00	150.0	± 9.6 %
		Y	2.08	66.17	13.48		150.0	
		Z	2.13	66.11	13.65		150.0	
10145-CAE	LTE-FDD (SC-FDMA, 100% RB, 1.4 MHz, QPSK)	X	1.17	64.40	11.32	0.00	150.0	± 9.6 %
		Y	0.99	63.23	9.93		150.0	
		Z	1.08	63.80	10.61		150.0	
10146-CAE	LTE-FDD (SC-FDMA, 100% RB, 1.4 MHz, 16-QAM)	X	2.07	66.79	12.08	0.00	150.0	± 9.6 %
		Y	1.74	65.46	10.58		150.0	
		Z	1.93	66.25	11.43		150.0	
10147-CAE	LTE-FDD (SC-FDMA, 100% RB, 1.4 MHz, 64-QAM)	X	2.41	68.68	13.11	0.00	150.0	± 9.6 %
		Y	2.02	67.13	11.50		150.0	
		Z	2.26	68.13	12.45		150.0	

10149-CAD	LTE-FDD (SC-FDMA, 50% RB, 20 MHz, 16-QAM)	X	2.87	67.13	15.54	0.00	150.0	± 9.6 %
		Y	2.81	67.29	15.59		150.0	
		Z	2.83	67.17	15.55		150.0	
10150-CAD	LTE-FDD (SC-FDMA, 50% RB, 20 MHz, 64-QAM)	X	2.99	67.13	15.61	0.00	150.0	± 9.6 %
		Y	2.93	67.31	15.66		150.0	
		Z	2.95	67.18	15.62		150.0	
10151-CAD	LTE-TDD (SC-FDMA, 50% RB, 20 MHz, QPSK)	X	9.21	81.33	22.45	3.98	65.0	± 9.6 %
		Y	9.55	83.12	23.24		65.0	
		Z	9.38	82.15	22.79		65.0	
10152-CAD	LTE-TDD (SC-FDMA, 50% RB, 20 MHz, 16-QAM)	X	7.89	77.12	21.32	3.98	65.0	± 9.6 %
		Y	7.75	77.78	21.62		65.0	
		Z	7.80	77.32	21.39		65.0	
10153-CAD	LTE-TDD (SC-FDMA, 50% RB, 20 MHz, 64-QAM)	X	8.33	78.05	22.06	3.98	65.0	± 9.6 %
		Y	8.20	78.76	22.36		65.0	
		Z	8.27	78.34	22.17		65.0	
10154-CAE	LTE-FDD (SC-FDMA, 50% RB, 10 MHz, QPSK)	X	2.19	68.34	15.77	0.00	150.0	± 9.6 %
		Y	2.13	68.58	15.88		150.0	
		Z	2.15	68.43	15.80		150.0	
10155-CAE	LTE-FDD (SC-FDMA, 50% RB, 10 MHz, 16-QAM)	X	2.54	67.61	15.66	0.00	150.0	± 9.6 %
		Y	2.49	67.93	15.66		150.0	
		Z	2.51	67.76	15.67		150.0	
10156-CAE	LTE-FDD (SC-FDMA, 50% RB, 5 MHz, QPSK)	X	1.75	67.70	14.83	0.00	150.0	± 9.6 %
		Y	1.67	67.86	14.67		150.0	
		Z	1.70	67.75	14.73		150.0	
10157-CAE	LTE-FDD (SC-FDMA, 50% RB, 5 MHz, 16-QAM)	X	2.01	66.49	13.77	0.00	150.0	± 9.6 %
		Y	1.89	66.41	13.28		150.0	
		Z	1.95	66.44	13.53		150.0	
10158-CAE	LTE-FDD (SC-FDMA, 50% RB, 10 MHz, 64-QAM)	X	2.70	67.82	15.85	0.00	150.0	± 9.6 %
		Y	2.64	68.13	15.83		150.0	
		Z	2.67	67.98	15.86		150.0	
10159-CAE	LTE-FDD (SC-FDMA, 50% RB, 5 MHz, 64-QAM)	X	2.11	66.90	14.04	0.00	150.0	± 9.6 %
		Y	1.98	66.74	13.50		150.0	
		Z	2.04	66.83	13.79		150.0	
10160-CAD	LTE-FDD (SC-FDMA, 50% RB, 15 MHz, QPSK)	X	2.69	68.21	15.87	0.00	150.0	± 9.6 %
		Y	2.64	68.50	16.02		150.0	
		Z	2.66	68.34	15.93		150.0	
10161-CAD	LTE-FDD (SC-FDMA, 50% RB, 15 MHz, 16-QAM)	X	2.88	67.04	15.53	0.00	150.0	± 9.6 %
		Y	2.82	67.25	15.56		150.0	
		Z	2.84	67.11	15.53		150.0	
10162-CAD	LTE-FDD (SC-FDMA, 50% RB, 15 MHz, 64-QAM)	X	2.99	67.17	15.64	0.00	150.0	± 9.6 %
		Y	2.93	67.43	15.68		150.0	
		Z	2.96	67.27	15.66		150.0	
10166-CAE	LTE-FDD (SC-FDMA, 50% RB, 1.4 MHz, QPSK)	X	3.67	69.76	19.07	3.01	150.0	± 9.6 %
		Y	3.59	70.61	19.72		150.0	
		Z	3.64	70.17	19.36		150.0	
10167-CAE	LTE-FDD (SC-FDMA, 50% RB, 1.4 MHz, 16-QAM)	X	4.60	72.78	19.56	3.01	150.0	± 9.6 %
		Y	4.59	74.59	20.58		150.0	
		Z	4.60	73.54	19.97		150.0	

10168-CAE	LTE-FDD (SC-FDMA, 50% RB, 1.4 MHz, 64-QAM)	X	5.10	75.00	20.86	3.01	150.0	± 9.6 %
		Y	5.17	77.15	22.00		150.0	
		Z	5.18	76.08	21.41		150.0	
10169-CAD	LTE-FDD (SC-FDMA, 1 RB, 20 MHz, QPSK)	X	3.14	69.82	19.09	3.01	150.0	± 9.6 %
		Y	2.99	70.11	19.57		150.0	
		Z	3.08	69.99	19.30		150.0	
10170-CAD	LTE-FDD (SC-FDMA, 1 RB, 20 MHz, 16-QAM)	X	4.48	76.11	21.47	3.01	150.0	± 9.6 %
		Y	4.42	77.92	22.61		150.0	
		Z	4.51	77.09	22.03		150.0	
10171-AAD	LTE-FDD (SC-FDMA, 1 RB, 20 MHz, 64-QAM)	X	3.64	71.74	18.65	3.01	150.0	± 9.6 %
		Y	3.56	73.31	19.70		150.0	
		Z	3.59	72.29	19.01		150.0	
10172-CAD	LTE-TDD (SC-FDMA, 1 RB, 20 MHz, QPSK)	X	21.10	104.74	32.18	6.02	65.0	± 9.6 %
		Y	44.31	124.23	38.59		65.0	
		Z	24.87	109.58	33.89		65.0	
10173-CAD	LTE-TDD (SC-FDMA, 1 RB, 20 MHz, 16-QAM)	X	37.36	109.91	31.76	6.02	65.0	± 9.6 %
		Y	100.00	131.53	37.83		65.0	
		Z	66.45	121.49	34.95		65.0	
10174-CAD	LTE-TDD (SC-FDMA, 1 RB, 20 MHz, 64-QAM)	X	28.71	103.81	29.50	6.02	65.0	± 9.6 %
		Y	93.12	128.22	36.43		65.0	
		Z	36.57	109.34	31.20		65.0	
10175-CAE	LTE-FDD (SC-FDMA, 1 RB, 10 MHz, QPSK)	X	3.10	69.50	18.83	3.01	150.0	± 9.6 %
		Y	2.96	69.84	19.35		150.0	
		Z	3.04	69.66	19.04		150.0	
10176-CAE	LTE-FDD (SC-FDMA, 1 RB, 10 MHz, 16-QAM)	X	4.49	76.13	21.48	3.01	150.0	± 9.6 %
		Y	4.43	77.95	22.63		150.0	
		Z	4.52	77.11	22.04		150.0	
10177-CAG	LTE-FDD (SC-FDMA, 1 RB, 5 MHz, QPSK)	X	3.13	69.65	18.93	3.01	150.0	± 9.6 %
		Y	2.98	69.97	19.42		150.0	
		Z	3.07	69.81	19.14		150.0	
10178-CAE	LTE-FDD (SC-FDMA, 1 RB, 5 MHz, 16-QAM)	X	4.43	75.88	21.35	3.01	150.0	± 9.6 %
		Y	4.39	77.75	22.52		150.0	
		Z	4.47	76.86	21.91		150.0	
10179-CAE	LTE-FDD (SC-FDMA, 1 RB, 10 MHz, 64-QAM)	X	4.01	73.75	19.90	3.01	150.0	± 9.6 %
		Y	3.96	75.54	21.04		150.0	
		Z	4.01	74.52	20.37		150.0	
10180-CAE	LTE-FDD (SC-FDMA, 1 RB, 5 MHz, 64-QAM)	X	3.63	71.66	18.60	3.01	150.0	± 9.6 %
		Y	3.55	73.25	19.66		150.0	
		Z	3.59	72.21	18.96		150.0	
10181-CAD	LTE-FDD (SC-FDMA, 1 RB, 15 MHz, QPSK)	X	3.13	69.64	18.92	3.01	150.0	± 9.6 %
		Y	2.98	69.95	19.42		150.0	
		Z	3.06	69.80	19.13		150.0	
10182-CAD	LTE-FDD (SC-FDMA, 1 RB, 15 MHz, 16-QAM)	X	4.42	75.86	21.34	3.01	150.0	± 9.6 %
		Y	4.38	77.72	22.51		150.0	
		Z	4.46	76.83	21.90		150.0	
10183-AAC	LTE-FDD (SC-FDMA, 1 RB, 15 MHz, 64-QAM)	X	3.62	71.63	18.59	3.01	150.0	± 9.6 %
		Y	3.55	73.22	19.65		150.0	
		Z	3.58	72.19	18.94		150.0	

10184-CAD	LTE-FDD (SC-FDMA, 1 RB, 3 MHz, QPSK)	X	3.14	69.68	18.95	3.01	150.0	± 9.6 %
		Y	2.99	69.99	19.44		150.0	
		Z	3.07	69.84	19.16		150.0	
10185-CAD	LTE-FDD (SC-FDMA, 1 RB, 3 MHz, 16-QAM)	X	4.45	75.93	21.38	3.01	150.0	± 9.6 %
		Y	4.40	77.80	22.55		150.0	
		Z	4.48	76.92	21.94		150.0	
10186-AAD	LTE-FDD (SC-FDMA, 1 RB, 3 MHz, 64-QAM)	X	3.64	71.70	18.62	3.01	150.0	± 9.6 %
		Y	3.56	73.30	19.69		150.0	
		Z	3.60	72.26	18.98		150.0	
10187-CAE	LTE-FDD (SC-FDMA, 1 RB, 1.4 MHz, QPSK)	X	3.15	69.73	19.01	3.01	150.0	± 9.6 %
		Y	3.00	70.06	19.51		150.0	
		Z	3.08	69.90	19.22		150.0	
10188-CAE	LTE-FDD (SC-FDMA, 1 RB, 1.4 MHz, 16-QAM)	X	4.60	76.65	21.77	3.01	150.0	± 9.6 %
		Y	4.55	78.49	22.93		150.0	
		Z	4.65	77.69	22.36		150.0	
10189-AAE	LTE-FDD (SC-FDMA, 1 RB, 1.4 MHz, 64-QAM)	X	3.72	72.15	18.90	3.01	150.0	± 9.6 %
		Y	3.65	73.76	19.97		150.0	
		Z	3.69	72.74	19.28		150.0	
10193-CAC	IEEE 802.11n (HT Greenfield, 6.5 Mbps, BPSK)	X	4.52	66.58	16.02	0.00	150.0	± 9.6 %
		Y	4.45	66.79	16.05		150.0	
		Z	4.48	66.63	16.03		150.0	
10194-CAC	IEEE 802.11n (HT Greenfield, 39 Mbps, 16-QAM)	X	4.70	66.91	16.15	0.00	150.0	± 9.6 %
		Y	4.60	67.08	16.18		150.0	
		Z	4.65	66.95	16.16		150.0	
10195-CAC	IEEE 802.11n (HT Greenfield, 65 Mbps, 64-QAM)	X	4.74	66.94	16.17	0.00	150.0	± 9.6 %
		Y	4.65	67.11	16.20		150.0	
		Z	4.69	66.98	16.18		150.0	
10196-CAC	IEEE 802.11n (HT Mixed, 6.5 Mbps, BPSK)	X	4.53	66.65	16.05	0.00	150.0	± 9.6 %
		Y	4.44	66.83	16.06		150.0	
		Z	4.48	66.69	16.05		150.0	
10197-CAC	IEEE 802.11n (HT Mixed, 39 Mbps, 16-QAM)	X	4.72	66.93	16.16	0.00	150.0	± 9.6 %
		Y	4.62	67.10	16.19		150.0	
		Z	4.66	66.97	16.17		150.0	
10198-CAC	IEEE 802.11n (HT Mixed, 65 Mbps, 64-QAM)	X	4.75	66.96	16.18	0.00	150.0	± 9.6 %
		Y	4.64	67.13	16.21		150.0	
		Z	4.69	67.00	16.19		150.0	
10219-CAC	IEEE 802.11n (HT Mixed, 7.2 Mbps, BPSK)	X	4.48	66.66	16.00	0.00	150.0	± 9.6 %
		Y	4.39	66.84	16.01		150.0	
		Z	4.43	66.70	16.00		150.0	
10220-CAC	IEEE 802.11n (HT Mixed, 43.3 Mbps, 16-QAM)	X	4.71	66.91	16.16	0.00	150.0	± 9.6 %
		Y	4.61	67.06	16.18		150.0	
		Z	4.66	66.94	16.16		150.0	
10221-CAC	IEEE 802.11n (HT Mixed, 72.2 Mbps, 64-QAM)	X	4.76	66.89	16.17	0.00	150.0	± 9.6 %
		Y	4.65	67.06	16.20		150.0	
		Z	4.70	66.93	16.18		150.0	
10222-CAC	IEEE 802.11n (HT Mixed, 15 Mbps, BPSK)	X	5.08	67.11	16.29	0.00	150.0	± 9.6 %
		Y	5.00	67.21	16.33		150.0	
		Z	5.03	67.12	16.30		150.0	

10223-CAC	IEEE 802.11n (HT Mixed, 90 Mbps, 16-QAM)	X	5.40	67.34	16.44	0.00	150.0	± 9.6 %
		Y	5.30	67.47	16.48		150.0	
		Z	5.35	67.37	16.45		150.0	
10224-CAC	IEEE 802.11n (HT Mixed, 150 Mbps, 64-QAM)	X	5.12	67.22	16.27	0.00	150.0	± 9.6 %
		Y	5.04	67.32	16.31		150.0	
		Z	5.08	67.23	16.28		150.0	
10225-CAB	UMTS-FDD (HSPA+)	X	2.77	65.87	15.07	0.00	150.0	± 9.6 %
		Y	2.71	66.11	14.95		150.0	
		Z	2.73	65.95	15.01		150.0	
10226-CAA	LTE-TDD (SC-FDMA, 1 RB, 1.4 MHz, 16-QAM)	X	40.90	111.69	32.33	6.02	65.0	± 9.6 %
		Y	100.00	131.74	37.97		65.0	
		Z	76.08	124.13	35.71		65.0	
10227-CAA	LTE-TDD (SC-FDMA, 1 RB, 1.4 MHz, 64-QAM)	X	32.04	105.79	30.14	6.02	65.0	± 9.6 %
		Y	100.00	129.20	36.63		65.0	
		Z	56.03	116.66	33.17		65.0	
10228-CAA	LTE-TDD (SC-FDMA, 1 RB, 1.4 MHz, QPSK)	X	32.49	113.40	34.73	6.02	65.0	± 9.6 %
		Y	63.93	131.79	40.55		65.0	
		Z	42.68	120.45	36.94		65.0	
10229-CAB	LTE-TDD (SC-FDMA, 1 RB, 3 MHz, 16-QAM)	X	37.48	109.96	31.78	6.02	65.0	± 9.6 %
		Y	100.00	131.51	37.84		65.0	
		Z	66.68	121.54	34.97		65.0	
10230-CAB	LTE-TDD (SC-FDMA, 1 RB, 3 MHz, 64-QAM)	X	29.78	104.42	29.68	6.02	65.0	± 9.6 %
		Y	100.00	129.07	36.54		65.0	
		Z	50.21	114.61	32.57		65.0	
10231-CAB	LTE-TDD (SC-FDMA, 1 RB, 3 MHz, QPSK)	X	30.12	111.79	34.20	6.02	65.0	± 9.6 %
		Y	57.30	129.38	39.87		65.0	
		Z	38.78	118.39	36.30		65.0	
10232-CAD	LTE-TDD (SC-FDMA, 1 RB, 5 MHz, 16-QAM)	X	37.48	109.97	31.78	6.02	65.0	± 9.6 %
		Y	100.00	131.53	37.84		65.0	
		Z	66.72	121.56	34.98		65.0	
10233-CAD	LTE-TDD (SC-FDMA, 1 RB, 5 MHz, 64-QAM)	X	29.77	104.42	29.68	6.02	65.0	± 9.6 %
		Y	100.00	129.09	36.55		65.0	
		Z	50.19	114.62	32.57		65.0	
10234-CAD	LTE-TDD (SC-FDMA, 1 RB, 5 MHz, QPSK)	X	28.05	110.17	33.63	6.02	65.0	± 9.6 %
		Y	51.99	127.09	39.16		65.0	
		Z	35.54	116.41	35.65		65.0	
10235-CAD	LTE-TDD (SC-FDMA, 1 RB, 10 MHz, 16-QAM)	X	37.64	110.05	31.80	6.02	65.0	± 9.6 %
		Y	100.00	131.54	37.84		65.0	
		Z	67.18	121.70	35.01		65.0	
10236-CAD	LTE-TDD (SC-FDMA, 1 RB, 10 MHz, 64-QAM)	X	30.09	104.58	29.72	6.02	65.0	± 9.6 %
		Y	100.00	129.03	36.52		65.0	
		Z	50.96	114.84	32.62		65.0	
10237-CAD	LTE-TDD (SC-FDMA, 1 RB, 10 MHz, QPSK)	X	30.42	112.00	34.26	6.02	65.0	± 9.6 %
		Y	58.39	129.80	39.98		65.0	
		Z	39.25	118.66	36.38		65.0	
10238-CAD	LTE-TDD (SC-FDMA, 1 RB, 15 MHz, 16-QAM)	X	37.48	109.98	31.78	6.02	65.0	± 9.6 %
		Y	100.00	131.54	37.84		65.0	
		Z	66.77	121.59	34.98		65.0	

10239-CAD	LTE-TDD (SC-FDMA, 1 RB, 15 MHz, 64-QAM)	X	29.75	104.43	29.68	6.02	65.0	± 9.6 %
		Y	100.00	129.11	36.55		65.0	
		Z	50.17	114.63	32.57		65.0	
10240-CAD	LTE-TDD (SC-FDMA, 1 RB, 15 MHz, QPSK)	X	30.30	111.94	34.24	6.02	65.0	± 9.6 %
		Y	58.14	129.72	39.96		65.0	
		Z	39.09	118.59	36.36		65.0	
10241-CAA	LTE-TDD (SC-FDMA, 50% RB, 1.4 MHz, 16-QAM)	X	11.80	86.80	27.35	6.98	65.0	± 9.6 %
		Y	13.67	92.53	29.81		65.0	
		Z	12.27	88.56	28.08		65.0	
10242-CAA	LTE-TDD (SC-FDMA, 50% RB, 1.4 MHz, 64-QAM)	X	10.15	83.59	26.03	6.98	65.0	± 9.6 %
		Y	12.26	90.20	28.90		65.0	
		Z	10.49	85.23	26.75		65.0	
10243-CAA	LTE-TDD (SC-FDMA, 50% RB, 1.4 MHz, QPSK)	X	8.15	80.45	25.67	6.98	65.0	± 9.6 %
		Y	9.07	85.16	28.03		65.0	
		Z	8.20	81.43	26.18		65.0	
10244-CAB	LTE-TDD (SC-FDMA, 50% RB, 3 MHz, 16-QAM)	X	8.77	79.58	20.12	3.98	65.0	± 9.6 %
		Y	8.68	79.98	19.73		65.0	
		Z	8.93	80.10	20.07		65.0	
10245-CAB	LTE-TDD (SC-FDMA, 50% RB, 3 MHz, 64-QAM)	X	8.56	78.94	19.83	3.98	65.0	± 9.6 %
		Y	8.27	79.00	19.30		65.0	
		Z	8.60	79.28	19.71		65.0	
10246-CAB	LTE-TDD (SC-FDMA, 50% RB, 3 MHz, QPSK)	X	9.05	82.96	21.42	3.98	65.0	± 9.6 %
		Y	8.67	82.79	20.89		65.0	
		Z	9.07	83.18	21.25		65.0	
10247-CAD	LTE-TDD (SC-FDMA, 50% RB, 5 MHz, 16-QAM)	X	7.31	77.47	20.01	3.98	65.0	± 9.6 %
		Y	6.88	77.10	19.42		65.0	
		Z	7.16	77.42	19.78		65.0	
10248-CAD	LTE-TDD (SC-FDMA, 50% RB, 5 MHz, 64-QAM)	X	7.23	76.85	19.75	3.98	65.0	± 9.6 %
		Y	6.75	76.40	19.13		65.0	
		Z	7.04	76.72	19.48		65.0	
10249-CAD	LTE-TDD (SC-FDMA, 50% RB, 5 MHz, QPSK)	X	10.55	85.88	23.24	3.98	65.0	± 9.6 %
		Y	11.23	87.71	23.62		65.0	
		Z	11.08	87.02	23.49		65.0	
10250-CAD	LTE-TDD (SC-FDMA, 50% RB, 10 MHz, 16-QAM)	X	8.37	79.97	22.44	3.98	65.0	± 9.6 %
		Y	8.25	80.64	22.58		65.0	
		Z	8.37	80.40	22.54		65.0	
10251-CAD	LTE-TDD (SC-FDMA, 50% RB, 10 MHz, 64-QAM)	X	7.79	77.55	21.17	3.98	65.0	± 9.6 %
		Y	7.62	78.12	21.26		65.0	
		Z	7.71	77.78	21.18		65.0	
10252-CAD	LTE-TDD (SC-FDMA, 50% RB, 10 MHz, QPSK)	X	10.26	85.03	23.77	3.98	65.0	± 9.6 %
		Y	11.07	87.53	24.67		65.0	
		Z	10.72	86.30	24.20		65.0	
10253-CAD	LTE-TDD (SC-FDMA, 50% RB, 15 MHz, 16-QAM)	X	7.69	76.53	21.09	3.98	65.0	± 9.6 %
		Y	7.57	77.22	21.35		65.0	
		Z	7.61	76.75	21.15		65.0	
10254-CAD	LTE-TDD (SC-FDMA, 50% RB, 15 MHz, 64-QAM)	X	8.11	77.42	21.76	3.98	65.0	± 9.6 %
		Y	7.99	78.11	22.01		65.0	
		Z	8.04	77.70	21.84		65.0	

10255-CAD	LTE-TDD (SC-FDMA, 50% RB, 15 MHz, QPSK)	X	8.87	80.90	22.51	3.98	65.0	± 9.6 %
		Y	9.18	82.66	23.26		65.0	
		Z	9.01	81.69	22.82		65.0	
10256-CAA	LTE-TDD (SC-FDMA, 100% RB, 1.4 MHz, 16-QAM)	X	7.19	76.04	17.83	3.98	65.0	± 9.6 %
		Y	6.37	74.72	16.60		65.0	
		Z	6.91	75.63	17.34		65.0	
10257-CAA	LTE-TDD (SC-FDMA, 100% RB, 1.4 MHz, 64-QAM)	X	6.95	75.20	17.41	3.98	65.0	± 9.6 %
		Y	6.01	73.59	16.03		65.0	
		Z	6.60	74.62	16.84		65.0	
10258-CAA	LTE-TDD (SC-FDMA, 100% RB, 1.4 MHz, QPSK)	X	7.08	78.57	19.08	3.98	65.0	± 9.6 %
		Y	5.96	76.36	17.58		65.0	
		Z	6.63	77.70	18.41		65.0	
10259-CAB	LTE-TDD (SC-FDMA, 100% RB, 3 MHz, 16-QAM)	X	7.72	78.37	20.87	3.98	65.0	± 9.6 %
		Y	7.43	78.48	20.58		65.0	
		Z	7.64	78.54	20.77		65.0	
10260-CAB	LTE-TDD (SC-FDMA, 100% RB, 3 MHz, 64-QAM)	X	7.71	78.04	20.75	3.98	65.0	± 9.6 %
		Y	7.37	78.04	20.41		65.0	
		Z	7.60	78.14	20.63		65.0	
10261-CAB	LTE-TDD (SC-FDMA, 100% RB, 3 MHz, QPSK)	X	9.91	84.71	23.20	3.98	65.0	± 9.6 %
		Y	10.51	86.66	23.72		65.0	
		Z	10.31	85.78	23.47		65.0	
10262-CAD	LTE-TDD (SC-FDMA, 100% RB, 5 MHz, 16-QAM)	X	8.35	79.91	22.40	3.98	65.0	± 9.6 %
		Y	8.23	80.57	22.53		65.0	
		Z	8.35	80.33	22.49		65.0	
10263-CAD	LTE-TDD (SC-FDMA, 100% RB, 5 MHz, 64-QAM)	X	7.78	77.53	21.17	3.98	65.0	± 9.6 %
		Y	7.61	78.09	21.25		65.0	
		Z	7.70	77.76	21.18		65.0	
10264-CAD	LTE-TDD (SC-FDMA, 100% RB, 5 MHz, QPSK)	X	10.16	84.83	23.68	3.98	65.0	± 9.6 %
		Y	10.94	87.30	24.57		65.0	
		Z	10.60	86.08	24.10		65.0	
10265-CAD	LTE-TDD (SC-FDMA, 100% RB, 10 MHz, 16-QAM)	X	7.89	77.12	21.33	3.98	65.0	± 9.6 %
		Y	7.75	77.78	21.62		65.0	
		Z	7.80	77.33	21.40		65.0	
10266-CAD	LTE-TDD (SC-FDMA, 100% RB, 10 MHz, 64-QAM)	X	8.32	78.04	22.05	3.98	65.0	± 9.6 %
		Y	8.20	78.75	22.36		65.0	
		Z	8.26	78.33	22.16		65.0	
10267-CAD	LTE-TDD (SC-FDMA, 100% RB, 10 MHz, QPSK)	X	9.19	81.29	22.44	3.98	65.0	± 9.6 %
		Y	9.53	83.07	23.22		65.0	
		Z	9.36	82.10	22.77		65.0	
10268-CAD	LTE-TDD (SC-FDMA, 100% RB, 15 MHz, 16-QAM)	X	8.37	76.65	21.54	3.98	65.0	± 9.6 %
		Y	8.20	77.22	21.85		65.0	
		Z	8.27	76.83	21.63		65.0	
10269-CAD	LTE-TDD (SC-FDMA, 100% RB, 15 MHz, 64-QAM)	X	8.29	76.22	21.43	3.98	65.0	± 9.6 %
		Y	8.13	76.76	21.72		65.0	
		Z	8.20	76.38	21.51		65.0	
10270-CAD	LTE-TDD (SC-FDMA, 100% RB, 15 MHz, QPSK)	X	8.55	78.25	21.44	3.98	65.0	± 9.6 %
		Y	8.58	79.32	21.98		65.0	
		Z	8.56	78.72	21.66		65.0	

10274-CAB	UMTS-FDD (HSUPA, Subtest 5, 3GPP Rel8.10)	X	2.53	66.08	14.88	0.00	150.0	± 9.6 %
		Y	2.52	66.54	14.91		150.0	
		Z	2.51	66.24	14.87		150.0	
10275-CAB	UMTS-FDD (HSUPA, Subtest 5, 3GPP Rel8.4)	X	1.51	66.90	14.72	0.00	150.0	± 9.6 %
		Y	1.52	67.44	14.98		150.0	
		Z	1.50	67.06	14.77		150.0	
10277-CAA	PHS (QPSK)	X	4.49	67.07	11.86	9.03	50.0	± 9.6 %
		Y	3.76	65.67	10.51		50.0	
		Z	4.09	66.15	11.03		50.0	
10278-CAA	PHS (QPSK, BW 884MHz, Rolloff 0.5)	X	8.37	78.55	19.37	9.03	50.0	± 9.6 %
		Y	7.19	76.56	17.89		50.0	
		Z	7.75	77.39	18.52		50.0	
10279-CAA	PHS (QPSK, BW 884MHz, Rolloff 0.38)	X	8.51	78.75	19.47	9.03	50.0	± 9.6 %
		Y	7.31	76.76	18.01		50.0	
		Z	7.88	77.58	18.63		50.0	
10290-AAB	CDMA2000, RC1, SO55, Full Rate	X	1.28	66.85	12.83	0.00	150.0	± 9.6 %
		Y	1.15	66.36	12.07		150.0	
		Z	1.21	66.57	12.40		150.0	
10291-AAB	CDMA2000, RC3, SO55, Full Rate	X	0.73	64.15	11.20	0.00	150.0	± 9.6 %
		Y	0.69	64.04	10.71		150.0	
		Z	0.69	63.98	10.82		150.0	
10292-AAB	CDMA2000, RC3, SO32, Full Rate	X	0.85	66.79	12.92	0.00	150.0	± 9.6 %
		Y	0.83	67.15	12.67		150.0	
		Z	0.82	66.81	12.63		150.0	
10293-AAB	CDMA2000, RC3, SO3, Full Rate	X	1.14	70.77	15.25	0.00	150.0	± 9.6 %
		Y	1.22	72.07	15.35		150.0	
		Z	1.16	71.38	15.20		150.0	
10295-AAB	CDMA2000, RC1, SO3, 1/8th Rate 25 fr.	X	11.92	86.64	24.71	9.03	50.0	± 9.6 %
		Y	15.63	91.98	26.09		50.0	
		Z	13.21	88.61	25.13		50.0	
10297-AAC	LTE-FDD (SC-FDMA, 50% RB, 20 MHz, QPSK)	X	2.66	69.01	16.01	0.00	150.0	± 9.6 %
		Y	2.60	69.22	16.21		150.0	
		Z	2.62	69.08	16.08		150.0	
10298-AAC	LTE-FDD (SC-FDMA, 50% RB, 3 MHz, QPSK)	X	1.46	66.51	13.33	0.00	150.0	± 9.6 %
		Y	1.32	65.99	12.56		150.0	
		Z	1.39	66.26	12.94		150.0	
10299-AAC	LTE-FDD (SC-FDMA, 50% RB, 3 MHz, 16-QAM)	X	2.70	69.70	14.37	0.00	150.0	± 9.6 %
		Y	2.67	70.31	14.00		150.0	
		Z	2.72	70.11	14.27		150.0	
10300-AAC	LTE-FDD (SC-FDMA, 50% RB, 3 MHz, 64-QAM)	X	2.09	65.56	11.69	0.00	150.0	± 9.6 %
		Y	1.84	65.02	10.77		150.0	
		Z	1.98	65.35	11.29		150.0	
10301-AAA	IEEE 802.16e WiMAX (29:18, 5ms, 10MHz, QPSK, PUSC)	X	5.46	67.87	18.50	4.17	80.0	± 9.6 %
		Y	5.32	68.03	18.43		80.0	
		Z	5.39	67.94	18.48		80.0	
10302-AAA	IEEE 802.16e WiMAX (29:18, 5ms, 10MHz, QPSK, PUSC, 3 CTRL symbols)	X	5.85	67.98	18.95	4.96	80.0	± 9.6 %
		Y	5.80	68.69	19.24		80.0	
		Z	5.75	67.96	18.88		80.0	

10303-AAA	IEEE 802.16e WiMAX (31:15, 5ms, 10MHz, 64QAM, PUSC)	X	5.66	67.92	18.92	4.96	80.0	± 9.6 %
		Y	5.61	68.61	19.19		80.0	
		Z	5.56	67.86	18.83		80.0	
10304-AAA	IEEE 802.16e WiMAX (29:18, 5ms, 10MHz, 64QAM, PUSC)	X	5.35	67.35	18.18	4.17	80.0	± 9.6 %
		Y	5.30	68.04	18.43		80.0	
		Z	5.26	67.36	18.12		80.0	
10305-AAA	IEEE 802.16e WiMAX (31:15, 10ms, 10MHz, 64QAM, PUSC, 15 symbols)	X	7.05	76.99	23.82	6.02	50.0	± 9.6 %
		Y	7.19	78.32	24.16		50.0	
		Z	6.80	76.50	23.43		50.0	
10306-AAA	IEEE 802.16e WiMAX (29:18, 10ms, 10MHz, 64QAM, PUSC, 18 symbols)	X	5.82	69.84	20.44	6.02	50.0	± 9.6 %
		Y	5.84	70.99	20.86		50.0	
		Z	6.02	71.90	21.62		50.0	
10307-AAA	IEEE 802.16e WiMAX (29:18, 10ms, 10MHz, QPSK, PUSC, 18 symbols)	X	6.31	73.07	22.13	6.02	50.0	± 9.6 %
		Y	5.83	71.38	20.88		50.0	
		Z	6.11	72.72	21.84		50.0	
10308-AAA	IEEE 802.16e WiMAX (29:18, 10ms, 10MHz, 16QAM, PUSC)	X	6.39	73.64	22.41	6.02	50.0	± 9.6 %
		Y	5.90	71.88	21.13		50.0	
		Z	6.20	73.31	22.13		50.0	
10309-AAA	IEEE 802.16e WiMAX (29:18, 10ms, 10MHz, 16QAM, AMC 2x3, 18 symbols)	X	5.91	70.12	20.60	6.02	50.0	± 9.6 %
		Y	5.91	71.23	21.02		50.0	
		Z	6.11	72.19	21.79		50.0	
10310-AAA	IEEE 802.16e WiMAX (29:18, 10ms, 10MHz, QPSK, AMC 2x3, 18 symbols)	X	6.22	72.50	21.95	6.02	50.0	± 9.6 %
		Y	5.84	71.19	20.88		50.0	
		Z	6.05	72.25	21.70		50.0	
10311-AAC	LTE-FDD (SC-FDMA, 100% RB, 15 MHz, QPSK)	X	3.00	68.33	15.71	0.00	150.0	± 9.6 %
		Y	2.96	68.52	15.89		150.0	
		Z	2.97	68.38	15.77		150.0	
10313-AAA	iDEN 1:3	X	6.99	77.76	18.02	6.99	70.0	± 9.6 %
		Y	8.29	81.34	19.42		70.0	
		Z	7.24	78.54	18.23		70.0	
10314-AAA	iDEN 1:6	X	10.49	86.54	23.63	10.00	30.0	± 9.6 %
		Y	12.83	91.81	25.63		30.0	
		Z	11.85	89.04	24.41		30.0	
10315-AAB	IEEE 802.11b WiFi 2.4 GHz (DSSS, 1 Mbps, 96pc duty cycle)	X	1.08	63.85	14.84	0.17	150.0	± 9.6 %
		Y	1.11	64.19	15.04		150.0	
		Z	1.08	63.97	14.91		150.0	
10316-AAB	IEEE 802.11g WiFi 2.4 GHz (ERP-OFDM, 6 Mbps, 96pc duty cycle)	X	4.62	66.77	16.25	0.17	150.0	± 9.6 %
		Y	4.54	66.97	16.29		150.0	
		Z	4.57	66.82	16.26		150.0	
10317-AAC	IEEE 802.11a WiFi 5 GHz (OFDM, 6 Mbps, 96pc duty cycle)	X	4.62	66.77	16.25	0.17	150.0	± 9.6 %
		Y	4.54	66.97	16.29		150.0	
		Z	4.57	66.82	16.26		150.0	
10400-AAD	IEEE 802.11ac WiFi (20MHz, 64-QAM, 99pc duty cycle)	X	4.70	66.97	16.15	0.00	150.0	± 9.6 %
		Y	4.59	67.15	16.19		150.0	
		Z	4.64	67.01	16.16		150.0	
10401-AAD	IEEE 802.11ac WiFi (40MHz, 64-QAM, 99pc duty cycle)	X	5.41	67.24	16.37	0.00	150.0	± 9.6 %
		Y	5.32	67.38	16.42		150.0	
		Z	5.38	67.33	16.41		150.0	

10402-AAD	IEEE 802.11ac WiFi (80MHz, 64-QAM, 99pc duty cycle)	X	5.66	67.55	16.37	0.00	150.0	± 9.6 %
		Y	5.56	67.58	16.37		150.0	
		Z	5.60	67.52	16.36		150.0	
10403-AAB	CDMA2000 (1xEV-DO, Rev. 0)	X	1.28	66.85	12.83	0.00	115.0	± 9.6 %
		Y	1.15	66.36	12.07		115.0	
		Z	1.21	66.57	12.40		115.0	
10404-AAB	CDMA2000 (1xEV-DO, Rev. A)	X	1.28	66.85	12.83	0.00	115.0	± 9.6 %
		Y	1.15	66.36	12.07		115.0	
		Z	1.21	66.57	12.40		115.0	
10406-AAB	CDMA2000, RC3, SO32, SCH0, Full Rate	X	31.97	105.65	26.52	0.00	100.0	± 9.6 %
		Y	100.00	119.11	28.78		100.0	
		Z	100.00	120.25	29.60		100.0	
10410-AAD	LTE-TDD (SC-FDMA, 1 RB, 10 MHz, QPSK, UL Subframe=2,3,4,7,8,9, Subframe Conf=4)	X	100.00	119.16	29.68	3.23	80.0	± 9.6 %
		Y	100.00	122.81	30.98		80.0	
		Z	100.00	120.19	29.97		80.0	
10415-AAA	IEEE 802.11b WiFi 2.4 GHz (DSSS, 1 Mbps, 99pc duty cycle)	X	0.96	62.46	13.98	0.00	150.0	± 9.6 %
		Y	0.99	62.90	14.23		150.0	
		Z	0.95	62.59	14.06		150.0	
10416-AAA	IEEE 802.11g WiFi 2.4 GHz (ERP-OFDM, 6 Mbps, 99pc duty cycle)	X	4.53	66.62	16.09	0.00	150.0	± 9.6 %
		Y	4.45	66.83	16.13		150.0	
		Z	4.48	66.68	16.10		150.0	
10417-AAB	IEEE 802.11a/h WiFi 5 GHz (OFDM, 6 Mbps, 99pc duty cycle)	X	4.53	66.62	16.09	0.00	150.0	± 9.6 %
		Y	4.45	66.83	16.13		150.0	
		Z	4.48	66.68	16.10		150.0	
10418-AAA	IEEE 802.11g WiFi 2.4 GHz (DSSS-OFDM, 6 Mbps, 99pc duty cycle, Long preamble)	X	4.51	66.76	16.09	0.00	150.0	± 9.6 %
		Y	4.44	67.00	16.16		150.0	
		Z	4.47	66.83	16.12		150.0	
10419-AAA	IEEE 802.11g WiFi 2.4 GHz (DSSS-OFDM, 6 Mbps, 99pc duty cycle, Short preamble)	X	4.54	66.72	16.10	0.00	150.0	± 9.6 %
		Y	4.46	66.94	16.15		150.0	
		Z	4.49	66.78	16.12		150.0	
10422-AAB	IEEE 802.11n (HT Greenfield, 7.2 Mbps, BPSK)	X	4.66	66.73	16.13	0.00	150.0	± 9.6 %
		Y	4.57	66.94	16.17		150.0	
		Z	4.61	66.79	16.14		150.0	
10423-AAB	IEEE 802.11n (HT Greenfield, 43.3 Mbps, 16-QAM)	X	4.83	67.07	16.25	0.00	150.0	± 9.6 %
		Y	4.72	67.22	16.28		150.0	
		Z	4.77	67.10	16.25		150.0	
10424-AAB	IEEE 802.11n (HT Greenfield, 72.2 Mbps, 64-QAM)	X	4.75	67.01	16.22	0.00	150.0	± 9.6 %
		Y	4.64	67.18	16.25		150.0	
		Z	4.69	67.05	16.23		150.0	
10425-AAB	IEEE 802.11n (HT Greenfield, 15 Mbps, BPSK)	X	5.37	67.43	16.45	0.00	150.0	± 9.6 %
		Y	5.26	67.46	16.45		150.0	
		Z	5.32	67.43	16.46		150.0	
10426-AAB	IEEE 802.11n (HT Greenfield, 90 Mbps, 16-QAM)	X	5.37	67.44	16.46	0.00	150.0	± 9.6 %
		Y	5.28	67.55	16.49		150.0	
		Z	5.33	67.49	16.49		150.0	

10427-AAB	IEEE 802.11n (HT Greenfield, 150 Mbps, 64-QAM)	X	5.38	67.41	16.44	0.00	150.0	± 9.6 %
		Y	5.27	67.46	16.44		150.0	
		Z	5.33	67.43	16.45		150.0	
10430-AAB	LTE-FDD (OFDMA, 5 MHz, E-TM 3.1)	X	4.17	70.27	17.81	0.00	150.0	± 9.6 %
		Y	4.03	70.48	17.58		150.0	
		Z	4.14	70.57	17.85		150.0	
10431-AAB	LTE-FDD (OFDMA, 10 MHz, E-TM 3.1)	X	4.21	67.11	16.05	0.00	150.0	± 9.6 %
		Y	4.09	67.33	16.03		150.0	
		Z	4.15	67.18	16.04		150.0	
10432-AAB	LTE-FDD (OFDMA, 15 MHz, E-TM 3.1)	X	4.51	67.03	16.15	0.00	150.0	± 9.6 %
		Y	4.40	67.23	16.17		150.0	
		Z	4.46	67.08	16.15		150.0	
10433-AAB	LTE-FDD (OFDMA, 20 MHz, E-TM 3.1)	X	4.76	67.04	16.24	0.00	150.0	± 9.6 %
		Y	4.66	67.21	16.27		150.0	
		Z	4.71	67.08	16.24		150.0	
10434-AAA	W-CDMA (BS Test Model 1, 64 DPCH)	X	4.23	70.97	17.72	0.00	150.0	± 9.6 %
		Y	4.07	71.14	17.40		150.0	
		Z	4.21	71.31	17.74		150.0	
10435-AAC	LTE-TDD (SC-FDMA, 1 RB, 20 MHz, QPSK, UL Subframe=2,3,4,7,8,9)	X	100.00	118.98	29.60	3.23	80.0	± 9.6 %
		Y	100.00	122.59	30.87		80.0	
		Z	100.00	119.99	29.88		80.0	
10447-AAB	LTE-FDD (OFDMA, 5 MHz, E-TM 3.1, Clipping 44%)	X	3.49	66.99	15.32	0.00	150.0	± 9.6 %
		Y	3.34	67.16	15.09		150.0	
		Z	3.41	67.04	15.22		150.0	
10448-AAB	LTE-FDD (OFDMA, 10 MHz, E-TM 3.1, Clipping 44%)	X	4.04	66.88	15.90	0.00	150.0	± 9.6 %
		Y	3.94	67.12	15.89		150.0	
		Z	3.99	66.95	15.89		150.0	
10449-AAB	LTE-FDD (OFDMA, 15 MHz, E-TM 3.1, Clipping 44%)	X	4.32	66.84	16.03	0.00	150.0	± 9.6 %
		Y	4.23	67.04	16.06		150.0	
		Z	4.27	66.90	16.04		150.0	
10450-AAB	LTE-FDD (OFDMA, 20 MHz, E-TM 3.1, Clipping 44%)	X	4.51	66.79	16.08	0.00	150.0	± 9.6 %
		Y	4.44	66.97	16.11		150.0	
		Z	4.47	66.83	16.09		150.0	
10451-AAA	W-CDMA (BS Test Model 1, 64 DPCH, Clipping 44%)	X	3.37	67.12	14.92	0.00	150.0	± 9.6 %
		Y	3.19	67.13	14.54		150.0	
		Z	3.28	67.11	14.76		150.0	
10456-AAB	IEEE 802.11ac WiFi (160MHz, 64-QAM, 99pc duty cycle)	X	6.23	67.99	16.62	0.00	150.0	± 9.6 %
		Y	6.17	68.10	16.67		150.0	
		Z	6.19	67.99	16.63		150.0	
10457-AAA	UMTS-FDD (DC-HSDPA)	X	3.77	65.25	15.79	0.00	150.0	± 9.6 %
		Y	3.75	65.50	15.83		150.0	
		Z	3.75	65.32	15.80		150.0	
10458-AAA	CDMA2000 (1xEV-DO, Rev. B, 2 carriers)	X	3.87	70.16	17.10	0.00	150.0	± 9.6 %
		Y	3.71	70.34	16.66		150.0	
		Z	3.84	70.49	17.05		150.0	
10459-AAA	CDMA2000 (1xEV-DO, Rev. B, 3 carriers)	X	5.00	67.94	17.87	0.00	150.0	± 9.6 %
		Y	4.81	68.13	17.56		150.0	
		Z	4.96	68.23	17.89		150.0	

10460-AAA	UMTS-FDD (WCDMA, AMR)	X	0.79	66.34	14.61	0.00	150.0	± 9.6 %
		Y	0.84	67.16	15.15		150.0	
		Z	0.79	66.65	14.76		150.0	
10461-AAA	LTE-TDD (SC-FDMA, 1 RB, 1.4 MHz, QPSK, UL Subframe=2,3,4,7,8,9)	X	100.00	122.59	31.33	3.29	80.0	± 9.6 %
		Y	100.00	128.70	33.71		80.0	
		Z	100.00	124.88	32.17		80.0	
10462-AAA	LTE-TDD (SC-FDMA, 1 RB, 1.4 MHz, 16-QAM, UL Subframe=2,3,4,7,8,9)	X	21.46	90.49	19.92	3.23	80.0	± 9.6 %
		Y	100.00	107.87	23.85		80.0	
		Z	100.00	106.49	23.49		80.0	
10463-AAA	LTE-TDD (SC-FDMA, 1 RB, 1.4 MHz, 64-QAM, UL Subframe=2,3,4,7,8,9)	X	5.25	74.65	14.70	3.23	80.0	± 9.6 %
		Y	19.71	88.51	18.38		80.0	
		Z	7.19	78.06	15.56		80.0	
10464-AAA	LTE-TDD (SC-FDMA, 1 RB, 3 MHz, QPSK, UL Subframe=2,3,4,7,8,9)	X	100.00	120.34	30.14	3.23	80.0	± 9.6 %
		Y	100.00	126.35	32.46		80.0	
		Z	100.00	122.50	30.92		80.0	
10465-AAA	LTE-TDD (SC-FDMA, 1 RB, 3 MHz, 16-QAM, UL Subframe=2,3,4,7,8,9)	X	11.73	83.97	18.05	3.23	80.0	± 9.6 %
		Y	100.00	107.24	23.55		80.0	
		Z	41.80	97.17	21.26		80.0	
10466-AAA	LTE-TDD (SC-FDMA, 1 RB, 3 MHz, 64-QAM, UL Subframe=2,3,4,7,8,9)	X	4.09	72.04	13.74	3.23	80.0	± 9.6 %
		Y	8.97	80.87	16.24		80.0	
		Z	4.77	73.97	14.19		80.0	
10467-AAC	LTE-TDD (SC-FDMA, 1 RB, 5 MHz, QPSK, UL Subframe=2,3,4,7,8,9)	X	100.00	120.57	30.24	3.23	80.0	± 9.6 %
		Y	100.00	126.64	32.58		80.0	
		Z	100.00	122.76	31.03		80.0	
10468-AAC	LTE-TDD (SC-FDMA, 1 RB, 5 MHz, 16-QAM, UL Subframe=2,3,4,7,8,9)	X	13.52	85.52	18.51	3.23	80.0	± 9.6 %
		Y	100.00	107.47	23.65		80.0	
		Z	60.78	101.09	22.20		80.0	
10469-AAC	LTE-TDD (SC-FDMA, 1 RB, 5 MHz, 64-QAM, UL Subframe=2,3,4,7,8,9)	X	4.11	72.11	13.77	3.23	80.0	± 9.6 %
		Y	9.29	81.22	16.33		80.0	
		Z	4.83	74.11	14.24		80.0	
10470-AAC	LTE-TDD (SC-FDMA, 1 RB, 10 MHz, QPSK, UL Subframe=2,3,4,7,8,9)	X	100.00	120.59	30.24	3.23	80.0	± 9.6 %
		Y	100.00	126.67	32.59		80.0	
		Z	100.00	122.78	31.03		80.0	
10471-AAC	LTE-TDD (SC-FDMA, 1 RB, 10 MHz, 16-QAM, UL Subframe=2,3,4,7,8,9)	X	13.37	85.38	18.46	3.23	80.0	± 9.6 %
		Y	100.00	107.40	23.62		80.0	
		Z	59.33	100.79	22.11		80.0	
10472-AAC	LTE-TDD (SC-FDMA, 1 RB, 10 MHz, 64-QAM, UL Subframe=2,3,4,7,8,9)	X	4.08	72.03	13.72	3.23	80.0	± 9.6 %
		Y	9.15	81.05	16.27		80.0	
		Z	4.78	73.98	14.18		80.0	
10473-AAC	LTE-TDD (SC-FDMA, 1 RB, 15 MHz, QPSK, UL Subframe=2,3,4,7,8,9)	X	100.00	120.56	30.23	3.23	80.0	± 9.6 %
		Y	100.00	126.64	32.58		80.0	
		Z	100.00	122.75	31.02		80.0	
10474-AAC	LTE-TDD (SC-FDMA, 1 RB, 15 MHz, 16-QAM, UL Subframe=2,3,4,7,8,9)	X	13.19	85.24	18.42	3.23	80.0	± 9.6 %
		Y	100.00	107.40	23.61		80.0	
		Z	57.55	100.49	22.04		80.0	
10475-AAC	LTE-TDD (SC-FDMA, 1 RB, 15 MHz, 64-QAM, UL Subframe=2,3,4,7,8,9)	X	4.06	71.97	13.71	3.23	80.0	± 9.6 %
		Y	8.99	80.90	16.23		80.0	
		Z	4.73	73.90	14.15		80.0	

10477-AAC	LTE-TDD (SC-FDMA, 1 RB, 20 MHz, 16-QAM, UL Subframe=2,3,4,7,8,9)	X	11.86	84.06	18.05	3.23	80.0	± 9.6 %
		Y	100.00	107.19	23.51		80.0	
		Z	43.65	97.56	21.32		80.0	
10478-AAC	LTE-TDD (SC-FDMA, 1 RB, 20 MHz, 64-QAM, UL Subframe=2,3,4,7,8,9)	X	4.02	71.87	13.66	3.23	80.0	± 9.6 %
		Y	8.76	80.61	16.13		80.0	
		Z	4.66	73.74	14.09		80.0	
10479-AAA	LTE-TDD (SC-FDMA, 50% RB, 1.4 MHz, QPSK, UL Subframe=2,3,4,7,8,9)	X	14.17	93.60	25.28	3.23	80.0	± 9.6 %
		Y	63.86	118.32	31.85		80.0	
		Z	30.71	105.97	28.68		80.0	
10480-AAA	LTE-TDD (SC-FDMA, 50% RB, 1.4 MHz, 16-QAM, UL Subframe=2,3,4,7,8,9)	X	12.48	86.47	21.39	3.23	80.0	± 9.6 %
		Y	53.06	106.13	26.31		80.0	
		Z	23.73	95.20	23.69		80.0	
10481-AAA	LTE-TDD (SC-FDMA, 50% RB, 1.4 MHz, 64-QAM, UL Subframe=2,3,4,7,8,9)	X	9.79	82.49	19.78	3.23	80.0	± 9.6 %
		Y	26.62	95.88	23.20		80.0	
		Z	15.46	88.60	21.40		80.0	
10482-AAA	LTE-TDD (SC-FDMA, 50% RB, 3 MHz, QPSK, UL Subframe=2,3,4,7,8,9)	X	4.76	76.35	18.33	2.23	80.0	± 9.6 %
		Y	4.38	75.77	17.66		80.0	
		Z	4.74	76.54	18.16		80.0	
10483-AAA	LTE-TDD (SC-FDMA, 50% RB, 3 MHz, 16-QAM, UL Subframe=2,3,4,7,8,9)	X	6.86	78.09	18.71	2.23	80.0	± 9.6 %
		Y	7.58	79.80	18.72		80.0	
		Z	7.91	80.19	19.17		80.0	
10484-AAA	LTE-TDD (SC-FDMA, 50% RB, 3 MHz, 64-QAM, UL Subframe=2,3,4,7,8,9)	X	6.29	76.73	18.22	2.23	80.0	± 9.6 %
		Y	6.51	77.64	17.97		80.0	
		Z	6.95	78.27	18.51		80.0	
10485-AAC	LTE-TDD (SC-FDMA, 50% RB, 5 MHz, QPSK, UL Subframe=2,3,4,7,8,9)	X	5.21	77.92	19.79	2.23	80.0	± 9.6 %
		Y	5.14	78.56	19.82		80.0	
		Z	5.34	78.68	19.95		80.0	
10486-AAC	LTE-TDD (SC-FDMA, 50% RB, 5 MHz, 16-QAM, UL Subframe=2,3,4,7,8,9)	X	4.30	72.12	17.19	2.23	80.0	± 9.6 %
		Y	4.02	71.85	16.65		80.0	
		Z	4.23	72.22	17.03		80.0	
10487-AAC	LTE-TDD (SC-FDMA, 50% RB, 5 MHz, 64-QAM, UL Subframe=2,3,4,7,8,9)	X	4.25	71.63	16.98	2.23	80.0	± 9.6 %
		Y	3.95	71.26	16.39		80.0	
		Z	4.16	71.66	16.79		80.0	
10488-AAC	LTE-TDD (SC-FDMA, 50% RB, 10 MHz, QPSK, UL Subframe=2,3,4,7,8,9)	X	5.17	76.41	19.90	2.23	80.0	± 9.6 %
		Y	5.01	76.93	20.15		80.0	
		Z	5.17	76.91	20.10		80.0	
10489-AAC	LTE-TDD (SC-FDMA, 50% RB, 10 MHz, 16-QAM, UL Subframe=2,3,4,7,8,9)	X	4.47	71.61	18.14	2.23	80.0	± 9.6 %
		Y	4.30	71.84	18.12		80.0	
		Z	4.42	71.84	18.19		80.0	
10490-AAC	LTE-TDD (SC-FDMA, 50% RB, 10 MHz, 64-QAM, UL Subframe=2,3,4,7,8,9)	X	4.53	71.33	18.05	2.23	80.0	± 9.6 %
		Y	4.36	71.56	18.01		80.0	
		Z	4.48	71.55	18.09		80.0	
10491-AAC	LTE-TDD (SC-FDMA, 50% RB, 15 MHz, QPSK, UL Subframe=2,3,4,7,8,9)	X	5.06	74.04	19.16	2.23	80.0	± 9.6 %
		Y	4.88	74.37	19.37		80.0	
		Z	5.01	74.33	19.30		80.0	
10492-AAC	LTE-TDD (SC-FDMA, 50% RB, 15 MHz, 16-QAM, UL Subframe=2,3,4,7,8,9)	X	4.71	70.55	18.02	2.23	80.0	± 9.6 %
		Y	4.54	70.71	18.05		80.0	
		Z	4.64	70.68	18.06		80.0	

10493-AAC	LTE-TDD (SC-FDMA, 50% RB, 15 MHz, 64-QAM, UL Subframe=2,3,4,7,8,9)	X	4.76	70.36	17.96	2.23	80.0	± 9.6 %
		Y	4.58	70.52	17.98		80.0	
		Z	4.69	70.49	18.00		80.0	
10494-AAC	LTE-TDD (SC-FDMA, 50% RB, 20 MHz, QPSK, UL Subframe=2,3,4,7,8,9)	X	5.60	75.75	19.64	2.23	80.0	± 9.6 %
		Y	5.37	76.02	19.87		80.0	
		Z	5.56	76.06	19.81		80.0	
10495-AAC	LTE-TDD (SC-FDMA, 50% RB, 20 MHz, 16-QAM, UL Subframe=2,3,4,7,8,9)	X	4.78	71.03	18.23	2.23	80.0	± 9.6 %
		Y	4.59	71.11	18.27		80.0	
		Z	4.71	71.14	18.28		80.0	
10496-AAC	LTE-TDD (SC-FDMA, 50% RB, 20 MHz, 64-QAM, UL Subframe=2,3,4,7,8,9)	X	4.83	70.65	18.12	2.23	80.0	± 9.6 %
		Y	4.64	70.74	18.15		80.0	
		Z	4.75	70.76	18.17		80.0	
10497-AAA	LTE-TDD (SC-FDMA, 100% RB, 1.4 MHz, QPSK, UL Subframe=2,3,4,7,8,9)	X	3.37	71.45	15.57	2.23	80.0	± 9.6 %
		Y	2.72	69.17	13.95		80.0	
		Z	3.09	70.50	14.83		80.0	
10498-AAA	LTE-TDD (SC-FDMA, 100% RB, 1.4 MHz, 16-QAM, UL Subframe=2,3,4,7,8,9)	X	2.40	64.81	11.76	2.23	80.0	± 9.6 %
		Y	1.75	62.03	9.60		80.0	
		Z	2.07	63.39	10.68		80.0	
10499-AAA	LTE-TDD (SC-FDMA, 100% RB, 1.4 MHz, 64-QAM, UL Subframe=2,3,4,7,8,9)	X	2.32	64.18	11.33	2.23	80.0	± 9.6 %
		Y	1.68	61.41	9.14		80.0	
		Z	1.99	62.76	10.23		80.0	
10500-AAA	LTE-TDD (SC-FDMA, 100% RB, 3 MHz, QPSK, UL Subframe=2,3,4,7,8,9)	X	5.05	76.85	19.69	2.23	80.0	± 9.6 %
		Y	4.98	77.59	19.85		80.0	
		Z	5.12	77.53	19.88		80.0	
10501-AAA	LTE-TDD (SC-FDMA, 100% RB, 3 MHz, 16-QAM, UL Subframe=2,3,4,7,8,9)	X	4.38	71.91	17.55	2.23	80.0	± 9.6 %
		Y	4.19	72.01	17.27		80.0	
		Z	4.33	72.13	17.50		80.0	
10502-AAA	LTE-TDD (SC-FDMA, 100% RB, 3 MHz, 64-QAM, UL Subframe=2,3,4,7,8,9)	X	4.41	71.66	17.40	2.23	80.0	± 9.6 %
		Y	4.21	71.71	17.09		80.0	
		Z	4.36	71.85	17.33		80.0	
10503-AAC	LTE-TDD (SC-FDMA, 100% RB, 5 MHz, QPSK, UL Subframe=2,3,4,7,8,9)	X	5.10	76.19	19.80	2.23	80.0	± 9.6 %
		Y	4.94	76.71	20.05		80.0	
		Z	5.10	76.67	19.99		80.0	
10504-AAC	LTE-TDD (SC-FDMA, 100% RB, 5 MHz, 16-QAM, UL Subframe=2,3,4,7,8,9)	X	4.44	71.51	18.08	2.23	80.0	± 9.6 %
		Y	4.28	71.74	18.06		80.0	
		Z	4.39	71.73	18.13		80.0	
10505-AAC	LTE-TDD (SC-FDMA, 100% RB, 5 MHz, 64-QAM, UL Subframe=2,3,4,7,8,9)	X	4.51	71.23	18.00	2.23	80.0	± 9.6 %
		Y	4.34	71.46	17.96		80.0	
		Z	4.45	71.44	18.03		80.0	
10506-AAC	LTE-TDD (SC-FDMA, 100% RB, 10 MHz, QPSK, UL Subframe=2,3,4,7,8,9)	X	5.55	75.59	19.57	2.23	80.0	± 9.6 %
		Y	5.33	75.87	19.80		80.0	
		Z	5.51	75.90	19.73		80.0	
10507-AAC	LTE-TDD (SC-FDMA, 100% RB, 10 MHz, 16-QAM, UL Subframe=2,3,4,7,8,9)	X	4.76	70.96	18.19	2.23	80.0	± 9.6 %
		Y	4.57	71.05	18.23		80.0	
		Z	4.69	71.07	18.24		80.0	

10508-AAC	LTE-TDD (SC-FDMA, 100% RB, 10 MHz, 64-QAM, UL Subframe=2,3,4,7,8,9)	X	4.81	70.58	18.08	2.23	80.0	± 9.6 %
		Y	4.62	70.68	18.11		80.0	
		Z	4.73	70.68	18.12		80.0	
10509-AAC	LTE-TDD (SC-FDMA, 100% RB, 15 MHz, QPSK, UL Subframe=2,3,4,7,8,9)	X	5.59	73.58	18.84	2.23	80.0	± 9.6 %
		Y	5.39	73.76	19.02		80.0	
		Z	5.53	73.76	18.95		80.0	
10510-AAC	LTE-TDD (SC-FDMA, 100% RB, 15 MHz, 16-QAM, UL Subframe=2,3,4,7,8,9)	X	5.20	70.42	18.08	2.23	80.0	± 9.6 %
		Y	4.99	70.43	18.12		80.0	
		Z	5.11	70.45	18.12		80.0	
10511-AAC	LTE-TDD (SC-FDMA, 100% RB, 15 MHz, 64-QAM, UL Subframe=2,3,4,7,8,9)	X	5.22	70.10	18.00	2.23	80.0	± 9.6 %
		Y	5.03	70.13	18.04		80.0	
		Z	5.14	70.14	18.03		80.0	
10512-AAC	LTE-TDD (SC-FDMA, 100% RB, 20 MHz, QPSK, UL Subframe=2,3,4,7,8,9)	X	6.02	75.44	19.39	2.23	80.0	± 9.6 %
		Y	5.78	75.56	19.57		80.0	
		Z	5.97	75.65	19.51		80.0	
10513-AAC	LTE-TDD (SC-FDMA, 100% RB, 20 MHz, 16-QAM, UL Subframe=2,3,4,7,8,9)	X	5.12	70.82	18.23	2.23	80.0	± 9.6 %
		Y	4.91	70.75	18.25		80.0	
		Z	5.03	70.83	18.26		80.0	
10514-AAC	LTE-TDD (SC-FDMA, 100% RB, 20 MHz, 64-QAM, UL Subframe=2,3,4,7,8,9)	X	5.09	70.31	18.08	2.23	80.0	± 9.6 %
		Y	4.90	70.27	18.11		80.0	
		Z	5.01	70.33	18.11		80.0	
10515-AAA	IEEE 802.11b WiFi 2.4 GHz (DSSS, 2 Mbps, 99pc duty cycle)	X	0.92	62.60	13.99	0.00	150.0	± 9.6 %
		Y	0.95	63.05	14.27		150.0	
		Z	0.91	62.72	14.07		150.0	
10516-AAA	IEEE 802.11b WiFi 2.4 GHz (DSSS, 5.5 Mbps, 99pc duty cycle)	X	0.48	67.26	14.71	0.00	150.0	± 9.6 %
		Y	0.54	68.48	15.75		150.0	
		Z	0.49	67.82	15.05		150.0	
10517-AAA	IEEE 802.11b WiFi 2.4 GHz (DSSS, 11 Mbps, 99pc duty cycle)	X	0.75	64.05	14.24	0.00	150.0	± 9.6 %
		Y	0.79	64.60	14.65		150.0	
		Z	0.75	64.23	14.37		150.0	
10518-AAB	IEEE 802.11a/h WiFi 5 GHz (OFDM, 9 Mbps, 99pc duty cycle)	X	4.52	66.69	16.06	0.00	150.0	± 9.6 %
		Y	4.44	66.90	16.10		150.0	
		Z	4.47	66.75	16.07		150.0	
10519-AAB	IEEE 802.11a/h WiFi 5 GHz (OFDM, 12 Mbps, 99pc duty cycle)	X	4.71	66.95	16.20	0.00	150.0	± 9.6 %
		Y	4.60	67.11	16.21		150.0	
		Z	4.65	66.98	16.20		150.0	
10520-AAB	IEEE 802.11a/h WiFi 5 GHz (OFDM, 18 Mbps, 99pc duty cycle)	X	4.56	66.90	16.11	0.00	150.0	± 9.6 %
		Y	4.46	67.05	16.12		150.0	
		Z	4.50	66.93	16.11		150.0	
10521-AAB	IEEE 802.11a/h WiFi 5 GHz (OFDM, 24 Mbps, 99pc duty cycle)	X	4.49	66.89	16.09	0.00	150.0	± 9.6 %
		Y	4.39	67.03	16.11		150.0	
		Z	4.44	66.91	16.09		150.0	
10522-AAB	IEEE 802.11a/h WiFi 5 GHz (OFDM, 36 Mbps, 99pc duty cycle)	X	4.55	66.96	16.17	0.00	150.0	± 9.6 %
		Y	4.45	67.16	16.21		150.0	
		Z	4.50	67.02	16.19		150.0	

10523-AAB	IEEE 802.11a/h WiFi 5 GHz (OFDM, 48 Mbps, 99pc duty cycle)	X	4.43	66.81	16.00	0.00	150.0	± 9.6 %
		Y	4.35	67.05	16.07		150.0	
		Z	4.38	66.88	16.02		150.0	
10524-AAB	IEEE 802.11a/h WiFi 5 GHz (OFDM, 54 Mbps, 99pc duty cycle)	X	4.50	66.89	16.14	0.00	150.0	± 9.6 %
		Y	4.39	67.08	16.18		150.0	
		Z	4.44	66.94	16.15		150.0	
10525-AAB	IEEE 802.11ac WiFi (20MHz, MCS0, 99pc duty cycle)	X	4.47	65.92	15.72	0.00	150.0	± 9.6 %
		Y	4.40	66.15	15.78		150.0	
		Z	4.43	65.98	15.74		150.0	
10526-AAB	IEEE 802.11ac WiFi (20MHz, MCS1, 99pc duty cycle)	X	4.65	66.29	15.87	0.00	150.0	± 9.6 %
		Y	4.55	66.47	15.91		150.0	
		Z	4.59	66.34	15.88		150.0	
10527-AAB	IEEE 802.11ac WiFi (20MHz, MCS2, 99pc duty cycle)	X	4.57	66.25	15.81	0.00	150.0	± 9.6 %
		Y	4.47	66.43	15.85		150.0	
		Z	4.52	66.29	15.82		150.0	
10528-AAB	IEEE 802.11ac WiFi (20MHz, MCS3, 99pc duty cycle)	X	4.58	66.27	15.84	0.00	150.0	± 9.6 %
		Y	4.49	66.45	15.88		150.0	
		Z	4.53	66.31	15.85		150.0	
10529-AAB	IEEE 802.11ac WiFi (20MHz, MCS4, 99pc duty cycle)	X	4.58	66.27	15.84	0.00	150.0	± 9.6 %
		Y	4.49	66.45	15.88		150.0	
		Z	4.53	66.31	15.85		150.0	
10531-AAB	IEEE 802.11ac WiFi (20MHz, MCS6, 99pc duty cycle)	X	4.58	66.38	15.85	0.00	150.0	± 9.6 %
		Y	4.46	66.51	15.87		150.0	
		Z	4.52	66.40	15.86		150.0	
10532-AAB	IEEE 802.11ac WiFi (20MHz, MCS7, 99pc duty cycle)	X	4.44	66.22	15.78	0.00	150.0	± 9.6 %
		Y	4.33	66.36	15.80		150.0	
		Z	4.38	66.25	15.78		150.0	
10533-AAB	IEEE 802.11ac WiFi (20MHz, MCS8, 99pc duty cycle)	X	4.59	66.30	15.83	0.00	150.0	± 9.6 %
		Y	4.49	66.51	15.88		150.0	
		Z	4.54	66.36	15.84		150.0	
10534-AAB	IEEE 802.11ac WiFi (40MHz, MCS0, 99pc duty cycle)	X	5.13	66.43	15.94	0.00	150.0	± 9.6 %
		Y	5.04	66.54	15.97		150.0	
		Z	5.08	66.45	15.95		150.0	
10535-AAB	IEEE 802.11ac WiFi (40MHz, MCS1, 99pc duty cycle)	X	5.20	66.61	16.01	0.00	150.0	± 9.6 %
		Y	5.10	66.71	16.05		150.0	
		Z	5.15	66.64	16.04		150.0	
10536-AAB	IEEE 802.11ac WiFi (40MHz, MCS2, 99pc duty cycle)	X	5.06	66.54	15.96	0.00	150.0	± 9.6 %
		Y	4.98	66.67	16.01		150.0	
		Z	5.01	66.57	15.98		150.0	
10537-AAB	IEEE 802.11ac WiFi (40MHz, MCS3, 99pc duty cycle)	X	5.12	66.52	15.95	0.00	150.0	± 9.6 %
		Y	5.03	66.63	15.99		150.0	
		Z	5.07	66.54	15.97		150.0	
10538-AAB	IEEE 802.11ac WiFi (40MHz, MCS4, 99pc duty cycle)	X	5.22	66.56	16.02	0.00	150.0	± 9.6 %
		Y	5.11	66.64	16.04		150.0	
		Z	5.16	66.56	16.02		150.0	
10540-AAB	IEEE 802.11ac WiFi (40MHz, MCS6, 99pc duty cycle)	X	5.14	66.57	16.03	0.00	150.0	± 9.6 %
		Y	5.04	66.62	16.05		150.0	
		Z	5.10	66.60	16.05		150.0	

10541-AAB	IEEE 802.11ac WiFi (40MHz, MCS7, 99pc duty cycle)	X	5.11	66.43	15.96	0.00	150.0	± 9.6 %
		Y	5.02	66.51	15.98		150.0	
		Z	5.07	66.45	15.97		150.0	
10542-AAB	IEEE 802.11ac WiFi (40MHz, MCS8, 99pc duty cycle)	X	5.27	66.51	16.02	0.00	150.0	± 9.6 %
		Y	5.18	66.61	16.04		150.0	
		Z	5.22	66.53	16.03		150.0	
10543-AAB	IEEE 802.11ac WiFi (40MHz, MCS9, 99pc duty cycle)	X	5.36	66.57	16.06	0.00	150.0	± 9.6 %
		Y	5.24	66.63	16.08		150.0	
		Z	5.30	66.57	16.07		150.0	
10544-AAB	IEEE 802.11ac WiFi (80MHz, MCS0, 99pc duty cycle)	X	5.43	66.55	15.94	0.00	150.0	± 9.6 %
		Y	5.37	66.65	15.97		150.0	
		Z	5.40	66.56	15.95		150.0	
10545-AAB	IEEE 802.11ac WiFi (80MHz, MCS1, 99pc duty cycle)	X	5.64	67.00	16.11	0.00	150.0	± 9.6 %
		Y	5.55	67.08	16.15		150.0	
		Z	5.60	67.02	16.13		150.0	
10546-AAB	IEEE 802.11ac WiFi (80MHz, MCS2, 99pc duty cycle)	X	5.50	66.78	16.02	0.00	150.0	± 9.6 %
		Y	5.41	66.80	16.02		150.0	
		Z	5.46	66.76	16.01		150.0	
10547-AAB	IEEE 802.11ac WiFi (80MHz, MCS3, 99pc duty cycle)	X	5.58	66.83	16.03	0.00	150.0	± 9.6 %
		Y	5.49	66.87	16.05		150.0	
		Z	5.53	66.81	16.03		150.0	
10548-AAB	IEEE 802.11ac WiFi (80MHz, MCS4, 99pc duty cycle)	X	5.89	67.94	16.56	0.00	150.0	± 9.6 %
		Y	5.69	67.68	16.43		150.0	
		Z	5.80	67.83	16.51		150.0	
10550-AAB	IEEE 802.11ac WiFi (80MHz, MCS6, 99pc duty cycle)	X	5.53	66.79	16.03	0.00	150.0	± 9.6 %
		Y	5.46	66.91	16.08		150.0	
		Z	5.49	66.81	16.05		150.0	
10551-AAB	IEEE 802.11ac WiFi (80MHz, MCS7, 99pc duty cycle)	X	5.53	66.82	16.01	0.00	150.0	± 9.6 %
		Y	5.44	66.85	16.02		150.0	
		Z	5.49	66.83	16.02		150.0	
10552-AAB	IEEE 802.11ac WiFi (80MHz, MCS8, 99pc duty cycle)	X	5.44	66.61	15.91	0.00	150.0	± 9.6 %
		Y	5.38	66.72	15.95		150.0	
		Z	5.40	66.62	15.92		150.0	
10553-AAB	IEEE 802.11ac WiFi (80MHz, MCS9, 99pc duty cycle)	X	5.53	66.66	15.96	0.00	150.0	± 9.6 %
		Y	5.45	66.72	15.99		150.0	
		Z	5.48	66.65	15.97		150.0	
10554-AAC	IEEE 802.11ac WiFi (160MHz, MCS0, 99pc duty cycle)	X	5.84	66.93	16.04	0.00	150.0	± 9.6 %
		Y	5.78	67.01	16.06		150.0	
		Z	5.81	66.94	16.05		150.0	
10555-AAC	IEEE 802.11ac WiFi (160MHz, MCS1, 99pc duty cycle)	X	5.98	67.25	16.17	0.00	150.0	± 9.6 %
		Y	5.90	67.29	16.19		150.0	
		Z	5.94	67.25	16.18		150.0	
10556-AAC	IEEE 802.11ac WiFi (160MHz, MCS2, 99pc duty cycle)	X	6.00	67.29	16.19	0.00	150.0	± 9.6 %
		Y	5.93	67.35	16.21		150.0	
		Z	5.96	67.30	16.20		150.0	
10557-AAC	IEEE 802.11ac WiFi (160MHz, MCS3, 99pc duty cycle)	X	5.96	67.20	16.16	0.00	150.0	± 9.6 %
		Y	5.88	67.23	16.17		150.0	
		Z	5.92	67.18	16.16		150.0	

10558-AAC	IEEE 802.11ac WiFi (160MHz, MCS4, 99pc duty cycle)	X	6.01	67.37	16.26	0.00	150.0	± 9.6 %
		Y	5.92	67.38	16.26		150.0	
		Z	5.97	67.35	16.26		150.0	
10560-AAC	IEEE 802.11ac WiFi (160MHz, MCS6, 99pc duty cycle)	X	6.01	67.21	16.22	0.00	150.0	± 9.6 %
		Y	5.92	67.24	16.23		150.0	
		Z	5.96	67.19	16.22		150.0	
10561-AAC	IEEE 802.11ac WiFi (160MHz, MCS7, 99pc duty cycle)	X	5.93	67.18	16.25	0.00	150.0	± 9.6 %
		Y	5.85	67.23	16.26		150.0	
		Z	5.89	67.18	16.25		150.0	
10562-AAC	IEEE 802.11ac WiFi (160MHz, MCS8, 99pc duty cycle)	X	6.07	67.61	16.46	0.00	150.0	± 9.6 %
		Y	5.94	67.50	16.40		150.0	
		Z	6.01	67.54	16.43		150.0	
10563-AAC	IEEE 802.11ac WiFi (160MHz, MCS9, 99pc duty cycle)	X	6.39	68.16	16.69	0.00	150.0	± 9.6 %
		Y	6.02	67.41	16.31		150.0	
		Z	6.19	67.71	16.48		150.0	
10564-AAA	IEEE 802.11g WiFi 2.4 GHz (DSSS-OFDM, 9 Mbps, 99pc duty cycle)	X	4.86	66.83	16.26	0.46	150.0	± 9.6 %
		Y	4.78	67.03	16.31		150.0	
		Z	4.81	66.87	16.27		150.0	
10565-AAA	IEEE 802.11g WiFi 2.4 GHz (DSSS-OFDM, 12 Mbps, 99pc duty cycle)	X	5.09	67.28	16.58	0.46	150.0	± 9.6 %
		Y	4.98	67.43	16.60		150.0	
		Z	5.03	67.31	16.59		150.0	
10566-AAA	IEEE 802.11g WiFi 2.4 GHz (DSSS-OFDM, 18 Mbps, 99pc duty cycle)	X	4.93	67.13	16.40	0.46	150.0	± 9.6 %
		Y	4.82	67.27	16.42		150.0	
		Z	4.87	67.15	16.40		150.0	
10567-AAA	IEEE 802.11g WiFi 2.4 GHz (DSSS-OFDM, 24 Mbps, 99pc duty cycle)	X	4.95	67.50	16.74	0.46	150.0	± 9.6 %
		Y	4.84	67.61	16.74		150.0	
		Z	4.90	67.52	16.74		150.0	
10568-AAA	IEEE 802.11g WiFi 2.4 GHz (DSSS-OFDM, 36 Mbps, 99pc duty cycle)	X	4.85	66.93	16.19	0.46	150.0	± 9.6 %
		Y	4.74	67.12	16.24		150.0	
		Z	4.79	66.97	16.19		150.0	
10569-AAA	IEEE 802.11g WiFi 2.4 GHz (DSSS-OFDM, 48 Mbps, 99pc duty cycle)	X	4.91	67.57	16.79	0.46	150.0	± 9.6 %
		Y	4.82	67.76	16.84		150.0	
		Z	4.86	67.64	16.82		150.0	
10570-AAA	IEEE 802.11g WiFi 2.4 GHz (DSSS-OFDM, 54 Mbps, 99pc duty cycle)	X	4.94	67.43	16.73	0.46	150.0	± 9.6 %
		Y	4.84	67.60	16.77		150.0	
		Z	4.89	67.48	16.75		150.0	
10571-AAA	IEEE 802.11b WiFi 2.4 GHz (DSSS, 1 Mbps, 90pc duty cycle)	X	1.25	65.19	15.53	0.46	130.0	± 9.6 %
		Y	1.27	65.45	15.71		130.0	
		Z	1.24	65.29	15.60		130.0	
10572-AAA	IEEE 802.11b WiFi 2.4 GHz (DSSS, 2 Mbps, 90pc duty cycle)	X	1.27	65.79	15.87	0.46	130.0	± 9.6 %
		Y	1.28	66.03	16.05		130.0	
		Z	1.26	65.90	15.96		130.0	
10573-AAA	IEEE 802.11b WiFi 2.4 GHz (DSSS, 5.5 Mbps, 90pc duty cycle)	X	2.61	85.52	21.81	0.46	130.0	± 9.6 %
		Y	2.97	88.51	23.34		130.0	
		Z	3.01	88.05	22.71		130.0	
10574-AAA	IEEE 802.11b WiFi 2.4 GHz (DSSS, 11 Mbps, 90pc duty cycle)	X	1.44	71.64	18.59	0.46	130.0	± 9.6 %
		Y	1.44	71.68	18.74		130.0	
		Z	1.45	72.00	18.80		130.0	

10575-AAA	IEEE 802.11g WiFi 2.4 GHz (DSSS-OFDM, 6 Mbps, 90pc duty cycle)	X	4.68	66.71	16.37	0.46	130.0	± 9.6 %
		Y	4.59	66.91	16.41		130.0	
		Z	4.63	66.76	16.38		130.0	
10576-AAA	IEEE 802.11g WiFi 2.4 GHz (DSSS-OFDM, 9 Mbps, 90pc duty cycle)	X	4.70	66.86	16.43	0.46	130.0	± 9.6 %
		Y	4.61	67.07	16.47		130.0	
		Z	4.65	66.92	16.44		130.0	
10577-AAA	IEEE 802.11g WiFi 2.4 GHz (DSSS-OFDM, 12 Mbps, 90pc duty cycle)	X	4.91	67.16	16.60	0.46	130.0	± 9.6 %
		Y	4.79	67.31	16.62		130.0	
		Z	4.85	67.20	16.60		130.0	
10578-AAA	IEEE 802.11g WiFi 2.4 GHz (DSSS-OFDM, 18 Mbps, 90pc duty cycle)	X	4.81	67.32	16.69	0.46	130.0	± 9.6 %
		Y	4.69	67.44	16.70		130.0	
		Z	4.75	67.35	16.70		130.0	
10579-AAA	IEEE 802.11g WiFi 2.4 GHz (DSSS-OFDM, 24 Mbps, 90pc duty cycle)	X	4.58	66.65	16.03	0.46	130.0	± 9.6 %
		Y	4.47	66.80	16.06		130.0	
		Z	4.52	66.66	16.02		130.0	
10580-AAA	IEEE 802.11g WiFi 2.4 GHz (DSSS-OFDM, 36 Mbps, 90pc duty cycle)	X	4.63	66.68	16.05	0.46	130.0	± 9.6 %
		Y	4.52	66.87	16.11		130.0	
		Z	4.57	66.71	16.05		130.0	
10581-AAA	IEEE 802.11g WiFi 2.4 GHz (DSSS-OFDM, 48 Mbps, 90pc duty cycle)	X	4.71	67.36	16.64	0.46	130.0	± 9.6 %
		Y	4.60	67.52	16.66		130.0	
		Z	4.65	67.41	16.65		130.0	
10582-AAA	IEEE 802.11g WiFi 2.4 GHz (DSSS-OFDM, 54 Mbps, 90pc duty cycle)	X	4.53	66.42	15.83	0.46	130.0	± 9.6 %
		Y	4.41	66.60	15.88		130.0	
		Z	4.46	66.43	15.82		130.0	
10583-AAB	IEEE 802.11a/h WiFi 5 GHz (OFDM, 6 Mbps, 90pc duty cycle)	X	4.68	66.71	16.37	0.46	130.0	± 9.6 %
		Y	4.59	66.91	16.41		130.0	
		Z	4.63	66.76	16.38		130.0	
10584-AAB	IEEE 802.11a/h WiFi 5 GHz (OFDM, 9 Mbps, 90pc duty cycle)	X	4.70	66.86	16.43	0.46	130.0	± 9.6 %
		Y	4.61	67.07	16.47		130.0	
		Z	4.65	66.92	16.44		130.0	
10585-AAB	IEEE 802.11a/h WiFi 5 GHz (OFDM, 12 Mbps, 90pc duty cycle)	X	4.91	67.16	16.60	0.46	130.0	± 9.6 %
		Y	4.79	67.31	16.62		130.0	
		Z	4.85	67.20	16.60		130.0	
10586-AAB	IEEE 802.11a/h WiFi 5 GHz (OFDM, 18 Mbps, 90pc duty cycle)	X	4.81	67.32	16.69	0.46	130.0	± 9.6 %
		Y	4.69	67.44	16.70		130.0	
		Z	4.75	67.35	16.70		130.0	
10587-AAB	IEEE 802.11a/h WiFi 5 GHz (OFDM, 24 Mbps, 90pc duty cycle)	X	4.58	66.65	16.03	0.46	130.0	± 9.6 %
		Y	4.47	66.80	16.06		130.0	
		Z	4.52	66.66	16.02		130.0	
10588-AAB	IEEE 802.11a/h WiFi 5 GHz (OFDM, 36 Mbps, 90pc duty cycle)	X	4.63	66.68	16.05	0.46	130.0	± 9.6 %
		Y	4.52	66.87	16.11		130.0	
		Z	4.57	66.71	16.05		130.0	
10589-AAB	IEEE 802.11a/h WiFi 5 GHz (OFDM, 48 Mbps, 90pc duty cycle)	X	4.71	67.36	16.64	0.46	130.0	± 9.6 %
		Y	4.60	67.52	16.66		130.0	
		Z	4.65	67.41	16.65		130.0	
10590-AAB	IEEE 802.11a/h WiFi 5 GHz (OFDM, 54 Mbps, 90pc duty cycle)	X	4.53	66.42	15.83	0.46	130.0	± 9.6 %
		Y	4.41	66.60	15.88		130.0	
		Z	4.46	66.43	15.82		130.0	

10591-AAB	IEEE 802.11n (HT Mixed, 20MHz, MCS0, 90pc duty cycle)	X	4.83	66.77	16.47	0.46	130.0	± 9.6 %
		Y	4.74	66.96	16.50		130.0	
		Z	4.78	66.82	16.48		130.0	
10592-AAB	IEEE 802.11n (HT Mixed, 20MHz, MCS1, 90pc duty cycle)	X	4.98	67.10	16.60	0.46	130.0	± 9.6 %
		Y	4.87	67.27	16.63		130.0	
		Z	4.93	67.14	16.61		130.0	
10593-AAB	IEEE 802.11n (HT Mixed, 20MHz, MCS2, 90pc duty cycle)	X	4.91	67.02	16.48	0.46	130.0	± 9.6 %
		Y	4.80	67.17	16.51		130.0	
		Z	4.85	67.05	16.49		130.0	
10594-AAB	IEEE 802.11n (HT Mixed, 20MHz, MCS3, 90pc duty cycle)	X	4.96	67.18	16.63	0.46	130.0	± 9.6 %
		Y	4.85	67.33	16.66		130.0	
		Z	4.90	67.22	16.64		130.0	
10595-AAB	IEEE 802.11n (HT Mixed, 20MHz, MCS4, 90pc duty cycle)	X	4.93	67.14	16.53	0.46	130.0	± 9.6 %
		Y	4.82	67.31	16.57		130.0	
		Z	4.87	67.18	16.54		130.0	
10596-AAB	IEEE 802.11n (HT Mixed, 20MHz, MCS5, 90pc duty cycle)	X	4.87	67.14	16.54	0.46	130.0	± 9.6 %
		Y	4.76	67.30	16.57		130.0	
		Z	4.81	67.18	16.54		130.0	
10597-AAB	IEEE 802.11n (HT Mixed, 20MHz, MCS6, 90pc duty cycle)	X	4.82	67.05	16.42	0.46	130.0	± 9.6 %
		Y	4.71	67.19	16.44		130.0	
		Z	4.76	67.07	16.42		130.0	
10598-AAB	IEEE 802.11n (HT Mixed, 20MHz, MCS7, 90pc duty cycle)	X	4.80	67.28	16.68	0.46	130.0	± 9.6 %
		Y	4.69	67.37	16.67		130.0	
		Z	4.74	67.29	16.67		130.0	
10599-AAB	IEEE 802.11n (HT Mixed, 40MHz, MCS0, 90pc duty cycle)	X	5.50	67.33	16.69	0.46	130.0	± 9.6 %
		Y	5.40	67.43	16.72		130.0	
		Z	5.46	67.38	16.72		130.0	
10600-AAB	IEEE 802.11n (HT Mixed, 40MHz, MCS1, 90pc duty cycle)	X	5.67	67.87	16.93	0.46	130.0	± 9.6 %
		Y	5.53	67.86	16.92		130.0	
		Z	5.61	67.87	16.94		130.0	
10601-AAB	IEEE 802.11n (HT Mixed, 40MHz, MCS2, 90pc duty cycle)	X	5.54	67.56	16.79	0.46	130.0	± 9.6 %
		Y	5.42	67.61	16.80		130.0	
		Z	5.48	67.56	16.80		130.0	
10602-AAB	IEEE 802.11n (HT Mixed, 40MHz, MCS3, 90pc duty cycle)	X	5.63	67.58	16.72	0.46	130.0	± 9.6 %
		Y	5.55	67.79	16.82		130.0	
		Z	5.59	67.64	16.76		130.0	
10603-AAB	IEEE 802.11n (HT Mixed, 40MHz, MCS4, 90pc duty cycle)	X	5.71	67.86	16.99	0.46	130.0	± 9.6 %
		Y	5.61	68.00	17.05		130.0	
		Z	5.65	67.89	17.01		130.0	
10604-AAB	IEEE 802.11n (HT Mixed, 40MHz, MCS5, 90pc duty cycle)	X	5.50	67.29	16.70	0.46	130.0	± 9.6 %
		Y	5.49	67.68	16.88		130.0	
		Z	5.47	67.39	16.75		130.0	
10605-AAB	IEEE 802.11n (HT Mixed, 40MHz, MCS6, 90pc duty cycle)	X	5.63	67.69	16.90	0.46	130.0	± 9.6 %
		Y	5.53	67.80	16.94		130.0	
		Z	5.59	67.74	16.92		130.0	
10606-AAB	IEEE 802.11n (HT Mixed, 40MHz, MCS7, 90pc duty cycle)	X	5.39	67.07	16.45	0.46	130.0	± 9.6 %
		Y	5.27	67.10	16.45		130.0	
		Z	5.31	66.99	16.41		130.0	

10607-AAB	IEEE 802.11ac WiFi (20MHz, MCS0, 90pc duty cycle)	X	4.65	66.04	16.07	0.46	130.0	± 9.6 %
		Y	4.58	66.26	16.12		130.0	
		Z	4.61	66.10	16.08		130.0	
10608-AAB	IEEE 802.11ac WiFi (20MHz, MCS1, 90pc duty cycle)	X	4.85	66.45	16.23	0.46	130.0	± 9.6 %
		Y	4.74	66.63	16.28		130.0	
		Z	4.79	66.50	16.25		130.0	
10609-AAB	IEEE 802.11ac WiFi (20MHz, MCS2, 90pc duty cycle)	X	4.74	66.30	16.07	0.46	130.0	± 9.6 %
		Y	4.63	66.48	16.11		130.0	
		Z	4.68	66.35	16.08		130.0	
10610-AAB	IEEE 802.11ac WiFi (20MHz, MCS3, 90pc duty cycle)	X	4.79	66.46	16.23	0.46	130.0	± 9.6 %
		Y	4.68	66.63	16.27		130.0	
		Z	4.73	66.50	16.25		130.0	
10611-AAB	IEEE 802.11ac WiFi (20MHz, MCS4, 90pc duty cycle)	X	4.70	66.28	16.09	0.46	130.0	± 9.6 %
		Y	4.60	66.45	16.12		130.0	
		Z	4.65	66.31	16.10		130.0	
10612-AAB	IEEE 802.11ac WiFi (20MHz, MCS5, 90pc duty cycle)	X	4.72	66.43	16.13	0.46	130.0	± 9.6 %
		Y	4.60	66.61	16.18		130.0	
		Z	4.66	66.47	16.14		130.0	
10613-AAB	IEEE 802.11ac WiFi (20MHz, MCS6, 90pc duty cycle)	X	4.72	66.33	16.02	0.46	130.0	± 9.6 %
		Y	4.60	66.47	16.05		130.0	
		Z	4.66	66.35	16.02		130.0	
10614-AAB	IEEE 802.11ac WiFi (20MHz, MCS7, 90pc duty cycle)	X	4.66	66.50	16.24	0.46	130.0	± 9.6 %
		Y	4.55	66.62	16.25		130.0	
		Z	4.60	66.53	16.25		130.0	
10615-AAB	IEEE 802.11ac WiFi (20MHz, MCS8, 90pc duty cycle)	X	4.71	66.12	15.87	0.46	130.0	± 9.6 %
		Y	4.60	66.33	15.93		130.0	
		Z	4.65	66.16	15.88		130.0	
10616-AAB	IEEE 802.11ac WiFi (40MHz, MCS0, 90pc duty cycle)	X	5.31	66.56	16.28	0.46	130.0	± 9.6 %
		Y	5.21	66.65	16.31		130.0	
		Z	5.26	66.57	16.29		130.0	
10617-AAB	IEEE 802.11ac WiFi (40MHz, MCS1, 90pc duty cycle)	X	5.38	66.74	16.35	0.46	130.0	± 9.6 %
		Y	5.29	66.86	16.39		130.0	
		Z	5.34	66.79	16.37		130.0	
10618-AAB	IEEE 802.11ac WiFi (40MHz, MCS2, 90pc duty cycle)	X	5.26	66.74	16.36	0.46	130.0	± 9.6 %
		Y	5.18	66.87	16.40		130.0	
		Z	5.22	66.77	16.38		130.0	
10619-AAB	IEEE 802.11ac WiFi (40MHz, MCS3, 90pc duty cycle)	X	5.29	66.59	16.22	0.46	130.0	± 9.6 %
		Y	5.19	66.67	16.25		130.0	
		Z	5.23	66.58	16.22		130.0	
10620-AAB	IEEE 802.11ac WiFi (40MHz, MCS4, 90pc duty cycle)	X	5.38	66.62	16.29	0.46	130.0	± 9.6 %
		Y	5.27	66.70	16.31		130.0	
		Z	5.32	66.62	16.29		130.0	
10621-AAB	IEEE 802.11ac WiFi (40MHz, MCS5, 90pc duty cycle)	X	5.37	66.71	16.45	0.46	130.0	± 9.6 %
		Y	5.27	66.80	16.47		130.0	
		Z	5.32	66.74	16.47		130.0	
10622-AAB	IEEE 802.11ac WiFi (40MHz, MCS6, 90pc duty cycle)	X	5.39	66.89	16.53	0.46	130.0	± 9.6 %
		Y	5.29	66.97	16.55		130.0	
		Z	5.34	66.92	16.55		130.0	

10623-AAB	IEEE 802.11ac WiFi (40MHz, MCS7, 90pc duty cycle)	X	5.26	66.41	16.17	0.46	130.0	± 9.6 %
		Y	5.16	66.51	16.20		130.0	
		Z	5.21	66.44	16.19		130.0	
10624-AAB	IEEE 802.11ac WiFi (40MHz, MCS8, 90pc duty cycle)	X	5.45	66.63	16.34	0.46	130.0	± 9.6 %
		Y	5.35	66.71	16.36		130.0	
		Z	5.40	66.64	16.35		130.0	
10625-AAB	IEEE 802.11ac WiFi (40MHz, MCS9, 90pc duty cycle)	X	5.87	67.75	16.95	0.46	130.0	± 9.6 %
		Y	5.59	67.32	16.72		130.0	
		Z	5.77	67.62	16.89		130.0	
10626-AAB	IEEE 802.11ac WiFi (80MHz, MCS0, 90pc duty cycle)	X	5.59	66.61	16.24	0.46	130.0	± 9.6 %
		Y	5.53	66.71	16.27		130.0	
		Z	5.56	66.63	16.25		130.0	
10627-AAB	IEEE 802.11ac WiFi (80MHz, MCS1, 90pc duty cycle)	X	5.86	67.23	16.51	0.46	130.0	± 9.6 %
		Y	5.77	67.31	16.54		130.0	
		Z	5.82	67.26	16.53		130.0	
10628-AAB	IEEE 802.11ac WiFi (80MHz, MCS2, 90pc duty cycle)	X	5.64	66.75	16.20	0.46	130.0	± 9.6 %
		Y	5.54	66.76	16.20		130.0	
		Z	5.59	66.73	16.20		130.0	
10629-AAB	IEEE 802.11ac WiFi (80MHz, MCS3, 90pc duty cycle)	X	5.74	66.86	16.25	0.46	130.0	± 9.6 %
		Y	5.63	66.85	16.25		130.0	
		Z	5.67	66.78	16.22		130.0	
10630-AAB	IEEE 802.11ac WiFi (80MHz, MCS4, 90pc duty cycle)	X	6.27	68.62	17.13	0.46	130.0	± 9.6 %
		Y	5.98	68.12	16.89		130.0	
		Z	6.16	68.44	17.05		130.0	
10631-AAB	IEEE 802.11ac WiFi (80MHz, MCS5, 90pc duty cycle)	X	6.08	68.18	17.10	0.46	130.0	± 9.6 %
		Y	5.89	67.92	16.96		130.0	
		Z	6.00	68.07	17.05		130.0	
10632-AAB	IEEE 802.11ac WiFi (80MHz, MCS6, 90pc duty cycle)	X	5.81	67.25	16.65	0.46	130.0	± 9.6 %
		Y	5.73	67.36	16.70		130.0	
		Z	5.78	67.29	16.68		130.0	
10633-AAB	IEEE 802.11ac WiFi (80MHz, MCS7, 90pc duty cycle)	X	5.70	66.88	16.30	0.46	130.0	± 9.6 %
		Y	5.61	66.94	16.32		130.0	
		Z	5.64	66.86	16.29		130.0	
10634-AAB	IEEE 802.11ac WiFi (80MHz, MCS8, 90pc duty cycle)	X	5.68	66.90	16.36	0.46	130.0	± 9.6 %
		Y	5.59	66.94	16.37		130.0	
		Z	5.63	66.89	16.36		130.0	
10635-AAB	IEEE 802.11ac WiFi (80MHz, MCS9, 90pc duty cycle)	X	5.57	66.28	15.80	0.46	130.0	± 9.6 %
		Y	5.47	66.33	15.83		130.0	
		Z	5.52	66.25	15.79		130.0	
10636-AAC	IEEE 802.11ac WiFi (160MHz, MCS0, 90pc duty cycle)	X	6.01	67.00	16.34	0.46	130.0	± 9.6 %
		Y	5.95	67.08	16.37		130.0	
		Z	5.98	67.00	16.35		130.0	
10637-AAC	IEEE 802.11ac WiFi (160MHz, MCS1, 90pc duty cycle)	X	6.18	67.41	16.53	0.46	130.0	± 9.6 %
		Y	6.10	67.45	16.54		130.0	
		Z	6.14	67.41	16.54		130.0	
10638-AAC	IEEE 802.11ac WiFi (160MHz, MCS2, 90pc duty cycle)	X	6.18	67.38	16.49	0.46	130.0	± 9.6 %
		Y	6.10	67.42	16.51		130.0	
		Z	6.14	67.38	16.50		130.0	

10639-AAC	IEEE 802.11ac WiFi (160MHz, MCS3, 90pc duty cycle)	X	6.15	67.32	16.51	0.46	130.0	± 9.6 %
		Y	6.07	67.34	16.50		130.0	
		Z	6.11	67.30	16.50		130.0	
10640-AAC	IEEE 802.11ac WiFi (160MHz, MCS4, 90pc duty cycle)	X	6.17	67.36	16.47	0.46	130.0	± 9.6 %
		Y	6.07	67.36	16.47		130.0	
		Z	6.11	67.32	16.45		130.0	
10641-AAC	IEEE 802.11ac WiFi (160MHz, MCS5, 90pc duty cycle)	X	6.20	67.22	16.42	0.46	130.0	± 9.6 %
		Y	6.14	67.34	16.48		130.0	
		Z	6.17	67.26	16.44		130.0	
10642-AAC	IEEE 802.11ac WiFi (160MHz, MCS6, 90pc duty cycle)	X	6.24	67.47	16.71	0.46	130.0	± 9.6 %
		Y	6.15	67.50	16.71		130.0	
		Z	6.19	67.46	16.71		130.0	
10643-AAC	IEEE 802.11ac WiFi (160MHz, MCS7, 90pc duty cycle)	X	6.08	67.18	16.46	0.46	130.0	± 9.6 %
		Y	6.01	67.25	16.50		130.0	
		Z	6.04	67.18	16.47		130.0	
10644-AAC	IEEE 802.11ac WiFi (160MHz, MCS8, 90pc duty cycle)	X	6.27	67.76	16.77	0.46	130.0	± 9.6 %
		Y	6.11	67.57	16.67		130.0	
		Z	6.19	67.64	16.72		130.0	
10645-AAC	IEEE 802.11ac WiFi (160MHz, MCS9, 90pc duty cycle)	X	6.75	68.75	17.22	0.46	130.0	± 9.6 %
		Y	6.24	67.62	16.66		130.0	
		Z	6.47	68.11	16.92		130.0	
10646-AAD	LTE-TDD (SC-FDMA, 1 RB, 5 MHz, QPSK, UL Subframe=2,7)	X	46.96	124.69	40.77	9.30	60.0	± 9.6 %
		Y	100.00	148.37	48.20		60.0	
		Z	67.01	134.85	43.85		60.0	
10647-AAC	LTE-TDD (SC-FDMA, 1 RB, 20 MHz, QPSK, UL Subframe=2,7)	X	46.42	125.36	41.11	9.30	60.0	± 9.6 %
		Y	100.00	149.72	48.78		60.0	
		Z	63.71	134.73	44.00		60.0	
10648-AAA	CDMA2000 (1x Advanced)	X	0.63	62.54	9.79	0.00	150.0	± 9.6 %
		Y	0.58	62.24	9.19		150.0	
		Z	0.59	62.30	9.35		150.0	
10652-AAB	LTE-TDD (OFDMA, 5 MHz, E-TM 3.1, Clipping 44%)	X	4.19	68.34	17.06	2.23	80.0	± 9.6 %
		Y	4.08	68.62	17.03		80.0	
		Z	4.14	68.48	17.06		80.0	
10653-AAB	LTE-TDD (OFDMA, 10 MHz, E-TM 3.1, Clipping 44%)	X	4.68	67.61	17.18	2.23	80.0	± 9.6 %
		Y	4.56	67.77	17.19		80.0	
		Z	4.62	67.66	17.19		80.0	
10654-AAB	LTE-TDD (OFDMA, 15 MHz, E-TM 3.1, Clipping 44%)	X	4.63	67.27	17.19	2.23	80.0	± 9.6 %
		Y	4.54	67.39	17.21		80.0	
		Z	4.58	67.31	17.20		80.0	
10655-AAB	LTE-TDD (OFDMA, 20 MHz, E-TM 3.1, Clipping 44%)	X	4.69	67.27	17.23	2.23	80.0	± 9.6 %
		Y	4.60	67.35	17.25		80.0	
		Z	4.64	67.28	17.23		80.0	
10658-AAA	Pulse Waveform (200Hz, 10%)	X	19.17	92.59	24.24	10.00	50.0	± 9.6 %
		Y	41.94	104.68	27.26		50.0	
		Z	24.50	96.17	24.98		50.0	
10659-AAA	Pulse Waveform (200Hz, 20%)	X	100.00	114.36	28.32	6.99	60.0	± 9.6 %
		Y	100.00	114.20	27.89		60.0	
		Z	100.00	113.56	27.75		60.0	

10660-AAA	Pulse Waveform (200Hz, 40%)	X	100.00	111.43	25.50	3.98	80.0	± 9.6 %
		Y	100.00	112.46	25.73		80.0	
		Z	100.00	110.79	25.07		80.0	
10661-AAA	Pulse Waveform (200Hz, 60%)	X	100.00	110.47	23.74	2.22	100.0	± 9.6 %
		Y	100.00	113.22	24.78		100.0	
		Z	100.00	109.90	23.38		100.0	
10662-AAA	Pulse Waveform (200Hz, 80%)	X	100.00	107.83	20.92	0.97	120.0	± 9.6 %
		Y	100.00	115.39	23.98		120.0	
		Z	100.00	107.00	20.48		120.0	

^E Uncertainty is determined using the max. deviation from linear response applying rectangular distribution and is expressed for the square of the field value.



Accredited by the Swiss Accreditation Service (SAS)
The Swiss Accreditation Service is one of the signatories to the EA
Multilateral Agreement for the recognition of calibration certificates

Accreditation No.: **SCS 0108**

Client **PC Test**

Certificate No: **EX3-7357_Apr18**

CALIBRATION CERTIFICATE

Object **EX3DV4 - SN:7357**

Calibration procedure(s) **QA CAL-01.v9, QA CAL-12.v9, QA CAL-14.v4, QA CAL-23.v5,
QA CAL-25.v6
Calibration procedure for dosimetric E-field probes**

Calibration date: **April 18, 2018**

*BNV ✓
05-01-2018*

This calibration certificate documents the traceability to national standards, which realize the physical units of measurements (SI).
The measurements and the uncertainties with confidence probability are given on the following pages and are part of the certificate.

All calibrations have been conducted in the closed laboratory facility: environment temperature (22 ± 3)°C and humidity < 70%.

Calibration Equipment used (M&TE critical for calibration)

Primary Standards	ID	Cal Date (Certificate No.)	Scheduled Calibration
Power meter NRP	SN: 104778	04-Apr-18 (No. 217-02672/02673)	Apr-19
Power sensor NRP-Z91	SN: 103244	04-Apr-18 (No. 217-02672)	Apr-19
Power sensor NRP-Z91	SN: 103245	04-Apr-18 (No. 217-02673)	Apr-19
Reference 20 dB Attenuator	SN: S5277 (20x)	04-Apr-18 (No. 217-02682)	Apr-19
Reference Probe ES3DV2	SN: 3013	30-Dec-17 (No. ES3-3013_Dec17)	Dec-18
DAE4	SN: 660	21-Dec-17 (No. DAE4-660_Dec17)	Dec-18
Secondary Standards	ID	Check Date (in house)	Scheduled Check
Power meter E4419B	SN: GB41293874	06-Apr-16 (in house check Jun-16)	In house check: Jun-18
Power sensor E4412A	SN: MY41498087	06-Apr-16 (in house check Jun-16)	In house check: Jun-18
Power sensor E4412A	SN: 000110210	06-Apr-16 (in house check Jun-16)	In house check: Jun-18
RF generator HP 8648C	SN: US3642U01700	04-Aug-99 (in house check Jun-16)	In house check: Jun-18
Network Analyzer HP 8753E	SN: US37390585	18-Oct-01 (in house check Oct-17)	In house check: Oct-18

Calibrated by: **Claudio Leubler** (Name) / **Laboratory Technician** (Function) / *[Signature]* (Signature)

Approved by: **Katja Pokovic** (Name) / **Technical Manager** (Function) / *[Signature]* (Signature)

Issued: April 19, 2018

This calibration certificate shall not be reproduced except in full without written approval of the laboratory.



Accredited by the Swiss Accreditation Service (SAS)

Accreditation No.: **SCS 0108**

The Swiss Accreditation Service is one of the signatories to the EA Multilateral Agreement for the recognition of calibration certificates

Glossary:

TSL	tissue simulating liquid
NORM _{x,y,z}	sensitivity in free space
ConvF	sensitivity in TSL / NORM _{x,y,z}
DCP	diode compression point
CF	crest factor (1/duty_cycle) of the RF signal
A, B, C, D	modulation dependent linearization parameters
Polarization φ	φ rotation around probe axis
Polarization ϑ	ϑ rotation around an axis that is in the plane normal to probe axis (at measurement center), i.e., $\vartheta = 0$ is normal to probe axis
Connector Angle	information used in DASY system to align probe sensor X to the robot coordinate system

Calibration is Performed According to the Following Standards:

- a) IEEE Std 1528-2013, "IEEE Recommended Practice for Determining the Peak Spatial-Averaged Specific Absorption Rate (SAR) in the Human Head from Wireless Communications Devices: Measurement Techniques", June 2013
- b) IEC 62209-1, "Measurement procedure for the assessment of Specific Absorption Rate (SAR) from hand-held and body-mounted devices used next to the ear (frequency range of 300 MHz to 6 GHz)", July 2016
- c) IEC 62209-2, "Procedure to determine the Specific Absorption Rate (SAR) for wireless communication devices used in close proximity to the human body (frequency range of 30 MHz to 6 GHz)", March 2010
- d) KDB 865664, "SAR Measurement Requirements for 100 MHz to 6 GHz"

Methods Applied and Interpretation of Parameters:

- **NORM_{x,y,z}**: Assessed for E-field polarization $\vartheta = 0$ ($f \leq 900$ MHz in TEM-cell; $f > 1800$ MHz: R22 waveguide). NORM_{x,y,z} are only intermediate values, i.e., the uncertainties of NORM_{x,y,z} does not affect the E²-field uncertainty inside TSL (see below ConvF).
- **NORM(f)_{x,y,z}** = NORM_{x,y,z} * frequency_response (see Frequency Response Chart). This linearization is implemented in DASY4 software versions later than 4.2. The uncertainty of the frequency response is included in the stated uncertainty of ConvF.
- **DCP_{x,y,z}**: DCP are numerical linearization parameters assessed based on the data of power sweep with CW signal (no uncertainty required). DCP does not depend on frequency nor media.
- **PAR**: PAR is the Peak to Average Ratio that is not calibrated but determined based on the signal characteristics
- **A_{x,y,z}; B_{x,y,z}; C_{x,y,z}; D_{x,y,z}; VR_{x,y,z}; A, B, C, D** are numerical linearization parameters assessed based on the data of power sweep for specific modulation signal. The parameters do not depend on frequency nor media. VR is the maximum calibration range expressed in RMS voltage across the diode.
- **ConvF and Boundary Effect Parameters**: Assessed in flat phantom using E-field (or Temperature Transfer Standard for $f \leq 800$ MHz) and inside waveguide using analytical field distributions based on power measurements for $f > 800$ MHz. The same setups are used for assessment of the parameters applied for boundary compensation (alpha, depth) of which typical uncertainty values are given. These parameters are used in DASY4 software to improve probe accuracy close to the boundary. The sensitivity in TSL corresponds to NORM_{x,y,z} * ConvF whereby the uncertainty corresponds to that given for ConvF. A frequency dependent ConvF is used in DASY version 4.4 and higher which allows extending the validity from ± 50 MHz to ± 100 MHz.
- **Spherical isotropy (3D deviation from isotropy)**: in a field of low gradients realized using a flat phantom exposed by a patch antenna.
- **Sensor Offset**: The sensor offset corresponds to the offset of virtual measurement center from the probe tip (on probe axis). No tolerance required.
- **Connector Angle**: The angle is assessed using the information gained by determining the NORM_x (no uncertainty required).

Probe EX3DV4

SN:7357

Manufactured: February 5, 2015
Calibrated: April 18, 2018

Calibrated for DASY/EASY Systems
(Note: non-compatible with DASY2 system!)

DASY/EASY - Parameters of Probe: EX3DV4 - SN:7357

Basic Calibration Parameters

	Sensor X	Sensor Y	Sensor Z	Unc (k=2)
Norm ($\mu\text{V}/(\text{V}/\text{m})^2$) ^A	0.37	0.48	0.40	$\pm 10.1 \%$
DCP (mV) ^B	89.1	99.1	96.4	

Modulation Calibration Parameters

UID	Communication System Name		A dB	B dB $\sqrt{\mu\text{V}}$	C	D dB	VR mV	Unc ^E (k=2)
0	CW	X	0.0	0.0	1.0	0.00	151.5	$\pm 2.7 \%$
		Y	0.0	0.0	1.0		139.1	
		Z	0.0	0.0	1.0		158.4	

Note: For details on UID parameters see Appendix.

Sensor Model Parameters

	C1 fF	C2 fF	α V ⁻¹	T1 ms.V ⁻²	T2 ms.V ⁻¹	T3 ms	T4 V ⁻²	T5 V ⁻¹	T6
X	37.91	303.3	40.25	6.413	0.832	4.998	0.00	0.454	1.006
Y	48.33	363.1	36.01	10.58	0.113	5.100	0.00	0.458	1.004
Z	39.38	305.2	38.03	5.76	0.610	5.046	0.00	0.461	1.008

The reported uncertainty of measurement is stated as the standard uncertainty of measurement multiplied by the coverage factor k=2, which for a normal distribution corresponds to a coverage probability of approximately 95%.

^A The uncertainties of Norm X,Y,Z do not affect the E²-field uncertainty inside TSL (see Pages 5 and 6).

^B Numerical linearization parameter; uncertainty not required.

^E Uncertainty is determined using the max. deviation from linear response applying rectangular distribution and is expressed for the square of the field value.

DASY/EASY - Parameters of Probe: EX3DV4 - SN:7357

Calibration Parameter Determined in Head Tissue Simulating Media

f (MHz) ^C	Relative Permittivity ^F	Conductivity (S/m) ^F	ConvF X	ConvF Y	ConvF Z	Alpha ^G	Depth ^G (mm)	Unc (k=2)
64	54.2	0.75	14.92	14.92	14.92	0.00	1.00	± 13.3 %
150	52.3	0.76	13.49	13.49	13.49	0.00	1.00	± 13.3 %
300	45.3	0.87	12.37	12.37	12.37	0.08	1.20	± 13.3 %
450	43.5	0.87	11.17	11.17	11.17	0.14	1.20	± 13.3 %
750	41.9	0.89	10.50	10.50	10.50	0.45	0.85	± 12.0 %
835	41.5	0.90	10.11	10.11	10.11	0.37	0.93	± 12.0 %
1750	40.1	1.37	8.80	8.80	8.80	0.38	0.86	± 12.0 %
1900	40.0	1.40	8.47	8.47	8.47	0.18	0.83	± 12.0 %
2300	39.5	1.67	7.83	7.83	7.83	0.33	0.86	± 12.0 %
2450	39.2	1.80	7.43	7.43	7.43	0.37	0.89	± 12.0 %
2600	39.0	1.96	7.13	7.13	7.13	0.27	0.98	± 12.0 %
5250	35.9	4.71	5.62	5.62	5.62	0.35	1.80	± 13.1 %
5600	35.5	5.07	4.93	4.93	4.93	0.40	1.80	± 13.1 %
5750	35.4	5.22	5.23	5.23	5.23	0.40	1.80	± 13.1 %

^C Frequency validity above 300 MHz of ± 100 MHz only applies for DASY v4.4 and higher (see Page 2), else it is restricted to ± 50 MHz. The uncertainty is the RSS of the ConvF uncertainty at calibration frequency and the uncertainty for the indicated frequency band. Frequency validity below 300 MHz is ± 10, 25, 40, 50 and 70 MHz for ConvF assessments at 30, 64, 128, 150 and 220 MHz respectively. Above 5 GHz frequency validity can be extended to ± 110 MHz.

^F At frequencies below 3 GHz, the validity of tissue parameters (ϵ and σ) can be relaxed to ± 10% if liquid compensation formula is applied to measured SAR values. At frequencies above 3 GHz, the validity of tissue parameters (ϵ and σ) is restricted to ± 5%. The uncertainty is the RSS of the ConvF uncertainty for indicated target tissue parameters.

^G Alpha/Depth are determined during calibration. SPEAG warrants that the remaining deviation due to the boundary effect after compensation is always less than ± 1% for frequencies below 3 GHz and below ± 2% for frequencies between 3-6 GHz at any distance larger than half the probe tip diameter from the boundary.

DASY/EASY - Parameters of Probe: EX3DV4 - SN:7357

Calibration Parameter Determined in Body Tissue Simulating Media

f (MHz) ^C	Relative Permittivity ^F	Conductivity (S/m) ^F	ConvF X	ConvF Y	ConvF Z	Alpha ^G	Depth ^G (mm)	Unc (k=2)
150	61.9	0.80	12.99	12.99	12.99	0.00	1.00	± 13.3 %
300	58.2	0.92	12.08	12.08	12.08	0.05	1.20	± 13.3 %
450	56.7	0.94	11.52	11.52	11.52	0.08	1.20	± 13.3 %
750	55.5	0.96	10.37	10.37	10.37	0.47	0.85	± 12.0 %
835	55.2	0.97	10.17	10.17	10.17	0.37	0.93	± 12.0 %
1750	53.4	1.49	8.43	8.43	8.43	0.37	0.86	± 12.0 %
1900	53.3	1.52	8.08	8.08	8.08	0.36	0.83	± 12.0 %
2300	52.9	1.81	7.74	7.74	7.74	0.38	0.85	± 12.0 %
2450	52.7	1.95	7.60	7.60	7.60	0.35	0.88	± 12.0 %
2600	52.5	2.16	7.44	7.44	7.44	0.33	0.93	± 12.0 %
5250	48.9	5.36	4.78	4.78	4.78	0.50	1.80	± 13.1 %
5600	48.5	5.77	4.20	4.20	4.20	0.50	1.80	± 13.1 %
5750	48.3	5.94	4.21	4.21	4.21	0.50	1.80	± 13.1 %

^C Frequency validity above 300 MHz of ± 100 MHz only applies for DASY v4.4 and higher (see Page 2), else it is restricted to ± 50 MHz. The uncertainty is the RSS of the ConvF uncertainty at calibration frequency and the uncertainty for the indicated frequency band. Frequency validity below 300 MHz is ± 10, 25, 40, 50 and 70 MHz for ConvF assessments at 30, 64, 128, 150 and 220 MHz respectively. Above 5 GHz frequency validity can be extended to ± 110 MHz.

^F At frequencies below 3 GHz, the validity of tissue parameters (ϵ and σ) can be relaxed to ± 10% if liquid compensation formula is applied to measured SAR values. At frequencies above 3 GHz, the validity of tissue parameters (ϵ and σ) is restricted to ± 5%. The uncertainty is the RSS of the ConvF uncertainty for indicated target tissue parameters.

^G Alpha/Depth are determined during calibration. SPEAG warrants that the remaining deviation due to the boundary effect after compensation is always less than ± 1% for frequencies below 3 GHz and below ± 2% for frequencies between 3-6 GHz at any distance larger than half the probe tip diameter from the boundary.

Frequency Response of E-Field (TEM-Cell:ifi110 EXX, Waveguide: R22)

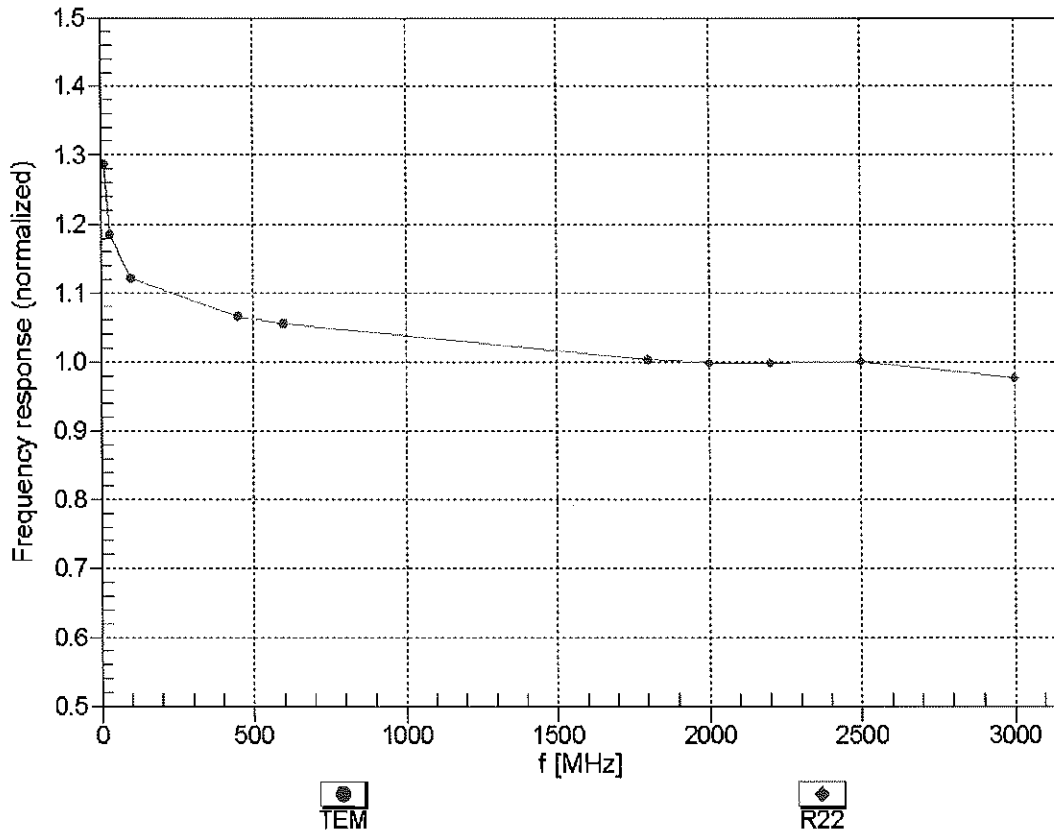

Uncertainty of Frequency Response of E-field: $\pm 6.3\%$ (k=2)

Receiving Pattern (ϕ), $\vartheta = 0^\circ$

f=600 MHz, TEM

f=1800 MHz, R22

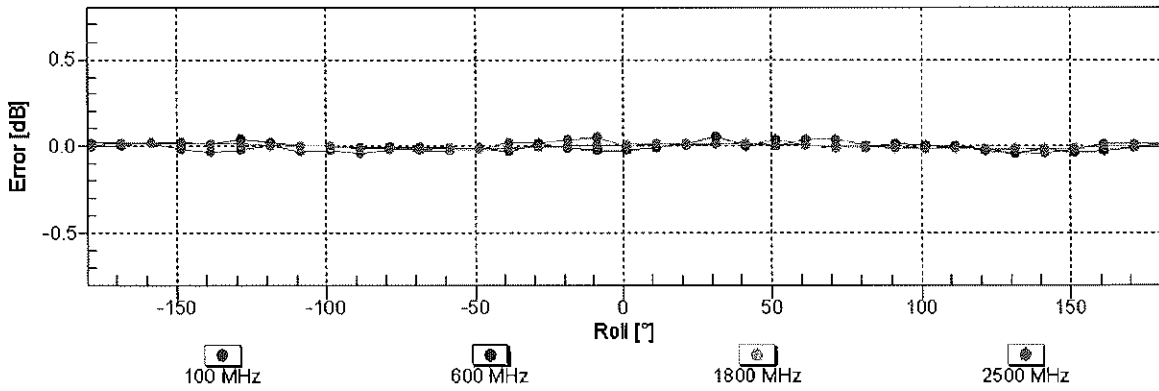
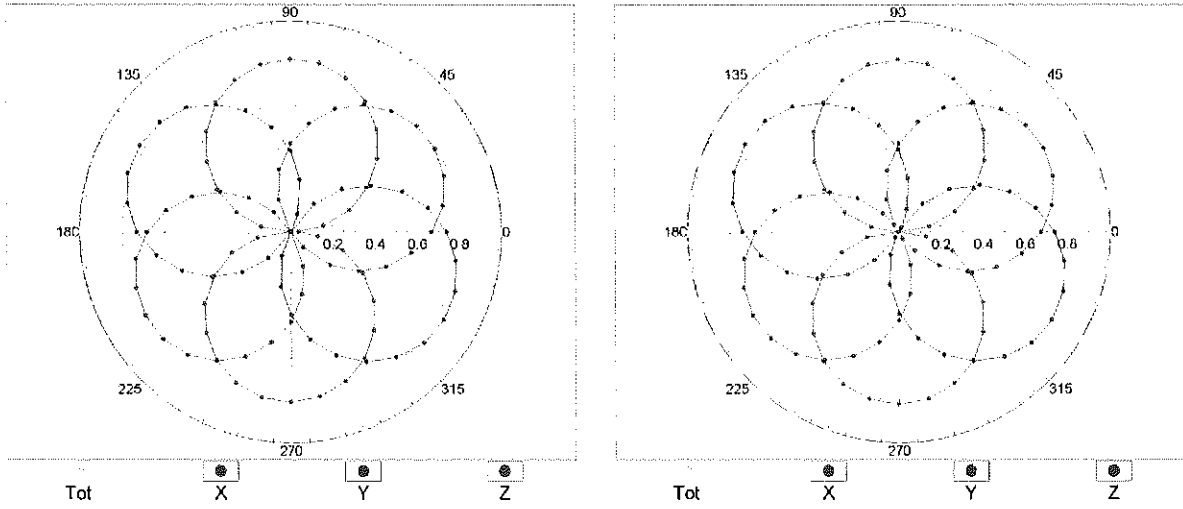

Uncertainty of Axial Isotropy Assessment: $\pm 0.5\%$ ($k=2$)

Dynamic Range $f(SAR_{head})$ (TEM cell , $f_{eval} = 1900$ MHz)

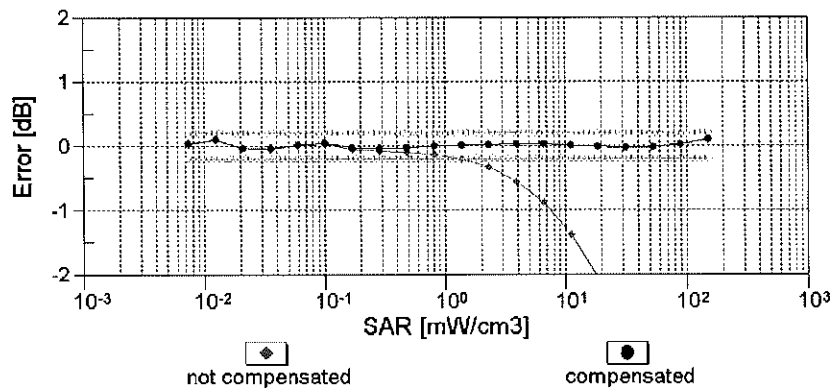
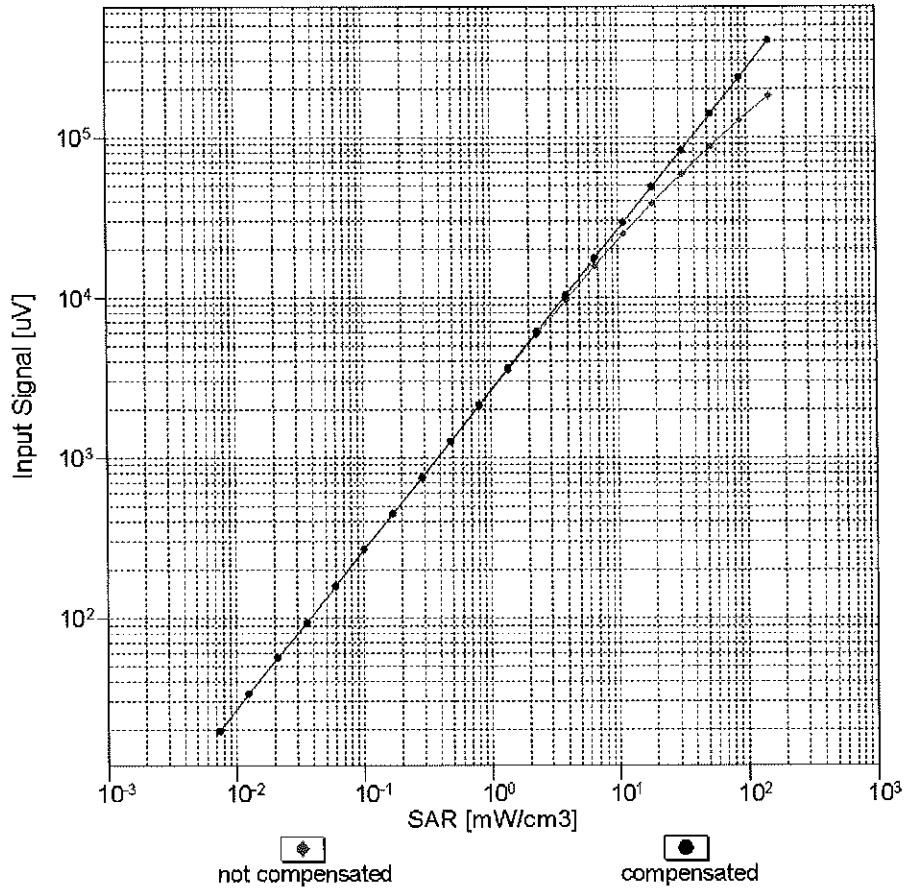

Uncertainty of Linearity Assessment: ± 0.6% (k=2)

Conversion Factor Assessment

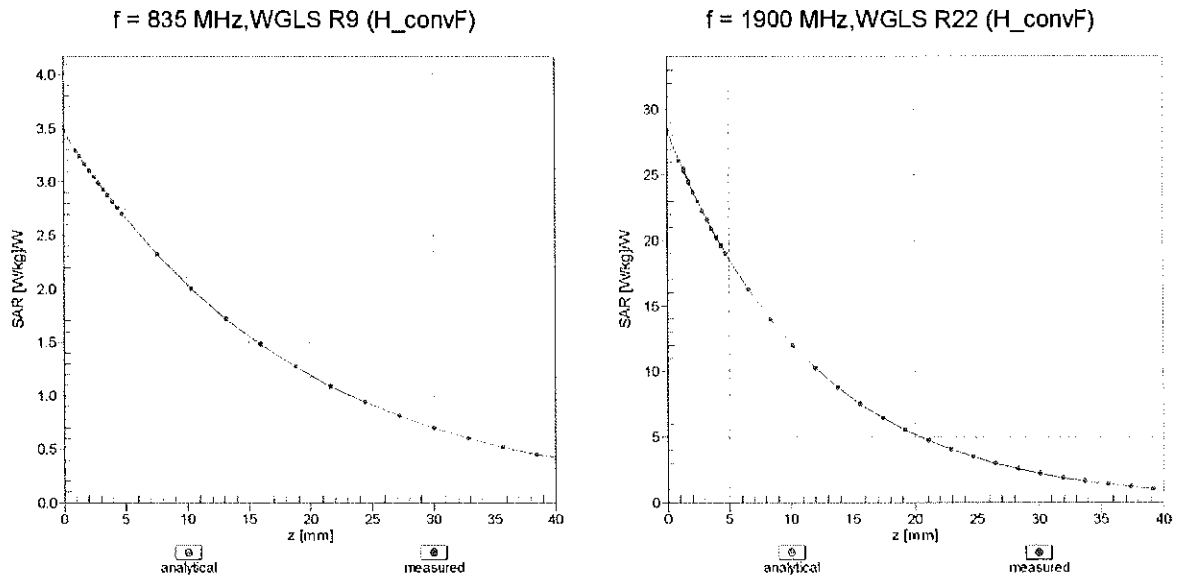

Deviation from Isotropy in Liquid Error (ϕ, ϑ), f = 900 MHz

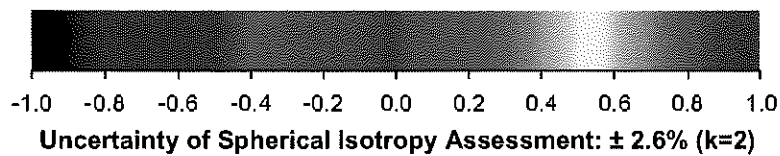
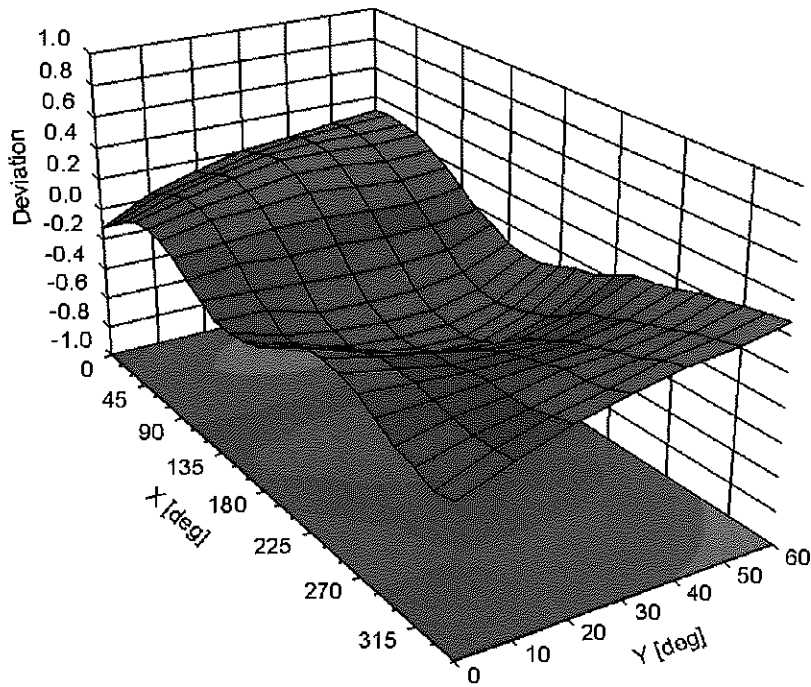

DASY/EASY - Parameters of Probe: EX3DV4 - SN:7357

Other Probe Parameters

Sensor Arrangement	Triangular
Connector Angle (°)	11.4
Mechanical Surface Detection Mode	enabled
Optical Surface Detection Mode	disabled
Probe Overall Length	337 mm
Probe Body Diameter	10 mm
Tip Length	9 mm
Tip Diameter	2.5 mm
Probe Tip to Sensor X Calibration Point	1 mm
Probe Tip to Sensor Y Calibration Point	1 mm
Probe Tip to Sensor Z Calibration Point	1 mm
Recommended Measurement Distance from Surface	1.4 mm

Appendix: Modulation Calibration Parameters

UID	Communication System Name		A dB	B dB $\sqrt{\mu}$ V	C	D dB	VR mV	Max Unc ^E (k=2)
0	CW	X	0.00	0.00	1.00	0.00	151.5	± 2.7 %
		Y	0.00	0.00	1.00		139.1	
		Z	0.00	0.00	1.00		158.4	
10010- CAA	SAR Validation (Square, 100ms, 10ms)	X	1.67	61.93	7.65	10.00	20.0	± 9.6 %
		Y	2.82	69.17	11.50		20.0	
		Z	1.68	62.20	7.72		20.0	
10011- CAB	UMTS-FDD (WCDMA)	X	0.91	67.36	14.64	0.00	150.0	± 9.6 %
		Y	1.03	67.52	15.32		150.0	
		Z	0.87	67.00	14.33		150.0	
10012- CAB	IEEE 802.11b WiFi 2.4 GHz (DSSS, 1 Mbps)	X	1.03	63.20	14.83	0.41	150.0	± 9.6 %
		Y	1.15	63.79	15.34		150.0	
		Z	1.01	63.27	14.81		150.0	
10013- CAB	IEEE 802.11g WiFi 2.4 GHz (DSSS-OFDM, 6 Mbps)	X	4.63	66.39	16.96	1.46	150.0	± 9.6 %
		Y	4.87	66.69	17.19		150.0	
		Z	4.64	66.53	16.99		150.0	
10021- DAC	GSM-FDD (TDMA, GMSK)	X	3.67	70.27	12.79	9.39	50.0	± 9.6 %
		Y	100.00	116.17	27.83		50.0	
		Z	17.04	87.58	18.77		50.0	
10023- DAC	GPRS-FDD (TDMA, GMSK, TN 0)	X	3.48	69.40	12.45	9.57	50.0	± 9.6 %
		Y	100.00	115.39	27.52		50.0	
		Z	8.91	80.25	16.55		50.0	
10024- DAC	GPRS-FDD (TDMA, GMSK, TN 0-1)	X	1.80	66.18	9.84	6.56	60.0	± 9.6 %
		Y	100.00	120.19	28.55		60.0	
		Z	100.00	103.30	20.82		60.0	
10025- DAC	EDGE-FDD (TDMA, 8PSK, TN 0)	X	3.42	64.49	22.34	12.57	50.0	± 9.6 %
		Y	6.04	85.62	35.55		50.0	
		Z	3.44	65.04	22.85		50.0	
10026- DAC	EDGE-FDD (TDMA, 8PSK, TN 0-1)	X	6.25	83.47	29.08	9.56	60.0	± 9.6 %
		Y	9.24	95.88	35.47		60.0	
		Z	6.56	85.41	30.17		60.0	
10027- DAC	GPRS-FDD (TDMA, GMSK, TN 0-1-2)	X	0.96	63.24	7.67	4.80	80.0	± 9.6 %
		Y	100.00	125.59	30.06		80.0	
		Z	100.00	100.14	18.62		80.0	
10028- DAC	GPRS-FDD (TDMA, GMSK, TN 0-1-2-3)	X	0.48	60.36	5.50	3.55	100.0	± 9.6 %
		Y	100.00	132.37	32.13		100.0	
		Z	99.97	95.45	15.98		100.0	
10029- DAC	EDGE-FDD (TDMA, 8PSK, TN 0-1-2)	X	4.19	75.28	24.64	7.80	80.0	± 9.6 %
		Y	5.35	81.78	28.49		80.0	
		Z	4.26	76.21	25.31		80.0	
10030- CAA	IEEE 802.15.1 Bluetooth (GFSK, DH1)	X	1.09	63.09	7.76	5.30	70.0	± 9.6 %
		Y	100.00	120.14	28.06		70.0	
		Z	4.93	76.05	12.90		70.0	
10031- CAA	IEEE 802.15.1 Bluetooth (GFSK, DH3)	X	0.27	60.00	3.17	1.88	100.0	± 9.6 %
		Y	100.00	135.00	31.47		100.0	
		Z	0.26	60.00	3.07		100.0	

10032-CAA	IEEE 802.15.1 Bluetooth (GFSK, DH5)	X	27.08	314.20	3.36	1.17	100.0	± 9.6 %
		Y	100.00	149.06	35.68		100.0	
		Z	1.21	330.96	55.77		100.0	
10033-CAA	IEEE 802.15.1 Bluetooth (PI/4-DQPSK, DH1)	X	3.08	73.10	16.00	5.30	70.0	± 9.6 %
		Y	100.00	136.30	37.75		70.0	
		Z	7.37	86.92	21.69		70.0	
10034-CAA	IEEE 802.15.1 Bluetooth (PI/4-DQPSK, DH3)	X	1.25	65.91	11.39	1.88	100.0	± 9.6 %
		Y	5.27	87.77	22.72		100.0	
		Z	1.70	70.42	13.93		100.0	
10035-CAA	IEEE 802.15.1 Bluetooth (PI/4-DQPSK, DH5)	X	0.99	64.64	10.52	1.17	100.0	± 9.6 %
		Y	2.59	77.96	18.88		100.0	
		Z	1.19	67.26	12.19		100.0	
10036-CAA	IEEE 802.15.1 Bluetooth (8-DPSK, DH1)	X	3.48	74.91	16.77	5.30	70.0	± 9.6 %
		Y	100.00	136.90	38.02		70.0	
		Z	11.33	93.27	23.71		70.0	
10037-CAA	IEEE 802.15.1 Bluetooth (8-DPSK, DH3)	X	1.18	65.50	11.18	1.88	100.0	± 9.6 %
		Y	4.66	86.12	22.16		100.0	
		Z	1.56	69.56	13.55		100.0	
10038-CAA	IEEE 802.15.1 Bluetooth (8-DPSK, DH5)	X	1.00	64.92	10.78	1.17	100.0	± 9.6 %
		Y	2.61	78.41	19.18		100.0	
		Z	1.21	67.70	12.52		100.0	
10039-CAB	CDMA2000 (1xRTT, RC1)	X	0.95	64.99	10.40	0.00	150.0	± 9.6 %
		Y	1.84	72.12	15.71		150.0	
		Z	1.02	65.84	10.98		150.0	
10042-CAB	IS-54 / IS-136 FDD (TDMA/FDM, PI/4-DQPSK, Halfrate)	X	1.77	64.37	9.09	7.78	50.0	± 9.6 %
		Y	100.00	113.16	25.71		50.0	
		Z	2.56	68.32	10.93		50.0	
10044-CAA	IS-91/EIA/TIA-553 FDD (FDMA, FM)	X	0.31	133.81	11.51	0.00	150.0	± 9.6 %
		Y	0.00	104.03	5.27		150.0	
		Z	0.33	142.49	0.98		150.0	
10048-CAA	DECT (TDD, TDMA/FDM, GFSK, Full Slot, 24)	X	4.01	66.51	12.74	13.80	25.0	± 9.6 %
		Y	100.00	110.91	26.95		25.0	
		Z	5.44	70.40	14.40		25.0	
10049-CAA	DECT (TDD, TDMA/FDM, GFSK, Double Slot, 12)	X	3.70	68.56	12.33	10.79	40.0	± 9.6 %
		Y	100.00	112.50	26.54		40.0	
		Z	5.22	72.87	14.17		40.0	
10056-CAA	UMTS-TDD (TD-SCDMA, 1.28 Mcps)	X	6.09	76.95	17.81	9.03	50.0	± 9.6 %
		Y	100.00	128.62	35.43		50.0	
		Z	13.22	89.10	22.41		50.0	
10058-DAC	EDGE-FDD (TDMA, 8PSK, TN 0-1-2-3)	X	3.39	71.63	22.33	6.55	100.0	± 9.6 %
		Y	4.14	76.10	25.11		100.0	
		Z	3.42	72.27	22.83		100.0	
10059-CAB	IEEE 802.11b WiFi 2.4 GHz (DSSS, 2 Mbps)	X	1.03	63.98	15.22	0.61	110.0	± 9.6 %
		Y	1.18	64.90	16.05		110.0	
		Z	1.02	64.18	15.34		110.0	
10060-CAB	IEEE 802.11b WiFi 2.4 GHz (DSSS, 5.5 Mbps)	X	5.25	93.28	23.11	1.30	110.0	± 9.6 %
		Y	100.00	145.92	38.93		110.0	
		Z	39.44	123.36	31.22		110.0	

10061-CAB	IEEE 802.11b WiFi 2.4 GHz (DSSS, 11 Mbps)	X	1.80	74.31	19.24	2.04	110.0	± 9.6 %
		Y	3.02	83.93	24.56		110.0	
		Z	2.14	78.36	21.37		110.0	
10062-CAC	IEEE 802.11a/h WiFi 5 GHz (OFDM, 6 Mbps)	X	4.44	66.41	16.45	0.49	100.0	± 9.6 %
		Y	4.68	66.67	16.57		100.0	
		Z	4.45	66.51	16.42		100.0	
10063-CAC	IEEE 802.11a/h WiFi 5 GHz (OFDM, 9 Mbps)	X	4.45	66.48	16.52	0.72	100.0	± 9.6 %
		Y	4.69	66.78	16.69		100.0	
		Z	4.46	66.59	16.51		100.0	
10064-CAC	IEEE 802.11a/h WiFi 5 GHz (OFDM, 12 Mbps)	X	4.70	66.70	16.72	0.86	100.0	± 9.6 %
		Y	4.99	67.05	16.93		100.0	
		Z	4.72	66.83	16.73		100.0	
10065-CAC	IEEE 802.11a/h WiFi 5 GHz (OFDM, 18 Mbps)	X	4.56	66.53	16.77	1.21	100.0	± 9.6 %
		Y	4.85	66.96	17.05		100.0	
		Z	4.58	66.69	16.81		100.0	
10066-CAC	IEEE 802.11a/h WiFi 5 GHz (OFDM, 24 Mbps)	X	4.57	66.51	16.90	1.46	100.0	± 9.6 %
		Y	4.87	66.98	17.22		100.0	
		Z	4.60	66.69	16.96		100.0	
10067-CAC	IEEE 802.11a/h WiFi 5 GHz (OFDM, 36 Mbps)	X	4.86	66.77	17.36	2.04	100.0	± 9.6 %
		Y	5.15	67.13	17.68		100.0	
		Z	4.89	66.94	17.44		100.0	
10068-CAC	IEEE 802.11a/h WiFi 5 GHz (OFDM, 48 Mbps)	X	4.88	66.65	17.49	2.55	100.0	± 9.6 %
		Y	5.20	67.19	17.93		100.0	
		Z	4.91	66.87	17.60		100.0	
10069-CAC	IEEE 802.11a/h WiFi 5 GHz (OFDM, 54 Mbps)	X	4.95	66.72	17.70	2.67	100.0	± 9.6 %
		Y	5.28	67.17	18.11		100.0	
		Z	4.99	66.91	17.80		100.0	
10071-CAB	IEEE 802.11g WiFi 2.4 GHz (DSSS/OFDM, 9 Mbps)	X	4.71	66.43	17.22	1.99	100.0	± 9.6 %
		Y	4.96	66.77	17.51		100.0	
		Z	4.73	66.59	17.28		100.0	
10072-CAB	IEEE 802.11g WiFi 2.4 GHz (DSSS/OFDM, 12 Mbps)	X	4.67	66.65	17.37	2.30	100.0	± 9.6 %
		Y	4.94	67.10	17.75		100.0	
		Z	4.69	66.85	17.47		100.0	
10073-CAB	IEEE 802.11g WiFi 2.4 GHz (DSSS/OFDM, 18 Mbps)	X	4.72	66.79	17.66	2.83	100.0	± 9.6 %
		Y	4.99	67.24	18.08		100.0	
		Z	4.75	67.01	17.79		100.0	
10074-CAB	IEEE 802.11g WiFi 2.4 GHz (DSSS/OFDM, 24 Mbps)	X	4.72	66.70	17.78	3.30	100.0	± 9.6 %
		Y	4.95	67.09	18.23		100.0	
		Z	4.74	66.91	17.92		100.0	
10075-CAB	IEEE 802.11g WiFi 2.4 GHz (DSSS/OFDM, 36 Mbps)	X	4.74	66.71	18.01	3.82	90.0	± 9.6 %
		Y	4.98	67.20	18.56		90.0	
		Z	4.76	66.94	18.18		90.0	
10076-CAB	IEEE 802.11g WiFi 2.4 GHz (DSSS/OFDM, 48 Mbps)	X	4.77	66.58	18.17	4.15	90.0	± 9.6 %
		Y	4.98	66.93	18.66		90.0	
		Z	4.79	66.78	18.33		90.0	
10077-CAB	IEEE 802.11g WiFi 2.4 GHz (DSSS/OFDM, 54 Mbps)	X	4.80	66.66	18.27	4.30	90.0	± 9.6 %
		Y	5.00	66.98	18.75		90.0	
		Z	4.82	66.86	18.43		90.0	

10081-CAB	CDMA2000 (1xRTT, RC3)	X	0.45	61.00	7.50	0.00	150.0	± 9.6 %
		Y	0.83	65.94	12.49		150.0	
		Z	0.46	61.34	7.83		150.0	
10082-CAB	IS-54 / IS-136 FDD (TDMA/FDM, PI/4-DQPSK, Fullrate)	X	0.68	60.00	3.10	4.77	80.0	± 9.6 %
		Y	0.78	61.11	4.54		80.0	
		Z	0.72	60.00	2.85		80.0	
10090-DAC	GPRS-FDD (TDMA, GMSK, TN 0-4)	X	1.84	66.30	9.91	6.56	60.0	± 9.6 %
		Y	100.00	120.24	28.59		60.0	
		Z	100.00	103.44	20.90		60.0	
10097-CAB	UMTS-FDD (HSDPA)	X	1.71	67.90	15.28	0.00	150.0	± 9.6 %
		Y	1.82	67.70	15.69		150.0	
		Z	1.68	67.71	15.15		150.0	
10098-CAB	UMTS-FDD (HSUPA, Subtest 2)	X	1.67	67.85	15.26	0.00	150.0	± 9.6 %
		Y	1.79	67.66	15.66		150.0	
		Z	1.64	67.65	15.11		150.0	
10099-DAC	EDGE-FDD (TDMA, 8PSK, TN 0-4)	X	6.29	83.56	29.10	9.56	60.0	± 9.6 %
		Y	9.34	96.14	35.56		60.0	
		Z	6.61	85.53	30.21		60.0	
10100-CAD	LTE-FDD (SC-FDMA, 100% RB, 20 MHz, QPSK)	X	2.90	69.76	16.53	0.00	150.0	± 9.6 %
		Y	3.14	70.37	16.71		150.0	
		Z	2.89	69.82	16.39		150.0	
10101-CAD	LTE-FDD (SC-FDMA, 100% RB, 20 MHz, 16-QAM)	X	3.04	67.08	15.83	0.00	150.0	± 9.6 %
		Y	3.24	67.51	15.94		150.0	
		Z	3.03	67.13	15.70		150.0	
10102-CAD	LTE-FDD (SC-FDMA, 100% RB, 20 MHz, 64-QAM)	X	3.15	67.10	15.95	0.00	150.0	± 9.6 %
		Y	3.34	67.47	16.02		150.0	
		Z	3.13	67.15	15.83		150.0	
10103-CAD	LTE-TDD (SC-FDMA, 100% RB, 20 MHz, QPSK)	X	4.81	72.04	18.88	3.98	65.0	± 9.6 %
		Y	6.41	77.25	21.56		65.0	
		Z	5.14	73.67	19.73		65.0	
10104-CAD	LTE-TDD (SC-FDMA, 100% RB, 20 MHz, 16-QAM)	X	5.09	70.84	19.13	3.98	65.0	± 9.6 %
		Y	5.94	73.69	20.83		65.0	
		Z	5.16	71.44	19.51		65.0	
10105-CAD	LTE-TDD (SC-FDMA, 100% RB, 20 MHz, 64-QAM)	X	4.78	69.37	18.75	3.98	65.0	± 9.6 %
		Y	5.83	73.15	20.89		65.0	
		Z	4.90	70.20	19.25		65.0	
10108-CAE	LTE-FDD (SC-FDMA, 100% RB, 10 MHz, QPSK)	X	2.51	69.24	16.41	0.00	150.0	± 9.6 %
		Y	2.74	69.60	16.54		150.0	
		Z	2.49	69.21	16.24		150.0	
10109-CAE	LTE-FDD (SC-FDMA, 100% RB, 10 MHz, 16-QAM)	X	2.68	67.06	15.67	0.00	150.0	± 9.6 %
		Y	2.89	67.36	15.84		150.0	
		Z	2.67	67.07	15.55		150.0	
10110-CAE	LTE-FDD (SC-FDMA, 100% RB, 5 MHz, QPSK)	X	1.99	68.49	15.84	0.00	150.0	± 9.6 %
		Y	2.22	68.71	16.15		150.0	
		Z	1.98	68.38	15.68		150.0	
10111-CAE	LTE-FDD (SC-FDMA, 100% RB, 5 MHz, 16-QAM)	X	2.41	68.19	15.80	0.00	150.0	± 9.6 %
		Y	2.61	68.17	16.11		150.0	
		Z	2.40	68.17	15.74		150.0	