



FCC 47 CFR PART 15 SUBPART E

UNII 802.11a/n/ac

CERTIFICATION TEST REPORT

FOR

GSM/WCDMA/LTE Phone + BT/BLE, DTS/UNII a/b/g/n/ac/ax, ANT+, NFC and WPT

MODEL NUMBER : SM-G973N

FCC ID: A3LSMG973KOR

REPORT NUMBER: 4788725709-E4V2

ISSUE DATE: JAN 17, 2019

Prepared for
SAMSUNG ELECTRONICS CO., LTD.
129 SAMSUNG-RO, YEONGTONG-GU, SUWON-SI,
GYEONGGI-DO, 16677, KOREA

Prepared by
UL Korea, Ltd.
26th floor, 152, Teheran-ro, Gangnam-gu Seoul, 06236, Korea

Suwon Test Site: UL Korea, Ltd. Suwon Laboratory
218 Maeyeong-ro, Yeongtong-gu,
Suwon-si, Gyeonggi-do, 16675, Korea
TEL: (031) 337-9902
FAX: (031) 213-5433



ACCREDITED*

Testing
Laboratory

TL-637

Revision History

<u>Rev.</u>	<u>Issue Date</u>	<u>Revisions</u>	<u>Revised By</u>
V1	01/07/19	Initial issue	Junwhan Lee
V2	01/17/19	Updated to address TCB's question	Junwhan Lee

TABLE OF CONTENTS

1. ATTESTATION OF TEST RESULTS	8
1.2. INTRODUCTION OF TEST DATA REUSE	9
1.3. DIFFERENCE	9
1.4. SPOT CHECK VERIFICATION DATA	9
1.4. REFERENCE DETAIL	10
2. TEST METHODOLOGY	11
3. FACILITIES AND ACCREDITATION	11
4. CALIBRATION AND UNCERTAINTY	11
4.1. MEASURING INSTRUMENT CALIBRATION	11
4.2. SAMPLE CALCULATION	11
4.3. MEASUREMENT UNCERTAINTY	12
5. EQUIPMENT UNDER TEST	13
5.1. DESCRIPTION OF EUT	13
5.2. MAXIMUM OUTPUT POWER	15
5.3. DESCRIPTION OF AVAILABLE ANTENNAS	16
5.4. List of test reduction and modes covering other modes:	16
5.5. WORST-CASE CONFIGURATION AND MODE	18
5.6. DESCRIPTION OF TEST SETUP	19
6. TEST AND MEASUREMENT EQUIPMENT	21
7. SUMMARY TABLE	22
8. MEASUREMENT METHODS	23
9. REFERENCE MEASUREMENTS RESULTS	24
9.1. ON TIME AND DUTY CYCLE RESULTS	24
9.2. DUTY CYCLE PLOTS	24
9.3. 26 dB BANDWIDTH	27
9.3.1. 802.11a MODE IN THE 5.2 GHz BAND	28
9.3.2. 802.11n HT20 MODE IN THE 5.2 GHz BAND	28
9.3.3. 802.11n HT40 MODE IN THE 5.2 GHz BAND	28
9.3.4. 802.11ac VHT80 MODE IN THE 5.2 GHz BAND	28
9.3.5. 802.11a MODE IN THE 5.3 GHz BAND	29
9.3.6. 802.11n HT20 MODE IN THE 5.3 GHz BAND	29
9.3.7. 802.11n HT40 MODE IN THE 5.3 GHz BAND	29
9.3.8. 802.11ac VHT80 MODE IN THE 5.3 GHz BAND	29
9.3.9. 802.11a MODE IN THE 5.5 GHz BAND	30

9.3.10.	802.11n HT20 MODE IN THE 5.5 GHz BAND	30
9.3.11.	802.11n HT40 MODE IN THE 5.5 GHz BAND	30
9.3.12.	802.11ac VHT80 MODE IN THE 5.5 GHz BAND	30
9.3.13.	802.11a MODE IN THE 5.8 GHz BAND	31
9.3.14.	802.11n HT20 MODE IN THE 5.8 GHz BAND	31
9.3.15.	802.11n HT40 MODE IN THE 5.8 GHz BAND	31
9.3.16.	802.11ac VHT80 MODE IN THE 5.8 GHz BAND	31
9.3.17.	26 dB BANDWIDTH PLOTS	32
9.4.	99% BANDWIDTH	45
9.4.1.	802.11a MODE IN THE 5.2 GHz BAND	45
9.4.2.	802.11n HT20 MODE IN THE 5.2 GHz BAND	46
9.4.3.	802.11n HT40 MODE IN THE 5.2 GHz BAND	46
9.4.4.	802.11ac VHT80 MODE IN THE 5.2 GHz BAND	46
9.4.5.	802.11a MODE IN THE 5.3 GHz BAND	46
9.4.6.	802.11n HT20 MODE IN THE 5.3 GHz BAND	47
9.4.7.	802.11n HT40 MODE IN THE 5.3 GHz BAND	47
9.4.8.	802.11ac VHT80 MODE IN THE 5.3 GHz BAND	47
9.4.9.	802.11a MODE IN THE 5.5 GHz BAND	48
9.4.10.	802.11n HT20 MODE IN THE 5.5 GHz BAND	48
9.4.11.	802.11n HT40 MODE IN THE 5.5 GHz BAND	48
9.4.12.	802.11ac VHT80 MODE IN THE 5.5 GHz BAND	48
9.4.13.	802.11a MODE IN THE 5.8 GHz BAND	49
9.4.14.	802.11n HT20 MODE IN THE 5.8 GHz BAND	49
9.4.15.	802.11n HT40 MODE IN THE 5.8 GHz BAND	49
9.4.16.	802.11ac VHT80 MODE IN THE 5.8 GHz BAND	49
9.4.17.	99% BANDWIDTH PLOTS	50
10.	ANTENNA PORT TEST RESULTS	63
10.1.	6 dB BANDWIDTH	63
10.1.1.	802.11a MODE IN THE 5.8 GHz BAND	64
10.1.2.	802.11n HT20 MODE IN THE 5.8 GHz BAND	64
10.1.3.	802.11n HT40 MODE IN THE 5.8 GHz BAND	64
10.1.4.	802.11n VHT80 MODE IN THE 5.8 GHz BAND	64
10.1.5.	6 dB BANDWIDTH PLOTS	65
10.2.	OUTPUT POWER AND PPSD	69
10.2.1.	802.11a 2Tx CDD MODE IN THE 5.2 GHz BAND	70
10.2.2.	802.11n HT20 2Tx CDD MODE IN THE 5.2 GHz BAND	71
10.2.3.	802.11n HT40 2Tx CDD MODE IN THE 5.2 GHz BAND	72
10.2.4.	802.11ac VHT80 2Tx CDD MODE IN THE 5.2 GHz BAND	73
10.2.5.	802.11a 2Tx CDD MODE IN THE 5.3 GHz BAND	74
10.2.6.	802.11n HT20 2Tx CDD MODE IN THE 5.3 GHz BAND	75
10.2.7.	802.11n HT40 2Tx CDD MODE IN THE 5.3 GHz BAND	76
10.2.8.	802.11ac VHT80 2Tx CDD MODE IN THE 5.3 GHz BAND	77
10.2.9.	802.11a 2Tx CDD MODE IN THE 5.5 GHz BAND	78
10.2.10.	802.11n 2Tx CDD HT20 MODE IN THE 5.5 GHz BAND	79
10.2.11.	802.11n HT40 2Tx CDD MODE IN THE 5.5 GHz BAND	80
10.2.12.	802.11ac VHT80 2Tx CDD MODE IN THE 5.5 GHz BAND	81
10.2.13.	802.11a 2Tx CDD MODE IN THE 5.8 GHz BAND	82
10.2.14.	802.11n HT20 2Tx CDD MODE IN THE 5.8 GHz BAND	83
10.2.15.	802.11n HT40 2Tx CDD MODE IN THE 5.8 GHz BAND	84

10.2.16.	802.11ac VHT80 2Tx CDD MODE IN THE 5.8 GHz BAND.....	85
10.2.17.	802.11a 2Tx CDD MODE IN THE STRADDLE CHANNEL	86
10.2.18.	802.11n HT20 2Tx CDD MODE IN THE STRADDLE CHANNEL.....	87
10.2.19.	802.11n HT40 2Tx CDD MODE IN THE STRADDLE CHANNEL.....	88
10.2.20.	802.11ac VHT80 2Tx CDD MODE IN THE STRADDLE CHANNEL.....	89
10.2.21.	OUTPUT POWER AND PPSD PLOTS.....	90
11.	TRANSMITTER ABOVE 1 GHz.....	107
11.1.	5.2 GHz.....	110
11.1.1.	TX Above 1GHz 802.11a 2Tx CDD MODE IN THE 5.2GHz BAND	110
11.1.2.	TX Above 1GHz 802.11a 1Tx ANT1 IN THE 5.2GHz BAND	118
11.1.3.	TX Above 1GHz 802.11a 1Tx ANT2 IN THE 5.2GHz BAND	126
11.1.4.	TX Above 1GHz 802.11n HT20 2Tx CDD MODE IN THE 5.2GHz BAND.....	134
11.1.5.	TX Above 1GHz 802.11n HT20 1Tx ANT1 IN THE 5.2GHz BAND.....	142
11.1.6.	TX Above 1GHz 802.11n HT20 1Tx ANT2 IN THE 5.2GHz BAND.....	150
11.1.7.	TX Above 1GHz 802.11n HT40 2Tx CDD MODE IN THE 5.2GHz BAND.....	158
11.1.8.	TX Above 1GHz 802.11n HT40 1Tx ANT1 IN THE 5.2GHz BAND.....	164
11.1.9.	TX Above 1GHz 802.11n HT40 1Tx ANT2 IN THE 5.2GHz BAND.....	170
11.1.10.	TX ABOVE 1GHz 802.11ac VHT80 2Tx CDD MODE IN THE 5.2GHz BAND.....	176
11.1.11.	TX ABOVE 1GHz 802.11ac VHT80 1Tx ANT1 MODE IN THE 5.2GHz BAND	180
11.1.12.	TX ABOVE 1GHz 802.11ac VHT80 1Tx ANT2 IN THE 5.2GHz BAND	184
11.2.	5.3 GHz.....	188
11.2.1.	TX ABOVE 1 GHz 802.11a 2Tx CDD MODE IN THE 5.3 GHz BAND	188
11.2.2.	TX ABOVE 1 GHz 802.11a 1Tx ANT1 IN THE 5.3 GHz BAND	196
11.2.3.	TX ABOVE 1 GHz 802.11a 1Tx ANT2 IN THE 5.3 GHz BAND	204
11.2.4.	TX ABOVE 1GHz 802.11n HT20 2Tx CDD MODE IN THE 5.3GHz BAND	212
11.2.5.	TX ABOVE 1GHz 802.11n HT20 1Tx ANT1 IN THE 5.3GHz BAND	220
11.2.6.	TX ABOVE 1GHz 802.11n HT20 1Tx ANT2 IN THE 5.3GHz BAND	228
11.2.7.	TX ABOVE 1GHz 802.11n HT40 2Tx CDD MODE IN THE 5.3GHz BAND	236
11.2.8.	TX ABOVE 1GHz 802.11n HT40 1Tx ANT1 IN THE 5.3GHz BAND	242
11.2.9.	TX ABOVE 1GHz 802.11n HT40 1Tx ANT2 MODE IN THE 5.3GHz BAND	248
11.2.10.	TX ABOVE 1GHz 802.11ac VHT80 2Tx CDD MODE IN THE 5.3GHz BAND	
11.2.11.	TX ABOVE 1GHz 802.11ac VHT80 1Tx ANT1 IN THE 5.3GHz BAND	
11.2.12.	TX ABOVE 1GHz 802.11ac VHT80 1Tx ANT2 IN THE 5.3GHz BAND	
11.3.	5.5-5.6 GHz.....	266
11.3.1.	TX ABOVE 1 GHz 802.11a 2Tx CDD MODE IN THE 5.5 GHz BAND	266
11.3.2.	TX ABOVE 1 GHz 802.11a 1Tx ANT1 IN THE 5.5 GHz BAND	276
11.3.3.	TX ABOVE 1 GHz 802.11a 1Tx ANT2 IN THE 5.5 GHz BAND	286
11.3.4.	TX ABOVE 1GHz 802.11n HT20 2Tx CDD MODE IN THE 5.5GHz BAND	296
11.3.5.	TX ABOVE 1GHz 802.11n HT20 1Tx ANT1 IN THE 5.5GHz BAND	306
11.3.6.	TX ABOVE 1GHz 802.11n HT20 1Tx ANT2 IN THE 5.5GHz BAND	316
11.3.7.	TX ABOVE 1GHz 802.11n HT40 2Tx CDD MODE IN THE 5.5GHz BAND	326
11.3.8.	TX ABOVE 1GHz 802.11n HT40 1Tx ANT1 IN THE 5.5GHz BAND	336
11.3.9.	TX ABOVE 1GHz 802.11n HT40 1Tx ANT2 IN THE 5.5GHz BAND	346
11.3.10.	TX ABOVE 1GHz 802.11ac VHT80 2Tx CDD MODE IN THE 5.5GHz BAND.....	356
11.3.11.	TX ABOVE 1GHz 802.11ac VHT80 1Tx ANT1 IN THE 5.5GHz BAND	364
11.3.12.	TX ABOVE 1GHz 802.11ac VHT80 1Tx ANT2 IN THE 5.5GHz BAND	372
11.3.13.	TX ABOVE 1GHz 802.11a 2Tx CDD MODE IN THE STRADDLE CHANNEL	380
11.3.14.	TX ABOVE 1GHz 802.11a 1Tx ANT1 IN THE STRADDLE CHANNEL	382
11.3.15.	TX ABOVE 1GHz 802.11a 1Tx ANT2 IN THE STRADDLE CHANNEL	384

11.3.16.	TX ABOVE 1GHz 802.11n HT20 2Tx CDD MODE IN THE STRADDLE CHANNEL	386
11.3.17.	TX ABOVE 1GHz 802.11n HT20 1Tx ANT1 IN THE STRADDLE CHANNEL	388
11.3.18.	TX ABOVE 1GHz 802.11n HT20 1Tx ANT2 IN THE STRADDLE CHANNEL	390
11.3.19.	TX ABOVE 1GHz 802.11n HT40 2Tx CDD MODE IN THE STRADDLE CHANNEL	392
11.3.20.	TX ABOVE 1GHz 802.11n HT40 1Tx ANT1 IN THE STRADDLE CHANNEL	394
11.3.21.	TX ABOVE 1GHz 802.11n HT40 1Tx ANT2 IN THE STRADDLE CHANNEL	396
11.3.22.	TX ABOVE 1GHz 802.11ac VHT80 2Tx CDD MODE IN THE STRADDLE CHANNEL	398
11.3.23.	TX ABOVE 1GHz 802.11ac VHT80 1Tx ANT1 IN THE STRADDLE CHANNEL	400
11.3.24.	TX ABOVE 1GHz 802.11ac VHT80 1Tx ANT2 IN THE STRADDLE CHANNEL	402
11.4.	5.8 GHz	404
11.4.1.	TX ABOVE 1GHz 802.11a 2Tx CDD MODE IN THE 5.8GHz BAND	404
11.4.2.	TX ABOVE 1GHz 802.11a 1Tx ANT1 IN THE 5.8GHz BAND	414
11.4.3.	TX ABOVE 1GHz 802.11a 1Tx ANT2 IN THE 5.8GHz BAND	424
11.4.4.	TX ABOVE 1GHz 802.11n HT20 2Tx CDD MODE IN THE 5.8GHz BAND	434
11.4.5.	TX ABOVE 1GHz 802.11n HT20 1Tx ANT1 IN THE 5.8GHz BAND	444
11.4.6.	TX ABOVE 1GHz 802.11n HT20 1Tx ANT2 IN THE 5.8GHz BAND	454
11.4.7.	TX ABOVE 1GHz 802.11n HT40 2Tx CDD MODE IN THE 5.8GHz BAND	464
11.4.8.	TX ABOVE 1GHz 802.11n HT40 1Tx ANT1 IN THE 5.8GHz BAND	472
11.4.9.	TX ABOVE 1GHz 802.11n HT40 1Tx ANT2 IN THE 5.8GHz BAND	480
11.4.10.	TX ABOVE 1GHz 802.11ac VHT80 2Tx CDD MODE IN THE 5.8GHz BAND	488
11.4.11.	TX ABOVE 1GHz 802.11ac VHT80 1Tx ANT1 IN THE 5.8GHz BAND	494
11.4.12.	TX ABOVE 1GHz 802.11ac VHT80 1Tx ANT2 IN THE 5.8GHz BAND	500
11.5.	Spurious Emissions for Simultaneous Transmission	506
11.5.1.	Worst test case condition	507
12.	WORST-CASE BELOW 1 GHz	519
13.	AC POWER LINE CONDUCTED EMISSIONS	521
14.	DYNAMIC FREQUENCY SELECTION	524
14.1.	OVERVIEW	524
14.1.1.	LIMITS	524
14.1.1.	TEST AND MEASUREMENT SYSTEM	528
14.1.2.	SETUP OF EUT	531
14.1.3.	DESCRIPTION OF EUT	532
14.2.	RESULTS FOR 20 MHz BANDWIDTH	533
14.2.1.	TEST CHANNEL	533
14.2.2.	RADAR WAVEFORM AND TRAFFIC	533
14.2.3.	OVERLAPPING CHANNEL TESTS	535
14.2.4.	MOVE AND CLOSING TIME	535
14.3.	RESULTS FOR 40 MHz BANDWIDTH	538
14.3.1.	TEST CHANNEL	538
14.3.2.	RADAR WAVEFORM AND TRAFFIC	538
14.3.3.	OVERLAPPING CHANNEL TESTS	540
14.3.4.	MOVE AND CLOSING TIME	540
14.4.	RESULTS FOR 80 MHz BANDWIDTH	543
14.4.1.	TEST CHANNEL	543

14.4.2. RADAR WAVEFORM AND TRAFFIC	543
14.4.3. OVERLAPPING CHANNEL TESTS	545
14.4.4. MOVE AND CLOSING TIME	545
15. SETUP PHOTOS.....	548

1. ATTESTATION OF TEST RESULTS

COMPANY NAME: SAMSUNG ELECTRONICS CO., LTD.

EUT DESCRIPTION: GSM/WCDMA/LTE Phone + BT/BLE, DTS/UNII a/b/g/n/ac/ax, ANT+, NFC and WPT

MODEL NUMBER: SM-G973N

SERIAL NUMBER: R38KA0BCW9H, R38KA0BCW8E (CONDUCTED, Original)
R38KA0BE04H, R38KA0BE5CF, R38KA0BE3PA, R38K8065W1D (RADIATED, Original);
R39KA0LF5PR, R39KA0LETVN (RADIATED, Spotcheck);

DATE TESTED: OCT 19, 2018 - DEC 26, 2018; (Original)
DEC 02, 2018 - DEC 26, 2018 (Spot check)

APPLICABLE STANDARDS	
STANDARD	TEST RESULTS
CFR 47 Part 15 Subpart E	Pass

UL Korea, Ltd. tested the above equipment in accordance with the requirements set forth in the above standards. All indications of Pass/Fail in this report are opinions expressed by UL Korea, Ltd. based on interpretations and/or observations of test results. Measurement Uncertainties were not taken into account and are published for informational purposes only. The test results show that the equipment tested is capable of demonstrating compliance with the requirements as documented in this report.

Note: The results documented in this report apply only to the tested sample, under the conditions and modes of operation as described herein. This document may not be altered or revised in any way unless done so by UL Korea, Ltd. and all revisions are duly noted in the revisions section. Any alteration of this document not carried out by UL Korea, Ltd. will constitute fraud and shall nullify the document. This report must not be used by the client to claim product certification, approval, or endorsement by IAS, any agency of the Federal Government, or any agency of any government.

Approved & Released For
UL Korea, Ltd. By:

Tested By:



SungGil Park
Suwon Lab Engineer
UL Korea, Ltd.

Junwhan Lee
Suwon Lab Engineer
UL Korea, Ltd.

1.2. INTRODUCTION OF TEST DATA REUSE

This report referenced from the FCC ID: A3LSMG973F UNII WLAN(FCC CFR 47 Part 15E). And the applicant takes full responsibility that the test data as referenced in this report represent compliance for this FCC ID.

1.3. DIFFERENCE

The FCC ID: A3LSMT973F, shares the same enclosure and circuit board as FCC ID: A3LSMG973F. The WLAN antennas and surrounding circuitry and layout are identical between these two units.

After confirming through preliminary radiated emissions that the performance of the FCC ID: A3LSMG973F remains representative of FCC ID: A3LSMG973KOR. The test data of FCC ID: A3LSMG973F being submitted for this application to cover WLAN features.

1.4. SPOT CHECK VERIFICATION DATA (Worst case of the radiated spurious and band edge emissions)

Band	Test Item	Mode	Frequency	Test Limit	Original model	Spot check model	Deviation	Remark
					SM-G973F/DS Results	SM-G973N Results		
					FCC ID : A3LSMG973F	FCC ID : A3LSMG973N		
UNII WLAN (5 GHz)	Band Edge	802.11ac_VHT80_ALL	5210 MHz	54 dBuV/m	47.57 dBuV/m	48.86 dBuV/m	1.29 dB	
	RSE	802.11n_HT20_ANT 2	5180 MHz	68.2 dBuV/m	64.90 dBuV/m	63.29 dBuV/m	-1.61 dB	2nd Harmonic
	Band Edge	802.11n_HT40_ALL	5310 MHz	54 dBuV/m	49.65 dBuV/m	49.67 dBuV/m	0.02 dB	
	RSE	802.11a_ANT 2	5300 MHz	54 dBuV/m	50.85 dBuV/m	48.77 dBuV/m	-2.08 dB	2nd Harmonic
	Band Edge	802.11n_HT40_ANT 2	5510 MHz	68.2 dBuV/m	65.53 dBuV/m	62.82 dBuV/m	-2.71 dB	
	RSE	802.11a_ALL	5500 MHz	54 dBuV/m	48.44 dBuV/m	49.08 dBuV/m	0.64 dB	2nd Harmonic
	Band Edge	802.11a_ANT 2	5825 MHz	-27 dBm	-31.89 dBm	-38.27 dBm	-6.38 dB	Noise Floor
	RSE	802.11a_ALL	5745 MHz	68.2 dBuV/m	62.51 dBuV/m	64.86 dBuV/m	2.35 dB	3rd Harmonic

Comparison of two models, upper deviation is within 3dB range and all test results are under FCC Technical Limits.

1.4. REFERENCE DETAIL

Reference application that contains the reused reference data.

Equipment Class	Reference FCC ID	Type Grant/ Permissive Change	Reference Application	Folder Test/RF Exposure	Report Tittle / Section
DTS	A3LSMG973F	Grant	4788725460-E2	Test	FCC Report DTS(802.11b/g/n) WLAN / All sections
			4788725460-E3	Test	FCC Report DTS(802.11ax) WLAN / All sections
			4788725460-E6	Test	FCC Report BLE / All sections
NII	A3LSMG973F	Grant	4788725460-E4	Test	FCC Report UNII (802.11a/b/g/n/ac) WLAN / All sections
			4788725460-E5	Test	FCC Report UNII(802.11ax) WLAN / All sections
DSS	A3LSMG973F	Grant	4788725460-E7	Test	FCC Report BT / All sections
DXX	A3LSMG973F	Grant	4788725460-E8	Test	FCC Report ANT+ / All sections
			4788725460-E9	Test	FCC Report NFC / All sections
DCD	A3LSMG973F	Grant	4788725460-E10	Test	FCC Report WPT / All sections

2. TEST METHODOLOGY

The tests documented in this report were performed in accordance with following methods.

1. FCC CFR 47 Part 2.
2. FCC CFR 47 Part 15.
3. KDB 789033 D02 General UNII Test Procedures New Rules v02r01
4. KDB 905462 D02 UNII DFS Compliance Procedures New Rules v02
5. KDB 905462 D03 UNII Clients Without Radar Detection New Rules v01r02
6. KDB 662911 D01 v02r01
7. ANSI C63.10-2013.
8. KDB 484596 D01 v01

3. FACILITIES AND ACCREDITATION

The test sites and measurement facilities used to collect data are located at 218 Maeyeong-ro, Yeongtong-gu, Suwon-si, Gyeonggi-do, 16675, Korea. Line conducted emissions are measured only at the 218 address. The following table identifies which facilities were utilized for radiated emission measurements documented in this report. Specific facilities are also identified in the test results sections.

218 Maeyeong-ro
<input checked="" type="checkbox"/> Chamber 1
<input checked="" type="checkbox"/> Chamber 2
<input checked="" type="checkbox"/> Chamber 3

UL Korea, Ltd. is accredited by IAS, Laboratory Code TL-637. The full scope of accreditation can be viewed at <http://www.iasonline.org/PDF/TL/TL-637.pdf>.

4. CALIBRATION AND UNCERTAINTY

4.1. MEASURING INSTRUMENT CALIBRATION

The measuring equipment utilized to perform the tests documented in this report has been calibrated in accordance with the manufacturer's recommendations, and is traceable to recognized national standards.

4.2. SAMPLE CALCULATION

Where relevant, the following sample calculation is provided:

$$\begin{aligned} \text{Field Strength (dBuV/m)} &= \text{Measured Voltage (dBuV)} + \text{Antenna Factor (dB/m)} + \\ &\text{Cable Loss (dB)} - \text{Preamp Gain (dB)} \\ 36.5 \text{ dBuV} + 18.7 \text{ dB/m} + 0.6 \text{ dB} - 26.9 \text{ dB} &= 28.9 \text{ dBuV/m} \end{aligned}$$

4.3. MEASUREMENT UNCERTAINTY

Where relevant, the following measurement uncertainty levels have been estimated for tests performed on the apparatus:

PARAMETER	UNCERTAINTY
Conducted Disturbance, 0.15 to 30 MHz	2.32 dB
Radiated Disturbance, Below 1GHz	3.86 dB
Radiated Disturbance, Above 1 GHz	5.97 dB

Uncertainty figures are valid to a confidence level of 95%.

5. EQUIPMENT UNDER TEST

5.1. DESCRIPTION OF EUT

The EUT is a GSM/WCDMA/LTE Phone + BT/BLE, DTS/UNII a/b/g/n/ac/ax, ANT+, NFC and WPT. This test report addresses the NII (UNII 802.11a/n/ac) operational mode.

WiFi MIMO Condition

Frequency	Mode	Antenna 1	Antenna 2
2.4GHz	802.11g	TX / RX	TX / RX
	802.11g MIMO	TX / RX	TX / RX
	802.11n	TX / RX	TX / RX
	802.11n MIMO	TX / RX	TX / RX
	802.11ax	TX / RX	TX / RX
	802.11ax MIMO	TX / RX	TX / RX
5 GHz	802.11a	TX / RX	TX / RX
	802.11a MIMO	TX / RX	TX / RX
	802.11n	TX / RX	TX / RX
	802.11n MIMO	TX / RX	TX / RX
	802.11ac	TX / RX	TX / RX
	802.11ac MIMO	TX / RX	TX / RX
	802.11ax	TX / RX	TX / RX
	802.11ax MIMO	TX / RX	TX / RX

Simultaneous TX Condition (RSDB)

	# TX	5GHz WIFI [dBm]		2.4GHz WIFI [dBm]	
		Ant1	Ant2	Ant1	Ant2
2.4 GHz + 5 GHz RSDB Only	2	A	-	-	B
	2	-	A	B	-
	2	A	-	B	-
	2	-	A	-	B
2.4 GHz + 5 GHz RSDB & MIMO	3	A	A	B	-
	3	A	A	-	B
	3	A	-	B	B
	3	-	A	B	B
2.4 GHz + 5 GHz RSDB MIMO	4	A	A	B	B

Simultaneous TX Condition Bluetooth with 5GHz WIFI (Not RSDB)

	# TX	5GHz WIFI		2.4GHz BT
		ANT1	ANT2	ANT1
2.4GHz BT+5GHz WIFI (Not RSBD)	2	A	-	B
	2	-	A	B
	3	A	A	B

Spurious Emissions for Simultaneous Transmission were reported on the section 11.5.

5.2. MAXIMUM OUTPUT POWER

The transmitter has a maximum total conducted average output power as follows:

Frequency Range [MHz]	Mode	Output Power [dBm]		Output Power [mW]	
		Antenna1	Antenna2	Antenna1	Antenna2
5180 - 5240	802.11a MIMO	17.24		52.97	
	802.11n HT20 MIMO	17.15		51.88	
5190 - 5230	802.11n HT40 MIMO	17.22		52.72	
5210	802.11ac VHT80 MIMO	16.12		40.93	
5260 - 5320	802.11a MIMO	17.46		55.72	
	802.11n HT20 MIMO	17.49		56.10	
5270 - 5310	802.11n HT40 MIMO	17.55		56.89	
5290	802.11ac VHT80 MIMO	16.20		41.69	
5500 - 5720	802.11a MIMO	18.45		69.98	
	802.11n HT20 MIMO	18.47		70.31	
5510 - 5710	802.11n HT40 MIMO	17.47		55.85	
5530 - 5690	802.11ac VHT80 MIMO	16.39		43.55	
5745 - 5825	802.11a MIMO	19.43		87.70	
	802.11n HT20 MIMO	19.42		87.50	
5755 - 5795	802.11n HT40 MIMO	17.17		52.12	
5775	802.11ac VHT80 MIMO	16.39		43.55	

5.3. DESCRIPTION OF AVAILABLE ANTENNAS

The radio utilizes a internal antenna, with a maximum gain of:

Frequency Range [MHz]	Antenna Gain [dBi]	
	Antenna 1	Antenna 2
UNII 1 5150 – 5250	-8.4	-7.3
UNII 2A 5250 – 5350	-7.4	-7.2
UNII 2C 5470 – 5725	-7.1	-6.5
UNII 3 5725 – 5850	-7.1	-6.8

5.4. List of test reduction and modes covering other modes:

The output power on covered modes is equal to or less than one referenced.

UNII 1

5150 - 5250 MHz Authorized Frequency Band		
Frequency Range [MHz]	Mode	Covered by
5180 - 5240	802.11a legacy 1TX	802.11a 2TX CDD
5180 - 5240	802.11HT20 1TX	802.11n HT20 2TX CDD
5180 - 5240	802.11HT20 2TX SDM/STBC	802.11n HT20 2TX CDD
5180 - 5240	802.11ac VHT20 1TX	802.11n HT20 2TX CDD
5180 - 5240	802.11ac VHT20 2TX SDM/STBC	802.11n HT20 2TX CDD
5190 - 5230	802.11n HT40 1TX	802.11n HT40 2TX CDD
5190 - 5230	802.11n HT40 2TX SDM/STBC	802.11n HT40 2TX CDD
5190 - 5230	802.11ac VHT40 1TX	802.11n HT40 2TX CDD
5190 - 5230	802.11ac VHT40 2TX SDM/STBC	802.11n HT40 2TX CDD
5210	802.11ac VHT80 1TX	802.11ac VHT80 2TX CDD
5210	802.11ac VHT80 2TX SDM/STBC	802.11ac VHT80 2TX CDD

UNII 2A

5250 - 5350 MHz Authorized Frequency Band		
Frequency Range [MHz]	Mode	Covered by
5260 - 5320	802.11a legacy 1TX	802.11a 2TX CDD
5260 - 5320	802.11HT20 1TX	802.11n HT20 2TX CDD
5260 - 5320	802.11HT20 2TX SDM/STBC	802.11n HT20 2TX CDD
5260 - 5320	802.11ac VHT20 1TX	802.11n HT20 2TX CDD
5260 - 5320	802.11ac VHT20 2TX SDM/STBC	802.11n HT20 2TX CDD
5270 - 5310	802.11n HT40 1TX	802.11n HT40 2TX CDD
5270 - 5310	802.11n HT40 2TX SDM/STBC	802.11n HT40 2TX CDD
5270 - 5310	802.11ac VHT40 1TX	802.11n HT40 2TX CDD
5270 - 5310	802.11ac VHT40 2TX SDM/STBC	802.11n HT40 2TX CDD
5290	802.11ac VHT80 1TX	802.11ac VHT80 2TX CDD
5290	802.11ac VHT80 2TX SDM/STBC	802.11ac VHT80 2TX CDD

UNII 2C

5470 - 5725 MHz Authorized Frequency Band		
Frequency Range [MHz]	Mode	Covered by
5500 - 5720	802.11a legacy 1TX	802.11a 2TX CDD
5500 - 5720	802.11HT20 1TX	802.11n HT20 2TX CDD
5500 - 5720	802.11HT20 2TX SDM/STBC	802.11n HT20 2TX CDD
5500 - 5720	802.11ac VHT20 1TX	802.11n HT20 2TX CDD
5500 - 5720	802.11ac VHT20 2TX SDM/STBC	802.11n HT20 2TX CDD
5510 - 5710	802.11n HT40 1TX	802.11n HT40 2TX CDD
5510 - 5710	802.11n HT40 2TX SDM/STBC	802.11n HT40 2TX CDD
5510 - 5710	802.11ac VHT40 1TX	802.11n HT40 2TX CDD
5510 - 5710	802.11ac VHT40 2TX SDM/STBC	802.11n HT40 2TX CDD
5530 - 5690	802.11ac VHT80 1TX	802.11ac VHT80 2TX CDD
5530 - 5690	802.11ac VHT80 2TX SDM/STBC	802.11ac VHT80 2TX CDD

UNII 3

5725 - 5850 MHz Authorized Frequency Band		
Frequency Range [MHz]	Mode	Covered by
5745 - 5825	802.11a legacy 1TX	802.11a 2TX CDD
5745 - 5825	802.11HT20 1TX	802.11n HT20 2TX CDD
5745 - 5825	802.11HT20 2TX SDM/STBC	802.11n HT20 2TX CDD
5745 - 5825	802.11ac VHT20 1TX	802.11n HT20 2TX CDD
5745 - 5825	802.11ac VHT20 2TX SDM/STBC	802.11n HT20 2TX CDD
5755 - 5795	802.11n HT40 1TX	802.11n HT40 2TX CDD
5755 - 5795	802.11n HT40 2TX SDM/STBC	802.11n HT40 2TX CDD
5755 - 5795	802.11ac VHT40 1TX	802.11n HT40 2TX CDD
5755 - 5795	802.11ac VHT40 2TX SDM/STBC	802.11n HT40 2TX CDD
5775	802.11ac VHT80 1TX	802.11ac VHT80 2TX CDD
5775	802.11ac VHT80 2TX SDM/STBC	802.11ac VHT80 2TX CDD

5.5. WORST-CASE CONFIGURATION AND MODE

Radiated emission below 1GHz and power line conducted emission were performed with the EUT set to transmit at the channel with highest output power as worst-case scenario.

Radiated emission above 1GHz was performed with the EUT set to transmit low/mid/high channels.

The fundamental of the EUT was investigated in three orthogonal orientations X, Y and Z it was determined that Y orientation was worst-case orientation; therefore, all final radiated testing was performed with the EUT in Y orientation.

Based on the baseline scan, the worst-case data rates were:

- 802.11a mode: 6 Mbps
- 802.11n HT20mode: MCS0
- 802.11n HT40mode: MCS0
- 802.11ac VHT80mode: MCS0

NOTE : Some radiated test results performed on the 1Tx antenna condition is worst, so test report described all radiated test results.(Antenna 1-1Tx, Antenna 2-1Tx, Antenna ALL 2Tx CDD)

5.6. DESCRIPTION OF TEST SETUP

SUPPORT EQUIPMENT

Support Equipment List				
Description	Manufacturer	Model	Serial Number	FCC ID
Charger	SAMSUNG	EP-TA200	R37KB5B03T1SE3	N/A
Data Cable	SAMSUNG	EP-DG970BBE	N/A	N/A
Earphone	SAMSUNG	EO-IG955	N/A	N/A

I/O CABLE

I/O Cable List						
Cable No	Port	# of identical ports	Connector Type	Cable Type	Cable Length (m)	Remarks
1	DC Power	1	C Type	Shielded	1.1m	N/A
2	Audio	2	Mini-Jack	Unshielded	1.2m	N/A

TEST SETUP

The EUT is a stand-alone unit during the tests.
 Test software exercised the EUT to enable NII mode.

SETUP DIAGRAM FOR TESTS (CONDUCTED TEST SETUP)

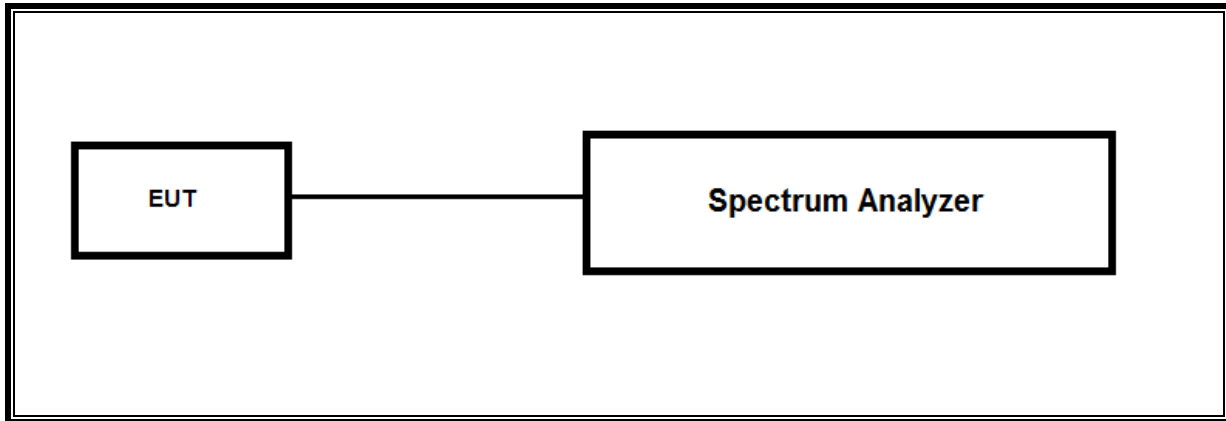

SETUP DIAGRAM FOR TESTS (RADIATED TEST SETUP)

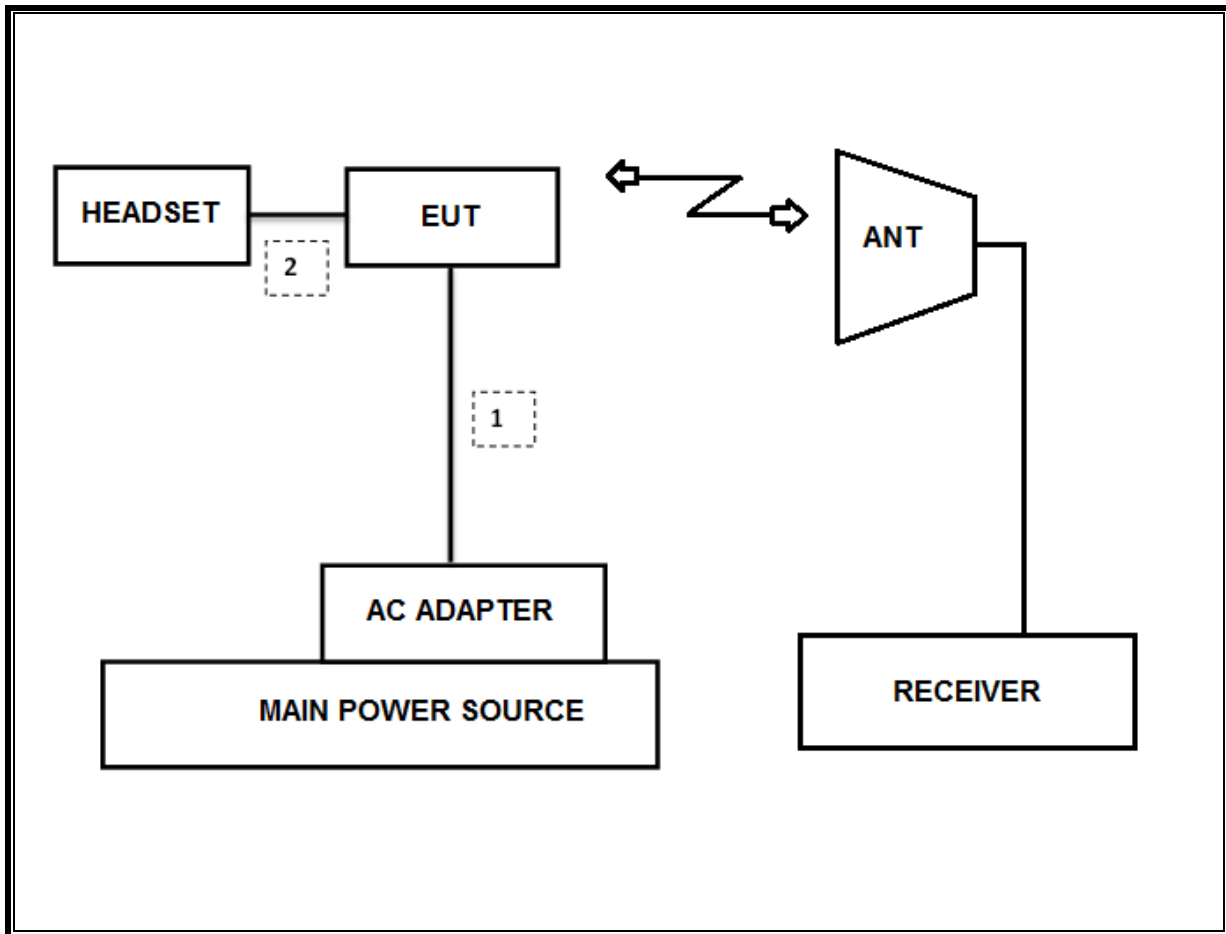

6. TEST AND MEASUREMENT EQUIPMENT

The following test and measurement equipment was utilized for the tests documented in this report:

Test Equipment List				
Description	Manufacturer	Model	S/N	New Cal Due
Antenna, Bilog, 30MHz-1GHz	SCHWARZBECK	VULB9163	750	08-04-20
Antenna, Bilog, 30MHz-1GHz	SCHWARZBECK	VULB9163	749	08-04-20
Antenna, Bilog, 30MHz-1GHz	SCHWARZBECK	VULB9163	845	08-04-20
Antenna, Horn, 18 GHz	ETS	3115	00167211	08-04-20
Antenna, Horn, 18 GHz	ETS	3115	00161451	08-04-20
Antenna, Horn, 18 GHz	ETS	3117	00168724	08-04-20
Antenna, Horn, 18 GHz	ETS	3117	00168717	08-04-20
Antenna, Horn, 18 GHz	ETS	3117	00205959	08-04-20
Antenna, Horn, 40 GHz	ETS	3116C	00166155	12-04-19
Antenna, Horn, 40 GHz	ETS	3116C	00168645	12-04-19
Antenna, Horn, 40 GHz	ETS	3116C-PA	00168841	08-09-19
Preamplifier, 1000 MHz	Sonoma	310N	341282	08-07-19
Preamplifier, 1000 MHz	Sonoma	310N	351741	08-07-19
Preamplifier, 1000 MHz	Sonoma	310N	370599	08-06-19
Preamplifier, 18 GHz	Miteq	AFS42-00101800-25-S-42	1876511	08-07-19
Preamplifier, 18 GHz	Miteq	AFS42-00101800-25-S-42	1896138	08-07-19
Preamplifier, 18 GHz	Miteq	AFS42-00101800-25-S-42	2029169	08-07-19
Spectrum Analyzer, 44 GHz	Agilent / HP	N9030A	MY54170614	08-07-19
Spectrum Analyzer, 44 GHz	Agilent / HP	N9030A	MY54490312	08-06-19
Spectrum Analyzer, 43.5 GHz	R&S	FSW43	104089	08-06-19
Average Power Sensor	Agilent / HP	U2000	MY54270007	08-07-19
Attenuator	PASTERNAK	PE7087-10	A001	08-08-19
Attenuator	PASTERNAK	PE7087-10	A008	08-08-19
Attenuator	PASTERNAK	PE7004-10	2	08-07-19
Attenuator	PASTERNAK	PE7087-10	A009	08-08-19
EMI Test Receive, 40 GHz	R&S	ESU40	100439	08-06-19
EMI Test Receive, 40 GHz	R&S	ESU40	100457	08-06-19
EMI Test Receive, 44 GHz	R&S	ESW44	101590	08-06-19
EMI Test Receive, 3 GHz	R&S	ESR3	101832	08-06-19
Low Pass Filter 5GHz	Micro-Tronics	LPS17541	009	08-07-19
Low Pass Filter 5GHz	Micro-Tronics	LPS17541	015	08-07-19
Low Pass Filter 5GHz	Micro-Tronics	LPS17541	020	08-06-19
High Pass Filter 3GHz	Micro-Tronics	HPM17543	010	08-07-19
High Pass Filter 3GHz	Micro-Tronics	HPM17543	015	08-07-19
High Pass Filter 3GHz	Micro-Tronics	HPM17543	020	08-06-19
High Pass Filter 6GHz	Micro-Tronics	HPS17542	009	08-07-19
High Pass Filter 6GHz	Micro-Tronics	HPS17542	016	08-07-19
High Pass Filter 6GHz	Micro-Tronics	HPS17542	021	08-06-19
Antenna, Loop, 9kHz-30MHz	R&S	HFH2-Z2	100418	10-26-19
LISN	R&S	ENV-216	101837	08-09-19
UL Software				
Description	Manufacturer	Model	Version	
Radiated software	UL	UL EMC	Ver 9.5	
AC Line Conducted software	UL	UL EMC	Ver 9.5	

7. SUMMARY TABLE

FCC Part Section	Test Description	Test Limit	Test Condition	Test Result
15.407(e)	6dB Band width (5.8Ghz)	500KHz	Condcuted	PASS
15.407 (a)(2)	TX Cond. Power 5.15-2.25, 5.25-5.35 & 5.47-5.725	<24dBm or 11+10Log(OBW)		PASS
15.407 (a)(3)	TX Cond. Power 5.725-5.825	< 30dBm or 17+10Log(OBW)		PASS
15.407 (a)(5)	PSD (5.2,5.3,5.5GHz)	<11dBm		PASS
15.407 (a)(5)	PSD (5.8GHz)	30dBm per 500kHz		PASS
15.207 (a)	AC Power Line conducted emissions	Section 10	Radiated	PASS
15.407 (b) & 15.209	Radiated Spurious Emission	< 54dBuV/m		PASS
15.407 (h)(2)	Dynamic Frequency Selection	N/A	Condcuted	PASS

8. MEASUREMENT METHODS

On-Time and Duty Cycle : KDB 789033 D02 v02r01, Section B.

6dB Emission BW : KDB 789033 D02 v02r01, Section C.2.

26dB Emission BW : KDB 789033 D02 v02r01, Section C.1.

99% Occupied BW : KDB 789033 D02 v02r01, Section D.

Conducted Output Power : KDB 789033 D02 v02r01, Section E.3.a(Method PM)

Conducted Output Power for Straddle Channel (ch144/142/138 for 20/40/80MHz BW):

KDB 789033 D02 v02r01, Section E.2.d(Method SA-2)

Power Spectral Density : KDB 789033 D02 v02r01, Section F.

Unwanted emissions in restricted bands : KDB 789033 D02 v02r01, Section G.

Unwanted emissions in non-restricted bands : KDB 789033 D02 v02r01, Section G.

AC Power Line Conducted Emission : ANSI C63.10-2013, Section 6.2.

9. REFERENCE MEASUREMENTS RESULTS

9.1. ON TIME AND DUTY CYCLE RESULTS

Mode	ON Time B [msec]	Period [msec]	Duty Cycle x [linear]	Duty Cycle [%]	Duty Cycle Correction Factor [dB]	1/T Minimum VBW [kHz]
802.11a	5.483	5.583	0.982	98.2%	0.00	0.010
802.11n HT20	5.08	5.179	0.981	98.1%	0.00	0.010
802.11n HT40	5.479	5.579	0.982	98.2%	0.00	0.010
802.11ac VHT80	5.226	5.328	0.981	98.1%	0.00	0.010

LIMITS

None; for reporting purposes only.

PROCEDURE

KDB 789033 D02 v02r01 Zero-Span Spectrum Analyzer Method.

9.2. DUTY CYCLE PLOTS

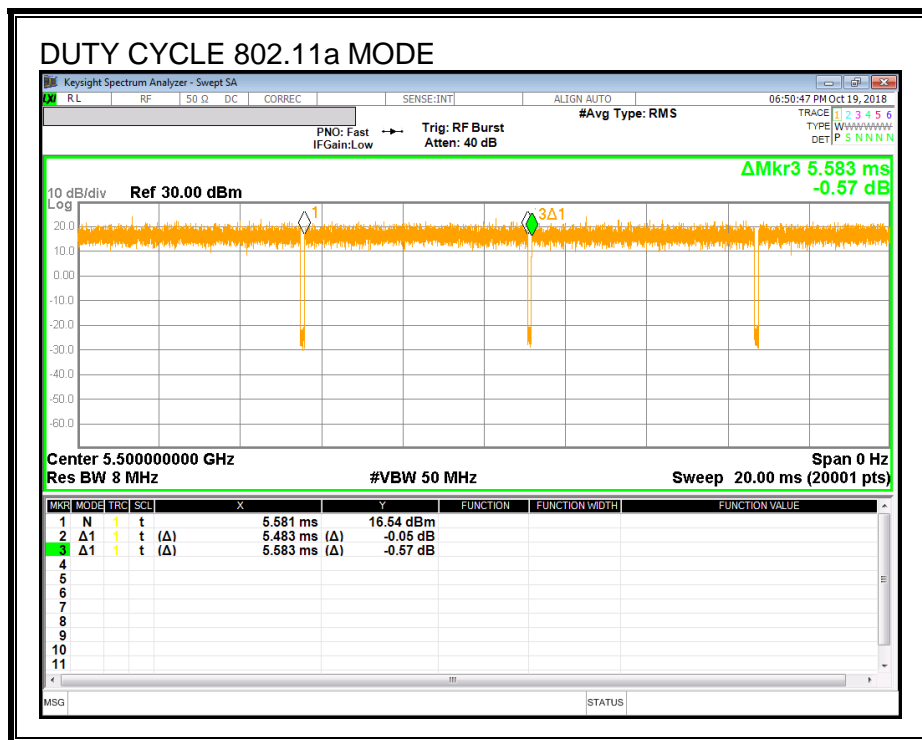

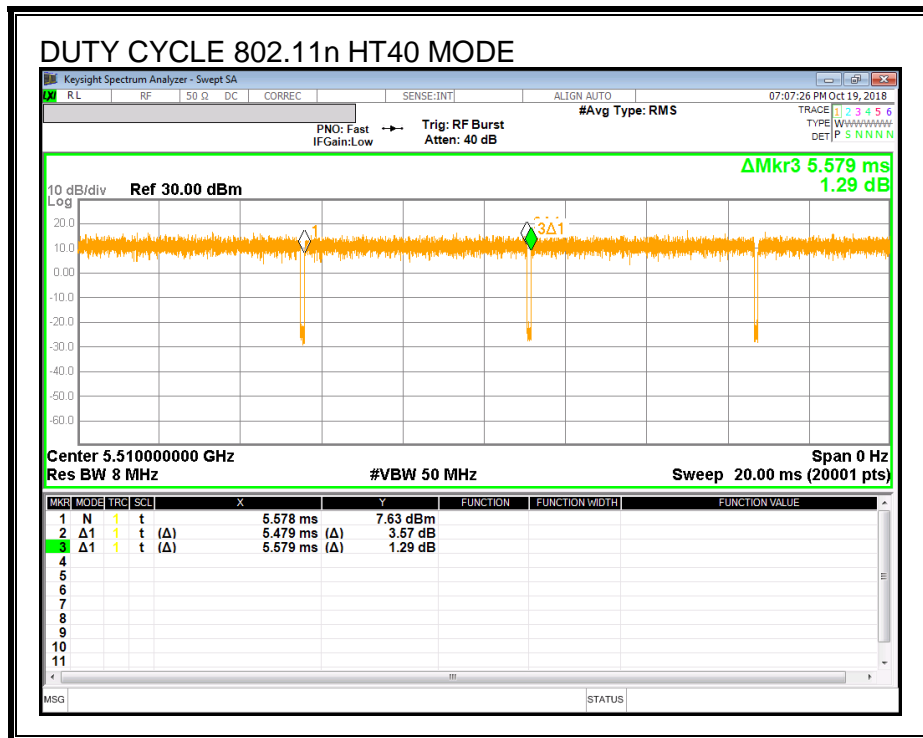
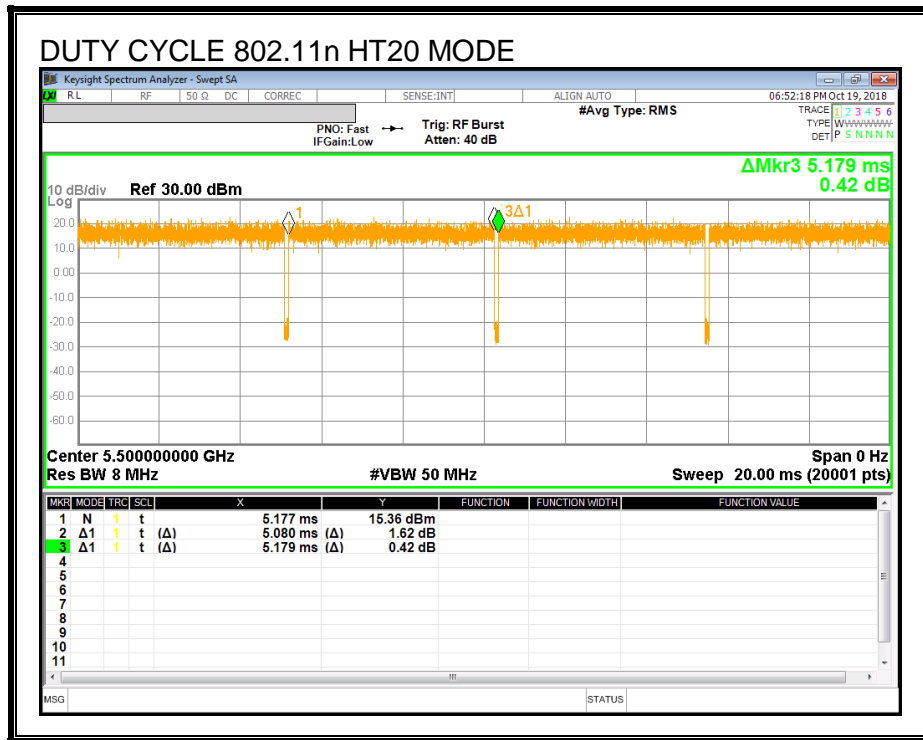

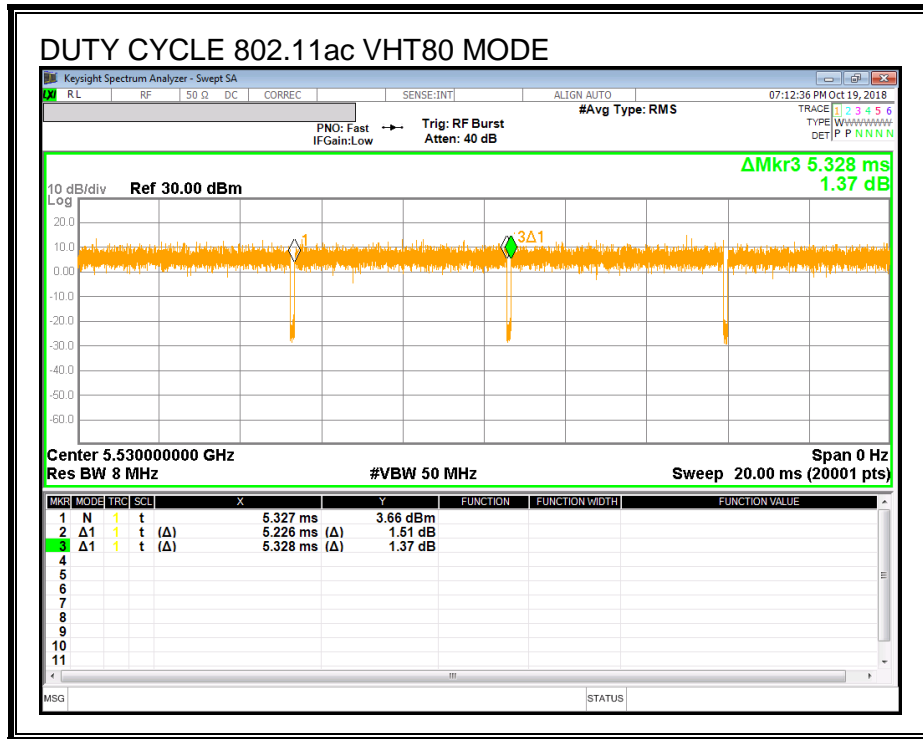

9.3. 26 dB BANDWIDTH

LIMITS

None; for reporting purposes only.

TEST PROCEDURE

Reference to 789033 D02 General UNII Test Procedures New Rules v02r01: The transmitter output is connected to a spectrum analyzer with the RBW set to approximately 1% of EBW, the VBW > RBW, peak detector and max hold.

NOTE

- Calculation for 26dB Bandwidth of UNII-2C and UNII-3 Straddle Channel
- ex) Fundamental frequency : 5720MHz
 - 26dB BW : 20.58MHz
 - Turning Frequency : 5725MHz
 - 26dB Bandwidth of UNII-2C band Portion
= $(5725 - (5720 - (20.58 / 2))) = 15.29$ MHz
 - 26dB Bandwidth of UNII-3 band Portion
= $(5720 + (20.58 / 2) - 5725) = 5.29$ MHz
- 26 dB Bandwidth test were performed each antenna port on SISO mode.

RESULTS

9.3.1. 802.11a MODE IN THE 5.2 GHz BAND

Channel	Frequency [MHz]	26 dB Bandwidth [MHz]	
		Antenna 1	Antenna 2
Low	5180	21.07	21.31
Mid	5200	21.16	21.28
High	5240	21.09	21.33
Worst		21.33	

9.3.2. 802.11n HT20 MODE IN THE 5.2 GHz BAND

Channel	Frequency [MHz]	26 dB Bandwidth [MHz]	
		Antenna 1	Antenna 2
Low	5180	21.39	21.44
Mid	5200	21.46	21.47
High	5240	21.24	21.28
Worst		21.47	

9.3.3. 802.11n HT40 MODE IN THE 5.2 GHz BAND

Channel	Frequency [MHz]	26 dB Bandwidth [MHz]	
		Antenna 1	Antenna 2
Low	5190	40.05	39.78
High	5230	40.23	41.16
Worst		41.16	

9.3.4. 802.11ac VHT80 MODE IN THE 5.2 GHz BAND

Channel	Frequency [MHz]	26 dB Bandwidth [MHz]	
		Antenna 1	Antenna 2
Middle	5210	81.50	81.84
Worst		81.84	

9.3.5. 802.11a MODE IN THE 5.3 GHz BAND

Channel	Frequency [MHz]	26 dB Bandwidth [MHz]	
		Antenna 1	Antenna 2
Low	5260	21.33	21.21
Mid	5300	21.12	21.24
High	5320	21.36	20.91
Worst		21.36	

9.3.6. 802.11n HT20 MODE IN THE 5.3 GHz BAND

Channel	Frequency [MHz]	26 dB Bandwidth [MHz]	
		Antenna 1	Antenna 2
Low	5260	21.24	21.46
Mid	5300	21.29	21.49
High	5320	21.49	21.32
Worst		21.49	

9.3.7. 802.11n HT40 MODE IN THE 5.3 GHz BAND

Channel	Frequency [MHz]	26 dB Bandwidth [MHz]	
		Antenna 1	Antenna 2
Low	5270	39.55	39.83
High	5310	41.44	41.27
Worst		41.44	

9.3.8. 802.11ac VHT80 MODE IN THE 5.3 GHz BAND

Channel	Frequency [MHz]	26 dB Bandwidth [MHz]	
		Antenna 1	Antenna 2
Middle	5290	82.19	82.03
Worst		82.19	

9.3.9. 802.11a MODE IN THE 5.5 GHz BAND

Channel	Frequency [MHz]	26 dB Bandwidth [MHz]	
		Antenna 1	Antenna 2
Low	5500	21.24	21.20
Mid	5580	21.01	21.37
High	5700	21.04	21.17
Straddle	5720	15.66	15.55
Worst		21.37	

9.3.10. 802.11n HT20 MODE IN THE 5.5 GHz BAND

Channel	Frequency [MHz]	26 dB Bandwidth [MHz]	
		Antenna 1	Antenna 2
Low	5500	21.43	21.35
Mid	5580	21.44	21.38
High	5700	21.34	21.25
Straddle	5720	15.66	15.65
Worst		21.44	

9.3.11. 802.11n HT40 MODE IN THE 5.5 GHz BAND

Channel	Frequency [MHz]	26 dB Bandwidth [MHz]	
		Antenna 1	Antenna 2
Low	5510	39.34	40.20
Mid	5590	40.71	39.70
High	5670	39.81	40.06
Straddle	5710	34.86	34.83
Worst		40.71	

9.3.12. 802.11ac VHT80 MODE IN THE 5.5 GHz BAND

Channel	Frequency [MHz]	26 dB Bandwidth [MHz]	
		Antenna 1	Antenna 2
Low	5530	83.41	81.90
High	5610	81.57	81.65
Staddle	5690	75.95	75.64
Worst		83.41	

9.3.13. 802.11a MODE IN THE 5.8 GHz BAND

Channel	Frequency [MHz]	26 dB Bandwidth [MHz]	
		Antenna 1	Antenna 2
Straddle	5720	5.66	5.55
Low	5745	21.25	21.12
Mid	5785	21.14	21.23
High	5825	21.25	21.02
Worst		21.25	

9.3.14. 802.11n HT20 MODE IN THE 5.8 GHz BAND

Channel	Frequency [MHz]	26 dB Bandwidth [MHz]	
		Antenna 1	Antenna 2
Straddle	5720	5.66	5.65
Low	5745	21.23	21.40
Mid	5785	21.17	21.53
High	5825	21.45	21.38
Worst		21.53	

9.3.15. 802.11n HT40 MODE IN THE 5.8 GHz BAND

Channel	Frequency [MHz]	26 dB Bandwidth [MHz]	
		Antenna 1	Antenna 2
Straddle	5710	4.86	4.83
Low	5755	39.71	40.09
High	5795	39.58	39.74
Worst		40.09	

9.3.16. 802.11ac VHT80 MODE IN THE 5.8 GHz BAND

Channel	Frequency [MHz]	26 dB Bandwidth [MHz]	
		Antenna 1	Antenna 2
Straddle	5690	5.95	5.64
Middle	5775	82.42	81.77
Worst		82.42	

9.3.17. 26 dB BANDWIDTH PLOTS

UNII 5.2 GHz IEEE 802.11a mode

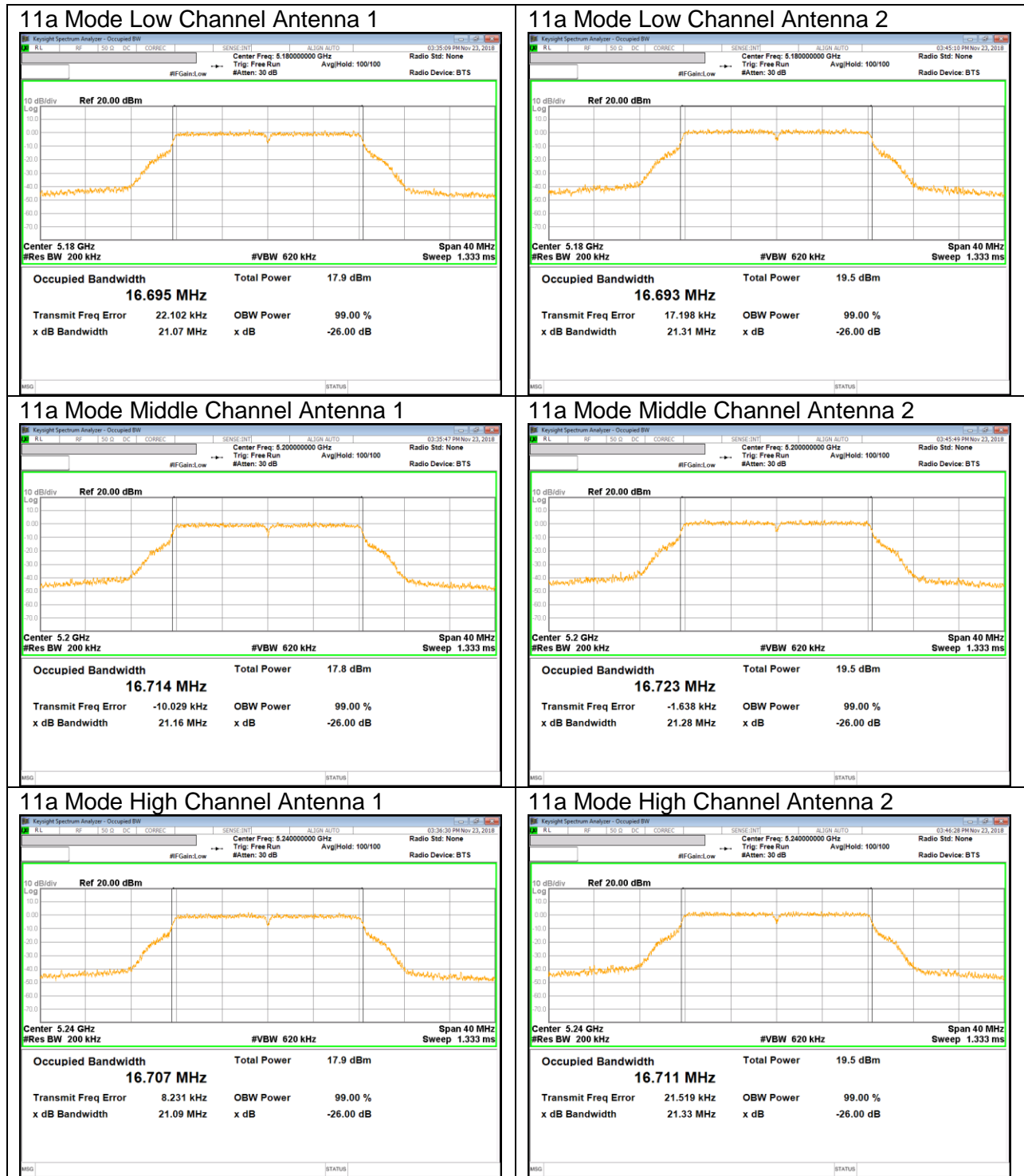

UNII 5.2 GHz IEEE 802.11n HT20 mode

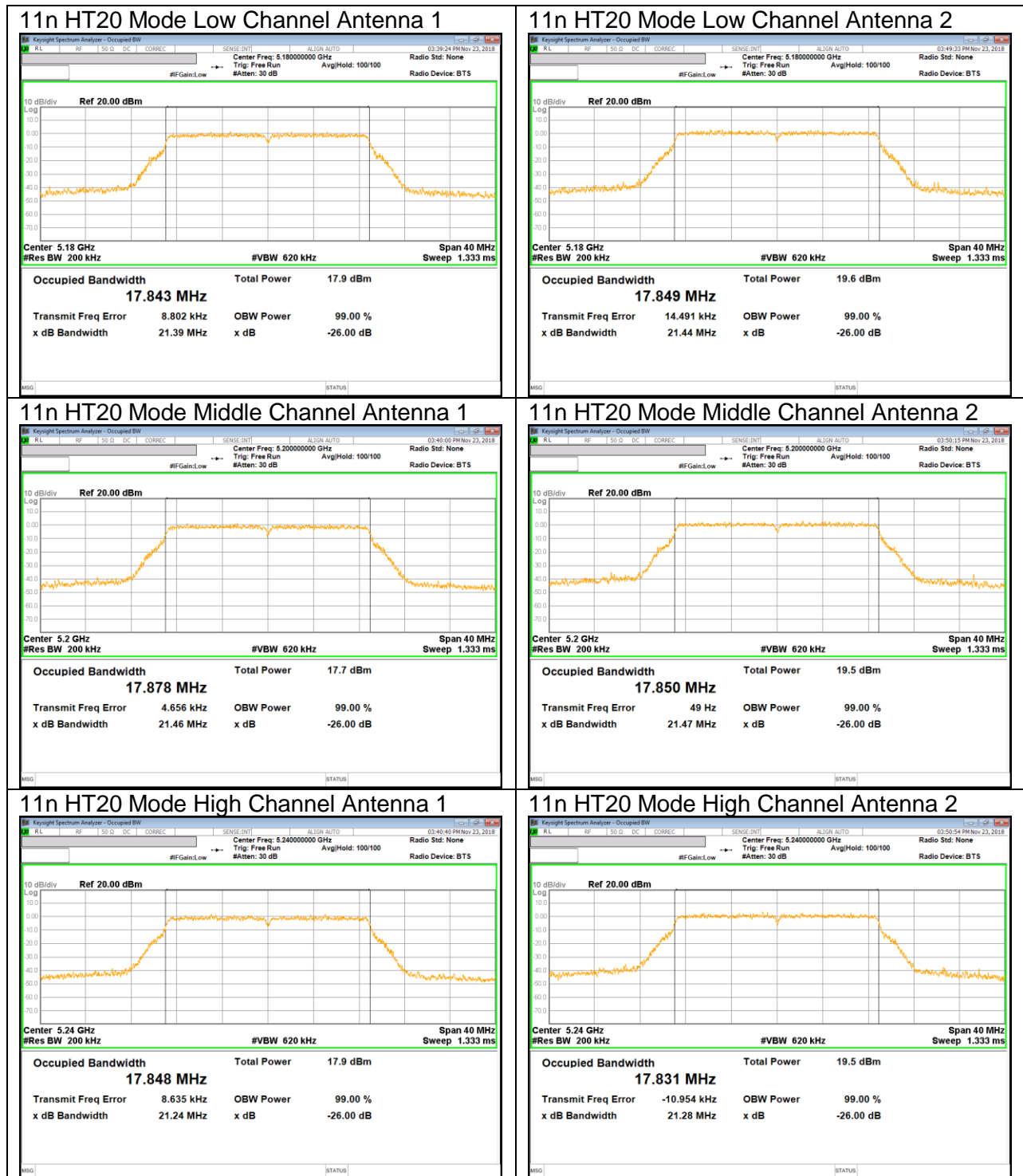

UNII 5.2 GHz IEEE 802.11n HT40 mode

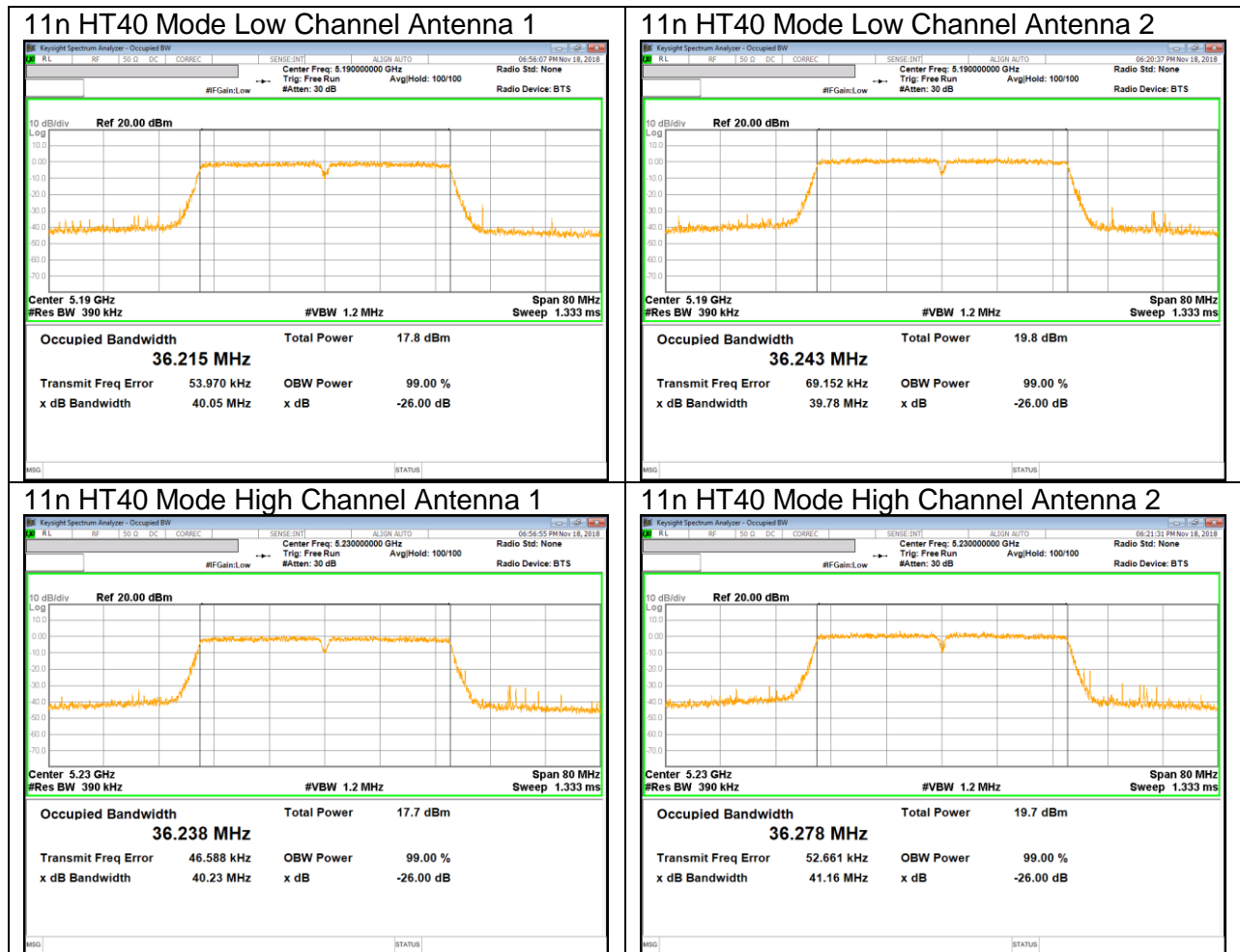

UNII 5.2 GHz IEEE 802.11ac VHT80 mode

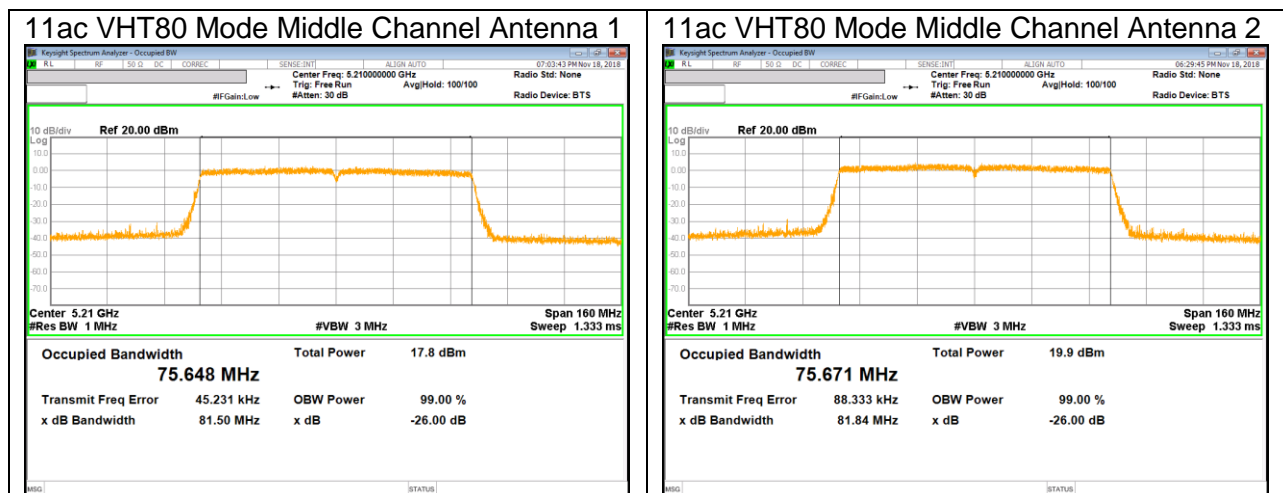

UNII 5.3 GHz IEEE 802.11a mode

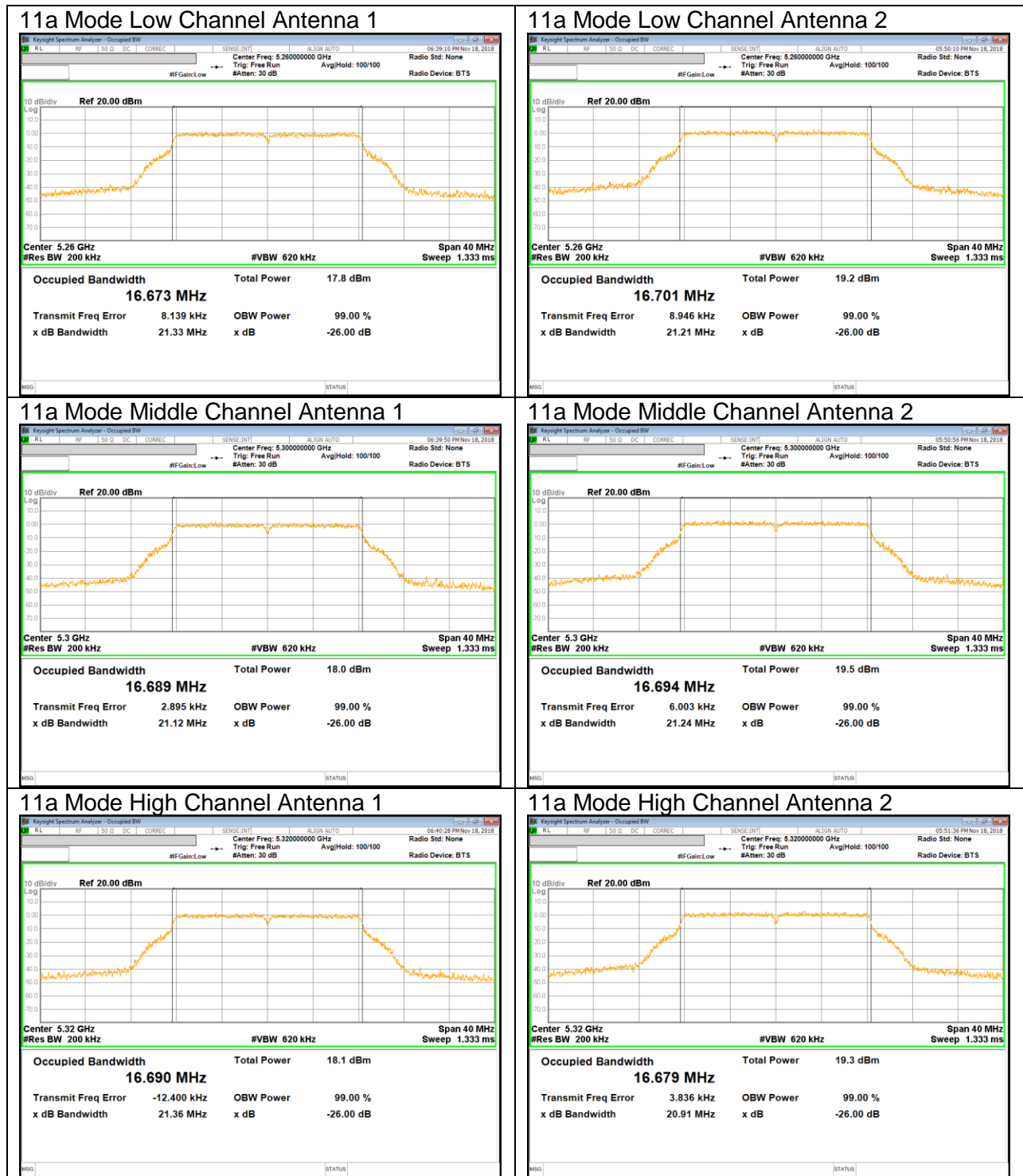

UNII 5.3 GHz IEEE 802.11n HT20 mode

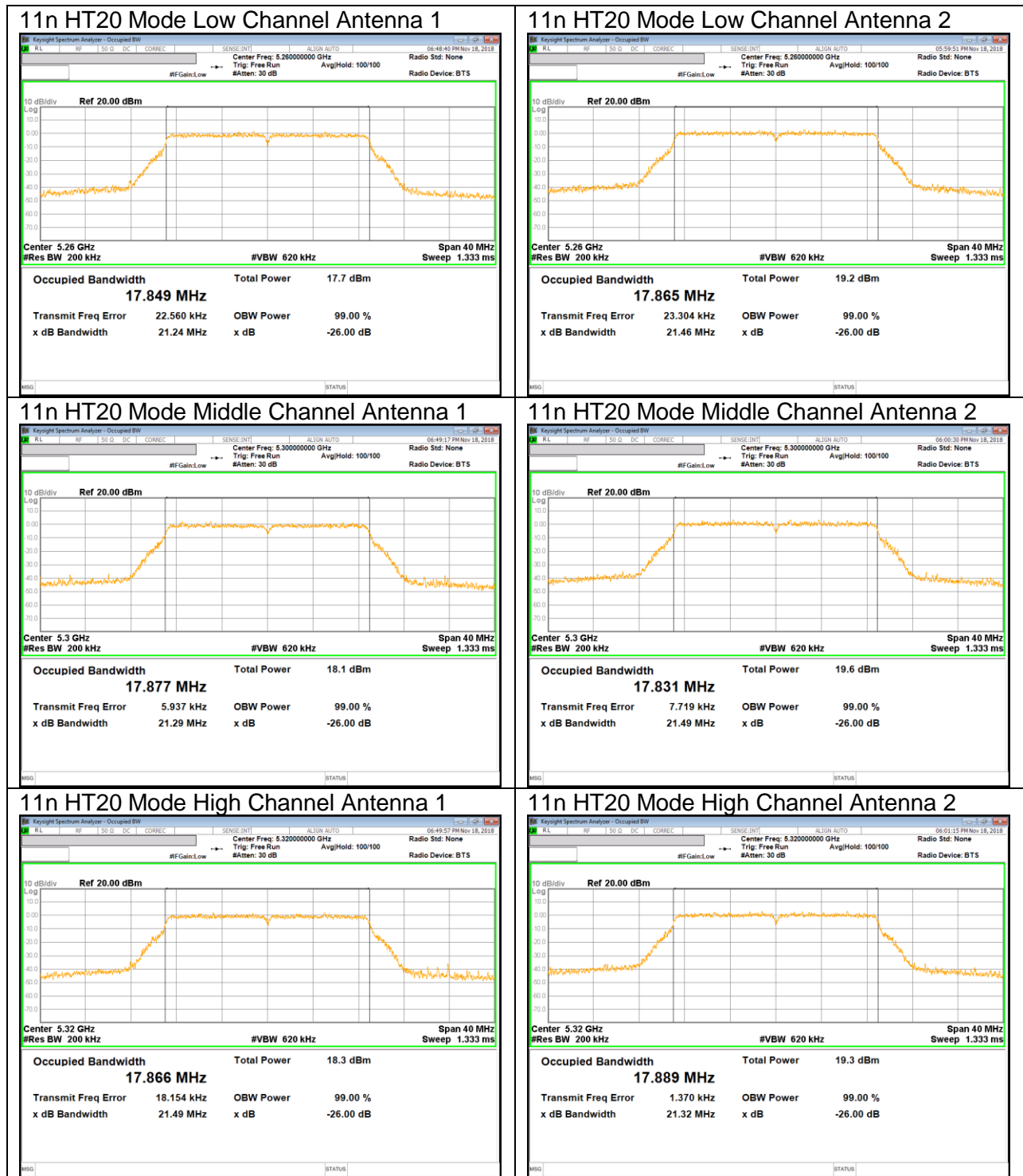

UNII 5.3 GHz IEEE 802.11n HT40 mode

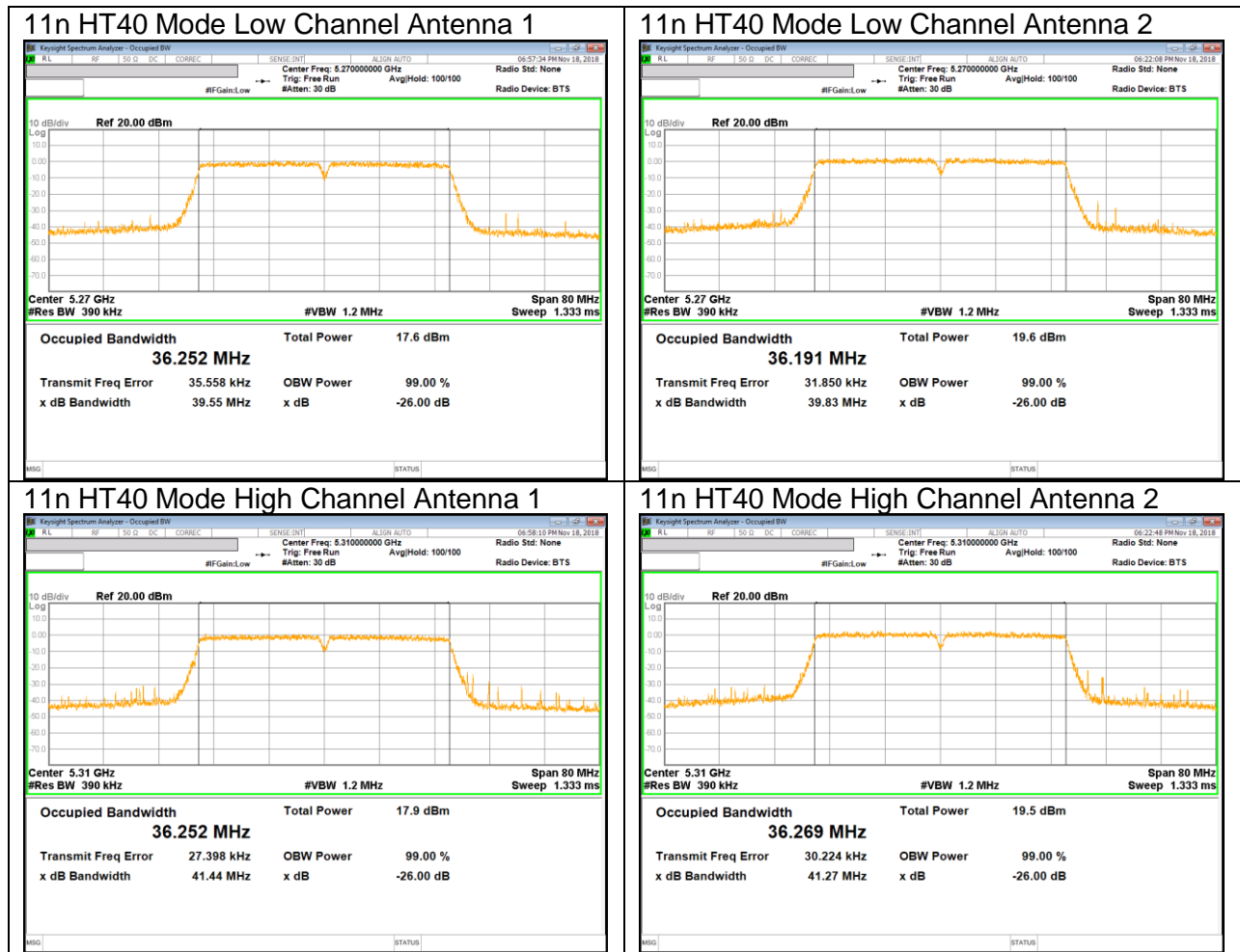

UNII 5.3 GHz IEEE 802.11ac VHT80 mode

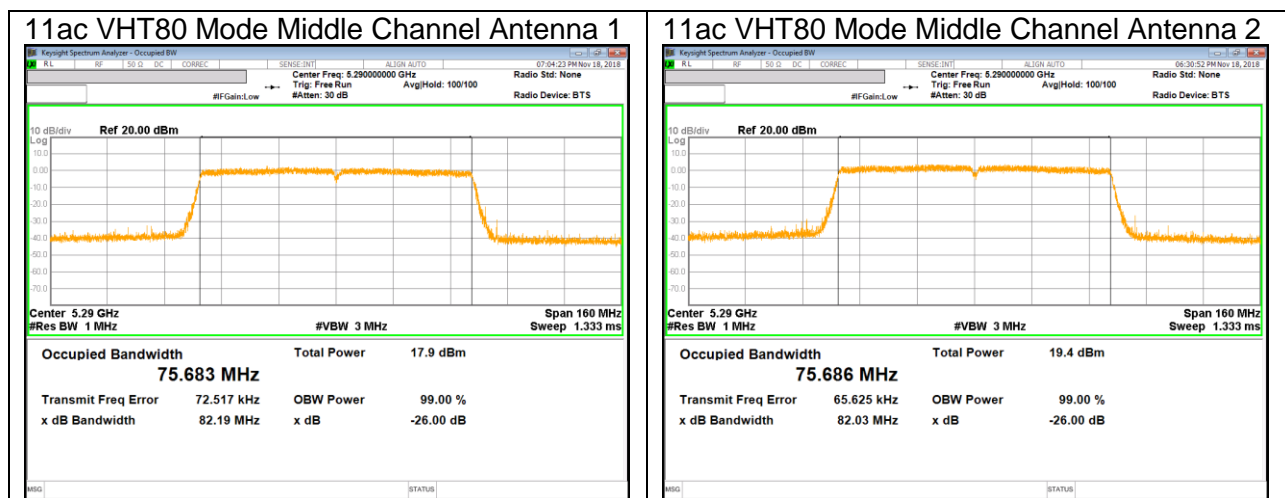

UNII 5.5 GHz IEEE 802.11a mode



UNII 5.5 GHz IEEE 802.11n HT20 mode

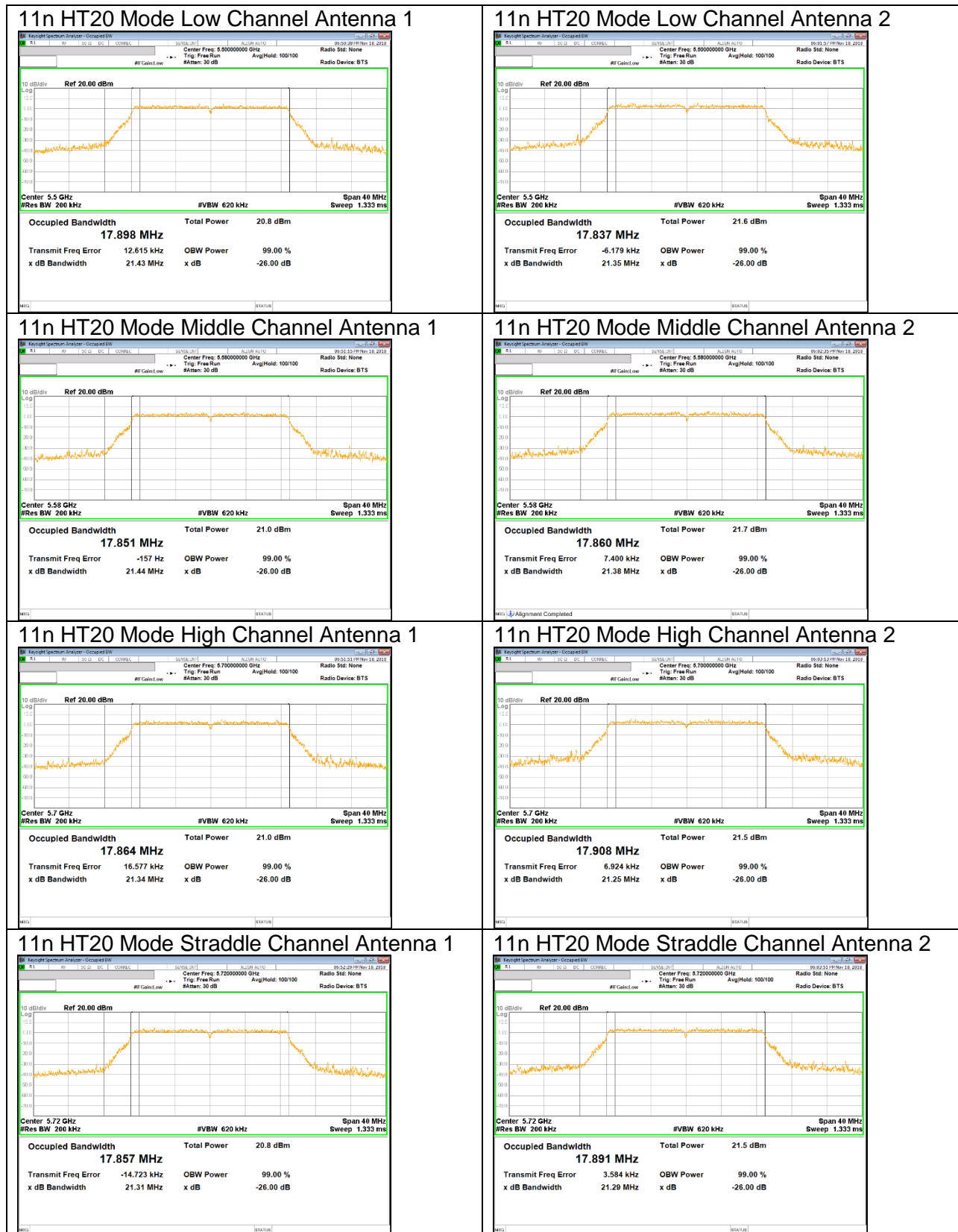

UNII 5.5 GHz IEEE 802.11n HT40 mode



UNII 5.5 GHz IEEE 802.11ac VHT80 mode

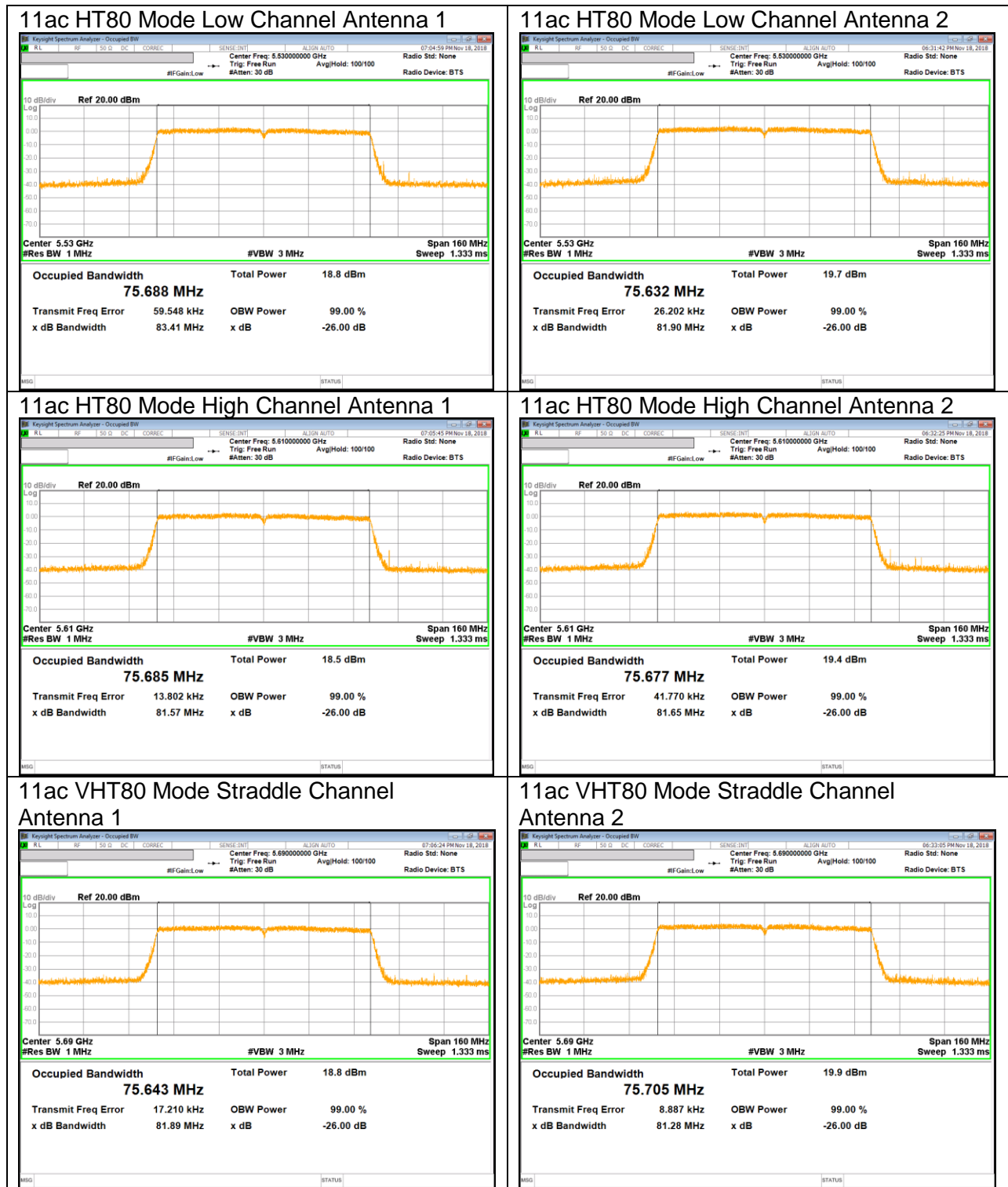

UNII 5.8 GHz IEEE 802.11a mode

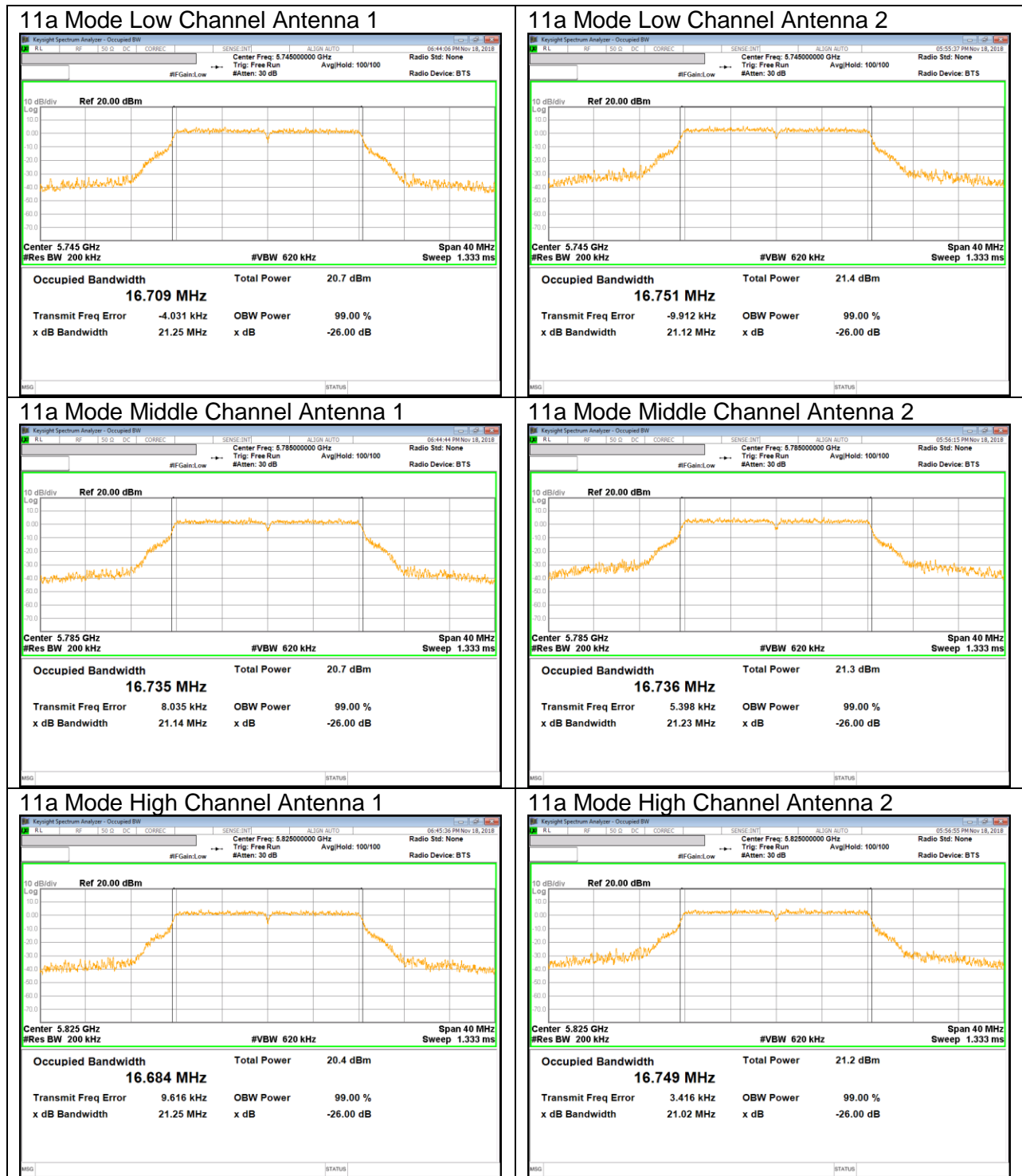

UNII 5.8 GHz IEEE 802.11n HT20 mode

